

<b>Pictorial index</b>	Search by illustration
<b>1 For safety and security</b>	Make sure to read through them
<b>2 Instrument cluster</b>	How to read the gauges and meters, the variety of warning lights and indicators, etc.
<b>3 Operation of each component</b>	Opening and closing the doors and windows, adjustment before driving, etc.
<b>4 Driving</b>	Operations and advices which are necessary for driving
<b>5 Interior features</b>	Usage of the interior features, etc.
<b>6 Maintenance and care</b>	Caring for your vehicle and maintenance procedures
<b>7 When trouble arises</b>	What to do in case of malfunction or emergency
<b>8 Vehicle specifications</b>	Vehicle specifications, customizable features, etc.
<b>9 For owners</b>	Reporting safety defects for U.S. owners, and seat belt and SRS airbag instructions for Canadian owners
<b>Index</b>	Search by symptom
	Search alphabetically

## 2 TABLE OF CONTENTS

---

For your information.....	8
Reading this manual.....	14
How to search.....	15
Pictorial index.....	16

### 1 For safety and security

<b>1-1. For safe use</b>	
Before driving.....	28
For safety drive.....	30
Seat belts.....	32
SRS airbags.....	38
Front passenger occupant classification system.....	50
Safety information for children.....	56
Child restraint systems.....	57
Installing child restraints.....	61
Exhaust gas precautions.....	71
<b>1-2. Hybrid system</b>	
Hybrid system features (hybrid vehicles).....	72
Hybrid system precautions (hybrid vehicles).....	76
<b>1-3. Theft deterrent system</b>	
Engine immobilizer system (gasoline vehicles).....	82
Immobilizer system (hybrid vehicles).....	84
Alarm.....	86

### 2 Instrument cluster

<b>2. Instrument cluster</b>	
Warning lights and indicators.....	90
Gauges and meters.....	95
Multi-information display.....	100
Energy monitor/ consumption screen.....	110

### 3 Operation of each component

<b>3-1. Key information</b>	
Keys.....	122
<b>3-2. Opening, closing and locking the doors and trunk</b>	
Smart access system with push-button start.....	125
Wireless remote control.....	139
Doors.....	142
Trunk.....	147
<b>3-3. Adjusting the seats</b>	
Front seats.....	154
Driving position memory.....	156
Head restraints.....	162
<b>3-4. Adjusting the steering wheel and mirrors</b>	
Steering wheel.....	166
Inside rear view mirror.....	168
Outside rear view mirrors.....	171
<b>3-5. Opening, closing the windows and moon roof</b>	
Power windows.....	174
Moon roof.....	177

## 4 Driving

### 4-1. Before driving

Driving the vehicle .....	184
Cargo and luggage.....	195
Vehicle load limits .....	198
Trailer towing .....	199
Dinghy towing .....	200

### 4-2. Driving procedures

Engine (ignition) switch (gasoline vehicles).....	201
Power (ignition) switch (hybrid vehicles).....	208
EV drive mode (hybrid vehicles).....	215
Automatic transmission (gasoline vehicles).....	218
Hybrid transmission (hybrid vehicles).....	221
Turn signal lever .....	225
Parking brake .....	226
Horn .....	227

### 4-3. Operating the lights and wipers

Headlight switch .....	228
Automatic High Beam.....	232
Fog light switch .....	238
Windshield wipers and washer .....	239

### 4-4. Refueling

Opening the fuel tank cap .....	243
---------------------------------	-----

### 4-5. Using the driving support systems

Cruise control .....	248
Dynamic radar cruise control.....	252
LDA (Lane Departure Alert).....	267
Intuitive parking assist.....	275
Rear view monitor system .....	288
Driving mode select switch.....	300
Driving assist systems .....	302
Hill-start assist control (hybrid vehicles).....	308
PCS (Pre-Collision System) .....	310
BSM (Blind Spot Monitor).....	317
• Blind Spot Monitor function .....	321
• Rear Cross Traffic Alert function .....	324

### 4-6. Driving tips

Hybrid vehicle driving tips (hybrid vehicles) .....	327
Winter driving tips .....	330

**5 Interior features**

**5-1. Lexus Display Audio system**

Lexus Display Audio system.....338  
Display settings.....343  
Setup menu .....345  
Mobile Assistant.....351

**5-2. Using the air conditioning system and defogger**

Automatic air conditioning system (with the Lexus Display Audio system).....353  
Automatic air conditioning system (without a navigation system or the Lexus Display Audio system).....365  
Rear window and outside rear view mirror defoggers.....378  
Windshield wiper de-icer.....380

**5-3. Using the Lexus**

**Display Audio system**

Audio system (with the Lexus Display Audio system).....382  
Using the radio .....385  
Using the CD player .....400  
Playing an audio CD and MP3/WMA discs .....401  
Listening to an iPod.....411  
Listening to a USB memory .....419  
Using the AUX port .....429  
Listening to Bluetooth® audio .....431  
Optimal use of the audio system .....446  
Using the steering wheel audio switches.....448  
Hands-free system (for cellular phone) .....451  
Using the Bluetooth® phone.....459  
Setting the hands-free system.....478  
Bluetooth® settings .....491



**5-4. Using the audio system**

Audio system (without a navigation system or the Lexus Display Audio system) .....	500
Using the radio .....	503
Using the CD player .....	512
Playing MP3 and WMA discs .....	521
Operating an iPod .....	529
Operating a USB memory .....	539
Bluetooth® audio system .....	548
Using the Bluetooth® audio system .....	552
Operating a Bluetooth® enabled portable player .....	557
Setting up a Bluetooth® enabled portable player .....	561
Bluetooth® audio system setup .....	568
Optimal use of the audio system .....	569
Using the AUX port .....	571
Using the steering wheel audio switches .....	573
Hands-free system (for cellular phone) .....	576
Using the hands-free system (for cellular phones) .....	581
Making a phone call .....	589
Setting a cellular phone .....	593
Security and system setup .....	598
Using the phone book .....	603

**5-5. Using the interior lights**

Interior lights list .....	611
• Interior light .....	612
• Personal lights .....	612

**5-6. Using the storage features**

List of storage features .....	614
• Glove box .....	616
• Console box .....	617
• Cup holders .....	618
• Auxiliary box .....	619
Trunk features .....	620

**5-7. Other interior features**

Sun visors and vanity mirrors .....	622
Clock .....	623
Power outlets .....	624
Heated steering wheel .....	626
Seat heaters and ventilators .....	628
Armrest .....	630
Rear sunshade/ rear door sunshades .....	631
Trunk storage extension .....	634
Coat hooks .....	635
Assist grips .....	636
Garage door opener .....	637
Compass .....	644
Safety Connect .....	649

**6 Maintenance and care**

**6-1. Maintenance and care**  
 Cleaning and protecting  
 the vehicle exterior ..... 658  
 Cleaning and protecting  
 the vehicle interior ..... 662

**6-2. Maintenance**  
 Maintenance  
 requirements ..... 665  
 General maintenance ..... 668  
 Emission inspection  
 and maintenance (I/M)  
 programs ..... 672

**6-3. Do-it-yourself maintenance**  
 Do-it-yourself service  
 precautions ..... 673  
 Hood ..... 677  
 Positioning a floor jack ..... 678  
 Engine compartment ..... 681  
 12-volt battery  
 (hybrid vehicles) ..... 698  
 Tires ..... 702  
 Tire inflation pressure ..... 712  
 Wheels ..... 715  
 Air conditioning filter ..... 717  
 Electronic key battery ..... 719  
 Checking and replacing  
 fuses ..... 721  
 Light bulbs ..... 733

**7 When trouble arises**

**7-1. Essential information**  
 Emergency flashers ..... 748  
 If your vehicle has to be  
 stopped in an emergency ..... 749

**7-2. Steps to take in an emergency**  
 If your vehicle needs  
 to be towed ..... 751  
 If you think  
 something is wrong ..... 757  
 Fuel pump shut off system  
 (gasoline vehicles) ..... 758  
 If a warning light turns on or  
 a warning buzzer sounds ..... 759  
 If a warning message  
 is displayed ..... 769  
 If you have a flat tire ..... 792  
 If the engine will not start  
 (gasoline vehicles) ..... 805  
 If the hybrid system will not  
 start (hybrid vehicles) ..... 807  
 If the shift lever cannot  
 be shifted from P ..... 809  
 If the electronic key does not  
 operate properly ..... 810

If the 12-volt battery is discharged (gasoline vehicles).....	813
If the 12-volt battery is discharged (hybrid vehicles).....	817
If your vehicle overheats (gasoline vehicles).....	821
If your vehicle overheats (hybrid vehicles).....	824
If the vehicle becomes stuck.....	828

## 8 Vehicle specifications

### 8-1. Specifications

Maintenance data (fuel, oil level, etc.).....	832
Fuel information.....	847
Tire information.....	850

### 8-2. Customization

Customizable features.....	862
----------------------------	-----

### 8-3. Items to initialize

Items to initialize.....	875
--------------------------	-----

## 9 For owners

Reporting safety defects for U.S. owners.....	878
Seat belt instructions for Canadian owners (in French).....	879
SRS airbag instructions for Canadian owners (in French).....	881

## Index

What to do if... (Troubleshooting).....	892
Alphabetical index.....	898

For vehicles with a navigation system, refer to the “Navigation System Owner’s Manual” for information regarding the equipment listed below.

- Navigation system
- Air conditioning controls
- Windshield wiper de-icer
- Audio/video system
- Rear window and outside rear view mirror defogging
- Lexus Enform with Safety Connect

## For your information

### Main Owner's Manual

Please note that this manual applies to all models and explains all equipment, including options. Therefore, you may find some explanations for equipment not installed on your vehicle.

All specifications provided in this manual are current at the time of printing. However, because of the Lexus policy of continual product improvement, we reserve the right to make changes at any time without notice.

Depending on specifications, the vehicle shown in the illustrations may differ from your vehicle in terms of color and equipment.

### Noise from under vehicle after turning off the engine <hybrid system>

Approximately five hours after the engine <hybrid system> is turned off, you may hear sound coming from under the vehicle for several minutes. This is the sound of a fuel evaporation leakage check and, it does not indicate a malfunction.

### Accessories, spare parts and modification of your Lexus

A wide variety of non-genuine spare parts and accessories for Lexus vehicles are currently available in the market. You should know that Toyota does not warrant these products and is not responsible for their performance, repair, or replacement, or for any damage they may cause to, or adverse effect they may have on, your Lexus vehicle.

This vehicle should not be modified with non-genuine Lexus products. Modification with non-genuine Lexus products could affect its performance, safety or durability, and may even violate governmental regulations. In addition, damage or performance problems resulting from the modification may not be covered under warranty.

---

## Installation of a mobile two-way radio system

The installation of a mobile two-way radio system in your vehicle could affect electronic systems such as:

- Multiport fuel injection system/sequential multiport fuel injection system
- Dynamic radar cruise control system
- Cruise control system
- Anti-lock brake system
- SRS airbag system
- Seat belt pretensioner system

Be sure to check with your Lexus dealer for precautionary measures or special instructions regarding installation of a mobile two-way radio system.

Hybrid vehicles: High voltage parts and cables on the hybrid vehicles emit approximately the same amount of electromagnetic waves as the conventional gasoline powered vehicles or home electronic appliances despite of their electromagnetic shielding.

Hybrid vehicles: Unwanted noise may occur in the reception of the mobile two-way radio.

## Vehicle data recordings

Your Lexus is equipped with several sophisticated computers that will record certain data, such as:

- Engine speed
- Electric motor speed (traction motor speed) (hybrid vehicles)
- Accelerator status
- Brake status
- Vehicle speed
- Shift position
- Hybrid battery (traction battery) status (hybrid vehicles)

The recorded data varies according to the vehicle grade level and options with which it is equipped. Furthermore, these computers do not record conversations, sounds or pictures.

### ● Data usage

Lexus may use the data recorded in these computers to diagnose malfunctions, conduct research and development, and improve quality.

Lexus will not disclose the recorded data to a third party except:

- With the consent of the vehicle owner or with the consent of the lessee if the vehicle is leased
- In response to an official request by the police, a court of law or a government agency
- For use by Lexus in a lawsuit
- For research purposes where the data is not tied to a specific vehicle or vehicle owner

### ● Usage of data collected through Safety Connect / Lexus Enform (U.S. mainland only)

If your Lexus has Safety Connect or Lexus Enform and if you have subscribed to those services, please refer to the Safety Connect / Lexus Enform Telematics Subscription Service Agreement for information on data collected and its usage.

## Event data recorder

This vehicle is equipped with an event data recorder (EDR). The main purpose of an EDR is to record, in certain crash or near crash-like situations, such as an air bag deployment or hitting a road obstacle, data that will assist in understanding how a vehicle's systems performed. The EDR is designed to record data related to vehicle dynamics and safety systems for a short period of time, typically 30 seconds or less.

The EDR in this vehicle is designed to record such data as:

- How various systems in your vehicle were operating;
- Whether or not the driver and passenger safety belts were buckled/fastened;
- How far (if at all) the driver was depressing the accelerator and/or brake pedal; and,
- How fast the vehicle was traveling.

These data can help provide a better understanding of the circumstances in which crashes and injuries occur.

NOTE: EDR data are recorded by your vehicle only if a nontrivial crash situation occurs; no data are recorded by the EDR under normal driving conditions and no personal data (e.g., name, gender, age, and crash location) are recorded. However, other parties, such as law enforcement, could combine the EDR data with the type of personally identifying data routinely acquired during a crash investigation.

To read data recorded by an EDR, special equipment is required, and access to the vehicle or the EDR is needed. In addition to the vehicle manufacturer, other parties, such as law enforcement, that have the special equipment, can read the information if they have access to the vehicle or the EDR.

### ● Disclosure of the EDR data

Lexus will not disclose the data recorded in an EDR to a third party except when:

- An agreement from the vehicle's owner (or the lessee for a leased vehicle) is obtained
- In response to an official request by the police, a court of law or a government agency
- For use by Lexus in a lawsuit

However, if necessary, Lexus may:

- Use the data for research on vehicle safety performance
- Disclose the data to a third party for research purposes without disclosing information about the specific vehicle or vehicle owner

### Scrapping of your Lexus

The SRS airbag and seat belt pretensioner devices in your Lexus contain explosive chemicals. If the vehicle is scrapped with the airbags and seat belt pretensioners left as they are, this may cause an accident such as fire. Be sure to have the systems of the SRS airbag and seat belt pretensioner removed and disposed of by a qualified service shop or by your Lexus dealer before you scrap your vehicle.

### Perchlorate Material

Special handling may apply, See [www.dtsc.ca.gov/hazardouswaste/perchlorate](http://www.dtsc.ca.gov/hazardouswaste/perchlorate).

Your vehicle has components that may contain perchlorate. These components may include airbag, seat belt pretensioners, and wireless remote control batteries.

#### CAUTION

##### ■ General precautions while driving

**Driving under the influence:** Never drive your vehicle when under the influence of alcohol or drugs that have impaired your ability to operate your vehicle. Alcohol and certain drugs delay reaction time, impair judgment and reduce coordination, which could lead to an accident that could result in death or serious injury.

**Defensive driving:** Always drive defensively. Anticipate mistakes that other drivers or pedestrians might make and be ready to avoid accidents.

**Driver distraction:** Always give your full attention to driving. Anything that distracts the driver, such as adjusting controls, talking on a cellular phone or reading can result in a collision with resulting death or serious injury to you, your occupants or others.

##### ■ General precaution regarding children's safety

Never leave children unattended in the vehicle, and never allow children to have or use the key.

Children may be able to start the vehicle or shift the vehicle into neutral. There is also a danger that children may injure themselves by playing with the windows, the moon roof, or other features of the vehicle. In addition, heat build-up or extremely cold temperatures inside the vehicle can be fatal to children.







## Reading this manual

 **CAUTION:**  
Explains something that, if not obeyed, could cause death or serious injury to people.

 **NOTICE:**  
Explains something that, if not obeyed, could cause damage to or a malfunction in the vehicle or its equipment.

... Indicates operating or working procedures. Follow the steps in numerical order.

 Indicates the action (pushing, turning, etc.) used to operate switches and other devices.

 Indicates the outcome of an operation (e.g. a lid opens).

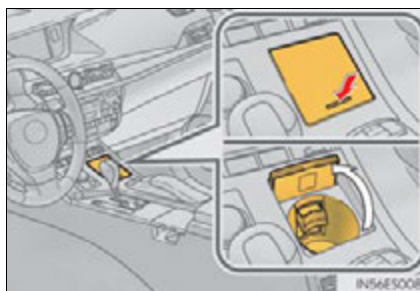

 Indicates the component or position being explained.

 Means "Do not", "Do not do this", or "Do not let this happen".

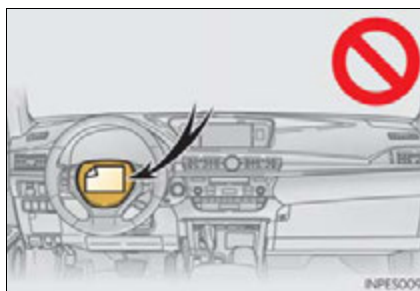

### ■ Different writing styles for gasoline and hybrid vehicles

Information for hybrid vehicles is written in brackets next to the information for gasoline vehicles

Example

Turn the engine<sup>\*1</sup> <power><sup>\*2</sup> switch to IGNITION ON<sup>\*1</sup> <ON><sup>\*2</sup> mode.

\*1: Gasoline vehicles

\*2: Hybrid vehicles

## How to search

- **Searching by name**
  - Alphabetical index ..... P. 898

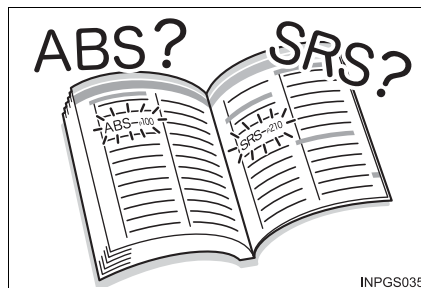

- **Searching by installation position**
  - Pictorial index..... P.16

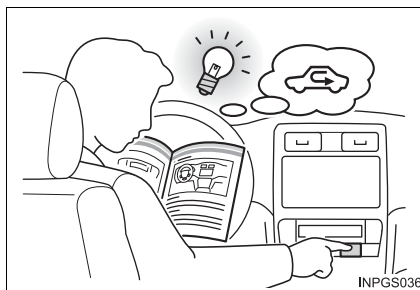

- **Searching by symptom or sound**
  - What to do if...  
(Troubleshooting)..... P. 892



- **Searching by title**
  - Table of contents ..... P. 2

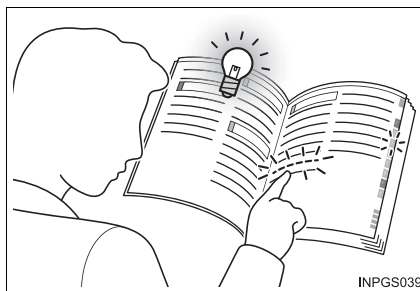

## Pictorial index

### Exterior

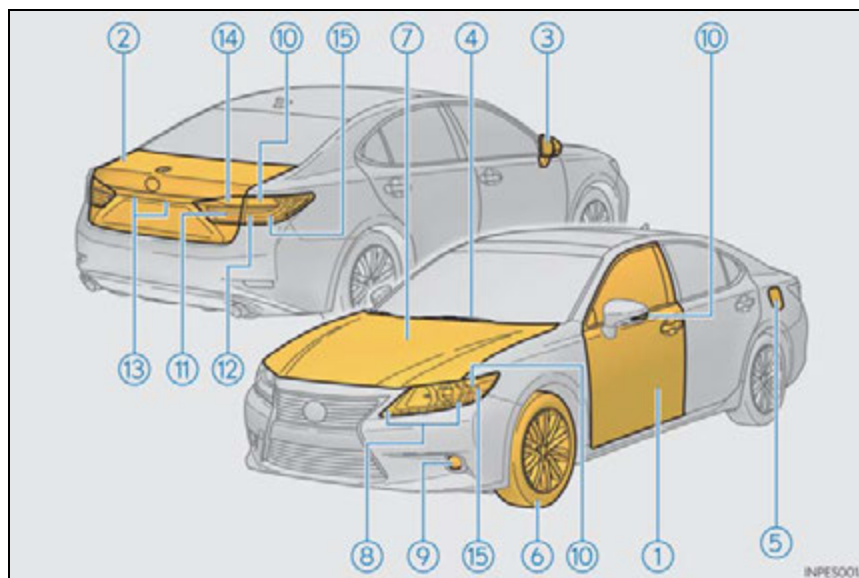

①	<b>Doors</b> .....	<b>P. 142</b>
	Locking/unlocking .....	P. 126, 139
	Opening/closing the door glasses .....	P. 174
	Locking/unlocking by using the mechanical key .....	P. 810
	Warning lights/warning messages .....	P. 762, 774
②	<b>Trunk</b> .....	<b>P. 147</b>
	Opening from inside .....	P. 147
	Opening from outside .....	P. 126, 139
	Opening by using the mechanical key .....	P. 811
	Warning lights/warning messages .....	P. 762, 775
③	<b>Outside rear view mirrors</b> .....	<b>P. 171</b>
	Adjusting the mirror angle .....	P. 171
	Folding the mirrors .....	P. 171
	Driving position memory* <sup>1</sup> .....	P. 156
	Defogging the mirrors .....	P. 378

④	<b>Windshield wipers</b> .....	P. 239
	Precautions against winter season .....	P. 330
	To prevent freezing (windshield wiper de-icer) <sup>*1</sup> .....	P. 380
	Precautions against car wash .....	P. 660
⑤	<b>Fuel filler door</b> .....	P. 243
	Refueling method .....	P. 243
	Fuel type/fuel tank capacity .....	P. 836
⑥	<b>Tires</b> .....	P. 702
	Tire size/inflation pressure .....	P. 844
	Winter tires/tire chain .....	P. 330
	Checking/rotation/tire pressure warning system .....	P. 702
	Coping with flat tires .....	P. 792
⑦	<b>Hood</b> .....	P. 677
	Opening .....	P. 677
	Engine compartment cover .....	P. 683
	Engine oil .....	P. 837
	Coping with overheat .....	P. 821, 824
	Warning messages .....	P. 774

### Light bulbs of the exterior lights for driving

(Replacing method: P. 733, Watts: P. 846)

⑧	<b>Headlights/parking lights/daytime running lights</b> .....	P. 228
⑨	<b>Fog lights</b> .....	P. 238
⑩	<b>Turn signal lights</b> .....	P. 225
⑪	<b>Tail lights</b> .....	P. 228
⑫	<b>Stop/tail lights</b>	
	Hill-start assist control <sup>*2</sup> .....	P. 308
⑬	<b>License plate lights</b> .....	P. 228
⑭	<b>Back-up lights</b>	
	Shifting the shift lever to R .....	P. 218, 221
⑮	<b>Side marker lights</b> .....	P. 228

<sup>\*1</sup>: If equipped  
<sup>\*2</sup>: Hybrid vehicles

■ Instrument panel

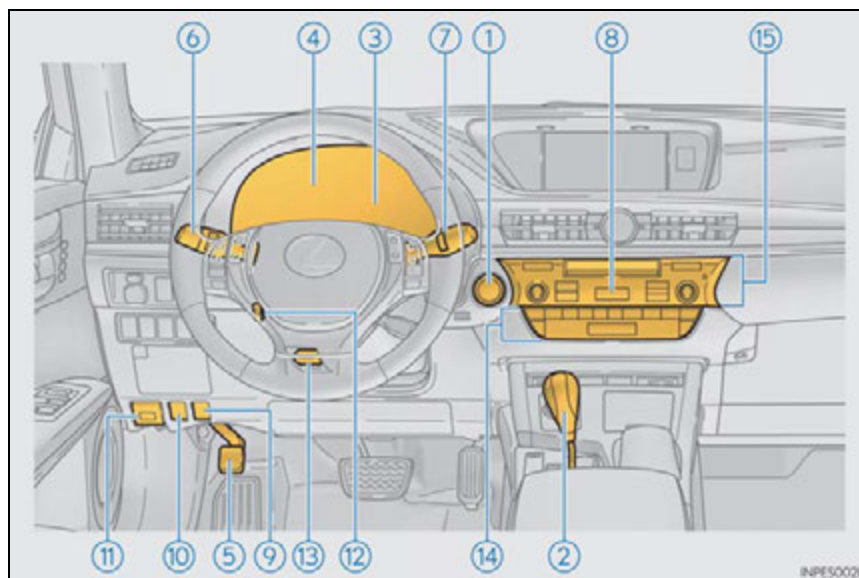

- ① **“START STOP ENGINE” <“POWER”> switch**..... P. 201, 208
  - Starting the engine <hybrid system>/changing the modes .....P. 201, 208
  - Emergency stop of the engine <hybrid system> ..... P. 749
  - When the engine <hybrid system> will not start..... P. 805, 807
  - Warning messages ..... P. 785
- ② **Shift lever** ..... P. 218, 221
  - Changing the shift position .....P. 218, 221
  - Precautions against towing .....P. 751
  - When the shift lever does not move.....P. 809
- ③ **Meters** .....P. 95
  - Reading the meters/adjusting the instrument panel light ..... P. 95
  - Warning lights/indicator lights ..... P. 90
  - When the warning lights come on ..... P. 759

④	<b>Multi-information display</b> .....	P. 100
	Display .....	P. 100
	When the warning messages are displayed .....	P. 769
⑤	<b>Parking brake</b> .....	P. 226
	Applying/releasing .....	P. 226
	Precautions against winter season .....	P. 331
	Warning buzzer/message .....	P. 769
⑥	<b>Turn signal lever</b> .....	P. 225
	<b>Headlight switch</b> .....	P. 228
	Headlights/parking lights/tail lights/daytime running lights .....	P. 228
	Fog lights .....	P. 238
⑦	<b>Windshield wiper and washer switch</b> .....	P. 239
	Usage .....	P. 239
	Adding washer fluid .....	P. 697
	Warning messages .....	P. 782
⑧	<b>Emergency flasher switch</b> .....	P. 748
⑨	<b>Fuel filler door opener</b> .....	P. 245
	Refueling method .....	P. 243
	Fuel type/fuel tank capacity .....	P. 836
⑩	<b>Trunk opener</b> .....	P. 147
⑪	<b>Hood lock release lever</b> .....	P. 677
⑫	<b>Tilt and telescopic steering control switch*</b> .....	P. 166
	Adjustment .....	P. 166
	Driving position memory .....	P. 156
⑬	<b>Tilt and telescopic steering lock release lever*</b> .....	P. 166
	Adjustment .....	P. 166
⑭	<b>Air conditioning system</b> .....	P. 353, 365
	Usage .....	P. 353, 365
	Rear window and outside rear view mirror defoggers .....	P. 378
⑮	<b>Audio system</b> .....	P. 382, 500
	Hands-free system .....	P. 451, 576

\*: If equipped

■ Switches

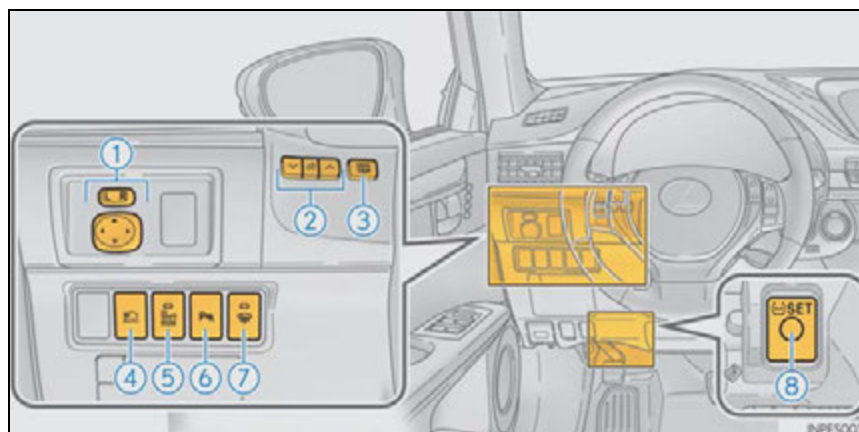

- ① Outside rear view mirror switches ..... P.171
- ② Instrument panel light control switches ..... P.96
- ③ Odometer/trip meter and trip meter reset button ..... P.96
- ④ Automatic High Beam switch\* ..... P.232
- ⑤ BSM (Blind Spot Monitor) main switch\* ..... P.317
- ⑥ Intuitive parking assist switch\* ..... P.275
- ⑦ Windshield wiper de-icer switch\* ..... P.380
- ⑧ Tire pressure warning reset switch ..... P.703



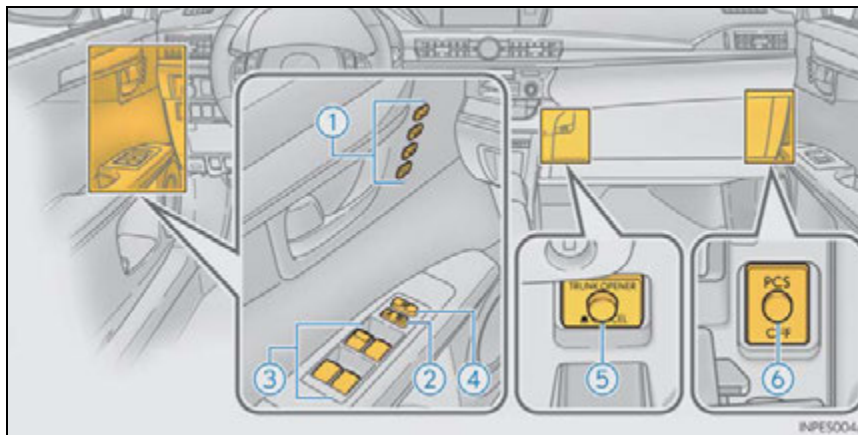

- ① Driving position memory switches\* ..... P.156
- ② Door lock switch..... P.142
- ③ Power window switches ..... P.174
- ④ Window lock switch ..... P.174
- ⑤ Trunk opener main switch ..... P.148
- ⑥ PCS OFF switch\* ..... P.311

\*: If equipped

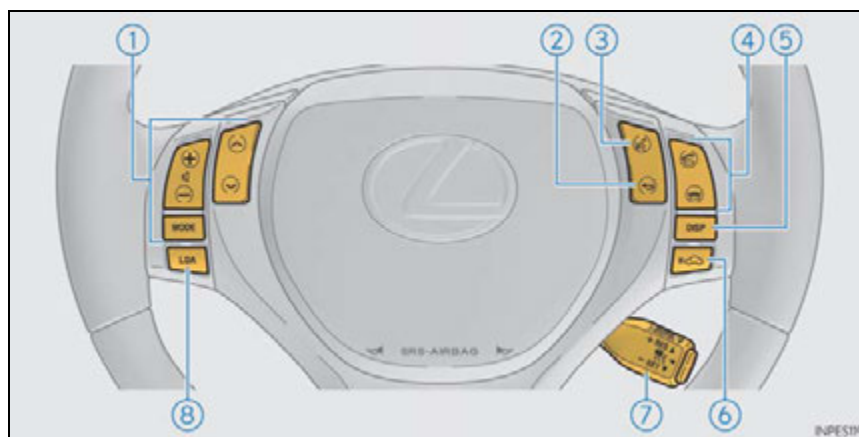

- ① Audio remote control switches ..... P. 448, 573
- ② Back switch \*1 ..... P. 451
- ③ Talk switch \*1 ..... P. 451, 582
- ④ Telephone switches \*1 ..... P. 451, 582
- ⑤ "DISP" button ..... P. 101
- ⑥ Vehicle-to-vehicle distance button \*2 ..... P. 255
- ⑦ Cruise control switch \*2 ..... P. 248  
     Dynamic radar cruise control switch \*2 ..... P. 252
- ⑧ LDA (Lane Departure Alert) switch \*2 ..... P. 268

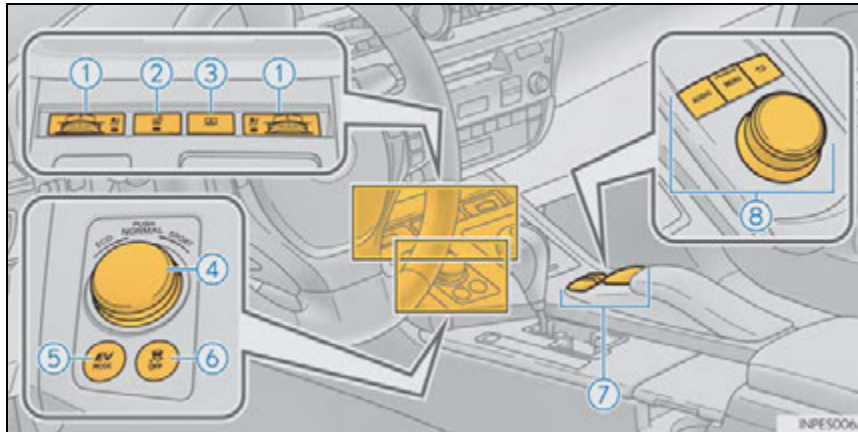

- ① Seat heater and ventilator switches <sup>\*2</sup> ..... P. 628
- ② Heated steering wheel switch <sup>\*2</sup> ..... P. 626
- ③ Rear sunshade switch <sup>\*2</sup> ..... P. 631
- ④ Driving mode select switch ..... P. 300
- ⑤ EV drive mode switch <sup>\*3</sup> ..... P. 215
- ⑥ VSC OFF switch ..... P. 304
- ⑦ Remote Touch <sup>\*1,2</sup> ..... P. 111
- ⑧ Lexus Display Audio controller <sup>\*2</sup> ..... P. 111, 338

\*1: Refer to "Navigation System Owner's Manual".

\*2: If equipped

\*3: Hybrid vehicles

■ Interior

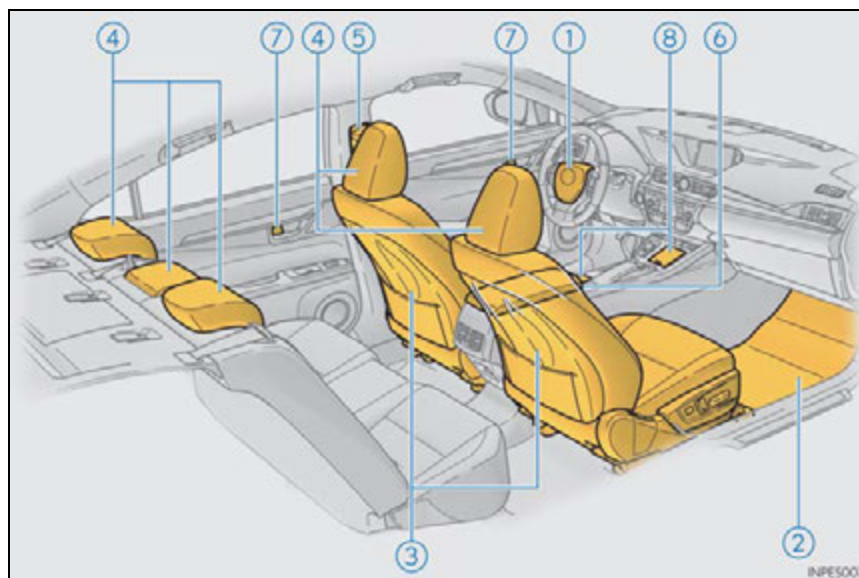

① SRS airbags.....	P. 38
② Floor mats.....	P. 28
③ Front seats.....	P. 154
④ Head restraints.....	P. 162
⑤ Seat belts.....	P. 32
⑥ Console box.....	P. 617
⑦ Inside lock button.....	P. 142
⑧ Cup holders.....	P. 618

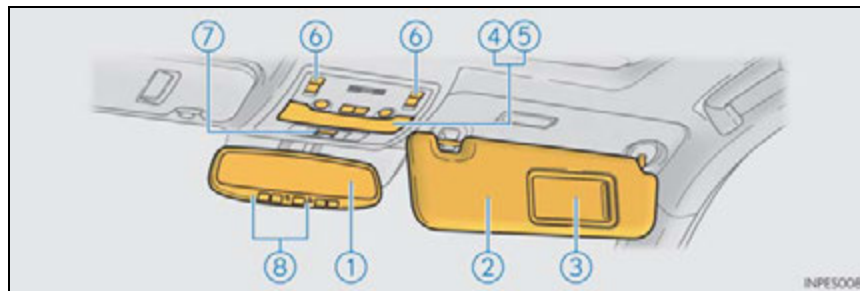

① Inside rear view mirror .....	P. 168
② Sun visors .....	P. 622
③ Vanity mirrors.....	P. 622
④ Interior light .....	P. 612
⑤ Personal lights *1 .....	P. 612
⑥ Moon roof switches .....	P. 177
⑦ "SOS" button *2 .....	P. 649
⑧ Garage door opener switches .....	P. 637

\*1: The illustration shows the front, but they are also equipped in the rear.

\*2: If equipped



<b>1-1. For safe use</b>	
Before driving.....	28
For safety drive.....	30
Seat belts .....	32
SRS airbags .....	38
Front passenger occupant classification system.....	50
Safety information for children.....	56
Child restraint systems .....	57
Installing child restraints.....	61
Exhaust gas precautions .....	71
<b>1-2. Hybrid system</b>	
Hybrid system features (hybrid vehicles).....	72
Hybrid system precautions (hybrid vehicles).....	76
<b>1-3. Theft deterrent system</b>	
Engine immobilizer system (gasoline vehicles).....	82
Immobilizer system (hybrid vehicles).....	84
Alarm .....	86

## Before driving

### Floor mat

Use only floor mats designed specifically for vehicles of the same model and model year as your vehicle. Fix them securely in place onto the carpet.

- 1 Insert the retaining hooks (clips) into the floor mat eyelets.

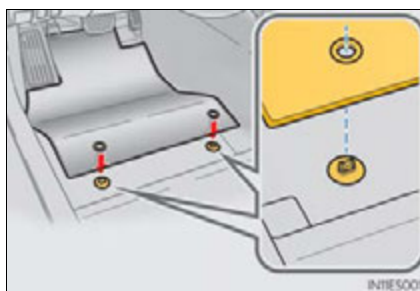

- 2 Turn the upper knob of each retaining hook (clip) to secure the floor mats in place.

\*: Always align the  $\triangle$  marks.

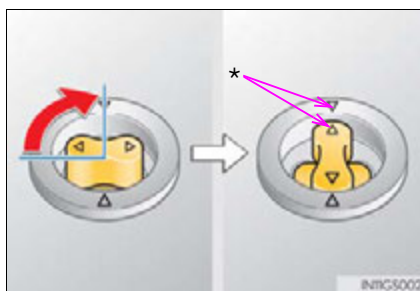

The shape of the retaining hooks (clips) may differ from that shown in the illustration.



**⚠ CAUTION**

Observe the following precautions.

Failure to do so may cause the driver's floor mat to slip, possibly interfering with the pedals while driving. An unexpectedly high speed may result or it may become difficult to stop the vehicle, leading to an accident, or leading to death or a serious injury.

**■ When installing the driver's floor mat**

- Do not use floor mats designed for other models or different model year vehicles, even if they are Lexus Genuine floor mats.
- Only use floor mats designed for the driver's seat.
- Always install the floor mat securely using the retaining hooks (clips) provided.
- Do not use two or more floor mats on top of each other.
- Do not place the floor mat bottom-side up or upside-down.

**■ Before driving**

- Check that the floor mat is securely fixed in the correct place with all the provided retaining hooks (clips). Be especially careful to perform this check after cleaning the floor.
- With the engine <hybrid system> stopped and the shift lever in P, fully depress each pedal to the floor to make sure it does not interfere with the floor mat.

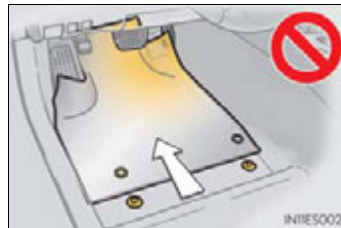

## For safety drive

For safe driving, adjust the seat and mirror to an appropriate position before driving.

### Correct driving posture

- ① Adjust the angle of the seatback so that you are sitting straight up and so that you do not have to lean forward to steer. (→P. 154)
- ② Adjust the seat so that you can depress the pedals fully and so that your arms bend slightly at the elbow when gripping the steering wheel. (→P. 154)
- ③ Lock the head restraint in place with the center of the head restraint closest to the top of your ears. (→P. 162)
- ④ Wear the seat belt correctly. (→P. 32)

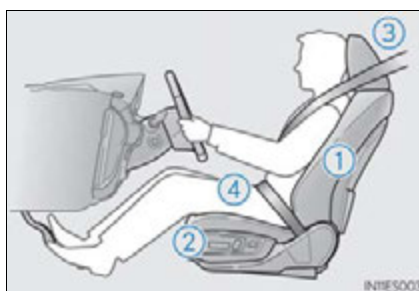

### Correct use of the seat belts

Make sure that all occupants are wearing their seat belts before driving the vehicle. (→P. 32)

Use a child restraint system appropriate for the child until the child becomes large enough to properly wear the vehicle's seat belt. (→P. 57)

### Adjusting the mirrors

Make sure that you can see backward clearly by adjusting the inside and outside rear view mirrors properly. (→P.168, 171)

#### CAUTION

Observe the following precautions.

Failure to do so may result in death or serious injury.

- Do not adjust the position of the driver's seat while driving.  
Doing so could cause the driver to lose control of the vehicle.
- Do not place a cushion between the driver or passenger and the seatback.  
A cushion may prevent correct posture from being achieved, and reduce the effectiveness of the seat belt and head restraint.
- Do not place anything under the front seats.  
Objects placed under the front seats may become jammed in the seat tracks and stop the seat from locking in place. This may lead to an accident and the adjustment mechanism may also be damaged.
- When driving over long distances, take regular breaks before you start to feel tired.  
Also, if you feel tired or sleepy while driving, do not force yourself to continue driving and take a break immediately.

## Seat belts

Make sure that all occupants are wearing their seat belts before driving the vehicle.

### Correct use of the seat belts

- Extend the shoulder belt so that it comes fully over the shoulder, but does not come into contact with the neck or slide off the shoulder.
- Position the lap belt as low as possible over the hips.
- Adjust the position of the seat-back. Sit up straight and well back in the seat.
- Do not twist the seat belt.



### Fastening and releasing the seat belt

- ① To fasten the seat belt, push the plate into the buckle until a click sound is heard.
- ② To release the seat belt, press the release button.

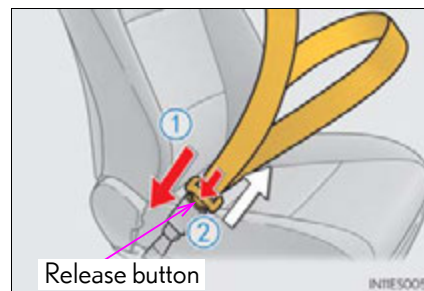

### Adjusting the seat belt shoulder anchor height (front seats)

- ① Push the seat belt shoulder anchor down while pressing the release button.
- ② Push the seat belt shoulder anchor up.

Move the height adjuster up and down as needed until you hear a click.



### Seat belt pretensioners (front and outboard rear seats)

The pretensioners help the seat belts to quickly restrain the occupants by retracting the seat belts when the vehicle is subjected to certain types of severe frontal collision.

The front seat belt pretensioners also active when the vehicle is subjected to certain types of severe side collision.

The pretensioners do not activate in the event of a minor frontal impact, a minor side impact, a rear impact or a vehicle rollover.

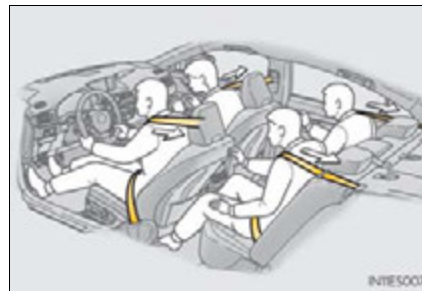

### Pre-collision seat belts (front seats of vehicles with pre-collision system)

If the system determines that a collision is unavoidable, the front seat belts will retract before the collision. (→P. 310)

#### ■ Emergency locking retractor (ELR)

The retractor will lock the belt during a sudden stop or on impact. It may also lock if you lean forward too quickly. A slow, easy motion will allow the belt to extend so that you can move around fully.

#### ■ Automatic locking retractor (ALR)

When a passenger's shoulder belt is completely extended and then retracted even slightly, the belt is locked in that position and cannot be extended. This feature is used to hold the child restraint system (CRS) firmly. To free the belt again, fully retract the belt and then pull the belt out once more. (→P. 61)

#### ■ Child seat belt usage

The seat belts of your vehicle were principally designed for persons of adult size.

- Use a child restraint system appropriate for the child, until the child becomes large enough to properly wear the vehicle's seat belt. (→P. 57)
- When the child becomes large enough to properly wear the vehicle's seat belt, follow the instructions regarding seat belt usage. (→P. 32)

#### ■ Replacing the belt after the pretensioner has been activated

If the vehicle is involved in multiple collisions, the pretensioner will activate for the first collision, but will not activate for the second or subsequent collisions.

#### ■ Seat belt extender

If your seat belts cannot be fastened securely because they are not long enough, a personalized seat belt extender is available from your Lexus dealer free of charge.



**⚠ CAUTION**

Observe the following precautions to reduce the risk of injury in the event of sudden braking, sudden swerving or an accident.

Failure to do so may cause death or serious injury.

**■ Wearing a seat belt**

- Ensure that all passengers wear a seat belt.
- Always wear a seat belt properly.
- Each seat belt should be used by one person only. Do not use a seat belt for more than one person at once, including children.
- Lexus recommends that children be seated in the rear seat and always use a seat belt and/or an appropriate child restraint system.
- To achieve a proper seating position, do not recline the seat more than necessary. The seat belt is most effective when the occupants are sitting up straight and well back in the seats.
- Do not wear the shoulder belt under your arm.
- Always wear your seat belt low and snug across your hips.

**■ Pregnant women**

Obtain medical advice and wear the seat belt in the proper way. (→P. 32)

Women who are pregnant should position the lap belt as low as possible over the hips in the same manner as other occupants, extending the shoulder belt completely over the shoulder and avoiding belt contact with the rounding of the abdominal area.

If the seat belt is not worn properly, not only the pregnant woman, but also the fetus could suffer death or serious injury as a result of sudden braking or a collision.

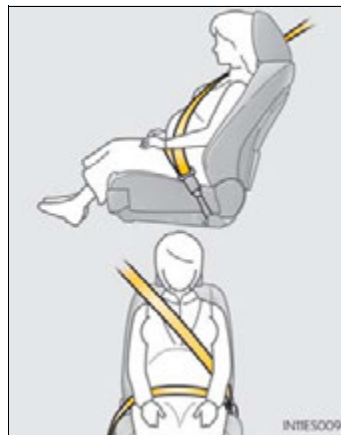

 **CAUTION****■ People suffering illness**

Obtain medical advice and wear the seat belt in the proper way. (→P. 32)

**■ When children are in the vehicle**

Do not allow children to play with the seat belt. If the seat belt becomes twisted around a child's neck, it may lead to choking or other serious injuries that could result in death.

If this occurs and the buckle cannot be unfastened, scissors should be used to cut the belt.

**■ Seat belt pretensioners**

If the pretensioner has activated, the SRS warning light will come on. In that case, the seat belt cannot be used again and must be replaced at your Lexus dealer.

**■ Adjustable shoulder anchor**

Always make sure the shoulder belt is positioned across the center of your shoulder. The belt should be kept away from your neck, but not falling off your shoulder. Failure to do so could reduce the amount of protection in an accident and cause death or serious injuries in the event of a sudden stop, sudden swerve or accident. (→P. 33)

**■ Seat belt damage and wear**

- Do not damage the seat belts by allowing the belt, plate, or buckle to be jammed in the door.
- Inspect the seat belt system periodically. Check for cuts, fraying, and loose parts. Do not use a damaged seat belt until it is replaced. Damaged seat belts cannot protect an occupant from death or serious injury.
- Ensure that the belt and plate are locked and the belt is not twisted. If the seat belt does not function correctly, immediately contact your Lexus dealer.
- Replace the seat assembly, including the belts, if your vehicle has been involved in a serious accident, even if there is no obvious damage.
- Do not attempt to install, remove, modify, disassemble or dispose of the seat belts. Have any necessary repairs carried out by your Lexus dealer. Inappropriate handling may lead to incorrect operation.



 CAUTION**■ Using a seat belt extender**

- Do not wear the seat belt extender if you can fasten the seat belt without the extender.
- Do not use the seat belt extender when installing a child restraint system because the belt will not securely hold the child restraint system, increasing the risk of death or serious injury in the event of an accident.
- The personalized extender may not be safe on another vehicle, when used by another person, or at a different seating position other than the one originally intended.

 NOTICE**■ When using a seat belt extender**

When releasing the seat belt, press on the buckle release button on the extender, not on the seat belt.  
This helps prevent damage to the vehicle interior and the extender itself.

## SRS airbags

The SRS airbags inflate when the vehicle is subjected to certain types of severe impacts that may cause significant injury to the occupants. They work together with the seat belts to help reduce the risk of death or serious injury.

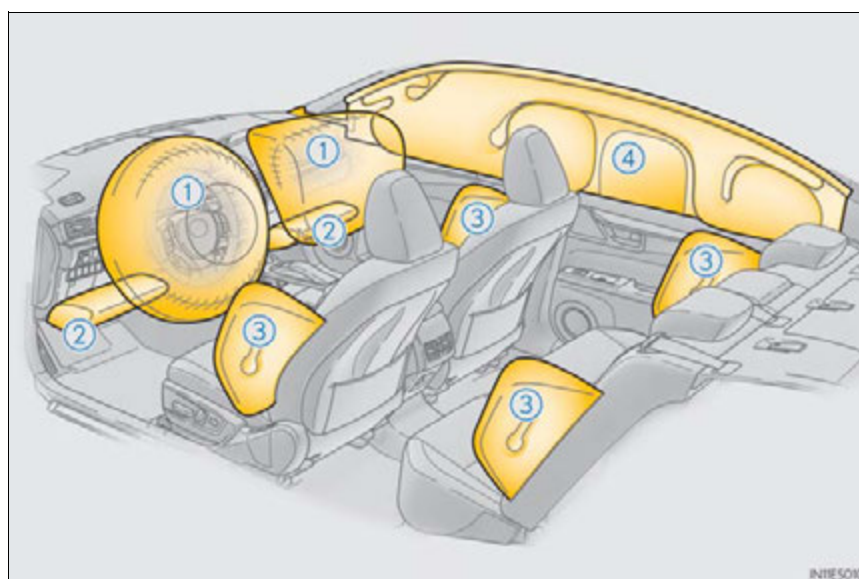

### ◆ SRS front airbags

- ① SRS driver airbag/front passenger airbag  
Can help protect the head and chest of the driver and front passenger from impact with interior components
- ② SRS knee airbags  
Can help provide driver and front passenger protection

---

◆ **SRS side and curtain shield airbags**

---

- ③ SRS front side airbags
  - Can help protect the torso of the front seat occupants
  - SRS rear side airbags
    - Can help protect the torso of occupants in the rear outer seats
- ④ SRS curtain shield airbags
  - Can help protect primarily the head of occupants in the outer seats

### SRS airbag system components

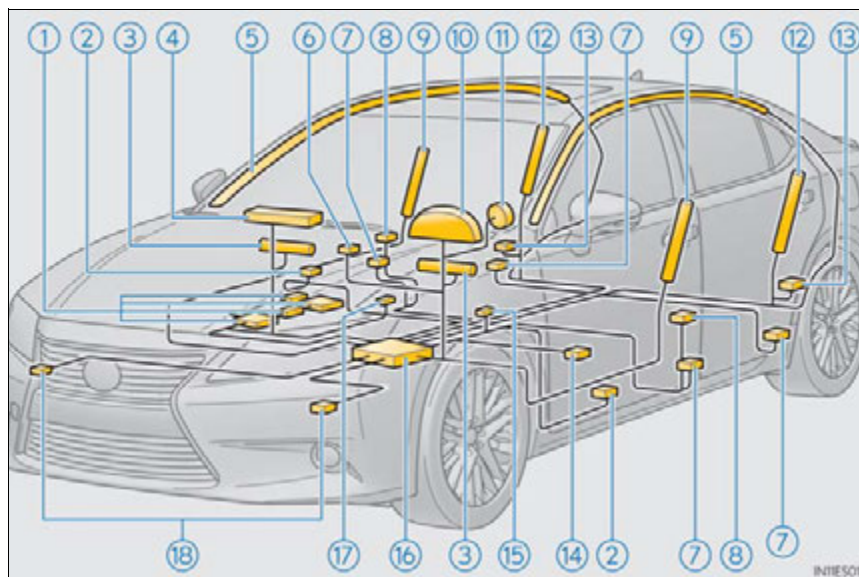

- |  |   |
|--|---|
| ① Front passenger occupant classification system (ECU and sensors) | ⑨ Front side airbags                        |
| ② Side impact sensors (front doors)                                | ⑩ SRS warning light                         |
| ③ Knee airbags   | ⑪ Driver airbag                             |
| ④ Front passenger airbag   | ⑫ Rear side airbags                         |
| ⑤ Curtain shield airbags   | ⑬ Side impact sensors (rear)                |
| ⑥ "AIR BAG ON" and "AIR BAG OFF" indicator lights                  | ⑭ Driver's seat position sensor             |
| ⑦ Seat belt pretensioners and force limiters                       | ⑮ Driver's seat belt buckle switch          |
| ⑧ Side impact sensors (front)                                      | ⑯ Airbag sensor assembly                    |
|  | ⑰ Front passenger's seat belt buckle switch |
|  | ⑱ Front impact sensors                      |

Your vehicle is equipped with ADVANCED AIRBAGS designed based on the US motor vehicle safety standards (FMVSS208). The airbag sensor assembly (ECU) controls airbag deployment based on information obtained from the sensors etc. shown in the system components diagram above. This information includes crash severity and occupant information. As the airbags deploy, a chemical reaction in the inflators quickly fills the airbags with non-toxic gas to help restrain the motion of the occupants.

 CAUTION

■ SRS airbag precautions

Observe the following precautions regarding the SRS airbags.  
Failure to do so may cause death or serious injury.

- The driver and all passengers in the vehicle must wear their seat belts properly. The SRS airbags are supplemental devices to be used with the seat belts.
- The SRS driver airbag deploys with considerable force, and can cause death or serious injury especially if the driver is very close to the airbag. The National Highway Traffic Safety Administration (NHTSA) advises:

Since the risk zone for the driver's airbag is the first 2 - 3 in. (50 - 75 mm) of inflation, placing yourself 10 in. (250 mm) from your driver airbag provides you with a clear margin of safety. This distance is measured from the center of the steering wheel to your breastbone. If you sit less than 10 in. (250 mm) away now, you can change your driving position in several ways:

- Move your seat to the rear as far as you can while still reaching the pedals comfortably.
- Slightly recline the back of the seat.  
Although vehicle designs vary, many drivers can achieve the 10 in. (250 mm) distance, even with the driver seat all the way forward, simply by reclining the back of the seat somewhat. If reclining the back of your seat makes it hard to see the road, raise yourself by using a firm, non-slippery cushion, or raise the seat if your vehicle has that feature.
- If your steering wheel is adjustable, tilt it downward. This points the airbag toward your chest instead of your head and neck.

The seat should be adjusted as recommended by NHTSA above, while still maintaining control of the foot pedals, steering wheel, and your view of the instrument panel controls.

**⚠ CAUTION****■ SRS airbag precautions**

- If the seat belt extender has been connected to the front seat belt buckle but the seat belt extender has not also been fastened to the latch plate of the seat belt, the SRS front airbags will judge that the driver and front passenger are wearing the seat belt even though the seat belt has not been connected. In this case, the SRS front airbags may not activate correctly in a collision, resulting in death or serious injury in the event of a collision. Be sure to wear the seat belt with the seat belt extender.



- The SRS front passenger airbag also deploys with considerable force, and can cause death or serious injury especially if the front passenger is very close to the airbag. The front passenger seat should be as far from the airbag as possible with the seatback adjusted, so the front passenger sits upright.
- Improperly seated and/or restrained infants and children can be killed or seriously injured by a deploying airbag. An infant or child who is too small to use a seat belt should be properly secured using a child restraint system. Lexus strongly recommends that all infants and children be placed in the rear seats of the vehicle and properly restrained. The rear seats are safer for infants and children than the front passenger seat. (→P. 57)
- Do not sit on the edge of the seat or lean against the dashboard.



**CAUTION**

■ SRS airbag precautions

- Do not allow a child to stand in front of the SRS front passenger airbag unit or sit on the knees of a front passenger.
- Do not allow the front seat occupants to hold items on their knees.
- Do not lean against the door, the roof side rail or the front, side and rear pillars.
- Do not allow anyone to kneel on the passenger seats toward the door or put their head or hands outside the vehicle.
- Do not attach anything to or lean anything against areas such as the dashboard, steering wheel pad, lower portion of the instrument panel and door of the glove box. These items can become projectiles when the SRS driver, front passenger and knee airbags deploy.
- Do not attach anything to areas such as a door, windshield glass, side door glass, front or rear pillar, roof side rail and assist grip.

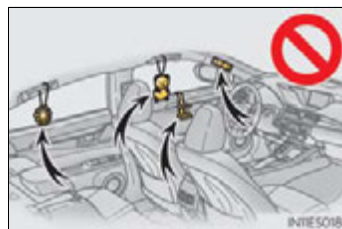
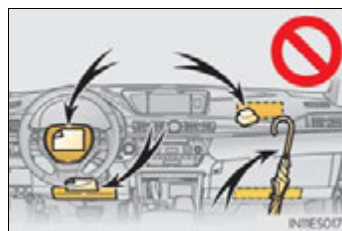

 CAUTION

## ■ SRS airbag precautions

- Do not hang coat hangers or hard objects on the coat hooks. All of these items could become projectiles and may cause death or serious injury, should the SRS curtain shield airbags deploy.
- If a vinyl cover is put on the area where the SRS knee airbag will deploy, be sure to remove it.
- Do not use seat accessories which cover the parts where the SRS side airbags inflate as they may interfere with inflation of the airbags. Such accessories may prevent the side airbags from activating correctly, disable the system or cause the side airbags to inflate accidentally, resulting in death or serious injury.
- Do not strike or apply significant levels of force to the area of the SRS airbag components.  
Doing so can cause the SRS airbags to malfunction.
- Do not touch any of the component parts immediately after the SRS airbags have deployed (inflated) as they may be hot.
- If breathing becomes difficult after the SRS airbags have deployed, open a door or window to allow fresh air in, or leave the vehicle if it is safe to do so. Wash off any residue as soon as possible to prevent skin irritation.
- If the areas where the SRS airbags are stored, such as the steering wheel pad and front and rear pillar garnishes are damaged or cracked, have them replaced by your Lexus dealer.



 CAUTION**■ Modification and disposal of SRS airbag system components**

Do not dispose of your vehicle or perform any of the following modifications without consulting your Lexus dealer. The SRS airbags may malfunction or deploy (inflate) accidentally, causing death or serious injury.

- Installation, removal, disassembly and repair of the SRS airbags
- Repairs, modifications, removal or replacement of the steering wheel, instrument panel, dashboard, glove box, seats or seat upholstery, front, side and rear pillars or roof side rails
- Repairs or modifications of the front fender, front bumper, or side of the occupant compartment
- Installation of a grille guard (bull bars, kangaroo bar, etc.), snow plows or winches
- Modifications to the vehicle's suspension system
- Installation of electronic devices such as mobile two-way radios and CD players
- Modifications to your vehicle for a person with a physical disability

**■ If the SRS airbags deploy (inflate)**

- Bruising and slight abrasions may result from contact with a deploying (inflating) SRS airbag.
- A loud noise and white powder will be emitted.
- Parts of the airbag module (steering wheel hub, airbag cover and inflator) as well as the seats, parts of the front and rear pillars, and roof side rails may be hot for several minutes. The airbag itself may also be hot.
- The windshield may crack.
- For Safety Connect subscribers, if the SRS airbags deploy or in the event of a severe rear-end collision, the system is designed to send an emergency call to the response center, notifying them of the vehicle's location (without needing to push the "SOS" button) and an agent will attempt to speak with the occupants to ascertain the level of emergency and assistance required. If the occupants are unable to communicate, the agent automatically treats the call as an emergency and helps to dispatch the necessary emergency services. (→P. 649)

**■ SRS airbag deployment conditions (SRS front airbags)**

- The SRS front airbags will deploy in the event of an impact that exceeds the set threshold level (the level of force corresponding to an approximately 12 - 18 mph [20 - 30 km/h] frontal collision with a fixed wall that does not move or deform).

However, this threshold velocity will be considerably higher in the following situations:

- If the vehicle strikes an object, such as a parked vehicle or sign pole, which can move or deform on impact
- If the vehicle is involved in an underride collision, such as a collision in which the front of the vehicle “underrides”, or goes under, the bed of a truck
- Depending on the type of collision, it is possible that only the seat belt pretensioners will activate.
- The SRS front airbags for the front passenger will not activate if there is no passenger sitting in the front passenger seat. However, the SRS front airbags for the front passenger may deploy if luggage is put in the seat, even if the seat is unoccupied. (→P. 50)

**■ SRS airbag deployment conditions (SRS side and curtain shield airbags)**

- The SRS side and curtain shield airbags will deploy in the event of an impact that exceeds the set threshold level (the level of force corresponding to the impact force produced by an approximately 3300 lb. [1500 kg] vehicle colliding with the vehicle cabin from a direction perpendicular to the vehicle orientation at an approximate speed of 12 - 18 mph [20 - 30 km/h]).
- The SRS curtain shield airbags may also deploy in the event of a severe frontal collision.

**■ Conditions under which the SRS airbags may deploy (inflate), other than a collision**

The SRS front airbags and SRS curtain shield airbag may also deploy if a serious impact occurs to the underside of your vehicle. Some examples are shown in the illustration.

- Hitting a curb, edge of pavement or hard surface
- Falling into or jumping over a deep hole
- Landing hard or falling

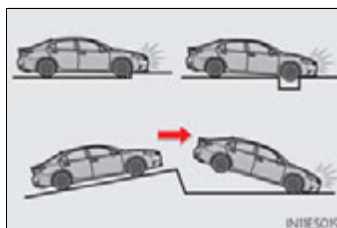

### ■ Types of collisions that may not deploy the SRS airbags (SRS front airbags)

The SRS front airbags do not generally inflate if the vehicle is involved in a side or rear collision, if it rolls over, or if it is involved in a low-speed frontal collision. But, whenever a collision of any type causes sufficient forward deceleration of the vehicle, deployment of the SRS front airbags may occur.

- Collision from the side
- Collision from the rear
- Vehicle rollover

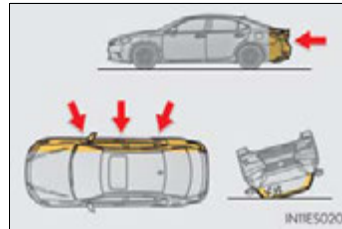

### ■ Types of collisions that may not deploy the SRS airbags (SRS side and curtain shield airbags)

The SRS side and curtain shield airbags may not activate if the vehicle is subjected to a collision from the side at certain angles, or a collision to the side of the vehicle body other than the passenger compartment.

- Collision from the side to the vehicle body other than the passenger compartment
- Collision from the side at an angle

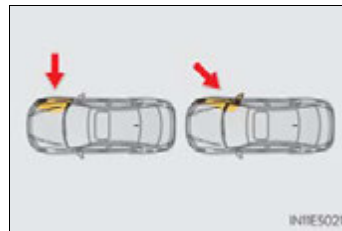

The SRS side airbags do not generally inflate if the vehicle is involved in a frontal or rear collision, if it rolls over, or if it is involved in a low-speed side collision.

- Collision from the front\*
- Collision from the rear
- Vehicle rollover

\*: Depending on the conditions and type of accident, the curtain shield airbags may deploy (inflate) upon frontal impact.

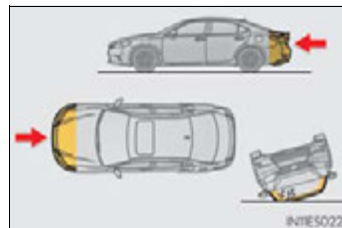

The SRS curtain shield airbags do not generally inflate if the vehicle is involved in a rear collision, if it rolls over, or if it is involved in a low-speed side or low-speed frontal collision.

- Collision from the rear
- Vehicle rollover

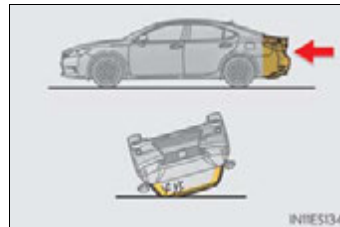

#### ■ When to contact your Lexus dealer

In the following cases, the vehicle will require inspection and/or repair. Contact your Lexus dealer as soon as possible.

- Any of the SRS airbags have been inflated.
- The front of the vehicle is damaged or deformed, or was involved in an accident that was not severe enough to cause the SRS front airbags to inflate.

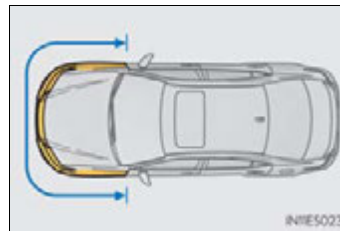

- A portion of a door is damaged or deformed, or the vehicle was involved in an accident that was not severe enough to cause the SRS side and curtain shield airbags to inflate.

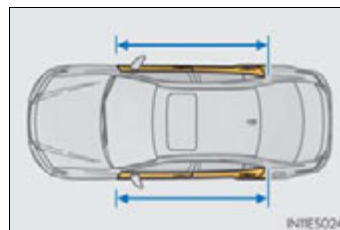

- The pad section of the steering wheel, dashboard near the front passenger airbag or lower portion of the instrument panel is scratched, cracked, or otherwise damaged.

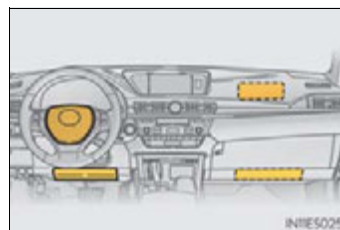

- The surface of the seats with the side airbag is scratched, cracked, or otherwise damaged.

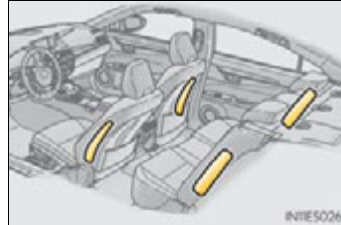

- The portion of the front pillars, rear pillars or roof side rail garnishes (padding) containing the curtain shield airbags inside is scratched, cracked, or otherwise damaged.

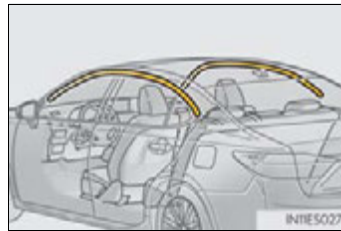

## Front passenger occupant classification system

Your vehicle is equipped with a front passenger occupant classification system. This system detects the conditions of the front passenger seat and activates or deactivates the devices for the front passenger.

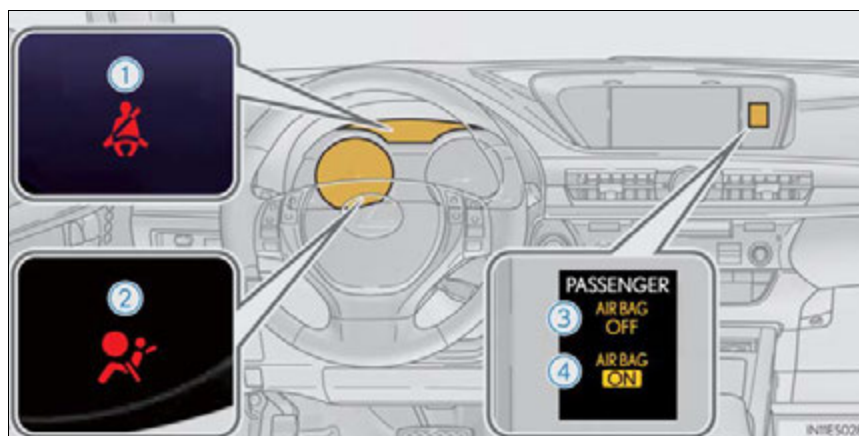

- ① Seat belt reminder light
- ② SRS warning light
- ③ "AIR BAG OFF" indicator light
- ④ "AIR BAG ON" indicator light

### Condition and operation in the front passenger occupant classification system

#### ■ Adult\*<sup>1</sup>

Indicator/ warning light	"AIR BAG ON" and "AIR BAG OFF" indicator lights	"AIR BAG ON"
	SRS warning light	Off
	Seat belt reminder light	Flashing * <sup>2</sup>
Devices	Front passenger airbag	Activated
	Side airbag on the front passenger seat	
	Curtain shield airbag in the front passenger side	
	Front passenger knee airbag	
	Front passenger's seat belt pretensioner	

#### ■ Child\*<sup>3</sup>

Indicator/ warning light	"AIR BAG ON" and "AIR BAG OFF" indicator lights	"AIR BAG OFF" or "AIR BAG ON"* <sup>3</sup>
	SRS warning light	Off
	Seat belt reminder light	Flashing * <sup>2</sup>
Devices	Front passenger airbag	Deactivated or activated* <sup>3</sup>
	Side airbag on the front passenger seat	Activated
	Curtain shield airbag in the front passenger side	
	Front passenger knee airbag	Deactivated or activated* <sup>3</sup>
	Front passenger's seat belt pretensioner	Activated

1

For safety and security

### ■ Child restraint system with infant\*4

Indicator/ warning light	"AIR BAG ON" and "AIR BAG OFF" indicator lights	"AIR BAG OFF"*5
	SRS warning light	Off
	Seat belt reminder light	Flashing *2
Devices	Front passenger airbag	Deactivated
	Side airbag on the front passenger seat	Activated
	Curtain shield airbag in the front passenger side	
	Front passenger knee airbag	Deactivated
	Front passenger's seat belt pretensioner	Activated

### ■ Unoccupied

Indicator/ warning light	"AIR BAG ON" and "AIR BAG OFF" indicator lights	"AIR BAG OFF"
	SRS warning light	Off
	Seat belt reminder light	
Devices	Front passenger airbag	Deactivated
	Side airbag on the front passenger seat	Activated
	Curtain shield airbag in the front passenger side	
	Front passenger knee airbag	Deactivated
	Front passenger's seat belt pretensioner	Activated



■ There is a malfunction in the system

Indicator/ warning light	"AIR BAG ON" and "AIR BAG OFF" indicator lights	"AIR BAG OFF"
	SRS warning light	On
	Seat belt reminder light	Off
Devices	Front passenger airbag	Deactivated
	Side airbag on the front passenger seat	Activated
	Curtain shield airbag in the front passenger side	
	Front passenger knee airbag	Deactivated
	Front passenger's seat belt pretensioner	Activated

\*1: The system judges a person of adult size as an adult. When a smaller adult sits in the front passenger seat, the system may not recognize him/her as an adult depending on his/her physique and posture.

\*2: In the event the front passenger does not wear a seat belt

\*3: For some children, child in seat, child in booster seat or child in convertible seat, the system may not recognize him/her as a child. Factors which may affect this can be the physique or posture.

\*4: Never install a rear-facing child restraint system on the front passenger seat. A forward-facing child restraint system should only be installed on the front passenger seat when it is unavoidable. (→P. 57)

\*5: In case the indicator light is not illuminated, consult this manual on how to install the child restraint system properly. (→P. 61)

 CAUTION**■ Front passenger occupant classification system precautions**

Observe the following precautions regarding the front passenger occupant classification system.

Failure to do so may cause death or serious injury.

- Wear the seat belt properly.
- Make sure the front passenger's seat belt plate has not been left inserted into the buckle before someone sits in the front passenger seat.
- Make sure the "AIR BAG OFF" indicator light is not illuminated when using the seat belt extender for the front passenger seat. If the "AIR BAG OFF" indicator light is illuminated, disconnect the extender tongue from the seat belt buckle, and reconnect the seat belt. Reconnect the seat belt extender after making sure the "AIR BAG ON" indicator light is illuminated. If you use the seat belt extender while the "AIR BAG OFF" indicator light is illuminated, the SRS airbags for the passenger may not activate correctly, which could cause death or serious injury in the event of a collision.
- Do not apply a heavy load to the front passenger seat or equipment (e.g. seat-back pockets or armrest).
- Do not put weight on the front passenger seat by putting your hands or feet on the front passenger seat seatback from the rear passenger seat.
- Do not let a rear passenger lift the front passenger seat with their feet or press on the seatback with their legs.
- Do not put objects under the front passenger seat.

 CAUTION**■ Front passenger occupant classification system precautions**

- Do not recline the front passenger seatback so far that it touches a rear seat. This may cause the "AIR BAG OFF" indicator light to be illuminated, which indicates that the passenger's airbags will not deploy in the event of a severe accident. If the seatback touches the rear seat, return the seatback to a position where it does not touch the rear seat. Keep the front passenger seatback as upright as possible when the vehicle is moving. Reclining the seatback excessively may lessen the effectiveness of the seat belt system.
- If an adult sits in the front passenger seat, the "AIR BAG ON" indicator light is illuminated. If the "AIR BAG OFF" indicator is illuminated, ask the passenger to sit up straight, well back in the seat, feet on the floor, and with the seat belt worn correctly. If the "AIR BAG OFF" indicator still remains illuminated, either ask the passenger to move to the rear seat, or if that is not possible, move the front passenger seat fully rearward.
- When it is unavoidable to install a forward-facing child restraint system on the front passenger seat, install the child restraint system on the front passenger seat in the proper order. (→P. 61)
- Do not modify or remove the front seats.
- Do not kick the front passenger seat or subject it to severe impact. Otherwise, the SRS warning light may come on to indicate a malfunction of the detection system. In this case, contact your Lexus dealer immediately.
- Child restraint systems installed on the rear seat should not contact the front seatbacks.
- Do not modify or replace the upholstery of the front seat.

## Safety information for children

Observe the following precautions when children are in the vehicle.  
Use a child restraint system appropriate for the child, until the child becomes large enough to properly wear the vehicle's seat belt.

- It is recommended that children sit in the rear seats to avoid accidental contact with the shift lever, wiper switch etc.
- Use the rear door child-protector lock or the window lock switch to avoid children opening the door while driving or operating the power window accidentally. (→P. 143, 174)
- Do not let small children operate equipment which may catch or pinch body parts, such as the power window, hood, trunk, seats etc.

### CAUTION

Never leave children unattended in the vehicle, and never allow children to have or use the key.

Children may be able to start the vehicle or shift the vehicle into neutral. There is also a danger that children may injure themselves by playing with the windows, the moon roof or other features of the vehicle. In addition, heat build-up or extremely cold temperatures inside the vehicle can be fatal to children.

## Child restraint systems

A child restraint system for a small child or baby must itself be properly restrained on the seat with the lap portion of the lap/shoulder belt.

The laws of all 50 states of the U.S.A. and Canada now require the use of child restraint systems.

### Points to remember

Studies have shown that installing a child restraint on a rear seat is much safer than installing one on the front passenger seat.

- Choose a child restraint system that suits your vehicle and is appropriate to the age and size of the child.
- For installation details, follow the instructions provided with the child restraint system.

General installation instructions are provided in this manual. (→P. 61)

### Types of child restraints

Child restraint systems are classified into the following 3 types according to the age and size of the child:

- ▶ Rear facing — Infant seat/convertible seat
- ▶ Forward facing — Convertible seat



- ▶ Booster seat



#### ■ Selecting an appropriate child restraint system

- Use a child restraint system appropriate for the child until the child becomes large enough to properly wear the vehicle's seat belt.
- If the child is too large for a child restraint system, sit the child on a rear seat and use the vehicle's seat belt. (→P. 32)

 CAUTION

## ■ Child restraint precautions

- For effective protection in automobile accidents and sudden stops, a child must be properly restrained, using a seat belt or child restraint system depending on the age and size of the child. Holding a child in your arms is not a substitute for a child restraint system. In an accident, the child can be crushed against the windshield, or between you and the vehicle's interior.
- Lexus strongly urges the use of a proper child restraint system that conforms to the size of the child, installed on the rear seat. According to accident statistics, the child is safer when properly restrained in the rear seat than in the front seat.
- Never install a rear-facing child restraint system on the front passenger seat even if the "AIR BAG OFF" indicator light is illuminated.  
In the event of an accident, the force of the rapid inflation of the front passenger airbag can cause death or serious injury to the child if the rear-facing child restraint system is installed on the front passenger seat.
- A forward-facing child restraint system may be installed on the front passenger seat only when it is unavoidable. A child restraint system that requires a top tether strap should not be used in the front passenger seat since there is no top tether strap anchor for the front passenger seat. Adjust the seatback as upright as possible and always move the seat as far back as possible even if the "AIR BAG OFF" indicator light is illuminated, because the front passenger airbag could inflate with considerable speed and force. Otherwise, the child may be killed or seriously injured.
- Do not use the seat belt extender when installing a child restraint system on the front or rear passenger seat. If installing a child restraint system with the seat belt extender connected to the seat belt, the seat belt will not securely hold the child restraint system, which could cause death or serious injury to the child or other passengers in the event of a sudden stop, sudden swerve or accident.
- Do not allow the child to lean his/her head or any part of his/her body against the door or the area of the seat, front and rear pillars or roof side rails from which the SRS side airbags or SRS curtain shield airbags deploy even if the child is seated in the child restraint system. It is dangerous if the SRS side airbags and curtain shield airbags inflate, and the impact could cause death or serious injury to the child.
- Make sure you have complied with all installation instructions provided by the child restraint manufacturer and that the system is properly secured. If it is not secured properly, it may cause death or serious injury to the child in the event of a sudden stop, sudden swerve or accident.

 CAUTION**■ When children are in the vehicle**

Do not allow children to play with the seat belt. If the seat belt becomes twisted around a child's neck, it may lead to choking or other serious injuries that could result in death.

If this occurs and the buckle cannot be unfastened, scissors should be used to cut the belt.

**■ When the child restraint system is not in use**

- Keep the child restraint system properly secured on the seat even if it is not in use. Do not store the child restraint system unsecured in the passenger compartment.

- If it is necessary to detach the child restraint system, remove it from the vehicle or store it securely in the trunk. This will prevent it from injuring passengers in the event of a sudden stop, sudden swerve or accident.



## Installing child restraints

Follow the child restraint system manufacturer's instructions. Firmly secure child restraints to the seats using the LATCH anchors or a seat belt. Attach the top tether strap when installing a child restraint. The lap/shoulder belt can be used if your child restraint system is not compatible with the LATCH (Lower Anchors and Tethers for Children) system.

### Child restraint LATCH anchors

LATCH anchors are provided for the outboard rear seats. (Buttons displaying the location of the anchors are attached to the seats.)

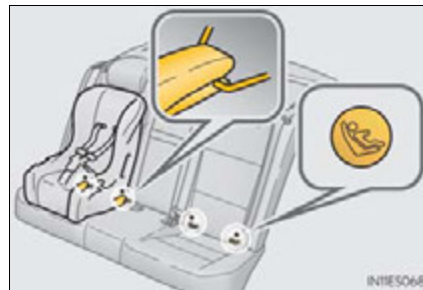

Seat belts equipped with a child restraint locking mechanism (ALR/ELR belts except driver's seat belt) (→P. 34)



Anchor brackets (for top tether strap)

An anchor bracket is provided for each rear seat.

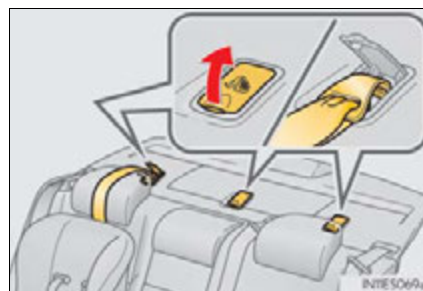

### Installation with LATCH system

- 1 Lower the head restraint in place at the lowest position.

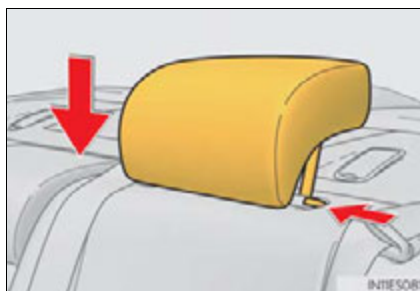

- 2 Widen the gap between the seat cushion and seatback slightly.
  - ▶ Type A

- 3 Latch the hooks of the lower straps onto the LATCH anchors. If the child restraint has a top tether strap, the top tether strap should be latched onto the top tether strap anchor.

For owners in Canada:

The symbol on a child restraint system indicates the presence of a lower connector system.

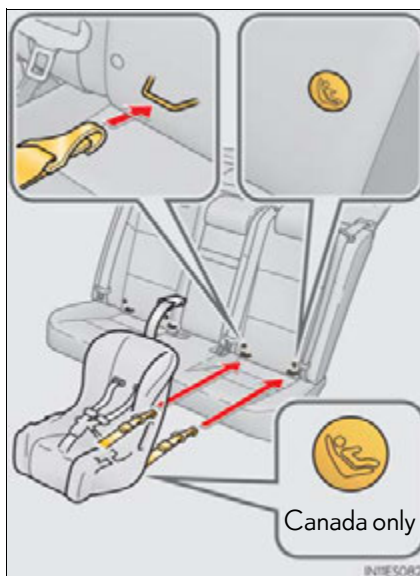

► Type B

- 3** Latch the buckles onto the LATCH anchors. If the child restraint has a top tether strap, the top tether strap should be latched onto the top tether strap anchor.

For owners in Canada:

The symbol on a child restraint system indicates the presence of a lower connector system.

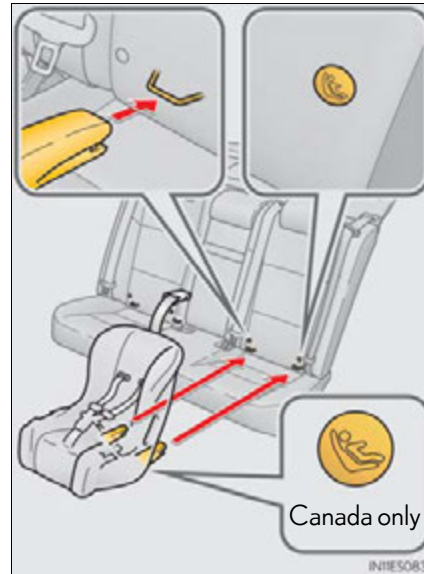

## Installing child restraints using a seat belt (child restraint lock function belt)

### ■ Rear-facing — Infant seat/convertible seat

- 1 Place the child restraint system on the rear seat facing the rear of the vehicle.



- 2 Run the seat belt through the child restraint system and insert the plate into the buckle. Make sure that the belt is not twisted.

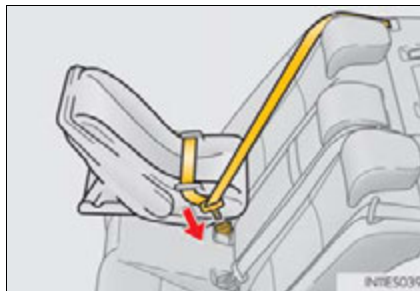

- 3 Fully extend the shoulder belt and allow it to retract to put it in lock mode. In lock mode, the belt cannot be extended.



- 4 While pushing the child restraint system down into the rear seat, allow the shoulder belt to retract until the child restraint system is securely in place.

After the shoulder belt has retracted to a point where there is no slack in the belt, pull the belt to check that it cannot be extended.

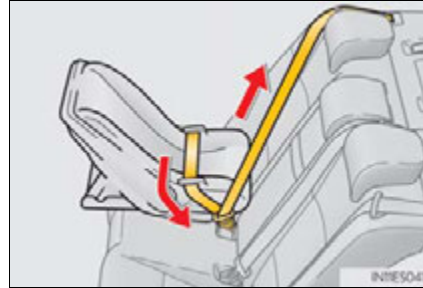

#### ■ Forward-facing — Convertible seat

- 1 Lower the head restraint in place at the lowest position.

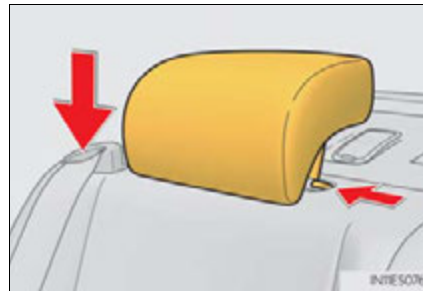

- 2 Place the child restraint system on the seat facing the front of the vehicle.



- 3 Run the seat belt through the child restraint system and insert the plate into the buckle. Make sure that the belt is not twisted.



- 4 Fully extend the shoulder belt and allow it to retract to put it in lock mode. In lock mode, the belt cannot be extended.



- 5 While pushing the child restraint system into the rear seat, allow the shoulder belt to retract until the child restraint system is securely in place.

After the shoulder belt has retracted to a point where there is no slack in the belt, pull the belt to check that it cannot be extended.



- 6 If the child restraint has a top tether strap, the top tether strap should be latched onto the top tether strap anchor. (→P. 68)

### ■ Booster seat

- 1 Place the child restraint system on the seat facing the front of the vehicle.



- 2 Sit the child in the child restraint system. Fit the seat belt to the child restraint system according to the manufacturer's instructions and insert the plate into the buckle. Make sure that the belt is not twisted.



Check that the shoulder belt is correctly positioned over the child's shoulder and that the lap belt is as low as possible. (→P. 32)

### Removing a child restraint installed with a seat belt

Push the buckle release button and fully retract the seat belt.

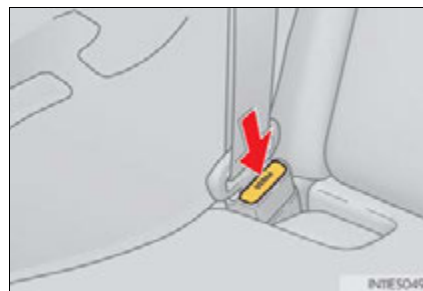

### Child restraint systems with a top tether strap

- 1 Lower the head restraint in place at the lowest position.

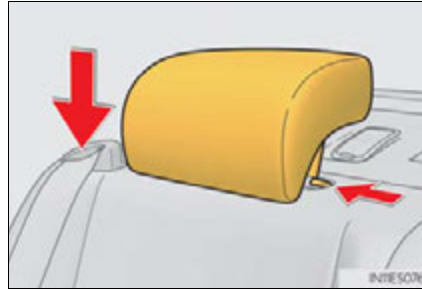

- 2 Secure the child restraint system using the seat belt or LATCH anchors.



- 3 Open the anchor bracket cover, latch the hook onto the anchor bracket and tighten the top tether strap.

Make sure the top tether strap is securely latched.

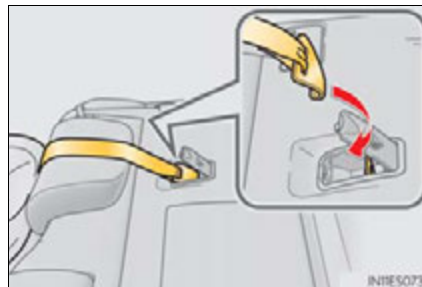

#### ■ Laws and regulations pertaining to anchorages

The LATCH system conforms to FMVSS225 or CMVSS210.2.

Child restraint systems conforming to FMVSS213 or CMVSS213 specifications can be used.

This vehicle is designed to conform to the SAE J1819.



**⚠ CAUTION**

■ **When installing a booster seat**

To prevent the belt from going into ALR lock mode, do not fully extend the shoulder belt. ALR mode causes the belt to tighten only. This could cause injury or discomfort to the child. (→P. 34)

■ **When installing a child restraint system**

Follow the directions given in the child restraint system installation manual and fix the child restraint system securely in place.

If the child restraint system is not correctly fixed in place, the child or other passengers may be seriously injured or even killed in the event of sudden braking, sudden swerving or an accident.

- If the driver's seat interferes with the child restraint system and prevents it from being attached correctly, attach the child restraint system to the right-hand rear seat.
- Adjust the front passenger seat so that it does not interfere with the child restraint system.
- Only put a forward-facing child restraint system on the front seat when unavoidable. When installing a forward-facing child restraint system on the front passenger seat, move the seat as far back as possible even if the "AIR BAG OFF" indicator light is illuminated. Failure to do so may result in death or serious injury if the airbags deploy (inflate).



**⚠ CAUTION****■ When installing a child restraint system**

- When a booster seat is installed, always ensure that the shoulder belt is positioned across the center of the child's shoulder. The belt should be kept away from the child's neck, but not so that it could fall off the child's shoulder. Failing to do so may result in death or serious injury in the event of sudden braking, sudden swerving or an accident.
- Ensure that the belt and plate are securely locked and the seat belt is not twisted.
- Shake the child restraint system left and right, and forward and backward to ensure that it has been securely installed.
- After securing a child restraint system, never adjust the seat.
- Follow all installation instructions provided by the child restraint system manufacturer.
- When using the left-hand rear seat for the child restraint system, do not sit in the center rear seat.

Seat belt function may be impaired, such as being positioned overly high or loose-fitting, which may result in death or serious injury in the event of sudden braking, sudden swerving or an accident.

**■ Do not use a seat belt extender**

If a seat belt extender is used when installing a child restraint system, the seat belt will not securely hold the child restraint system, which could cause death or serious injury to the child or other passengers in the event of sudden braking, sudden swerving or an accident.

**■ To correctly attach a child restraint system to the anchors**

When using the LATCH anchors, be sure that there are no foreign objects around the anchors and that the seat belt is not caught behind the child restraint system. Make sure the child restraint system is securely attached, or it may cause death or serious injury to the child or other passengers in the event of sudden braking, sudden swerving or an accident.

## Exhaust gas precautions

Harmful substance to the human body is included in exhaust gases if inhaled.

### CAUTION

Exhaust gases include harmful carbon monoxide (CO), which is colorless and odorless. Observe the following precautions.

Failure to do so may cause exhaust gases enter the vehicle and may lead to an accident caused by light-headedness, or may lead to death or a serious health hazard.

#### ■ Important points while driving

- Keep the trunk lid closed.
- If you smell exhaust gases in the vehicle even when the trunk lid is closed, open the windows and have the vehicle inspected at your Lexus dealer as soon as possible.

#### ■ When parking

- If the vehicle is in a poorly ventilated area or a closed area, such as a garage, stop the engine <hybrid system>.
- Do not leave the vehicle with the engine running <hybrid system operating> for a long time.  
If such a situation cannot be avoided, park the vehicle in an open space and ensure that exhaust fumes do not enter the vehicle interior.
- Do not leave the engine running <hybrid system operating> in an area with snow build-up, or where it is snowing. If snowbanks build up around the vehicle while the engine is running <hybrid system is operating>, exhaust gases may collect and enter the vehicle.

#### ■ Exhaust pipe

The exhaust system needs to be checked periodically. If there is a hole or crack caused by corrosion, damage to a joint or abnormal exhaust noise, be sure to have the vehicle inspected and repaired by your Lexus dealer.

## Hybrid system features (hybrid vehicles)

Your vehicle is a hybrid vehicle. It has characteristics different from conventional vehicles. Be sure you are closely familiar with the characteristics of your vehicle, and operate with care.

The hybrid system combines the use of a gasoline engine and an electric motor (traction motor) according to driving conditions, improving fuel efficiency and reducing exhaust emissions.

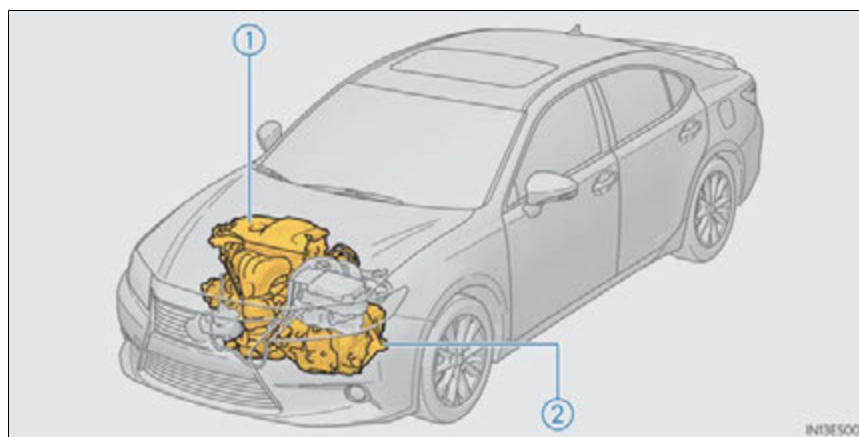

- ① Gasoline engine
- ② Electric motor (traction motor)

---

**◆ When stopped/during start off**

---

The gasoline engine stops when the vehicle is stopped. During start off, the electric motor (traction motor) drives the vehicle. At slow speeds or when traveling down a gentle slope, the engine is stopped and the electric motor (traction motor) is used.

---

**◆ During normal driving**

---

The gasoline engine is predominantly used. The electric motor (traction motor) charges the hybrid battery (traction battery) as necessary.

---

**◆ When accelerating sharply**

---

When the accelerator pedal is depressed heavily, the power of the hybrid battery (traction battery) is added to that of the gasoline engine via the electric motor (traction motor).

---

**◆ When braking (regenerative braking)**

---

The electric motor (traction motor) charges the hybrid battery (traction battery).

---

**Vehicle proximity notification system**

---

When driving with the gasoline engine stopped, a sound, which changes in accordance with the driving speed, will be played in order to warn people nearby of the vehicle's approach. The sound will stop when the vehicle speed exceeds approximately 15 mph (25 km/h).

### ■ Regenerative braking

In the following situations, kinetic energy is converted to electric energy and deceleration force can be obtained in conjunction with the recharging of the hybrid battery (traction battery).

- The accelerator pedal is released while driving with the shift position in D or S.
- The brake pedal is depressed while driving with the shift position in D or S.

### ■ EV indicator

The EV indicator comes on when driving the vehicle using only the electric motor (traction motor).



### ■ Conditions in which the gasoline engine may not stop

The gasoline engine starts and stops automatically. However, it may not stop automatically in the following conditions:

- During gasoline engine warm-up
- During hybrid battery (traction battery) charging
- When the temperature of the hybrid battery (traction battery) is high or low
- When the heater is switched on

### ■ Charging the hybrid battery (traction battery)

- As the gasoline engine charges the hybrid battery (traction battery), the battery does not need to be charged from an outside source. However, if the vehicle is left parked for a long time the hybrid battery will slowly discharge. For this reason, be sure to drive the vehicle at least once every few months for at least 30 minutes or 10 miles (16 km). If the hybrid battery becomes fully discharged and you are unable to jump-start the vehicle with the 12-volt battery, contact your Lexus dealer.
- If the shift lever is in N, the hybrid battery (traction battery) will not be charged. Always put the shift lever in P when the vehicle is stopped. When driving in heavy traffic, operate the vehicle with the shift lever in D or S to avoid discharging the battery.

### ■ Charging the 12-volt battery

→P. 819

**■ After the 12-volt battery has discharged or has been changed or removed**

The gasoline engine may not stop even if the vehicle is running on the hybrid battery (traction battery). If this continues for a few days, contact your Lexus dealer.

**■ Sounds and vibrations specific to a hybrid vehicles**

There may be no engine sounds or vibration even though the vehicle is able to move. For safety, apply the parking brake and make sure to shift the shift position to P when parked.

The following sounds or vibrations may occur when the hybrid system is operating and are not a malfunction:

- Motor sounds may be heard from the engine compartment.
- Sounds may be heard from the hybrid battery (traction battery) behind the rear seats when the hybrid system starts or stops.
- Sounds from the hybrid system may be heard when the trunk lid is open.
- Sounds may be heard from the hybrid transmission when the hybrid system starts or stops.
- Engine sounds may be heard when accelerating sharply.
- Sounds may be heard due to regenerative braking when the brake pedal is depressed.
- Vibration may be felt when the gasoline engine starts or stops.
- Cooling fan sounds may be heard from the air intake vent on rear left seat.

**■ Vehicle proximity notification system**

In the following cases, the vehicle proximity notification system may be difficult for surrounding people to hear.

- In very noisy areas
- In the wind or the rain

Also, as the vehicle proximity notification system is installed on the front of the vehicle, it may be more difficult to hear from the rear of the vehicle compared to the front.

**■ Maintenance, repair, recycling, and disposal**

Contact your Lexus dealer regarding maintenance, repair, recycling and disposal. Do not dispose of the vehicle yourself.

**■ Customization**

Settings (e.g. on/off operation of the EV indicator) can be changed.  
(Customizable features: →P. 862)

## Hybrid system precautions (hybrid vehicles)

Take care when handling the hybrid system, as it contains a high voltage system (about 650 V at maximum) as well as parts that become extremely hot when the hybrid system is operating. Obey the caution labels attached to the vehicle.

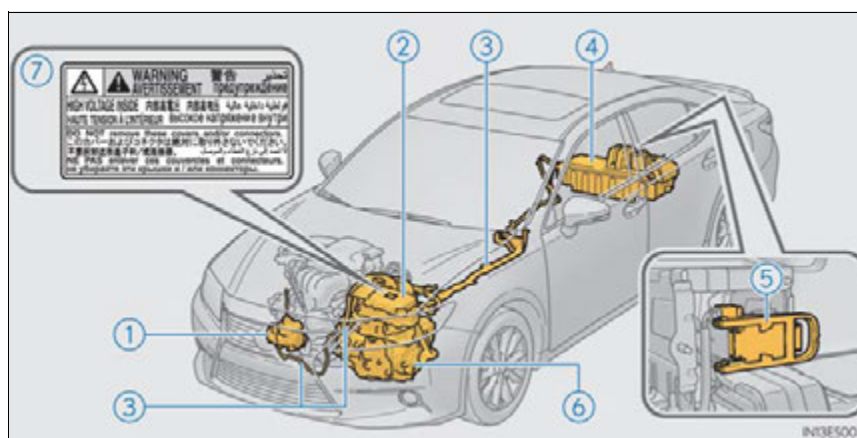

- ① Air conditioning compressor
- ② Power control unit with DC/DC converter
- ③ High voltage cables (orange)
- ④ Hybrid battery (traction battery)
- ⑤ Service plug
- ⑥ Electric motor (traction motor)
- ⑦ Caution label



### Hybrid battery (traction battery) air vent

There is an air intake vent beside the rear left seat for the purpose of cooling the hybrid battery (traction battery). If the vent becomes blocked, the hybrid battery may overheat, leading to a reduction in hybrid battery output.



### Emergency shut off system

When a certain level of impact is detected by the impact sensor, the emergency shut off system blocks off the high voltage current and stops the fuel pump to minimize the risk of electrocution and fuel leakage. If the emergency shut off system activates, your vehicle will not restart. To restart the hybrid system, contact your Lexus dealer.

### Hybrid warning message

A message is automatically displayed when a malfunction occurs in the hybrid system or an improper operation is attempted.

If a warning message is shown on the multi-information display, read the message and follow the instructions. (→P. 769)

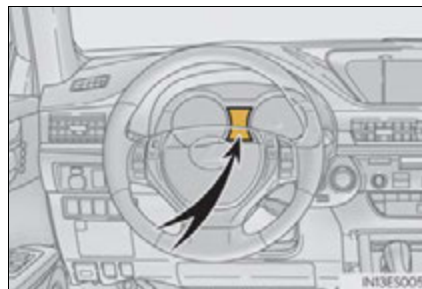

**■ If a warning light comes on, a warning message is displayed, or the 12-volt battery is disconnected**

The hybrid system may not start. In that case, try to start the system again. If the "READY" indicator does not come on, contact your Lexus dealer.

**■ Running out of fuel**

When the vehicle has run out of fuel and the hybrid system cannot be started, refuel the vehicle with at least enough gasoline to make the low fuel level warning light (→P. 762) go off. If there is only a small amount of fuel, the hybrid system may not be able to start. (The minimum amount of fuel to add to make the low fuel level warning light go out is about 3.0 gal. [11.3 L, 2.5 Imp.gal.], when the vehicle is on a level surface. This value may vary when the vehicle is on a slope.)

**■ Electromagnetic waves**

- High voltage parts and cables on the hybrid vehicles incorporate electromagnetic shielding, and therefore emit approximately the same amount of electromagnetic waves as conventional gasoline powered vehicles or home electronic appliances.
- Your vehicle may cause sound interference in some third party-produced radio parts.

**■ Hybrid battery (traction battery)**

The hybrid battery (traction battery) has a limited service life. The lifespan of the hybrid battery (traction battery) can change in accordance with driving style and driving conditions.

**⚠ CAUTION****■ High voltage precautions**

The vehicle has high voltage DC and AC systems as well as a 12-volt system. DC and AC high voltage is very dangerous and can cause severe burns and electric shock that may result in death or serious injury.

- Never touch, disassemble, remove or replace the high voltage parts, cables or their connectors.
- The hybrid system will become hot after starting as the system uses high voltage. Be careful of both the high voltage and the high temperature, and always obey the caution labels attached to the vehicle.
- Never try to open the service plug access hole located behind the rear seats. The service plug is used only when the vehicle is serviced and is subject to high voltage.

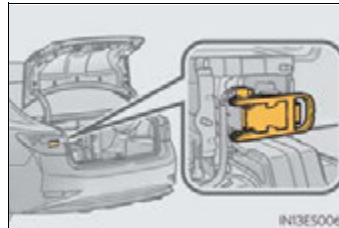

1

For safety and security

 **CAUTION****■ Road accident cautions**

Observe the following precautions to reduce the risk of death or serious injury:

- Pull your vehicle off the road, apply the parking brake, shift the shift lever to P, and turn the hybrid system off.
- Do not touch the high voltage parts, cables and connectors.
- If electric wires are exposed inside or outside your vehicle, an electric shock may occur. Never touch exposed electric wires.
- If a fluid leak occurs, do not touch the fluid as it may be strong alkaline electrolyte from the hybrid battery (traction battery). If it comes into contact with your skin or eyes, wash it off immediately with a large amount of water or, if possible, boric acid solution. Seek immediate medical attention.
- If a fire occurs in the hybrid vehicles, leave the vehicle as soon as possible. Never use a fire extinguisher that is not meant for electric fires. Using even a small amount of water may be dangerous.
- If your vehicle needs to be towed, do so with front wheels raised. If the wheels connected to the electric motor (traction motor) are on the ground when towing, the motor may continue to generate electricity. This may cause an electricity leakage leading to a fire. (→P. 751)
- Carefully inspect the ground under the vehicle. If you find that liquid has leaked onto the ground, the fuel system may have been damaged. Leave the vehicle as soon as possible.

 CAUTION**■ Hybrid battery (traction battery)**

- Your vehicle contains a sealed nickel-metal hydride battery. Never resell, hand over or modify the hybrid battery. To prevent accidents, hybrid batteries that have been removed from a disposed vehicle are collected through Lexus dealer. Do not dispose of the battery yourself.

Unless the battery is properly collected, the following may occur, resulting in death or serious injury:

- The hybrid battery may be illegally disposed of or dumped, and it is hazardous to the environment or someone may touch a high voltage part, resulting in an electric shock.
- The hybrid battery is intended to be used exclusively with your hybrid vehicle. If the hybrid battery is used outside of your vehicle or modified in any way, accidents such as electric shock, heat generation, smoke generation, an explosion and electrolyte leakage may occur.

When reselling or handing over your vehicle, the possibility of an accident is extremely high because the person receiving the vehicle may not be aware of these dangers.

- If your vehicle is disposed of without the hybrid battery having been removed, there is a danger of serious electric shock if high voltage parts, cables and their connectors are touched. In the event that your vehicle must be disposed of, the hybrid battery must be disposed of by your Lexus dealer or a qualified service shop. If the hybrid battery is not disposed of properly, it may cause electric shock that can result in death or serious injury.

 NOTICE**■ Hybrid battery air vent**

- Do not put foreign objects near the air vent. The hybrid battery (traction battery) may overheat and be damaged.
- Clean the air vent regularly to prevent the hybrid battery (traction battery) from overheating.
- Do not wet or allow foreign substances to enter the air vent as this may cause a short circuit and damage the hybrid battery (traction battery).
- Do not carry large amounts of water such as water cooler bottles in the vehicle. If water spills onto the hybrid battery (traction battery), the battery may be damaged. Have the vehicle inspected by your Lexus dealer.

## Engine immobilizer system (gasoline vehicles)

The vehicle's keys have built-in transponder chips that prevent the engine from starting if a key has not been previously registered in the vehicle's on-board computer.

Never leave the keys inside the vehicle when you leave the vehicle.

This system is designed to help prevent vehicle theft but does not guarantee absolute security against all vehicle thefts.

The indicator light flashes after the "START STOP ENGINE" switch has been turned off to indicate that the system is operating.

The indicator light stops flashing after the "START STOP ENGINE" switch has been turned to ACCESSORY or IGNITION ON mode to indicate that the system has been canceled.

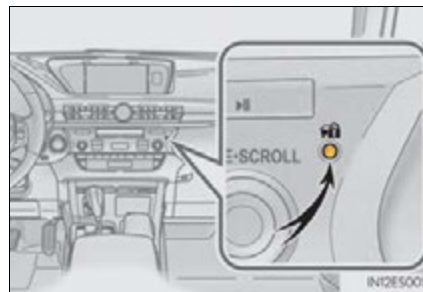

### ■ System maintenance

The vehicle has a maintenance-free type engine immobilizer system.

### ■ Conditions that may cause the system to malfunction

- If the grip portion of the key is in contact with a metallic object
- If the key is in close proximity to or touching a key to the security system (key with a built-in transponder chip) of another vehicle

**■ Certifications for the engine immobilizer system**

- ▶ For vehicles sold in the U.S.A.

FCC ID: NI4TMIMB-3

NOTE:

This device complies with part 15 of the FCC Rules. Operation is subject to the following two conditions: (1) This device may not cause harmful interference, and (2) this device must accept any interference received, including interference that may cause undesired operation.

- ▶ For vehicles sold in Canada

NOTE:

This device complies with Industry Canada licence-exempt RSS standard(s). Operation is subject to the following two conditions: (1) this device may not cause interference, and (2) this device must accept any interference, including interference that may cause undesired operation of the device.

**⚠ CAUTION****■ Certifications for the engine immobilizer system**

Changes or modifications not expressly approved by the party responsible for compliance could void the user's authority to operate the equipment.

**⚠ NOTICE****■ To ensure the system operates correctly**

Do not modify or remove the system. If modified or removed, the proper operation of the system cannot be guaranteed.

## Immobilizer system (hybrid vehicles)

The vehicle's keys have built-in transponder chips that prevent the hybrid system from starting if a key has not been previously registered in the vehicle's on-board computer.

Never leave the keys inside the vehicle when you leave the vehicle.

This system is designed to help prevent vehicle theft but does not guarantee absolute security against all vehicle thefts.

The indicator light flashes after the "POWER" switch has been turned off to indicate that the system is operating.

The indicator light stops flashing after the "POWER" switch has been turned to ACCESSORY or ON mode to indicate that the system has been canceled.

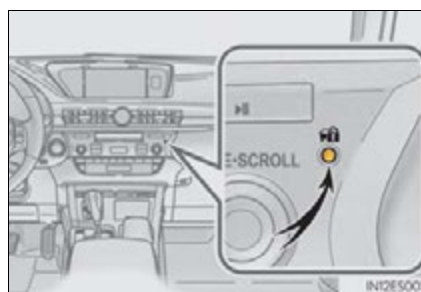

### ■ System maintenance

The vehicle has a maintenance-free type immobilizer system.

### ■ Conditions that may cause the system to malfunction

- If the grip portion of the key is in contact with a metallic object
- If the key is in close proximity to or touching a key to the security system (key with a built-in transponder chip) of another vehicle



**■ Certifications for the immobilizer system**

- ▶ For vehicles sold in the U.S.A.

FCC ID: NI4TMIMB-3

NOTE:

This device complies with part 15 of the FCC Rules. Operation is subject to the following two conditions: (1) This device may not cause harmful interference, and (2) this device must accept any interference received, including interference that may cause undesired operation.

- ▶ For vehicles sold in Canada

NOTE:

This device complies with Industry Canada licence-exempt RSS standard(s). Operation is subject to the following two conditions: (1) this device may not cause interference, and (2) this device must accept any interference, including interference that may cause undesired operation of the device.

**⚠ CAUTION****■ Certifications for the immobilizer system**

Changes or modifications not expressly approved by the party responsible for compliance could void the user's authority to operate the equipment.

**⚠ NOTICE****■ To ensure the system operates correctly**

Do not modify or remove the system. If modified or removed, the proper operation of the system cannot be guaranteed.

## Alarm

### The alarm

The alarm uses light and sound to give an alert when an intrusion is detected.

The alarm is triggered in the following situations when the alarm is set:

- A locked door or trunk is unlocked or opened in any way other than using the entry function, wireless remote control or mechanical key. (The doors will lock again automatically.)
- The hood is opened.

### Setting the alarm system

Close the doors, trunk and hood, and lock all the doors. The system will be set automatically after 30 seconds.

The indicator light changes from being on to flashing when the system is set.

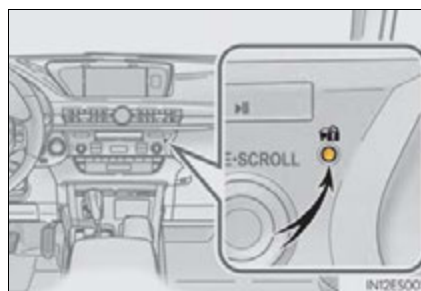

### Deactivating or stopping the alarm

Do one of the following to deactivate or stop the alarms:

- Unlock the doors or open the trunk.
- Turn the "START STOP ENGINE" <"POWER"> switch to ACCESSORY or IGNITION ON <ON> mode, or start the engine <hybrid system>. (The alarm will be deactivated or stopped after a few seconds.)

**■ System maintenance**

The vehicle has a maintenance-free type alarm system.

**■ Items to check before locking the vehicle**

To prevent unexpected triggering of the alarm and vehicle theft, make sure of the following:

- Nobody is in the vehicle.
- The windows and moon roof are closed before the alarm is set.
- No valuables or other personal items are left in the vehicle.

**■ Triggering of the alarm**

The alarm may be triggered in the following situations:  
(Stopping the alarm deactivates the alarm system.)

- A person inside the vehicle opens a door, the trunk or hood.

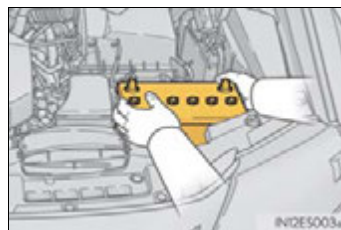
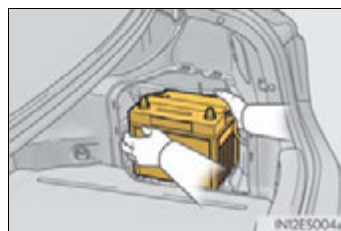

- The 12-volt battery is recharged or replaced when the vehicle is locked. (→P. 815)

**▶ Gasoline vehicles****▶ Hybrid vehicles**

**■ Alarm-operated door lock**

- When the alarm is operating, the doors are locked automatically to prevent intruders.
- Do not leave the key inside the vehicle when the alarm is operating, and make sure the key is not inside the vehicle when recharging or replacing the battery.

 **NOTICE****■ To ensure the system operates correctly**

Do not modify or remove the system. If modified or removed, the proper operation of the system cannot be guaranteed.

2. Instrument cluster

Warning lights  
and indicators ..... 90

Gauges and meters ..... 95

Multi-information display ..... 100

Energy monitor/  
consumption screen ..... 110

## Warning lights and indicators

The warning lights and indicators on the instrument cluster and center panel inform the driver of the status of the vehicle's various systems. For the purpose of explanation, the following illustration displays all warning lights and indicators illuminated.

### ◆ Instrument cluster



The units used on the speedometer and some indicators may differ depending on the target region or grade/type.

### ◆ Center panel





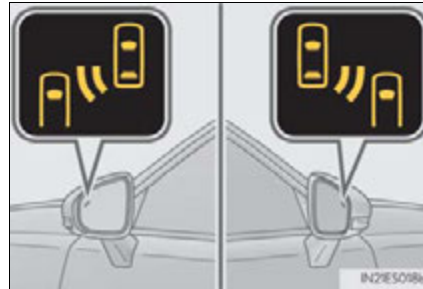









◆ Outside rear view mirrors (vehicles with BSM)









2

**Warning lights**

Warning lights inform the driver of malfunctions in the indicated vehicle's systems.

<p><sup>*1</sup>                    BRAKE                  (U.S.A.)</p>	<p>Brake system warning light                  (→P. 759)</p>	<p><sup>*1</sup>  </p>	<p>Electric power steering                  system warning light                  (→P. 761)</p>
<p><sup>*1</sup>                    (Canada)</p>	<p>Brake system warning light                  (→P. 759)</p>	<p><sup>*1</sup>  </p>	<p>Slip indicator (→P. 761)</p>
<p><sup>*1</sup>  </p>	<p>Charging system warning                  light (→P. 760)</p>	<p><sup>*1</sup>                    (hybrid                  vehicles)</p>	<p>Brake system warning light                  (→P. 761)</p>
<p><sup>*1</sup>                    (U.S.A.)</p>	<p>Malfunction indicator                  lamp (→P. 760)</p>	<p><sup>*1</sup>                    (if equipped)</p>	<p>Automatic headlight level-                  ing system warning light                  (→P. 761)</p>
<p><sup>*1</sup>                    (Canada)</p>	<p>Malfunction indicator                  lamp (→P. 760)</p>	<p><sup>*1</sup>  </p>	<p>Open door warning light                  (→P. 762)</p>
<p><sup>*1</sup>  </p>	<p>SRS warning light                  (→P. 760)</p>	<p><sup>*1</sup>  </p>	<p>Low fuel level warning light                  (→P. 762)</p>

Instrument cluster

<p><sup>*1</sup>                    ABS                  (U.S.A.)</p>	<p>ABS warning light                  (→P. 760)</p>	<p></p>	<p>Seat belt reminder light                  (→P. 762)</p>
<p><sup>*1</sup>                    (ABS)                  (Canada)</p>	<p>ABS warning light                  (→P. 760)</p>	<p><sup>*1</sup>  </p>	<p>Master warning light                  (→P. 762)</p>
<p><sup>*1,2</sup>                    PCS                  (if equipped)</p>	<p>“PCS” warning light                  (→P. 761, 772)</p>	<p><sup>*1</sup>  </p>	<p>Tire pressure warning light                  (→P. 763)</p>

\*1: These lights turn on when the “START STOP ENGINE” <“POWER”> switch is turned to IGNITION ON <ON> mode to indicate that a system check is being performed. They will turn off after the engine <hybrid system> is on, or after a few seconds. There may be a malfunction in a system if the lights do not turn on, or turn off. Have the vehicle inspected by your Lexus dealer.

\*2: The light flashes to indicate a malfunction.



## Indicators

The indicators inform the driver of the operating state of the vehicle's various systems.

	Turn signal indicator (→P. 225)		Cruise control "SET" indicator (→P. 248, 252)
	Headlight indicator (→P. 228) (U.S.A.)		"LDA" (Lane Departure Alert) indicator (→P. 268) (if equipped)
	Tail light indicator (→P. 228) (Canada)		Intuitive parking assist indicator (→P. 275) (if equipped)
	Headlight high beam indicator (→P. 229)		Slip indicator (→P. 303, 308) *1,2
	Automatic High Beam indicator (→P. 232) (if equipped)		VSC OFF indicator (→P. 308) *1
	Front fog light indicator (→P. 238)		"PCS" warning light (→P. 311) *1,3 (if equipped)
	"READY" indicator (→P. 208) (hybrid vehicles)		BSM outside rear view mirror indicators (→P. 317) *4 (if equipped)
	EV indicator (→P. 74) (hybrid vehicles)		Eco Driving Indicator Light (→P. 107) *1 (gasoline vehicles)
	Cruise control indicator (→P. 248, 252)		"AIR BAG ON/OFF" indicator (→P. 50) *1
	Radar cruise control indicator (→P. 252) (if equipped)		

2

Instrument cluster

\*1: These lights turn on when the "START STOP ENGINE" <"POWER"> switch is turned to IGNITION ON <ON> mode to indicate that a system check is being performed. They will turn off after the engine <hybrid system> is on, or after a few seconds. There may be a malfunction in a system if the lights do not turn on, or turn off. Have the vehicle inspected by your Lexus dealer.

\*2: The light flashes to indicate that the system is operating.

\*3: The light turns on when the system is turned off. The light flashes quickly to indicate that the system is operating.

\*4: In order to confirm operation, the BSM outside rear view mirror indicators illuminate in the following situations:

- When the "START STOP ENGINE" <"POWER"> switch is turned to IGNITION ON <ON> mode while the BSM main switch is set to ON.
- When the BSM main switch is set to ON while the "START STOP ENGINE" <"POWER"> switch is in IGNITION ON <ON> mode.

If the system is functioning correctly, the BSM outside rear view mirror indicators will turn off after a few seconds.

If the BSM outside rear view mirror indicators do not illuminate or do not turn off, there may be a malfunction with the system. If this occurs, have the vehicle inspected by your Lexus dealer.

 CAUTION

■ **If a safety system warning light does not come on**

Should a safety system light such as the ABS and SRS warning light not come on when you start the engine <hybrid system>, this could mean that these systems are not available to help protect you in an accident, which could result in death or serious injury. Have the vehicle inspected by your Lexus dealer immediately if this occurs.

## Gauges and meters



The units used on the speedometer may differ depending on the target region.

- ① Engine coolant temperature gauge  
Displays the engine coolant temperature
- ② Tachometer/Hybrid System Indicator
  - ▶ Tachometer  
Gasoline vehicles, or hybrid vehicles with sport mode selected (→P. 300)  
Displays the engine speed in revolutions per minute
  - ▶ Hybrid System Indicator  
Hybrid vehicles with other than sport mode selected (→P. 300)  
Displays hybrid system output or regeneration level (→P. 98)
- ③ ECO lamp and SPORT lamp  
Changes colors according to driving mode (→P. 99)
- ④ Multi-information display  
Presents the driver with a variety of driving-related data (→P. 100)
- ⑤ Speedometer  
Displays the vehicle speed

- ⑥ Fuel gauge
  - Displays the quantity of fuel remaining in the tank
- ⑦ Shift position and shift range
  - Displays the selected shift position or selected shift range (→P. 218, 221)
- ⑧ Odometer and trip meter display
  - ▶ Odometer
    - Displays the total distance the vehicle has been driven
  - ▶ Trip meter
    - Displays the distance the vehicle has been driven since the meter was last reset.
    - Trip meters "A" and "B" can be used to record and display different distances independently.

### Changing the display

Switches between odometer and trip meter displays. When the trip meter is displayed, pressing and holding the button will reset the trip meter.

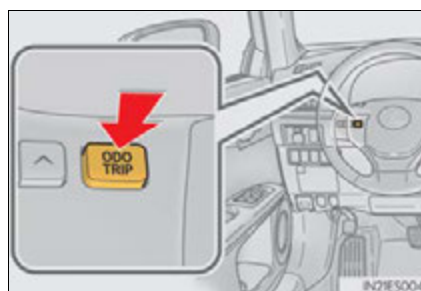

### Instrument panel light control

The brightness of the instrument panel lights can be adjusted.

- ① Darker
- ② Brighter

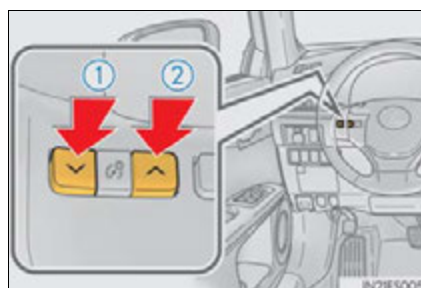

**■ The meters and display illuminate when**

The "START STOP ENGINE" <"POWER"> switch is in IGNITION ON <ON> mode.

**■ Instrument panel brightness adjustment**

The instrument panel brightness levels when the tail lights are on and off can be adjusted individually. However, when the surroundings are bright (daytime, etc.), turning on the tail lights will not change the instrument panel brightness. At this time, any adjustments made to the instrument panel brightness levels will be applied to both settings at once.

**■ Limitation of brightness adjustment**

The brightness of the instrument panel lights is automatically adjusted based on the light sensor detecting how bright the surroundings are. However, if the instrument panel brightness has been manually set to either the brightest or darkest setting, the automatic adjustment will not be performed.

■ Hybrid System Indicator (hybrid vehicles)

- ① Power area  
Shows that an Eco-friendly driving range is being exceeded (during full power driving etc.)
- ② Eco area  
Shows that the vehicle is being driven in an Eco-friendly manner.
- ③ Hybrid Eco area  
Shows that gasoline engine power is not being used very often.  
The gasoline engine will automatically stop and restart under various conditions.



- ④ Charge area  
Shows regenerative charging.
  - Hybrid System Indicator is displayed when the driving mode is other than the sport mode.
  - By keeping the indicator needle within Eco area, more Eco-friendly driving can be achieved.
  - Charge area indicates regeneration\* status. Regenerated energy will be used to charge the battery.
- \*: When used in this manual, “regeneration” refers to the conversion of energy created by the movement of the vehicle into electrical energy.

### ■ ECO lamp and SPORT lamp

- When sport mode is selected, SPORT lamp (red) will illuminate.
- When all of the following conditions are satisfied and Eco-friendly driving, ECO lamp (blue) will illuminate. (ECO lamp will become brighter the more Eco-friendly driving you perform. Also, while the vehicle is stopped or the acceleration exceeds Zone of Eco driving, ECO lamp turns off. (→P. 107) However, when Eco drive mode is selected, while the vehicle is stopped or the acceleration exceeds Zone of Eco driving, ECO lamp does not turn off.):
  - Driving with the shift lever in D
  - Either normal mode or Eco drive mode is selected.
  - The vehicle speed is approximately 80 mph (130 km/h) or below.

### ■ Tachometer (hybrid vehicles)

Hybrid System Indicator automatically switches to the tachometer when driving mode is in sport mode.

### ■ Engine speed (hybrid vehicles)

Engine speed is precisely controlled in order to help improve fuel efficiency and reduce exhaust emissions etc.

There are times when the engine speed that is displayed may differ even when vehicle operation and driving conditions are the same.

### ■ Odometer and trip meter display

→P. 205, 213

### ■ Customization

Settings (e.g. on/off operation of ECO lamp) can be changed.  
(Customizable features →P. 862)



#### NOTICE

#### ■ To prevent damage to the engine and its components

- Do not let the indicator needle of the tachometer enter the red zone, which indicates the maximum engine speed.
- The engine may be overheating if the engine coolant temperature gauge is in the red zone (H). In this case, immediately stop the vehicle in a safe place, and check the engine after it has cooled completely. (→P. 821, 824)

## Multi-information display

### Display contents

The multi-information display presents the driver with a variety of driving-related data including the current outside air temperature.

- Eco Driving Indicator Zone Display (gasoline vehicles) (→P. 107)
- Energy monitor (hybrid vehicles) (→P. 110)
- Outside temperature display (→P. 101)
- Trip information (→P. 101)

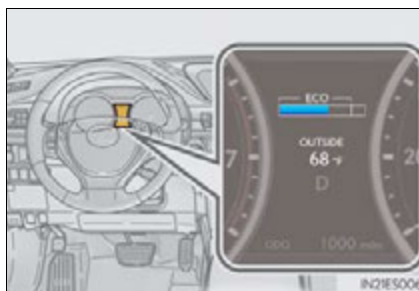

Displays driving range, fuel consumption and other cruising related information

- Tire inflation pressure (→P. 712)
- Drive monitor (→P. 104)
- Intuitive parking assist display\* (if equipped) (→P. 277)
- Dynamic radar cruise control display\* (if equipped) (→P. 252)
- LDA (Lane Departure Alert) display\* (if equipped) (→P. 269)
- Warning messages (→P. 769)

Automatically displayed when a malfunction occurs in one of the vehicle's systems. Display can be switched by pressing the "DISP" button. (→P. 101)

\*: Automatically displayed when the system is used. Display can be switched by pressing the "DISP" button. (→P. 101)



## Trip information

### ■ Switching the display

Items displayed can be switched by pressing the “DISP” button.

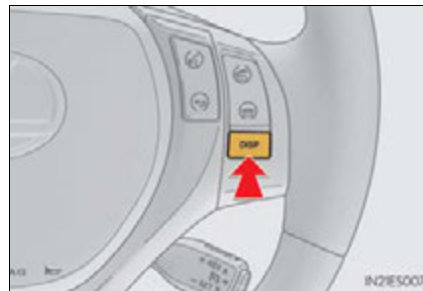

### ■ Eco Driving Indicator Zone Display (gasoline vehicles)

→P. 107

### ■ Energy monitor (hybrid vehicles)

→P. 110

### ■ Outside temperature



Displays the outside air temperature

The temperature range that can be displayed is from -40°F (-40°C) to 122°F (50°C)

### ■ Current fuel consumption

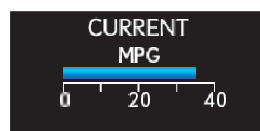

Displays the current rate of fuel consumption

■ Average fuel consumption after refueling



Displays the average fuel consumption since the vehicle was last refueled

Use the displayed average fuel consumption as a reference.

■ Average fuel consumption

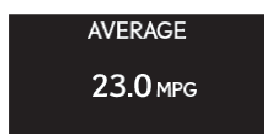

Displays the average fuel consumption since the function was reset

- The function can be reset by pressing the “DISP” button for longer than 1 second when the average fuel consumption is displayed.
- Use the displayed average fuel consumption as a reference.

■ Average vehicle speed

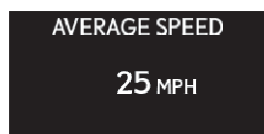

Displays the average vehicle speed since the function was reset

The function can be reset by pressing the “DISP” button for longer than 1 second when the average vehicle speed is displayed.

### ■ Driving range



Displays the estimated maximum distance that can be driven with the quantity of fuel remaining

- This distance is computed based on your average fuel consumption. As a result, the actual distance that can be driven may differ from that displayed.
- When only a small amount of fuel is added to the tank, the display may not be updated.

When refueling, turn the "START STOP ENGINE" <"POWER"> switch off. If the vehicle is refueled without turning the "START STOP ENGINE" <"POWER"> switch off, the display may not be updated.

### ■ Elapsed time

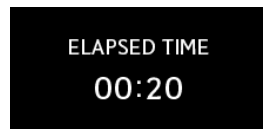

Displays the elapsed time since the engine <hybrid system> was started

### ■ Tire inflation pressure



Displays inflation pressure of each tire

For the vehicles with a full-size spare tire: The inflation pressure of the spare tire will be displayed.

### Drive monitor

Outside temperature, average fuel consumption after refueling or driving range can be selected and displayed.

If displayed on the drive monitor, other trip information or warning messages can be displayed simultaneously.

For display and selection procedures, follow the “Setting up the displays”.

The information displayed on the drive monitor will not be displayed on the trip information screen.



### Setting up the displays

- 1 While the vehicle is stopped, press the "DISP" button until the "Settings" screen appears.

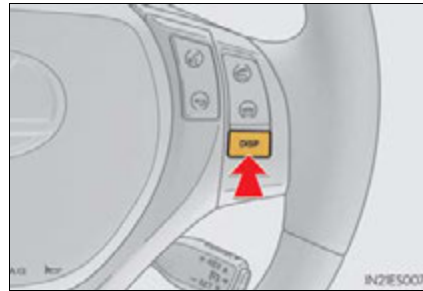

- 2 Press and hold the "DISP" button until the screen changes.

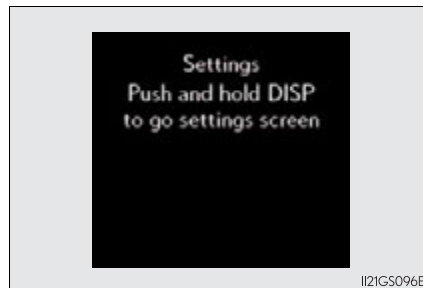

Vehicles without Lexus Display Audio system or a navigation system: Press and hold the "DISP" button after selecting the desired setting item ("Meter", "Vehicle" or "Ambient illumin." [if equipped]) by pressing the "DISP" button.

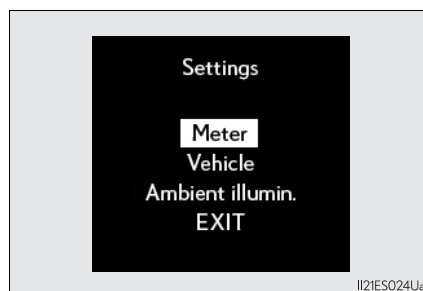

- 3 Press and hold the "DISP" button after selecting the desired setting item by pressing the "DISP" button.



2

Instrument cluster

- 4 Press and hold the “DISP” button after selecting the desired setting by pressing the “DISP” button.

The display goes back to step 3.



- 5 Press and hold the “DISP” button after selecting the “EXIT” by pressing the “DISP” button.

The display goes back to step 1.

(The display goes back to step 1 automatically in few seconds without proceeding step 5.)



### ■ System check display

After turning the "START STOP ENGINE" <"POWER"> switch to IGNITION ON <ON> mode, "SYSTEM CHECK" is displayed while system operation is checked.

### ■ Eco Driving Indicator (gasoline vehicles)

Suggests Zone of Eco driving and Eco driving ratio based on acceleration.

#### ① Eco Driving Indicator Light

Eco Driving Indicator Light availability can be customized. The default setting is off. (→P. 862)

During Eco-friendly acceleration (Eco driving), Eco Driving Indicator Light will turn on.

When the acceleration exceeds Zone of Eco driving, or when the vehicle is stopped, the light turns off.

#### ② Eco Driving Indicator Zone Display

#### ③ Zone of Eco driving

#### ④ Eco driving ratio based on acceleration

If the acceleration exceeds Zone of Eco driving, the right side of Eco Driving Indicator Zone Display blinks.

Eco Driving Indicator will not operate in the following conditions:

- The shift lever is anything other than D.
- Neither normal mode nor Eco drive mode is selected. (→P. 300)
- The vehicle speed is approximately 80 mph (130 km/h) or higher.

### ■ Outside temperature display

In the following situations, the correct outside temperature may not be displayed, or the display may take longer than normal to change.

- When stopped, or driving at low speeds (less than 12 mph [20 km/h])
- When the outside temperature has changed suddenly (at the entrance/exit of a garage, tunnel, etc.)

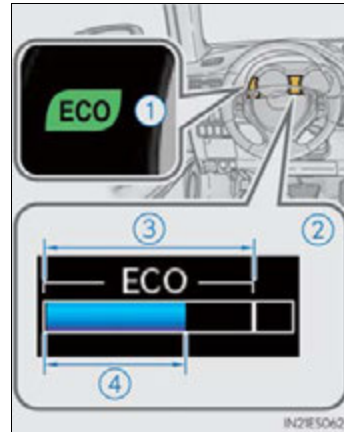

**■ Setting display automatic cancelation**

In the following situations, setting display in which the settings can be changed through the "DISP" button will automatically be turned off.

- When a warning message appears while the setting display is displayed
- When the vehicle begins to move while the setting display is displayed

**■ Tire inflation pressure**

- It may take a few minutes to display the tire inflation pressure after the "START STOP ENGINE" <"POWER"> switch is turned to IGNITION ON <ON> mode. It may also take a few minutes to display the tire inflation pressure after inflation pressure has been adjusted.
- "---" may be displayed if the tire position information cannot be determined due to unfavorable radio wave conditions.
- Tire inflation pressure changes with temperature. The displayed values may also be different from the values measured using a tire pressure gauge.

**■ Liquid crystal display**

Small spots or light spots may appear on the display. This phenomenon is characteristic of liquid crystal displays, and there is no problem continuing to use the display.

**■ Customization**

Setting of available languages can be changed. (Customizable features →P. 862)



 CAUTION**■ The multi-information display at low temperatures**

Allow the interior of the vehicle to warm up before using the liquid crystal multi-information display. At extremely low temperatures, the multi-information display monitor may respond slowly, and display changes may be delayed.

For example, there is a lag between the driver's shifting and the new gear number appearing on the display. This lag could cause the driver to downshift again, causing rapid and excessive engine braking and possibly an accident resulting in death or injury.

**■ Cautions during setting up the display**

As the engine needs to be running <hybrid system needs to be operating> during setting up the display, ensure that the vehicle is parked in a place with adequate ventilation. In a closed area such as a garage, exhaust gases including harmful carbon monoxide (CO) may collect and enter the vehicle. This may lead to death or a serious health hazard.

 NOTICE**■ During setting up the display**

To prevent 12-volt battery discharge, ensure that the engine is running <hybrid system is operating> while setting up the display features.

## Energy monitor/consumption screen

You can view the status of your vehicle on the multi-information display and the navigation system screen or Lexus Display Audio system screen.

- ① Navigation system screen or Lexus Display Audio system screen (if equipped)
- ② Multi-information display

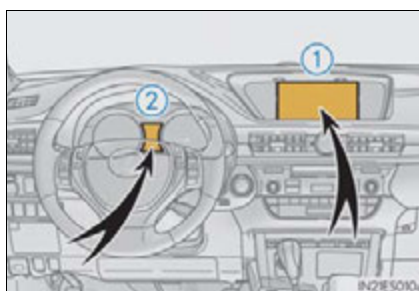

### Remote Touch/Lexus Display Audio controller (if equipped)

- ▶ Navigation system

Remote Touch\*

- ① "MENU" button
- ② Remote Touch knob

\*: For use of Remote Touch, refer to the "Navigation System Owner's Manual".

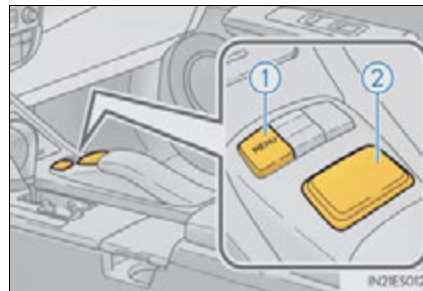

- ▶ Lexus Display Audio system

Lexus Display Audio controller  
(→P. 338)

- ① "MENU" button
- ② Lexus Display Audio controller

Displaying the "MENU" screen

Turn or move the controller in the four direction to select a function, number and screen button.

Push the controller to enter the selected function, number and screen button.

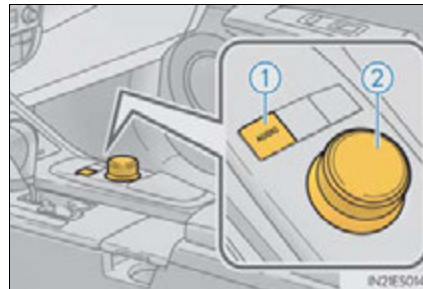

### Energy monitor (hybrid vehicles)

■ Navigation system screen or Lexus Display Audio system screen (if equipped)

▶ Vehicles with a navigation system

- 1 Press the “MENU” button on Remote Touch.
- 2 Select “Info/Apps” on the “Menu” screen.



- 3 Select “Fuel Consumption” on the “Information” screen.

If the “Energy Monitor” screen is not displayed, select “Energy”.



▶ Vehicles with Lexus Display Audio system

- 1 Press the “MENU” button on the Lexus Display Audio controller.
- 2 Select “Car” on the “Menu” screen.

If the “Energy Monitor” screen is not displayed, select “Energy”.







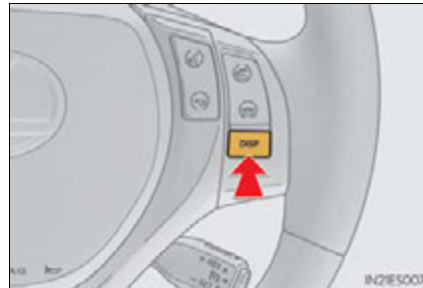



### ■ Multi-information display

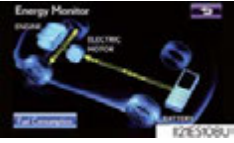
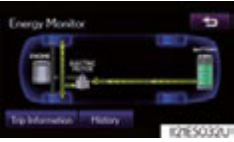

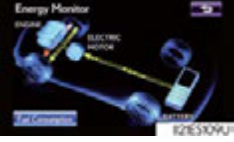

Press the “DISP” button on the steering wheel several times to select the energy monitor display.

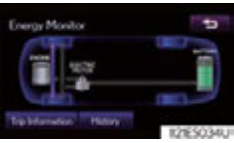

2

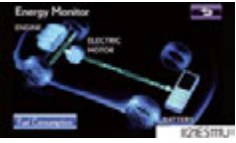

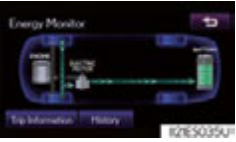
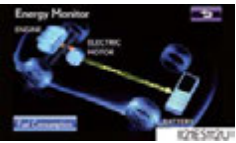
Instrument cluster

	Navigation system screen/Lexus Display Audio system screen	Multi-information display
When the vehicle is powered by the electric motor (traction motor)	<ul style="list-style-type: none"> <li>▶ Navigation system</li> <li></li> <li>▶ Lexus Display Audio system</li> <li></li> </ul>	
When the vehicle is powered by both the gasoline engine and the electric motor (traction motor)	<ul style="list-style-type: none"> <li>▶ Navigation system</li> <li></li> <li>▶ Lexus Display Audio system</li> <li></li> </ul>	
When the vehicle is powered by the gasoline engine	<ul style="list-style-type: none"> <li>▶ Navigation system</li> <li></li> <li>▶ Lexus Display Audio system</li> <li></li> </ul>	

	Navigation system screen/Lexus Display Audio system screen	Multi-information display
When the vehicle is charging the hybrid battery (traction battery)	▶ Navigation system 	
	▶ Lexus Display Audio system 	
When there is no energy flow	▶ Navigation system 	
	▶ Lexus Display Audio system 	

2

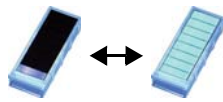
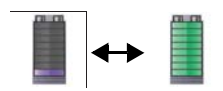
Instrument cluster

	Navigation system screen/Lexus Display Audio system screen	Multi-information display
Hybrid battery (traction battery) status	<p>▶ Navigation system</p> <p>Low Full</p>  <p>▶ Lexus Display Audio system</p> 	<p>Low Full</p> 

These images are examples only, and may vary slightly from actual conditions.



### Consumption (if equipped)

- ▶ Vehicles with a navigation system

**1** Press the “MENU” button on Remote Touch, then select “Info/Apps” on the “Menu” screen.

**2** Select “Fuel Consumption” on the “Information” screen.

Hybrid vehicles: If the “Energy Monitor” screen is displayed, select “Fuel Consumption”.

- ▶ Vehicles with Lexus Display Audio system

Press the “MENU” button on the Lexus Display Audio controller, then select “Car” on the “Menu” screen.

Hybrid vehicles: If the “Energy Monitor” screen is displayed, select “Fuel Consumption”.

■ Trip information

If the “Trip Information” screen is not displayed, select “Trip Information”.

▶ Navigation system

▶ Lexus Display Audio system

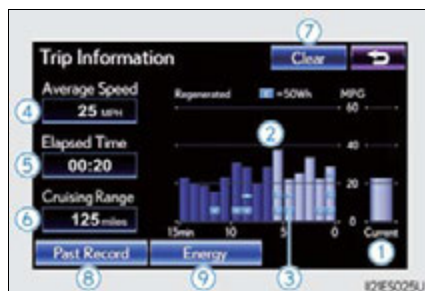

- ① Current fuel consumption
- ② Fuel consumption in the past 15 minutes
- ③ Hybrid vehicles: Regenerated energy in the past 15 minutes  
One symbol indicates 50 Wh. Up to 5 symbols are shown.
- ④ Displays the average vehicle speed since the engine <hybrid system> was started.
- ⑤ Displays the elapsed time since the engine <hybrid system> was started.
- ⑥ Cruising range (→P. 120)
- ⑦ Reset the consumption data
- ⑧ “Past Record” (Navigation system) or “History” (Lexus Display Audio system) screen appears
- ⑨ Hybrid vehicles: “Energy Monitor” screen appears

Average fuel consumption for the past 15 minutes is divided by color into past averages and averages attained since the “START STOP ENGINE” <“POWER”> switch was last turned to IGNITION ON <ON> mode. Use the displayed average fuel consumption as a reference.

The image is an example only, and may vary slightly from actual conditions.

### ■ Past record

If the “History” or “Past Record” screen is not displayed, select “History” or “Past Record”.

#### ▶ Navigation system



#### ▶ Lexus Display Audio system



- ① Average fuel consumption
- ② Previous fuel consumption record
- ③ Best recorded fuel consumption
- ④ Update the average fuel consumption data
- ⑤ Reset the past record data
- ⑥ “Trip Information” screen appears
- ⑦ Hybrid vehicles: “Energy Monitor” screen appears

The average fuel consumption history is divided by color into past averages and the average fuel consumption since the last updated. Use the displayed average fuel consumption as a reference.

The image is an example only, and may vary slightly from actual conditions.

**■ Updating the past record data**

Update the average fuel consumption by selecting "Update" to measure the current fuel consumption again.

**■ Resetting the data**

The fuel consumption data can be deleted by selecting "Clear".

**■ Cruising range**

Displays the estimated maximum distance that can be driven with the quantity of fuel remaining.

This distance is computed based on your average fuel consumption.

As a result, the actual distance that can be driven may differ from that displayed.

<b>3-1. Key information</b>	
Keys .....	122
<b>3-2. Opening, closing and locking the doors and trunk</b>	
Smart access system with push-button start .....	125
Wireless remote control .....	139
Doors .....	142
Trunk.....	147
<b>3-3. Adjusting the seats</b>	
Front seats.....	154
Driving position memory.....	156
Head restraints .....	162
<b>3-4. Adjusting the steering wheel and mirrors</b>	
Steering wheel.....	166
Inside rear view mirror.....	168
Outside rear view mirrors.....	171
<b>3-5. Opening, closing the windows and moon roof</b>	
Power windows .....	174
Moon roof.....	177

## Keys

### The keys

The following keys are provided with the vehicle.

- ① Electronic keys
  - Operating the smart access system with push-button start (→P.125)
  - Operating the wireless remote control function (→P.139)
- ② Mechanical keys
- ③ Key number plate

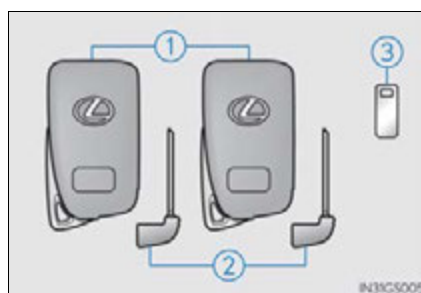

### Using the mechanical key

To take out the mechanical key, push the release button and take the key out.

The mechanical key can only be inserted in one direction, as the key only has grooves on one side. If the key cannot be inserted in a lock cylinder, turn it over and re-attempt to insert it.

After using the mechanical key, store it in the electronic key. Carry the mechanical key together with the electronic key. If the electronic key battery is depleted or the entry function does not operate properly, you will need the mechanical key. (→P. 810)

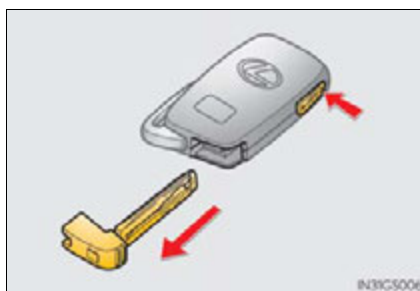

**■ When required to leave the vehicle's key with a parking attendant**

Turn the trunk opener main switch off and lock the glove box as circumstances demand. (→P. 148, 616)

Remove the mechanical key for your own use and provide the attendant with the electronic key only.

**■ If you lose your mechanical keys**

New genuine mechanical keys can be made by your Lexus dealer using the other mechanical key and the key number stamped on your key number plate. Keep the plate in a safe place such as your wallet, not in the vehicle.

**■ When riding in an aircraft**

When bringing an electronic key onto an aircraft, make sure you do not press any buttons on the electronic key while inside the aircraft cabin. If you are carrying an electronic key in your bag etc., ensure that the buttons are not likely to be pressed accidentally. Pressing a button may cause the electronic key to emit radio waves that could interfere with the operation of the aircraft.

 NOTICE**■ To prevent key damage**

- Do not drop the keys, subject them to strong shocks or bend them.
- Do not expose the keys to high temperatures for long periods of time.
- Do not get the keys wet or wash them in an ultrasonic washer etc.
- Do not attach metallic or magnetic materials to the keys or place the keys close to such materials.
- Do not disassemble the keys.
- Do not attach a sticker or anything else to the surface of the electronic key.
- Do not place the keys near objects that produce magnetic fields, such as TVs, audio systems and induction cookers, or medical electrical equipment, such as low-frequency therapy equipment.

**■ Carrying the electronic key on your person**

Carry the electronic key 3.9 in. (10 cm) or more away from electric appliances that are turned on. Radio waves emitted from electric appliances within 3.9 in. (10 cm) of the electronic key may interfere with the key, causing the key to not function properly.

**■ In case of a smart access system with push-button start malfunction or other key-related problems**

Take your vehicle with all the electronic keys provided with your vehicle to your Lexus dealer.

**■ When an electronic key is lost**

If the electronic key remains lost, the risk of vehicle theft increases significantly. Visit your Lexus dealer immediately with all remaining electronic keys that was provided with your vehicle.



## Smart access system with push-button start

### Function summary

The following operations can be performed simply by carrying the electronic key on your person, for example in your pocket. (The driver should always carry the electronic key.)

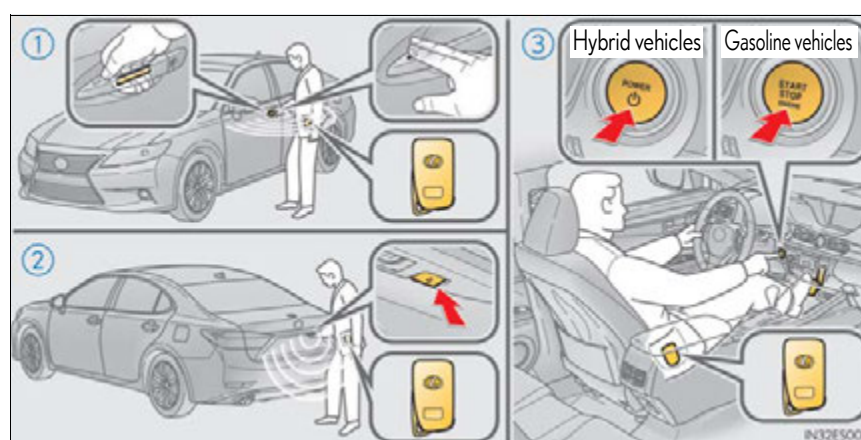

- ① Locks and unlocks the doors (→P. 126)
- ② Opens the trunk (→P. 126)
- ③ Starts the engine (→P. 201)  
Starts the hybrid system (→P. 208)

3

Operation of each component

#### ■ Operation signals

A buzzer sounds and the emergency flashers flash to indicate that the doors have been locked/unlocked. (Locked: once; Unlocked: twice)

#### ■ Security feature

If a door is not opened within approximately 60 seconds after the vehicle is unlocked, the security feature automatically locks the vehicle again.

#### ■ Welcome light illumination control

The side marker, parking, tail and license plate lights automatically turn on at night when the doors are unlocked using the entry function or wireless remote control if the light switch is in the "AUTO" position.

### Unlocking and locking the doors

Grip the driver's door handle to unlock the door. Grip the passenger's door handle to unlock all the doors.\*

Make sure to touch the sensor on the back of the handle.

The doors cannot be unlocked for 3 seconds after the doors are locked.

\*: The door unlock settings can be changed. (→P.130)

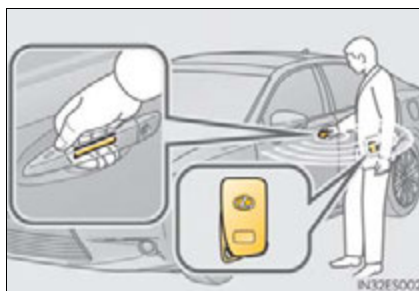

Touch the lock sensor (the indentation on the upper part of the door handle) to lock all the doors.

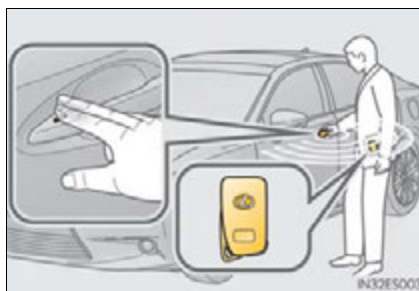

### Opening the trunk

Press the button.

If the vehicle is equipped with power trunk opener and closer, the trunk lid automatically opens fully.

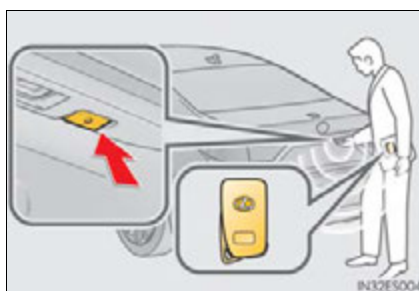

### Antenna location and effective range

#### ■ Antenna location

- ① Antennas outside the cabin
- ② Antennas inside the cabin
- ③ Antenna outside the trunk
- ④ Antenna inside the trunk

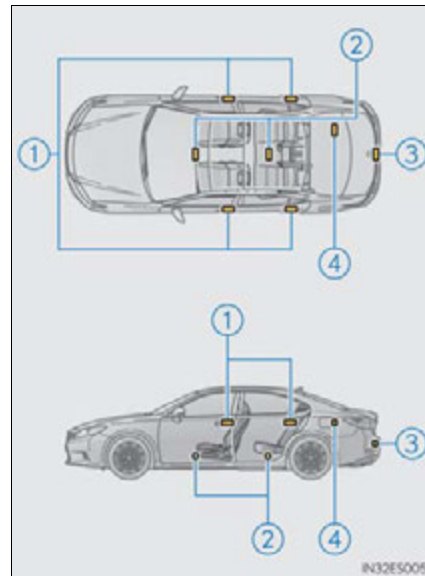

3

Operation of each component

### ■ Effective range (areas within which the electronic key is detected)

- When locking or unlocking the doors

The system can be operated when the electronic key is within about 2.3 ft. (0.7 m) of an outside door handle. (Only the doors detecting the key can be operated.)

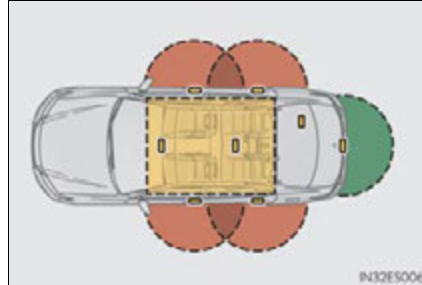

- When opening the trunk

The system can be operated when the electronic key is within about 2.3 ft. (0.7 m) of the trunk release button.

- When starting the engine <hybrid system> or changing "START STOP ENGINE" <"POWER"> switch modes

The system can be operated when the electronic key is inside the vehicle.

### ■ When the door cannot be locked by the lock sensor on the upper part of the door handle

If the door will not lock even when the topside sensor area is touched, try touching both the topside and underside sensor areas at the same time.



### ■ Alarms and warning indicators





An alarm sounds and warning message displays shown on the multi-information display are used to protect against unexpected accidents or theft of the vehicle resulting from erroneous operation. When a warning message is displayed, take appropriate measures based on the displayed message. (→P. 769)

When only an alarm sounds, circumstances and correction procedures are as follows.



Alarm	Situation	Correction procedure
Exterior alarm sounds once for 5 seconds	The trunk was closed while the electronic key was still inside the trunk and all the doors were locked.	Retrieve the electronic key from the trunk and close the trunk lid.
	An attempt was made to lock the vehicle while a door was open.	Close all of the doors and lock the doors again.
Interior alarm sounds continuously	The "START STOP ENGINE" <"POWER"> switch was turned to ACCESSORY mode while the driver's door was open (or the driver's door was opened while the "START STOP ENGINE" <"POWER"> switch was in ACCESSORY mode).	Turn the "START STOP ENGINE" <"POWER"> switch off and close the driver's door.

■ Changing the door unlock function setting

It is possible to set which doors the entry function unlocks using the wireless remote control.

- 1 Turn the "START STOP ENGINE" <"POWER"> switch off.
- 2 When the indicator light on the key surface is not on, press and hold  ,  or  for approximately 5 seconds while pressing and holding  .

The setting changes each time an operation is performed, as shown below. (When changing the setting continuously, release the buttons, wait for at least 5 seconds, and repeat step 2.)

Multi-information display	Unlocking function	Beep
	Holding the driver's door handle unlocks only the driver's door.	Exterior: Beeps 3 times Interior: Pings once
	Holding a passenger's door handle unlocks all the doors.	
	Holding a door handle unlocks all the doors.	Exterior: Beeps twice Interior: Pings once

To prevent unintended triggering of the alarm, unlock the doors using the wireless remote control and open and close a door once after the settings have been changed. (If a door is not opened within 60 seconds after  is pressed, the doors will be locked again and the alarm will automatically be set.)  
In case that the alarm is triggered, immediately stop the alarm. (→P. 86)



### ■ Battery-saving function

The battery-saving function will be activated in order to prevent the electronic key battery and the vehicle battery from being discharged while the vehicle is not in operation for a long time.

- In the following situations, the smart access system with push-button start may take some time to unlock the doors.
  - The electronic key has been left in an area of approximately 6 ft. (2 m) of the outside of the vehicle for 10 minutes or longer.
  - The smart access system with push-button start has not been used for 5 days or longer.
- If the smart access system with push-button start has not been used for 14 days or longer, the doors cannot be unlocked at any doors except the driver's door. In this case, take hold of the driver's door handle, or use the wireless remote control or the mechanical key, to unlock the doors.

### ■ Electronic Key Battery-Saving Function

When battery-saving mode is set, battery depletion is minimized by stopping the electronic key from receiving radio waves.

Press  twice while pressing and holding . Confirm that the electronic key indicator flashes 4 times.

While the battery-saving mode is set, the smart access system with push-button start cannot be used. To cancel the function, press any of the electronic key buttons.

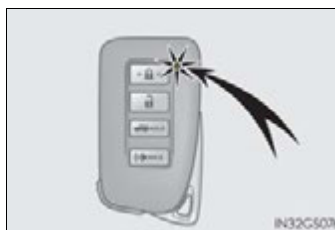

3

Operation of each component

**■ Conditions affecting operation**

The smart access system with push-button start uses weak radio waves. In the following situations, the communication between the electronic key and the vehicle may be affected, preventing the smart access system with push-button start, wireless remote control and engine immobilizer system <immobilizer system> from operating properly. (Ways of coping: →P. 810)

- When the electronic key battery is depleted
- Near a TV tower, electric power plant, gas station, radio station, large display, airport or other facility that generates strong radio waves or electrical noise
- When carrying a portable radio, cellular phone, cordless phone or other wireless communication device
- When the electronic key is in contact with, or is covered by the following metallic objects
  - Cards to which aluminum foil is attached
  - Cigarette boxes that have aluminum foil inside
  - Metallic wallets or bags
  - Coins
  - Hand warmers made of metal
  - Media such as CDs and DVDs
- When other wireless keys (that emit radio waves) are being used nearby
- When carrying the electronic key together with the following devices that emit radio waves
  - Another vehicle's electronic key or a wireless key that emits radio waves
  - Personal computers or personal digital assistants (PDAs)
  - Digital audio players
  - Portable game systems
- If window tint with a metallic content or metallic objects are attached to the rear window



**■ Note for the entry function**

- Even when the electronic key is within the effective range (detection areas), the system may not operate properly in the following cases:
  - The electronic key is too close to the window or outside door handle, near the ground, or in a high place when the doors are locked or unlocked.
  - The electronic key is near the ground or in a high place, or too close to the rear bumper center when the trunk is opened.
  - The electronic key is on the instrument panel, rear package tray or floor, or in the door pockets or glove box when the engine <hybrid system> is started or "START STOP ENGINE" <"POWER"> switch modes are changed.
- Do not leave the electronic key on top of the instrument panel or near the door pockets when exiting the vehicle. Depending on the radio wave reception conditions, it may be detected by the antenna outside the cabin and the door will become lockable from the outside, possibly trapping the electronic key inside the vehicle.
- As long as the electronic key is within the effective range, the doors may be locked or unlocked by anyone. However, only the doors detecting the electronic key can be used to unlock the vehicle.
- Even if the electronic key is not inside the vehicle, it may be possible to start the engine <hybrid system> if the electronic key is near the window.
- The doors may unlock or lock if a large amount of water splashes on the door handle, such as in the rain or in a car wash when the electronic key is within the effective range. (The doors will automatically be locked after approximately 60 seconds if the doors are not opened and closed.)
- If the wireless remote control is used to lock the doors when the electronic key is near the vehicle, there is a possibility that the door may not be unlocked by the entry function. (Use the wireless remote control to unlock the doors.)

■ **Note for locking the doors**

- Touching the door lock sensor while wearing gloves may delay or prevent lock operation. Remove the gloves and touch the lock sensor again.
- If the door handle becomes wet while the electronic key is within the effective range, the door may lock and unlock repeatedly. In that case, follow the following correction procedures to wash the vehicle:
  - Place the electronic key in a location 6 ft. (2 m) or more away from the vehicle. (Take care to ensure that the key is not stolen.)
  - Set the electronic key to battery-saving mode to disable the smart access system with push-button start. (→P. 131)
- If the electronic key is inside the vehicle and a door handle becomes wet during a car wash, a message may be shown on the multi-information display and a buzzer will sound outside the vehicle. To turn off the alarm, lock all the doors.
- The lock sensor may not work properly if it comes into contact with ice, snow, mud, etc. Clean the lock sensor and attempt to operate it again, or use the lock sensor on the lower part of the door handle.
- Fingernails may scrape against the door during operation of the door handle. Be careful not to injure fingernails or damage the surface of the door.

■ **Note for the unlocking function**

- A sudden approach to the effective range or door handle may prevent the doors from being unlocked. In this case, return the door handle to the original position and check that the doors unlock before pulling the door handle again.
- Gripping the door handle when wearing a glove may not unlock the door.
- If the door handle becomes wet while the electronic key is within the effective range, the door may lock and unlock repeatedly. In that case, follow the following correction procedures to wash the vehicle:
  - Place the electronic key in a location 6 ft. (2 m) or more away from the vehicle. (Take care to ensure that the key is not stolen.)
  - Set the electronic key to battery-saving mode to disable the smart access system with push-button start. (→P. 131)
- If there is another electronic key in the detection area, it may take slightly longer to unlock the doors after the door handle is gripped.
- Fingernails may scrape against the door during operation of the door handle. Be careful not to injure fingernails or damage the surface of the door.

**■ When the vehicle is not driven for extended periods**

- To prevent theft of the vehicle, do not leave the electronic key within 6 ft. (2 m) of the vehicle.
- The smart access system with push-button start can be deactivated in advance. (→P. 862)

**■ Alarm**

Using the smart access system with push-button start to lock the doors will set the alarm system. (→P. 86)

**■ To operate the system properly**

- Make sure to carry the electronic key when operating the system. Do not get the electronic key too close to the vehicle when operating the system from the outside of the vehicle.

Depending on the position and holding condition of the electronic key, the key may not be detected correctly and the system may not operate properly. (The alarm may go off accidentally, or the door lock prevention function may not operate.)

- Do not leave the electronic key inside the luggage compartment. The key confinement prevention function may not operate, depending on the location of the key (close to a spare tire, the inside edge of the luggage compartment), conditions (inside a metal bag, close to metallic objects) and the radio waves in the surrounding area. (→P. 149)

**■ If the smart access system with push-button start does not operate properly**

- Locking and unlocking the doors and opening the trunk: Use the mechanical key. (→P. 810)
- Starting the engine <hybrid system>: →P. 811

■ **Electronic key battery depletion**

- The standard battery life is 1 to 2 years.
- If the battery becomes low, an alarm will sound in the cabin when the engine <hybrid system> stops. (→P. 789)
- As the electronic key always receives radio waves, the battery will become depleted even if the electronic key is not used. The following symptoms indicate that the electronic key battery may be depleted. Replace the battery when necessary. (→P. 719)
  - The smart access system with push-button start or the wireless remote control does not operate.
  - The detection area becomes smaller.
  - The LED indicator on the key surface does not turn on.
- To avoid serious deterioration, do not leave the electronic key within 3 ft. (1 m) of the following electrical appliances that produce a magnetic field:
  - TVs
  - Personal computers
  - Cellular phones, cordless phones and battery chargers
  - Recharging cellular phones or cordless phones
  - Table lamps
  - Induction cookers

■ **When the electronic key battery is fully depleted**

→P. 719

■ **Customization**

Settings (e. g. smart access system with push-button start) can be changed.  
(Customizable features: →P. 862)

■ **If the smart access system with push-button start has been deactivated in a customized setting**

- Locking and unlocking the doors and opening the trunk:  
Use the wireless remote control or mechanical key. (→P. 139, 810)
- Starting the engine and changing “START STOP ENGINE” <“POWER”> switch modes: →P. 811
- Stopping the engine <hybrid system>: (→P. 202, 209)

**■ Certification for the smart access system with push-button start**

- ▶ For vehicles sold in the U.S.A., Hawaii, Guam and Puerto Rico

FCC ID: HYQ23AAB    FCC ID: HYQ14FBA

FCC ID: NI4TMLF10-8    FCC ID: NI4TMLF10-3

FCC ID: NI4TMLF10-50    FCC ID: NI4TMLF10-51

**NOTE:**

This device complies with part 15 of the FCC Rules. Operation is subject to the following two conditions: (1) This device may not cause harmful interference, and (2) this device must accept any interference received, including interference that may cause undesired operation.

**FCC WARNING:**

Changes or modifications not expressly approved by the party responsible for compliance could void the user's authority to operate the equipment.

- ▶ For vehicles sold in Canada

**NOTE:**

Operation is subject to the following two conditions: (1) this device may not cause interference, and (2) this device must accept any interference, including interference that may cause undesired operation of the device.

This device complies with Industry Canada licence-exempt RSS standard(s). Operation is subject to the following two conditions: (1) this device may not cause interference, and (2) this device must accept any interference, including interference that may cause undesired operation of the device.

 CAUTION**■ Caution regarding interference with electronic devices**

- People with implantable cardiac pacemakers, cardiac resynchronization therapy-pacemakers or implantable cardioverter defibrillators should keep away from the smart access system with push-button start antennas. (→P. 127)

The radio waves may affect the operation of such devices. If necessary, the entry function can be disabled. Ask your Lexus dealer for details, such as the frequency of radio waves and timing of the emitted radio waves. Then, consult your doctor to see if you should disable the entry function.

- Users of any electrical medical device other than implantable cardiac pacemakers, cardiac resynchronization therapy-pacemakers or implantable cardioverter defibrillators should consult the manufacturer of the device for information about its operation under the influence of radio waves.

Radio waves could have unexpected effects on the operation of such medical devices.

Ask your Lexus dealer for details on disabling the entry function.

## Wireless remote control

### Function summary

The wireless remote control can be used to lock and unlock the vehicle.

- ① Locks all the doors
- ② Unlocks all the doors  
Pressing the button unlocks the driver's door. Pressing the button again within 5 seconds unlocks the other doors.
- ③ Opens the windows and moon roof (press and hold)\*
- ④ Opens the trunk (press and hold)  
If the vehicle is equipped with a power trunk opener and closer, the trunk lid automatically opens fully.
- ⑤ Sounds the alarm (press and hold) (→P. 140)

\*: This setting must be customized at your Lexus dealer.

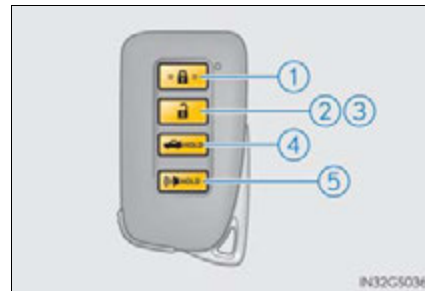

3

Operation of each component

**■ Operation signals**

Doors:

A buzzer sounds and the emergency flashers flash to indicate that the doors have been locked/unlocked. (Locked: once; Unlocked: twice)

Trunk:

A buzzer sounds to indicate that the trunk has been opened.

Windows and moon roof:

A buzzer sounds to indicate that the windows and moon roof are operating.

**■ Welcome light illumination control**

→P.125

**■ Door lock buzzer**

If an attempt to lock the doors is made when a door is not fully closed, a buzzer sounds continuously for 5 seconds. Fully close the door to stop the buzzer, and lock the vehicle once more.

**■ Panic mode**

When  is pressed for longer than about one second, an alarm will sound intermittently and the vehicle lights will flash to deter any person from trying to break into or damage your vehicle.

To stop the alarm, press any button on the electronic key.

**■ Security feature**

→P.125

**■ Alarm**

Using the wireless remote control to lock the doors will set the alarm system. (→P.86)

**■ Conditions affecting operation**

→P.132



**■ If the wireless remote control does not operate properly**

Locking and unlocking the doors and opening the trunk: Use the mechanical key.  
(→P. 810)

**■ Electronic key battery depletion**

→P. 136

**■ When the electronic key battery is fully depleted**

→P. 719

**■ Confirmation of the registered key number**

The number of keys already registered to the vehicle can be confirmed. Ask your Lexus dealer for details.

**■ Customization**

Settings (e.g. wireless remote control system) can be changed.  
(Customizable features: →P. 862)

**■ Certification for wireless remote control**

- ▶ For vehicles sold in the U.S.A., Hawaii, Guam and Puerto Rico

FCC ID: HYQ23AAB    FCC ID: HYQ14FBA

**NOTE:**

This device complies with part 15 of the FCC Rules. Operation is subject to the following two conditions: (1) This device may not cause harmful interference, and (2) this device must accept any interference received, including interference that may cause undesired operation.

**FCC WARNING:**

Changes or modifications not expressly approved by the party responsible for compliance could void the user's authority to operate the equipment.

- ▶ For vehicles sold in Canada

**NOTE:**

Operation is subject to the following two conditions: (1) this device may not cause interference, and (2) this device must accept any interference, including interference that may cause undesired operation of the device.

## Doors

### Unlocking and locking the doors

The vehicle can be locked and unlocked using the entry function, wireless remote control or door lock switches.

#### ◆ Entry function

→P. 125

#### ◆ Wireless remote control

→P. 139

#### ◆ Door lock switch

- ① Locks all the doors
- ② Unlocks all the doors

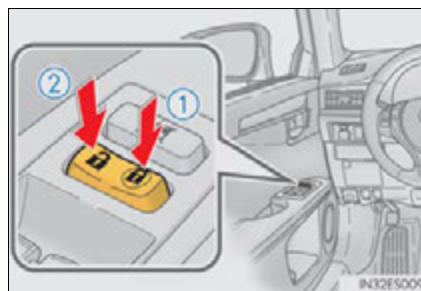

#### ◆ Inside lock buttons

- ① Locks the door
- ② Unlocks the door

The front doors can be opened by pulling the inside handle even if the lock buttons are in the lock position.

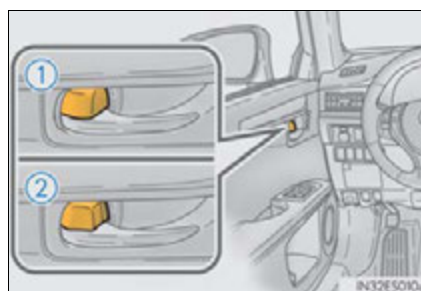

### Locking the front doors from the outside without a key

- 1 Move the inside lock button to the lock position.
- 2 Close the door.

The door cannot be locked if the “START STOP ENGINE” <“POWER”> switch is in ACCESSORY or IGNITION ON <ON> mode, or the electronic key is left inside the vehicle.

The key may not be detected correctly and the door may be locked.

### Rear door child-protector lock

The door cannot be opened from inside the vehicle when the lock is set.

- 1 Unlock
- 2 Lock

These locks can be set to prevent children from opening the rear doors. Push down on each rear door switch to lock both rear doors.

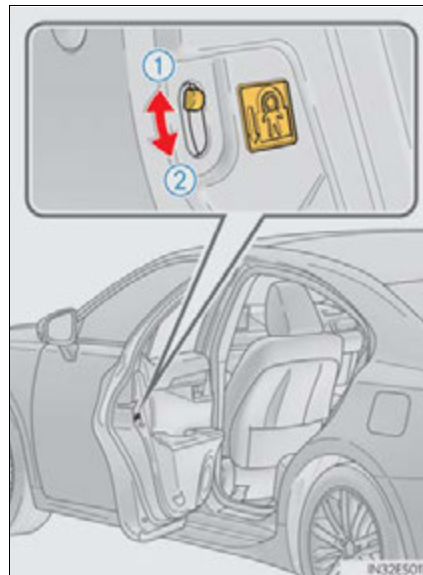

3

Operation of each component



### Automatic door locking and unlocking systems

The following functions can be set or canceled:

Function	Operation
Shift position linked door locking function	Shifting the shift lever out of P locks all doors.
Shift position linked door unlocking function	Shifting the shift lever to P unlocks all doors.
Speed linked door locking function	All doors are locked when the vehicle speed is approximately 12 mph (20 km/h) or higher.
Driver's door linked door unlocking function	All doors are unlocked when the driver's door is opened within 45 seconds after turning the "START STOP ENGINE" <"POWER"> switch off.

#### ■ Setting and canceling the functions





To switch between setting and canceling, follow the procedure below:

- 1 Close all the doors and turn the "START STOP ENGINE" <"POWER"> switch to IGNITION ON <ON> mode. (Perform step 2 within 20 seconds.)
- 2 Shift the shift lever to P or N, and press and hold the driver's door lock switch (  or  ) for approximately 5 seconds and then release.

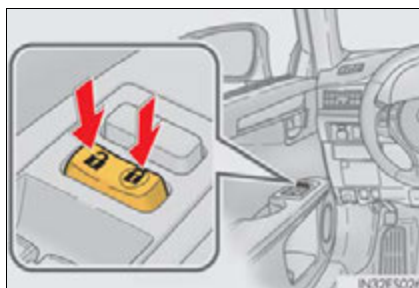
The shift lever and switch positions corresponding to the desired function to be set are shown as follows.

Use the same procedure to cancel the function.



Function	Shift lever position	Driver's door lock switch position
Shift position linked door locking function	P	
Shift position linked door unlocking function		
Speed linked door locking function	N	
Driver's door linked door unlocking function		

When the setting or canceling operation is complete, all doors are locked and then unlocked.

3

Operation of each component

#### ■ Impact detection door lock release system

In the event that the vehicle is subject to a strong impact, all the doors are unlocked. Depending on the force of the impact or the type of accident, however, the system may not operate.

#### ■ Using the mechanical key

The doors can also be locked and unlocked with the mechanical key. (→P. 810)

#### ■ If a wrong key is used

The key cylinder rotates freely to isolate inside mechanism.

#### ■ Customization

Settings (e.g. unlocking function using a key) can be changed.  
(Customizable features: →P. 862)

 CAUTION**■ To prevent an accident**

Observe the following precautions while driving the vehicle.  
Failure to do so may result in a door opening and an occupant throwing out of the vehicle, resulting in death or serious injury.

- Ensure that all doors are properly closed and locked.
- Do not pull the inside handle of the doors while driving.  
Be especially careful for the front doors, as the doors may be opened even if the inside lock buttons are in locked position.
- Set the rear door child-protector locks when children are seated in the rear seats.

## Trunk

The trunk can be opened using the trunk opener, trunk release button or wireless remote control.

If the vehicle is equipped with a power trunk opener and closer, the trunk can be closed using the trunk closer.

### Opening the trunk from inside the vehicle

Press the opener switch.

If the vehicle is equipped with a power trunk opener and closer, the trunk lid automatically opens fully.

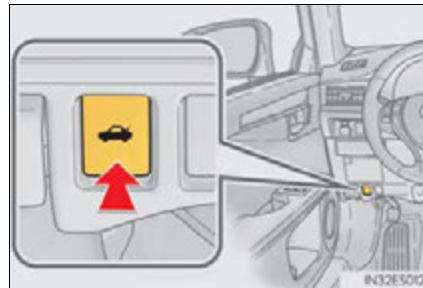

### Opening the trunk from outside the vehicle

#### ■ Trunk release button

While carrying the electronic key, press the button on the trunk lid.

When all the doors are unlocked with the power door lock system, the trunk can be opened without carrying the electronic key.

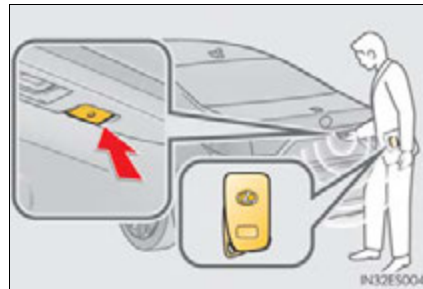

#### ■ Wireless remote control

→P. 139

3

Operation of each component

### Trunk closer switch (vehicles with power trunk opener and closer)

Pressing the switch closes the trunk lid automatically. (A buzzer sounds.)

Pressing the switch while the trunk lid is closing opens the trunk lid again.

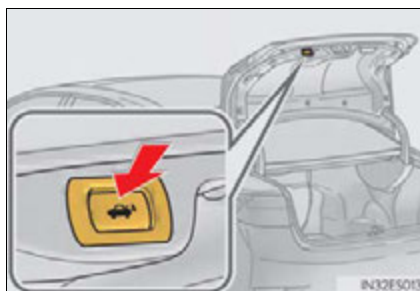

### When closing the trunk

Using the trunk grip, lower the trunk without applying force to the side and push the trunk down from the outside to close it.



### Luggage security system

The trunk opener switch can be temporarily disabled to protect luggage stored in the trunk against theft.

Turn the main switch in the glove box off to disable the trunk opener.

- ① On
- ② Off

The trunk lid cannot be opened even with the wireless remote control or the entry function.

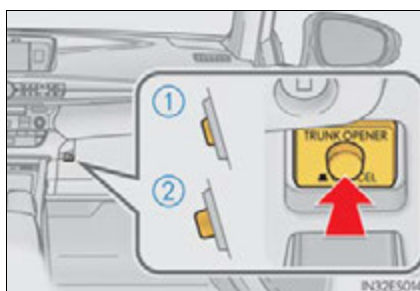



**■ Trunk light**

The trunk light turns on when the trunk is opened.

**■ Trunk easy closer (vehicles with power trunk opener and closer)**

In the event that the trunk lid is left slightly open, the trunk easy closer will automatically close it to the fully closed position.

**■ Function to prevent the trunk being locked with the electronic key inside**

- When all doors are being locked, closing the trunk lid with the electronic key left inside the trunk will sound an alarm.

In this case, the trunk lid can be opened pressing the trunk release button on the trunk lid.

- Even when the spare electronic key is put in the trunk with all the doors locked, the key confinement prevention function can be activated so the trunk can be opened. In order to prevent theft, take all electronic keys with you when leaving the vehicle.

- Even when the electronic key is put in the trunk with all the doors are locked, the key may not be detected depending on the places and the surrounding radio wave conditions. In this case, the key confinement prevention function cannot be activated, causing the doors to lock when the trunk is closed. Make sure to check where the key is before closing the trunk.

- The key confinement prevention function cannot be activated if any one of the doors is unlocked. In this case, open the trunk using the trunk opener.

**■ Overload protection function (vehicles with power trunk opener and closer)**

The trunk lid will not operate when excessive load is present on the top of the trunk lid.

**■ Fall-down protection function (vehicles with power trunk opener and closer)**

While the trunk lid is opening automatically, applying excessive force to it will stop the opening operation to prevent the trunk lid from rapidly falling down.

**■ Jam protection function (vehicles with power trunk opener and closer)**

While the trunk lid is closing automatically, the trunk lid will stop closing and open if something gets caught.

■ **Internal trunk release lever**

The trunk lid can be opened by pulling the glow-in-the-dark lever located on the inside of the trunk lid to the side.

The lever will continue to glow for some time after the trunk lid is closed.

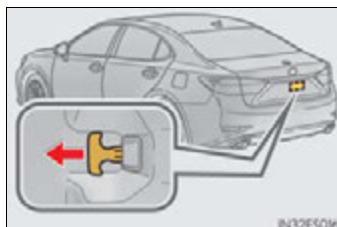

■ **Using the mechanical key**

The trunk can be also opened using the mechanical key. (→P. 811)

■ **When leaving a key to the vehicle with a parking attendant**

→P. 123

**⚠ CAUTION**

Observe the following precautions.  
Failure to do so may result in death or serious injury.

■ **Before driving**

- Make sure that the trunk lid is fully closed. If the trunk lid is not fully closed, it may open unexpectedly while driving and hit near-by objects or luggage in the trunk may be thrown out, causing an accident.
- Do not allow children to play in the trunk.  
If a child is accidentally locked in the trunk, they could suffer from heat exhaustion, suffocation or other injuries.
- Do not allow a child to open or close the trunk lid.  
Doing so may cause the trunk lid to open unexpectedly, or cause the child's hands, head, or neck to be caught by the closing trunk lid.

■ **Important points while driving**

Never let anyone sit in the trunk. In the event of sudden braking or a collision, they are susceptible to death or serious injury.

**CAUTION****■ Using the trunk**

Observe the following precautions.

Failure to do so may cause parts of the body to be caught, resulting in serious injury.

- Remove any heavy loads, such as snow and ice, from the trunk lid before opening it. Failure to do so may cause the trunk lid to suddenly shut again after it is opened.
- When opening or closing the trunk lid, thoroughly check to make sure the surrounding area is safe.
- If anyone is in the vicinity, make sure they are safe and let them know that the trunk is about to open or close.
- Use caution when opening or closing the trunk lid in windy weather as it may move abruptly in strong wind.

- Vehicles without power trunk lid: The trunk lid may suddenly shut if it is not opened fully. It is more difficult to open or close the trunk lid on an incline than on a level surface, so beware of the trunk lid unexpectedly opening or closing by itself. Make sure that the trunk lid is fully open and secure before using the trunk.



- When closing the trunk lid, take extra care to prevent your fingers etc. from being caught.



- Vehicles without power trunk lid: When closing the trunk lid, make sure to press it lightly on its outer surface. If the trunk grip is used to fully close the trunk lid, it may result in hands or arms being caught.

- Do not attach any accessories other than genuine Lexus parts to the trunk lid. Such additional weight on the trunk lid may cause the lid to suddenly shut again after it is opened.

 CAUTION

■ **Trunk easy closer (vehicles with power trunk opener and closer)**

In the event that the trunk lid is left slightly open, the trunk easy closer will automatically close it to the fully closed position. It takes several seconds before the trunk easy closer begins to operate. Be careful not to catch fingers or anything else in the trunk lid, as this may cause bone fractures or other serious injuries.



■ **Power trunk opener and closer (if equipped)**

Observe the following precautions when operating the power trunk opener and closer.

Failure to do so may cause serious injury.

- Check the safety of the surrounding area to make sure there are no obstacles or anything that could cause any of your belongings to get caught.
- If anyone is in the vicinity, make sure they are safe and let them know that the trunk is about to open or close.
- If the trunk closer switch is pressed while the trunk lid is opening during automatic operation, the trunk lid stops opening. Take extra care when on an incline, as the trunk lid may open or close suddenly.
- On an incline, the trunk lid may fall after it opens automatically. Make sure the trunk lid is fully open and secure before using the trunk.
- In the following situations, the power trunk opener and closer may detect an abnormality and automatic operation may be stopped. In this case, the trunk lid has to be operated manually. Take extra care in this situation, as the stopped trunk lid may suddenly fall, causing an accident.
  - When the trunk lid contacts an obstacle
  - When the 12-volt battery voltage suddenly drops, such as when the "START STOP ENGINE" <"POWER"> switch is turned to IGNITION ON <ON> mode or the engine <hybrid system> is started during automatic operation
- Do not attach any accessories other than genuine Lexus parts to the trunk lid. The power trunk opener and closer may not operate, causing itself to malfunction, or the trunk lid may fall closed again after it is opened.

 CAUTION**■ Jam protection function (vehicles with power trunk opener and closer)**

Observe the following precautions.  
Failure to do so may cause serious injury.

- Never use any part of your body to intentionally activate the jam protection function.
- The jam protection function may not work if something gets caught just before the trunk lid fully closes. Be careful not to catch fingers or anything else in the trunk lid.
- The jam protection function may not work depending on the shape of the object that is caught. Be careful not to catch fingers or anything else.

 NOTICE**■ To prevent trunk easy closer malfunctions (vehicles with power trunk opener and closer)**

Do not apply force to the trunk lid while the trunk easy closer is operating.

**■ To prevent damage to the power trunk opener and closer (vehicles with power trunk opener and closer)**

- Make sure that there is no luggage or snow on the trunk lid before operating the power trunk opener and closer. In addition, make sure that there is no ice between the trunk lid and frame that prevents movement of the trunk lid. Operating the power trunk opener and closer when excessive load is present on the trunk lid may cause a malfunction.
- Do not apply excessive force to the trunk lid while the power trunk opener and closer is operating.

## Front seats

### Adjustment procedure



- ① Seat position adjustment switch
- ② Seatback angle adjustment switch
- ③ Seat cushion (front) angle adjustment switch
- ④ Vertical height adjustment switch
- ⑤ Lumbar support adjustment switch
- ⑥ Seat cushion length adjustment switch (if equipped)

**■ Power easy access system**

The driver's seat and steering wheel move in accordance with "START STOP ENGINE" <"POWER"> switch mode and the driver's seat belt condition. (→P. 156)

**⚠ CAUTION****■ When adjusting the seat position**

- Take care when adjusting the seat position to ensure that other passengers are not injured by the moving seat.
- Do not put your hands under the seat or near the moving parts to avoid injury. Fingers or hands may become jammed in the seat mechanism.

**■ Seat adjustment**

To reduce the risk of sliding under the lap belt during a collision, do not recline the seat more than necessary.

If the seat is too reclined, the lap belt may slide past the hips and apply restraint forces directly to the abdomen, or your neck may contact the shoulder belt, increasing the risk of death or serious injury in the event of an accident.

Adjustments should not be made while driving as the seat may unexpectedly move and cause the driver to lose control of the vehicle.

**■ When adjusting the seat positions**

Make sure to leave enough space around the feet so they do not get stuck.

## Driving position memory\*

This feature automatically adjusts the front seats, steering wheel (power adjustment type) and outside rear view mirrors to make entering and exiting the vehicle easier or to suit your preferences.

### Power easy access system

The seat and steering wheel are automatically adjusted to allow the driver to enter and exit the vehicle easily.

When all of the following have been performed, the driver's seat and steering wheel are automatically adjusted to a position that allows driver to enter and exit the vehicle easily.

- The shift lever has been shifted to P.
- The "START STOP ENGINE" <"POWER"> switch has been turned off.
- The driver's seat belt has been unfastened.

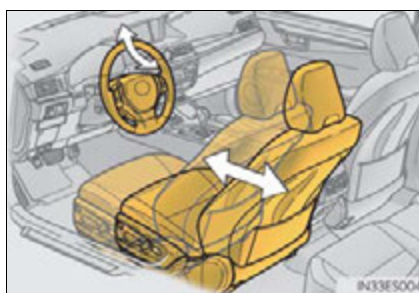

When any of the following has been performed, the driver's seat and steering wheel automatically return to their original positions.

- The "START STOP ENGINE" <"POWER"> switch has been turned to ACCESSORY mode or IGNITION ON <ON> mode.
- The driver's seat belt has been fastened.

\*: If equipped



### ■ Operation of the power easy access system

When exiting the vehicle, the power easy access system may not operate if the seat is already close to the rearmost position, etc.

### ■ Customization

The seat movement amount settings of the power easy access system can be customized. (Customizable features: →P. 862)

## Driving position memory

Your preferred driving position (the position of the driver's seat, steering wheel and outside rear view mirrors) can be recorded and recalled by pressing a button.

Three different driving positions can be recorded into memory.

### ■ Recording procedure

- 1 Check that the shift lever is in P.
- 2 Turn the "START STOP ENGINE" <"POWER"> switch to IGNITION ON <ON> mode.
- 3 Adjust the driver's seat, steering wheel, and outside rear view mirrors to the desired positions.
- 4 While pressing the "SET" button, or within 3 seconds after the "SET" button is pressed, press button "1", "2" or "3" until the buzzer sounds.

If the selected button has already been preset, the previously recorded position will be overwritten.

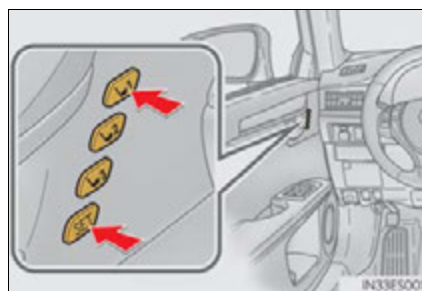

Vehicles with the driving position memory for the front passenger's seat: To record the position of the front passenger's seat, adjust the front passenger's seat to the desired position and perform step 4 using the buttons on the front passenger's side.

■ **Recall procedure**

- 1 Check that the shift lever is in P.
- 2 Turn the "START STOP ENGINE" <"POWER"> switch to IGNITION ON <ON> mode.
- 3 Press one of the buttons for the driving position you want to recall until the buzzer sounds.

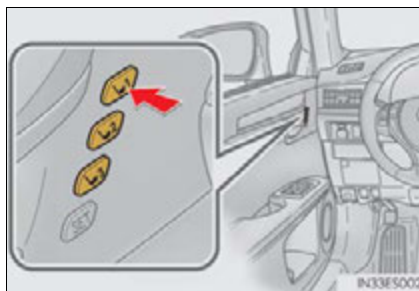

■ **To stop the position recall operation part-way through**

Perform any of the following:

- Press the "SET" button.
- Press button "1", "2" or "3".
- Operate any of the seat adjustment switches (only cancels seat position recall).
- Operate the tilt and telescopic steering control switch (only cancels steering wheel position recall).

■ **Seat positions that can be memorized (→P. 154)**

The adjusted positions other than the position adjusted by lumbar support switch can be recorded.

**■ Operating the driving position memory after turning the “START STOP ENGINE” <“POWER”> switch off**

Driver's seat:

Recorded seat positions can be activated up to 180 seconds after the driver's door is opened and another 60 seconds after it is closed again.

Front passenger's seat:

Recorded seat positions can be activated up to 180 seconds after the front passenger's door is opened.

**■ In order to correctly use the driving position memory function**

If a seat position is already in the furthest possible position and the seat is operated in the same direction, the recorded position may be slightly different when it is recalled.

**Memory recall function (driver's side only)**

Each electronic key can be registered to recall your preferred driving position.

**■ Registering procedure**

Record your driving position to button “1”, “2” or “3” before performing the following:

Carry only the key you want to register, and then close the driver's door. If 2 or more keys are in the vehicle, the driving position cannot be recorded properly.

- 1** Check that the shift lever is in P.
- 2** Turn the “START STOP ENGINE” <“POWER”> switch to IGNITION ON <ON> mode.
- 3** Recall the driving position that you want to record.

- 4 While pressing the recalled button, press and hold the door lock switch (either lock or unlock) until the buzzer sounds.

If the button could not be registered, the buzzer sounds continuously for approximately 3 seconds.

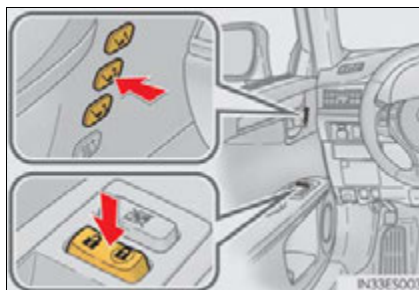

#### ■ Recall procedure

- 1 Carry the electronic key that has been registered to the driving position, and then unlock and open the driver's door using the smart access system with push-button start or wireless remote control.

The driving position will move to the recorded position (not including the steering wheel). However, the seat will move to a position slightly behind the recorded position in order to make entering the vehicle easier.

If the driving position is in a position that has already been recorded, the seat and outside rear view mirrors will not move.

- 2 Turn the "START STOP ENGINE" <"POWER"> switch to ACCESSORY mode or IGNITION ON <ON> mode, or fasten a seat belt.

The seat and steering wheel will move to the recorded position.

### ■ Cancellation procedure

Carry only the key you want to cancel and then close the driver's door. If 2 or more keys are in the vehicle, the driving position cannot be canceled properly.

- 1 Turn the "START STOP ENGINE" <"POWER"> switch to IGNITION ON <ON> mode.
- 2 While pressing the "SET" button, press and hold the door lock switch (either lock or unlock) until the buzzer sounds twice.

If the button could not be canceled, the buzzer sounds continuously for approximately 3 seconds.

### ■ Recalling the driving position using the memory recall function

- Different driving positions can be registered for each electronic key. Therefore, the driving position that is recalled may be different depending on the key being carried.
- If a door other than the driver's door is unlocked with the smart access system with push-button start, the driving position cannot be recalled. In this case, press the driving position button which has been set.

### ■ Customization

The unlock door settings of the memory recall function can be customized. (Customizable features: →P. 862)

### ▲ CAUTION

#### ■ Seat adjustment caution

Take care during seat adjustment so that the seat does not strike the rear passenger or squeeze your body against the steering wheel.

## Head restraints

Head restraints are provided for all seats.

### Front seats

#### Vertical adjustment

- ① Up  
Pull the head restraints up.
- ② Down  
Push the head restraint down while pressing the lock release button.

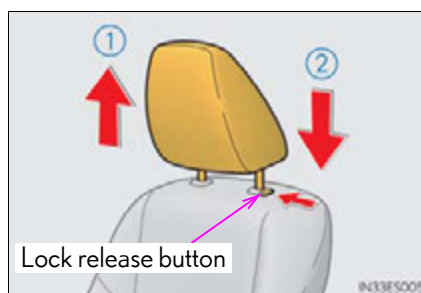

#### Horizontal adjustment

The position of the head restraint can be adjusted forward in 4 stages.

If the head restraint is pulled forward from the foremost position, it will return to the rearmost position.

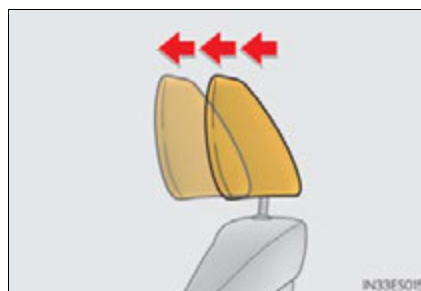

## Rear seats

### ▶ Outboard

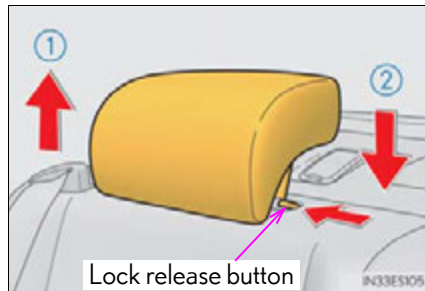

### ▶ Center

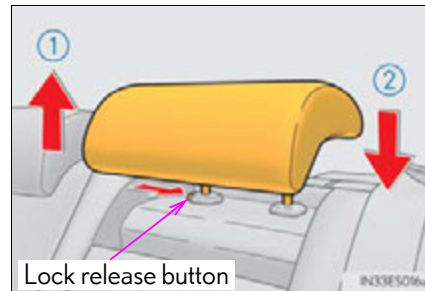

#### ① Up

Pull the head restraints up.

#### ② Down

Push the head restraint down while pressing the lock release button.

### ■ Removing the head restraints

Pull the head restraint up while pressing the lock release button.



3

Operation of each component

■ Installing the head restraints

▶ Front seats

Align the head restraint with the installation holes and push it down to the lock position. Press and hold the lock release button when lowering the head restraint.

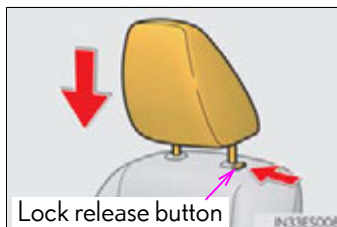

▶ Rear seats

Align the head restraint with the installation holes and push it down to the lowest lock position while pressing the lock release button.

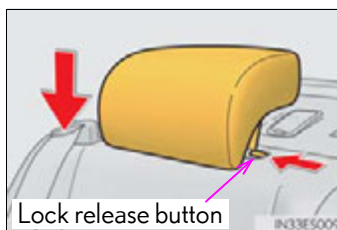

■ Adjusting the height of the head restraints

Make sure that the head restraints are adjusted so that the center of the head restraint is closest to the top of your ears.

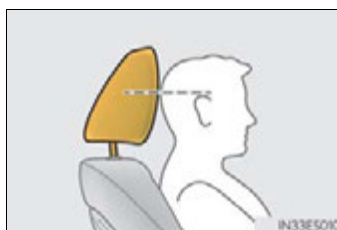

■ Adjusting the rear seat head restraint

Always raise the head restraint one level from the stowed position when using.



 CAUTION**■ Head restraint precautions**

Observe the following precautions regarding the head restraints. Failure to do so may result in death or serious injury.

- Use the head restraints designed for each respective seat.
- Adjust the head restraints to the correct position at all times.
- After adjusting the head restraints, push down on them and make sure they are locked in position.
- Do not drive with the head restraints removed.

## Steering wheel

### Adjustment procedure

► Manual adjustment

- 1 Hold the steering wheel and pull the lever down.

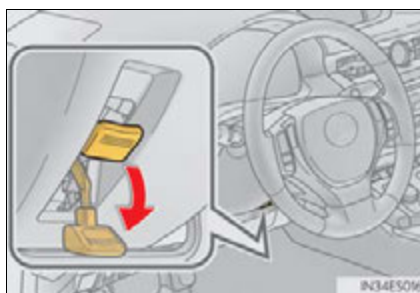

- 2 Adjust to the ideal position by moving the steering wheel horizontally and vertically.

After adjustment, pull the lever up to secure the steering wheel.

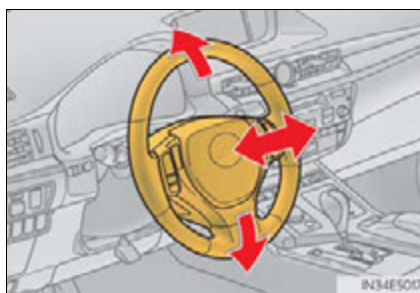

► Power adjustment

Operating the switch moves the steering wheel in the following directions:

- 1 Up
- 2 Down
- 3 Toward the driver
- 4 Away from the driver

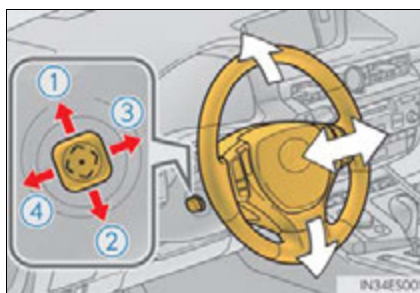

**■ The power adjustment type steering wheel can be adjusted when**

The "START STOP ENGINE" <"POWER"> switch is in ACCESSORY or IGNITION ON <ON> mode\*.

\*: If the driver's seat belt is fastened, the steering wheel can be adjusted regardless of "START STOP ENGINE" <"POWER"> switch mode.

**■ Automatic adjustment of the steering position (power adjustment type)**

A desired steering position can be entered to memory and recalled automatically by the driving position memory system. (→P. 156)

**■ Power easy access system (power adjustment type)**

The steering wheel and driver's seat move in accordance with "START STOP ENGINE" <"POWER"> switch mode and the driver's seat belt condition. (→P. 156)

**⚠ CAUTION****■ Caution while driving**

Do not adjust the steering wheel while driving.  
Doing so may cause the driver to mishandle the vehicle and cause an accident, resulting in death or serious injury.

**■ After adjusting the steering wheel (manual adjustment type)**

Make sure that the steering wheel is securely locked.  
Otherwise, the steering wheel may move suddenly, possibly causing an accident, and resulting in death or serious injury.

## Inside rear view mirror

The rear view mirror's position can be adjusted to enable sufficient confirmation of the rear view.

### Adjusting the height of rear view mirror

The height of the rear view mirror can be adjusted to suit your driving posture.

Adjust the height of the rear view mirror by moving it up and down.

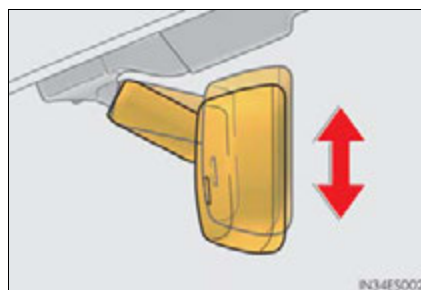

### Anti-glare function

Responding to the level of brightness of the headlights of vehicles behind, the reflected light is automatically reduced.

#### ▶ Without compass

Changing automatic anti-glare function mode

- ① ON
- ② OFF

When the automatic anti-glare function is in ON mode, the indicator illuminates.

The function will set to ON mode each time the "START STOP ENGINE" <"POWER"> switch is turned to IGNITION ON <ON> mode.

Pressing the button turns the function to OFF mode. (The indicator also turns off.)

#### ▶ With compass

Turning automatic anti-glare function mode on/off

When the automatic anti-glare function is in ON mode, the indicator illuminates.

The function will set to ON mode each time the "START STOP ENGINE" <"POWER"> switch is turned to IGNITION ON <ON> mode.

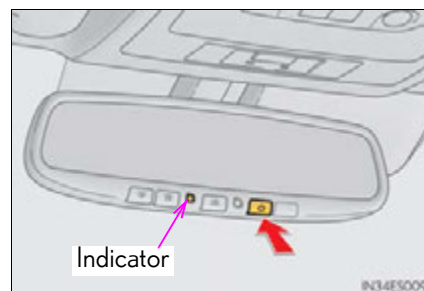
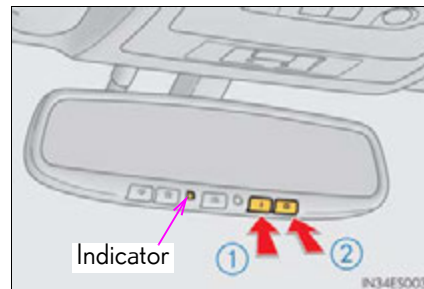

3

Operation of each component

■ To prevent sensor error

To ensure that the sensors operate properly, do not touch or cover them.

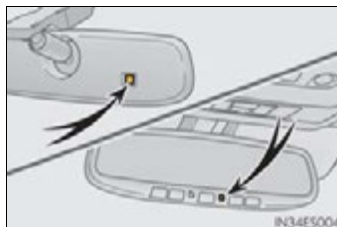

**⚠ CAUTION**

Do not adjust the position of the mirror while driving. Doing so may lead to mishandling of the vehicle and cause an accident, resulting in death or serious injury.

## Outside rear view mirrors

### Adjustment procedure

**1** To select a mirror to adjust, press the switch.

- ① Left
- ② Right

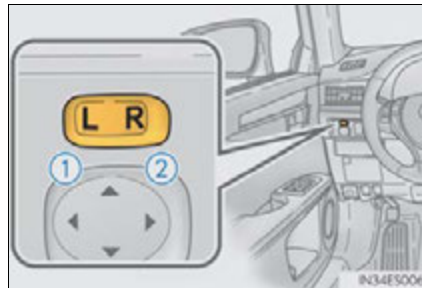

**2** To adjust the mirror, press the switch.

- ① Up
- ② Right
- ③ Down
- ④ Left

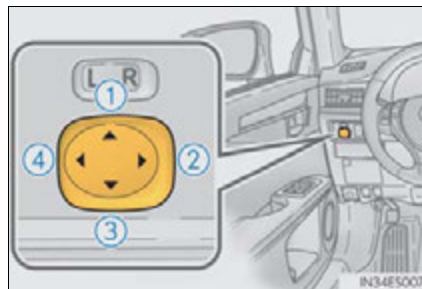

### Folding the mirrors

Push the mirror back in the direction of the vehicle's rear.

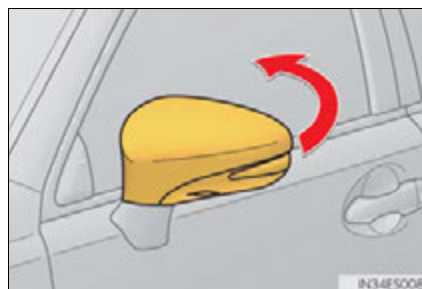

3

Operation of each component

■ **Mirror angle can be adjusted when**

The "START STOP ENGINE" <"POWER"> switch is in ACCESSORY or IGNITION ON <ON> mode.

■ **Linked mirror function when reversing**

● When either "L" or "R" of the mirror select switch is selected, the outside rear view mirrors will automatically angle downwards when the vehicle is reversing in order to give a better view of the ground. To disable this function, select neither "L" nor "R".

● If the mirror angle adjustment switch is operated while the linked mirror function is in operation, the angle and position of the mirrors can be remembered, and the mirrors will operate at the angle adjusted to the last time the linked mirror function was operated.

However, because the mirrors move based on the angle they are in when the linked mirror function is not operating, the mirror angle when the linked mirror function is operating will also be changed if the mirrors are adjusted while the function is not operating.

■ **When the mirrors are fogged up**

The outside rear view mirrors can be cleared using the mirror defoggers. Turn on the rear window defogger to turn on the outside rear view mirror defoggers. (→P. 378)

■ **Automatic adjustment of the mirror angle**

A desired mirror face angle can be entered to memory and recalled automatically by the driving position memory. (→P. 156)

■ **Auto anti-glare function**

When the anti-glare inside rear view mirror is set to automatic mode, the outside rear view mirrors will activate in conjunction with the anti-glare inside rear view mirror to reduce reflected light. (→P. 169)



 CAUTION**■ Important points while driving**

Observe the following precautions while driving.  
Failure to do so may result in loss of control of the vehicle and cause an accident, resulting in death or serious injury.

- Do not adjust the mirrors while driving.
- Do not drive with the mirrors folded.
- Both the driver and passenger side mirrors must be extended and properly adjusted before driving.

**■ When a mirror is moving**

To avoid personal injury and mirror malfunction, be careful not to get your hand caught by the moving mirror.

**■ When the mirror defoggers are operating**

Do not touch the rear view mirror surfaces, as they can become very hot and burn you.

## Power windows

### Opening and closing procedures

The power windows can be opened and closed using the switches.

Operating the switch moves the windows as follows:

- ① Closing
- ② One-touch closing\*
- ③ Opening
- ④ One-touch opening\*

\*: To stop the window partway, operate the switch in the opposite direction.

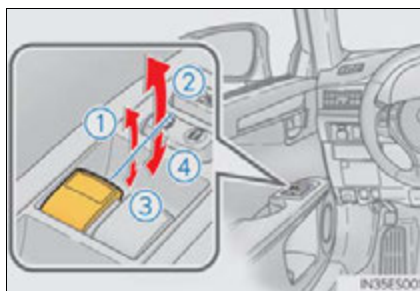

### Window lock switch

Press the switch to lock the passenger window switches.

Use this switch to prevent children from accidentally opening or closing a passenger window.

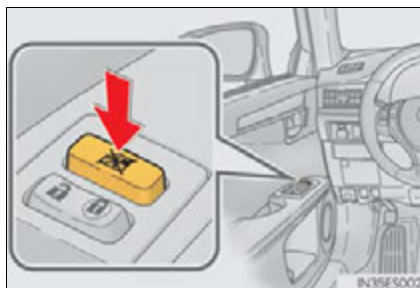

**■ The power windows can be operated when**

The "START STOP ENGINE" <"POWER"> switch is in IGNITION ON <ON> mode.

**■ Operating the power windows after turning the engine <hybrid system> off**

The power windows can be operated for approximately 45 seconds even after the "START STOP ENGINE" <"POWER"> switch is turned to ACCESSORY mode or turned off. They cannot, however, be operated once either front door is opened.

**■ Jam protection function**

If an object becomes caught between the window and the window frame, window travel is stopped and the window is opened slightly.

**■ When the power window does not close normally**

If the jam protection function is operating abnormally and a window cannot be closed, perform the following operations using the power window switch on the relevant door.

- After stopping the vehicle, the window can be closed by holding the power window switch in the one-touch closing position while the "START STOP ENGINE" <"POWER"> switch is turned to IGNITION ON <ON> mode.
- If the window still cannot be closed even by carrying out the operation as explained above, initialize the function by performing the following procedure.
  - 1 Hold the power window switch in the one-touch closing position. Continue holding the switch for a further 6 seconds after the window has closed.
  - 2 Hold the power window switch in the one-touch opening position. Continue holding the switch for a further 2 seconds after the window has opened completely.
  - 3 Hold the power window switch in the one-touch closing position once again. Continue holding the switch for a further 2 seconds after the window has closed.

If you release the switch while the window is moving, start again from the beginning. If the window continues to close but then re-open slightly even after performing the above procedure correctly, have the vehicle inspected by your Lexus dealer.

■ **Door lock linked window operation**

- The power windows can be opened and closed using the mechanical key.\* (→P. 810)
  - The power windows can be opened using the wireless remote control.\* (→P. 139)
- \*: These settings must be customized at your Lexus dealer.

■ **When the 12-volt battery is disconnected**

The window lock switch is disabled. If necessary, press the window lock switch after reconnecting the battery.

■ **Power windows open warning buzzer**

The buzzer sounds and a message is shown on the multi-information display in the instrument cluster when the "START STOP ENGINE" <"POWER"> switch is turned off and the driver's door is opened with the power windows open.

■ **Customization**

Settings (e.g. linked door lock operation) can be changed.  
(Customizable features: →P. 862)

 **CAUTION**

Observe the following precautions.  
Failure to do so may result in death or serious injury.

■ **Closing the windows**

- Check to make sure that all passengers do not have any part of their body in a position where it could be caught when a window is being operated.
- Do not allow children to operate the power windows.  
Closing a power window on someone can cause serious injury, and in some instances, even death.

■ **Jam protection function**

- Never use any part of your body to intentionally activate the jam protection function.
- The jam protection function may not work if something gets caught just before the window fully closes.

## Moon roof

Use the overhead switches to open and close the moon roof and tilt it up and down.

### Opening and closing

#### ► Standard type

##### ① Opens the moon roof\*

The moon roof stops slightly before the fully open position to reduce wind noise.

Press the switch again to fully open the moon roof.

##### ② Closes the moon roof\*

\*: Lightly press either way of the moon roof switch to stop the moon roof partway.

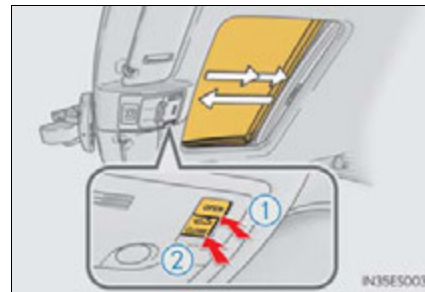

#### ► Glass type

##### ① Opens the moon roof

##### ② Closes the moon roof (push and hold)\*

\*: The moon roof stops once. Push and hold the switch again to fully close.

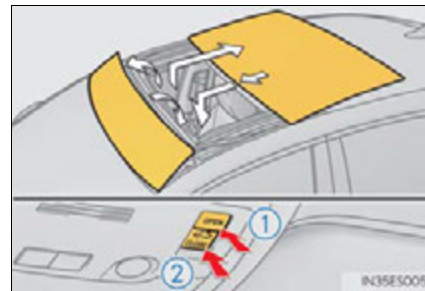

3

Operation of each component

### Tilting up and down

► Standard type

- ① Tilts the moon roof up\*
- ② Tilts the moon roof down\*

\*: Lightly press either way of the moon roof switch to stop the moon roof partway.

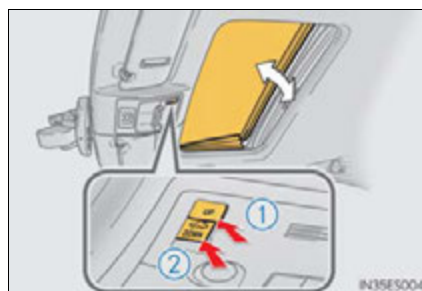

► Glass type

- ① Tilts the moon roof up\*
- ② Tilts the moon roof down (push and hold)

\*: Lightly press either way of the moon roof switch to stop the moon roof partway.

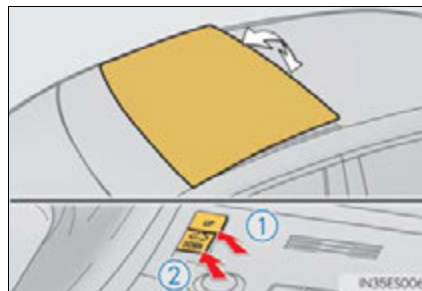

**■ The moon roof can be operated when**

The "START STOP ENGINE" <"POWER"> switch is in IGNITION ON <ON> mode.

**■ Operating the moon roof after turning the engine <hybrid system> off**

The moon roof can be operated for approximately 45 seconds after the "START STOP ENGINE" <"POWER"> switch is turned to ACCESSORY mode or turned off. It cannot, however, be operated once either front door is opened.

**■ Jam protection function**

If an object is detected between the moon roof and the frame while the moon roof is closing or tilting down, travel is stopped and the moon roof opens slightly.

**■ Sunshade**

The sunshade can be opened and closed manually. However, the sunshade will open automatically when the moon roof is opened.

**■ Door lock linked moon roof operation**

- The moon roof can be opened and closed using the mechanical key.\* (→P. 810)
- The moon roof can be opened using the wireless remote control.\* (→P. 139)

\*: These settings must be customized at your Lexus dealer.

**■ When the moon roof does not close normally**

Perform the following procedure:

- If the moon roof closes but then re-opens slightly

- 1 Stop the vehicle.
- 2 Press and hold the "CLOSE" switch.\*1  
The moon roof will close, reopen and pause for approximately 10 seconds.\*2  
Then it will close again, tilt up and pause for approximately 1 second. Finally, it will tilt down, open and close.
- 3 Check to make sure that the moon roof is completely closed and then release the switch.

- If the moon roof tilts down but then tilts back up

- 1 Stop the vehicle.
- 2 Press and hold the "UP" switch\*1 until the moon roof moves into the tilt up position and stops.
- 3 Release the "UP" switch once and then press and hold the "UP" switch again.\*1  
The moon roof will pause for approximately 10 seconds in the tilt up position.\*2  
Then it will adjust slightly and pause for approximately 1 second. Finally, it will tilt down, open and close.
- 4 Check to make sure that the moon roof is completely closed and then release the switch.

\*1: If the switch is released at the incorrect time, the procedure will have to be performed again from the beginning.

\*2: If the switch is released after the above mentioned 10 second pause, automatic operation will be disabled. In that case, press and hold the "CLOSE" or "UP" switch, and the moon roof will tilt up and pause for approximately 1 second. Then it will tilt down, open and close. Check to make sure that the moon roof is completely closed and then release the switch.

If the moon roof does not fully close even after performing the above procedure correctly, have the vehicle inspected by your Lexus dealer.



#### ■ Moon roof open warning buzzer

The buzzer sounds and a message is shown on the multi-information display in the instrument cluster when the "START STOP ENGINE" <"POWER"> switch is turned off and the driver's door is opened with the moon roof open.

#### ■ Customization

Settings (e.g. linked door lock operation) can be changed.  
(Customizable features: →P. 862)

### CAUTION

Observe the following precautions.  
Failure to do so may cause death or serious injury.

#### ■ Opening the moon roof

- Do not allow any passengers to put their hands or heads outside the vehicle while it is moving.
- Do not sit on top of the moon roof.

#### ■ Closing the moon roof

- Check to make sure that all passengers do not have any part of their body in a position where it could be caught when the moon roof is being operated.
- Do not allow children to operate the moon roof.  
Closing the moon roof on someone can cause death or serious injury.

#### ■ Jam protection function

- Never use any part of your body to intentionally activate the jam protection function.
- The jam protection function may not work if something gets caught just before the moon roof fully closes.



- 4-1. Before driving**
- Driving the vehicle ..... 184
  - Cargo and luggage ..... 195
  - Vehicle load limits ..... 198
  - Trailer towing ..... 199
  - Dinghy towing ..... 200
- 4-2. Driving procedures**
- Engine (ignition) switch  
(gasoline vehicles) ..... 201
  - Power (ignition) switch  
(hybrid vehicles) ..... 208
  - EV drive mode  
(hybrid vehicles) ..... 215
  - Automatic transmission  
(gasoline vehicles) ..... 218
  - Hybrid transmission  
(hybrid vehicles) ..... 221
  - Turn signal lever ..... 225
  - Parking brake ..... 226
  - Horn ..... 227
- 4-3. Operating the lights and wipers**
- Headlight switch ..... 228
  - Automatic High Beam ..... 232
  - Fog light switch ..... 238
  - Windshield wipers  
and washer ..... 239
- 4-4. Refueling**
- Opening the fuel tank cap ..... 243
- 4-5. Using the driving support systems**
- Cruise control ..... 248
  - Dynamic radar  
cruise control ..... 252
  - LDA  
(Lane Departure Alert) ..... 267
  - Intuitive parking assist ..... 275
  - Rear view monitor system ..... 288
  - Driving mode select  
switch ..... 300
  - Driving assist systems ..... 302
  - Hill-start assist control  
(hybrid vehicles) ..... 308
  - PCS  
(Pre-Collision System) ..... 310
  - BSM (Blind Spot Monitor) ..... 317
    - Blind Spot Monitor  
function ..... 321
    - Rear Cross Traffic Alert  
function ..... 324
- 4-6. Driving tips**
- Hybrid vehicle driving tips  
(hybrid vehicles) ..... 327
  - Winter driving tips ..... 330

## Driving the vehicle

The following procedures should be observed to ensure safe driving:

### Starting the engine <hybrid system>

→P. 201, 208

### Driving

- 1 With the brake pedal depressed, shift the shift lever to D.  
(→P. 218, 221)
- 2 Release the parking brake. (→P. 226)
- 3 Gradually release the brake pedal and gently depress the accelerator pedal to accelerate the vehicle.

### Stopping

- 1 With the shift lever in D, depress the brake pedal.
- 2 If necessary, set the parking brake.

Gasoline vehicles: If the vehicle is to be stopped for an extended period of time, shift the shift lever to P or N. (→P. 218)

Hybrid vehicles: If the vehicle is to be stopped for an extended period of time, shift the shift lever to P. (→P. 221)

### Parking the vehicle

- 1 With the shift lever in D, depress the brake pedal.
- 2 Shift the shift lever to P. (→P. 218, 221)
- 3 Set the parking brake. (→P. 226)
- 4 Press the “START STOP ENGINE” <“POWER”> switch to stop the engine <hybrid system>.
- 5 Lock the door, making sure that you have the electronic key on your person.

If parking on a hill, block the wheels as needed.

### Starting off on a steep uphill

- 1 Make sure that the parking brake is set and shift the shift lever to D.
- 2 Gently depress the accelerator pedal.
- 3 Release the parking brake.

4

Driving

#### ■ When starting off on a uphill (hybrid vehicles)

The hill-start assist control is available. (→P. 308)

#### ■ Driving in the rain

- Drive carefully when it is raining, because visibility will be reduced, the windows may become fogged-up, and the road will be slippery.
- Drive carefully when it starts to rain, because the road surface will be especially slippery.
- Refrain from high speeds when driving on an expressway in the rain, because there may be a layer of water between the tires and the road surface, preventing the steering and brakes from operating properly.

#### ■ Engine speed while driving

In the following conditions, the engine speed may become high while driving. This is due to automatic up-shifting control or down-shifting implementation to meet driving conditions. It does not indicate sudden acceleration.

- The vehicle is judged to be driving uphill or downhill
- When the accelerator pedal is released

**■ Breaking in your new Lexus**

To extend the life of the vehicle, observing the following precautions is recommended:

- For the first 186 miles (300 km):  
Avoid sudden stops.
- For the first 621 miles (1000 km):
  - Do not drive at extremely high speeds.
  - Avoid sudden acceleration.
  - Do not drive continuously in low gears.
  - Do not drive at a constant speed for extended periods.

**■ Drum-in-disc type parking brake system**

Your vehicle has a drum-in-disc type parking brake system. This type of brake system needs bedding-down of the brake shoes periodically or whenever the parking brake shoes and/or drum are replaced. Have your Lexus dealer perform the bedding down operation.

**■ Operating your vehicle in a foreign country**

Comply with the relevant vehicle registration laws and confirm the availability of the correct fuel. (→P. 847)

**■ For efficient use (hybrid vehicles)**

- Shift the shift lever to D when driving.  
In the N position, the gasoline engine operates but electricity cannot be generated. The hybrid battery (traction battery) will discharge, requiring unnecessary engine power to recharge.
- Drive your vehicle smoothly.  
Avoid abrupt acceleration and deceleration. Gradual acceleration and deceleration will make more effective use of the electric motor (traction motor) without having to use gasoline engine power.
- Avoid repeated acceleration.  
Repeated acceleration consumes hybrid battery (traction battery) power, resulting in poor acceleration. Battery power can be restored by driving with the accelerator pedal slightly released.
- Shift the shift lever to P when parking.  
In the N position, the hybrid battery (traction battery) does not recharge. Leaving the shift lever in the N position for an extended period of time may discharge the hybrid battery. The vehicle cannot run if the hybrid battery is discharged.

### ■ Eco-friendly driving

Gasoline vehicles: →P. 107

Hybrid vehicles: →P. 98

### ■ Customization (gasoline vehicles)

Setting of Eco Driving Indicator Light can be changed.  
(Customizable features: →P. 862)

## ⚠ CAUTION

Observe the following precautions.  
Failure to do so may result in death or serious injury.

### ■ When starting the vehicle

Always keep your foot on the brake pedal while stopped with the engine running <hybrid system operating>. This prevents the vehicle from creeping.

### ■ When driving the vehicle

- Do not drive if you are unfamiliar with the location of the brake and accelerator pedals to avoid depressing the wrong pedal.
  - Accidentally depressing the accelerator pedal instead of the brake pedal will result in sudden acceleration that may lead to an accident.
  - When backing up, you may twist your body around, leading to a difficulty in operating the pedals. Make sure to operate the pedals properly.
  - Make sure to keep a correct driving posture even when moving the vehicle only slightly. This allows you to depress the brake and accelerator pedals properly.
  - Depress the brake pedal using your right foot. Depressing the brake pedal using your left foot may delay response in an emergency, resulting in an accident.
- Hybrid vehicles only: When the hybrid vehicles are driven using the electric motor only, no engine noise is made. As such, pedestrians, people riding bicycles or other people and vehicles in the surrounding area may not realize that the vehicle is approaching. Even with the vehicle proximity notification system active, people may not realize the vehicle is approaching when the surrounding area is noisy and so forth. Therefore, take extra care while driving.
- Do not drive the vehicle over or stop the vehicle near flammable materials. The exhaust system and exhaust gases can be extremely hot. These hot parts may cause a fire if there is any flammable material nearby.

 **CAUTION**

Observe the following precautions.  
Failure to do so may result in death or serious injury.

**■ When driving the vehicle**

- During normal driving, do not turn off the engine <hybrid system>. Turning the engine <hybrid system> off while driving will not cause loss of steering or braking control, but the power assist to these systems will be lost. This will make it more difficult to steer and brake, so you should pull over and stop the vehicle as soon as it is safe to do so.  
However, in the event of an emergency, such as if it becomes impossible to stop the vehicle in the normal way: →P. 749
- Use engine braking (downshift) to maintain a safe speed when driving down a steep hill.  
Using the brakes continuously may cause the brakes to overheat and lose effectiveness. (→P. 219, 222)
- Do not adjust the positions of the steering wheel, the seat, or the inside or outside rear view mirrors while driving.  
Doing so may result in a loss of vehicle control.
- Always check that all passengers' arms, heads or other parts of their body are not outside the vehicle.
- Do not drive in excess of the speed limit. Even if the legal speed limit permits it, do not drive over 85 mph (140 km/h) unless your vehicle has high-speed capability tires. Driving over 85 mph (140 km/h) may result in tire failure, loss of control and possible injury. Be sure to consult a tire dealer to determine whether the tires on your vehicle are high-speed capability tires or not before driving at such speeds.



 **CAUTION**

Observe the following precautions.  
Failure to do so may result in death or serious injury.

**■ When driving on slippery road surfaces**

- Sudden braking, acceleration and steering may cause tire slippage and reduce your ability to control the vehicle.
- Sudden acceleration, engine braking due to shift changing, or changes in engine speed could cause the vehicle to skid, resulting in an accident.
- After driving through a puddle, lightly depress the brake pedal to make sure that the brakes are functioning properly. Wet brake pads may prevent the brakes from functioning properly. If the brakes on only one side are wet and not functioning properly, steering control may be affected.

**■ When shifting the shift lever**

- Do not let the vehicle roll backward while the shift lever is in a driving position, or roll forward while the shift lever is in R.  
Gasoline vehicles: Doing so may cause the engine to stall or lead to poor brake and steering performance, resulting in an accident or damage to the vehicle.  
Hybrid vehicles: Doing so may result in an accident or damage to the vehicle.
- Do not shift the shift lever to P while the vehicle is moving.  
Doing so can damage the transmission and may result in a loss of vehicle control.
- Do not shift the shift lever to R while the vehicle is moving forward.  
Doing so can damage the transmission and may result in a loss of vehicle control.
- Do not shift the shift lever to D while the vehicle is moving backward.  
Doing so can damage the transmission and may result in a loss of vehicle control.
- Gasoline vehicles: Moving the shift lever to N while the vehicle is moving will disengage the engine from the transmission. Engine braking is not available when N is selected.  
Hybrid vehicles: Moving the shift lever to N while the vehicle is moving will disengage the hybrid system. Engine braking is not available when N is selected.
- Be careful not to shift the shift lever with the accelerator pedal depressed. Shifting the shift lever to a gear other than P or N may lead to unexpected rapid acceleration of the vehicle that may cause an accident and result in death or serious injury.

 **CAUTION****■ If you hear a squealing or scraping noise (brake pad wear limit indicators)**

Have the brake pads checked and replaced by your Lexus dealer as soon as possible.

Rotor damage may result if the pads are not replaced when needed.

It is dangerous to drive the vehicle when the wear limits of the brake pads and/or those of the brake discs are exceeded.

**■ When the vehicle is stopped**

- Gasoline vehicles: Do not race the engine.

If the vehicle is in any gear other than P or N, the vehicle may accelerate suddenly and unexpectedly, causing an accident.

Hybrid vehicles: Do not depress the accelerator pedal unnecessarily.

If the vehicle is in any gear other than P or N, the vehicle may accelerate suddenly and unexpectedly, causing an accident.

- In order to prevent accidents due to the vehicle rolling away, always keep depressing the brake pedal while the engine is running <the "READY" indicator is on>, and apply the parking brake as necessary.

- If the vehicle is stopped on an incline, in order to prevent accidents caused by the vehicle rolling forward or backward, always depress the brake pedal and securely apply the parking brake as needed.

- Avoid revving or racing the engine.

Running the engine at high speed while the vehicle is stopped may cause the exhaust system to overheat, which could result in a fire if combustible material is nearby.

 CAUTION

## ■ When the vehicle is parked

- Do not leave glasses, cigarette lighters, spray cans, or soft drink cans in the vehicle when it is in the sun.  
Doing so may result in the following:
  - Gas may leak from a cigarette lighter or spray can, and may lead to a fire.
  - The temperature inside the vehicle may cause the plastic lenses and plastic material of glasses to deform or crack.
  - Soft drink cans may fracture, causing the contents to spray over the interior of the vehicle, and may also cause a short circuit in the vehicle's electrical components.
- Do not leave cigarette lighters in the vehicle. If a cigarette lighter is in a place such as the glove box or on the floor, it may be lit accidentally when luggage is loaded or the seat is adjusted, causing a fire.
- Do not attach adhesive discs to the windshield or windows. Do not place containers such as air fresheners on the instrument panel or dashboard. Adhesive discs or containers may act as lenses, causing a fire in the vehicle.
- Do not leave a door or window open if the curved glass is coated with a metallized film such as a silver-colored one. Reflected sunlight may cause the glass to act as a lens, causing a fire.
- Always apply the parking brake, shift the shift lever to P, stop the engine <hybrid system> and lock the vehicle.  
Do not leave the vehicle unattended while the engine is running <hybrid system is operating>.
- Do not touch the exhaust pipes while the engine is running <hybrid system is operating> or immediately after turning the engine <hybrid system> off.  
Doing so may cause burns.

 **CAUTION****■ When taking a nap in the vehicle**

Always turn the engine <hybrid system> off. Otherwise, if you accidentally move the shift lever or depress the accelerator pedal, this could cause an accident or fire due to engine <hybrid system> overheating. Additionally, if the vehicle is parked in a poorly ventilated area, exhaust gases may collect and enter the vehicle, leading to death or a serious health hazard.

**■ When braking**

- When the brakes are wet, drive more cautiously.

Braking distance increases when the brakes are wet, and this may cause one side of the vehicle to brake differently than the other side. Also, the parking brake may not securely hold the vehicle.

- If the brake booster (gasoline vehicles) or brake actuator (hybrid vehicles) does not operate, do not follow other vehicles closely and avoid hills or sharp turns that require braking.

In this case, braking is still possible, but the brake pedal should be depressed more firmly than usual. Also, the braking distance will increase. Have your brakes fixed immediately.

- Gasoline vehicles only: Do not pump the brake pedal if the engine stalls.

Each push on the brake pedal uses up the reserve for the power-assisted brakes.

- Gasoline vehicles: The brake system consists of 2 individual hydraulic systems; if one of the systems fails, the other will still operate. In this case, the brake pedal should be depressed more firmly than usual and the braking distance will increase. Have your brakes fixed immediately.

Hybrid vehicles: The brake system consists of 2 or more individual hydraulic systems; if one of the systems fails, the other(s) will still operate. In this case, the brake pedal should be depressed more firmly than usual and the braking distance will increase. Have your brakes fixed immediately.

 NOTICE**■ When driving the vehicle**

- Do not depress the accelerator and brake pedals at the same time during driving, as this may restrain driving torque.
- Do not use the accelerator pedal or depress the accelerator and brake pedals at the same time to hold the vehicle on a hill.

**■ When parking the vehicle**

Always shift the shift lever to P. Failure to do so may cause the vehicle to move or the vehicle may accelerate suddenly if the accelerator pedal is accidentally depressed.

**■ Avoiding damage to vehicle parts**

- Do not turn the steering wheel fully in either direction and hold it there for an extended period of time.  
Doing so may damage the power steering motor.
- When driving over bumps in the road, drive as slowly as possible to avoid damaging the wheels, underside of the vehicle, etc.

**■ If you get a flat tire while driving**

A flat or damaged tire may cause the following situations. Hold the steering wheel firmly and gradually depress the brake pedal to slow down the vehicle.

- It may be difficult to control your vehicle.
- The vehicle will make abnormal sounds or vibrations.
- The vehicle will lean abnormally.

Information on what to do in case of a flat tire (→P. 792)

 NOTICE**■ When encountering flooded roads**

Do not drive on a road that has flooded after heavy rain etc. Doing so may cause the following serious damage to the vehicle:

- Engine stalling
- Short in electrical components
- Engine damage caused by water immersion

In the event that you drive on a flooded road and the vehicle is flooded, be sure to have your Lexus dealer check the following:

- Brake function
- Changes in quantity and quality of engine oil, fluid used for automatic transaxle <hybrid transaxle>, etc.
- Lubricant condition for the bearings and suspension joints (where possible), and the function of all joints, bearings, etc.

## Cargo and luggage

Take notice of the following information about storage precautions, cargo capacity and load:

### Capacity and distribution

Cargo capacity depends on the total weight of the occupants.

(Cargo capacity) = (Total load capacity) – (Total weight of occupants)

#### Steps for Determining Correct Load Limit —

- (1) Locate the statement “The combined weight of occupants and cargo should never exceed XXX kg or XXX lbs.” on your vehicle’s placard.
- (2) Determine the combined weight of the driver and passengers that will be riding in your vehicle.
- (3) Subtract the combined weight of the driver and passengers from XXX kg or XXX lbs.
- (4) The resulting figure equals the available amount of cargo and luggage load capacity.  
  
For example, if the “XXX” amount equals 1400 lbs. and there will be five 150 lb passengers in your vehicle, the amount of available cargo and luggage load capacity is 650 lbs. (1400 – 750 (5 × 150) = 650 lbs.)
- (5) Determine the combined weight of luggage and cargo being loaded on the vehicle. That weight may not safely exceed the available cargo and luggage load capacity calculated in Step 4.
- (6) If your vehicle will be towing a trailer, load from your trailer will be transferred to your vehicle. Consult this manual to determine how this reduces the available cargo and luggage load capacity of your vehicle. (→P.198)

Lexus does not recommend towing a trailer with your vehicle. Your vehicle is not designed for trailer towing.

### Calculation formula for your vehicle

- ① Cargo capacity
- ② Total load capacity (vehicle capacity weight) (→P. 832)

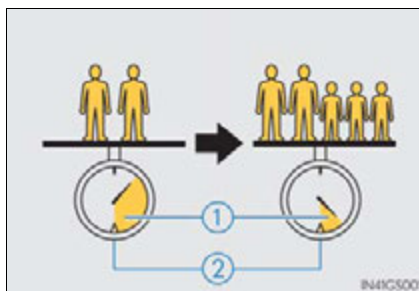

When 2 people with the combined weight of A lb. (kg) are riding in your vehicle, which has a total load capacity (vehicle capacity weight) of B lb. (kg), the available amount of cargo and luggage load capacity will be C lb. (kg) as follows:

$$B^{*2} \text{ lb. (kg)} - A^{*1} \text{ lb. (kg)} = C^{*3} \text{ lb. (kg)}$$

\*1: A = Weight of people

\*2: B = Total load capacity

\*3: C = Available cargo and luggage load

In this condition, if 3 more passengers with the combined weight of D lb. (kg) get on, the available cargo and luggage load will be reduced E lb. (kg) as follows:

$$C \text{ lb. (kg)} - D^{*4} \text{ lb. (kg)} = E^{*5} \text{ lb. (kg)}$$

\*4: D = Additional weight of people

\*5: E = Available cargo and luggage load

As shown in the example above, if the number of occupants increases, the cargo and luggage load will be reduced by an amount that equals the increased weight due to the additional occupants. In other words, if an increase in the number of occupants causes an excess of the total load capacity (combined weight of occupants plus cargo and luggage load), you must reduce the cargo and luggage on your vehicle.



 **CAUTION****■ Things that must not be carried in the trunk**

The following things may cause a fire if loaded in the trunk:

- Receptacles containing gasoline
- Aerosol cans

**■ Storage precautions**

Observe the following precautions.

Failure to do so may prevent the pedals from being depressed properly, may block the driver's vision, or may result in items hitting the driver or passengers, possibly causing an accident.

- Stow cargo and luggage in the trunk whenever possible.
- Do not place cargo or luggage in or on the following locations.
  - At the feet of the driver
  - On the front passenger or rear seats (when stacking items)
  - On the package tray
  - On the instrument panel
  - On the dashboard
  - In front of the navigation system screen, Lexus Display Audio system screen or the audio/air conditioning system display
- Secure all items in the occupant compartment.

**■ Capacity and distribution**

- Do not exceed the maximum axle weight rating or the total vehicle weight rating.
- Even if the total load of occupant's weight and the cargo load is less than the total load capacity, do not apply the load unevenly. Improper loading may cause deterioration of steering or braking control which may cause death or serious injury.

## Vehicle load limits

Vehicle load limits include total load capacity, seating capacity, towing capacity and cargo capacity.

### ◆ Total load capacity (vehicle capacity weight): →P. 832

Total load capacity means the combined weight of occupants, cargo and luggage.

### ◆ Seating capacity: 5 occupants (Front 2, Rear 3)

Seating capacity means the maximum number of occupants whose estimated average weight is 150 lb. (68 kg) per person.

### ◆ Towing capacity

Lexus does not recommend towing a trailer with your vehicle.

### ◆ Cargo capacity

Cargo capacity may increase or decrease depending on the weight and the number of occupants.

### ■ Total load capacity and seating capacity

These details are also described on the tire and loading information label. (→P. 712)

### CAUTION

#### ■ Overloading the vehicle

Do not overload the vehicle.  
It may not only cause damage to the tires, but also degrade steering and braking ability, resulting in an accident.

## Trailer towing

Lexus does not recommend towing a trailer with your vehicle. Lexus also does not recommend the installation of a tow hitch or the use of a tow hitch carrier for a wheelchair, scooter, bicycle, etc. Your vehicle is not designed for trailer towing or for the use of tow hitch mounted carriers.



4

Driving

## Dinghy towing

Your vehicle is not designed to be dinghy towed (with 4 wheels on the ground) behind a motor home.



 NOTICE

- To avoid serious damage to your vehicle  
Do not tow your vehicle with the four wheels on the ground.

## Engine (ignition) switch (gasoline vehicles)

Performing the following operations when carrying the electronic key on your person starts the engine or changes “START STOP ENGINE” switch modes.

### Starting the engine

- 1 Check that the parking brake is set.
- 2 Check that the shift lever is set in P.
- 3 Firmly depress the brake pedal.



will be displayed on the multi-information display.

If it is not displayed, the engine cannot be started.

- 4 Press the “START STOP ENGINE” switch.

The engine will crank until it starts or for up to 30 seconds, whichever is less.

Continue depressing the brake pedal until the engine is completely started.

The engine can be started from any “START STOP ENGINE” switch mode.

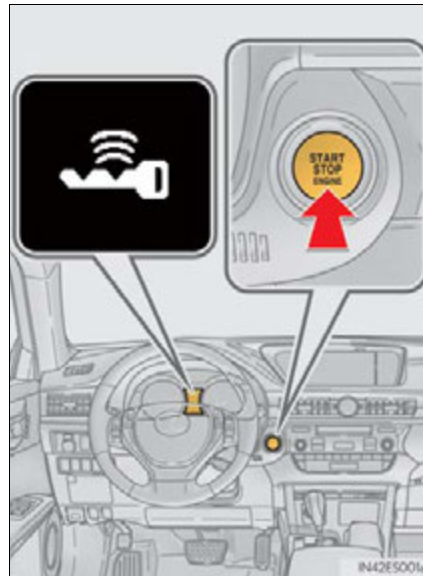

### Stopping the engine

- 1 Stop the vehicle.
- 2 Shift the shift lever to P.
- 3 Set the parking brake. (→P. 226)
- 4 Press the “START STOP ENGINE” switch.
- 5 Release the brake pedal and check that “POWER ON” on the multi-information display is off.

### Changing “START STOP ENGINE” switch modes

Modes can be changed by pressing the “START STOP ENGINE” switch with brake pedal released. (The mode changes each time the switch is pressed.)

#### Off\*

The emergency flashers can be used.  
The multi-information display will not be displayed.

#### ACCESSORY mode

Some electrical components such as the audio system can be used.  
“POWER ON” will be displayed on the multi-information display.

#### IGNITION ON mode

All electrical components can be used.  
“POWER ON” will be displayed on the multi-information display.

\*: If the shift lever is in a position other than P when turning off the engine, the “START STOP ENGINE” switch will be turned to ACCESSORY mode, not to off.

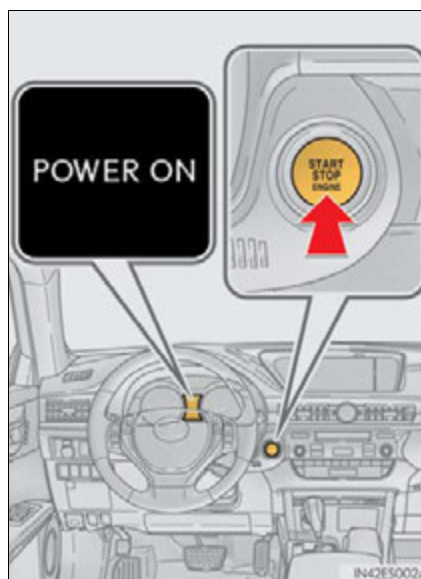

### When stopping the engine with the shift lever in a position other than P

If the engine is stopped with the shift lever in a position other than P, the "START STOP ENGINE" switch will not be turned off but instead be turned to ACCESSORY mode. Perform the following procedure to turn the switch off:

- 1 Check that the parking brake is set.
- 2 Shift the shift lever to P.
- 3 Check that "POWER ON" and "Turn Power OFF" are displayed alternately on the multi-information display and then press the "START STOP ENGINE" switch once.
- 4 Check that "POWER ON" and "Turn Power OFF" on the multi-information display are off.

**■ Auto power off function**

If the vehicle is left in ACCESSORY mode for more than 20 minutes or IGNITION ON mode (the engine is not running) for more than an hour with the shift lever in P, the "START STOP ENGINE" switch will automatically turn off. However, this function cannot entirely prevent 12-volt battery discharge. Do not leave the vehicle with the "START STOP ENGINE" switch in ACCESSORY or IGNITION ON mode for long periods of time when the engine is not running.

**■ Electronic key battery depletion**

→P. 136

**■ Conditions affecting operation**

→P. 132

**■ Notes for the entry function**

→P. 133

**■ If the engine does not start**

- The engine immobilizer system may not have been deactivated. (→P. 82)  
Contact your Lexus dealer.
- Check that the shift lever is securely set in P. The engine may not start if the shift lever is displaced out of P. "Shift to P position to Start" will be displayed on the multi-information display.

**■ Steering lock**

After turning the "START STOP ENGINE" switch off and opening and closing the doors, the steering wheel will be locked due to the steering lock function. Operating the "START STOP ENGINE" switch again automatically cancels the steering lock.



#### ■ When the steering lock cannot be released

“Steering Lock active” will be displayed on the multi-information display.

Check that the shift lever is set in P. Press the “START STOP ENGINE” switch while turning the steering wheel left and right.

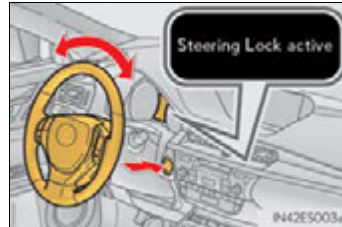

#### ■ Steering lock motor overheating prevention

To prevent the steering lock motor from overheating, the motor may be suspended if the engine is turned on and off repeatedly in a short period of time. In this case, refrain from operating the engine. After about 10 seconds, the steering lock motor will resume functioning.

#### ■ When “Check Access System with Elec. Key” is displayed on the multi-information display

The system may be malfunctioning. Have the vehicle inspected by your Lexus dealer immediately.

#### ■ If the electronic key battery is depleted

→P. 719

#### ■ Operation of the “START STOP ENGINE” switch

- When operating the “START STOP ENGINE” switch, one short, firm press is enough. If the switch is pressed improperly, the engine may not start or the “START STOP ENGINE” switch mode may not change. It is not necessary to press and hold the switch.

- If attempting to restart the engine immediately after turning the “START STOP ENGINE” switch off, the engine may not start in some cases. After turning the “START STOP ENGINE” switch off, please wait a few seconds before restarting the engine.

#### ■ If the smart access system with push-button start has been deactivated in a customized setting

→P. 810

#### ■ Odometer and trip meter display

When the “START STOP ENGINE” switch is turned off, the odometer or trip meter display will extinguish after approximately 30 seconds.

 **CAUTION****■ When starting the engine**

Always start the engine while sitting in the driver's seat. Do not depress the accelerator pedal while starting the engine under any circumstances. Doing so may cause an accident resulting in death or serious injury.

**■ Caution while driving**

If engine failure occurs while the vehicle is moving, do not lock or open the doors until the vehicle reaches a safe and complete stop. Activation of the steering lock in this circumstance may lead to an accident, resulting in death or serious injury.

**■ Stopping the engine in an emergency**

If you want to stop the engine in an emergency while driving the vehicle, press and hold the "START STOP ENGINE" switch for more than 2 seconds, or press it briefly 3 times or more in succession. (→P. 749)

However, do not touch the "START STOP ENGINE" switch while driving except in an emergency. Turning the engine off while driving will not cause loss of steering or braking control, but the power assist to these systems will be lost. This will make it more difficult to steer and brake, so you should pull over and stop the vehicle as soon as it is safe to do so.

 NOTICE**■ To prevent 12-volt battery discharge**

- Do not leave the “START STOP ENGINE” switch in ACCESSORY or IGNITION ON mode for long periods of time without the engine running.
- If “POWER ON” is displayed on the multi-information display, the “START STOP ENGINE” switch is not off. Exit the vehicle after turning the “START STOP ENGINE” switch off.
- Do not stop the engine when the shift lever is in a position other than P. If the engine is stopped in another shift lever position, the “START STOP ENGINE” switch will not be turned off but instead be turned to ACCESSORY mode. If the vehicle is left in ACCESSORY mode, 12-volt battery discharge may occur.

**■ When starting the engine**

- Do not race a cold engine.
- If the engine becomes difficult to start or stalls frequently, have your vehicle checked by your Lexus dealer immediately.

**■ Symptoms indicating a malfunction with the “START STOP ENGINE” switch**

If the “START STOP ENGINE” switch seems to be operating somewhat differently than usual, such as the switch sticking slightly, there may be a malfunction. Contact your Lexus dealer immediately.

## Power (ignition) switch (hybrid vehicles)

Performing the following operations when carrying the electronic key on your person starts the hybrid system or changes “POWER” switch modes.

### Starting the hybrid system

- 1 Check that the parking brake is set.
- 2 Check that the shift lever is set in P.
- 3 Firmly depress the brake pedal.



will be displayed on the multi-information display.

If it is not displayed, the hybrid system cannot be started.

- 4 Press the “POWER” switch.

Continue depressing the brake pedal until the hybrid system is completely started.

The hybrid system can be started from any “POWER” switch mode.

- 5 Check that the “READY” indicator is on.

The vehicle will not move when the “READY” indicator is off.

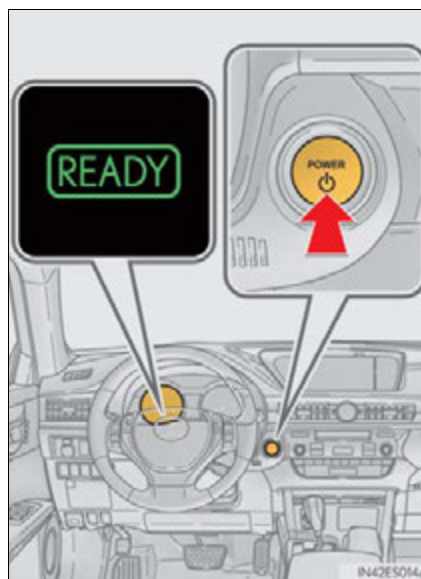

### Stopping the hybrid system

- 1 Stop the vehicle.
- 2 Shift the shift lever to P.
- 3 Set the parking brake. (→P. 226)
- 4 Press the “POWER” switch.
- 5 Release the brake pedal and check that “POWER ON” on the multi-information display is off.

### Changing “POWER” switch modes

Modes can be changed by pressing the “POWER” switch with brake pedal released. (The mode changes each time the switch is pressed.)

#### Off\*

The emergency flashers can be used.

The multi-information display will not be displayed.

#### ACCESSORY mode

Some electrical components such as the audio system can be used.

“POWER ON” will be displayed on the multi-information display.

#### ON mode

All electrical components can be used.

“POWER ON” will be displayed on the multi-information display.

\*: If the shift lever is in a position other than P when turning off the hybrid system, the “POWER” switch will be turned to ACCESSORY mode, not to off.

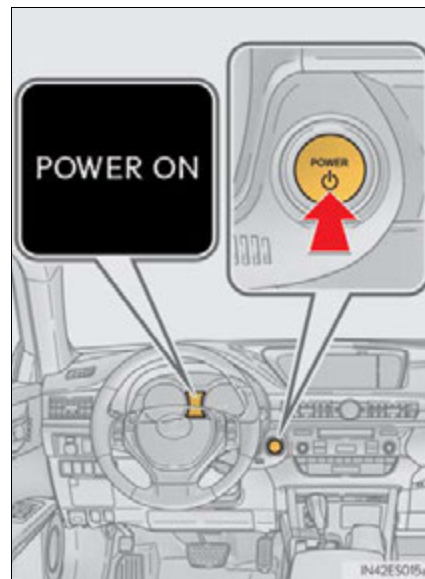

**When stopping the hybrid system with the shift lever in a position other than P**

If the hybrid system is stopped with the shift lever in a position other than P, the "POWER" switch will not be turned off but instead be turned to ACCESSORY mode. Perform the following procedure to turn the switch off:

- 1 Check that the parking brake is set.
- 2 Shift the shift lever to P.
- 3 Check that "POWER ON" and "Turn Power OFF" are displayed alternately on the multi-information display and then press the "POWER" switch once.
- 4 Check that "POWER ON" and "Turn Power OFF" on the multi-information display are off.

**■ Auto power off function**

If the vehicle is left in ACCESSORY mode for more than 20 minutes or ON mode (the hybrid system is not operating) for more than an hour with the shift lever in P, the "POWER" switch will automatically turn off. However, this function cannot entirely prevent 12-volt battery discharge. Do not leave the vehicle with the "POWER" switch in ACCESSORY or ON mode for long periods of time when the hybrid system is not operating.

**■ Sounds and vibrations specific to a hybrid vehicles**

→P. 75

**■ Electronic key battery depletion**

→P. 136

**■ When the ambient temperature is low, such as during winter driving conditions**

It may take time until the "READY" indicator comes on.

**■ Conditions affecting operation**

→P. 132

**■ Notes for the entry function**

→P. 133

**■ If the hybrid system does not start**

- The immobilizer system may not have been deactivated. (→P. 84)  
Contact your Lexus dealer.
- Check that the shift lever is securely set in P. The hybrid system may not start if the shift lever is displaced out of P. "Shift to P position when starting" will be displayed on the multi-information display.

**■ Steering lock**

After turning the "POWER" switch off and opening and closing the doors, the steering wheel will be locked due to the steering lock function. Operating the "POWER" switch again automatically cancels the steering lock.

■ **When the steering lock cannot be released**

“Steering Lock active” will be displayed on the multi-information display.

Check that the shift lever is set in P. Press the “POWER” switch while turning the steering wheel left and right.

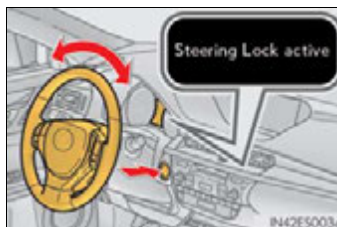

■ **Steering lock motor overheating prevention**

To prevent the steering lock motor from overheating, the motor may be suspended if the hybrid system is turned on and off repeatedly in a short period of time. In this case, refrain from operating the hybrid system. After about 10 seconds, the steering lock motor will resume functioning.

■ **When “Check Access System with Elec. Key” is displayed on the multi-information display**

The system may be malfunctioning. Have the vehicle inspected by your Lexus dealer immediately.

■ **If the “READY” indicator does not come on**

If the “READY” indicator does not come on when you press the “POWER” switch with the shift lever in P and the brake pedal depressed, contact your Lexus dealer immediately.

■ **If the hybrid system is malfunctioning**

→P. 770

■ **If the electronic key battery is depleted**

→P. 719

■ **Operation of the “POWER” switch**

- When operating the “POWER” switch, one short, firm press is enough. If the switch is pressed improperly, the hybrid system may not start or the “POWER” switch mode may not change. It is not necessary to press and hold the switch.

- If attempting to restart the hybrid system immediately after turning the “POWER” switch off, the hybrid system may not start in some cases. After turning the “POWER” switch off, please wait a few seconds before restarting the hybrid system.

■ **If the smart access system with push-button start has been deactivated in a customized setting**

→P. 810



**■ Odometer and trip meter display**

When the "POWER" switch is turned off, the odometer or trip meter display will extinguish after approximately 30 seconds.

**▲ CAUTION****■ When starting the hybrid system**

Always start the hybrid system while sitting in the driver's seat. Do not depress the accelerator pedal while starting the hybrid system under any circumstances. Doing so may cause an accident resulting in death or serious injury.

**■ Caution while driving**

If hybrid system failure occurs while the vehicle is moving, do not lock or open the doors until the vehicle reaches a safe and complete stop. Activation of the steering lock in this circumstance may lead to an accident, resulting in death or serious injury.

**■ Stopping the hybrid system in an emergency**

If you want to stop the hybrid system in an emergency while driving the vehicle, press and hold the "POWER" switch for more than 2 seconds, or press it briefly 3 times or more in succession. (→P. 749)

However, do not touch the "POWER" switch while driving except in an emergency. Turning the hybrid system off while driving will not cause loss of steering or braking control, however, power assist to the steering will be lost. This will make it more difficult to steer smoothly, so you should pull over and stop the vehicle as soon as it is safe to do so.

 NOTICE**■ To prevent 12-volt battery discharge**

- Do not leave the “POWER” switch in ACCESSORY or ON mode for long periods of time without the hybrid system on.
- If “POWER ON” is displayed on the multi-information display, the “POWER” switch is not off. Exit the vehicle after turning the “POWER” switch off.
- Do not stop the hybrid system when the shift lever is in a position other than P. If the hybrid system is stopped in another shift lever position, the “POWER” switch will not be turned off but instead be turned to ACCESSORY mode. If the vehicle is left in ACCESSORY mode, 12-volt battery discharge may occur.

**■ When starting the hybrid system**

- Do not depress the accelerator pedal unnecessarily.
- If the hybrid system becomes difficult to start, have your vehicle checked by your Lexus dealer immediately.

**■ Symptoms indicating a malfunction with the “POWER” switch**

If the “POWER” switch seems to be operating somewhat differently than usual, such as the switch sticking slightly, there may be a malfunction. Contact your Lexus dealer immediately.

## EV drive mode (hybrid vehicles)

In EV drive mode the electric motor (traction motor), powered by the hybrid battery (traction battery), is used to drive the vehicle.

This mode allows you to drive in residential areas early in the morning and late at night, or in indoor parking lots etc. without concern for noises and gas emissions.

However, when the vehicle proximity notification system is active, the vehicle may produce sound.

### Turns EV drive mode on/off

When EV drive mode is turned on, "EV MODE" will be displayed on the multi-information display. Pressing the switch when in EV drive mode will return the vehicle to normal driving (using the gasoline engine and electric motor [traction motor]).

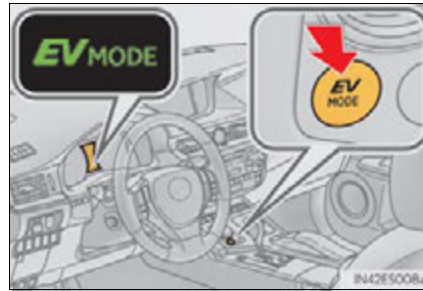

4

Driving

### ■ Situations in which EV drive mode cannot be turned on

It may not be possible to turn EV drive mode on in the following situations. If it cannot be turned on, a buzzer will sound and a message will be shown on the multi-information display.

- The temperature of the hybrid system is high.  
The vehicle has been left in the sun, driven on a hill, driven at high speeds, etc.
- The temperature of the hybrid system is low.  
The vehicle has been left in temperatures lower than about 68°F (20°C) for a long period of time etc.
- The gasoline engine is warming up.
- The hybrid battery (traction battery) is low.  
The remaining battery level indicated in the "Energy Monitor" screen or the multi-information display is low. (→P.112)
- Vehicle speed is about 25 mph (40 km/h) or more.
- The accelerator pedal is depressed firmly.
- The windshield defogger is in use.

■ **Switching to EV drive mode when the gasoline engine is cold**

If the hybrid system is started while the gasoline engine is cold, the gasoline engine will start automatically in order to warm up. In this case, you will become unable to switch to EV drive mode.

After the hybrid system has started and the "READY" indicator has illuminated, press the EV drive mode switch before the gasoline engine starts to switch to EV drive mode.

■ **Automatic cancelation of EV drive mode**

When driving in EV drive mode, the gasoline engine may automatically restart in the following situations. When EV drive mode is canceled, a buzzer will sound and the EV indicator will flash 3 times and go off.

- The hybrid battery (traction battery) becomes low.  
The remaining battery level indicated in the "Energy Monitor" screen or the multi-information display is low. (→P.112)
- Vehicle speed becomes more than about 25 mph (40 km/h).
- The accelerator pedal is depressed firmly.

When it is possible to inform the driver of automatic cancelation in advance, a prior notice screen will appear on the multi-information display.

■ **Possible driving distance when driving in EV drive mode**

EV drive mode's possible driving distance ranges from a few hundred meters to approximately 1.3 mile (2 km). Driving is possible at speeds of less than approximately 25 mph (40 km/h). However, depending on vehicle conditions, there are situations when EV drive mode cannot be used.

(The distance that is possible depends on the hybrid battery [traction battery] level and driving conditions.)

■ **Fuel economy**

Your Lexus is designed to achieve the best possible fuel economy during normal driving (using the gasoline engine and electric motor [traction motor]). Driving in EV drive mode more than necessary may lower fuel economy.

 **CAUTION****■ Caution while driving**

When driving in EV drive mode no engine noise is made. As such, pedestrians, people riding bicycles or other people and vehicles in the surrounding area may not be aware of the vehicle starting off or approaching them. Therefore, take extra care while driving even if the vehicle proximity notification system is active.

## Automatic transmission (gasoline vehicles)

### Shifting the shift lever

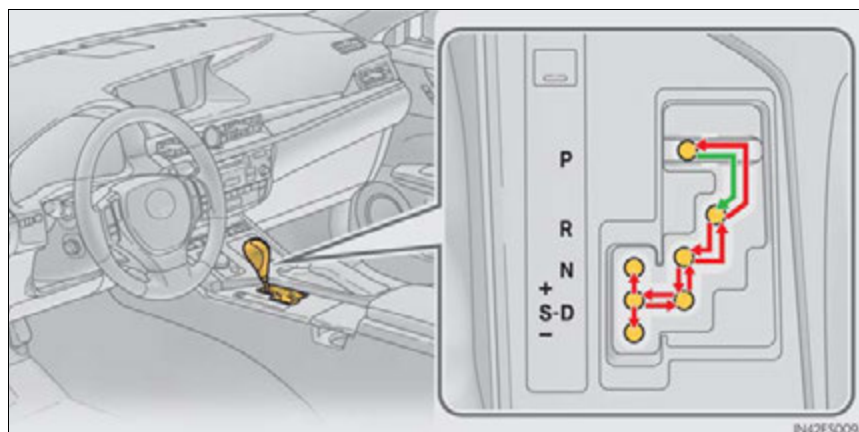

← While the “START STOP ENGINE” switch is in IGNITION ON mode, move the shift lever with the brake pedal depressed.

When shifting the shift lever between P and D, make sure that the vehicle is completely stopped.

### Shift position purpose

Shift position	Objective or function
P	Parking the vehicle/starting the engine
R	Reversing
N	Neutral
D	Normal driving <sup>*1</sup>
S	S mode driving <sup>*2</sup> (→P. 219)

<sup>\*1</sup>: Shifting the shift lever to D allows the system to select a gear suitable for the driving conditions.

Setting the shift lever to D is recommended for normal driving.

<sup>\*2</sup>: Selecting shift ranges using S mode restricts the upper limit of the possible gear ranges, controls engine braking force, and prevents unnecessary upshifting.

### Selecting gears in the S position

When the shift lever is in S, the shift lever can be operated as follows:

- ① Upshifting
- ② Downshifting

The selected shift range, from S1 to S6, will be displayed in the meter.

The initial shift range in S mode is set automatically to S5 or S4 according to vehicle speed. However, the initial shift range may be set to S3 if AI-SHIFT has operated while the shift lever was in D. (→P. 220)

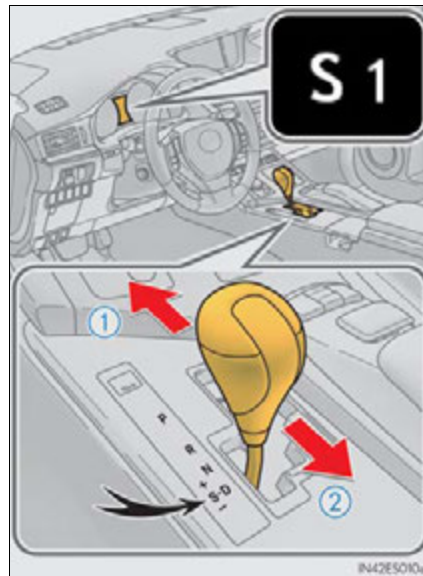

#### ■ Shift ranges and their functions

- Automatically selecting gears between 1 and 6 according to vehicle speed and driving conditions. However, the gear is limited according to selected shift range.
- You can choose from 6 levels of engine braking force.
- A lower shift range will provide greater engine braking force than a higher shift range, and the engine speed will also increase.

**■ S mode**

- When the shift range is S4 or lower, holding the shift lever toward “+” sets the shift range to S6.
- To prevent excessive engine speed, a function was adopted that automatically selects a higher shift range before the engine speed becomes too high.
- To protect the automatic transmission, a function is adopted that automatically selects a higher shift range when the fluid temperature is high.

**■ When driving with cruise control activated**

Even when performing the following actions with the intent of enabling engine braking, the engine brake will not operate in the S mode, even when downshifting to 5 or 4. (→P. 248)

**■ Downshifting restrictions warning buzzer**

To help ensure safety and driving performance, downshifting operation may sometimes be restricted. In some circumstances, downshifting may not be possible even when the shift lever is operated. (A buzzer will sound twice.)

**■ If the S indicator does not come on even after shifting the shift lever to S**

This may indicate a malfunction in the automatic transmission system. Have the vehicle inspected by your Lexus dealer immediately.  
(In this situation, the transmission will operate in the same manner as when the shift lever is in D.)

**■ If the shift lever cannot be shifted from P**

→P. 809

**■ AI-SHIFT**

AI-SHIFT automatically selects the suitable gear according to driver performance and driving conditions.

AI-SHIFT automatically operates when the shift lever is in D. (Shifting the shift lever to S cancels the function.)

**⚠ CAUTION****■ When driving on slippery road surfaces**

Do not accelerate or shift gears suddenly.  
Sudden changes in engine braking may cause the vehicle to spin or skid, resulting in an accident.



## Hybrid transmission (hybrid vehicles)

### Shifting the shift lever

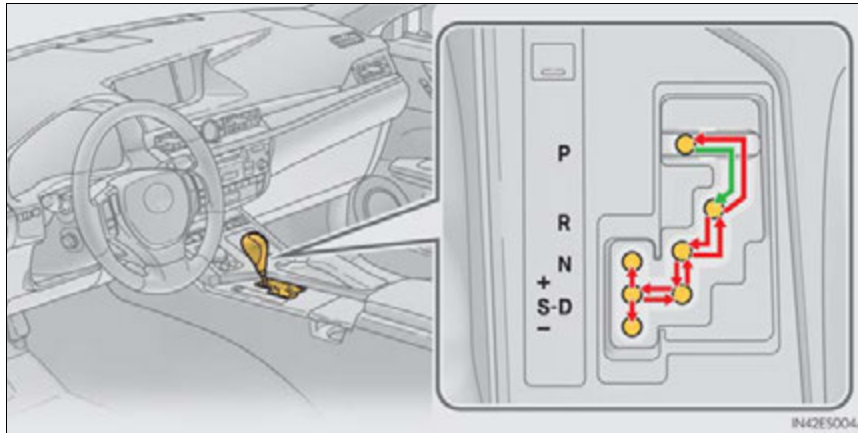

← While the “POWER” switch is in ON mode, move the shift lever with the brake pedal depressed.

When shifting the shift lever between P and D, make sure that the vehicle is completely stopped.

4

Driving

### Shift position purpose

Shift position	Objective or function
P	Parking the vehicle/starting the hybrid system
R	Reversing
N	Neutral
D	Normal driving <sup>*1</sup>
S	S mode driving <sup>*2</sup> (→P. 222)

<sup>\*1</sup>: To improve fuel efficiency and reduce noises, set the shift lever in D for normal driving.

<sup>\*2</sup>: By selecting shift ranges using S mode, you can control engine braking forces.

### Selecting shift ranges in the S position

To enter S mode, shift the shift lever to S. Shift ranges can then be selected by operating the shift lever, allowing you to drive in the shift range of your choosing.

- ① Upshifting
- ② Downshifting

The selected shift range, from S1 to S6, will be displayed in the meter.

The initial shift range in S mode is automatically set to S4 or S5 according to vehicle speed.

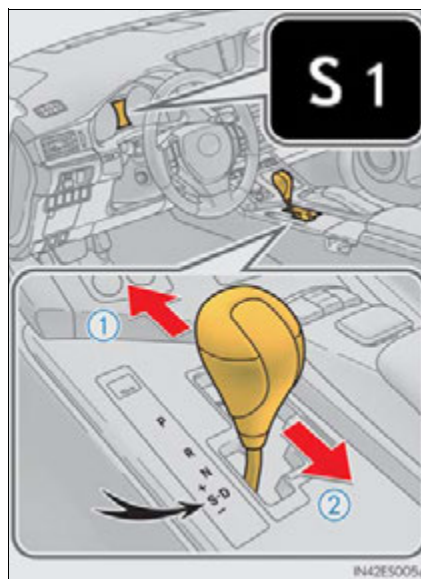

#### ■ Shift ranges and their functions

- You can choose from 6 levels of engine braking force.
- A lower shift range will provide greater engine braking force than a higher shift range, and the engine revolutions will also increase.
- If you accelerate while in ranges S1 to S4, the shift range may automatically range up in accordance with the vehicle's speed.

**■ S mode**

- When the shift range is S4 or lower, holding the shift lever toward “+” sets the shift range to S6.
- To prevent excessive engine speed, a function was adopted that automatically selects a higher shift range before the engine speed becomes too high.

**■ When driving with cruise control activated**

Even when performing the following actions with the intent of enabling engine braking, the engine brake will not operate in the S mode, even when downshifting to 5 or 4. (→P. 248)

**■ Downshifting restrictions warning buzzer**

To help ensure safety and driving performance, downshifting operation may sometimes be restricted. In some circumstances, downshifting may not be possible even when the shift lever is operated. (A buzzer will sound twice.)

**■ If the S indicator does not come on even after shifting the shift lever to S**

This may indicate a malfunction in the automatic transmission system. Have the vehicle inspected by your Lexus dealer immediately.  
(In this situation, the transmission will operate in the same manner as when the shift lever is in D.)

**■ If the shift lever cannot be shifted from P**

→P. 809

**■ AI-SHIFT**

AI-SHIFT automatically selects the suitable gear according to driver performance and driving conditions.

AI-SHIFT automatically operates when the shift lever is in the D position. (Shifting the shift lever to the S position cancels the function.)

 CAUTION**■ When driving on slippery road surfaces**

Do not accelerate or shift gears suddenly.  
Sudden changes in engine braking may cause the vehicle to spin or skid, resulting in an accident.

 NOTICE**■ Hybrid battery (traction battery) charge**

If the shift lever is in N, the hybrid battery (traction battery) will not be charged even when the engine is running. Therefore, if the vehicle is left with the shift lever in N for a long period of time, the hybrid battery (traction battery) will discharge, and this may result in the vehicle not being able to start.

## Turn signal lever

### Operating instructions

- ① Right turn
- ② Lane change to the right (move the lever partway and then release it)  
The right hand signals will flash 3 times.
- ③ Lane change to the left (move the lever partway and then release it)  
The left hand signals will flash 3 times.
- ④ Left turn

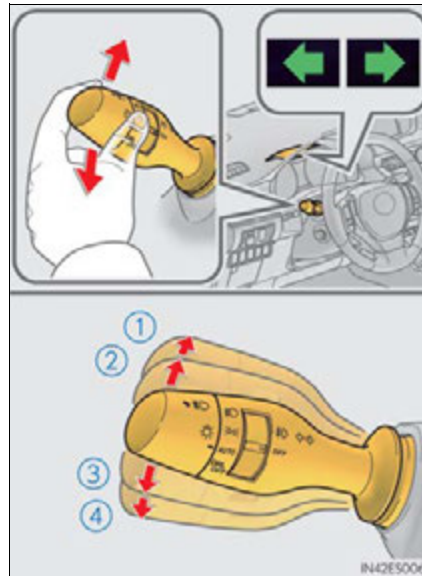

4

Driving

#### ■ Turn signals can be operated when

The "START STOP ENGINE" <"POWER"> switch is in IGNITION ON <ON> mode.

#### ■ If the indicator flashes faster than usual

Check that a light bulb in the front or rear turn signal lights has not burned out.

#### ■ If the turn signals stop flashing before a lane change has been performed

Operate the lever again.

#### ■ To discontinue flashing of the turn signals during a lane change

Operate the lever in the opposite direction.

#### ■ Customization

The number of times the turn signals flash during a lane change can be changed. (→P. 862)

## Parking brake

To set the parking brake, fully depress the parking brake pedal with your left foot while depressing the brake pedal with your right foot. (Depressing the pedal again releases the parking brake.)



### ■ Usage in winter time

→P. 331

### ⚠ NOTICE

#### ■ Before driving

Fully release the parking brake.

Driving the vehicle with the parking brake set will lead to brake components overheating, which may affect braking performance and increase brake wear.

## Horn

To sound the horn, press on or close to the  mark.

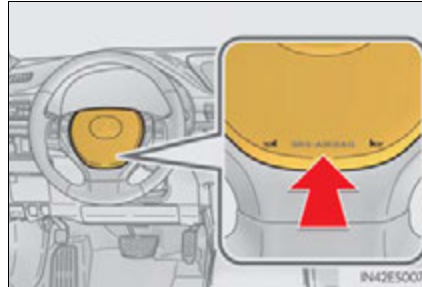

### ■ After adjusting the steering wheel (manual adjustment type)

Make sure that the steering wheel is securely locked.



The horn may not sound if the steering wheel is not securely locked. (→P. 166)

## Headlight switch

The headlights can be operated manually or automatically.

### Operating instructions

Turning the end of the lever turns on the lights as follows:

- ①  The side marker, daytime running, tail, license plate and instrument panel lights turn on.
- ②  The headlights, parking and all lights listed above (except daytime running lights) turn on.
- ③ **AUTO** The headlights, daytime running lights and all the lights listed above turn on and off automatically.  
(When the "START STOP ENGINE" <"POWER"> switch is in IGNITION ON <ON> mode.)
- ④  Off  
(U.S.A.)
  - The daytime running lights  
(Canada) turn on.

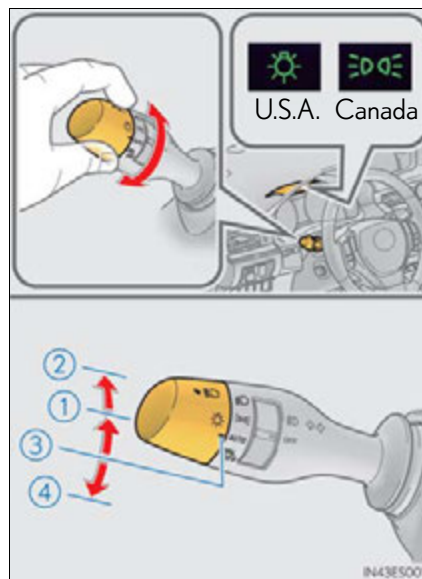



### Turning on the high beam headlights

- ① With the headlights on, push the lever away from you to turn on the high beams.

Pull the lever toward you to the center position to turn the high beams off.

- ② Pull the lever toward you and release it to flash the high beams once.

You can flash the high beams with the headlights on or off.

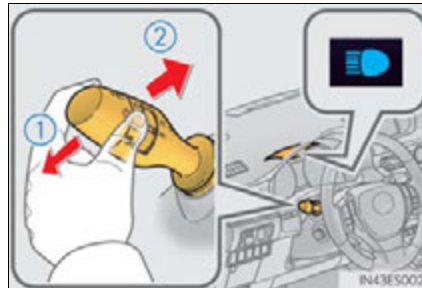

■ **Daytime running light system**

To make your vehicle more visible to other drivers, the parking lights turn on automatically (at an increased intensity) whenever the engine <hybrid system> is started and the parking brake is released. Daytime running lights are not designed for use at night.

For the U.S.A.: Daytime running lights can be turned off by operating the switch.

■ **Headlight control sensor**

The sensor may not function properly if an object is placed on the sensor, or anything that blocks the sensor is affixed to the windshield.

Doing so interferes with the sensor detecting the level of ambient light and may cause the automatic headlight system to malfunction.

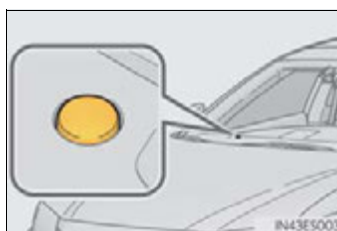

■ **Automatic light off system**

When the light switch is in AUTO, ➤⦿ or ➤⦿ : The headlights and tail lights turn off 30 seconds after the "START STOP ENGINE" <"POWER"> switch is turned to ACCESSORY mode or turned off and a door is opened and all of the doors and trunk are closed. (The lights turn off immediately if ➤ on the key is pressed twice after all the doors are closed.)

To turn the lights on again, turn the "START STOP ENGINE" <"POWER"> switch to IGNITION ON <ON> mode, or turn the light switch off once and then back to ➤⦿ or ➤⦿ .

If any of the doors or trunk lid is kept open, the lights automatically turn off after 20 minutes.

**■ Light reminder buzzer**

A buzzer sounds when the "START STOP ENGINE" <"POWER"> switch is turned off or turned to ACCESSORY mode and the driver's door is opened while the lights are turned on.

**■ Automatic headlight leveling system (if equipped)**

The level of the headlights is automatically adjusted according to the number of passengers and the loading condition of the vehicle to ensure that the headlights do not interfere with other road users.

**■ Customization**

Settings (e.g. light sensor sensitivity) can be changed.  
(Customizable features: →P. 862)

 **NOTICE****■ To prevent 12-volt battery discharge**

Do not leave the lights on longer than necessary when the engine is not running <hybrid system is not operating>.

## Automatic High Beam\*

The Automatic High Beam uses an in-vehicle camera sensor to assess the brightness of streetlights, the lights of oncoming and preceding vehicles, etc., and automatically turns high beam on or off as necessary.

### Activating the Automatic High Beam system

- 1 Push the lever away from you with the headlight switch in AUTO or  position.

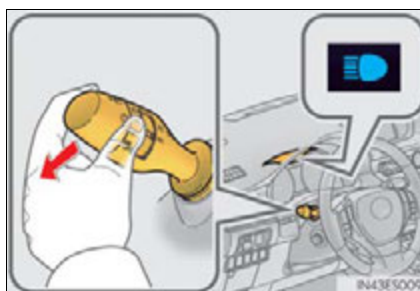

- 2 Press the Automatic High Beam switch.

The Automatic High Beam indicator will come on when the headlights are turned on automatically to indicate that the system is active.

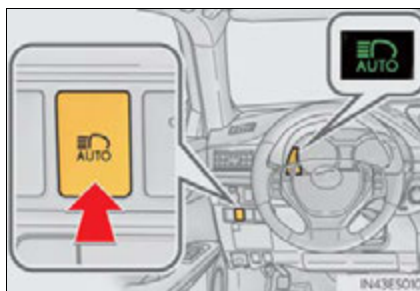

\*: If equipped

### High beam automatic turning on or off conditions

When all of the following conditions are fulfilled, high beam will be automatically turned on:

- Vehicle speed is above approximately 21 mph (34 km/h).
- The area ahead of the vehicle is dark.
- There are no oncoming or preceding vehicles with headlights or tail lights turned on.
- There are few streetlights on the road ahead.

If any of the following conditions are fulfilled, high beam will be automatically turned off:

- Vehicle speed drops below approximately 17 mph (27 km/h).
- The area ahead of the vehicle is not dark.
- Oncoming or preceding vehicles have headlights or tail lights turned on.
- There are many streetlights on the road ahead.

### Turning the high beam on/off manually

#### ■ Switching to low beam

Pull the lever to original position.

The Automatic High Beam indicator will turn off.

Push the lever away from you to activate the Automatic High Beam system again.

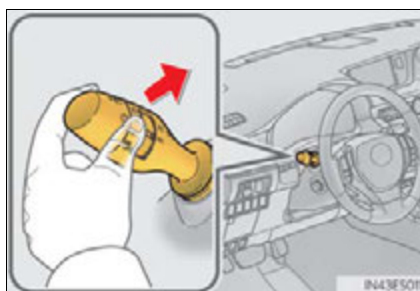

#### ■ Switching to high beam

Press the Automatic High Beam switch.

The Automatic High Beam indicator will turn off and the high beam indicator will turn on.

Press the switch to activate the Automatic High Beam system again.

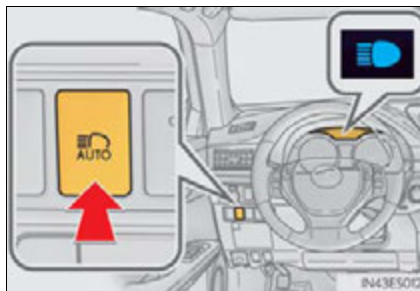

**■ The Automatic High Beam can be operated when**

The "START STOP ENGINE" <"POWER"> switch is in IGNITION ON <ON> mode.

**■ Camera sensor detection information**

- High beam may not be automatically turned off in the following situations:
  - When oncoming vehicles suddenly appear from a curve
  - When the vehicle is cut in front of by another
  - When oncoming or preceding vehicles are hidden from sight due to repeated curves, road dividers or roadside trees
  - When oncoming vehicles appear from the faraway lane on wide road
  - When oncoming or preceding vehicles have no lights
- High beam may be turned off if an oncoming vehicle that is using fog lights without using the headlights is detected.
- House lights, street lights, red traffic signals, and illuminated billboards or signs may cause the high beam to turn off.
- The following factors may affect the amount of time taken to turn high beam on or off:
  - The brightness of headlights, fog lights, and tail lights of oncoming and preceding vehicles
  - The movement and direction of oncoming and preceding vehicles
  - When a oncoming or preceding vehicle only has operational lights on one side
  - When a oncoming or preceding vehicle is a two-wheeled vehicle
  - The condition of the road (gradient, curve, condition of the road surface etc.)
  - The number of passengers and amount of luggage
- High beam may be turned on or off when unexpected by the driver.

- In the situations below, the system may not be able to correctly detect the surrounding brightness levels, and may flash or expose nearby pedestrians to the high beam. Therefore, you should consider turning the high beams on or off manually rather than relying on the Automatic High Beam system.
  - In bad weather (rain, snow, fog, sandstorms etc.)
  - The windshield is obscured by fog, mist, ice, dirt etc.
  - The windshield is cracked or damaged.
  - The camera sensor is deformed or dirty.
  - The camera sensor temperature is extremely high.
  - Surrounding brightness levels are equal to those of headlights, tail lights or fog lights.
  - Vehicles ahead have headlights or tail lights that are either switched off, dirty, are changing color, or are not aimed properly.
  - When driving through an area of intermittently changing brightness and darkness.
  - When frequently and repeatedly driving ascending/descending roads, or roads with rough, bumpy or uneven surfaces (such as stone-paved roads, gravel tracks etc.).
  - When frequently and repeatedly taking curves or driving on a winding road.
  - There is a highly reflective object ahead of the vehicle, such as a sign or a mirror.
  - The back of a vehicle ahead is highly reflective, such as a container on a truck.
  - The vehicle's headlights are damaged or dirty, or are not aimed properly.
  - The vehicle is listing or tilting, due to a flat tire, a trailer being towed etc.
  - The high beam and low beam are repeatedly being switched between in an abnormal manner.
  - The driver believes that the high beam may be causing problems or distress to other drivers or pedestrians nearby.

#### ■ Temporarily lowering sensor sensitivity

The sensitivity of the sensor can be temporarily lowered.

- 1 Turn the "START STOP ENGINE" <"POWER"> switch off while the following conditions are met.
  - The headlight switch is in **AUTO** or **☰D**.
  - The headlight switch lever is in high beam position.
  - Automatic High Beam switch is on.
- 2 Turn the "START STOP ENGINE" <"POWER"> switch to IGNITION ON <ON> mode.
- 3 Within 5 seconds after 2, repeat pulling the headlight switch lever to the original position then pushing it to the high beam position quickly 9 times, then leave the lever in high beam position.

Automatic High Beam (headlights) may turn on even the vehicle is stopped.



**⚠ CAUTION****■ Limitations of the Automatic High Beam**

Do not rely on the Automatic High Beam. Always drive safely, taking care to observe your surroundings and turning high beam on or off manually if necessary.

**⚠ NOTICE****■ Notes when using the Automatic High Beam system**

Observe the following to ensure that the Automatic High Beam functions correctly.

- Do not touch the camera sensor.
- Do not subject the camera sensor to a strong impact.
- Do not disassemble the camera sensor.
- Do not spill liquid onto the camera sensor.
- Do not apply window tinting or stickers to the camera sensor or the area of windshield near the camera sensor.
- Do not place items on the dashboard. There is a possibility that the camera sensor will mistake items reflected in the windshield for streetlights, the headlights of other vehicles, etc.
- Do not install a parking tag or any other accessories near or around the camera sensor.
- Do not overload the vehicle.
- Do not modify the vehicle.
- Do not replace windshield with non-genuine windshield.  
Contact your Lexus dealer.
- Do not replace headlights with non-genuine headlights.  
Contact your Lexus dealer.

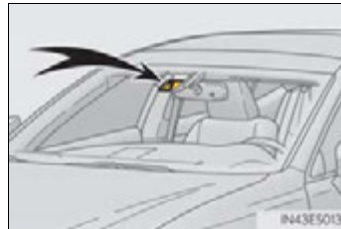

## Fog light switch

The fog lights secure excellent visibility in difficult driving conditions, such as in rain and fog.

- ① OFF (U.S.A.) or ○ (Canada)  
Turns the fog lights off
- ②  Turns the fog lights on

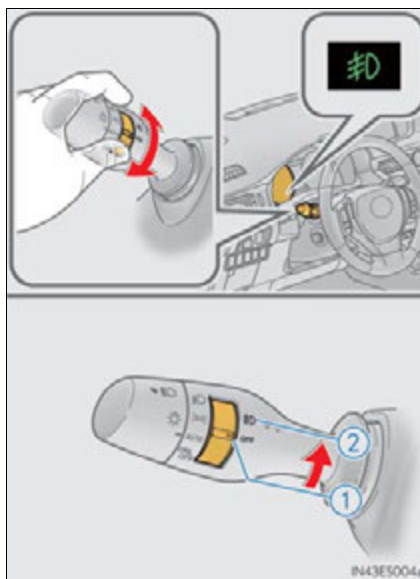

- Fog lights can be used when  
The headlights are on in low beam.

## Windshield wipers and washer

### Operating the wiper lever

The wiper operation is selected by moving the lever as follows.

► Intermittent windshield wipers with interval adjuster

- ① Temporary operation
- ② Intermittent operation
- ③ Low speed operation
- ④ High speed operation

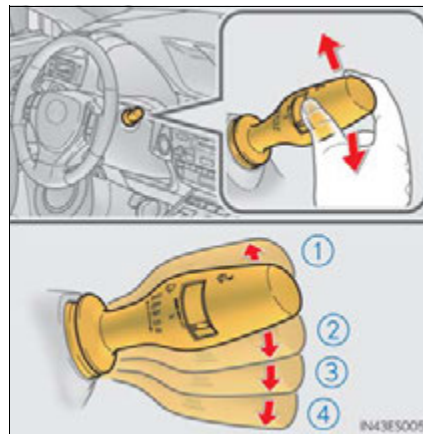

Wiper intervals can be adjusted when intermittent operation is selected.

- ⑤ Increases the intermittent windshield wiper frequency
- ⑥ Decreases the intermittent windshield wiper frequency

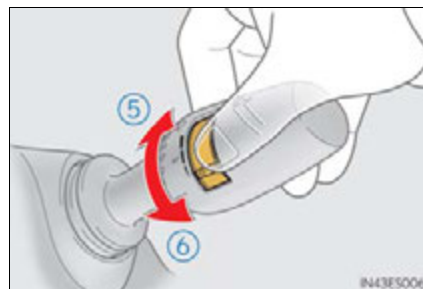

- ⑦ Washer/wiper dual operation

Wipers will automatically operate a couple of times after the washer squirts.

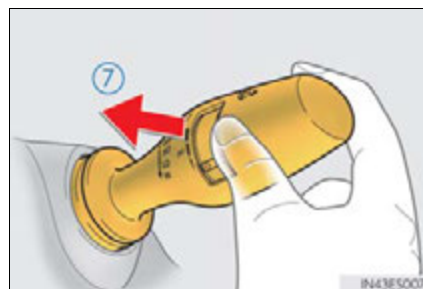

► Rain-sensing windshield wipers

- ① Temporary operation
- ② Rain-sensing wiper operation (AUTO)
- ③ Low speed operation
- ④ High speed operation

When AUTO is selected, the wipers will operate automatically when the sensor detects falling rain. The system automatically adjusts wiper timing in accordance with rain volume and vehicle speed.

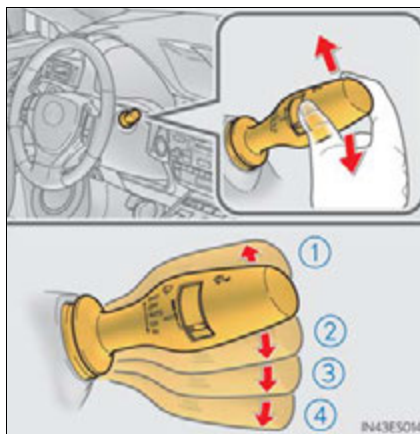

The sensor sensitivity can be adjusted when AUTO is selected.

- ⑤ Increases the sensitivity
- ⑥ Decreases the sensitivity

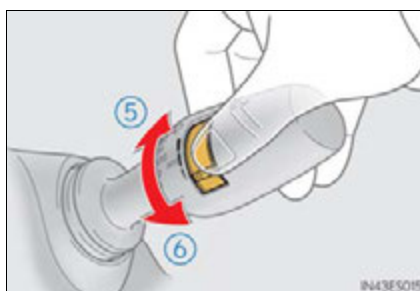

- ⑦ Washer/wiper dual operation
- Wipers will automatically operate a couple of times after the washer squirts.

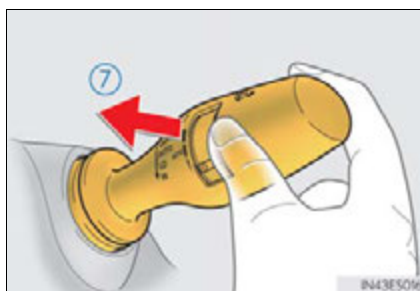

■ The windshield wiper and washer can be operated when

The "START STOP ENGINE" <"POWER"> switch is in IGNITION ON <ON> mode.

#### ■ Raindrop sensor (vehicles with rain-sensing windshield wipers)

- The raindrop sensor judges the amount of raindrops.

An optical sensor is adopted. It may not operate properly when sunlight from the rising or setting of the sun intermittently strikes the windshield, or if bugs etc. are present on the windshield.

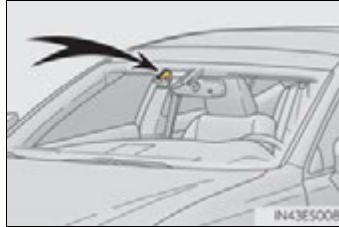

- If the wiper switch is turned to AUTO position while the "START STOP ENGINE" <"POWER"> switch is in IGNITION ON <ON> mode, the wipers will operate once to show that AUTO mode is activated.
- When the sensor sensitivity ring is turned toward high while in AUTO mode, the wipers will operate once to indicate that the sensor sensitivity is enhanced.
- If the temperature of the raindrop sensor is 185°F (85°C) or higher, or -22°F (-30°C) or lower, automatic operation may not occur. In this case, operate the wipers in any mode other than AUTO mode.

#### ■ If no windshield washer fluid sprays

Check that the washer nozzles are not blocked if there is washer fluid in the windshield washer fluid reservoir.

#### ⚠ CAUTION

##### ■ Caution regarding the use of windshield wipers in AUTO mode (vehicles with rain-sensing windshield wipers)

The windshield wipers may operate unexpectedly if the sensor is touched or the windshield is subject to vibration in AUTO mode. Take care that your fingers or anything else do not become caught in the windshield wipers.

##### ■ Caution regarding the use of washer fluid

When it is cold, do not use the washer fluid until the windshield becomes warm. The fluid may freeze on the windshield and cause low visibility. This may lead to an accident, resulting in death or serious injury.

 NOTICE

■ **When the windshield is dry**

Do not use the wipers, as they may damage the windshield.

■ **When there is no washer fluid spray from the nozzle**

Damage to the washer fluid pump may be caused if the lever is pulled toward you and held continually.

■ **When a nozzle becomes blocked**

In this case, contact your Lexus dealer.

Do not try to clear it with a pin or other object. The nozzle will be damaged.

■ **When standing the windshield wipers up**

Raise the wipers in line with the windshield. (→P. 333)

Failure to do so may result in damage to the wipers and/or the hood.

## Opening the fuel tank cap

Perform the following steps to open the fuel tank cap:

### Before refueling the vehicle

- Close all the doors and windows, and turn the “START STOP ENGINE” <“POWER”> switch off.
- Confirm the type of fuel.

### ■ Fuel types

Unleaded gasoline (Octane rating 87 [Research Octane Number 91] or higher)

 CAUTION**■ When refueling the vehicle**

Observe the following precautions while refueling the vehicle. Failure to do so may result in death or serious injury.

- After exiting the vehicle and before opening the fuel door, touch an unpainted metal surface to discharge any static electricity. It is important to discharge static electricity before refueling because sparks resulting from static electricity can cause fuel vapors to ignite while refueling.
- Always hold the grips on the fuel tank cap and turn it slowly to remove it. A whooshing sound may be heard when the fuel tank cap is loosened. Wait until the sound cannot be heard before fully removing the cap. In hot weather, pressurized fuel may spray out the filler neck and cause injury.
- Do not allow anyone that has not discharged static electricity from their body to come close to an open fuel tank.
- Do not inhale vaporized fuel. Fuel contains substances that are harmful if inhaled.
- Do not smoke while refueling the vehicle. Doing so may cause the fuel to ignite and cause a fire.
- Do not return to the vehicle or touch any person or object that is statically charged. This may cause static electricity to build up, resulting in a possible ignition hazard.

**■ When refueling**

Observe the following precautions to prevent fuel overflowing from the fuel tank:

- Securely insert the fuel nozzle into the fuel filler neck.
- Stop filling the tank after the fuel nozzle automatically clicks off.
- Do not top off the fuel tank.

 NOTICE**■ Refueling**

Do not spill fuel during refueling.

Doing so may damage the vehicle, such as causing the emission control system to operate abnormally or damaging fuel system components or the vehicle's painted surface.



### Opening the fuel tank cap

- 1 Press the opener switch to open the fuel filler door.

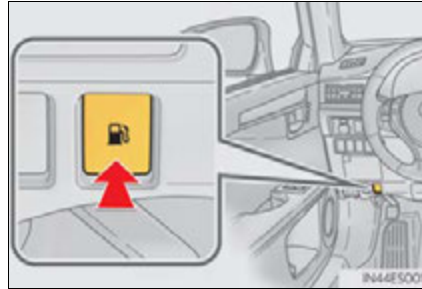

- 2 Turn the fuel tank cap slowly to open.

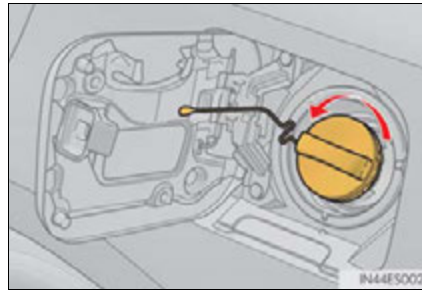

- 3 Hang the fuel tank cap on the back of the fuel filler door.

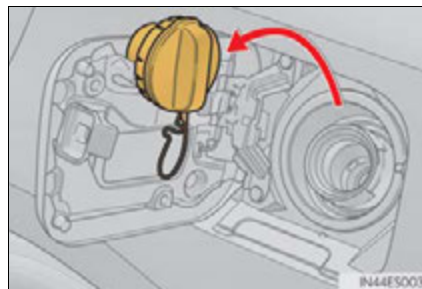

■ When the fuel filler door cannot be opened by pressing the inside switch

Remove the cover inside the trunk and pull the lever.

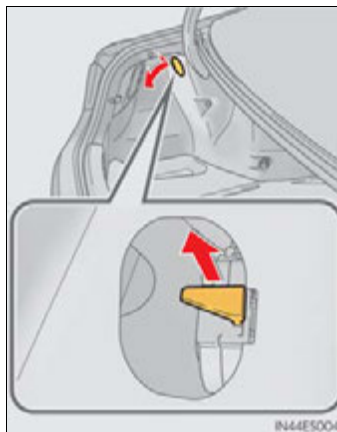

### Closing the fuel tank cap

After refueling, turn the fuel tank cap until you hear a click. Once the cap is released, it will turn slightly in the opposite direction.

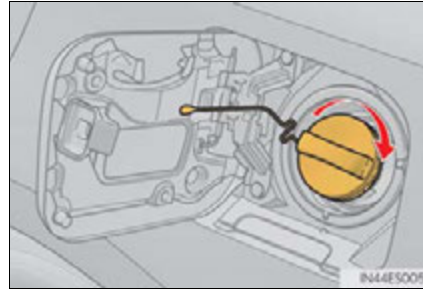

### CAUTION

#### ■ When replacing the fuel tank cap

Do not use anything but a genuine Lexus fuel tank cap designed for your vehicle. Doing so may cause a fire or other incident which may result in death or serious injury.

## Cruise control\*

### Summary of functions

Use the cruise control to maintain a set speed without depressing the accelerator pedal.

- ① Indicators
- ② Cruise control switch

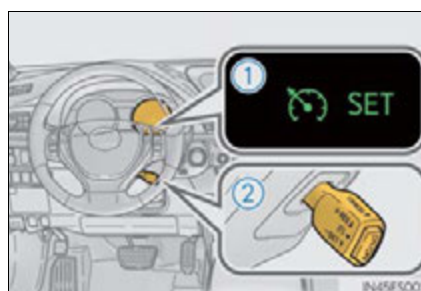

### Setting the vehicle speed

- ① Press the “ON/OFF” button to activate the cruise control.

Cruise control indicator will come on.

Press the button again to deactivate the cruise control.

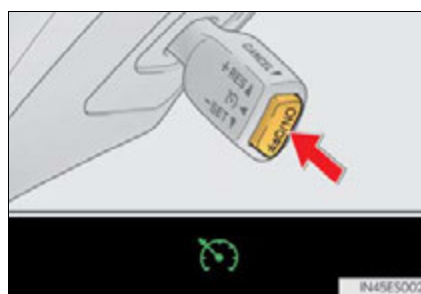

- ② Accelerate or decelerate the vehicle to the desired speed, and push the lever down to set the speed.

“SET” indicator will come on.

The vehicle speed at the moment the lever is released becomes the set speed.

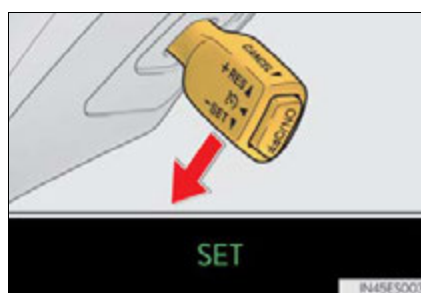

\*: If equipped

### Adjusting the set speed

To change the set speed, operate the lever until the desired set speed is obtained.

- ① Increases the speed
- ② Decreases the speed

Fine adjustment: Momentarily move the lever in the desired direction.

Large adjustment: Hold the lever in the desired direction.

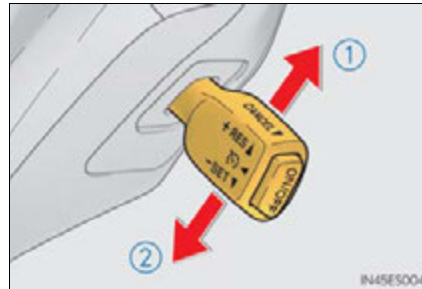

The set speed will be increased or decreased as follows:

Fine adjustment: By approximately 1 mph (1.6 km/h) each time the lever is operated.

Large adjustment: The set speed can be increased or decreased continually until the lever is released.

### Canceling and resuming the constant speed control

- ① Pulling the lever toward you cancels the constant speed control.  
The speed setting is also canceled when the brakes are applied.
- ② Pushing the lever up resumes the constant speed control.

Resuming is available when the vehicle speed is more than approximately 25 mph (40 km/h).

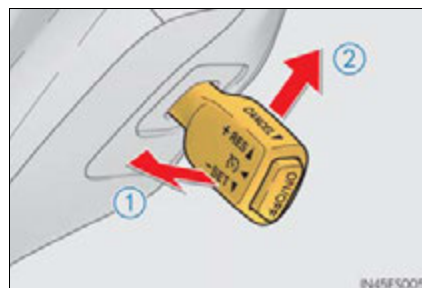

■ **Cruise control can be set when**

- The shift lever is in D or range S4 or higher of S has been selected.
- Vehicle speed is above approximately 25 mph (40 km/h).

■ **Accelerating after setting the vehicle speed**

- The vehicle can be accelerated normally. After acceleration, the set speed resumes.
- Even without canceling the cruise control, the set speed can be increased by first accelerating the vehicle to the desired speed and then pushing the lever down to set the new speed.

■ **Automatic cruise control cancelation**

Cruise control will stop maintaining the vehicle speed in any of the following situations.

- Actual vehicle speed falls more than approximately 10 mph (16 km/h) below the preset vehicle speed.  
At this time, the memorized set speed is not retained.
- Actual vehicle speed is below approximately 25 mph (40 km/h).
- VSC is activated.

■ **If the warning message for the cruise control is shown on the multi-information display**

Press the "ON/OFF" button once to deactivate the system, and then press the button again to reactivate the system.

If the cruise control speed cannot be set or if the cruise control cancels immediately after being activated, there may be a malfunction in the cruise control system. Have the vehicle inspected by your Lexus dealer.

 **CAUTION****■ To avoid operating the cruise control by mistake**

Switch the cruise control off using the “ON/OFF” button when not in use.

**■ Situations unsuitable for cruise control**

Do not use cruise control in any of the following situations.

Doing so may result in loss of control and could cause an accident resulting in death or serious injury.

- In heavy traffic
- On roads with sharp bends
- On winding roads
- On slippery roads, such as those covered with rain, ice or snow
- On steep hills  
Vehicle speed may exceed the set speed when driving down a steep hill.
- During emergency towing

## Dynamic radar cruise control\*

### Summary of functions

Dynamic radar cruise control supplements conventional cruise control with a vehicle-to-vehicle distance control. In vehicle-to-vehicle distance control mode, the vehicle automatically accelerates or decelerates in order to maintain a set following distance from vehicles ahead.

- ① Vehicle-to-vehicle distance button
- ② Display
- ③ Set speed
- ④ Indicators
- ⑤ Cruise control switch

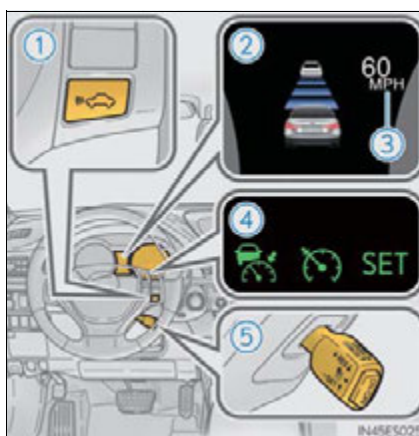

\*: If equipped



### Setting the vehicle speed (vehicle-to-vehicle distance control mode)

- 1 Press the "ON/OFF" button to activate the cruise control.

Radar cruise control indicator will come on.

Press the button again to deactivate the cruise control.



- 2 Accelerate or decelerate the vehicle to the desired speed, and push the lever down to set the speed.

"SET" indicator will come on.

The vehicle speed at the moment the lever is released becomes the set speed.

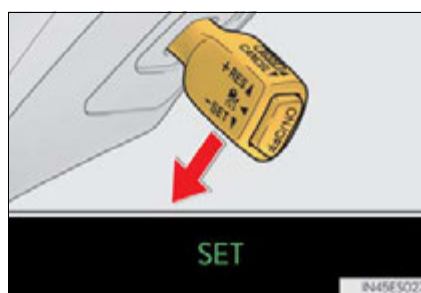

### Adjusting the set speed

To change the set speed, operate the lever until the desired set speed is displayed.

① Increases the speed

② Decreases the speed

Fine adjustment: Momentarily move the lever in the desired direction.

Large adjustment: Hold the lever in the desired direction.

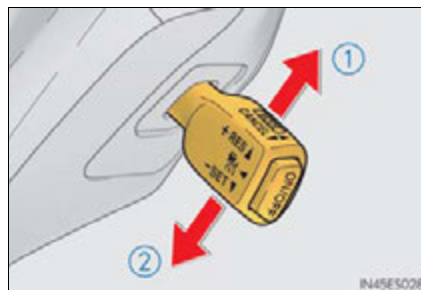

In the vehicle-to-vehicle distance control mode, the set speed will be increased or decreased as follows:

- When the set speed is shown in "MPH"
  - Fine adjustment: By approximately 1 mph (1.6 km/h) each time the lever is operated
  - Large adjustment: By approximately 5 mph (8 km/h) for each 0.75 seconds the lever is held
- When the set speed is shown in "km/h"
  - Fine adjustment: By approximately 0.6 mph (1 km/h) each time the lever is operated
  - Large adjustment: By approximately 3.1 mph (5 km/h) for each 0.75 seconds the lever is held

In the constant speed control mode (→P. 259), the set speed will be increased or decreased as follows:

- Fine adjustment: By approximately 1 mph (1.6 km/h) each time the lever is operated
- Large adjustment: The set speed can be increased or decreased continually until the lever is released.

### Changing the vehicle-to-vehicle distance

Pressing the button changes the vehicle-to-vehicle distance as follows:

- ① Long
- ② Medium
- ③ Short

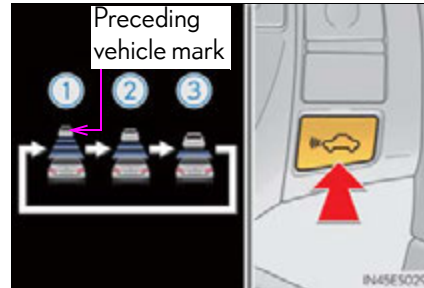

The vehicle-to-vehicle distance is set automatically to long mode when the "START STOP ENGINE" <"POWER"> switch is turned to IGNITION ON <ON> mode.

If a vehicle is running ahead of you, the preceding vehicle mark will also be displayed.

### Vehicle-to-vehicle distance settings

Select a distance from the table below. Note that the distances shown correspond to a vehicle speed of 50 mph (80 km/h). Vehicle-to-vehicle distance increases/decreases in accordance with vehicle speed.

Distance options	Vehicle-to-vehicle distance
Long	Approximately 160 ft. (50 m)
Medium	Approximately 130 ft. (40 m)
Short	Approximately 100 ft. (30 m)

### Canceling and resuming the speed control

- ① Pulling the lever toward you cancels the cruise control.

The speed setting is also canceled when the brakes are applied.

- ② Pushing the lever up resumes the cruise control and returns vehicle speed to the set speed.

Resuming is available when the vehicle speed is more than approximately 25 mph (40 km/h).

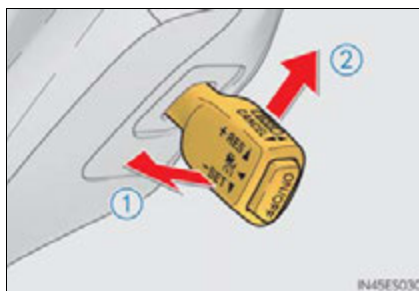

### Driving in vehicle-to-vehicle distance control mode

This mode employs a radar sensor to detect the presence of vehicles up to approximately 400 ft. (120 m) ahead, determines the current vehicle-to-vehicle following distance, and operates to maintain a suitable following distance from the vehicle ahead.

Note that vehicle-to-vehicle distance will close in when traveling on long downhill slopes.

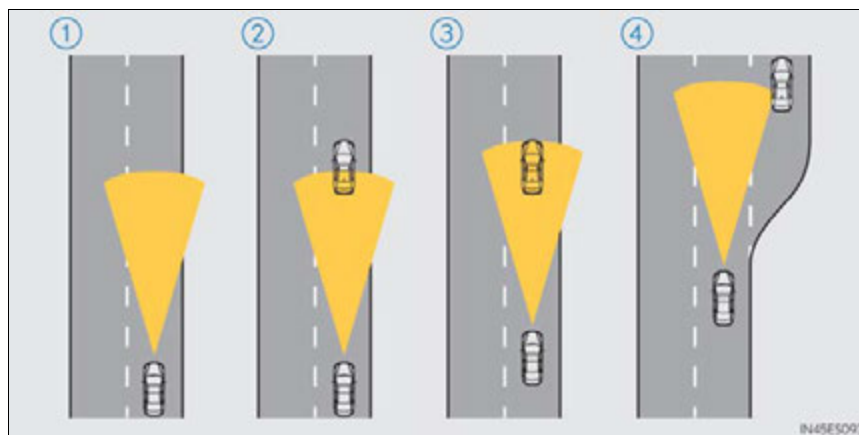

- ① Example of constant speed cruising  
When there are no vehicles ahead

The vehicle travels at the speed set by the driver. The desired vehicle-to-vehicle distance can also be set by operating the vehicle-to-vehicle distance control.

- ② Example of deceleration cruising  
When the vehicle ahead is driving slower than the set speed

When a vehicle is detected running ahead of you, the system automatically decelerates your vehicle. When a greater reduction in vehicle speed is necessary, the system applies the brakes. A warning tone warns you when the system cannot decelerate sufficiently to prevent your vehicle from closing in on the vehicle ahead.

③ Example of follow-up cruising

When following a vehicle driving slower than the set speed

The system continues follow-up cruising while adjusting for changes in the speed of the vehicle ahead in order to maintain the vehicle-to-vehicle distance set by the driver.

④ Example of acceleration

When there are no longer any vehicles ahead driving slower than the set speed

The system accelerates until the set speed is reached. The system then returns to constant speed cruising.

### Approach warning

When your vehicle is too close to a vehicle ahead, and sufficient automatic deceleration via the cruise control is not possible, the display will flash and the buzzer will sound to alert the driver. An example of this would be if another driver cuts in front of you while you are following a vehicle. Apply the brakes to ensure an appropriate vehicle-to-vehicle distance.

■ **Warnings may not occur when**

In the following instances, there is a possibility that the warnings will not occur:

- When the speed of the vehicle ahead matches or exceeds your vehicle speed
- When the vehicle ahead is traveling at an extremely slow speed
- Immediately after the cruise control speed was set
- At the instant the accelerator is applied

### Selecting conventional constant speed control mode

When constant speed control mode is selected, your vehicle will maintain a set speed without controlling the vehicle-to-vehicle distance. Select this mode only when vehicle-to-vehicle distance control mode does not function correctly due to dirt etc.

- ① Press the "ON/OFF" button to activate the cruise control.

Radar cruise control indicator will come on.

Press the button again to deactivate the cruise control.

- ② Switch to constant speed control mode.

(Push the lever forward and hold for approximately 1 second.)

Cruise control indicator will come on.

When in constant speed control mode, to return to vehicle-to-vehicle distance control mode, push the lever forward again and hold for approximately 1 second.

After the desired speed has been set, it is not possible to return to vehicle-to-vehicle distance control mode.

If the "START STOP ENGINE" <"POWER"> switch is turned off and then turned to IGNITION ON <ON> mode again, the vehicle will automatically return to vehicle-to-vehicle distance control mode.

Adjusting the speed setting: →P. 249

Canceling and resuming the speed setting: →P. 249

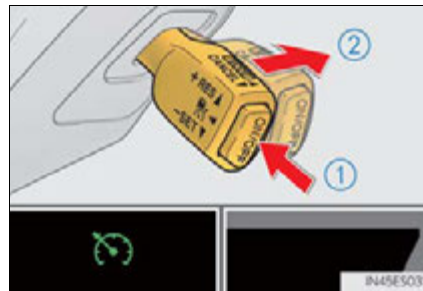

■ **Dynamic radar cruise control can be set when**

- The shift lever is in D or range 4 or higher of S has been selected.
- Vehicle speed is above approximately 30 mph (50 km/h).

■ **Accelerating after setting the vehicle speed**

The vehicle can accelerate normally. After acceleration, the set speed resumes. However, during vehicle-to-vehicle distance control mode, the vehicle speed may decrease below the set speed in order to maintain the distance to the vehicle ahead.

■ **Automatic cancelation of vehicle-to-vehicle distance control**

Vehicle-to-vehicle distance control driving is automatically canceled in the following situations:

- Actual vehicle speed falls below approximately 25 mph (40 km/h).
- VSC is activated.
- The sensor cannot operate correctly because it is covered in some way.
- The windshield wipers are operating at high speed (when the wipers are in AUTO mode or the high speed wiper operation).

If vehicle-to-vehicle distance control driving is automatically canceled for any other reason, there may be a malfunction in the system. Contact your Lexus dealer.



**■ Automatic cancelation of constant speed control**

The cruise control will stop maintaining the vehicle speed in the following situations:

- Actual vehicle speed is more than approximately 10 mph (16 km/h) below the set vehicle speed.  
At this time, the memorized set speed is not retained.
- Vehicle speed falls below approximately 25 mph (40 km/h).
- VSC is activated.

**■ Radar sensor and grille cover**

Always keep the sensor and grille cover clean to ensure that the vehicle-to-vehicle distance control operates properly. (Some obstructions, such as snow, ice and plastic objects, cannot be detected by the obstruction sensor.)

Dynamic radar cruise control is canceled if an obstruction is detected.

- ① Grille cover
- ② Radar sensor

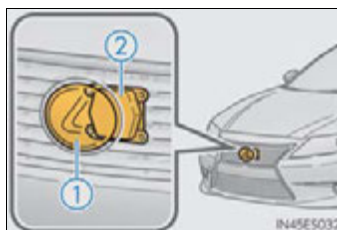

4

Driving

**■ Warning messages and buzzers for dynamic radar cruise control**

Warning messages and buzzers are used to indicate a system malfunction or to inform the driver of the need for caution while driving. (→P. 771)

■ **Certification**

- ▶ For vehicles sold in the U.S.A.

FCC ID: HYQDNMWR004

This device complies with Part 15 of the FCC Rules. Operation is subject to the following two conditions: (1) This device may not cause harmful interference, and (2) this device must accept any interference received, including interference that may cause undesired operation.

**FCC WARNING**

Changes or modifications not expressly approved by the party responsible for compliance could void the user's authority to operate the equipment.

Radiofrequency radiation exposure Information:

This equipment complies with FCC radiation exposure limits set forth for an uncontrolled environment.

This equipment should be installed and operated with minimum distance of 20 cm between the radiator (antenna) and your body.

This transmitter must not be co-located or operating in conjunction with any other antenna or transmitter.

- ▶ For vehicles sold in Canada

This device complies with Industry Canada licence-exempt RSS standards. Operation is subject to the following two conditions: (1) this device may not cause interference, and (2) this device must accept any interference, including interference that may cause undesired operation of the device.

 CAUTION**■ Before using dynamic radar cruise control**

Do not overly rely on vehicle-to-vehicle distance control.

Be aware of the set speed. If automatic deceleration/acceleration is not appropriate, adjust the vehicle speed, as well as the distance between your vehicle and vehicles ahead by applying the brakes etc.

**■ Cautions regarding the driving assist systems**

Observe the following precautions.

Failure to do so may cause an accident resulting in death or serious injury.

**● Assisting the driver to measure following distance**

The dynamic radar cruise control is only intended to help the driver in determining the following distance between the driver's own vehicle and a designated vehicle traveling ahead. It is not a mechanism that allows careless or inattentive driving, and it is not a system that can assist the driver in low-visibility conditions. It is still necessary for driver to pay close attention to the vehicle's surroundings.

**● Assisting the driver to judge proper following distance**

The dynamic radar cruise control determines whether the following distance between the driver's own vehicle and a designated vehicle traveling ahead is appropriate or not. It is not capable of making any other type of judgement. Therefore, it is absolutely necessary for the driver to remain vigilant and to determine whether or not there is a possibility of danger in any given situation.

**● Assisting the driver to operate the vehicle**

The dynamic radar cruise control has no capability to prevent or avoid a collision with a vehicle traveling ahead. Therefore, if there is ever any danger, the driver must take immediate and direct control of the vehicle and act appropriately in order to ensure the safety of all involved.

 **CAUTION****■ To avoid inadvertent cruise control activation**

Switch the cruise control off using the “ON/OFF” button when not in use.

**■ Situations unsuitable for dynamic radar cruise control**

Do not use dynamic radar cruise control in any of the following situations. Doing so may result in inappropriate speed control and could cause an accident resulting in death or serious injury.

- In heavy traffic
- On roads with sharp bends
- On winding roads
- On slippery roads, such as those covered with rain, ice or snow
- On steep downhill, or where there are sudden changes between sharp up and down gradients  
Vehicle speed may exceed the set speed when driving down a steep hill.
- At entrances to expressways
- When weather conditions are bad enough that they may prevent the sensors from functioning correctly (fog, snow, sandstorm, heavy rain, etc.)
- When an approach warning buzzer is heard often
- During emergency towing

**⚠ CAUTION****■ When the sensor may not be correctly detecting the vehicle ahead**

Apply the brakes as necessary when any of the following types of vehicles are in front of you.

As the sensor may not be able to correctly detect these types of vehicles, the approach warning (→P. 258) will not be activated, and a fatal or serious accident may result.

- Vehicles that cut in suddenly
- Vehicles traveling at low speeds
- Vehicles that are not moving
- Vehicles with small rear ends (trailers with no load on board etc.)
- Motorcycles traveling in the same lane

**■ Conditions under which the vehicle-to-vehicle distance control may not function correctly**

Apply the brakes as necessary in the following conditions as the radar sensor may not be able to correctly detect vehicles ahead, and a fatal or serious accident may result:

- When water or snow thrown up by the surrounding vehicles hinders the functioning of the sensor
- When your vehicle is pointing upwards (caused by a heavy load in the trunk etc.)
- When the road curves or when the lanes are narrow
- When steering wheel operation or your position in the lane is unstable
- When the vehicle ahead of you decelerates suddenly

 CAUTION**■ Handling the radar sensor**

Observe the following to ensure the cruise control system can function effectively. Otherwise, the system may not function correctly and could result in an accident.

- Keep the sensor and grille cover clean at all times.  
Clean the sensor and grille cover with a soft cloth so you do not mark or damage them.
- Do not subject the sensor or surrounding area to a strong impact.  
If the sensor moves even slightly off position, the system may malfunction. If the sensor or surrounding area is subject to a strong impact, always have the area inspected and adjusted by your Lexus dealer.
- Do not disassemble the sensor.
- Do not attach accessories or stickers to the sensor, grille cover or surrounding area.
- Do not modify or paint the sensor and grille cover.
- Do not replace them with non-genuine parts.

## LDA (Lane Departure Alert)\*

### Summary of function

While driving on a road that has lane markers, this system recognizes the lane markers using a camera as a sensor to alert the driver when the vehicle deviates from its lane.

If the system judges that the vehicle may deviate from its lane, it alerts the driver using beeping and indications on the multi-information display.

Camera sensor

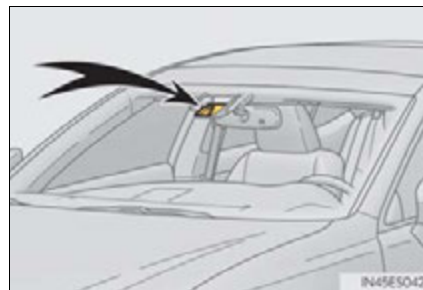

4

Driving

\*: If equipped

### Turning the LDA system on

Press the "LDA" switch to activate the system.

"LDA" indicator and the lane lines will come on.

Press the switch again to turn the LDA system off.

The LDA system will remain on or off even if the "START STOP ENGINE" <"POWER"> switch is turned to IGNITION ON <ON> mode.

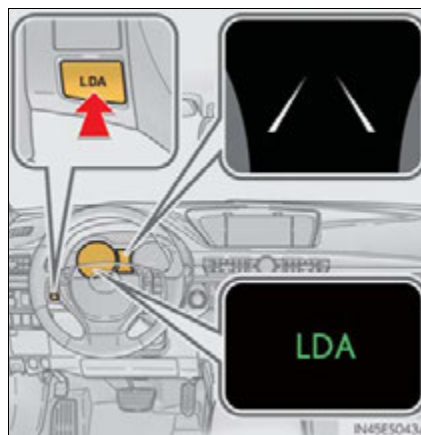

### Operating conditions

- When the vehicle speed is approximately 32 mph (50 km/h) or more
- When the lane width is more than approximately 8.2 ft. (2.5 m)
- When driving on a straight road or through a curve with a radius of more than approximately 328 ft. (100 m)



### Indication on the multi-information display

When the LDA system is on, the lane lines are shown.

The inside of the lane lines turn white when the right and left lane markers are recognized.

If the vehicle deviates from the lane, the lane line on the side the vehicle deviates from will flash.



The inside of the recognized lane line turns white when the right or left lane marker is recognized.

If the vehicle deviates from a lane that has lane markers recognized, the lane line will flash.



The inside of the lane lines turn black when no lane marker is recognized or the LDA system is temporarily canceled.



**■ Temporary cancelation of the LDA system**

If any of the following occurs, the LDA system will be temporarily canceled.

The function will resume after the necessary operating conditions have returned.

- The vehicle speed deviates from the operating range of the LDA system.
- The turn signal lever is operated.
- When the lane lines cannot be recognized while driving.
- When the lane departure warning sounds.

The lane departure warning function will not operate again for a several seconds after it has been activated, even if the vehicle leaves the lane again.

**■ The lane departure warning**

Depending on the audio system sound level or air conditioning fan noise while the audio system or air conditioning system is in use, it may be difficult to hear the warning sound.

**■ After the vehicle has been parked in the sun**

The LDA system may not be available and a warning message (→P. 779) will be displayed for a while after driving has started. When the temperature in the cabin decreases and the temperature around the camera sensor (→P. 267) becomes suitable for its operation, the functions will begin to operate.

**■ If there are lane markers on only one side of the vehicle**

The lane departure warning will not operate for the side on which lane markers could not be recognized.

**■ Conditions in which the function may not operate correctly**

In the following conditions, the camera sensor may be unable to recognize lane markers causing the lane departure warning function to operate incorrectly. However, this does not indicate a malfunction.

- When driving through an area with no lane markers, such as a tollbooth, a crossing or before a ticket checkpoint
- When driving on a sharp curve
- When lane markers are extremely narrow or extremely wide
- When the vehicle leans to one side an unusual amount due to a heavy load or improper tire inflation pressure
- When the following distance between your vehicle and the vehicle ahead is extremely short
- When the lane markers are yellow (These may be more difficult for the system to recognize compared to white markers.)
- When the lane markers are broken, "Botts' dots", "Raised pavement marker" or stones

- When the lane markers are on a curb etc.
  - When lane markers are obscured or partially obscured by sand, dirt, etc.
  - When there are shadows on the road running parallel with lane markers, or if a shadow covers the lane markers
  - When driving on a particularly bright road surface, such as concrete
  - When driving on a road surface that is bright due to reflected light
  - When driving in a location where the light level changes rapidly, such as the entrance to or exit from a tunnel
  - When sunlight or the headlights of oncoming vehicles are shining directly into the camera lens
  - When driving on roads that are branching or merging
  - When driving on a road surface that is wet due to rain, previous rainfall, standing water, etc.
  - When the vehicle experiences strong up-and-down motion such as when driving on an extremely rough road or on a seam in the pavement
  - When headlight brightness at nighttime is reduced due to dirt on the lenses, or when the headlights are misaligned
  - When driving on winding roads or roads that are uneven
  - When driving on rough or unpaved roads
- **When changing the tires**  
Depending on the tires used, sufficient performance may not be maintainable.
- **Warning messages for LDA system**  
Warning messages are used to indicate a system malfunction or to inform the driver of the need for caution while driving. (→P. 772, 779)

 CAUTION

■ **Before using the LDA system**

Do not rely solely on the LDA system. The LDA system does not drive the vehicle automatically, nor does it reduce the amount of care you need to take. As such, the driver must always assume full responsibility for understanding his/her surroundings, for operating the steering wheel to correct the driving line, and for driving safely.

Inappropriate or negligent driving could lead to an accident.

■ **To avoid operating the LDA by mistake**

Switch the LDA system off using the "LDA" switch when not in use.

■ **Situations unsuitable for LDA system**

Do not use LDA system in any of the following situations.

Otherwise, the system may not function correctly and could result in an accident.

- When driving with tire chains, a spare tire, or similar equipment
- When there are objects or structures along the roadside that might be misinterpreted as lane markers (such as guardrails, curb, reflector posts, etc.)
- When driving on snowy roads
- When pavement lane markers are difficult to see due to rain, snow, fog, sand, dirt, etc.
- When there are visible lines on the pavement from road repairs, or if the remains of old lane markers are still visible on the road
- When driving on a road with lane closures due to maintenance, or when driving in a temporary lane

 NOTICE

■ **To prevent damage to or incorrect operation of the LDA system**

- Do not modify the headlights or attach stickers to the surface of the lights.
- Do not modify the suspension or replace it with non-genuine parts.
- Do not install or place anything on the hood or the grille. Also, do not install a grille guard (bull bars, kangaroo bar etc.).
- If your windshield needs repairs, contact your Lexus dealer.

■ **Camera sensor (→P. 267)**

Observe the following to ensure that the LDA system functions correctly.

- Keep the windshield clean at all times.  
Performance could be affected if the windshield is dirty, or if raindrops, condensation or ice are adhering to the windshield.
- Do not attach a sticker or other items to the windshield near the camera sensor.



- Do not spill liquid onto the camera sensor.
- Do not attach window tinting to the windshield.
- Do not install an antenna in front of the camera lens.
- If the windshield is fogged up, use the windshield defogger to remove fog from the windshield.  
When it is cold, using the heater with air blowing to the feet may allow the upper part of the windshield to fog up. This will have a negative effect on the images.

 NOTICE

- Do not scratch the camera lens, or let it get dirty.  
When cleaning the inside of the windshield, be careful not to get any glass cleaner etc. on the lens. Also, do not touch the lens.  
For lens repair, contact your Lexus dealer.
- Do not change the installation position or direction of the camera sensor or remove it. The direction of the camera sensor is precisely adjusted.
- Do not subject the camera sensor to strong impact or force, and do not disassemble the camera sensor.
- Do not replace windshield with non-genuine windshield.  
Contact your Lexus dealer.

## Intuitive parking assist\*

The distance from your vehicle to nearby obstacles when parallel parking or maneuvering into a garage is measured by the sensors and communicated via the multi-information display, navigation system screen or Lexus Display Audio system screen and a buzzer. Always check the surrounding area when using this system.

### ■ Types of sensors

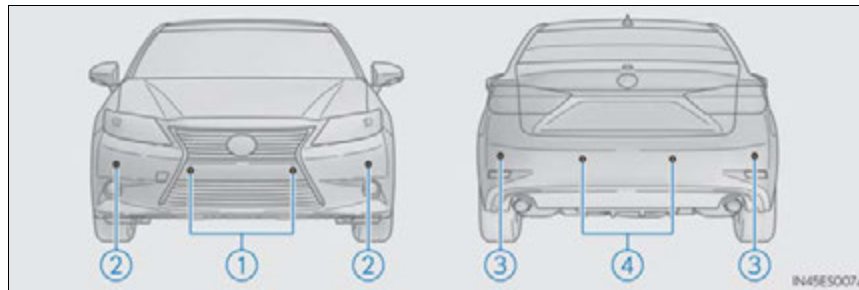

- ① Front center sensors
- ② Front corner sensors
- ③ Rear corner sensors
- ④ Rear center sensors

4

Driving

\*: If equipped

■ Intuitive parking assist switch

Turns the intuitive parking assist on/off

When on, the indicator light comes on to inform the driver that the system is operational.

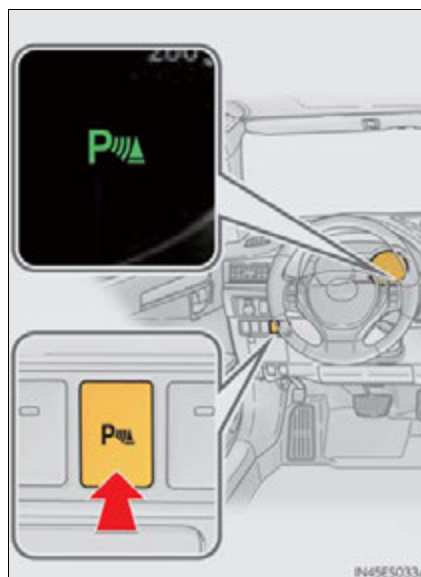



## Display

When the sensors detect an obstacle, a graphic is shown on the multi-information display and navigation system screen or Lexus Display Audio system screen depending on the position and distance to the obstacle.

### ■ Multi-information display

- ① Front corner sensor detection
- ② Front center sensor detection
- ③ Rear corner sensor detection
- ④ Rear center sensor detection

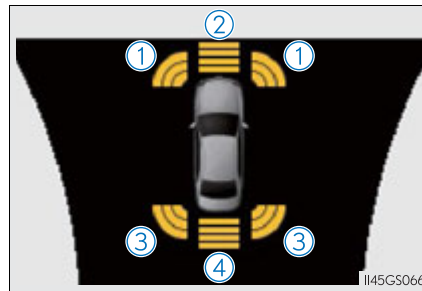

4

Driving

■ Navigation system screen/Lexus Display Audio system screen (if equipped)

- ① When the rear view monitor system is not displayed

A graphic is automatically displayed when an obstacle is detected. The screen can be set so that the graphic is not displayed. (→P. 283)





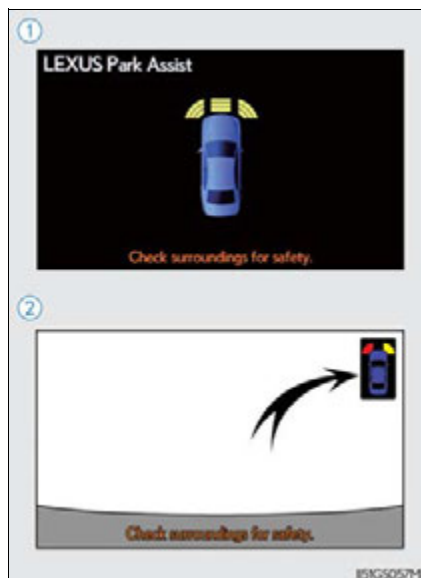















- ② When the rear view monitor system is displayed (insert display)

A simplified image is displayed on the right upper corner of the navigation system screen or Lexus Display Audio system screen when an obstacle is detected.

















**Sensor detection display, obstacle distance**













■ **Front center sensor**

Approximate distance to obstacle	Multi-information display	Navigation system	Navigation system (insert display)	Lexus Display Audio system	Lexus Display Audio system (insert display)
3.3 ft. (100 cm) to 1.7 ft. (50 cm)	 (continuous)	 (continuous)	 (blinking slowly)	 (continuous)	 (blinking slowly)
1.7 ft. (50 cm) to 1.3 ft. (40 cm)	 (continuous)	 (continuous)	 (blinking)	 (continuous)	 (blinking)
1.3 ft. (40 cm) to 1.0 ft. (30 cm)	 (continuous)	 (continuous)	 (blinking rapidly)	 (continuous)	 (blinking rapidly)
Less than 1.0 ft. (30 cm)	 (blinking)	 (continuous)	 (continuous)	 (continuous)	 (continuous)

■ Corner sensors

Approximate distance to obstacle	Multi-information display	Navigation system	Navigation system (insert display)	Lexus Display Audio system	Lexus Display Audio system (insert display)
2.0 ft. (60 cm) to 1.5 ft. (45 cm)	 (continuous)	 (continuous)	 (blinking)	 (continuous)	 (blinking)
1.5 ft. (45 cm) to 1.0 ft. (30 cm)	 (continuous)	 (continuous)	 (blinking rapidly)	 (continuous)	 (blinking rapidly)
Less than 1.0 ft. (30 cm)	 (blinking)	 (continuous)	 (continuous)	 (continuous)	 (continuous)

■ Rear center sensor

Approximate distance to obstacle	Multi-information display	Navigation system (insert display)	Lexus Display Audio system (insert display)
4.9 ft. (150 cm) to 2.0 ft. (60 cm)	 (continuous)	 (blinking slowly)	 (blinking slowly)
2.0 ft. (60 cm) to 1.5 ft. (45 cm)	 (continuous)	 (blinking)	 (blinking)
1.5 ft. (45 cm) to 1.1 ft. (35 cm)	 (continuous)	 (blinking rapidly)	 (blinking rapidly)
Less than 1.1 ft. (35 cm)	 (blinking)	 (continuous)	 (continuous)

4  
Driving

■ **Buzzer operation and distance to an obstacle**

A buzzer sounds when the sensors are operating.

- The buzzer beeps faster as the vehicle approaches an obstacle. When the vehicle comes within the following distance of the obstacle, the buzzer sounds continuously:
  - Front center sensors: Approximately 1.0 ft. (30 cm)
  - Corner sensors: Approximately 1.0 ft. (30 cm)
  - Rear center sensors: Approximately 1.1 ft. (35 cm)
- When 2 or more obstacles are detected simultaneously, the buzzer system responds to the nearest obstacle. If one or both come within the above distances, the beep will repeat a long tone, followed by fast beeps.

**Detection range of the sensors**

- ① Approximately 3.3 ft. (100 cm)
- ② Approximately 4.9 ft. (150 cm)
- ③ Approximately 2.0 ft. (60 cm)

The diagram shows the detection range of the sensors. Note that the sensors cannot detect obstacles that are extremely close to the vehicle.

The range of the sensors may change depending on the shape of the object etc.

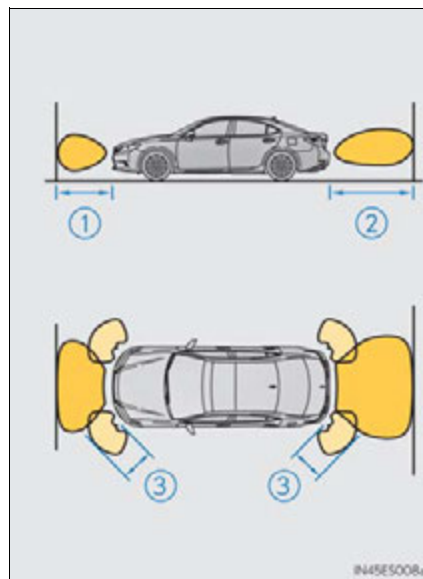

### Setting up intuitive parking assist (if equipped)

You can change the warning beep volume and navigation system screen or Lexus Display Audio system screen operating conditions.

- 1 Press the "MENU" button on Remote Touch (navigation system) or Lexus Display Audio controller (Lexus Display Audio system). (→P. 111)
- 2 Select "SETUP" on the "Menu" screen.
- 3 Select "Vehicle" on the "Setup" screen.
- 4 Select "LEXUS Park Assist" on the "Vehicle Settings" screen.

▶ Navigation system

▶ Lexus Display Audio system

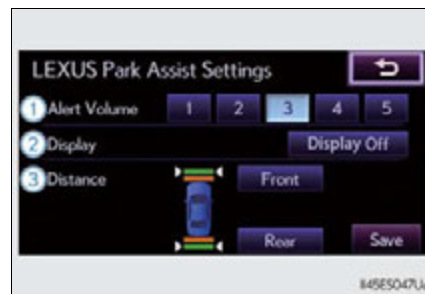
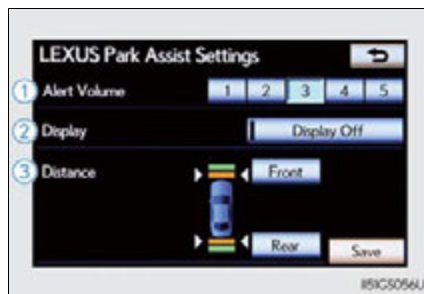

- 1 Alert volume setting
- 2 Display on/off setting
- 3 Alert distance setting

Make sure to save after changing settings.

■ **Alert volume setting**

The alert volume can be adjusted.

- 1 Select "1" to "5" on the "LEXUS Park Assist settings".
- 2 Select "Save".

■ **Display on/off setting**

On or off can be selected for intuitive parking assist display.

- 1 Select "Display Off".  
When the "Display Off" indicator is turned on, the display of intuitive parking assist will be off. Select "Display Off" again to turn the display of intuitive parking assist on.
- 2 Select "Save".

■ **Alert distance setting**

Front or rear center sensors display and tone indication can be set.

- 1 Select "Front" or "Rear".  
Long distance or short distance can be selected.
- 2 Select "Save".

---

■ **The intuitive parking assist can be operated when**

- Front center sensors:
  - The "START STOP ENGINE" <"POWER"> switch is in IGNITION ON <ON> mode.
  - The shift lever is in a position other than P or R.
  - The vehicle speed is less than about 6 mph (10 km/h).
- Front corner sensors:
  - The "START STOP ENGINE" <"POWER"> switch is in IGNITION ON <ON> mode.
  - The shift lever is in a position other than P.
  - The vehicle speed is less than about 6 mph (10 km/h).  
(At any speed when the shift lever is in R)
- Rear corner and rear center sensors:
  - The "START STOP ENGINE" <"POWER"> switch is in IGNITION ON <ON> mode.
  - The shift lever is in R.



**■ Intuitive parking assist display**

When an obstacle is detected while the rear view monitor system is in use, the warning indicator will appear in the top right of the screen even if the display setting has been set to off.

**■ Sensor detection information**

- The sensor's detection areas are limited to the areas around the vehicle's front corners and rear bumper.
- Certain vehicle conditions and the surrounding environment may affect the ability of the sensor to correctly detect obstacles. Particular instances where this may occur are listed below.
  - There is dirt, snow or ice on the sensor. (Wiping the sensors will resolve this problem.)
  - The sensor is frozen. (Thawing the area will resolve this problem.)  
In especially cold weather, if a sensor is frozen the screen may show an abnormal display, or obstacles may not be detected.
  - The sensor is covered in any way.
  - The vehicle is leaning considerably to one side.
  - On an extremely bumpy road, on an incline, on gravel, or on grass.
  - The vicinity of the vehicle is noisy due to vehicle horns, motorcycle engines, air brakes of large vehicles, or other loud noises producing ultrasonic waves.
  - There is another vehicle equipped with parking assist sensors in the vicinity.
  - The sensor is coated with a sheet of spray or heavy rain.
  - The vehicle is equipped with a fender pole or wireless antenna.
  - Towing eyelets are installed.
  - The bumper or sensor receives a strong impact.
  - The vehicle is approaching a tall or curved curb.
  - In harsh sunlight or intense cold weather.
  - The area directly under the bumpers is not detected.
  - If obstacles draw too close to the sensor.
  - A non-genuine Lexus suspension (lowered suspension etc.) is installed.
  - People may not be detected if they are wearing certain types of clothing.

In addition to the examples above, there are instances in which, because of their shape, signs and other objects may be judged by the sensor to be closer than they are.

- The shape of the obstacle may prevent the sensor from detecting it. Pay particular attention to the following obstacles:
  - Wires, fences, ropes, etc.
  - Cotton, snow and other materials that absorb sound waves
  - Sharply-angled objects
  - Low obstacles
  - Tall obstacles with upper sections projecting outwards in the direction of your vehicle
- The following situations may occur during use.
  - Depending on the shape of the obstacle and other factors, the detection distance may shorten, or detection may be impossible.
  - Obstacles may not be detected if they are too close to the sensor.
  - There will be a short delay between obstacle detection and display. Even at slow speeds, there is a possibility that the obstacle will come within the sensor's detection areas before the display is shown and the warning beep sounds.
  - Thin posts or objects lower than the sensor may not be detected for collision when approached, even if they have been detected once.
  - It might be difficult to hear beeps due to the volume of audio system or air flow noise of air conditioning system.

■ **If a message is displayed on the multi-information display**

→P. 771, 778

■ **Certification**

- ▶ For vehicles sold in the U.S.A.

This device complies with Part 15 of the FCC Rules. Operation is subject to the following two conditions; (1) This device may not cause harmful interference, and (2) this device must accept any interference received, including interference that may cause undesired operation.

- ▶ For vehicles sold in Canada

This ISM device complies with Canadian ICES-001.

Cet appareil ISM est conforme à la norme NMB-001 du Canada.

 CAUTION**■ When using the intuitive parking assist**

Observe the following precautions.

Failing to do so may result in the vehicle being unable to be driven safely and possibly cause an accident.

- Do not use the sensor at speeds in excess of 6 mph (10 km/h).
- The sensors' detection areas and reaction times are limited. When moving forward or reversing, check the areas surrounding the vehicle (especially the sides of the vehicle) for safety, and drive slowly, using the brake to control the vehicle's speed.
- Do not install accessories within the sensors' detection areas.

 NOTICE**■ When using intuitive parking assist-sensor**

In the following situations, the system may not function correctly due to a sensor malfunction etc. Have the vehicle checked by your Lexus dealer.

- The intuitive parking assist operation display flashes, and a beep sounds when no obstacles are detected.
- If the area around a sensor collides with something, or is subjected to strong impact.
- If the bumper collides with something.
- If the display shows continuously without a beep.
- If a display error occurs, first check the sensor.  
If the error occurs even if there is no ice, snow or mud on the sensor, it is likely that the sensor is malfunctioning.

**■ Notes when washing the vehicle**

Do not apply intensive bursts of water or steam to the sensor area.

Doing so may result in the sensor malfunctioning.

## Rear view monitor system\*

The rear view monitor system assists the driver by displaying an image of the view behind the vehicle and fixation guide lines while backing up, for example while parking.

The screen illustrations used in this text are intended as examples, and may differ from the image that is actually displayed on the screen.

▶ Vehicles with a navigation system

Owners of models equipped with a navigation system should refer to the “Navigation System Owner’s Manual”.

▶ Vehicles with the Lexus Display Audio system

Rear view monitor system will activate when the shift lever is in R.

If you move the lever out of R, the rear view monitor system will be deactivated.

When the shift lever is shifted to the R position and any mode button (such as “MENU”) is pressed, the rear view monitor system is canceled, and the screen is switched to the mode of the button that was pressed.

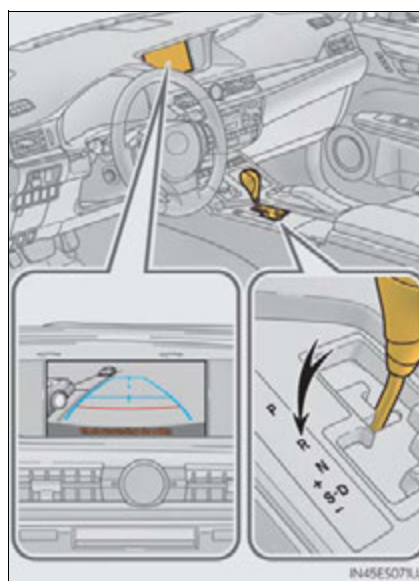

\*: If equipped

## Using the rear view monitor system

### ■ Screen description

The rear view monitor system screen will be displayed if the shift lever is shifted to R while the power switch is in ON mode.

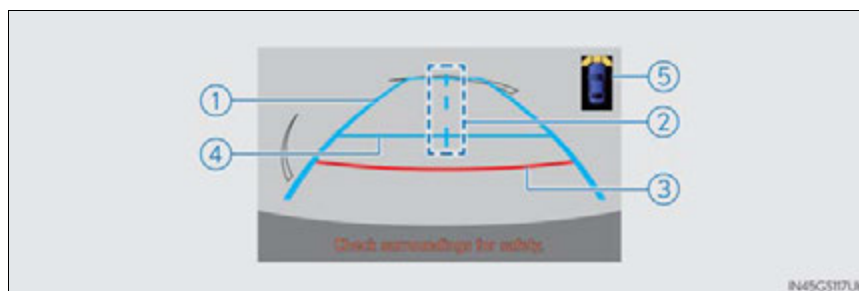

- ① Vehicle width extension guide line  
The line indicates a guide path when the vehicle is being backed straight up. The displayed width is wider than the actual vehicle width.
- ② Vehicle center guide lines  
These lines indicate the estimated vehicle center on the ground.
- ③ Distance guide line  
The line shows points approximately 1.5 ft. (0.5 m) (red) from the center of the edge of the bumper.
- ④ Distance guide line  
The line shows distance behind the vehicle, a point approximately 3 ft. (1 m) (blue) from the edge of the bumper.
- ⑤ Intuitive parking assist display (if equipped)  
If an obstacle is detected while the Intuitive parking assist-sensor is on, a display is shown in the top right corner of the screen.

### Rear view monitor system precautions

#### ■ Area displayed on screen

The rear view monitor system displays an image of the view from the bumper of the rear area of the vehicle.

To adjust the image on the rear view monitor system screen.  
(→P. 344)

- The area displayed on the screen may vary according to vehicle orientation conditions.
- Objects which are close to either corner of the bumper or under the bumper cannot be displayed.
- The camera uses a special lens. The distance of the image that appears on the screen differs from the actual distance.
- Items which are located higher than the camera may not be displayed on the monitor.

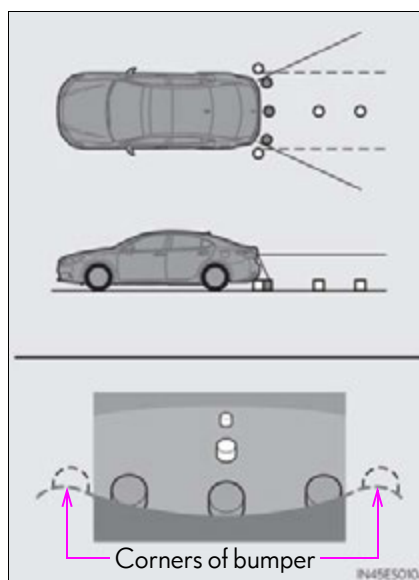

### ■ Rear view monitor system camera

The camera for the rear view monitor system is located above the license plate.

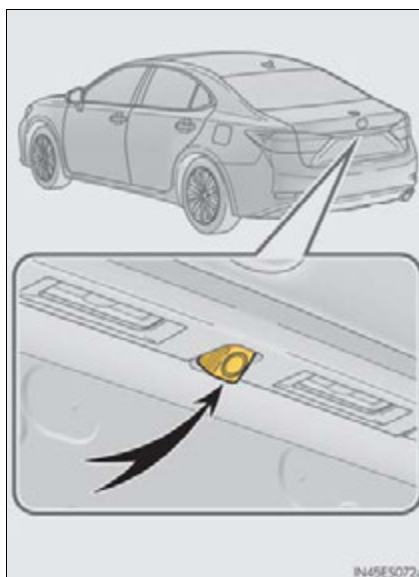

### ● Using the camera

If the camera lens becomes dirty, it cannot transmit a clear image. If water droplets, snow or mud adhere to the lens, rinse with water and wipe with a soft cloth. If the lens is extremely dirty, wash it with a mild cleanser and rinse.

### ■ Differences between the screen and the actual road

The distance guide lines and the vehicle width extension guide lines may not actually be parallel with the dividing lines of the parking space, even when they appear to be so. Be sure to check visually.

The distances between the vehicle width extension guide lines and the left and right dividing lines of the parking space may not be equal, even when they appear to be so. Be sure to check visually.

The distance guide lines give a distance guide for flat road surfaces. In any of the following situations, there is a margin of error between the fixation guide lines on the screen and the actual distance/course on the road.

- When the ground behind the vehicle slopes up sharply

The distance guide lines will appear to be closer to the vehicle than the actual distance. Because of this, objects will appear to be farther away than they actually are. In the same way, there will be a margin of error between the guidelines and the actual distance/course on the road.

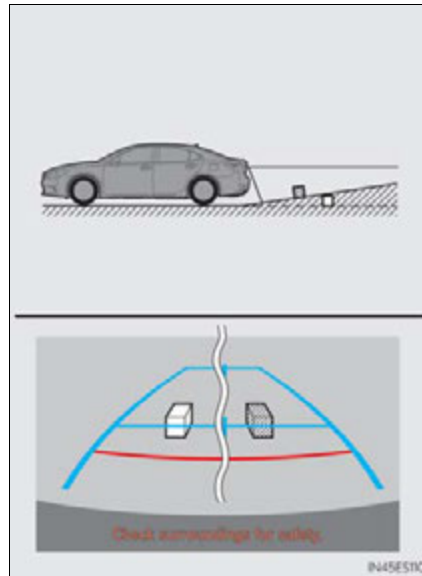

- When the ground behind the vehicle slopes down sharply

The distance guide lines will appear to be further from the vehicle than the actual distance. Because of this, objects will appear to be closer than they actually are. In the same way, there will be a margin of error between the guidelines and the actual distance/course on the road.

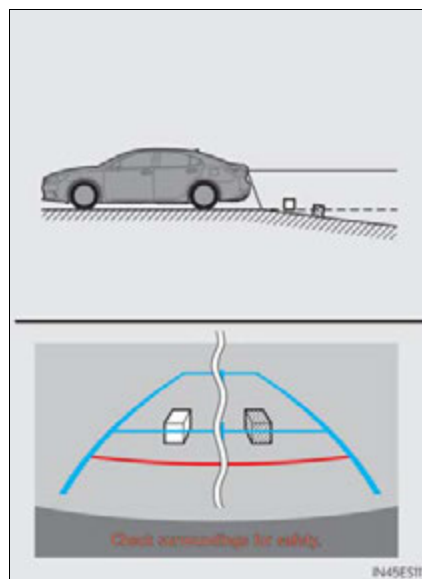



- When any part of the vehicle sags

When any part of the vehicle sags due to the number of passengers or the distribution of the load, there is a margin of error between the fixation guide lines on the screen and the actual distance/course on the road.

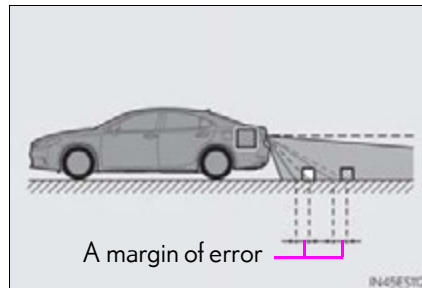

- When approaching three-dimensional objects

The distance guide lines are displayed according to flat surfaced objects (such as the road). It is not possible to determine the position of three-dimensional objects (such as vehicles) using the distance guide lines. When approaching a three-dimensional object that extends outward (such as the flatbed of a truck), be careful of the following.

- Distance guidelines

Visually check the surroundings and the area behind the vehicle. On the screen, it appears that a truck is parking at point ②. However, in reality if you back up to point ①, you will hit the truck. On the screen, it appears that ① is closest and ③ is furthest away. However, in reality, the distance to ① and ③ is the same, and ② is farther than ① and ③.

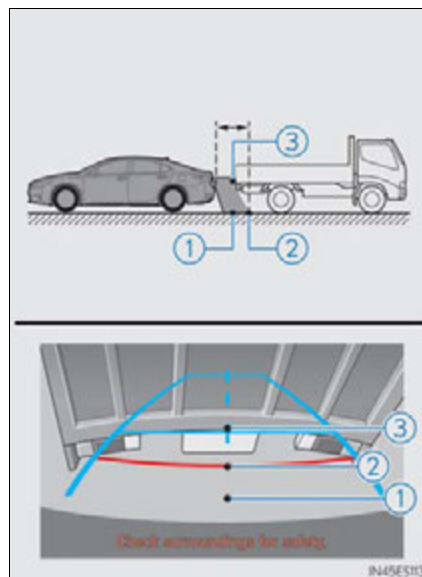

■ Vehicle width extension guide lines

Visually check the surroundings and the area behind the vehicle. In the case shown below, the truck appears to be outside of the vehicle width extension guide lines and the vehicle does not look as if it hits the truck. However, the rear body of the truck may actually cross over the vehicle width extension guide lines. In reality if you back up as guided by the vehicle width extension guide lines, the vehicle may hit the truck.

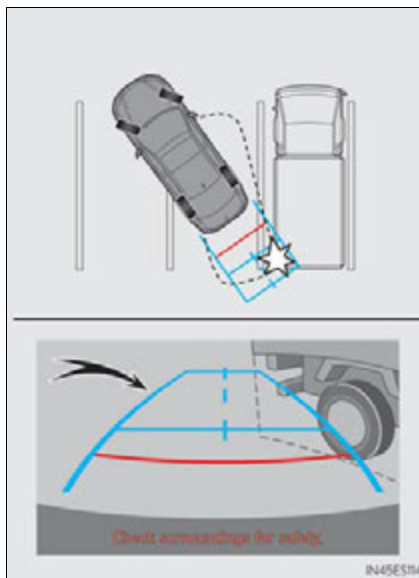

### Things you should know

#### ■ If you think something is wrong

If you notice any of the following symptoms, refer to the likely cause and the solution, and re-check.

If the symptom is not resolved by the solution, have the vehicle inspected by your Lexus dealer.

Symptom	Likely cause	Solution
The image is difficult to see	<ul style="list-style-type: none"> <li>• The vehicle is in a dark area</li> <li>• The temperature around the lens is either high or low</li> <li>• The outside temperature is low</li> <li>• There are water droplets on the camera</li> <li>• It is raining or humid</li> <li>• Foreign matter (mud etc.) is adhering to the camera</li> <li>• There are scratches on the camera</li> <li>• Sunlight or headlights are shining directly into the camera</li> <li>• The vehicle is under fluorescent lights, sodium lights, mercury lights etc.</li> </ul>	<p>If this happens due to these causes, it does not indicate a malfunction. Back up while visually checking the vehicle's surroundings. (Use the monitor again once conditions have been improved.)</p> <p>To adjust the image on the rear view monitor system screen. (→P. 344)</p>
The image is blurry	Dirt or foreign matter (such as water droplets, snow, mud etc.) is adhering to the camera.	<p>Rinse the camera lens with water and wipe it clean with a soft cloth.</p> <p>Wash with a mild soap if the dirt is stubborn.</p>

Symptom	Likely cause	Solution
The image is out of alignment	The camera or surrounding area has received a strong impact.	Have the vehicle inspected by your Lexus dealer.
The fixation guide lines are very far out of alignment	The camera position is out of alignment.	Have the vehicle inspected by your Lexus dealer.

**⚠ CAUTION****■ When using the rear view monitor system**

When backing up, be sure to check visually behind and all around the vehicle before proceeding.

Observe the following precautions to avoid an accident that could result in death or serious injuries.

- The rear view monitor system is a supplemental device intended to assist the driver when backing up. Never depend on the rear view monitor system entirely when backing up. Always make sure your intended path is clear. Use caution, just as you would when backing up any vehicle.
- Never back up while looking only at the screen. The image shown on the screen may differ from the actual state, and you could collide with another vehicle or obstacles if backing up looking only at the screen, possibly causing an accident. When backing up, be sure to check in front of and behind the vehicle, both directly and with mirrors.
- Be sure to back up slowly, depressing the brake pedal to control vehicle speed.
- The instructions given are only guidelines. When and how much to turn the steering wheel will vary according to traffic conditions, road surface conditions, vehicle condition, etc. when parking. It is necessary to be fully aware of this before using the rear view monitor system.
- When parking, be sure to check that the parking space will accommodate your vehicle before maneuvering into it.
- Do not use system in the following cases:
  - On icy or slick road surfaces, or in snow
  - When using tire chains or the compact spare tire
  - When the trunk lid is not closed completely
  - On roads that are not flat or straight, such as curves or slopes.
- In low temperatures, the screen may darken or the image may become faint. The image could distort when the vehicle is moving, or you may become unable to see the image on the screen. Be sure to check direct visually and with mirror all around the vehicle before proceeding.
- If the tire sizes are changed, the position of the fixation guide lines displayed on the screen may change.
- The camera uses a special lens. The distances between objects and pedestrians that appear in the image displayed on the screen will differ from the actual distances. (→P. 291)

**⚠ CAUTION****■ When using the rear view monitor system screen**

- The position of the fixation guide lines displayed on the screen may change in accordance with the number of passengers, the amount of cargo etc. Be sure to check behind and all around the vehicle direct visually and with mirror before proceeding.
- The vehicle width extension guide lines are wider than the actual width of the vehicle. When backing up, be sure to check behind and all around the vehicle direct visually and with mirror before proceeding.

 NOTICE■ **How to use the camera**

- The rear view monitor system may not operate properly in the following cases, or if the precautions described below are not followed.
  - If the back of the vehicle is hit, the position and mounting angle of the camera may change.
  - As the camera has a water proof construction, do not detach, disassemble or modify it. This may cause incorrect operation.
  - Do not strongly rub the camera lens. If the camera lens is scratched, it cannot transmit a clear image.
  - Do not allow organic solvent, car wax, window cleaner or glass coat to adhere to the camera. If this happens, wipe it off as soon as possible.
  - If the temperature changes rapidly, such as when hot water is poured on the vehicle in cold weather, the system may not operate normally.
  - When washing the vehicle, do not apply intensive bursts of water to the camera or camera area. Doing so may result in the camera malfunctioning.
  - When the camera is used under fluorescent lights, sodium light or mercury light etc., the lights and the illuminated areas may appear to flicker.
- Do not expose the camera to strong impact as this could cause a malfunction. If this happens, have the vehicle inspected by your Lexus dealer as soon as possible.

## Driving mode select switch

The driving modes can be selected to suit driving condition.

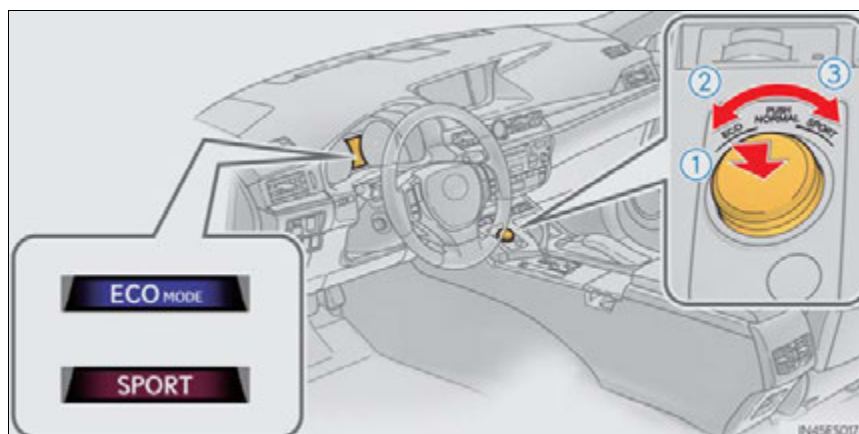

### ① Normal mode

For normal driving.

Press the switch to change the driving mode to normal mode when selected to Eco mode or sport mode.

### ② Eco drive mode

Use Eco mode to help achieve low fuel consumption during trips that involve frequent accelerating.

When not in Eco drive mode and the driving mode select switch is turned to the left, the "ECO MODE" indicator comes on in the multi-information display.

### ③ Sport mode

Assists acceleration response by controlling the steering and transmission <hybrid system>. Suitable for when precise handling is desirable, for example when driving on mountain roads.

When not in Sport mode and the driving mode select switch is turned to the right, the "SPORT" indicator comes on in the multi-information display.

Hybrid vehicles: The hybrid system indicator changes to the tachometer.

(→P. 95)



**■ Operation of the air conditioning system in Eco drive mode**

Eco drive mode controls the heating/cooling operations and fan speed of the air conditioning system to enhance fuel efficiency (→P. 353, 365). To improve air conditioning performance, adjust the fan speed or turn off Eco drive mode.

**■ Sport mode automatic deactivation**

Sport mode is automatically deactivated if the "START STOP ENGINE" <"POWER"> switch is turned off after driving in sport mode.

## Driving assist systems

To help enhance driving safety and performance, the following systems operate automatically in response to various driving situations. Be aware, however, that these systems are supplementary and should not be relied upon too heavily when operating the vehicle.

### ◆ ABS (Anti-lock Brake System)

---

Helps to prevent wheel lock when the brakes are applied suddenly, or if the brakes are applied while driving on a slippery road surface

### ◆ Brake assist

---

Generates an increased level of braking force after the brake pedal is depressed when the system detects a panic stop situation

### ◆ VSC (Vehicle Stability Control)

---

Helps the driver to control skidding when swerving suddenly or turning on slippery road surfaces

### ◆ Enhanced VSC (Enhanced Vehicle Stability Control)

---

Provides cooperative control of the ABS, TRAC, VSC and EPS. Helps to maintain directional stability when swerving on slippery road surfaces by controlling steering performance.

### ◆ TRAC (Traction Control)

---

Helps to maintain drive power and prevent the drive wheels from spinning when starting the vehicle or accelerating on slippery roads

### ◆ Hill-start assist control (hybrid vehicles)

---

→P. 308

**◆ EPS (Electric Power Steering)**

Employs an electric motor to reduce the amount of effort needed to turn the steering wheel

**◆ PCS (Pre-Collision System) (if equipped)**

→P. 310

**When the TRAC/VSC/ABS (hybrid vehicles) systems are operating****▶ Gasoline vehicles**

The slip indicator light will flash while the TRAC/VSC systems are operating.

**▶ Hybrid vehicles**

The slip indicator light will flash while the TRAC/VSC/ABS systems are operating.



### Disabling the TRAC system

If the vehicle gets stuck in mud, dirt or snow, the TRAC system may reduce power from the engine <hybrid system> to the wheels. Pressing



to turn the system off may make it easier for you to rock the vehicle in order to free it.

To turn the TRAC system off, quickly

press and release .

The "TRAC OFF" will be shown on the multi-information display. Press



again to turn the system back on.

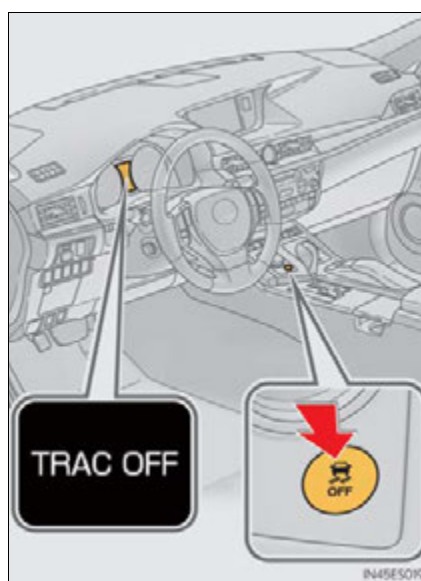

### ■ Turning off both TRAC and VSC systems

To turn the TRAC and VSC systems off, press and hold  for more than 3 seconds while the vehicle is stopped.

The VSC OFF indicator light will come on and the "TRAC OFF" will be shown on the multi-information display.

Press  again to turn the systems back on.

**■ When the message is displayed on the multi-information display showing that TRAC has been disabled even if the VSC OFF switch has not been pressed**

TRAC and hill-start assist control (hybrid vehicles) cannot be operated. Contact your Lexus dealer.

**■ When the 12-volt battery is disconnected**

The steering wheel may move from its straight forward position, but this will be corrected automatically when driving.

**■ Sounds and vibrations caused by the ABS, brake assist, VSC and TRAC systems**

- A sound may be heard from the engine compartment when the brake pedal is depressed repeatedly, when the engine <hybrid system> is started or just after the vehicle begins to move. This sound does not indicate that a malfunction has occurred in any of these systems.
- Any of the following conditions may occur when the above systems are operating. None of these indicates that a malfunction has occurred.
  - Vibrations may be felt through the vehicle body and steering.
  - A motor sound may be heard after the vehicle comes to a stop.
  - The brake pedal may pulsate slightly after the ABS is activated (gasoline vehicles).
  - The brake pedal may move down slightly after the ABS is activated (gasoline vehicles).

**■ EPS operation sound**

When the steering wheel is operated, a motor sound (whirring sound) may be heard. This does not indicate a malfunction.

**■ Automatic reactivation of TRAC and VSC systems**

After turning the TRAC and VSC systems off, the systems will be automatically re-enabled in the following situations:

- When the "START STOP ENGINE" <"POWER"> switch is turned off
- If only the TRAC system is turned off, the TRAC will turn on when vehicle speed increases.  
If both the TRAC and VSC systems are turned off, automatic re-enabling will not occur when vehicle speed increases.

**■ Reduced effectiveness of the EPS system**

The effectiveness of the EPS system is reduced to prevent the system from overheating when there is frequent steering input over an extended period of time. The steering wheel may feel heavy as a result. Should this occur, refrain from excessive steering input or stop the vehicle and turn the engine <hybrid system> off. The effectiveness will improve after a short while.

**▲ CAUTION****■ The ABS does not operate effectively when**

- The limits of tire gripping performance have been exceeded (such as excessively worn tires on a snow covered road).
- The vehicle hydroplanes while driving at high speed on wet or slick roads.

**■ Stopping distance when the ABS is operating may exceed that of normal conditions**

The ABS is not designed to shorten the vehicle's stopping distance. Always maintain a safe distance from the vehicle in front of you, especially in the following situations:

- When driving on dirt, gravel or snow-covered roads
- When driving with tire chains
- When driving over bumps in the road
- When driving over roads with potholes or uneven surfaces

**■ TRAC may not operate effectively when**

Directional control and power may not be achievable while driving on slippery road surfaces, even if the TRAC system is operating.

Drive the vehicle carefully in conditions where stability and power may be lost.

**■ When the VSC is activated**

The slip indicator light flashes. Always drive carefully. Reckless driving may cause an accident. Exercise particular care when the indicator light flashes.

**■ When the TRAC/VSC systems are turned off**

Be especially careful and drive at a speed appropriate to the road conditions. As these are the systems to ensure vehicle stability and driving force, do not turn the TRAC/VSC systems off unless necessary.

 **CAUTION****■ Replacing tires**

Make sure that all tires are of the specified size, brand, tread pattern and total load capacity. In addition, make sure that the tires are inflated to the recommended tire inflation pressure level.

The ABS, TRAC and VSC systems will not function correctly if different tires are installed on the vehicle.

Contact your Lexus dealer for further information when replacing tires or wheels.

**■ Handling of tires and the suspension**

Using tires with any kind of problem or modifying the suspension will affect the driving assist systems, and may cause a system to malfunction.

## Hill-start assist control (hybrid vehicles)

Assists with starting off and temporarily maintains braking power even if the foot is removed from the brake pedal when starting off on an incline or a slippery slope.

To engage hill-start assist control, further depress the brake pedal when the vehicle is stopped completely.

A buzzer will sound once to indicate the system is activated. The slip indicator will also start flashing.

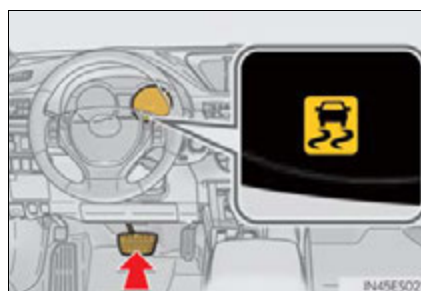

### ■ Hill-start assist control operating conditions

- The system operates in the following situations:
  - The shift lever is in a position other than P.
  - The parking brake is not applied.
  - The accelerator pedal is not depressed.
- Hill-start assist control cannot be operated while the slip indicator light is illuminated.

### ■ Hill-start assist control

- While hill-start assist control is operating, the brakes remain automatically applied after the driver releases the brake pedal. The stop lights and the high mounted stoplight turn on.
- Hill-start assist control operates for about 2 seconds after the brake pedal is released.
- If the slip indicator does not flash and the buzzer does not sound when the brake pedal is further depressed, slightly reduce the pressure on the brake pedal (do not allow the vehicle to roll backward) and then firmly depress it again. If the system still does not operate, check that the operating conditions explained above have been met.



**■ Hill-start assist control buzzer**

- When hill-start assist control is activated, the buzzer will sound once.
- In the following situations, hill-start assist control will be canceled and the buzzer will sound twice.
  - No attempt is made to drive the vehicle within approximately 2 seconds of releasing the brake pedal.
  - The shift lever is moved to P.
  - The parking brake is applied.
  - The brake pedal is depressed again.
  - The brake pedal has been depressed for more than approximately 3 minutes.

**■ If the slip indicator comes on**

It may indicate a malfunction in the system. Contact your Lexus dealer.

**⚠ CAUTION****■ Hill-start assist control**

- Do not overly rely on hill-start assist control. Hill-start assist control may not operate effectively on steep inclines and roads covered with ice.
- Unlike the parking brake, hill-start assist control is not intended to hold the vehicle stationary for an extended period of time. Do not attempt to use hill-start assist control to hold the vehicle on an incline, as doing so may lead to an accident.

## PCS (Pre-Collision System)\*

When the radar sensor detects possibility of a frontal collision, the pre-collision system such as the brakes and seat belts are automatically engaged to lessen impact as well as vehicle damage.

The pre-collision system can be turned on and off as necessary by operating the switch. (→P. 311)

### ◆ Pre-collision seat belts (front seats only)

If the pre-collision sensor detects that a collision is unavoidable, the pre-collision system will retract the seat belt before the collision occurs. The same will happen if the driver makes an emergency braking or loses control of the vehicle. (→P. 34)

However, when the VSC system is disabled, the system will not operate in the event of skidding.

### ◆ Pre-collision brake assist

When there is a high possibility of a frontal collision, the system applies greater braking force in relation to how strongly the brake pedal is depressed.

### ◆ Pre-collision braking

When there is a high possibility of a frontal collision, the system warns the driver using a warning light, warning display and buzzer. If the system determines that a collision is unavoidable, the brakes are automatically applied to reduce the collision speed.

\*: If equipped

### Disabling pre-collision system

- ① Enabled
- ② Disabled

The “PCS” warning light turns on when pre-collision system is disabled.

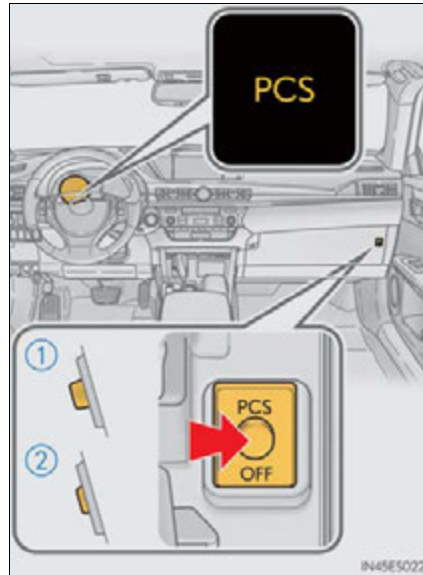

### Radar sensor

The radar sensor detects vehicles or other obstacles on or near the road ahead and determines whether a collision is imminent based on the position, speed, and heading of the obstacles.

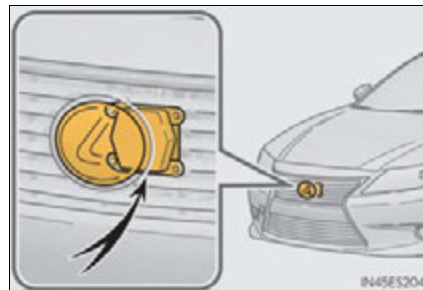

■ **The pre-collision system is operational when**

The pre-collision system off switch is not pressed and the following conditions are met:

- Pre-collision seat belts (operating conditions A):
  - Vehicle speed is greater than about 19 mph (30 km/h).
  - The system detects sudden braking or skidding.
  - The front occupants are wearing a seat belt.
- Pre-collision seat belts (operating conditions B):
  - Vehicle speed is greater than about 4 mph (5 km/h).
  - The speed at which your vehicle is approaching the obstacle or the vehicle running ahead of you is greater than about 19 mph (30 km/h).
  - The front occupants are wearing a seat belt.
- Pre-collision brake assist:
  - Vehicle speed is greater than about 19 mph (30 km/h).
  - The speed at which your vehicle is approaching the obstacle or the vehicle running ahead of you is greater than about 19 mph (30 km/h).
  - The brake pedal is depressed.
- Pre-collision braking:
  - Vehicle speed is greater than about 10 mph (15 km/h).
  - The speed at which your vehicle is approaching the obstacle or the vehicle running ahead of you is greater than about 10 mph (15 km/h).

**■ Conditions that may trigger the system even if there is no possibility of a collision**

- When there is an object by the roadside at the entrance to a curve
- When passing an oncoming vehicle on a curve
- When driving over a narrow iron bridge
- When there is a metal object on the road surface
- When driving on an uneven road surface
- When passing an oncoming vehicle on a left-turn
- When your vehicle rapidly closes on the vehicle in front
- When a grade separation/interchange, sign, billboard, or other structure appears to be directly in the vehicle's line of travel
- When the steep angle of the road causes a metal object located beneath the road surface to be seen ahead of the vehicle
- When an extreme change in vehicle height occurs
- When the axis of the radar is out of adjustment
- When passing through certain toll gates
- When passing through an overpass

When the system is activated in the situations described above, there is also a possibility that the seat belts will retract quickly and the brakes will be applied with a force greater than normal. When the seat belt is locked in the retracted position, stop the vehicle in a safe place, release the seat belt and refasten it.

**■ Obstacles not detected**

The sensor cannot detect plastic obstacles such as traffic cones. There may also be occasions when the sensor cannot detect pedestrians, animals, bicycles, motorcycles, trees, or snowdrifts.

**■ Situations in which the pre-collision system does not function properly**

The system may not function effectively in situations such as the following:

- On roads with sharp bends or uneven surfaces
- If a vehicle suddenly moves in front of your vehicle, such as at an intersection
- If a vehicle suddenly cuts in front of your vehicle, such as when overtaking
- In inclement weather such as heavy rain, fog, snow or sand storms
- When your vehicle is skidding such as the VSC system off
- When your vehicle is steeply inclined
- When the axis of the radar is out of adjustment

■ **Automatic cancelation of the pre-collision system**

When a malfunction occurs due to sensor contamination, etc. that results in the sensors being unable to detect obstacles, the pre-collision system will be automatically disabled. In this case, the system will not activate even if there is a collision possibility.

■ **When there is a malfunction in the system, or if the system is temporarily unusable**

“PCS” warning light will flash and warning messages will be displayed.  
(→P. 761, 771)

■ **Certification**

► For vehicles sold in the U.S.A.

FCC ID: HYQDNMWR004

This device complies with Part 15 of the FCC Rules. Operation is subject to the following two conditions: (1) This device may not cause harmful interference, and (2) this device must accept any interference received, including interference that may cause undesired operation.

**FCC WARNING**

Changes or modifications not expressly approved by the party responsible for compliance could void the user’s authority to operate the equipment.

Radiofrequency radiation exposure Information:

This equipment complies with FCC radiation exposure limits set forth for an uncontrolled environment.

This equipment should be installed and operated with minimum distance of 20 cm between the radiator (antenna) and your body.

This transmitter must not be co-located or operating in conjunction with any other antenna or transmitter.

► For vehicles sold in Canada

This device complies with Industry Canada licence-exempt RSS standards. Operation is subject to the following two conditions: (1) this device may not cause interference, and (2) this device must accept any interference, including interference that may cause undesired operation of the device.

 CAUTION**■ Limitations of the pre-collision system**

Do not overly rely on the pre-collision system. Always drive safely, taking care to observe your surroundings and checking for any obstacles or other road hazards. Failure to do so may cause an accident resulting in death or serious injury.

**■ When the sensor may not be correctly detecting the vehicle ahead**

Apply the brakes as necessary in any of the following situations.

- When water or snow thrown up by the surrounding vehicles hinders the functioning of the sensor
- When your vehicle is pointing upwards (caused by a heavy load in the luggage compartment etc.)
- Vehicles that cut in suddenly
- Vehicles with small rear ends (trailers with no load on board etc.)
- Motorcycles traveling in the same lane

**■ Handling the radar sensor**

Observe the following to ensure the pre-collision system can function effectively. Otherwise, the system may not function correctly and could result in an accident.

- Keep the sensor and grille cover clean at all times.  
Clean the sensor and grille cover with a soft cloth so you do not mark or damage them.
- Do not subject the sensor or surrounding area to a strong impact.  
If the sensor moves even slightly off position, the system may become inaccurate or malfunction. If the sensor or surrounding area is subject to a strong impact, always have the area inspected and adjusted by your Lexus dealer.
- Do not disassemble the sensor.
- Do not attach accessories or stickers to the sensor, grille cover or surrounding area.
- Do not modify or paint the sensor and grille cover.
- Do not replace them with non-genuine parts.

 CAUTION

■ **Cautions regarding the assist contents of the system**

By means of alarms and brake control, the pre-collision system is intended to assist the driver in avoiding collisions through the process of LOOK-JUDGE-ACT. There are limits to the degree of assistance the system can provide, so please keep in mind the following important points.

● **Assisting the driver in watching the road**

The pre-collision system is only able to detect obstacles directly in front of the vehicle, and only within a limited range. It is not a mechanism that allows careless or inattentive driving, and it is not a system that can assist the driver in low-visibility conditions. It is still necessary for the driver to pay close attention to the vehicle's surroundings.

● **Assisting the driver in making correct judgment**

When attempting to estimate the possibility of a collision, the only data available to the pre-collision system is that from obstacles it has detected directly in front of the vehicle. Therefore, it is absolutely necessary for the driver to remain vigilant and to determine whether or not there is a possibility of collision in any given situation.

● **Assisting the driver in taking action**

The pre-collision system's braking assist feature is designed to help reduce the severity of a collision, and so only acts when the system has judged that a collision is unavoidable. This system by itself is not capable of automatically avoiding a collision or bringing the vehicle to a stop safely. For this reason, when encountering a dangerous situation the driver must take direct and immediate action in order to ensure the safety of all involved.



## BSM (Blind Spot Monitor)\*

### Summary of the Blind Spot Monitor

The Blind Spot Monitor is a system that has 2 functions;

- The Blind Spot Monitor function
  - Assists the driver in making the decision when changing lanes
- The Rear Cross Traffic Alert function
  - Assists the driver when backing up

These functions use same sensors.

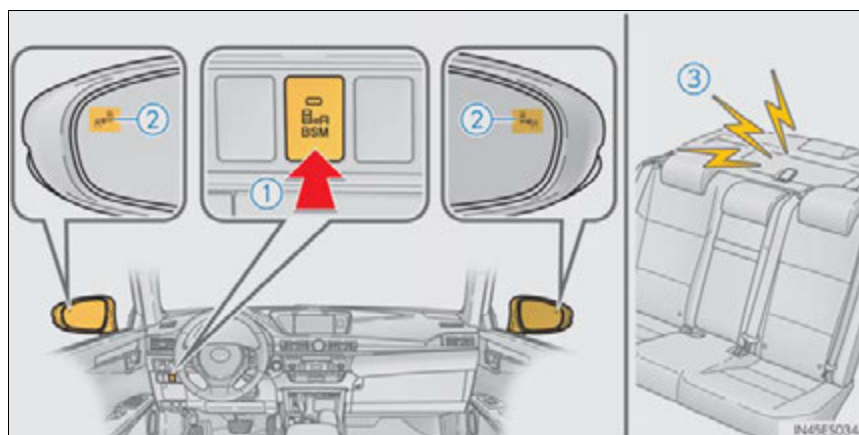

#### ① BSM main switch

Pressing the switch turns the system on or off. When the switch is set to on, the switch's indicator illuminates. Common switch for Blind Spot Monitor function and Rear Cross Traffic Alert function.

4

Driving

\*: If equipped

② Outside rear view mirror indicator

Blind Spot Monitor function:

When a vehicle is detected in the blind spot, the outside rear view mirror indicator comes on while the turn signal lever is not operated and the outside rear view mirror indicator flashes while the turn signal lever is operated.

Rear Cross Traffic Alert function:

When a vehicle approaching from the right or left rear of the vehicle is detected, the outside rear view mirror indicators flash.

③ Rear Cross Traffic Alert buzzer (Rear Cross Traffic Alert function only)

When a vehicle approaching from the right or left rear of the vehicle is detected, a buzzer sounds from behind the rear seat.

**■ The outside rear view mirror indicators visibility**

When under strong sunlight, the outside rear view mirror indicator may be difficult to see.

**■ Rear Cross Traffic Alert buzzer hearing**

Rear Cross Traffic Alert function may be difficult to hear over loud noises such as high audio volume.

**■ When there is a malfunction in the Blind Spot Monitor system**

If a system malfunction is detected due to any of the following reasons, warning messages will be displayed: (→P. 773)

- There is a malfunction with the sensors
- The sensors have become dirty
- The outside temperature is extremely high or low
- The sensor voltage has become abnormal

**■ Certification for the Blind Spot Monitor system**

- ▶ For vehicles sold in the U.S.A.

FCC ID: OAYSRR2A

This device complies with part 15 of the FCC Rules. Operation is subject to the following two conditions:

- (1) This device may not cause harmful interference, and
- (2) this device must accept any interference received, including interference that may cause undesired operation.

**FCC WARNING**

Changes or modifications not expressly approved by the party responsible for compliance could void the user's authority to operate the equipment.

- ▶ For vehicles sold in Canada

Applicable law: Canada 310

This device complies with Industry Canada licence-exempt RSS standard(s). Operation is subject to the following two conditions: (1) this device may not cause interference, and (2) this device must accept any interference, including interference that may cause undesired operation of the device.

Frequency bands: 24.05-24.25 GHz

Output power: less than 20 milliwatts

**⚠ CAUTION****■ Handling the radar sensor**

One Blind Spot Monitor sensor is installed inside the left and right side of the vehicle rear bumper respectively. Observe the following to ensure the Blind Spot Monitor system can function correctly.

- Keep the sensor and its surrounding area on the bumper clean at all times.

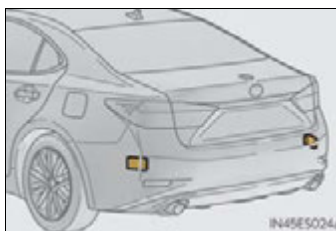

- Do not subject the sensor or surrounding area on the bumper to a strong impact. If the sensor moves even slightly off position, the system may malfunction and vehicles that enter the detection area may not be detected. If the sensor or surrounding area is subject to a strong impact, always have the area inspected by your Lexus dealer.
- Do not disassemble the sensor.
- Do not attach accessories or stickers to the sensor or surrounding area on the bumper.
- Do not modify the sensor or surrounding area on the bumper.
- Do not paint the sensor or surrounding area on the bumper.

### The Blind Spot Monitor function

The Blind Spot Monitor function uses radar sensors to detect vehicles that are traveling in an adjacent lane in the area that is not reflected in the outside rear view mirror (the blind spot), and advises the driver of the vehicles existence via the outside rear view mirror indicator.

### The Blind Spot Monitor function detection areas

The areas that vehicles can be detected in are outlined below.

The range of the detection area extends to:

- ① Approximately 11.5 ft. (3.5 m) from the side of the vehicle  
The first 1.6 ft. (0.5 m) from the side of the vehicle is not in the detection area
- ② Approximately 9.8 ft. (3 m) from the rear bumper
- ③ Approximately 3.3 ft. (1 m) forward of the rear bumper

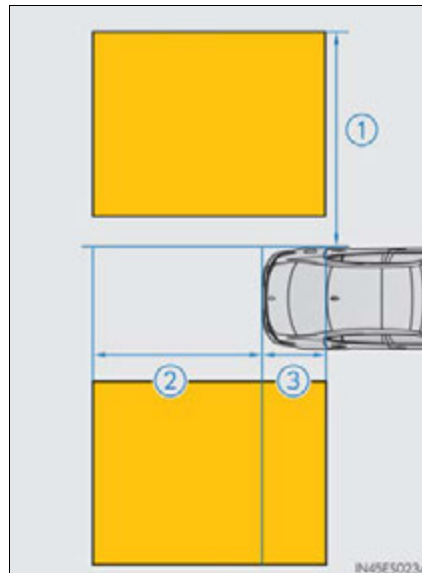

4

Driving

#### ⚠ CAUTION

##### ■ Cautions regarding the use of the system

The driver is solely responsible for safe driving. Always drive safely, taking care to observe your surroundings.

The Blind Spot Monitor function is a supplementary function which alerts the driver that a vehicle is present in the blind spot. Do not overly rely on the Blind Spot Monitor function. The function cannot judge if it is safe to change lanes, therefore over reliance could cause an accident resulting in death or serious injury.

According to conditions, the system may not function correctly. Therefore the driver's own visual confirmation of safety is necessary.

■ **The Blind Spot Monitor function is operational when**

- The BSM main switch is set to on
- Vehicle speed is greater than approximately 10 mph (16 km/h).

■ **The Blind Spot Monitor function will detect a vehicle when**

- A vehicle in an adjacent lane overtakes your vehicle.
- Another vehicle enters the detection area when it changes lanes.

■ **Conditions under which the Blind Spot Monitor function will not detect a vehicle**

The Blind Spot Monitor function is not designed to detect the following types of vehicles and/or objects:

- Small motorcycles, bicycles, pedestrians etc. \*
- Vehicles traveling in the opposite direction
- Guardrails, walls, signs, parked vehicles and similar stationary objects \*
- Following vehicles that are in the same lane \*
- Vehicles driving 2 lanes across from your vehicle \*

\*: Depending on conditions, detection of a vehicle and/or object may occur.

**■ Conditions under which the Blind Spot Monitor function may not function correctly**

- The Blind Spot Monitor function may not detect vehicles correctly in the following conditions:
  - During bad weather such as heavy rain, fog, snow etc.
  - When ice or mud etc. is attached to the rear bumper
  - When driving on a road surface that is wet due to rain, standing water etc.
  - When there is a significant difference in speed between your vehicle and the vehicle that enters the detection area
  - When a vehicle is in the detection area from a stop and remains in the detection area as your vehicle accelerates
  - When driving up or down consecutive steep inclines, such as hills, a dip in the road etc.
  - When multiple vehicles approach with only a small gap between each vehicle
  - When vehicle lanes are wide, and the vehicle in the next lane is too far away from your vehicle
  - When the vehicle that enters the detection area is traveling at about the same speed as your vehicle
  - When there is a significant difference in height between your vehicle and the vehicle that enters the detection area
  - Directly after the BSM main switch is set to on
  - When items such as a bicycle carrier are installed on the rear of the vehicle
- Instances of the Blind Spot Monitor function unnecessarily detecting a vehicle and/or object may increase under the following conditions:
  - When there is only a short distance between your vehicle and a guardrail, wall etc.
  - When there is only a short distance between your vehicle and a following vehicle
  - When vehicle lanes are narrow and a vehicle driving 2 lanes across from your vehicle enters the detection area
  - When items such as a bicycle carrier are installed on the rear of the vehicle

### The Rear Cross Traffic Alert function

The Rear Cross Traffic Alert functions when your vehicle is in reverse. It can detect other vehicles approaching from the right or left rear of the vehicle. It uses radar sensors to alert the driver of the other vehicle's existence through flashing the outside rear view mirror indicators and sounding a buzzer.

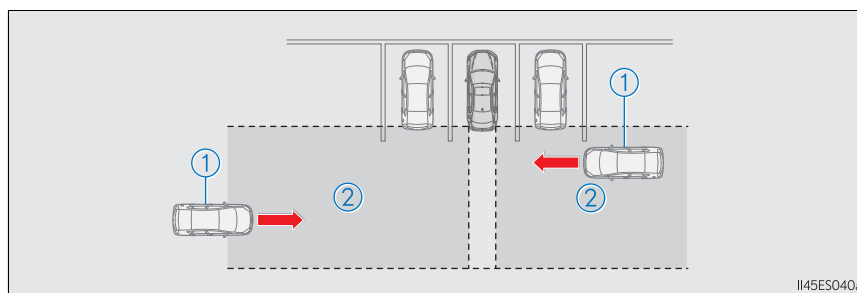

① Approaching vehicles                      ② Detection areas

#### ⚠ CAUTION

##### ■ Cautions regarding the use of the system

The driver is solely responsible for safe driving. Always drive safely, taking care to observe your surroundings.

The Rear Cross Traffic Alert function is only an assist and is not a replacement for careful driving. Driver must be careful when backing up, even when using Rear Cross Traffic Alert function. The driver's own visual confirmation of behind you and your vehicle is necessary and be sure there are no pedestrians, other vehicles etc. before backing up. Failure to do so could cause death or serious injury.

According to conditions, the system may not function correctly. Therefore the driver's own visual confirmation of safety is necessary.



### The Rear Cross Traffic Alert function detection areas

The areas that vehicles can be detected in are outlined below.

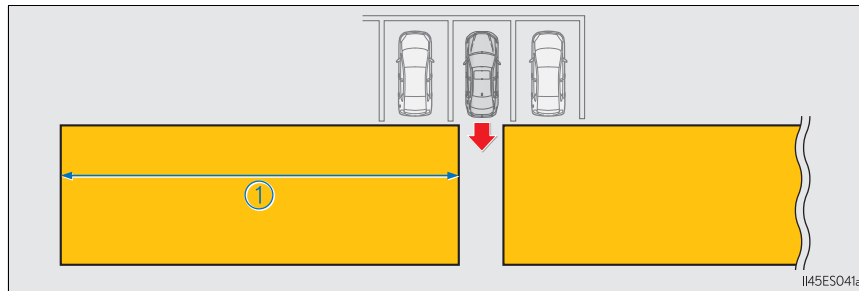

To give the driver a more consistent time to react, the buzzer can alert for faster vehicles from farther away.

Example:

Approaching vehicle	Speed	① Approximate alert distance
Fast	18 mph (28 km/h)	65 ft. (20 m)
Slow	5 mph (8 km/h)	18 ft. (5.5 m)

4

Driving

#### ■ The Rear Cross Traffic Alert function is operational when

- The BSM main switch is set to on.
- The shift lever is in R.
- Vehicle speed is less than approximately 5 mph (8 km/h).
- Approaching vehicle speed is between approximately 5 mph (8 km/h) and 18 mph (28 km/h).

■ **Conditions under which the Rear Cross Traffic Alert function will not detect a vehicle**

The Rear Cross Traffic Alert function is not designed to detect the following types of vehicles and/or objects.

- Small motorcycles, bicycles, pedestrians etc. \*
- Vehicles approaching from directly behind
- Guardrails, walls, signs, parked vehicles and similar stationary objects \*
- Vehicles moving away from your vehicle
- Vehicles approaching from the parking spaces next to your vehicle \*
- Vehicles backing up in the parking space next to your vehicle \*

\*: Depending on conditions, detection of a vehicle and/or object may occur.

■ **Conditions under which the Rear Cross Traffic Alert function may not function correctly**

The Rear Cross Traffic Alert function may not detect vehicles correctly in the following conditions:

- When ice or mud etc. is attached to the rear bumper
- During bad weather such as heavy rain, fog, snow etc.
- When multiple vehicles approach continuously
- Shallow angle parking
- When a vehicle is approaching at high speed
- When parking on a steep incline, such as hills, a dip in the road etc.
- Directly after the BSM main switch is set to on
- Vehicles that the sensors cannot detect because of obstacles

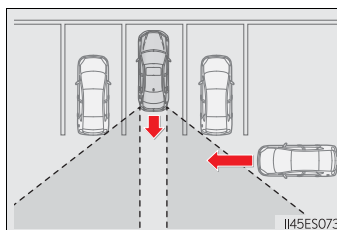

## Hybrid vehicle driving tips (hybrid vehicles)

For economical and ecological driving, pay attention to the following points:

### Using Eco drive mode

When using Eco drive mode, the torque corresponding to the accelerator pedal depression amount can be generated more smoothly than it is in normal conditions. In addition, the operation of the air conditioning system (heating/cooling) will be minimized, improving the fuel economy. (→P. 300)

### Use of Hybrid System Indicator

The Eco-friendly driving is possible by keeping the indicate of Hybrid System Indicator within Eco area. (→P. 98)

### When braking the vehicle

Make sure to operate the brakes gently and in good time. A greater amount of electrical energy can be retained when slowing down.

### Delays

Repeated acceleration and deceleration, as well as long waits at traffic lights, will lead to bad fuel consumption. Check traffic reports before leaving and avoid delays as much as possible. When encountering a delay, gently release the brake pedal to allow the vehicle to move forward slightly while avoiding overuse of the accelerator pedal. Doing so can help control excessive gasoline consumption.

### Highway driving

Control your speed and keep at a constant speed. Also, before stopping at a toll booth or similar, allow plenty of time to release the accelerator and gently apply the brakes. A greater amount of electrical energy can be retained when slowing down.

### Air conditioning

Use the air conditioning only when necessary. Doing so can help control excessive gasoline consumption.

In summer: In high temperatures, use the recirculated air mode. Doing so will help to reduce the burden on the air conditioner and reduce fuel consumption as well.

In winter: Because the gasoline engine will not automatically cut out until the gasoline engine and the interior of the vehicle are warm, it will consume fuel. Also, fuel consumption can be improved by avoiding overuse of the heater.

### Checking tire inflation pressure

Make sure to check the tire inflation pressure frequently. Improper tire inflation pressure can cause poor fuel consumption.

Also, as snow tires can cause large amounts of friction, their use on dry roads can lead to poor fuel consumption. Use a tire that is appropriate for the season.

### Luggage

Carrying heavy luggage can lead to poor fuel consumption. Avoid carrying unnecessary luggage. Installing a large roof rack can also cause poor fuel consumption.

### Warming up before driving

Since the gasoline engine starts up and cuts out automatically when cold, warming up the engine is unnecessary. Moreover, frequently driving short distances will cause the engine to repeatedly warm up, which can lead to poor fuel consumption.

## Winter driving tips

Carry out the necessary preparations and inspections before driving the vehicle in winter. Always drive the vehicle in a manner appropriate to the prevailing weather conditions.

### Preparation for winter

- Use fluids that are appropriate to the prevailing outside temperatures.
  - Engine oil
  - Engine coolant
  - Power control unit coolant (hybrid vehicles)
  - Washer fluid
- Have a service technician inspect the condition of the 12-volt battery.
- Have the vehicle fitted with four snow tires or purchase a set of tire chains for the front tires.

Ensure that all tires are the specified size and brand, and that chains match the size of the tires.

### Before driving the vehicle

Perform the following according to the driving conditions:

- Do not try to forcibly open a window or move a wiper that is frozen. Pour warm water over the frozen area to melt the ice. Wipe away the water immediately to prevent it from freezing.
- To ensure proper operation of the climate control system fan, remove any snow that has accumulated on the air inlet vents in front of the windshield.
- Check for and remove any excess ice or snow that may have accumulated on the exterior lights, vehicle's roof, chassis, around the tires or on the brakes.
- Remove any snow or mud from the bottom of your shoes before getting in the vehicle.

### When driving the vehicle

Accelerate the vehicle slowly, keep a safe distance between you and the vehicle ahead, and drive at a reduced speed suitable to road conditions.

### When parking the vehicle

Park the vehicle and move the shift lever to P without setting the parking brake. The parking brake may freeze up, preventing it from being released. If necessary, block the wheels to prevent inadvertent sliding or creeping.

### Selecting tire chains

Use the correct tire chain size when mounting the tire chains.  
Chain size is regulated for each tire size.

► Side chain

- ① 0.12 in. (3 mm) in diameter
- ② 0.39 in. (10 mm) in width
- ③ 1.18 in. (30 mm) in length

► Cross chain

- ④ 0.16 in. (4 mm) in diameter
- ⑤ 0.55 in. (14 mm) in width
- ⑥ 0.98 in. (25 mm) in length

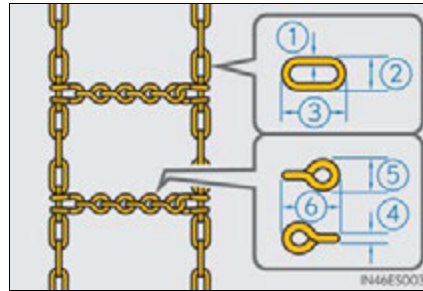

### Regulations on the use of tire chains

Regulations regarding the use of tire chains vary depending on location and type of road. Always check local regulations before installing chains.

#### ■ Tire chain installation

Observe the following precautions when installing and removing chains:

- Install and remove tire chains in a safe location.
- Install tire chains on the front tires. Do not install tire chains on the rear tires.
- Install tire chains on front tires as tightly as possible. Retighten chains after driving 1/4—1/2 mile (0.5—1.0 km).
- Install tire chains following the instructions provided with the tire chains.



### Shifting the windshield wiper position

If heavy snow or icy condition is expected, shift the rest position manually. Grip the hook section of the wiper arm firmly when shifting the wiper position.

#### ■ To rest position

Raise the wiper in line with the windshield until it locks.

You can stand the wipers up for the rest position.

★: More than 3.9 in. (10 cm)

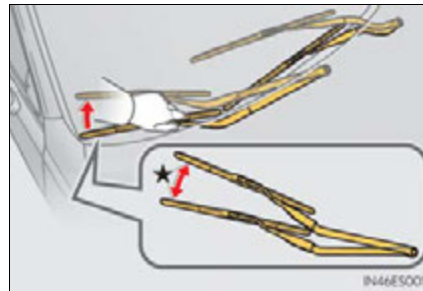

#### ■ To retract position

Lower the wipers by pressing on the upper part of the hook section.

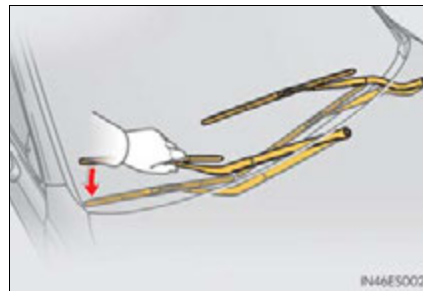

 CAUTION**■ Driving with snow tires**

Observe the following precautions to reduce the risk of accidents. Failure to do so may result in a loss of vehicle control and cause death or serious injury.

- Use tires of the specified size.
- Maintain the recommended level of air pressure.
- Do not drive in excess of 75 mph (120 km/h), regardless of the type of snow tires being used.
- Use snow tires on all, not just some wheels.

**■ Driving with tire chains**

Observe the following precautions to reduce the risk of accidents. Failure to do so may result in the vehicle being unable to be driven safely, and may cause death or serious injury.

- Do not drive in excess of the speed limit specified for the tire chains being used, or 30 mph (50 km/h), whichever is lower.
- Avoid driving on bumpy road surfaces or over potholes.
- Avoid sudden acceleration, abrupt steering, sudden braking and shifting operations that cause sudden engine braking.
- Slow down sufficiently before entering a curve to ensure that vehicle control is maintained.
- Do not use LDA (Lane Departure Alert) system.

 NOTICE**■ Repairing or replacing snow tires**

Request repairs or replacement of snow tires from Lexus dealers or legitimate tire retailers.

This is because the removal and attachment of snow tires affects the operation of the tire pressure warning valves and transmitters.

**■ Fitting tire chains**

The tire pressure warning valves and transmitters may not function correctly when tire chains are fitted.

**■ When standing the windshield wipers up**

Raise the wipers in line with the windshield. (→P. 333)

Failure to do so may result in damage to the wipers and/or the hood.

**5-1. Lexus Display Audio system**

Lexus Display Audio system .....	338
Display settings .....	343
Setup menu.....	345
Mobile Assistant.....	351

**5-2. Using the air conditioning system and defogger**

Automatic air conditioning system (with the Lexus Display Audio system) .....	353
Automatic air conditioning system (without a navigation system or the Lexus Display Audio system) .....	365
Rear window and outside rear view mirror defoggers.....	378
Windshield wiper de-icer .....	380

**5-3. Using the Lexus****Display Audio system**

Audio system (with the Lexus Display Audio system).....	382
Using the radio.....	385
Using the CD player.....	400
Playing an audio CD and MP3/WMA discs .....	401
Listening to an iPod.....	411
Listening to a USB memory .....	419
Using the AUX port .....	429
Listening to Bluetooth® audio .....	431
Optimal use of the audio system.....	446
Using the steering wheel audio switches.....	448
Hands-free system (for cellular phone).....	451
Using the Bluetooth® phone .....	459
Setting the hands-free system .....	478
Bluetooth® settings .....	491

## Interior features

## 5

**5-4. Using the audio system**

Audio system (without a navigation system or the Lexus Display Audio system).....	500
Using the radio.....	503
Using the CD player.....	512
Playing MP3 and WMA discs.....	521
Operating an iPod.....	529
Operating a USB memory.....	539
Bluetooth® audio system.....	548
Using the Bluetooth® audio system.....	552
Operating a Bluetooth® enabled portable player.....	557
Setting up a Bluetooth® enabled portable player.....	561
Bluetooth® audio system setup.....	568
Optimal use of the audio system.....	569
Using the AUX port.....	571
Using the steering wheel audio switches.....	573
Hands-free system (for cellular phone).....	576
Using the hands-free system (for cellular phones).....	581
Making a phone call.....	589
Setting a cellular phone.....	593
Security and system setup.....	598
Using the phone book.....	603

**5-5. Using the interior lights**

Interior lights list.....	611
• Interior light.....	612
• Personal lights.....	612

**5-6. Using the storage features**

List of storage features.....	614
• Glove box.....	616
• Console box.....	617
• Cup holders.....	618
• Auxiliary box.....	619
Trunk features.....	620

**5-7. Other interior features**

Sun visors and vanity mirrors.....	622
Clock.....	623
Power outlets.....	624
Heated steering wheel.....	626
Seat heaters and ventilators.....	628
Armrest.....	630
Rear sunshade/ rear door sunshades.....	631
Trunk storage extension.....	634
Coat hooks.....	635
Assist grips.....	636
Garage door opener.....	637
Compass.....	644
Safety Connect.....	649

## Lexus Display Audio system\*

By using the Lexus Display Audio controller, you can control the audio system and hands-free system, etc.

### Lexus Display Audio controller

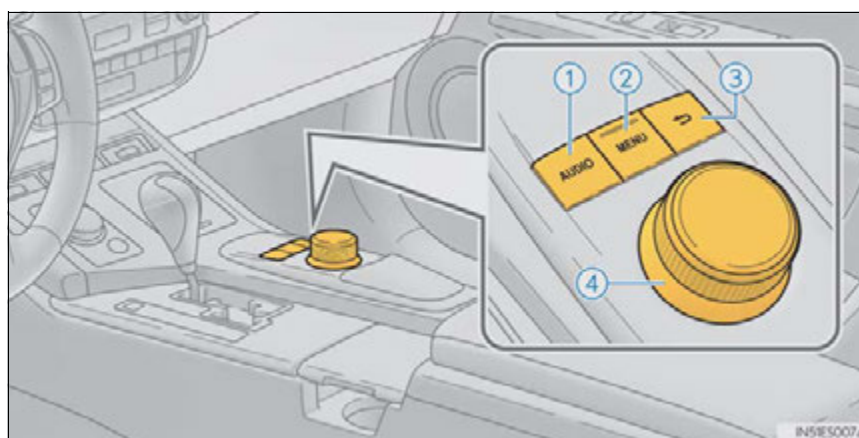

- ① Displaying the audio control screen (→P. 382)
- ② Displaying the “Menu” screen (→P. 339)
- ③ Displaying the previous screen
- ④ Turn or move the controller to select a function, number and screen button.  
Push the controller to enter the selected function, number and screen button.

\*: If equipped

### “Menu” screen

To display the “Menu” screen, press the “MENU” button on the Lexus Display Audio controller.



Button	Function
“Climate”	Automatic air conditioning system (→P. 353)
“Phone”	Hands-free system (→P. 451)
“Car”	Vehicle information (→P. 110)
“Setup”	Setup menu (→P. 345)
“Display”	Display settings (→P. 343)

### Initial screen

When the “START STOP ENGINE” <“POWER”> switch is turned to ACCESSORY or IGNITION ON <ON> mode, the initial screen will be displayed for a few seconds as the system starts up.

Images shown on the initial screen can be changed to image1 or image2.  
(→P. 346)





**Lexus Display Audio system operation**

■ **Using the Lexus Display Audio controller**

- ① Select: Turn or move the controller.
- ② Enter: Push the controller.

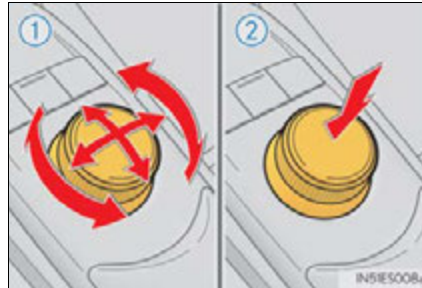

■ **Basic screen operation**

When a list is displayed, use the appropriate button to scroll through the list.



: This indicator turn on when the list box is selected.



: To scroll to the next or previous page.



: To return to the previous screen.

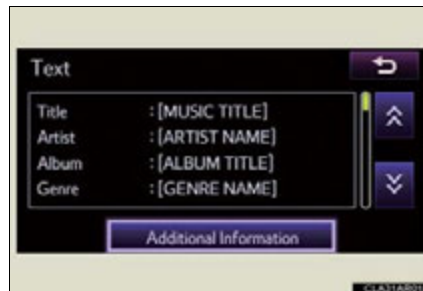

■ **When using the screen**

- Under extremely cold conditions, the Lexus Display Audio controller may react slowly.
- If the screen is cold, the display may be dark, or the system may seem to be operating slightly slower than normal.
- The screen may seem dark and hard to see when viewed through sunglasses. Change your angle of viewing, adjust the display on the "Display Settings" screen (→P. 343) or remove your sunglasses.

 **CAUTION**

■ **Using the Lexus Display Audio controller**

- Do not allow fingers, fingernails or hair to become caught in the Lexus Display Audio controller as this may cause an injury.
- Be careful when touching the Lexus Display Audio controller in extreme temperatures as it may become very hot or cold due to the temperature inside the vehicle.

 **NOTICE**

■ **To prevent the Lexus Display Audio controller malfunction**

- Do not allow the Lexus Display Audio controller to come into contact with food, liquid, stickers or lit cigarettes as doing so may cause it to change color, emit a strange odor or stop functioning.
- Do not subject the Lexus Display Audio controller to excessive pressure or strong impact as the controller may bend or break off.
- Do not allow coins, contact lenses or other such items to become caught in the Lexus Display Audio controller as this may cause it to stop functioning.
- Items of clothing may rip if they become caught on the Lexus Display Audio controller.
- If your hand or any object is on the Lexus Display Audio controller when the "START STOP ENGINE" <"POWER"> switch is turned to ACCESSORY mode, the Lexus Display Audio controller may not operate properly.

## Display settings

You can adjust the contrast and brightness of the screen and also turn the display off.

To display the “Display Settings” screen, press the “MENU” button on the Lexus Display Audio controller and then select “Display” on the “Menu” screen.

### ① Turns off screen

The screen is turned off. To turn it on, press the “AUDIO” or “MENU” button on the Lexus Display Audio controller.

### ② Changes to day mode (→P. 343)

### ③ Adjusts screen contrast/brightness (→P. 344)

### ④ Adjusts screen contrast/brightness of rear view monitor camera (→P. 344)

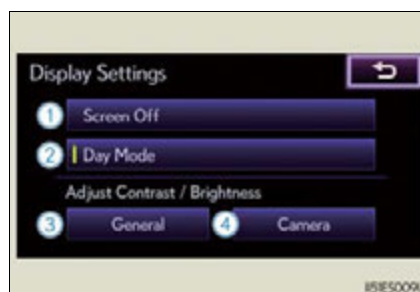

## Changing between day mode and night mode

When the headlights are turned on, the screen dims.

However, the screen can be switched to day mode by selecting “Day Mode”.

If the screen is set in day mode with the headlight switch turned on, this condition is memorized even with the “START STOP ENGINE” <“POWER”> switch is turned off.

### Adjusting the screen contrast/brightness

- 1 Select "General" or "Camera" on the "Display Settings" screen.
- 2 Adjust the display as desired using "+" or "-".  
Select "Contrast" or "Brightness" using the "<<" or ">>".



	"-"	"+"
"Contrast"	Weaker	Stronger
"Brightness"	Darker	Brighter

- 3 Select "OK".

## Setup menu

You can change the Lexus Display Audio system to your desired setting.

To display the "Setup" screen, press the "MENU" button on the Lexus Display Audio controller and then select "Setup" on the "Menu" screen.

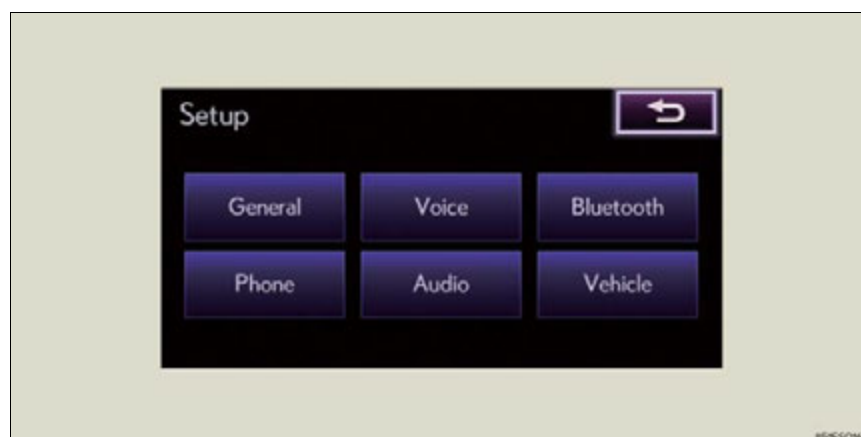

Button	Page
"General"	P. 346
"Voice"	P. 350
"Bluetooth <sup>*</sup> "	P. 459
"Phone"	P. 478
"Audio"	P. 349
"Vehicle"	P. 348

\*: Bluetooth is a registered trademark of Bluetooth SIG, Inc.

### General settings

This screen is used for various settings.

- 1 Display the "Setup" screen. (→P. 345)
- 2 Select "General" on the "Setup" screen.

▶ Page 1

▶ Page 2

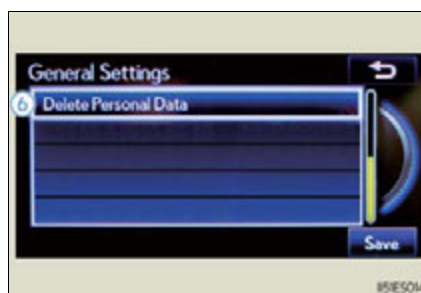

- 1 Select language (→P. 347)

- 2 Beep on/off

- 3 Select button color

- 4 Customize Startup Image

The initial screen displayed when the "START STOP ENGINE" <"POWER"> switch is turned to ACCESSORY or IGNITION ON <ON> mode can be changed to image 1, or image 2 which displays the vehicle screen.

- 5 Animation on/off

The animation effect for audio source selection screen, screen transitions, etc. can be set to "On" or "Off".

- 6 Personal data can be deleted. (→P. 347)

- 3 When you complete settings, select "Save".

### ■ Selecting a language

1 Select "Language" on the "General Settings" screen.

2 Select the desired language.

The selectable languages may differ depending on the model or region.

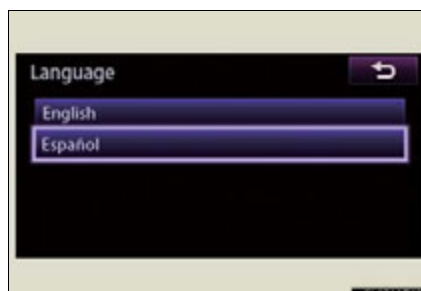

### ■ Delete personal data

1 Select "Delete Personal Data" on the "General Settings" screen.

2 Select "Delete".

Check carefully beforehand, as data cannot be retrieved once deleted.

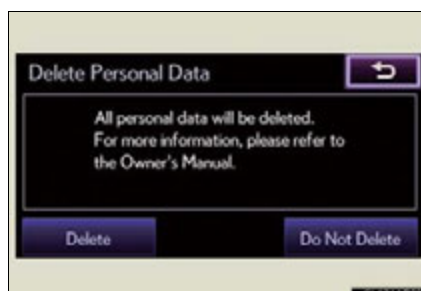

3 A confirmation screen will be displayed. Select "Yes".

The following personal data can be deleted or turned to their default settings.

- Phonebook data
- Call history data
- Speed dial data
- Bluetooth® devices data
- Phone sound settings
- Detailed Bluetooth® settings
- Sound settings
- Preset switch data
- Last used radio station

## Vehicle settings

This screen is used for various vehicle settings.

- 1 Display the "Setup" screen. (→P. 345)
- 2 Select "Vehicle" on the "Setup" screen.
  - ① Vehicle customization settings (→P. 348)
  - ② LEXUS park assist settings\* (→P. 283)

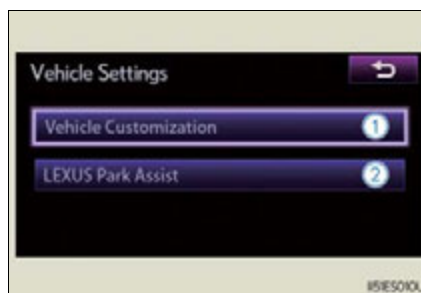

### ■ Vehicle customization settings

Various setting can be changed.

- 1 Select "Vehicle Customization" on the "Vehicle Settings" screen.

Refer to the list of settings that can be changed for details. (→P. 863)

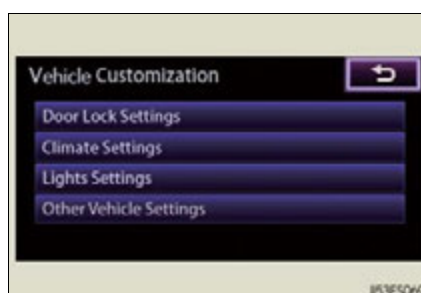

- 2 When you complete settings, select "Save".

\*: If equipped



## Audio settings

This screen is used for various audio settings.

- 1 Display the "Setup" screen. (→P. 345)
- 2 Select "Audio" on the "Setup" screen.
  - ① HD Radio™ technology settings (→P. 391)
  - ② iPod setting (→P. 349)

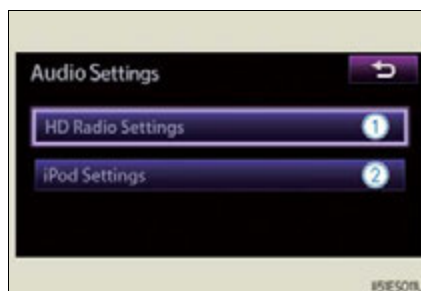

- 3 When you complete settings, select "Save".

### ■ iPod setting

This screen is used for iPod setting.

- 1 Select "iPod Settings" on the "Audio Settings" screen. (→P. 349)
- 2 Select "Display Cover Art".

"On" or "Off" can be selected to display/iPod cover art in the screen.

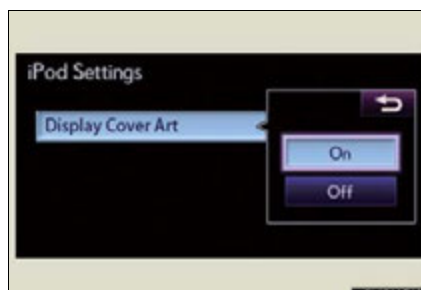

### Voice settings

This screen is used for guidance for Bluetooth® hands-free systems setting.

- 1 Display the "Setup" screen. (→P. 345)
- 2 Select "Voice" on the "Setup" screen.
  - 1 Voice guidance volume setting
  - 2 Voice recognition prompts on/off
  - 3 Restore default settings

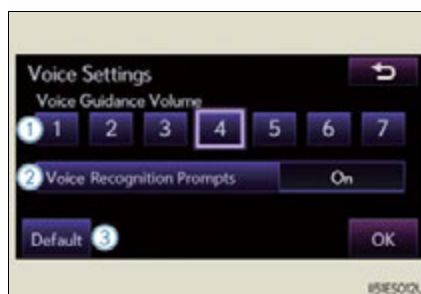

- 3 When you complete settings, select "OK".

## Mobile Assistant

The Mobile Assistant feature on this system allows the activation of Apple's Siri® Eyes Free mode via the steering wheel switches. To operate the Mobile Assistant, a compatible cellular phone must be registered and connected to this system via Bluetooth®. (→P. 459)

- 1 Press and hold the off hook switch until you hear the beeps that indicate the system is listening.

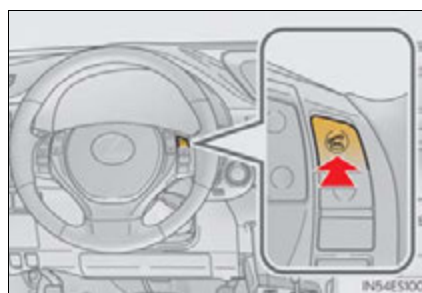

- 2 The Mobile Assistant can be used only when the neighboring screen is displayed.

To cancel the Mobile Assistant, select "Cancel", or press and hold the off hook switch.

To restart the Mobile Assistant for additional commands, press the off hook switch. Mobile Assistant can only be restarted after the system responds to a voice command. After some phone and music commands, the Mobile Assistant feature will automatically end to complete the requested action.



5

Interior features

### ■ Adjusting the volume

The volume of the Mobile Assistant can be adjusted using the "PWR•VOL" knob or steering wheel volume switches. The Mobile Assistant and phone call volumes are synchronized.

■ **Microphone**

It is not necessary to speak directly into the microphone when using the Mobile Assistant.

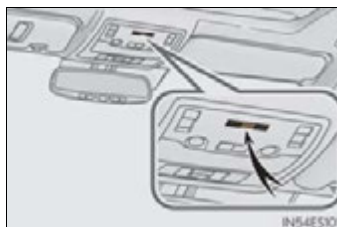

- Wait for the listening beeps before using the Mobile Assistant.
- The Mobile Assistant may not recognize commands in the following situations:
  - When spoken too quickly.
  - When spoken at a low or high volume.
  - When the roof or windows are open.
  - When passengers are talking while the Mobile Assistant is being used.
  - When the air conditioning system's fan speed is set high.
  - When the air conditioning vents are turned toward the microphone.

■ **Mobile Assistant precautions**

- The available features and functions may vary based on the iOS version installed on the connected device.
- Some Siri features are limited in Eyes Free mode. If you attempt to use an unavailable function, Siri will inform you that the function is not available.
- If Siri is not enabled on the cellular phone connected via Bluetooth<sup>®</sup>, an error message will be displayed on the screen.
- While a phone call is active, the Mobile Assistant cannot be used.
- If using the navigation feature of the cellular phone, ensure the active audio source is Bluetooth<sup>®</sup> audio or iPod in order to hear turn by turn direction prompts.

## Automatic air conditioning system (with the Lexus Display Audio system)

Air outlets and fan speed are automatically adjusted according to the temperature setting.

To display the air conditioning operation screen, press the “MENU” button on the Lexus Display Audio controller and then select “Climate”.

- ▶ Vehicles with a navigation system  
Owners of models equipped with a navigation system should refer to the “Navigation System Owner’s Manual”.
- ▶ Vehicles without a navigation system or the Lexus Display Audio system  
→P. 365

Control panel



- ① Air conditioning operation screen
- ② Outside temperature display
- ③ Automatic mode button
- ④ "OFF" button
- ⑤ Fan speed control button
- ⑥ Air outlet selector button
- ⑦ Windshield defogger button
- ⑧ DUAL mode button
- ⑨ Passenger's side temperature control buttons
- ⑩ Passenger's side temperature display
- ⑪ Outside/recirculated air mode button
- ⑫ Driver's side temperature display
- ⑬ Driver's side temperature control buttons

### Automatic air conditioning system control screen

- ① Adjusting driver's side temperature setting
- ② Adjusting passenger's side temperature setting
- ③ Adjusting the fan speed
- ④ Selecting air outlet mode
- ⑤ Cooling and dehumidification function on/off
- ⑥ Dual mode on/off
- ⑦ Micro dust and pollen filter on/off
- ⑧ Windshield wiper de-icer on/off

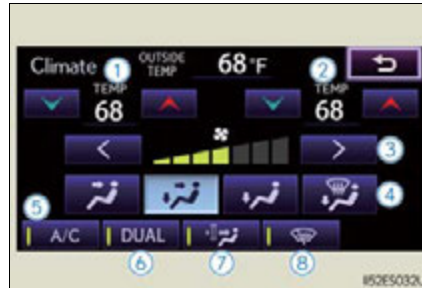

### Using the automatic air conditioning system





- 1 Press .

The air conditioning system begins to operate. Air outlets and fan speed are automatically adjusted according to the temperature setting.





- 2 Press or select of the "TEMP" to increase the temperature and or to decrease the temperature.



When is selected (the indicator on is on) or the passenger's side temperature control button is pressed, the temperature for the driver and passenger seats can be adjusted separately.

### Adjusting the settings manually

- 1 To turn on the air conditioning system and adjust the fan speed, press  on  to increase the fan speed and  to decrease the fan speed or select ">" of  to increase the fan speed and "<" to decrease the fan speed.

Press  to turn the fan off.

- 2 To adjust the temperature setting, press  or select  of the "TEMP" to increase the temperature and  or  to decrease the temperature.

When  is selected (the indicator on  is on) or the passenger's side temperature control button is pressed, the temperature for the driver and passenger seats can be adjusted separately.

- 3 To change the air outlets, press  or select an air outlet switch on the operation screen.





**Defogging the windshield**

Press .

The dehumidification function operates and fan speed increases.

Set the outside/recirculated air mode button to outside air mode if the recirculated air mode is used. (It may switch automatically.)

To defog the windshield and the side windows early, turn the air flow and temperature up.

To return to the previous mode, press  again when the windshield is defogged.

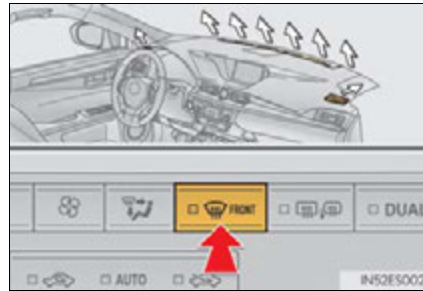

**Air outlets and air flow**

Upper body

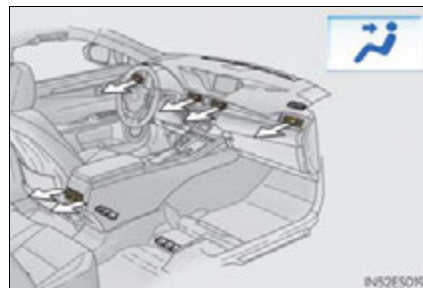

Upper body and feet

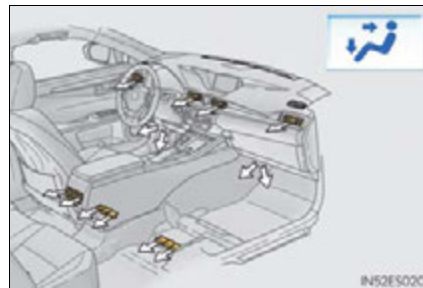

Feet

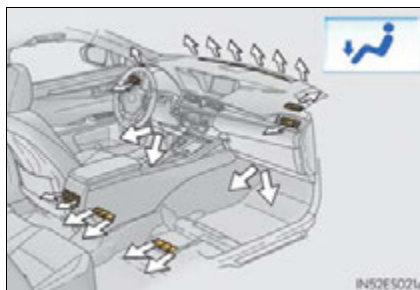

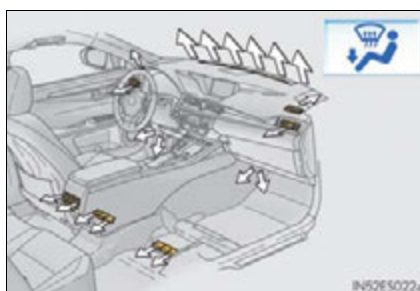

Feet and windshield



### Switching between outside air and recirculated air modes

Press .

The mode switches among  (recirculated air mode), automatic and  (outside air mode) modes each time the button is pressed.

When the system is switched to automatic mode, the air conditioning system operates automatically.

### Micro dust and pollen filter button

Operates micro dust and pollen filter on/off.

Outside air mode switches to  (recirculated air) mode. Pollen is removed from the air and the air flows to the upper part of the body.

Usually the system will turn off automatically after approximately 1 to 3 minutes.



**Adjusting the position of and opening and closing the air outlets**

## ■ Front center outlets and front side outlets

- ① Direct air flow to the left or right, up or down.
- ② Turn the knob to open or close the vent.

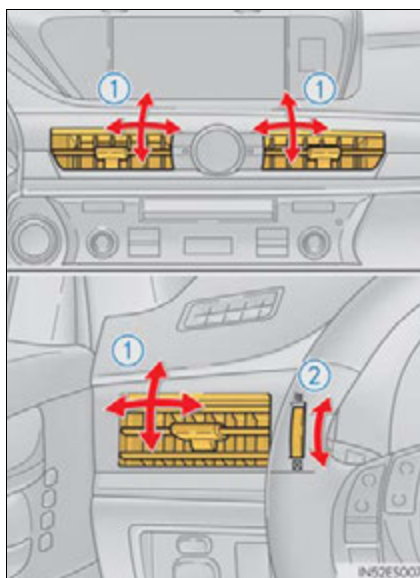

## ■ Rear seat outlets

- ① Direct air flow to the left or right, up or down.
- ② Turn the knob to open or close the vent.

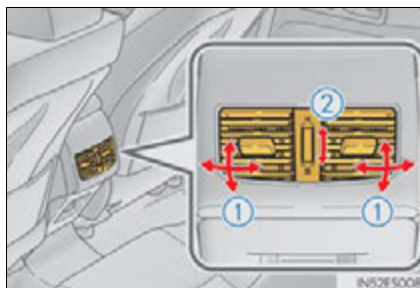

### ■ Registering air conditioning settings to electronic keys

- Unlocking the vehicle using an electronic key and turning the “START STOP ENGINE” <“POWER”> switch to IGNITION ON <ON> mode will recall that key’s registered air conditioning settings.
- When the “START STOP ENGINE” <“POWER”> is turned off, the current air conditioning settings will automatically be registered to the electronic key that was used to unlock the vehicle.

The system may not operate correctly if more than one electronic key is in the vicinity or if the smart access system with push-button start is used to unlock a passenger door.

Settings for the electronic key and the corresponding door can be changed.



Contact your Lexus dealer.

### ■ Using automatic mode

Fan speed is adjusted automatically according to the temperature setting and the ambient conditions.

Therefore, the fan may stop for a while until warm or cool air is ready to flow immediately after  is pressed.

### ■ Fogging up of the windows

- The windows will easily fog up when the humidity in the vehicle is high. Selecting  on will dehumidify the air from the outlets and defog the windshield effectively.
- If you turn  off, the windows may fog up more easily.
- The windows may fog up if the recirculated air mode is used.

### ■ Windshield fog detection function (if equipped)

When automatic mode is set, the humidity sensor (→P. 364) detects fog on the windshield and controls the air conditioning system to prevent fog.

### ■ Outside/recirculated air mode

- When driving on dusty roads such as tunnels or in heavy traffic, set the outside/recirculated air mode button to the recirculated air mode. This is effective in preventing outside air from entering the vehicle interior. During cooling operation, setting the recirculated air mode will also cool the vehicle interior effectively.
- Outside/recirculated air mode may automatically switch depending on the temperature setting or the inside temperature.

■ **When the outside temperature exceeds 75°F (24°C) and the air conditioning system is on**



- In order to reduce the air conditioning power consumption, the air conditioning system may switch to recirculated air mode automatically. This may also reduce fuel consumption.
- Recirculated air mode is selected as a default mode when the “START STOP ENGINE” <“POWER”> switch is turned on.
- It is possible to switch to outside air mode at any time by pressing .

■ **Automatic mode for air intake control**

In automatic mode, the system detects exhaust gas and other pollutants and automatically switches between outside air and recirculated air modes.

When the dehumidification function is off, and the fan is operating, turning automatic mode on will activate the dehumidification function.

■ **Micro dust and pollen filter**

- In order to prevent the windshield from fogging up when the outside air is cold, the following may occur:
  - Outside air mode does not switch to  (recirculated air) mode.
  - The dehumidification function operates.
  - The operation cancels after approximately 1 minute.
- In rainy weather, the windows may fog up. Press .
- In extremely humid weather, the windows may fog up.
- The pollens are filtered out even if the micro dust and pollen filter is turned off.

■ **Operation of the air conditioning system in Eco drive mode**

In the Eco drive mode, the air conditioning system is controlled as follows to prioritize fuel efficiency:

- Engine speed and compressor operation controlled to restrict heating/cooling capacity
- Fan speed restricted when automatic mode is selected

To improve air conditioning performance, perform the following operations:

- Adjust the fan speed
- Turn off Eco drive mode

■ **When the outside temperature falls to nearly 32°F (0°C)**

The dehumidification function may not operate even when  is pressed.

**■ Air conditioning odors**

- During use, various odors from inside and outside the vehicle may enter into and accumulate in the air conditioning system. This may then cause odor to be emitted from the vents.
- To reduce potential odors from occurring:
  - It is recommended that the air conditioning system be set to outside air mode prior to turning the vehicle off.
  - The start timing of the blower may be delayed for a short period of time immediately after the air conditioning system is started in automatic mode.

**■ Air conditioning filter**

→P. 717

**■ Customization**

Settings (e.g. exhaust gas sensor sensitivity) can be changed.  
(Customizable features →P. 863)

**⚠ CAUTION****■ To prevent the windshield from fogging up**

Do not use  during cool air operation in extremely humid weather. The difference between the temperature of the outside air and that of the windshield can cause the outer surface of the windshield to fog up, blocking your vision.

 NOTICE**■ Humidity sensor (if equipped)**

In order to detect fog on the windshield, a sensor which monitors the temperature of the windshield, the surround humidity, etc. is installed. (→P. 361)

Follow these points to avoid damaging the sensor:

- Do not disassemble the sensor
- Do not spray the glass cleaner on the sensor or subject it to strong impacts
- Do not stick anything on the sensor

**■ To prevent 12-volt battery discharge**

Do not leave the air conditioning system on longer than necessary when the engine <hybrid system> is off.





## Automatic air conditioning system (without a navigation system or the Lexus Display Audio system)

Air outlets and fan speed are automatically adjusted according to the temperature setting.

- ▶ Vehicles with a navigation system

Owners of models equipped with a navigation system should refer to the “Navigation System Owner’s Manual”.

- ▶ Vehicles with the Lexus Display Audio system

→P. 353



- ① Driver's side temperature display
- ② Airflow display
- ③ Fan speed display
- ④ Outside temperature
- ⑤ Passenger's side temperature display
- ⑥ Air outlet selector button
- ⑦ Cooling and dehumidification function on/off button
- ⑧ DUAL mode button
- ⑨ Passenger's side temperature control button
- ⑩ Micro dust and pollen filter button
- ⑪ Outside air or recirculated mode button
- ⑫ Off button
- ⑬ Driver's side temperature control button
- ⑭ Automatic mode button
- ⑮ Fan speed control button
- ⑯ Windshield defogger button

### Using the automatic air conditioning system



- 1 Press .

The dehumidification function begins to operate. Air outlets and fan speed are automatically adjusted according to the temperature setting and humidity.









- 2 Press  to switch to automatic air intake mode.

The air conditioning system automatically switches between outside air and recirculated air modes.

- 3 Press “^” on  to increase the temperature and “v” to decrease the temperature.

When  is selected (the indicator on  is on) or the passenger's side temperature control button is pressed, the temperature for the driver and passenger seats can be adjusted separately.

### Adjusting the settings manually

- 1** To adjust the fan speed, select  on  to increase the fan speed and  to decrease the fan speed. Press  to turn the fan off.
- 2** To adjust the temperature setting, press “^” on  to increase the temperature and “v” to decrease the temperature. When  is selected (the indicator on  is on) or the passenger’s side temperature control button is pressed, the temperature for the driver and passenger seats can be adjusted separately.
- 3** To change the air outlets, press . The air outlets used are switched each time the switch is pressed.

**Defogging the windshield**

Press .

The dehumidification function operates and fan speed increases. Set the outside/recirculated air mode button to outside air mode if the recirculated air mode is used. (It may switch automatically.)

To defog the windshield and the side windows early, turn the air flow and temperature up.

To return to the previous mode, press

 again when the windshield is defogged.

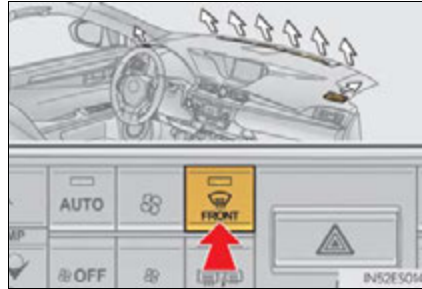

**Air outlets and air flow**

Upper body

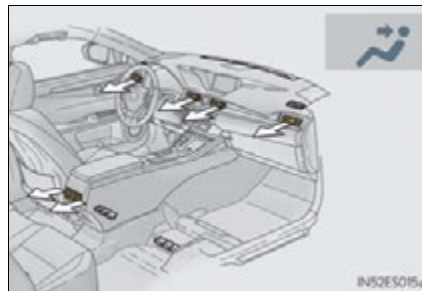

Upper body and feet

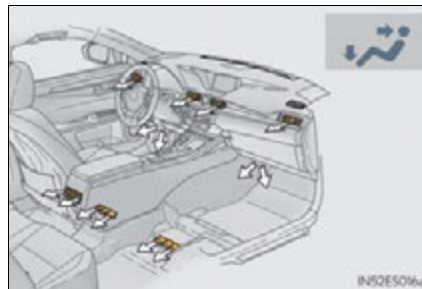

Feet

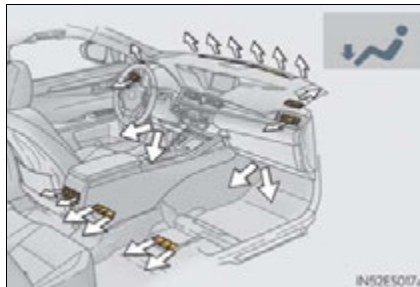

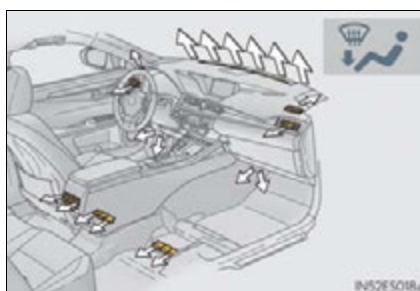

Feet and windshield



### Switching between outside air and recirculated air modes

Press  .

The mode switches among  (recirculated air mode), automatic and  (outside air mode) modes each time the button is pressed.

When the system is switched to automatic mode, the air conditioning system operates automatically.

### Micro dust and pollen filter button

Operates micro dust and pollen filter on/off.

Outside air mode switches to  (recirculated air) mode. Pollen is removed from the air and the air flows to the upper part of the body.

Usually the system will turn off automatically after approximately 1 to 3 minutes.

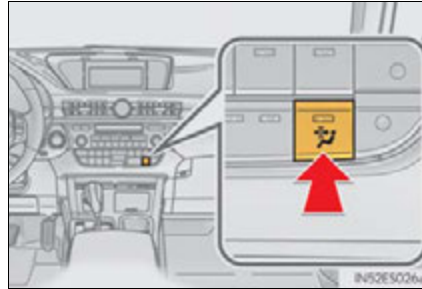

**Adjusting the sensitivity of the air intake control in automatic mode**

- 1** Press  for 2 or more seconds.

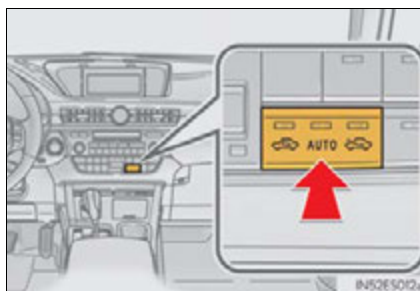

- 2** Press “^” (increase) or “v” (decrease) on . From - 3 (low) to 3 (high) can be set.

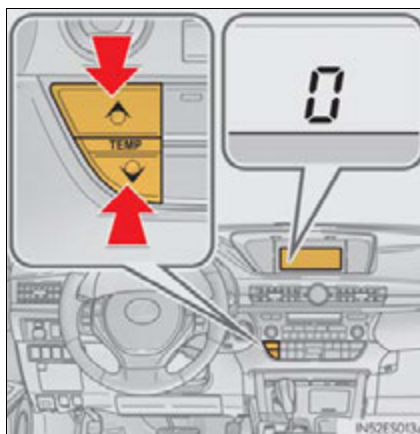



**Adjusting the position of and opening and closing the air outlets**

## ■ Front center outlets and front side outlets

- ① Direct air flow to the left or right, up or down.
- ② Turn the knob to open or close the vent.

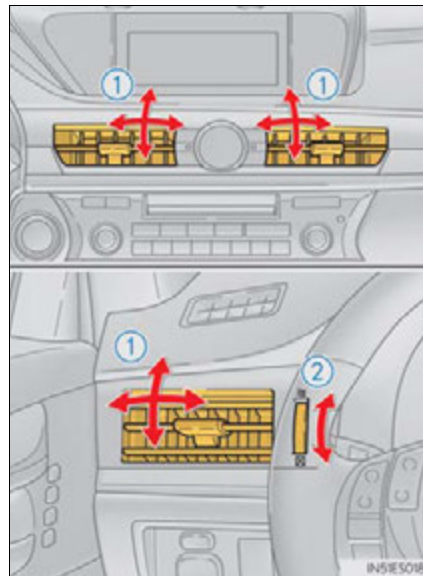

## ■ Rear seat outlets

- ① Direct air flow to the left or right, up or down.
- ② Turn the knob to open or close the vent.

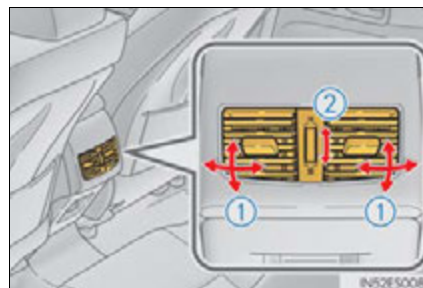

■ **Registering air conditioning settings to electronic keys**

- Unlocking the vehicle using an electronic key and turning the “START STOP ENGINE” <“POWER”> switch to IGNITION ON <ON> mode will recall that key’s registered air conditioning settings.
- When the “START STOP ENGINE” <“POWER”> is turned off, the current air conditioning settings will automatically be registered to the electronic key that was used to unlock the vehicle.

The system may not operate correctly if more than one electronic key is in the vicinity or if the smart access system with push-button start is used to unlock a passenger door.

Settings for the electronic key and the corresponding door can be changed.



Contact your Lexus dealer.

■ **Using automatic mode**

Fan speed is adjusted automatically according to the temperature setting and the ambient conditions.

Therefore, the fan may stop for a while until warm or cool air is ready to flow immediately after  is pressed.

■ **Fogging up of the windows**

- The windows will easily fog up when the humidity in the vehicle is high. Selecting  on will dehumidify the air from the outlets and defog the windshield effectively.
- If you turn  off, the windows may fog up more easily.
- The windows may fog up if the recirculated air mode is used.

■ **Windshield fog detection function (if equipped)**

When automatic mode is set, the humidity sensor (→P. 377) detects fog on the windshield and controls the air conditioning system to prevent fog.

■ **Outside/recirculated air mode**

- When driving on dusty roads such as tunnels or in heavy traffic, set the outside/recirculated air mode button to the recirculated air mode. This is effective in preventing outside air from entering the vehicle interior. During cooling operation, setting the recirculated air mode will also cool the vehicle interior effectively.
- Outside/recirculated air mode may automatically switch depending on the temperature setting or the inside temperature.

### ■ When the outside temperature exceeds 75°F (24°C) and the air conditioning system is on



- In order to reduce the air conditioning power consumption, the air conditioning system may switch to recirculated air mode automatically. This may also reduce fuel consumption.
- Recirculated air mode is selected as a default mode when the “START STOP ENGINE” <“POWER”> switch is turned on.
- It is possible to switch to outside air mode at any time by pressing .

### ■ Automatic mode for air intake control

In automatic mode, the system detects exhaust gas and other pollutants and automatically switches between outside air and recirculated air modes.

When the dehumidification function is off, and the fan is operating, turning automatic mode on will activate the dehumidification function.

### ■ Micro dust and pollen filter

- In order to prevent the windshield from fogging up when the outside air is cold, the following may occur:
  - Outside air mode does not switch to  (recirculated air) mode.
  - The dehumidification function operates.
  - The operation cancels after approximately 1 minute.
- In rainy weather, the windows may fog up. Press .
- In extremely humid weather, the windows may fog up.
- The pollens are filtered out even if the micro dust and pollen filter is turned off.

### ■ Operation of the air conditioning system in Eco drive mode

In the Eco drive mode, the air conditioning system is controlled as follows to prioritize fuel efficiency:

- Engine speed and compressor operation controlled to restrict heating/cooling capacity
- Fan speed restricted when automatic mode is selected

To improve air conditioning performance, perform the following operations:

- Adjust the fan speed
- Turn off Eco drive mode

### ■ When the outside temperature falls to nearly 32°F (0°C)

The dehumidification function may not operate even when  is pressed.

■ **Air conditioning odors**

- During use, various odors from inside and outside the vehicle may enter into and accumulate in the air conditioning system. This may then cause odor to be emitted from the vents.
- To reduce potential odors from occurring:
  - It is recommended that the air conditioning system be set to outside air mode prior to turning the vehicle off.
  - The start timing of the blower may be delayed for a short period of time immediately after the air conditioning system is started in automatic mode.

■ **Air conditioning filter**

→P. 717

■ **Customization**

Settings (e.g. exhaust gas sensor sensitivity) can be changed.  
(Customizable features →P. 863)

 **CAUTION**

■ **To prevent the windshield from fogging up**

Do not use  during cool air operation in extremely humid weather. The difference between the temperature of the outside air and that of the windshield can cause the outer surface of the windshield to fog up, blocking your vision.

 NOTICE**■ Humidity sensor (if equipped)**

In order to detect fog on the windshield, a sensor which monitors the temperature of the windshield, the surround humidity, etc. is installed. (→P. 374)

Follow these points to avoid damaging the sensor:

- Do not disassemble the sensor
- Do not spray the glass cleaner on the sensor or subject it to strong impacts
- Do not stick anything on the sensor

**■ To prevent 12-volt battery discharge**

Do not leave the air conditioning system on longer than necessary when the engine <hybrid system> is off.

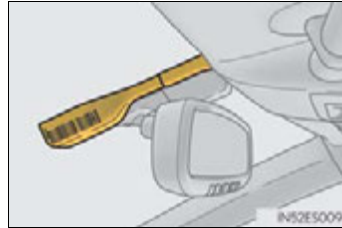

## Rear window and outside rear view mirror defoggers

These features are used to defog the rear window, and to remove rain-drops, dew and frost from the outside rear view mirrors.

- ▶ Vehicles with a navigation system

Owners of models equipped with a navigation system should refer to the "Navigation System Owner's Manual".

- ▶ Vehicles with the Lexus Display Audio system

On/off

The defoggers will automatically turn off after 15 to 60 minutes. The operation time changes according to the ambient temperature and vehicle speed.

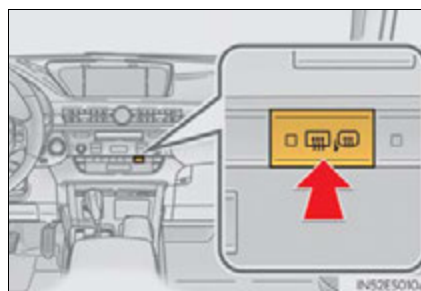

- ▶ Vehicles without a navigation system or the Lexus Display Audio system

On/off

The defoggers will automatically turn off after 15 to 60 minutes. The operation time changes according to the ambient temperature and vehicle speed.

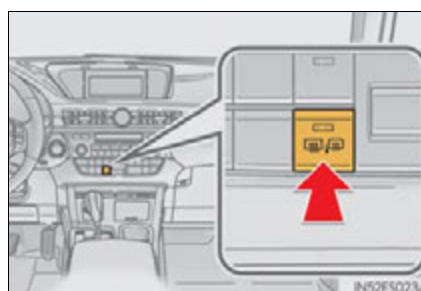

**■ Operating conditions**

The "START STOP ENGINE" <"POWER"> switch must be in the IGNITION ON <ON> mode.

**⚠ CAUTION****■ When the outside rear view mirror defoggers are on**

Do not touch the rear view mirror surfaces, as they can become very hot and burn you.

**⚠ NOTICE****■ To prevent 12-volt battery discharge**

Turn the defoggers off when the engine <hybrid system> is off.

## Windshield wiper de-icer\*

This feature is used to prevent ice from building up on the windshield and wiper blades.

- ▶ Vehicles with a navigation system

Owners of models equipped with a navigation system should refer to the "Navigation System Owner's Manual".

- ▶ Vehicles with the Lexus Display Audio system

1 Display the air conditioning operation screen. (→P. 353)

2 Select  to the windshield wiper de-icer on/off

The windshield wiper de-icer will automatically turn off after approximately 15 minutes.

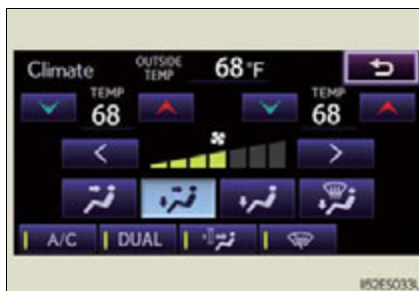

- ▶ Vehicles without a navigation system and the Lexus Display Audio system

On/off

The windshield wiper de-icer will automatically turn off after approximately 15 minutes.

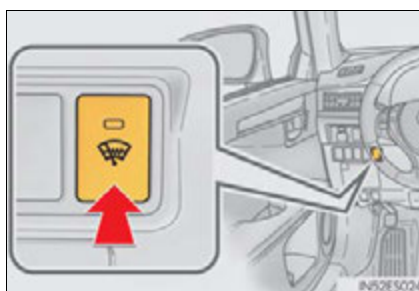

\*: If equipped



**■ Operating conditions**

The "START STOP ENGINE" <"POWER"> switch must be in the IGNITION ON <ON> mode.

**⚠ CAUTION****■ When the windshield wiper de-icer is on**

Do not touch the glass at the lower part of the windshield or to the side of the front pillars as the surfaces can become very hot and burn you.

## Audio system (with the Lexus Display Audio system)

To display the audio control screen, press the “MEDIA” button, “RADIO” button or the “AUDIO” button on the Lexus Display Audio controller.

- ▶ Vehicles with a navigation system  
Owners of models equipped with a navigation system should refer to the “Navigation System Owner’s Manual”.
- ▶ Vehicles without a navigation system or a Lexus Display Audio system  
→P. 500



Button	Page
Using the radio	P. 385
Using the CD player	P. 400
Playing an audio CD and MP3/WMA discs	P. 401
Listening to an iPod	P. 411
Listening to a USB memory	P. 419
Using the AUX port	P. 429
Listening to Bluetooth® audio	P. 431
Optimal use of the audio system	P. 446
Using the steering wheel audio switches	P. 448
Hands-free system for cellular phone	P. 451

### Switching the audio source

- 1 Press the “MEDIA” button, “RADIO” button or the “AUDIO” button on the Lexus Display Audio controller to display the audio control screen.
- 2 Select “Source” or press the “AUDIO” button on the Lexus Display Audio controller to display the audio source selection screen.
 

Each time the “MEDIA” button is pressed, an audio source other than radio is changed to.

Each time the “RADIO” button is pressed, radio mode is changed.
- 3 Select the desired audio source.

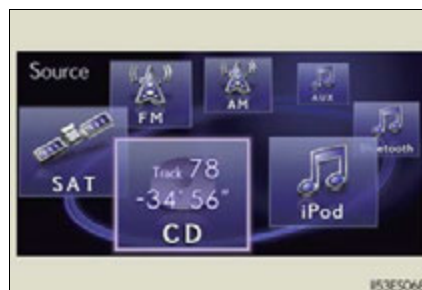
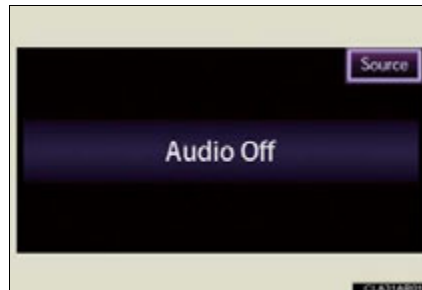

■ Using cellular phones

Interference may be heard through the audio system's speakers if a cellular phone is being used inside or close to the vehicle while the audio system is operating.

 CAUTION

■ Certification

● Part 15 of the FCC Rules

FCC Warning:

Any unauthorized changes or modifications to this equipment will void the user's authority to operate this device.

● Laser products

- USE OF CONTROL OR ADJUSTMENT OR PERFORMANCE OF PROCEDURES OTHER THAN THOSE SPECIFIED HEREIN MAY RESULT IN HAZARDOUS RADIATION EXPOSURE.
- THE USE OF OPTICAL INSTRUMENTS WITH THIS PRODUCT WILL INCREASE EYE HAZARD.

 NOTICE

■ To prevent 12-volt battery discharge

Do not leave the audio system on longer than necessary when the engine <hybrid system> is off.

■ To avoid damaging the audio system

Take care not to spill drinks or other fluids on the audio system.

## Using the radio

Press the “RADIO” button or “AUDIO” button on the Lexus Display Audio controller and then select “AM”, “FM” or “SAT”.

### Control panel



- ① Audio control screen
- ② Mute button
- ③ Frequency adjustment knob
- ④ Seek/preset station selector button
- ⑤ AM/FM/SAT mode buttons
- ⑥ Power
- ⑦ Volume

### Audio control screen

Pressing the “RADIO” button or “AUDIO” button on the Lexus Display Audio controller displays the audio control screen from any screens of the selected source.

▶ “Presets” screen

▶ “Options” screen

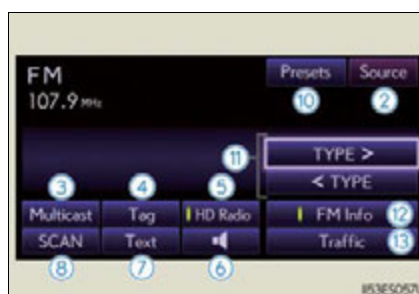
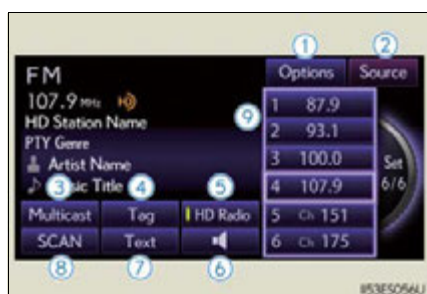

- ① “Options” screen appears
- ② Audio source selection screen appears
- ③ Changing the Multicast Ch
- ④ Information in the music under broadcasting is memorized
- ⑤ Selecting HD Radio™ technology
- ⑥ Setting the sound (→P. 446)
- ⑦ Displaying text messages
- ⑧ Scanning for receivable station
- ⑨ Preset stations
- ⑩ “Presets” screen appears
- ⑪ Selecting program type or channel category
- ⑫ RBDS message display on/off
- ⑬ Displaying traffic messages

### Selecting a station

#### ■ Seek tuning

Press and hold “^” or “v” on the “PRST•TRACK” button.

#### ■ Manual tuning

Turn the “TUNE•SCROLL” knob.

#### ■ Preset stations

Press “^” or “v” on the “PRST•TRACK” button or select desired preset stations.

### Setting station presets (excluding XM<sup>®</sup> Satellite Radio)

Radio mode has a mix preset function, which can store up to 36 stations (6 station per page × 6 page) from any of the AM, FM or SAT bands.

- 1 Search for desired stations by turning the “TUNE•SCROLL” knob or pressing and holding “^” or “v” on the “PRST•TRACK” button.
- 2 Select and hold one of the preset stations (1-6 every page).

### Scanning radio stations (excluding XM<sup>®</sup> Satellite Radio)

- 1 Select “SCAN” on the screen.

“SCAN” appears on the screen. The radio will find the next station and stay there for 10 seconds if “All” or “HD Only” is selected, or 5 seconds if “Analog” is selected (→P. 391), and then scan again.
- 2 Select “SCAN” once again when the desired station is reached.

### RBDS (Radio Broadcast Data System)

This feature allows your radio to receive station identification information and program information (classical, jazz, etc.) from radio stations which broadcast this information. RBDS features are available only when listening to an FM station that broadcasts RBDS information and the “FM Info” indicator is on.

#### ■ Selecting a desired type

- 1 Select “Options”.



- 2 Select “FM Info” to turn the indicator on.





- 3** Select “TYPE >” or “< TYPE” to select program types.

The type of program changes each time the button is selected.

- Classical
- Country
- EasyLis (Easy Listening)
- Inform (Information)
- Jazz
- News
- Oldies
- Other
- Pop Music
- Religion
- Rock
- R&B (Rhythm and Blues)
- Sports
- Talk
- Traffic (Not available when “HD Radio Settings” are set to analog)
- Alert (Emergency Alert)

When a program is set, “TYPE SEEK” appears.

- 4** Select “TYPE SEEK”.

The radio seeks or scans for stations by the relevant program type.

If no relevant program can be found, “no type” will appear on the screen.

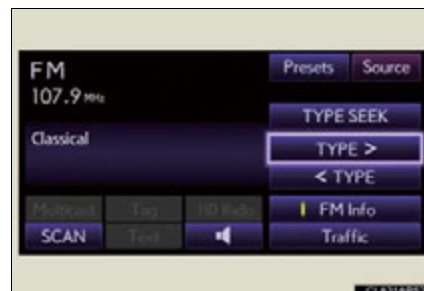

■ **Traffic announcement**

Select “Traffic” on the “Options” screen.

“TRAF SEEK” appears on the screen, and the radio will start seeking any station broadcasting traffic program information.

If no traffic program station is found, “No Traffic” appears on the screen.

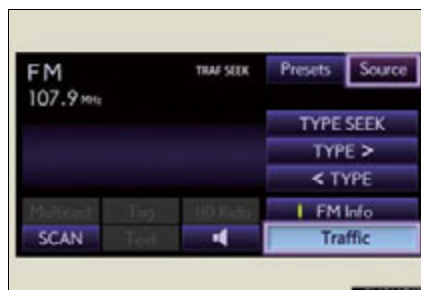

**HD Radio™ technology information (if equipped)**

HD Radio™ Technology is the digital evolution of analog AM/FM radio. Your radio product has a special receiver which allows it to receive digital broadcasts (where available) in addition to the analog broadcasts it already receives. Digital broadcasts have better sound quality than analog broadcasts as digital broadcasts provide free, crystal clear audio with no static or distortion. For more information, and a guide to available radio stations and programming, refer to [www.hdradio.com](http://www.hdradio.com).



HD Radio Technology manufactured under license from iBiquity Digital Corporation. U.S. and Foreign Patents. HD Radio™ and the HD, HD Radio, and “Arc” logos are proprietary trademarks of iBiquity Digital Corp.

### ■ HD Radio™ technology settings

- 1 Display the “Setup” screen. (→P. 345)
- 2 Select “Audio” on the “Setup” screen.
- 3 Select “HD Radio Settings”.

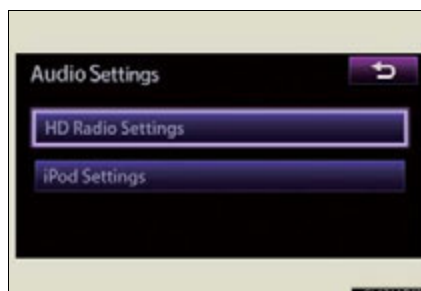

- 4 Select “HD Radio/Analog Settings”.

- 1 Receiving both analog and digital broadcasts
- 2 Receiving only digital broadcasts
- 3 Receiving only analog broadcasts

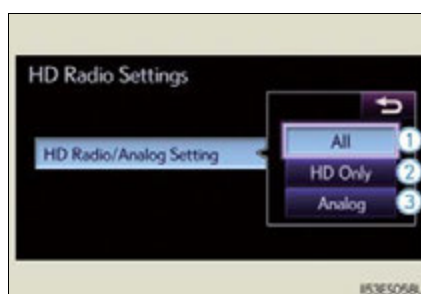

### ■ Using HD Radio™ technology

- 1 Select “HD Radio” portion to turn the indicator on.

The radio receiver will automatically tune from an analog signal to a digital signal within 5 seconds.

An orange “HD)” logo indicator will be displayed when in digital.



- 2 Search for desired stations by turning the “TUNE•SCROLL” knob or pressing and holding “^” or “v” on the “PRST•TRACK” button.

■ **Selecting a desired type**

- 1 Select "Options".
- 2 Select "TYPE >" or "< TYPE" to select program types.  
 The type of program changes each time the button is selected. (→P. 388)  
 When a program is set, "TYPE SEEK" appears.
- 3 Select "TYPE SEEK".  
 The radio seeks or scans for stations by the relevant program type.  
 If no relevant program can be found, "no type" will appear on the screen.

■ **Displaying text information**

Information such as the artist name, song title, album title and music genre being listened to are displayed on the text screen.

- 1 Select "Text".

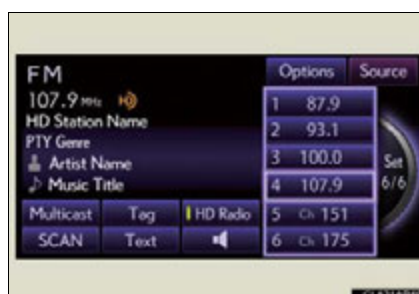

- 2 Select "Additional Information" to display messages from the station.

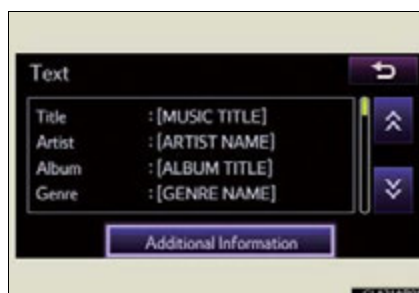

### ■ Changing the multiple or supplemental programs

On the FM radio frequency most digital stations have multiple or supplemental programs on one FM station.

Select “Multicast”.

Each time “Multicast” is selected, the supplemental program changes.

If “Multicast” is selected when tuned to the last of the supplemental programs, the main program will be returned to.

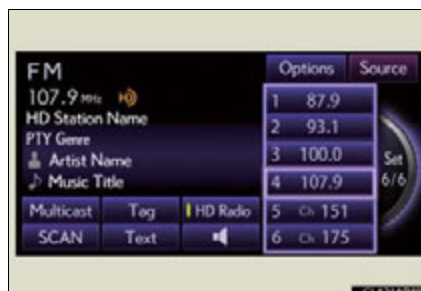

### ■ Preserving tag information

Tag information in the music broadcasting is preserved in the system and transmits to an iPod.

- 1 Select “Tag” to bookmark the music information.

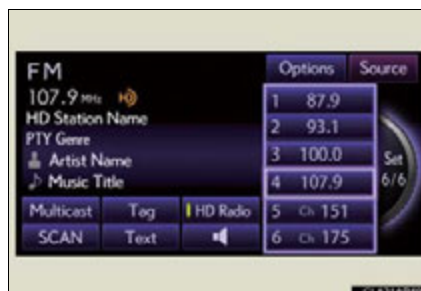

- 2 Connect iPod using an iPod cable. (→P. 411)

The music tag moves from the system into the iPod.

If tagging the music information fails, error message will be displayed on the screen. If this occurs, tag the information again.

Turn on the power of the iPod if it is not turned on.

When the iPod is connected to iTunes, the “tagged” information of the songs which were tagged while listening to the radio can be viewed. Then a user may decide to purchase the song or CD/Album.

■ HD Radio™ technology troubleshooting guide

Experience	Cause	Action
Mismatch of time alignment- a user may hear a short period of programming replayed or an echo, stutter or skip.	The radio stations analog and digital volume is not properly aligned or the station is in ballgame mode.	None, radio broadcast issue. A user can contact the radio station.
Sound fades, blending in and out.	Radio is shifting between analog and digital audio.	Reception issue, may clear-up as the vehicle continues to be driven. Selecting "Analog" can force radio in an analog audio.
Audio mute condition when an HD2/HD3 multicast channel had been playing.	The radio does not have access to digital signals at the moment.	This is normal behavior, wait until the digital signal returns. If out of the coverage area, seek a new station.
Audio mute delay when selecting an HD2/HD3 multicast channel preset.	The digital multicast content is not available until HD Radio™ broadcast can be decoded and make the audio available. This takes up to 7 seconds.	This is normal behavior, wait for the audio to become available.
Text information does not match the present song audio.	Data service issue by the radio broadcaster.	Broadcaster should be notified. Complete the form; <a href="http://www.ibiquity.com/automotive/report_radio_station_experiences">www.ibiquity.com/automotive/report_radio_station_experiences</a> .
No text information shown for the present selected frequency.	Data service issue by the radio broadcaster.	Broadcaster should be notified. Complete the form; <a href="http://www.ibiquity.com/automotive/report_radio_station_experiences">www.ibiquity.com/automotive/report_radio_station_experiences</a> .

## XM<sup>®</sup> Satellite Radio (if equipped)

### ■ Receiving XM<sup>®</sup> Satellite Radio

- 1 Press the "RADIO" button or select "SAT" on the audio source selection.
- 2 Turn the "TUNE•SCROLL" knob to select the desired channel in the all categories or press and hold "∧" or "∨" on the "PRST•TRACK" button to select the desired channel in the current category.

### ■ Setting XM<sup>®</sup> Satellite Radio channel presets

Select the desired channel. Select and hold one of the preset stations (1-6 every page).

■ **Changing the channel category**

- 1 Select "Options".



- 2 Select "TYPE >" or "<TYPE".

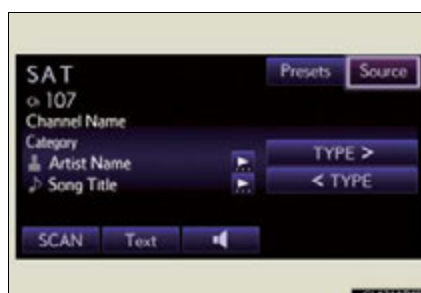

■ **Scanning XM® Satellite Radio channels**

Scanning channels in the current category

- 1 Select "SCAN" on the screen.  
"SCAN" appears on the screen.
- 2 Select "SCAN" once again when the desired channel is reached.

■ **Displaying the title and artist name**

Select "Text".

The screen will show up to 64 characters.





**■ When the 12-volt battery is disconnected**

All preset stations are erased.

**■ Reception sensitivity**

- Cargo loaded on the roof luggage carrier, especially metal objects, may adversely affect the reception of XM<sup>®</sup> Satellite Radio.
- It is difficult to maintain perfect radio reception at all times due to the continually changing position of the antenna, differences in signal strength and surrounding objects, such as trains and transmitters.
- The radio antenna is mounted inside the trunk and the rear window. To maintain clear radio reception, do not attach metallic window tinting or other metallic objects to the antenna wire mounted inside the rear window.

**■ XM<sup>®</sup> Satellite Radio**

An XM<sup>®</sup> Satellite Radio is a tuner designed exclusively to receive broadcasts provided under a separate subscription. Availability is limited to the 48 contiguous states and 10 Canadian provinces.

**● XM<sup>®</sup> subscriptions**

For detailed information about XM<sup>®</sup> Satellite Radio or to subscribe:  
U.S.A. —

Visit on the web at [www.siriusxm.com](http://www.siriusxm.com) or call 1-866-635-2349.

Canada —

Visit on the web at [www.xmradio.ca](http://www.xmradio.ca) or call 1-877-438-9677.

**● Radio ID**

You will need the radio ID when activating XM<sup>®</sup> service or reporting a problem. Select "CH000" using the "TUNE•SCROLL" knob, and the receiver's 8-character ID number will appear.

**● Satellite tuner**

The tuner supports only Audio Services (Music and Talk) and the accompanying Text Information of XM<sup>®</sup> Satellite Radio.

■ **If the satellite radio does not operate normally**

If a problem occurs with the XM<sup>®</sup> tuner, a message will appear on the display. Refer to the table below to identify the problem, and take the suggested corrective action.

Message	Explanation
SAT Check Antenna	The XM antenna is not connected. Check whether the XM antenna cable is attached securely.
	A short circuit occurs in the antenna or the surrounding antenna cable. See a Lexus certified dealer for assistance.
SAT Ch Unauthorized	You have not subscribed to XM Satellite Radio. The radio is being updated with the latest encryption code. Contact XM Satellite Radio for subscription information. When a contract is canceled, you can choose "CH 000" and all free-to-air channels.
	The premium channel you selected is not authorized. Wait for about 2 seconds until the radio returns to the previous channel or "CH001". If it does not change automatically, select another channel. To listen to the premium channel, contact XM Satellite Radio.
SAT No Signal	The XM signal is too weak at the current location. Wait until your vehicle reaches a location with a stronger signal.
Loading	The unit is acquiring audio or program information. Wait until the unit has received the information.
SAT Channel Off Air	The channel you selected is not broadcasting any programming. Select another channel.

Message	Explanation
-----	There is no song/program title or artist name/feature associated with the channel at that time. No action is required.
SAT Chan Unavailable	The channel you selected is no longer available. Wait for about 2 seconds until the radio returns to the previous channel or "CH 001". If it does not change automatically, select another channel.

Contact the XM® Listener Care Center at 1-866-635-2349 (U.S.A.) or 1-877-438-9677 (Canada).

#### ■ Certifications for XM® Satellite Radio

This device complies with RSS-310 of Industry Canada. Operation is subject to the condition that this device does not cause harmful interference.

Cet appareil est conforme au CNR-310 d'Industrie Canada. Son exploitation est autorisée sous réserve que l'appareil ne cause pas de brouillage préjudiciable.

## Using the CD player



- ① Audio control screen
- ② Playback/Pause button
- ③ Track/file selector knob
- ④ Track/file selector button
- ⑤ Audio source selector button
- ⑥ Power
- ⑦ Volume
- ⑧ Eject button

### Loading a disc

Insert a disc into the disc slot.

### Ejecting a disc

Press  and remove the disc.

## Playing an audio CD and MP3/WMA discs

Insert a disc or press the “MEDIA” button or the “AUDIO” button on the Lexus Display Audio controller and then select “CD” with a disc inserted.

### Audio control screen

Pressing the “MEDIA” button or the “AUDIO” button on the Lexus Display Audio controller displays the audio control screen from any screens of the selected source.

#### ▶ Audio CD

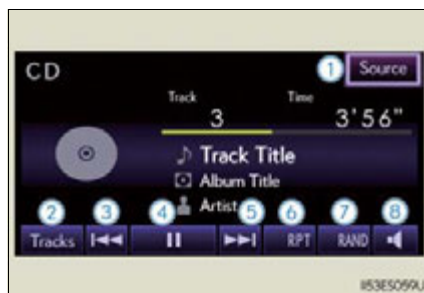

#### ▶ MP3/WMA disc



- ① Audio source selection screen appears
- ② Displaying the track/file list
- ③ Select: Playing the previous track/file  
Select and hold: Reversing a track/file
- ④ Pause  
Select  to play
- ⑤ Select: Playing the next track/file  
Select and hold: Fast-forwarding a track/file
- ⑥ Repeat play
- ⑦ Random playback
- ⑧ Setting the sound (→P. 446)
- ⑨ Displaying the folder list

### Selecting, fast-forwarding and reversing tracks (Audio CD)

#### ■ Selecting a track

Press “^” or “v” on the “PRST•TRACK” button or turn the “TUNE•SCROLL” knob to select the desired track number.

To fast-forward or reverse, press and hold “v” or “^” on the “PRST•TRACK” button until you hear a beep.

#### ■ Selecting a track from audio control screen

Select  or .

To fast-forward or reverse, select and hold  or  until you hear a beep.

#### ■ Selecting a track from the track list

- 1 Select “Tracks” on the screen.
- 2 Select the desired track number.



### Selecting, fast-forwarding and reversing files (MP3/WMA disc)



#### ■ Selecting a file

Press “^” or “v” on the “PRST•TRACK” button or turn the “TUNE•SCROLL” knob to select the desired file number.

To fast-forward or reverse, press and hold “v” or “^” on the “PRST•TRACK” button until you hear a beep.

#### ■ Selecting a file from audio control screen

Select  or .

To fast-forward or reverse, select and hold  or  until you hear a beep.

**■ Selecting a file from the file list**

- 1 Select "Files" on the screen.
- 2 Select the desired file number.

**Selecting a folder (MP3/WMA disc)**

- 1 Select "Folders" on the screen.
- 2 Select the desired folder number.



- 3 Select the desired file number.



### Random playback

Each time **RAND** is selected, the mode changes in the following order:

▶ Audio CD

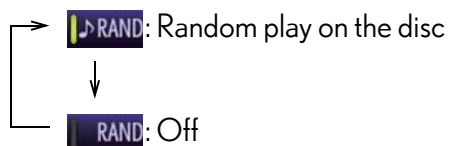

▶ MP3/WMA disc

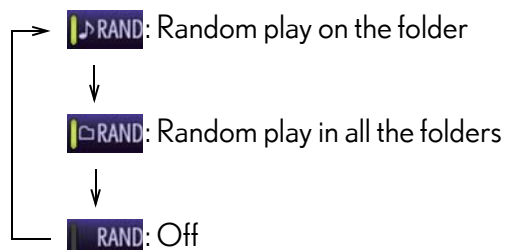

### Repeat play

Each time **RPT** is selected, the mode changes in the following order:

▶ Audio CD



▶ MP3/WMA disc

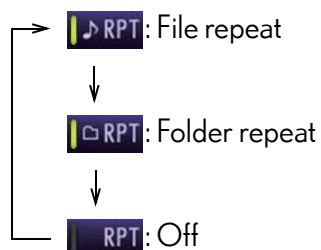



### ■ Displaying the title and artist name

If a CD-TEXT disc is inserted, the title of the disc and track will be displayed.

### ■ Error messages

If the following error messages appear on the screen, refer to the table and take the appropriate measures. If the problem is not rectified, take the vehicle to your Lexus dealer.

Message	Cause	Correction procedures
Check DISC	<ul style="list-style-type: none"> <li>• The disc is dirty or damaged.</li> <li>• The disc is inserted upside down.</li> <li>• The disc is not playable with the player.</li> </ul>	<ul style="list-style-type: none"> <li>• Clean the disc.</li> <li>• Insert the disc correctly.</li> <li>• Confirm the disc is playable with the player.</li> </ul>
DISC Error	There is a malfunction within the system.	Eject the disc.
No music files found.	This indicates that no playable data is included in the disc.	Eject the disc.

### ■ Discs that can be used

Discs with the marks shown below can be used.

Playback may not be possible depending on recording format or disc features, or due to scratches, dirt or deterioration.



CDs with copy-protection features may not play correctly.

### ■ CD player protection feature

To protect the internal components, playback is automatically stopped when a problem is detected.

### ■ If disc is left inside the CD player or in the ejected position for extended periods

Disc may be damaged and may not play properly.

**■ Lens cleaners**

Do not use lens cleaners. Doing so may damage the CD player.

**■ MP3 and WMA files**

MP3 (MPEG Audio LAYER 3) is a standard audio compression format.

Files can be compressed to approximately 1/10 of their original size by using MP3 compression.

WMA (Windows Media Audio) is a Microsoft audio compression format.

This format compresses audio data to a size smaller than that of the MP3 format.

There is a limit to the MP3 and WMA file standards that can be used and to the media/formats on which the files are recorded.

**● MP3 file compatibility**

- Compatible standards  
MP3 (MPEG1 LAYER3, MPEG2 LSF LAYER3)
- Compatible sampling frequencies  
MPEG1 LAYER3: 32, 44.1, 48 (kHz)  
MPEG2 LSF LAYER3: 16, 22.05, 24 (kHz)
- Compatible bit rates (compatible with VBR)  
MPEG1 LAYER3: 32–320 (kbps)  
MPEG2 LSF LAYER3: 8–160 (kbps)
- Compatible channel modes: stereo, joint stereo, dual channel and monaural

**● WMA file compatibility**

- Compatible standards  
WMA Ver. 7, 8, 9
- Compatible sampling frequencies  
32, 44.1, 48 (kHz)  
Compatible bit rates (only compatible with 2-channel playback)  
Ver. 7, 8: CBR 48–192 (kbps)  
Ver. 9: CBR 48–320 (kbps)

**● Compatible media**

Media that can be used for MP3 and WMA playback are CD-Rs and CD-RWs.

Playback in some instances may not be possible if the CD-R or CD-RW is not finalized. Playback may not be possible or the audio may jump if the disc is scratched or marked with fingerprints.

- Compatible disc formats

The following disc formats can be used.

- Disc formats:
  - CD-ROM Mode 1 and Mode 2
  - CD-ROM XA Mode 2, Form 1 and Form 2
- File formats:
  - ISO9660 Level 1, Level 2, (Romeo, Joliet)
  - UDF (2.01 or lower)
  - MP3 and WMA files written in any format other than those listed above may not play correctly, and their file names and folder names may not be displayed correctly.

Items related to standards and limitations are as follows.

- Maximum directory hierarchy: 8 levels (including the root)
- Maximum length of folder names/file names: 32 characters
- Maximum number of folders: 192 (including the root)
- Maximum number of files per disc: 255

- File names

The only files that can be recognized as MP3/WMA and played are those with the extension .mp3 or .wma.

- Discs containing multi-session recordings

As the audio system is compatible with multi-sessions, it is possible to play discs that contain MP3 and WMA files. However, only the first session can be played.

- ID3 and WMA tags

ID3 tags can be added to MP3 files, making it possible to record the track title, artist name, etc.

The system is compatible with ID3 Ver. 1.0, 1.1, and Ver. 2.2, 2.3 ID3 tags. (The number of characters is based on ID3 Ver. 1.0 and 1.1.)

WMA tags can be added to WMA files, making it possible to record the track title and artist name in the same way as with ID3 tags.

- MP3 and WMA playback

When a disc containing MP3 or WMA files is inserted, all files on the disc are first checked. Once the file check is finished, the first MP3 or WMA file is played. To make the file check finish more quickly, we recommend you do not write in any files other than MP3 or WMA files or create any unnecessary folders.

Discs that contain a mixture of music data and MP3 or WMA format data cannot be played.

- Extensions

If the file extensions .mp3 and .wma are used for files other than MP3 and WMA files, they may be mistakenly recognized and played as MP3 and WMA files. This may result in large amounts of interference and damage to the speakers.

- Playback

- To play MP3 files with steady sound quality, we recommend a fixed bit rate of at least 128 kbps and a sampling frequency of 44.1 kHz.
- CD-R or CD-RW playback may not be possible in some instances, depending on the characteristics of the disc.
- There is a wide variety of freeware and other encoding software for MP3 and WMA files on the market, and depending on the status of the encoding and the file format, poor sound quality or noise at the start of playback may result. In some cases, playback may not be possible at all.
- When files other than MP3 or WMA files are recorded on a disc, it may take more time to recognize the disc and in some cases, playback may not be possible at all.
- Microsoft, Windows, and Windows Media are the registered trademarks of Microsoft Corporation in the U.S.A. and other countries.

 NOTICE■ **CDs and adapters that cannot be used**

Do not use the following types of CDs.  
Also, do not use 3 in. (8 cm) CD adapters, DualDiscs or printable discs.  
Doing so may damage the CD player and/or the CD load/eject function.

- CDs that have a diameter that is not 4.7 in. (12 cm)

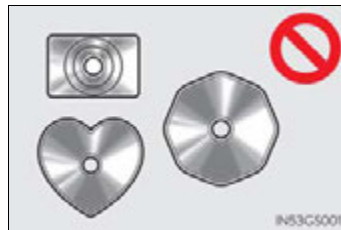

- Low-quality and deformed CDs

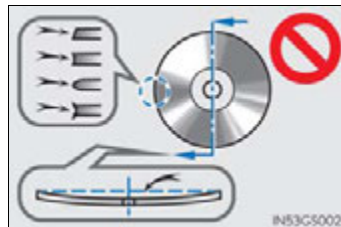

- CDs with a transparent or translucent recording area

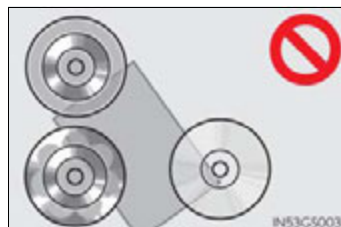

- CDs that have had tape, stickers or CD-R labels attached to them, or that have had the label peeled off

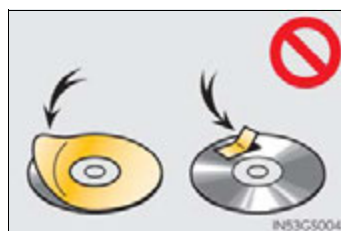

 NOTICE**■ CD player precautions**

Failure to follow the precautions below may result in serious damage to the CDs or the player itself.

- Do not insert anything other than CDs into the CD slot.
- Do not apply oil to the CD player.
- Store CDs away from direct sunlight.
- Never try to disassemble any part of the CD player.

## Listening to an iPod

Connecting an iPod enables you to enjoy music from the vehicle speakers.

Press the “MEDIA” button or the “AUDIO” button on the Lexus Display Audio controller and then select “iPod” with an iPod connected.

### Connecting an iPod

- 1 Push the knob to release the lock, and lift the armrest to open fully.

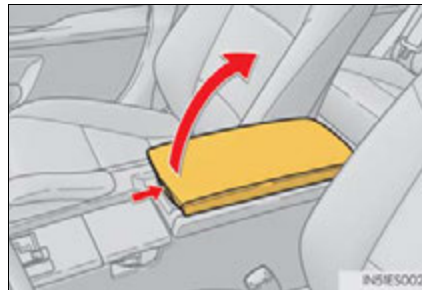

- 2 Open the cover and connect an iPod using an iPod cable.

Turn on the power of the iPod if it is not turned on.



### Control panel



- ① Audio control screen
- ② Playback/Pause button
- ③ Song selector knob
- ④ Song selector button
- ⑤ Audio source selector button
- ⑥ Power
- ⑦ Volume



### Audio control screen

Pressing the “MEDIA” button or the “AUDIO” button on the Lexus Display Audio controller displays the audio control screen from any screens of the selected source.

- ① iPod video mode
- ② Selecting the play mode
- ③ Audio source selection screen appears
- ④ Setting the sound (→P. 446)
- ⑤ Shuffle play
- ⑥ Repeat play
- ⑦ Select: Playing the next song  
Select and hold: Fast-forwarding a song
- ⑧ Pause  
Select  to playback
- ⑨ Select: Playing the previous song  
Select and hold: Reversing a song
- ⑩ Displaying the song list

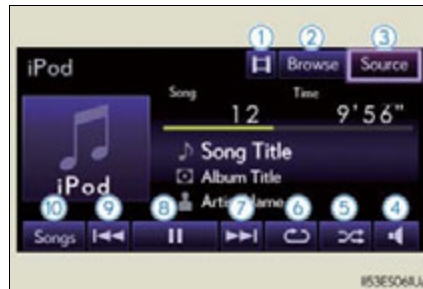

### Selecting a play mode

- 1 Select "Browse" on the screen.
- 2 Select the desired play mode by selecting the "Playlists", "Artists", "Albums", "Songs", "Podcasts", "Audiobooks", "Genres" or "Composers" tabs.

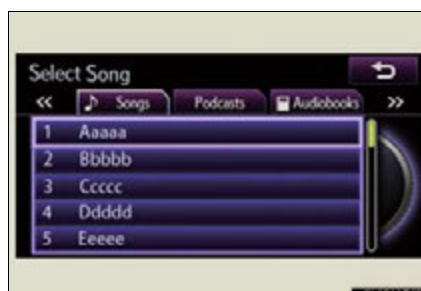

### Selecting, fast-forwarding and reversing songs



#### ■ Selecting one song at a time

Press "∧" or "∨" on the "PRST•TRACK" button or turn the "TUNE•SCROLL" knob to select the desired song.

To fast-forward or reverse, press and hold "∨" or "∧" on the "PRST•TRACK" button until you hear a beep.

#### ■ Selecting a song from audio control screen

Select  or .

To fast-forward or reverse, select and hold  or  until you hear a beep.

#### ■ Selecting a song from the list

- 1 Select "Songs" on the screen.
- 2 Select the desired song.

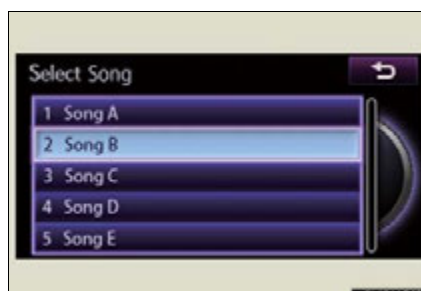

### Shuffle play

Each time  is selected, the mode changes in the following order:

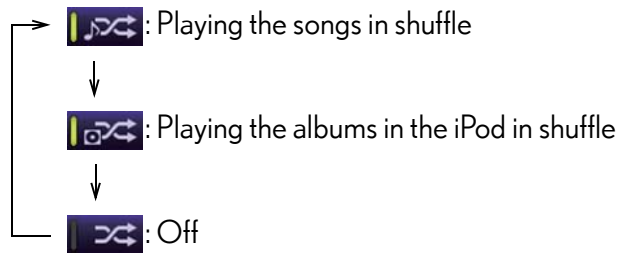

When a large number of songs is stored in an iPod, shuffle selection may take time.

### Repeat play

Each time  is selected, the mode changes in the following order:

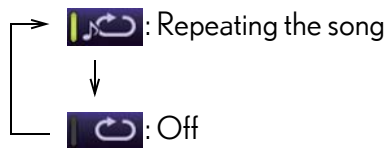

■ About iPod



- “Made for iPod” and “Made for iPhone” mean that an electronic accessory has been designed to connect specifically to iPod, or iPhone, respectively, and has been certified by the developer to meet Apple performance standards.
- Apple is not responsible for the operation of this device or its compliance with safety and regulatory standards. Please note that the use of this accessory with iPod or iPhone may affect wireless performance.
- iPhone, iPod, iPod classic, iPod nano and iPod touch are trademarks of Apple Inc., registered in the U.S. and other countries.

■ iPod cover art

- Depending on the iPod and songs in the iPod, iPod cover art may be displayed.
- This function can be changed to “On” or “Off”. (→P. 349)
- It may take time to display iPod cover art, and the iPod may not be operated while the cover art display is in process.
- Only iPod cover art that is saved in a JPEG format can be displayed.

■ iPod functions

- When the iPod connected to the system includes iPod video, the system can only output the sound by selecting  on the “iPod” screen.
- Depending on the iPod, the video sound may not be able to be heard.
- When an iPod is connected and the audio source is changed to iPod mode, the iPod will resume play from the same point in which it was last used.
- Depending on the iPod that is connected to the system, certain functions may not be available. If a function is unavailable due to a malfunction (as opposed to a system specification), disconnecting the device and reconnecting it once again may resolve the problem.
- While connected to the system, the iPod cannot be operated with its own controls. It is necessary to use the controls of the vehicle’s audio system instead.
- When the battery level of an iPod is very low, the iPod may not operate. If so, charge the iPod before use.
- Supported models (→P. 417)

**■ iPod problems**

To resolve most problems encountered when using your iPod, disconnect your iPod from the vehicle iPod connection and reset it. For instructions on how to reset your iPod, refer to your iPod Owner's Manual.

**■ Error messages**

"Connection error. Please consult your Owner's Manual for instructions on how to connect the iPod.":

This indicates a problem in the iPod or its connection.

"There are no songs available for playback. Please load compatible media to your iPod.":

This indicates that there is no music data in the iPod.

**■ Compatible models**

The following iPod®, iPod nano®, iPod classic®, iPod touch® and iPhone® devices can be used with this system.

**● Made for**

- iPod touch (4th generation)
- iPod touch (3rd generation)
- iPod touch (2nd generation)
- iPod touch (1st generation)
- iPod classic
- iPod with video
- iPod nano (6th generation)
- iPod nano (5th generation)
- iPod nano (4th generation)
- iPod nano (3rd generation)
- iPod nano (2nd generation)
- iPod nano (1st generation)
- iPhone 4
- iPhone 3GS
- iPhone 3G
- iPhone

Depending on differences between models or software versions etc., some models might be incompatible with this system.

 CAUTION■ **Caution while driving**

Do not connect iPod or operate the controls.

 NOTICE■ **If the armrest cannot be fully closed**

Depending on the size and shape of the iPod that is connected to the system, the armrest may not close fully. In this case, do not forcibly close the armrest as this may damage the iPod or the terminal, etc.

■ **To prevent damage to iPod**

- Do not leave iPod in the vehicle. The temperature inside the vehicle may become high, resulting in damage to the player.
- Do not push down on or apply unnecessary pressure to the iPod while it is connected as this may damage the iPod or its terminal.
- Do not insert foreign objects into the port as this may damage the iPod or its terminal.

## Listening to a USB memory

Connecting a USB memory enables you to enjoy music from the vehicle speakers.

Press the "MEDIA" button or the "AUDIO" button on the Lexus Display Audio controller and then select "USB" with a USB memory connected.

### Connecting a USB memory

- 1 Push the knob to release the lock, and lift the armrest to open fully.

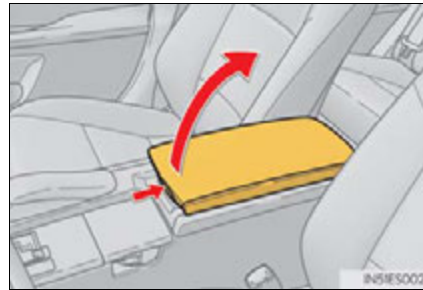

- 2 Open the cover and connect a USB memory.

Turn on the power of the USB memory if it is not turned on.

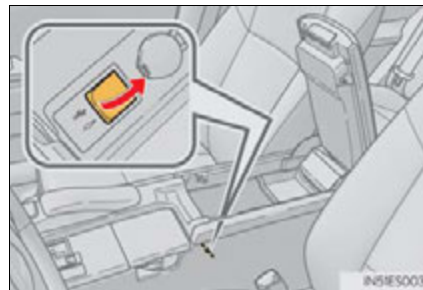

### Control panel



- ① Audio control screen
- ② Playback/Pause button
- ③ File selector knob
- ④ File selector button
- ⑤ Audio source selector button
- ⑥ Power
- ⑦ Volume



### Audio control screen

Pressing the “MEDIA” button or the “AUDIO” button on the Lexus Display Audio controller displays the audio control screen from any screens of the selected source.

- ① Audio source selection screen appears
- ② Displaying the folder list
- ③ Displaying the file list
- ④ Select: Playing the previous file  
Select and hold: Reversing a file
- ⑤ Pause  
Select  to playback
- ⑥ Select: Playing the next file  
Select and hold: Fast-forwarding a file
- ⑦ Repeat play
- ⑧ Random playback
- ⑨ Setting the sound (→P. 446)



### Selecting, fast-forwarding and reversing files



#### ■ Selecting one file at time

Press “^” or “v” on the “PRST•TRACK” button or turn the “TUNE•SCROLL” knob to select the desired file.

To fast-forward or reverse, press and hold “v” or “^” on the “PRST•TRACK” button until you hear a beep.

#### ■ Selecting a file from audio control screen

Select  or .

To fast-forward or reverse, select and hold  or  until you hear a beep.

#### ■ Selecting a file from the list

- 1 Select “Files” on the screen.
- 2 Select the desired file number.



### Selecting a folder

- 1 Select "Folders" on the screen.
- 2 Select the desired folder number.



- 3 Select the desired file number.



### Random playback

Each time **RAND** is selected, the mode changes in the following order:

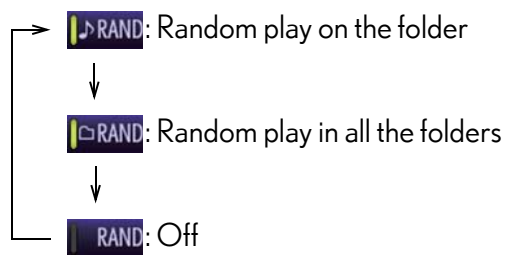

### Repeat play

Each time **RPT** is selected, the mode changes in the following order:

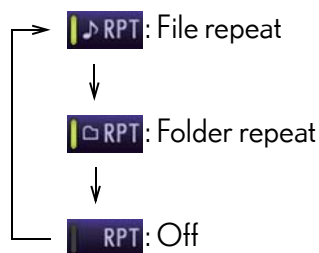

---

#### ■ USB memory functions

- Depending on the USB memory that is connected to the system, the device itself may not be operable and certain functions may not be available. If the device is inoperable or a function is unavailable due to a malfunction (as opposed to a system specification), disconnecting the device and reconnecting it once again may resolve the problem.
- If the USB memory still does not begin operation after being disconnected and reconnected, format the memory.

#### ■ Error messages for USB memory

“Connection error. Please consult your Owner’s Manual for instructions on how to connect the USB device.”:

This indicates a problem in the USB memory or its connection.

“No compatible audio files found. Please add compatible files to your USB device.”:

This indicates that no MP3/WMA files are included in the USB memory.

### ■ USB memory

#### ● Compatible devices

USB memory that can be used for MP3 and WMA playback.

#### ● Compatible device formats

The following device formats can be used:

- USB communication formats: USB2.0 HS (480Mbps)
  - File formats: FAT16/32 (Windows)
  - Correspondence class: Mass storage class
- MP3 and WMA files written in any format other than those listed above may not play correctly, and their file names and folder names may not be displayed correctly.

Items related to standards and limitations are as follows:

- Maximum directory hierarchy: 8 levels
- Maximum number of folders in a device: 3000 (including the root)
- Maximum number of files in a device: 9999
- Maximum number of files per folder: 255

#### ● MP3 and WMA files

MP3 (MPEG Audio LAYER 3) is a standard audio compression format.

Files can be compressed to approximately 1/10 of their original size using MP3 compression.

WMA (Windows Media Audio) is a Microsoft audio compression format. This format compresses audio data to a size smaller than that of the MP3 format.

There is a limit to the MP3 and WMA file standards that can be used and to the media/formats on which the files are recorded.

- MP3 file compatibility
  - Compatible standards  
MP3 (MPEG1 AUDIO LAYERII, III, MPEG2 AUDIO LAYERII, III, MPEG2.5)
  - Compatible sampling frequencies  
MPEG1 AUDIO LAYERII, III: 32, 44.1, 48 (kHz)  
MPEG2 AUDIO LAYERII, III: 16, 22.05, 24 (kHz)
  - Compatible bit rates (compatible with VBR)  
MPEG1 AUDIO LAYERII, III: 32-320 (kbps)  
MPEG2 AUDIO LAYERII, III: 8-160 (kbps)
  - Compatible channel modes: stereo, joint stereo, dual channel and monaural
- WMA file compatibility
  - Compatible standards  
WMA Ver. 7, 8, 9
  - Compatible sampling frequencies  
HIGH PROFILE 32, 44.1, 48 (kHz)
  - Compatible bit rates  
HIGH PROFILE 48-320 (kbps, VBR)
- File names

The only files that can be recognized as MP3/WMA and played are those with the extension .mp3 or .wma.
- ID3 and WMA tags

ID3 tags can be added to MP3 files, making it possible to record the track title, artist name, etc.

The system is compatible with ID3 Ver. 1.0, 1.1, and Ver. 2.2, 2.3, 2.4 ID3 tags. (The number of characters is based on ID3 Ver. 1.0 and 1.1.)

WMA tags can be added to WMA files, making it possible to record the track title and artist name in the same way as with ID3 tags.

- MP3 and WMA playback

- When a device containing MP3 or WMA files is connected, all files in the USB memory device are checked. Once the file check is finished, the first MP3 or WMA file is played. To make the file check finish more quickly, we recommend that you do not include any files other than MP3 or WMA files or create any unnecessary folders.
- When the USB device is connected and the audio source is changed to USB memory mode, the USB device will start playing the first file in the first folder. If the same device is removed and reinserted (and the contents have not been changed), the USB device will resume play from the same point in which it was last used.

- Extensions

If the file extensions .mp3 and .wma are used for files other than MP3 and WMA files, they will be skipped (not played).

- Playback

- To play MP3 files with steady sound quality, we recommend a fixed bit rate of at least 128 kbps and a sampling frequency of 44.1 kHz.
- There is a wide variety of freeware and other encoding software for MP3 and WMA files on the market, and depending on the status of the encoding and the file format, poor sound quality or noise at the start of playback may result. In some cases, playback may not be possible at all.
- Microsoft, Windows, and Windows Media are the registered trademarks of Microsoft Corporation in the U.S.A. and other countries.

 **CAUTION**

 **Caution while driving**

Do not connect USB memories or operate the controls.

 NOTICE**■ If the armrest cannot be fully closed**

Depending on the size and shape of the USB memory that is connected to the system, the armrest may not close fully. In this case, do not forcibly close the armrest as this may damage the USB memory or the terminal, etc.

**■ To prevent damage to USB memories**

- Do not leave USB memories in the vehicle. The temperature inside the vehicle may become high, resulting in damage to the player.
- Do not push down on or apply unnecessary pressure to the USB memory while it is connected as this may damage the USB memory or its terminal.
- Do not insert foreign objects into the port as this may damage the USB memory or its terminal.



## Using the AUX port

This port can be used to connect a portable audio device and listen to it through the vehicle's speakers.

- 1 Push the knob to release the lock, and lift the armrest to open fully.

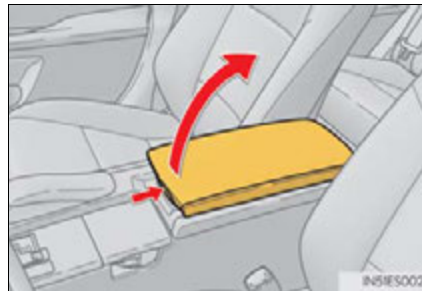

- 2 Open the cover and connect the portable audio device.

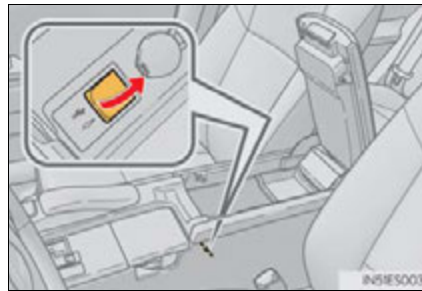

- 3 Press the "MEDIA" button or the "AUDIO" button on the Lexus Display Audio controller and then select "AUX".

### ■ Operating portable audio devices connected to the audio system

The volume can be adjusted using the vehicle's audio controls. All other adjustments must be made on the portable audio device itself.

### ■ When using a portable audio device connected to the power outlet

Noise may occur during playback. Use the power source of the portable audio device.

 **CAUTION**

■ **Caution while driving**

Do not connect portable audio device or operate the controls.

 **NOTICE**

■ **If the armrest cannot be fully closed**

Depending on the size and shape of the portable audio device that is connected to the system, the armrest may not close fully. In this case, do not forcibly close the armrest as this may damage the portable audio device or the terminal, etc.

■ **To prevent damage to portable audio device**

- Do not leave portable audio device in the vehicle. The temperature inside the vehicle may become high, resulting in damage to the player.
- Do not push down on or apply unnecessary pressure to the portable audio device while it is connected as this may damage the portable audio device or its terminal.
- Do not insert foreign objects into the port as this may damage the portable audio device or its terminal.

## Listening to Bluetooth® audio

The Bluetooth® audio system enables users to enjoy music played on a portable player from the vehicle speaker via wireless communication. This audio system supports Bluetooth®, a wireless data system capable of playing portable audio music without cables. If your portable player does not support Bluetooth®, the Bluetooth® audio system will not function.

Press the “MEDIA” button or the “AUDIO” button on the Lexus Display Audio controller and then select “Bluetooth\*”.

\*: Bluetooth is a registered trademark of Bluetooth SIG, Inc.

### Control panel



- ① Audio control screen
- ② Playback/Pause button
- ③ Track selector knob
- ④ Track selector button
- ⑤ Audio source selector button
- ⑥ Power
- ⑦ Volume

### Audio control screen

Pressing the “MEDIA” button or the “AUDIO” button on the Lexus Display Audio controller displays the audio control screen from any screens of the selected source.

- ① Audio source selection screen appears
- ② Displaying the list
- ③ Connecting a Bluetooth® audio player
- ④ Displaying the track list
- ⑤ Select: Playing the previous track  
Select and hold: Reversing a track
- ⑥ Playback
- ⑦ Pause
- ⑧ Select: Playing the next track  
Select and hold: Fast-forwarding a track
- ⑨ Repeat play
- ⑩ Random playback
- ⑪ Setting the sound (→P. 446)

Some titles and controls may not be displayed depending on the type of portable audio player.







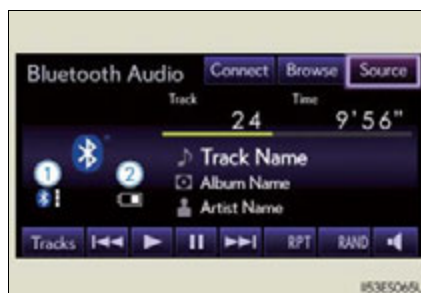

### Status display

You can check such indicators as signal strength and battery charge on the screen.

- ① Connection status
- ② Battery charge



Indicators	Conditions		
Connection status	Good 	$\longleftrightarrow$ 	No connection 
Battery charge	Full 	$\longleftrightarrow$ 	Empty 

### Registering a Bluetooth® audio player

To use the Bluetooth® audio system, you need to register your portable audio player into the system. Once registered, you can enjoy your music on the vehicle's audio system.

You can register up to 5 devices in the system.

- 1 Display the "Bluetooth\* Audio" screen.
- 2 Select "Connect".

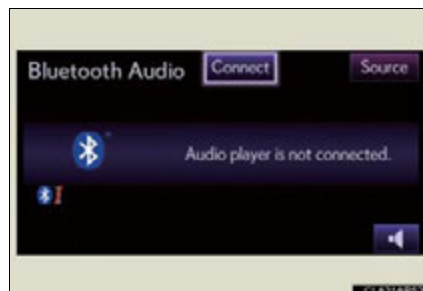

- 3 Select "Yes".

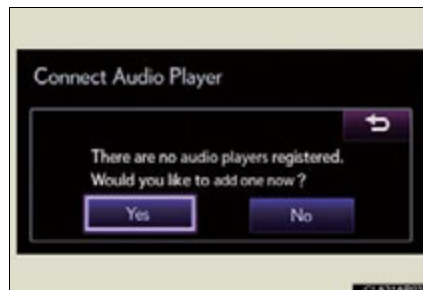

5

Interior features

\*: Bluetooth is a registered trademark of Bluetooth SIG, Inc.

- 4 Input the passcode displayed on the screen into your portable audio player.

For the operation of the portable audio player, see the manual that comes with your portable audio player.

Passcodes are not required for SSP (Secure Simple Pairing) compatible Bluetooth® devices. Depending on the device, you may need to select “Yes” to register, or “No” to cancel on your Bluetooth® device.

If you want to cancel it, select “Cancel”.

If a completion message is displayed, registration is complete.

If an error message is displayed, follow the guidance on the screen to try again.

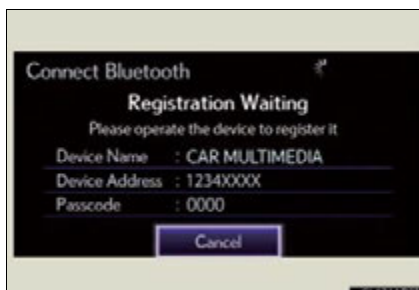



### Selecting the Bluetooth® audio player

If multiple Bluetooth® devices are registered, follow the procedure below to select the Bluetooth® device to be used. You may only use one device at a time.

- 1 Display the "Bluetooth\* Audio" screen.
- 2 Select "Connect".

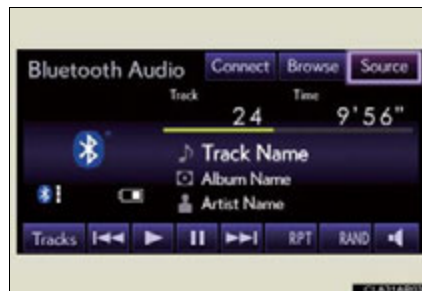

- 3 Select the device to connect.

"Add New": Registering a Bluetooth® device. (→P. 492)

The selection indicator is displayed on left side of the selected device name.

The Bluetooth® mark is displayed when you connected the device.

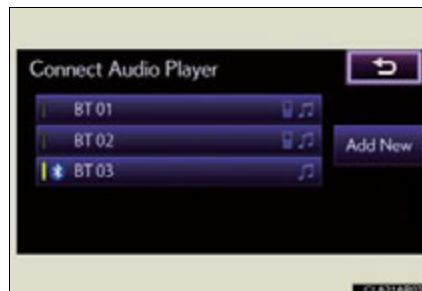

\*: Bluetooth is a registered trademark of Bluetooth SIG, Inc.

### Connecting the Bluetooth® audio player

There are two connection methods available.

■ **When the connection method is set to “From Vehicle”**

When the portable audio player is on standby for the connection, it will be automatically connected whenever the “START STOP ENGINE” <“POWER”> switch is in either ACCESSORY or IGNITION ON <ON> mode.

■ **When the connection method is set to “From Audio Player”**

Operate the portable player and connect it to the Bluetooth® audio system.

- 1 Display the “Bluetooth\* Audio” screen.
- 2 Select “Connect”.

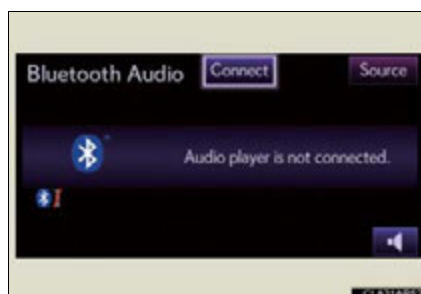

\*: Bluetooth is a registered trademark of Bluetooth SIG, Inc.

**3** Select the device to connect.

A message is shown if connection has been successful.

If connection fails, a message will be displayed and connection will be re-attempted.

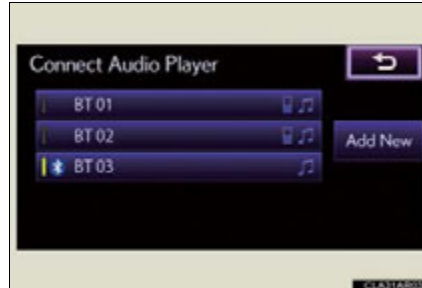

### Selecting, fast-forwarding and reversing tracks



#### ■ Selecting a track

Press “^” or “v” on the “PRST•TRACK” button or turn the “TUNE•SCROLL” knob to select the desired track number.

To fast-forward or reverse, press and hold “v” or “^” on the “PRST•TRACK” button until you hear a beep.

#### ■ Selecting a track from audio control screen

Select  or .

To fast-forward or reverse, select and hold  or  until you hear a beep.

#### ■ Selecting a track from the list

► From “Tracks”

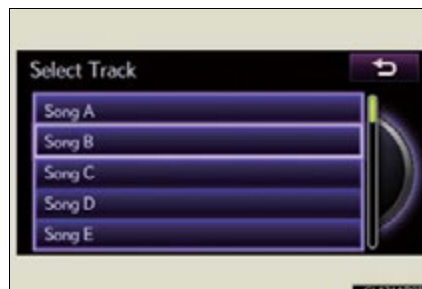
**1** Select “Tracks” on the screen.**2** Select the desired track.

► From “Browse”

1 Select “Browse” on the screen.

2 Select the desired item.

Continue to select the applicable screen button until its track list is displayed.



3 Select the desired track.

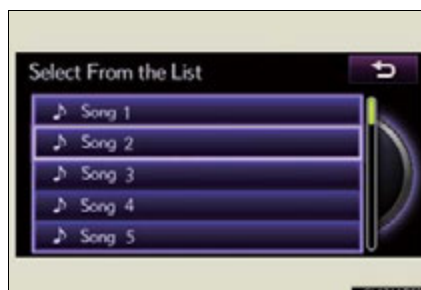

### Random playback

Each time **RAND** is selected, the mode changes in the following order:

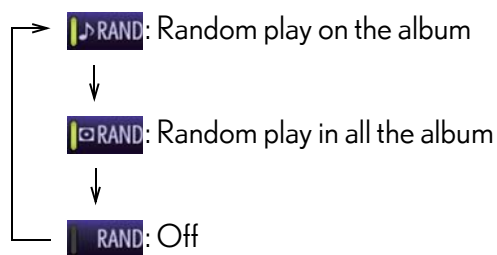

## Repeat play

Each time **RPT** is selected, the mode changes in the following order:



### ■ When using the Bluetooth® audio system

- In the following conditions, the system may not function.
  - If the portable audio player is turned off
  - If the portable audio player is not connected
  - If the portable audio player's battery is low
  - If the portable player is behind the seat or in the glove box or console box
  - If metal is covering or touching the portable player
- There may be a delay if phone connection is carried out during Bluetooth® audio play.
- Depending on the type of portable audio player that is connected to the system, operation may differ slightly and certain functions may not be available.

### ■ Bluetooth® antenna

The antenna is built into the display. If the portable audio player is behind the seat or in the glove box or console box, or is touching or covered by metal objects, connection status may deteriorate.

### ■ Battery charge/signal status

This display may not correspond exactly with the portable audio player, and this system does not have a charging function.

■ **About Bluetooth®**

The Bluetooth® word mark and logos are registered trademarks owned by Bluetooth SIG, Inc. and any use of such marks by PIONEER CORPORATION is under license. Other trademarks and trade names are those of their respective owners.



■ **Compatible models**

Portable audio players must correspond to the specifications.

● Bluetooth® specifications:

Ver. 1.1, or higher (Recommended: Ver. 2.1 + EDR or higher)

● Profiles:

- A2DP (Advanced Audio Distribution Profile) Ver. 1.0, or higher (Recommended: Ver. 1.2 or higher)

This is a profile to transmit stereo audio or high quality sounds to the headphone.

- AVRCP (Audio/Video Remote Control Profile) Ver. 1.0 or higher (Recommended: Ver. 1.4 or higher)

This is a profile to remote control the A/V equipment.

However, please note that some functions may be limited depending on the type of portable audio player.

Please go to the website at <http://www.lexus.com/MobileLink> to find approved portable players for this system.

**■ Certification for the Bluetooth® audio system**

FCC ID: AJDK046

IC ID: 775E-K046

This device complies with Part 15 of FCC Rules and Industry Canada licence-exempt RSS standard(s). Operation is subject to the following two conditions: (1) this device may not cause interference, and (2) this device must accept any interference, including interference that may cause undesired operation of this device.

Le présent appareil est conforme aux la partie 15 des règles de la FCC et CNR d'Industrie Canada applicables aux appareils radio exempts de licence. L'exploitation est autorisée aux deux conditions suivantes : (1) l'appareil ne doit pas produire de brouillage, et (2) l'utilisateur de l'appareil doit accepter tout brouillage radioélectrique subi, même si le brouillage est susceptible d'en compromettre le fonctionnement.

**■ Reconnecting the portable audio player**

If the portable audio player is disconnected with a poor reception when the "START STOP ENGINE" <"POWER"> switch is in ACCESSORY or IGNITION ON <ON> mode, the system automatically reconnects the portable audio player.

If you have switched off the portable audio player yourself, follow the instructions below to reconnect:

- Select the portable audio player again
- Enter the portable audio player

**■ When you release your car**

Be sure to initialize your data. (→P. 347)

 CAUTION

## ■ FCC WARNING

This equipment complies with FCC/IC radiation exposure limits set forth for an uncontrolled environment and meets the FCC radio frequency (RF) Exposure Guidelines in Supplement C to OET65 and RSS-102 of the IC radio frequency (RF) Exposure rules. This equipment has very low levels of RF energy that it deemed to comply without maximum permissive exposure evaluation (MPE). But it is desirable that it should be installed and operated keeping the radiator at least 20 cm or more away from person's body (excluding extremities: hands, wrists, feet and ankles).

Cet équipement est conforme aux limites d'exposition aux rayonnements énoncées pour un environnement non contrôlé et respecte les règles les radioélectriques (RF) de la FCC lignes directrices d'exposition dans le Supplément C à OET65 et d'exposition aux fréquences radioélectriques (RF) CNR-102 de l'IC. Cet équipement émet une énergie RF très faible qui est considérée conforme sans évaluation de l'exposition maximale autorisée.

Cependant, cet équipement doit être installé et utilisé en gardant une distance de 20 cm ou plus entre le dispositif rayonnant et le corps (à l'exception des extrémités : mains, poignets, pieds et chevilles).

► For vehicles sold in the U.S.A.

Changes or modifications not expressly approved by the party responsible for compliance could void the user's authority to operate the equipment.

This transmitter must not be co-located or operated in conjunction with any other antenna or transmitter.

► For vehicles sold in Canada

Under Industry Canada regulations, this radio transmitter may only operate using an antenna of a type and maximum (or lesser) gain approved for the transmitter by Industry Canada. To reduce potential radio interference to other users, the antenna type and its gain should be so chosen that the equivalent isotropically radiated power (e.i.r.p.) is not more than that necessary for successful communication.

Conformément à la réglementation d'Industrie Canada, le présent émetteur radio peut fonctionner avec une antenne d'un type et d'un gain maximal (ou inférieur) approuvé pour l'émetteur par Industrie Canada. Dans le but de réduire les risques de brouillage radioélectrique à l'intention des autres utilisateurs, il faut choisir le type d'antenne et son gain de sorte que la puissance isotrope rayonnée équivalente (p.i.r.e.) ne dépasse pas l'intensité nécessaire à l'établissement d'une communication satisfaisante.



 CAUTION**■ Caution while driving**

Do not connect portable players or operate the controls.

**■ Caution regarding interference with electronic devices**

- Your audio unit is fitted with Bluetooth® antennas. People with implantable cardiac pacemakers, cardiac resynchronization therapy-pacemakers or implantable cardioverter defibrillators should maintain a reasonable distance between themselves and the Bluetooth® antennas. The radio waves may affect the operation of such devices.
- Before using Bluetooth® devices, users of any electrical medical device other than implantable cardiac pacemakers, cardiac resynchronization therapy-pacemakers or implantable cardioverter defibrillators should consult the manufacturer of the device for information about its operation under the influence of radio waves. Radio waves could have unexpected effects on the operation of such medical devices.

 NOTICE**■ To prevent damage to portable players**

Do not leave portable players in the vehicle. The temperature inside the vehicle may become high, resulting in damage to the player.

## Optimal use of the audio system

Press the “MEDIA” button or the “AUDIO” button on the Lexus Display Audio controller.

Select  on the audio control screen to adjust the sound settings.

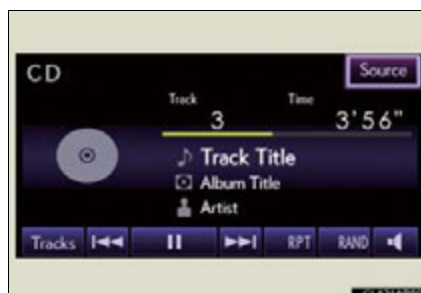

► “Sound” tab

- ① ② ③ Select “-” or “+” to adjust the treble, mid or bass to a level between -5 to 5.
- ④ ⑤ Select “Front” or “Rear” to adjust the front/rear audio balance to a level between Front 7 and Rear 7.
- ⑥ ⑦ Select “L” or “R” to adjust the left/right audio balance to a level between L7 and R7.

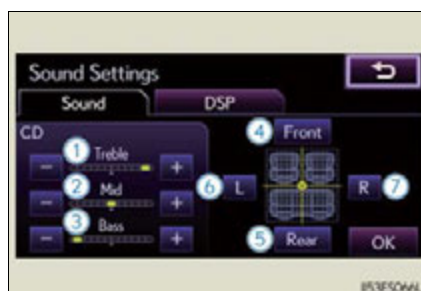

► “DSP” tab

- ① Surround on/off
- ② Automatic sound levelizer (ASL) on/off



---

**■ The sound quality level is adjusted individually**

The treble, mid and bass levels can be adjusted for the each audio mode separately.

**■ About Automatic Sound Leveliser (ASL)**

ASL automatically adjusts the volume and tone quality according to the vehicle speed.

## Using the steering wheel audio switches

Some audio features can be controlled using the switches on the steering wheel.

Operation may differ depending on the type of audio system or navigation system. For details, refer to the manual provided with the audio system or navigation system.

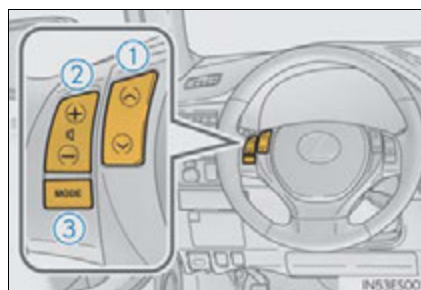

- ① Radio mode:  
Selects radio stations
- CD mode:  
Selects tracks/files and folders (MP3/WMA)
- iPod mode: Selects songs
- USB memory mode:  
Selects files and folders
- Bluetooth<sup>®</sup> audio mode:  
Selects tracks and albums
- ② Increases/decreases volume
- ③ Press: Turns the power on, selects audio source  
Press and hold: Pause or mute



### Turning the audio system on



To turn the audio system on, press  .

### Changing the audio source

Press  when the audio system is turned on. The audio source changes as follows each time  is pressed. If no discs are inserted in the player, or if the external device is not connected, that mode will be skipped.

FM→SAT→CD player→iPod or USB memory→  
Bluetooth® audio→AUX→AM→FM

### Adjusting the volume

Press  to increase the volume and  to decrease the volume.

Hold the button in that position to continue increasing or decreasing the volume.

### Silencing a sound



Press and hold .

To cancel, press and hold .

### Selecting a radio station



**1** Press  to select the radio mode.

**2** Press  or  to select a radio station.



To seek stations, press and hold  or  until you hear a beep.

To cancel, press either switch.

### Selecting a track/file or song

- 1 Press  to select the CD, Bluetooth<sup>®</sup> audio, iPod or USB memory mode.
- 2 Press  or  to select the desired track/file or song.

### Selecting a folder or album

- 1 Press  to select the CD (only when MP3/WMA disc is in use), Bluetooth<sup>®</sup> audio or USB memory mode.
- 2 Press and hold  or  until you hear a beep.

### CAUTION

 **To reduce the risk of an accident**

Exercise care when operating the audio switches on the steering wheel.

## Hands-free system (for cellular phone)

The hands-free system is a function that allows you to use your cellular phone without touching it.

This system supports Bluetooth<sup>®</sup>. Bluetooth<sup>®</sup> is a wireless data system that allows the cellular phone to wirelessly connect to the hands-free system and make/receive calls.

### Telephone switch

- ① Volume switch
  - During an incoming call: Adjusts the ring tone volume
  - During an ongoing call: Adjusts the receiver volume
  - The voice guidance volume cannot be adjusted using this button.
- ② Talk switch
  - Press: Turns the voice command system on
  - Press and hold: Turns the voice command system off
- ③ Off hook switch
  - Sending
  - Receiving
  - "Phone" screen display
- ④ On hook switch
  - End call
  - Refuse call

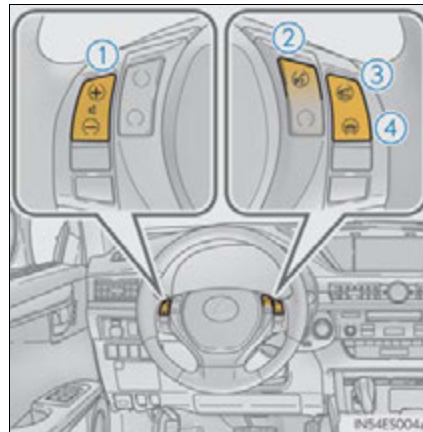

■ **Microphone**

You can use the microphone when talking on the phone.

The person you are speaking to can be heard from the front speakers.

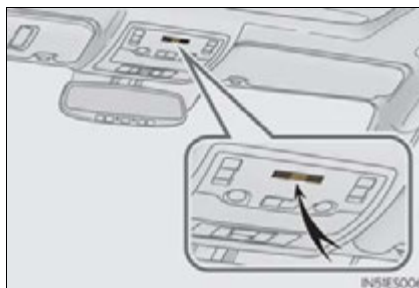

To use the hands-free system, you must register your Bluetooth<sup>®</sup> phone in the system. (→P. 460)







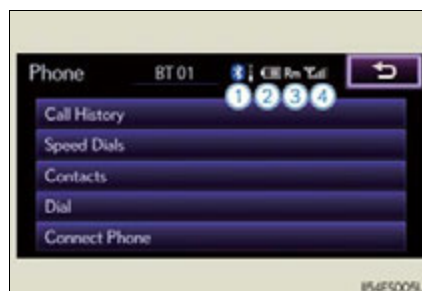

### Status display

You can check indicators such as signal strength and battery charge on the “Phone” screen.

- ① Connection status
- ② Battery charge
- ③ Call area
- ④ Signal strength



Indicators	Conditions
Connection status	Good  ↔ Not connected 
Battery charge	Full  ↔ Empty 
Call area	“Rm”: Roaming area
Signal strength	Excellent  ↔ Poor 

#### ■ When using the hands-free system

- The audio system is muted when making a call.
- If both parties speak at the same time, it may be difficult to hear.
- If the received call volume is overly loud, an echo may be heard.  
If the Bluetooth® phone is too close to the system, quality of the sound may deteriorate and connecting condition may go down.

- In the following circumstances, it may be difficult to hear the other party:
  - When driving on unpaved roads
  - When driving at high speeds
  - If a window is open
  - If the air conditioning is blowing directly on the microphone
  - There is an effect from the network of the cellular phone

■ **Conditions under which the system will not operate**

- If using a cellular phone that does not support Bluetooth®
- If the cellular phone is turned off
- If you are outside service range
- If the cellular phone is not connected
- If the cellular phone's battery is low
- When outgoing is controlled, due to heavy traffic on telephone lines, etc.
- When the cellular phone itself cannot be used
- When transferring the phonebook data from the cellular phone

■ **Bluetooth® antenna**

The antenna is built into the display. If the cellular phone is behind the seat or in the console box, or touching or covered by metal objects, connection status may deteriorate.

■ **Battery charge/Signal status**

- This display may not correspond exactly with the cellular phone itself.
- This system does not have a charging function.
- The Bluetooth® phone battery will burn quickly when it is connected to Bluetooth®.
- When the cellular phone is not connected, "No Connect" is displayed.
- When you are out of service area or in a place inaccessible by radio waves, "No service" is displayed.

■ **When using Bluetooth® audio and hands-free system at the same time**

The following problems may occur.

- The Bluetooth® connection may be cut.
- Noise may be heard on the Bluetooth® audio playback.

### ■ About the phonebook in this system

The following data is stored for every registered phone. When another phone is connecting, you cannot read the registered data.

- Phonebook data
- Call history data
- Speed dial

When you delete the phone, the above-mentioned data is also deleted.

### ■ When you release your car

Be sure to initialize your data. (→P. 347)

### ■ About Bluetooth®

The Bluetooth® word mark and logos are registered trademarks owned by Bluetooth SIG, Inc. and any use of such marks by PIONEER CORPORATION is under license. Other trademarks and trade names are those of their respective owners.



### ■ Compatible models

This system supports the following service.

- Bluetooth® Specification:
  - Ver. 1.1 or higher (Recommended: Ver. 2.1+EDR or higher)
- Profiles:
  - HFP (Hands Free Profile) Ver. 1.0 or higher (Recommended: Ver. 1.5 or higher)  
This is a profile to allow hands-free phone calls using the cellular phone or head sets. It has an outgoing and incoming call function.
  - OPP (Object Push Profile) Ver. 1.1 or higher  
This is a profile to exchange phonebook data. When the Bluetooth® phone has PBAP and OPP, OPP cannot be used.
  - PBAP (Phone Book Access Profile) Ver. 1.0 or higher  
This is a profile to transfer phonebook data.

If your cellular phone does not support HFP, you cannot enter the Bluetooth® phone. You need to take OPP or PBAP service individually.

Please go to the website at <http://www.lexus.com/MobileLink> to find approved portable players for this system.

■ **Certification for the hands-free system**

FCC ID: AJDK046

IC ID: 775E-K046

This device complies with Part 15 of FCC Rules and Industry Canada licence-exempt RSS standard(s). Operation is subject to the following two conditions: (1) this device may not cause interference, and (2) this device must accept any interference, including interference that may cause undesired operation of this device.

Le présent appareil est conforme aux la partie 15 des règles de la FCC et CNR d'Industrie Canada applicables aux appareils radio exempts de licence. L'exploitation est autorisée aux deux conditions suivantes : (1) l'appareil ne doit pas produire de brouillage, et (2) l'utilisateur de l'appareil doit accepter tout brouillage radioélectrique subi, même si le brouillage est susceptible d'en compromettre le fonctionnement.

**⚠ CAUTION****■ FCC WARNING**

This equipment complies with FCC/IC radiation exposure limits set forth for an uncontrolled environment and meets the FCC radio frequency (RF) Exposure Guidelines in Supplement C to OET65 and RSS-102 of the IC radio frequency (RF) Exposure rules. This equipment has very low levels of RF energy that it deemed to comply without maximum permissive exposure evaluation (MPE). But it is desirable that it should be installed and operated keeping the radiator at least 20 cm or more away from person's body (excluding extremities: hands, wrists, feet and ankles).

Cet équipement est conforme aux limites d'exposition aux rayonnements énoncées pour un environnement non contrôlé et respecte les règles les radioélectriques (RF) de la FCC lignes directrices d'exposition dans le Supplément C à OET65 et d'exposition aux fréquences radioélectriques (RF) CNR-102 de l'IC. Cet équipement émet une énergie RF très faible qui est considérée conforme sans évaluation de l'exposition maximale autorisée.

Cependant, cet équipement doit être installé et utilisé en gardant une distance de 20 cm ou plus entre le dispositif rayonnant et le corps (à l'exception des extrémités : mains, poignets, pieds et chevilles).

► For vehicles sold in the U.S.A.

Changes or modifications not expressly approved by the party responsible for compliance could void the user's authority to operate the equipment.

This transmitter must not be co-located or operated in conjunction with any other antenna or transmitter.

► For vehicles sold in Canada

Under Industry Canada regulations, this radio transmitter may only operate using an antenna of a type and maximum (or lesser) gain approved for the transmitter by Industry Canada. To reduce potential radio interference to other users, the antenna type and its gain should be so chosen that the equivalent isotropically radiated power (e.i.r.p.) is not more than that necessary for successful communication.

Conformément à la réglementation d'Industrie Canada, le présent émetteur radio peut fonctionner avec une antenne d'un type et d'un gain maximal (ou inférieur) approuvé pour l'émetteur par Industrie Canada. Dans le but de réduire les risques de brouillage radioélectrique à l'intention des autres utilisateurs, il faut choisir le type d'antenne et son gain de sorte que la puissance isotrope rayonnée équivalente (p.i.r.e.) ne dépasse pas l'intensité nécessaire à l'établissement d'une communication satisfaisante.

 CAUTION

■ **Caution while driving**

Do not use a cellular phone or connect the Bluetooth® phone.

■ **Caution regarding interference with electronic devices**

- Your audio unit is fitted with Bluetooth® antennas. People with implantable cardiac pacemakers, cardiac resynchronization therapy-pacemakers or implantable cardioverter defibrillators should maintain a reasonable distance between themselves and the Bluetooth® antennas. The radio waves may affect the operation of such devices.
- Before using Bluetooth® devices, users of any electrical medical device other than implantable cardiac pacemakers, cardiac resynchronization therapy-pacemakers or implantable cardioverter defibrillators should consult the manufacturer of the device for information about its operation under the influence of radio waves. Radio waves could have unexpected effects on the operation of such medical devices.

 NOTICE

■ **To prevent damage to cellular phones**

Do not leave cellular phones in the vehicle. The temperature inside the vehicle may become high, resulting in damage to the phone.

## Using the Bluetooth® phone

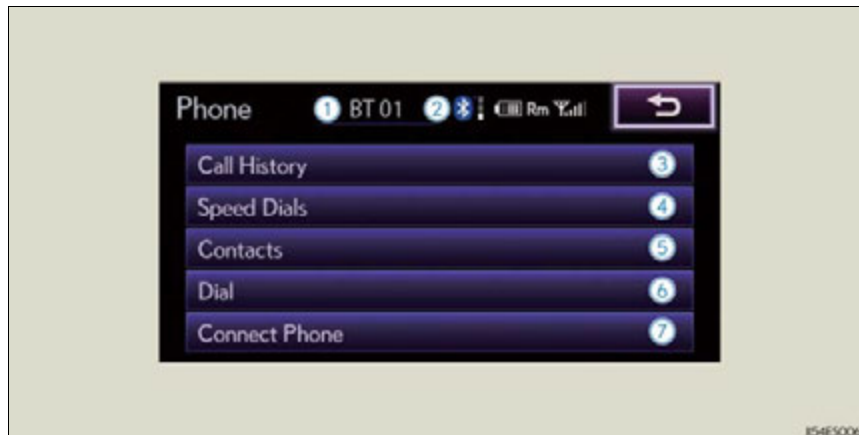

- ① Device name
- ② Bluetooth® connection status (→P. 453)
- ③ Dialing from history (→P. 469)
- ④ Speed dialing (→P. 469)
- ⑤ Dialing from the phonebook (→P. 467)
- ⑥ Dialing by inputting a number (→P. 466)
- ⑦ Connecting a Bluetooth® phone (→P. 462)

To display the screen shown above, press  on the steering wheel or press the “MENU” button on the Lexus Display Audio controller and then select “Phone” on the “Menu” screen.

### Registering a Bluetooth® phone

To use the hands-free system, you must register a Bluetooth® phone in the system. You can register up to 5 phones in the system.

- 1 Display the "Phone" screen. (→P. 459)
- 2 Select "Yes".

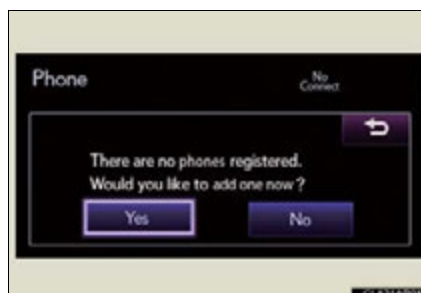



- 3 Input the passcode displayed on the screen into your phone.

For the operation of the phone, see the manual that comes with your cellular phone.

Depending on the type of phone, further phone operations may be required after inputting the passcode (for example to confirm if connection is to be received or not) when registering a phone.

Passcodes are not required for SSP (Secure Simple Pairing) compatible Bluetooth® devices. Depending on the phone, you may need to select “Yes” to register, or “No” to cancel on your cellular phone.

If you want to cancel it, select “Cancel”.

If a completion message is displayed, registration is complete.

If an error message is displayed, follow the guidance on the screen to try again.



### Selecting the Bluetooth® phone

If multiple Bluetooth® devices are registered, follow the procedure below to select the Bluetooth® device to be used. You may only use one device at a time.

- 1 Display the "Phone" screen. (→P. 459)
- 2 Select "Connect Phone".

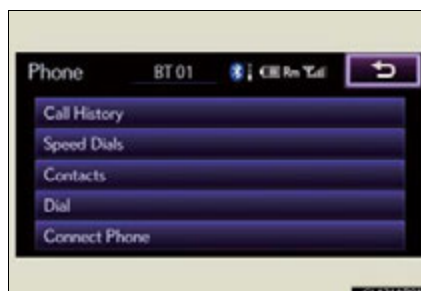

- 3 Select the device to connect.

"Add New": Registering a Bluetooth® device. (→P. 492)

The selection indicator is displayed on left side of the selected device name.

The Bluetooth® mark is displayed when you connected the device.

When the system cannot get the device names, alternate names will be displayed such as "Device1", "Device2", etc.

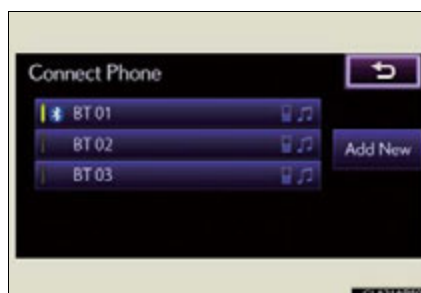

## Connecting a Bluetooth® phone

There are two connecting methods available-automatic and manual.

### ■ Automatic

When you register your phone, auto connection will be activated. Always set it to this mode and leave the Bluetooth® phone in a place where connection can be established.

When the “START STOP ENGINE” <“POWER”> switch is turned to ACCESSORY or IGNITION ON <ON> mode, the system will search for a nearby cellular phone you have registered.

Next, the system automatically connects with the most recent of the phones connected to in the past. Then, the connection result is displayed.

Depending on the type of phone, phone operations may be required (to confirm if connection is to be received or not) even when automatically connected.

■ Manual

When the auto connection has failed or “Bluetooth\* Power” is turned off (→P. 498), you must connect Bluetooth® manually.

\*: Bluetooth is a registered trademark of Bluetooth SIG, Inc.

1 Display the “Phone” screen. (→P. 459)

2 Select “Connect Phone”.

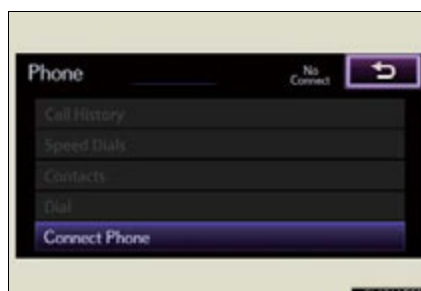

3 Select the device to connect.

A message is shown if connection has been successful.

If connection fails, a message will be displayed and connection will be re-attempted.

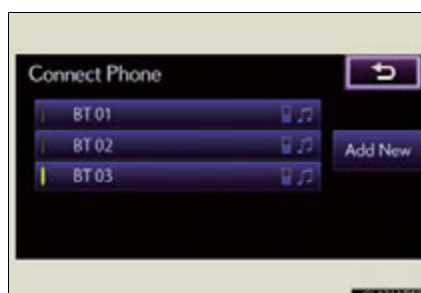

**■ Reconnecting to the Bluetooth® phone**

If the system cannot connect due to poor signal strength with the “START STOP ENGINE” <“POWER”> switch in ACCESSORY or IGNITION ON <ON> mode, the system will automatically attempt to reconnect.

If the phone is turned off, the system will not attempt to reconnect. In this case, connection must be made manually, or the phone must be re-selected.

**■ Connecting the phone while Bluetooth® audio is playing**

- Bluetooth® audio will stop temporarily.
- It may take time to connect.

### Making a call

Once the Bluetooth<sup>®</sup> phone is registered, you can make a call using the following procedure:

#### ■ Dialing

- 1 Display the "Phone" screen. (→P. 459)
- 2 Select "Dial" on the "Phone" screen.
- 3 Input the phone number.

To delete the inputted phone number, select .

For the first digit, you can enter "+" by selecting "\*" for a while.



- 4 Press  on the steering wheel or select .

Depending on the type of phone, when internet communication functions such as skype are available, phone operations (selecting between normal phone communication or internet communication) may be necessary after dialing operations are performed.



### ■ Dialing from the phonebook

You can dial a number from the phonebook data imported from your cellular phone. The system has one phonebook for each telephone. Up to 1000 entries may be stored in each phonebook. (→P. 481)

- 1 Display the "Phone" screen. (→P. 459)
- 2 Select "Contacts" on the "Phone" screen.
- 3 Choose the desired data to call from the list.

If the phonebook is empty, a message will be displayed. (→P. 468)



- 4 Choose the number and then press  on the steering wheel or select .

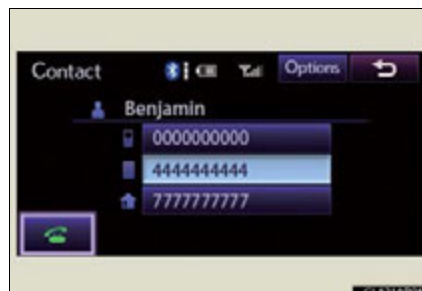

5

Interior features

● When the phonebook is empty

You can transfer the phone numbers in your Bluetooth<sup>®</sup> phone to the system.

Operation methods differ between PBAP compatible and PBAP incompatible Bluetooth<sup>®</sup> phones. If your cellular phone does not support either PBAP or OPP service, you cannot transfer contacts.

**1** Select “Contacts” on the “Phone” screen.

**2** If the phonebook is empty, a message will be displayed.

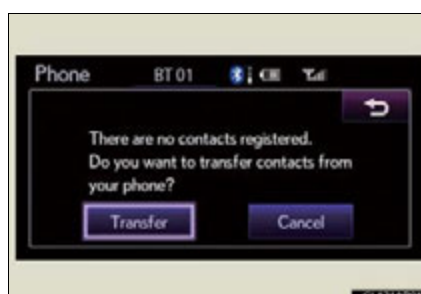

▶ For PBAP compatible Bluetooth<sup>®</sup> phone

**3** Select “Yes” if you want to transfer new contacts from a cellular phone.

Select “No” if you want to cancel transferring the contacts.

Depending on the type of phone, phone operations may be necessary when transferring contacts by PBAP.

▶ For PBAP incompatible and OPP compatible Bluetooth<sup>®</sup> phone

**3** Select “Transfer” if you want to transfer new contacts from a cellular phone.

Select “Cancel” if you want to cancel transferring the contacts.

You need to operate your phone to transfer new contacts.



### ■ Calling using speed dial

You can make a call using numbers registered from the phonebook.

- 1 Display the "Phone" screen. (→P. 459)
- 2 Select "Speed Dials" on the "Phone" screen.
- 3 Select the desired tab and choose the desired number to make a call.

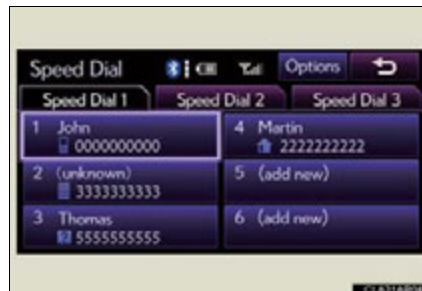

### ■ Dialing from history

You can call using the call history which has the 4 functions below.

"All": all the calls below which were memorized

"Missed": calls which you missed

"Incoming": calls which you received

"Outgoing": calls which you called

- 1 Display the "Phone" screen. (→P. 459)
- 2 Select "Call History" on the "Phone" screen.
- 3 Select the desired tab and choose the desired data from the list.



- 4 Press  on the steering wheel or select .

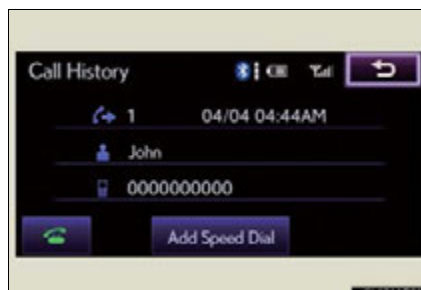

■ Calling using voice recognition

Calls can be made by giving a voice command.

- 1 Press the talk switch.

To cancel voice recognition press and hold the talk switch.

- 2 Following the system guidance, wait for the beep, and then say the desired voice commands.

① Voice prompts on/off

② Voice commands

Voice commands are marked with .

③ Canceling voice recognition system



- Dial by name

The procedure below shows “Call <name>” or “Call <name> at <type>”. Follow similar procedures for the other operations.

- 1 Press the talk switch.
- 2 Say the name, or the name and type of phone, of a registered contact.
- 3 Say “Dial” or press  on the steering wheel.  
Say or select “Go Back” to return to the previous screen.

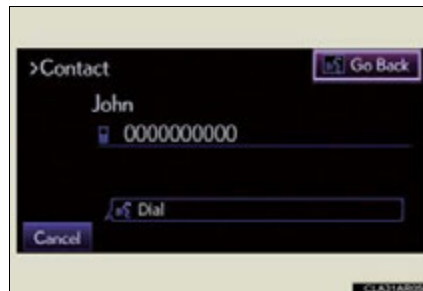

- Call history list

- If you make a call to or receive a call from a number registered in the phonebook, the name is displayed in the call history.
- If you make multiple calls to the same number, only the last call made is displayed in the call history.





- When driving

The functions “Dialing”, “Dialing from the phonebook”, and “Dialing from history” (only the 6th page of “All” tab) are unavailable.

- International calls

You may not be able to make international calls, depending on the cellular phone in use.

- Calling by using the latest call history item

- 1 Press  on the steering wheel to display the “Phone” screen.
- 2 Press  on the steering wheel to display the “Call History” screen.
- 3 Press  on the steering wheel to select the latest history item.
- 4 Press  on the steering wheel or select  to call the latest history item.

**■ Voice guidance function**

- Voice guidance for the voice recognition system can be skipped by pressing the talk switch.
- When “Voice Prompts (on/off)” is selected, voice recognition will be temporarily suspended. Press the talk switch again.
- Voice guidance can be canceled by setting voice prompts to off. Use this setting when it is desirable to say a command immediately after pressing the talk switch.

**■ Using voice command**

- Using voice command “Call <name>” or “Call <name> at <type>”
  - In the same manner as it is displayed on the screen, “Call <name>” or “Call <name> at <type>”, after saying “Call” say the name, or the name and type of phone, of a contact.  
For example: “Call”, “John Smith” or “Call”, “Mary Davis”, “at”, “Mobile”
  - There are 4 types of phones: Home, Mobile, Work and Other.
  - Short or abbreviated names in the phonebook may not be recognized. Change names in the phonebook to full names.
  - Sometimes a voice recognition result confirmation screen will be displayed. After confirming the result, say “Yes” or “No”.
  - When the system recognizes multiple names from the phonebook, a name candidate list will be displayed on the screen. If the desired name is not displayed on the top of the screen, say the number of the name from the candidate list (number 1 or number 2) to select a name from the candidate list.
  - When a contact has multiple phone numbers registered in the phonebook, a candidate list will be displayed. If the desired phone number is not displayed on the top of the screen, say the number of the desired phone number from the candidate list (number 1 or number 2) to select a phone number from the candidate list.

- Using voice command "Dial <number>"
  - In the same manner as it is displayed on the screen, "Dial <number>", after saying "Dial" say the phone number.
  - Say the phone number one digit at a time.  
For example, if the phone number is 2345678:  
Say "two three four five six seven eight"  
Do not say "twenty three forty five sixty seven eight"
  - The system can recognize the following types of the phone numbers:  
3 digit numbers (911, 411, 611)  
7 digit numbers (Local phone numbers)  
10 digit numbers (Area code + Local phone number)  
11 digit phone numbers (1 + Area code + Local phone number)
  - As the system cannot recognize additional numbers, say the complete number without stopping.
  - When the system recognizes multiple phone numbers, a phone number candidate list will be displayed on the screen. If the desired phone number is not displayed on the top of the screen, say the number of the desired phone number from the candidate list (number 1 or number 2) to select a phone number from the candidate list.
- Using voice command "International call".

Up to 20 digits can be recognized when using the international call function. The number can also be divided into multiple groups and recognized.



■ **When using voice recognition**

Speak clearly when using the voice recognition, otherwise the system may not correctly recognize your voice. Wind or other noises may also cause the system not to recognize your voice.

### Receiving a call

When a call is received, the following screen is displayed together with a sound.

To answer the phone:

- Press  on the steering wheel.
- Select .

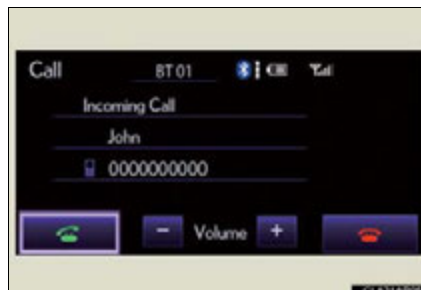

#### ■ To refuse a call

Press  on the steering wheel or select .

#### ■ To adjust the incoming call volume

Select “-” or “+”. You can also adjust the volume using the steering switches or volume knob.

---

#### ■ International calls

Received international calls may not be displayed correctly depending on the cellular phone in use.

### Speaking on the phone

The following screen is displayed when speaking on the phone.

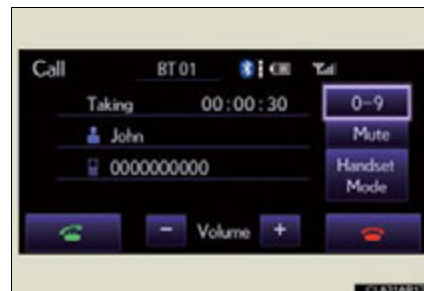

- **To adjust the receiver volume**

Select “-” or “+”. You can also adjust the volume using the steering switches or the volume knob.

- **To prevent the other party from hearing your voice**

Select “Mute”.

- **Inputting tones**

When using phone services such as an answering service or a bank, you can store phone numbers and code numbers in the phonebook.

- 1 Select “0-9”.
- 2 Input the number.



- 3 If repeated tone symbols\* are stored in the phone book, "Send" and "Exit" are displayed on the right side of the screen.

\*: Repeated tone symbols are symbols or numbers displayed as p or w, that come after the phone number. (e.g. 056133w0123p#1\*)



- 4 Confirm the number displayed on the screen, and select "Send".

If you select "Exit", this function will end.

■ **To transfer a call**

Select "Handset Mode" to change from Hands-free call to cellular phone call.

Select "Handsfree Mode" to change from cellular phone call to Hands-free call.

■ **To hang up**



Press  on the steering wheel or select .





### ■ Call waiting

When a call is interrupted by a third party while talking, the incoming call message will be displayed.



To talk with the other party:

- Press  on the steering wheel.
- Select .

To refuse the call:

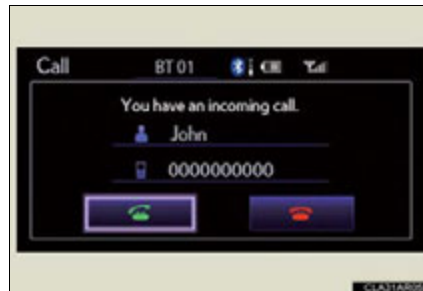
- Press  on the steering wheel.
- Select .



Every time you press  on the steering wheel or select  during call waiting, you will be switched to the other party.

### ■ Transferring calls

- It is not possible to transfer from hands-free to the cellular phone while driving.
- If you transfer from the cellular phone to hands-free, the hands-free screen will be displayed, and you can operate the system using the screen.
- Transfer method and operate may vary according to the cellular phone used.
- For operation of the cellular phone in use, see the phone's manual.

### ■ Call waiting operation

Call waiting operation may differ depending on your phone company and cellular phone.

## Setting the hands-free system

You can set the hands-free system to your desired settings.

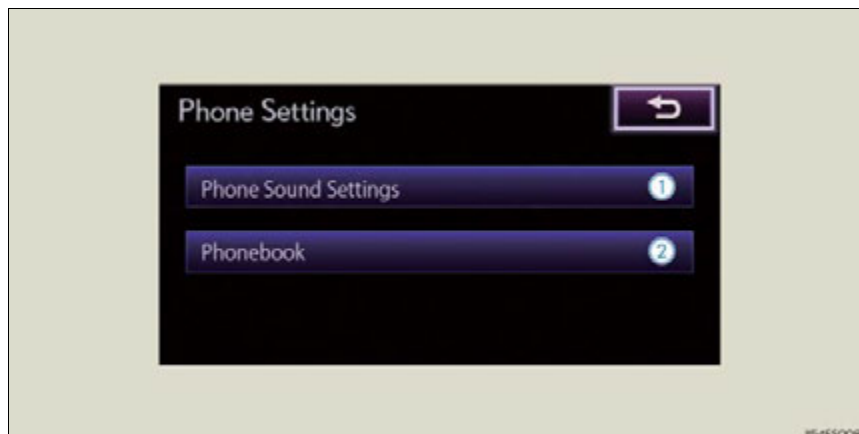

- ① Setting the sound
- ② Phonebook settings

To display the screen shown above, follow the steps below.

- 1 Press the "MENU" button on the Lexus Display Audio controller.
- 2 Select "Setup" on the "Menu" screen.
- 3 Select "Phone" on the "Setup" screen.

### Setting the sound

- 1 Display the "Phone Settings" screen. (→P. 478)
- 2 Select "Phone Sound Settings" on the "Phone Settings" screen.
  - ① Changes the speaker volume (→P. 479)
  - ② Changes the ring tone volume (→P. 479)
  - ③ Changes the ring tone (→P. 480)
  - ④ Restore default settings
- 3 When you complete settings, select "Save".

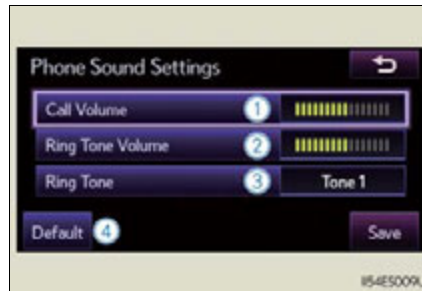

#### ■ Setting the volume

- 1 Select "Call Volume" or "Ring Tone Volume" on the "Phone Sound Settings" screen.
- 2 Select "-" or "+" to lower or raise the volume, and then "OK".

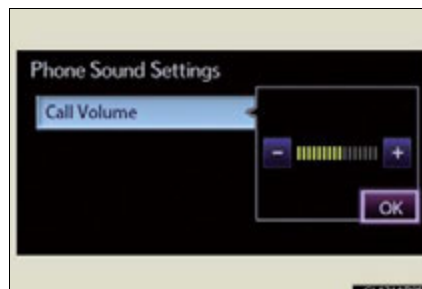

■ **Setting the ring tone**

- 1 Select "Ring Tone" on the "Phone Sound Settings" screen.
- 2 Select "Tone1", "Tone2" or "Tone3" to change the ring tone, and then "OK".

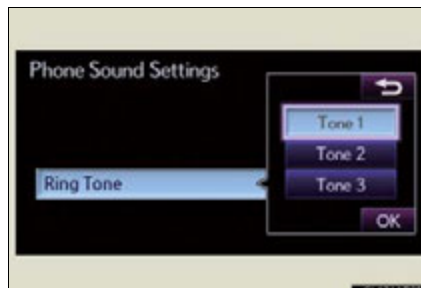

### Phonebook settings

The phonebook manages a maximum of 5 phones in total. The data for 1000 contacts (up to 3 numbers per contact) can be registered in each phonebook.

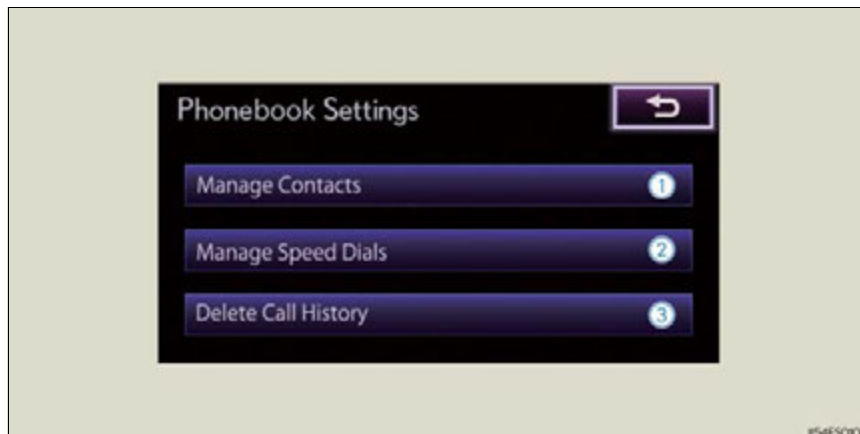

- ① Managing the contacts
- ② Managing the speed dials
- ③ Deleting the call history

To display the screen above, follow the steps below.

- 1 Display the "Phone Settings" screen. (→P. 478)
- 2 Select "Phonebook" on the "Phone Settings" screen.

■ **Managing the contacts**

● **Transferring a phone number**

You can transfer the phone numbers in your Bluetooth® phone to the system. Operation methods differ between PBAP compatible and PBAP incompatible Bluetooth® phones. If your cellular phone does not support either PBAP or OPP services, you cannot transfer contacts.

- 1 Display the “Phonebook Settings” screen. (→P. 481)
- 2 Select “Manage Contacts” on the “Phonebook Settings” screen.
- 3 Select “Transfer Contacts”.

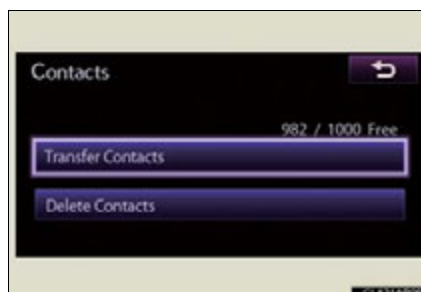

▶ For PBAP compatible Bluetooth® phones

- 1 Automatic phonebook download on/off

The phonebook data can be automatically transferred.

Depending on the cellular phone, call history will be also transferred.

- 2 Update phonebook

The phonebook data can be updated.

- 3 Restore default settings

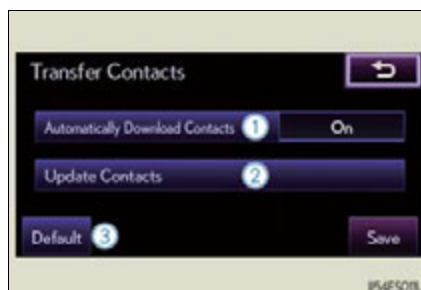

▶ For PBAP incompatible Bluetooth® phones

- ① Replace contacts  
The phonebook data can be replaced.
- ② Add contacts  
The phonebook can be added.



● Deleting the phonebook data

- 1 Display the "Phonebook Settings" screen. (→P. 481)
- 2 Select "Manage Contacts" on the "Phonebook Settings" screen.
- 3 Select "Delete Contacts".

If your phone supports PBAP service, "Automatically Download Contacts" setting needs to be set to "Off". (→P. 482)

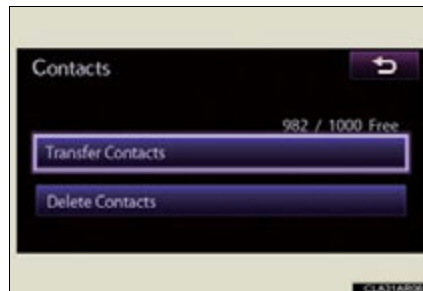

- 4 Choose the data to delete.  
To delete all data, select "All Delete".

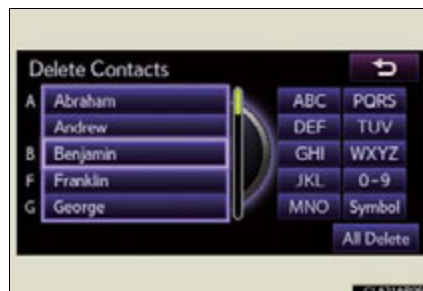

- 5 A confirmation message will be displayed. If everything is correct, select "Yes".

**■ Phonebook data**

Phonebook data is managed for every registered phone. When another phone is connecting, you cannot read the registered data.

**■ Setting the phonebook in a different way (To display the “Contacts” screen)**

- 1 Display the “Phone” screen. (→P. 459)
- 2 Select “Contacts” on the “Phone” screen.
- 3 Select “Options” on the “Contacts” screen.
- 4 Select “Manage Contacts” on the “Contacts” screen.

**■ When transferring a phone number**

Transfer the phone number while engine is running <hybrid system is operating>. If your cellular phone is OPP or PBAP compatible, you may need to input “1234” by your cellular phone for OBEX certification.

**■ When you have selected “Update Contacts” to transfer the phone number**

- If your cellular phone does not support PBAP service, you cannot use this function.
- If your phone supports PBAP service, you can transfer the phonebook data without operating your phone.

**■ When you have selected “Replace Contacts” or “Add Contacts” to transfer the phone number**

If your cellular phone does not support OPP service, you cannot use these functions. You can transfer the phonebook data only by operating your phone.

**■ Transferring the phone number in a different way (To display the “Transfer Contacts” screen)**

- 1 Display the “Phone” screen. (→P. 459)
- 2 Select “Contacts” on the “Phone” screen.
- 3 Select “Transfer” on the “Contacts” screen.

**■ Transferring the phone number while Bluetooth® audio is playing**

Bluetooth® audio will disconnect. It will reconnect automatically when data transfer finishes. It will not be reconnected depending on the phone you are using.



**■ Deleting the phonebook data in a different way**

- 1 Display the "Phone" screen. (→P. 459)
- 2 Select "Contacts" on the "Phone" screen.
- 3 Choose the desired data from the list.
- 4 Select "Options" on the "Contact" screen.
- 5 Select "Delete" on the "Contact" screen.
- 6 A confirmation message will be displayed. If everything is correct, select "Yes".

If your phone supports PBAP service, "Automatically Download Contacts" setting needs to be set to "Off". (→P. 482)

When you delete a Bluetooth® phone, the phonebook data will be deleted at the same time.

### Managing the speed dials

#### ■ Registering the speed dial from contacts

You can register the desired phone number from phonebook. Up to 18 numbers per phone can be registered.

- 1 Display the “Phonebook Settings” screen. (→P. 481)
- 2 Select “Manage Speed Dials” on the “Phonebook Settings” screen.
- 3 Select “New Speed Dial from Contacts”.

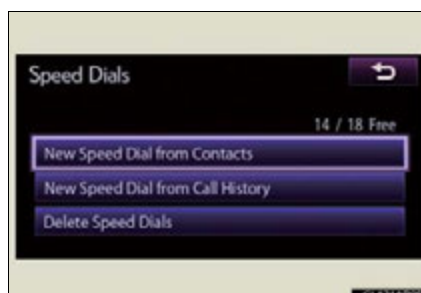

- 4 Choose the data to register.



- 5 Select the desired phone number.

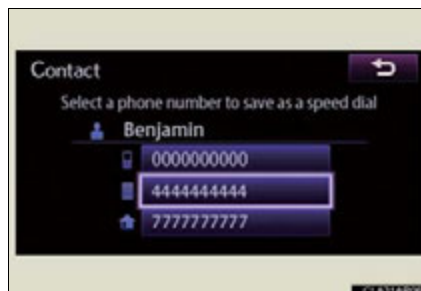

- 6 Select the switch you want to register the number in.



- 7 If you select a switch you registered before, a confirmation message will be displayed. If you want to replace it, select "Yes".

■ **Registering the speed dial from call history**

- 1 Display the "Phonebook Settings" screen. (→P. 481)
- 2 Select "Manage Speed Dials" on the "Phonebook Settings" screen.
- 3 Select "New Speed Dial from Call History" on the "Speed Dials" screen.
- 4 Choose the data to register.



- 5 Select the switch you want to register the number in.

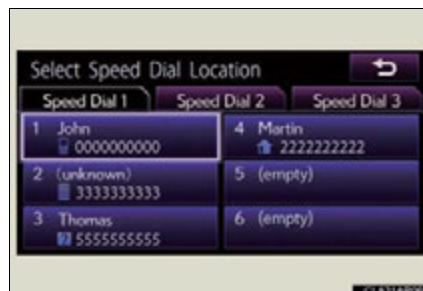

- 6 If you select a switch you registered before, a confirmation message will be displayed. If you want to replace it, select "Yes".

■ **Deleting the speed dial**

- 1 Display the “Phonebook Settings” screen. (→P. 481)
- 2 Select “Manage Speed Dials” on the “Phonebook Settings” screen.
- 3 Select “Delete Speed Dials” on the “Speed Dials” screen.
- 4 Choose the data to delete.  
To delete all data, select “All Delete”.

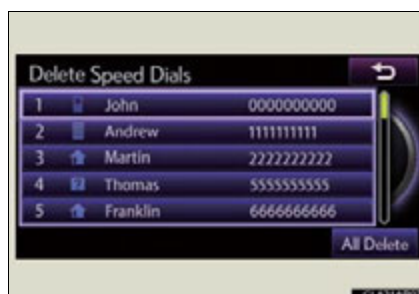

- 5 A confirmation message will be displayed. If everything is correct, select “Yes”.

---

■ **Setting the speed dials in a different way (From “Speed Dial” screen)**

- 1 Display the “Phone” screen. (→P. 459)
- 2 Select “Speed Dials” on the “Phone” screen.
- 3 Select “Options” on the “Speed Dial” screen.

■ **Setting the speed dials in a different way (From “Contacts” screen)**

- 1 Display the “Phone” screen. (→P. 459)
- 2 Select “Contacts” on the “Phone” screen.
- 3 Select “Options” on the “Contacts” screen.
- 4 Select “Manage Speed Dials” on the “Contacts” screen.

**■ Registering the speed dial in a different way (From “Speed Dial” screen)**

- 1 Display the “Phone” screen. (→P. 459)
- 2 Select “Speed Dials” on the “Phone” screen.
- 3 Select “(add new)” on the “Speed Dial” screen.
- 4 Select “Contacts” or “History” to set new speed dial.  
Select “Cancel” to cancel it.
- 5 Choose the desired data from the list.
- 6 Select the desired phone number.

**■ Registering the speed dial in a different way (From “Contact” screen)**

- 1 Display the “Phone” screen. (→P. 459)
- 2 Select “Contacts” on the “Phone” screen.
- 3 Choose the desired data from the list.
- 4 Select “Options” on the “Contact” screen.
- 5 Select “Set Speed Dial” on the “Contact” screen.
- 6 Select the desired telephone number.
- 7 Follow the steps “Registering the speed dial from contacts” from 6  
(→P. 486).

**■ Registering the speed dial in a different way (From “Call History” screen)**

- 1 Display the “Phone” screen. (→P. 459)
- 2 Select “Call History” on the “Phone” screen.
- 3 Choose the desired data from the list.
- 4 Select “Add Speed Dial” on the “Call History” screen.
- 5 Follow the steps “Registering the speed dial from call history” from 5.  
(→P. 487)

### Deleting the call history

- 1 Display the "Phonebook Settings" screen. (→P. 481)
- 2 Select "Delete Call History" on the "Phonebook Settings" screen.  
If your phone supports PBAP service, the "Automatically Download Contacts" setting needs to be set to "Off". (→P. 482)

- 3 Choose the desired history to delete.

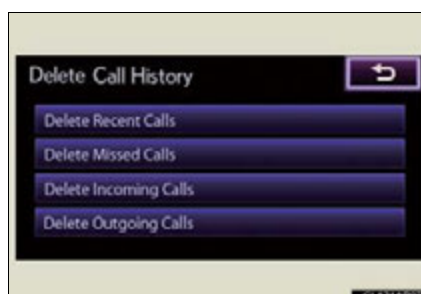

- 4 Choose the data to delete.  
To delete all data, select "All Delete".



- 5 A confirmation message will be displayed. If everything is correct, select "Yes".

#### Deleting call history in a different way

- 1 Display the "Phone" screen. (→P. 459)
- 2 Select "Call History" on the "Phone" screen.
- 3 Select "Delete" on the "Call History" screen.
- 4 Follow the steps "Deleting the call history" from 4. (→P. 490)

## Bluetooth® settings

You can set the Bluetooth® system to your desired settings.



- ① Registered devices settings
- ② Connecting telephone
- ③ Connecting audio player
- ④ Detailed Bluetooth® settings

To display the screen shown above, follow the steps below.

- 1 Press the “MENU” button on the Lexus Display Audio controller.
- 2 Select “Setup” on the “Menu” screen.
- 3 Select “Bluetooth\*” on the “Setup” screen.

\*: Bluetooth is a registered trademark of Bluetooth SIG, Inc.

### Registered devices settings

#### ■ Registering a Bluetooth® device

Bluetooth® devices compatible with phones (HFP) and portable audio players (AVP) can be registered simultaneously. You can register up to 5 Bluetooth® devices.

- 1 Display the “Bluetooth\* Settings” screen. (→P. 491)
- 2 Select “Registered Devices” on the “Bluetooth\* Settings” screen.
- 3 Select “Add New”.



\*: Bluetooth is a registered trademark of Bluetooth SIG, Inc.



- 4 When this screen is displayed, input the passcode displayed on the screen into your Bluetooth® device.

For the operation of the Bluetooth® device, see the manual that comes with your Bluetooth® device.

Depending on the type of phone, further phone operations may be required after inputting the passcode (for example to confirm if connection is to be received or not) when registering a phone.

Passcodes are not required for SSP (Secure Simple Pairing) compatible Bluetooth® devices. Depending on the phone, you may need to select “Yes” to register, or “No” to cancel on your cellular phone.

If you want to cancel it, select “Cancel”.

If a completion message is displayed, registration is complete.

If an error message is displayed, follow the guidance on the screen to try again.



#### ■ Removing a Bluetooth® device

- 1 Display the “Bluetooth\* Settings” screen. (→P. 491)
- 2 Select “Registered Devices” on the “Bluetooth\* Settings” screen.

\*: Bluetooth is a registered trademark of Bluetooth SIG, Inc.

- 3 Select "Remove".



- 4 Select the device to remove.



- 5 A confirmation message will be displayed, select "Yes" to remove the device.

■ **Displaying a Bluetooth® device details**

You can confirm and change the device details.

- 1 Display the "Bluetooth\* Settings" screen. (→P. 491)  
2 Select "Registered Devices" on the "Bluetooth\* Settings" screen.  
3 Select "Details".



\*: Bluetooth is a registered trademark of Bluetooth SIG, Inc.

- 4 Select the device.

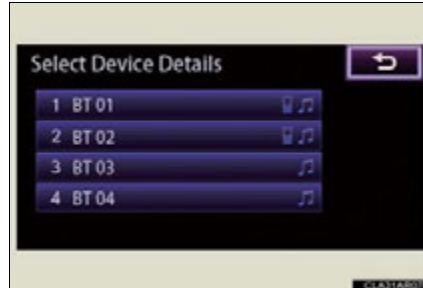

- 5 Following screen is displayed:

- ① Display device name
- ② Display device address
- ③ Display your telephone number

The number may not be displayed depending on the phones.

- ④ Display compatibility profile of the device
  - ⑤ Change connection method (→P. 496)
  - ⑥ Restore default settings
- 6 When you complete settings, select "OK".

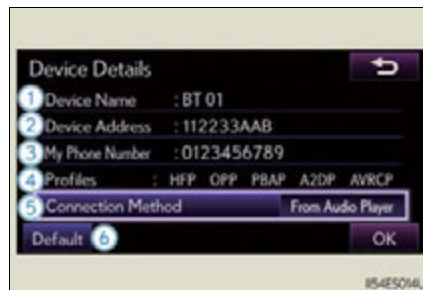

● Changing connection method

- 1 Select "Connection Method" on the "Device Details" screen.
- 2 Select "From Vehicle" or "From Audio Player".

"From Vehicle": Connect the audio system to the portable audio player.  
 "From Audio Player": Connect the portable audio player to the audio system.

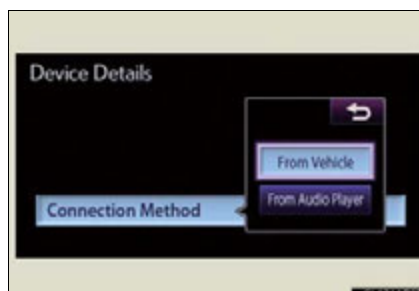

**Selecting the Bluetooth® phone**

If multiple Bluetooth® devices are registered, follow the procedure below to select the Bluetooth® device to be used. You may only use one device at a time.

- 1 Display the "Bluetooth\* Settings" screen. (→P. 491)
- 2 Select "Connect Phone" on the "Bluetooth\* Settings" screen.
- 3 Select the device to connect.

"Add New": Registering a Bluetooth® device. (→P. 492)  
 The selection indicator is displayed on left side of the selected device name.  
 The Bluetooth® mark is displayed when you connected the device.

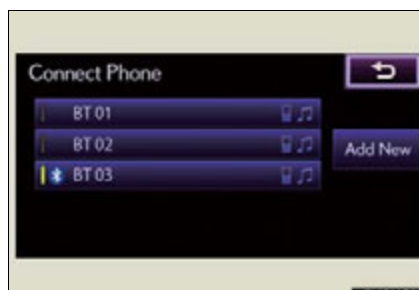

\*: Bluetooth is a registered trademark of Bluetooth SIG, Inc.

### Selecting the audio player

If multiple Bluetooth<sup>®</sup> devices are registered, follow the procedure below to select the Bluetooth<sup>®</sup> device to be used. You may only use one device at a time.

- 1 Display the "Bluetooth\* Settings" screen. (→P. 491)
- 2 Select "Connect Audio Player" on the "Bluetooth\* Settings" screen.
- 3 Select the device to connect.

"Add New": Registering a Bluetooth<sup>®</sup> device. (→P. 492)

The selection indicator is displayed on left side of the selected device name.

The Bluetooth<sup>®</sup> mark is displayed when you connected the device.

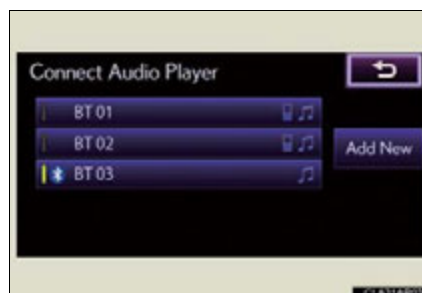

\*: Bluetooth is a registered trademark of Bluetooth SIG, Inc.

### Detailed Bluetooth® settings

You can confirm and change the detailed Bluetooth® settings.

- 1 Display the “Bluetooth\* Settings” screen. (→P. 491)
- 2 Select “Detailed Bluetooth\* Settings” on the “Bluetooth\* Settings” screen.
- 3 Following screen is displayed:

- 1 Change Bluetooth® power on/off

You can change Bluetooth® function to “On” or “Off”

- 2 Display device name
- 3 Change passcode (→P. 499)
- 4 Display device address
- 5 Restore default settings
- 6 Display compatibility profile of the system
- 7 Change displaying telephone status on/off

You can set the system to show the status confirmation display when connecting telephone

- 8 Change displaying audio player status on/off

You can set the system to show the status confirmation display when connecting audio player

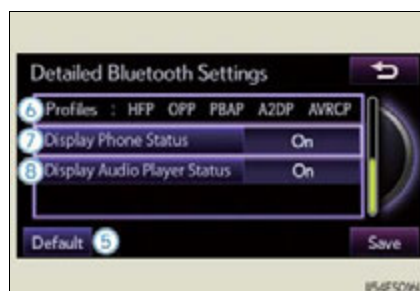
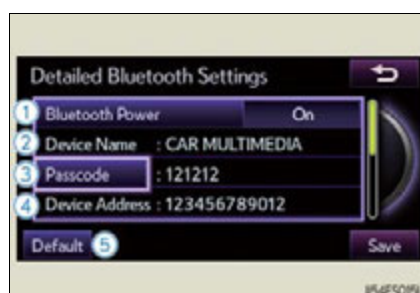

- 4 When you complete settings, select “Save”.

\*: Bluetooth is a registered trademark of Bluetooth SIG, Inc.

### ■ Editing the passcode

You can change the passcode that you use to register your Bluetooth<sup>®</sup> device in the system.

**1** Select “Passcode” on the “Detailed Bluetooth\* Settings” screen.

**2** Input a passcode, and select “OK”.

To delete the inputted phone number, select .



\*: Bluetooth is a registered trademark of Bluetooth SIG, Inc.





### Audio system (without a navigation system or the Lexus Display Audio system)

- ▶ Vehicles with a navigation system

Owners of models equipped with a navigation system should refer to the “Navigation System Owner’s Manual”.

- ▶ Vehicles with the Lexus Display Audio system

→P. 382

- ▶ CD player with a changer and AM/FM radio (type A)



## ▶ CD player with a changer and AM/FM radio (type B)

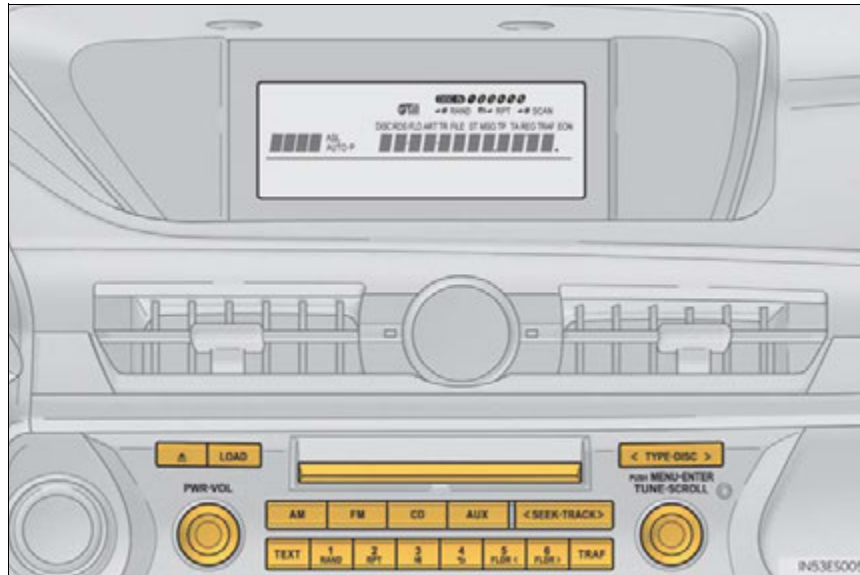

Title	Page
Using the radio	P. 503
Using the CD player	P. 512
Playing MP3 and WMA discs	P. 521
Operating an iPod	P. 529
Operating a USB memory	P. 539
Using the Bluetooth <sup>®</sup> audio system	P. 552
Optimal use of the audio system	P. 569
Using the AUX port	P. 571
Using the steering wheel audio switches	P. 573
Hands-free system for cellular phones	P. 576

## ■ Using cellular phones

Interference may be heard through the audio system's speakers if a cellular phone is being used inside or close to the vehicle while the audio system is operating.

 CAUTION

■ **Certification**

- Part 15 of the FCC Rules

FCC Warning:

Any unauthorized changes or modifications to this equipment will void the user's authority to operate this device.

- Laser products

- USE OF CONTROL OR ADJUSTMENT OR PERFORMANCE OF PROCEDURES OTHER THAN THOSE SPECIFIED HEREIN MAY RESULT IN HAZARDOUS RADIATION EXPOSURE.
- THE USE OF OPTICAL INSTRUMENTS WITH THIS PRODUCT WILL INCREASE EYE HAZARD.

 NOTICE

■ **To prevent 12-volt battery discharge**

Do not leave the audio system on longer than necessary when the engine <hybrid system> is off.

■ **To avoid damaging the audio system**

Take care not to spill drinks or other fluids over the audio system.

## Using the radio

### ► Type A

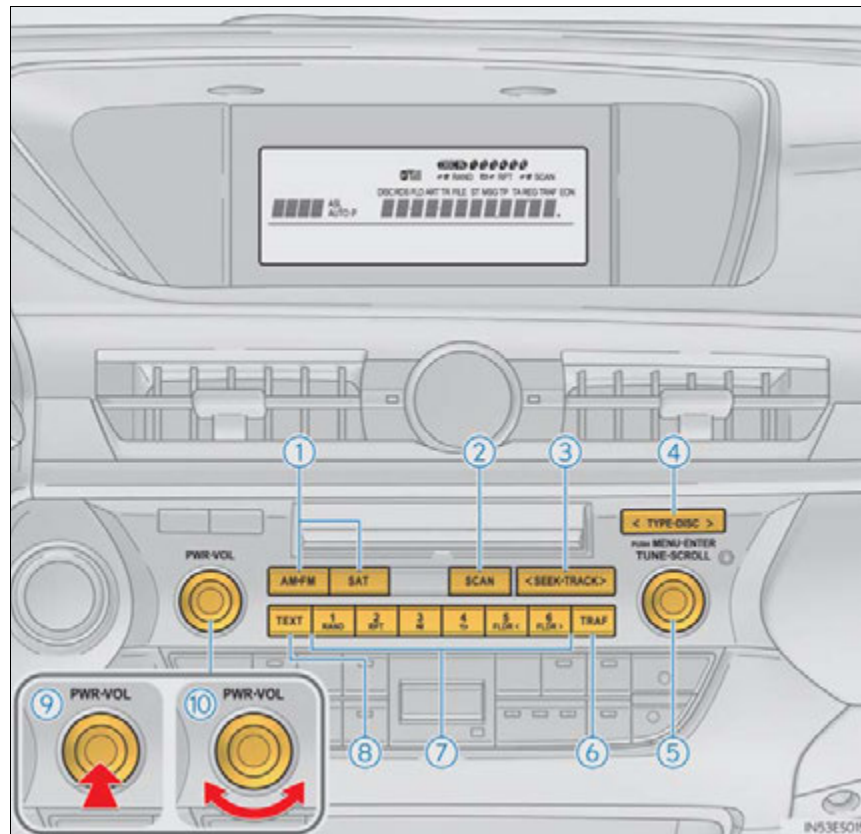



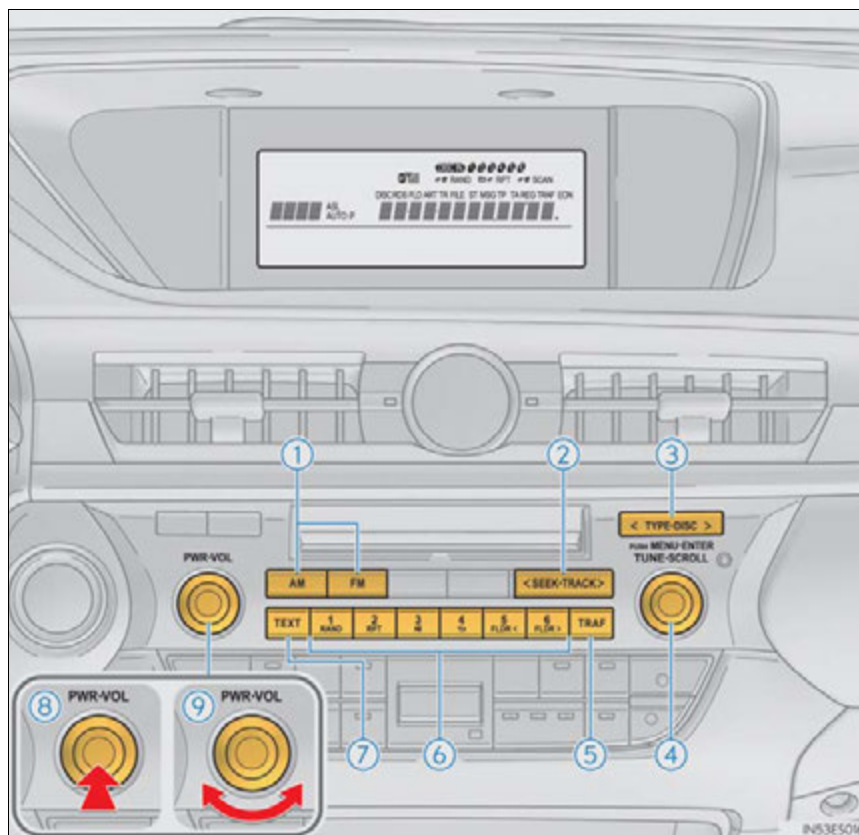

- |   |                              |
|---|------------------------------|
| ① AM-FM/SAT mode buttons  | ⑥ Traffic information button |
| ② Scan button   | ⑦ Preset station buttons     |
| ③ Seek button   | ⑧ Radio text message button  |
| ④ Channel category button                                       | ⑨ Power                      |
| ⑤ Frequency adjustment (AM/FM mode) and channel (SAT mode) knob | ⑩ Volume                     |

► Type B



- ① AM·FM buttons
- ② Seek button
- ③ Channel category button
- ④ Frequency adjustment knob
- ⑤ Traffic information button
- ⑥ Preset station buttons
- ⑦ Radio text message button
- ⑧ Power
- ⑨ Volume

### Setting station presets (excluding XM® Satellite Radio)

- 1 Search for the desired stations by turning  or pressing ">" or "<" on .
- 2 Press and hold the button (from  to ) the station is to be set to until you hear a beep.

### Scanning radio stations (excluding XM® Satellite Radio) (type A)

#### ■ Scanning the preset radio stations

- 1 Press and hold  until you hear a beep.  
Preset stations will be played for 5 seconds each.
- 2 When the desired station is reached, press the button again.

#### ■ Scanning all the radio stations within range

- 1 Press .
- 2 When the desired station is reached, press the button again.

## RBDS (Radio Broadcast Data System)

This feature allows your radio to receive station identification information and program information (classical, jazz, etc.) from radio stations which broadcast this information.

### ■ Receiving RBDS broadcasts

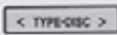
- 1 Press “>” or “<” on  during FM reception.

The type of program changes each time the button is pressed.

- “ROCK”
- “EASYLIS” (Easy listening)
- “CLS/JAZZ” (Classical music and Jazz)
- “R & B” (Rhythm and Blues)
- “INFORM” (Information)
- “RELIGION”
- “MISC” (Miscellaneous)
- “ALERT” (Emergency messages)

If the system receives no RBDS stations, “NO PTY” appears on the display.

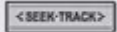
- 2 Press , or “>” or “<” on .

The radio seeks or scans for stations of the relevant program type.



### ■ Displaying radio station names

Press .

### ■ Displaying radio text messages

Press  twice.

A text message is displayed when “MSG” is shown on the screen.

If the text continues past the end of the display,  is displayed. Press and hold  until you hear a beep.

## XM<sup>®</sup> Satellite Radio (type A)

### ■ Receiving XM<sup>®</sup> Satellite Radio

1 Press .



The display changes as follows each time the button is pressed:

“SAT1” → “SAT2” → “SAT3”

2 Turn  to select the desired channel in all the categories or

press “>” or “<” on  to select the desired channel in the current category.

### ■ Setting XM<sup>®</sup> Satellite Radio channel presets

Select the desired channel. Press and hold the button (from  to ) the channel is to be set to until you hear a beep.

### ■ Changing the channel category

Press “>” or “<” on .



■ **Scanning the XM<sup>®</sup> Satellite Radio channels**

- Scanning the channels in the current category

- 1 Press  .
- 2 When the desired channel is reached, press the button again.

- Scanning the preset channels

- 1 Press and hold  until you hear a beep.
- 2 When the desired channel is reached, press the button again.

■ **Displaying text information**

Press  .

The display will show up to 10 characters.

The display changes as follows each time the button is pressed:

- CH NAME
- TITLE (SONG/PROGRAM TITLE)
- NAME (ARTIST NAME/FEATURE)
- CH NUMBER

### ■ When the 12-volt battery is disconnected

All preset stations are erased.

### ■ Reception sensitivity

- Cargo loaded on the roof luggage carrier, especially metal objects, may adversely affect the reception of XM<sup>®</sup> Satellite Radio.
- It is difficult to maintain perfect radio reception at all times due to the continually changing position of the antenna, differences in signal strength and surrounding objects, such as trains and transmitters.
- The radio antenna is mounted inside the trunk and the rear window. To maintain clear radio reception, do not attach metallic window tinting or other metallic objects to the antenna wire mounted inside the rear window.

### ■ Receiving XM<sup>®</sup> Satellite Radio

An XM<sup>®</sup> Satellite Radio is a tuner designed exclusively to receive broadcasts provided under a separate subscription. Availability is limited to the 48 contiguous states and 10 Canadian provinces.

#### ● XM<sup>®</sup> subscriptions

For detailed information about XM<sup>®</sup> Satellite Radio or to subscribe:  
U.S.A. —

Visit on the web at [www.siriusxm.com](http://www.siriusxm.com) or call 1-866-635-2349.

Canada —

Visit on the web at [www.xmradio.ca](http://www.xmradio.ca) or call 1-877-438-9677.

#### ● Radio ID

You will need the radio ID when activating XM<sup>®</sup> service or reporting a problem.

Select "CH000" using , and the receiver's 8-character ID number will appear.

#### ● Satellite tuner

The tuner supports only Audio Services (Music and Talk) and the accompanying Text Information of XM<sup>®</sup> Satellite Radio.

■ **If the satellite radio does not operate normally**

If a problem occurs with the XM<sup>®</sup> tuner, a message will appear on the display. Refer to the table below to identify the problem, and take the suggested corrective action.

"ANTENNA"	The XM <sup>®</sup> antenna is not connected. Check whether the XM <sup>®</sup> antenna cable is attached securely.
	There is a short-circuit in the antenna or the surrounding antenna cable. See a Lexus certified dealer.
"UNAUTH"	You have not subscribed to the XM <sup>®</sup> Satellite Radio. The radio is being updated with the latest encryption code. Contact the XM <sup>®</sup> Satellite Radio for subscription information. When a contract is canceled, you can choose the "CH000" and all the free-to-air channels.
	The premium channel you selected is not authorized. Wait for about 2 seconds until the radio returns to the previous channel or "CH001". If it does not change automatically, select another channel. If you want to listen to the premium channel, contact the XM <sup>®</sup> Satellite Radio.
"NO SIGNAL"	The XM <sup>®</sup> signal is too weak at the current location. Wait until your vehicle reaches a location with a stronger signal.
"LOADING"	The unit is acquiring audio or program information. Wait until the unit has received the information.
"OFF AIR"	The channel you selected is not broadcasting any programming. Select another channel.
"-----"	There is no song/program title or artist name/feature associated with the channel at that time. No action needed.
"CH UNAVL"	The channel you selected is no longer available. Wait for about 2 seconds until the radio returns to the previous channel or "CH001". If it does not change automatically, select another channel.

Contact the XM<sup>®</sup> Listener Care Center at 1-866-635-2349 (U.S.A.) or 1-877-438-9677 (Canada).

**■ Certifications for XM<sup>®</sup> Satellite Radio**

This device complies with RSS-310 of Industry Canada. Operation is subject to the condition that this device does not cause harmful interference.

Cet appareil est conforme au CNR-310 d'Industrie Canada. Son exploitation est autorisée sous réserve que l'appareil ne cause pas de brouillage préjudiciable.

## Using the CD player

► Type A

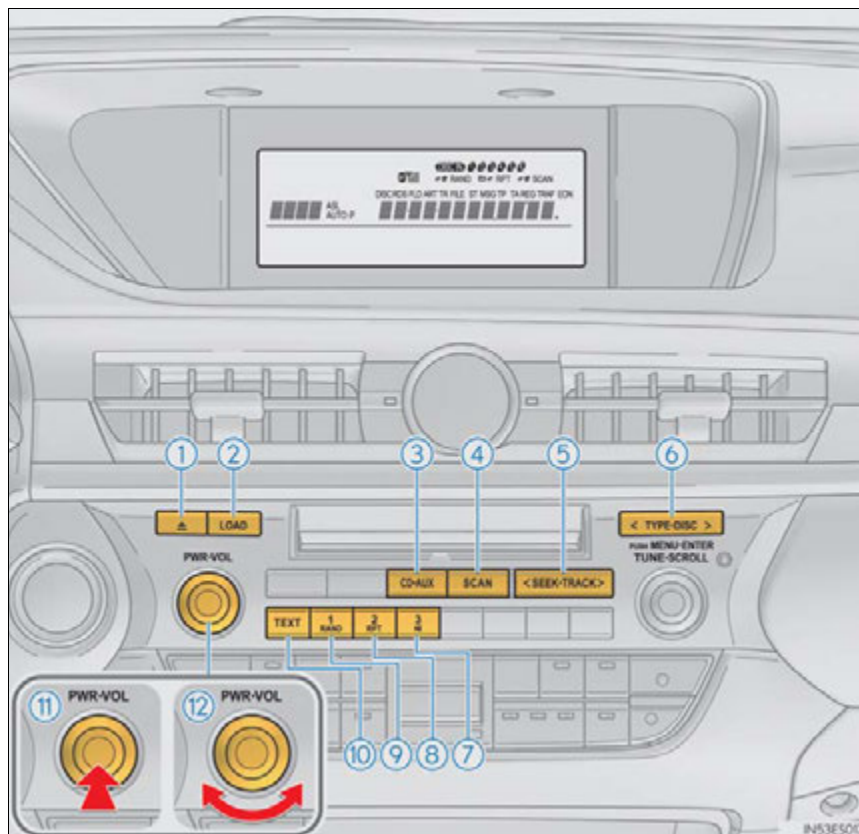

- ① Eject button
- ② Load button
- ③ Playback button
- ④ Search playback button
- ⑤ Track selector button
- ⑥ CD selector button
- ⑦ Playback/Pause button
- ⑧ Repeat play button
- ⑨ Random playback button
- ⑩ Text button
- ⑪ Power
- ⑫ Volume

## ► Type B

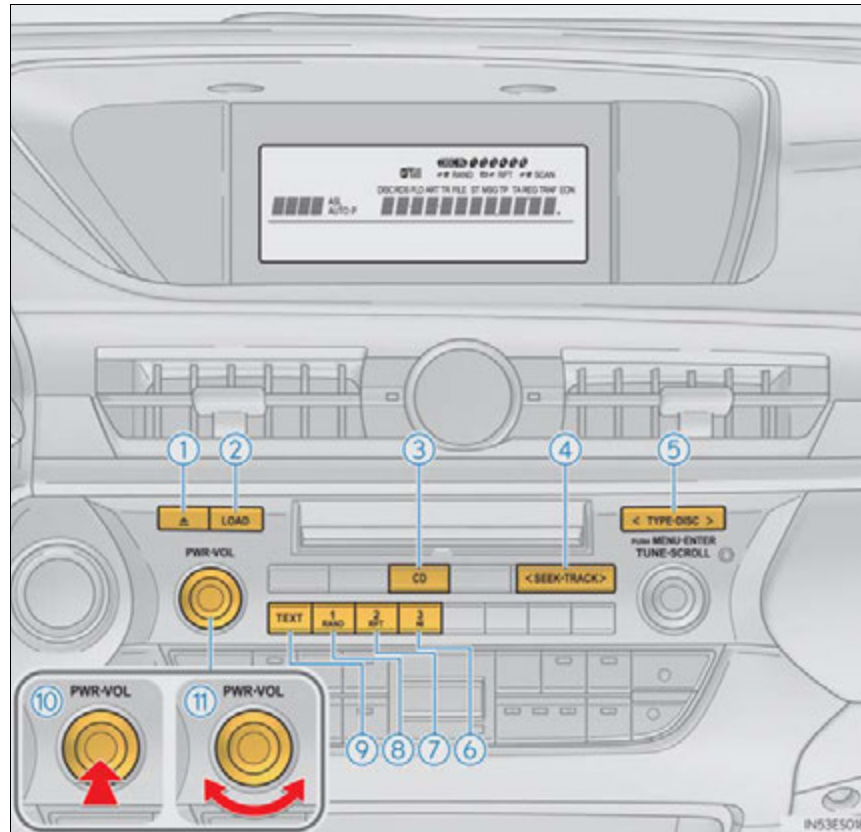



- |                         |                          |
|-------------------------|--------------------------|
| ① Eject button          | ⑦ Repeat play button     |
| ② Load button           | ⑧ Random playback button |
| ③ Playback button       | ⑨ Text button            |
| ④ Track selector button | ⑩ Power                  |
| ⑤ CD selector button    | ⑪ Volume                 |
| ⑥ Playback/Pause button |                          |

### Loading a CD

#### ■ Loading a CD

- 1 Press .  
“WAIT” is shown on the display.
- 2 When the indicator on the slot turns from amber to green, insert a CD.  
The display changes from “WAIT” to “LOAD”.

#### ■ Loading multiple CDs

- 1 Press and hold  until you hear a beep.  
“WAIT” is shown on the display.
- 2 When the indicator on the slot turns from amber to green, insert a CD.  
The display changes from “WAIT” to “LOAD”.  
The indicator on the slot turns to amber when the CD is being inserted.
- 3 When the indicator on the slot turns from amber to green, insert the next CD.  
Repeat the procedure for the remaining CDs.  
To cancel the operation, press . If you do not insert a disc within 15 seconds, loading will be canceled automatically.

## Ejecting CDs

### ■ Ejecting a CD

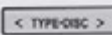
- 1 To select the CD to be ejected, press “>” or “<” on . The selected disc number is shown on the display.



- 2 Press  and remove the CD.

### ■ Ejecting all the CDs

Press and hold  until you hear a beep, and then remove the CDs.

## Selecting, fast-forwarding, reversing and scanning tracks

### ■ Selecting a track

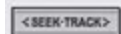
Press “>” to move up or “<” to move down using  until the desired track number is displayed.

### ■ Fast-forwarding and reversing tracks

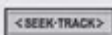
To fast-forward or reverse, press and hold “>” or “<” on  until you hear a beep.

### ■ Scanning tracks (type A)

- 1 Press .

The first ten seconds of each track will be played.

To cancel, press  again.

- 2 Press the button again when the desired track is reached.



### Selecting a CD

#### ■ Selecting a CD to play

To select the desired CD, press “>” or “<” on .

#### ■ Scanning loaded CDs (type A)

**1** Press and hold  until you hear a beep.

The first ten seconds of the first track on each CD will be played.

To cancel, press  again.

**2** Press the button again when the desired CD is reached.

### Playing and pausing tracks

To play or pause a track, press .

### Random playback

#### ■ Current CD

Press .

Songs are played in random order.

To cancel, press  again.

#### ■ All CDs

Press and hold  until you hear a beep.

Tracks on all loaded CDs are played in random order.

To cancel, press  again.

## Repeat play

### ■ Repeating a track

Press .

To cancel, press  again.

### ■ Repeating all of the tracks on a CD

Press and hold  until you hear a beep.

To cancel, press  again.

## Switching the display

Press .

Each time the button is pressed, the display changes in the following order:

Elapsed time → CD title → Track title

■ **CD player protection feature**

To protect the internal components, playback is automatically stopped when a problem is detected.

■ **Display**

Up to 12 characters can be displayed at a time.

If there are 13 or more characters, pressing and holding  until you hear a beep enables to display the remaining characters.

A maximum of 24 characters can be displayed.

If  is pressed until you hear a beep again or has not been operated for more than 6 seconds, the display will return to the first 12 characters.

Depending on the contents recorded, the characters may not be displayed properly or may not be displayed at all.



■ **When “ERROR” or “WAIT” is shown on the display**

“ERROR”:

This indicates a problem either in the CD or inside the player. The CD may be dirty, damaged, or inserted up-side down.

“WAIT”:

This indicates that operation is stopped due to a high temperature inside the player.

Wait for a while and then press  or . If the CD still cannot be played back, contact your Lexus dealer.

■ **Discs that can be used**

Discs with the marks shown below can be used.

Playback may not be possible depending on recording format or disc features, or due to scratches, dirt or deterioration.



CDs with copy-protection features may not be used.

■ **Lens cleaners**

Do not use lens cleaners. Doing so may damage the CD player.

■ **If discs are left inside the CD player or in the ejected position for extended periods of time**

The discs may be damaged and may not play properly.

 NOTICE

■ **CDs and adapters that cannot be used**

Do not use the following types of CDs.

Also, do not use 3 in. (8 cm) CD adapters, DualDiscs or printable discs. Doing so may damage the CD player and/or the CD load/eject function.

- CDs that have a diameter that is not 4.7 in. (12 cm)

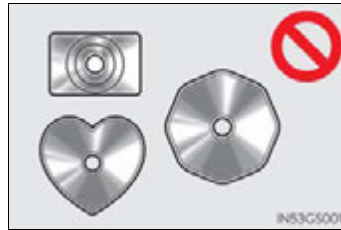

- Low-quality and deformed CDs

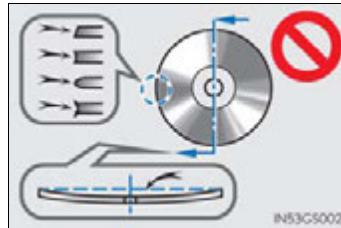

- CDs with a transparent or translucent recording area

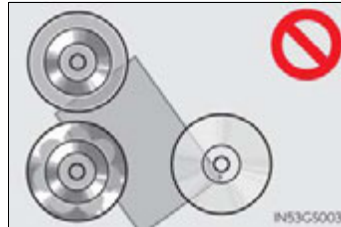

- CDs that have had tape, stickers or CD-R labels attached to them, or that have had the label peeled off

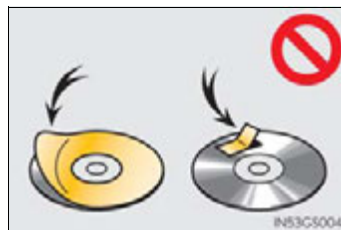

 NOTICE

## ■ CD player precautions

Failure to follow the precautions below may result in serious damage to the CDs or the player itself.

- Do not insert anything other than CDs into the CD slot.
- Do not apply oil to the CD player.
- Store CDs away from direct sunlight.
- Never try to disassemble any part of the CD player.
- Do not insert more than one CD at a time.



## Playing MP3 and WMA discs

### ► Type A

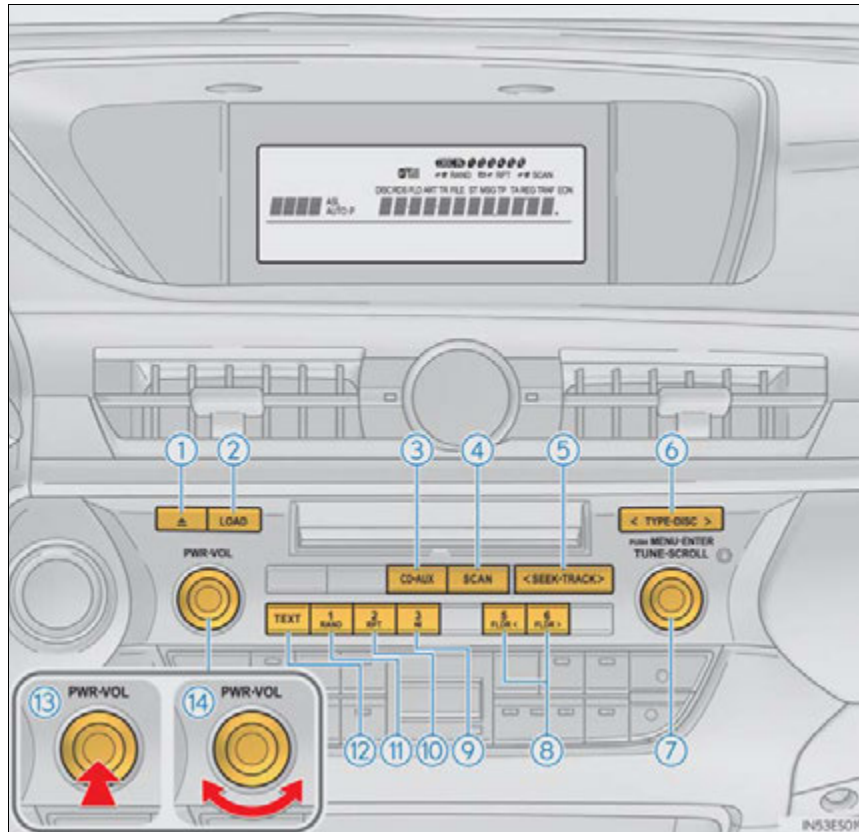

- |                          |                           |
|--------------------------|---------------------------|
| ① Eject button           | ⑧ Folder selector buttons |
| ② Load button            | ⑨ Playback/Pause button   |
| ③ Playback button        | ⑩ Repeat play button      |
| ④ Search playback button | ⑪ Random playback button  |
| ⑤ File selector button   | ⑫ Text button             |
| ⑥ Disc selector button   | ⑬ Power                   |
| ⑦ File selector knob     | ⑭ Volume                  |

► Type B

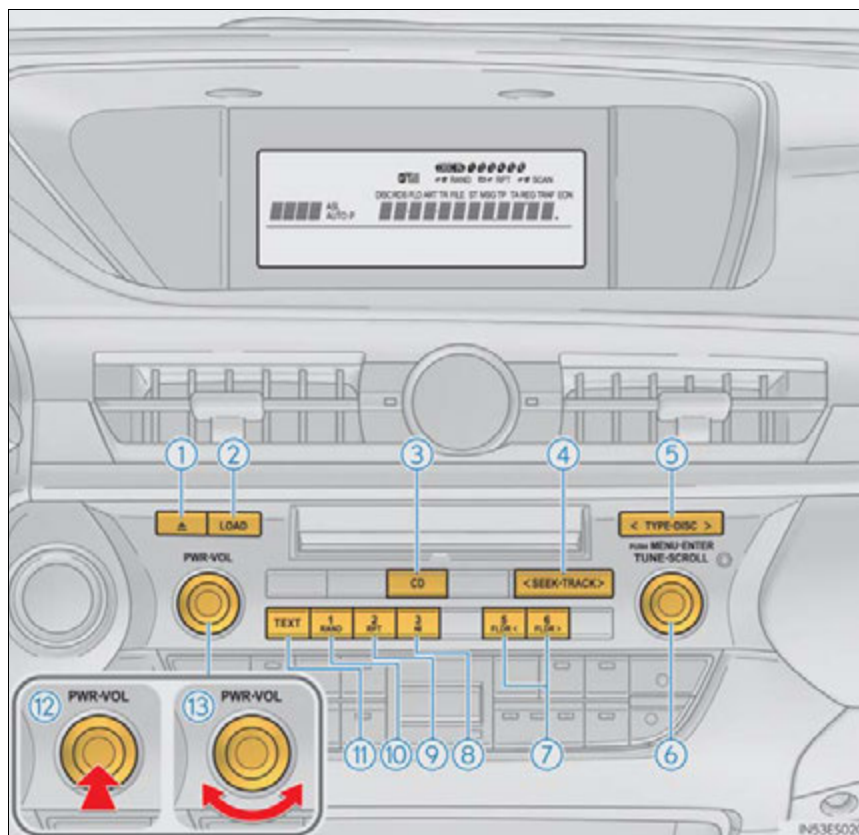

- ① Eject button
- ② Load button
- ③ Playback button
- ④ File selector button
- ⑤ Disc selector button
- ⑥ File selector knob
- ⑦ Folder selector buttons
- ⑧ Playback/Pause button
- ⑨ Repeat play button
- ⑩ Random playback button
- ⑪ Text button
- ⑫ Power
- ⑬ Volume

### Loading and ejecting MP3 and WMA discs



→P. 514, 515

### Selecting MP3 and WMA discs

→P. 516

### Selecting and scanning a folder

#### ■ Selecting a folder one at a time

Press  or  to select the desired folder.

#### ■ Returning to the first folder

Press and hold  until you hear a beep.

#### ■ Scanning the first file of all the folders (type A)

**1** Press and hold  until you hear a beep.

The first ten seconds of the first file in each folder will be played.

**2** When the desired folder is reached, press  again.

### Fast-forwarding and reversing files

To fast-forward or reverse, press and hold ">" or "<" on  until you hear a beep.



### Selecting and scanning files

#### ■ Selecting a file

Turn  or press ">" or "<" on  to select the desired file.

#### ■ Scanning the files in a folder (type A)

Press .

The first ten seconds of each file will be played.

To cancel, press  again.

When the desired file is reached, press  again.

### Playing and pausing files

To play or pause a file, press .

### Random playback

#### ■ Playing files from a folder in random order

Press .

To cancel, press  again.

#### ■ Playing all the files from a disc in random order

Press and hold  until you hear a beep.

To cancel, press  again.

## Repeat play

### ■ Repeating a file

Press .

To cancel, press  again.

### ■ Repeating all the files in a folder

Press and hold  until you hear a beep.

To cancel, press  again.

## Switching the display

Press .

Each time the button is pressed, the display changes in the following order: Folder no./File no./Elapsed time → Folder name → File name → Album title (MP3 only) → Track title → Artist name

**■ CD player protection feature**



→P. 518

**■ Display**

→P. 518

**■ When “ERROR”, “WAIT” or “NO MUSIC” is shown on the display**

“ERROR”: This indicates a problem either in the CD or inside the player. The CD may be dirty, damaged, or inserted up-side down.

“WAIT”: This indicates that operation is stopped due to a high temperature inside the player. Wait for a while and then press  or . If the CD still cannot be played back, contact your Lexus dealer.

“NO MUSIC”: This indicates that an MP3/WMA file is not included in the CD.

**■ Discs that can be used**

→P. 518

**■ Lens cleaners**

→P. 518

**■ If discs are left inside the CD player or in the ejected position for extended periods of time**

→P. 518

**■ MP3 and WMA files**

MP3 (MPEG Audio LAYER 3) is a standard audio compression format.

Files can be compressed to approximately 1/10 of their original size by using MP3 compression.

WMA (Windows Media Audio) is a Microsoft audio compression format.

This format compresses audio data to a size smaller than that of the MP3 format.

There is a limit to the MP3 and WMA file standards that can be used and to the media/formats on which the files are recorded.

**● MP3 file compatibility**

- Compatible standards  
MP3 (MPEG1 LAYER3, MPEG2 LSF LAYER3)
- Compatible sampling frequencies  
MPEG1 LAYER3: 32, 44.1, 48 (kHz)  
MPEG2 LSF LAYER3: 16, 22.05, 24 (kHz)
- Compatible bit rates (compatible with VBR)  
MPEG1 LAYER3: 64, 80, 96, 112, 128, 160, 192, 224, 256, 320 (kbps)  
MPEG2 LSF LAYER3: 64, 80, 96, 112, 128, 144, 160 (kbps)
- Compatible channel modes: stereo, joint stereo, dual channel and monaural

- WMA file compatibility

- Compatible standards  
WMA Ver. 7, 8, 9
- Compatible sampling frequencies  
32, 44.1, 48 (kHz)
- Compatible bit rates (only compatible with 2-channel playback)  
Ver. 7, 8: CBR 48, 64, 80, 96, 128, 160, 192 (kbps)  
Ver. 9: CBR 48, 64, 80, 96, 128, 160, 192, 256, 320 (kbps)

- Compatible media

Media that can be used for MP3 and WMA playback are CD-Rs and CD-RWs.

Playback in some instances may not be possible if the CD-R or CD-RW is not finalized. Playback may not be possible or the audio may jump if the disc is scratched or marked with fingerprints.

- Compatible disc formats

The following disc formats can be used:

- Disc formats: CD-ROM Mode 1 and Mode 2  
CD-ROM XA Mode 2, Form 1 and Form 2
- File formats: ISO9660 Level 1, Level 2, (Romeo, Joliet)  
MP3 and WMA files written in any format other than those listed above may not play correctly, and their file names and folder names may not be displayed correctly.

Items related to standards and limitations are as follows:

- Maximum directory hierarchy: 8 levels (including the root)
- Maximum length of folder names/file names: 32 characters
- Maximum number of folders: 192 (including the root)
- Maximum number of files per disc: 255

- File names

The only files that can be recognized as MP3/WMA and played are those with the extension .mp3 or .wma.

- Discs containing multi-session recordings

As the audio system is compatible with multi-sessions, it is possible to play discs that contain MP3 and WMA files. However, only the first session can be played.

- ID3 and WMA tags

ID3 tags can be added to MP3 files, making it possible to record the track title, artist name, etc.

The system is compatible with ID3 Ver. 1.0, 1.1, and Ver. 2.2, 2.3 ID3 tags. (The number of characters is based on ID3 Ver. 1.0 and 1.1.)

WMA tags can be added to WMA files, making it possible to record the track title and artist name in the same way as with ID3 tags.

- **MP3 and WMA playback**

When a disc containing MP3 or WMA files is inserted, all files on the disc are first checked. Once the file check is finished, the first MP3 or WMA file is played. To make the file check finish more quickly, we recommend you do not write in any files other than MP3 or WMA files or create any unnecessary folders.

Discs that contain a mixture of music data and MP3 or WMA format data cannot be played.

- **Extensions**

If the file extensions .mp3 and .wma are used for files other than MP3 and WMA files, they will be mistakenly recognized and played as MP3 and WMA files. This may result in large amounts of interference and damage to the speakers.

- **Playback**

- To play MP3 files with steady sound quality, we recommend a fixed bit rate of at least 128 kbps and a sampling frequency of 44.1 kHz.
- CD-R or CD-RW playback may not be possible in some instances, depending on the characteristics of the disc.
- There is a wide variety of freeware and other encoding software for MP3 and WMA files on the market, and depending on the status of the encoding and the file format, poor sound quality or noise at the start of playback may result. In some cases, playback may not be possible at all.
- When files other than MP3 or WMA files are recorded on a disc, it may take more time to recognize the disc and in some cases, playback may not be possible at all.
- Microsoft, Windows, and Windows Media are registered trademarks of Microsoft Corporation in the U.S.A. and other countries.

 **NOTICE**

■ **CDs and adapters that cannot be used**

→P. 519

■ **CD player precautions**

→P. 520

## Operating an iPod

Connecting an iPod enables you to enjoy music from the vehicle speakers.

### ► Type A

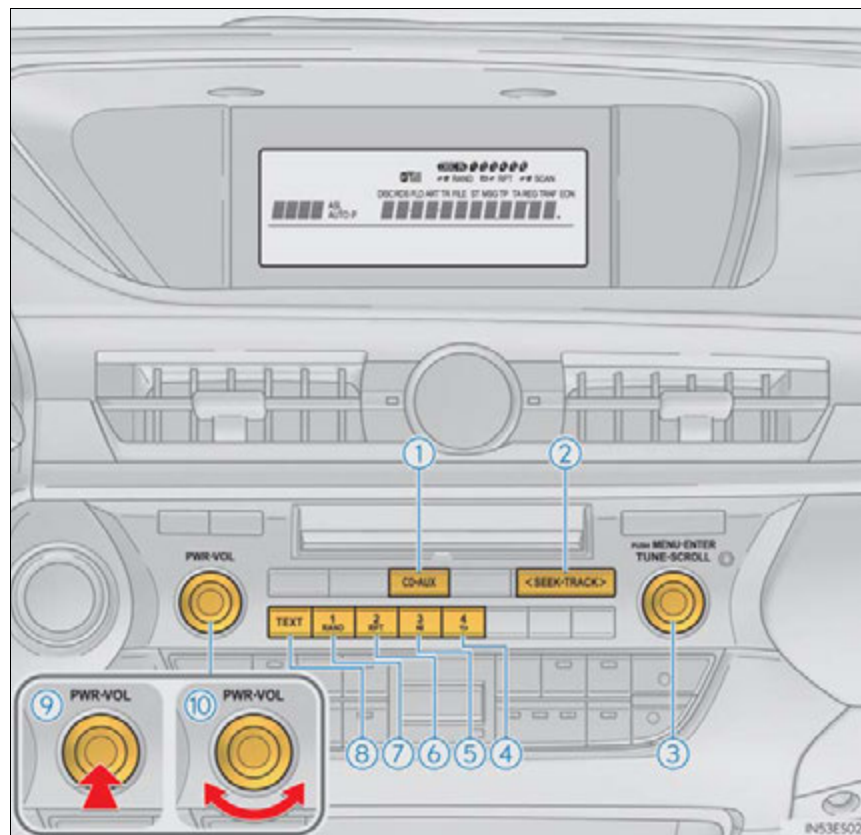

- |                                |                           |
|--------------------------------|---------------------------|
| ① Playback button              | ⑥ Repeat play button      |
| ② Song selector button         | ⑦ Shuffle playback button |
| ③ iPod menu/Song selector knob | ⑧ Text button             |
| ④ Go back button               | ⑨ Power                   |
| ⑤ Playback/Pause button        | ⑩ Volume                  |

► Type B

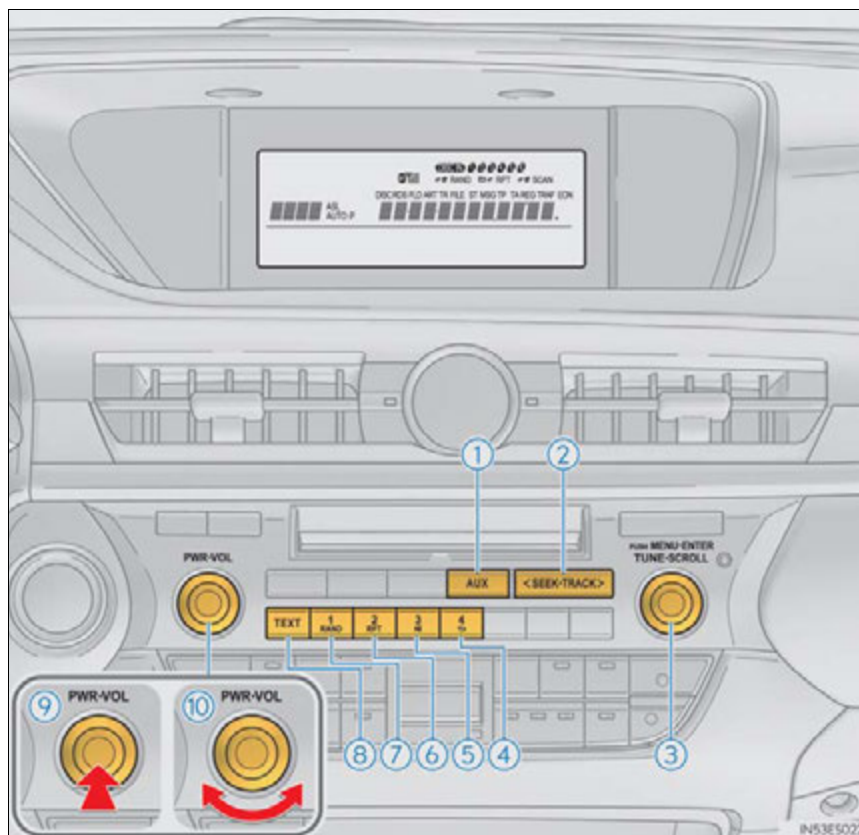

- ① Playback button
- ② Song selector button
- ③ iPod menu/Song selector knob
- ④ Go back button
- ⑤ Playback/Pause button
- ⑥ Repeat play button
- ⑦ Shuffle playback button
- ⑧ Text button
- ⑨ Power
- ⑩ Volume

### Connecting an iPod

- 1 Push the knob to release the lock, and lift the armrest to open fully.

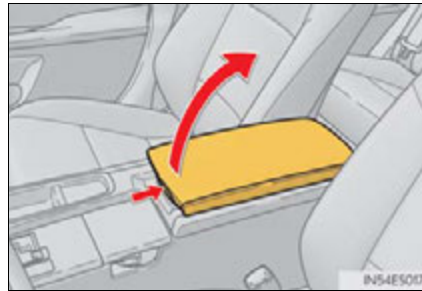

- 2 Open the cover and connect an iPod using an iPod cable.

Turn on the power of the iPod if it is not turned on.

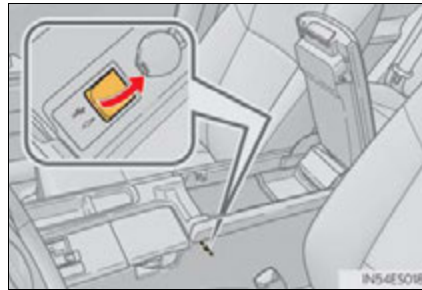

- 3 Press **CD-AUX** or **AUX**.



### Selecting a play mode

- 1 Press  to select iPod menu mode.
- 2 Turning  changes the play mode in the following order:  
 "PLAYLISTS" → "ARTISTS" → "ALBUMS" → "SONGS" →  
 "PODCASTS" → "GENRES" → "COMPOSERS" →  
 "AUDIOBOOKS"
- 3 Press  to select the desired play mode.

#### ■ Play mode list

Play mode	First selection	Second selection	Third selection	Fourth selection
"PLAYLISTS"	Playlists select	Songs select	-	-
"ARTISTS"	Artists select	Albums select	Songs select	-
"ALBUMS"	Albums select	Songs select	-	-
"SONGS"	Songs select	-	-	-
"PODCASTS"	Albums select	Songs select	-	-
"GENRES"	Genre select	Artists select	Albums select	Songs select
"COMPOSERS"	Composers select	Albums select	Songs select	-
"AUDIOBOOKS"	Songs select	-	-	-

### ■ Selecting a list

**1** Turn  to display the first selection list.



**2** Press  to select the desired item.

Pressing the knob changes to the second selection list.

**3** Repeat the same procedure to select the desired item.

To return to the previous selection list, select "GO BACK" or press .

### Selecting songs

Turn  or press ">" or "<" on  to select the desired song.

### Playing and pausing songs

To play or pause a song, press  .

### Fast-forwarding and reversing songs

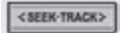
To fast-forward or reverse, press and hold “>” or “<” on  until you hear a beep.

### Shuffle playback

#### ■ Playing songs from one playlist or album in random order

Press  .

To cancel, press  again.

#### ■ Playing songs from all the playlists or albums in random order

Press and hold  until you hear a beep.

To cancel, press  again.

### Repeat play

Press  .



To cancel, press  again.

### Switching the display

Press  .

Each time the button is pressed, the display changes in the following order:  
Elapsed time → Album title → Track title → Artist name

## Adjusting sound quality and volume balance

- 1 Press  to enter iPod menu mode.
- 2 Pressing  changes sound modes. (→P. 569)

### ■ About iPod



- “Made for iPod” and “Made for iPhone” mean that an electronic accessory has been designed to connect specifically to iPod, or iPhone, respectively, and has been certified by the developer to meet Apple performance standards.
- Apple is not responsible for the operation of this device or its compliance with safety and regulatory standards. Please note that the use of this accessory with iPod or iPhone may affect wireless performance.
- iPhone, iPod, iPod classic, iPod nano and iPod touch are trademarks of Apple Inc., registered in the U.S. and other countries.

### ■ iPod functions

- When an iPod is connected and the audio source is changed to iPod mode, the iPod will resume play from the same point in which it was last used.
- Depending on the iPod that is connected to the system, certain functions may not be available. If a function is unavailable due to a malfunction (as opposed to a system specification), disconnecting the device and reconnecting it once again may resolve the problem.
- While connected to the system, the iPod cannot be operated with its own controls. It is necessary to use the controls of the vehicle’s audio system instead.
- When the battery level of an iPod is very low, the iPod may not operate. If so, charge the iPod before use.
- Supported models (→P. 537)

■ **iPod problems**

To resolve most problems encountered when using your iPod, disconnect your iPod from the vehicle iPod connection and reset it.

For instructions on how to reset your iPod, refer to your iPod Owner's Manual.

■ **Display**

→P. 518

■ **Error messages**

“ERROR”:

This indicates a problem in the iPod or its connection.

“NO MUSIC”:

This indicates that there is no music data in the iPod.

“EMPTY”:

This indicates that some available songs are not found in a selected playlist.

“UPDATE”:

This indicates that the version of the iPod is not compatible. Upgrade your iPod software to the latest version.

### Compatible models

The following iPod®, iPod nano®, iPod classic®, iPod touch® and iPhone® devices can be used with this system.

#### Made for

- iPod touch (4th generation)
- iPod touch (3rd generation)
- iPod touch (2nd generation)
- iPod touch (1st generation)
- iPod classic
- iPod with video
- iPod nano (6th generation)
- iPod nano (5th generation)
- iPod nano (4th generation)
- iPod nano (3rd generation)
- iPod nano (2nd generation)
- iPod nano (1st generation)
- iPhone 4
- iPhone 3GS
- iPhone 3G
- iPhone

Depending on differences between models or software versions etc., some models might be incompatible with this system.

Items related to standards and limitations are as follows:

- Maximum number of lists in device: 9999
- Maximum number of songs in device: 65535
- Maximum number of songs per list: 65535

### CAUTION

#### Caution while driving

Do not connect iPod or operate the controls.

 NOTICE**■ If the armrest cannot be fully closed**

Depending on the size and shape of the iPod that is connected to the system, the armrest may not close fully. In this case, do not forcibly close the armrest as this may damage the iPod or the terminal, etc.

**■ To prevent damage to iPod**

- Do not leave iPod in the vehicle. The temperature inside the vehicle may become high, resulting in damage to the player.
- Do not push down on or apply unnecessary pressure to the iPod while it is connected as this may damage the iPod or its terminal.
- Do not insert foreign objects into the port as this may damage the iPod or its terminal.

## Operating a USB memory

Connecting a USB memory enables you to enjoy music from the vehicle speakers.

### ► Type A

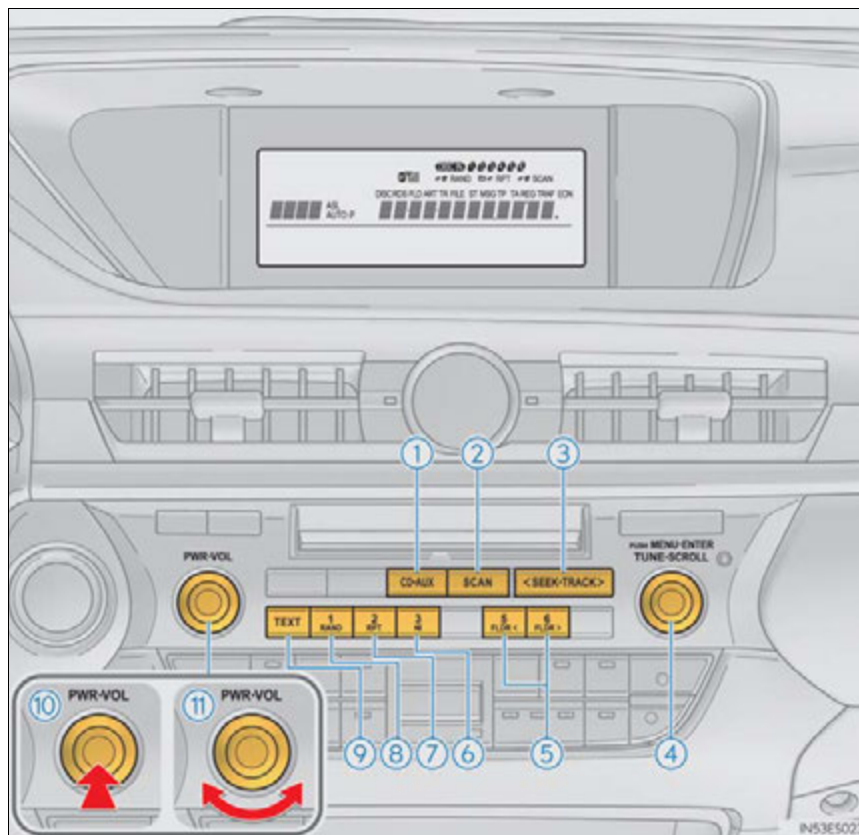

- |                           |                          |
|---------------------------|--------------------------|
| ① Playback button         | ⑥ Playback/Pause button  |
| ② Search playback button  | ⑦ Repeat play button     |
| ③ File selector button    | ⑧ Random playback button |
| ④ File selector knob      | ⑨ Text button            |
| ⑤ Folder selector buttons | ⑩ Power                  |
|                           | ⑪ Volume                 |



► Type B

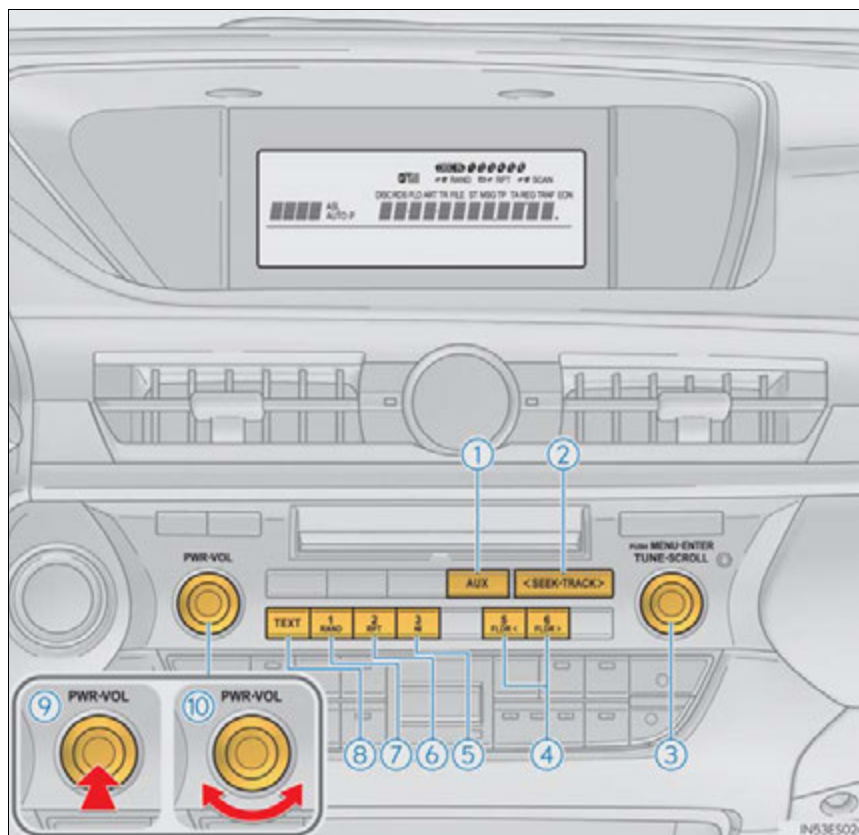

- ① Playback button
- ② File selector button
- ③ File selector knob
- ④ Folder selector buttons
- ⑤ Playback/Pause button
- ⑥ Repeat play button
- ⑦ Random playback button
- ⑧ Text button
- ⑨ Power
- ⑩ Volume

### Connecting a USB memory

- 1** Push the knob to release the lock, and lift the armrest to open fully.

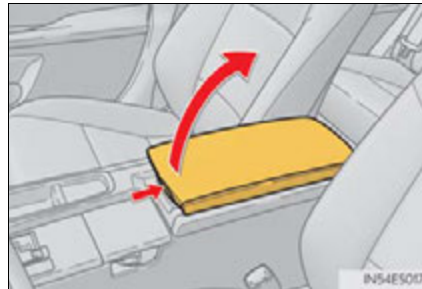

- 2** Open the cover and connect a USB memory.

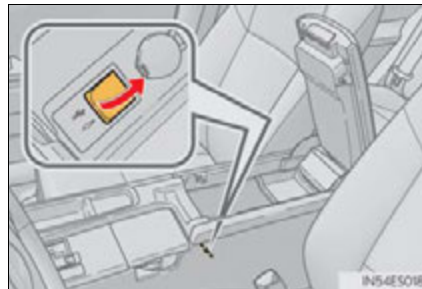

Turn on the power of the USB memory if it is not turned on.



- 3** Press  or  .

### Selecting and scanning a folder

#### ■ Selecting folders one at a time

Press  or  to select the desired folder.

#### ■ Returning to the first folder

Press and hold  until you hear a beep.

#### ■ Scanning the first file of all the folders (type A)

1 Press and hold  until you hear a beep.

The first ten seconds of the first file in each folder will be played.

2 When the desired folder is reached, press  again.

### Selecting and scanning files

#### ■ Selecting a file

Turn  or press ">" or "<" on  to select the desired file.

#### ■ Scanning the files in a folder (type A)

Press .

The first ten seconds of each file will be played.

To cancel, press  again.

When the desired file is reached, press  again.

### Playing and pausing files

To play or pause a file, press .

### Fast-forwarding and reversing files

To fast-forward or reverse, press and hold ">" or "<" on  until you hear a beep.

## Random playback

### ■ Playing files from a folder in random order

Press .

To cancel, press  again.

### ■ Playing all the files from a USB memory in random order

Press and hold  until you hear a beep.

To cancel, press  again.

## Repeat play

### ■ Repeating a file

Press .

To cancel, press  again.

### ■ Repeating all the files in a folder

Press and hold  until you hear a beep.

To cancel, press  again.

## Switching the display

Press .

Each time the button is pressed, the display changes in the following order:  
Elapsed time → Folder name → File name → Album title (MP3 only) → Track title → Artist name

■ **USB memory functions**

- Depending on the USB memory that is connected to the system, the device itself may not be operable and certain functions may not be available. If the device is inoperable or a function is unavailable due to a malfunction (as opposed to a system specification), disconnecting the device and reconnecting it once again may resolve the problem.
- If the USB memory still does not begin operation after being disconnected and reconnected, format the memory.

■ **Display**

→P. 518

■ **Error messages**

“ERROR”:

This indicates a problem in the USB memory or its connection.

“NO MUSIC”:

This indicates that no MP3/WMA files are included in the USB memory.

### ■ USB memory

#### ● Compatible devices

USB memories that can be used for MP3 and WMA playback

#### ● Compatible device formats

The following device formats can be used:

- USB communication formats: USB2.0 FS (12 Mbps)
- File formats: FAT16/32 (Windows)
- Correspondence class: Mass storage class

MP3 and WMA files written in any format other than those listed above may not play correctly, and their file names and folder names may not be displayed correctly.

Items related to standards and limitations are as follows:

- Maximum directory hierarchy: 8 levels
- Maximum number of folders in a device: 999 (including the root)
- Maximum number of files in a device: 65025
- Maximum number of files per folder: 255

#### ● MP3 and WMA files

MP3 (MPEG Audio LAYER 3) is a standard audio compression format.

Files can be compressed to approximately 1/10 of their original size using MP3 compression.

WMA (Windows Media Audio) is a Microsoft audio compression format.

This format compresses audio data to a size smaller than that of the MP3 format.

There is a limit to the MP3 and WMA file standards that can be used and to the media/formats on which the files are recorded.

#### ● MP3 file compatibility

- Compatible standards  
MP3 (MPEG1 AUDIO LAYERII, III, MPEG2 AUDIO LAYERII, III, MPEG2.5)
- Compatible sampling frequencies  
MPEG1 AUDIO LAYERII, III: 32, 44.1, 48 (kHz)  
MPEG2 AUDIO LAYERII, III: 16, 22.05, 24 (kHz)  
MPEG2.5: 8, 11.025, 12 (kHz)
- Compatible bit rates (compatible with VBR)  
MPEG1 AUDIO LAYERII, III: 32-320 (kbps)  
MPEG2 AUDIO LAYERII, III: 32-160 (kbps)  
MPEG2.5: 32-160 (kbps)
- Compatible channel modes: stereo, joint stereo, dual channel and monaural

- WMA file compatibility

- Compatible standards  
WMA Ver. 9
- Compatible sampling frequencies  
HIGH PROFILE 32, 44.1, 48 (kHz)
- Compatible bit rates  
HIGH PROFILE 32-320 (kbps, VBR)

- File names

The only files that can be recognized as MP3/WMA and played are those with the extension .mp3 or .wma.

- ID3 and WMA tags

ID3 tags can be added to MP3 files, making it possible to record the track title, artist name, etc.

The system is compatible with ID3 Ver. 1.0, 1.1, and Ver. 2.2, 2.3, 2.4 ID3 tags. (The number of characters is based on ID3 Ver. 1.0 and 1.1.)

WMA tags can be added to WMA files, making it possible to record the track title and artist name in the same way as with ID3 tags.

- MP3 and WMA playback

- When a device containing MP3 or WMA files is connected, all files in the USB memory device are checked. Once the file check is finished, the first MP3 or WMA file is played. To make the file check finish more quickly, we recommend that you do not include any files other than MP3 or WMA files or create any unnecessary folders.
- When the USB device is connected and the audio source is changed to USB memory mode, the USB device will start playing the first file in the first folder. If the same device is removed and reinserted (and the contents have not been changed), the USB device will resume play from the same point in which it was last used.

- Extensions

If the file extensions .mp3 and .wma are used for files other than MP3 and WMA files, they will be skipped (not played).

- Playback

- To play MP3 files with steady sound quality, we recommend a fixed bit rate of at least 128 kbps and a sampling frequency of 44.1 kHz.
- There is a wide variety of freeware and other encoding software for MP3 and WMA files on the market, and depending on the status of the encoding and the file format, poor sound quality or noise at the start of playback may result. In some cases, playback may not be possible at all.
- Microsoft, Windows, and Windows Media are registered trademarks of Microsoft Corporation in the U.S.A. and other countries.

 CAUTION■ **Caution while driving**

Do not connect USB memories or operate the controls.

 NOTICE■ **If the armrest cannot be fully closed**

Depending on the size and shape of the USB memory that is connected to the system, the armrest may not close fully. In this case, do not forcibly close the armrest as this may damage the USB memory or the terminal, etc.

■ **To prevent damage to USB memories**

- Do not leave USB memories in the vehicle. The temperature inside the vehicle may become high, resulting in damage to the player.
- Do not push down on or apply unnecessary pressure to the USB memory while it is connected as this may damage the USB memory or its terminal.
- Do not insert foreign objects into the port as this may damage the USB memory or its terminal.



## Bluetooth® audio system

The Bluetooth® audio system enables you to enjoy music played on a portable digital audio player (portable player) from the vehicle speakers via wireless communication.

This audio system supports Bluetooth®, a wireless data system capable of playing portable audio music without cables. If your portable player does not support Bluetooth®, the Bluetooth® audio system will not function.

Title	Page
Using the Bluetooth® audio system	P. 552
Operating a Bluetooth® enabled portable player	P. 557
Setting up a Bluetooth® enabled portable player	P. 561
Bluetooth® audio system setup	P. 568

### ■ Conditions under which the system will not operate

- If using a portable player that does not support Bluetooth®
- If the portable player is switched off
- If the portable player is not connected
- If the portable player's battery is low
- If the portable player is behind the seat or in the glove box or console box
- If metal is covering or touching the portable player

### ■ When transferring ownership of the vehicle

Be sure to initialize the system to prevent personal data from being improperly accessed. (→P. 601)

### ■ About Bluetooth®

The Bluetooth® word mark and logos are registered trademarks owned by Bluetooth SIG, Inc. and any use of such marks by PIONEER CORPORATION is under license. Other trademarks and trade names are those of their respective owners.



### ■ Compatible models

- Bluetooth® specifications:  
Ver. 1.1, or higher (Recommended: Ver. 1.2)
- Following profiles:
  - A2DP (Advanced Audio Distribution Profile) Ver. 1.0, or higher (Conformed: Ver. 1.2)
  - AVRCP (Audio/Video Remote Control Profile) Ver. 1.0 or higher (Conformed: Ver. 1.3)

Portable players must correspond to the above specifications in order to be connected to the Bluetooth® audio system. However, please note that some functions may be limited depending on the type of portable player.

Please go to the website at <http://www.lexus.com/MobileLink> to find approved portable players for this system.

### ■ Certification for the Bluetooth® audio system

FCC ID: AJDK018

IC ID: 775E-K018

This device complies with Part 15 of FCC Rules and Industry Canada licence-exempt RSS standard(s). Operation is subject to the following two conditions: (1) this device may not cause interference, and (2) this device must accept any interference, including interference that may cause undesired operation of this device.

Le présent appareil est conforme aux la partie 15 des règles de la FCC et CNR d'Industrie Canada applicables aux appareils radio exempts de licence. L'exploitation est autorisée aux deux conditions suivantes : (1) l'appareil ne doit pas produire de brouillage, et (2) l'utilisateur de l'appareil doit accepter tout brouillage radioélectrique subi, même si le brouillage est susceptible d'en compromettre le fonctionnement.

 CAUTION

## ■ FCC WARNING

This equipment complies with FCC/IC radiation exposure limits set forth for an uncontrolled environment and meets the FCC radio frequency (RF) Exposure Guidelines in Supplement C to OET65 and RSS-102 of the IC radio frequency (RF) Exposure rules. This equipment has very low levels of RF energy that it deemed to comply without maximum permissive exposure evaluation (MPE). But it is desirable that it should be installed and operated keeping the radiator at least 20 cm or more away from person's body (excluding extremities: hands, wrists, feet and ankles).

Cet équipement est conforme aux limites d'exposition aux rayonnements énoncées pour un environnement non contrôlé et respecte les règles les radioélectriques (RF) de la FCC lignes directrices d'exposition dans le Supplément C à OET65 et d'exposition aux fréquences radioélectriques (RF) CNR-102 de l'IC. Cet équipement émet une énergie RF très faible qui est considérée conforme sans évaluation de l'exposition maximale autorisée.

Cependant, cet équipement doit être installé et utilisé en gardant une distance de 20 cm ou plus entre le dispositif rayonnant et le corps (à l'exception des extrémités : mains, poignets, pieds et chevilles).

► For vehicles sold in the U.S.A.

Changes or modifications not expressly approved by the party responsible for compliance could void the user's authority to operate the equipment.

This transmitter must not be co-located or operated in conjunction with any other antenna or transmitter.

► For vehicles sold in Canada

Under Industry Canada regulations, this radio transmitter may only operate using an antenna of a type and maximum (or lesser) gain approved for the transmitter by Industry Canada. To reduce potential radio interference to other users, the antenna type and its gain should be so chosen that the equivalent isotropically radiated power (e.i.r.p.) is not more than that necessary for successful communication.

Conformément à la réglementation d'Industrie Canada, le présent émetteur radio peut fonctionner avec une antenne d'un type et d'un gain maximal (ou inférieur) approuvé pour l'émetteur par Industrie Canada. Dans le but de réduire les risques de brouillage radioélectrique à l'intention des autres utilisateurs, il faut choisir le type d'antenne et son gain de sorte que la puissance isotrope rayonnée équivalente (p.i.r.e.) ne dépasse pas l'intensité nécessaire à l'établissement d'une communication satisfaisante.

 CAUTION**■ Caution while driving**

Do not connect portable players or operate the controls.

**■ Caution regarding interference with electronic devices**

- Your audio unit is fitted with Bluetooth<sup>®</sup> antennas. People with implantable cardiac pacemakers, cardiac resynchronization therapy-pacemakers or implantable cardioverter defibrillators should maintain a reasonable distance between themselves and the Bluetooth<sup>®</sup> antennas. The radio waves may affect the operation of such devices.
- Before using Bluetooth<sup>®</sup> devices, users of any electrical medical device other than implantable cardiac pacemakers, cardiac resynchronization therapy-pacemakers or implantable cardioverter defibrillators should consult the manufacturer of the device for information about its operation under the influence of radio waves. Radio waves could have unexpected effects on the operation of such medical devices.

 NOTICE**■ To prevent damage to portable players**

Do not leave portable players in the vehicle. The temperature inside the vehicle may become high, resulting in damage to the player.

## Using the Bluetooth® audio system

### Audio unit

- ① Display  
A message, name, number, etc. is displayed.  
Lower-case characters and special characters cannot be displayed.
- ② Displays information that is too long to be displayed at one time on the display (press and hold)
- ③ Selects items such as menu and number  
Turn: Selects an item  
Press: Inputs the selected item
- ④ Bluetooth® connection condition  
If "BT" is not displayed, the Bluetooth® audio system cannot be used.

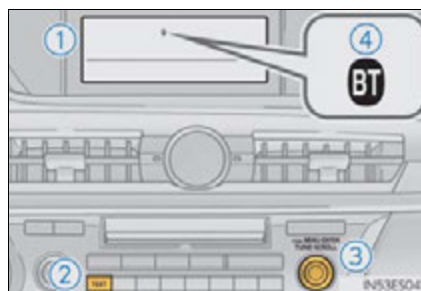

## Operating the system using voice commands

By following voice guidance instructions output from the speaker, voice commands enable the operation of the Bluetooth<sup>®</sup> audio system without

the need to check the display or operate



### ■ Operation procedure when using voice commands

Press the talk switch and follow voice guidance instructions.

### ■ Auxiliary commands when using voice commands

The following auxiliary commands can be used when operating the system using a voice command:

“Cancel”:

Exits the Bluetooth<sup>®</sup> audio system

“Repeat”:

Repeats the previous voice guidance instruction

“Go back”:



Returns to the previous procedure

“Help”:

Reads aloud the function summary if a help comment is registered for the selected function

### Using the Bluetooth® audio system for the first time

Before using the Bluetooth® audio system, it is necessary to register a Bluetooth® enabled portable player in the system. Follow the procedure below to register (pair) a portable player:

- 1 Press  and select “BT•A MENU” using .

- 2 Press the talk switch or select “BT•A Setup” using .

The introductory guidance and portable player name registration instructions are heard.

- 3 Select “Pair Audio Player (Pair Audio)” using a voice command or .

- 4 Register a portable player name by either of the following methods:

- Select “Record Name” using , and say the name to be registered.
- Press the talk switch and say the name to be registered.

A voice guidance instruction to confirm the input is heard.

- 5 Select “Confirm” using a voice command or .

A passkey is displayed and heard, and a voice guidance instruction for inputting the passkey into the portable player is heard.

- 6** Input the passkey into the portable player.

Refer to the manual that comes with the portable player for the operation of the portable player.

Guidance for registration completion is heard.

If the portable player has a Bluetooth<sup>®</sup> phone, the phone can be registered at the same time. A voice guidance instruction to register a Bluetooth<sup>®</sup> phone is heard.

- 7** Select “Yes” or “No” using a voice command or (Bluetooth<sup>®</sup> phone →P. 577)



### Menu list of the Bluetooth<sup>®</sup> audio system

First menu	Second menu	Third menu	Operation detail
“Setup”	“BT•A Setup”	“Pair Audio”	Registering a portable player
		“Connect”	Selecting a portable player to be used
		“Change Name”	Changing the registered name of a portable player
		“List Audios”	Listing the registered portable players
		“Set Passkey”	Changing the passkey
		“Delete Audio”	Deleting a registered portable player
	“System Setup”	“Guidance Vol”	Setting voice guidance volume
		“Device Name”	Displaying the Bluetooth <sup>®</sup> device address and name
		“Initialize”	Initializing the system



■ **When using a voice command**

For numbers, say a combination of single digits from zero to nine.

Say the command correctly and clearly.

■ **Situations in which the system may not recognize your voice**

- When driving on rough roads
- When driving at high speeds
- When air is blowing out of the vents onto the microphone
- When the air conditioning fan emits a loud noise

■ **Operations that cannot be performed while driving**

- Operating the system with 
- Registering a portable player to the system

■ **Changing the passkey**

→P. 566

## Operating a Bluetooth® enabled portable player

### ► Type A

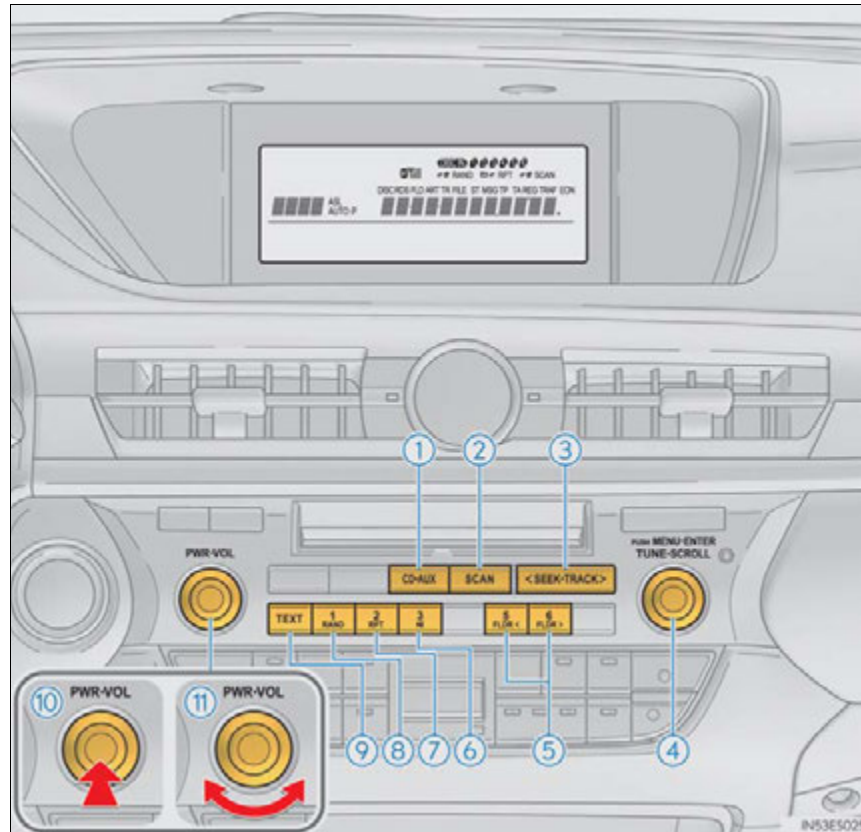

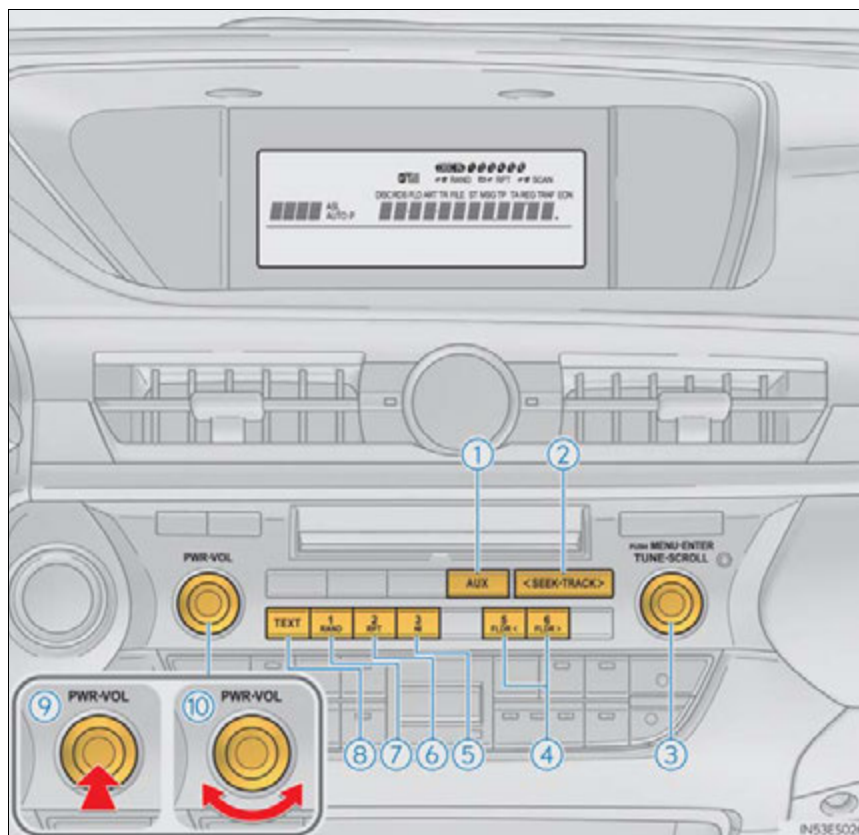

- |                          |                          |
|--------------------------|--------------------------|
| ① Playback button        | ⑥ Playback/Pause button  |
| ② Search playback button | ⑦ Repeat play button     |
| ③ Track selector button  | ⑧ Random playback button |
| ④ BT•A menu knob         | ⑨ Text button            |
| ⑤ Album selector buttons | ⑩ Power                  |
|                          | ⑪ Volume                 |

► Type B



- ① Playback button
- ② Track selector button
- ③ BT•A menu knob
- ④ Album selector buttons
- ⑤ Playback/Pause button
- ⑥ Repeat play button
- ⑦ Random playback button
- ⑧ Text button
- ⑨ Power
- ⑩ Volume

### Selecting an album

To select the desired album, press  or .

### Selecting tracks

Press ">" or "<" on  to select the desired track.

### Playing and pausing tracks

To play or pause a track, press .

### Fast-forwarding and reversing tracks

To fast-forward or reverse, press and hold ">" or "<" on  until you hear a beep.

### Random playback

Press .

To cancel, press  again.

### Repeat play

Press .

To cancel, press  again.

### Scanning tracks (type A)

Press .

To cancel, press  again.

### Switching the display

Press .

Each time the button is pressed, the display changes in the following order:  
Elapsed time → Album title → Track title → Artist name

■ **Bluetooth® audio system functions**

Depending on the portable player that is connected to the system, certain functions may not be available.

■ **Display**

→P. 518

■ **Error messages**

“Memory Error”: This indicates a problem in the system.

## Setting up a Bluetooth® enabled portable player

Registering a portable player in the Bluetooth® audio system allows the system to function. The following functions can be used for registered portable players:

### Functions and operation procedures



#### ▶ Pattern A

To enter the menu for each function, follow the steps below using a voice

command or  :

- Registering a portable player
  1. "Setup" → 2. "Bluetooth Audio Setup (BT•A Setup)" → 3. "Pair Audio Player (Pair Audio)"
- Selecting a portable player to be used
  1. "Setup" → 2. "Bluetooth Audio Setup (BT•A Setup)" → 3. "Connect Audio Player (Connect)"
- Changing the registered name of a portable player
  1. "Setup" → 2. "Bluetooth Audio Setup (BT•A Setup)" → 3. "Change Name"
- Listing the registered portable players
  1. "Setup" → 2. "Bluetooth Audio Setup (BT•A Setup)" → 3. "List Audio Players (List Audios)"
- Changing the passkey
  1. "Setup" → 2. "Bluetooth Audio Setup (BT•A Setup)" → 3. "Set Passkey"
- Deleting a registered portable player
  1. "Setup" → 2. "Bluetooth Audio Setup (BT•A Setup)" → 3. "Delete Audio Player (Delete Audio)"

▶ Pattern B

- 1 Press  to select "BT•A MENU".
  
- 2 Press the talk switch or select "BT•A Setup" using .
  
- 3 Select one of the following functions using a voice command or .
  - Registering a portable player  
"Pair Audio Player (Pair Audio)"
  - Selecting a portable player to be used  
"Connect Audio Player (Connect)"
  - Changing the registered name of a portable player  
"Change Name"
  - Listing the registered portable players  
"List Audio Players (List Audios)"
  - Changing the passkey  
"Set Passkey"
  - Deleting a registered portable player  
"Delete Audio Player (Delete Audio)"

### Registering a portable player

Select "Pair Audio Player (Pair Audio)" using a voice command or , and perform the procedure for registering a portable player. (→P. 554)

### Selecting a portable player to be used

- 1 Select “Connect Audio Player (Connect)” using a voice command or



- ▶ Pattern A

- 2 Select the portable player to be used by either of the following meth-

ods, and select “Confirm” by using a voice command or



- Press the talk switch and say the name of the desired portable player.
- Press the talk switch and say “List Audio Players”. When the name of the desired portable player is read aloud, press the talk switch.

- ▶ Pattern B

- 2 Select the portable player to be used using



- ▶ Pattern A

- 3 Press the talk switch and say “From Car” or “From Audio player”, and

select “Confirm” by using a voice command or



- ▶ Pattern B

- 3 Select “From Car” or “From Audio”, using



If “From Car” is selected, the portable player will be automatically connected whenever the “START STOP ENGINE” <“POWER”> switch is in either ACCESSORY or IGNITION ON <ON> mode.



### Changing the registered name of a portable player

- 1 Select "Change Name" using a voice command or



▶ Pattern A

- 2 Select the name of the portable player to be changed by either of the following methods, and select "Confirm" using a voice command or



- a. Press the talk switch and say the name of the desired portable player.
- b. Press the talk switch and say "List Audio Players". When the name of the desired portable player is read aloud, press the talk switch.

▶ Pattern B

- 2 Select the desired portable player name to be changed using



- 3 Press the talk switch or select "Record Name" using



the new name.

- 4 Select "Confirm" using a voice command or



### Listing the registered portable players

Select “List Audio Players (List Audios)” using a voice command or



. The list of registered portable players will be read aloud.

When listing is complete, the system returns to “BT•A Setup”.

Pressing the talk switch while the name of a portable player is being read aloud selects the portable player, and the following functions will become available:

- Selecting a portable player: “Connect Audio Player (Connect)”
- Changing a registered name: “Change Name”
- Deleting a portable player: “Delete Audio Player (Delete Audio)”

### Changing the passkey

- 1 Select "Set Passkey" using a voice command or .

▶ Pattern A

- 2 Press the talk switch, say a 4 to 8-digit number, and select "Confirm"

using a voice command or .

▶ Pattern B

- 2 Select a 4 to 8-digit number using .

The number should be input 1 digit at a time.

- 3 When the entire number to be registered as a passkey has been input,

press  again.

If the number to be registered has 8 digits, pressing of the knob is not necessary.

### Deleting a registered portable player

- 1 Select “Delete Audio Player (Delete Audio)” using a voice command



- ▶ Pattern A

- 2 Select the portable player to be deleted by either of the following meth-

ods and select “Confirm” using a voice command or  :

- Press the talk switch and say the name of the desired portable player.
- Press the talk switch and say “List Audio Players”. When the name of the desired portable player is read aloud, press the talk switch.

- ▶ Pattern B

- 2 Select the desired portable player to be deleted using .

If the portable player to be deleted is paired as a Bluetooth<sup>®</sup> phone, the registration of the cellular phone can be deleted at the same time. A voice guidance instruction to delete a cellular phone is heard.

- 3 Select “Yes” or “No” using a voice command or .

(Bluetooth<sup>®</sup> phone →P. 577)

#### ■ The number of portable players that can be registered

Up to 2 portable players can be registered in the system.

## Bluetooth® audio system setup

### System setup items and operation procedures

▶ Pattern A

To enter the menu for each function, follow the steps below using a voice

command or  : (→P. 598)

▶ Pattern B

**1** Press  to select “BT•A MENU”.

**2** Select “System Setup” using .

**3** Select one of the following items using  :

- Setting voice guidance volume  
“Guidance Vol” (→P. 600)
- Displaying the Bluetooth® device address and name  
“Device Name” (→P. 601)
- Initializing the system  
“Initialize” (→P. 601)

## Optimal use of the audio system

- ① Displays the current mode
- ② Changes the following settings:
  - Sound quality and volume balance →P. 570  
The sound quality and balance setting can be changed to produce the best sound.
  - Automatic Sound Levelizer on/off →P. 570

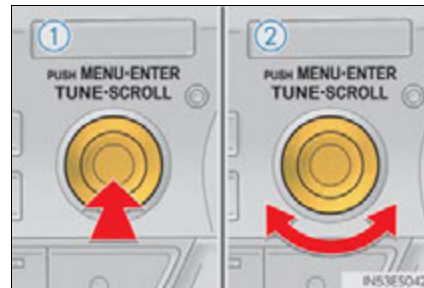

### Adjusting sound quality and volume balance

#### ■ Changing sound quality modes



Pressing the button changes sound modes in the following order:  
“BAS” → “MID” → “TRE” → “FAD” → “BAL” → “ASL”



■ Adjusting sound quality

Turning  adjusts the level.

Mode displayed	Sound quality mode	Level	Turn counter-clockwise	Turn clockwise
"BAS"	Bass*	-5 to 5	Low	High
"MID"	Mid-range*	-5 to 5		
"TRE"	Treble*	-5 to 5		
"FAD"	Front/rear volume balance	F7 to R7	Shifts to rear	Shifts to front
"BAL"	Left/right volume balance	L7 to R7	Shifts to left	Shifts to right

\*: The sound quality level is adjusted individually in each audio mode.

**Turning the Automatic Sound Levelizer (ASL) on/off**

Turning  clockwise turns on the ASL, and turning  counterclockwise turns off the ASL.

ASL automatically adjusts the volume and tone quality according to the noise level as you drive your vehicle.

## Using the AUX port

This port can be used to connect a portable audio device and listen to it through the vehicle's speakers.

- 1 Push the knob to release the lock, and lift the armrest to open fully.

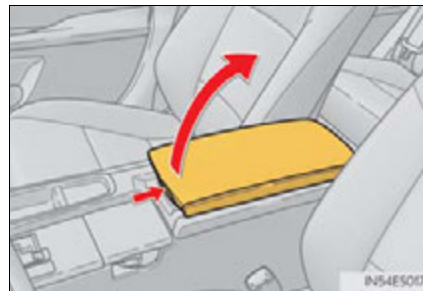

- 2 Open the cover and connect the portable audio device.



- 3 Press  or  .

### ■ Operating portable audio devices connected to the audio system

The volume can be adjusted using the vehicle's audio controls. All other adjustments must be made on the portable audio device itself.

### ■ When using a portable audio device connected to the power outlet

Noise may occur during playback. Use the power source of the portable audio device.



 CAUTION

## ■ Caution while driving

→P. 430

 NOTICE

## ■ If the armrest cannot be fully closed

→P. 430

## ■ To prevent damage to portable audio device

→P. 430

## Using the steering wheel audio switches

Some audio features can be controlled using the switches on the steering wheel.

Operation may differ depending on the type of audio system or navigation system. For details, refer to the manual provided with the audio system or navigation system.

- ① Radio mode: Selects a radio station
- CD mode: Selects a track, file (MP3 and WMA) and disc
- Bluetooth<sup>®</sup> audio mode: Selects a track and album
- iPod mode: Selects a song
- USB memory mode: Selects a file and folder
- ② Increases/decreases volume
- ③ Turns the power on, selects an audio source

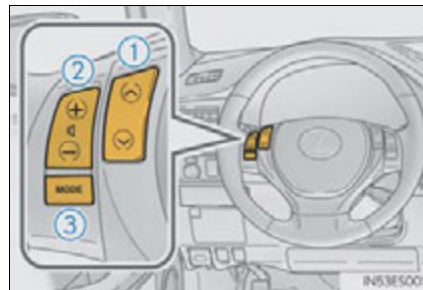

5

Interior features

### Turning the power on

Press **MODE** when the audio system is turned off.

The audio system can be turned off by holding the switch down until you hear a beep.

### Changing the audio source

Press  when the audio system is turned on. The audio source changes as follows each time the button is pressed. If no discs are inserted in the player, that mode will be skipped.



Type A:

FM1→FM2→SAT1→SAT2→SAT3→CD player→  
Bluetooth<sup>®</sup> audio→AUX→iPod or USB memory→  
AM→FM1

Type B:

FM1→FM2→CD player→Bluetooth<sup>®</sup> audio→AUX→  
iPod or USB memory→AM→FM1

### Adjusting the volume



Press  to increase the volume and  to decrease the volume.

Hold down the button to continue increasing or decreasing the volume.

### Selecting a radio station



**1** Press  to select radio mode.

**2** Press  or  to select a radio station.

To scan for receivable stations, press and hold  or  on the button until you hear a beep.

To cancel, press either switch.



### Selecting a track/file or song

- 1 Press  to select CD, Bluetooth<sup>®</sup> audio, iPod or USB memory mode.
- 2 Press  or  to select the desired track/file or song.



### Selecting an album

- 1 Press  to select Bluetooth<sup>®</sup> audio mode.
- 2 Press and hold  or  until you hear a beep.

### Selecting a folder

- 1 Press  to select USB memory mode.
- 2 Press and hold  or  until you hear a beep.

### Selecting a disc in the CD player

- 1 Press  to select CD mode.
- 2 Press and hold  or  until you hear a beep.

#### CAUTION

 **To reduce the risk of an accident**

Exercise care when operating the audio switches on the steering wheel.

## Hands-free system (for cellular phone)

The hands-free system is a function that allows you to use your cellular phone without touching it.

This system supports Bluetooth<sup>®</sup> cellular phones. Bluetooth<sup>®</sup> is a wireless data system that allows the cellular phone to wirelessly connect to the hands-free system and make/receive calls.

Title	Page
Using the hands-free system	P. 581
Making a phone call	P. 589
Setting a cellular phone	P. 593
Security and system setup	P. 598
Using the phone book	P. 603

### ■ Conditions under which the system will not operate

- If using a cellular phone that does not support Bluetooth<sup>®</sup>
- If the cellular phone is switched off
- If you are outside service range
- If the cellular phone is not connected
- If the cellular phone's battery is low
- If the cellular phone is behind the seat or in the glove box or console box
- If metal is covering or touching the phone

**■ When using the hands-free system**

- The audio system and voice guidance are muted when making a call.
- If both parties speak at the same time, it may be difficult to hear.
- If the incoming call volume is overly loud, an echo may be heard.
- Try to face toward the microphone as much as possible when speaking.
- In the following circumstances, it may be difficult to hear the other party:
  - When driving on unpaved roads
  - When driving at high speeds
  - When a window is open
  - When the air conditioning is blowing directly on the microphone
  - When the air conditioning is set to high

**■ When transferring ownership of the vehicle**

Be sure to initialize the system to prevent personal data from being improperly accessed. (→P. 601)

**■ About Bluetooth®**

The Bluetooth® word mark and logos are registered trademarks owned by Bluetooth SIG, Inc. and any use of such marks by PIONEER CORPORATION is under license. Other trademarks and trade names are those of their respective owners.

**■ Compatible models**

Compatible with HFP (Hands Free Profile) Ver. 1.0 or higher (Conformed: Ver. 1.5) and OPP (Object Push Profile) Ver. 1.1.

If your cellular phone does not support HFP, you cannot enter the Bluetooth® phone. If your cellular phone supports OPP alone, you cannot use the Bluetooth® phone.

Please go to the website at <http://www.lexus.com/MobileLink> to find approved Bluetooth® phones for this system.

■ **Certification for the hands-free system**

FCC ID: AJDK018

IC ID: 775E-K018

This device complies with Part 15 of FCC Rules and Industry Canada licence-exempt RSS standard(s). Operation is subject to the following two conditions: (1) this device may not cause interference, and (2) this device must accept any interference, including interference that may cause undesired operation of this device.

Le présent appareil est conforme aux la partie 15 des règles de la FCC et CNR d'Industrie Canada applicables aux appareils radio exempts de licence. L'exploitation est autorisée aux deux conditions suivantes : (1) l'appareil ne doit pas produire de brouillage, et (2) l'utilisateur de l'appareil doit accepter tout brouillage radioélectrique subi, même si le brouillage est susceptible d'en compromettre le fonctionnement.

 **CAUTION****FCC WARNING**

This equipment complies with FCC/IC radiation exposure limits set forth for an uncontrolled environment and meets the FCC radio frequency (RF) Exposure Guidelines in Supplement C to OET65 and RSS-102 of the IC radio frequency (RF) Exposure rules. This equipment has very low levels of RF energy that it deemed to comply without maximum permissive exposure evaluation (MPE). But it is desirable that it should be installed and operated keeping the radiator at least 20 cm or more away from person's body (excluding extremities: hands, wrists, feet and ankles).

Cet équipement est conforme aux limites d'exposition aux rayonnements énoncées pour un environnement non contrôlé et respecte les règles les radioélectriques (RF) de la FCC lignes directrices d'exposition dans le Supplément C à OET65 et d'exposition aux fréquences radioélectriques (RF) CNR-102 de l'IC. Cet équipement émet une énergie RF très faible qui est considérée conforme sans évaluation de l'exposition maximale autorisée.

Cependant, cet équipement doit être installé et utilisé en gardant une distance de 20 cm ou plus entre le dispositif rayonnant et le corps (à l'exception des extrémités : mains, poignets, pieds et chevilles).

► For vehicles sold in the U.S.A.

Changes or modifications not expressly approved by the party responsible for compliance could void the user's authority to operate the equipment.

This transmitter must not be co-located or operated in conjunction with any other antenna or transmitter.

► For vehicles sold in Canada

Under Industry Canada regulations, this radio transmitter may only operate using an antenna of a type and maximum (or lesser) gain approved for the transmitter by Industry Canada. To reduce potential radio interference to other users, the antenna type and its gain should be so chosen that the equivalent isotropically radiated power (e.i.r.p.) is not more than that necessary for successful communication.

Conformément à la réglementation d'Industrie Canada, le présent émetteur radio peut fonctionner avec une antenne d'un type et d'un gain maximal (ou inférieur) approuvé pour l'émetteur par Industrie Canada. Dans le but de réduire les risques de brouillage radioélectrique à l'intention des autres utilisateurs, il faut choisir le type d'antenne et son gain de sorte que la puissance isotrope rayonnée équivalente (p.i.r.e.) ne dépasse pas l'intensité nécessaire à l'établissement d'une communication satisfaisante.



 CAUTION**■ Caution while driving**

Do not use a cellular phone or connect the Bluetooth<sup>®</sup> phone.

**■ Caution regarding interference with electronic devices**

- Your audio unit is fitted with Bluetooth<sup>®</sup> antennas. People with implantable cardiac pacemakers, cardiac resynchronization therapy-pacemakers or implantable cardioverter defibrillators should maintain a reasonable distance between themselves and the Bluetooth<sup>®</sup> antennas. The radio waves may affect the operation of such devices.
- Before using Bluetooth<sup>®</sup> devices, users of any electrical medical device other than implantable cardiac pacemakers, cardiac resynchronization therapy-pacemakers or implantable cardioverter defibrillators should consult the manufacturer of the device for information about its operation under the influence of radio waves. Radio waves could have unexpected effects on the operation of such medical devices.

 NOTICE**■ To prevent damage to cellular phones**

Do not leave cellular phones in the vehicle. The temperature inside the vehicle may become high, resulting in damage to the phone.

## Using the hands-free system (for cellular phones)

### Audio unit

- ① Display  
A message, name, phone number, etc. is displayed.  
Lower-case characters and special characters cannot be displayed.
- ② Displays information that is too long to be displayed at one time on the display (press and hold)
- ③ Selects speed dials
- ④ Selects items such as menu and number  
Turn: Selects an item  
Press: Inputs the selected item
- ⑤ Bluetooth<sup>®</sup> connection condition  
If "BT" is not displayed, the hands-free phone system cannot be used.
- ⑥ Reception level

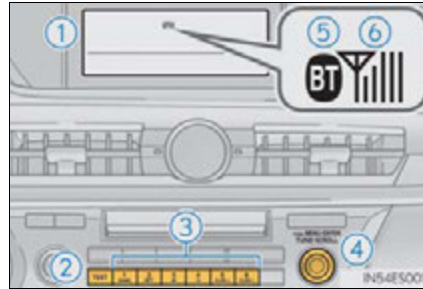

### Steering wheel switches

- ① Volume
  - During an incoming call: Adjusts the ring tone volume
  - During an ongoing call: Adjusts the receiver volume
  - The voice guidance volume cannot be adjusted using this button.
- ② Talk switch
  - Turns the voice command system on (press)/turns the voice command system off (press and hold)
- ③ Off-hook switch
  - Turns the hands-free system on/starts a call
- ④ On-hook switch
  - Turns the hands-free system off/ends a call/refuses a call

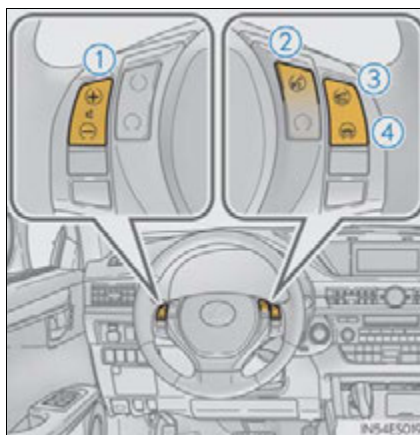

### Microphone

You can use the microphone when talking on the phone.

The person you are speaking to can be heard from the front speakers.

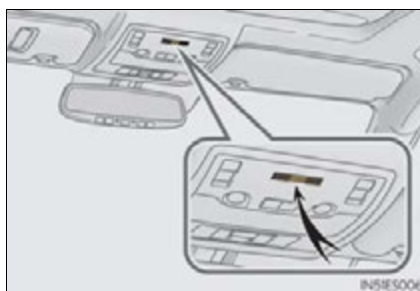

To use the hands-free system, you must register your Bluetooth<sup>®</sup> phone in the system. (→P. 584)

### Operating the system using voice commands

By following voice guidance instructions output from the speaker, voice commands enable the operation of the hands-free phone system without

the need to check the display or operate



#### ■ Operation procedure when using voice commands

Press the talk switch and follow voice guidance instructions.

#### ■ Auxiliary commands when using voice commands

The following auxiliary commands can be used when operating the system using a voice command:

“Cancel”:

Exits the hands-free phone system

“Repeat”:

Repeats the previous voice guidance instruction

“Go back”:

Returns to the previous procedure

“Help”:

Reads aloud the function summary if a help comment is registered for the selected function

### Using the hands-free phone system for the first time

Before using the hands-free phone system, it is necessary to register a cellular phone in the system. The system will enter phone registration mode automatically when starting the system with no cellular phone registered. Follow the procedure below to register (pair) a cellular phone:

- 1 Press the off-hook switch or the talk switch.

The introductory guidance and phone name registration instructions are heard.

- 2 Select "Pair Phone" using a voice command or .

- 3 Register a phone name by either of the following methods:

- a. Select "Record Name" using , and say the name to be registered.

- b. Press the talk switch and say the name to be registered.

A voice guidance instruction to confirm the input is heard.

- 4 Select "Confirm" using a voice command or .

A passkey is displayed and heard, and a voice guidance instruction for inputting the passkey into the cellular phone is heard.

- 5 Input the passkey into the cellular phone.

Refer to the manual that comes with the cellular phone for the operation of the phone.

Guidance for registration completion is heard.

If the cellular phone has a Bluetooth<sup>®</sup> audio player, the audio player can be registered at the same time. A voice guidance instruction to register a Bluetooth<sup>®</sup> audio player is heard.

- 6 Select “Yes” or “No” using a voice command or .

(Bluetooth® audio player →P. 549)

### Menu list of the hands-free phone system

#### ■ Normal operation

First menu	Second menu	Third menu	Operation detail
“Callback”	-	-	Dialing a number stored in the incoming call history memory
“Redial”	-	-	Dialing a number stored in the outgoing call history memory
“Phone-book”	“Add Entry”	-	Adding a new phone number
	“Change Name”	-	Changing the registered name in the phone book
	“Delete Entry”	-	Deleting the registered data
	“Del Spd Dial”	-	Deleting speed dials
	“List Names”	-	Listing the registered data
	“Speed Dial”	-	Setting speed dials

First menu	Second menu	Third menu	Operation detail
"Setup"	"Security"	"Set PIN"	Setting a PIN code
		"Phbk Lock"	Locking the phone book
		"Phbk Unlock"	Unlocking the phone book
	"Phone Setup"	"Pair Phone"	Registering the cellular phone to be used
		"Connect"	Selecting a cellular phone to be used
		"Change Name"	Changing the registered name of a cellular phone
		"List Phones"	Listing the registered cellular phones
		"Set Passkey"	Changing the passkey
		"Delete Phone"	Deleting a registered cellular phone
	"System Setup"	"Guidance Vol"	Setting voice guidance volume
		"Device Name"	Displaying the Bluetooth <sup>®</sup> device address and name
"Initialize"		Initializing the system	

### ■ Short cut key operation

First menu Second menu	Second menu	Operation detail
"Dial XXX (name)"	-	Dialing a name registered in the phone book
"Phone book add Entry"	-	Adding a new phone number
"Phone book Change name"	-	Changing a registered name in the phone book
"Phone book Delete Entry"	-	Deleting the registered data
"Phone book List names"	-	Listing the registered data
"Phone book Set Speed Dial"	-	Setting speed dials
"Phone book Delete Speed Dial"	-	Deleting speed dials
"Dial XXX (number)"	-	Dialing by inputting a number
"Phonebook"	"Phonebook Unlock"	Unlocking the phone book
	"Phonebook Lock"	Locking the phone book



■ **Automatic volume adjustment**

When vehicle speed reaches 50 mph (80 km/h) or more, the volume automatically increases. The volume returns to the previous volume setting when vehicle speed drops to 43 mph (70 km/h) or less.

■ **When using a voice command**

For numbers, say a combination of single digits from zero to nine, # (pound), \* (star), and + (plus).

Say the command correctly and clearly.

■ **Situations in which the system may not recognize your voice**

- When driving on rough roads
- When driving at high speeds
- When air is blowing out of the vents onto the microphone
- When the air conditioning fan emits a loud noise

■ **Operations that cannot be performed while driving**

- Operating the system with 
- Registering a cellular phone to the system

■ **Changing the passkey**

→P. 596

## Making a phone call

### Functions

- **Making a phone call**
  - Dialing by inputting a number  
“Dial by number”
  - Dialing by inputting a name  
“Dial by name”
  - Speed dialing
  - Dialing a number stored in the outgoing history memory  
“Redial”
  - Dialing a number stored in the incoming history memory  
“Call back”
- **Receiving a phone call**
  - Answering a phone call
  - Refusing a phone call
- **Transferring a phone call**
- **Call waiting**
- **Using the call history memory**
  - Dialing
  - Storing number in the phone book
  - Deleting

### Dialing by inputting a number

- 1 Press the talk switch and say “Dial by number”.
- 2 Press the talk switch and say the phone number.
- 3 Dial by one of the following methods:
  - a. Press the off-hook switch.
  - b. Press the talk switch and say “Dial”.

- 
- 
- c. Select “Dial” using



### Dialing by inputting a name

- 1 Press the talk switch and say “Dial by name”.
- 2 Select a registered name to be input by either of the following methods:
  - a. Press the talk switch and say a registered name.
  - b. Press the talk switch and say “List Names”. Press the talk switch when the desired name is read aloud.
- 3 Dial by one of the following methods:
  - a. Press the off-hook switch.
  - b. Press the talk switch and say “Dial”.

- 
- 
- c. Select “Dial” using



### Speed dialing

- 1 Press the off-hook switch.
- 2 Press the preset button in which the desired number is registered.
- 3 Press the off-hook switch.

### When receiving a phone call

#### ■ Answering a phone call

Press the off-hook switch.

#### ■ Refusing a phone call

Press the on-hook switch.

### Transferring a phone call

A call can be transferred between the cellular phone and system while dialing, receiving a call, or during a call. Use one of the following methods:

a. Operate the cellular phone.

Refer to the manual that comes with the cellular phone for the operation of the phone.

b. Press the off-hook switch\*<sup>1</sup>.

c. Press the talk switch and say "Call Transfer"\*<sup>2</sup>.

\*<sup>1</sup>: This operation can be performed only when transferring a call from the cellular phone to the system during a call.

\*<sup>2</sup>: While the vehicle is in motion, calls cannot be transferred from the system to the cellular phone.

### Call waiting

When a call is interrupted by an incoming call from a third party, the following options will become available:

● Answer the incoming call: Press the off-hook switch. (Press the off-hook switch again as necessary to switch back and forth between calls.)

● Refuse the incoming call: Press the on-hook switch.

### Using the call history memory

Follow the procedure below to use a number stored in the call history memory:

- 1 Press the talk switch and say “Redial” (when using a number stored in the outgoing call history memory) or “Call back” (when using a number stored in the incoming call history memory).
- 2 Select the number by either of the following methods:
  - a. Say “Previous” or “Go back” until the desired number is displayed.

b. Select the desired number using  .

- 3 The following operations can be performed:

Dialing: Press the off-hook switch or select “Dial” using a voice com-

mand or  .

Storing the number in the phone book: Select “Store” and then

“Confirm” using a voice command or  .

Deleting: Select “Delete” and then “Confirm” using a voice command

or  .

---

■ **Call waiting**

- If your phone does not support HFP Ver. 1.5, this function cannot be used.
- Call waiting operation may differ depending on your cellular phone and service provider.

■ **Call history**

Up to 5 numbers can be stored in each of the outgoing and incoming call history memories.

■ **When talking on the phone**

- Do not talk at the same time as the other party.
- Keep the volume of the incoming voice down. Otherwise, voice echo will increase.

## Setting a cellular phone

Registering a cellular phone in the hands-free phone system allows the system to function. The following functions can be used for registered cellular phones:

### Functions and operation procedures

To enter the menu for each function, follow the steps below using a voice

command or  :

- Registering a cellular phone
  1. "Setup" → 2. "Phone Setup" → 3. "Pair Phone"
- Selecting a cellular phone to be used
  1. "Setup" → 2. "Phone Setup" → 3. "Connect Phone (Connect)"
- Changing the registered name of a cellular phone
  1. "Setup" → 2. "Phone Setup" → 3. "Change Name"
- Listing the registered cellular phones
  1. "Setup" → 2. "Phone Setup" → 3. "List Phones"
- Changing the passkey
  1. "Setup" → 2. "Phone Setup" → 3. "Set Passkey"
- Deleting a registered cellular phone
  1. "Setup" → 2. "Phone Setup" → 3. "Delete Phone"

### Registering a cellular phone

Select "Pair Phone" using a voice command or  , and perform the procedure for registering a cellular phone. (→P. 584)

### Selecting a cellular phone to be used

- 1 Select "Connect Phone (Connect)" using a voice command or



- ▶ Pattern A

- 2 Select the cellular phone to be used by either of the following methods,

and select "Confirm" by using a voice command or



- a. Press the talk switch and say the name of the desired cellular phone.
- b. Press the talk switch and say "List Phones". When the name of the desired cellular phone is read aloud, press the talk switch.

- ▶ Pattern B

- 3 Select the cellular phone to be used using



### Changing the registered name of a cellular phone

- 1 Select "Change Name" using a voice command or



- ▶ Pattern A

- 2 Select the name of the cellular phone to be changed by either of the following methods, and select "Confirm" using a voice command or



- a. Press the talk switch and say the name of the desired cellular phone.
- b. Press the talk switch and say "List Phones". When the name of the desired cellular phone is read aloud, press the talk switch.

## ▶ Pattern B

2 Select the desired cellular phone name to be changed using .

3 Press the talk switch or select “Record Name” using , and say the new name.

4 Select “Confirm” using a voice command or .

### Listing the registered cellular phones

Select “List Phones” using a voice command or . The list of registered cellular phones will be read aloud.

When listing is complete, the system returns to “Phone Setup”.

Pressing the talk switch while the name of a cellular phone is being read aloud selects the cellular phone, and the following functions will become available:

- Selecting a cellular phone: “Connect Phone (Connect)”
- Changing a registered name: “Change Name”
- Deleting a cellular phone: “Delete Phone”



### Changing the passkey

- 1 Select "Set Passkey" using a voice command or .

▶ Pattern A

- 2 Press the talk switch, say a 4 to 8-digit number, and select "Confirm"

using a voice command or .

▶ Pattern B

- 2 Select a 4 to 8-digit number using .

The number should be input 1 digit at a time.

- 3 When the entire number to be registered as a passkey has been input,

press  again.

If the number to be registered has 8 digits, pressing of the knob is not necessary.

### Deleting a registered cellular phone

- 1 Select "Delete Phone" using a voice command or .

▶ Pattern A

- 2 Select the cellular phone to be deleted by either of the following meth-

ods and select "Confirm" using a voice command or .

- Press the talk switch and say the name of the desired cellular phone.
- Press the talk switch and say "List Phones". When the name of the desired cellular phone is read aloud, press the talk switch.

---

▶ Pattern B

- 2 Select the desired cellular phone to be deleted using .

If the cellular phone to be deleted is paired as a Bluetooth<sup>®</sup> audio player, the registration of the audio player can be deleted at the same time. A voice guidance instruction to delete a Bluetooth<sup>®</sup> audio player is heard.

- 3 Select “Yes” or “No” using a voice command or .

(Bluetooth<sup>®</sup> audio player →P. 549)

---

■ **The number of cellular phones that can be registered**

Up to 6 cellular phones can be registered in the system.

## Security and system setup

### Security setting items and operation procedures

To enter the menu for each function, follow the steps below using a voice

command or  :

- Setting or changing the PIN (Personal Identification Number)
  1. "Setup" → 2. "Security" → 3. "Set PIN"
- Locking the phone book
  1. "Setup" → 2. "Security" → 3. "Phonebook Lock (Phbk Lock)"
- Unlocking the phone book
  1. "Setup" → 2. "Security" → 3. "Phonebook Unlock (Phbk Unlock)"

### System setup items and operation procedures

To enter the menu for each function, follow the steps below using  :

- Setting voice guidance volume
  1. "Setup" → 2. "System Setup" → 3. "Guidance Vol"
- Displaying the Bluetooth<sup>®</sup> device address and name
  1. "Setup" → 2. "System Setup" → 3. "Device Name"
- Initializing the system
  1. "Setup" → 2. "System Setup" → 3. "Initialize"

## Setting or changing the PIN

### ■ Setting a PIN

- 1 Select "Set PIN" using a voice command or .

- 2 Enter a PIN using a voice command or .

When using , input the code 1 digit at a time.

### ■ Changing the PIN

- 1 Select "Set PIN" using a voice command or .

- 2 Enter the registered PIN using a voice command or .

- 3 Enter a new PIN using a voice command or .

When using , input the code 1 digit at a time.

### Locking or unlocking the phone book

- 1 Select "Phonebook Lock (Phbk Lock)" or "Phonebook Unlock (Phbk

Unlock)" using a voice command or  .

- 2 Input the PIN by either of the following methods and select "Confirm"

using a voice command or  :

a. Press the talk switch and say the registered PIN.

b. Input a new PIN using  .

### Setting voice guidance volume



- 1 Select "Guidance Vol" using  .

- 2 Change the voice guidance volume.



To decrease the volume: Turn  counterclockwise.

To increase the volume: Turn  clockwise.

### Displaying the Bluetooth® device address and name

- 1 Select “Device Name” using .
- 2 Turn  to display the Bluetooth® device address and name.
- 3 Select “Go Back” using  to return to “System Setup”.

### Initializing the system

- 1 Select “Initialize” and then “Confirm” using .
- 2 Select “Confirm” again using .

■ **Initialization**

- The following data in the system can be initialized:
  - Phone book
  - Outgoing and incoming call history
  - Speed dials
  - Registered cellular phone data
  - Security code
  - Registered Bluetooth<sup>®</sup> enabled portable player data
  - Passkey for the cellular phones
  - Passkey for the Bluetooth<sup>®</sup> audio players
  - Guidance volume
  - Receiver volume
  - Ring tone volume
- Once the initialization has been completed, the data cannot be restored to its original state.

■ **When the phone book is locked**

The following functions cannot be used:

- Dialing by inputting a name
- Speed dialing
- Dialing a number stored in the call history memory
- Using the phone book

## Using the phone book

### Phonebook items and operation procedures

To enter the menu for each function, follow the steps below using a voice

command or  :

- Adding a new phone number
  1. "Phonebook" → 2. "Add Entry"
- Changing the registered name in the phone book
  1. "Phonebook" → 2. "Change Name"
- Listing the registered data
  1. "Phonebook" → 2. "List Names"
- Setting speed dials
  1. "Phonebook" → 2. "Set Speed Dial (Speed Dial)"
- Deleting the registered data
  1. "Phonebook" → 2. "Delete Entry"
- Deleting speed dials
  1. "Phonebook" → 2. "Delete Speed Dial (Del Spd Dial)"

### Adding a new phone number

The following methods can be used to add a new phone number:

- Inputting a phone number using a voice command
- Transferring data from the cellular phone
- Inputting a phone number using 
- Selecting a phone number from the outgoing or incoming call history



■ Adding procedure

1 Select "Add Entry" using a voice command or .

2 Use one of the following methods to input a telephone number:

Inputting a telephone number using a voice command:

STEP2-1 Select "By Voice" using a voice command or .

STEP2-2 Press the talk switch, say the desired number, and select "Confirm" using a voice command.

Transferring data from the cellular phone:

STEP2-1 Select "By Phone" and then "Confirm" using a voice com-

mand or .

STEP2-2 Transfer the data from the cellular phone.

Refer to the manual that comes with the cellular phone for details on transferring data.



STEP2-3 Select the data to be registered by either of the following methods:

a. Say "Previous" or "Next" until the desired data is displayed, and select "Confirm" using a voice command.

b. Select the desired data using .

Inputting a phone number using  :

STEP2-1 Select "Manual Input" using .

STEP2-2 Input a phone number using , and press  again.

Input the phone number 1 digit at a time.

Selecting a phone number from the outgoing or incoming call history:

STEP2-1 Select "Call History" using a voice command or .

STEP2-2 Select "Outgoing" or "Incoming" using a voice command

or .

STEP2-3 Select the data to be registered by either of the following methods:

a. Say "Previous" or "Go back" until the desired data is displayed, and select "Confirm" using a voice command.

b. Select the desired data using .

3 Select the name to be registered by either of the following methods,

and select "Confirm" using a voice command or  :

a. Press the talk switch and say the desired name.

b. Select "Record Name" using  and say the desired name.

4 Select "Confirm" using a voice command or  .

In 4, selecting "Set Speed Dial (Speed Dial)" instead of "Confirm" registers the newly added phone number as a speed dial.

## Changing the registered name in the phone book

- 1** Select “Change Name” using a voice command or



- ▶ Pattern A

- 2** Select the name to be changed by either of the following methods, and

select “Confirm” using a voice command or



- Press the talk switch and say the desired name.
- Press the talk switch and say “List Names”. When the desired name is read aloud, press the talk switch.

- ▶ Pattern B

- 2** Select the desired name to be changed using



- 3** Press the talk switch or select “Record Name” using



- 4** Select “Confirm” using a voice command or



### Listing the registered data

Select “List Names” using a voice command or . The list of the registered data will be read aloud.

When listing is complete, the system returns to the “Phonebook”.

Pressing the talk switch while the desired data is being read aloud selects the data, and the following function will become available:

- Dialing: “Dial”
- Changing a registered name: “Change Name”
- Deleting an entry: “Delete Entry”
- Setting a speed dial: “Set Speed Dial (Speed Dial)”

### Setting speed dials

- 1 Select “Set Speed Dial (Speed Dial)” using a voice command or



- ▶ Pattern A

- 2 Select the data to be registered as a speed dial by either of the follow-

ing methods and select “Confirm” using a voice command or  :

- a. Press the talk switch and say the desired name.
- b. Press the talk switch and say “List Names”. When the desired name is read aloud, press the talk switch.

- ▶ Pattern B

- 2 Select the desired data using .

- 3 Select the desired preset button and register the data into speed dial by either of the following methods:
  - a. Press the desired preset button and select “Confirm” by using a voice

command or  .

- b. Press and hold the desired preset button.

### Deleting the registered data

- 1 Select “Delete Entry” using a voice command or  .

▶ Pattern A

- 2 Select the data to be deleted by either of the following methods and

select “Confirm” using a voice command or  :

- a. Press the talk switch and say the name of the desired phone number.
  - b. Press the talk switch and say “List Names”. When the name of the desired phone number is read aloud, press the talk switch.

▶ Pattern B

- 2 Select the desired data to be deleted using  .

### Deleting speed dials

- 1 Select "Delete Speed Dial (Del Spd Dial)" using a voice command or



- 2 Press the preset button to which the desired speed dial is registered

and select "Confirm" using a voice command or



---

#### ■ Limitation of number of digits

A phone number that exceeds 24 digits cannot be registered.

## Interior lights list

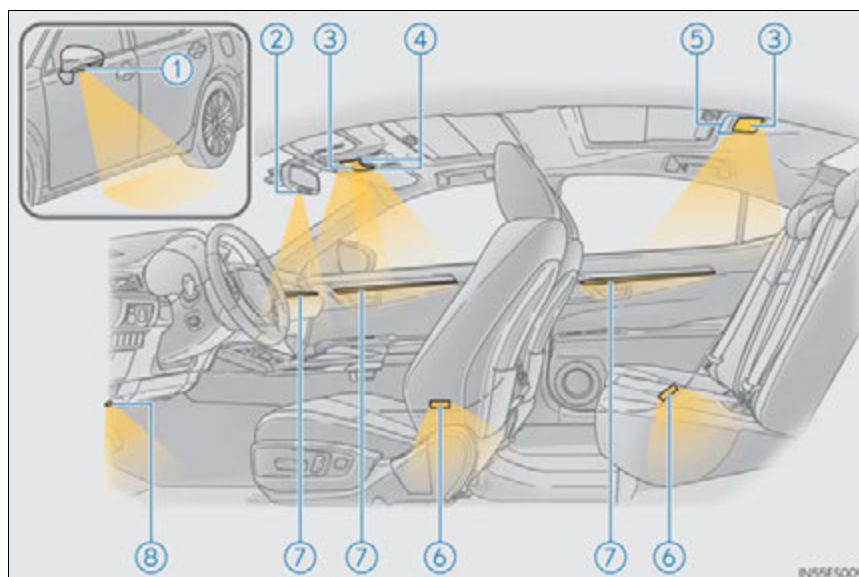

- |                                   |                                  |
|-----------------------------------|----------------------------------|
| ① Outer foot lights               | ⑤ Rear personal lights (→P. 612) |
| ② Shift lever light               | ⑥ Door courtesy lights           |
| ③ Interior light (→P. 612)        | ⑦ Ornament lights (if equipped)  |
| ④ Front personal lights (→P. 612) | ⑧ Footwell lights                |

When the instrument panel light control switch is turned to minimum and the tail lights are on, the ornament lights and the footwell lights will turn off. (→P. 96)



### Interior light

- ① Turns the light on/off

The rear personal lights are also turned on/off by the interior light operation. However, if the interior light is turned off after being turned on while the rear personal lights are turned on, the rear personal lights will not turn off simultaneously.

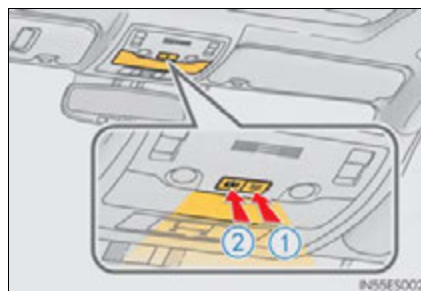

- ② Turns the door position on

### Personal lights

#### ■ Front

Turns the light on/off

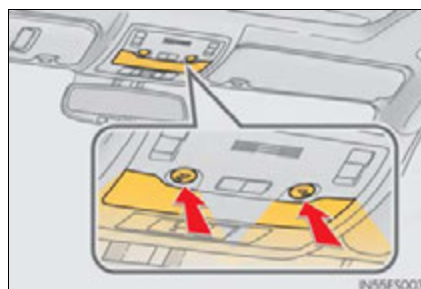

#### ■ Rear

Turns the light on/off

If the lights are turned on by interior light operation, the lights cannot turn off by pressing the switch.

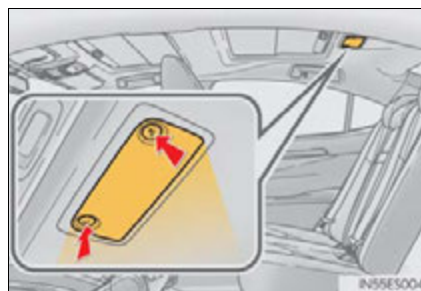

**■ Illuminated entry system**

The lights automatically turn on/off according to "START STOP ENGINE" <"POWER"> switch mode, the presence of the electronic key, whether the doors are locked/unlocked, and whether the doors are opened/closed.

**■ To prevent 12-volt battery discharge**

If the following lights remain on when the "START STOP ENGINE" <"POWER"> switch is turned off the lights will go off automatically after 20 minutes:

- Outer foot lights
- Personal/interior light
- Door courtesy lights
- Ornament lights (if equipped)
- Footwell lights

**■ Customization**

Setting (e.g. the time elapsed before lights turn off) can be changed.  
(Customizable features: →P. 862)

## List of storage features

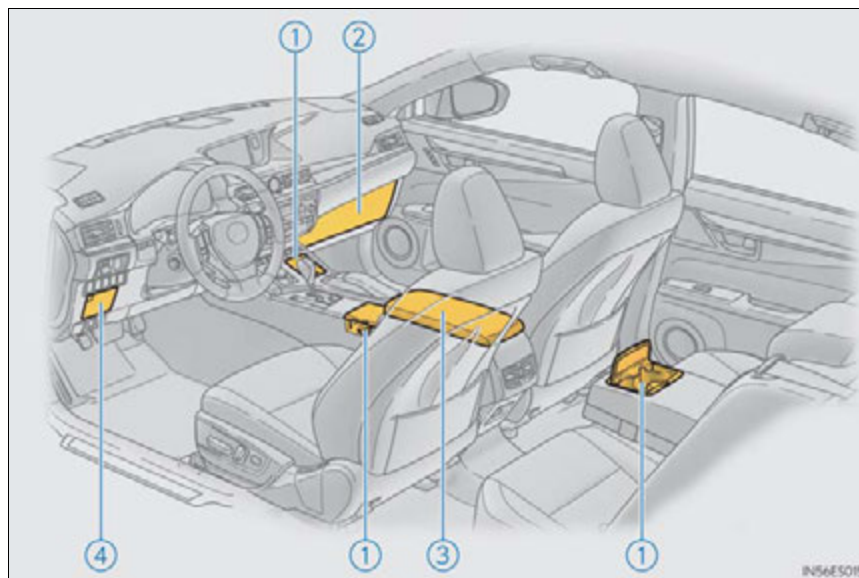

- |               |           |                 |           |
|---------------|-----------|-----------------|-----------|
| ① Cup holders | (→P. 618) | ③ Console box   | (→P. 617) |
| ② Glove box   | (→P. 616) | ④ Auxiliary box | (→P. 619) |

 **CAUTION****■ Items that should not be left in the storage spaces**

Do not leave glasses, lighters or spray cans in the storage spaces, as this may cause the following when cabin temperature becomes high:

- Glasses may be deformed by heat or cracked if they come into contact with other stored items.
- Lighters or spray cans may explode. If they come into contact with other stored items, the lighter may catch fire or the spray can may release gas, causing a fire hazard.

**■ When driving or when the storage compartments are not in use**

Keep the lids closed.

In the event of sudden braking or sudden swerving, an accident may occur due to an occupant being struck by an open lid or the items stored inside.

### Glove box

- ① Open (press the button)
- ② Unlock with the mechanical key
- ③ Lock with the mechanical key

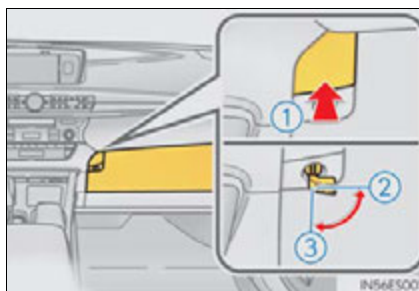

#### ■ Glove box light

The glove box light turns on when the tail lights are on.

#### ■ Trunk opener main switch

The trunk opener main switch is located in the glove box. (→P. 148)

#### ■ Removing the insert

The insert inside the glove box can be removed. (→P. 717)

### Console box

Push the knob to release the lock, and lift the armrest to open fully.

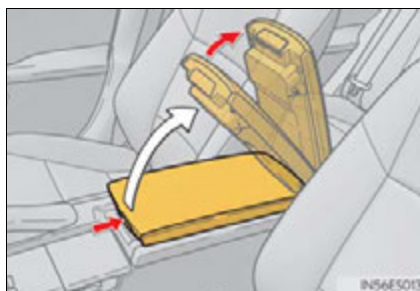

### Tray in the console box

The tray slides forward/backward and can be removed.

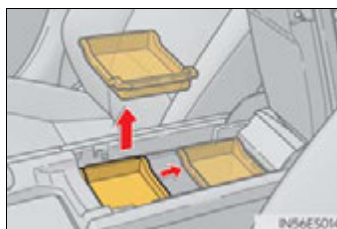

### Console box light

The console box light turns on when the tail lights are on.

### ⚠ CAUTION

When using the console box with half-open, do not apply too much load on the armrest. Doing so may damage the armrest and may cause you to injure yourself.

## Cup holders

### ■ Driver's side

- ① To open, move the cup holder lid until it locks.
- ② To close, press and release the cup holder lid.

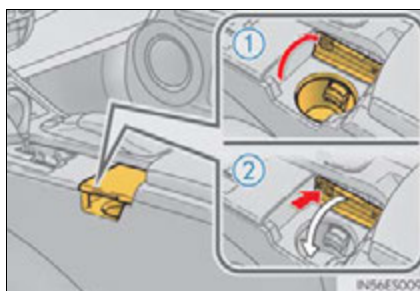

### ■ Front passenger's side

To open, press down and release the cup holder lid.

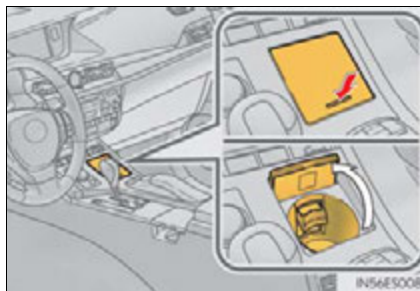

### ■ Rear

To open, pull down the armrest and press in and release the rear cup holder on the armrest.

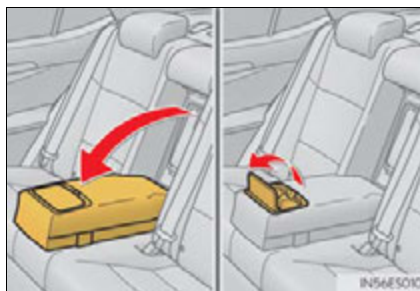

**⚠ CAUTION****■ Items unsuitable for the cup holders**

Do not place anything other than cups or aluminum cans in the cup holders. Other items may be thrown out of the holders in the event of an accident or sudden braking, causing injury. If possible, cover hot drinks to prevent burns.

**■ Items unsuitable for the cup holder (front passenger's side)**

Do not place anything larger than a 32 oz cup in the cup holder. Doing so may prevent the switches from being operated properly or block the driver's view of the switches, which may cause an accident.

**⚠ NOTICE****■ To prevent damage to the rear cup holder**

Stow the cup holder before stowing the armrest.

**Auxiliary box**

Press in the button.

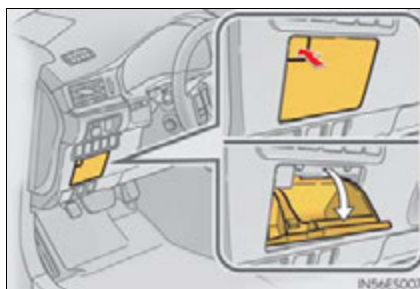



## Trunk features

### Cargo hooks

Raise the hooks when needed.

The cargo hooks are provided for securing loose items.

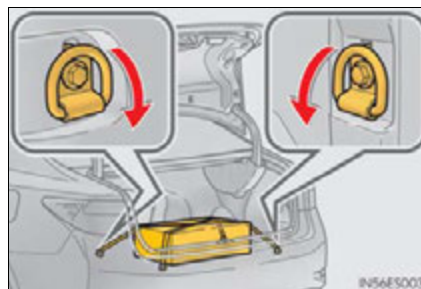

### Grocery bag hooks



### Luggage mat

- 1 Pull the lever upwards when lifting the luggage mat up.

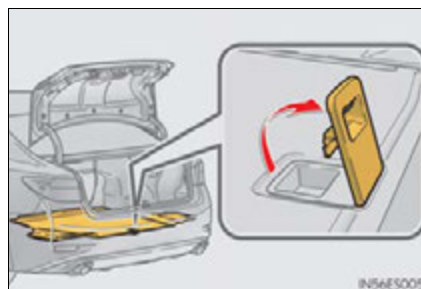

- 2 The lever can be hooked on the edge of the trunk.

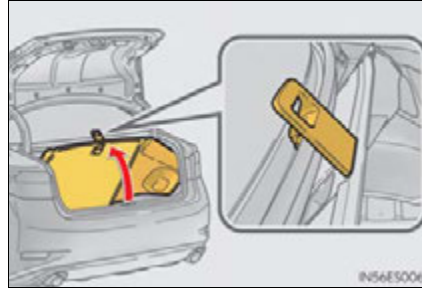

**⚠ CAUTION**

■ **When the cargo hooks are not in use**

To avoid injury, always return the cargo hooks to their stowed positions.

**⚠ NOTICE**

■ **When closing the trunk**

Do not leave the luggage mat lever hooked on the edge of the trunk.  
The luggage mat may get damaged.

## Sun visors and vanity mirrors

### Sun visors

- ① To set the visor in the forward position, flip it down.
- ② To set the visor in the side position, flip down, unhook, and swing it to the side.
- ③ To use the side extender, place the visor in the side position, then slide it backward.

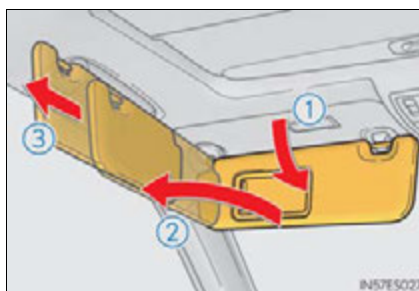

### Vanity mirrors

Slide the cover to open.

The light turns on when the cover is opened.

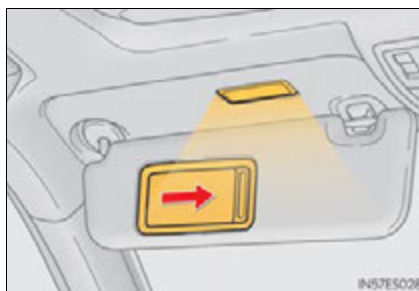

#### NOTICE

■ **To prevent 12-volt battery discharge**

Do not leave the vanity lights on for extended periods while the engine is not running <hybrid system is not operating>.

## Clock

The clock can be adjusted by pressing the buttons.

- ① Pressing and holding will move the clock hands backward.
- ② Pressing and holding will move the clock hands forward.

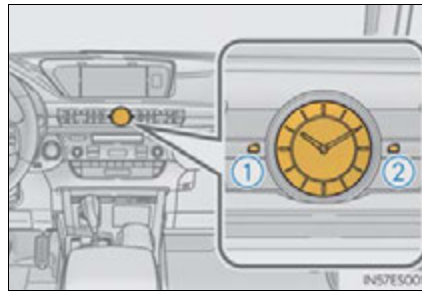

## Power outlets

The power outlets can be used for 12V accessories that run on less than 10A.

### ■ Front

Open the lid.

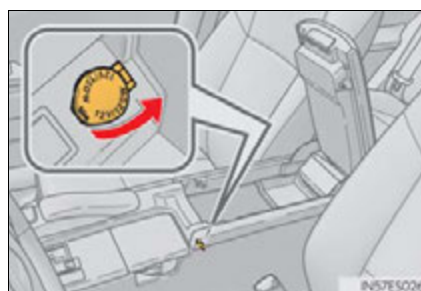

### ■ Rear

Open the lid.



### ■ The power outlets can be used when

The "START STOP ENGINE" <"POWER"> switch is in ACCESSORY or IGNITION ON <ON> mode.

 NOTICE**■ To avoid damaging the power outlets**

Close the power outlet lids when the power outlets are not in use.  
Foreign objects or liquids that enter the power outlets may cause a short circuit.

**■ To prevent blown fuse**

Do not use an accessory that uses more than 12V 10A.

**■ To prevent 12-volt battery discharge**

Do not use the power outlets longer than necessary when the engine is not running  
<hybrid system is not operating>.

## Heated steering wheel\*

The heated steering wheel heats the side grips of the steering wheel.

Turns the heater on/off

The indicator light comes on when the heater is operating.

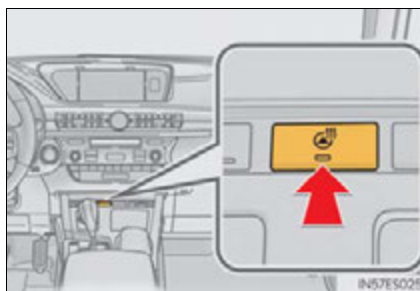

### ■ Operating condition

The "START STOP ENGINE" <"POWER"> switch is in IGNITION ON <ON> mode.

### ■ Timer

The heated steering wheel will automatically turn off after about 30 minutes.

\*: If equipped

 CAUTION**■ Burns**

Care should be taken to prevent injury if anyone in the following categories comes in contact with the steering wheel when the heated steering wheel is on:

- Babies, small children, the elderly, the sick and the physically challenged
- Persons with sensitive skin
- Persons who are fatigued
- Persons who have taken alcohol or drugs that induce sleep (sleeping drugs, cold remedies, etc.)

 NOTICE**■ To prevent 12-volt battery discharge**

Turn the switch off when the engine is not running <hybrid system is not operating>.



## Seat heaters and ventilators\*

The seat heaters and ventilators heat the seats and maintain good air-flow by blowing air from the seats.

① Heats the seat

The indicator light comes on.

The higher the number of dots, the warmer the seat becomes.

② Blows air from the seat

The indicator light comes on.

The higher the number of dots, the stronger the airflow becomes.

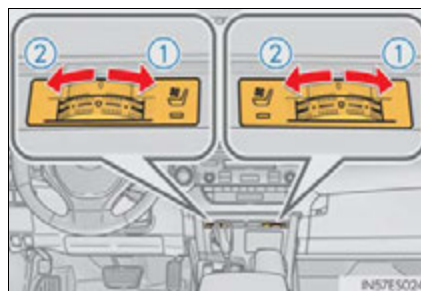

■ The seat heaters/seat ventilators can be used when

The "START STOP ENGINE" <"POWER"> switch is in IGNITION ON <ON> mode.

\*: If equipped

 CAUTION**■ Burns**

- Use caution when seating the following persons in a seat with the seat heater on to avoid the possibility of burns:
  - Babies, small children, the elderly, the sick and the physically challenged
  - Persons with sensitive skin
  - Persons who are fatigued
  - Persons who have taken alcohol or drugs that induce sleep (sleeping drugs, cold remedies, etc.)
- Do not cover the seat with anything when using the seat heater. Using the seat heater with a blanket or cushion increases the temperature of the seat and may lead to overheating.
- Do not use seat heater more than necessary. Doing so may cause minor burns or overheating.

 NOTICE**■ To prevent damage to the seat heaters/seat ventilators**

Do not put heavy objects that have an uneven surface on the seat and do not stick sharp objects (needles, nails, etc.) into the seat.

**■ To prevent 12-volt battery discharge**

Turn the seat heaters/seat ventilators off when the engine is not running <hybrid system is not operating>.

## Armrest

Fold down the armrest for use.



 NOTICE

- To prevent damage to the armrest  
Do not apply too much load on the armrest.

## Rear sunshade\* /rear door sunshades\*

### Rear sunshade

The rear sunshade can be raised and lowered by operating the button shown below.

Raise/lower

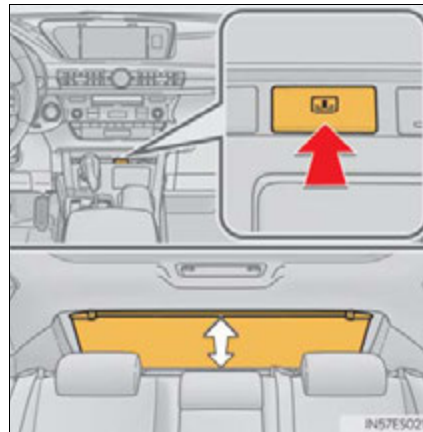

### Rear door sunshades

Pull the tab of the rear door sunshade and hook the shade on using the anchors.

To retract the rear door sunshade, unhook the shade and retract it slowly.

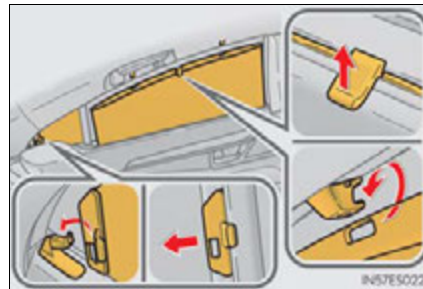

5

Interior features

\*: If equipped

■ **The rear sunshade can be used when**

The "START STOP ENGINE" <"POWER"> switch is in IGNITION ON <ON> mode.

■ **Operating the rear sunshade after the engine <hybrid system> is turned off**

The rear sunshade can be operated for approximately 1 minute even after the "START STOP ENGINE" <"POWER"> switch is turned to ACCESSORY mode or turned off.

■ **Reverse operation feature**

To ensure adequate rear visibility, the rear sunshade automatically lowers when the shift lever is shifted to R.

However, the rear sunshade is raised again if any of the following occurs:

- The button is pressed again.\*
- Shift the shift lever into P.
- The shift lever is shifted out of R, and the vehicle reaches a speed of 9 mph (15 km/h).

If the engine <hybrid system> is off when the rear sunshade has been lowered due to the reverse operation feature, it will not be raised even when the engine <hybrid system> is turned on again and the vehicle reaches a speed of 9 mph (15 km/h). To raise the sunshade again, press the button.

\*: Occasionally, the reverse function may not be carried out after the switch has been pressed. Repeat the above operation to operate the function.

■ **Customization**

Time elapsed before the reverse operation feature activates can be changed.  
(Customizable features: →P. 862)

 CAUTION**■ When the rear sunshade is being operated**

Do not place fingers or other objects in the fastener section or in the opening. They may get caught, causing injury.

 NOTICE**■ To prevent 12-volt battery discharge**

Do not operate the rear sunshade when the engine is not running <hybrid system is not operating>.

**■ To ensure normal operation of the rear sunshade and rear door sunshades**

Observe the following precautions.

- Do not place excessive load on the motor or other components of the rear sunshade.
- Do not place objects where they may hinder opening and closing operations.
- Do not attach items to the rear sunshade and rear door sunshades.
- Keep the opening clean and clear of obstructions.
- Do not operate the rear sunshade continuously for long periods of time.

## Trunk storage extension\*

Long objects can be loaded into the vehicle by utilizing the trunk space and rear seat area.

- 1 Fold down the armrest.



- 2 Fold down the handle and open the armrest door.



### CAUTION

#### ■ When not in use

Ensure that the armrest door is closed.  
In the event of sudden braking, items stored in the trunk may be thrown forward into the cabin, resulting in injury.

\*: If equipped

## Coat hooks

The coat hooks are provided with the rear assist grips.



### CAUTION

#### ■ Items that cannot be hung on the coat hook

Do not hang coat hangers or other hard or sharp objects on the hook. If the SRS curtain shield airbags deploy, these items may become projectiles, causing death or serious injury.



## Assist grips

An assist grip installed on the ceiling can be used to support your body while sitting on the seat.

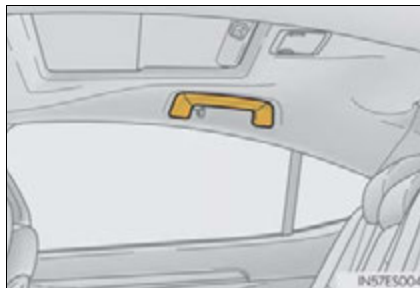

### CAUTION

#### ■ Assist grip

Do not use the assist grip when getting in or out of the vehicle or rising from your seat.

### NOTICE

#### ■ To prevent damage to the assist grip

Do not hang any heavy object or put a heavy load on the assist grip.

## Garage door opener

The garage door opener can be programmed to operate garage doors, gates, entry doors, door locks, home lighting systems, security systems, and other devices.

The garage door opener (HomeLink<sup>®</sup> Universal Transceiver) is manufactured under license from HomeLink<sup>®</sup>.

### Programming the HomeLink<sup>®</sup>

The HomeLink<sup>®</sup> compatible transceiver in your vehicle has 3 buttons which can be programmed to operate 3 different devices. Refer to the programming method below appropriate for the device.

- ① Indicator light
- ② Buttons

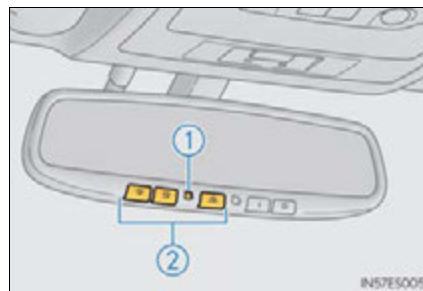

#### ■ Before programming HomeLink<sup>®</sup>

- During programming, it is possible that garage doors, gates, or other devices may operate. For this reason, make sure that people and objects are clear of the garage door or other devices to prevent injury or other potential harm.
- It is recommended that a new battery be placed in the remote control transmitter for more accurate programming.
- Garage door openers manufactured after 1995 may be equipped with **rolling code protection**. If this is the case, you will need a step-ladder or other sturdy, safe device to reach the “Learn” or “Smart” button on the garage door opener motor.

■ Programming HomeLink®

- 1 Point the remote control transmitter for the device 1 to 3 in. (25 to 75 mm) from the HomeLink® buttons.

Keep the HomeLink® indicator light in view while programming.



- ▶ For U.S.A. owner's

- 2 Press and hold the HomeLink® button you want to program and the handheld transmitter button simultaneously. When the HomeLink® indicator light changes from a slow to a rapid flash, you can release both buttons.

Programming has completed when the indicator light changes to a rapid flash.

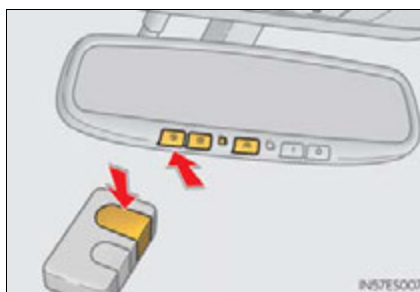

- ▶ Programming an entry gate (for U.S.A. owners)/Programming a device in the Canadian market

- 2 With one hand, press and hold the HomeLink® button you want to program. With your other hand, press and release the remote control transmitter every 2 seconds and repeat this cycle until the HomeLink® indicator light starts to flash rapidly. Then, release the buttons.

**3** Test the HomeLink<sup>®</sup> operation by pressing the newly programmed button and observing the indicator light:

- If the indicator light is solid/continuous, programming has been completed and your device should activate when the HomeLink<sup>®</sup> button is pressed and released.
- If the indicator light blinks rapidly for 2 seconds and then turns into a solid/continuous light, proceed with the following instructions **4** for programming a rolling code system.

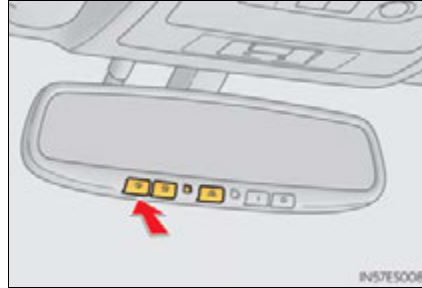

- ▶ Programming a rolling code system

- 4** Locate the “Learn” or “Smart” button on the garage door opener motor in the garage.

This button can usually be found where the hanging antenna wire is attached to the unit. The name and color of the button may vary by manufacturer. Please refer to the operator’s manual supplied with the garage door opener motor for details.

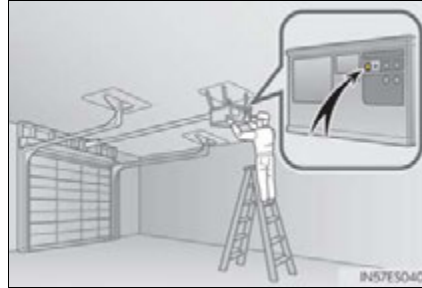

- 5** Press and release the “Learn” or “Smart” button.

Perform **6** within 30 seconds after performing **5**.

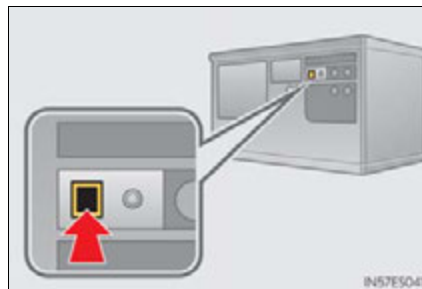

- 6** Press and hold the programmed HomeLink® button (located inside the vehicle) for 2 seconds and release it. Repeat this sequence (press/hold/release) up to 3 times to complete programming.

If the garage door opener motor activates when the HomeLink® button is pressed, the garage door opener motor recognizes the HomeLink® signal.

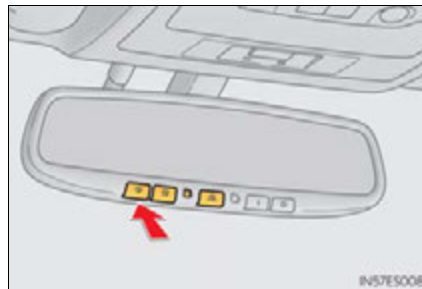

- 7** Repeat the steps above to program another device for any of the remaining HomeLink® buttons.

### ■ Reprogramming a single HomeLink<sup>®</sup> button

When the following procedure is performed, buttons which already have devices registered to them can be overwritten:

- 1 With one hand, press and hold the desired HomeLink<sup>®</sup> button.
- 2 When the HomeLink<sup>®</sup> indicator starts flashing, continue to hold the HomeLink<sup>®</sup> button and perform “Programming HomeLink<sup>®</sup>” from 1 (it takes 20 seconds for the HomeLink<sup>®</sup> indicator to start flashing).

### Erasing the entire HomeLink<sup>®</sup> memory (all three programs)

Press and hold the 2 outside buttons shown in the illustration for 10 seconds until the indicator light flashes.

If you sell your vehicle, be sure to erase the programs stored in the HomeLink<sup>®</sup> memory.

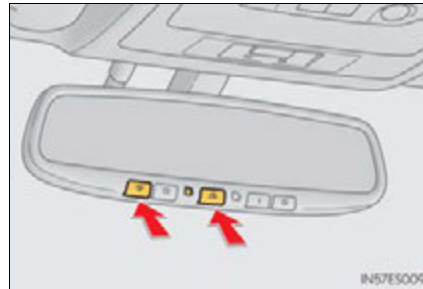

■ **Programs stored in the HomeLink® memory**

- The registered codes are not erased even if the 12-volt battery cable is disconnected.
- If learning failed when registering a different code to a HomeLink® button that already has a code registered to it, the already registered code is not erased.

■ **Certification for the garage door opener**

- ▶ For vehicles sold in the U.S.A.

FCC ID: NZLOBIHL4

FCC ID: NZLWZLHL4

NOTE:

This device complies with Part 15 of the FCC Rules. Operation is subject to the following two conditions: (1) this device may not cause harmful interference, and (2) this device must accept any interference received, including interference that may cause undesired operation.

FCC WARNING:

Changes or modifications not expressly approved by the party responsible for compliance could void the user's authority to operate the equipment.

- ▶ For vehicles sold in Canada

NOTE:

Operation is subject to the following two conditions:

- (1) this device may not cause interference, and
- (2) this device must accept any interference, including interference that may cause undesired operation of the device.

■ **When support is necessary**

Visit on the web at [www.homelink.com](http://www.homelink.com) or call 1-800-355-3515.

**⚠ CAUTION****■ When programming a garage door or other remote control device**

The garage door or other device may operate, so ensure people and objects are out of danger to prevent potential harm.

**■ Conforming to federal safety standards**

Do not use the HomeLink<sup>®</sup> compatible transceiver with any garage door opener or device that lacks safety stop and reverse features as required by federal safety standards.

This includes any garage door that cannot detect an interfering object. A door or device without these features increases the risk of death or serious injury.

**■ When operating or programming HomeLink<sup>®</sup>**

Never allow a child to operate or play with the HomeLink<sup>®</sup> buttons.



## Compass\*

The compass on the inside rear view mirror indicates the direction in which the vehicle is heading.

### Operation

To turn the compass on or off, push the switch.

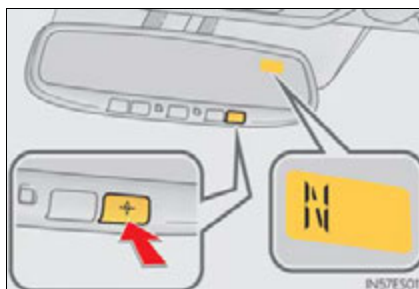

### Displays and directions

Display	Direction
"N"	North
"NE"	Northeast
"E"	East
"SE"	Southeast
"S"	South
"SW"	Southwest
"W"	West
"NW"	Northwest

\*: If equipped

### Calibrating the compass

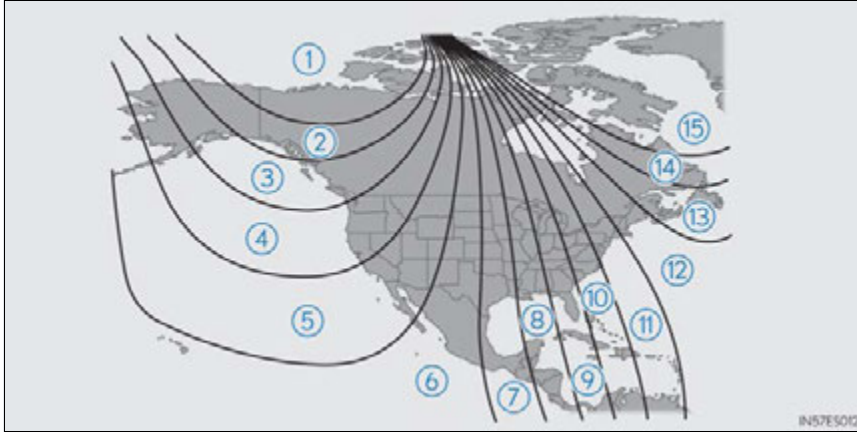

The direction display deviates from the true direction determined by the earth's magnetic field. The amount of deviation varies according to the geographic position of the vehicle.

If you cross over one of the map boundaries shown in illustration, the compass will deviate.

To obtain higher precision or perfect calibration, refer to "Deviation calibration".

■ **Deviation calibration**

- 1 Stop the vehicle in a place where it is safe to drive in a circle.
- 2 Press the switch until a number (1 to 15) appears on the compass display.

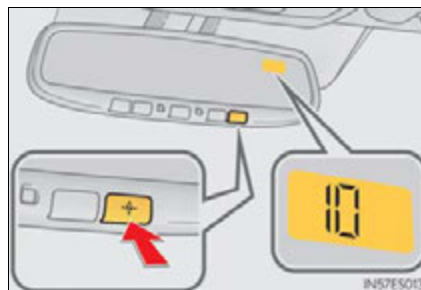

- 3 Press the switch and referring to the map above, select the number of the zone where you are.  
If the direction is displayed several seconds after adjustment, the calibration is complete.

■ **Circling calibration**

When "C" appears on the display, drive the vehicle at 5 mph (8 km/h) or less in a circle until a direction is displayed.

If there is not enough space to drive in a circle, drive around the block until the direction is displayed.

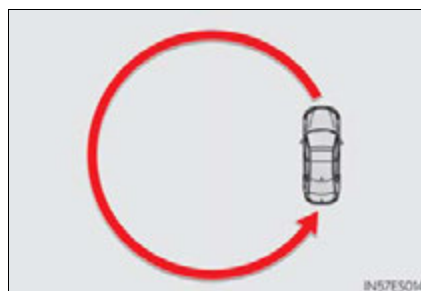

**■ Conditions unfavorable to correct operation**

The compass may not show the correct direction in the following conditions:

- The vehicle is stopped immediately after turning.
- The vehicle is on an inclined surface.
- The vehicle is in a place where the earth's magnetic field is subject to interference by artificial magnetic fields (underground car park/parking lot, under a steel tower, between buildings, roof car park/parking lot, near an intersection, near a large vehicle, etc.).
- The vehicle has become magnetized.  
(There is a magnet or metal object near the inside rear view mirror.)
- The 12-volt battery has been disconnected.
- A door is open.

**⚠ CAUTION****■ While driving the vehicle**

Do not adjust the display. Adjust the display only when the vehicle is stopped.

**■ When doing the circling calibration**

Secure a wide space, and watch out for people and vehicles in the vicinity. Do not violate any local traffic rules while performing circling calibration.

 NOTICE

■ **To avoid the compass malfunctions**

Do not place magnets or any metal objects near the inside rear view mirror.  
Doing this may cause the compass sensor to malfunction.

■ **To ensure normal operation of the compass**

- Do not perform a circling calibration of the compass in a place where the earth's magnetic field is subject to interference by artificial magnetic fields.
- During calibration, do not operate electric systems (moon roof, power windows, etc.) as they may interfere with the calibration.

## Safety Connect\*

Safety Connect is a subscription-based telematics service that uses Global Positioning System (GPS) data and embedded cellular technology to provide safety and security features to subscribers. Safety Connect is supported by Lexus' designated response center, which operates 24 hours per day, 7 days per week.

Safety Connect service is available by subscription on select, telematics hardware-equipped vehicles.

By using the Safety Connect service, you are agreeing to be bound by the Telematics Subscription Service Agreement and its Terms and Conditions, as in effect and amended from time to time, a current copy of which is available at Lexus.com. All use of the Safety Connect service is subject to such then-applicable Terms and Conditions.

### System components

- ① "SOS" button
- ② LED light indicators
- ③ Microphone

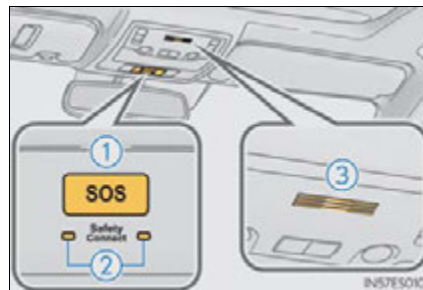

5

Interior features

\*: If equipped

### Services

Subscribers have the following Safety Connect services available:

- Automatic Collision Notification\*  
Helps drivers receive necessary response from emergency service providers. (→P. 652)  
\*: U.S. Patent No. 7,508,298 B2
- Stolen Vehicle Location  
Helps drivers in the event of vehicle theft. (→P. 653)
- Emergency Assistance Button (“SOS”)  
Connects drivers to response-center support. (→P. 653)
- Enhanced Roadside Assistance  
Provides drivers various on-road assistance. (→P. 653)

### Subscription

After you have signed the Telematics Subscription Service Agreement and are enrolled, you can begin receiving services.

A variety of subscription terms is available for purchase. Contact your Lexus dealer, call 1-800-25-LEXUS (1-800-255-3987) or push the “SOS” button in your vehicle for further subscription details.

**■ Safety Connect Services Information**

- Phone calls using the vehicles Bluetooth® technology will not be possible during Safety Connect.
- Safety Connect is available beginning Fall 2009 on select Lexus models. Contact with the Safety Connect response center is dependent upon the telematics device being in operative condition, cellular connection availability, and GPS satellite signal reception, which can limit the ability to reach the response center or receive emergency service support. Enrollment and Telematics Subscription Service Agreement required. A variety of subscription terms is available; charges vary by subscription term selected.
- Automatic Collision Notification, Emergency Assistance and Stolen Vehicle Location will function in the United States, including Hawaii and Alaska, and in Canada, and Enhanced Roadside Assistance will function in the United States (except Hawaii) and in Canada. No Safety Connect services will function outside of the United States in countries other than Canada.
- Safety Connect services are not subject to section 255 of the Telecommunications Act and the device is not TTY compatible.

**■ Languages**

The Safety Connect response center will offer support in multiple languages. The Safety Connect system will offer voice prompts in English and Spanish. Please indicate your language of choice when enrolling.

**■ When contacting the response center**

You may be unable to contact the response center if the network is busy.



### **Safety Connect LED light Indicators**

When the “START STOP ENGINE” <“POWER”> switch is turned to IGNITION ON <ON> mode, the red indicator light comes on for 2 seconds then turns off. Afterward, the green indicator light comes on, indicating that the service is active.

The following indicator light patterns indicate specific system usage conditions:

- Green indicator light on = Active service
- Green indicator light flashing = Safety Connect call in process
- Red indicator light (except at vehicle start-up) = System malfunction (contact your Lexus dealer)
- No indicator light (off) = Safety Connect service not active

### **Safety Connect services**

#### **■ Automatic Collision Notification**

In case of either airbag deployment or severe rear-end collision, the system is designed to automatically call the response center. The responding agent receives the vehicle’s location and attempts to speak with the vehicle occupants to assess the level of emergency. If the occupants are unable to communicate, the agent automatically treats the call as an emergency, contacts the nearest emergency services provider to describe the situation, and requests that assistance be sent to the location.

### ■ Stolen Vehicle Location

If your vehicle is stolen, Safety Connect can work with local authorities to assist them in locating and recovering the vehicle. After filing a police report, call the Safety Connect response center at 1-800-25-LEXUS (1-800-255-3987) and follow the prompts for Safety Connect to initiate this service.

In addition to assisting law enforcement with recovery of a stolen vehicle, Safety-Connect-equipped vehicle location data may, under certain circumstances, be shared with third parties to locate your vehicle. Further information is available at [Lexus.com](http://Lexus.com).

### ■ Emergency Assistance Button (“SOS”)

In the event of an emergency on the road, push the “SOS” button to reach the Safety Connect response center. The answering agent will determine your vehicle’s location, assess the emergency, and dispatch the necessary assistance required.

If you accidentally press the “SOS” button, tell the response-center agent that you are not experiencing an emergency.

### ■ Enhanced Roadside Assistance

Enhanced Roadside Assistance adds GPS data to the already included warranty-based Lexus roadside service.

Subscribers can press the “SOS” button to reach a Safety Connect response-center agent, who can help with a wide range of needs, such as: towing, flat tire, fuel delivery, etc. For a description of the Roadside Assistance services and their limitations, please see the Safety Connect Terms and Conditions, which are available at [Lexus.com](http://Lexus.com).

### Safety information for Safety Connect

Important! Read this information before using Safety Connect.

#### ■ Exposure to radio frequency signals

The Safety Connect system installed in your vehicle is a low-power radio transmitter and receiver. It receives and also sends out radio frequency (RF) signals.

In August 1996, the Federal Communications Commission (FCC) adopted RF exposure guidelines with safety levels for mobile wireless phones. Those guidelines are consistent with the safety standards previously set by the following U.S. and international standards bodies.

- ANSI (American National Standards Institute) C95.1 [1992]
- NCRP (National Council on Radiation Protection and Measurement) Report 86 [1986]
- ICNIRP (International Commission on Non-Ionizing Radiation Protection) [1996]

Those standards were based on comprehensive and periodic evaluations of the relevant scientific literature. Over 120 scientists, engineers, and physicians from universities, and government health agencies and industries reviewed the available body of research to develop the ANSI Standard (C95.1).

The design of Safety Connect complies with the FCC guidelines in addition to those standards.

---

**■ Certification for Lexus Enform with Safety Connect**

FCC ID: N7NGTM2

FCC ID: O6Y-CDMRF101

**NOTE:**

This device complies with Part 15 of the FCC Rules. Operation is subject to the following two conditions: (1) This device may not cause harmful interference, and (2) this device must accept any interference received, including interference that may cause undesired operation.

**FCC WARNING:**

Changes or modifications not expressly approved by the party responsible for compliance could void the user's authority to operate the equipment.



**6-1. Maintenance and care**

Cleaning and protecting  
the vehicle exterior.....658

Cleaning and protecting  
the vehicle interior..... 662

**6-2. Maintenance**

Maintenance  
requirements..... 665

General maintenance.....668

Emission inspection  
and maintenance (I/M)  
programs .....672

**6-3. Do-it-yourself maintenance**

Do-it-yourself service  
precautions.....673

Hood .....677

Positioning a floor jack..... 678

Engine compartment ..... 681

12-volt battery  
(hybrid vehicles).....698

Tires..... 702

Tire inflation pressure .....712

Wheels .....715

Air conditioning filter .....717

Electronic key battery .....719

Checking and replacing  
fuses.....721

Light bulbs..... 733

## Cleaning and protecting the vehicle exterior

Perform the following to protect the vehicle and maintain it in prime condition:

- Working from top to bottom, liberally apply water to the vehicle body, wheel wells and underside of the vehicle to remove any dirt and dust.
- Wash the vehicle body using a sponge or soft cloth, such as a chamois.
- For hard-to-remove marks, use car wash soap and rinse thoroughly with water.
- Wipe away any water.
- Wax the vehicle when the waterproof coating deteriorates.  
If water does not bead on a clean surface, apply wax when the vehicle body is cool.

---

### ■ Automatic car washes

- Fold the mirrors before washing the vehicle. Start washing from the front of the vehicle. Make sure to extend the mirrors before driving.
- Brushes used in automatic car washes may scratch the vehicle surface and harm your vehicle's paint.
- Hybrid vehicles: Rear spoiler may not be washable in some automatic car washes. There may also be an increased risk of damage to vehicle.

### ■ High pressure car washes

- Do not allow the nozzles of the car wash to come within close proximity of the windows.
- Before using the car wash, check that the fuel filler door on your vehicle is closed properly.

**■ Notes for a smart access system with push-button start**

If the door handle becomes wet while the electronic key is within the effective range, the door may lock and unlock repeatedly. In that case, follow the following correction procedures to wash the vehicle:

- Place the key in a position 6 ft. (2 m) or more separate from the vehicle while the vehicle is being washed. (Take care to ensure that the key is not stolen.)
- Set the electronic key to battery-saving mode to disable the smart access system with push-button start. (→P. 131)

**■ Aluminum wheels**

- Remove any dirt immediately by using a neutral detergent. Do not use hard brushes or abrasive cleaners. Do not use strong or harsh chemical cleaners. Use the same mild detergent and wax as used on the paint.
- Do not use detergent on the wheels when they are hot, for example after driving for long distance in the hot weather.
- Wash detergent from the wheels immediately after use.

**■ Bumpers and side moldings**

Do not scrub with abrasive cleaners.



**⚠ CAUTION****■ When washing the vehicle**

Do not apply water to the inside of the engine compartment. Doing so may cause the electrical components etc. to catch fire.

**■ When cleaning the windshield (vehicles with rain-sensing windshield wipers)**

Turn off the wiper switch.  
If AUTO mode is selected, the wipers may operate unexpectedly in the following situations, and may result in hands being caught or other serious injuries and cause damage to the wiper blades.

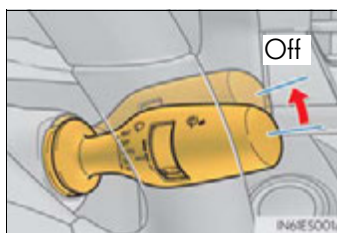

- When the upper part of the windshield where the raindrop sensor is located is touched by hand
- When a wet rag or similar is held close to the raindrop sensor
- If something bumps against the windshield
- If you directly touch the raindrop sensor body or if something bumps into the raindrop sensor

**■ Precautions regarding exhaust pipes**

Exhaust gases cause exhaust pipes to become quite hot.  
When washing the vehicle, be careful not to touch any pipes until they have cooled sufficiently, as touching hot exhaust pipes can cause burns.

**■ Precaution regarding the Blind Spot Monitor (if equipped)**

If the paint of the rear bumper is chipped or scratched, the system may malfunction. If this occurs, consult your Lexus dealer.

 NOTICE**■ To prevent paint deterioration and corrosion on the body and components (aluminum wheels etc.)**

- Wash the vehicle immediately in the following cases:
  - After driving near the sea coast
  - After driving on salted roads
  - If coal tar or tree sap is present on the paint surface
  - If dead insects, insect droppings or bird droppings are present on the paint surface
  - After driving in an area contaminated with soot, oily smoke, mine dust, iron powder or chemical substances
  - If the vehicle becomes heavily soiled with dust or mud
  - If liquids such as benzene and gasoline are spilled on the paint surface
- If the paint is chipped or scratched, have it repaired immediately.
- To prevent the wheels from corroding, remove any dirt and store in a place with low humidity when storing the wheels.

**■ Cleaning the exterior lights**

- Wash carefully. Do not use organic substances or scrub with a hard brush. This may damage the surfaces of the lights.
- Do not apply wax to the surfaces of the lights. Wax may cause damage to the lenses.

**■ When using an automatic car wash (vehicles with rain-sensing windshield wipers)**

Turn off the wiper switch.  
If AUTO mode is selected, the wipers may operate and the wiper blades may be damaged.

**■ When cleaning the windshield**

Raise the wipers in line with the windshield. (→P. 333)  
Failure to do so may result in damage to the wipers and/or the hood.

## Cleaning and protecting the vehicle interior

The following procedures will help protect your vehicle's interior and keep it in top condition:

### Protecting the vehicle interior

Remove dirt and dust using a vacuum cleaner. Wipe dirty surfaces with a cloth dampened with lukewarm water.

### Cleaning the leather areas

- Remove dirt and dust using a vacuum cleaner.
- Wipe off any excess dirt and dust with a soft cloth dampened with diluted detergent.  
Use a diluted water solution of approximately 5% neutral wool detergent.
- Wring out any excess water from the cloth and thoroughly wipe off all remaining traces of detergent.
- Wipe the surface with a dry, soft cloth to remove any remaining moisture. Allow the leather to dry in a shaded and ventilated area.

### Cleaning the synthetic leather areas

- Remove loose dirt using a vacuum cleaner.
- Apply a mild soap solution to the synthetic leather using a sponge or soft cloth.
- Allow the solution to soak in for a few minutes. Remove the dirt and wipe off the solution with a clean, damp cloth.

### ■ Caring for leather areas

Lexus recommends cleaning the interior of the vehicle at least twice a year to maintain the quality of the vehicle's interior.

### ■ Shampooing the carpets

There are several commercial foaming-type cleaners available. Use a sponge or brush to apply the foam. Rub in overlapping circles. Do not use water. Wipe dirty surfaces and let them dry. Excellent results are obtained by keeping the carpet as dry as possible.

### ■ Seat belts

Clean with mild soap and lukewarm water using a cloth or sponge. Also check the belts periodically for excessive wear, fraying or cuts.

### ■ When cleaning the carpeted portions of the glove box, console box, etc.

If a strong adhesive tape is used, there is a possibility that the surface of the carpet could be damaged.

## ⚠ CAUTION

### ■ Water in the vehicle

- Gasoline vehicles: Do not splash or spill liquid in the vehicle.  
Doing so may cause electrical components etc. to malfunction or catch fire.
- Hybrid vehicles: Do not splash or spill liquid in the vehicle, such as on the floor and in the hybrid battery (traction battery) air vents or in the luggage compartment.  
Doing so may cause the hybrid battery, electrical components, etc. to malfunction or catch fire.
- Do not get any of the SRS components or wiring in the vehicle interior wet.  
(→P. 40)  
An electrical malfunction may cause the airbags to deploy or not function properly, resulting in death or serious injury.

### ■ Cleaning the interior (especially instrument panel)

Do not use polish wax or polish cleaner. The instrument panel may reflect off the windshield, obstructing the driver's view and leading to an accident, resulting in death or serious injury.

 NOTICE**■ Cleaning detergents**

- Do not use the following types of detergent, as they may discolor the vehicle interior or cause streaks or damage to painted surfaces:
  - Non-seat portions: Organic substances such as benzene or gasoline, alkaline or acidic solutions, dye, and bleach
  - Seats: Alkaline or acidic solutions, such as thinner, benzene, and alcohol
- Do not use polish wax or polish cleaner. The instrument panel's or other interior part's painted surface may be damaged.

**■ Preventing damage to leather surfaces**

Observe the following precautions to avoid damage to and deterioration of leather surfaces:

- Remove any dust or dirt from leather surfaces immediately.
- Do not expose the vehicle to direct sunlight for extended periods of time. Park the vehicle in the shade, especially during summer.
- Do not place items made of vinyl, plastic, or containing wax on the upholstery, as they may stick to the leather surface if the vehicle interior heats up significantly.

**■ Water on the floor**

Do not wash the vehicle floor with water.

Vehicle systems such as the audio system may be damaged if water comes into contact with electrical components such as the audio system above or under the floor of the vehicle. Water may also cause the body to rust.

**■ When cleaning the inside of the windshield (vehicles with LDA [Lane Departure Alert] and Automatic High Beam)**

Be careful not to touch the camera sensor (→P. 273).

If the camera is accidentally scratched or hit, LDA and Automatic High Beam system may not operate properly or may cause a malfunction.

**■ Cleaning the inside of the rear window**

- Do not use glass cleaner to clean the rear window, as this may cause damage to the rear window defogger heater wires or antenna. Use a cloth dampened with lukewarm water to gently wipe the window clean. Wipe the window in strokes running parallel to the heater wires or antenna.
- Be careful not to scratch or damage the heater wires or antenna.

## Maintenance requirements

To ensure safe and economical driving, day-to-day care and regular maintenance are essential. It is the owner's responsibility to perform regular checks. Lexus recommends the following maintenance:

### General maintenance

General maintenance should be performed on a daily basis. This can be done by yourself or by a Lexus dealer.

### Scheduled maintenance

Scheduled maintenance should be performed at specified intervals according to the maintenance schedule.

For details about maintenance items and schedules, refer to the "Warranty and Service Guide", "Owner's Manual Supplement" or "Scheduled Maintenance".

### Do-it-yourself maintenance

You can perform some maintenance procedures by yourself. Please be aware that do-it-yourself maintenance may affect warranty coverage.

The use of Lexus repair manuals is recommended.

For details about warranty coverage, refer to the separate "Owner's Guide", "Warranty and Service Guide", "Owner's Manual Supplement" or "Warranty Booklet".

**■ Repair and replacement**

It is recommended that genuine Lexus parts be used for repairs to ensure performance of each system. If non-Lexus parts are used in replacement or if a repair shop other than a Lexus dealer performs repairs, confirm the warranty coverage.

**■ Resetting the message indicating maintenance is required (U.S.A. only)**

After the required maintenance is performed according to the maintenance schedule, please reset the maintenance data.

To reset the data, follow the procedure described below:

- 1 Switch the display to the trip meter "A" (→P. 96) when the engine <hybrid system> is running <operating>.
- 2 Turn the "START STOP ENGINE" <"POWER"> switch off.
- 3 While pressing the "ODO TRIP" button (→P. 96), turn the "START STOP ENGINE" <"POWER"> switch to the IGNITION ON <ON> mode (do not start the engine <hybrid system> because otherwise the reset mode will be canceled).

The message shown in the illustration will appear on the display.

Continue to press and hold the button until the trip meter displays "000000".

**■ Allow inspection and repairs to be performed by a Lexus dealer**

- Lexus technicians are well-trained specialists and are kept up to date with the latest service information. They are well informed about the operations of all systems on your vehicle.
- Keep a copy of the repair order. It proves that the maintenance that has been performed is under warranty coverage. If any problem should arise while your vehicle is under warranty, your Lexus dealer will promptly take care of it.

 **CAUTION****■ If your vehicle is not properly maintained**

Improper maintenance could result in serious damage to the vehicle and possible death or serious injury.

**■ Handling of the 12-volt battery**

- Engine exhaust, some of its constituents, and a wide variety of automobile components contain or emit chemicals known to the State of California to cause cancer and birth defects and other reproductive harm. Work in a well ventilated area.
- Oils, fuels and fluids contained in vehicles as well as waste produced by component wear contain or emit chemicals known to the State of California to cause cancer and birth defects or other reproductive harm. Avoid exposure and wash any affected area immediately.
- 12-volt battery posts, terminals and related accessories contain lead and lead compounds which are known to cause brain damage. Wash your hands after handling. (→P. 693, 698)



## General maintenance

Listed below are the general maintenance items that should be performed at the intervals specified in the “Warranty and Service Guide” or “Owner’s Manual Supplement”. It is recommended that any problem you notice should be brought to the attention of your Lexus dealer or qualified service shop for advice.

### Engine compartment

Items	Check points
12-volt battery (gasoline vehicles)	Check the battery fluid level and connections. (→P. 693)
Brake fluid	Is the brake fluid at the correct level? (→P. 692)
Engine coolant (gasoline vehicles)	Is the engine coolant at the correct level? (→P. 689)
Engine/power control unit coolant (hybrid vehicles)	Is the engine/power control unit coolant at the correct level? (→P. 689)
Engine oil	Is the engine oil at the correct level? (→P. 684)
Exhaust system	There should not be any fumes or strange sounds.
Radiator/condenser	The radiator and condenser should be free from foreign objects. (→P. 691)
Washer fluid	Is there sufficient washer fluid? (→P. 697)

### Luggage compartment

Items	Check points
12-volt battery (hybrid vehicles)	Check the connections. (→P. 698)

### Vehicle interior

Items	Check points
Accelerator pedal	<ul style="list-style-type: none"> <li>The accelerator pedal should move smoothly (without uneven pedal effort or catching).</li> </ul>
Automatic transmission "Park" mechanism (gasoline vehicles)/Hybrid transmission "Park" mechanism (hybrid vehicles)	<ul style="list-style-type: none"> <li>When parked on a slope and the shift lever is in P, is the vehicle securely stopped?</li> </ul>
Brake pedal	<ul style="list-style-type: none"> <li>Does the brake pedal move smoothly?</li> <li>Does the brake pedal have appropriate clearance from the floor? (→P. 843)</li> <li>Does the brake pedal have the correct amount of free play? (→P. 843)</li> </ul>
Brakes	<ul style="list-style-type: none"> <li>The vehicle should not pull to one side when the brakes are applied.</li> <li>The brakes should work effectively.</li> <li>The brake pedal should not feel spongy.</li> <li>The brake pedal should not get too close to the floor when the brakes are applied.</li> </ul>

Items	Check points
Head restraints	<ul style="list-style-type: none"> <li>• Do the head restraints move smoothly and lock securely?</li> </ul>
Indicators/buzzers	<ul style="list-style-type: none"> <li>• Do the indicators and buzzers function properly?</li> </ul>
Lights	<ul style="list-style-type: none"> <li>• Do all the lights come on?</li> <li>• Are the headlights aimed correctly?</li> </ul>
Parking brake	<ul style="list-style-type: none"> <li>• Does the parking brake pedal move smoothly?</li> <li>• When parked on a slope and the parking brake is on, is the vehicle securely stopped?</li> </ul>
Seat belts	<ul style="list-style-type: none"> <li>• Do the seat belts operate smoothly?</li> <li>• The seat belts should not be damaged.</li> </ul>
Seats	<ul style="list-style-type: none"> <li>• Do the seat controls operate properly?</li> </ul>
Steering wheel	<ul style="list-style-type: none"> <li>• Does the steering wheel rotate smoothly?</li> <li>• Does the steering wheel have the correct amount of free play?</li> <li>• There should not be any strange sounds coming from the steering wheel.</li> </ul>

### Vehicle exterior

Items	Check points
Doors/trunk	<ul style="list-style-type: none"> <li>Do the doors/trunk operate smoothly?</li> </ul>
Engine hood	<ul style="list-style-type: none"> <li>Does the engine hood lock system work properly?</li> </ul>
Fluid leaks	<ul style="list-style-type: none"> <li>There should not be any signs of fluid leakage after the vehicle has been parked.</li> </ul>
Tires	<ul style="list-style-type: none"> <li>Is the tire inflation pressure correct?</li> <li>The tires should not be damaged or excessively worn.</li> <li>Have the tires been rotated according to the maintenance schedule?</li> <li>The wheel nuts should not be loose.</li> </ul>
Windshield wipers	<ul style="list-style-type: none"> <li>The wiper blades should not show any signs of cracking, splitting, wear, contamination or deformation.</li> <li>The wiper blades should clear the windshield without streaking or skipping.</li> </ul>

#### CAUTION

**■ If the engine <hybrid system> is running <operating>**

Turn the engine <hybrid system> off and ensure that there is adequate ventilation before performing maintenance checks.

## Emission inspection and maintenance (I/M) programs

Some states have vehicle emission inspection programs which include OBD (On Board Diagnostics) checks. The OBD system monitors the operation of the emission control system.

### If the malfunction indicator lamp comes on

The OBD system determines that a problem exists somewhere in the emission control system. Your vehicle may not pass the I/M test and may need to be repaired. Contact your Lexus dealer to service the vehicle.

### Your vehicle may not pass the I/M test in the following situations:

- When the 12-volt battery is disconnected or discharged  
Readiness codes that are set during ordinary driving are erased. Also, depending on your driving habits, the readiness codes may not be completely set.
- When the fuel tank cap is loose  
The malfunction indicator lamp comes on indicating a temporary malfunction and your vehicle may not pass the I/M test.

### When the malfunction indicator lamp still remains on after several driving trips

The error code in the OBD system will not be cleared unless the vehicle is driven 40 or more times.

### If your vehicle does not pass the I/M test

Contact your Lexus dealer to prepare the vehicle for re-testing.

## Do-it-yourself service precautions

If you perform maintenance by yourself, be sure to follow the correct procedure as given in these sections.

Items	Parts and tools
12-volt battery condition (gasoline vehicles) (→P. 693)	<ul style="list-style-type: none"> <li>• Warm water</li> <li>• Baking soda</li> <li>• Grease</li> <li>• Conventional wrench (for terminal clamp bolts)</li> <li>• Distilled water</li> </ul>
12-volt battery condition (hybrid vehicles) (→P. 698)	<ul style="list-style-type: none"> <li>• Grease</li> <li>• Conventional wrench (for terminal clamp bolts)</li> </ul>
Brake fluid level (→P. 692)	<ul style="list-style-type: none"> <li>• FMVSS No.116 DOT 3 or SAE J1703 brake fluid</li> <li>• Rag or paper towel</li> <li>• Funnel (used only for adding brake fluid)</li> </ul>
Engine coolant level (gasoline vehicles) (→P. 689)	<ul style="list-style-type: none"> <li>• "Toyota Super Long Life Coolant" or a similar high quality ethylene glycol-based non-silicate, non-amine, non-nitrite and non-borate coolant with long-life hybrid organic acid technology</li> </ul> <p>For the U.S.A.:</p> <p>"Toyota Super Long Life Coolant" is pre-mixed with 50% coolant and 50% deionized water.</p> <p>For Canada:</p> <p>"Toyota Super Long Life Coolant" is pre-mixed with 55% coolant and 45% deionized water.</p>
Engine/power control unit coolant level (hybrid vehicles) (→P. 689)	<ul style="list-style-type: none"> <li>• Funnel (used only for adding coolant)</li> </ul>

**674** 6-3. Do-it-yourself maintenance

Items	Parts and tools
Engine oil level (→P. 684)	<ul style="list-style-type: none"> <li>• “Toyota Genuine Motor Oil” or equivalent</li> <li>• Rag or paper towel</li> <li>• Funnel (used only for adding engine oil)</li> </ul>
Fuses (→P. 721)	<ul style="list-style-type: none"> <li>• Fuse with same amperage rating as original</li> </ul>
Light bulbs (→P. 733)	<ul style="list-style-type: none"> <li>• Bulb with same number and wattage rating as original</li> <li>• Phillips-head screwdriver</li> <li>• Flathead screwdriver</li> <li>• Wrench</li> </ul>
Radiator and condenser (→P. 691)	—
Tire inflation pressure (→P. 712)	<ul style="list-style-type: none"> <li>• Tire pressure gauge</li> <li>• Compressed air source</li> </ul>
Washer fluid (→P. 697)	<ul style="list-style-type: none"> <li>• Water or washer fluid containing anti-freeze (for winter use)</li> <li>• Funnel (used only for adding water or washer fluid)</li> </ul>

 **CAUTION**

The engine compartment contains many mechanisms and fluids that may move suddenly, become hot, or become electrically energized. To avoid death or serious injury, observe the following precautions.

**■ When working on the engine compartment**

- Hybrid vehicles: Make sure that the “POWER ON” on the multi-information display and the “READY” indicator are both off.
- Keep hands, clothing and tools away from the moving fan and engine drive belt.
- Gasoline vehicles: Be careful not to touch the engine, radiator, exhaust manifold, etc. right after driving as they may be hot. Oil and other fluids may also be hot.
- Hybrid vehicles: Be careful not to touch the engine, power control unit, radiator, exhaust manifold, etc. right after driving as they may be hot. Oil and other fluids may also be hot.
- Do not leave anything that may burn easily, such as paper and rags, in the engine compartment.
- Gasoline vehicles: Do not smoke, cause sparks or expose an open flame to fuel or the 12-volt battery. Fuel and 12-volt battery fumes are flammable.
- Hybrid vehicles: Do not smoke, cause sparks or expose an open flame to fuel. Fuel fumes are flammable.
- Gasoline vehicles: Be extremely cautious when working on the 12-volt battery. It contains poisonous and corrosive sulfuric acid.



 CAUTION**■ When working near the electric cooling fans or radiator grille**

Be sure the "START STOP ENGINE" <"POWER"> switch is off.  
With the "START STOP ENGINE" <"POWER"> switch in IGNITION ON <ON> mode, the electric cooling fans may automatically start to run if the air conditioning is on and/or the coolant temperature is high. (→P. 691)

**■ Safety glasses**

Wear safety glasses to prevent flying or falling material, fluid spray, etc. from getting in your eyes.

 NOTICE**■ If you remove the air cleaner filter**

Driving with the air cleaner filter removed may cause excessive engine wear due to dirt in the air.

## Hood

Release the lock from the inside of the vehicle to open the hood.

- 1 Pull the hood lock release lever.

The hood will pop up slightly.

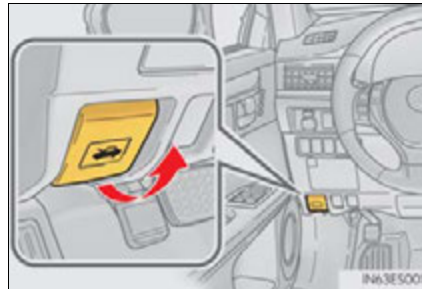

- 2 Pull up the auxiliary catch lever and lift the hood.

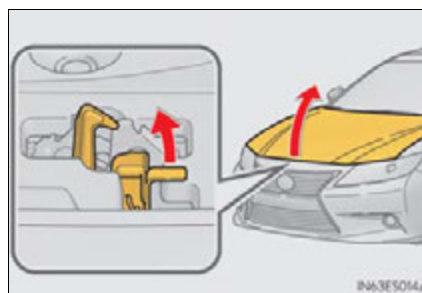

### CAUTION

#### ■ Pre-driving check

Check that the hood is fully closed and locked.

If the hood is not locked properly, it may open while the vehicle is in motion and cause an accident, which may result in death or serious injury.

## Positioning a floor jack

When raising your vehicle with a floor jack, position the jack correctly. Improper placement may damage your vehicle or cause injury.

### ◆ Front

#### ▶ Gasoline vehicles

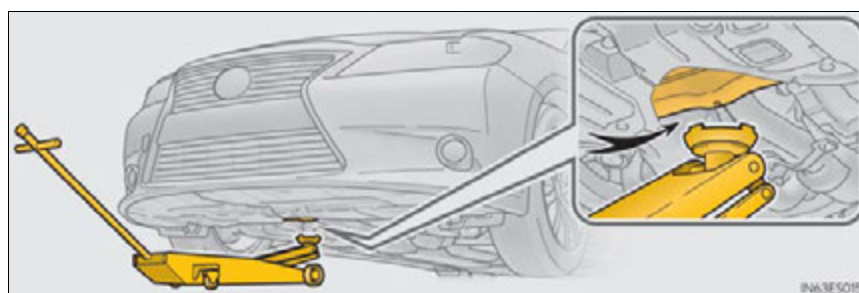

#### ▶ Hybrid vehicles

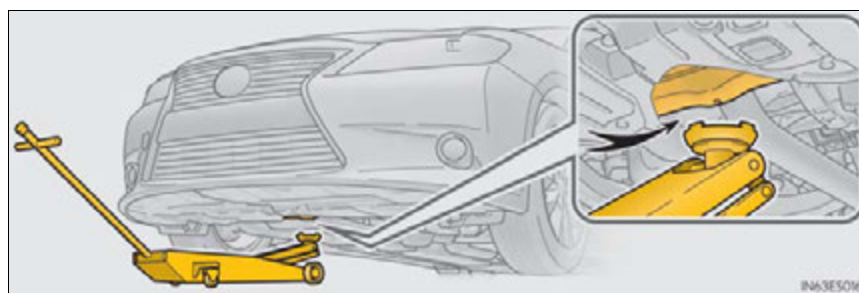

◆ Rear

▶ Gasoline vehicles

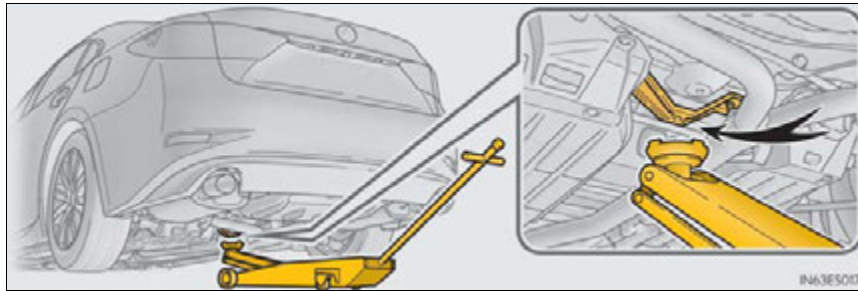

▶ Hybrid vehicles

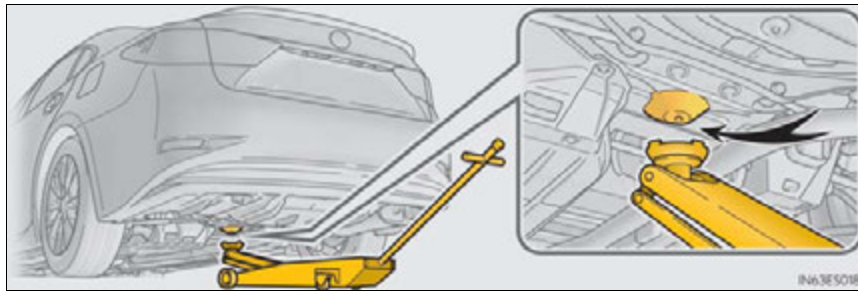

**⚠ CAUTION****■ When raising your vehicle**

Make sure to observe the following precautions to reduce the possibility of death or serious injury:

- Lift up the vehicle using a floor jack such as the one shown in the illustration.



- When using a floor jack, follow the instructions of the manual provided with the jack.
- Do not use the jack that was supplied with your vehicle.
- Do not put any part of your body underneath the vehicle when it is supported only by the floor jack.
- Always use floor jack and/or automotive jack stands on a solid, flat, level surface.
- Do not start the engine <hybrid system> while the vehicle is supported by the floor jack.
- Stop the vehicle on level, firm ground, firmly set the parking brake and shift the shift lever to P.
- Make sure to set the floor jack properly at the jack point.  
Raising the vehicle with an improperly positioned floor jack will damage the vehicle and may cause the vehicle to fall off the floor jack.
- Do not raise the vehicle while someone is in the vehicle.
- When raising the vehicle, do not place any object on top of or underneath the floor jack.

## Engine compartment

► Gasoline vehicles (2GR-FE engine)

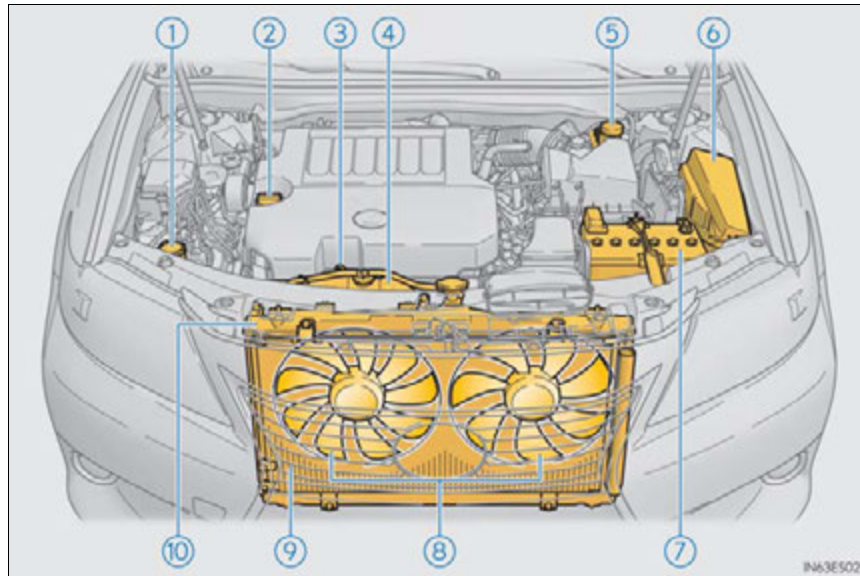

- |                                       |                                   |
|---------------------------------------|-----------------------------------|
| ① Washer fluid tank (→P. 697)         | ⑤ Brake fluid reservoir (→P. 692) |
| ② Engine oil filler cap (→P. 686)     | ⑥ Fuse box (→P. 721)              |
| ③ Engine oil level dipstick (→P. 684) | ⑦ 12-volt battery (→P. 693)       |
| ④ Engine coolant reservoir (→P. 689)  | ⑧ Electric cooling fans           |
|                                       | ⑨ Condenser (→P. 691)             |
|                                       | ⑩ Radiator (→P. 691)              |

6

Maintenance and care

► Hybrid vehicles (2AR-FXE engine)

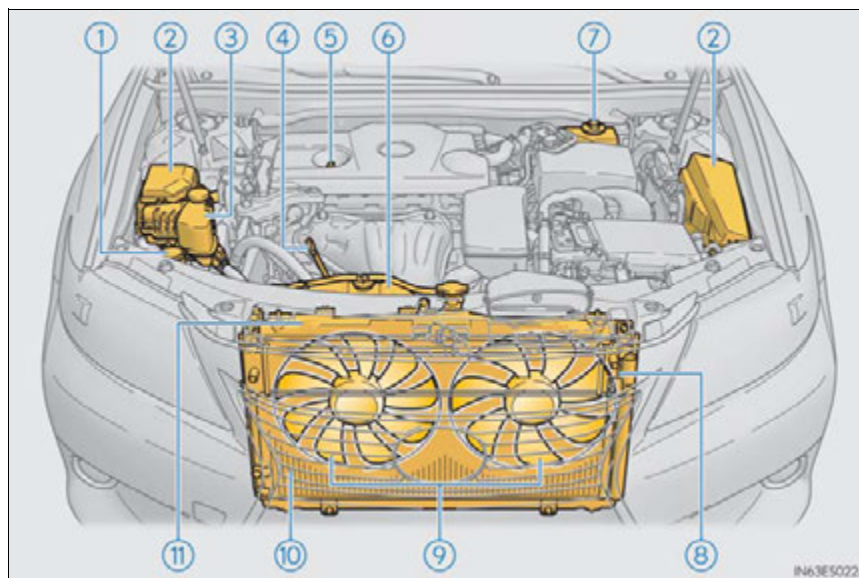

- |  |   |
|--|---|
| ① Washer fluid tank (→P. 697)                    | ⑥ Engine coolant reservoir (→P. 689)            |
| ② Fuse boxes (→P. 721)                           | ⑦ Brake fluid reservoir (→P. 692)               |
| ③ Power control unit coolant reservoir (→P. 689) | ⑧ Power control unit coolant radiator (→P. 691) |
| ④ Engine oil level dipstick (→P. 684)            | ⑨ Electric cooling fans                         |
| ⑤ Engine oil filler cap (→P. 686)                | ⑩ Condenser (→P. 691)                           |
|  | ⑪ Engine coolant radiator (→P. 691)             |

■ 12-volt battery (hybrid vehicles)

→P. 698

## Engine compartment cover

### ■ Removing the engine compartment cover



### ■ Installing the clips

- ① Push up center portion
- ② Insert
- ③ Press

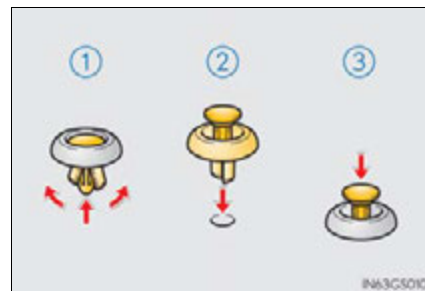

### ⚠ NOTICE

#### ■ Checking the engine compartment cover after installation

Make sure that the cover is securely installed in its original position.



## Engine oil

With the engine at operating temperature and turned off, check the oil level on the dipstick.

### ■ Checking the engine oil

**1** Park the vehicle on level ground.

▶ Gasoline vehicles

After warming up the engine and turning it off, wait more than 5 minutes for the oil to drain back into the bottom of the engine.

▶ Hybrid vehicles

After warming up the engine and turning off the hybrid system, wait more than 5 minutes for the oil to drain back into the bottom of the engine.

**2** Holding a rag under the end, pull the dipstick out.

▶ Gasoline vehicles

▶ Hybrid vehicles

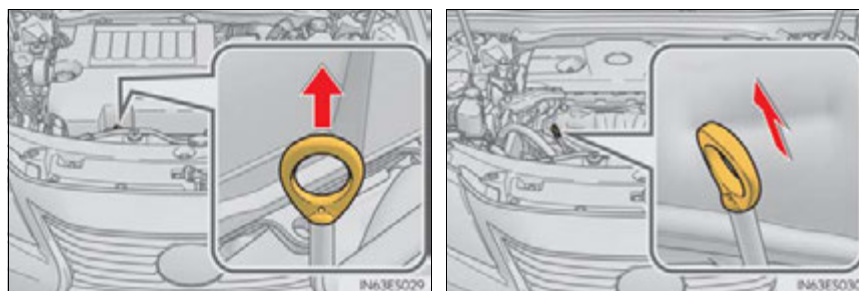

**3** Wipe the dipstick clean.

**4** Reinsert the dipstick fully.

5 Holding a rag under the end, pull the dipstick out and check the oil level.

- ① Low
- ② Normal
- ③ Excessive

► Flat dipstick

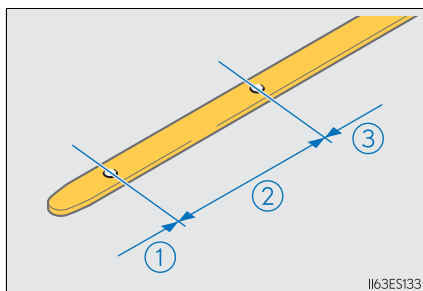

► Non-flat dipstick

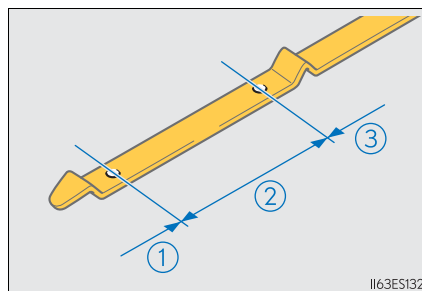

The shape of the dipstick may differ depending on the type of vehicle or engine.

6 Wipe the dipstick and reinsert it fully.

■ Adding engine oil

If the oil level is below or near the low level mark, add engine oil of the same type as that already in the engine.

▶ Gasoline vehicles

▶ Hybrid vehicles

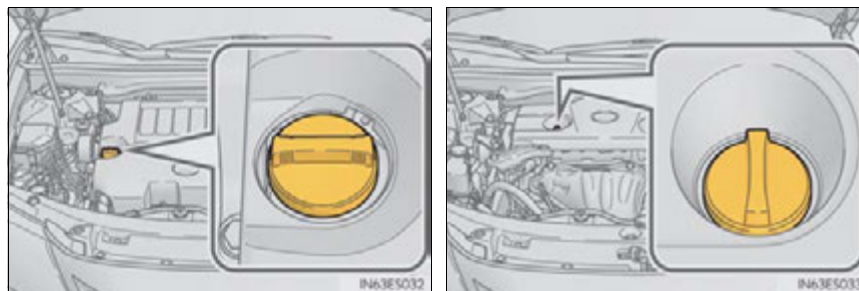

Make sure to check the oil type and prepare the items needed before adding oil.

Engine oil selection	→P. 838
Oil quantity (Low → Full)	1.6 qt. (1.5 L, 1.3 Imp.qt.)
Items	Clean funnel

- 1 Remove the oil filler cap by turning it counterclockwise.
- 2 Add engine oil slowly, checking the dipstick.
- 3 Install the oil filler cap by turning it clockwise.

### ■ Engine oil consumption

A certain amount of engine oil will be consumed while driving. In the following situations, oil consumption may increase, and engine oil may need to be refilled in between oil maintenance intervals.

- When the engine is new, for example directly after purchasing the vehicle or after replacing the engine
- If low quality oil or oil of an inappropriate viscosity is used
- When driving at high engine speeds or with a heavy load, or when driving while accelerating or decelerating frequently
- When leaving the engine idling for a long time, or when driving frequently through heavy traffic

### CAUTION

#### ■ Used engine oil

- Used engine oil contains potentially harmful contaminants which may cause skin disorders such as inflammation and skin cancer, so care should be taken to avoid prolonged and repeated contact. To remove used engine oil from your skin, wash thoroughly with soap and water.
- Dispose of used oil and filters only in a safe and acceptable manner. Do not dispose of used oil and filters in household trash, in sewers or onto the ground. Call your Lexus dealer, service station or auto parts store for information concerning recycling or disposal.
- Do not leave used engine oil within the reach of children.

 NOTICE**■ To prevent serious engine damage**

Check the oil level on a regular basis.

**■ When replacing the engine oil**

- Be careful not to spill engine oil on the vehicle components.
- Avoid overfilling, or the engine could be damaged.
- Check the oil level on the dipstick every time you refill the vehicle.
- Be sure the engine oil filler cap is properly tightened.

## Coolant

The coolant level is satisfactory if it is between the “FULL” and “LOW” lines on the reservoir when the engine <hybrid system> is cold.

### ■ Engine coolant reservoir

- ① Reservoir cap
- ② “FULL” line
- ③ “LOW” line

If the level is on or below the “LOW” line, add coolant up to the “FULL” line. (→P. 821, 824)

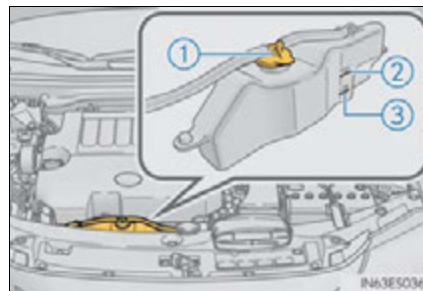

### ■ Power control unit coolant reservoir (hybrid vehicles)

- ① Reservoir cap
- ② “FULL” line
- ③ “LOW” line

If the level is on or below the “LOW” line, add coolant up to the “FULL” line. (→P. 824)

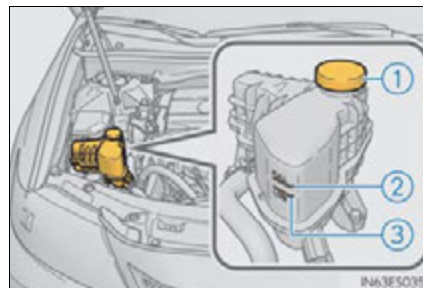

**■ Coolant selection**

Only use "Toyota Super Long Life Coolant" or a similar high quality ethylene glycol based non-silicate, non-amine, non-nitrite, and non-borate coolant with long-life hybrid organic acid technology.

U.S.A.:

"Toyota Super Long Life Coolant" is a mixture of 50% coolant and 50% deionized water. (Minimum temperature: -31°F [-35°C])

Canada:

"Toyota Super Long Life Coolant" is a mixture of 55% coolant and 45% deionized water. (Minimum temperature: -44°F [-42°C])

For more details about coolant, contact your Lexus dealer.

**■ If the coolant level drops within a short time of replenishing**

Visually check the radiator, hoses, engine/power control unit coolant reservoir caps, drain cock and water pump.

If you cannot find a leak, have your Lexus dealer test the cap and check for leaks in the cooling system.

**⚠ CAUTION****■ When the engine <hybrid system> is hot**

Do not remove the engine/power control unit coolant reservoir cap or the radiator cap.

The cooling system may be under pressure and may spray hot coolant if the cap is removed, causing serious injuries, such as burns.

**⚠ NOTICE****■ When adding coolant**

Coolant is neither plain water nor straight antifreeze. The correct mixture of water and antifreeze must be used to provide proper lubrication, corrosion protection and cooling. Be sure to read the antifreeze or coolant label.

**■ If you spill coolant**

Be sure to wash it off with water to prevent it from damaging parts or paint.

### Radiator and condenser

Check the radiator and condenser and clear away any foreign objects. If either of the above parts is extremely dirty or you are not sure of their condition, have your vehicle inspected by your Lexus dealer.

#### CAUTION

■ **When the engine <hybrid system> is hot**

Do not touch the radiator or condenser as they may be hot and cause serious injuries, such as burns.



## Brake fluid

### ■ Checking fluid level

The brake fluid level should be between the “MAX” and “MIN” lines on the tank.

#### ▶ Gasoline vehicles

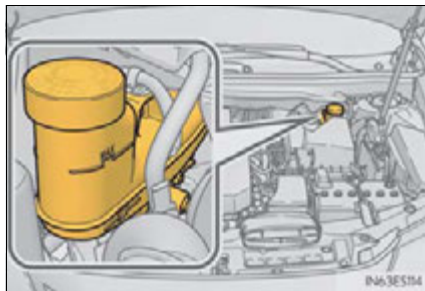

#### ▶ Hybrid vehicles

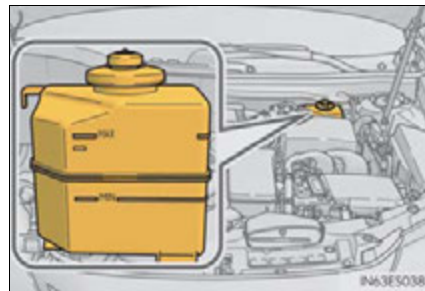

### ■ Adding fluid

Make sure to check the fluid type and prepare the necessary item.

Fluid type	FMVSS No.116 DOT 3 or SAE J1703 brake fluid
Items	Clean funnel

### ■ Brake fluid can absorb moisture from the air

Excess moisture in the brake fluid can cause a dangerous loss of braking efficiency. Use only newly opened brake fluid.

### ⚠ CAUTION

#### ■ When filling the reservoir

Take care as brake fluid can harm your hands and eyes and damage painted surfaces. If fluid gets on your hands or in your eyes, flush the affected area with clean water immediately. If you still experience discomfort, see a doctor.

 NOTICE

■ If the fluid level is low or high

It is normal for the brake fluid level to go down slightly as the brake pads wear out or when the fluid level in the accumulator is high.  
If the reservoir needs frequent refilling, there may be a serious problem.

### 12-volt battery (gasoline vehicles)

Check the 12-volt battery as follows.

■ 12-volt battery exterior

Make sure that the 12-volt battery terminals are not corroded and that there are no loose connections, cracks, or loose clamps.

- ① Terminals
- ② Hold-down clamp

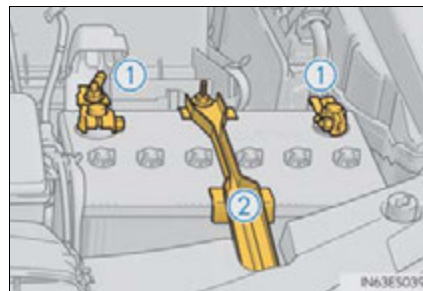

■ Checking 12-volt battery fluid

Check that the level is between the “UPPER LEVEL” and “LOWER LEVEL” lines.

- ① “UPPER LEVEL” line
- ② “LOWER LEVEL” line

If the fluid level is at or below the “LOWER LEVEL” line, add distilled water.

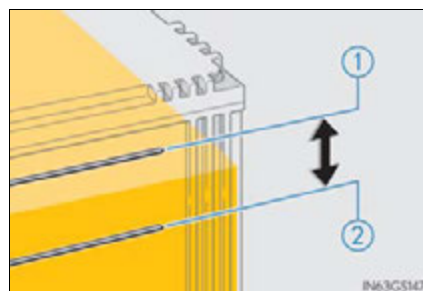

■ **Adding distilled water**

1 Remove the vent plug.

2 Add distilled water.

If the "UPPER LEVEL" line cannot be seen, check the fluid level by looking directly at the cell.

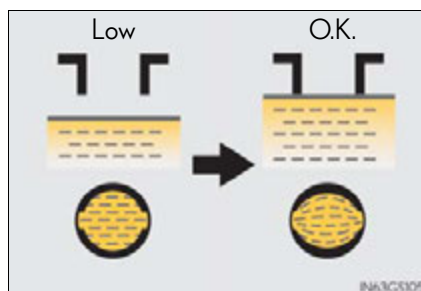

3 Put the vent plug back on and close it securely.

---

■ **Before recharging**

When recharging, the 12-volt battery produces hydrogen gas which is flammable and explosive. Therefore, observe the following before recharging:

- If recharging with the 12-volt battery installed on the vehicle, be sure to disconnect the ground cable.
- Make sure the power switch on the charger is off when connecting and disconnecting the charger cables to the 12-volt battery.

### ■ After recharging/reconnecting the 12-volt battery

The engine may not start. Follow the procedure below to initialize the system.

- 1 Shift the shift lever to P.
- 2 Open and close any of the doors.
- 3 Restart the engine.
  - Unlocking the doors using the smart access system with push-button start may not be possible immediately after reconnecting the 12-volt battery. If this happens, use the wireless remote control or the mechanical key to lock/unlock the doors.
  - Start the engine with the "START STOP ENGINE" switch in ACCESSORY mode. The engine may not start with the "START STOP ENGINE" switch turned off. However, the engine will operate normally from the second attempt.
  - The "START STOP ENGINE" switch mode is recorded by the vehicle. If the 12-volt battery is reconnected, the vehicle will return the "START STOP ENGINE" switch mode to the status it was in before the 12-volt battery was disconnected. Make sure to turn off the engine before disconnect the 12-volt battery. Take extra care when connecting the 12-volt battery if the "START STOP ENGINE" switch mode prior to discharge is unknown.

If the engine will not start even after multiple attempts, contact your Lexus dealer.

### ⚠ CAUTION

#### ■ Chemicals in the 12-volt battery

Batteries contain poisonous and corrosive sulfuric acid and may produce hydrogen gas which is flammable and explosive. To reduce the risk of death or serious injury, take the following precautions while working on or near the 12-volt battery:

- Do not cause sparks by touching the 12-volt battery terminals with tools.
- Do not smoke or light a match near the 12-volt battery.
- Avoid contact with eyes, skin and clothes.
- Never inhale or swallow electrolyte.
- Wear protective safety glasses when working near the 12-volt battery.
- Keep children away from the 12-volt battery.

 CAUTION**■ Where to safely charge the 12-volt battery**

Always charge the 12-volt battery in an open area. Do not charge the 12-volt battery in a garage or closed room where there is insufficient ventilation.

**■ How to recharge the 12-volt battery**

Only perform a slow charge (5 A or less). The 12-volt battery may explode if charged at a quicker rate.

**■ Emergency measures regarding electrolyte**

- If electrolyte gets in your eyes  
Flush your eyes with clean water for at least 15 minutes and get immediate medical attention. If possible, continue to apply water with a sponge or cloth while traveling to the nearest medical facility.
- If electrolyte gets on your skin  
Wash the affected area thoroughly. If you feel pain or burning, get medical attention immediately.
- If electrolyte gets on your clothes  
It can soak through clothing on to your skin. Immediately take off the clothing and follow the procedure above if necessary.
- If you accidentally swallow electrolyte  
Drink a large quantity of water or milk. Get emergency medical attention immediately.

 NOTICE**■ When recharging the 12-volt battery**

Never recharge the 12-volt battery while the engine is running. Also, be sure all accessories are turned off.

**■ When adding distilled water**

Avoid overfilling. Water spilled during 12-volt battery recharging may cause corrosion.

## Washer fluid

If any washer does not work or the warning message appears on the multi-information display, the washer tank may be empty. Add washer fluid.

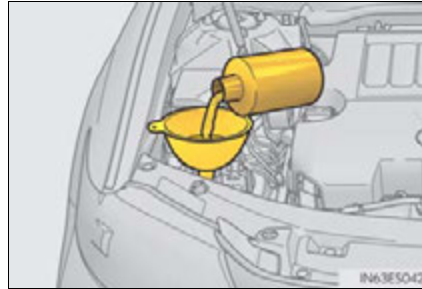

### ⚠ CAUTION

#### ■ When adding washer fluid

Do not add washer fluid when the engine <hybrid system> is hot or running <operating> as washer fluid contains alcohol and may catch fire if spilled on the engine etc.

### ⚠ NOTICE

#### ■ Do not use any fluid other than washer fluid

Do not use soapy water or engine antifreeze instead of washer fluid. Doing so may cause streaking on the vehicle's painted surfaces.

#### ■ Diluting washer fluid

Dilute washer fluid with water as necessary. Refer to the freezing temperatures listed on the label of the washer fluid bottle.

## 12-volt battery (hybrid vehicles)

### Location

The 12-volt battery is located on the right-hand side of luggage compartment.

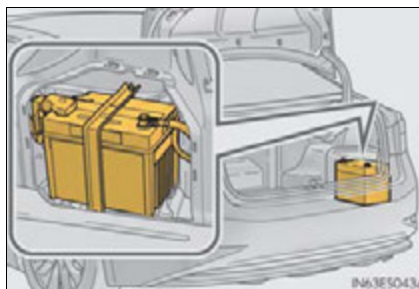

### Removing the 12-volt battery cover

Remove the 12-volt battery cover.

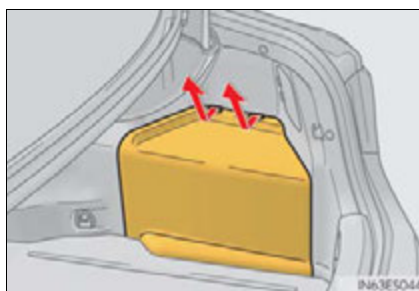

### Installing the 12-volt battery cover

- ① Install the cover
- ② Lift the tab to secure to the trunk liner

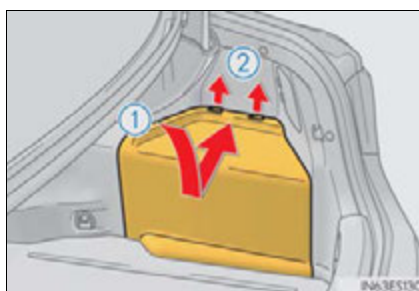

## Exterior

Make sure that the 12-volt battery terminals are not corroded and that there are no loose connections, cracks, or loose clamps.

- ① Terminals
- ② Hold-down clamp

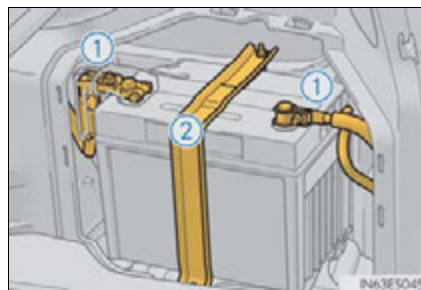

### ■ Before recharging

When recharging, the 12-volt battery produces hydrogen gas which is flammable and explosive. Therefore, observe the following precautions before recharging:

- If recharging with the 12-volt battery installed on the vehicle, be sure to disconnect the ground cable.
- Make sure the power switch on the charger is off when connecting and disconnecting the charger cables to the 12-volt battery.

### ■ After recharging/reconnecting the 12-volt battery

- The hybrid system may not start. Follow the procedure below to initialize the system.
  - 1 Shift the shift lever to P.
  - 2 Open and close any of the doors.
  - 3 Restart the hybrid system.
- Unlocking the doors using the smart access system with push-button start may not be possible immediately after reconnecting the 12-volt battery. If this happens, use the wireless remote control or the mechanical key to lock/unlock the doors.
- Start the hybrid system with the "POWER" switch in ACCESSORY mode. The hybrid system may not start with the "POWER" switch turned off. However, the hybrid system will operate normally from the second attempt.
- The "POWER" switch mode is recorded by the vehicle. If the 12-volt battery is reconnected, the vehicle will return the "POWER" switch mode to the status it was in before the 12-volt battery was disconnected. Make sure to turn off the "POWER" switch before disconnecting the 12-volt battery. Take extra care when connecting the 12-volt battery if the "POWER" switch mode prior to discharge is unknown.

If the system will not start even after multiple attempts at all methods above, contact your Lexus dealer.



 CAUTION

■ **Chemicals in the 12-volt battery**

The 12-volt battery contains poisonous and corrosive sulfuric acid and may produce hydrogen gas which is flammable and explosive. To reduce the risk of death or serious injury, take the following precautions while working on or near the 12-volt battery:

- Do not cause sparks by touching the 12-volt battery terminals with tools.
- Do not smoke or light a match near the 12-volt battery.
- Avoid contact with eyes, skin and clothes.
- Never inhale or swallow electrolyte.
- Wear protective safety glasses when working near the 12-volt battery.
- Keep children away from the 12-volt battery.

■ **Where to safely charge the 12-volt battery**

Always charge the 12-volt battery in an open area. Do not charge the 12-volt battery in a garage or closed room where there is insufficient ventilation.

■ **How to recharge the 12-volt battery**

Only perform a slow charge (5 A or less). The 12-volt battery may explode if charged at a quicker rate.

 CAUTION**■ Emergency measures regarding electrolyte**

- If electrolyte gets in your eyes  
Flush your eyes with clean water for at least 15 minutes and get immediate medical attention. If possible, continue to apply water with a sponge or cloth while traveling to the nearest medical facility.
- If electrolyte gets on your skin  
Wash the affected area thoroughly. If you feel pain or burning, get medical attention immediately.
- If electrolyte gets on your clothes  
It can soak through clothing on to your skin. Immediately take off the clothing and follow the procedure above if necessary.
- If you accidentally swallow electrolyte  
Drink a large quantity of water or milk. Get emergency medical attention immediately.

**■ When replacing the 12-volt battery**

Use a 12-volt battery designed for this vehicle. Failure to do so may cause gas (hydrogen) to enter the passenger compartment, causing a fire or explosion.

For replacement of the 12-volt battery, contact your Lexus dealer.

 NOTICE**■ When recharging the 12-volt battery**

Never recharge the 12-volt battery while the hybrid system is operating. Also, be sure all accessories are turned off.

## Tires

Replace or rotate tires in accordance with maintenance schedules and treadwear.

### Checking tires

- ① New tread
- ② Treadwear indicator
- ③ Worn tread

The location of treadwear indicators is shown by the "TWI" or "Δ" marks, etc., molded on the sidewall of each tire.

Check spare tire condition and pressure if not rotated.

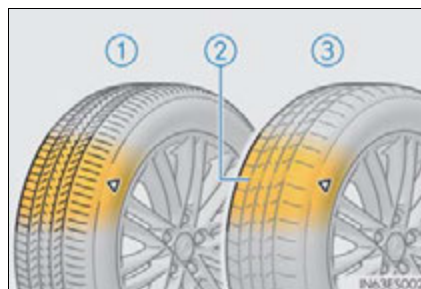

### Tire rotation

Rotate the tires in the order shown.

- ▶ Vehicles with compact spare tire
- ▶ Vehicles with full-size spare tire

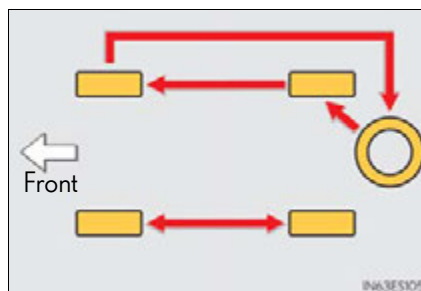
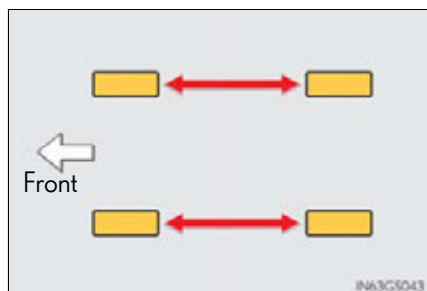

To equalize tire wear and extend tire life, Lexus recommends that tire rotation is carried out at the same interval as tire inspection.

Do not fail to initialize the tire pressure warning system after tire rotation.

### Tire pressure warning system

Your vehicle is equipped with a tire pressure warning system that uses tire pressure warning valves and transmitters to detect low tire inflation pressure before serious problems arise.

- If the tire pressure drops below a predetermined level, the driver is warned by a screen display and a warning light. (→P. 783)
- The tire pressure detected by the tire pressure warning system can be displayed on the multi-information display. (→P. 103)

#### ◆ Installing tire pressure warning valves and transmitters

When replacing tires or wheels, tire pressure warning valves and transmitters must also be installed.

When new tire pressure warning valves and transmitters are installed, new ID codes must be registered in the tire pressure warning computer and the tire pressure warning system must be initialized. Have tire pressure warning valve and transmitter ID codes registered by your Lexus dealer. (→P. 705)

#### ◆ Initializing the tire pressure warning system

- The tire pressure warning system must be initialized in the following circumstances:
  - When rotating the tires.
  - When the tire inflation pressure is changed such as when changing traveling speed or load weight.

When the tire pressure warning system is initialized, the current tire inflation pressure is set as the benchmark pressure.

**■ How to initialize the tire pressure warning system**

- 1** Park the vehicle in a safe place and turn the “START STOP ENGINE” <“POWER”> switch off.

Initialization cannot be performed while the vehicle is moving.

- 2** Adjust the tire inflation pressure to the specified cold tire inflation pressure level. (→P. 844)

Make sure to adjust the tire pressure to the specified cold tire inflation pressure level. The tire pressure warning system will operate based on this pressure level.

- 3** Turn the “START STOP ENGINE” <“POWER”> switch to IGNITION ON <ON> mode.

- 4** Press and hold the tire pressure warning reset switch until the tire pressure warning light blinks slowly 3 times.

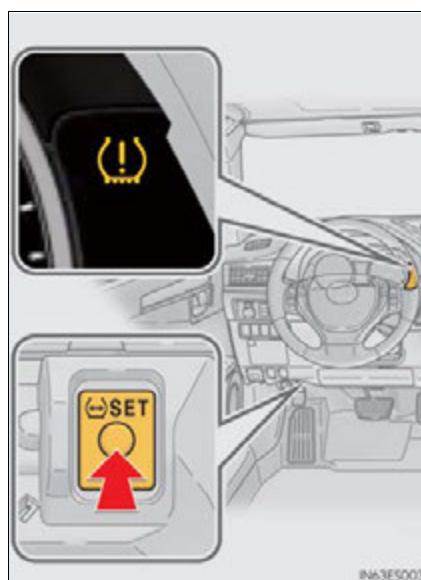

- 5** Wait for a few minutes with the “START STOP ENGINE” <“POWER”> switch in IGNITION ON <ON> mode and then turn the “START STOP ENGINE” <“POWER”> switch off.

---

### ◆ Registering ID codes

---

The tire pressure warning valve and transmitter is equipped with a unique ID code. When replacing a tire pressure warning valve and transmitter, it is necessary to register the ID code. Have the ID code registered by your Lexus dealer.

---

#### ■ When to replace your vehicle's tires

Tires should be replaced if:

- You have tire damage such as cuts, splits, cracks deep enough to expose the fabric, and bulges indicating internal damage
- A tire goes flat repeatedly or cannot be properly repaired due to the size or location of a cut or other damage

If you are not sure, consult with your Lexus dealer.

#### ■ Replacing tires and wheels

If the ID code of the tire pressure warning valve and transmitter is not registered, the tire pressure warning system will not work properly. After driving for about 20 minutes, the tire pressure warning light blinks for 1 minute and stays on to indicate a system malfunction.

#### ■ Tire life

Any tire over 6 years old must be checked by a qualified technician even if it has seldom or never been used or damage is not obvious.

#### ■ Routine tire inflation pressure checks

The tire pressure warning system does not replace routine tire inflation pressure checks. Make sure to check tire inflation pressure as part of your routine of daily vehicle checks.

#### ■ When rotating the tires

Make sure that the "START STOP ENGINE" <"POWER"> switch is off. If the tires are rotated while the "START STOP ENGINE" <"POWER"> switch is in IGNITION ON <ON> mode, the tire position information will not be updated.

If this accidentally occurs, either turn the "START STOP ENGINE" <"POWER"> switch to off and then to IGNITION ON <ON> mode, or initialize the system after checking that the tire pressure is properly adjusted.

#### ■ Low profile tires (P225/45R18 tires)

Generally, low profile tires will wear more rapidly and tire grip performance will be reduced on snowy and/or icy roads when compared to standard tires. Be sure to use snow tires or tire chains on snowy and/or icy roads and drive carefully at a speed appropriate for road and weather conditions.

#### ■ Maximum load of tire

Check that the maximum load of the replacement tire is greater than 1/2 of the Gross Axle Weight Ratings (GAWR) of either the front axle or the rear axle, whichever is greater.

For the GAWR, see the Certification Label. For the maximum load of the tire, see the load limit at maximum cold tire inflation pressure mentioned on the sidewall of the tire. (→P. 850)

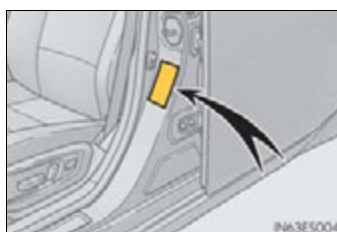

#### ■ Tire types

##### ● Summer tires

Summer tires are high-speed performance tires best suited to highway driving under dry conditions. Since summer tires do not have the same traction performance as snow tires, summer tires are inadequate for driving on snow-covered or icy roads. For driving on snow-covered roads or icy roads, the use of snow tires is recommended. When installing snow tires, be sure to replace all four tires.

##### ● All season tires

All season tires are designed to provide better traction in snow and to be adequate for driving in most winter conditions as well as for use year-round. All season tires, however, do not have adequate traction performance compared with snow tires in heavy or loose snow. Also, all season tires fall short in acceleration and handling performance compared with summer tires in highway driving.

##### ● Snow tires

For driving on snow-covered roads or icy roads, we recommend using snow tires. If you need snow tires, select tires of the same size, construction and load capacity as the originally installed tires. Since your vehicle has radial tires as original equipment, make sure your snow tires also have radial construction. Do not install studded tires without first checking local regulations for possible restrictions. Snow tires should be installed on all wheels. (→P. 330)

**■ If the tread on snow tires wears down below 0.16 in. (4 mm)**

The effectiveness of the tires as snow tires is lost.

**■ Situations in which the tire pressure warning system may not operate properly**

- In the following cases, the tire pressure warning system may not operate properly.
  - If non-genuine Lexus wheels are used.
  - A tire has been replaced with a tire that is not an OE (Original Equipment) tire.
  - A tire has been replaced with a tire that is not of the specified size.
  - Tire chains etc. are equipped.
  - Lock nuts are equipped.
  - An auxiliary-supported run-flat tire is equipped.
  - If a window tint that affects the radio wave signals is installed.
  - If there is a lot of snow or ice on the vehicle, particularly around the wheels or wheel housings.
  - If the tire inflation pressure is extremely higher than the specified level.
  - If the spare tire is in a location subject to poor radio wave signal reception.\*
  - If a large metallic object which can interfere with signal reception is put in the trunk.\*

\*: Vehicles with a full-size spare tire only

- Performance may be affected in the following situations.
  - Near a TV tower, electric power plant, gas station, radio station, large display, airport or other facility that generates strong radio waves or electrical noise
  - When carrying a portable radio, cellular phone, cordless phone or other wireless communication deviceIf tire position information is not correctly displayed due to the radio wave conditions, the display may be corrected by driving and changing the radio wave conditions.
- When the vehicle is parked, the time taken for the warning to start or go off could be extended.
- When tire inflation pressure declines rapidly for example when a tire has burst, the warning may not function.



**■ The initialization operation**

- Make sure to carry out initialization after adjusting the tire inflation pressure. Also, make sure the tires are cold before carrying out initialization or tire inflation pressure adjustment.
- If you have accidentally turned the "START STOP ENGINE" <"POWER"> switch off during initialization, it is not necessary to press the reset switch again as initialization will restart automatically when the "START STOP ENGINE" <"POWER"> switch has been turned to IGNITION ON <ON> mode for the next time.
- If you accidentally press the reset switch when initialization is not necessary, adjust the tire inflation pressure to the specified level when the tires are cold, and conduct initialization again.

**■ When initialization of the tire pressure warning system has failed**

Initialization can be completed in a few minutes. However, in the following cases, the settings have not been recorded and the system will not operate properly. If repeated attempts to record tire inflation pressure settings are unsuccessful, have the vehicle inspected by your Lexus dealer.

- When operating the tire pressure warning reset switch, the tire pressure warning light does not blink 3 times.
- After carrying out the initialization procedure, the tire pressure warning light blinks for 1 minute then stays on after driving for 20 minutes.

**■ Tire pressure warning system certification**

MODEL/FCC IDs:

Transmitter: PAXPMVC010

Initiator: HYQ22AAA

► For vehicles sold in the U.S.A.

Note:

This device complies with part 15 of the FCC Rules. Operation is subject to the following two conditions: (1) This device may not cause harmful interference, and (2) this device must accept any interference received, including interference that may cause undesired operation.

FCC WARNING:

Changes or modifications not expressly approved by the party responsible for compliance could void the user's authority to operate the equipment.

► For vehicles sold in Canada

**● Transmitter**

NOTE:

Operation is subject to the following two conditions: (1) this device may not cause interference, and (2) this device must accept any interference, including interference that may cause undesired operation of the device.

**● Initiator**

Note:

This device complies with Industry Canada licence-exempt RSS standard(s). Operation is subject to the following two conditions: (1) this device may not cause interference, and (2) this device must accept any interference, including interference that may cause undesired operation of the device.

**⚠ CAUTION****■ When inspecting or replacing tires**

Observe the following precautions to prevent accidents. Failure to do so may cause damage to parts of the drive train as well as dangerous handling characteristics, which may lead to an accident resulting in death or serious injury.

- Do not mix tires of different makes, models or tread patterns.  
Also, do not mix tires of remarkably different treadwear.
- Do not use tire sizes other than those recommended by Lexus.
- Do not mix differently constructed tires (radial, bias-belted or bias-ply tires).
- Do not mix summer, all season and snow tires.
- Do not use tires that have been used on another vehicle.  
Do not use tires if you do not know how they were used previously.
- Do not tow if your vehicle has a compact spare tire (if equipped) installed.

**■ When initializing the tire pressure warning system**

Do not operate the tire pressure warning reset switch without first adjusting the tire inflation pressure to the specified level. Otherwise, the tire pressure warning light may not come on even if the tire inflation pressure is low, or it may come on when the tire inflation pressure is actually normal.

**■ Caution regarding interference with electronic devices**

- People with implantable cardiac pacemakers, cardiac resynchronization therapy-pacemakers or implantable cardioverter defibrillators should not come within 17.7 in. (450 mm) of the tire pressure warning system initiators. The radio waves may affect the operation of such devices.



- Users of any electrical medical device other than implantable cardiac pacemakers, cardiac resynchronization therapy-pacemakers or implantable cardioverter defibrillators should consult the manufacturer of the device for information about its operation under the influence of radio waves.  
Radio waves could have unexpected effects on the operation of such medical devices.

 NOTICE**■ Repairing or replacing tires, wheels, tire pressure warning valves, transmitters and tire valve caps**

- When removing or fitting the wheels, tires or the tire pressure warning valves and transmitters, contact your Lexus dealer as the tire pressure warning valves and transmitters may be damaged if not handled correctly.
- Make sure to install the tire valve caps. If the tire valve caps are not installed, water could enter the tire pressure warning valves and the tire pressure warning valves could be bound.
- When replacing tire valve caps, do not use tire valve caps other than those specified. The cap may become stuck.

**■ To avoid damage to the tire pressure warning valves and transmitters**

When a tire is repaired with liquid sealants, the tire pressure warning valve and transmitter may not operate properly. If a liquid sealant is used, contact your Lexus dealer or other qualified service shop as soon as possible. Make sure to replace the tire pressure warning valve and transmitter when replacing the tire. (→P. 703)

**■ Driving on rough roads**

Take particular care when driving on roads with loose surfaces or potholes. These conditions may cause losses in tire inflation pressure, reducing the cushioning ability of the tires. In addition, driving on rough roads may cause damage to the tires themselves, as well as the vehicle's wheels and body.

**■ Low profile tires (P225/45R18 tires)**

Low profile tires may cause greater damage than usual to the tire wheel when sustaining impact from the road surface. Therefore, pay attention to the following:

- Be sure to use proper tire inflation pressure. If tires are under-inflated, they may be damaged more severely.
- Avoid potholes, uneven pavement, curbs and other road hazards. Failure to do so may lead to severe tire and wheel damage.

**■ If tire inflation pressure of each tire becomes low while driving**

Do not continue driving, or your tires and/or wheels may be ruined.

## Tire inflation pressure

### Tire inflation pressure

The recommended cold tire inflation pressure and tire size are displayed on the tire and loading information label. (→P. 844)

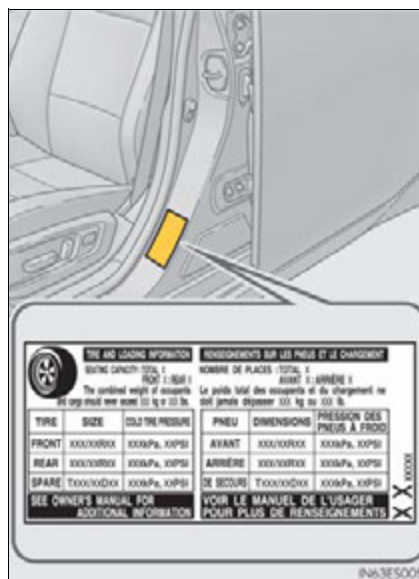

### Inspection and adjustment procedure

- ① Tire valve
- ② Tire pressure gauge

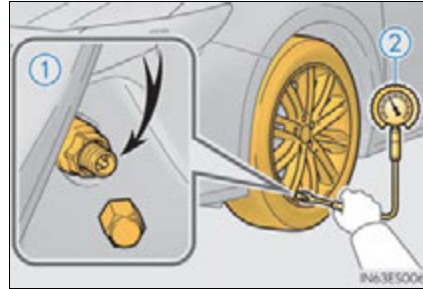

- 1 Remove the tire valve cap.
- 2 Press the tip of the tire pressure gauge onto the tire valve.
- 3 Read the pressure using the gauge gradations.
- 4 If the tire inflation pressure is not at the recommended level, adjust the pressure.  
If you add too much air, press the center of the valve to deflate.
- 5 After completing the tire inflation pressure measurement and adjustment, apply soapy water to the valve and check for leakage.
- 6 Put the tire valve cap back on.

#### ■ Tire inflation pressure check interval

You should check tire inflation pressure every two weeks, or at least once a month. Do not forget to check the spare.

#### ■ Effects of incorrect tire inflation pressure

Driving with incorrect tire inflation pressure may result in the following:

- Reduced fuel efficiency
- Reduced driving comfort and tire life
- Reduced safety
- Damage to the drive train

If a tire needs frequent inflating, have it checked by your Lexus dealer.

■ **Instructions for checking tire inflation pressure**

When checking tire inflation pressure, observe the following:

- Check only when the tires are cold.  
If your vehicle has been parked for at least 3 hours or has not been driven for more than 1 mile or 1.5 km, you will get an accurate cold tire inflation pressure reading.
- Always use a tire pressure gauge.  
The appearance of the tire can be misleading. In addition, tire inflation pressure that is even just a few pounds off can affect ride quality and handling.
- Do not reduce tire inflation pressure after driving. It is normal for tire inflation pressure to be higher after driving.
- Never exceed the vehicle capacity weight.  
Passengers and luggage weight should be placed so that the vehicle is balanced.

 **CAUTION**

■ **Proper inflation is critical to save tire performance**

Keep your tires properly inflated. Otherwise, the following conditions may occur and result in an accident causing death or serious injury:

- Excessive wear
- Uneven wear
- Poor handling
- Possibility of blowouts resulting from overheated tires
- Poor sealing of the tire bead
- Wheel deformation and/or tire separation
- A greater possibility of tire damage from road hazards

 **NOTICE**

■ **When inspecting and adjusting tire inflation pressure**

Be sure to put the tire valve caps back on.  
Without the valve caps, dirt or moisture could get into the valve and cause air leakage, which could result in an accident. If the caps are lost, replace them as soon as possible.

## Wheels

If a wheel is bent, cracked or heavily corroded, it should be replaced. Otherwise, the tire may separate from the wheel or cause a loss of handling control.

### Wheel selection

When replacing wheels, care should be taken to ensure that they are equivalent to those removed in load capacity, diameter, rim width and inset\*.

Replacement wheels are available at your Lexus dealer.

\*: Conventionally referred to as "offset".

Lexus does not recommend using the following:

- Wheels of different sizes or types
- Used wheels
- Bent wheels that have been straightened

### Aluminum wheel precautions

- Use only Lexus wheel nuts and wrenches designed for use with your aluminum wheels.
- When rotating, repairing or changing your tires, check that the wheel nuts are still tight after driving 1000 miles (1600 km).
- Be careful not to damage the aluminum wheels when using tire chains.
- Use only Lexus genuine balance weights or equivalent and a plastic or rubber hammer when balancing your wheels.



**■ When replacing wheels**

The wheels of your vehicle are equipped with tire pressure warning valves and transmitters that allow the tire pressure warning system to provide advance warning in the event of a loss in tire inflation pressure. Whenever wheels are replaced, tire pressure warning valves and transmitters must be installed. (→P. 703)

**⚠ CAUTION****■ When replacing wheels**

- Do not use wheels that are a different size from those recommended in the Owner's Manual, as this may result in a loss of handling control.
- Never use an inner tube in a leaking wheel which is designed for a tubeless tire. Doing so may result in an accident, causing death or serious injury.

**■ Use of defective wheels prohibited**

Do not use cracked or deformed wheels.  
Doing so could cause the tire to leak air during driving, possibly causing an accident.

**⚠ NOTICE****■ Replacing tire pressure warning valves and transmitters**

- Because tire repair or replacement may affect the tire pressure warning valves and transmitters, make sure to have tires serviced by your Lexus dealer or other qualified service shop. In addition, make sure to purchase your tire pressure warning valves and transmitters at your Lexus dealer.
- Ensure that only genuine Lexus wheels are used on your vehicle.  
Tire pressure warning valves and transmitters may not work properly with non-genuine wheels.

## Air conditioning filter

The air conditioning filter must be changed regularly to maintain air conditioning efficiency.

### Removal method

- 1 Turn the "START STOP ENGINE" <"POWER"> switch off.
- 2 Open the glove box. Lift and remove the partition.

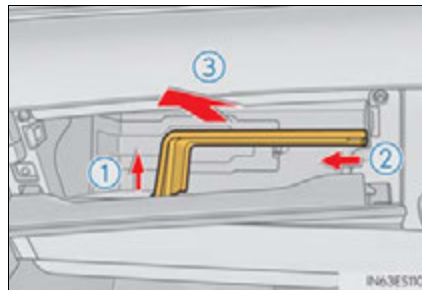

- 3 Remove the glove box cover.

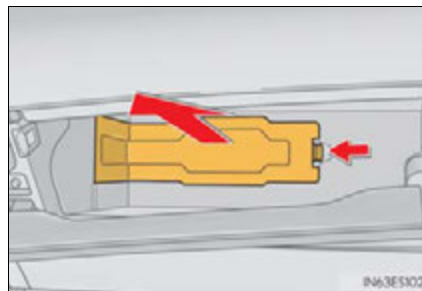

- 4 Remove the filter cover.

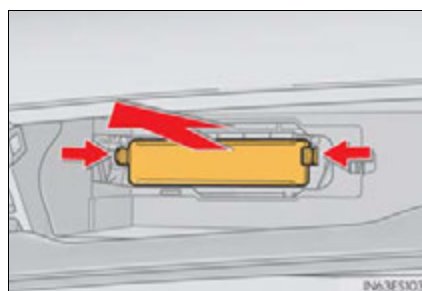

- 5 Slide and pull out the filter. Replace it with a new one. The “↑UP” marks shown on the filter should be pointing up.

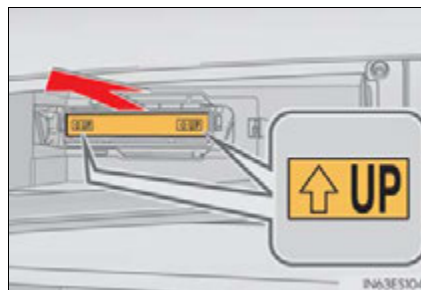

■ **Changing interval**

Inspect and replace the air conditioning filter according to the maintenance schedule. In dusty areas or areas with heavy traffic flow, early replacement may be required. (For scheduled maintenance information, please refer to the “Owner’s Manual Supplement” or “Scheduled Maintenance”.)

■ **If air flow from the vents decreases dramatically**

The filter may be clogged. Check the filter and replace if necessary.

 **NOTICE**

■ **When using the air conditioning system**

Make sure that a filter is always installed.  
Using the air conditioning system without a filter may cause damage to the system.

## Electronic key battery

Replace the battery with a new one if it is depleted.

### You will need the following items:

- Flathead screwdriver
- Small flathead screwdriver
- Lithium battery CR2032

### Replacing the battery

- 1 Take out the mechanical key.

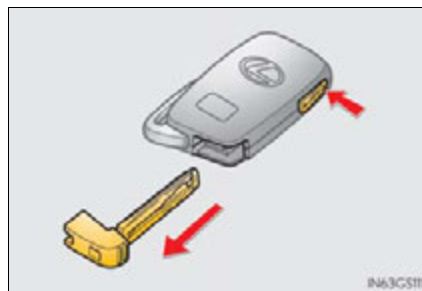

- 2 Remove the cover.

To prevent damage to the key, cover the tip of the screwdriver with a rag.

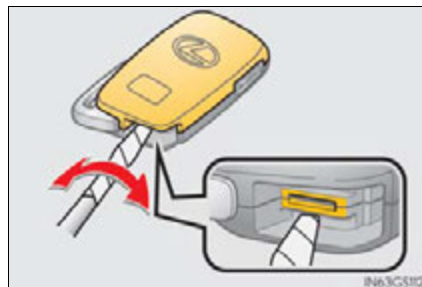

- 3 Remove the depleted battery.

Insert a new battery with the "+" terminal facing up.

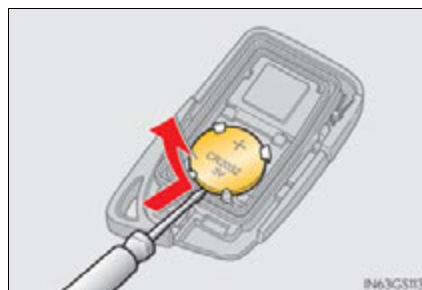

■ **Use a CR2032 lithium battery**

- Batteries can be purchased at your Lexus dealer, local electrical appliance shops or camera stores.
- Replace only with the same or equivalent type recommended by the manufacturer.
- Dispose of used batteries according to local laws.

■ **If the electronic key battery is depleted**

The following symptoms may occur:

- The smart access system with push-button start and wireless remote control will not function properly.
- The operational range will be reduced.

 **CAUTION**

■ **Removed battery and other parts**

These parts are small and if swallowed by a child, they can cause choking. Keep away from children. Failure to do so could result in death or serious injury.

 **NOTICE**

■ **For normal operation after replacing the battery**

Observe the following precautions to prevent accidents:

- Always work with dry hands.  
Moisture may cause the battery to rust.
- Do not touch or move any other component inside the remote control.
- Do not bend either of the battery terminals.

## Checking and replacing fuses

If any of the electrical components do not operate, a fuse may have blown. If this happens, check and replace the fuses as necessary.

- 1 Turn the "START STOP ENGINE" <"POWER"> switch off.
- 2 After a system failure, see "Fuse layout and amperage ratings" for details about which fuse to check. (→P. 724)
- 3 Open the Fuse box cover.
  - ▶ Engine compartment (type A fuse box)

Push the tab in and lift the lid off.

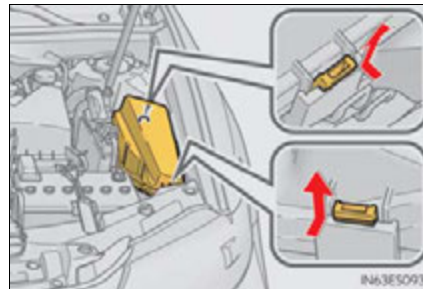

- ▶ Engine compartment (type B fuse box) (hybrid vehicles only)

Push the tab in and lift the lid off.

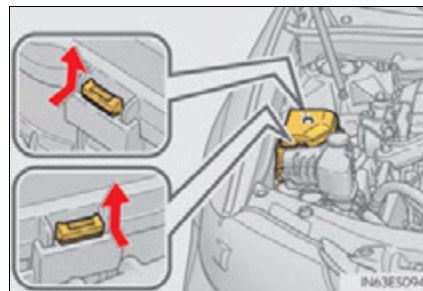

▶ Driver's side instrument panel

Remove the lid.

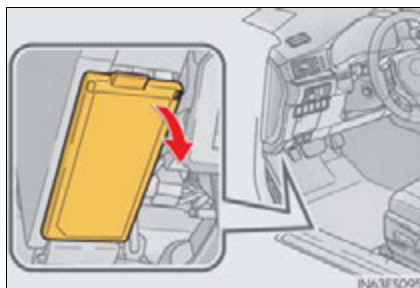

**4** Remove the fuse with the pullout tool.

Only type A fuse can be removed using the pullout tool.



**5** Check if the fuse is blown.

- ① Normal fuse
- ② Blown fuse

Type A and B:

Replace the blown fuse with a new fuse of an appropriate amperage rating. The amperage rating can be found on the fuse box lid.

Type C:

Contact your Lexus dealer.

## ▶ Type A

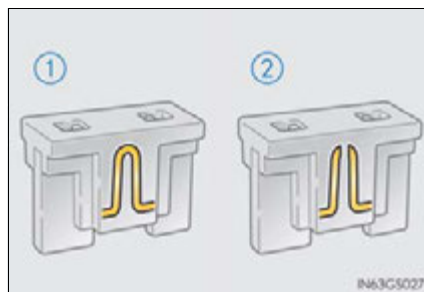

## ▶ Type B

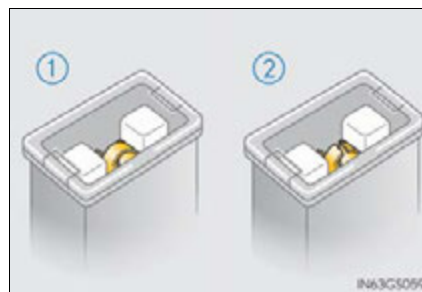

## ▶ Type C

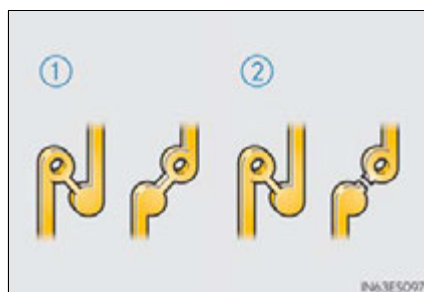



### Fuse layout and amperage ratings

■ Engine compartment (type A fuse box)

- Fuse block

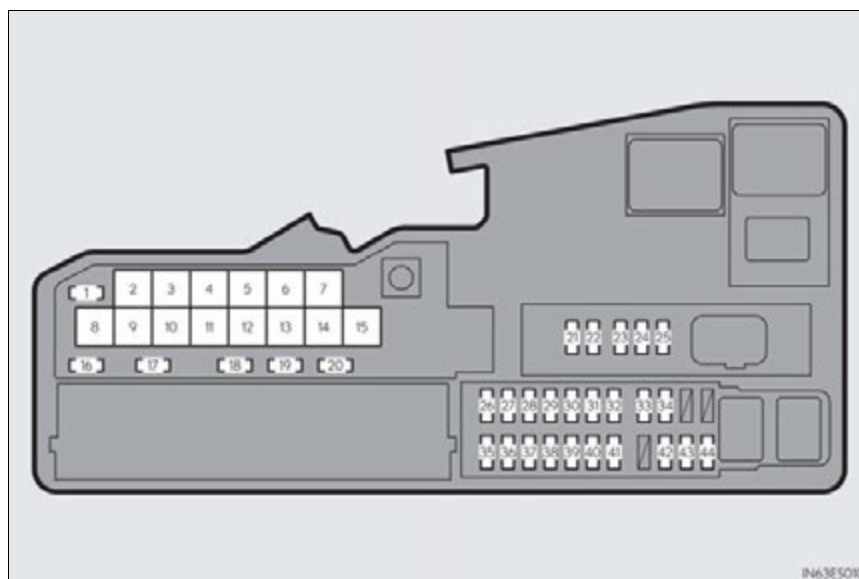

- Fuse block on the back of the cover

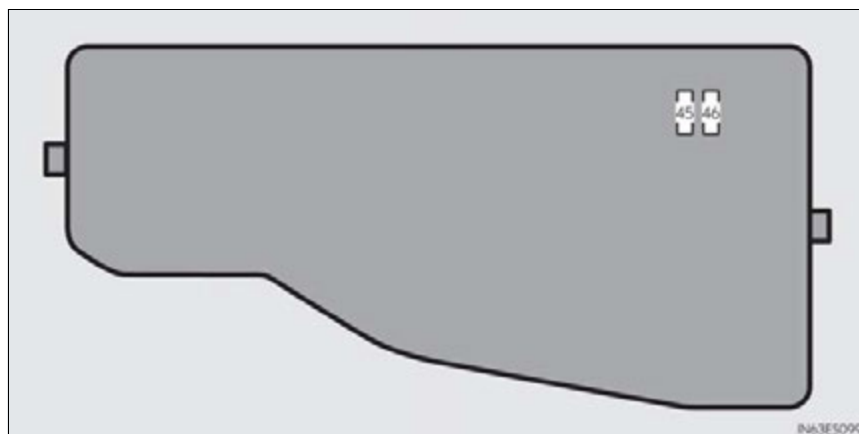

Fuse		Ampere	Circuit
1	WIP-S	5	Driver support system, windshield wipers
2	FAN	50	Electric cooling fan
3	H-LP CLN	30	No circuit
4	ENG W/PMP*1	30	Cooling system
5	PTC HTR NO.2	50	PTC heater
6	PTC HTR NO.1	50	PTC heater
7	HTR	50	Air conditioning system
8	ALT*2	140	Charging system
	DC/DC*1	120	Hybrid system
9	ABS NO.2*2	30	VSC, ABS
10	ST/AM2*2	30	Starting system
	ABS NO.1*1	30	VSC, ABS
11	H-LP-MAIN	30	H-LP RH-LO, H-LP LH-LO
12	ABS MTR NO.2*1	50	VSC, ABS
13	ABS NO.1*2	50	VSC, ABS
	ABS MTR NO.1*1	50	VSC, ABS
14	R/B NO.2*1	50	IGCT MAIN, INV W/PMP
15	EPS	80	Electric power steering
16	S-HORN	7.5	S-HORN
17	DEICER	15	Windshield wiper de-icer
18	HORN	10	Horn
19	TV	15	Multi-information display, audio display, Remote Touch, audio system, gauges and meters
20	AMP NO.2	30	Audio system
21	EFI NO.2	15	Multipoint fuel injection system, sequential multipoint fuel system, electronic controlled transmission

Fuse		Ampere	Circuit
22	EFI NO.3	10*2	Multiport fuel injection system, sequential multiport fuel system, air intake system, exhaust system
		7.5*1	Multiport fuel injection system, sequential multiport fuel system, air intake system
23	INJ	7.5	Multiport fuel injection system, sequential multiport fuel system
24	ECU-IG2 NO.3	7.5	Multiport fuel injection system, sequential multiport fuel system, electronic controlled transmission, power management system, steering lock system, cruise control system
25	IGN	15	Starting system
26	D/L-AM2	25	Power door lock system
27	IG2-MAIN	25	INJ, IGN
28	ALT-S*2	7.5	Charging system
	DC/DC-S*1	7.5	Hybrid system
29	MAYDAY	5	MAYDAY
30	TURN&HAZ	15	Turn signal lights, emergency flashers
31	STRG LOCK	10	Steering lock system
32	AMP	30	Audio system
33	H-LP LH-LO	15	Left-hand headlight
34	H-LP RH-LO	15	Right-hand headlight
35	EFI-MAIN NO.1	30	EFI NO.2, EFI NO.3, fuel system
36	SMART	5	Smart access system with push-button start, occupant classification system
37	ETCS	10	Multiport fuel injection system, sequential multiport fuel system
38	ABS NO.2*1	7.5	VSC, ABS
39	EFI NO.1	7.5	Multiport fuel injection system, sequential multiport fuel system, electronic controlled transmission

Fuse		Ampere	Circuit
40	A/F*2	20	Air intake system
	EFI-MAIN NO.2*1	20	Fuel system, air intake system, exhaust system
41	AM2	7.5	Power management system, smart access system with push-button start
42	PANEL	10	Switch illumination, audio system, multi-information display, audio display, shift lever light, glove box light, console box light, Remote Touch, intuitive parking assist switch illumination
43	DOME	7.5	Clock, footwell lights, vanity lights, ornament lights, personal lights, door courtesy lights, outer foot lights
44	ECU-B NO.1	10	Smart access system with push-button start, main body ECU, steering sensor, gauges and meters, gateway ECU, electric tilt and telescopic steering column, power seats, overhead module, outside mirror control ECU, power trunk opener and closer ECU
45	SPARE	25	Spare fuse
46	SPARE	30	Spare fuse

\*1: Hybrid vehicles

\*2: Gasoline vehicles

■ Engine compartment (type B fuse box) (hybrid vehicles only)

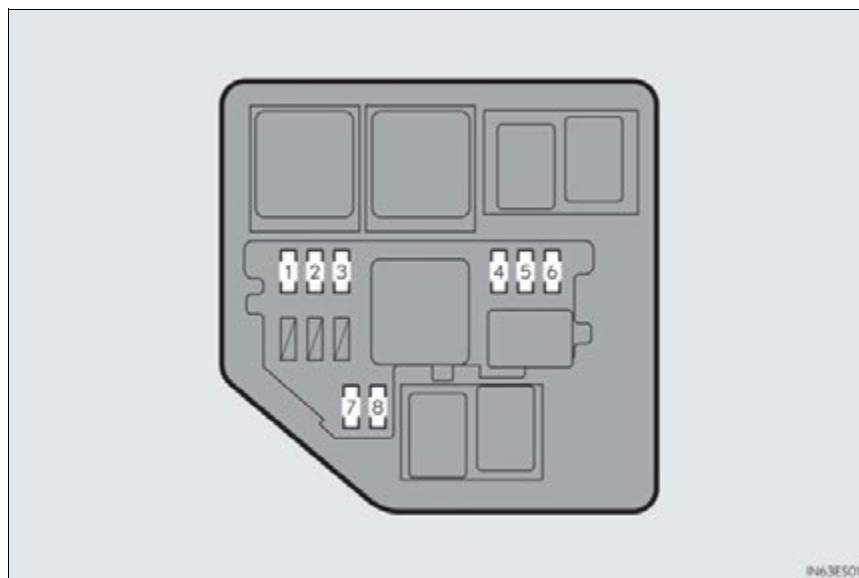

Fuse		Ampere	Circuit
1	BATT FAN	7.5	Battery cooling fan
2	INV W/PMP RLY	7.5	INV W/PMP RLY
3	DC/DC IGCT	10	Hybrid system
4	INV	7.5	Hybrid system
5	BATT VL SSR	10	Hybrid system
6	PM IGCT	7.5	Power management system, hybrid system
7	IGCT-MAIN	25	INV W/PMP RLY, INV, DC/DC IGCT, BATT VL SSR, PM IGCT, BATT FAN
8	INV W/PMP	15	Hybrid system

### ■ Driver's side instrument panel

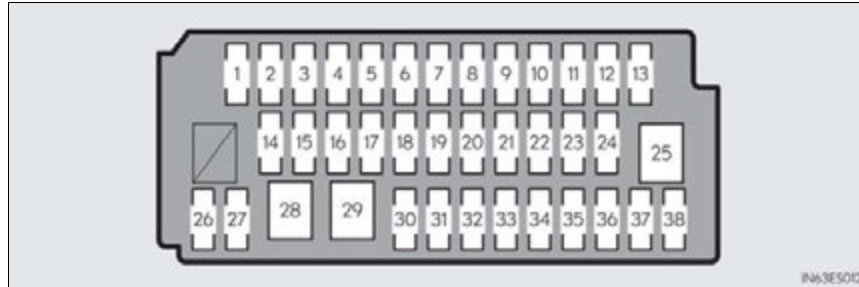

Fuse		Ampere	Circuit
1	ECU-IG1NO.2	10	Main body ECU, audio system, shift lock system, outside mirror control ECU, tension reducer, windshield wipers, heated steering wheel, multi-information display, audio display, intuitive parking assist, tire pressure warning system, moon roof, auto anti-glare inside rear view mirror, raindrop sensor, rear sunshade, wireless door lock system, power trunk opener and closer ECU
2	ECU-IG1NO.1	10	Electric cooling fan, windshield wiper deicer, VSC, ABS, charging system, steering sensor, electronic controlled transmission, electric power steering, gateway ECU, electric tilt and telescopic steering column
3	PANEL NO.2	5	Clock
4	TAIL	15	Parking lights, side marker lights, license plate lights
5	DOOR F/R	20	Power window, outside mirror control ECU
6	DOOR R/R	20	Power window
7	DOOR F/L	20	Power window, outside mirror control ECU
8	DOOR R/L	20	Power window
9	H-LP LVL	7.5	Automatic headlight leveling system
10	WASHER	10	Windshield washer
11	A/C-IG1	7.5	Air conditioning system, PTC heater, gauges and meters, seat heaters and ventilators

	Fuse	Ampere	Circuit
12	WIPER	25	Windshield wipers
13	BKUP LP	7.5	Multiport fuel injection system, sequential multiport fuel system, electronic controlled transmission, audio system, navigation system, back-up lights
14	FUEL OPN	10	Fuel filler door opener
15	EPS-IG1	10	Electric power steering
16	P/OUTLET RR	15	Power outlet
17	RADIO-ACC	5	Audio system, Remote Touch, multi-information display, audio display, navigation system
18	S/HTR&FAN F/R	10	Seat heaters and ventilators
19	S/HTR&FAN F/L	10	Seat heaters and ventilators
20	OBD	7.5	On-Board diagnosis system
21	ECU-B NO.2	10	Power window master switch, air conditioning system, smart access system with push-button start, tire pressure warning system, rear sunshade
22	STRG HTR	10	Heated steering wheel
23	PTL	25	Power trunk opener and closer ECU
24	STOP	7.5	Power management system, multiport fuel injection system, sequential multiport fuel system, VSC, ABS, electronic controlled transmission, driver support system, engine room junction block assy, tail lights, high mounted stoplight, smart access system with push-button start, shift lock system
25	P/SEAT F/L	30	Power seats
26	A/C-B	7.5	Air conditioning system
27	S/ROOF	10	Moon roof
28	P/SEAT F/R	30	Power seats
29	PSB	30	Pre-collision seat belt
30	D/L-AM1	20	Main body ECU, power door lock system

	Fuse	Ampere	Circuit
31	TI&TE	20	Electric tilt and telescopic steering column
32	A/B	10	Occupant classification system, SRS airbag system
33	ECU-IG2 NO.1	7.5	Gauges and meters
34	ECU-IG2 NO.2	7.5	VSC, ABS, gateway ECU, smart access system with push-button start
35	CIG& P/OUTLET	15	Power outlet
36	ECU-ACC	7.5	Main body ECU, gauges and meters, outside rear view mirrors
37	ECU-IG1 NO.3	10	Intuitive parking assist, driver support system, skid control buzzer, Blind Spot Monitor, radar sensor
38	S/HTR RR	20	No circuit



■ **After a fuse is replaced**

- If the lights do not turn on even after the fuse has been replaced, a bulb may need replacement. (→P.733)
- If the replaced fuse blows again, have the vehicle inspected by your Lexus dealer.

■ **If there is an overload in a circuit**

The fuses are designed to blow, protecting the wiring harness from damage.

■ **When replacing light bulbs**

Lexus recommends that you use genuine Lexus products designed for this vehicle. Because certain bulbs are connected to circuits designed to prevent overload, non-genuine parts or parts not designed for this vehicle may be unusable.

 **CAUTION**

■ **To prevent system breakdowns and vehicle fire**

Observe the following precautions.

Failure to do so may cause damage to the vehicle, and possibly a fire or injury.

- Never use a fuse of a higher amperage rating than that indicated, or use any other object in place of a fuse.
- Always use a genuine Lexus fuse or equivalent.  
Never replace a fuse with a wire, even as a temporary fix.
- Do not modify the fuses or fuse boxes.

 **NOTICE**

■ **Before replacing fuses**

Have the cause of electrical overload determined and repaired by your Lexus dealer as soon as possible.

## Light bulbs

You may replace the following bulbs by yourself. The difficulty level of replacement varies depending on the bulb. If necessary bulb replacement seems difficult to perform, contact your Lexus dealer.

For more information about replacing other light bulbs, contact your Lexus dealer.

### Preparing for light bulb replacement

Check the wattage of the light bulb to be replaced. (→P. 846)

### Bulb locations

#### ■ Front

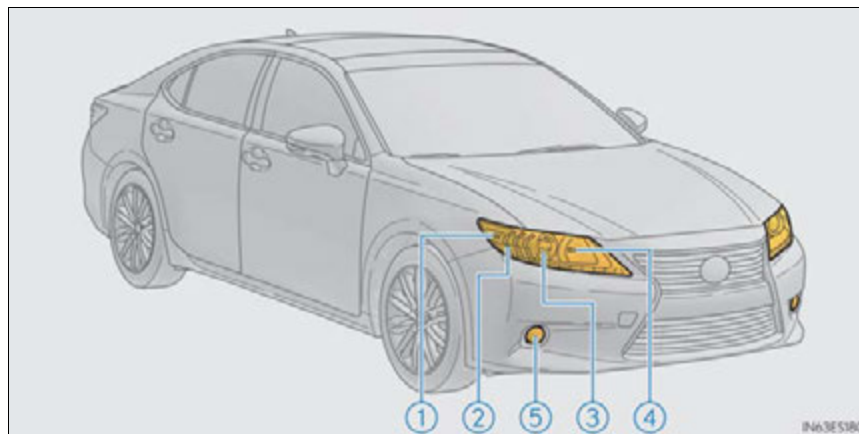

- |                                     |                                   |
|-------------------------------------|-----------------------------------|
| ① Front side marker light           | ④ Headlight high beam             |
| ② Front turn signal light           | ⑤ Halogen fog light (if equipped) |
| ③ Headlight low beam (halogen bulb) |                                   |

■ Rear

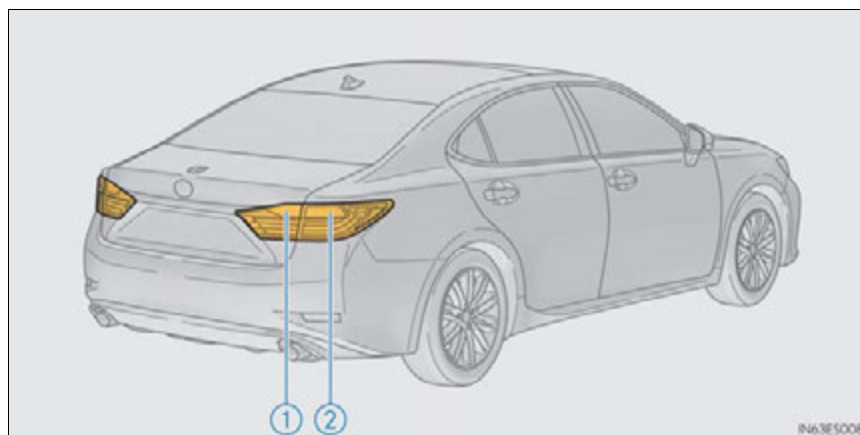

① Back-up light

② Rear turn signal light

## Replacing light bulbs

### ■ Headlight high beam

- 1 Turn the bulb base counter-clockwise.

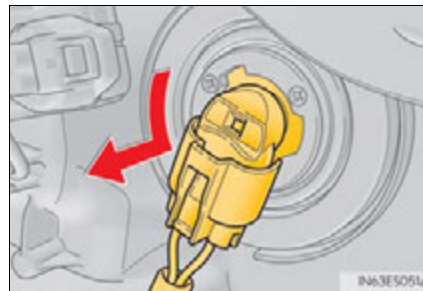

- 2 Unplug the connector while pressing the lock release.

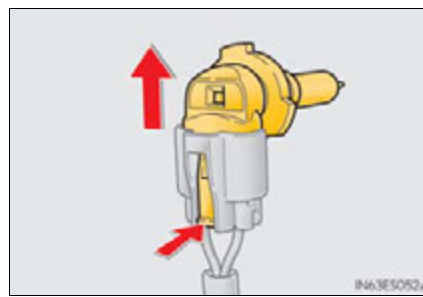

- 3 Exchange the light bulb, and install the bulb base.

Align the 3 tabs on the light bulb with the mounting, and insert.

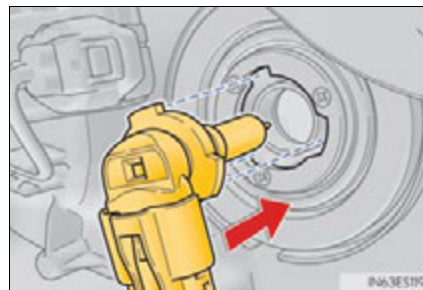

- 4 Turn and secure the bulb base.

Shake the bulb base gently to check that it is not loose, turn the headlights on once and visually confirm that no light is leaking through the mounting.

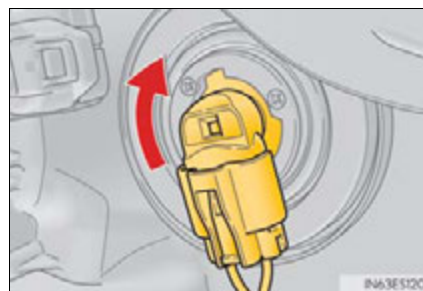

■ Headlight low beam (halogen bulb)

- 1 Turn the bulb base counter-clockwise.

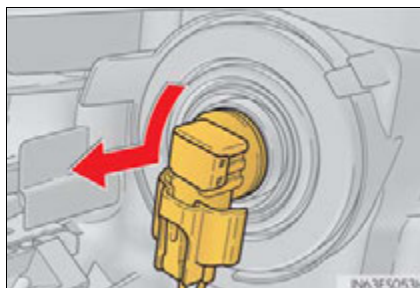

- 2 Unplug the connector while pressing the lock release.

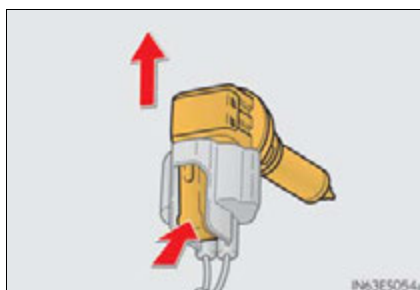

- 3 Exchange the light bulb, and install the bulb base.

Align the 3 tabs on the light bulb with the mounting, and insert.

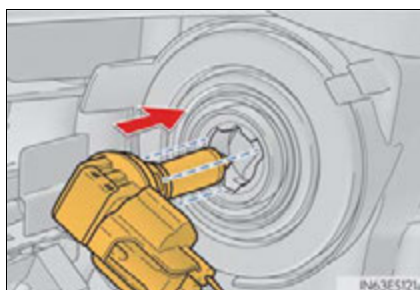

- 4 Turn and secure the bulb base.

Shake the bulb base gently to check that it is not loose, turn the headlights on once and visually confirm that no light is leaking through the mounting.

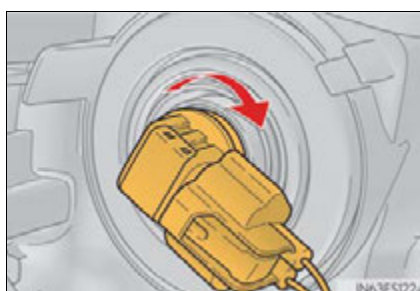

**■ Halogen fog lights (if equipped)**

- 1** Remove the bolt and partly remove the under cover, and unplug the connector while pushing the lock release.

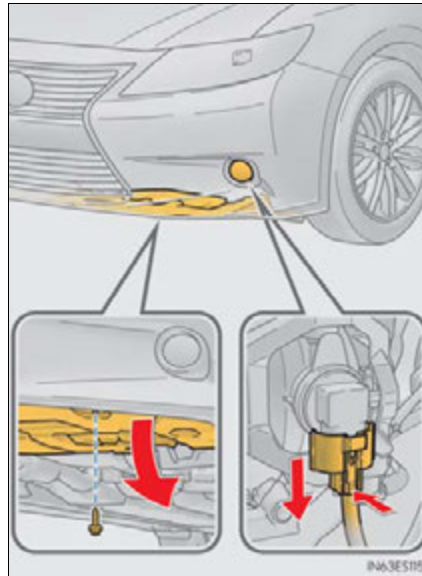

- 2** Turn the bulb base counter-clockwise.

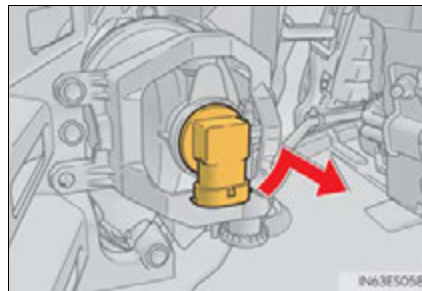

- 3** Set the new light bulb.  
Align the 3 tabs on the light bulb with the mounting, and insert. Turn it clockwise to set.

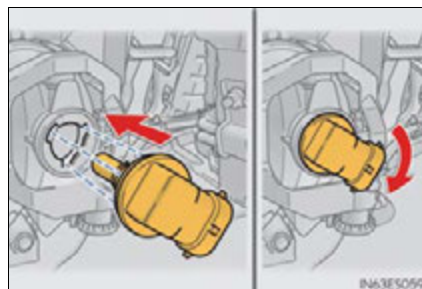

**4** Set the connector.

After installing the connector, shake the bulb base gently to check that it is not loose, turn the fog lights on once and visually confirm that no light is leaking through the mounting.

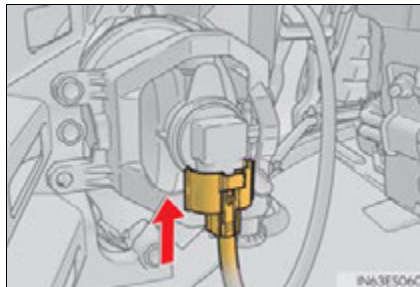

### ■ Front turn signal lights

- 1 To allow enough working space, turn the steering wheel to the opposite side of the bulb to be replaced.

Remove the 3 fender liner clips and 1 screw.

Turn the steering wheel to the left when replacing the right side light bulb, and turn the steering wheel to the right when replacing the left side light bulb.

To take out the clips, turn the head of the clip to unlock, then remove by pulling.

- 2 While holding the clamp open, pull and remove the tabs and open the fender liner.

- 3 Turn the bulb base counter-clockwise.

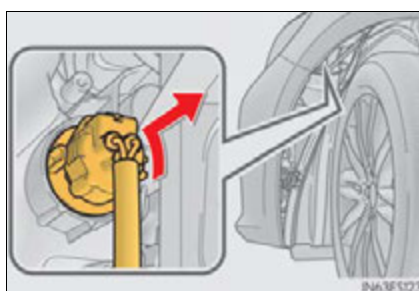
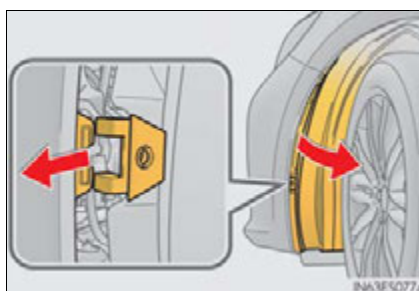
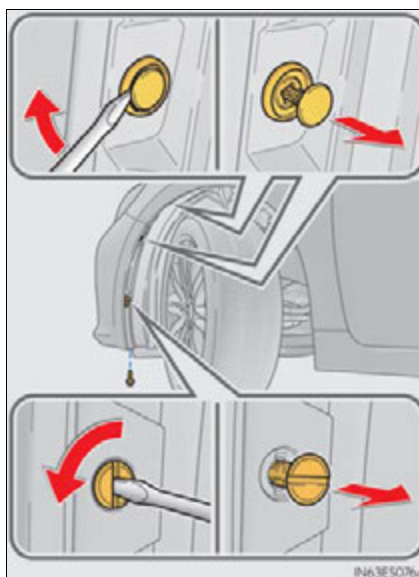



- 4** Remove the light bulb.

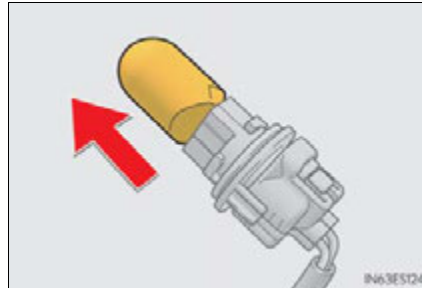

- 5** When installing, reverse the steps listed.

After installing the bulb base, reinstall the fender liner and install the clips and screw.

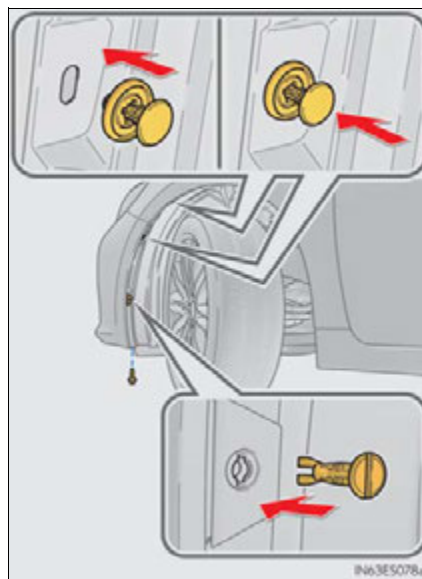

**■ Front side marker lights**

- 1** Partly remove the fender liner.

Perform the procedure for "Front turn signal lights" from step 1 to 2.  
(→P.739)

- 2** Turn the bulb base counter-clockwise.

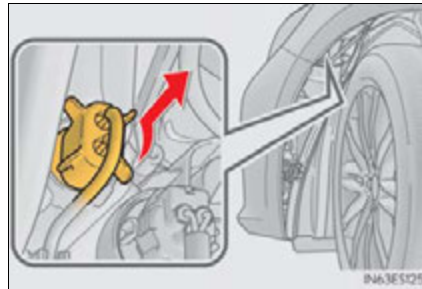

- 3** Remove the code from clip.

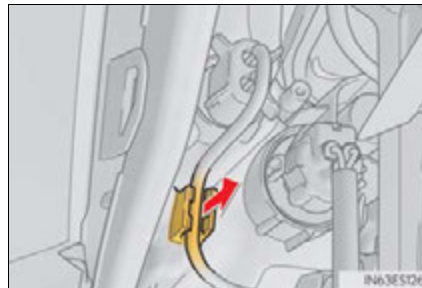

- 4** Remove the light bulb.

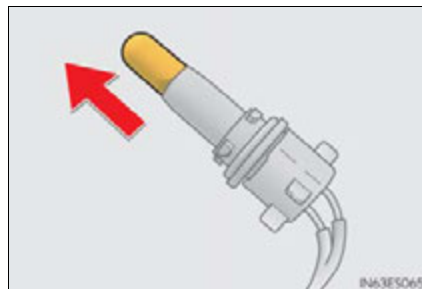

- 5** When installing, reverse the steps listed.

After installing the bulb base, reinstall the fender liner and install the clips and screw.

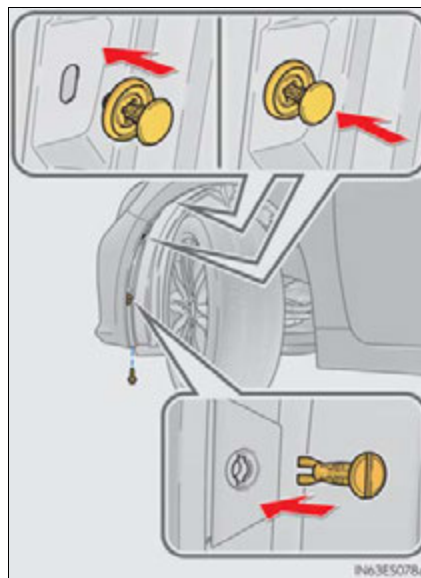

**■ Rear turn signal lights**

- 1** Open the trunk lid and remove the cover.

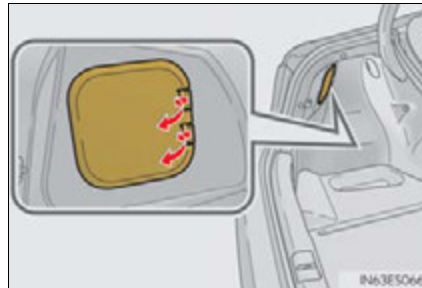

- 2** Turn the bulb base counter-clockwise.

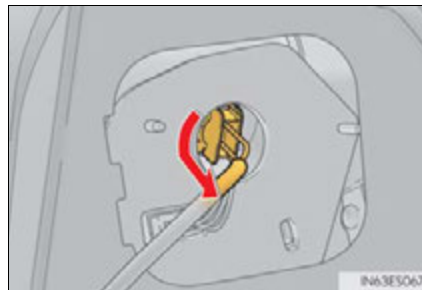

- 3** Remove the light bulb.



- 4** When installing, reverse the steps listed.

■ Back-up lights

- 1 Open the trunk lid.
- 2 For the left side (vehicles with power trunk opener and closer only): Pry out each side of the trunk closer switch in turn by inserting a screwdriver into the base.

To prevent damage, cover the tip of the screwdriver with a rag.

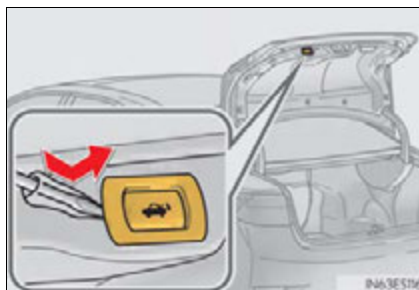

- 3 Remove the clips on whichever side you are replacing and open the cover of the trunk lid.

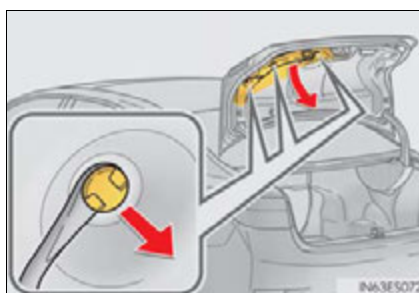

- 4 Turn the bulb base counter-clockwise.

When installing, pass the wire around the connector rib and make sure that it does not rest on top of the connector rib.

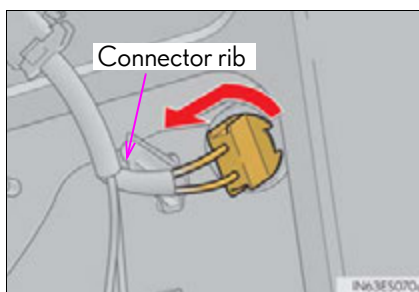

- 5 Remove the light bulb.

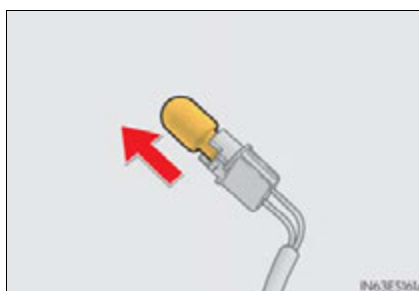

- 6 When installing, reverse the steps listed.

**■ Replacing the following bulbs**

If any of the lights listed below has burnt out, have it replaced by your Lexus dealer.

- Headlight low beams (discharge bulbs)
- Parking lights/daytime running lights
- Side turn signal lights
- LED fog lights (if equipped)
- Stop/tail lights
- Tail lights
- Rear side marker lights
- High mounted stoplight
- License plate lights
- Outer foot lights

**■ Discharge headlights (if equipped)**

If voltage to the discharge bulbs is insufficient, the bulbs may not come on, or may go out temporarily. The discharge bulbs will come on when normal power is restored.

**■ LED lights**

The parking lights/daytime running lights, side turn signal lights, LED fog lights (if equipped), stop/tail lights, tail lights, rear side marker lights, high mounted stoplight, license plate lights and outer foot lights consist of a number of LEDs. If any of the LEDs burn out, take your vehicle to your Lexus dealer to have the light replaced.

**■ Condensation build-up on the inside of the lens**

Temporary condensation build-up on the inside of the headlight lens does not indicate a malfunction. Contact your Lexus dealer for more information in the following situations:

- Large drops of water have built up on the inside of the lens.
- Water has built up inside the headlight.

**■ When replacing light bulbs**

→P. 732

 **CAUTION****■ Replacing light bulbs**

- Turn off the lights. Do not attempt to replace the bulb immediately after turning off the lights.  
The bulbs become very hot and may cause burns.
- Do not touch the glass portion of the light bulb with bare hands. When it is unavoidable to hold the glass portion, use and hold with a clean dry cloth to avoid getting moisture and oils on the bulb.  
Also, if the bulb is scratched or dropped, it may blow out or crack.
- Fully install light bulbs and any parts used to secure them. Failure to do so may result in heat damage, fire, or water entering the headlight unit. This may damage the headlights or cause condensation to build up on the lens.

**■ Discharge headlights (if equipped)**

- Contact your Lexus dealer before replacing the discharge headlights (including light bulbs).
- Do not touch the discharge headlight's high voltage socket when the headlights are turned on.  
An extremely high voltage of 25000 V will be discharged and could result in death or serious injury by electric shock.
- Do not attempt to take apart or repair the headlight bulbs, connectors, power supply circuits, or related components.  
Doing so could result in electric shock and death or serious injury.

**■ To prevent damage or fire**

- Make sure bulbs are fully seated and locked.
- Check the wattage of the bulb before installing to prevent heat damage.

## When trouble arises

## 7

## 7-1. Essential information

- Emergency flashers..... 748
- If your vehicle has to be  
stopped in an emergency .....749

## 7-2. Steps to take in an emergency

- If your vehicle needs  
to be towed..... 751
- If you think  
something is wrong ..... 757
- Fuel pump shut off system  
(gasoline vehicles)..... 758
- If a warning light turns on or  
a warning buzzer sounds..... 759
- If a warning message  
is displayed ..... 769
- If you have a flat tire..... 792
- If the engine will not start  
(gasoline vehicles)..... 805
- If the hybrid system will not  
start (hybrid vehicles)..... 807
- If the shift lever cannot  
be shifted from P ..... 809
- If the electronic key does not  
operate properly ..... 810
- If the 12-volt battery is  
discharged (gasoline  
vehicles)..... 813
- If the 12-volt battery is  
discharged (hybrid  
vehicles)..... 817
- If your vehicle overheats  
(gasoline vehicles)..... 821
- If your vehicle overheats  
(hybrid vehicles)..... 824
- If the vehicle becomes  
stuck ..... 828



## Emergency flashers

The emergency flashers are used to warn other drivers when the vehicle has to be stopped in the road due to a breakdown, etc.

Press the switch.

All the turn signal lights will flash.

To turn them off, press the switch once again.

▶ Type A

▶ Type B

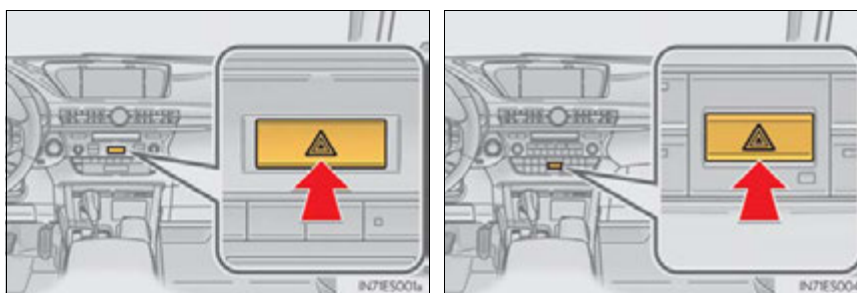

### ■ Emergency flashers

Gasoline vehicles: If the emergency flashers are used for a long time while the engine is not operating, the 12-volt battery may discharge.

Hybrid vehicles: If the emergency flashers are used for a long time while the hybrid system is not operating (while the "READY" indicator is not illuminated), the 12-volt battery may discharge.

## If your vehicle has to be stopped in an emergency

Only in an emergency, such as if it becomes impossible to stop the vehicle in the normal way, stop the vehicle using the following procedure:

- 1 Steadily step on the brake pedal with both feet and firmly depress it.  
Do not pump the brake pedal repeatedly as this will increase the effort required to slow the vehicle.
- 2 Shift the shift lever to N.
  - ▶ If the shift lever is shifted to N
- 3 After slowing down, stop the vehicle in a safe place by the road.
- 4 Stop the engine <hybrid system>.
  - ▶ If the shift lever cannot be shifted to N
- 3 Keep depressing the brake pedal with both feet to reduce vehicle speed as much as possible.

- 4 Gasoline vehicles: To stop the engine, press and hold the "START STOP ENGINE" switch for 2 consecutive seconds or more, or press it briefly 3 times or more in succession.

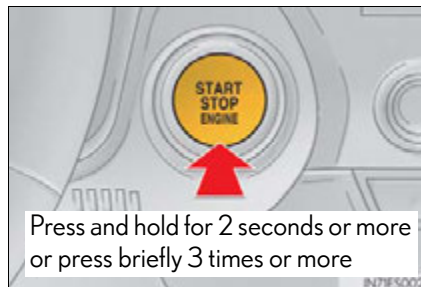

Hybrid vehicles: To stop the hybrid system, press and hold the "POWER" switch for 2 consecutive seconds or more, or press it briefly 3 times or more in succession.

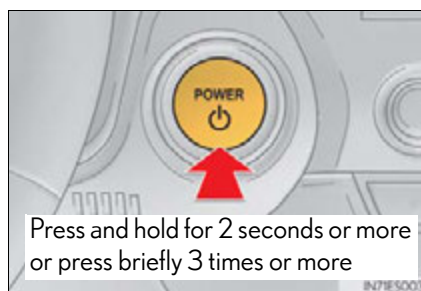

- 5 Stop the vehicle in a safe place by the road.

 CAUTION**■ If the engine <hybrid system> has to be turned off while driving**

Power assist for the steering wheel will be lost, making the steering wheel heavier to turn. Decelerate as much as possible before turning off the engine <hybrid system>.

## If your vehicle needs to be towed

If towing is necessary, we recommend having your vehicle towed by your Lexus dealer or a commercial towing service, using a lift-type truck or flat bed truck.

Use a safety chain system for all towing, and abide by all state/provincial and local laws.

### Before towing

The following may indicate a problem with your transmission <hybrid transmission>. Contact your Lexus dealer before towing.

- The engine is running <hybrid system is operating> but the vehicle will not move.
- The vehicle makes an abnormal sound.

### Emergency towing

Gasoline vehicles: If a tow truck is not available in an emergency, your vehicle may be temporarily towed using a cable or chain secured to the emergency towing eyelet. This should only be attempted on hard surfaced roads for short distances at low speeds.

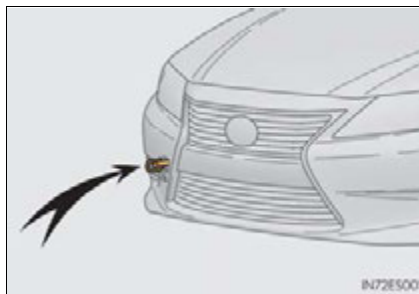

A driver must be in the vehicle to steer and operate the brakes. The vehicle's wheels, drive train, axles, steering and brakes must be in good condition.

Hybrid vehicles: If a tow truck is not available in an emergency, your vehicle may be temporarily towed using a cable or chain secured to the emergency towing eyelet. This should only be attempted on hard surfaced roads for short distances at under 18 mph (30 km/h).

A driver must be in the vehicle to steer and operate the brakes. The vehicle's wheels, drive train, axles, steering and brakes must be in good condition.

### Installing towing eyelet

1 Take out the towing eyelet. (→P. 793)

2 Remove the eyelet cover using a flathead screwdriver.

To protect the bodywork, place a rag between the screwdriver and the vehicle body as shown in the illustration.

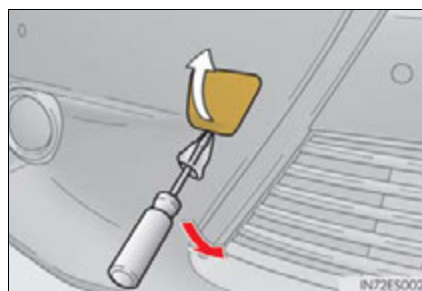

3 Insert the towing eyelet into the hole and tighten partially by hand.

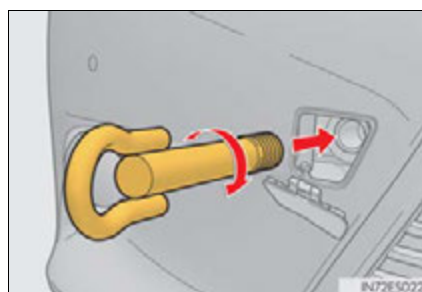

4 Tighten down the towing eyelet securely using a wheel nut wrench.

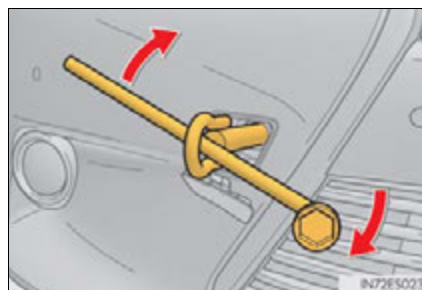

### Towing with a sling-type truck

Do not tow with a sling-type truck to prevent body damage.

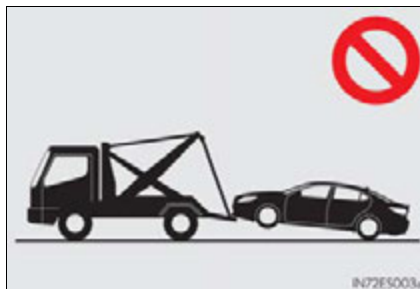

### Towing with a wheel-lift type truck

► From the front

Release the parking brake.

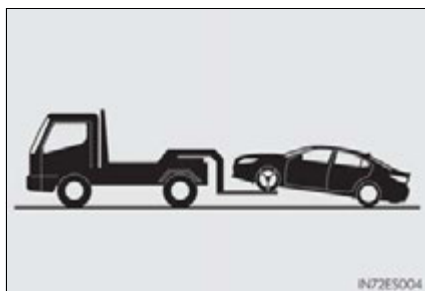

► From the rear

Use a towing dolly under the front wheels.

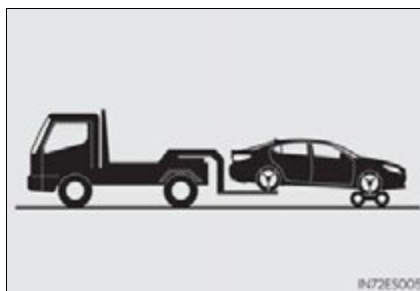

### Using a flat bed truck

If your Lexus is transported by a flat bed truck, it should be tied down at the locations shown in the illustration.

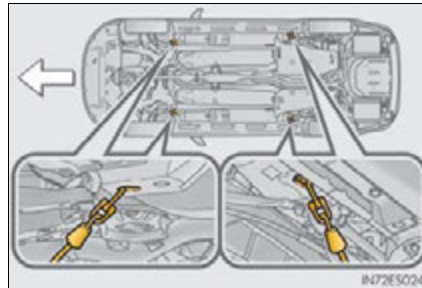

If you use chains or cables to tie down your vehicle, the angles shaded in black must be 45°.

Do not overly tighten the tie downs or the vehicle may be damaged.

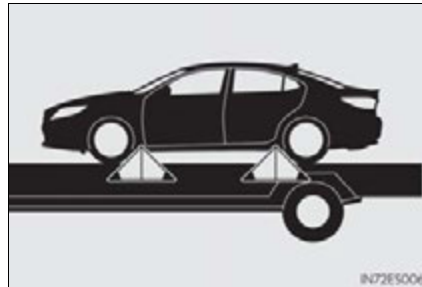

#### ■ Before emergency towing

- 1 Release the parking brake.
- 2 Shift the shift lever to N.
- 3 Gasoline vehicles: Turn the "START STOP ENGINE" switch to ACCESSORY (engine off) or IGNITION ON (engine running) mode.  
Hybrid vehicles: Turn the "POWER" switch to ACCESSORY (hybrid system off) or ON (hybrid system operating) mode.



 CAUTION

Observe the following precautions.  
Failure to do so may result in death or serious injury.

■ **Caution while towing**

- Use extreme caution when towing the vehicle.  
Avoid sudden starts or erratic driving maneuvers which place excessive stress on the emergency towing eyelet and the cable or chain. Always be cautious of the surroundings and other vehicles while towing.
- Gasoline vehicles: If the engine is not running, the power assist for the brakes and steering will not function, making steering and braking more difficult.  
Hybrid vehicles: If the hybrid system is off, the power assist for the brakes and steering will not function, making steering and braking more difficult.

■ **Installing towing eyelet to the vehicle**

Make sure that towing eyelet is installed securely.  
If not securely installed, towing eyelet may come loose during towing.

 NOTICE

■ **To prevent causing serious damage to the transmission when towing using a wheel-lift type truck**

Never tow this vehicle from the rear with the front wheels on the ground. This may cause serious damage to the transmission.

■ **To prevent damage to the vehicle when towing using a wheel-lift type truck**

When raising the vehicle, ensure adequate ground clearance for towing at the opposite end of the raised vehicle. Without adequate clearance, the vehicle could be damaged while being towed.

■ **To prevent body damage when towing with a sling-type truck**

Do not tow with a sling-type truck, either from the front or rear.

## If you think something is wrong

If you notice any of the following symptoms, your vehicle probably needs adjustment or repair. Contact your Lexus dealer as soon as possible.

### Visible symptoms

- Fluid leaks under the vehicle.  
(Water dripping from the air conditioning after use is normal.)
- Flat-looking tires or uneven tire wear
- Engine coolant temperature gauge needle continually points higher than normal.

### Audible symptoms

- Changes in exhaust sound
- Excessive tire squeal when cornering
- Strange noises related to the suspension system
- Pinging or other noises related to the engine <hybrid system>

### Operational symptoms

- Engine missing, stumbling or running roughly
- Appreciable loss of power
- Vehicle pulls heavily to one side when braking
- Vehicle pulls heavily to one side when driving on a level road
- Loss of brake effectiveness, spongy feeling, pedal almost touches the floor

## Fuel pump shut off system (gasoline vehicles)

To minimize the risk of fuel leakage when the engine stalls or when an airbag inflates upon collision, the fuel pump shut off system stops the supply of fuel to the engine.

Follow the procedure below to restart the engine after the system is activated.

- 1 Turn the "START STOP ENGINE" switch to ACCESSORY mode or turn it off.
- 2 Restart the engine.

### NOTICE

#### ■ Before starting the engine

Inspect the ground under the vehicle.



If you find that fuel has leaked onto the ground, the fuel system has been damaged and is in need of repair. Do not restart the engine.

## If a warning light turns on or a warning buzzer sounds

Calmly perform the following actions if any of the warning lights comes on or flashes. If a light comes on or flashes, but then goes off, this does not necessarily indicate a malfunction in the system. However, if this continues to occur, have the vehicle inspected by your Lexus dealer.

**Stop the vehicle immediately. Continuing to drive the vehicle may be dangerous.**

The following warning indicates a possible problem in the brake system. Immediately stop the vehicle in a safe place and contact your Lexus dealer.

Warning light	Warning light/Details
 (U.S.A.)	<b>Brake system warning light (warning buzzer)*</b> <ul style="list-style-type: none"> <li>• Low brake fluid</li> <li>• Malfunction in the brake booster system</li> </ul> This light also comes on when the parking brake is not released. If the light turns off after the parking brake is fully released the system is operating normally.
 (Canada)	

\*: Brake system warning buzzer (hybrid vehicles):

When there is a possible problem that could affect braking performance, the warning light will come on and a warning buzzer will sound.

Parking brake engaged warning buzzer:

→P. 776

### ■ Brake system warning light operation (hybrid vehicles)

Although depressing the brake pedal repeatedly may cause the red brake system warning light to turn on and the buzzer to sound, this does not indicate a malfunction.





**Stop the vehicle immediately.**





The following warning indicates the possibility of damage to the vehicle that may lead to an accident. Immediately stop the vehicle in a safe place and contact your Lexus dealer.

Warning light	Warning light/Details
	<b>Charging system warning light</b> Indicates a malfunction in the vehicle's charging system

**Have the vehicle inspected by your Lexus dealer immediately.**





Failure to investigate the cause of the following warnings may lead to the system operating abnormally and possibly cause an accident. Have the vehicle inspected by your Lexus dealer immediately.

Warning light	Warning light/Details
 (U.S.A.)  (Canada)	<b>Malfunction indicator lamp</b> Indicates a malfunction in: <ul style="list-style-type: none"> <li>• The hybrid system (hybrid vehicles);</li> <li>• The electronic engine control system;</li> <li>• The electronic throttle control system;</li> <li>• The electronic automatic transmission control system (gasoline vehicles); or</li> <li>• The electronic hybrid transmission control system (hybrid vehicles)</li> </ul>
	<b>SRS warning light</b> Indicates a malfunction in: <ul style="list-style-type: none"> <li>• The SRS airbag system;</li> <li>• The front passenger occupant classification system; or</li> <li>• The seat belt pretensioner system</li> </ul>
 (U.S.A.)  (Canada)	<b>ABS warning light</b> Indicates a malfunction in: <ul style="list-style-type: none"> <li>• The ABS; or</li> <li>• The brake assist system</li> </ul>

Warning light	Warning light/Details
	<p><b>Electric power steering system warning light (warning buzzer)</b> Indicates a malfunction in the EPS (Electric Power Steering) system</p>
 (Flashes) (If equipped)	<p><b>Pre-collision system warning light</b> Indicates a malfunction in the pre-collision system The warning light will operate as follows, even when the system is not malfunctioning:</p> <ul style="list-style-type: none"> <li>• The light will flash quickly when the system is operating. (→P. 310)</li> <li>• The light will turn on when the pre-collision system is disabled. (→P. 311)</li> <li>• The light will flash when the system cannot temporarily be used. (→P. 779)</li> </ul>
	<p><b>Slip indicator</b> Indicates a malfunction in:</p> <ul style="list-style-type: none"> <li>• The VSC system;</li> <li>• The TRAC system; or</li> <li>• The hill-start assist control system (hybrid vehicles)</li> </ul> <p>Gasoline vehicles: The light will flash when the VSC or the TRAC is operating. Hybrid vehicles: The light will flash when the ABS, the VSC, the TRAC or the hill-start assist control system is operating.</p>
 (Hybrid vehicles)	<p><b>Brake system warning light</b> Indicates a malfunction in:</p> <ul style="list-style-type: none"> <li>• The regenerative brake system; or</li> <li>• The electronically controlled brake system</li> </ul>
 (If equipped)	<p><b>Automatic headlight leveling system warning light</b> Indicates a malfunction in the automatic headlight leveling system</p>

**Follow the correction procedures.**

After taking the specified steps to correct the suspected problem, check that the warning light goes off.

Warning light	Warning light/Details	Correction procedure
	<b>Open door warning light (warning buzzer)*1</b> Indicates that a door or the trunk is not fully closed	Check that all the doors and the trunk are closed.
	<b>Low fuel level warning light</b> Indicates remaining fuel is approximately 2.6 gal. (9.7 L, 2.1 Imp.gal.)	Refuel the vehicle.
	<b>Seat belt reminder light (warning buzzer)*2</b> Warns the driver and/or front passenger to fasten their seat belts	Fasten the seat belt. If the front passenger's seat is occupied, the front passenger's seat belt also needs to be fastened to make the warning light (warning buzzer) off.
	<b>Master warning light</b> A buzzer sounds and the warning light comes on and flashes to indicate that the master warning system has detected a malfunction.	→P. 769

Warning light	Warning light/Details	Correction procedure
	<b>Tire pressure warning light</b>	
	When the light comes on: Low tire inflation pressure such as <ul style="list-style-type: none"> <li>• Natural causes (→P. 765)</li> <li>• Flat tire (→P. 792)</li> </ul>	Adjust the tire inflation pressure (including the full-size spare tire) to the specified level. The light will turn off after a few minutes. In case the light does not turn off even if the tire inflation pressure is adjusted, have the system checked by your Lexus dealer.
	When the light comes on after blinking for 1 minute: Malfunction in the tire pressure warning system	Have the system checked by your Lexus dealer.

\*1: Open door warning buzzer:

→P. 774

\*2: Driver's seat belt buzzer:

The driver's seat belt buzzer sounds to alert the driver that his or her seat belt is not fastened. Once the "START STOP ENGINE" <"POWER"> switch is turned to IGNITION ON <ON> mode, the buzzer sounds for 6 seconds. If the vehicle reaches a speed of 12 mph (20 km/h), the buzzer sounds once. If the seat belt is still unfastened after 30 seconds, the buzzer will sound intermittently for 10 seconds. Then, if the seat belt is still unfastened, the buzzer will sound in a different tone for 20 more seconds.

Front passenger's seat belt buzzer:

The front passenger's seat belt buzzer sounds to alert the front passenger that his or her seat belt is not fastened. The buzzer sounds once if the vehicle reaches a speed of 12 mph (20 km/h). If the seat belt is still unfastened after 30 seconds, the buzzer will sound intermittently for 10 seconds. Then, if the seat belt is still unfastened, the buzzer will sound in a different tone for 20 more seconds.



■ **SRS warning light**

This warning light system monitors the airbag sensor assembly, front impact sensors, side impact sensors (front door), side impact sensors (front), side impact sensors (rear), driver's seat position sensor, driver's seat belt buckle switch, front passenger occupant classification system (ECU and sensors), "AIR BAG ON" indicator light, "AIR BAG OFF" indicator light, front passenger's seat belt buckle switch, seat belt pretensioner assemblies, airbags, interconnecting wiring and power sources.  
(→P. 40)

■ **Front passenger detection sensor, seat belt reminder and warning buzzer**

- If luggage is placed on the front passenger seat, the front passenger detection sensor may cause the warning light to flash and the warning buzzer to sound even if a passenger is not sitting in the seat.
- If a cushion is placed on the seat, the sensor may not detect a passenger, and the warning light may not operate properly.

■ **If the malfunction indicator lamp comes on while driving**

First check the following:

- Is the fuel tank empty?  
If it is, fill the fuel tank immediately.
- Is the fuel tank cap loose?  
If it is, tighten it securely.

The light will go off after several driving trips.

If the light does not go off even after several trips, contact your Lexus dealer as soon as possible.

■ **When the tire pressure warning light comes on**

Check the tire inflation pressure and adjust to the appropriate level. Pushing the tire pressure warning reset switch will not turn off the tire pressure warning light.

**■ The tire pressure warning light may come on due to natural causes**

The tire pressure warning light may come on due to natural causes such as natural air leaks and tire inflation pressure changes caused by temperature. In this case, adjusting the tire inflation pressure will turn off the warning light (after a few minutes).

**■ When a tire is replaced with a spare tire**

Vehicles with a compact spare tire: The compact spare tire is not equipped with a tire pressure warning valve and transmitter. If a tire goes flat, the tire pressure warning light will not turn off even though the flat tire has been replaced with the spare tire.

Vehicles with a full-size spare tire: The spare tire is also equipped with a tire pressure warning valve and transmitter. The tire pressure warning light will turn on if the tire inflation pressure of the spare tire is low. If a tire goes flat, the tire pressure warning light will not turn off even though the flat tire has been replaced with the spare tire.

**■ Conditions that the tire pressure warning system may not function properly**

→P. 707

**■ If the tire pressure warning light frequently comes on after blinking for 1 minute**

If the tire pressure warning light frequently comes on after blinking for 1 minute when the "START STOP ENGINE" <"POWER"> switch is turned to IGNITION ON <ON> mode, have it checked by your Lexus dealer.

**■ Electric power steering system warning light (warning buzzer)**

When the 12-volt battery charge becomes insufficient or the voltage temporarily drops, the electric power steering system warning light may come on and the warning buzzer may sound.

**■ Warning buzzer**

In some cases, the buzzer may not be heard because of noisy place or an audio sound.

 CAUTION**■ If both the ABS and the brake system warning lights remain on**

Stop your vehicle in a safe place immediately and contact your Lexus dealer. The vehicle will become extremely unstable during braking, and the ABS system may fail, which could cause an accident resulting in death or serious injury.

**■ When the electric power steering system warning light comes on**

The steering wheel may become extremely heavy.

If the steering wheel becomes heavier than usual when operating, hold firmly and operate using more force than usual.

**■ If the tire pressure warning light comes on**

Be sure to observe the following precautions. Failure to do so could cause a loss of vehicle control and result in death or serious injury.

- Stop your vehicle in a safe place as soon as possible. Adjust the tire inflation pressure immediately.
- If the tire pressure warning light comes on even after tire inflation pressure adjustment, it is probable that you have a flat tire. Check the tires. If a tire is flat, change it with the spare tire and have the flat tire repaired by the nearest Lexus dealer.
- Avoid abrupt maneuvering and braking. If the vehicle tires deteriorate, you could lose control of the steering wheel or the brakes.

**■ If a blowout or sudden air leakage should occur**

The tire pressure warning system may not activate immediately.

 CAUTION**■ Maintenance of the tires**

Each tire, including the spare (if provided), should be checked monthly when cold and inflated to the inflation pressure recommended by the vehicle manufacturer on the vehicle placard or tire inflation pressure label (tire and load information label). (If your vehicle has tires of a different size than the size indicated on the vehicle placard or tire inflation pressure label [tire and load information label], you should determine the proper tire inflation pressure for those tires.)

As an added safety feature, your vehicle has been equipped with a tire pressure monitoring system (TPMS-tire pressure warning system) that illuminates a low tire pressure telltale (tire pressure warning light) when one or more of your tires is significantly under-inflated. Accordingly, when the low tire pressure telltale (tire pressure warning light) illuminates, you should stop and check your tires as soon as possible, and inflate them to the proper pressure. Driving on a significantly under-inflated tire causes the tire to overheat and can lead to tire failure. Under-inflation also reduces fuel efficiency and tire tread life, and may affect the vehicle's handling and stopping ability.

Please note that the TPMS (tire pressure warning system) is not a substitute for proper tire maintenance, and it is the driver's responsibility to maintain correct tire pressure, even if under-inflation has not reached the level to trigger illumination of the TPMS low tire pressure telltale (tire pressure warning light).

Your vehicle has also been equipped with a TPMS (tire pressure warning system) malfunction indicator to indicate when the system is not operating properly. The TPMS (tire pressure warning system) malfunction indicator is combined with the low tire pressure telltale (tire pressure warning light). When the system detects a malfunction, the telltale will flash for approximately one minute and then remain continuously illuminated. This sequence will continue upon subsequent vehicle start-ups as long as the malfunction exists. When the malfunction indicator is illuminated, the system may not be able to detect or signal low tire pressure as intended.

 CAUTION

TPMS (tire pressure warning system) malfunctions may occur for a variety of reasons, including the installation of replacement or alternate tires or wheels on the vehicle that prevent the TPMS (tire pressure warning system) from functioning properly. Always check the TPMS (tire pressure warning system) malfunction telltale after replacing one or more tires or wheels on your vehicle to ensure that the replacement or alternate tires and wheels allow the TPMS (tire pressure warning system) to continue to function properly.

 NOTICE **Precaution when installing a different tire**

When differently constructed tires or tires of different makers, models or tread patterns are installed, the tire pressure warning system may not operate properly.

## If a warning message is displayed

If a warning is shown on the multi-information display, stay calm and perform the following actions:



- ① Master warning light  
The master warning light also comes on or flashes in order to indicate that a message is currently being displayed on the multi-information display.
- ② Multi-information display



If any of the warning light comes on again after the following actions have been performed, contact your Lexus dealer.







**Stop the vehicle immediately.**

A buzzer sounds and a warning message is shown on the multi-information display. The following warning indicates the possibility of damage to the vehicle that may lead to an accident. Immediately stop the vehicle in a safe place and contact your Lexus dealer.





Warning message	Details
<p data-bbox="405 719 651 775">Engine Oil Pressure Low</p>  	<p data-bbox="676 792 1235 887">Indicates abnormal engine oil pressure The warning light may come on if the engine oil pressure is too low.</p>
<p data-bbox="395 1010 651 1133">Check Hybrid System</p>  <p data-bbox="432 1218 616 1252">(Hybrid vehicles)</p>	<p data-bbox="676 1115 1126 1144">Indicates a malfunction in the hybrid system</p>



### Have the vehicle inspected immediately.

A buzzer sounds and a warning message is shown on the multi-information display. Failure to investigate the cause of the following warnings may lead to the system operating abnormally and possibly cause an accident. Have the vehicle inspected by your Lexus dealer.

Warning message	Details
 <p>Check PCS System</p>  <p>PCS (Flashes)</p>  <p>(If equipped)</p>	<p>Indicates a malfunction in the pre-collision system</p>
 <p>Check Park Sonar System</p>  <p>(If equipped)</p>	<p>Indicates a malfunction in the intuitive parking assist The malfunctioning assist-sensor is flashing.</p>
 <p>Check Cruise Control System</p> 	<p>Indicates a malfunction in the dynamic radar cruise control system (if equipped) or the cruise control system Press the "ON/OFF" button once to deactivate the system, and then press the button again to reactivate the system.</p>









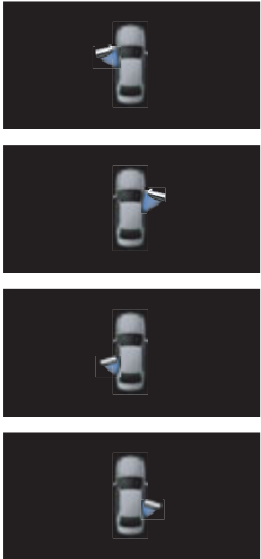

Warning message	Details
<div data-bbox="392 472 654 600" style="background-color: black; color: white; padding: 5px; text-align: center;">                     Check LDA System                 </div> <div data-bbox="392 618 488 678" style="text-align: center;">  </div> <div data-bbox="448 683 592 719" style="text-align: center;">                     (If equipped)                 </div>	Indicates a malfunction in the LDA (Lane Departure Alert) system
<div data-bbox="392 759 654 887" style="background-color: black; color: white; padding: 5px; text-align: center;">                     Check AHB System                 </div> <div data-bbox="392 904 488 965" style="text-align: center;">  </div> <div data-bbox="448 969 592 1005" style="text-align: center;">                     (If equipped)                 </div>	Indicates a malfunction in the Automatic High Beam system
<div data-bbox="392 1046 654 1173" style="background-color: black; color: white; padding: 5px; text-align: center;">                     Check Power Steering System                 </div> <div data-bbox="392 1191 488 1252" style="text-align: center;">  </div> <div data-bbox="392 1270 488 1330" style="text-align: center;">  </div>	Indicates a malfunction in the EPS (Electric Power Steering) system

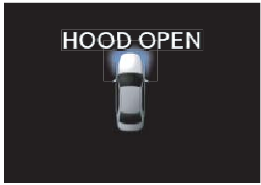



Warning message	Details
<p data-bbox="395 477 651 600"><b>Check BSM System</b></p> <p data-bbox="395 622 483 678"></p> <p data-bbox="451 689 595 723">(If equipped)</p>	<p data-bbox="675 577 1185 611">Indicates a malfunction in the Blind Spot Monitor</p>
<p data-bbox="395 768 651 857"><b>Check Access System with Elec. Key</b></p> <p data-bbox="395 902 483 958"></p> <p data-bbox="491 913 595 947">(Flashes)</p>	<p data-bbox="675 824 1233 891">Indicates a malfunction in the smart access system with push-button start</p>





**Follow the correction procedures.**

A buzzer sounds and a warning message is shown on the multi-information display. After taking the specified steps to correct the suspected problem, check that the warning message goes off.



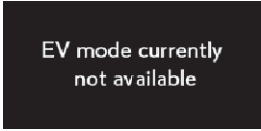



Warning message	Details	Correction procedure
	<p>Indicates that one or more of the doors is not fully closed</p> <p>The system also indicates which doors are not fully closed.</p> <p>If the vehicle reaches a speed of 3 mph (5 km/h),  flashes and a buzzer sounds to indicate that the door(s) are not yet fully closed.</p>	<p>Make sure that all the doors are closed.</p>
	<p>Indicates that the hood is not fully closed</p> <p>If the vehicle reaches a speed of 3 mph (5 km/h),  flashes and a buzzer sounds to indicate that the hood is not yet fully closed.</p>	<p>Close the hood.</p>





Warning message	Details	Correction procedure
	<p>Indicates that the trunk is not fully closed</p> <p>If the vehicle reaches a speed of 3 mph (5 km/h),  flashes and a buzzer sounds to indicate that the trunk is not yet fully closed.</p>	<p>Close the trunk.</p>
<p>Window opened</p>  (Flashes)	<p>Indicates that the windows are not fully closed (with the "START STOP ENGINE" &lt;"POWER"&gt; switch off, and the driver's door open)</p>	<p>Close all the windows.</p>
<p>Moon Roof opened</p>  (Flashes)	<p>Indicates that the moon roof is not fully closed (with the "START STOP ENGINE" &lt;"POWER"&gt; switch off, and the driver's door open)</p>	<p>Close the moon roof.</p>
<p>Window/ Moon Roof opened</p>  (Flashes)	<p>Indicates that the windows and the moon roof are not fully closed (with the "START STOP ENGINE" &lt;"POWER"&gt; switch off, and the driver's door open)</p>	<p>Close all the windows and the moon roof.</p>

Warning message	Details	Correction procedure
<p style="text-align: center;">Release Parking Brake</p> 	<p>Indicates that the parking brake is still engaged If the vehicle reaches a speed of 3 mph (5 km/h),  flashes and a buzzer sounds to indicate that the parking brake is still engaged.</p>	<p>Release the parking brake.</p>
<p style="text-align: center;">Traction Battery Low Charges when not in N position</p>  (Flashes) (Hybrid vehicles)	<p>Indicates that the hybrid battery (traction battery) is low</p>	<p>When stopping the vehicle for a long period of time, shift the shift lever to P. The battery cannot be charged with the shift lever in N.</p>
<p style="text-align: center;">Traction battery preservation mode Restart after shifting to the P position</p>  (Flashes) (Hybrid vehicles)	<p>Indicates that the hybrid battery (traction battery) power has dropped because a long period of time has elapsed after shifting the shift lever to N</p>	<p>Restart the hybrid system when starting the vehicle.</p>
<p style="text-align: center;">N position</p>  (Flashes) (Hybrid vehicles)	<p>Indicates that the accelerator pedal is depressed while the shift position is in N</p>	<p>Release the accelerator pedal and shift the shift lever to D or R.</p>







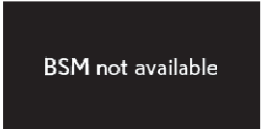

Warning message	Details	Correction procedure
 <p>(Hybrid vehicles)</p>	<p>Indicates that the EV drive mode is not available*</p> <p>The reason the EV drive mode is not available (the vehicle is idling, battery charge is low, speed is higher than the EV drive mode operating speed range, accelerator pedal is depressed too much) may be displayed.</p>	<p>Use the EV drive mode when it becomes available.</p>
 <p>(Hybrid vehicles)</p>	<p>Indicates that the EV drive mode has been automatically canceled*</p> <p>The reason the EV drive mode is not available (the battery charge is low, speed is higher than the EV drive mode operating speed range, accelerator pedal is depressed too much) may be displayed.</p>	<p>Drive the vehicle for a while.</p>
  <p>(If equipped)</p>	<p>Indicates that engine oil level is low</p>	<p>Check the level of engine oil, and add if necessary.</p>

\*: For the EV drive mode operating conditions: →P. 215

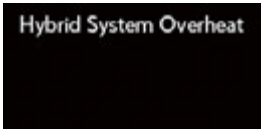
Warning message	Details	Correction procedure
 <p>Clean Park Sonar</p>  <p>(If equipped)</p>	<p>Indicates that intuitive parking assist sensor is dirty or covered with ice</p>	<p>Clean the sensor.</p>
 <p>Clean Radar Sensor</p>  <p>(If equipped)</p>	<p>Indicates that the radar sensor is dirty or covered with ice</p>	<p>Clean the sensor.</p>
 <p>Cruise Control not available</p>  <p>(If equipped)</p>	<p>Indicates that the radar cruise control system is unable to judge vehicle-to-vehicle distance</p>	<ul style="list-style-type: none"> <li>• Turn off the snow mode.</li> <li>• If the windshield wipers are on, turn them off or set them to a mode other than AUTO or high speed wiper operation.</li> </ul>
 <p>60 MPH</p> <p>(If equipped)</p>	<p>Indicates that your vehicle is nearing the vehicle ahead (in vehicle-to-vehicle distance mode)</p>	<p>Slow the vehicle by applying the brakes.</p>

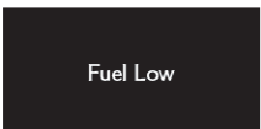
Warning message	Details	Correction procedure
 <p><b>PCS</b> (Flashes) (If equipped)</p>	<p>Indicates that there is a high possibility of a frontal collision, or that the pre-collision braking function is operating</p>	<p>Slow the vehicle by applying the brakes.</p>
  <p>(If equipped)</p>	<p>Indicates that the LDA (Lane Departure Alert) system is suspended The camera sensor temperature is higher than the operation temperature range.</p>	<p>Restart the LDA (Lane Departure Alert) system after driving for a while.</p>
 <p>(If equipped)</p>	<p>Alerts the driver that the vehicle is out of the lane markers (while the LDA [Lane Departure Alert] system is operating) The warning buzzer sounds continuously. The lane line on the side the vehicle deviates from flashes in yellow.</p>	<p>Check around the vehicle and steer the vehicle back within the lane markers with safe steering.</p>

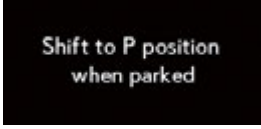

Warning message	Details	Correction procedure
  (If equipped)	Indicates that the Blind Spot Monitor sensors or the surrounding area on the bumper is dirty or covered with ice	Clean the sensor and its surrounding area on the bumper.
  (Hybrid vehicles)	Indicates that the hybrid system has overheated This message may be displayed when driving under severe operating conditions. (For example, when driving up a long steep hill.)	Stop and check. (→P. 824)
	Indicates that remaining fuel is approximately 2.6 gal. (9.7 L, 2.1 Imp.gal.) or less	Refuel the vehicle.
  (Flashes)	Indicates that the “START STOP ENGINE” <“POWER”> switch is turned off or turned to ACCESSORY mode and the driver’s door is opened while the lights are turned on	Turn the lights off.
  (Flashes) (Hybrid vehicles)	Indicates that the driver’s door was opened with the shift position in any position other than P	Shift the shift position to P.

**■ Warning message in radar cruise mode (if equipped)**

In the following cases, the warning message may not be displayed even if vehicle-to-vehicle distance decreases:

- When your vehicle and the vehicle ahead are traveling at the same speed or the vehicle ahead is traveling more quickly than your vehicle
- When the vehicle ahead is traveling at a very low speed
- Immediately after cruise control speed is set
- At the instant the accelerator pedal is depressed

**■ The LDA (Lane Departure Alert) system (if equipped)**





In the following cases, the warning message will not be displayed even if the vehicle deviates from the lane markers.



- When the vehicle speed deviates from the operating range of the LDA system functions
- When the lane markers cannot be recognized

**Follow the correction procedures.**

A warning message is shown on the multi-information display. After taking the specified steps to correct the suspected problem, check that the warning message goes off.

Warning message	Details	Correction procedure
<p>Turn on the high beam to activate AHB System (If equipped)</p>	<p>Indicates that the Automatic High Beam switch is pressed while the headlights are in low beam.</p>	<p>Turn the high beam on and press the Automatic High Beam switch again.</p>
<p>Washer Fluid Low</p>	<p>Indicates that the washer fluid level is low</p>	<p>Add washer fluid.</p>
<p>Maintenance required soon (U.S.A. only)</p>	<p>Indicates that all maintenance according to the driven distance on the maintenance schedule* should be performed soon.  Comes on approximately 4500 miles (7200 km) after the maintenance data has been reset.</p>	<p>If necessary, perform maintenance.</p>

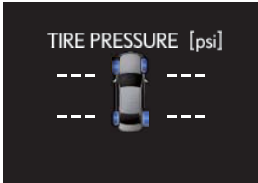



Warning message	Details	Correction procedure
 <p>Maintenance required (U.S.A. only)</p>	<p>Indicates that all maintenance is required to correspond to the driven distance on the maintenance schedule*.</p> <p>Comes on approximately 5000 miles (8000 km) after the maintenance data has been reset. (The indicator will not work properly unless the maintenance data has been reset.)</p>	<p>Perform the necessary maintenance. Please reset the maintenance data after the maintenance is performed (→P. 666)</p>
 <p>TIRE PRESSURE [psi] 33.0 33.0 33.0</p> 	<p>Indicates that the tire inflation pressure is low</p>	<p>Check the tire inflation pressure, and adjust to the appropriate level.</p>
 <p>TIRE PRESSURE</p> 	<p>Indicates a malfunction in the tire pressure warning system</p>	<p>Stop the vehicle in a safe place and turn the "START STOP ENGINE" &lt;"POWER"&gt; switch off then on again.</p> <p>If the tire pressure warning indicator flashes for 1 minute then illuminates, there is a malfunction in the system. Have the vehicle inspected at your Lexus dealer.</p>





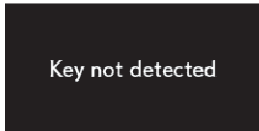

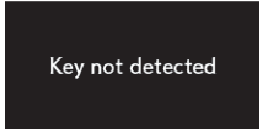
Warning message	Details	Correction procedure
	<p>Indicates that the tire position information cannot be recognized</p>	<p>Drive for a short while and check if the display updates.</p> <p>If the radio wave conditions improve, the display may return to normal. If the tire pressure is still not displayed after driving for several minutes, stop the vehicle in a safe place, turn the "START STOP ENGINE" &lt;"POWER"&gt; switch off then on again, and start driving.</p> <p>If the tire pressure is still not displayed even after repeating this several times, have the vehicle inspected at your Lexus dealer.</p>
  (Flashes) (If equipped)	<p>Indicates that the pre-collision system is not currently functional because the grille cover or the sensor is dirty</p> <p>This message also appears when the pre-collision system is not functional due to overheating.</p>	<ul style="list-style-type: none"> <li>• Check the grille cover and the sensor and clean them if they are dirty.</li> <li>• In case of overheating, the system will become functional once the system cools down.</li> </ul>



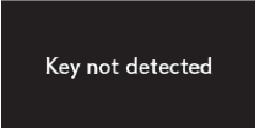
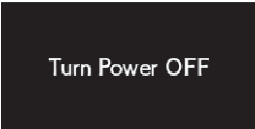

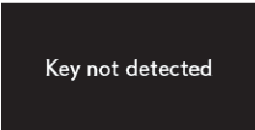

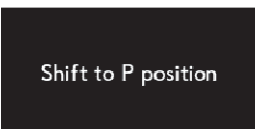
\*: Refer to the separate "Scheduled Maintenance" or "Owner's Manual Supplement" for the maintenance interval applicable to your vehicle.

**Have the malfunction repaired immediately.**

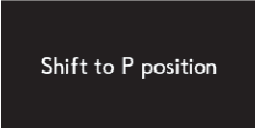
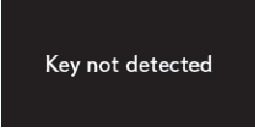







After taking the specified steps to correct the suspected problem, check that the warning message and light go off.



Interior buzzer	Exterior buzzer	Warning message	Details	Correction procedure
Once	—	  (Flashes)	The electronic key is not detected when an attempt is made to start the engine <hybrid system>.	Start the engine with the electronic key present.
Once	3 times	  (Flashes)	<p>The electronic key was carried outside the vehicle and a door other than the driver's door was opened and closed while the "START STOP ENGINE" &lt;"POWER"&gt; switch was in a mode other than off.</p> <p>The driver's door was opened and closed while the electronic key was not in the vehicle, the shift lever was in P and the "START STOP ENGINE" &lt;"POWER"&gt; switch was not turned off.</p>	<p>Bring the electronic key back into the vehicle.</p> <p>Turn the "START STOP ENGINE" &lt;"POWER"&gt; switch off or bring the electronic key back into the vehicle.</p>

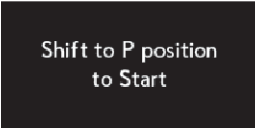

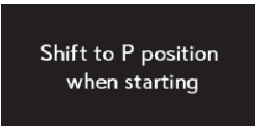

Interior buzzer	Exterior buzzer	Warning message	Details	Correction procedure
Once	Con- tinuous	  (Displayed alternately)  (Flashes)	An attempt was made to exit the vehicle with the electronic key and lock the doors without first turning the "START STOP ENGINE" <"POWER"> switch off when the shift lever was in P.	Turn the "START STOP ENGINE" <"POWER"> switch off and lock the doors again.
9 times	—	  (Flashes)	An attempt was made to drive when the regular key was not inside the vehicle.	Confirm that the electronic key is inside the vehicle.
Con- tinuous	—	  (Flashes)	The driver's door was opened when the shift lever was not in P and the "START STOP ENGINE" <"POWER"> switch was not turned off.	Shift the shift lever to P.

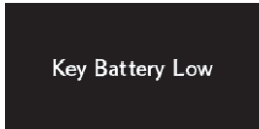



Interior buzzer	Exterior buzzer	Warning message	Details	Correction procedure
Continuous	Continuous	  (Displayed alternately)  (Flashes)	The driver's door was opened and closed while the electronic key was not in the vehicle, the shift lever was not in P and the "START STOP ENGINE" <"POWER"> switch was not turned off.	<ul style="list-style-type: none"> <li>• Shift the shift lever to P.</li> <li>• Bring the electronic key back into the vehicle.</li> </ul>
—	Continuous	  (Flashes)	An attempt was made to lock the doors using the smart access system with push-button start while the electronic key was still inside the vehicle.	Retrieve the electronic key from the vehicle and lock the doors again.
Once	Continuous	  (Flashes)	An attempt was made to lock either front door by opening a door and putting the inside lock button into the lock position, then closing the door with the electronic key still inside the vehicle.	Retrieve the electronic key from the vehicle and lock the doors again.

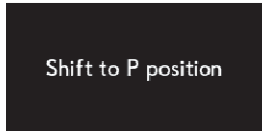

Interior buzzer	Exterior buzzer	Warning message	Details	Correction procedure
Once	—	<p>▶ Gasoline vehicles</p>  <p> (Flashes)</p> <p>▶ Hybrid vehicles</p>  <p> (Flashes)</p>	<ul style="list-style-type: none"> <li>When the doors were unlocked with the mechanical key and then the “START STOP ENGINE” &lt;“POWER”&gt; switch was pressed, the electronic key could not be detected in the vehicle.</li> <li>The electronic key could not be detected in the vehicle even after the “START STOP ENGINE” &lt;“POWER”&gt; switch was pressed two consecutive times.</li> </ul>	<p>Touch the electronic key to the “START STOP ENGINE” &lt;“POWER”&gt; switch while depressing the brake pedal.</p>
Once	—	<p>▶ Gasoline vehicles</p>  <p> (Flashes)</p> <p>▶ Hybrid vehicles</p>  <p> (Flashes)</p>	<p>An attempt was made to start the engine &lt;hybrid system&gt; with the shift lever in an incorrect position.</p>	<p>Shift the shift lever to P and start the engine &lt;hybrid system&gt;.</p>

Interior buzzer	Exterior buzzer	Warning message	Details	Correction procedure
—	—		Power was turned off due to the automatic power off function.	Next time when starting the engine <hybrid system>, increase the engine speed slightly and maintain that level for approximately 5 minutes to recharge the 12-volt battery.
Once	—	 	The electronic key has a low battery.	Replace the electronic key battery. (→P. 719)

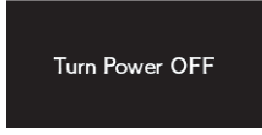
Interior buzzer	Exterior buzzer	Warning message	Details	Correction procedure
Once	—	<p>► Gasoline vehicles</p>  <p> (Flashes)</p> <p>► Hybrid vehicles</p>  <p> (Flashes)</p>	<p>The driver's door was opened and closed with the "START STOP ENGINE" &lt;"POWER"&gt; switch turned off and then the "START STOP ENGINE" &lt;"POWER"&gt; switch was put in ACCESSORY mode twice without the engine &lt;hybrid system&gt; being started.</p>	<p>Press the "START STOP ENGINE" &lt;"POWER"&gt; switch while depressing the brake pedal.</p>
		<p>Steering Lock active</p>  (Flashes)	<p>The steering lock could not be released within 3 seconds of the "START STOP ENGINE" &lt;"POWER"&gt; switch being pressed.</p>	<p>Press the "START STOP ENGINE" &lt;"POWER"&gt; switch while depressing the brake pedal and moving the steering wheel left and right.</p>

Interior buzzer	Exterior buzzer	Warning message	Details	Correction procedure
Once	—	  (Flashes)	The "START STOP ENGINE" <"POWER"> switch has been turned off with the shift lever in a position other than P or N.	Shift the shift lever to P.
Once	—	  (Flashes)	After the "START STOP ENGINE" <"POWER"> switch has been turned off with the shift lever in a position other than P, the shift lever has been shifted to P.	Turn the "START STOP ENGINE" <"POWER"> switch off.

#### ■ Warning buzzer

In some cases, the buzzer may not be heard because of noisy place or an audio sound.

## If you have a flat tire

Remove the flat tire and replace it with the spare tire provided.

For details about tires: →P. 702

### CAUTION

#### ■ If you have a flat tire

Do not continue driving with a flat tire.

Driving even a short distance with a flat tire can damage the tire and the wheel beyond repair, which could result in an accident.

## Before jacking up the vehicle

- Stop the vehicle on a hard, flat surface.
- Set the parking brake.
- Shift the shift lever to P.
- Stop the engine <hybrid system>.
- Turn on the emergency flashers. (→P. 748)

### Location of the spare tire, jack and tools

- Vehicles with a compact spare tire

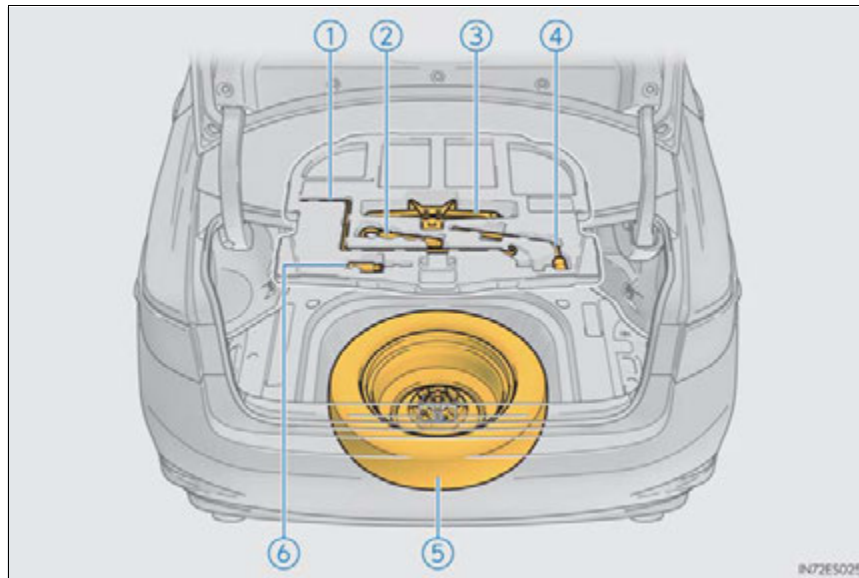

- |                 |                    |
|-----------------|--------------------|
| ① Jack handle   | ④ Wheel nut wrench |
| ② Towing eyelet | ⑤ Spare tire       |
| ③ Jack          | ⑥ Screwdriver      |

► Vehicles with a full-size spare tire

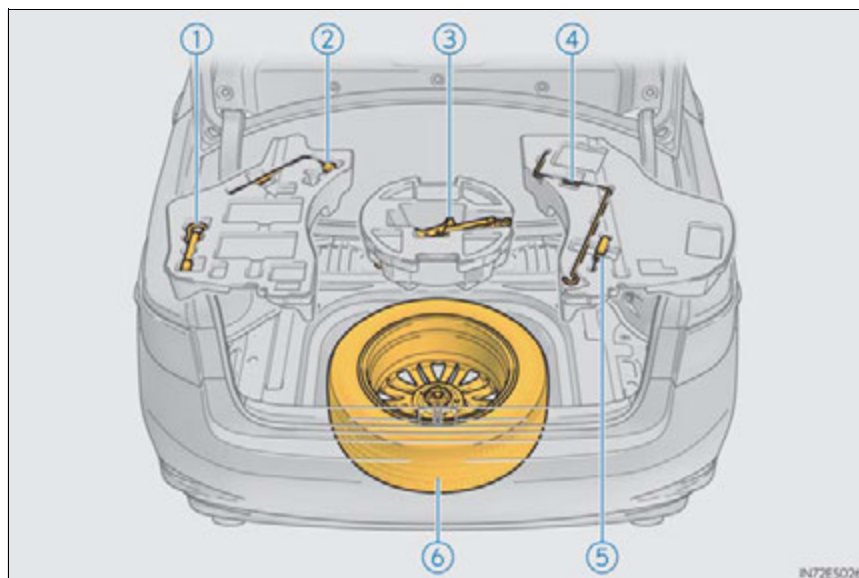

- ① Towing eyelet
- ② Wheel nut wrench
- ③ Jack
- ④ Jack handle
- ⑤ Screwdriver
- ⑥ Spare tire

 CAUTION

## ■ Using the tire jack

Observe the following precautions.

Improper use of the tire jack may cause the vehicle to suddenly fall off the jack, leading to death or serious injury.

- Do not use the tire jack for any purpose other than replacing tires or installing and removing tire chains.
- Only use the tire jack that comes with this vehicle for replacing a flat tire. Do not use it on other vehicles, and do not use other tire jacks for replacing tires on this vehicle.
- Put the jack properly in its jack point.
- Do not put any part of your body under the vehicle while it is supported by the jack.
- Do not start the engine <hybrid system> or drive the vehicle while the vehicle is supported by the jack.
- Do not raise the vehicle while someone is inside.
- When raising the vehicle, do not put an object on or under the jack.
- Do not raise the vehicle to a height greater than that required to replace the tire.
- Use a jack stand if it is necessary to get under the vehicle.
- When lowering the vehicle, make sure that there is no-one near the vehicle. If there are people nearby, warn them vocally before lowering.



### Taking out the spare tire

1 Open the luggage mat. (→P. 620)

2 Remove the auxiliary boxes.

▶ Vehicles with a compact spare tire

▶ Vehicles with a full-size spare tire

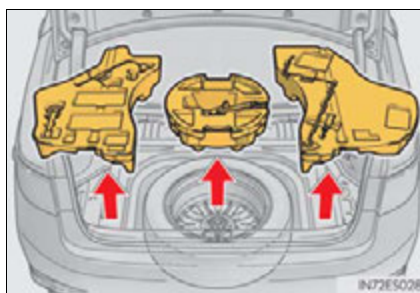
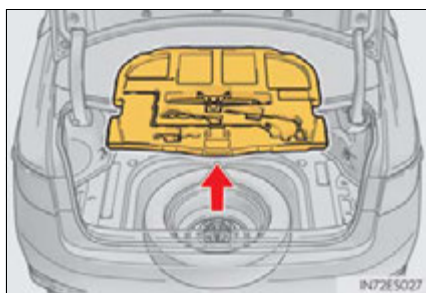

3 Loosen the center fastener that secures the spare tire.

▶ Vehicles with a compact spare tire

▶ Vehicles with a full-size spare tire

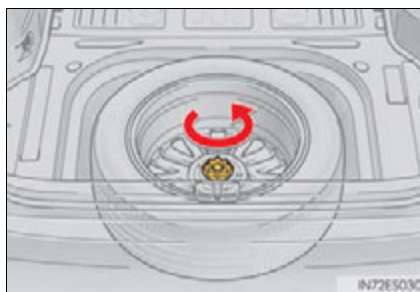
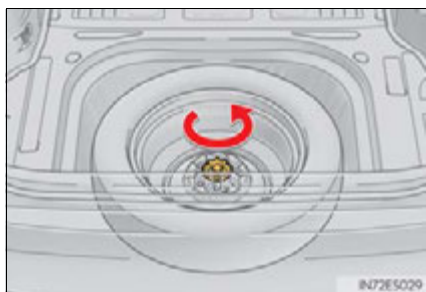

#### ⚠ CAUTION

##### ■ When storing the spare tire

Be careful not to catch fingers or other body parts between the spare tire and the body of the vehicle.

## Replacing a flat tire

- 1 Chock the tires.

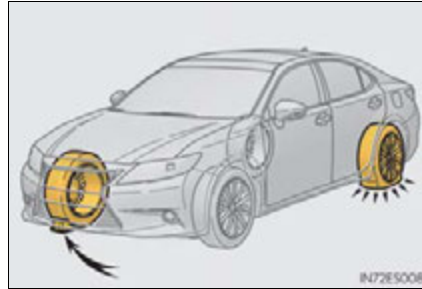

Flat tire		Wheel chock positions
Front	Left-hand side	Behind the rear right-hand side tire
	Right-hand side	Behind the rear left-hand side tire
Rear	Left-hand side	In front of the front right-hand side tire
	Right-hand side	In front of the front left-hand side tire

- 2 Slightly loosen the wheel nuts (one turn).

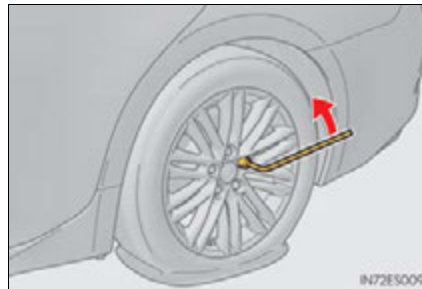

- 3 Turn the tire jack portion (A) by hand until the notch of the jack is in contact with the jack point.

The jack point guides are located under the rocker panel. They indicate the jack point positions.

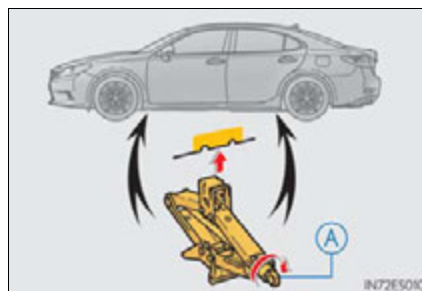

- 4 Raise the vehicle until the tire is slightly raised off the ground.

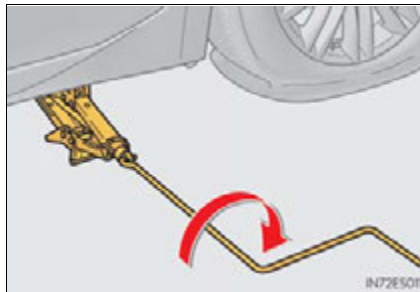

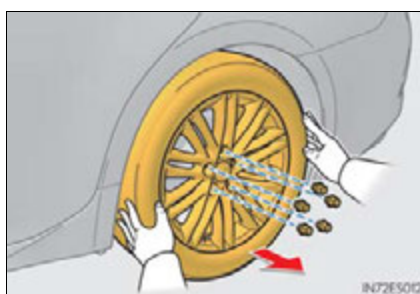

- 5 Remove all the wheel nuts and the tire.

When resting the tire on the ground, place the tire so that the wheel design faces up to avoid scratching the wheel surface.

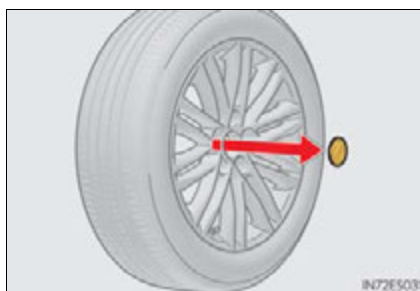

- 6 Vehicles with a full-size spare tire: Remove the wheel ornament by pushing from the reverse side.



 CAUTION

## ■ Replacing a flat tire

- Observe the following precautions.

Failure to do so may result in serious injury:

- Do not try to remove the wheel ornament by hand. Take due care in handling the ornament to avoid unexpected personal injury.
- Do not touch the disc wheels or the area around the brakes immediately after the vehicle has been driven.

After the vehicle has been driven the disc wheels and the area around the brakes will be extremely hot. Touching these areas with hands, feet or other body parts while changing a tire, etc. may result in burns.

- Failure to follow these precautions could cause the wheel nuts to loosen and the tire to fall off, resulting in death or serious injury.
  - Never use oil or grease on the wheel bolts or wheel nuts.  
Oil and grease may cause the wheel nuts to be excessively tightened, leading to bolt or disc wheel damage. In addition, the oil or grease can cause the wheel nuts to loosen and the wheel may fall off, causing a serious accident. Remove any oil or grease from the wheel bolts or wheel nuts.
  - Have the wheel nuts tightened with a torque wrench to 76 ft•lbf (103 N•m, 10.5 kgf•m) as soon as possible after changing wheels.
  - Do not attach a heavily damaged wheel ornament, as it may fly off the wheel while the vehicle is moving.
  - When installing a tire, only use wheel nuts that have been specifically designed for that wheel.
  - If there are any cracks or deformations in the bolt screws, nut threads or bolt holes of the wheel, have the vehicle inspected by your Lexus dealer.

### Installing the spare tire

- 1 Remove any dirt or foreign matter from the wheel contact surface.

If foreign matter is on the wheel contact surface, the wheel nuts may loosen while the vehicle is in motion, causing the tire to come off.

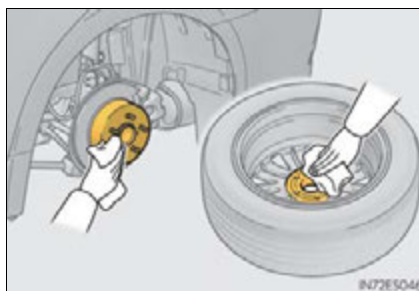

- 2 Install the spare tire and loosely tighten each wheel nut by hand by approximately the same amount.

When replacing an aluminum wheel with an aluminum wheel, turn the wheel nuts until the washers come into contact with the disc wheel.

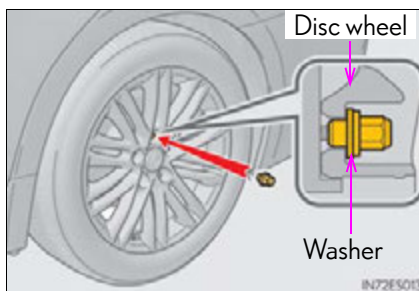

When replacing an aluminum wheel with a steel wheel, tighten the wheel nuts until the tapered portion comes into loose contact with the disc wheel seat.

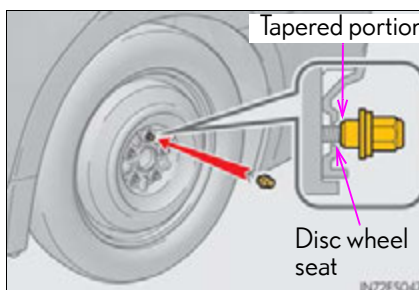

- 3 Lower the vehicle.

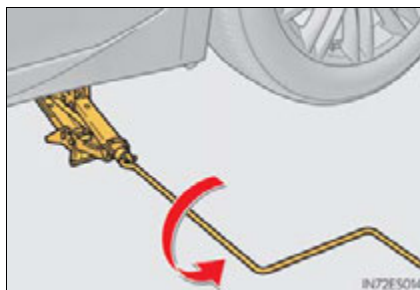

- 4 Firmly tighten each wheel nut two or three times in the order shown in the illustration.

**Tightening torque:**  
76 ft•lbf (103 N•m, 10.5 kgf•m)

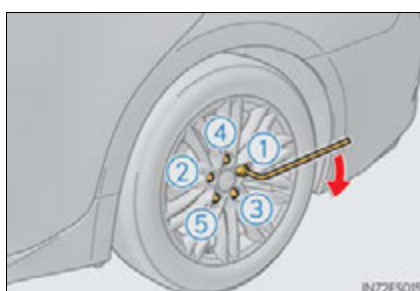

- 5 Vehicles with a full-size spare tire:  
Reinstall the wheel ornament.

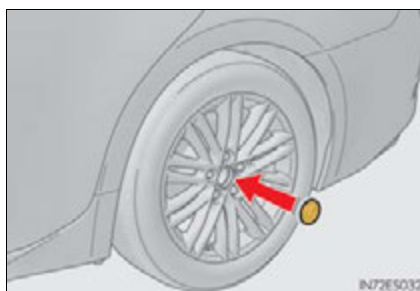

- 6 Stow the flat tire, tire jack and all tools.

■ **The compact spare tire**

- The compact spare tire is identified by the label “TEMPORARY USE ONLY” on the tire sidewall.  
Use the compact spare tire temporarily, and only in an emergency.
- Make sure to check the tire inflation pressure of the compact spare tire.  
(→P. 844)

■ **When using the compact spare tire**

As the compact spare tire is not equipped with a tire pressure warning valve and transmitter, low inflation pressure of the spare tire will not be indicated by the tire pressure warning system. Also, if you replace the compact spare tire after the tire pressure warning light comes on, the light remains on.

■ **When the compact spare tire is equipped**

The vehicle becomes lower when driving with the compact spare tire compared to when driving with standard tires.

■ **If you have a flat front tire on a road covered with snow or ice (vehicles with a compact spare tire)**

Install the compact spare tire on one of the rear wheels of the vehicle. Perform the following steps and fit tire chains to the front tires:

- 1 Replace a rear tire with the compact spare tire.
- 2 Replace the flat front tire with the tire removed from the rear of the vehicle.
- 3 Fit tire chains to the front tires.

 CAUTION**■ When using the compact spare tire**

- Remember that the compact spare tire provided is specifically designed for use with your vehicle. Do not use your compact spare tire on another vehicle.
- Do not use more than one compact spare tire simultaneously.
- Replace the compact spare tire with a standard tire as soon as possible.
- Avoid sudden acceleration, abrupt steering, sudden braking and shifting operations that cause sudden engine braking.

**■ When the compact spare tire is attached**

The vehicle speed may not be correctly detected, and the following systems may not operate correctly:

- ABS & Brake assist
- VSC
- TRAC
- Cruise control
- Dynamic radar cruise control (if equipped)
- PCS (if equipped)
- EPS
- LDA (Lane Departure Alert) (if equipped)
- Rear view monitor system (if equipped)
- Intuitive parking assist (if equipped)
- Navigation system (if equipped)

**■ Speed limit when using the compact spare tire**

Do not drive at speeds in excess of 50 mph (80 km/h) when a compact spare tire is installed on the vehicle.

The compact spare tire is not designed for driving at high speeds. Failure to observe this precaution may lead to an accident causing death or serious injury.

**■ After using the tools and jack**

Before driving, make sure all the tools and jack are securely in place in their storage location to reduce the possibility of personal injury during a collision or sudden braking.



 NOTICE

■ **Driving with tire chains and the compact spare tire**

Do not fit tire chains to the compact spare tire.  
Tire chains may damage the vehicle body and adversely affect driving performance.

■ **When replacing the tires**

When removing or fitting the wheels, tires or the tire pressure warning valve and transmitter, contact your Lexus dealer as the tire pressure warning valve and transmitter may be damaged if not handled correctly.

## If the engine will not start (gasoline vehicles)

If the engine will not start even though correct starting procedures are being followed (→P. 201), consider each of the following points:

### The engine will not start even though the starter motor operates normally.

One of the following may be the cause of the problem:

- There may not be sufficient fuel in the vehicle's tank.  
Refuel the vehicle.
- The engine may be flooded.  
Try to restart the engine again following correct starting procedures.  
(→P. 201)
- There may be a malfunction in the engine immobilizer system.  
(→P. 82)

### The starter motor turns over slowly, the interior lights and headlights are dim, or the horn does not sound or sounds at a low volume.

One of the following may be the cause of the problem:

- The 12-volt battery may be discharged. (→P. 813)
- The 12-volt battery terminal connections may be loose or corroded.

### The starter motor does not turn over

The engine starting system may be malfunctioning due to an electrical problem such as electronic key battery depletion or a blown fuse. However, an interim measure is available to start the engine. (→P. 806)

**The starter motor does not turn over, the interior lights and headlights do not turn on, or the horn does not sound.**

One of the following may be the cause of the problem:

- One or both of the 12-volt battery terminals may be disconnected.
- The 12-volt battery may be discharged. (→P. 813)
- There may be a malfunction in the steering lock system.

Contact your Lexus dealer if the problem cannot be repaired, or if repair procedures are unknown.

**Emergency start function**

When the engine does not start, the following steps can be used as an interim measure to start the engine if the “START STOP ENGINE” switch is functioning normally:

- 1** Set the parking brake.
- 2** Shift the shift lever to P.
- 3** Turn the “START STOP ENGINE” switch to ACCESSORY mode.
- 4** Press and hold the “START STOP ENGINE” switch for about 15 seconds while depressing the brake pedal firmly.

Even if the engine can be started using the above steps, the system may be malfunctioning. Have the vehicle inspected by your Lexus dealer.

## If the hybrid system will not start (hybrid vehicles)

Reasons for the hybrid system not starting vary depending on the situation. Check the following and perform the appropriate procedure:

### The hybrid system will not start even though the correct starting procedure is being followed. (→P. 208)

One of the following may be the cause of the problem:

- The electronic key may not be functioning properly. (→P. 811)
- There may not be sufficient fuel in the vehicle's tank.  
Refuel the vehicle.
- There may be a malfunction in the immobilizer system. (→P. 84)
- There may be a malfunction in the steering lock system.
- The hybrid system may be malfunctioning due to an electrical problem such as electronic key battery depletion or a blown fuse. However, depending on the type of malfunction, an interim measure is available to start the hybrid system. (→P. 808)

### The interior lights and headlights are dim, or the horn does not sound or sounds at a low volume.

One of the following may be the cause of the problem:

- The 12-volt battery may be discharged. (→P. 817)
- The 12-volt battery terminal connections may be loose or corroded.

**The interior lights and headlights do not turn on, or the horn does not sound.**

One of the following may be the cause of the problem:

- One or both of the 12-volt battery terminals may be disconnected.
- The 12-volt battery may be discharged. (→P. 817)

Contact your Lexus dealer if the problem cannot be repaired, or if repair procedures are unknown.

**Emergency start function**

When the hybrid system does not start, the following steps can be used as an interim measure to start the hybrid system if the "POWER" switch is functioning normally:

- 1** Set the parking brake.
- 2** Shift the shift lever to P.
- 3** Turn the "POWER" switch to ACCESSORY mode.
- 4** Press and hold the "POWER" switch for about 15 seconds while depressing the brake pedal firmly.

Even if the hybrid system can be started using the above steps, the system may be malfunctioning. Have the vehicle inspected by your Lexus dealer.

## If the shift lever cannot be shifted from P

If the shift lever cannot be shifted with your foot on the brake pedal, there may be a problem with the shift lock system (a system to prevent accidental operation of the shift lever). Have the vehicle inspected by your Lexus dealer immediately.

The following steps may be used as an emergency measure to ensure that the shift lever can be shifted:

- 1 Set the parking brake.
- 2 Turn the "START STOP ENGINE" <"POWER"> switch to ACCESSORY mode.
- 3 Depress the brake pedal.

- 4 Pry the cover up with a flathead screwdriver or equivalent tool.

To prevent damage to the cover, cover the tip of the screwdriver with a rag.

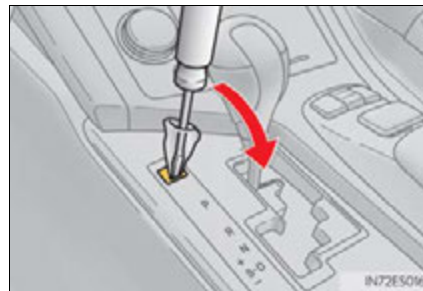

- 5 Press the shift lock override button.

The shift lever can be shifted while the button is pressed.



## If the electronic key does not operate properly

If communication between the electronic key and vehicle is interrupted (→P. 132) or the electronic key cannot be used because the battery is depleted, the smart access system with push-button start and wireless remote control cannot be used. In such cases, the doors and trunk can be opened and the engine <hybrid system> can be started by following the procedure below.

### Locking and unlocking the doors, unlocking the trunk and key linked functions

#### ■ Doors

Use the mechanical key (→P. 122) in order to perform the following operations:

- ① Locks all the doors
- ② Closes the windows and moon roof (turn and hold)\*
- ③ Unlocks the door
 

Turning the key rearward unlocks the driver's door. Turning the key once again within 5 seconds unlocks the other doors.
- ④ Opens the windows and moon roof (turn and hold)\*

\*: This setting must be customized at your Lexus dealer.

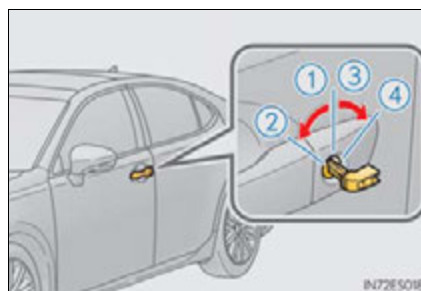

### ■ Trunk

Turn the mechanical key clockwise to open.

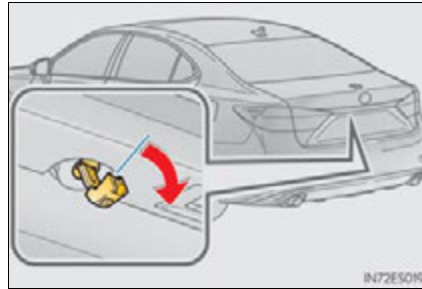



### Starting the engine <hybrid system>

- 1 Ensure that the shift lever is in P and depress the brake pedal.
- 2 Touch the Lexus emblem side of the electronic key to the "START STOP ENGINE" <"POWER"> switch.

The "START STOP ENGINE" <"POWER"> switch will turn to IGNITION ON <ON> mode.

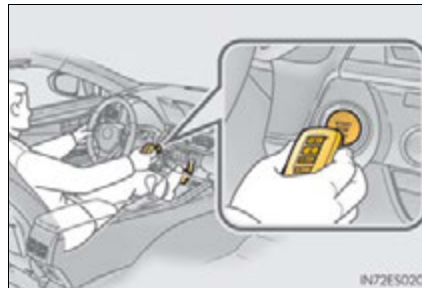
When the smart access system with push-button start is deactivated in customization setting, the "START STOP ENGINE" <"POWER"> switch will turn to ACCESSORY mode.



- 3 Firmly depress the brake pedal and check that  is shown on the multi-information display.
- 4 Press the "START STOP ENGINE" <"POWER"> switch.

In the event that the engine <hybrid system> still cannot be started, contact your Lexus dealer.



■ **Stopping the engine <hybrid system>**

Shift the shift lever to P and press the “START STOP ENGINE” <“POWER”> switch as you normally do when stopping the engine <hybrid system>.

■ **Replacing the key battery**

As the above procedure is a temporary measure, it is recommended that the electronic key battery be replaced immediately when the battery is depleted. (→P. 719)

■ **Changing “START STOP ENGINE” <“POWER”> switch modes**

Release the brake pedal and press the “START STOP ENGINE” <“POWER”> switch in step 3 above.

The engine <hybrid system> does not start and modes will be changed each time the switch is pressed. (→P. 202, 209)

■ **When the electronic key does not work properly**

- Make sure that the smart access system with push-button start has not been deactivated in the customization setting. If it is off, turn the function on. (Customizable features →P. 862)
- Check if battery-saving mode is set. If it is set, cancel the function. (→P. 131)

## If the 12-volt battery is discharged (gasoline vehicles)

The following procedures may be used to start the engine if the 12-volt battery is discharged.

You can also call your Lexus dealer or a qualified repair shop.

If you have a set of jumper (or booster) cables and a second vehicle with a 12-volt battery, you can jump start your vehicle by following the steps below.

- 1 Open the hood (→P. 677)
- 2 Connect the jumper cables according to the following procedure:

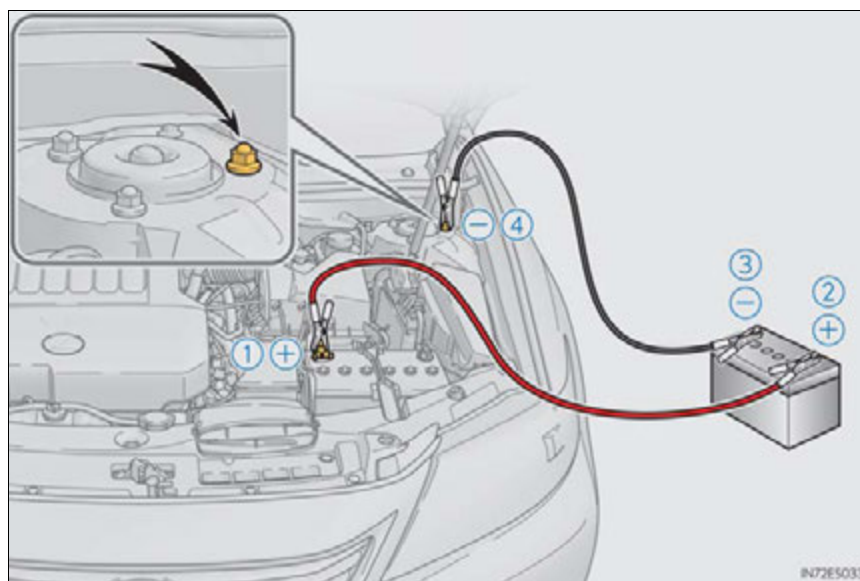

- ① Connect a positive jumper cable clamp to the positive (+) battery terminal on your vehicle.
- ② Connect the clamp on the other end of the positive cable to the positive (+) battery terminal on the second vehicle.
- ③ Connect a negative cable clamp to the negative (-) battery terminal on the second vehicle.
- ④ Connect the clamp at the other end of the negative cable to a solid, stationary, unpainted metallic point away from the 12-volt battery and any moving parts, as shown in the illustration.
- ③ Start the engine of the second vehicle. Increase the engine speed slightly and maintain at that level for approximately 5 minutes to recharge the 12-volt battery of your vehicle.
- ④ Open and close any of the doors of your vehicle with the “START STOP ENGINE” switch off.
- ⑤ Maintain the engine speed of the second vehicle and start the engine of your vehicle by turning the “START STOP ENGINE” switch to IGNITION ON mode.
- ⑥ Once the vehicle’s engine has started, remove the jumper cables in the exact reverse order from which they were connected.

Once the engine starts, have the vehicle inspected at your Lexus dealer as soon as possible.

---

■ **Starting the engine when the 12-volt battery is discharged**

The engine cannot be started by push-starting.

■ **To prevent 12-volt battery discharge**

- Turn off the headlights and the audio system while the engine is off.
- Turn off any unnecessary electrical components when the vehicle is running at a low speed for an extended period, such as in heavy traffic.

**■ Charging the 12-volt battery**

The electricity stored in the 12-volt battery will discharge gradually even when the vehicle is not in use, due to natural discharge and the draining effects of certain electrical appliances. If the vehicle is left for a long time, the 12-volt battery may discharge, and the engine may be unable to start. (The 12-volt battery recharges automatically during driving.)

**■ When recharging or replacing the 12-volt battery**

- Make sure that the key is not inside the vehicle when recharging or replacing the 12-volt battery. The key may be locked in the vehicle if the alarm is activated. (→P. 87)
- In some cases, it may not be possible to unlock the doors using the smart access system with push-button start when the 12-volt battery is discharged. Use the wireless remote control or the mechanical key to lock or unlock the doors.
- The engine may not start on the first attempt after the 12-volt battery has recharged but will start normally after the second attempt. This is not a malfunction.
- The “START STOP ENGINE” switch mode is memorized by the vehicle. When the 12-volt battery is reconnected, the system will return to the mode it was in before the 12-volt battery was discharged. Before disconnecting the 12-volt battery, turn the “START STOP ENGINE” switch off.  
If you are unsure what mode the “START STOP ENGINE” switch was in before the 12-volt battery discharged, be especially careful when reconnecting the 12-volt battery.

**⚠ CAUTION****■ Avoiding 12-volt battery fires or explosions**

Observe the following precautions to prevent accidentally igniting the flammable gas that may be emitted from the 12-volt battery:

- Make sure each jumper cable is connected to the correct terminal and that it is not unintentionally in contact with any other than the intended terminal.
- Do not allow the other end of the jumper cable connected to the “+” terminal to come into contact with any other parts or metal surfaces in the area, such as brackets or unpainted metal.
- Do not allow the + and - clamps of the jumper cables to come into contact with each other.
- Do not smoke, use matches, cigarette lighters or allow open flame near the 12-volt battery.

 CAUTION**■ 12-volt battery precautions**

The 12-volt battery contains poisonous and corrosive acidic electrolyte, while related parts contain lead and lead compounds. Observe the following precautions when handling the 12-volt battery:

- When working with the 12-volt battery, always wear safety glasses and take care not to allow any battery fluids (acid) to come into contact with skin, clothing or the vehicle body.
- Do not lean over the 12-volt battery.
- In the event that battery fluid comes into contact with the skin or eyes, immediately wash the affected area with water and seek medical attention.  
Place a wet sponge or cloth over the affected area until medical attention can be received.
- Always wash your hands after handling the battery support, terminals, and other battery-related parts.
- Do not allow children near the 12-volt battery.

 NOTICE**■ When handling jumper cables**

When connecting the jumper cables, ensure that they do not become entangled in the cooling fans or engine drive belt.

## If the 12-volt battery is discharged (hybrid vehicles)

The following procedures may be used to start the hybrid system if the 12-volt battery is discharged.

You can also call your Lexus dealer or a qualified repair shop.

If you have a set of jumper (or booster) cables and a second vehicle with a 12-volt battery, you can jump start your vehicle by following the steps below.

- 1 Open the trunk lid and remove the 12-volt battery cover. (→P. 698)  
In the event that the trunk opener cannot be used, use the mechanical key to open the trunk. (→P. 810)
- 2 Connect the jumper cables according to the following procedure:

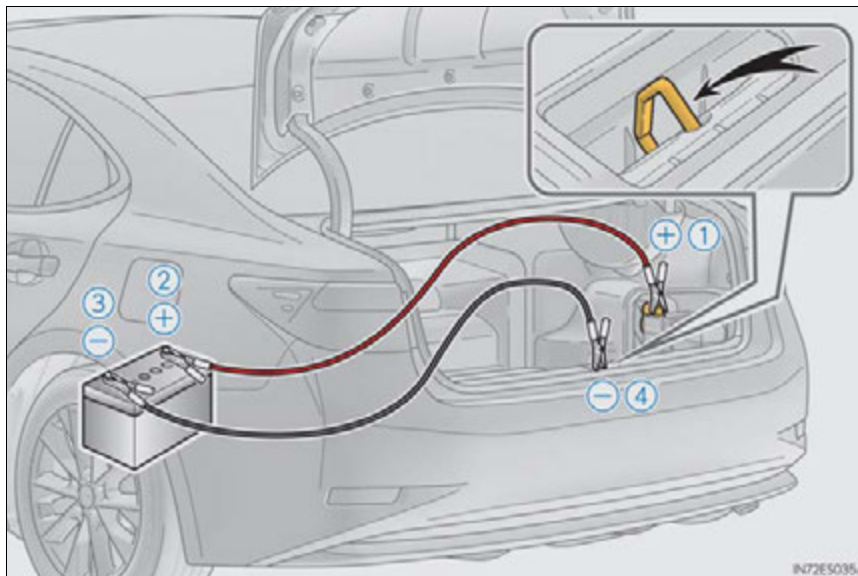

- ① Connect a positive jumper cable clamp to the positive (+) battery terminal on your vehicle.
- ② Connect the clamp on the other end of the positive cable to the positive (+) battery terminal on the second vehicle.
- ③ Connect a negative cable clamp to the negative (-) battery terminal on the second vehicle.
- ④ Connect the clamp at the other end of the negative cable to a solid, stationary, unpainted metallic point away from the 12-volt battery and any moving parts, as shown in the illustration.
- ③ Start the engine of the second vehicle. Increase the engine speed slightly and maintain at that level for approximately 5 minutes to recharge the 12-volt battery of your vehicle.
- ④ Open and close any of the doors of your vehicle with the "POWER" switch off.
- ⑤ Maintain the engine speed of the second vehicle and start the hybrid system of your vehicle by turning the "POWER" switch to ON mode.
- ⑥ Make sure the "READY" indicator comes on. If the indicator does not come on, contact your Lexus dealer.
- ⑦ Once the hybrid system has started, remove the jumper cables in the exact reverse order from which they were connected.

Once the hybrid system starts, have the vehicle inspected at your Lexus dealer as soon as possible.

**■ Starting the hybrid system when the 12-volt battery is discharged**

The hybrid system cannot be started by push-starting.

**■ To prevent 12-volt battery discharge**

- Turn off the headlights and the audio system while the hybrid system is off.
- Turn off any unnecessary electrical components when the vehicle is running at a low speed for an extended period, such as in heavy traffic.

**■ Charging the 12-volt battery**

The electricity stored in the 12-volt battery will discharge gradually even when the vehicle is not in use, due to natural discharge and the draining effects of certain electrical appliances. If the vehicle is left for a long time, the 12-volt battery may discharge, and the hybrid system may be unable to start. (The 12-volt battery recharges automatically while the hybrid system is operating.)

**■ When recharging or replacing the 12-volt battery**

- Make sure that the key is not inside the vehicle when recharging or replacing the 12-volt battery. The key may be locked in the vehicle if the alarm is activated. (→P. 87)
- In some cases, it may not be possible to unlock the doors using the smart access system with push-button start when the 12-volt battery is discharged. Use the wireless remote control or the mechanical key to lock or unlock the doors.
- The hybrid system may not start on the first attempt after the 12-volt battery has recharged but will start normally after the second attempt. This is not a malfunction.
- The "POWER" switch mode is memorized by the vehicle. When the 12-volt battery is reconnected, the system will return to the mode it was in before the 12-volt battery was discharged. Before disconnecting the 12-volt battery, turn the "POWER" switch off.  
If you are unsure what mode the "POWER" switch was in before the 12-volt battery discharged, be especially careful when reconnecting the 12-volt battery.



 **CAUTION****■ Avoiding 12-volt battery fires or explosions**

Observe the following precautions to prevent accidentally igniting the flammable gas that may be emitted from the battery:

- Make sure each jumper cable is connected to the correct terminal and that it is not unintentionally in contact with any other than the intended terminal.
- Do not allow the other end of the jumper cable connected to the "+" terminal to come into contact with any other parts or metal surfaces in the area, such as brackets or unpainted metal.
- Do not allow the + and - clamps of the jumper cables to come into contact with each other.
- Do not smoke, use matches, cigarette lighters or allow open flame near the battery.

**■ 12-volt battery precautions**

The 12-volt battery contains poisonous and corrosive acidic electrolyte, while related parts contain lead and lead compounds. Observe the following precautions when handling the 12-volt battery:

- When working with the 12-volt battery, always wear safety glasses and take care not to allow any 12-volt battery fluids (acid) to come into contact with skin, clothing or the vehicle body.
- Do not lean over the 12-volt battery.
- In the event that 12-volt battery fluid comes into contact with the skin or eyes, immediately wash the affected area with water and seek medical attention. Place a wet sponge or cloth over the affected area until medical attention can be received.
- Always wash your hands after handling the 12-volt battery support, terminals, and other battery-related parts.
- Do not allow children near the 12-volt battery.

**■ After recharging the 12-volt battery**

Have the 12-volt battery inspected at your Lexus dealer as soon as possible. If the 12-volt battery is deteriorating, continued use may cause the 12-volt battery to emit a malodorous gas, which may be detrimental to the health of passengers.

**■ When replacing the 12-volt battery**

→P. 701

## If your vehicle overheats (gasoline vehicles)

The following may indicate that your vehicle is overheating.

- The needle of the engine coolant temperature gauge (→P. 95) enters the red zone or a loss of engine power is experienced. (For example, the vehicle speed does not increase.)
- Steam comes out from under the hood.

### Correction procedures

- 1 Stop the vehicle in a safe place and turn off the air conditioning system, and then stop the engine.
- 2 If you see steam:  
Carefully lift the hood after the steam subsides.  
  
If you do not see steam:  
Carefully lift the hood.
- 3 After the engine has cooled down sufficiently, inspect the hoses and radiator core (radiator) for any leaks.
  - 1 Radiator
  - 2 Cooling fans  
If a large amount of coolant leaks, immediately contact your Lexus dealer.

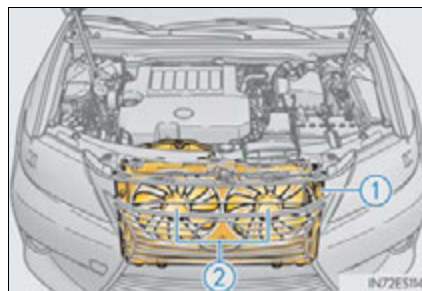

- 4** The coolant level is satisfactory if it is between the “FULL” and “LOW” line on the reservoir.

- ① Reservoir
- ② “FULL”
- ③ “LOW”
- ④ Radiator cap

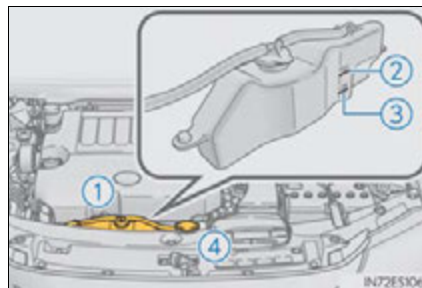

- 5** Add coolant if necessary.  
Water can be used in an emergency if coolant is unavailable.

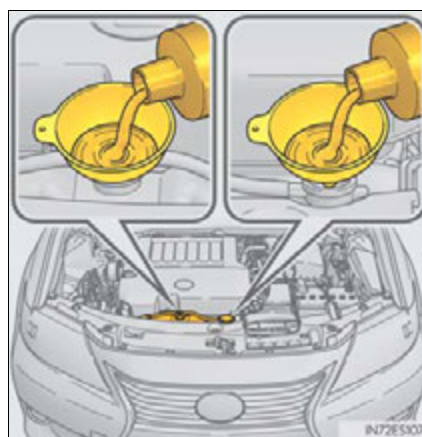

- 6** Start the engine and turn the air conditioning system on to check that the radiator cooling fans operate and to check for coolant leaks from the radiator or hoses.

The fans operate when the air conditioning system is turned on immediately after a cold start. Confirm that the fans are operating by checking the fan sound and air flow. If it is difficult to check these, turn the air conditioning system on and off repeatedly. (The fans may not operate in freezing temperatures.)

- 7** If the fans are not operating:  
Stop the engine immediately and contact your Lexus dealer.
- If the fans are operating:  
Have the vehicle inspected at the nearest Lexus dealer.

 CAUTION**■ When inspecting under the hood of your vehicle**

Observe the following precautions.

Failure to do so may result in serious injury such as burns.

- If steam is seen coming from under the hood, do not open the hood until the steam has subsided. The engine compartment may be very hot.
- Keep hands and clothing (especially a tie, a scarf or a muffler) away from the fans and belts. Failure to do so may cause the hands or clothing to be caught, resulting in serious injury.
- Do not loosen the radiator cap or the coolant reservoir cap while the engine and radiator are hot. High temperature steam or coolant could spray out.

 NOTICE**■ When adding engine coolant**

Add coolant slowly after the engine has cooled down sufficiently. Adding cool coolant to a hot engine too quickly can cause damage to the engine.

**■ To prevent damage to the cooling system**

Observe the following precautions:

- Avoid contaminating the coolant with foreign matter (such as sand or dust etc.).
- Do not use any coolant additives.

## If your vehicle overheats (hybrid vehicles)

The following may indicate that your vehicle is overheating.

- The needle of the engine coolant temperature gauge (→P. 95) enters the red zone or a loss of hybrid system power is experienced. (For example, the vehicle speed does not increase.)
- “Hybrid System Overheat” (→P. 780) is shown on the multi-information display.
- Steam comes out from under the hood.

### Correction procedures

■ If the needle of the engine coolant temperature gauge enters the red zone

- 1 Stop the vehicle in a safe place and turn off the air conditioning system, and then stop the hybrid system.
- 2 If you see steam:  
Carefully lift the hood after the steam subsides.  
  
If you do not see steam:  
Carefully lift the hood.
- 3 After the hybrid system has cooled down sufficiently, inspect the hoses and cooling system for leaks.

① Radiator

② Cooling fans

If a large amount of coolant leaks, immediately contact your Lexus dealer.

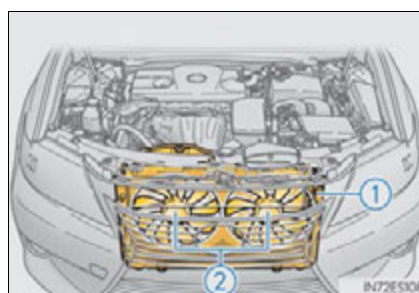

- 4** The coolant level is satisfactory if it is between the “FULL” and “LOW” line on the reservoir.

- ① Reservoir
- ② “FULL”
- ③ “LOW”
- ④ Radiator cap

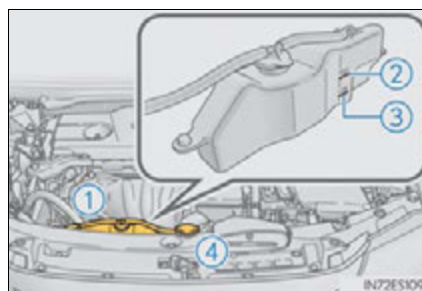

- 5** Add coolant if necessary.

Water can be used in an emergency if coolant is unavailable.

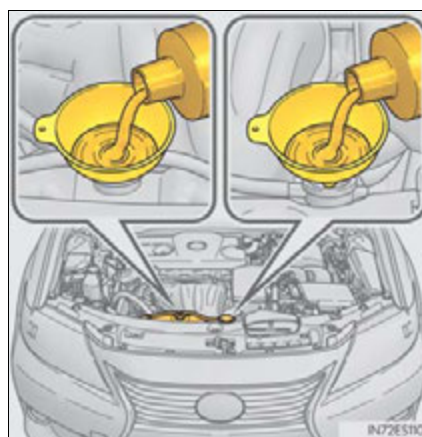

- 6** Start the hybrid system and turn the air conditioning system on to check that the radiator cooling fans operate and to check for coolant leaks from the radiator or hoses.

The fans operate when the air conditioning system is turned on immediately after a cold start. Confirm that the fans are operating by checking the fan sound and air flow. If it is difficult to check these, turn the air conditioning system on and off repeatedly. (The fans may not operate in freezing temperatures.)

- 7** If the fans are not operating:

Stop the hybrid system immediately and contact your Lexus dealer.

If the fans are operating:

Have the vehicle inspected at the nearest Lexus dealer.

■ If “Hybrid System Overheat” is shown on the multi-information display

- 1 Stop the vehicle in a safe place.
- 2 Stop the hybrid system and carefully lift the hood.
- 3 After the hybrid system has cooled down, inspect the hoses and radiator core (radiator) for any leaks.

- 1 Radiator
- 2 Cooling fans

If a large amount of coolant leaks, immediately contact your Lexus dealer.

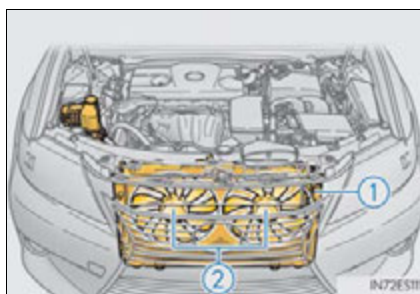

- 4 The coolant level is satisfactory if it is between the “FULL” and “LOW” line on the reservoir.

- 1 Reservoir
- 2 “FULL”
- 3 “LOW”

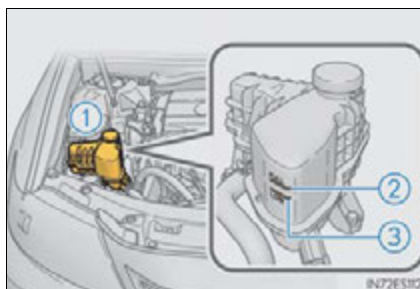

- 5 Add coolant if necessary.  
Water can be used in an emergency if coolant is unavailable.

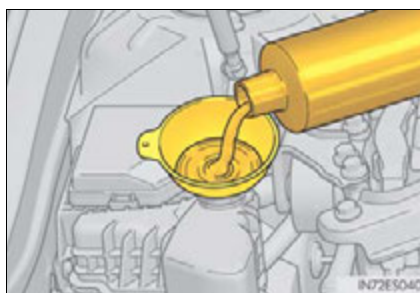

- 6 Start the hybrid system and check for the multi-information display.

If the message does not disappear:

Stop the hybrid system and contact your Lexus dealer.

If the message is not displayed:

Have the vehicle inspected at the nearest Lexus dealer.

 CAUTION

■ **When inspecting under the hood of your vehicle**

Observe the following precautions.

Failure to do so may result in serious injury such as burns.

- If steam is seen coming from under the hood, do not open the hood until the steam has subsided. The engine compartment may be very hot.
- After the hybrid system has been turned off, check that the indicator on the "POWER" switch and the "READY" indicator are off.  
When the hybrid system is operating, the gasoline engine may automatically start, or the cooling fan may suddenly operate even if the gasoline engine stops. Do not touch or approach rotating parts such as the fan, which may lead to fingers or clothing (especially a tie, a scarf or a muffler) getting caught, resulting in serious injury.
- Do not loosen the radiator cap or the coolant reservoir cap while the hybrid system and radiator are hot. High temperature steam or coolant could spray out.

 NOTICE

■ **When adding engine/power control unit coolant**

Add coolant slowly after the hybrid system has cooled down sufficiently. Adding cool coolant to a hot hybrid system too quickly can cause damage to the hybrid system.

■ **To prevent damage to the cooling system**

Observe the following precautions:

- Avoid contaminating the coolant with foreign matter (such as sand or dust etc.).
- Do not use any coolant additives.



## If the vehicle becomes stuck

Carry out the following procedures if the tires spin or the vehicle becomes stuck in mud, dirt or snow:

- 1 Stop the engine <hybrid system>. Set the parking brake and shift the shift lever to P.
- 2 Remove the mud, snow or sand from around the front wheels.
- 3 Place wood, stones or some other material under the front wheels to help provide traction.
- 4 Restart the engine <hybrid system>.
- 5 Shift the shift lever to D or R and release the parking brake. Then, while exercising caution, depress the accelerator pedal.

### ■ When it is difficult to free the vehicle

Press  to turn off TRAC. (→P. 304)

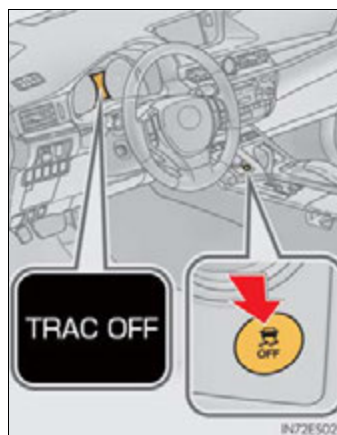

 CAUTION**■ When attempting to free a stuck vehicle**

If you choose to push the vehicle back and forth to free it, make sure the surrounding area is clear to avoid striking other vehicles, objects or people. The vehicle may also lunge forward or lunge back suddenly as it becomes free. Use extreme caution.

**■ When shifting the shift lever**

Be careful not to shift the shift lever with the accelerator pedal depressed. This may lead to unexpected rapid acceleration of the vehicle that may cause an accident resulting in death or serious injury.

 NOTICE**■ To avoid damaging the transmission and other components**

- Avoid spinning the front wheels and depressing the accelerator pedal more than necessary.
- If the vehicle remains stuck even after these procedures are performed, the vehicle may require towing to be freed.



## Vehicle specifications

# 8

831

### 8-1. Specifications

Maintenance data (fuel, oil level, etc.).....	832
Fuel information.....	847
Tire information.....	850

### 8-2. Customization

Customizable features .....	862
-----------------------------	-----

### 8-3. Items to initialize

Items to initialize .....	875
---------------------------	-----

## Maintenance data (fuel, oil level, etc.)

### Dimensions and weight

Overall length	192.7 in. (4895mm)	
Overall width	71.7 in. (1820mm)	
Overall height*	57.1 in. (1450mm)	
Wheelbase	111.0 in. (2820mm)	
Tread	Front	62.6 in. (1590mm)
	Rear	62.0 in. (1575mm)
Vehicle capacity weight (Occupants + luggage)	905 lb. (410 kg)	

\*: Unladen vehicle

## Vehicle identification

### ■ Vehicle identification number

The vehicle identification number (VIN) is the legal identifier for your vehicle. This is the primary identification number for your Lexus. It is used in registering the ownership of your vehicle.

This number is stamped on the top left of the instrument panel.

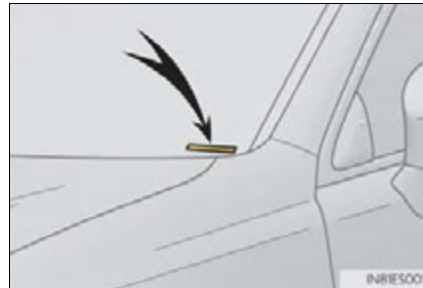

This number is also on the Certification Label.

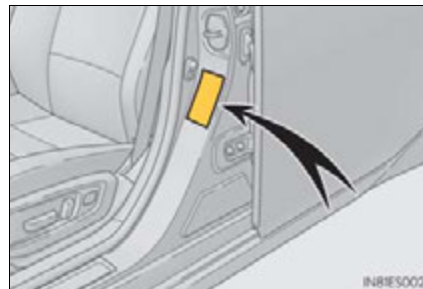

This number is also stamped under the right-hand front seat.

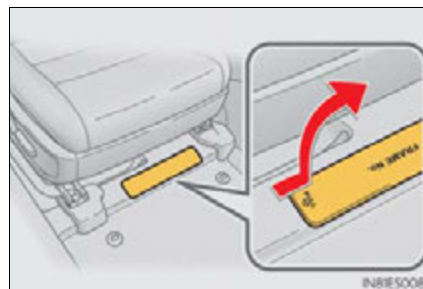

■ **Engine number**

The engine number is stamped on the engine block as shown.

▶ 2GR-FE engine

▶ 2AR-FXE engine

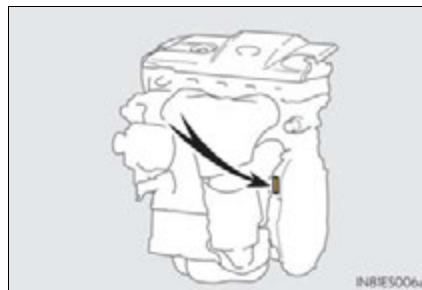
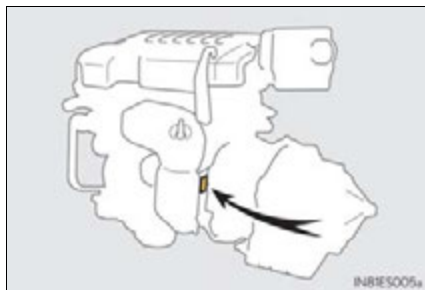

## Engine

### ► Gasoline vehicles

Model	3.5L 6-cylinder (2GR-FE)
Type	6-cylinder V type, 4-cycle, gasoline
Bore and stroke	3.70 × 3.27 in. (94.0 × 83.0 mm)
Displacement	210.9 cu.in. (3456 cm <sup>3</sup> )
Valve clearance	Automatic adjustment
Drive belt tension	

### ► Hybrid vehicles

Model	2.5L 4-cylinder (2AR-FXE)
Type	4-cylinder in line, 4-cycle, gasoline
Bore and stroke	3.54 × 3.86 in. (90.0 × 98.0 mm)
Displacement	152.2 cu.in. (2494 cm <sup>3</sup> )
Valve clearance	Automatic adjustment



**Fuel**

Fuel type	Unleaded gasoline only
Octane Rating	87 (Research Octane Number 91) or higher
Fuel tank capacity (Reference)	17.0 gal. (64.35 L, 14.2 Imp.gal.)

**Electric motor (Traction motor) (hybrid vehicles)**

Type	Permanent magnet synchronous motor
Maximum output	105 kW
Maximum torque	199 ft•lbf (270 N•m, 27.5 kgf•m)

**Hybrid battery (Traction battery) (hybrid vehicles)**

Type	Nickel-metal hydride battery
Voltage	7.2 V/module
Capacity	6.5 Ah (3HR)
Quantity	34 modules
Overall voltage	244.8 V

## Lubrication system

Oil capacity (Drain and refill—reference*)	
With filter	<ul style="list-style-type: none"> <li>▶ Gasoline vehicles 6.4 qt. (6.1 L, 5.4 Imp.qt.)</li> <li>▶ Hybrid vehicles 4.6 qt. (4.4 L, 3.9 Imp.qt.)</li> </ul>
Without filter	<ul style="list-style-type: none"> <li>▶ Gasoline vehicles 6.0 qt. (5.7 L, 5.0 Imp.qt.)</li> <li>▶ Hybrid vehicles 4.2 qt. (4.0 L, 3.5 Imp.qt.)</li> </ul>

\*: The engine oil capacity is a reference quantity to be used when changing the engine oil. Warm up and turn off the engine (Gasoline vehicles) or hybrid system (Hybrid vehicles), wait more than 5 minutes, and check the oil level on the dipstick.

### ■ Engine oil selection

“Toyota Genuine Motor Oil” is used in your Lexus vehicle. Use Lexus approved “Toyota Genuine Motor Oil” or equivalent to satisfy the following grade and viscosity.

Oil grade: ILSAC GF-5 multigrade engine oil

Recommended viscosity: SAE 0W-20

SAE 0W-20 is the best choice for good fuel economy and good starting in cold weather.

If SAE 0W-20 is not available, SAE 5W-20 oil may be used. However, it must be replaced with SAE 0W-20 at the next oil change.

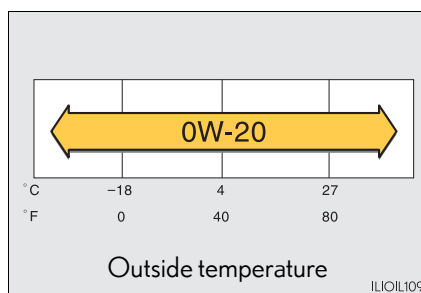

Oil viscosity (0W-20 is explained here as an example):

- The 0W in 0W-20 indicates the characteristic of the oil which allows cold startability. Oils with a lower value before the W allow for easier starting of the engine in cold weather.
- The 20 in 0W-20 indicates the viscosity characteristic of the oil when the oil is at high temperature. An oil with a higher viscosity (one with a higher value) may be better suited if the vehicle is operated at high speeds, or under extreme load conditions.

How to read oil container label:

The International Lubricant Specification Advisory Committee (ILSAC) Certification Mark is added to some oil containers to help you select the oil you should use.



## Cooling system

### ► Gasoline vehicles

Capacity	9.7 qt. (9.2 L, 8.1 Imp.qt.)
Coolant type	Use either of the following: <ul style="list-style-type: none"> <li>• “Toyota Super Long Life Coolant”</li> <li>• Similar high-quality ethylene glycol-based non-silicate, non-amine, non-nitrite, and non-borate coolant with long-life hybrid organic acid technology</li> </ul> Do not use plain water alone.

### ► Hybrid vehicles

Capacity	Gasoline engine	7.6 qt. (7.2 L, 6.3 Imp.qt.)
	Power control unit	3.4 qt. (3.2 L, 2.8 Imp.qt.)
Coolant type		Use either of the following: <ul style="list-style-type: none"> <li>• “Toyota Super Long Life Coolant”</li> <li>• Similar high-quality ethylene glycol-based non-silicate, non-amine, non-nitrite, and non-borate coolant with long-life hybrid organic acid technology</li> </ul> Do not use plain water alone.

### Ignition system

Spark plug	
Make	<ul style="list-style-type: none"><li>▶ Gasoline vehicles DENSO FK20HR11</li><li>▶ Hybrid vehicles DENSO FK16HR-A8</li></ul>
Gap	<ul style="list-style-type: none"><li>▶ Gasoline vehicles 0.043 in. (1.1 mm)</li><li>▶ Hybrid vehicles 0.031 in. (0.8 mm)</li></ul>

 NOTICE

■ **Iridium-tipped spark plugs**

Use only iridium-tipped spark plugs. Do not adjust the spark plug gap.

## Electrical system

### ▶ Gasoline vehicles

12-volt battery	
Specific gravity reading at 68°F (20°C):	1.250 – 1.290 Fully charged 1.160 – 1.200 Half charged 1.060 – 1.100 Discharged
Charging rates	
Quick charge	15 A max.
Slow charge	5 A max.

### ▶ Hybrid vehicles

12-volt battery	
Open voltage at 68°F (20°C):	12.5 V or higher: Fully charged 11.0 – 12.4 V: Half charged 10.9 V or lower: Discharged (Voltage is checked 20 minutes after the hybrid system and all lights are turned off.)
Charging rates	4 – 5 A

### Automatic transaxle (gasoline vehicles)

Fluid capacity*	6.9 qt. (6.5 L, 5.7 Imp.qt.)
Fluid type	Toyota Genuine ATF WS

\*: The fluid capacity is the quantity of reference.  
If replacement is necessary, contact your Lexus dealer.

 NOTICE

■ **Transmission fluid type**

Using transmission fluid other than “Toyota Genuine ATF WS” may cause deterioration in shift quality, locking up of your transmission accompanied by vibration, and ultimately damage the transmission of your vehicle.

### Hybrid transaxle (hybrid vehicles)

Fluid capacity*	3.9 qt. (3.7 L, 3.3 Imp.qt.)
Fluid type	Toyota Genuine ATF WS

\*: The fluid capacity is a reference quantity.  
If replacement is necessary, contact your Lexus dealer.

 NOTICE

■ **Transmission fluid type**

Using transmission fluid other than “Toyota Genuine ATF WS” may cause deterioration in shift quality, locking up of your transmission accompanied by vibration, and ultimately damage the transmission of your vehicle.

## Brakes

Pedal clearance <sup>*1</sup>	<ul style="list-style-type: none"> <li>▶ Gasoline vehicles 3.58 in. (91 mm) Min.</li> <li>▶ Hybrid vehicles 3.62 in. (92 mm) Min.</li> </ul>
Pedal free play	0.04 – 0.24 in. (1.0 – 6.0 mm)
Front and rear brake pad wear limit	0.04 in. (1.0 mm)
Parking brake lining wear limit	0.04 in. (1.0 mm)
Parking brake pedal travel <sup>*2</sup>	7 — 10 clicks
Fluid type	SAE J1703 or FMVSS No. 116 DOT 3

<sup>\*1</sup>: Minimum pedal clearance when depressed with a force of 112.4 lbf (500 N, 51.0 kgf) while the engine <hybrid system> is running <operating>.

<sup>\*2</sup>: Parking brake pedal travel when depressed with a force of 67.4 lbf (300 N, 30.6 kgf).

## Steering

Free play	Less than 1.2 in. (30 mm)
-----------	---------------------------



**Tires and wheels**

► Type A

Tire size	P215/55R17 93V
Tire inflation pressure (Recommended cold tire inflation pressure)	Front tire 33 psi (230 kPa, 2.3 kgf/cm <sup>2</sup> or bar) <sup>*1</sup> 36 psi (250 kPa, 2.5 kgf/cm <sup>2</sup> or bar) <sup>*2</sup> Rear tire 33 psi (230 kPa, 2.3 kgf/cm <sup>2</sup> or bar)
Wheel size	17 × 7J
Wheel nut torque	76 ft•lbf (103 N•m, 10.5 kgf•m)

\*1: 112 mph (180 km/h) or less

\*2: More than 112 mph (180 km/h)

► Type B

Tire size	P225/45R18 91V
Tire inflation pressure (Recommended cold tire inflation pressure)	Front tire 33 psi (230 kPa, 2.3 kgf/cm <sup>2</sup> or bar) <sup>*1</sup> 38 psi (260 kPa, 2.6 kgf/cm <sup>2</sup> or bar) <sup>*2</sup> Rear tire 33 psi (230 kPa, 2.3 kgf/cm <sup>2</sup> or bar)
Wheel size	18 × 7 1/2J
Wheel nut torque	76 ft•lbf (103 N•m, 10.5 kgf•m)

\*1: 99 mph (160 km/h) or less

\*2: More than 99 mph (160 km/h)

## ▶ Compact spare tire (if equipped)

Tire size	T155/70D17 110M
Tire inflation pressure (Recommended cold tire inflation pressure)	60 psi (420 kPa, 4.2 kgf/cm <sup>2</sup> or bar)
Wheel size	17 × 4T
Wheel nut torque	76 ft•lbf (103 N•m, 10.5 kgf•m)

Light bulbs

	Light Bulbs	Bulb No.	W	Type
Exterior	Headlights High beam	9005	60	A
	Low beam (halogen bulbs)	—	55	B
	Low beam (discharge bulbs)	—	35	C
	Fog lights*	—	19	D
	Front turn signal lights	7444NA	28/8	E
	Front side marker lights	W5W	5	F
	Rear turn signal lights	WY21W	21	E
Interior	Back-up lights	W16W	16	F
	Outer foot lights	W5W	5	F
	Door courtesy lights	—	5	F
	Vanity lights	—	5	F
	Interior light	—	8	F
	Personal lights	—	8	F
	Trunk light	—	5	F

A: HB3 halogen bulbs

B: H11 halogen bulbs

C: D4S discharge bulbs

D: H16 halogen bulbs

E: Wedge base bulbs (amber)

F: Wedge base bulbs (clear)

\*: If equipped

## Fuel information

**You must only use unleaded gasoline in your vehicle. Select octane rating 87 (Research Octane Number 91) or higher. Use of unleaded gasoline with an octane rating lower than 87 may result in engine knocking. Persistent knocking can lead to engine damage.**

At minimum, the gasoline you use should meet the specifications of ASTM D4814 in the U.S.A. and CGSB3.5-M93 in Canada.

### ■ Fuel tank opening for unleaded gasoline

To help prevent incorrect fueling, your vehicle has a fuel tank opening that only accommodates the special nozzle on unleaded fuel pumps.

### ■ Gasoline quality

In very few cases, driveability problems may be caused by the brand of gasoline you are using. If driveability problems persist, try changing the brand of gasoline. If this does not correct the problem, consult your Lexus dealer.

### ■ Gasoline quality standards

- Automotive manufacturers in the U.S.A., Europe and Japan have developed a specification for fuel quality called the World-Wide Fuel Charter (WWFC), which is expected to be applied worldwide.
- The WWFC consists of four categories that are based on required emission levels. In the U.S., category 4 has been adopted.
- The WWFC improves air quality by lowering emissions in vehicle fleets, and improves customer satisfaction through better performance.

■ **Recommendation of the use of gasoline containing detergent additives**

- Lexus recommends the use of gasoline that contains detergent additives to avoid the build-up of engine deposits.
- All gasoline sold in the U.S.A. contains minimum detergent additives to clean and/or keep clean intake systems, per EPA's lowest additives concentration program.
- Lexus strongly recommends the use of Top Tier Detergent Gasoline. For more information on Top Tier Detergent Gasoline and a list of marketers, please go to the official website [www.toptiergas.com](http://www.toptiergas.com).

■ **Recommendation of the use of cleaner burning gasoline**

Cleaner burning gasoline, including reformulated gasoline that contains oxygenates such as ethanol or MTBE (Methyl Tertiary Butyl Ether) is available in many areas.

Lexus recommends the use of cleaner burning gasoline and appropriately blended reformulated gasoline. These types of gasoline provide excellent vehicle performance, reduce vehicle emissions and improve air quality.

■ **Non-recommendation of the use of blended gasoline**

- Use only gasoline containing up to 15% ethanol.  
DO NOT use any flex-fuel or gasoline that could contain more than 15% ethanol, including from any pump labeled E30, E50, E85 (which are only some examples of fuel containing more than 15% ethanol).

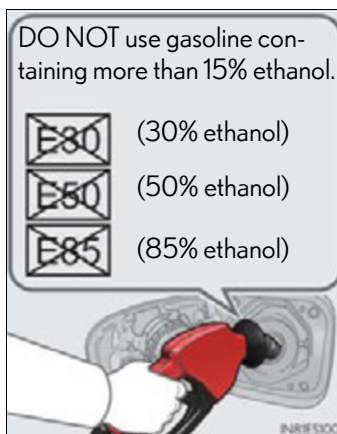

- If you use gasohol in your vehicle, be sure that it has an octane rating no lower than 87.
- Lexus does not recommend the use of gasoline containing methanol.

### ■ Non-recommendation of the use of gasoline containing MMT

Some gasoline contains an octane enhancing additive called MMT (Methylcyclopentadienyl Manganese Tricarbonyl).

Lexus does not recommend the use of gasoline that contains MMT. If fuel containing MMT is used, your emission control system may be adversely affected.

The malfunction indicator lamp on the instrument cluster may come on. If this happens, contact your Lexus dealer for service.

### ■ If your engine knocks

- Consult your Lexus dealer.
- You may occasionally notice light knocking for a short time while accelerating or driving uphill. This is normal and there is no need for concern.

#### NOTICE

##### ■ Notice on fuel quality

- Do not use improper fuels. If improper fuels are used, the engine will be damaged.
- Do not use leaded gasoline.  
Leaded gasoline can cause damage to your vehicle's three-way catalytic converters causing the emission control system to malfunction.
- Do not use gasohol other than the type previously stated.  
Other gasohol may cause fuel system damage or vehicle performance problems.
- Using unleaded gasoline with an octane number or rating lower than the level previously stated will cause persistent heavy knocking.  
At worst, this will lead to engine damage.

##### ■ Fuel-related poor driveability

If poor driveability is encountered after using a different type of fuel (poor hot starting, vaporization, engine knocking, etc.), discontinue the use of that type of fuel.

##### ■ When refueling with gasohol

Take care not to spill gasohol. It can damage your vehicle's paint.

## Tire information

### Typical tire symbols

► Full-size tire

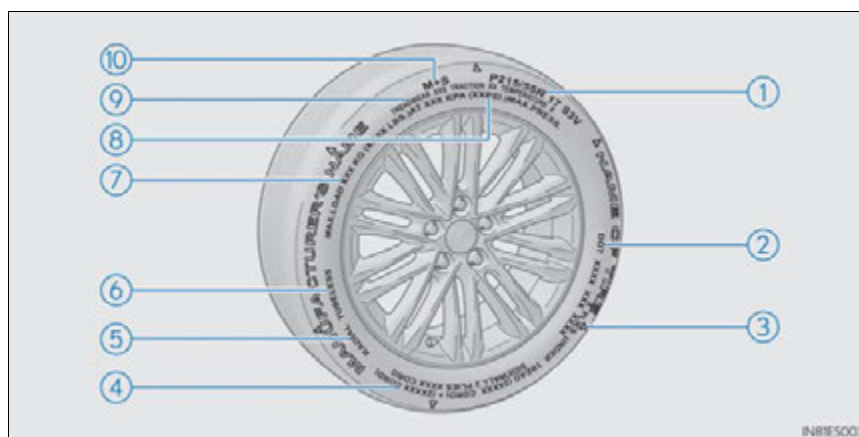

► Compact spare tire

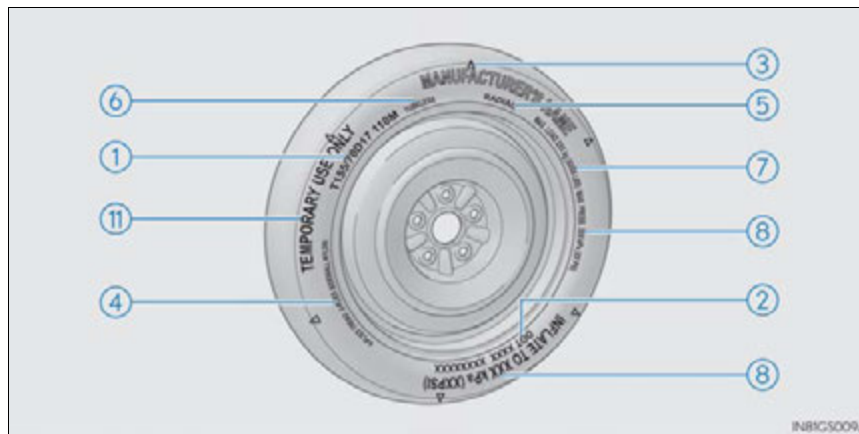

- ① Tire size (→P. 853)
- ② DOT and Tire Identification Number (TIN) (→P. 852)
- ③ Location of treadwear indicators (→P. 702)
- ④ Tire ply composition and materials  
Plies are layers of rubber-coated parallel cords. Cords are the strands which form the plies in a tire.
- ⑤ Radial tires or bias-ply tires  
A radial tire has "RADIAL" on the sidewall. A tire not marked "RADIAL" is a bias-ply tire.
- ⑥ TUBELESS or TUBE TYPE  
A tubeless tire does not have a tube and air is directly put into the tire. A tube type tire has a tube inside the tire and the tube maintains the air pressure.
- ⑦ Load limit at maximum cold tire inflation pressure (→P. 857)
- ⑧ Maximum cold tire inflation pressure (→P. 857)  
This means the pressure to which a tire may be inflated.
- ⑨ Uniform tire quality grading  
For details, see "Uniform Tire Quality Grading" that follows.
- ⑩ Summer tires or all season tires (→P. 706)  
An all season tire has "M+S" on the sidewall. A tire not marked "M+S" is a summer tire.
- ⑪ "TEMPORARY USE ONLY"  
A compact spare tire is identified by the phrase "TEMPORARY USE ONLY" molded on its sidewall. This tire is designed for temporary emergency use only.



### Typical DOT and Tire Identification Number (TIN)

- ① DOT symbol\*
- ② Tire Identification Number (TIN)
- ③ Tire manufacturer's identification mark
- ④ Tire size code
- ⑤ Manufacturer's optional tire type code (3 or 4 letters)
- ⑥ Manufacturing week
- ⑦ Manufacturing year

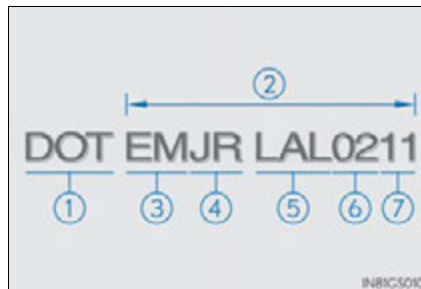

\*: The DOT symbol certifies that the tire conforms to applicable Federal Motor Vehicle Safety Standards.

## Tire size

### ■ Typical tire size information

The illustration indicates typical tire size.

- ① Tire use (P = Passenger car, T = Temporary use)
- ② Section width (millimeters)
- ③ Aspect ratio (tire height to section width)
- ④ Tire construction code (R = Radial, D = Diagonal)
- ⑤ Wheel diameter (inches)
- ⑥ Load index (2 digits or 3 digits)
- ⑦ Speed symbol (alphabet with one letter)

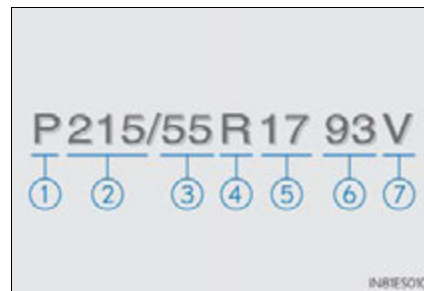

### ■ Tire dimensions

- ① Section width
- ② Tire height
- ③ Wheel diameter

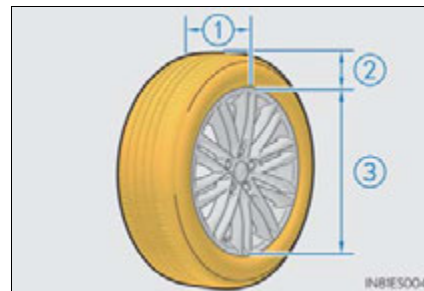

### Tire section names

- ① Bead
- ② Sidewall
- ③ Shoulder
- ④ Tread
- ⑤ Belt
- ⑥ Inner liner
- ⑦ Reinforcing rubber
- ⑧ Carcass
- ⑨ Rim lines
- ⑩ Bead wires
- ⑪ Chafer

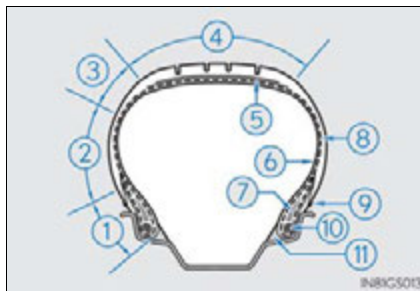

## Uniform Tire Quality Grading

This information has been prepared in accordance with regulations issued by the National Highway Traffic Safety Administration of the U.S. Department of Transportation.

It provides the purchasers and/or prospective purchasers of Lexus vehicles with information on uniform tire quality grading.

Your Lexus dealer will help answer any questions you may have as you read this information.

### ■ DOT quality grades

All passenger vehicle tires must conform to Federal Safety Requirements in addition to these grades. Quality grades can be found where applicable on the tire sidewall between tread shoulder and maximum section width.

For example: Treadwear 200 Traction AA Temperature A

### ■ Treadwear

The treadwear grade is a comparative rating based on the wear rate of the tire when tested under controlled conditions on a specified government test course.

For example, a tire graded 150 would wear one and a half (1 - 1/2) times as well on the government course as a tire graded 100.

The relative performance of tires depends upon the actual conditions of their use. Performance may differ significantly from the norm due to variations in driving habits, service practices and differences in road characteristics and climate.

### ■ Traction AA, A, B, C

The traction grades, from highest to lowest, are AA, A, B and C, and they represent the tire's ability to stop on wet pavement as measured under controlled conditions on specified government test surfaces of asphalt and concrete.

A tire marked C may have poor traction performance.

Warning: The traction grade assigned to this tire is based on braking (straight ahead) traction tests and does not include cornering (turning) traction.

■ **Temperature A, B, C**

The temperature grades are A (the highest), B, and C, representing the tire's resistance to the generation of heat and its ability to dissipate heat when tested under controlled conditions on a specified indoor laboratory test wheel.

Sustained high temperature can cause the material of the tire to degenerate and reduce tire life, and excessive temperature can lead to sudden tire failure.

Grade C corresponds to a level of performance which all passenger car tires must meet under the Federal Motor Vehicle Safety Standard No. 109.

Grades B and A represent higher levels of performance on the laboratory test wheel than the minimum required by law.

Warning: The temperature grades of a tire assume that it is properly inflated and not overloaded.

Excessive speed, underinflation, or excessive loading, either separately or in combination, can cause heat buildup and possible tire failure.

### Glossary of tire terminology

Tire related term	Meaning
Cold tire inflation pressure	Tire pressure when the vehicle has been parked for three hours or more, or has not been driven more than 1 mile or 1.5 km under that condition
Maximum inflation pressure	The maximum cold inflated pressure to which a tire may be inflated, shown on the sidewall of the tire
Recommended inflation pressure	Cold tire inflation pressure recommended by a manufacturer
Accessory weight	The combined weight (in excess of those standard items which may be replaced) of automatic transmission, power steering, power brakes, power windows, power seats, radio and heater, to the extent that these items are available as factory-installed equipment (whether installed or not)
Curb weight	The weight of a motor vehicle with standard equipment, including the maximum capacity of fuel, oil and coolant, and if so equipped, air conditioning and additional weight optional engine
Maximum loaded vehicle weight	The sum of: (a) Curb weight (b) Accessory weight (c) Vehicle capacity weight (d) Production options weight
Normal occupant weight	150 lb. (68 kg) times the number of occupants specified in the second column of Table 1* that follows
Occupant distribution	Distribution of occupants in a vehicle as specified in the third column of Table 1* below
Production options weight	The combined weight of installed regular production options weighing over 5 lb. (2.3 kg) in excess of the standard items which they replace, not previously considered in curb weight or accessory weight, including heavy duty brakes, ride levelers, roof rack, heavy duty battery, and special trim
Rim	A metal support for a tire or a tire and tube assembly upon which the tire beads are seated

Tire related term	Meaning
Rim diameter (Wheel diameter)	Nominal diameter of the bead seat
Rim size designation	Rim diameter and width
Rim type designation	The industry manufacturer's designation for a rim by style or code
Rim width	Nominal distance between rim flanges
Vehicle capacity weight (Total load capacity)	The rated cargo and luggage load plus 150 lb. (68 kg) times the vehicle's designated seating capacity
Vehicle maximum load on the tire	The load on an individual tire that is determined by distributing to each axle its share of the maximum loaded vehicle weight, and dividing by two
Vehicle normal load on the tire	The load on an individual tire that is determined by distributing to each axle its share of curb weight, accessory weight, and normal occupant weight (distributed in accordance with Table 1* below), and dividing by two
Weather side	The surface area of the rim not covered by the inflated tire
Bead	The part of the tire that is made of steel wires, wrapped or reinforced by ply cords and that is shaped to fit the rim
Bead separation	A breakdown of the bond between components in the bead
Bias ply tire	A pneumatic tire in which the ply cords that extend to the beads are laid at alternate angles substantially less than 90 degrees to the centerline of the tread
Carcass	The tire structure, except tread and sidewall rubber which, when inflated, bears the load
Chunking	The breaking away of pieces of the tread or sidewall
Cord	The strands forming the plies in the tire
Cord separation	The parting of cords from adjacent rubber compounds
Cracking	Any parting within the tread, sidewall, or innerliner of the tire extending to cord material

Tire related term	Meaning
CT	A pneumatic tire with an inverted flange tire and rim system in which the rim is designed with rim flanges pointed radially inward and the tire is designed to fit on the underside of the rim in a manner that encloses the rim flanges inside the air cavity of the tire
Extra load tire	A tire designed to operate at higher loads and at higher inflation pressures than the corresponding standard tire
Groove	The space between two adjacent tread ribs
Innerliner	The layer(s) forming the inside surface of a tubeless tire that contains the inflating medium within the tire
Innerliner separation	The parting of the innerliner from cord material in the carcass
Intended outboard sidewall	(a) The sidewall that contains a whitewall, bears white lettering, or bears manufacturer, brand, and/or model name molding that is higher or deeper than the same molding on the other sidewall of the tire, or (b) The outward facing sidewall of an asymmetrical tire that has a particular side that must always face outward when mounted on a vehicle
Light truck (LT) tire	A tire designated by its manufacturer as primarily intended for use on lightweight trucks or multipurpose passenger vehicles
Load rating	The maximum load that a tire is rated to carry for a given inflation pressure
Maximum load rating	The load rating for a tire at the maximum permissible inflation pressure for that tire
Maximum permissible inflation pressure	The maximum cold inflation pressure to which a tire may be inflated
Measuring rim	The rim on which a tire is fitted for physical dimension requirements
Open splice	Any parting at any junction of tread, sidewall, or innerliner that extends to cord material
Outer diameter	The overall diameter of an inflated new tire



Tire related term	Meaning
Overall width	The linear distance between the exteriors of the sidewalls of an inflated tire, including elevations due to labeling, decorations, or protective bands or ribs
Passenger car tire	A tire intended for use on passenger cars, multipurpose passenger vehicles, and trucks, that have a gross vehicle weight rating (GVWR) of 10,000 lb. or less.
Ply	A layer of rubber-coated parallel cords
Ply separation	A parting of rubber compound between adjacent plies
Pneumatic tire	A mechanical device made of rubber, chemicals, fabric and steel or other materials, that, when mounted on an automotive wheel, provides the traction and contains the gas or fluid that sustains the load
Radial ply tire	A pneumatic tire in which the ply cords that extend to the beads are laid at substantially 90 degrees to the centerline of the tread
Reinforced tire	A tire designed to operate at higher loads and at higher inflation pressures than the corresponding standard tire
Section width	The linear distance between the exteriors of the sidewalls of an inflated tire, excluding elevations due to labeling, decoration, or protective bands
Sidewall	That portion of a tire between the tread and bead
Sidewall separation	The parting of the rubber compound from the cord material in the sidewall
Snow tire	A tire that attains a traction index equal to or greater than 110, compared to the ASTM E-1136 Standard Reference Test Tire, when using the snow traction test as described in ASTM F-1805-00, Standard Test Method for Single Wheel Driving Traction in a Straight Line on Snow-and Ice-Covered Surfaces, and which is marked with an Alpine Symbol (  ) on at least one sidewall
Test rim	The rim on which a tire is fitted for testing, and may be any rim listed as appropriate for use with that tire

Tire related term	Meaning
Tread	That portion of a tire that comes into contact with the road
Tread rib	A tread section running circumferentially around a tire
Tread separation	Pulling away of the tread from the tire carcass
Treadwear indicators (TWI)	The projections within the principal grooves designed to give a visual indication of the degrees of wear of the tread
Wheel-holding fixture	The fixture used to hold the wheel and tire assembly securely during testing

\*: Table 1 — Occupant loading and distribution for vehicle normal load for various designated seating capacities

Designated seating capacity, Number of occupants	Vehicle normal load, Number of occupants	Occupant distribution in a normally loaded vehicle
2 through 4	2	2 in front
5 through 10	3	2 in front, 1 in second seat
11 through 15	5	2 in front, 1 in second seat, 1 in third seat, 1 in fourth seat
16 through 20	7	2 in front, 2 in second seat, 2 in third seat, 1 in fourth seat

## Customizable features

Your vehicle includes a variety of electronic features that can be personalized to your preferences. These preferences can be changed by using the “DISP” button, by using Remote Touch, Lexus Display Audio system screen, or at your Lexus dealer.

### Customizing vehicle features

- **Changing by using Remote Touch (vehicles with a navigation system)**  
Refer to “Navigation System Owner’s Manual”.
- **Changing by using the Lexus Display Audio system screen**  
→P. 348
- **Changing by using the “DISP” button**  
→P. 105

### Customizable features

Some function settings are changed simultaneously with other functions being customized. Contact your Lexus dealer for further details.

- ① Vehicles with a Lexus Display Audio system: Settings that can be changed using the Lexus Display Audio system
- ② Vehicles with a Lexus Display Audio system: Settings that can be changed using the "DISP" button
- ③ Vehicles with a navigation system: Settings that can be changed using the screen of the navigation system
- ④ Vehicles with a navigation system: Settings that can be changed using the "DISP" button
- ⑤ Vehicles without a Lexus Display Audio system and navigation system: Settings that can be changed using the "DISP" button
- ⑥ Settings that can be changed by your Lexus dealer

Definition of symbols: ○ = Available, – = Not available

■ Multi-information display (→P.100)

Function	Default setting	Customized setting	①	②	③	④	⑤	⑥
"Language"*	"English" (English)	"Français" (French)	-	○	-	○	○	-
		"Español" (Spanish)	-	○	-	○	○	-
"Units"*	"miles (MPG)"	"km (km/L)"	-	○	-	○	○	-
		"km (L/100km)"	-	○	-	○	○	-
"ECO lamp" (gasoline vehicles) ECO lamp/Eco Driving Indicator Light	"On (Self-lighting)"/ "Off"	"Off"/"Off"	-	○	-	○	○	-
		"On (Always)"/ "Off"	-	○	-	○	○	-
		"On (Always)"/ "On"	-	○	-	○	○	-
"ECO lamp" (hybrid vehicles)	"On (Self-lighting)"	"Off"	-	○	-	○	○	-
		"On (Always)"	-	○	-	○	○	-
"Drive monitor"	"Outside"	"Fuel consumption"	-	○	-	○	○	-
		"Cruising range"	-	○	-	○	○	-
"Tachometer Settings" (hybrid vehicles)	"On (Self-lighting)"	"HV Meter (Always)"	-	○	-	○	○	-
		"Tachometer (Always)"	-	○	-	○	○	-

Function	Default setting	Customized setting	①	②	③	④	⑤	⑥
"Lamp brightness"	"Standard"	"Bright"	-	○	-	○	○	-
"SPORT lamp"	"On"	"Off"	-	○	-	○	○	-
"EV driving Indicator" (hybrid vehicles)	"On"	"Off"	-	○	-	○	○	-

\*: The default setting varies according to countries.

### ■ Door lock (→P.142, 810)

Function	Default setting	Customized setting	①	②	③	④	⑤	⑥
"Unlock on Second Key Turn" (Allows all doors to be unlocked by turning the mechanical key twice in the driver' door)	On (Driver's door unlocked in one step, all doors unlocked in two steps)	Off (All doors unlocked in one step)	-	-	○	-	-	○
"Auto Lock by Speed" (All doors are automatically locked when vehicle speed is approximately 12 mph [20 km/h] or higher)	Off	On	○	-	○	-	○	○
"Auto Lock by Shift from P" (All doors are automatically locked when shifting the shift lever to position other than P)	On	Off	○	-	○	-	○	○
"Auto Unlock by Shift to P" (All doors are automatically unlocked when shifting the shift lever to P)	On	Off	○	-	○	-	○	○
"Auto Unlock by Driver Door" (All doors are automatically unlocked when driver's door is opened)	Off	On	○	-	○	-	○	○

Function	Default setting	Customized setting	①	②	③	④	⑤	⑥
Locking/unlocking of the trunk when all doors are locked/unlocked	On	Off	-	-	-	-	-	○

■ Smart access system with push-button start (→P. 125) and wireless remote control (→P. 139)

Function	Default setting	Customized setting	①	②	③	④	⑤	⑥
“Lock/Unlock Feedback-Tone” (Adjust the volume of buzzer sounds)	5	Off						
		1 to 7	○	-	○	-	○	○
“Lock/Unlock Feedback-Lights” (Enable/disable the operation of the emergency flashers when the vehicle is locked or unlocked)	On	Off	○	-	○	-	○	○
“Auto Relock Timer” (Adjust the time elapsed before the automatic door lock function is activated if a door is not opened after being unlocked)	60 seconds	Off						
		30 seconds	○	-	○	-	○	○
		120 seconds						
Operation buzzer (When the vehicle is locked or unlocked)	On	Off	-	-	-	-	-	○
Open door reminder buzzer (When locking the vehicle)	On	Off	-	-	-	-	-	○

### ■ Smart access system with push-button start (→P. 125)

Function	Default setting	Customized setting	①	②	③	④	⑤	⑥
“Access System with Elec. Key” (Smart access system with push-button start can be disabled)	On	Off	-	-	○	-	○	○
“Select Doors to Unlock” (The doors that are unlocked using the smart access system with push-button start can be selected)	Driver’s door	All the doors	○	-	○	-	○	○
Number of consecutive door lock operations	2 times	As many as desired	-	-	-	-	-	○

### ■ Wireless remote control (→P. 139)

Function	Default setting	Customized setting	①	②	③	④	⑤	⑥
Wireless remote control	On	Off	-	-	-	-	-	○
“Remote 2-Press Unlock” (Allows all doors to be unlocked by pressing  on the electronic key twice)	On (Driver’s door unlocked in one step, all doors unlocked in two steps)	Off (All doors unlocked in one step)	○	-	○	-	○	○
Trunk unlocking operation	Press and hold (short)	One short press						
		Push twice	-	-	-	-	-	○
		Press and hold (long)						
		Off						
Alarm (panic mode)	On	Off	-	-	-	-	-	○



■ Driving position memory\* (→P. 156)

Function	Default setting	Customized setting	①	②	③	④	⑤	⑥
“Driver’s Seat Easy Exit” (Driver’s seat movement when exiting the vehicle)	Standard	Off	○	–	○	–	○	○
		Partial	○	–	○	–	○	○
Selecting the door linking driving position memory with door unlock operation	Driver’s door	All doors	–	–	–	–	–	○
Automatic adjustment of the mirror angle	On	Off	–	–	–	–	–	○

\*: If equipped

■ Power windows (→P. 174) and moon roof (→P. 177)

Function	Default setting	Customized setting	①	②	③	④	⑤	⑥
Mechanical key linked operation	Off	On	–	–	–	–	–	○
Wireless remote control linked operation (DOWN)	Off	On	–	–	–	–	–	○
Buzzer sounds if operated using wireless remote control	On	Off	–	–	–	–	–	○

### ■ Power windows (→P. 174)

Function	Default setting	Customized setting	①	②	③	④	⑤	⑥
One-touch closing	On	Off	-	-	-	-	-	○

### ■ Moon roof (→P. 177)

Function	Default setting	Customized setting	①	②	③	④	⑤	⑥
Linked operation of components when door key is used	Slide only	Tilt only	-	-	-	-	-	○
Linked operation of components when wireless remote control is used	Slide only	Tilt only	-	-	-	-	-	○
Automatic operation	On	Off	-	-	-	-	-	○

### ■ Turn signal lever (→P. 225)

Function	Default setting	Customized setting	①	②	③	④	⑤	⑥
"Lane Change Signal Flashes" (Time of flashing of the lane change signal flashers)	3	OFF						
		5	-	-	-	-	-	○
		7						

■ Automatic light control system (→P. 228)

Function	Default setting	Customized setting	①	②	③	④	⑤	⑥
“Headlamps-On Sensitivity” (Adjust the sensitivity of the ambient light sensor)	Standard	-2 to 2	○	-	○	-	○	○
“Headlamps Auto-Off Timer” (Adjust the time elapsed before the headlights automatically turn off)	30 seconds	Off						
		60 seconds	○	-	○	-	○	○
		90 seconds						
Welcome light illumination control	On	Off	-	-	-	-	-	○

■ Lights (→P. 228)

Function	Default setting	Customized setting	①	②	③	④	⑤	⑥
“Daytime Running Lights” (Daytime running lights can be disabled)*	On	Off	○	-	○	-	○	○

\*: Except for Canada

### ■ Intuitive parking assist\* (→P. 275)

Function	Default setting	Customized setting	①	②	③	④	⑤	⑥
“Distance (Front)” (Detection distance of the front center sensor)	Far	Near	<input type="radio"/>	-	<input type="radio"/>	-	-	<input type="radio"/>
“Distance (Rear)” (Detection distance of the rear center sensor)	Far	Near	<input type="radio"/>	-	<input type="radio"/>	-	-	<input type="radio"/>
“Alert Volume” (Alert volume can be adjusted)	3	1 to 5	<input type="radio"/>	-	<input type="radio"/>	-	-	<input type="radio"/>
“Display” (when intuitive parking assist is operating)	All sensors displayed	Display off	<input type="radio"/>	-	<input type="radio"/>	-	-	<input type="radio"/>

\*: If equipped

### ■ Automatic air conditioning system (→P. 353, 365)

Function	Default setting	Customized setting	①	②	③	④	⑤	⑥
“Efficient Ventilation Mode” (Switching between outside air and recirculated air mode linked to “AUTO” switch operation)	On	Off	-	-	<input type="radio"/>	-	-	<input type="radio"/>
“Auto A/C Mode” (A/C Auto switch operation)	On	Off	<input type="radio"/>	-	<input type="radio"/>	-	-	<input type="radio"/>
“Smog Sensor Sensitivity” (Exhaust gas sensor sensitivity)	Standard	-3 to 3	<input type="radio"/>	-	<input type="radio"/>	-	-	<input type="radio"/>

■ Illumination (→P. 611)

Function	Default setting	Customized setting	①	②	③	④	⑤	⑥
Interior lights illumination control	On	Off	-	-	-	-	-	○
“Interior Lights Off Timer” (Time elapsed before the interior lights turn off)	15 seconds	Off						
		7.5 seconds	○	-	○	-	○	○
		30 seconds						
Operation after the “START STOP ENGINE” <“POWER”> switch is turned off	On	Off	-	-	-	-	-	○
Operation when the doors are unlocked	On	Off	-	-	-	-	-	○
Operation when you approach the vehicle with the electronic key on your person	On	Off	-	-	-	-	-	○
Footwell lighting	On	Off	-	-	-	-	-	○
Outer foot lights	On	Off	-	-	-	-	-	○
“Exterior Lights Off Timer” (Time elapsed before the outer foot lights turn off)	15 seconds	Off						
		7.5 seconds	○	-	○	-	○	○
		30 seconds						
“Ambient illumin. (instrument panel)” (Enable/disable operation of the ornament lights on the instrument panel)*	On	Off	-	○	-	○	○	○
Sensitivity of the ambient light sensor used for dimming the meter lights etc.	Standard	-2 to +2	-	-	-	-	-	○
Sensitivity of the ambient light sensor used for brightening the meter lights etc.	Standard	-2 to +2	-	-	-	-	-	○

Function	Default setting	Customized setting	①	②	③	④	⑤	⑥
Enable/disable operation of the outer foot lights when you approach the vehicle with the electronic key on your person	On	Off	-	-	-	-	-	○
Enable/disable operation of the outer foot lights when the doors are unlocked with the power door lock switch	On	Off	-	-	-	-	-	○

\*: If equipped

#### ■ Rear sunshade\* (→P. 631)

Function	Default setting	Customized setting	①	②	③	④	⑤	⑥
Reverse operation	On	Off	-	-	-	-	-	○
Time elapsed before the reverse operation feature activates	0.7 seconds	0 second						○
		0.9 seconds	-	-	-	-	-	
		1.2 seconds						

\*: If equipped

### ■ Vehicle customization

- When the “Auto Lock by Speed” and “Auto Lock by Shift from P” are both on, the door lock operates as follows.
  - When shifting the shift lever to any position other than P, all the doors will be locked.
  - If the vehicle is started with all the doors locked, the “Auto Lock by Speed” would not operate.
  - If the vehicle is started with any door unlocked, the “Auto Lock by Speed” will operate.
- When the smart access system with push-button start is off, the “Select Doors to Unlock” cannot be customized.
- When the doors remain closed after unlocking the doors and the “Auto Relock Timer” activates, the signals will be generated in accordance with the “Lock/Unlock Feedback-Tone” and the “Lock/Unlock Feedback-Lights” settings.

### ■ When customizing using Remote Touch

Stop the vehicle in a safe place, apply the parking brake, and shift the shift lever to P. Also, to prevent 12-volt battery discharge, leave the engine <hybrid system> running <operating> while customizing the features.

#### CAUTION

##### ■ During customization

As the engine <hybrid system> needs to be running <operating> during customization, ensure that the vehicle is parked in a place with adequate ventilation. In a closed area such as a garage, exhaust gases including harmful carbon monoxide (CO) may collect and enter the vehicle. This may lead to death or a serious health hazard.

#### NOTICE

##### ■ During customization

To prevent 12-volt battery discharge, ensure that the engine <hybrid system> is running <operating> while customizing features.

## Items to initialize

The following items must be initialized for normal system operation after such cases as the battery being reconnected, or maintenance being performed on the vehicle:

Item	When to initialize	Reference
Maintenance data (U.S.A. only)	<ul style="list-style-type: none"><li>• After the maintenance is performed</li></ul>	P. 666
Tire pressure warning system	<ul style="list-style-type: none"><li>• When rotating the tires</li><li>• When changing the tire inflation pressure by changing traveling speed or load weight, etc.</li></ul>	P. 704





For owners

9

877

Reporting safety defects for U.S. owners.....	878
Seat belt instructions for Canadian owners (in French).....	879
SRS airbag instructions for Canadian owners (in French).....	881

## Reporting safety defects for U.S. owners

If you believe that your vehicle has a defect which could cause a crash or could cause injury or death, you should immediately inform the National Highway Traffic Safety Administration (NHTSA) in addition to notifying the Lexus Division of Toyota Motor Sales, U.S.A., Inc. (Toll-free: 1-800-25-LEXUS).

If NHTSA receives similar complaints, it may open an investigation, and if it finds that a safety defect exists in a group of vehicles, it may order a recall and remedy campaign. However, NHTSA cannot become involved in individual problems between you, your dealer, or Lexus Division of Toyota Motor Sales, U.S.A., Inc.

To contact NHTSA, you may call the Vehicle Safety Hotline toll-free at 1-888-327-4236 (TTY: 1-800-424-9153); go to <http://www.safercar.gov>; or write to: Administrator, NHTSA, 1200 New Jersey Ave, S.E., Washington, DC 20590. You can also obtain other information about motor vehicle safety from <http://www.safercar.gov>.

## Seat belt instructions for Canadian owners (in French)

The following is a French explanation of seat belt instructions extracted from the seat belt section in this manual.

See the seat belt section for more detailed seat belt instructions in English.

### Utilisation adéquate des ceintures de sécurité

- Tirez sur la ceinture épaulière jusqu'à ce qu'elle recouvre entièrement l'épaule; elle ne doit cependant pas toucher le cou ni glisser de l'épaule.
- Placez la ceinture abdominale le plus bas possible sur les hanches.
- Réglez la position du dossier. Tenez-vous assis bien au fond du siège, le dos droit.
- Ne vrillez pas la ceinture de sécurité.



## Entretien et soin

### ■ Ceintures de sécurité

Avec un chiffon ou une éponge, nettoyez à l'aide d'un savon doux et de l'eau tiède. Vérifiez aussi les ceintures régulièrement pour vous assurer qu'elles ne présentent pas d'usure excessive, d'effilochage ou de coupures.

### ATTENTION

#### ■ Dommages et usure de la ceinture de sécurité

Vérifiez périodiquement le système de ceintures de sécurité. Assurez-vous qu'il n'y a pas de coupures, d'effilochures ni de pièces desserrées. N'utilisez pas une ceinture de sécurité endommagée avant qu'elle ne soit remplacée. Les ceintures de sécurité endommagées ne peuvent pas protéger les occupants contre les blessures graves, voire mortelles.

## SRS airbag instructions for Canadian owners (in French)

The following is a French explanation of SRS airbag instructions extracted from the SRS airbag section in this manual.

See the SRS airbag section for more detailed SRS airbag instructions in English.

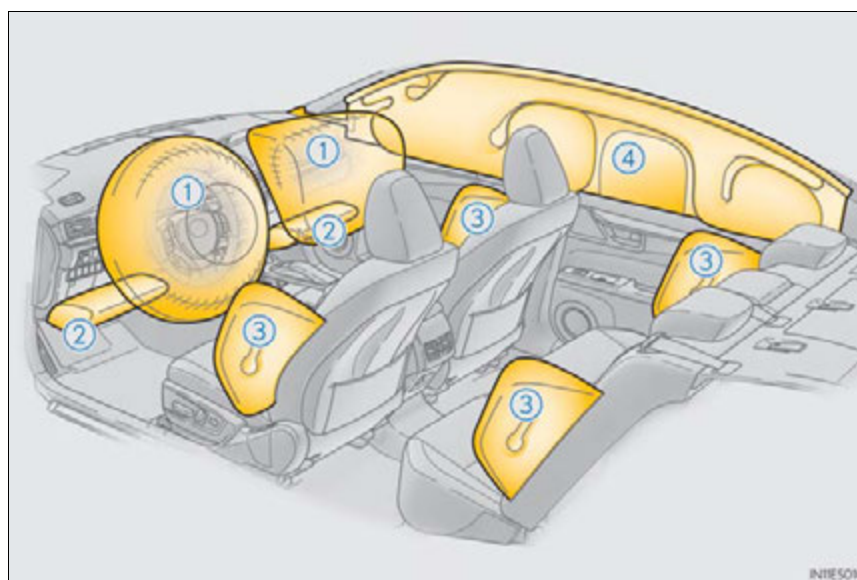

### ◆ Coussins gonflables SRS avant

- ① Coussin gonflable SRS du conducteur/du passager avant  
Peuvent aider à protéger la tête et la poitrine du conducteur et du passager avant contre les impacts avec des composants intérieurs
- ② Coussins gonflables SRS de protection des genoux  
Peuvent aider à protéger le conducteur et le passager avant  
Un coussin gonflable SRS de protection des genoux pour le siège du passager avant est intégré dans la porte de la boîte à gants.

◆ **Coussins gonflables SRS latéraux et en rideau**

---

- ③ Coussins gonflables SRS latéraux avant  
Peuvent aider à protéger le torse des occupants des sièges avant
- Coussins gonflables SRS latéraux arrière  
Peuvent aider à protéger le torse des occupants des sièges latéraux arrière
- ④ Coussins gonflables SRS en rideau  
Peuvent aider à protéger principalement la tête des occupants des sièges latéraux

## Composants du système de coussins gonflables SRS

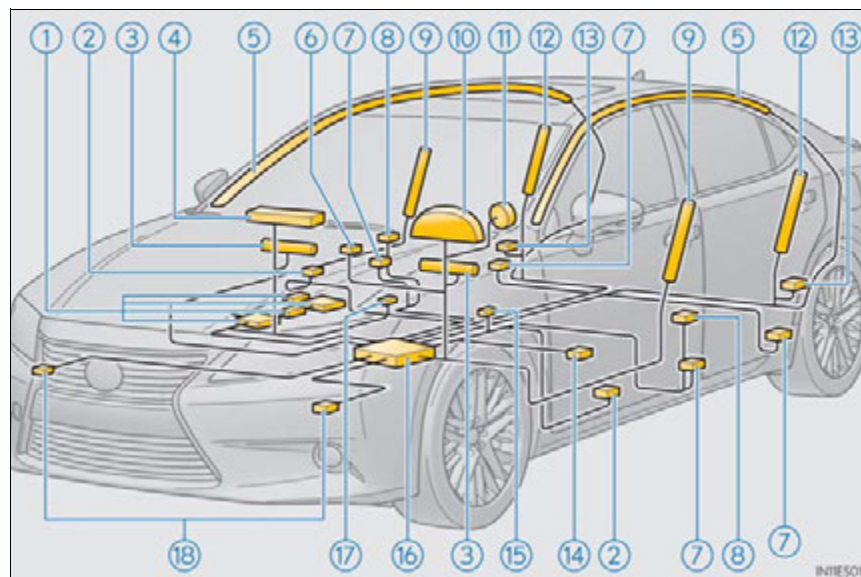

- |  |  |
|--|--|
| ① Système de classification de l'occupant du siège du passager avant (ECU et capteurs) | ⑩ Lampe témoin SRS   |
| ② Capteurs de choc latéral (portières avant)   | ⑪ Coussin gonflable du conducteur                                |
| ③ Coussins gonflables de protection des genoux   | ⑫ Coussins gonflables latéraux arrière                           |
| ④ Coussin gonflable du passager avant  | ⑬ Capteurs de choc latéral (arrière)                             |
| ⑤ Coussins gonflables en rideau  | ⑭ Capteur de position de siège du conducteur                     |
| ⑥ Lampes témoins "AIR BAG ON" et "AIR BAG OFF"   | ⑮ Contacteur de boucle de ceinture de sécurité du conducteur     |
| ⑦ Dispositifs de tension et limiteurs de force des ceintures de sécurité               | ⑯ Module de capteur de coussin gonflable                         |
| ⑧ Capteurs de choc latéral (avant)   | ⑰ Contacteur de boucle de ceinture de sécurité du passager avant |
| ⑨ Coussins gonflables latéraux avant   | ⑱ Capteurs de choc avant   |



Votre véhicule est doté de COUSSINS GONFLABLES ÉVOLUÉS dont la conception s'appuie sur les normes de sécurité des véhicules à moteur américains (FMVSS208). Le module de capteur de coussin gonflable (ECU) contrôle le déploiement des coussins gonflables en fonction des informations obtenues des capteurs et d'autres éléments affichés dans le diagramme des composants du système ci-dessus. Ces informations comprennent des données relatives à la gravité de l'impact et aux passagers. Au moment du déploiement des coussins gonflables, une réaction chimique se produit dans les gonfleurs et les coussins gonflables se remplissent rapidement d'un gaz non toxique pour limiter le mouvement des occupants.

**⚠ ATTENTION****■ Précautions relatives aux coussins gonflables SRS**

Observez les précautions suivantes en ce qui concerne les coussins gonflables SRS.

Les négliger pourrait occasionner des blessures graves, voire mortelles.

- Le conducteur et tous les passagers du véhicule doivent porter leur ceinture de sécurité de la manière appropriée.

Les coussins gonflables SRS sont des dispositifs supplémentaires qui doivent être utilisés de concert avec les ceintures de sécurité.

- Le coussin gonflable SRS du conducteur se déploie avec une force considérable et peut occasionner des blessures graves, voire mortelles, notamment lorsque le conducteur se trouve très près du coussin gonflable. La National Highway Traffic Safety Administration (NHTSA), aux États-Unis, donne les recommandations suivantes :

La zone à risque d'un coussin gonflable côté conducteur couvre 2 à 3 in. (50 à 75 mm) de la zone de déploiement du coussin gonflable. Pour assurer une marge de sécurité suffisante, restez à 10 in. (250 mm) du coussin gonflable. Cette distance est mesurée depuis le centre du volant jusqu'à votre sternum. Si vous vous tenez à moins de 10 in. (250 mm), vous pouvez changer votre position de conduite de plusieurs manières :

- Reculez votre siège à la position maximale vous permettant d'atteindre encore aisément les pédales.
- Inclinez légèrement le dossier du siège.  
Même si les véhicules sont conçus différemment, la plupart des conducteurs peuvent maintenir une distance de 10 in. (250 mm), même si le siège se trouve complètement vers l'avant, simplement en inclinant un peu le dossier du siège vers l'arrière. Si la visibilité avant est moindre après avoir incliné le dossier du siège, utilisez un coussin ferme et non glissant pour être assis plus haut ou relevez le siège si cette option est disponible sur votre véhicule.
- Si votre volant est réglable en hauteur, inclinez-le vers le bas. Cela vous permet d'orienter le coussin gonflable vers votre buste plutôt que vers la tête et vers le cou.

Le siège doit être réglé de la manière recommandée ci-dessus par la NHTSA, tout en gardant le contrôle des pédales et du volant, et la vue sur les commandes du bloc d'instrumentation.

**⚠ ATTENTION****■ Précautions relatives aux coussins gonflables SRS**

● Si la rallonge de ceinture de sécurité a été reliée à la boucle des ceintures de sécurité des sièges avant sans avoir été attachée à la plaque de blocage des ceintures de sécurité, les coussins gonflables SRS avant considéreront que le conducteur et le passager avant portent tout de même leur ceinture même si elles ne sont pas attachées. Les coussins gonflables SRS avant peuvent alors ne pas s'activer correctement lors d'une collision, ce qui représente un risque de blessures graves, voire mortelles. Bouclez toujours votre ceinture de sécurité lorsque vous utilisez la rallonge.



● Le coussin gonflable SRS du passager avant se déploie également avec une force considérable et peut occasionner des blessures graves, voire mortelles, notamment lorsque le passager avant se trouve très près du coussin gonflable. Le siège du passager avant doit se trouver le plus loin possible du coussin gonflable et le dossier doit être réglé de manière à ce que le passager avant soit assis bien droit.

● Le déploiement d'un coussin gonflable risque d'infliger des blessures graves, voire mortelles, aux bébés et aux enfants mal assis ou mal attachés. Un bébé ou un enfant trop petit pour utiliser une ceinture de sécurité doit être correctement retenu à l'aide d'un dispositif de retenue pour enfants. Lexus recommande vivement de placer et d'attacher correctement tous les bébés et tous les enfants sur les sièges arrière du véhicule à l'aide de dispositifs de retenue adaptés. Les sièges arrière sont plus sécuritaires pour les bébés et les enfants que le siège du passager avant. (→P. 57)

**ATTENTION**

■ **Précautions relatives aux coussins gonflables SRS**

- Ne vous asseyez pas sur le bord du siège et ne vous appuyez pas sur le tableau de bord.



- Ne laissez pas un enfant se tenir face au coussin gonflable SRS du passager avant ni s'asseoir sur les genoux d'un passager avant.



- Ne laissez pas les occupants du siège avant tenir des objets sur leurs genoux.

- Ne vous appuyez pas sur la portière ou sur le longeron du toit, ni sur les montants avant, latéraux ou arrière.



- Ne laissez personne s'agenouiller face à la portière sur le siège du passager ni sortir la tête ou les mains à l'extérieur du véhicule.



**⚠ ATTENTION**

■ **Précautions relatives aux coussins gonflables SRS**

- Ne fixez et n'appuyez rien sur des zones telles que le tableau de bord, le tampon de volant, la partie inférieure du bloc d'instrumentation et la porte de la boîte à gants. Ces objets peuvent se transformer en projectiles lorsque les coussins gonflables SRS du conducteur, du passager avant ou de protection des genoux se déploient.

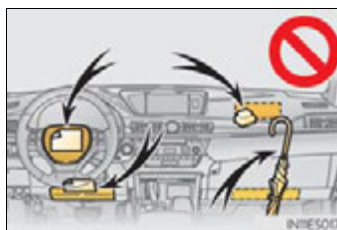

- Ne fixez rien sur les portières, le pare-brise, les glaces latérales, les montants avant ou arrière, le longeron du toit et la poignée d'appui.

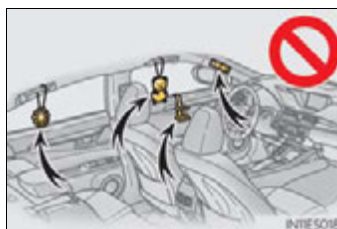

- N'accrochez pas de cintres ni d'objets rigides sur les crochets porte-vêtements. Tous ces objets pourraient se transformer en projectiles et vous occasionner des blessures graves, voire mortelles, en cas de déploiement des coussins gonflables SRS en rideau.
- Si un recouvrement de vinyle est placé sur la zone de déploiement du coussin SRS de protection des genoux, veillez à le retirer.
- N'utilisez pas d'accessoires recouvrant les parties du siège où les coussins gonflables SRS latéraux se déploient, car ceux-ci pourraient nuire au déploiement de ces coussins. De tels accessoires peuvent empêcher les coussins gonflables latéraux de se déployer correctement, rendre le système inopérant ou provoquer accidentellement le déploiement des coussins gonflables latéraux, occasionnant des blessures graves, voire mortelles.
- Ne frappez pas et n'appliquez pas une pression importante à l'emplacement des composants de coussins gonflables SRS. Vous risqueriez de provoquer un mauvais fonctionnement des coussins gonflables SRS.

 **ATTENTION**
**■ Précautions relatives aux coussins gonflables SRS**

- Ne touchez à aucun composant des coussins gonflables SRS immédiatement après leur déploiement (gonflage), car ils pourraient être chauds.
- Si vous avez de la difficulté à respirer après le déploiement des coussins gonflables SRS, ouvrez une portière ou une glace pour laisser entrer l'air, ou quittez le véhicule si vous pouvez le faire en toute sécurité. Dès que possible, nettoyez tous les résidus afin d'éviter les irritations cutanées.
- Si les emplacements de stockage des coussins gonflables SRS, notamment le tampon de volant et les garnitures des montants avant et arrière, sont endommagés ou fissurés, faites-les remplacer par votre concessionnaire Lexus.

**■ Modification et mise au rebut des composants du système de coussins gonflables SRS**

Ne mettez pas le véhicule au rebut et n'effectuez aucune des modifications suivantes sans d'abord consulter votre concessionnaire Lexus. Les coussins gonflables SRS pourraient fonctionner de manière incorrecte ou se déployer (gonfler) accidentellement, ce qui serait susceptible d'occasionner des blessures graves, voire mortelles.

- Installation, retrait, démontage et réparation des coussins gonflables SRS
- Réparations, modifications, retrait ou remplacement du volant, du bloc d'instrumentation, du tableau de bord, des sièges ou du capitonnage des sièges, des montants avant, latéraux ou arrière et des longerons du toit
- Réparations ou modifications de l'aile ou du pare-chocs avant, ou du côté de l'habitacle
- Installation d'une protection de calandre (barre safari, barre kangourou, etc.), de lames de déneigement ou de treuils
- Modifications du système de suspension du véhicule
- Installation d'appareils électroniques tels qu'un émetteur-récepteur radio ou un lecteur de CD
- Modifications à votre véhicule pour une personne aux capacités physiques réduites



## Index

891

What to do if... (Troubleshooting).....	892
Alphabetical index.....	898

For vehicles with a navigation system, refer to the “Navigation System Owner’s Manual” for information regarding the equipment listed below.

- Navigation system
- Air conditioning controls
- Windshield wiper de-icer
- Audio/video system
- Rear window and outside rear view mirror defogging
- Lexus Enform with Safety Connect



## What to do if... (Troubleshooting)

If you have a problem, check the following before contacting your Lexus dealer.

### The doors cannot be locked, unlocked, opened or closed



#### You lose your keys

- If you lose your mechanical keys, new genuine mechanical keys can be made by your Lexus dealer. (→P. 123)
- If you lose your electronic keys, the risk of vehicle theft increases significantly. Contact your Lexus dealer immediately. (→P. 124)



#### The doors cannot be locked or unlocked

- Is the electronic key battery weak or depleted? (→P. 719)
- Is the “START STOP ENGINE” <“POWER”> switch in IGNITION ON <ON> mode?  
When locking the doors, turn the “START STOP ENGINE” <“POWER”> switch off. (→P. 202, 209)
- Is the electronic key left inside the vehicle?  
When locking the doors, make sure that you have the electronic key on your person.
- The function may not operate properly due to the condition of the radio wave. (→P. 132)

**The rear door cannot be opened**

- Is the child-protector lock set?

The rear door cannot be opened from inside the vehicle when the lock is set. Open the rear door from outside and then unlock the child-protector lock. (→P. 143)

---

**The trunk lid is closed with the electronic key left inside**

- The function to prevent the electronic key from being left inside the trunk will operate and you can open the trunk as usual. Take the key out from the trunk. (→P. 149)

**If you think something is wrong**



**The engine <hybrid system> does not start**

- Did you press the "START STOP ENGINE" <"POWER"> switch while firmly depressing the brake pedal? (→P. 201, 208)
- Is the shift lever in P? (→P. 204, 211)
- Is the electronic key anywhere detectable inside the vehicle? (→P. 128)
- Is the steering wheel unlocked? (→P. 205, 212)
- Is the electronic key battery weak or depleted?  
In this case, the engine <hybrid system> can be started in a temporary way. (→P. 811)
- Is the 12-volt battery discharged? (→P. 813, 817)



**The shift lever cannot be shifted from P even if you depress the brake pedal**

- Is the "START STOP ENGINE" <"POWER"> switch in IGNITION ON <ON> mode?  
If you cannot release the shift lever by depressing the brake pedal with the "START STOP ENGINE" <"POWER"> switch in IGNITION ON <ON> mode (→P. 809)



The steering wheel cannot be turned after the engine <hybrid system> is stopped

- It is locked automatically to prevent theft of the vehicle. (→P. 204, 211)
- 



The windows do not open or close by operating the power window switches

- Is the window lock switch pressed?  
The power window except for the one at the driver's seat cannot be operated if the window lock switch is pressed. (→P. 174)
- 



The "START STOP ENGINE" <"POWER"> switch is turned off automatically

- Gasoline vehicles: The auto power off function will be operated if the vehicle is left in ACCESSORY or IGNITION ON mode (the engine is not running) for a period of time. (→P. 204)
- Hybrid vehicles: The auto power off function will be operated if the vehicle is left in ACCESSORY or ON mode (the hybrid system is not operating) for a period of time. (→P. 211)

**A warning buzzer sounds during driving**

- The seat belt reminder light is flashing

Are the driver and the front passenger wearing the seat belts?  
(→P. 762)

- The parking brake indicator is on

Is the parking brake released? (→P. 226)

Depending on the situation, other types of warning buzzer may also sound. (→P. 759, 769)

---

**An alarm is activated and the horn sounds**

- Did anyone inside the vehicle open a door during setting the alarm?

The sensor detects it and the alarm sounds. (→P. 86)

To stop the alarm, turn the "START STOP ENGINE" <"POWER"> switch to IGNITION ON <ON> mode or start the engine <hybrid system>.

---

**A warning buzzer sounds when leaving the vehicle**

- Is the electronic key left inside the vehicle or the moon roof opened?

Check the message on the multi-information display.  
(→P. 769)

**A warning light turns on or a warning message is displayed**

- When a warning light turns on or a warning message is displayed, refer to P. 759, 769.

**When a problem has occurred****If you have a flat tire**

- Stop the vehicle in a safe place and replace the flat tire with the spare tire. (→P. 792)

**The vehicle becomes stuck**

- Try the procedure for when the vehicle becomes stuck in mud, dirt, or snow. (→P. 828)

## Alphabetical index

### A

#### A/C

- Air conditioning filter ..... 717
- Automatic air conditioning system\* ..... 353, 365
- Humidity sensor ..... 361, 374
- Micro dust and pollen filter ..... 359, 371

#### ABS (Anti-lock Brake System)

- Function ..... 302
- Warning light ..... 760

#### Air conditioning filter ..... 717

#### Air conditioning system\*

- Air conditioning filter ..... 717
- Automatic air conditioning system\* ..... 353, 365
- Humidity sensor ..... 361, 374
- Micro dust and pollen filter ..... 359, 371

#### Airbags

- Airbag operating conditions ..... 46
- Airbag precautions
  - for your child ..... 41
- Airbag warning light ..... 760
- Correct driving posture ..... 30
- Curtain shield airbag
  - operating conditions ..... 46
- Curtain shield airbag precautions ..... 43
- Front passenger occupant classification system ..... 50
- General airbag precautions ..... 41
- Locations of airbags ..... 38
- Modification and disposal of airbags ..... 45
- Side airbag operating conditions ..... 46
- Side airbag precautions ..... 41
- Side and curtain shield airbags
  - operating conditions ..... 46
- Side and curtain shield airbags precautions ..... 41
- SRS airbags ..... 38
- Alarm ..... 86
  - Warning buzzer ..... 759, 769
- Anchor brackets ..... 61
- Antennas (smart access system with push-button start) ..... 127
- Anti-lock Brake System (ABS)
  - Function ..... 302
  - Warning light ..... 760
- Approach warning (dynamic radar cruise control) ..... 258
- Armrest ..... 630

Armrest door .....	634
Assist grip .....	636
Audio input .....	429, 571
Audio system * .....	382, 500
Audio input .....	429, 571
AUX port .....	429, 571
Bluetooth® audio .....	431, 548
CD player .....	400, 512
iPod .....	411, 529
MP3/WMA disc .....	401, 521
Optimal use .....	446, 569
Portable music player .....	429, 571
Radio .....	385, 503
Steering wheel audio switch .....	448, 573
USB memory .....	419, 539
Automatic air conditioning system * .....	353, 365
Automatic headlight leveling system .....	231
Automatic High Beam .....	232
Automatic light control system .....	228
Automatic transmission .....	218
If the shift lever cannot be shifted from P .....	809
AUX port .....	429, 571
Auxiliary box .....	619

**B**

Back-up lights	
Replacing light bulbs .....	744
Wattage .....	846
Battery (12-volt battery) .....	693, 698
If the 12-volt battery is discharged .....	813, 817
Preparing and checking before winter .....	330
Warning light .....	760
Battery (traction battery) .....	76
Bluetooth®*	
Audio system .....	431, 548
Hands-free system (for cellular phone) .....	451, 576
Brake	
Fluid .....	692
Parking brake .....	226
Warning light .....	759, 761
Brake assist .....	302
Break-in tips .....	186
Brightness control	
Instrument panel light control .....	96
BSM (Blind Spot Monitor) .....	317

\*: For vehicles with a navigation system, refer to the "Navigation System Owner's Manual".



## C

## Care

Aluminum wheels .....	659
Exterior.....	658
Interior .....	662
Seat belts.....	663

Cargo capacity.....	198
---------------------	-----

Cargo hooks .....	620
-------------------	-----

CD player * .....	400, 512
-------------------	----------

Chains .....	332
--------------	-----

## Child restraint system

Booster seats, definition .....	57
Booster seats, installation.....	67
Convertible seats, definition.....	57
Convertible seats, installation.....	64
Front passenger occupant classification system .....	50
Infant seats, definition .....	57
Infant seats, installation .....	64
Installing CRS with LATCH anchors .....	62
Installing CRS with seat belts.....	64
Installing CRS with top tether strap.....	68

Child safety.....	56
-------------------	----

12-volt battery precautions .....	695, 816
--------------------------------------	----------

Airbag precautions.....	41
-------------------------	----

Child restraint system.....	57
-----------------------------	----

How your child should wear the seat belt.....	34
--	----

Installing child restraints .....	61
-----------------------------------	----

Moon roof precautions .....	181
-----------------------------	-----

Power window lock switch.....	174
-------------------------------	-----

Power window precautions.....	176
-------------------------------	-----

Rear door child-protectors.....	143
---------------------------------	-----

Removed electronic key battery precautions .....	720
---	-----

Seat belt extender precautions .....	37
---	----

Seat belt precautions.....	60
----------------------------	----

Seat heater precautions.....	629
------------------------------	-----

Trunk precautions.....	150
------------------------	-----

Child-protectors .....	143
------------------------	-----

## Cleaning

Aluminum wheels.....	659
----------------------	-----

Exterior .....	658
----------------	-----

Interior .....	662
----------------	-----

Seat belts.....	663
-----------------	-----

Clock.....	623
------------	-----

Coat hooks .....	635
------------------	-----

Condenser.....	691
----------------	-----

Console box.....	617
------------------	-----

Console box light.....	617
------------------------	-----

Consumption screen.....	117
-------------------------	-----

## Cooling system

Engine overheating .....	821
--------------------------	-----

Hybrid system overheating.....	824
--------------------------------	-----

## Cruise control

Cruise control .....	248
----------------------	-----

Dynamic radar cruise control .....	252
------------------------------------	-----

Cup holders.....	618
Curtain shield airbags .....	39
Customizable features.....	862

## D

Daytime running light system.....	230
Defogger*	
Front windshield.....	369
Outside rear view mirrors.....	378
Rear window .....	378
Dimension .....	832
Dinghy towing.....	200
Display	
Dynamic radar cruise control.....	252
LDA (Lane Departure Alert).....	269
Multi-information display .....	100
Trip information .....	101
Warning message.....	769
Display Audio system.....	338
Display settings .....	343
Setup menu.....	345
Do-it-yourself maintenance.....	673
Door courtesy lights	
Location.....	611
Wattage.....	846
Doors	
Automatic door locking and unlocking system.....	144
Door glasses .....	174
Door lock.....	142
Open door warning buzzer.....	129
Open door warning light.....	762
Outside rear view mirrors.....	171
Rear door child-protector.....	143

Driver's seat position memory.....	156
Driving position memory.....	157
Memory recall function .....	159
Power easy access system.....	156

## Driving

Break-in tips.....	186
Correct driving posture.....	30
Driving mode select switch.....	300
Hybrid vehicle driving tips.....	327
Procedures.....	184
Winter drive tips .....	330

## Dynamic radar cruise control

Function.....	252
Warning message.....	771, 778

## E

Eco drive mode.....	300
Eco Driving Indicator .....	107
EDR (Event data recorder).....	11
Electric motor (traction motor).....	72
Electric Power Steering (EPS)	
Function.....	303
Warning light.....	761
Warning message.....	772
Electronic key.....	122
Battery-saving function .....	131
If the electronic key does not operate properly .....	810
Replacing the battery .....	719

\*: For vehicles with a navigation system, refer to the "Navigation System Owner's Manual".

**Emergency, in case of**

If a warning buzzer sounds.....	759
If a warning light turns on.....	759
If a warning message is displayed.....	769
If the 12-volt battery is discharged.....	813, 817
If the electronic key does not operate properly.....	810
If the engine will not start.....	805
If the hybrid system will not start.....	807
If the shift lever cannot be shifted from P.....	809
If you have a flat tire.....	792
If you think something is wrong.....	757
If your vehicle becomes stuck.....	828
If your vehicle has to be stopped in an emergency.....	749
If your vehicle needs to be towed.....	751
If your vehicle overheats.....	821, 824
Emergency flashers.....	748
Energy monitor.....	112

**Engine**

Accessory mode.....	202
Compartment.....	681
Engine switch.....	201, 208
Hood.....	677
How to start the engine.....	201
How to start the hybrid system.....	208
Identification number.....	834
If the engine will not start.....	805
Ignition switch ("POWER" switch).....	208
Ignition switch ("START STOP ENGINE" switch).....	201
Overheating.....	821, 824
"Power" switch.....	208
"START STOP ENGINE" switch.....	201
Engine compartment cover.....	683
Engine coolant	
Capacity.....	839
Checking.....	689
Preparing and checking before winter.....	330
Engine coolant temperature gauge.....	95
Engine immobilizer system.....	82
Engine oil	
Capacity.....	837
Checking.....	684
Oil level warning message.....	777
Oil pressure warning message.....	770
Preparing and checking before winter.....	330

Enhanced VSC .....	302
EPS (Electronic Power Steering)	
Function .....	303
Warning light .....	761
Warning message .....	772
Event data recorder (EDR) .....	11

## F

Flat tire .....	792
Floor mats .....	28
Fluid	
Automatic transaxle .....	842
Brake .....	843
Hybrid transaxle .....	842
Washer .....	697
Fog lights	
Replacing light bulbs .....	737
Switch .....	238
Wattage .....	846
Footwell light .....	611
Front passenger occupant classification system .....	50
Front personal lights .....	612
Front seats	
Adjustment .....	154
Cleaning .....	662
Correct driving posture .....	30
Driving position memory .....	156
Head restraints .....	162
Power easy access system .....	156
Seat heaters .....	628
Seat position memory .....	156
Seat ventilators .....	628

Front side marker lights	
Light switch .....	228
Replacing light bulbs .....	741
Welcome light illumination control .....	125
Wattage .....	846
Front turn signal lights	
Replacing light bulbs .....	739
Turn signal lever .....	225
Wattage .....	846
Fuel	
Capacity .....	836
Fuel gauge .....	95
Fuel pump shut off system .....	758
Information .....	847
Refueling .....	243
Type .....	836
Warning light .....	762
Warning messages .....	780
Fuel filler door .....	243
Refueling .....	243
When the fuel filler door cannot be opened .....	246
Fuel pump shut off system .....	758
Fuses .....	721

## G

Garage door opener .....	637
Gauges .....	95
Glove box .....	616
Glove box light .....	616
Grocery bag hooks .....	620

**H**

Hands-free system  
 (for cellular phone)\* ..... 451, 576

Head restraints ..... 162

Headlights  
   Discharge headlights  
     precautions..... 746

  Light switch ..... 228

  Replacing light  
     bulbs..... 735, 736, 745

  Wattage..... 846

Heaters  
   Air conditioning  
     system\* ..... 353, 365

  Heated steering wheel..... 626

  Seat heaters ..... 628

  Outside rear view mirrors\* ..... 378

High-voltage components ..... 76

Hill-start assist control ..... 308

Hood..... 677  
   Warning message..... 774

Hooks  
   Cargo hooks..... 620

  Coat hooks ..... 635

  Grocery bag hooks..... 620

  Retaining hooks (floor mat)..... 28

Horn..... 227

Hybrid battery  
   (traction battery) ..... 76

Hybrid battery  
   (traction battery) air vents ..... 77

Hybrid system..... 72  
   Emergency shut off system ..... 77

  Energy monitor/consumption  
     screen ..... 110

  EV drive mode ..... 215

  High voltage components ..... 76

  Hybrid System Indicator ..... 98

  Hybrid system precautions ..... 76

  Hybrid vehicle driving tips ..... 327

  If the hybrid system will  
     not start ..... 807

  Overheating..... 824

  "Power" (ignition) switch ..... 208

  Starting the hybrid system..... 208

  Vehicle proximity notification  
     system ..... 73

Hybrid System Indicator ..... 98

Hybrid transmission ..... 221  
   If the shift lever cannot be  
     shifted from P ..... 809

## I

I/M test .....	672
Identification	
Engine.....	834
Vehicle.....	833
Ignition switch ("POWER" switch).....	208
Ignition switch ("START STOP ENGINE" switch).....	201
Illuminated entry system.....	613
Immobilizer system.....	82, 84
Indicators .....	93
Initialization	
Maintenance.....	666
Tire pressure warning system.....	703
Initiators (tire pressure warning system).....	710
Inside rear view mirror .....	168
Instrument panel light control .....	96
Interior light.....	611
Intuitive parking assist	
Function .....	275
Warning message.....	771, 778

## J

Jack	
Positioning a floor jack.....	678
Vehicle-equipped jack .....	793
Jack handle .....	793
Jam protection function	
Moon roof .....	179
Power trunk opener and closer .....	149
Power windows.....	175

## K

Keyless entry	
Smart access system with push-button start.....	125
Wireless remote control.....	139
Keys	
Battery-saving function .....	131
Electronic key .....	122
Engine switch .....	201, 208
If the electronic key does not operate properly.....	810
Key number plate.....	122
Keyless entry.....	125, 139
Mechanical key.....	122
"Power" switch.....	208
Replacing the battery .....	719
"START STOP ENGINE" switch .....	201
Warning buzzer.....	129
Wireless remote control key .....	139
Knee airbags .....	38

\*: For vehicles with a navigation system, refer to the "Navigation System Owner's Manual".

## L

Language	
(multi-information display).....	863
LATCH anchors .....	62
LDA (Lane Departure Alert) .....	267
Lever	
Auxiliary catch lever .....	677
Hood lock release lever .....	677
Internal trunk release lever .....	150
Shift lever .....	218, 221
Turn signal lever .....	225
Wiper lever .....	239
Lexus Display Audio system.....	338
Display settings .....	343
Setup menu .....	345
Lexus Enform *	
License plate lights	
Light switch .....	228
Replacing light bulbs .....	745
Welcome light	
illumination control .....	125
Light bulbs	
Replacing .....	733
Wattage .....	846

## Lights

Fog light switch.....	238
Headlight switch .....	228
Illuminated entry system.....	613
Interior light.....	612
Interior lights list.....	611
Personal lights .....	612
Replacing light bulbs .....	733
Trunk light.....	149
Turn signal lever .....	225
Vanity lights .....	622
Wattage .....	846
Welcome light illumination	
control.....	125
Lock steering column.....	204
Low profile tire .....	706
Luggage security system .....	148

## M

Maintenance	
Do-it-yourself maintenance .....	673
General maintenance .....	668
Maintenance data.....	832
Maintenance requirements .....	665
Malfunction indicator lamp.....	760
Master warning light .....	762
Meter.....	95
Indicators .....	93
Instrument panel light control .....	96
Multi-information display.....	100
Warning lights.....	91
Micro dust and pollen filter .....	371

## Mirrors

Inside rear view mirror.....	168
Outside rear view mirror defoggers* .....	378
Outside rear view mirrors.....	171
Vanity mirrors.....	622
<b>Mobile Assistant*</b> .....	351
<b>Moon roof</b>	
Door lock linked moon roof operation.....	179
Jam protection function.....	179
Operation .....	177
Warning message.....	775
<b>MP3 disc*</b> .....	401, 521
<b>Multi-information display</b> .....	100
Dynamic radar cruise control.....	252
Energy monitor .....	112
Language .....	862
Switching the display.....	101
Trip information .....	101
Warning message.....	769

## N

<b>Navigation system*</b>	
Noise from under vehicle .....	8

## O

<b>Odometer</b> .....	95
<b>Oil</b>	
Engine oil.....	837
<b>Opener</b>	
Hood.....	677
Trunk.....	147
<b>Ornament lights</b> .....	611
<b>Outer foot lights</b>	
Outer foot lights.....	611
Wattage .....	846
<b>Outside rear view mirrors</b>	
Adjusting and folding .....	171
Blind spot monitor .....	317
Linked mirror function when reversing.....	172
Mirror position memory .....	156
Outside rear view mirror defoggers* .....	378
<b>Outside temperature display</b> .....	101
<b>Overheating</b> .....	821, 824

\*: For vehicles with a navigation system, refer to the "Navigation System Owner's Manual".



## P

Parking assist sensors (intuitive parking assist) .....	275
<b>Parking brake</b>	
Operation .....	226
Parking brake engaged warning buzzer .....	776
Parking brake engaged warning message .....	776
<b>Parking lights</b>	
Light switch .....	228
Replacing light bulbs .....	745
Welcome light illumination control .....	125
<b>PCS (Pre-Collision System)</b>	
Function .....	310
PCS OFF switch .....	311
Warning light .....	761
Warning message .....	771, 779, 784
Personal lights .....	612
Power control unit .....	76
<b>Power control unit coolant</b>	
Capacity .....	839
Checking .....	689
Preparing and checking before winter .....	330
Radiator .....	691
<b>Power easy access system</b> .....	156
<b>Power outlets</b> .....	624
<b>Power steering (Electric Power Steering system)</b> .....	303
Warning light .....	761
Warning message .....	772
“Power” switch .....	208

Power trunk opener and closer .....	147
<b>Power windows</b>	
Door lock linked window operation .....	176
Jam protection function .....	175
Operation .....	174
Window lock switch .....	174
<b>Pre-Collision System (PCS)</b>	
Function .....	310
PCS OFF switch .....	311
Warning light .....	761
Warning message .....	771, 779, 784

## R

<b>Radar cruise control (dynamic radar cruise control)</b> .....	252
<b>Radiator</b> .....	691
<b>Radio *</b> .....	385, 503
<b>RBDS (Radio Broadcast Data Systems) *</b> .....	388, 506
<b>RCTA (Rear Cross Traffic Alert)</b> .....	317
<b>Rear personal lights</b> .....	612
<b>Rear side marker lights</b>	
Light switch .....	228
Replacing light bulbs .....	745
Welcome light illumination control .....	125
<b>Rear door sunshades</b> .....	631
<b>Rear sunshade</b>	
Operation .....	631
Reverse operation feature .....	632

Rear turn signal lights  
 Replacing light bulbs.....743  
 Turn signal lever .....225  
 Wattage.....846

Rear view mirror  
 Inside rear view mirror.....168  
 Outside rear view mirrors.....171

Rear window defoggers \* .....378

Refueling .....243  
 Capacity .....836  
 Fuel types.....836  
 Opening the fuel tank cap.....245  
 When the fuel filler door  
 cannot be opened .....246

Regenerative braking.....74

Remote Touch\* .....111

Replacing  
 Electronic key battery.....719  
 Fuses.....721  
 Light bulbs .....733  
 Tires .....792

Reporting safety defects  
 for U.S. owners.....878

Reset the maintenance data .....666

Road accident cautions .....80

S

Safety Connect.....649

Seat belts  
 Adjusting the seat belt.....33  
 Automatic Locking Retractor .....34  
 Child restraint system  
 installation .....64  
 Cleaning and maintaining  
 the seat belt.....663  
 Emergency Locking  
 Retractor.....34  
 How to wear your seat belt.....32  
 How your child should wear  
 the seat belt.....34  
 Pre-collision seat belts.....34  
 Pregnant women, proper  
 seat belt use .....35  
 Reminder light and buzzer .....762  
 Seat belt extender .....34  
 Seat belt pretensioners.....33  
 SRS warning light .....760

Seat heaters.....628

Seat position memory .....156

Seat ventilators.....628

Seating capacity .....198

\*: For vehicles with a navigation system, refer to the "Navigation System Owner's Manual".

- Seats**
- Adjustment ..... 154
  - Adjustment precautions ..... 155
  - Child seats/child restraint
    - system installation ..... 61
  - Cleaning ..... 662
  - Driving position memory ..... 156
  - Head restraints ..... 162
  - Power easy access system ..... 156
  - Properly sitting in the seat ..... 30
  - Seat heaters ..... 628
  - Seat position memory ..... 156
  - Seat ventilators ..... 628
- Sensor**
- Automatic headlight system ..... 230
  - Humidity sensor ..... 364, 377
  - Inside rear view mirror ..... 170
  - Intuitive parking assist ..... 275
  - LDA (Lane Departure Alert) ..... 273
  - Radar sensor ..... 261, 311, 320
  - Rain-sensing windshield
    - wipers ..... 241
- Service reminder indicators ..... 90**
- Shift lever**
- Automatic transmission ..... 218
  - Hybrid transmission ..... 221
  - If the shift lever
    - cannot be shifted from P ..... 809
- Shift lever light ..... 611**
- Shift lock system ..... 809**
- Side airbags ..... 39**
- Side marker lights**
- Light switch ..... 228
  - Replacing light bulbs ..... 741, 745
  - Welcome light illumination
    - control ..... 125
- Side mirrors**
- Adjusting and folding ..... 171
  - Blind Spot Monitor ..... 317
  - Linked mirror function
    - when reversing ..... 172
  - Mirror position memory ..... 156
- Side turn signal lights**
- Replacing light bulbs ..... 745
  - Turn signal lever ..... 225
- Smart access system**
- with push-button start**
- Antenna location ..... 127
  - Entry functions ..... 125
  - Starting the engine ..... 201
  - Starting the hybrid system ..... 208
  - Warning message ..... 773
- Snow tires ..... 334**
- Spare tire ..... 792**
- Inflation pressure ..... 845
  - Storage location ..... 793
- Spark plug ..... 840**
- Specifications ..... 832**
- Speedometer ..... 95**
- "START STOP ENGINE"**
- switch ..... 201

Steering lock .....	204	Switches	
Column lock release.....	205	Audio remote control	
Steering lock system		switches* .....	448, 573
warning message.....	790	BSM (Blind spot monitor)	
Steering wheel		switch.....	317
Adjustment.....	166	Cruise control switch .....	248
Audio switches* .....	448, 573	“DISP” button.....	101
Heated steering wheel.....	626	Door lock switches.....	142
Power easy access system .....	156	Driving mode select switch.....	300
Steering wheel		Driving position memory	
position memory.....	156	switches .....	156
Stop lights		Dynamic radar cruise	
Replacing light bulbs.....	745	control switch.....	252
Storage feature .....	614	Emergency flashers switch.....	748
Stuck		EV drive mode switch .....	215
If the vehicle becomes stuck.....	828	Fog light switch.....	238
Sun visors.....	622	Garage door opener	
Sun shade		switches .....	637
Rear.....	631	Heated steering wheel	
Rear door.....	631	switch .....	626
Roof.....	179	Ignition switch.....	201, 208
		Intuitive parking assist.....	275
		Light switches.....	228
		LDA (Lane Departure Alert)	
		switch .....	268
		Moon roof switches .....	177
		Outside rear view mirror	
		switches .....	171
		PCS OFF switch.....	311
		Power door lock switch.....	142
		“Power” switch.....	208
		Power window switches.....	174

\*: For vehicles with a navigation system, refer to the “Navigation System Owner’s Manual”.

Rear sunshade switch..... 631  
 Rear window and outside  
   rear view mirror defoggers  
   switch\* .....378  
 Seat heater switches..... 628  
 Seat ventilator switches ..... 628  
 "SOS" button..... 649  
 "START STOP ENGINE"  
   switch..... 201  
 Talk switch\* .....451, 582  
 Telephone switches\* .....451, 582  
 Tilt and telescopic  
   steering control switch ..... 166  
 Tire pressure warning reset  
   switch.....704  
 Trunk closer switch..... 148  
 Trunk opener switch .....147  
 Trunk opener main switch..... 148  
 Vehicle-to-vehicle distance  
   button ..... 255  
 VSC OFF switch ..... 304  
 Window lock switch.....174  
 Windshield wipers  
   and washer switch .....239

**T**

**Tachometer** ..... 95  
**Tail lights**  
   Light switch.....228  
   Replacing light bulbs .....745  
   Welcome light illumination  
     control.....125  
**Talk switch\*** ..... 451, 582  
**Telephone switches\*** ..... 451, 582  
**Theft deterrent system**  
   Alarm .....86  
   Engine immobilizer system ..... 82  
   Immobilizer system.....84  
**Tire inflation pressure**  
   Maintenance data.....844  
   Tire inflation pressure display  
     function..... 103  
   Warning light.....763  
   Warning message.....783  
**Tire information** ..... 850  
   Glossary.....857  
   Size .....853  
   Tire identification number .....852  
   Uniform Tire Quality  
     Grading ..... 855  
**Tire pressure warning system**  
   Function.....703  
   Initializing .....703  
   Installing tire pressure warning  
     valves and transmitters.....703  
   Registering ID codes .....705  
   Tire pressure warning reset  
     switch .....704  
   Warning light.....763  
   Warning message.....783, 784

**Tires**

Chains.....	332
Checking.....	702
If you have a flat tire .....	792
Inflation pressure.....	844
Information.....	850
Replacing .....	792
Rotating tires .....	702
Size.....	844
Snow tires .....	334
Spare tire.....	792
Tire inflation pressure display function.....	103
Tire pressure warning system .....	703
Warning light .....	763
Warning message.....	783
<b>Tools.....</b>	<b>793</b>
<b>Top tether strap.....</b>	<b>68</b>
<b>Total load capacity .....</b>	<b>198</b>
<b>Towing</b>	
Dinghy towing .....	200
Emergency towing.....	751
Towing eyelet.....	753
Trailer towing .....	199
<b>TRAC (Traction Control).....</b>	<b>302</b>
<b>Traction battery (hybrid battery) .....</b>	<b>76</b>
<b>Traction motor (electric motor).....</b>	<b>76</b>
<b>Transmission</b>	
Automatic transmission .....	218
Driving mode select switch .....	300
Hybrid transmission.....	221
If the shift lever cannot be shifted from P .....	809
<b>Trip information.....</b>	<b>101</b>
<b>Trip meters .....</b>	<b>95</b>

**Trunk**

Internal trunk release lever .....	150
Jam protection function.....	149
Luggage security system.....	148
Open trunk warning message....	775
Power trunk opener and closer ..	147
Smart access system with push-button start.....	126
Trunk closer switch.....	148
Trunk easy closer .....	149
Trunk features.....	620
Trunk handle.....	148
Trunk light.....	149
Trunk opener main switch.....	148
Trunk opener switch.....	147
Trunk storage extension .....	634
Wireless remote control.....	139
<b>Trunk light</b>	
Trunk light.....	149
Wattage .....	846
<b>Turn signal lights</b>	
Replacing light bulbs .....	739, 743
Turn signal lever.....	225
Wattage .....	846

**U**

USB memory .....	419, 539
------------------	----------

\*: For vehicles with a navigation system, refer to the "Navigation System Owner's Manual".

## V

Vanity lights	
Vanity lights .....	622
Wattage .....	846
Vanity mirrors .....	622
Vehicle data recordings .....	10
Vehicle identification number .....	833
Vehicle Stability Control	
(VSC) .....	302
Ventilators (seat ventilators) .....	628
VSC	
(Vehicle Stability Control) .....	302

## W

Warning buzzers	
Brake system .....	759
Downshifting .....	220
Key reminder .....	787
Open door .....	774
Open moon roof .....	775
Open hood .....	774
Open trunk .....	775
Open window .....	775
Seat belt reminder .....	762
Warning lights .....	91
ABS .....	760
Brake system .....	759, 761
Charging system .....	760
Electric power steering .....	761
Low fuel level .....	762
Malfunction indicator lamp .....	760
Master warning light .....	762
Open door .....	762
Pre-collision system .....	761
Seat belt reminder light .....	762
Slip indicator .....	761
SRS .....	760
Tire pressure .....	763
Warning messages .....	769
Washer	
Checking .....	697
Low washer fluid	
warning message .....	782
Preparing and checking	
before winter .....	330
Switch .....	239
Washing and waxing .....	658

<b>Weight</b>	
Cargo capacity.....	198
Load limits.....	198
Weight.....	832
<b>Welcome light illumination</b>	
control.....	125
<b>Wheels</b>	
Replacing wheels.....	715
Size.....	844
<b>Window glasses.....</b>	174
<b>Window lock switch.....</b>	174
<b>Windows</b>	
Power windows.....	174
Rear window defogger*.....	378
<b>Windshield wiper de-icer.....</b>	380
<b>Windshield wipers</b>	
Intermittent windshield	
wipers with interval adjuster.....	239
Position.....	333
Rain-sensing windshield	
wipers.....	240
<b>Winter driving tips.....</b>	330
<b>Wireless remote control key</b>	
Battery-Saving Function.....	131
Locking/Unlocking.....	139
Replacing the battery.....	719
<b>WMA disc*.....</b>	401, 521

\*: For vehicles with a navigation system, refer to the "Navigation System Owner's Manual".

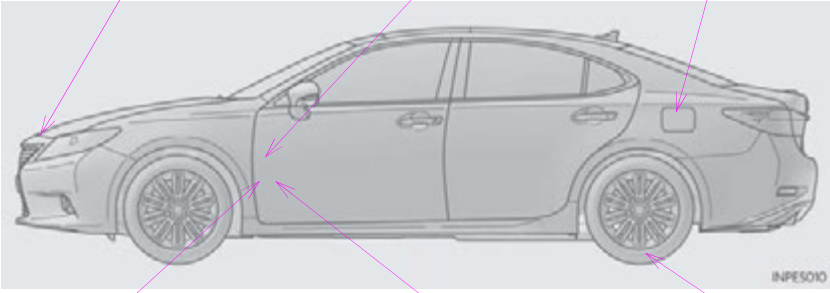

<b>GAS STATION INFORMATION</b>										
Auxiliary catch lever P. 677	Trunk opener P. 147	Fuel filler door P. 245								
										
Hood lock release lever P. 677	Fuel filler door opener P. 245	Tire inflation pressure P. 844								
Fuel tank capacity (Reference)	17.0 gal. (64.35 L, 14.2 Imp.gal.)									
Fuel type	Unleaded gasoline only	P. 836								
Cold tire inflation pressure		P. 844								
Engine oil capacity (Drain and refill – reference)	<table border="0"> <tr> <td></td> <td style="text-align: center;">2GR-FE</td> <td style="text-align: center;">qt. (L, Imp.qt.) 2AR-FXE</td> </tr> <tr> <td>With filter</td> <td style="text-align: center;">6.4 (6.1, 5.4)</td> <td style="text-align: center;">4.6 (4.4, 3.9)</td> </tr> <tr> <td>Without filter</td> <td style="text-align: center;">6.0 (5.7, 5.0)</td> <td style="text-align: center;">4.2 (4.0, 3.5)</td> </tr> </table>		2GR-FE	qt. (L, Imp.qt.) 2AR-FXE	With filter	6.4 (6.1, 5.4)	4.6 (4.4, 3.9)	Without filter	6.0 (5.7, 5.0)	4.2 (4.0, 3.5)
	2GR-FE	qt. (L, Imp.qt.) 2AR-FXE								
With filter	6.4 (6.1, 5.4)	4.6 (4.4, 3.9)								
Without filter	6.0 (5.7, 5.0)	4.2 (4.0, 3.5)								
Engine oil type	“Toyota Genuine Motor Oil” or equivalent Oil grade: ILSAC GF-5 multigrade engine oil Recommended viscosity: SAE 0W-20 P. 837									