

<b>Quick guide</b>	<ul style="list-style-type: none"> <li>• Giving guidance for the route quickly</li> </ul>	1
<b>Basic function</b>	<ul style="list-style-type: none"> <li>• Information to be read before operation</li> <li>• Setting initial settings before operation</li> <li>• Connecting the Bluetooth<sup>®</sup> device</li> </ul>	2
<b>Navigation system</b>	<ul style="list-style-type: none"> <li>• Operating the map screen</li> <li>• Searching the map</li> <li>• Activating the route guidance</li> </ul>	3
<b>Audio/visual system</b>	<ul style="list-style-type: none"> <li>• Listening to the radio</li> <li>• Enjoying music and video</li> </ul>	4
<b>Voice command system</b>	<ul style="list-style-type: none"> <li>• Operating the voice command system</li> </ul>	5
<b>Information</b>	<ul style="list-style-type: none"> <li>• Operating the information screen such as the weather information, etc.</li> </ul>	6
<b>Peripheral monitoring system</b>	<ul style="list-style-type: none"> <li>• Checking the situation around the vehicle</li> </ul>	7
<b>Phone</b>	<ul style="list-style-type: none"> <li>• Operating the phone (Hands-free system for cellular phones)</li> </ul>	8
<b>Lexus Enform</b>	<ul style="list-style-type: none"> <li>• Operating the Lexus Enform</li> </ul>	9
<b>Index</b>	<ul style="list-style-type: none"> <li>• Search alphabetically</li> </ul>	

## 2 TABLE OF CONTENTS

Introduction .....	6	2-3. Other settings	
Reading this manual .....	8	General settings.....	53
<b>1 Quick guide</b>		Voice settings.....	56
1-1. Basic function		Vehicle settings .....	57
Display and operation switches..	12	<b>3 Navigation system</b>	
Remote Touch.....	14	3-1. Basic operation	
Menu screen .....	16	Navigation .....	62
Split-screen.....	18	Map screen operation .....	64
Home screen .....	20	Map screen information .....	67
Sub menu.....	21	Traffic information .....	70
Status icon.....	22	3-2. Destination search	
“Setup” screen.....	24	Destination search operation .....	73
1-2. Navigation operation		Starting route guidance .....	80
Operating the map screen.....	25	3-3. Route guidance	
Guiding the route .....	26	Route guidance screen .....	84
Registering home.....	27	Typical voice guidance prompts	87
<b>2 Basic function</b>		Editing route .....	88
2-1. Basic information before operation		3-4. Setup	
Initial screen.....	30	Navigation settings .....	90
How to use the Remote Touch....	31	Detailed navigation settings .....	95
Entering letters and numbers/list screen operation .....	33	Traffic settings .....	98
Display settings (screen adjustment).....	36	3-5. Tips for the navigation system	
Linking multi-information display and navigation/multimedia system .....	38	GPS (Global Positioning System) .....	102
2-2. Connectivity settings		Map database version and covered area.....	104
Registering/Connecting a Bluetooth® device .....	39	<b>4 Audio/visual system</b>	
Setting Bluetooth® details .....	43	4-1. Basic operation	
Wi-Fi® Hotspot.....	49	Quick reference.....	106
		Some basics .....	107

- 4-2. Radio operation**
  - AM/FM/SiriusXM (SXM) radio **111**
  - Internet radio ..... **119**
- 4-3. Media operation**
  - CD..... **120**
  - DVD..... **122**
  - USB memory ..... **125**
  - iPod..... **128**
  - Bluetooth® audio..... **130**
  - AUX ..... **133**
- 4-4. Audio/visual remote controls**
  - Steering switches ..... **135**
- 4-5. Setup**
  - Audio settings..... **136**
- 4-6. Tips for operating the audio/visual system**
  - Operating information..... **142**

**5 Voice command system**

- 5-1. Voice command system operation**
  - Voice command system..... **156**
  - Natural language understanding ..... **159**
  - Command list ..... **159**
- 5-2. Mobile Assistant operation**
  - Mobile Assistant..... **164**

**6 Information**

- 6-1. Information display**
  - Information screen ..... **168**
  - Weather information ..... **169**
  - Data services settings..... **170**

<b>7</b>	<b>Peripheral monitoring system</b>	<b>1</b>
	<b>7-1. Lexus parking assist monitor</b>	<b>2</b>
	Lexus parking assist monitor.....	<b>174</b>
	Guide lines displayed on the screen .....	<b>176</b>
	Lexus parking assist monitor pre- cautions.....	<b>179</b>
	Things you should know.....	<b>184</b>
	<b>7-2. Panoramic view monitor</b>	<b>3</b>
	Panoramic view monitor.....	<b>186</b>
	Checking around the vehicle..	<b>189</b>
	Checking the front and around the vehicle.....	<b>191</b>
	Checking the sides and around the vehicle.....	<b>194</b>
	Checking the rear and around the vehicle.....	<b>196</b>
	When folding the outside rear view mirrors.....	<b>201</b>
	Magnifying function.....	<b>202</b>
	Panoramic view monitor precau- tions.....	<b>203</b>
	Things you should know.....	<b>213</b>
	Product license.....	<b>215</b>
		<b>4</b>
		<b>5</b>
		<b>6</b>
		<b>7</b>
		<b>8</b>
		<b>9</b>

## 4 TABLE OF CONTENTS

### 8 Phone

#### 8-1. Phone operation (Hands-free system for cellular phones)

- Quick reference..... 218
- Some basics..... 219
- Placing a call using the Bluetooth<sup>®</sup> hands-free system..... 222
- Receiving a call using the Bluetooth<sup>®</sup> hands-free system..... 225
- Talking on the Bluetooth<sup>®</sup> hands-free system..... 226
- Bluetooth<sup>®</sup> phone message function..... 228

#### 8-2. Setup

- Phone settings ..... 232

#### 8-3. What to do if...

- Troubleshooting ..... 241

### 9 Lexus Enform

#### 9-1. Lexus Enform overview

- Lexus Enform..... 246
- Type A: Function achieved by using a smart phone or DCM..... 247
- Type B: Function achieved by using DCM and the navigation/multi-media system ..... 249
- Type C: Function achieved by using DCM ..... 250
- Type D: Function achieved by using DCM and a smart phone..... 253

#### 9-2. Lexus Enform operation

- Lexus Enform App Suite 2.0... 255
- Lexus Enform Destinations ..... 258

#### 9-3. Setup

- Lexus Enform App Suite 2.0 settings ..... 260

### Index

- Alphabetical Index ..... 262

---

	1
	2
	3
	4
	5
	6
	7
	8
	9

## Introduction

### Navigation and multimedia system owner's manual

This manual explains the operation of the system. Please read this manual carefully to ensure proper use. Keep this manual in your vehicle at all times.

The screens shown in this manual may differ from the actual screen of the system depending on availability of functions, Lexus Enform subscription status, and map data available at the time this manual was produced.

The screens in this manual will also differ if the screen theme settings have been changed. (Theme setting: →P.53)

In some situations when changing between screens, it may take longer than normal for the screen to change, the screen may be blank momentarily or noise may be displayed.

Please be aware that the content of this manual may be different from the system in some cases, such as when the system's software is updated.

### Navigation system

The navigation system is one of the most technologically advanced vehicle accessories ever developed. The system receives satellite signals from the Global Positioning System (GPS) operated by the U.S. Department of Defense. Using these signals and other vehicle sensors, the system indicates

your present position and assists in locating a desired destination.

The navigation system is designed to select efficient routes from your present starting location to your destination. The system is also designed to direct you to a destination that is unfamiliar to you in an efficient manner. The system uses AISIN AW maps. The calculated routes may not be the shortest nor the least traffic congested. Your own personal local knowledge or "short cut" may at times be faster than the calculated routes.

The navigation system's database includes Point of Interest categories to allow you to easily select destinations such as restaurants and hotels. If a destination is not in the database, you can enter the street address close to it and the system will guide you there.

The system will provide both a visual map and audio instructions. The audio instructions will announce the distance remaining and the direction to turn in when approaching an intersection. These voice instructions will help you keep your eyes on the road and are timed to provide enough time to allow you to maneuver, change lanes or slow down.

Please be aware that all current vehicle navigation systems have certain limitations that may affect their ability to perform properly. The accuracy of the vehicle's position depends on satellite conditions, road configuration, vehicle condition or other circumstances. For more information on the limitations of



the system, refer to page 102.

TOYOTA MOTOR CORPORATION

**Reading this manual**



Explains symbols used in this manual

**Symbols in this manual**

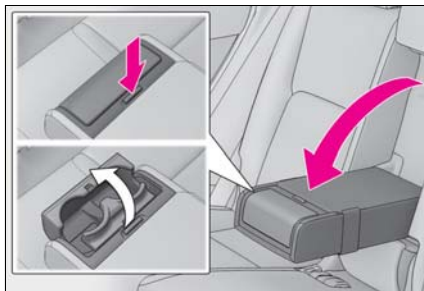

Symbols	Meanings
	<b>WARNING:</b> Explains something that, if not obeyed, could cause death or serious injury to people.
	<b>NOTICE:</b> Explains something that, if not obeyed, could cause damage to or a malfunction in the vehicle or its equipment.
	Indicates operating or working procedures. Follow the steps in numerical order.

**Symbols in illustrations**

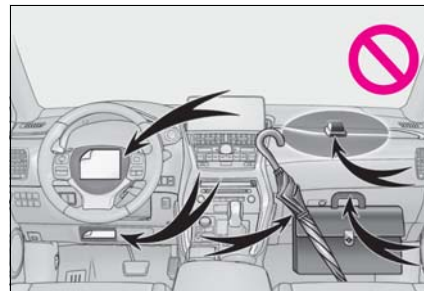

Symbols	Meanings
	Indicates the action (pushing, turning, etc.) used to operate switches and other devices.
	Indicates the outcome of an operation (e.g. a lid opens).



Symbols	Meanings
	Indicates the component or position being explained.
	Means <b>Do not</b> , <b>Do not do this</b> , or <b>Do not let this happen</b> .

**Different writing styles for gasoline and hybrid vehicles**

Information for hybrid vehicles is written in brackets next to the information for gasoline vehicles.

Example

Turn the engine switch<sup>\*1</sup> <power switch><sup>\*2</sup> to IGNITION ON mode<sup>\*1</sup> <ON mode><sup>\*2</sup> mode.

\*1: NX300

\*2: NX300h



### Safety instruction (10.3-inch display model)

To use this system in the safest possible manner, follow all the safety tips shown below.

This system is intended to assist in reaching the destination and, if used properly, can do so. The driver is solely responsible for the safe operation of your vehicle and the safety of your passengers.

Do not use any feature of this system to the extent it becomes a distraction and prevents safe driving. The first priority while driving should always be the safe operation of the vehicle. While driving, be sure to observe all traffic regulations.

Prior to the actual use of this system, learn how to use it and become thoroughly familiar with it. Read the entire manual to make sure you understand the system. Do not allow other people to use this system until they have read and understood the instructions in this manual.

For your safety, some functions may become inoperable when driving. Unavailable screen buttons are dimmed.

#### WARNING

- For safety, the driver should not operate the system while he/she is driving. Insufficient attention to the road and traffic may cause an accident.

- While driving, be sure to obey the traffic regulations and maintain awareness of the road conditions. If a traffic sign on the road has been changed, route guidance may not have the updated information such as the direction of a one way street.

While driving, listen to the voice instructions as much as possible and glance at the screen briefly and only when it is safe. However, do not totally rely on voice guidance. Use it just for reference. If the system cannot determine the current position correctly, there is a possibility of incorrect, late, or non-voice guidance.

The data in the system may occasionally be incomplete. Road conditions, including driving restrictions (no left turns, street closures, etc.) frequently change. Therefore, before following any instructions from the system, look to see whether the instruction can be done safely and legally.

This system cannot warn about such things as the safety of an area, condition of streets, and availability of emergency services. If unsure about the safety of an area, do not drive into it. Under no circumstances is this system a substitute for the driver's personal judgement.

Use this system only in locations where it is legal to do so. Some states/provinces may have laws prohibiting the use of video and navigation screens next to the driver.

**Safety instruction (8-inch display model)**

To use this system in the safest possible manner, follow all the safety tips shown below.

Do not use any feature of this system to the extent it becomes a distraction and prevents safe driving. The first priority while driving should always be the safe operation of the vehicle. While driving, be sure to observe all traffic regulations.

Prior to the actual use of this system, learn how to use it and become thoroughly familiar with it. Read the entire manual to make sure you understand the system. Do not allow other people to use this system until they have read and understood the instructions in this manual.

For your safety, some functions may become inoperable when driving. Unavailable screen buttons are dimmed.

**WARNING**

- For safety, the driver should not operate the system while he/she is driving. Insufficient attention to the road and traffic may cause an accident.

Quick guide

1

11

1

Quick guide

- 1-1. **Basic function**
  - Display and operation switches **12**
  - Remote Touch ..... **14**
  - Menu screen ..... **16**
  - Split-screen ..... **18**
  - Home screen ..... **20**
  - Sub menu ..... **21**
  - Status icon ..... **22**
  - “Setup” screen ..... **24**
- 1-2. **Navigation operation**
  - Operating the map screen ..... **25**
  - Guiding the route ..... **26**
  - Registering home ..... **27**

## Display and operation switches

### System components

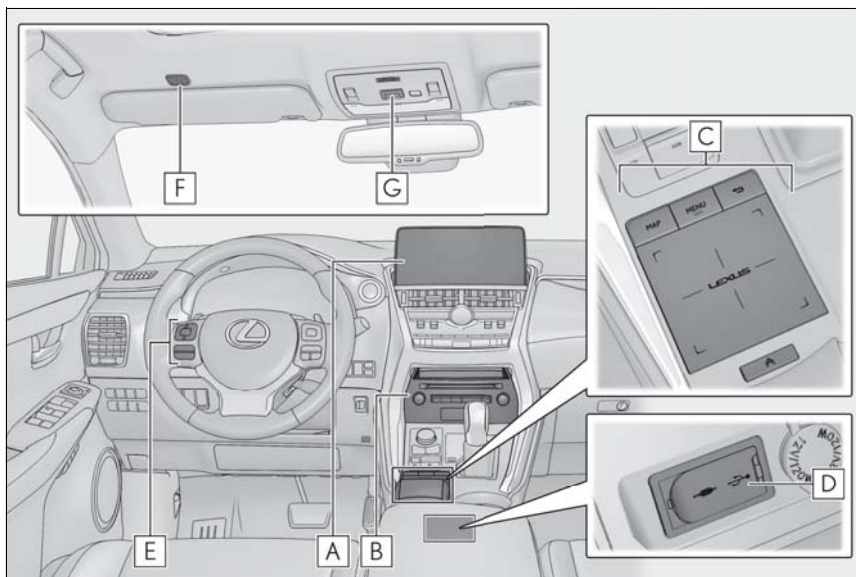

- A** Display
- B** Audio control switch (→P.106)
- C** Remote Touch (→P.14)
- D** USB/AUX port (→P.108)
- E** Steering switches (→P.135, 156, 220)
- F** Microphone (→P.156, 220)
- G** “SOS” button<sup>\*</sup>

<sup>\*</sup>: Refer to the “OWNER’S MANUAL”

- When the temperature is -4 °F (-20°C) or less, the system may not operate.
- When the LCD screen is viewed at an angle, it looks lighter or darker.
- When light from the sun or another external light source strikes the screen, the screen is difficult to see.
- When wearing sunglasses with polarized lenses, the screen looks lighter or darker.

**⚠ WARNING**

- For safety reasons, drivers should avoid performing operations as much as possible while driving. Performing operations while driving may cause the driver to mistakenly operate the steering wheel, which may lead to an accident. Stop the vehicle before using. Furthermore, avoid looking at the screen as much as possible while driving.
- Always follow the actual traffic regulations and drive according to the road conditions. Routes displayed by the destination guidance may include routes where the vehicle is prohibited from entering due to changes to speed limit signs and routes where the road is too narrow to pass through.

**⚠ NOTICE**

- To prevent the 12-volt battery from becoming fully depleted, do not use the Remote Touch for long periods of time while the engine/hybrid system is turned off.

**Software licence for the 10.3-inch display**

Free/Open Source Software Information

This product contains Free/Open Source Software (FOSS).

The license information and/or the source code of such FOSS can be found at the following URL.

<http://www.globaldenso.com/en/open-source/ivi/toyota/>

## Remote Touch

The navigation/multimedia system is primarily operated by the Remote Touch. Remote Touch is the name for the device that includes the “MAP” (“HOME”) button, “MENU” button, back button, touchpad and sub function button.

### System components

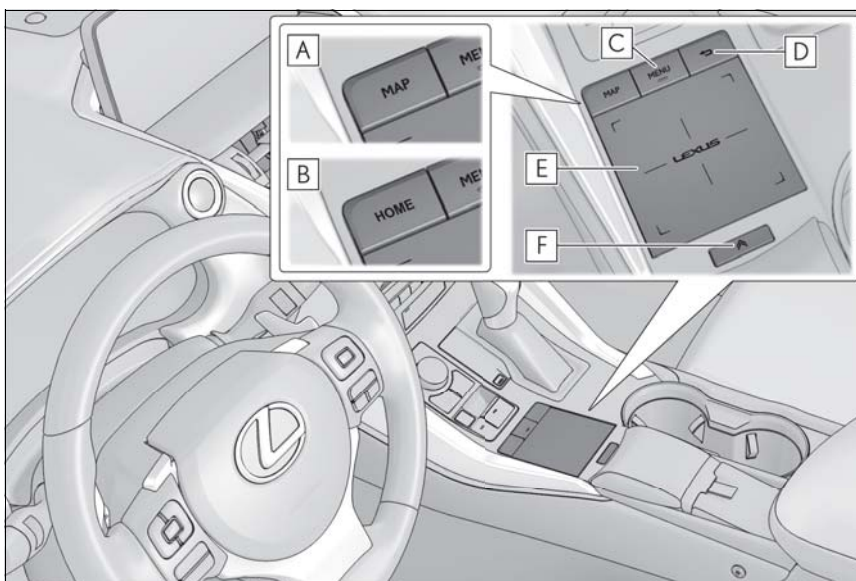

**A** “MAP” button<sup>\*1</sup>

Press to display the current location. (→P.62, 64)

**B** “HOME” button<sup>\*2</sup>

Press to display the home screen. (→P.20)

**C** “MENU” button

Press to display the menu screen. (→P.16)

**D** Back button

Press to display the previous screen.

**E** Touchpad

Operate to select/confirm a button on the screen. (→P.31)

Operate to scroll list screens and enlarge/shrink the map. (→P.32)

**F** Sub function button



When  is displayed on the screen, a function screen assigned to the screen can be displayed. (→P.15)

\*1: 10.3-inch display model

\*2: 8-inch display model

### Using the sub function button

Optional functions assigned to the screen can be operated.

- 1 When the  is displayed on the screen, press the  button on the Remote Touch.

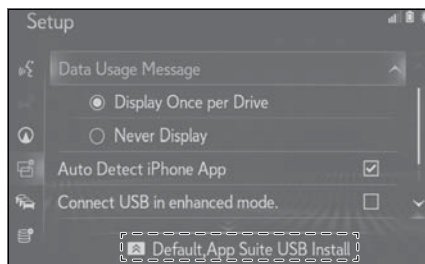

- 2 Select the desired item.

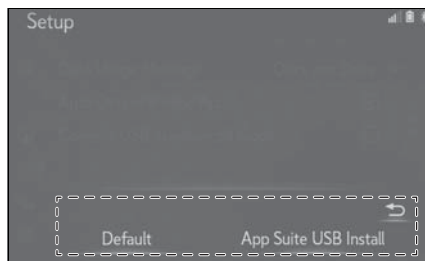

## Menu screen

### Menu screen operation

Press the "MENU" button on the Remote Touch to display the menu screen.

▶ 10.3-inch display model



▶ 8-inch display model

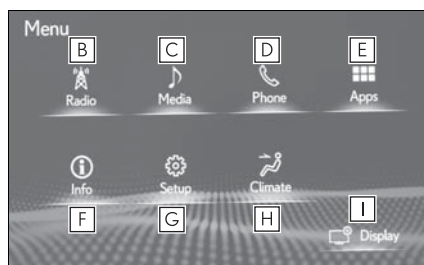

- A** Select to display the destination screen. (→P.73)
- B** Select to display the radio control screen. (→P.106)
- C** Select to display the media control screen. (→P.106)
- D** Select to display the hands-free control screen. (→P.218)
- E** Select to display the "Apps" screen. <sup>\*1</sup>(→P.255)
- F** Select to display the information screen. (→P.168)
- G** Select to display the "Setup" screen. (→P.24)
- H** Select to display the air conditioning control screen. <sup>\*2</sup>
- I** Select to adjust the contrast and brightness of the screens, turn the screen off, etc. (→P.36)

<sup>\*1</sup>: This function is not made available in some countries or areas.

<sup>\*2</sup>: Refer to the "OWNER'S MANUAL"



**On cursor shortcut (10.3-inch display model)**

Moving the cursor over a switch on the menu screen causes shortcut switches to display for that switch.

The shortcut switches can be used to perform operation procedures more quickly.

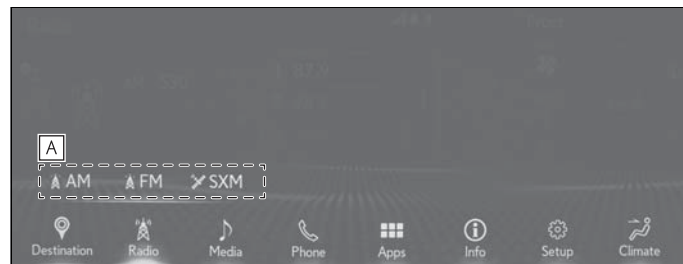

**A** On cursor shortcut

**Split-screen\***

\*: 10.3-inch display model

The screen can be operated in full screen or split-screen mode. Split-screen mode can display different information on the left and right of the screen. For example, navigation system screen can be displayed and operated while the radio screen is being displayed.

**Display overview**

► Full screen display

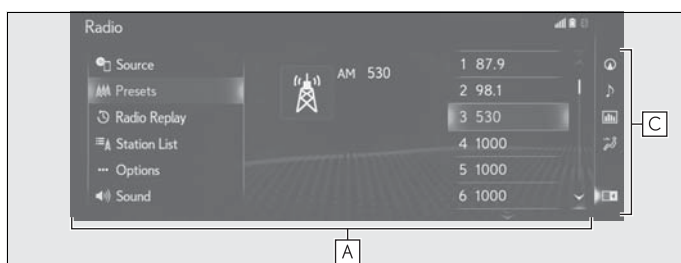

► Split-screen display

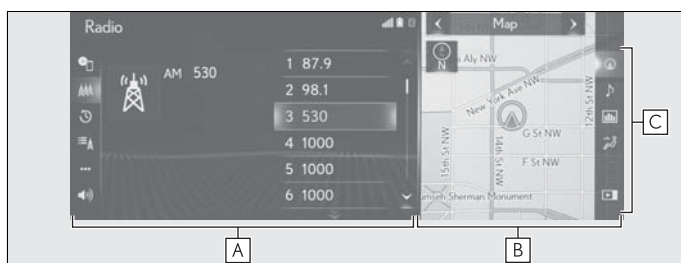

**A** Main display

For details about each function and operation on the main display, refer to the respective section.

**B** Side display

The following functions can be displayed and operated on the side display.

- Navigation
- Audio
- Vehicle information
- Air conditioning

**C** Side display icons

Select to open/close the side display and change the displayed function.

**Side display**

To change the screen displayed on the side display, use the screen buttons on the right side of the display.



- A** Select to display the navigation screen. (→P.19)
- B** Select to display the audio control screen. (→P.19)
- C** Select to display the vehicle information screen.\*
- D** Select to display the air conditioning control screen.\*
- E** Select to open/close the side display.

\*: Refer to the "OWNER'S MANUAL"

**Navigation screen operation****Map scale**

- 1 Select **+** or **-** to change the scale of the map screen.

**Map orientation**

- 1 Select **↻**, **↺** or **↻** to change the orientation of the map screen.

**Switching the map mode**

- 1 Select **<** or **>** to change the map mode. (→P.68)

**Editing map**

- 1 Select any point on the map.
- 2 Select the desired item.

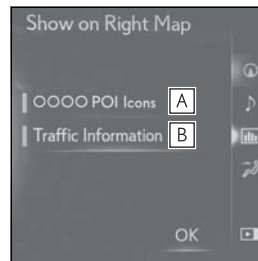

- A** Select to display POI icons. (→P.67)
- B** Select to show traffic information. (→P.70)

**Audio control screen operation****Selecting an audio source**

- 1 Select **▼**.

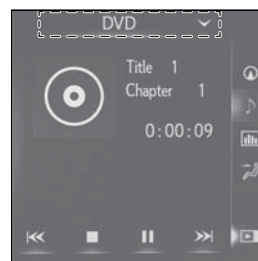

- 2 Select the desired source.

**Radio operation**

On the side display, preset stations can

be selected.

### ■ Media operation

Operations such as selecting a chapter, file or track are carried out on the screen.

## Home screen\*

\*: 8-inch display model

The home screen can display multiple information screens, such as the audio, fuel consumption and apps, simultaneously.

### Home screen operation

- 1 Press the "HOME" button on the Remote Touch.

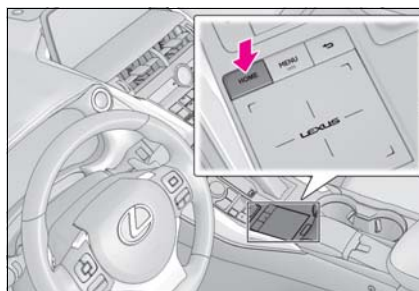

- 2 Check that the home screen is displayed.

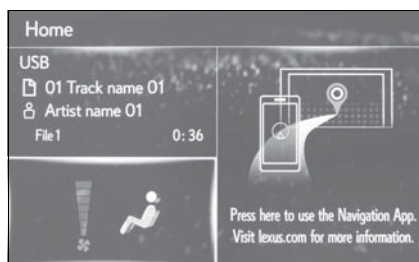

- When a screen is selected, the selected screen is switches to a full-screen display.
- 
- The display information and area on the home screen can be customize.
  - The home screen can be set to several types of split layouts.

### Customizing the home screen

The display information/area on the home screen and the home screen layout can be changed.

- 1 Press the "MENU" button on the Remote Touch.
- 2 Select "Setup".
- 3 Select "Customize Home Screen".
- 4 Select the items to be set.

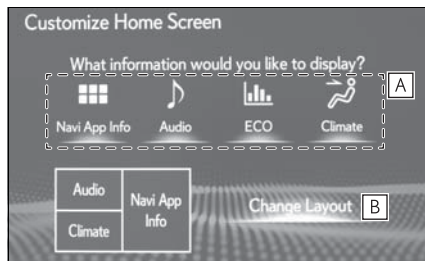

- A** Select to change the display information and area on the home screen.
- B** Select to change the home screen layout.

### Sub menu

Various options can be selected using the sub menu displayed on the left side of the main screen.

Move the cursor over the sub menu icon to display the sub menu.

### Displaying the sub menu

- 1 Move the cursor over the sub menu icon.



- 2 Select the desired option on the sub menu.



- The sub menu closes when the cursor is moved away from the sub menu.
- The sub menu items differ according to the function.
- In the full screen display on the 10.3-inch display model, the sub menu is opened all the time.

**Status icon**

Status icons are displayed at the top of the screen.

**Status icon explanation**

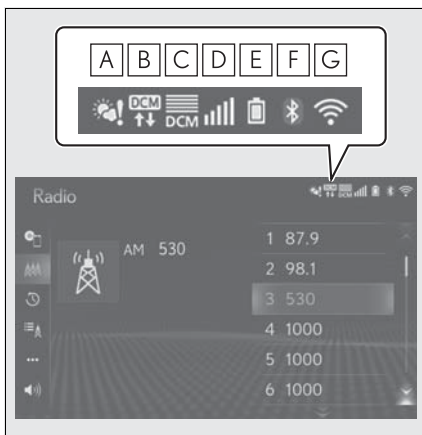

- A** Weather alert display (→P.169)
  - Select to display important weather information for the current location or along the route.
- B** Indicate during data communication performed via Data Communication Module (DCM)
- C** The reception level of Data Communication Module (DCM) display (→P.22)
- D** The reception level of the connected phone display (→P.22)
- E** Remaining battery charge display (→P.23)
- F** Bluetooth® phone connection condition display (→P.23)
- G** Wi-Fi® connection condition display (→P.22)

- The number of status icons that can be displayed differs depending on the displayed screen.

**Reception level display**



- ▶ While connected with cellular phone

The level of reception does not always correspond with the level displayed on the cellular phone. The level of reception may not be displayed depending on the phone you have.



When the cellular phone is out of the service area or in a place inaccessible by radio waves,  is displayed.

“Rm” is displayed when receiving in a roaming area. While roaming, display “Rm” top-left on the icon.

The receiving area may not be displayed depending on the type of phone you have.



Level	Indicators
Poor	
Excellent	

- ▶ When using Wi-Fi® Hotspot

Level	Indicators
No connection	
Connected	

- When Wi-Fi® Hotspot is off, no item is displayed.

- ▶ While using Data Communication Module (DCM)



Level	Indicators
Poor	
Excellent	

### Remaining battery charge display

The amount displayed does not always correspond with the amount displayed on the Bluetooth<sup>®</sup> device.

The amount of battery charge left may not be displayed depending on the type of the Bluetooth<sup>®</sup> device connected.

This system does not have a charging function.

Remaining charge	Indicators
Empty	
Low	
Full	



### Bluetooth<sup>®</sup> connection condition display

An antenna for the Bluetooth<sup>®</sup> connection is built into the instrument panel.

The condition of the Bluetooth<sup>®</sup> connection may deteriorate and the system may not function when a Bluetooth<sup>®</sup> phone is used in the following conditions and/or places:

- The cellular phone is obstructed by certain objects (such as when it is behind the seat or in the glove box or console box).
- The cellular phone is touching or is covered with metal materials.

Leave the Bluetooth<sup>®</sup> phone in a place where the condition of the Bluetooth<sup>®</sup> connection is good.

Indicators	Conditions
 (Blue)	Indicates that the condition of the Bluetooth <sup>®</sup> connection is good.
 (Gray)	While in this condition, sound quality during phone calls may deteriorate.
	Indicates that the cellular phone is not connected via Bluetooth <sup>®</sup> .

## "Setup" screen

### Displaying the "Setup" screen

- 1 Press the "MENU" button on the Remote Touch.

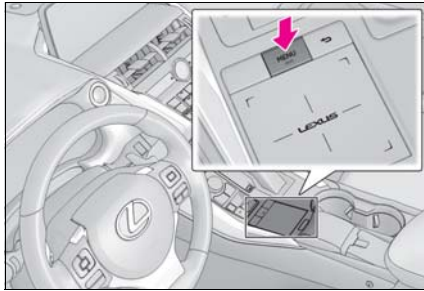

- 2 Select "Setup".
  - 3 Select the desired item on the sub menu.
- The sub menu is displayed when the cursor is moved over the sub menu icon on the left side of screen.

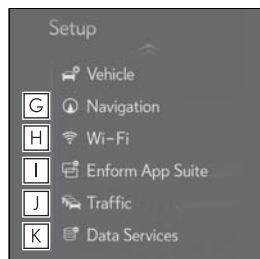
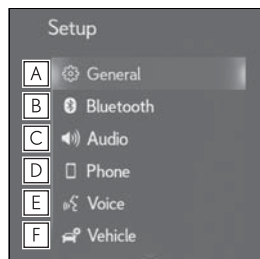

- A Select to change the selected language, operation sound, etc. (→P.53)

- B Select to set Bluetooth® device and Bluetooth® system settings. (→P.43)
- C Select to set audio settings. (→P.136)
- D Select to set the phone sound, contacts, message settings, etc. (→P.232)
- E Select to set the voice settings. (→P.56)
- F Select to set vehicle information such as maintenance information. (→P.57)
- G Select to set memory points (home, favorites entries, areas to avoid), navigation details.\*1 (→P.90)
- H Select to set Wi-Fi® connection settings.\*2 (→P.50)
- I Select to set Lexus Enform App Suite 2.0 settings.\*2 (→P.260)
- J Select to set traffic information settings.\*1,2 (→P.98)
- K Select to set data services settings.\*1,2 (→P.170)

\*1: 10.3-inch display model

\*2: This function is not made available in some countries or areas.



## Operating the map screen\*

\*: 10.3-inch display model

### Displaying the current position of the vehicle on the map screen

- 1 Press the "MAP" button on the Remote Touch.

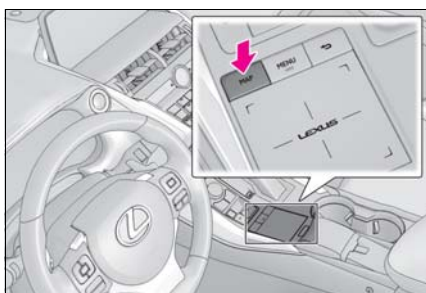

- The current position of the vehicle is displayed on the map screen.



### ■ Displaying the map screen

The following operations can also be performed.

- Changing the map direction (→P.65)
- Displaying 3D map (→P.65)
- Changing the map display color (→P.95)
- Displaying the micro city map (→P.64)

### Moving the map screen

- 1 Select the desired point on the map screen.



- Move the desired point on the center of the map screen.



- Press the "MAP" button on the Remote Touch to return to the current position.

### Zooming in /out the map

#### ■ Zooming in the map

- 1 Select or pinch out on the touchpad of the Remote Touch. (→P.64)

#### ■ Zooming out the map

- 1 Select or pinch in on the touchpad of the Remote Touch. (→P.64)

### Guiding the route\*

\*: 10.3-inch display model

#### Setting the destination

- 1 Press the "MAP" button on the Remote Touch.

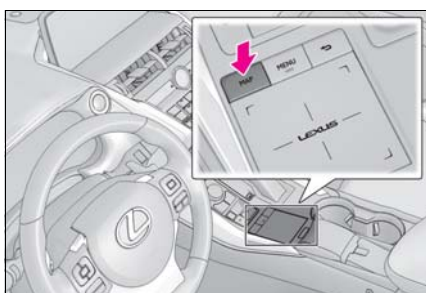

- 2 Select .
- 3 Search for a destination.

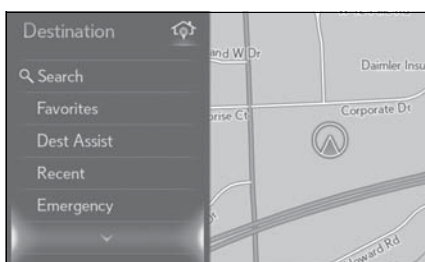

- There are different kinds of methods to search for a destination. (→P.73)
- 4 Select "Go".
  - Check that the route overview is displayed. (→P.81)
  - 5 Select "OK".
  - Selecting routes other than the one recommended (→P.81)
  - Guidance to the destination is displayed on the screen and can be heard via voice guidance.

#### Deleting destinations

When route guidance is no longer necessary, such as when you know the rest of the route to your destination, the destination can be deleted.

- 1 Press the "MAP" button on the Remote Touch.

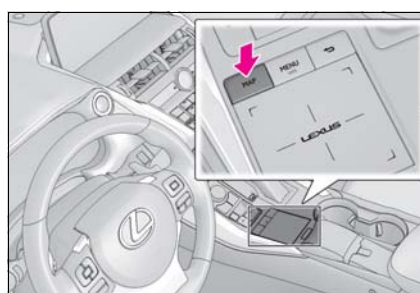

- 2 Select .



- 3 Select "Yes" when the confirmation screen appears.
- When more than 1 destination has been set, a list will be displayed on the screen. Select the desired item(s) to be deleted.



## Registering home\*

\*: 10.3-inch display model

### Registering home

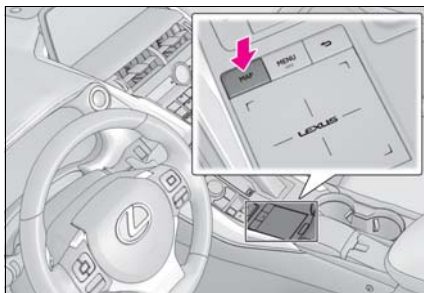
- 1 Press the "MAP" button on the Remote Touch.





- 2 Select .
- 3 Select .
- 4 Select "Yes".
- 5 Search for your home.
  - There are different kinds of methods to search for your home. (→P.73)
- 6 Select "OK".
  - Registration of home is complete.
    - Registering home in a different way →P.90
    - Editing the name, location and icon →P.91

### Setting home as the destination

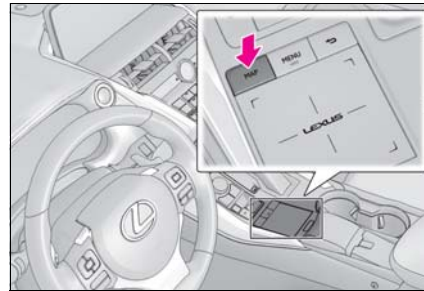
- 1 Press the "MAP" button on the Remote Touch.



- 2 Select .
- 3 Select .
- 4 Select "OK".
  - Selecting routes other than the one recommended (→P.81)
  - Guidance to the destination is displayed on the screen and can be heard via voice guidance.



- 2-1. Basic information before operation**
  - Initial screen..... **30**
  - How to use the Remote Touch **31**
  - Entering letters and numbers/list screen operation ..... **33**
  - Display settings (screen adjustment) ..... **36**
  - Linking multi-information display and navigation/multimedia system..... **38**
- 2-2. Connectivity settings**
  - Registering/Connecting a Bluetooth® device ..... **39**
  - Setting Bluetooth® details ..... **43**
  - Wi-Fi® Hotspot ..... **49**
- 2-3. Other settings**
  - General settings ..... **53**
  - Voice settings ..... **56**
  - Vehicle settings ..... **57**

### Initial screen

When the engine switch <power switch> is turned to ACCESSORY or IGNITION ON mode <ON mode>, the initial screen will be displayed and the system will begin operating.

### Caution screen

After a few seconds, the caution screen will be displayed.

Waiting about 5 seconds or selecting "Continue", the caution screen switches to the next screen.

### ⚠ WARNING

- When the vehicle is stopped with the engine running <hybrid system operating>, always apply the parking brake for safety.

### Maintenance information\*

\*: 10.3-inch display model

This system reminds users when to replace certain parts or components and shows dealer information (if registered) on the screen.

When the vehicle reaches a previously set driving distance or date specified for a scheduled maintenance check, the maintenance remainder screen will be displayed when the system is turned on.

- To prevent this screen from being displayed again, select "Do Not Tell Me Again".

- To register maintenance information: →P.58
- If  is selected, the registered phone number can be called.

### Restarting the system

When system response is extremely slow, the system can be restarted.

- 1 Press and hold the "PWR•VOL" knob for 3 seconds or more.

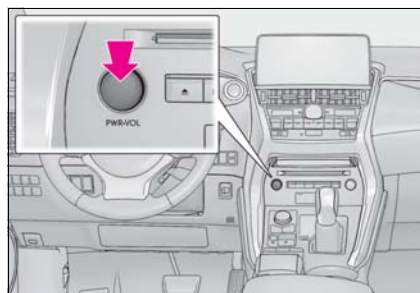

## How to use the Remote Touch

This system can be operated by the Remote Touch when the engine switch <power switch> is in **ACCESSORY** or **IGNITION ON mode <ON mode>**.

## Touchpad operation

- 1 Use the touchpad of the Remote Touch to select the desired button on the screen.

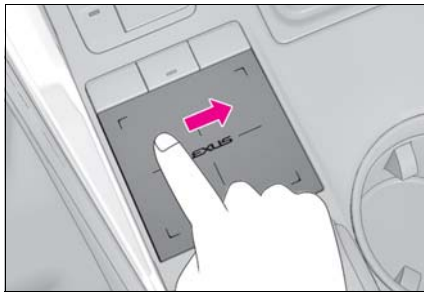

- 2 The buttons on the screen can be selected by either depressing or double tapping on the touchpad. Once a button has been selected, the screen will change.

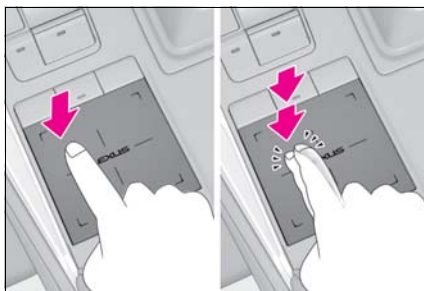

- When the pointer moves close to a button, it will automatically snap to that button and a haptic feedback

force (vibration) is generated by the touchpad.

This feedback force can be adjusted. (→P.53)

- Perform touchpad operations using a finger. Do not use nails or other objects like pens, etc.
- Perform pointer movement operations using only one finger. The pointer can not be operated by using more than one finger.
- When water or other foreign materials are on the touchpad, a malfunction may occur. In those cases, wipe off the water or foreign materials and wait about 30 seconds before operating the touchpad.
- In the following cases, there is a possibility that the touchpad may not react normally:
  - When wearing gloves, etc.
  - When operated with a wet hand.
  - When a film, paint-like substance, etc., is on the touchpad.
  - Near a TV tower, electrical power plant, gas station, large display, airport or other facility that generates strong radio waves or electrical noise.
  - When wireless devices, such as portable radios and mobile phones are nearby.
  - When the following metal items are placed on the touchpad:
    - Coins
    - Keys
    - Metal parts of a wallet or purse
    - A card in which aluminum foil, etc., is attached
    - A box of cigarettes that uses aluminum foil
    - Disposable hand warmers
    - Media such as CD/DVDs, USB cables, etc.
  - When the temperature is -4 °F (-20°C) or less
- If a hand or object was placed on the touchpad when the engine switch <power switch> is in **ACCESSORY** or **IGNITION ON mode <ON mode>**, the touchpad may not react normally. In those cases, remove what was set on the touchpad and operate it after waiting about 30

seconds. If there still no reaction, turn off the engine switch <power switch> and then turn it to ACCESSORY or IGNITION ON mode <ON mode> again.

- Clean the touchpad frequently, as the reaction of the touch operation may worsen if the touchpad is dirty. In order to prevent malfunctions when cleaning the touchpad, turn the engine switch <power switch> off.



#### NOTICE

- Do not allow the Remote Touch to come into contact with food, liquid, stickers or lit cigarettes as doing so may cause damage.
- Do not subject the Remote Touch to excessive pressure or strong impact as doing so may cause damage.
- Do not push the touchpad with a strong force or use a sharp pointed object to operate the pad, as it is possible to cause damage.

### Touchpad gestures

Operations are performed by touching the touchpad with your finger.

- Setting for the touchpad, such as movement speed of the pointer, can be changed. (→P.53)

#### Trace

Trace the pad surface while maintaining contact with the touchpad.

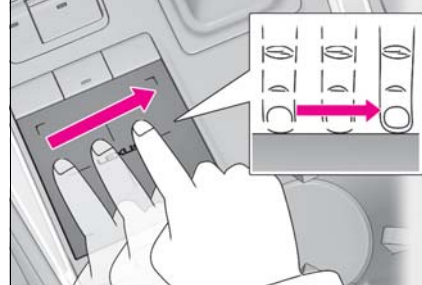

- Moving the cursor and the pointer.

#### Double tap

Tap the touchpad twice, quickly.

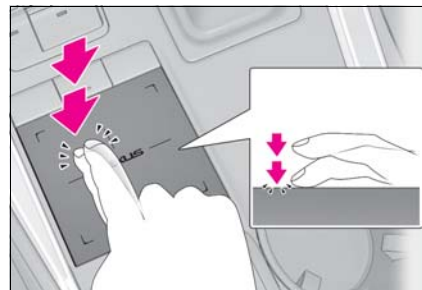

- Selecting the button on the screen.

#### Flick

Quick and long movement along the touchpad with your finger.

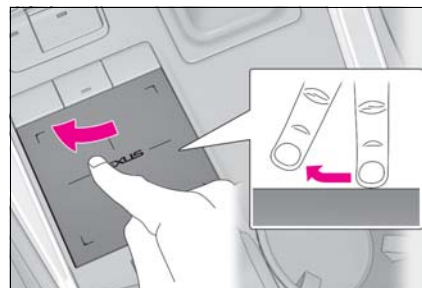

- Moving the list screen or map screen.



- To move the map, "Map Flick" on the detailed navigation settings is required to be "On". (→P.95)
- The behavior of the flick operation differs depending on whether the vehicle is in motion or parked.

### Pinch in/Pinch out

Slide fingers toward each other or apart on the touchpad.

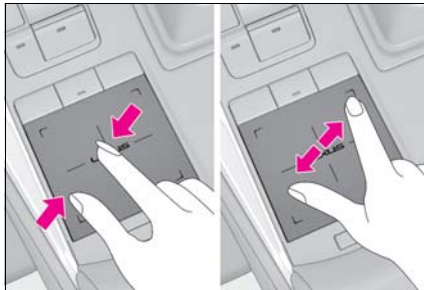

- Changing the scale of the map.

## Entering letters and numbers/list screen operation

### Entering letters and numbers

When searching by an address, name, etc., or entering data, letters and numbers can be entered via the screen.

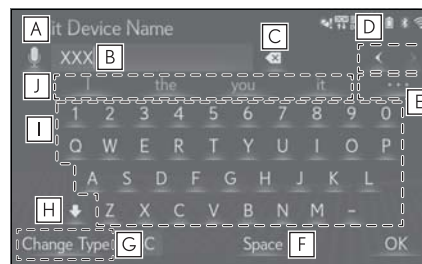

- A** When this icon is displayed, select to enable the dictation function. (English only)
- B** Text field. Entered character(s) will be displayed.
- C** Select to erase one character. Select and hold to continue erasing characters.
- D** Select to move the cursor.
- E** Select to display a list of predictive text candidates when there is more than one. (→P.34)
- F** Select to make a space on cursor.
- G** Select to change character and keyboard types. (→P.34)
- H** Select to enter characters in lower case or in upper case.
- I** Select to enter desired characters.
- J** Select to display predictive text candidates for entered text.

2

Basic function

- Keyboard layout can be changed. (→P.53)

**Changing character and keyboard type**

1 Select "Change Type".

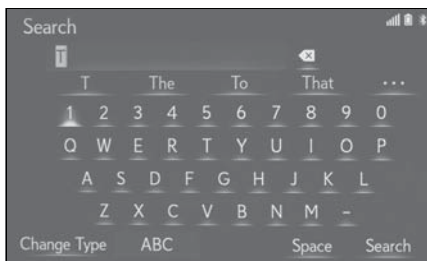

2 Select the desired character and keyboard.

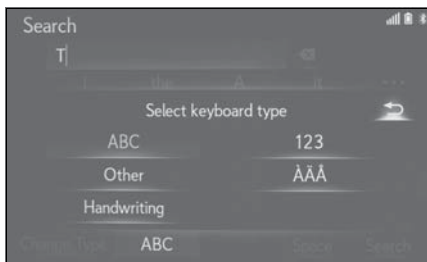

- Depending on the screen being displayed, it may not be possible to change keyboard characters.

**Select to display predictive text candidates**

When text is input, the system predicts the text that may complete the currently unconfirmed text and displays predictive replacement candidates that match the beginning of the text.

1 Input text.

2 Select the desired candidate.

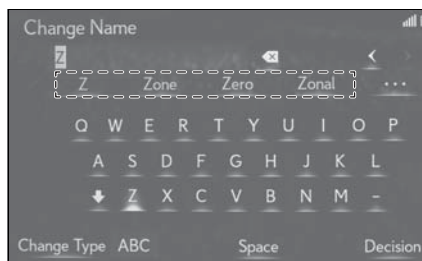

- To select a candidate that is not displayed, select "...", and then select the desired predictive replacement candidate.

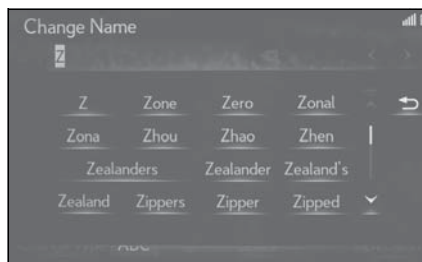

**Hand writing method**

Characters can be entered by hand writing.

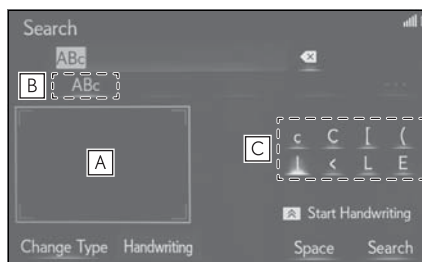

- A** Write the characters to be entered.
- B** Select the candidate character that corresponds to the entered hand written character.
- C** Select the candidate character that is displayed to enter the next

desired character.

- Depending on the input screen and conditions, the following operations can be performed.
- Back space: Draw a straight line from the bottom right to the bottom left.
- Space: Draw a line from the top left to the bottom left and then continue to the bottom right at a right angle.
- Line Break: Draw a line from the top right to the bottom right and then continue to the bottom left at a right angle.

- To deselect the handwriting input range, press the touchpad of the Remote Touch or sub function button.

**List screen operation**

The list screen may be displayed after entering characters. When a list is displayed, use the appropriate screen button to scroll through the list.

**Scrolling list screen**

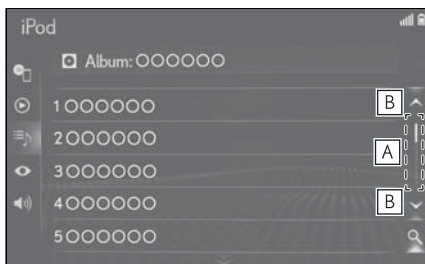

- A** Select this part to scroll the list by operating the scroll bar. To release scrolling the list, select the scroll bar again.
- B** Select to scroll the list.

- Matching items from the database are

listed even if the entered address or name is incomplete.

- The list will be displayed automatically if the maximum number of characters is entered or matching items can be displayed on a single list screen.
- The number of matching items is shown on the right side of the screen. If the number of matching items is more than 999, the system displays “\*\*\*” on the screen.
- It can be performed even if the “Map Flick” is set to “Off”. (→P.95)

**List screen flick operation**

The list can be scrolled by flick operation when the cursor is over the top or bottom part of the list.

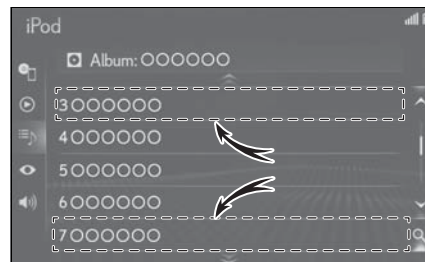

**Searching a list**

Items are displayed in the list with the most similar results of the search at the top.

- 1 Select

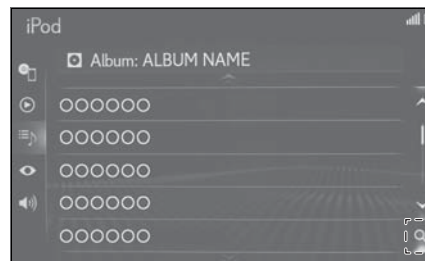

2 Input text.

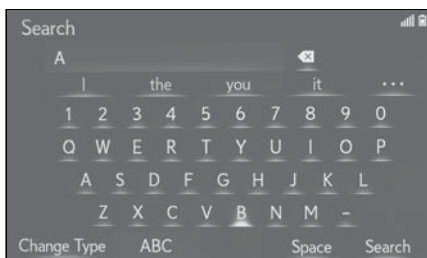

3 Select "Search".

4 The list is displayed.



● 10.3-inch display model: When text is input, a candidate list of items to search for is displayed on the side screen.

### Sorting

The order of a list displayed on the screen can be sorted in the order of distance from the current location, date, category, etc.

1 Press the button on the Remote Touch.



2 Select the desired sorting criteria.

### Display settings (screen adjustment)

The contrast and brightness of the screen display and the image of the camera display can be adjusted. The screen can also be turned off, and/or changed to either day or night mode.  
(For information regarding audio/visual screen adjustment: →P.136)

### Displaying the display settings screen

1 Press the "MENU" button on the Remote Touch.

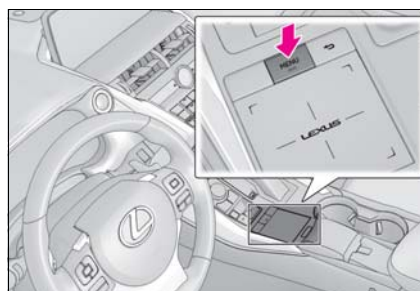

- ▶ 10.3-inch display model
- 2 Select "Setup".
- 3 Select "Display".
- 4 Select the desired items to be set.
- ▶ 8-inch display model
- 2 Select "Display".
- 3 Select the desired items to be set.

### Display settings screen

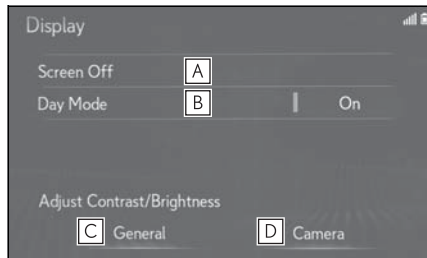

- A** Select to turn the screen off. To turn it on, press any button on the audio panel or on the Remote Touch.
- B** Select to turn day mode on/off. (→P.37)
- C** Select to adjust the screen display. (→P.37)
- D** Select to adjust the camera display. (→P.37)

### Changing between day and night mode

Depending on the position of the headlight switch, the screen changes to day or night mode. This feature is available when the headlight is switched on.

- 1** To display the screen in day mode even with the headlight switch on, select "Day Mode".

- If the screen is set to day mode with the headlight switch turned on, this condition is memorized even with the engine <hybrid system> turned off.

### Adjusting the contrast/brightness

The contrast and brightness of the screen can be adjusted according to

the brightness of your surroundings.



- 1** Select "General" or "Camera".
- 2** Select the desired item.

- "Contrast"

Select "+" or "-" to adjust the contrast of the screen.

- "Brightness"

Select "+" or "-" to adjust the brightness of the screen.

- "Display (General)" screen only: Select  or  to select the desired display.

2

Basic function

### **Linking multi-information display and navigation/multimedia system**

The following functions of the navigation/multimedia system are linked with the multi-information display in the instrument cluster:

- Navigation (10.3-inch display model)
- Audio
- Phone

etc.

These functions can be operated using multi-information display control switches on the steering wheel. For details, refer to "OWNER'S MANUAL".

### Registering/Connecting a Bluetooth® device

To use the hands-free system, it is necessary to register a Bluetooth® phone with the system.

Once the phone has been registered, it is possible to use the hands-free system.

This operation cannot be performed while driving.

### Registering a Bluetooth® phone for the first time

#### Registering from the navigation/multimedia system

- 1 Turn the Bluetooth® connection setting of your cellular phone on.
  - This function is not available when Bluetooth® connection setting of your cellular phone is set to off.
- 2 Press the "MENU" button on the Remote Touch.

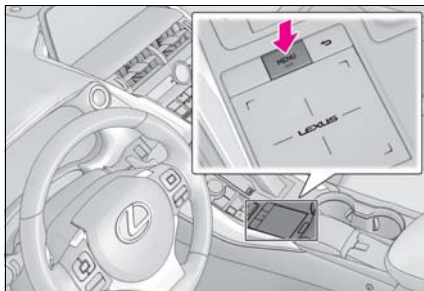

- 3 Select "Phone".
  - Operations up to this point can also be performed by pressing the 

switch on the steering wheel.

- 4 Select "Yes" to register a phone.
- 5 Select the desired Bluetooth® device.

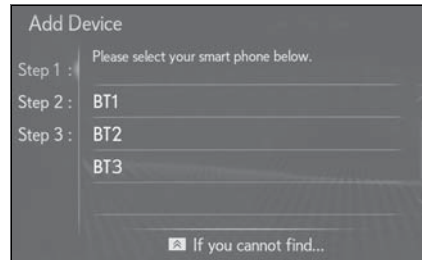

- If the desired Bluetooth® phone is not on the list, select "If you cannot find..." and follow the guidance on the screen. (→P.40)
- 6 Register the Bluetooth® device using your Bluetooth® device.
    - For details about operating the Bluetooth® device, see the manual that comes with it.
    - A PIN code is not required for SSP (Secure Simple Pairing) compatible Bluetooth® devices. Depending on the type of Bluetooth® device being connected, a message confirming registration may be displayed on the Bluetooth® device's screen. Respond and operate the Bluetooth® device according to the confirmation message.

2

Basic function

- 7 Check that the following screen is displayed, indicating pairing was successful.

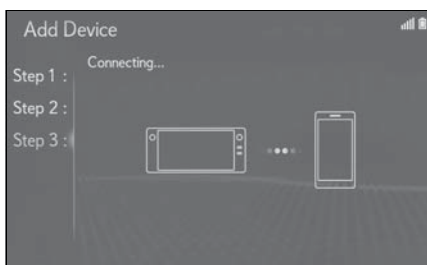

- 8 Check that "Connected" is displayed and registration is complete.

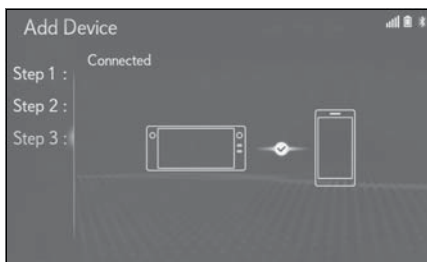

- If an error message is displayed, follow the guidance on the screen to try again.
- If a cellular phone does not operate properly after being connected, turn the cellular phone off and on and then connect it again.

### Registering from phone

When registering from the navigation/multimedia system is failed, or the phone name doesn't appear on the registering screen, need to connect the Bluetooth® phone manually.

- 1 Press the "MENU" button on the Remote Touch.
- 2 Select "Phone".

- 3 Select "Yes" to register the new phone.

- 4 Press the  button on the Remote Touch to select "If you cannot find..." on the bottom of the screen.

- 5 Select "Register from Phone".

- 6 Register the Bluetooth® device using your Bluetooth® device.

- A PIN code is not required for SSP (Secure Simple Pairing) compatible Bluetooth® devices. Depending on the type of Bluetooth® device being connected, a message confirming registration may be displayed on the Bluetooth® device's screen. Respond and operate the Bluetooth® device according to the confirmation message.

- 7 Check that the following screen is displayed, indicating pairing was successful.

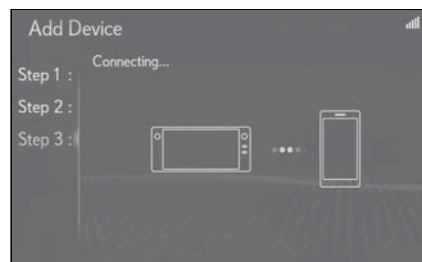



- 8 Check that “Connected” is displayed and registration is complete.

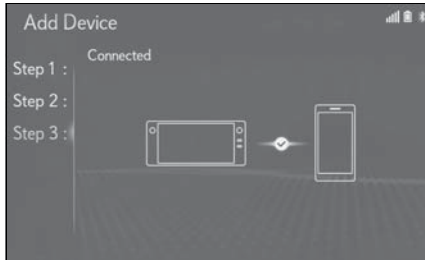

- If an error message is displayed, follow the guidance on the screen to try again.
- If a cellular phone does not operate properly after being connected, turn the cellular phone off and on and then connect it again.

### Registering a Bluetooth® audio player for the first time

To use the Bluetooth® audio, it is necessary to register an audio player with the system.

Once the player has been registered, it is possible to use the Bluetooth® audio.

This operation cannot be performed while driving.

For details about registering a Bluetooth® device: →P.43

- 1 Turn the Bluetooth® connection setting of your audio player on.
- This function is not available when the Bluetooth® connection setting of your audio player is set to off.

- 2 Press the “MENU” button on the Remote Touch.

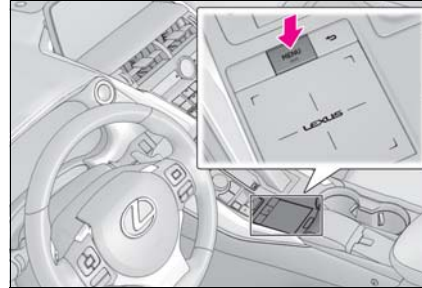

- 3 Select “Media”.
- 4 Select  “Source” on the sub menu.
- 5 Select “Bluetooth”.

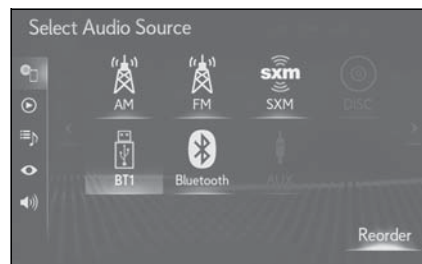

- 6 Select “Yes” to register a audio player.

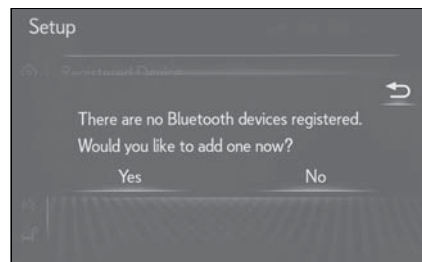

- 7 Follow the steps in “Registering a Bluetooth® phone for the first time” from step 5. (→P.39)

2

Basic function

### Supported Bluetooth® profiles and services

This system supports the following services.

#### ■ Bluetooth® Core Specification

- Ver. 2.0 (Recommended: Ver. 4.1 +EDR)

#### ■ Profiles

- HFP (Hands Free Profile) Ver. 1.0 (Recommended: Ver. 1.7)

- This is a profile to allow hands-free phone calls using a cellular phone or head set. It has outgoing and incoming call functions.

- OPP (Object Push Profile) Ver. 1.1 (Recommended: Ver. 1.2)

- This is a profile to transfer contacts data.

- PBAP (Phone Book Access Profile) Ver. 1.0 (Recommended: Ver. 1.2)

- This is a profile to transfer phonebook data.

- MAP (Message Access Profile) Recommended: Ver. 1.2

- This is a profile to use phone message functions.

- SPP (Serial Port Profile) Recommended: Ver. 1.2

- This is a profile to use the Lexus Enform function.

- A2DP (Advanced Audio Distribution Profile) Ver. 1.0 (Recommended: Ver. 1.3)

- This is a profile to transmit stereo audio or high quality sound to the audio system.

- AVRCP (Audio/Video Remote

Control Profile) Ver. 1.0 (Recommended: Ver. 1.6)

- This is a profile to allow remote control the A/V equipment.

- If your cellular phone does not support HFP, registering the Bluetooth® phone or using OPP, PBAP, MAP or SPP profiles individually will not be possible.

- If the connected Bluetooth® device version is older than recommended or incompatible, the Bluetooth® device function may not work properly.

- Refer to <http://www.lexus.com/MobileLink> to find approved Bluetooth® phones for this system.

- Certification



Bluetooth is a registered trademark of Bluetooth SIG, Inc.

## Setting Bluetooth® details

### Displaying the Bluetooth® setup screen

- 1 Press the "MENU" button on the Remote Touch.

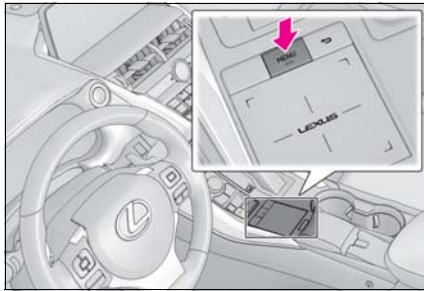

- 2 Select "Setup".
- 3 Select Bluetooth icon "Bluetooth" on the sub menu.
- 4 Select the desired item to be set.

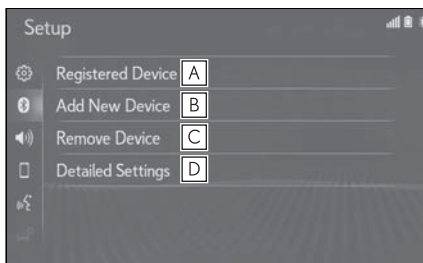

- A Connecting a Bluetooth® device and editing the Bluetooth® device information (→P.44, 46)
- B Registering a Bluetooth® device (→P.43)
- C Deleting a Bluetooth® device (→P.43)
- D Setting the Bluetooth® system (→P. 47)

## Registering a Bluetooth® device

Up to 5 Bluetooth® devices can be registered.

Bluetooth® compatible phones (HFP) and audio players (AVP) can be registered simultaneously.

This operation cannot be performed while driving.

- 1 Display the Bluetooth® setup screen:
  - "MENU" button → "Setup" → Bluetooth icon
- 2 Select "Add New Device".
  - ▶ When another Bluetooth® device is connected
  - To disconnect the Bluetooth® device, select "Yes".
  - ▶ When 5 Bluetooth® devices have already been registered
  - A registered device needs to be replaced. Select "Yes", and select the device to be replaced.
- 3 Follow the steps in "Registering a Bluetooth® phone for the first time" from step 5. (→P.39)

## Deleting a Bluetooth® device

This operation cannot be performed while driving.

- 1 Display the Bluetooth® setup screen:
  - "MENU" button → "Setup" → Bluetooth icon

- 2 Select "Remove Device".
- 3 Select the desired device.

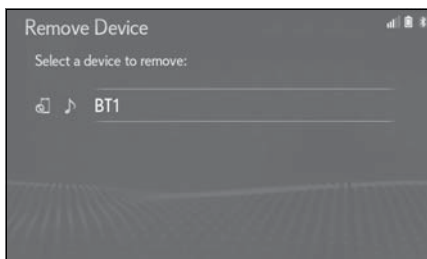

- 4 Select "Yes" when the confirmation screen appears.
- 5 Check that a confirmation screen is displayed when the operation is complete.

- When deleting a Bluetooth® phone, the contact data will be deleted at the same time.

### Connecting a Bluetooth® device



Up to 5 Bluetooth® devices (Phones (HFP) and audio players (AVP)) can be registered.

If more than 1 Bluetooth® device has been registered, select which device to connect to.

- 1 Display the Bluetooth® setup screen:
  - "MENU" button → "Setup" → 
  - "Bluetooth" on the sub menu
- 2 Select "Registered Device".

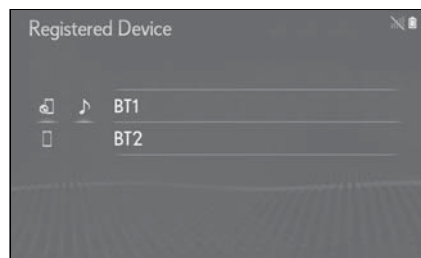
- 3 Select the device to be connected.



- : Phone
- : Audio player
- : Phone/Lexus Enform service

- The profile icon for a currently connected device will be displayed in color.
- Selecting a profile icon which is not currently connected will switch the connection to the function.
- If the desired Bluetooth® device is not on the list, select "Add New Device" to register the device. (→P.43)

- 4 Select the desired connection.

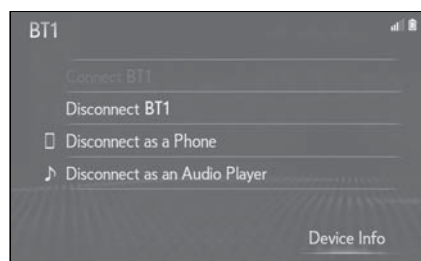

- 5 Check that a confirmation screen is displayed when the connection is complete.
  - ▶ When another Bluetooth® device is connected
  - To disconnect the Bluetooth®

device, select "Yes".

- If an error message is displayed, follow the guidance on the screen to try again.

- It may take time if the device connection is carried out during Bluetooth® audio playback.
- Depending on the type of Bluetooth® device being connected, it may be necessary to perform additional steps on the device.
- When disconnecting a Bluetooth® device, it is recommended to disconnect using the system.

#### Connecting a Bluetooth® device in a different way (from phone top screen)

- 1 Press the "MENU" button on the Remote Touch.
- 2 Select "Phone".
- 3 Select  "Select Device" on the sub menu.
- 4 Select desired device name from the list.

#### Connecting a Bluetooth® device in a different way (from Bluetooth® audio top screen)

- 1 Press the "MENU" button on the Remote Touch.
- 2 Select "Media".
- 3 Select  "Source" on the sub menu.
- 4 Select "Bluetooth".
- 5 Select "Connect".

- 6 Select desired device name from the list.

#### ■ Auto connection mode

To turn auto connection mode on, set "Bluetooth Power" to on. (→P.47)  
Leave the Bluetooth® device in a location where the connection can be established.

- When the engine switch <power switch> is in ACCESSORY or IGNITION ON mode <ON mode>, the system searches for a nearby registered device.
- The system will connect with the registered device that was last connected, if it is nearby. When automatic connection priority is set to on and there is more than one registered Bluetooth® phone available, the system will automatically connect to the Bluetooth® phone with the highest priority. (→P.48)

#### ■ Connecting manually

When the auto connection has failed or "Bluetooth Power" is turned off, it is necessary to connect the Bluetooth® device manually.

- 1 Display the Bluetooth® setup screen:
  - "MENU" button → "Setup" →  "Bluetooth" on the sub menu
- 2 Follow the steps in "Connecting a Bluetooth® device" from step 2. (→P.44)

■ **Reconnecting the Bluetooth® phone**

If a Bluetooth® phone is disconnected due to poor reception from the Bluetooth® network when the engine switch <power switch> is in ACCESSORY or IGNITION ON mode <ON mode>, the system automatically reconnects the Bluetooth® phone.

**Editing the Bluetooth® device information**

The Bluetooth® device's information can be displayed on the screen. The displayed information can be edited.

This operation cannot be performed while driving.

- 1 Display the Bluetooth® setup screen:
  - "MENU" button → "Setup" → 
  - "Bluetooth" on the sub menu
- 2 Select "Registered Device".
- 3 Select the desired device to be edited.
- 4 Select "Device Info".

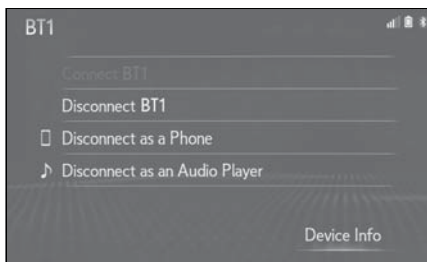

- 5 Confirm and change the Bluetooth® device information.

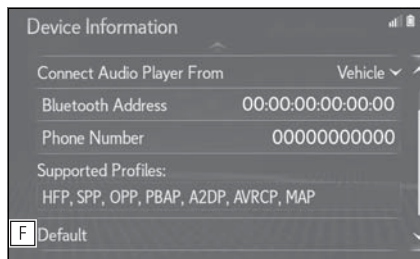
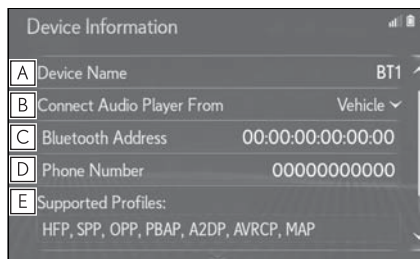

- A The name of the Bluetooth® device is displayed. It can be changed to a desired name. (→P.47)
- B Select to set the Bluetooth® audio player connection method. (→P.47)
- C Device address is unique to the device and cannot be changed.
- D Phone number of the Bluetooth® phone and cannot be changed.
- E Compatibility profile of the Bluetooth® device and cannot be changed.
- F Select to reset all setup items.

- If 2 Bluetooth® devices have been registered with the same device name, the devices can be distinguished referring to the device's address.
- Depending on the type of phone, some information may not be displayed.

### Changing a device name

- 1 Select "Device Name".
- 2 Enter the name and select "OK".

- Even if the device name is changed, the name registered in your Bluetooth® device does not change.

### Setting audio player connection method

- 1 Select "Connect Audio Player From".
- 2 Select the desired connection method.

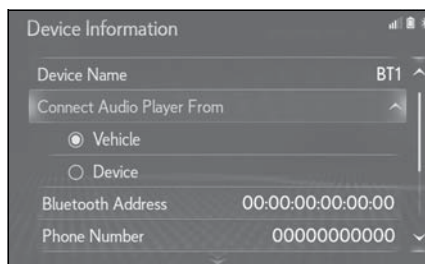

"Vehicle": Select to connect the audio player from the vehicle's audio system.

"Device": Select to connect the vehicle's audio system from the audio player.

- Depending on the audio player, the "Vehicle" or "Device" connection method may be best. As such, refer to the manual that comes with the audio player.

### "Detailed Settings" screen

The Bluetooth® settings can be confirmed and changed.

- 1 Display the Bluetooth® setup screen:

- "MENU" button → "Setup" → 
- 2 Select "Bluetooth" on the sub menu
  - 3 Select "Detailed Settings".

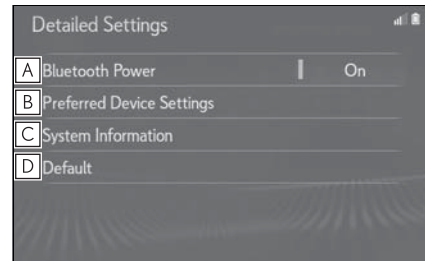

- A Select to set Bluetooth® connection on/off. (→P.47)
- B Select to change the automatic connection priority of the registered Bluetooth® devices. (→P.48)
- C Select to edit the system information. (→P.48)
- D Select to reset all setup items.

### Changing "Bluetooth Power"

- 1 Select "Bluetooth Power".

When "Bluetooth Power" is on:  
The Bluetooth® device is automatically connected when the engine switch <power switch> is in ACCESSORY or IGNITION ON mode <ON mode>.

When "Bluetooth Power" is off:  
The Bluetooth® device is disconnected, and the system will not connect to it next time.

- While driving, the auto connection state can be changed from off to on, but cannot be changed from on to off.

2

Basic function

**Setting automatic connection priority**

The automatic connection priority of the registered Bluetooth® devices can be changed.

- 1 Select "Preferred Device Settings".
- 2 Select the desired item to be set.



- A Select to set automatic connection priority on/off.
- B Select to change the automatic connection priority of the registered Bluetooth® phones. (→P.48)
- C Select to change the automatic connection priority of the registered Bluetooth® audio players. (→P.48)
- D Select to reset all setup items.

● A newly registered Bluetooth® device will automatically be given the highest automatic connection priority.

■ **Changing phone automatic connection priority**

- 1 Select "Preferred Phones".
- 2 Select the desired Bluetooth® device and select "Move Up" or

"Move Down" to change the preferred order.

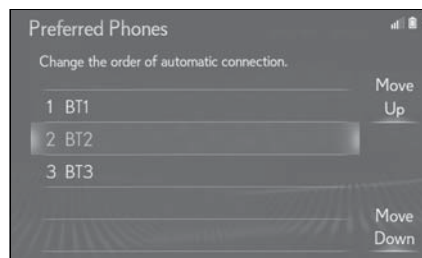

■ **Changing audio player automatic connection priority**

- 1 Select "Preferred Audio Players".
- 2 Select the desired Bluetooth® device and select "Move Up" or "Move Down" to change the preferred order.

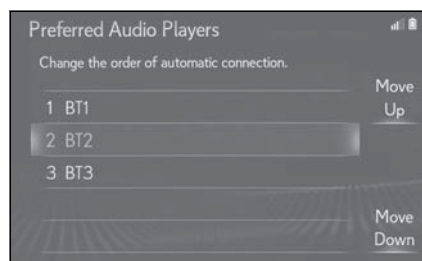

**Editing the system information**

- 1 Select "System Information".



## 2 Select the desired item to be set.

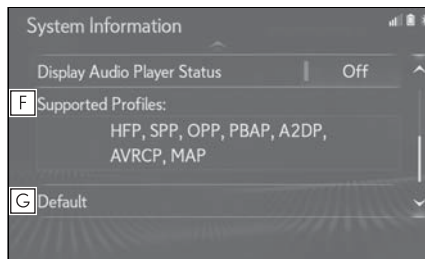
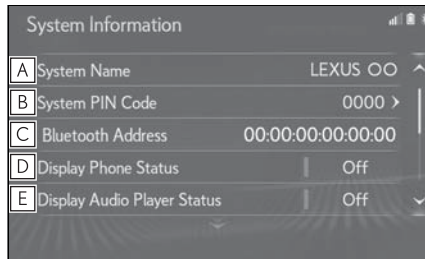

- A** Displays system name. Can be changed to a desired name.
- B** PIN code used when the Bluetooth® device was registered. Can be changed to a desired code.
- C** Device address is unique to the device and cannot be changed.
- D** Select to set the phone connection status display on/off.
- E** Select to set the connection status display of the audio player on/off.
- F** Compatibility profile of the system
- G** Select to reset all setup items.

## Wi-Fi® Hotspot\*

\*: This function is not made available in some countries or areas.

**By connecting a device to the vehicle via Wi-Fi®, it can access the internet through the DCM.**

**To use this function, a Wi-Fi® Hotspot service subscription from Verizon Wireless is required. Contact your Lexus dealer for details.**

- Wi-Fi is a registered mark of the Wi-Fi Alliance®.
- If a connected device is taken out of the Wi-Fi® connection area, the connection will be severed.
- If the vehicle is driven out of the cellular communication coverage area, connecting to the internet via the Wi-Fi® Hotspot will not be possible.
- If a Bluetooth® device is used while a device is connected using the Wi-Fi® Hotspot function, the communication speed may decrease.
- Depending on the environment in which the access point is used, the communication speed may be low or communication may not be possible.
- The condition of Wi-Fi® connection appears on the right upper side of the screen. (→P.22)
- Communication standards
  - 802.11b
  - 802.11g
  - 802.11n (2.4GHz)
- Security
  - WPA™
  - WPA2™
- WPA and WPA2 are registered mark of the Wi-Fi Alliance®.

2

Basic function

**⚠ WARNING**

- Use Wi-Fi<sup>®</sup> devices only when safe and legal to do so.
- Your audio unit is fitted with Wi-Fi<sup>®</sup> antennas. People with implantable cardiac pacemakers, cardiac resynchronization therapy-pacemakers or implantable cardioverter defibrillators should maintain a reasonable distance between themselves and the Wi-Fi<sup>®</sup> antennas.  
The radio waves may affect the operation of such devices.
- Before using Wi-Fi<sup>®</sup> devices, users of any electrical medical device other than implantable cardiac pacemakers, cardiac resynchronization therapy-pacemakers or implantable cardioverter defibrillators should consult the manufacturer of the device for information about its operation under the influence of radio waves. Radio waves could have unexpected effects on the operation of such medical devices.

**Connecting a device to the in-vehicle access point****Searching for and connecting a device to the vehicle access point**

- 1 Enable the Wi-Fi<sup>®</sup> Hotspot function. (→P.50)
  - 2 Disable the “Hide Access Point” function. (→P.50)
  - 3 Search for the vehicle access point using the device you wish to connect.
  - 4 Operate the device to connect it to the vehicle access point.
- To check the vehicle access point password, select “Password”.

(→P.50)

- For the operation of the device, see the manual that comes with it.
- Hints for connecting to the vehicle via Wi-Fi<sup>®</sup> can be displayed. (→P.50)

**Connecting a device to the in-vehicle access point using the access point name (SSID)**

- 1 Enable the Wi-Fi<sup>®</sup> Hotspot function. (→P.50)
  - 2 Enable the “Hide Access Point” function. (→P.50)
  - 3 Enter the access point name (SSID) into the device you wish to connect and connect it.
- To check the vehicle access point password, select “Password”. (→P.50)
  - The security settings on the device must be the same as that displayed for “Security”. (→P.50)

- For the operation of the device, see the manual that comes with it.

**Setting Wi-Fi<sup>®</sup> details**

- 1 Press the “MENU” button on the Remote Touch.

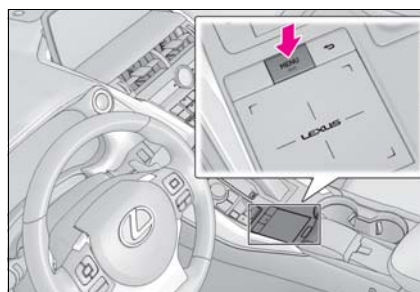

- 2 Select "Setup".
- 3 Select  "Wi-Fi" on the sub menu.
- 4 Select the desired item to be set.

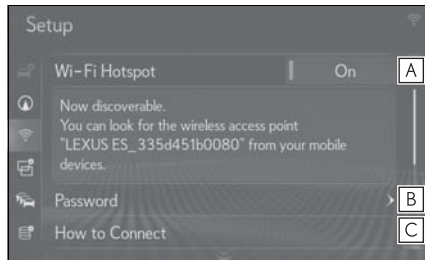

- A** Select to enable/disable the Wi-Fi<sup>®</sup> Hotspot function. (→P.51)
- B** Select to check/change the access point password. (→P.51)
- C** Select to display hints for connecting to the vehicle via Wi-Fi<sup>®</sup>.
- D** Select to make the access point searchable/unsearchable.
- E** Select to check/change the security protocol of the access point (for authentication and encryption). (→P.52)
- F** Select to change the access point name (SSID). (→P.52)
- G** Select to change the Wi-Fi<sup>®</sup> connection channel (within the 2.4GHz frequency band). (→P.52)

- If any settings have been changed, it will be necessary to reset the Wi-Fi<sup>®</sup> system to complete the changes. To reset the Wi-Fi<sup>®</sup> system, select "Yes" on the popup displayed after changing the settings.

### Enabling/disabling the Wi-Fi<sup>®</sup> hotspot function

When the Wi-Fi<sup>®</sup> Hotspot function is enabled, the system checks for a valid Hotspot service subscription.

If a Hotspot service subscription has not been started, start the App Suite application to activate the service subscription. (If the App Suite application has not been installed, install the application.)

Contact your Lexus dealer for details about the App Suite application.

### Checking/changing the password

- 1 Display the Wi-Fi<sup>®</sup> setup screen:
  - "MENU" button → "Setup" →  "Wi-Fi" on the sub menu
- 2 Select "Password".
- 3 Check that the following screen is displayed.

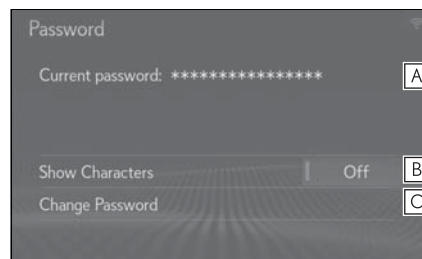

- A** Displays the password

2

Basic function

- B** Select to display/hide the entered password.
- C** Select to change the password.

#### Changing the password

- 1 Select "Change Password".
- 2 Enter the desired password and select "OK".
  - The password must be at least 8 characters long.
  - The password with non-ASCII can not be used.

#### Changing the security protocol

- 1 Display the Wi-Fi® setup screen:
  - "MENU" button → "Setup" →  "Wi-Fi" on the sub menu
- 2 Select "Security".
- 3 Select the desired security protocol.

#### Changing the access point name (SSID)

- 1 Display the Wi-Fi® setup screen:
  - "MENU" button → "Setup" →  "Wi-Fi" on the sub menu
- 2 Select "Access Point Name".
- 3 Enter the desired access point name (SSID) and select "OK".

#### Selecting a Wi-Fi® connection channel

- 1 Display the Wi-Fi® setup screen:
  - "MENU" button → "Setup" →  "Wi-Fi" on the sub menu
- 2 Select "Channel".
- 3 Check that the following screen is displayed.

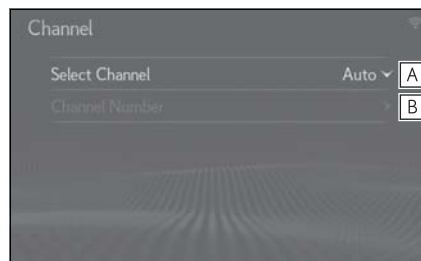

- A** Select to change the channel selection to automatic/manual.
- B** When "Manual" is selected, select to change the channel.

#### Changing the channel

- 1 Set "Select Channel" to "Manual".
- 2 Select "Channel Number".
- 3 Enter the desired channel number and select "OK".
  - Channels 1 through 11 can be selected.

## General settings

Settings are available for automatic screen change, operation sounds, etc.

### Displaying the general settings screen

- 1 Press the "MENU" button on the Remote Touch.

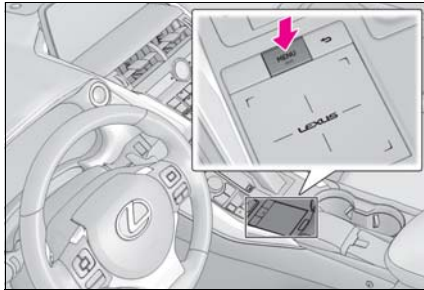

- 2 Select "Setup".
- 3 Select the desired items to be set.

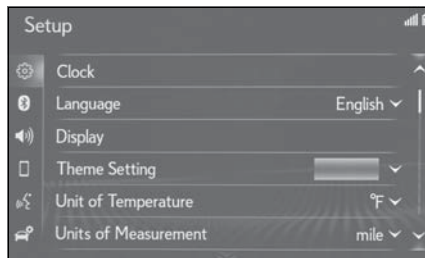

- "Clock"  
Select to change the time zone, set the daylight saving time on/off and set the automatic adjustment of the clock on/off. (→P.54)
- "Language"  
Select to change the language.
- "Customize Home Screen"\*2

Select to change the display information/area on the home screen and the home screen layout.

- "Display"\*1  
Select to adjust the contrast and brightness of the screens, turn the screen off, etc. (→P.36)

- "Theme Setting"  
Select to change the screen theme setting.

- "Beep"\*2  
Select to sound beeps.

- "Unit of Temperature"\*1  
Select to change the unit of temperature.

- "Units of Measurement"  
Select to change the unit of measure for distance/fuel consumption.

- "Auto Change to Screen"\*1  
Select to set automatic screen changes from the audio/air conditioning control screen to the map screen to on/off. When set to on, the screen will automatically return to the map screen from the audio/air conditioning control screen after 20 seconds.

- "Selection Sound"\*1  
Select to set the selection sounds on/off.

- "Pointer Sound"\*1  
Select to set the pointer sounds on/off.

- "Error Sound"\*1  
Select to set the error sounds on/off.

- "Pointer Sound Volume"\*1  
Select to adjust the pointer sound volume.

- "Feedback Force"  
Select to adjust the level of the haptic feedback force (vibration) to the touchpad, when selecting a screen button.

- “Cursor Speed”  
Select to adjust the pointer speed.
- “Multi-Touch Command”  
Select to set the multi-touch command on/off.
- “Keyboard Layout”  
Select to change the keyboard layout.
- “Delete Keyboard History”  
Select to delete the keyboard history.
- “Memorize Keyboard History”  
Select to set the memorize keyboard history on/off.
- “Animation”<sup>\*2</sup>  
Select to turn the animations on/off.
- “Delete Search History”<sup>\*1</sup>  
Select to delete the search history.
- “Delete Personal Data”  
Select to delete personal data. (→P.55)
- “Software Update”  
Select to update software versions. For details, contact your Lexus dealer.
- “Software Update Settings”  
Select to set software update setting. (→P.55)
- “Gracenote Database Update”  
Select to update Gracenote database versions. For details, contact your Lexus dealer.
- “Software Information”  
Select to display the software information. Notices related to third party software used in this product are enlisted. (This includes instructions for obtaining such software, where applicable.)

<sup>\*1</sup>: 10.3-inch display model

<sup>\*2</sup>: 8-inch display model

### Clock settings

Used for changing the time zone and setting of daylight saving time and automatic time adjustment on/off.

- 1 Display the general settings screen:
  - “MENU” button → “Setup” →  “General” on the sub menu
- 2 Select “Clock”.
- 3 Select the desired items to be set.

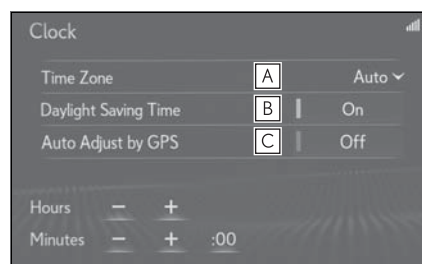

- A** Select to change the time zone. (→P.54)
- B** Select to set daylight saving time on/off.
- C** Select to set automatic adjustment of the clock by GPS on/off. When set to off, the clock can be manually adjusted. (→P.55)

### Setting the time zone

- 1 Select “Time Zone”.
- 2 Select the desired time zone.
  - If “Auto” is selected, the time zone is selected automatically by current vehicle position.
  - If “Other” is selected, the zone can be adjusted manually.

Select “+” or “-” to adjust the time zone.

### Manual clock setting

When “Auto Adjust by GPS” is turned “Off”, the clock can be manually adjusted.

- 1 Select the desired item.

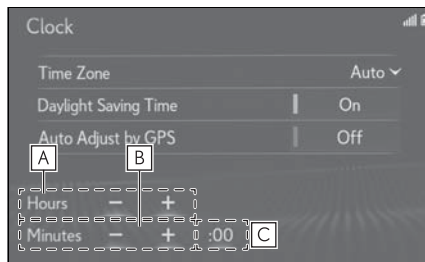

- A Select “+” to set the time forward one hour and “-” to set the time back one hour.
- B Select “+” to set the time forward one minute and “-” to set the time back one minute.
- C Select to round to the nearest hour.

e.g.

1:00 to 1:29 → 1:00

1:30 to 1:59 → 2:00

### Deleting personal data

Registered or changed personal settings will be deleted or returned to their default conditions.

- 1 Display the general settings screen:
  - “MENU” button → “Setup” → “General” on the sub menu
- 2 Select “Delete Personal Data”.
- 3 Select “Delete”.

- 4 Select “Yes” when the confirmation screen appears.

Examples of settings that can be returned to their default conditions:

- General settings
- Navigation settings
- Audio settings
- Phone settings
- Lexus Enform App Suite 2.0 settings

etc.

### Software update settings

When the automatic update check function is enabled, if a software update is available from the Lexus Enform center, a message will be displayed.

- 1 Display the general settings screen:
  - “MENU” button → “Setup” → “General” on the sub menu
- 2 Select “Software Update Settings”.
- 3 Select “Automatic Update Check” to enable/disable the automatic update check function.

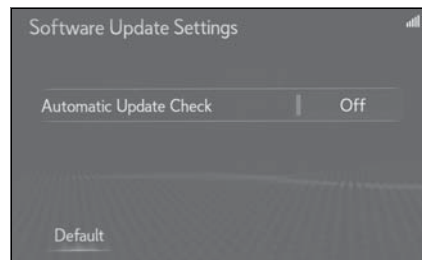

- When software update information is displayed, contact your Lexus dealer.

## Voice settings

Voice volume, etc. can be set.

### Displaying the voice settings screen

- 1 Press the "MENU" button on the Remote Touch.

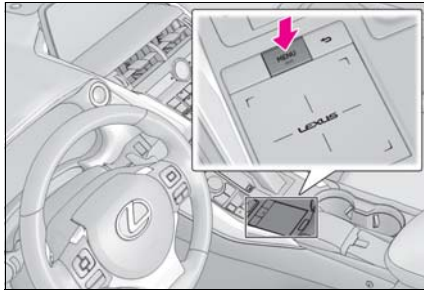

- 2 Select "Setup".
- 3 Select  "Voice" on the sub menu.
- 4 Select the desired items to be set.

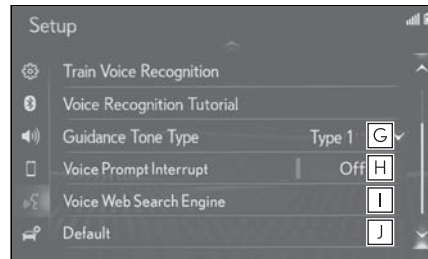
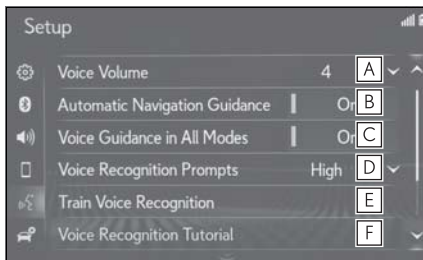

- A Select to adjust the volume of voice

guidance.

- B Select to set the voice guidance during route guidance on/off.\*
- C Select to set the voice guidance during audio/visual and/or air conditioning system use on/off.\*
- D Select to set the voice recognition prompts.
- E Select to train voice recognition. The voice command system adapt the user accent.
- F Select to start the voice recognition tutorial.
- G Select to set the beep sound of navigation guidance.\*
- H Select to set the voice prompt interrupt on/off.
- I Select to set the web search engine. The search engines are Lexus Enform App Suite 2.0 applications. (→P.260)
- J Select to reset all setup items.

\* : 10.3-inch display model



**Vehicle settings**

Settings are available for maintenance, vehicle customization, intuitive parking assist, etc.

**Displaying the vehicle settings screen**

- 1 Press the "MENU" button on the Remote Touch.

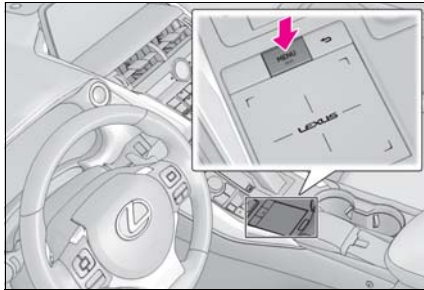

- 2 Select "Setup".
- 3 Select "Vehicle" on the sub menu.
- 4 Select the desired items to be set.

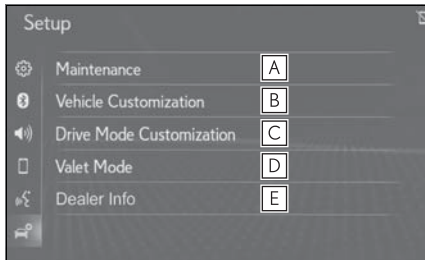

- A** Select to set maintenance.<sup>\*1</sup> (→P.58)
- B** Select to set vehicle customization.<sup>\*3</sup>
- C** Select to set driving mode.<sup>\*3,4</sup>

- D** Select to set valet mode. (→P.59)
- E** Select to set dealer information.<sup>\*2</sup> (→P.59)

<sup>\*1</sup>: 10.3-inch display model  
<sup>\*2</sup>: 8-inch display model  
<sup>\*3</sup>: Refer to the "OWNER'S MANUAL"  
<sup>\*4</sup>: If equipped

**Maintenance\***

\*: 10.3-inch display model

When the system is turned on, the maintenance reminder screen displays when it is time to replace a part or certain components. (→P.30)

- 1 Display the vehicle settings screen:
  - "MENU" button → "Setup" →
  - "Vehicle" on the sub menu
- 2 Select "Maintenance".
- 3 Select the desired item.

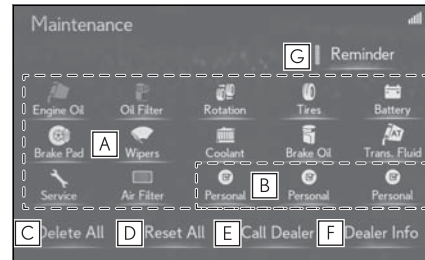

- A** Select to set a reminder for a part or component. (→P.58)
- B** Select to add a reminder other than the provided ones.
- C** Select to cancel all reminders which have been entered.
- D** Select to reset all reminders which have expired.

2  
Basic function

- E** Select to call the registered dealer.
- F** Select to register/edit dealer information. (→P.58)
- G** The system is set to give maintenance information with the maintenance reminder screen. (→P.30)

● When the vehicle needs to be serviced, the screen button color will change to orange.

**Maintenance information setting**

- 1 Select the desired part or component screen button.
- 2 Set the conditions.

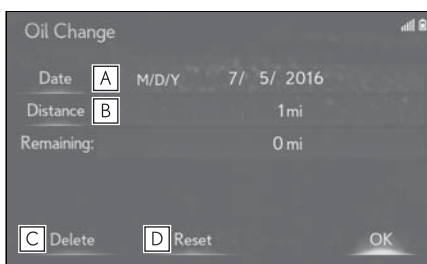

- A** Select to enter the next maintenance date.
  - B** Select to enter the driving distance until the next maintenance check.
  - C** Select to cancel the conditions which have been entered.
  - D** Select to reset the conditions which have expired.
- 3 Select "OK" after entering the conditions.

● For scheduled maintenance information, refer to "Warranty and Services Guide/Owner's Manual Supplement/Scheduled Maintenance".

● Depending on driving or road conditions,

the actual date and distance that maintenance should be performed may differ from the stored date and distance in the system.

**Dealer setting**

Dealer information can be registered in the system. With dealer information registered, route guidance to the dealer is available.

- 1 Select "Set Dealer".
  - 2 Select the desired item to search for the location. (→P.73)
- The editing dealer screen appears after setting the location.
- 3 Select the desired items to be edited.

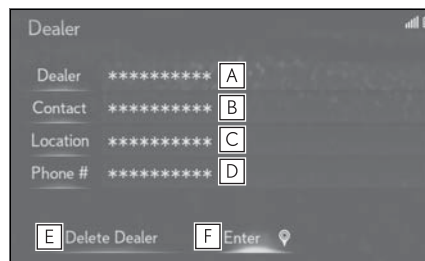

- A** Select to enter the name of a dealer. (→P.59)
- B** Select to enter the name of a dealer member. (→P.59)
- C** Select to set the location. (→P.59)
- D** Select to enter the phone number. (→P.59)
- E** Select to delete the dealer information displayed on the screen.
- F** Select to set the displayed dealer as a destination. (→P.80)

**Editing dealer or contact name**

- 1 Select "Dealer" or "Contact".
- 2 Enter the name and select "OK".

**Editing the location**

- 1 Select "Location".
- 2 Scroll the map to the desired point (→P.66) and select "Enter".

**Editing phone number**

- 1 Select "Phone #".
- 2 Enter the phone number and select "OK".

**Setting the valet mode**

The security system can be set to on by entering a security code (4-digit number).

When set to on, the system will become inoperative once the electrical power source is disconnected until the security code is entered.

- 1 Display the vehicle settings screen:
  - "MENU" button → "Setup" →  "Vehicle" on the sub menu
- 2 Select "Valet Mode".
- 3 Enter the 4-digit personal code and select "OK".
- 4 Enter the same 4-digit personal code again and select "OK".
- The system will request that you input the security code again to confirm that you remember it cor-

rectly.

- When valet mode activates, the system stops and a security code (4-digit number) standby screen is displayed.

- If the 4-digit personal code is forgotten, please contact your Lexus dealer.

**If the valet mode has been activated**

- 1 Enter the 4-digit personal code and select "OK".

- If an incorrect security code (4-digit number) is entered 6 times, the system will not accept another security code (4-digit number) for 10 minutes.

**Setting dealer information \***

\*: 8-inch display model

Dealer information can be registered in the system. If the vehicle alert screen is displayed, selecting the call dealer button on the screen will call the phone number registered in the dealer information.

- 1 Display the vehicle settings screen:
  - "MENU" button → "Setup" →  "Vehicle" on the sub menu
- 2 Select "Dealer Info".

2

Basic function

- 3 Select the desired items to be edited.

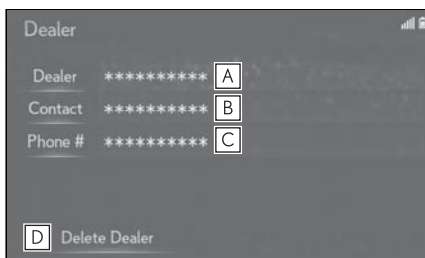

- A** Select to enter the name of a dealer. (→P.58)
- B** Select to enter the name of a dealer member. (→P.58)
- C** Select to enter the phone number. (→P.58)
- D** Select to delete the dealer information displayed on the screen.

## Navigation system

3

61

- 3-1. Basic operation**
  - Navigation..... 62
  - Map screen operation ..... 64
  - Map screen information..... 67
  - Traffic information..... 70
- 3-2. Destination search**
  - Destination search operation . 73
  - Starting route guidance..... 80
- 3-3. Route guidance**
  - Route guidance screen..... 84
  - Typical voice guidance prompts  
..... 87
  - Editing route..... 88
- 3-4. Setup**
  - Navigation settings..... 90
  - Detailed navigation settings .... 95
  - Traffic settings..... 98
- 3-5. Tips for the navigation system**
  - GPS (Global Positioning System)  
..... 102
  - Map database version and covered area ..... 104

3

Navigation system

## Navigation\*

\*: 10.3-inch display model

The navigation system indicates your present position and assists in locating a desired destination. To display the map screen, press the “MAP” button on the Remote Touch.

### Map screen overview



- A** Map orientation button (→P.65)  
Indicates whether the map orientation is set to north-up or heading-up. The letter(s) under this symbol indicate the vehicle’s heading direction (e.g. N for north). In 3D map, only a heading-up view is available.
- B** Destination button (→P.73)  
Select to display the destination screen.
- C** Map options button (→P.67)  
Select to display the map options screen.
- D** Route options button (→P.88)  
Select to display the route options screen.
- E** Mute button  
Select to mute the voice guidance.
- F** Micro city map button (→P.64)

Select to display the micro city map screen.

**G** Zoom in/out button (→P.64)

Select to magnify or reduce the map scale. When either button is selected, the map scale indicator bar appears at the bottom of the screen.

**H** Route information bar (→P.84)

Displays the distance with the estimated travel time/arrival time to the destination. The route information bar fills from left to right as the vehicle progresses on the route.

**I** Delete destination button (→P.26)

Select to delete destinations.

**J** Speed limit icon (→P.67)

Indicates the speed limit on the current road. The display of the speed limit icon can be set to on/off.

- 
- When the vehicle is not receiving GPS signals, such as when driving in a tunnel,  will be displayed at the bottom left corner of the screen.
  - Certain screen buttons on the map screen will disappear several seconds after the Remote Touch has been operated. This setting can be changed so that all the screen buttons will always be displayed. (→P.95)
  - Press the “MAP” button on the Remote Touch to display the address of the current position on the map screen or repeat voice guidance.

### Map screen operation

#### Current position display

- 1 Press the "MAP" button on the Remote Touch.

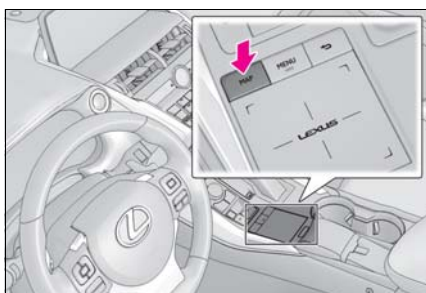

- 2 Check that the current position mark is displayed.
    - To correct the current position manually: →P.97
- While driving, the current position mark is fixed on the screen and the map moves.
  - The current position is automatically set as the vehicle receives signals from the GPS (Global Positioning System). If the current position is not correct, it is automatically corrected after the vehicle receives signals from the GPS.
  - After the 12-volt battery disconnection, or on a new vehicle, the current position may not be correct. As soon as the system receives signals from the GPS, the correct current position is displayed.

### Map scale

- 1 Select or to change the scale of the map screen.



- The scale of the map screen can be changed on the touchpad of the Remote Touch with your finger. Pinch out on the touchpad to zoom in and pinch in to zoom out.(→P.32)
- The scale indicator bar appears at the bottom of the screen.
- Select and hold or to continue changing the scale of the map screen.
- The scale of the map screen can also be changed by selecting the scale bar directly. This function is not available while driving.
- In areas where the micro city map is available the map scale changes from to when at the minimum range.

#### Micro city map

For areas covered by the micro city map (some major cities), a micro city map on a scale of 75 ft. (25 m) can be selected.



When the map is scaled down to 150 ft. (50 m), changes to and can be selected to display the micro city map.

- 1 Select on the map screen.



- 2 Check that the micro city map is displayed.





- To return to the normal map display, select .
- If the map or the current position is moved to the area which is not covered by the micro city map, the screen scale automatically changes to 150 ft. (50 m).
- On the micro city map, a one way street is displayed by .
- Scrolling the micro city map is not available while driving.
- Certification

Building micro cities in the database were created and provided by HERE.

### Map orientation

The orientation of the map can be changed between 2D north-up, 2D heading-up and 3D heading-up by selecting the orientation symbol displayed at the top left of the screen.

: North-up symbol  
Regardless of the direction of vehicle travel, north is always up.

: Heading-up symbol  
The direction of vehicle travel is always up.

: 3D Heading-up symbol  
The direction of vehicle travel is always up.

- The letter(s) under this symbol indicate the vehicle's heading direction (e.g. N for north).

### Map scroll operation

The map can be scrolled to view locations that are different than your current position.

- 1 Select the desired point on the map screen.
- Move the desired point on the center of the map screen.

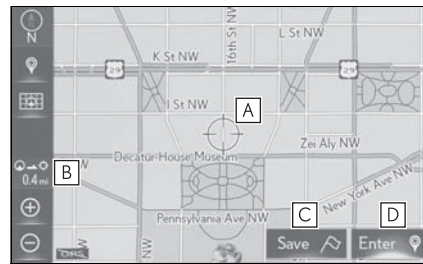

- A** Cursor mark
- B** Distance from the current position to the cursor mark
- C** Select to register as a memory point. To change the icon, name, etc.: →P.91
- D** Select to set as a destination. (→P.80)

- Press the "MAP" button on the Remote Touch to return to the current position.

### Flick scroll operation

The map screen can be moved to drag or flick the touchpad on the Remote Touch. To activate drag/flick operation, "Map Flick" is required to be "On".

(→P.95)

- 1 Select the desired point on the map screen.
- 2 Use flick or drag operations on the touchpad to scroll the map.



- When the  button on the Remote Touch is pressed, the following buttons can be displayed.

“Save”: Select to register as a memory point. To change the icon, name, etc.: →P.91

“Enter”: Select to set as a destination.

“Go”: Select to delete the existing destination(s) and set a new one.

“Add to Route”: Select to add a destination.

- Press the touchpad again, the switches on the display can be selected.

### Adjusting location in small increments

The cursor location can be adjusted in small increments. 8 directional arrows may appear in the following cases.

- When “Adjust Location” is selected on the map screen
- When changing the location of memory points on the editing screen (→P.91)

- When adjusting the current position mark manually on the calibration screen (→P.97)

- 1 Select one of the 8 directional arrows to move the cursor to the desired point and then select “OK”.



### Map screen information

Information such as POI icons, route trace, speed limit, etc. can be displayed on the map screen.

### Displaying the map options screen

- 1 Select  on the map screen.
- 2 Select the desired items to be displayed.

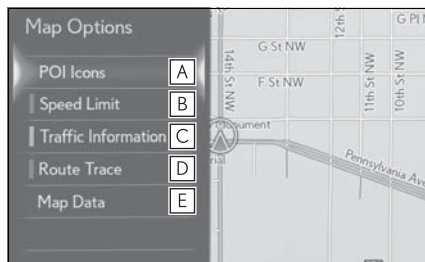

- A** Select to select or change POI icons. (→P.67)
- B** Select to display speed limit icon.
- C** Select to display traffic information.\* (→P.70)
- D** Select to display route trace. (→P.68)
- E** Select to display the map version and coverage area. (→P.104)

\*: This function is not made available in some countries or areas.

- To hide the map options screen, select any part of the map screen.

### Selecting the POI icons

- 1 Select  on the map screen.

- 2 Select "POI Icons".
- 3 Select the desired POI category and select "OK".

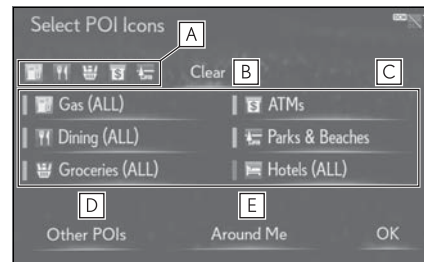

- A** Displays up to 5 selected POI icons on the map screen.
- B** Select to cancel the selected POI icons.
- C** Displays up to 6 POI icons as favorite POI categories. If a POI category is selected to be displayed on the map, its icon will be displayed above. (→P.96)
- D** Select to display other POI categories if the desired POIs cannot be found on the screen. (→P.67)
- E** Select to search for the nearest POIs. (→P.68)

### Selecting other POI icons to be displayed

- 1 Select "Other POIs".
- 2 Select the desired POI categories and select "OK".

"List All Categories": Select to display all POI categories.

### Displaying the local POI list

POIs that are within 20 miles (32 km)

of the current position will be listed from among the selected categories.

- 1 Select "Around Me".
- 2 Select the desired POI.
  - Press the  button on the Remote Touch. The following buttons can be displayed.

"Near Here": Select to search for POIs near the current position.

"Along My Route": Select to search for POIs along the route.

- 3 Check that the selected POI is displayed on the map screen.

### Route trace

The traveled route can be stored and retraced on the map screen. This feature is available when the map scale is 30 miles (50 km) or less.

### Start recording the route trace

- 1 Select  on the map screen.
- 2 Select "Route Trace".
- The route trace starts.
- 3 Check that the traveled line is displayed.



### Stop recording the route trace

- 1 Select  on the map screen.
- 2 Select "Route Trace" again.
- 3 A confirmation screen will be displayed.



"Yes": Select to keep the recorded route trace.

"No": Select to erase the recorded route trace.

- The traveled route can be stored up to approximately 621 miles (1000km).

### Switching the map mode on the side display

The map mode on the side display can be changed.

- 1 Select  or  to change the map mode.



"Map": Display the single map screen.

"Compass": Display the compass mode screen. (→P.69)

"Freeway Exit List": Display the freeway exit list screen. (→P.85)

"Turn List": Display the turn list screen. (→P.87)

"Turn-by-Turn Arrow": Display the turn-by-turn arrow screen. (→P.87)

- Depending on the conditions, certain screen configuration buttons cannot be selected.

**Compass**

Information about the destination, current position and a compass is displayed on the screen.

- The destination mark is displayed in the direction of the destination. When driving, refer to the longitude and latitude coordinates, and the compass, to make sure that the vehicle is headed in the direction of the destination.
- When the vehicle travels out of the coverage area, the guidance screen changes to the whole compass mode screen.

**Displaying information about the icon where the cursor is set**

When the cursor is placed over an icon on the map screen, and the  button on the Remote Touch is pressed, the name of icon is displayed. If "Info" appears on the bottom of the name, detailed information can be displayed.

- 1 Place the cursor over an icon.
- 2 Press the  button on the Remote Touch.

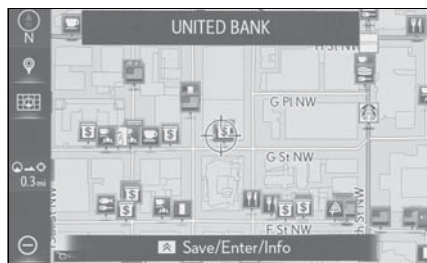

- 3 Select "Info".

- 4 Check that the information screen is displayed.

"Save": Select to register as a memory point. To change the icon, name, etc.: →P.91

"Go" / "Enter": Select to set as a destination.

: Select to call the registered number.





"Delete": Select to delete destination or memory point.



"Edit": Select to display the edit memory point screen.

"Detail": Select to display detailed information.

- Even when traffic information is not currently being received, traffic information and "Info" will be displayed for a while after traffic information has been received.
- In some situations, calls to a POI may automatically change to an international call or may not be possible as a domestic call.

**Standard map icons**

Icon	Name
	Park/Recreation
	Business facility
	Airport
	Military
	University
	Hospital

Icon	Name
	Stadium
	Shopping
	Golf course

### Traffic information\*

\*: This function is not made available in some countries or areas.

Traffic data can be received via HD Radio broadcast or via DCM to display traffic information on the map screen.

### Displaying the traffic screen

- 1 Press the "MENU" button on the Remote Touch.

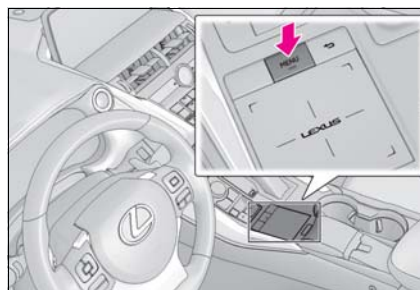

- 2 Select "Info".
- 3 Select  "Traffic Incidents" on the sub menu.
- 4 Select the desired item.
  - "Traffic Events on Current Road"  
Select to display traffic information for the current road. (→P.71)
  - "Traffic Events on Current Route"  
Select to display traffic information for the set route. (→P.71)
  - "Traffic Events Nearby"  
Select to display nearby traffic information. (→P.71)
  - "Predictive Traffic Map"  
Select to display a map with predictive traffic data. (→P.71)

- “My Traffic Routes”  
Select to display traffic along the saved routes. (→P.71)

- If a large amount of information is being received, it may take longer than normal for the information to be displayed on the screen.
- If traffic information cannot be received because the vehicle is outside of HD Radio coverage area, it may still be able to be received using DCM. (→P.170)

### Displaying traffic information

A list of current traffic information can be displayed along with information on the location of each incident.

- 1 Display the traffic incidents screen:

- “MENU” button → “Info” →  “Traffic Incidents” on the sub menu

- 2 Select “Traffic Events on Current Road”, “Traffic Events on Current Route” or “Traffic Events Nearby”.

- 3 Select the desired traffic information.

- ▶ When “Traffic Events Nearby” is selected, depending on whether the traffic flow information is enabled/disabled, the following will be displayed:

When enabled: Traffic event and congestion information

When disabled: Traffic event information only

- 4 Check that the traffic information is displayed.

“Detail”: Select to display detailed traffic information.

### Displaying predictive traffic information

A map with predictive traffic data can be displayed.

- 1 Display the traffic incidents screen:

- “MENU” button → “Info” →  “Traffic Incidents” on the sub menu

- 2 Select “Predictive Traffic Map”.
- 3 Scroll the map to the desired point (→P.65) and set the time of predictive traffic information.

- The time of the predictive traffic information can be changed in 15-minute intervals up to +45 minutes.

“+”: Moves the time forward 15 minutes.

“-”: Moves the time back 15 minutes.

### My traffic routes

Traffic information along the saved routes can be displayed. To use this function, it is necessary to register a route. (→P.99)

- 1 Display the traffic incidents screen:

- “MENU” button → “Info” →  “Traffic Incidents” on the sub menu

- 2 Select “My Traffic Routes”.

- If map data has been updated, a confirmation screen will be displayed. Select “OK” or “Do Not Tell Me Again”.

- 3 Select the desired route.

“Options”: Select to add, edit or delete personal routes. (→P.99)

- If routes have not been registered

yet, a confirmation screen will be displayed. Select "Yes" to register the route.

- 4** Select the desired traffic information.
- 5** Check that the traffic information is displayed.

"Detail": Select to display detailed traffic information.

### Displaying traffic information on the map

- 1** Select  on the map screen.
- 2** Select "Traffic Information".
- 3** Check that the traffic information is displayed.

- 
- The icons indicate traffic incidents such as construction, accidents, etc. Select an icon to hear more detail by voice.
  - The arrows indicate the flow of traffic. The color changes depending on the speed.



## Destination search operation

The destination screen enables to search for a destination.

### Displaying the destination search screen

- ▶ From the map screen
  - 1 Press the “MAP” button on the Remote Touch.
  - 2 Select .
  - 3 Select the desired search method.
- ▶ From the menu screen
  - 1 Press the “MENU” button on the Remote Touch.
  - 2 Select “Destination”.
  - 3 Select the desired search method.

### Destination search screen

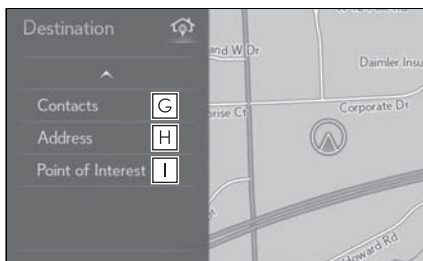

- A** Select to set a destination by home.



(→P.73)

- B** Select to search for a destination by entering keywords. (→P.74)
- C** Select to search for a destination from a registered entry in “Favorites”. (→P.74)
- D** Select to search for a destination via the Lexus response center.\* (→P.258)
- E** Select to search for a destination from recent set destinations. (→P.76)
- F** Select to search for a destination from emergency service points. (→P.78)
- G** Select to search for a destination from contact data which had been transferred to the system from a registered cellular phone. (→P.78)
- H** Select to search for a destination by address. (→P.75)
- I** Select to search for a destination by point of interest. (→P.76)

\*: This function is not made available in some countries or areas.

### Setting home as destination

To use this function, it is necessary to register a home address. (→P.90)

- 1 Display the destination search screen by either operation:
  - “MAP” button → 
  - “MENU” button → “Destination”
- 2 Select .
  - The navigation system performs a

search for the route and the route overview is displayed. (→P.81)

### Searching by keyword

The destination can be searched by entering various keywords.

- 1 Display the destination search screen by either operation:
  - “MAP” button → 
  - “MENU” button → “Destination”
- 2 Select “Search”.
- 3 Enter characters on the keyboard and select “Search”.
- 4 Select the desired item from the list.

: Select to display updated information about the selected entry.

- To search for a facility name using multiple search words, put a space between each word.
- When entering characters, the list of predicted destinations for it may be appeared. The destination can be set by selecting it.
- Search results may differ depending on the Lexus Enform subscription status and communication status.

### Searching by Destination Assist\*

\*: This function is not made available in some countries or areas.

A Destination Assist Connect operator can search for a destination. You can request a specific business, address, or ask for help locating your desired destination. (→P.258)

- 1 Display the destination search screen by either operation:

- “MAP” button → 
- “MENU” button → “Destination”

- 2 Select “Dest Assist”.

### Searching by favorites list

To use this function, it is necessary to register an favorites list entry. (→P.91)

- 1 Display the destination search screen by either operation:

- “MAP” button → 
- “MENU” button → “Destination”

- 2 Select “Favorites”.

- 3 Select the desired favorites list entry.

### Selecting search area

The selected state (province) can be changed to set a destination from a different state (province) by using “Address” or “Point of Interest”.

- 1 Display the destination search screen by either operation:

- “MAP” button → 
- “MENU” button → “Destination”

- 2 Select “Address” or “Point of Interest”.

- 3 Select “Select State/Province” or “Change State/Province”.

- If a state (province) has not been selected yet, “Select State/Province” is displayed.

#### 4 Select the desired state (province).



- To change countries, select “United States”, “Canada” or “Mexico”.

#### Searching by address

There are 2 methods to search for a destination by address.

- 1 Display the destination search screen by either operation:
  - “MAP” button →
  - “MENU” button → “Destination”
- 2 Select “Address”.
- 3 Select the desired search method.

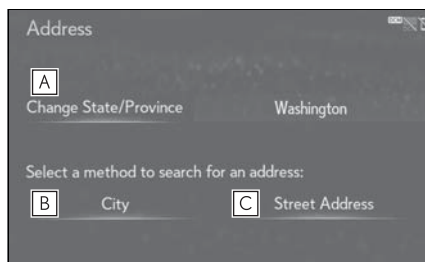

- A Select to change the search area. (→P.74)
- B Select to search by city. (→P.75)
- C Select to search by street address. (→P.75)

#### Searching by city

- 1 Select “City”.
- 2 Enter a city name and select “Search”.

“Last 5 Cities”: Select the desired city name from the list of the last 5 cities.

- 3 Select the desired city name.
- 4 Enter a street name and select “Search”.
- 5 Select the desired street name.
- 6 Enter a house number and select “Search”.

- If multiple locations with the same address exist, the address list screen will be displayed. Select the desired address.

#### Searching by street address

- 1 Select “Street Address”.
- 2 Enter a house number and select “Search”.
- 3 Enter a street name and select “Search”.
- 4 Select the desired street name.
- 5 Enter a city name and select “Search”.
- 6 Select the desired city name.

- If multiple locations with the same address exist, the address list screen will be displayed. Select the desired address.



- A street name can be searched using only the body part of its name.  
For example: S WESTERN AVE

3

Navigation system

- A search can be performed by entering “S WESTERN AVE”, “WESTERN AVE” or “WESTERN”.

### Searching from recent destinations

- 1 Display the destination search screen by either operation:
  - “MAP” button → 
  - “MENU” button → “Destination”
- 2 Select “Recent”.
- 3 Select the desired destination.
  - Press the  button on the Remote Touch. The following buttons can be displayed.

“Delete Recent Destination”: Select to delete the recent destination.

“Delete All Recent Destinations”: Select to delete all destinations on the list.

- Up 100 previously set destinations are displayed on the screen.

### Searching by point of interest

There are 3 methods to search for a destination by Points of Interest.

- 1 Display the destination search screen by either operation:
  - “MAP” button → 
  - “MENU” button → “Destination”
- 2 Select “Point of Interest”.

- 3 Select the desired search method.

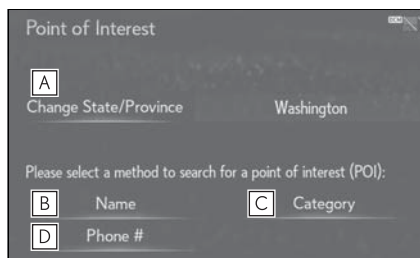

- A Select to change the search area. (→P.74)
- B Select to search by name. (→P.76)
- C Select to search by category. (→P.77)
- D Select to search by phone number. (→P.78)

### Searching by name

- 1 Select “Name”.
- 2 Enter a POI name and select “Search”.
- 3 Select the desired POI.



- When the  button on the Remote Touch is pressed, the following buttons can be displayed.

“Change POI category”: Select to search for POI from the category list. (→P.77)

“Enter a city name”: Select to search for POI in the desired city. (→P.77)

- When entering the name of a specific POI, and there are 2 or more sites with the same name, the list screen will be displayed. Select the desired POI.

- To search for a facility name using multiple search words, put a space between each word.

### Selecting a city to search

- 1 Press the  button on the Remote Touch.
- 2 Select "Enter a city name".
- 3 Enter a city name and select "Search".

"Any City": Select to cancel the city setting.

- 4 Select the desired city name.
- 5 Select the desired POI.

### Selecting from the categories

- 1 Press the  button on the Remote Touch.
  - 2 Select "Change POI category".
  - 3 Select the desired category.
- If there is more than 1 result for the selected category, a detailed list will be displayed.

"List All Categories": Select to display all POI categories.

- 4 Select the desired POI.

### Searching by category

- 1 Select "Category".

- 2 Select the desired search point.

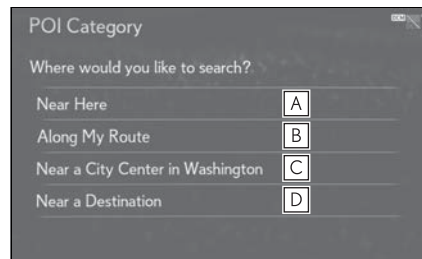

- A Select to search for POIs near your current position.
- B Select to search for POIs along the set route.
- C Select to search for POIs near a specific city center. (→P.78)
- D Select to search for POIs near a destination. When more than 1 destination has been set, a list will be displayed on the screen. Select the desired destination.

- 3 Select the desired POI category.

- If there is more than 1 result for the selected category, a detailed list will be displayed.

"List All Categories": Select to display all POI categories.

"Favorite POI Categories": Select to use the 6 POIs that have been previously set. (→P.96)

- 4 Select the desired POI.

- The names of POIs located within approximately 200 miles (320 km) from the selected search point can be displayed. They are displayed up to 200 names.

### When "Near a City Center in ##" is selected

- 1 Select "Near a City Center in ##".
  - 2 Enter a city name and select "Search".
- "Last 5 Cities": Select the desired city name from the list of the last 5 cities.
- 3 Select the desired city name.
  - 4 Select "OK" when the city center map screen is displayed.
  - 5 Follow the steps in "Searching by category" from step 3. (→P.77)

\*: ## represents the selected search area name.

- If the navigation system has never been used, selecting the city name from "Last 5 Cities" will not be available.

### Searching by phone number

- 1 Select "Phone #".
  - 2 Enter a phone number and select "OK".
- If multiple locations with the same phone number exist, the list screen will be displayed.

- If there is no match for the entered phone number, a list of identical numbers with different area codes will be displayed.

### Searching by emergency

- 1 Display the destination search screen by either operation:
  - "MAP" button → 
  - "MENU" button → "Destination"

- 2 Select "Emergency".
- 3 Select the desired emergency category.
- 4 Select the desired destination.

- The navigation system does not guide in areas where route guidance is unavailable. (→P.102)

### Searching by contact

To use this function, it is necessary to have contact data which had been transferred to the system from a registered cellular phone. (→P.223)

- 1 Display the destination search screen by either operation:
  - "MAP" button → 
  - "MENU" button → "Destination"
- 2 Select "Contacts".
- 3 Select the desired contact.
- 4 Select "Addresses".
- 5 Select the desired address.
- 6 Follow the steps in "Searching by keyword" from step 4. (→P.74)

- This function may not be available depending on the type of cellular phone.

### One-touch setting home/favorite as a destination

The one-touch buttons for home and favorite destinations are displayed on the map after the engine switch <power switch> has been in ACCESSORY or IGNITION ON mode <ON mode>.

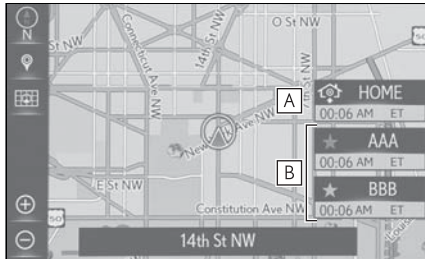
**1** Select the desired destination.

**A** Select to set the registered home as the destination.

**B** Select to set a registered favorite as the destination. (Up to 2 favorites can be registered as preset destinations.)

- The estimated time of arrival to the registered home and favorite destinations from the current position will be displayed on the one-touch buttons.
- To use this function, it is necessary to register a home and/or favorite locations. If a home or preset destinations have not been registered, the display switches to destination setting screen when you select the button. (→P.90, 91)
- The color of the button changes depending on the traffic information received.

**2** The navigation system performs a search for the route and the entire route map is displayed. (→P.81)

- The one-touch buttons for home and favorites will disappear after the vehicle has been driven for a while.
- The color of the estimated arrival time indicator may change depending on the traffic information received.

- This function is available when “Automatic Destination List Info” is set to on. (→P.95)

### Starting route guidance

When the destination is set, the confirm destination screen will be displayed.

### Starting route guidance

- 1 Select "Go" on the confirm destination screen.

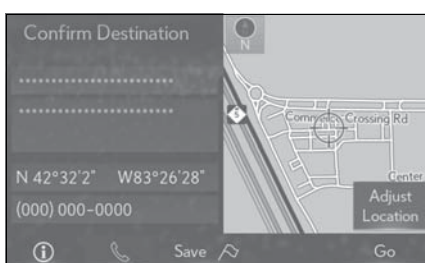

- For details about this screen: →P.80

- 2 Select "OK" on the route overview screen.



- For details about this screen: →P.81

- The route for returning may not be the same as that for going.
- The route guidance to the destination may not be the shortest route or a route without traffic congestion.
- Route guidance may not be available if there is no road data for the specified location.
- When setting the destination on a map

with a scale more than 0.5 mile (800 m), the map scale changes to 0.5 mile (800 m) automatically. If this occurs, set the destination again.

- If a destination that is not located on a road is set, the vehicle will be guided to the point on a road nearest to the destination. The road nearest to the selected point is set as the destination.

### WARNING

- Be sure to obey traffic regulations and keep road conditions in mind while driving. If a traffic sign on the road has been changed, the route guidance may not indicate such changed information.

### Confirm destination screen

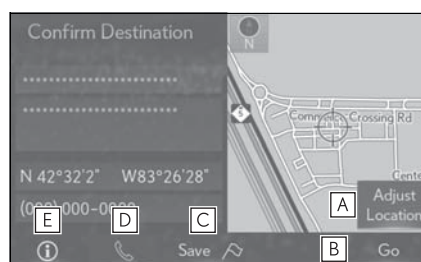

- A** Select to adjust the position in smaller increments. (→P.66)

- B** Select to search for the route. (→P.80)

- If a destination has already been set, "Go Directly" and "Add to Route" will be displayed.

"Go Directly": Select to delete the existing destination(s) and set a new one.

"Add to Route": Select to add a destination to the current route.

- C** Select to register as a memory point.

- D** Select to call the registered number.



- E** Select to update information about the selected entry.\*

\*: This function is displayed only when there is information from the Lexus Enform center. (→P.74)

### Route overview screen

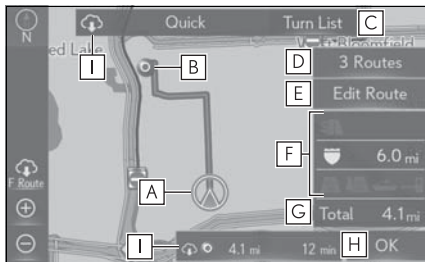

- A** Current position
- B** Destination point
- C** Select to display a list of the turns required to reach the destination. (→P.82)
- D** Select the desired route from 3 possible routes. (→P.81)
- E** Select to change the route. (→P.82)
- F** Type of route and its distance
- G** Distance of the entire route
- H** Select to start guidance.  
Select and hold to start demo mode. (→P.81)
- I** Displayed when the route displayed is from the Lexus Enform center. (→P.83)

### Starting demo mode

Before starting the route guidance, the demonstration of the route guidance

can be viewed.

- 1 Select and hold "OK" on the route overview screen until a beep sounds.
- Press the "MAP" button on the Remote Touch to end demo mode.

### 3 routes selection

- 1 Select "3 Routes".
- 2 Select the desired route.

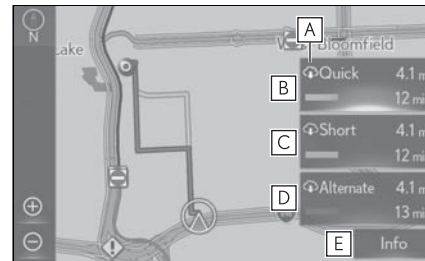

- A** Displays  icon when the route available from the Lexus Enform center. (→P.83)
- B** Select to display the quickest route.
- C** Select to display the route that is the shortest distance to the set destination.
- D** Select to display the alternative route.
- E** Select to display the information about the 3 routes. (→P.81)

### Displaying 3 routes information

- 1 Select "Info".

- 2 Check that the 3 routes information screen is displayed.

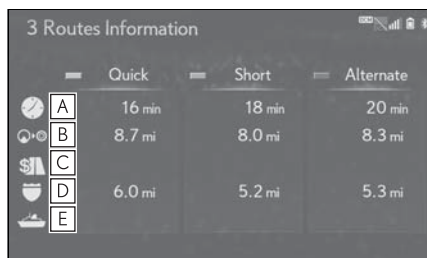

- A** Time necessary for the entire trip
- B** Distance of the entire trip
- C** Distance of the toll road
- D** Distance of the freeway
- E** Distance of the ferry trip

### Displaying turn list

A list of turn information from the current position to the destination can be displayed.

- 1 Select "Turn List".
- 2 Check that the turn list is displayed.

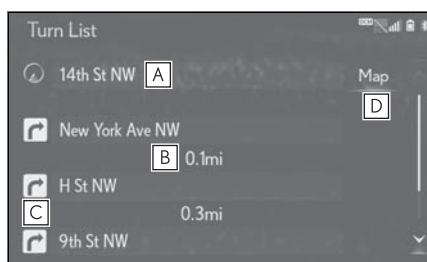

- A** Current position
- B** Distance to the next turn
- C** Turn direction at the intersection
- D** Select to display the map of the selected point.

- Not all road names on the route may

appear on the list. If a road changes its name without requiring a turn (such as on a street that runs through 2 or more cities), the name change will not appear on the list. The street names will be displayed in order from the starting point, along with the distance to the next turn.

### Editing route

Destinations can be added, reordered or deleted, and conditions for the route to the destination can be changed.

- 1 Select "Edit Route".
- 2 Select the desired item.

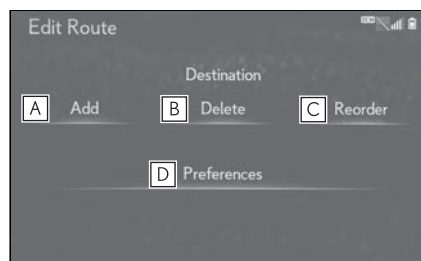

- A** Select to add destinations. (→P.82)
- B** Select to delete destinations. (→P.83)
- C** Select to reorder destinations. (→P.88)
- D** Select to set route preferences. (→P.88)

### Adding destinations

- 1 Select "Add".
  - 2 Search for an additional destination in the same way as a destination search. (→P.73)
- Up to 5 destinations can be set.

- ▶ When the vehicle is stopped
- 3 Select "Add Destination Here" at the position in the route which you want to add the destination.
- ▶ While driving
- 3 Select "Beginning" or "End".

#### Deleting destinations

- 1 Select "Delete".
- 2 Select "Yes" when the confirmation screen appears.
  - If more than 1 destination has been set, select the destination(s) to be deleted. (The system will recalculate route(s) to the remaining set destination(s).)
  - When the  button on the Remote Touch is pressed, the following button can be displayed.

"Delete All": Select to delete all destinations on the list.

#### A route from the Lexus Enform center\*

\* : This function is not made available in some countries or areas.

When starting route guidance or rerouting, a route can be provided automatically by the Lexus Enform center. This function is available when dynamic route setting is enabled. (→P.95)

**Route guidance screen**

During the route guidance, various types of guidance screens can be displayed depending on conditions.

**Screen for route guidance**

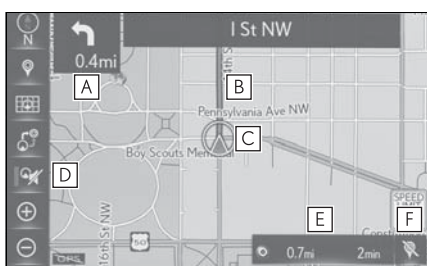

- A** Distance to the next turn and an arrow indicating the turning direction
- B** Guidance route
- C** Current position
- D** Select to mute the voice guidance.
- E** Route information
- F** Select to delete destinations. (→P.26)

- If the vehicle goes off the guidance route, the route will be recalculated.
- For some areas, the roads have not been completely digitized in the database. For this reason, the route guidance may select a road that should not be traveled on.
- When arriving at the set destination, the destination name will be displayed on the upper part of the screen.
- When the automatic zoom function is enabled, the map will automatically change to a detailed map as the vehicle approaches a guidance point.
- Vehicle with head-up display: When the

head-up display is set to on, turn-by-turn guidance arrows will be displayed on the windshield.

**Distance and time to the destination**

When the vehicle is on the guidance route, the route information bar displays the distance with the estimated travel/arrival time to the destination.

- ▶ When a destination is set
  - 1 Select the route information bar to change the display between the estimated travel time and the estimated arrival time.



- ▶ When more than 1 destination is set
  - 1 Select the route information bar.
  - 2 Check that the list of the distance and time is displayed.



- By selecting one of the number buttons, the desired route information is displayed.
- “Arrival Time”: Select to display the esti-

mated arrival time.

“Time to Dest.”: Select to display the estimated travel time.

- When the vehicle is on the guidance route, the distance measured along the route is displayed. Travel time and arrival time are calculated based on the average speed for the specified speed limit.
- When the vehicle gets off the guidance route, the arrow facing the destination is displayed instead of the estimated travel/arrival time.
- The route information bar fills from left to right as the vehicle progresses on the route.

### During freeway driving

During freeway driving, the freeway information screen can be displayed on the side display.

- 1 Select **<** or **>** to display the “Freeway Exit List” screen on the side display.

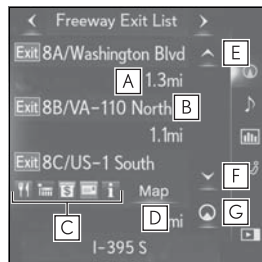

- A** Distance from the current position to the freeway exit/rest area.
- B** Name of the freeway exit/rest area.
- C** POIs that are close to a freeway exit
- D** Select to display the selected map of the exit vicinity.
- E** Select to scroll to farther freeway

exits/rest areas.

- F** Select to scroll to closer freeway exits/rest areas.
- G** Select to display the nearest freeway exits/rest areas from the current position.

### When approaching freeway exit or junction

When the vehicle approaches an exit or junction, the freeway guidance screen will be displayed on the side display.

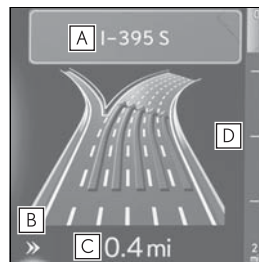

- A** Next exit or junction name
- B** Select to hide the freeway guidance screen.
  - To return to the freeway guidance screen, press the “MAP” button on the Remote Touch.
- C** Distance from the current position to the exit or junction
- D** Remaining distance bar to the guidance point

### When approaching tollgate

When the vehicle approaches a tollgate, the tollgate view will be displayed on the side display.

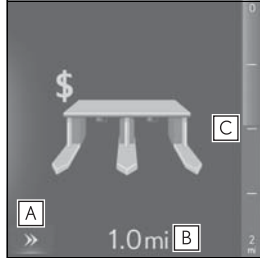

- A** Select to hide the tollgate guidance screen.
  - To return to the tollgate guidance screen, press the “MAP” button on the Remote Touch.
- B** Distance from the current position to the tollgate
- C** Remaining distance bar to the guidance point

#### When approaching junction

When the vehicle approaches a junction, the junction view with signage will be displayed on the side display.

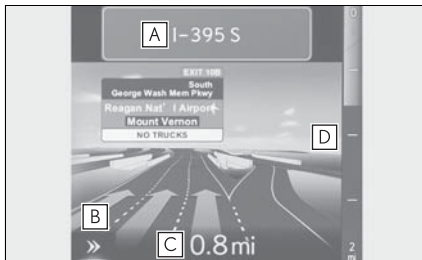

- A** Next junction or street name
- B** Select to hide the real freeway junction view.
  - To return to the real freeway junction view, press the “MAP” button on the Remote Touch.
- C** Distance from the current position to the next junction
- D** Remaining distance bar to the guid-

ance point

#### When approaching intersection

When the vehicle approaches an intersection, the intersection guidance screen will be displayed on the side display.

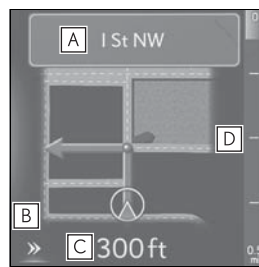

- A** Next street name
- B** Select to hide the intersection guidance screen.
  - To return to the intersection guidance screen, press the “MAP” button on the Remote Touch.
- C** Distance to the intersection
- D** Remaining distance bar to the guidance point

#### Turn list screen

- 1 Select **<** or **>** to display the “Turn List” screen on the side display.

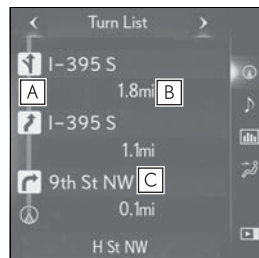

- A** Turn direction
- B** Distance between turns
- C** Next street or destination name

### Turn-by-turn arrow screen

On this screen, information about the next turn on the guidance route can be displayed on the side display.

- 1 Select **<** or **>** to display the "Turn-by-Turn Arrow" screen on the side display.



- A** Exit number and street name
- B** Turn direction
- C** Distance to the next turn

### Typical voice guidance prompts

As the vehicle approaches an intersection, or point, where maneuvering the vehicle is necessary, the system's voice guidance will provide various messages.

- If a voice guidance command cannot be heard, press the "MAP" button on the Remote Touch.
- To adjust the voice guidance volume: →P.56
- To mute the voice guidance: →P.84
- Voice guidance may be made early or late.
- If the system cannot determine the current position correctly, you may not hear voice guidance or may not see the magnified intersection on the screen.

### ⚠ WARNING

- Be sure to obey the traffic regulations and keep the road condition in mind especially when you are driving on IPD roads (roads that are not completely digitized in the database). The route guidance may not have the updated information such as the direction of a one way street.

## Editing route

### Displaying the edit route screen

- 1 Select  on the map screen.
- 2 Select the desired item to be set.

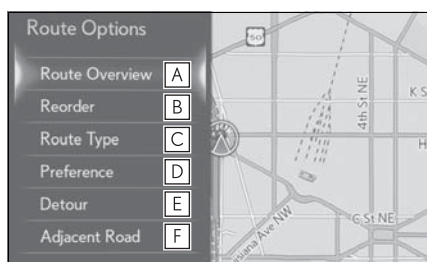

- A Select to display the overview of the entire route. (→P.81)
  - B Select to reorder destinations. (→P.88)
  - C Select to change route type. (→P.88)
  - D Select to set route preferences. (→P.88)
  - E Select to set detours. (→P.88)
  - F Select to start from adjacent road. (→P.89)
- 3 Check that the route overview is displayed. (→P.81)

### Reordering destinations

When more than 1 destination has been set, the arrival order of the destinations can be changed.

- 1 Select  on the map screen.
- 2 Select "Reorder".
- 3 Select the desired destination and select "Move Up" or "Move Down"

to change the arrival order. Then select "OK".

### Selecting route type

- 1 Select  on the map screen.
- 2 Select "Route Type".
- 3 Select the desired route type.
  - The entire route from the starting point to the destination is displayed. (→P.81)
  - During driving, the route guidance starts after selecting the desired route type.

### Setting route preferences

The conditions to determine the route can be selected from various choices such as freeways, toll roads, ferries, etc.

- 1 Select  on the map screen.
  - 2 Select "Preferences".
  - 3 Select the desired route preferences and select "OK".
- Even if the "Freeways" route preference is turned off, the route may not be able to avoid freeways in some cases.
  - If the calculated route includes a trip by ferry, the route guidance shows a sea route. After traveling by ferry, the current position may be incorrect. Upon reception of GPS signals, it is automatically corrected.

### Detour setting

During the route guidance, the route can be changed to detour around a section of the route where a delay is



caused by road repairs, an accident, etc.

- 1 Select  on the map screen.
- 2 Select "Detour".
- 3 Select the desired detour distance.

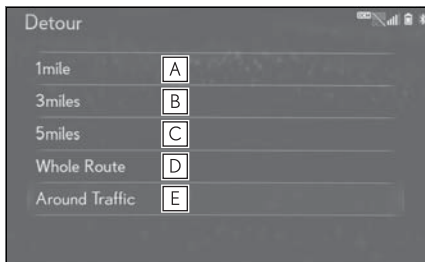

- A** Select to detour within 1 mile of the current position.
- B** Select to detour within 3 miles of the current position.
- C** Select to detour within 5 miles of the current position.
- D** Select to detour on the entire route.
- E** Select to make the system search for the route based on traffic congestion information received from traffic information. \* (→P.70)

\*: This function is not made available in some countries or areas.

- This picture shows an example of how the system would guide around a delay caused by a traffic jam.

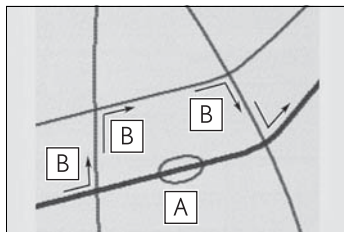

- A** This position indicates the location of a

traffic jam caused by road repairs, an accident, etc.

- B** This route indicates the detour suggested by the system.
- When the vehicle is on a freeway, the detour distance selections are 5, 15 and 25 miles (or 5, 15 and 25 km if units are in km).
- The system may not be able to calculate a detour route depending on the selected distance and surrounding road conditions.

### Adjacent road

When a freeway and a surface road run in parallel, the system may show the guidance route going on the freeway while driving on the surface road, or vice versa.

If this happens, you can instantly choose the adjacent road for the route guidance.

- 1 Select  on the map screen.
- 2 Select "Adjacent Road".

- When there is no adjacent road, this screen button will not be displayed.

## Navigation settings

Home, favorites list entries, areas to avoid can be set as memory points. The registered points can be used as the destinations. (→P.73)  
Registered areas to avoid, will be avoided when the system searches for a route.

## Displaying navigation settings screen

- 1 Press the "MENU" button on the Remote Touch.

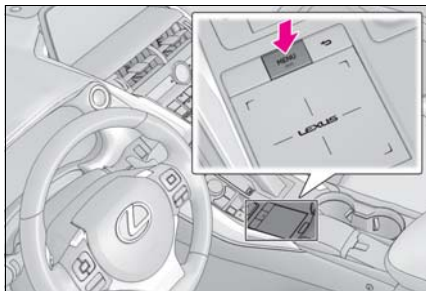

- 2 Select "Setup".
- 3 Select  "Navigation" on the sub menu.
- 4 Select the desired item to be set.

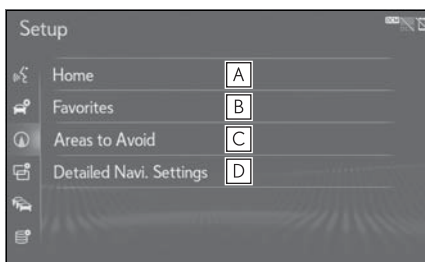



- A** Select to set home. (→P.90)
- B** Select to set the favorites list.

(→P.91)

- C** Select to set areas to avoid. (→P.93)
- D** Select to set detailed navigation settings. (→P.95)

## Setting up home

If home has been registered, that information can be recalled by selecting  on the destination screen. (→P.73)

- 1 Display the navigation settings screen:
  - "MENU" button → "Setup" →  "Navigation" on the sub menu
- 2 Select "Home".
- 3 Select the desired item to be set.

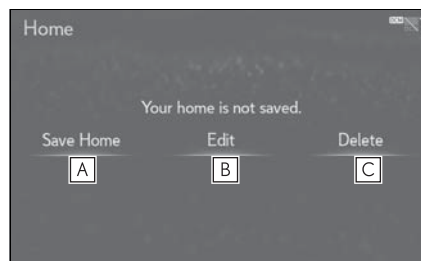

- A** Select to register home. (→P.90)
- B** Select to edit home. (→P.91)
- C** Select to delete home.

## Registering home

- 1 Select "Save Home".
- 2 Select the desired item to search for the location. (→P.73)
- 3 Select "Enter" when the setting map screen appears.

- 4 Select "OK" when the editing home screen appears.

### Editing home

- 1 Select "Edit".
- 2 Select the desired item to be edited.

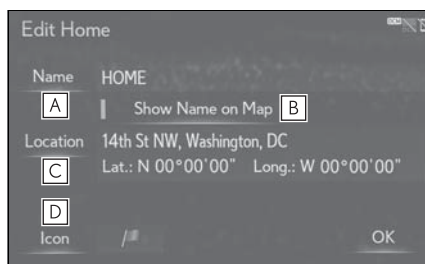

- A Select to edit the home name.
  - B Select to set display of the home name on/off.
  - C Select to edit location information. (→P.92)
  - D Select to change the icon to be displayed on the map screen. (→P.92)
- 3 Select "OK".

### Setting up favorites list

Points on the map can be registered.

- 1 Display the navigation settings screen:
  - "MENU" button → "Setup" →  "Navigation" on the sub menu
- 2 Select "Favorites".

- 3 Select the desired item.

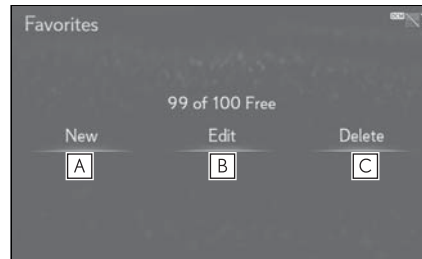

- A Select to register favorites list entries. (→P.91)
- B Select to edit favorites list entries. (→P.91)
- C Select to delete favorites list entries. (→P.92)

### Registering favorites list entries

- 1 Select "New".
- 2 Select the desired item to search for the location. (→P.73)
- 3 Select "Enter" when the setting map screen appears.
- 4 Select "OK" when the editing favorites list screen appears. (→P.91)

- Up to 100 favorites list entries can be registered.

### Editing favorites list entries

The icon, name, location and/or phone number of a registered favorites list entry can be edited.

- 1 Select "Edit".
- 2 Select the desired favorites list entry.
  - Each time a star icon is selected, its

3

Navigation system

color will change. Colored star icons indicate that the favorite is registered to the corresponding preset destination button. Up to 2 entries can be registered as quick favorite destinations. (→P.78)

- 3 Select the desired item to be edited.

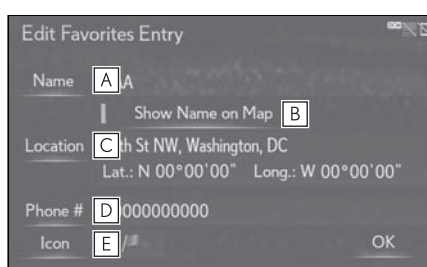

- A** Select to edit the favorites list entry name.
  - B** Select to set display of the favorites list entry name on/off.
  - C** Select to edit location information. (→P.92)
  - D** Select to edit the phone number.
  - E** Select to change the icon to be displayed on the map screen. (→P.92)
- 4 Select "OK".

#### Changing the location

- 1 Select "Location".
- 2 Scroll the map to the desired point (→P.66) and select "OK".

#### Changing the icon

- 1 Select "Icon".

- 2 Select the desired icon.

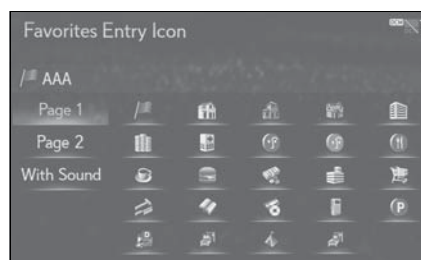

- "Page 1"/"Page 2": Select to change pages.

Select the desired icons with sound

#### ■ When "With Sound" is selected

A sound for some favorites list entries can be set. When the vehicle approaches the location of the favorites list entry, the selected sound will be heard.

- 1 Select "With Sound".
- 2 Select the desired sound icon.

: Select to play the sound.

- When "Bell (with Direction)" is selected, select an arrow to adjust the direction and select "OK".
- The bell sounds only when the vehicle approaches this point in the direction that has been set.

#### Deleting favorites list entries

- 1 Select "Delete".
- 2 Select the desired item to be deleted.

- Press the button on the Remote Touch. The following button can be displayed.

"Delete All": Select to delete all favorites on the list.

- 3 Select "Yes" when the confirmation screen appears.

### Setting up areas to avoid

Areas to be avoided because of traffic jams, construction work or other reasons can be registered as "Areas to Avoid".

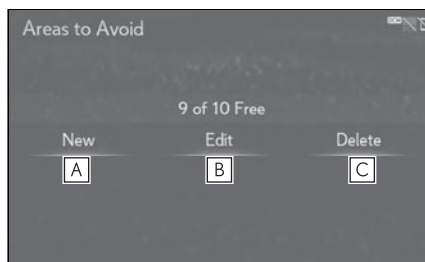

- 1 Display the navigation settings screen:
  - "MENU" button → "Setup" →  "Navigation" on the sub menu
- 2 Select "Areas to Avoid".
- 3 Select the desired item.



- A Select to register areas to avoid. (→P.93)
- B Select to edit areas to avoid. (→P.93)
- C Select to delete areas to avoid. (→P.94)

### Registering areas to avoid

- 1 Select "New".
- 2 Select the desired item to search for the location. (→P.73)
- 3 Select "Enter" when the setting map screen appears.

- 4 Select either  or  to change the size of the area to be avoided and select "OK".



- 5 Select "OK" when the area to avoid screen appears.

- If a destination is entered in the area to avoid or the route calculation cannot be made without running through the area to avoid, a route passing through the area to be avoided may be shown.
- Up to 10 locations can be registered as points/areas to avoid.

### Editing areas to avoid

The name, location and/or area size of a registered area can be edited.

- 1 Select "Edit".
- 2 Select the desired area.
- 3 Select the desired item to be edited.

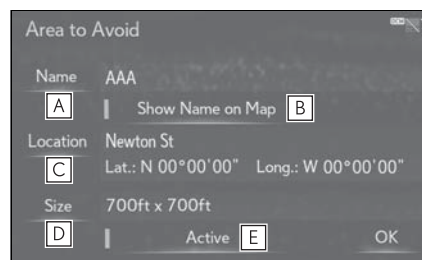

- A Select to edit the name of the area to avoid. (→P.94)

3

Navigation system

- B** Select to set display of the area to avoid name on/off.
  - C** Select to edit area location. (→P.94)
  - D** Select to edit area size. (→P.94)
  - E** Select to set the area to avoid function on/off.
- 4** Select "OK".
- 3** Select "Yes" when the confirmation screen appears.



#### Changing the name

- 1** Select "Name".
- 2** Enter a name and select "OK".

#### Changing the location

- 1** Select "Location".
- 2** Scroll the map to the desired point (→P.66) and select "OK".

#### Changing the area size

- 1** Select "Size".
- 2** Select either  or  to change the size of the area to be avoided and select "OK".

#### Deleting areas to avoid

- 1** Select "Delete".
  - 2** Select the desired area to be deleted.
- Press the  button on the Remote Touch. The following button can be displayed.
- "Delete All": Select to delete all destinations on the list.

## Detailed navigation settings

Settings are available for auto hide buttons, favorite POI categories, low fuel warning, etc.

### Displaying the detailed navigation settings screen

- 1 Press the "MENU" button on the Remote Touch.

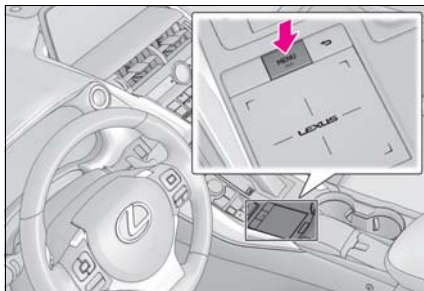

- 2 Select "Setup".
- 3 Select  "Navigation" on the sub menu.
- 4 Select "Detailed Navi. Settings".
- 5 Select the desired items to be set.

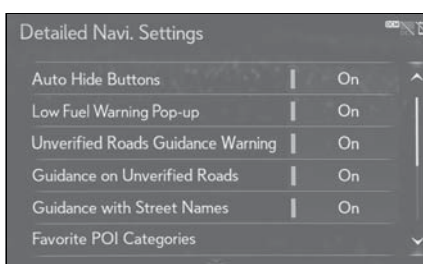

- "Auto Hide Buttons"

Select to set the automatic screen button hiding function on/off. When set to on, certain screen buttons on the map screen will disappear several seconds after the Remote Touch has been operated. When

set to off, all the screen buttons will always be displayed.

- "Low Fuel Warning Pop-up"

Select to set display of low fuel warning on/off. (→P.96)

- "Unverified Roads Guidance Warning"

Select to set unverified roads guidance warning on/off.

- "Guidance on Unverified Roads"

Select to set IPD road (roads that are not completely digitized in the database) guidance on/off.

- "Guidance with Street Names"

Select to set the voice guidance for the next street name on/off.

- "Favorite POI Categories"

Select to set favorite POI categories that are used for POI selection to display on the map screen. (→P.96)

- "Calibration"

Select to adjust the current position mark manually or to adjust miscalculation of the distance caused by tire replacement. (→P.97)

- "Adaptive Route"

Select to enable/disable adaptive routes. When enabled, the system will provide frequently used routes.

- "Reset Adaptive Route"

Select to erase adaptive route data.

- "Automatic Destination List Info"

Select to set automatic destination list information on/off. When set to on, the estimated time of arrival to the registered home and preset destinations from the current position will be displayed.

- “Intersection Zoom Map”

Select to set display of a guidance screen on/off.

- “Automatic Zoom”

Select to set automatic zoom function on/off. When it is enabled, as the vehicle approaches a guidance point, the map will change to a detailed map automatically.

- “State border guidance”

Select to set cross-border guidance on/off.

- “Map Color Customization”

Select to set the map display color.

- “Map Animation”

Select to set map animation on/off.

- “Dynamic Route”\*

Select to enable/disable routes sourced from the Lexus Enform center. (→P.83)

- “Map Flick”

Select to set drag/flick operation on the map screen on/off. (→P.65)

- “Restore the default settings”

Select to reset all setup items.

\*: This function is not made available in some countries or areas.

### Low fuel warning

When the fuel level is low, a warning message will pop up on the screen.

**1** Display the detailed navigation settings screen:

- “MENU” button → “Setup” → 

“Navigation” on the sub menu → “Detailed Navi. Settings”

**2** Select “Low Fuel Warning Pop-up”.

- Each time the button is selected,

“On” and “Off” are switched.

### Searching gas station in low fuel warning

A nearby gas station can be selected as a destination when the fuel level is low.

- 1** Select “Yes” when the low fuel warning appears.
- 2** Select the desired nearby gas station.
- 3** Select “Enter” to set as a destination.

“Info”: Select to display gas station information. (→P.69)

### Favorite POI categories (Select POI icons)

Up to 6 POI icons, which are used for selecting POIs on the map screen, can be selected as favorites.

**1** Display the detailed navigation settings screen:

- “MENU” button → “Setup” → 

“Navigation” on the sub menu → “Detailed Navi. Settings”

**2** Select “Favorite POI Categories”.

**3** Select the desired category to be changed.

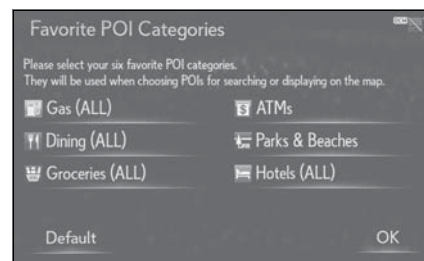



“Default”: Select to set the default categories.

**4** Select the desired POI category.

“List All Categories”: Select to display all POI categories.

**5** Select the desired POI icon.

**6** Select “OK”.

### Current position/Tire change calibration

The current position mark can be adjusted manually. Miscalculation of the distance caused by tire replacement can also be adjusted.

**1** Display the detailed navigation settings screen:

● “MENU” button → “Setup” → 

“Navigation” on the sub menu →  
“Detailed Navi. Settings”

**2** Select “Calibration”.

**3** Select the desired item.

● For additional information on the accuracy of a current position:  
→P.102

### Position/Direction calibration

When driving, the current position mark will be automatically corrected by GPS signals. If GPS reception is poor due to location, the current position mark can be adjusted manually.

**1** Select “Position/Direction”.

**2** Scroll the map to the desired point (→P.66) and select “OK”.

**3** Select an arrow to adjust the direction of the current position mark and select “OK”.

### Tire change calibration

The tire change calibration function will be used when replacing the tires. This function will adjust miscalculation caused by the circumference difference between the old and new tires.

**1** Select “Tire Change”.

● The message appears and the quick distance calibration starts automatically.

● If this procedure is not performed when the tires are replaced, the current position mark may be incorrectly displayed.

3

Navigation system

### Traffic settings\*

\*: This function is not made available in some countries or areas.

Traffic information such as traffic congestion or traffic incident warnings can be made available.

### Displaying the traffic settings screen

- 1 Press the "MENU" button on the Remote Touch.

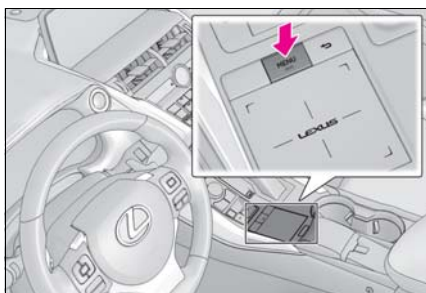

- 2 Select "Setup".
- 3 Select  "Traffic" on the sub menu.

- 4 Select the desired items to be set.

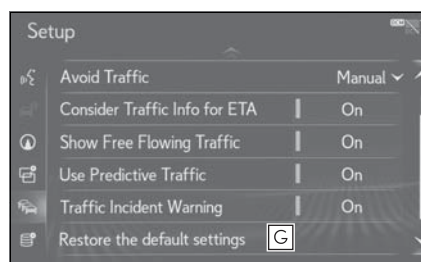
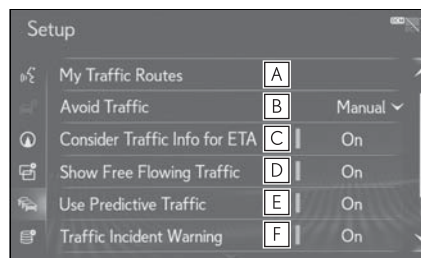

- Select to set specific routes (such as frequently used routes) on which you wish to receive traffic information. (→P.99)
- Select to set the avoid traffic function auto/manual. (→P.101)
- Select to set the usage of traffic information for the estimated arrival time on/off.
- Select to set the display of an arrow of free flowing traffic on/off.
- Select to set to on/off whether to consider the predictive traffic information (→P.71) with estimated arrival time and detoured route search.
- Select to set traffic incident voice warning on/off.
- Select to reset all setup items.

### My traffic routes

Specific routes (such as frequently used routes) on which you wish to receive traffic information can be registered as "My Traffic Routes". A route is set by defining a start point and end point, and can be adjusted by setting up to 2 preferred roads.

- 1 Display the traffic settings screen:
  - "MENU" button → "Setup" →  "Traffic" on the sub menu
- 2 Select "My Traffic Routes".
- 3 Select the desired item.

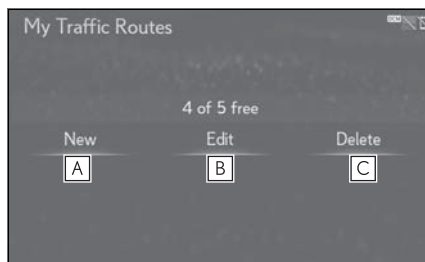

- A** Select to register personal routes. (→P.99)
- B** Select to edit personal routes. (→P.100)
- C** Select to delete personal routes. (→P.100)

### Registering personal routes

- 1 Select "New".

- 2 Select "Name".

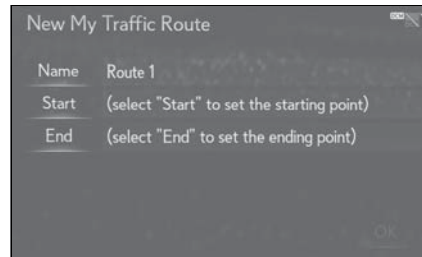

- 3 Enter the name and select "OK".
- 4 Select "Start".
- 5 Select the desired item to search for the location. (→P.73)
- 6 Select "End".
- 7 Select the desired item to search for the location. (→P.73)
- 8 Select "OK".
- 9 Check that the route overview is displayed.

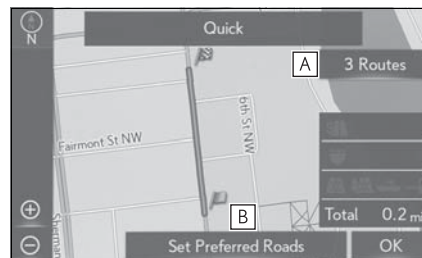

- A** Select the desired route from 3 possible routes. (→P.81)
  - B** Select to modify the route. The routes can be adjusted by setting preferred roads.
- 10 Select "OK".

- Up to 5 routes can be registered.

3

Navigation system

### Editing personal routes

- 1 Select "Edit".
- 2 Select the desired traffic route.
- 3 Select the desired item to be edited.

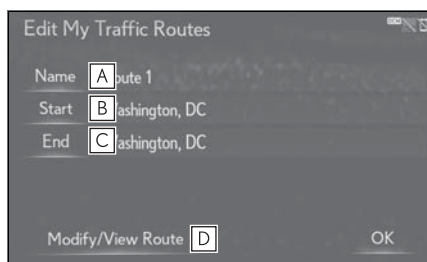

- A Select to edit the name of the personal route. (→P.99)
  - B Select to edit start location. (→P.99)
  - C Select to edit end location. (→P.99)
  - D Select to see and modify the entire route. (→P.100)
- 4 Select "OK".
  - 5 Follow the steps in "Registering personal routes" from step 9. (→P.99)

### Deleting personal routes

- 1 Select "Delete".
- 2 Select the desired traffic route to be deleted and select "Delete".
- 3 Select "Yes" when the confirmation screen appears.

### Setting preferred roads

"My Traffic Routes" can be adjusted by

setting up to 2 preferred roads.

- 1 Select "Set Preferred Roads".



- 2 Select the desired item.

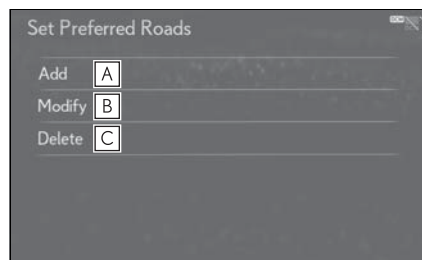

- A Select to add preferred roads. (→P.100)
- B Select to modify preferred roads. (→P.101)
- C Select to delete preferred roads. (→P.101)

#### ■ Adding preferred roads

- 1 Select "Add".
- 2 Scroll the map to the desired point (→P.65) and select "OK".
- 3 Select "OK" to use this road.

"Next": Select to change road.

- 4 Select "Add Here" for the desired location.
- If a preferred road is already set, a second preferred road can be added anywhere between the start point, the end point and the existing preferred road.

■ **Modifying preferred roads**

- 1 Select "Modify".
- 2 Select the desired preferred road to be modified if 2 preferred roads have been set.
- 3 Scroll the map to the desired point (→P.65) and select "OK".
- 4 Select "OK" to use this road.

"Next": Select to change road.

■ **Deleting preferred roads**

- 1 Select "Delete".
- 2 Select the desired preferred road to be deleted if 2 preferred roads have been set.

"Delete All": Select to delete all preferred roads on the list.

- 3 Select "Yes" when the confirmation screen appears.

**Avoid traffic**

- 1 Display the traffic settings screen:
  - "MENU" button → "Setup" → 
  - "Traffic" on the sub menu
- 2 Select "Avoid Traffic".
- 3 Select the desired item.

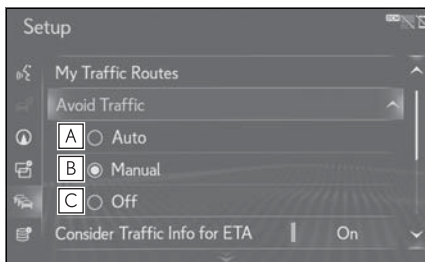

- A Select to automatically change routes when congestion information of the guidance route has been

received.

- B Select to select manually whether or not to change routes when congestion information of the guidance route has been received. In this mode, a screen will appear to ask if you wish to reroute.
- C Select to not reroute when congestion information for the guidance route has been received.

**Changing the route manually**

When the navigation system calculates a new route, a confirmation screen will be displayed.

- 1 Select the desired item.
  - "Yes": Select to start route guidance using the new route.
  - "View Map": Select to confirm the new route and current route on the map.
  - "No": Select to continue the current route guidance.

3  
Navigation system

## GPS (Global Positioning System)

This navigation system calculates the current position using satellite signals, various vehicle signals, map data, etc. However, an accurate position may not be shown depending on satellite conditions, road configuration, vehicle condition or other circumstances.



### NOTICE

- The installation of window tinting may obstruct the GPS signals. Most window tinting contains some metallic content that will interfere with GPS signal reception of the antenna in the instrument panel. We advise against the use of window tinting on vehicles equipped with navigation systems.

## Limitations of the navigation system

The Global Positioning System (GPS) developed and operated by the U.S. Department of Defense provides an accurate current position, normally using 4 or more satellites, and in some case 3 satellites. The GPS system has a certain level of inaccuracy. While the navigation system compensates for this most of the time, occasional positioning errors of up to 300 ft. (100 m) can and should be expected. Generally, position errors will be corrected within a few seconds.

When the vehicle is not receiving signals from satellites, the unreceived GPS mark appears on the map screen.

When the vehicle is receiving the signals, the unreceived GPS mark does not appear on the map screen.

The GPS signal may be physically obstructed, leading to inaccurate vehicle position on the map screen. Tunnels, tall buildings, trucks, or even the placement of objects on the instrument panel may obstruct the GPS signals.

The GPS satellites may not send signals due to repairs or improvements being made to them.

Even when the navigation system is receiving clear GPS signals, the vehicle position may not be shown accurately or inappropriate route guidance may occur in some cases.

- Accurate current position may not be shown in the following cases:
  - When driving on a small angled Y-shaped road.
  - When driving on a winding road.
  - When driving on a slippery road such as in sand, gravel, snow, etc.
  - When driving on a long straight road.
  - When freeway and surface streets run in parallel.
  - After moving by ferry or vehicle carrier.
  - When a long route is searched during high speed driving.
  - When driving without setting the current position calibration correctly.
  - After repeating a change of direction by going forward and backward, or turning on a turntable in a parking lot.
  - When leaving a covered parking lot or parking garage.
  - When a roof carrier is installed.

- When driving with tire chains installed.
  - When the tires are worn.
  - After replacing a tire or tires.
  - When using tires that are smaller or larger than the factory specifications.
  - When the tire pressure in any of the 4 tires is not correct.
  - If the vehicle cannot receive GPS signals, the current position can be adjusted manually. For information on setting the current position calibration: →P.97
  - Inappropriate route guidance may occur in the following cases:
    - When turning at an intersection off the designated route guidance.
    - If you set more than 1 destination but skip any of them, auto reroute will display a route returning to the destination on the previous route.
    - When turning at an intersection for which there is no route guidance.
    - When passing through an intersection for which there is no route guidance.
    - During auto reroute, the route guidance may not be available for the next turn to the right or left.
    - During high speed driving, it may take a long time for auto reroute to operate. In auto reroute, a detour route may be shown.
    - After auto reroute, the route may not be changed.
    - If an unnecessary U-turn is shown or announced.
    - If a location has multiple names and the system announces 1 or more of them.
    - When a route cannot be searched.
  - If the route to your destination includes gravel, unpaved roads or alleys, the route guidance may not be shown.
  - Your destination point might be shown on the opposite side of the street.
  - When a portion of the route has regulations prohibiting the entry of the vehicle that vary by time, season or other reasons.
  - The road and map data stored in the navigation system may not be complete or may not be the latest version.
  - After replacing a tire: →P.97
- 
- This navigation system uses tire turning data and is designed to work with factory-specified tires for the vehicle. Installing tires that are larger or smaller than the originally equipped diameter may cause inaccurate display of the current position. The tire pressure also affects the diameter of the tires, so make sure that the tire pressure of all 4 tires is correct.

### Map database version and covered area

Coverage areas and legal information can be displayed and map data can be updated.

#### Map information

- 1 Select  on the map screen.
- 2 Select "Map Data".
- 3 Check that the map data screen is displayed.

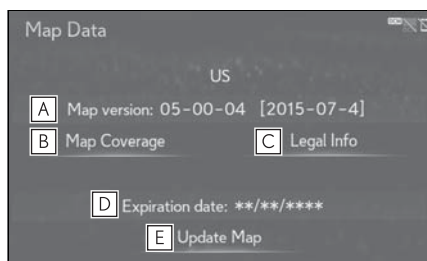

- A** Map version
- B** Select to display map coverage areas.
- C** Select to display legal information.
- D** Expiration date of temporary updates of the map and a route from the Lexus Enform center. When "\*\*\*" is displayed for the expiration date, the validity period has not yet been set for the service. The validity period will be set automatically. Map updates are available even before the period is set.
- E** Select to update map.

- For map data updates, contact your Lexus dealer.

### Temporary updates of the map \*

\* : This function is not made available in some countries or areas.

If the map data has been provided from the Lexus Enform center for any of the following areas and the map data in the system is older than what has been provided, the displayed map will be updated temporarily:

- Areas around the area displayed on the map screen (example: areas around current position)
  - Areas around destinations
  - Areas along the set route
- 
- The updated data will temporarily be saved in the system.
  - If temporary update data exceeds the available memory in the temporary map cache, the oldest data will be deleted.
  - The temporary map data will disappear when the expiration date has passed.



## Audio/visual system

## 4

- 4-1. Basic operation**
  - Quick reference..... 106
  - Some basics..... 107
- 4-2. Radio operation**
  - AM/FM/SiriusXM (SXM) radio  
..... 111
  - Internet radio ..... 119
- 4-3. Media operation**
  - CD ..... 120
  - DVD..... 122
  - USB memory ..... 125
  - iPod..... 128
  - Bluetooth® audio..... 130
  - AUX ..... 133
- 4-4. Audio/visual remote controls**
  - Steering switches ..... 135
- 4-5. Setup**
  - Audio settings..... 136
- 4-6. Tips for operating the audio/visual system**
  - Operating information..... 142

### Quick reference

The audio control screen can be reached by the following methods:

- ▶ Using the audio control switches  
Press the “RADIO” or “MEDIA” button.

- ▶ Using the Remote Touch  
Press the “MENU” button on the Remote Touch, then select “Radio” or “Media”.

The following functions are available on the system:

- Using the radio (→P.111)
- Playing an audio CD or MP3/WMA/AAC disc (→P.120)
- Playing a DVD (→P.122)
- Playing a USB memory (→P.125)
- Playing an iPod® (→P.128)
- Playing a Bluetooth® device (→P.130)
- Using the AUX port (→P.133)
- Using the steering wheel audio switches (→P.135)
- Audio system settings (→P.136)

### Controls

#### Control screen

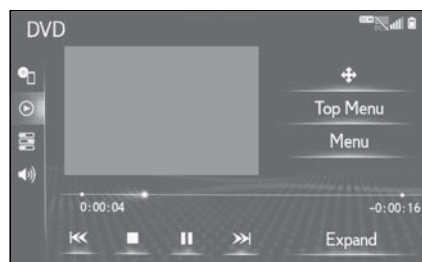

- 10.3-inch display model:  
The audio functions can also be displayed and operated on the side display. (→P.19)

#### Audio control switches

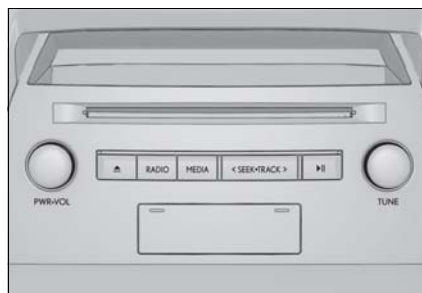

- The display and button positions will differ depending on the type of the system.

**Some basics**

This section describes some of the basic features of the audio/visual system. Some information may not pertain to your system.

Your audio/visual system works when the engine switch <power switch> is in ACCESSORY or IGNITION ON mode <ON mode>.

■ Certification

CAUTION:  
THIS PRODUCT IS A CLASS I LASER PRODUCT. USE OF CONTROLS OR ADJUSTMENTS OR PERFORMANCE OF PROCEDURES OTHER THAN THOSE SPECIFIED HEREIN MAY RESULT IN HAZARDOUS RADIATION EXPOSURE. DO NOT OPEN COVERS AND DO NOT REPAIR BY YOURSELF. REFER SERVICING TO QUALIFIED PERSONNEL.

 NOTICE

- To prevent the 12-volt battery from being discharged, do not leave the audio/visual system on longer than necessary when the engine is not running <hybrid system is not operating>.

**Turning the system on and off**

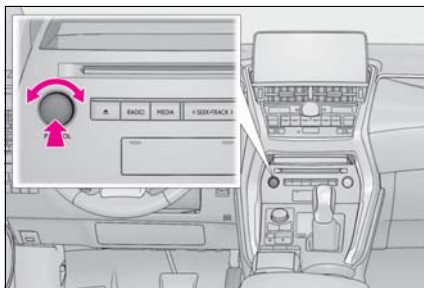

“PWR•VOL” knob: Press to turn the audio/visual system on and off. The system turns on in the last mode used. Turn this knob to adjust the volume.

**Selecting an audio source**

**Using the audio control switches**

- 1 Display the audio control screen.
- 2 Each time the “RADIO” or “MEDIA” button is pressed, the audio source changes.

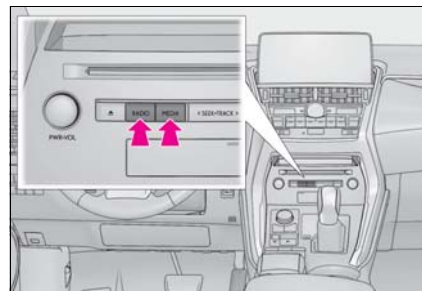

“RADIO” button: Press to change radio modes.

“MEDIA” button: Press to change media modes.

**Selecting from the audio source selection screen**

- 1 Display the audio control screen.
- 2 Select  “Source” on the sub menu.

3 Select the desired source.

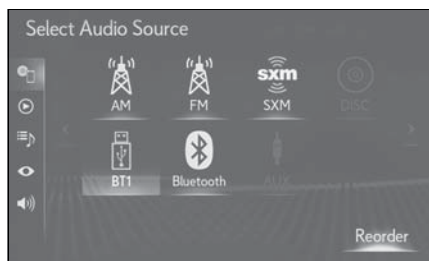

- Dimmed screen buttons cannot be operated.
- When there are two pages, select or to change the page.

#### Reordering the audio source

- 1 Select "Reorder".
- 2 Select the desired audio source then or to reorder.

#### Disc slot

##### ■ Inserting a disc

- 1 Insert a disc into the disc slot.



- After insertion, the disc is automatically loaded.

##### ■ Ejecting the disc

- 1 Press the button and remove the disc.

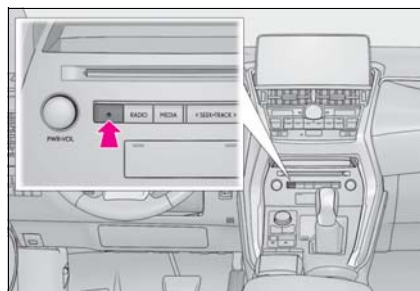

- The player is intended for use with 4.7 in. (12 cm) discs only.
- When inserting a disc, gently insert the disc with the label facing up.

#### NOTICE

- Never try to disassemble or oil any part of the CD/DVD player. Do not insert anything other than a disc into the slot.

#### USB/AUX port

There are 2 USB ports and an AUX port in the console box.

- 1 Press the button to release the lock and lift the armrest.

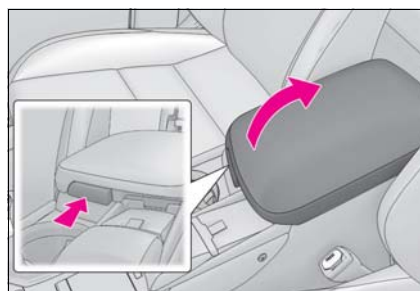

- 2 Open the cover and connect a device.

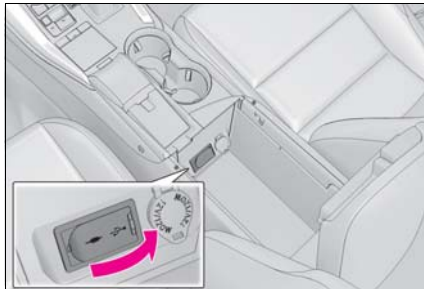

- Turn on the power of the device if it is not turned on.

- The AUX port only supports audio input.
- If 2 devices are connected to the USB ports, depending on the devices, both may not be able to be recognized by the system at the same time.

### Sound settings

- 1 Display the audio control screen.
- 2 Select "Sound" on the sub menu.
- 3 Select the desired item to be set.

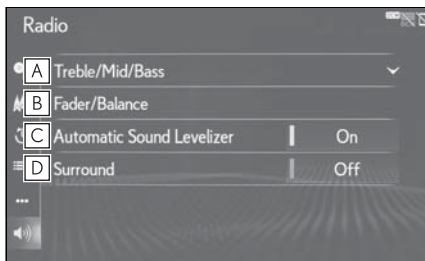

- A** Select to set the treble/mid/bass. (→P.109)
- B** Select to set the fader/balance. (→P.109)
- C** Select to set the automatic sound levelizer.

The system adjusts to the optimum volume and tone quality according to vehicle speed to compensate for increased vehicle noise.

- D** Select to set the surround on/off.\* This function can create a feeling of presence.

\*: 10.3-inch display model

### ■ Treble/Mid/Bass

How good an audio program sounds is largely determined by the mix of the treble, mid and bass levels. In fact, different kinds of music and vocal programs usually sound better with different mixes of treble, mid and bass.

- 1 Select "Treble/Mid/Bass" and select the desired item to be set.

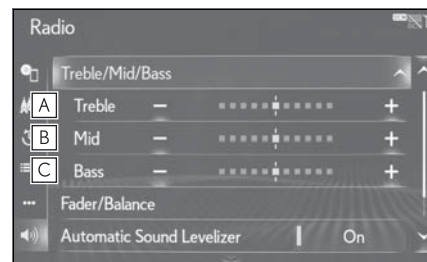

- A** Select "+" or "-" to adjust high-pitched tones.
- B** Select "+" or "-" to adjust mid-pitched tones.
- C** Select "+" or "-" to adjust low-pitched tones.

### ■ Fader/Balance

A good balance of the left and right stereo channels and of the front and rear sound levels is also important.

Keep in mind that when listening to a stereo recording or broadcast, chang-

ing the right/left balance will increase the volume of 1 group of sounds while decreasing the volume of another.

- 1 Select "Fader/Balance" and select the desired item to be set.

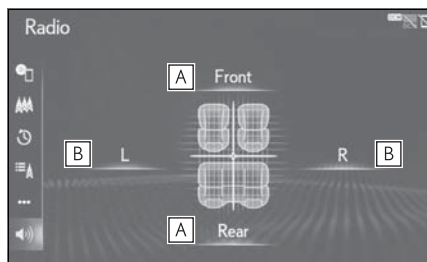

- A** Select to adjust the sound balance between the front and rear speakers.
- B** Select to adjust the sound balance between the left and right speakers.

### Voice command system

- 1 Press this switch to operate the voice command system.

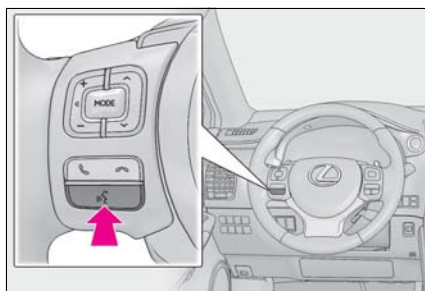

- The voice command system and its list of commands can be operated. (→P.156)

### AM/FM/SiriusXM (SXM) radio

#### Displaying the radio control screen

- ▶ Using the audio control switches
  - 1 Press the "RADIO" button.
  - Each time the button is pressed, the radio mode changes.
- ▶ Using the Remote Touch
  - 1 Press the "MENU" button on the Remote Touch.
  - 2 Select "Radio".
  - 3 Select  "Source" on the sub menu.
  - 4 Select the "AM", "FM" or "SXM".

#### Control screen

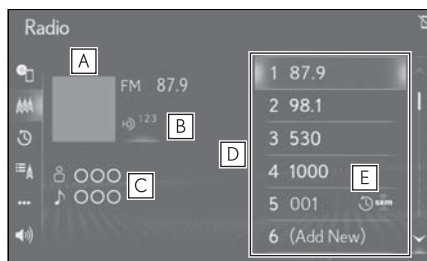

- A** Displays cover art
- B** Select to display HD) multicast channels available. (→P.115)
- C** Displays the artist info and song title or album and genre. Select to change the displayed information. Displays messages when available from RBDS. (→P.114)
- D** Select to tune to preset sta-

tions/channels. (→P.111)

- E** Displays items on the channels registered to smart favorites. (→P.117)

#### Audio control switches

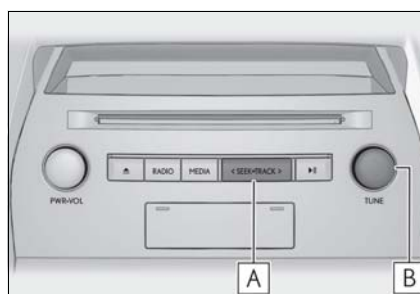

- A** Press to seek up/down.
- B** Turn to step up/down frequencies/channels. Turn to move up/down the list.

- The radio automatically changes to stereo reception when a stereo broadcast is received.

#### Presetting a station

Radio mode has a mix preset function, which can store up to 36 stations (6 stations per page x 6 pages) from any of the AM, FM or SXM bands.

- 1 Tune in the desired station.
- 2 Select "(Add New)".

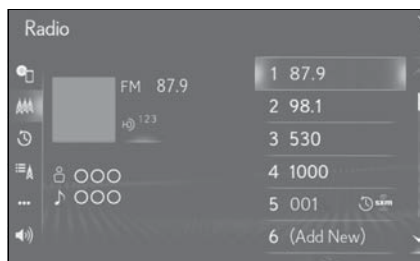

- To change the preset station to a different one, select and hold the preset station.
- 3 Select “Yes” on the confirmation screen.
- 4 Select “OK” after setting the new preset station.

- The number of preset radio stations displayed on the screen can be changed. (→P.137)

### Sub menu

To select the options, use the sub menu on the left side of the screen. Move the cursor over the sub menu icon to display the sub menu.

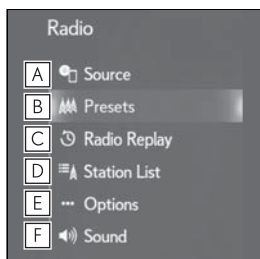

- A** Select to display the audio source selection screen. (→P.107)
- B** Select to display the preset station screen.
- C** Select to display the cache radio control screen. \* (→P.112)
- D** Select to display a list of receivable stations. (→P.113)
- E** Select to display the radio options screen. (→P.113)
- F** Select to display the sound setting screen. (→P.109)

\*: This function is not made available on some radio mode.

### Caching a radio program

A radio program can be cached and played back in a time-shifted manner.

### Playing back the cache manually

The broadcast cached in the program cache can be played back manually. It can also be played back automatically. (→P.113)

- 1 Select “Radio Replay” on the sub menu.
- 2 Select the desired cache radio operation button.

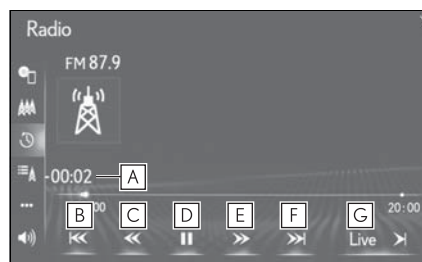

- A** Displays the replay offset from the current time
- B** Skips backward 2 minutes (AM/FM)  
Select to change the track (SXM)
- C** Fast rewinds continuously
- D** Pauses the playback (To restart, select )
- E** Fast forwards continuously
- F** Skips forward 2 minutes (AM/FM)  
Select to change the track (SXM)



**G** Returns to the live radio broadcast

- The system can store up to 20 minutes of AM/FM and less than 60 minutes of SXM. Cached data will be erased when the radio mode or station is changed or when the audio system is turned off.
- AM/FM: If noise or silence occurs during the caching process, cache writing will continue, with the noise or silence recorded as is. In this case, the cached broadcast will contain the noise or silence when played back.

**Automatic playback of the cache**

If the radio broadcast is interrupted by another audio output, such as an incoming phone call, the system will automatically cache the interrupted portion and perform time-shift playback when the interruption ends.

**Selecting a station from the list**

- 1 Select "Station List" on the sub menu.
- 2 Select "AM", "FM" or "SXM".
- 3 Select the desired station.

**Refreshing the station list (AM/FM)**

- 1 Select on the station list screen  
 "Cancel Refresh": Select to cancel the refresh.  
 "Source": Select to change to another audio source while refreshing.

- The audio system sound is muted during refresh operation.
- In some situations, it may take some time to update the station list.

**Radio options**

- 1 Select "Options" on the sub menu.
- 2 Select the desired item to be set.

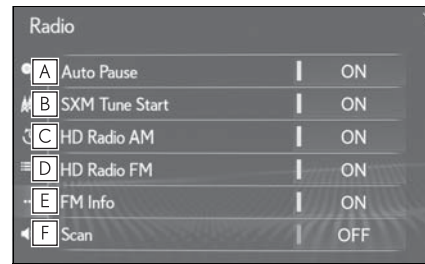

- A** Select to automatic playback of the cache on/off.
  - If the radio broadcast is interrupted by another audio output, such as an incoming phone call, the system will automatically cache the interrupted portion and perform time-shift playback when the interruption ends.
- B** When "SXM Tune Start" is turned on, the current song is played from the beginning when you select the channel.
- C** Select to turn digital AM Radio mode on/off.
- D** Select to turn digital FM Radio mode on/off.
- E** Analog FM only: Select to display RBDS text messages.
- F** Select to scan for receivable stations. (Type scan in case SXM is current audio source)

**Radio broadcast data system**

This audio system is equipped with Radio Broadcast Data Systems

4 Audio/visual system

(RBDS). RBDS mode allows text messages to be received from radio stations that utilize RBDS transmitters.

When RBDS is on, the radio can do the following functions.

- Only selecting stations of a particular program type
- Displaying messages from radio stations
- Searching for a stronger signal station

RBDS features are available only when listening to an FM station that broadcasts RBDS information and the “FM Info” indicator is on.

### Using HD Radio™ technology

HD Radio™ Technology is the digital evolution of analog AM/FM radio. Your radio product has a special receiver which allows it to receive digital broadcasts (where available) in addition to the analog broadcasts it already receives. Digital broadcasts have better sound quality than analog broadcasts as digital broadcasts provide free, crystal clear audio with no static or distortion. For more information, and a guide to available radio stations and programming, refer to [www.hdradio.com](http://www.hdradio.com).

HD Radio features included in Lexus radios:

- Digital Sound—HD Radio broadcasts deliver crystal-clear, digital audio quality to listeners.
- HD2/HD3 Channels—FM stations can provide additional digital

only audio programming with expanded content and format choices on HD2/HD3 channels.

- PSD—Program Service Data (PSD) gives you on-screen information such as artist name and song title.
- Artist Experience—Images related to the broadcast are displayed on the radio screen, such as album cover art and station logos.

### ■ Certification



HD Radio Technology manufactured under license from iBiquity Digital Corporation. U.S. and Foreign Patents. HD Radio™ and the HD, HD Radio, and “Arc” logos are proprietary trademarks of iBiquity Digital Corp.

### Available HD Radio™ technology

#### ■ Multicast

On the FM radio frequency most digital stations have “multiple” or supplemental programs on one FM station.

**1** Select the “HD)” logo.

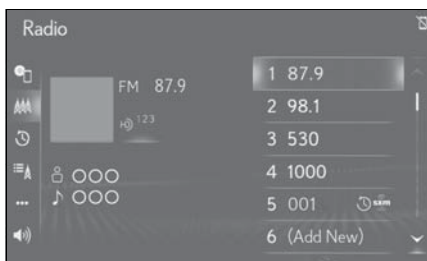

**2** Select the desired channel.  
 ● Turning the “TUNE” knob can also select the desired multicast channel.

**Troubleshooting guide**

■ **Experience**

● Mismatch of time alignment- a user may hear a short period of programming replayed or an echo, stutter or skip.

Cause: The radio stations analog and digital volume is not properly aligned or the station is in ballgame mode.

Action: None, radio broadcast issue. A user can contact the radio station.

● Sound fades, blending in and out.

Cause: Radio is shifting between analog and digital audio.

Action: Reception issue, may clear-up as the vehicle continues to be driven. Turning the indicator of the “HD Radio AM” and “HD Radio FM” button off can force radio in an analog audio.

● Audio mute condition when an HD2/HD3 multicast channel had been playing.

Cause: The radio does not have access to digital signals at the moment.

Action: This is normal behavior, wait until

the digital signal returns. If out of the coverage area, seek a new station.

● Audio mute delay when selecting an HD2/HD3 multicast channel preset.

Cause: The digital multicast content is not available until HD Radio™ broadcast can be decoded and make the audio available. This takes up to 7 seconds.

Action: This is normal behavior, wait for the audio to become available.

● Text information does not match the present song audio.

Cause: Data service issue by the radio broadcaster.

Action: Broadcaster should be notified. Complete the form; [hdradio.com/stations/feedback](http://hdradio.com/stations/feedback)

● No text information shown for the present selected frequency.

Cause: Data service issue by the radio broadcaster.

Action: Broadcaster should be notified. Complete the form; [hdradio.com/stations/feedback](http://hdradio.com/stations/feedback)

**How to subscribe to SiriusXM Satellite Radio**

To listen to a satellite radio broadcast in the vehicle, a subscription to the SiriusXM Satellite Radio service is necessary.

A SiriusXM Satellite Radio is a tuner designed exclusively to receive broadcasts provided under a separate subscription. Availability is limited to the 48 contiguous U.S. states and some Canadian provinces.

4

Audio/visual system

### ■ How to subscribe

It is necessary to enter into a separate service agreement with SiriusXM Satellite Radio in order to receive satellite broadcast programming in the vehicle. Additional activation and service subscription fees apply that are not included in the purchase price of the vehicle and digital satellite tuner.

- For complete information on subscription rates and terms, or to subscribe to SiriusXM Satellite Radio:

▶ U.S.A.

Refer to [www.siriusxm.com](http://www.siriusxm.com) or call 1-877-447-0011.

▶ Canada

Refer to [www.siriusxm.ca](http://www.siriusxm.ca) or call 1-877-438-9677.

- 
- SiriusXM Radio Services — Descriptions
    - Radio and Entertainment
 

SiriusXM offers more than 170 satellite radio channels of commercial-free music and premier sports, news, talk, and entertainment. SiriusXM is broadcast via satellites to millions of listeners across the continental United States. SiriusXM subscribers listen to SiriusXM on satellite radio receivers for the car, home, and portable use. More information about SiriusXM is available online at [www.siriusxm.com](http://www.siriusxm.com) (U.S.A.) or [www.siriusxm.ca](http://www.siriusxm.ca) (Canada).
  - SiriusXM Radio Services — Subscription Instructions
    - For SiriusXM Services requiring a subscription (such as SiriusXM Satellite Radio), the following paragraph shall be included.
 

Required SiriusXM Radio monthly subscriptions sold separately after trial period. Subscription fee is consumer only. All fees and programming subject to change. Subscriptions are subject to the

Customer Agreement available at [www.siriusxm.com](http://www.siriusxm.com) (U.S.A.) or [www.siriusxm.ca](http://www.siriusxm.ca) (Canada) XM service only available in the 48 contiguous United States and 10 Canadian provinces. © 2011 Sirius XM Radio Inc. Sirius, XM and all related marks and logos are trademarks of Sirius XM Radio Inc. All other marks, channel names and logos are the property of their respective owners.

For more information, program schedules, and to subscribe or extend subscription after complimentary trial period; more information is available at:

U.S.A. Customers:

Visit [www.siriusxm.com](http://www.siriusxm.com) or call 1-877-447-0011

Canadian Customers:

Visit [www.siriusxm.ca](http://www.siriusxm.ca) or call 1-877-438-9677

- SiriusXM Satellite Radio is solely responsible for the quality, availability and content of the satellite radio services provided, which are subject to the terms and conditions of the SiriusXM Satellite Radio customer service agreement.
- Customers should have their radio ID ready; the radio ID can be found by tuning to “Ch 000” on the radio. For details, see (→P.117).
- All fees and programming are the responsibility of SiriusXM Satellite Radio and are subject to change.

 NOTICE

- SiriusXM Satellite Radio Services — Legal Disclaimers and Warnings
- Fees and Taxes — Subscription fee, taxes, one time activation fee, and other fees may apply. Subscription fee is consumer only. All fees and programming subject to change. Subscriptions subject to Customer Agreement available at [www.siriusxm.com](http://www.siriusxm.com) (U.S.A.) or [www.siriusxm.ca](http://www.siriusxm.ca) (Canada) SiriusXM service only available in the 48 contiguous United States and Canada. Explicit Language Notice — Channels with frequent explicit language are indicated with an “XL” preceding the channel name. Channel blocking is available for SiriusXM Satellite Radio receivers by notifying SiriusXM at; U.S.A. Customers: Visit [www.siriusxm.com](http://www.siriusxm.com) or calling 1-877-447-0011 Canadian Customers: Visit [www.siriusxm.ca](http://www.siriusxm.ca) or calling 1-877-438-9677
- It is prohibited to copy, decompile, disassemble, reverse engineer, hack, manipulate, or otherwise make available any technology or software incorporated in receivers compatible with the SiriusXM Satellite Radio System or that support the XM website, the Online Service or any of its content. Furthermore, the AMBE<sup>®</sup> voice compression software included in this product is protected by intellectual property rights including patent rights, copyrights, and trade secrets of Digital Voice Systems, Inc.
- Note: this applies to SiriusXM Satellite Radio receivers only and not XM Ready devices.

■ **Satellite tuner technology notice**

Lexus’s satellite radio tuners are awarded Type Approval Certificates from SiriusXM Satellite Radio Inc. as proof of compatibility with the services

offered by SiriusXM Satellite Radio.

- Satellite tuner  
The tuner supports only Audio Services (Music and Talk) and the accompanying Text Information of XM<sup>®</sup> Satellite Radio.

**Displaying the radio ID**

Each SiriusXM tuner is identified with a unique radio ID. The radio ID is required when activating an SiriusXM Satellite service or when reporting a problem.

- If “Ch 000” is selected using the “TUNE” knob, the ID code, which is 8 alphanumeric characters, will be displayed. If another channel is selected, the ID code will no longer be displayed. The channel (000) alternates between displaying the radio ID and the specific radio code.

**Smart favorites**

Up to 20 channels can be registered as presets in the cache. For channel registration, refer to (→P.137).

- 1 Select channels registered to smart favorites.
  - 2 Select to  “Radio Replay” on the sub menu.
- Caches the latest less than 30 minutes for each channel.
  - The radio plays the track from start when that track has not previously been heard by the user and the station is registered as “Smart Favorite”.
  - Displays icons on the channels registered to smart favorites. (→P.111)

### If the satellite radio tuner malfunctions

When problems occur with the SXM tuner, a message will appear on the screen. Referring to the table below to identify the problem, take the suggested corrective action.

Message	Explanation
"Check Antenna"	The SXM antenna is not connected. Check whether the SXM antenna cable is attached securely. Contact your Lexus certified dealer for assistance.
	A short circuit occurs in the antenna or the surrounding antenna cable. Contact your Lexus certified dealer for assistance.
"No Signal"	The SXM signal is too weak at the current location. Wait until your vehicle reaches a location with a stronger signal.
"Channel Unavailable"	The channel you selected is not broadcasting any programming. Select another channel.
"Ch Unsubscribed"	The channel you selected is no longer available. Wait for about 2 seconds until the radio returns to the previous channel or "Ch 001". If it does not change automatically, select another channel.
"Subscription updated"	Subscription is updated. Select "OK" to clear this message.

- Contact the SiriusXM Listener Care Center at 1-877-447-0011 (U.S.A.) or 1-877-438-9677 (Canada).

## Internet radio

One of Lexus Enform App Suite 2.0's features is the ability to listen to internet radio. In order to use this service, a compatible phone and the system needs to be set up. For details: →P.255

## Listening to internet radio

- 1 Press the "MENU" button on the Remote Touch.
  - 2 Select "Media".
  - 3 Select  "Source" on the sub menu.
  - 4 Select the internet radio application icon.
  - 5 Select the desired application screen button.
- The internet radio application screen is displayed.
  - Perform operations according to the displayed application screen.
- 
- Other applications can be activated while listening to internet radio.
  - Some parts of applications can be adjusted using the switches on the steering wheel.
  - For additional information, refer to <http://www.lexus.com/enform/> or call 1-800-255-3987.

**CD**

**Displaying the CD control screen**

- ▶ Using the audio control switches
- 1 Press the “MEDIA” button.
- Each time the button is pressed, the media mode changes.
- ▶ Using the Remote Touch
- 1 Press the “MENU” button on the Remote Touch.
- 2 Select “Media”.
- 3 Select  “Source” on the sub menu.
- 4 Select the disc icon.

● Inserting a disc (→P.108)

**Control screen**

- ▶ Audio CD

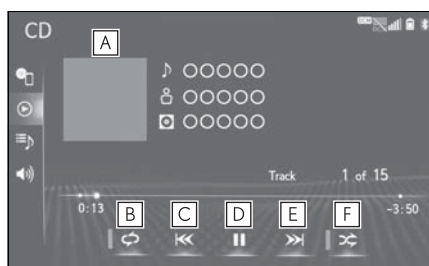

- A** Displays cover art
- B** Select to set repeat playback. (→P.120)
- C** Select to change the track/file. Select and hold to fast rewind.
- D** Select to play/pause.
- E** Select to change the track/file.

Select and hold to fast forward.

- F** Select to set random playback. (→P.121)

- ▶ MP3/WMA/AAC disc

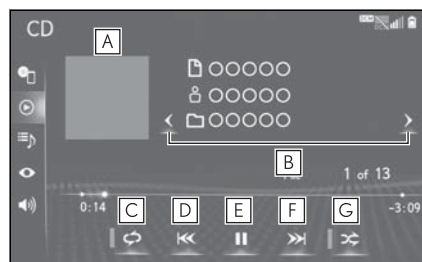

- A** Displays cover art
- B** Select to change the folder.
- C** Select to set repeat playback. (→P.120)
- D** Select to change the track/file. Select and hold to fast rewind.
- E** Select to play/pause.
- F** Select to change the track/file. Select and hold to fast forward.
- G** Select to set random playback. (→P.121)

● If a disc contains CD-DA files and MP3/WMA/AAC files, only the CD-DA files can be played back.

● If a CD-TEXT disc is inserted, the title of the disc and track will be displayed.

**Repeating**

The track/file or folder currently being listened to can be repeated.

- 1 Select .

● Each time  is selected, the mode



changes as follows:

- ▶ Audio CD
  - track repeat → off
- ▶ MP3/WMA/AAC disc
  - file repeat → folder repeat → off\*<sup>1</sup>
  - file repeat → off\*<sup>2</sup>

\*<sup>1</sup>: When random playback is off

\*<sup>2</sup>: When random playback is on

### Random order

Tracks/files or folders can be automatically and randomly selected.

- 1 Select .

- Each time  is selected, the mode

changes as follows:

- ▶ Audio CD
  - random (1 disc random) → off
- ▶ MP3/WMA/AAC disc
  - random (1 folder random) → folder random (1 disc random) → off

### Audio control switches

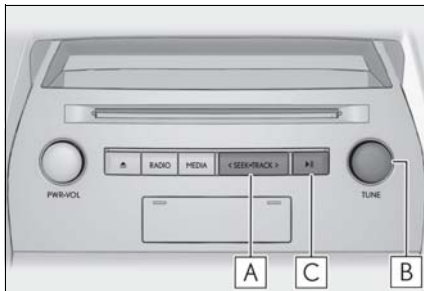

- A** Press to select a track/file.  
Press and hold to fast forward/rewind.
- B** Turn to select a track/file.  
Turn to move up/down the list.
- C** Press to pause/play.

### Sub menu

To select the options, use the sub menu on the left side of the screen. Move the cursor over the sub menu icon to display the sub menu.

- ▶ Audio CD

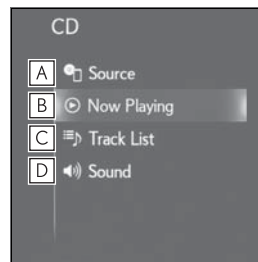

- A** Select to display the audio source selection screen. (→P.107)
- B** Select to return to the control screen.
- C** Select to display the track list screen.
- D** Select to display the sound setting screen. (→P.109)

- ▶ MP3/WMA/AAC disc

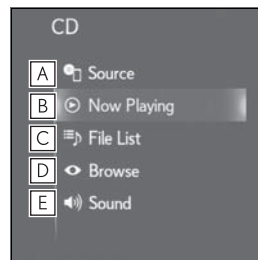

- A** Select to display the audio source selection screen. (→P.107)
- B** Select to return to the control screen.
- C** Select to display a file list screen.
- D** Select to display a browse list.

4

Audio/visual system

- E** Select to display the sound setting screen. (→P.109)

## DVD\*

\*: 10.3-inch display model

**For safety reasons, the DVD video discs can only be viewed when the following conditions are met:**

- The vehicle is completely stopped.
- The engine switch <power switch> is in ACCESSORY or IGNITION ON mode <ON mode>.
- The parking brake is applied.

**While driving in DVD video mode, only the DVD's audio can be heard.**

**The playback condition of some DVD discs may be determined by the DVD software producer. This DVD player plays a disc as the software producer intended. As such, some functions may not work properly. Be sure to read the instruction manual that comes with the individual DVD disc. (→P.143)**

## Displaying the DVD control screen

- ▶ Using the audio control switches
  - 1 Press the "MEDIA" button.
  - Each time the button is pressed, the media mode changes.
- ▶ Using the Remote Touch
  - 1 Press the "MENU" button on the Remote Touch.
  - 2 Select "Media".

- 3 Select  "Source" on the sub menu.
- 4 Select the disc icon.

● Inserting a disc (→P.108)

**⚠ WARNING**

● Conversational speech on some DVDs are recorded at a low volume to emphasize the impact of sound effects. If you adjust the volume assuming that the conversations represent the maximum volume level that the DVD will play, you may be startled by louder sound effects or when you change to a different audio source. The louder sounds may have a significant impact on the human body or pose a driving hazard. Keep this in mind when you adjust the volume.

### Control screen

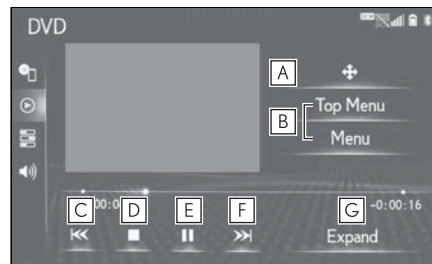

- A** Select to display the menu control key.
- B** Select to display the menu screen.
- C** Select to change the chapter.  
Select and hold to rewind.
- D** Select to stop the video screen.
- E** Select to play/pause.
- F** Select to change the chapter.  
During playback: Select and hold to fast forward.

During a pause: Select and hold to slow forward.

- G** Select to display expanded screen video.

● According to the DVD disc, some menu items can be selected directly. (For details, see the manual that comes with the DVD disc provided separately.)

- If  appears on the screen when a control is selected, the operation relevant to the control is not permitted.

### Audio control switches

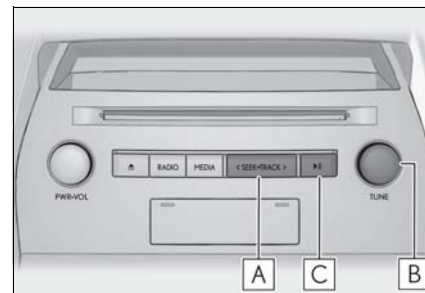

- A** Press to select a chapter.  
Press and hold to fast forward/rewind.
- B** Turn to select a chapter.
- C** Press to pause/play.

### Sub menu

To select the options, use the sub menu on the left side of the screen. Move the cursor over the sub menu icon to display the sub menu.

4 Audio/visual system



- A** Select to display the audio source selection screen. (→P.107)
- B** Select to return to the control screen.
- C** Select to display the option screen. (→P.124)
- D** Select to display the key code input screen.
- E** Select to display the sound setting screen. (→P.109)

#### DVD options

- 1 Select  "Options" on the sub menu.
- 2 The following screen is displayed.

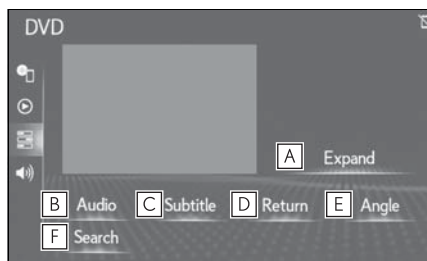

- A** Select to display expanded screen video.
- B** Select to display the audio language selection screen. (→P.124)
- C** Select to display the subtitle selection screen. (→P.124)

- D** Select to display the predetermined scene on the screen and start playing.
- E** Select to display the angle selection screen. (→P.124)
- F** Select to display the title search screen. (→P.125)

#### Changing the audio language

- 1 Select "Audio".
    - Each time "Audio" is selected, the audio language is changed.
- 
- The languages available are restricted to those available on the DVD disc.

#### Changing the subtitle language

- 1 Select "Subtitle".
  - 2 Each time "Change" is selected, the language the subtitles are displayed in is changed.
- 
- The languages available are restricted to those available on the DVD disc.
  - When "Hide" is selected, the subtitles can be hidden.

#### Changing the angle

The angle can be selected for discs that are multi-angle compatible when the angle mark () appears on the screen.

- 1 Select "Angle".
    - Each time "Angle" is selected, the angle is changed.
- 
- The angles available are restricted to

those available on the DVD disc.

**Searching by title**

- 1 Select "Search".
- 2 Enter the title number and select "OK".
- The player starts playing video for that title number.

**USB memory**

**Displaying the USB memory control screen**

- ▶ Using the audio control switches
  - 1 Press the "MEDIA" button.
  - Each time the button is pressed, the media mode changes.
- ▶ Using the Remote Touch
  - 1 Press the "MENU" button on the Remote Touch.
  - 2 Select "Media".
  - 3 Select  "Source" on the sub menu.
  - 4 Select the USB icon.

- Connecting a USB memory (→P.108)

**WARNING**

- Do not attempt to connect a USB device or operate the controls while driving.

**NOTICE**

- Do not leave the USB device in the car. In particular, high temperatures inside the vehicle may damage the USB device.
- Do not push down on or apply unnecessary pressure to the USB device while it is connected as this may damage the USB device or its terminal.
- Do not insert foreign objects into the USB port as this may damage the USB device or its terminal.

**Control screen**

▶ USB audio

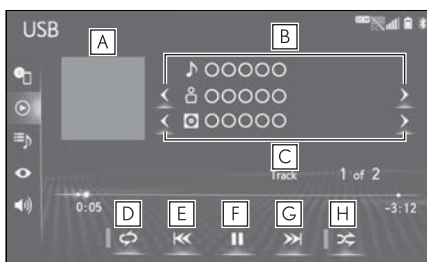

- A** Displays cover art
- B** Select to change the artist.
- C** Select to change the folder/album.
- D** Select to set repeat playback. (→P.126)
- E** Select to change the file/track. Select and hold to fast rewind.
- F** Select to play/pause.
- G** Select to change the file/track. Select and hold to fast forward.
- H** Select to set random playback. (→P.126)

▶ USB video

- 1 Select  "Browse" on the sub menu.
- 2 Select "Videos".
- 3 Select the desired folder and file.

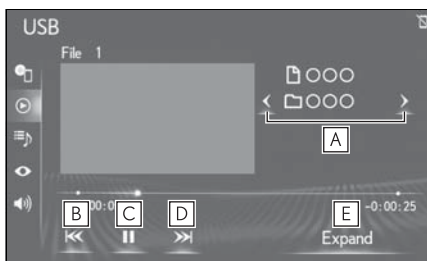

- A** Select to change the folder.
- B** Select to change the file. Select and hold to fast rewind.
- C** Select to play/pause.
- D** Select to change the file. Select and hold to fast forward.
- E** Select to display expanded screen video.

- If tag information exists, the file/folder names will be changed to track/album names.

**Repeating**

The file/track or folder/album currently being listened to can be repeated.

- 1 Select .

- Each time  is selected, the mode changes as follows:
  - ▶ When random playback is off
    - file/track repeat → folder/album repeat → off
  - ▶ When random playback is on
    - file/track repeat → off

**Random order**

Files/tracks or folders/albums can be automatically and randomly selected.

- 1 Select .

- Each time  is selected, the mode changes as follows:
  - random (1 folder/album random) → folder/album random (all folder/album random) → off

**Audio control switches**

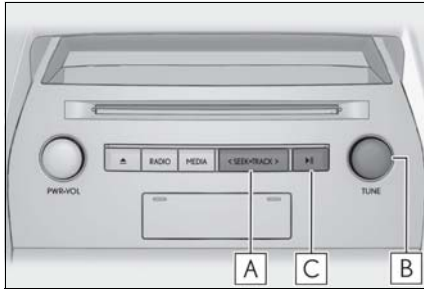

**E** Select to display the sound setting screen. (→P.109)

- A** Press to select a file/track.  
Press and hold to fast forward/rewind.
- B** Turn to select a file/track.  
Turn to move up/down the list.
- C** Press to pause/play.

**Sub menu**

To select the options, use the sub menu on the left side of the screen. Move the cursor over the sub menu icon to display the sub menu.

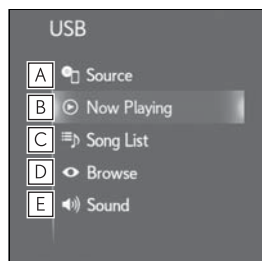

- A** Select to display the audio source selection screen. (→P.107)
- B** Select to return to the control screen.
- C** Select to display a file list screen.
- D** Select to display the play mode selection screen.

**iPod**

**Displaying the iPod control screen**

- ▶ Using the audio control switches
- 1 Press the “MEDIA” button.
- Each time the button is pressed, the media mode changes.
- ▶ Using the Remote Touch
- 1 Press the “MENU” button on the Remote Touch.
- 2 Select “Media”.
- 3 Select  “Source” on the sub menu.
- 4 Select the iPod icon.

● Connecting an iPod (→P.108)

**! WARNING**

● Do not attempt to connect an iPod or operate the controls while driving.

**! NOTICE**

- Do not leave the iPod in the car. In particular, high temperatures inside the vehicle may damage the iPod.
- Do not push down on or apply unnecessary pressure to the iPod while it is connected as this may damage the iPod or its terminal.
- Do not insert foreign objects into the USB port as this may damage the iPod or its terminal.

**Control screen**

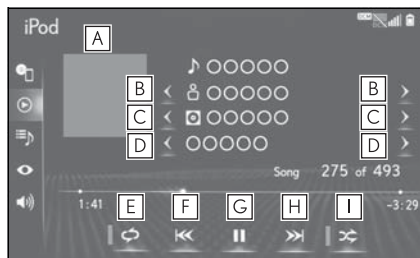

- A** Displays cover art
- B** Select to change the artist.
- C** Select to change the album.
- D** Select to change the playlist.
- E** Select to set repeat playback. (→P.129)
- F** Select to change the track. Select and hold to fast rewind.
- G** Select to play/pause.
- H** Select to change the track. Select and hold to fast forward.
- I** Select to set random playback. (→P.129)

- When an iPod is connected using a genuine iPod cable, the iPod starts charging its battery.
- Depending on the iPod and the songs in the iPod, iPod cover art may be displayed. This function can be changed to “On” or “Off”. (→P.136) It may take time to display iPod cover art, and the iPod may not be operated while the cover art display is in process.
- When an iPod is connected and the audio source is changed to iPod mode, the iPod will resume playing from the same point it was last used.
- Depending on the iPod that is connected to the system, certain functions may not be available.



- If an iPhone is connected via Bluetooth® and USB at the same time, system operation may become unstable. For known phone compatibility information, refer to <http://www.lexus.com/enform/>.
- The system may not function properly if a conversion adapter is used to connect a device.

**Repeating**

The track currently being listened to can be repeated.

1 Select .

- Each time  is selected, the mode changes as follows:
  - ▶ When shuffle is off (iPhone5 or later)
    - file/track repeat → folder/album repeat → off

It depends on the models.

The operation may be different depending on iPod/iPhone.

- ▶ When shuffle is off (iPhone4S or earlier)
  - file/track repeat → off
- ▶ When shuffle is on
  - file/track repeat → off

**Random order**

Tracks or albums can be automatically and randomly selected.

1 Select .

- Each time  is selected, the mode changes as follows:
    - track shuffle → album shuffle → off
- It depends on the model.

**Audio control switches**

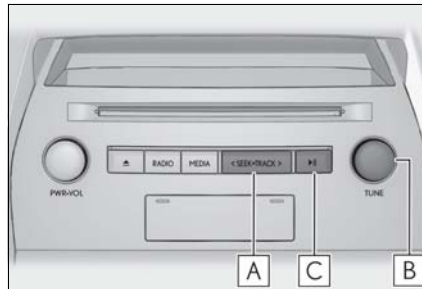

- A** Press to select a track. Press and hold to fast forward/rewind.
- B** Turn to select a track. Turn to move up/down the list.
- C** Press to pause/play.

**Sub menu**

To select the options, use the sub menu on the left side of the screen. Move the cursor over the sub menu icon to display the sub menu.

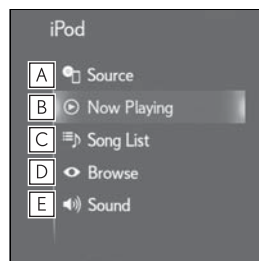

- A** Select to display the audio source selection screen. (→P.107)
- B** Select to return to the control screen.
- C** Select to display a file list screen.
- D** Select to display the play mode selection screen.

4  
Audio/visual system

- E** Select to display the sound setting screen. (→P.109)

### Bluetooth® audio

The Bluetooth® audio system enables users to enjoy listening to music that is played on a portable player on the vehicle speakers via wireless communication.

This audio system supports Bluetooth®, a wireless data system capable of playing portable audio music without cables. If your device does not support Bluetooth®, the Bluetooth® audio system will not function.

### Displaying the Bluetooth® audio control screen

- ▶ Using the audio control switches
    - 1 Press the “MEDIA” button.
    - Each time the button is pressed, the media mode changes.
  - ▶ Using the Remote Touch
    - 1 Press the “MENU” button on the Remote Touch.
    - 2 Select “Media”.
    - 3 Select  “Source” on the sub menu.
    - 4 Select the Bluetooth® icon.
- 
- Depending on the type of portable player connected, some functions may not be available and/or the screen may look differently than shown in this manual.
  - Connecting a Bluetooth® audio device (→P.132)

**⚠ WARNING**

- Do not attempt to connect a Bluetooth® device or operate the controls while driving.
- Your audio unit is fitted with Bluetooth® antennas. People with implantable cardiac pacemakers, cardiac resynchronization therapy-pacemakers or implantable cardioverter defibrillators should maintain a reasonable distance between themselves and the Bluetooth® antennas. The radio waves may affect the operation of such devices.
- Before using Bluetooth® devices, users of any electrical medical device other than implantable cardiac pacemakers, cardiac resynchronization therapy-pacemakers or implantable cardioverter defibrillators should consult the manufacturer of the device for information about its operation under the influence of radio waves. Radio waves could have unexpected effects on the operation of such medical devices.

**⚠ NOTICE**

- Do not leave Bluetooth® device in the vehicle. In particular, high temperatures inside the vehicle may damage Bluetooth® device.

**Control screen**

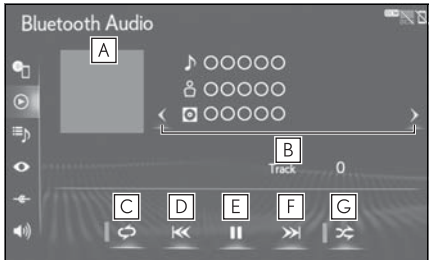

- A** Displays cover art
- B** Select to change the album.

- C** Select to set repeat playback. (→P.132)
- D** Select to change the track. Select and hold to fast rewind.
- E** Select to play/pause.
- F** Select to change the track. Select and hold to fast forward.
- G** Select to set random playback. (→P.132)

- Depending on the Bluetooth® device that is connected to the system, the music may start playing when selecting **⏸** while it is paused. Conversely, the music may pause when selecting **▶** while it is playing.
- In the following conditions, the system may not function:
  - The Bluetooth® device is turned off.
  - The Bluetooth® device is not connected.
  - The Bluetooth® device has a low battery.
- When using the Bluetooth® audio and Wi-Fi® Hotspot functions at the same time, the following problems may occur:
  - It may take longer than normal to connect to the Bluetooth® device.
  - The sound may cut out.
- It may take time to connect the phone when Bluetooth® audio is being played.
- For operating the portable player, see the instruction manual that comes with it.
- If the Bluetooth® device is disconnected due to poor reception from the Bluetooth® network when the engine switch <power switch> is in ACCESSORY or IGNITION ON mode <ON mode>, the system automatically reconnects the portable player.
- Bluetooth® device information is registered when the Bluetooth® device is connected to the Bluetooth® audio system. When selling or disposing of the vehicle, remove the Bluetooth® audio information from the system. (→P.55)

- In some situations, sound output via the Bluetooth<sup>®</sup> audio system may be out of sync with the connected device or output intermittently.

### Repeating

The track or album currently being listened to can be repeated.

- 1 Select .

- Each time  is selected, the mode changes as follows:
  - track repeat → album repeat → off

### Random order

Tracks or albums can be automatically and randomly selected.

- 1 Select .

- Each time  is selected, the mode changes as follows:
  - album random → all track random → off

### Audio control switches

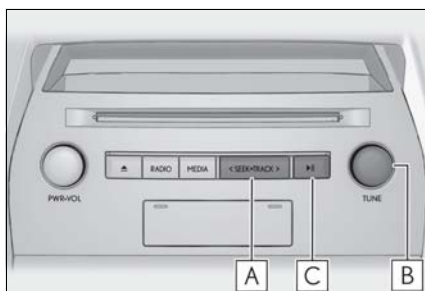



- Press to select a track.  
Press and hold to fast forward/rewind.
- Turn to select a track.  
Turn to move up/down the list.

- Press to pause/play.

### Connecting a Bluetooth<sup>®</sup> device

To use the Bluetooth<sup>®</sup> audio system, it is necessary to register a Bluetooth<sup>®</sup> device with the system.

- ▶ Registering an additional device
  - 1 Press the "MENU" button on the Remote Touch.
  - 2 Select "Setup".
  - 3 Select  "Bluetooth" on the sub menu.
  - 4 Select "Add New Device".
  - For more information: →P.43
- ▶ Selecting a registered device
  - 1 Select  "Connect" on the sub menu.
  - 2 Select the device to be connected.

### Sub menu

To select the options, use the sub menu on the left side of the screen. Move the cursor over the sub menu icon to display the sub menu.

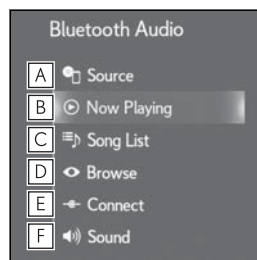

- Select to display the audio source selection screen. (→P.107)

- B** Select to return to the control screen.
- C** Select to display a file list screen.
- D** Select to display the play mode selection screen.
- E** Select to display the portable device connection screen.
- F** Select to display the sound setting screen. (→P.109)

## AUX

### Displaying the AUX control screen

- ▶ Using the audio control switches
  - 1 Press the "MEDIA" button.
    - Each time the button is pressed, the media mode changes.
  - ▶ Using the Remote Touch
    - 1 Press the "MENU" button on the Remote Touch.
    - 2 Select "Media".
    - 3 Select  "Source" on the sub menu.
    - 4 Select "AUX".

- Connecting a device to the AUX port (→P.108)

#### WARNING

- Do not attempt to connect portable audio device or operate the controls while driving.

#### NOTICE

- Do not leave portable audio device in the vehicle. The temperature inside the vehicle may become high, resulting in damage to the device.
- Do not push down on or apply unnecessary pressure to the portable audio device while it is connected as this may damage the portable audio device or its terminal.
- Do not insert foreign objects into the AUX port as this may damage the portable audio device or its terminal.

### Control screen

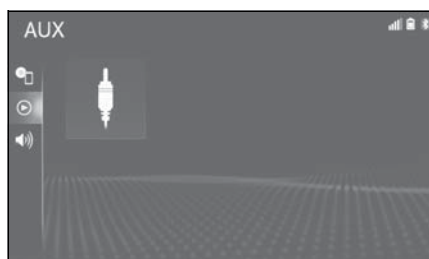

### Sub menu

To select the options, use the sub menu on the left side of the screen. Move the cursor over the sub menu icon to display the sub menu.



- A** Select to display the audio source selection screen. (→P.107)
- B** Select to return to the control screen.
- C** Select to display the sound setting screen. (→P.109)

**Steering switches**

**Steering switch operation**

Some parts of the audio/visual system can be adjusted using the switches on the steering wheel.

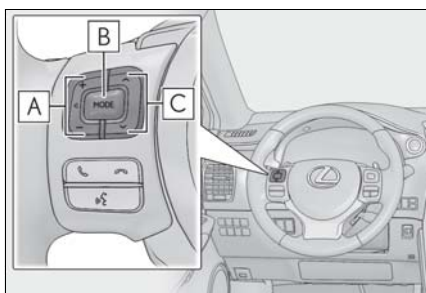

**A** Volume control switch

Mode	Operation/function
All	Press: Volume up/down
	Press and hold: Volume up/down continuously

**B** "MODE" switch

Mode	Operation/function
All	Press: Change audio sources
	Press and hold: Pause or Mute

**C** " ^ v " switch

Mode	Operation/function
AM, FM, HD	Press: Preset station up/down
	Press and hold: Seek up/down continuously while the switch is being pressed

Mode	Operation/function
SXM	Press: Preset channel up/down
	Press and hold (0.8 sec. or more): Type seek up/down
	Press and hold (1.5 sec. or more): Fast up/down
CD,MP3/WMA/AAC disc, USB, iPod, Bluetooth® audio	Press: Track/File up/down
	Press and hold: Fast forward/rewind
DVD	Press: Chapter up/down
	Press and hold: Fast forward/rewind

● In the APPS mode, some operation may be done on the screen depend on the selected APPS.

### Audio settings

Detailed audio settings can be changed.

### Displaying the audio settings screen

- 1 Press the "MENU" button on the Remote Touch.

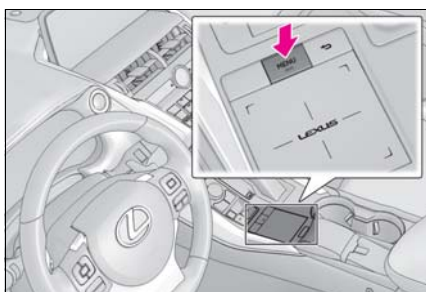

- 2 Select "Setup".
- 3 Select "Audio" on the sub menu.
- 4 Select the desired item to be set.



- A** Select to set the common settings. (→P.136)
- B** Select to set the radio settings. (→P.137)
- C** Select to set detailed DVD settings.\* (→P.138)

\*: 10.3-inch display model

### Common settings

- 1 Display the audio settings screen:
  - "MENU" button → "Setup" → "Audio" on the sub menu
- 2 Select "Common".
- 3 Select the desired item to be set.

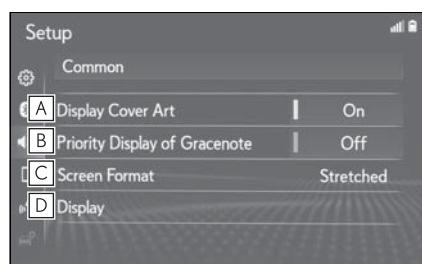

- A** Select to set the cover art display on/off.
- B** Select to prioritize the display of information from the Gracenote database.
- C** Select to change the screen size. (→P.136)
- D** Select to display the image quality adjustment screen. (→P.137)

● Depending on the audio source, some functions may not be available.

### Screen size settings

The screen size can be selected for each type of media.

- 1 Select "Screen Format".



- 2 Select the desired screen format to be set.

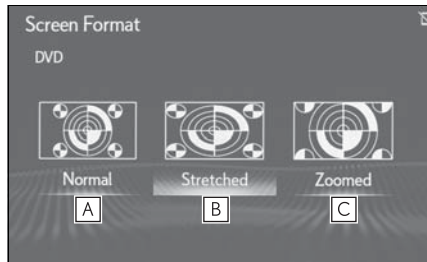

- A** Select to display a 4 : 3 screen, with either side in black.
- B** Select to enlarge the image horizontally and vertically to full screen.
- C** Select to enlarge the image by the same ratio horizontally and vertically.

**Contrast, brightness, color and tone adjustment**

The brightness, contrast, color and tone of the screen can be adjusted.

- 1 Select "Display".
- 2 Select the desired item to be adjusted.
  - "Color"  
Select "R" or "G" to adjust the red and green color of the screen.
  - "Tone"  
Select "+" or "-" to adjust the tone of the screen.
  - "Contrast"  
Select "+" or "-" to adjust the contrast of the screen.
  - "Brightness"  
Select "+" or "-" to adjust the brightness of the screen.

**Radio settings**

- 1 Display the audio settings screen:
  - "MENU" button → "Setup" → "Audio" on the sub menu
- 2 Select "Radio".
- 3 Select the desired item to be set.

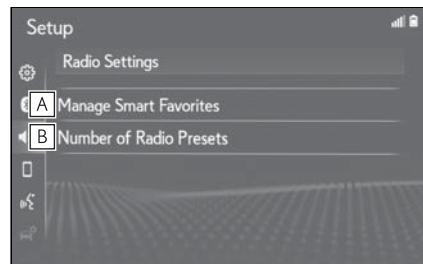

- A** Edit smart favorites. (→P.137)
- B** Select to change the number of preset radio stations displayed on the screen. (→P.138)

**Manage smart favorites**

- 1 Select "Manage Smart Favorites".
- 2 Select the desired channel to be set.

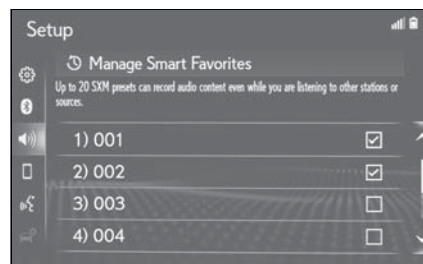

- Displays the registered preset channels.
- Up to 20 channels can be registered.

4 Audio/visual system

**Setting the number of radio presets**

- 1 Select "Number of Radio Presets".
- 2 Select the button with the desired number to be displayed.

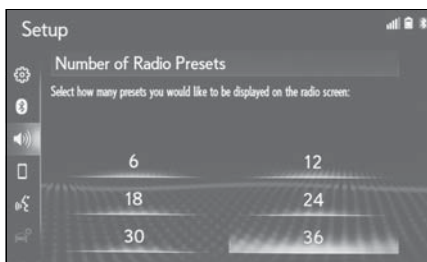

**DVD settings**

- 1 Display the audio settings screen:
  - "MENU" button → "Setup" →  "Audio" on the sub menu
- 2 Select "DVD".
- 3 Select the desired items to be set.

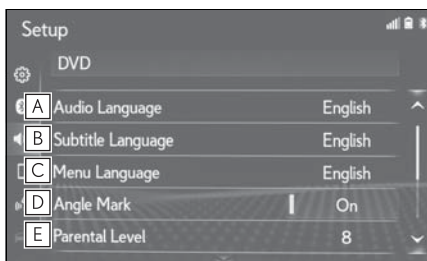

- A** Select to change the audio language.

- B** Select to change the subtitle language.
- C** Select to change the language of the DVD video menu.
- D** Select to set the angle mark on/off.
- E** Select to set the parental lock. (→P.138)
- F** Select to set the auto start playback on/off.  
Discs that are inserted while the vehicle is in motion will automatically start playing. Certain discs may not play.
- G** Select to set a dynamic range. (→P.138)
- H** Select to initialize all menus.

**Parental lock**

- 1 Select "Parental Level".
- 2 Enter the 4-digit personal code.
- 3 Select a parental level (1-8).

**Sound dynamic range**

The difference between the lowest volume and the highest volume can be adjusted.

- 1 Select "Sound Dynamic Range".
- 2 Select "MAX", "MID" or "MIN".

**Enter audio/subtitle/menu language**

If "Other" on the "Audio Language" screen, "Subtitle Language" screen or "Menu Language" screen is selected, the desired language to be heard or read can be selected by entering a lan-

guage code.

- 1** Enter the 4-digit language code.  
(→P.139)
- 2** Select "OK".

#### Language codes list

Code	Language
0514	English
1001	Japanese
0618	French
0405	German
0920	Italian
0519	Spanish
2608	Chinese
1412	Dutch
1620	Portuguese
1922	Swedish
1821	Russian
1115	Korean
0512	Greek
0101	Afar
0102	Abkhazian
0106	Afrikaans
0113	Amharic
0118	Arabic
0119	Assamese
0125	Aymara
0126	Azerbaijani
0201	Bashkir
0205	Belorussian

Code	Language
0207	Bulgarian
0208	Bihari
0209	Bislama
0214	Bengali, Bangla
0215	Tibetan
0218	Breton
0301	Catalan
0315	Corsican
0319	Czech
0325	Welsh
0401	Danish
0426	Bhutani
0515	Esperanto
0520	Estonian
0521	Basque
0601	Persian
0609	Finnish
0610	Fiji
0615	Faroese
0625	Frisian
0701	Irish
0704	Scottish-Gaelic
0712	Galician
0714	Guarani
0721	Gujarati
0801	Hausa
0809	Hindi
0818	Croatian
0821	Hungarian

Code	Language
0825	Armenian
0901	Interlingua
0905	Interlingue
0911	Inupiak
0914	Indonesian
0919	Icelandic
0923	Hebrew
1009	Yiddish
1023	Javanese
1101	Georgian
1111	Kazakh
1112	Greenlandic
1113	Cambodian
1114	Kannada
1119	Kashmiri
1121	Kurdish
1125	Kirghiz
1201	Latin
1214	Lingala
1215	Laotian
1220	Lithuanian
1222	Latvian, Lettish
1307	Malagasy
1309	Maori
1311	Macedonian
1312	Malayalam
1314	Mongolian
1315	Moldavian
1318	Marathi

Code	Language
1319	Malay
1320	Maltese
1325	Burmese
1401	Nauru
1405	Nepali
1415	Norwegian
1503	Occitan
1513	(Afan) Oromo
1518	Oriya
1601	Punjabi
1612	Polish
1619	Pashto, Pushto
1721	Quechua
1813	Rhaeto-Romance
1814	Kirundi
1815	Romanian
1823	Kinyarwanda
1901	Sanskrit
1904	Sindhi
1907	Sango
1908	Serbo-Croatian
1909	Sinhalese
1911	Slovak
1912	Slovenian
1913	Samoan
1914	Shona
1915	Somali
1917	Albanian
1918	Serbian

Code	Language
1919	Siswati
1920	Sesotho
1921	Sundanese
1923	Swahili
2001	Tamil
2005	Telugu
2007	Tajik
2008	Thai
2009	Tigrinya
2011	Turkmen
2012	Tagalog
2014	Setswana
2015	Tongan
2018	Turkish
2019	Tsonga
2020	Tatar
2023	Twi
2111	Ukrainian
2118	Urdu
2126	Uzbek
2209	Vietnamese
2215	Volapük
2315	Wolof
2408	Xhosa
2515	Yoruba
2621	Zulu

### Operating information

- The use of a cellular phone inside or near the vehicle may cause a noise from the speakers of the audio/visual system which you are listening to. However, this does not indicate a malfunction.



#### NOTICE

- To avoid damage to the audio/visual system:
  - Be careful not to spill beverages over the audio/visual system.
  - Do not put anything other than an appropriate disc into the disc slot.

### Radio

Usually, a problem with radio reception does not mean there is a problem with the radio — it is just the normal result of conditions outside the vehicle.

For example, nearby buildings and terrain can interfere with FM reception. Power lines or phone wires can interfere with AM signals. And of course, radio signals have a limited range. The farther the vehicle is from a station, the weaker its signal will be. In addition, reception conditions change constantly as the vehicle moves.

Here, some common reception problems that probably do not indicate a problem with the radio are described.

#### ■ FM

**Fading and drifting stations:** Generally, the effective range of FM is about 25 miles (40 km). Once outside this range, you may notice fading and drifting, which increase with the distance

from the radio transmitter. They are often accompanied by distortion.

**Multi-path:** FM signals are reflective, making it possible for 2 signals to reach the vehicle's antenna at the same time. If this happens, the signals will cancel each other out, causing a momentary flutter or loss of reception.

**Static and fluttering:** These occur when signals are blocked by buildings, trees or other large objects. Increasing the bass level may reduce static and fluttering.

**Station swapping:** If the FM signal being listened to is interrupted or weakened, and there is another strong station nearby on the FM band, the radio may tune in the second station until the original signal can be picked up again.

#### ■ AM

**Fading:** AM broadcasts are reflected by the upper atmosphere — especially at night. These reflected signals can interfere with those received directly from the radio station, causing the radio station to sound alternately strong and weak.

**Station interference:** When a reflected signal and a signal received directly from a radio station are very nearly the same frequency, they can interfere with each other, making it difficult to hear the broadcast.

**Static:** AM is easily affected by external sources of electrical noise, such as high tension power lines, lightening or electrical motors. This results in static.

■ **SiriusXM**

- Cargo loaded on the roof luggage carrier, especially metal objects, may adversely affect the reception of SiriusXM Satellite Radio.
- Alternation or modifications carried out without appropriate authorization may invalidate the user's right to operate the equipment.

**CD/DVD player and disc**

- This CD/DVD player is intended for use with 4.7 in. (12 cm). discs only.
- Extremely high temperatures can keep the CD/DVD player from working. On hot days, use the air conditioning system to cool the inside of the vehicle before using the player.
- Bumpy roads or other vibrations may make the CD/DVD player skip.
- If moisture gets into the CD/DVD player, the discs may not be able to be played. Remove the discs from the player and wait until it dries.

**⚠ WARNING**

- The CD/DVD player uses an invisible laser beam which could cause hazardous radiation exposure if directed outside the unit. Be sure to operate the player correctly.

■ **Discs that can be used**

Audio CDs	
DVD video discs	
DVD-R/RW discs	

- Use only discs marked as shown above. The following products may not be playable on your player:
  - SACD
  - dts CD
  - Copy-protected CD
  - DVD-Audio
  - Video CD
  - DVD-RAM
- DVD logo is a trademark of DVD Format/Logo Licensing Corporation.

- Handle discs carefully, especially when inserting them. Hold them on the edge and do not bend them. Avoid getting fingerprints on them, particularly on the shiny side.



- Dirt, scratches, warping, pin holes or other disc damage could cause the player to skip or to repeat a section of a track. (To see a pin hole, hold the disc up to the light.)
- Remove discs from the players when not in use. Store them in their plastic cases away from moisture, heat and direct sunlight.
- To clean a disc: Wipe it with a soft, lint-free cloth that has been dampened with water. Wipe in a straight line from the center to the edge of the disc (not in circles). Dry it with another soft, lint-free cloth. Do not use a conventional record cleaner or anti-static device.

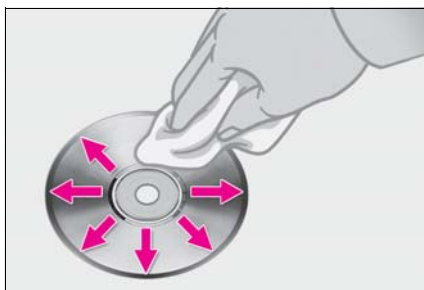

 NOTICE

- Do not use special shaped, transparent/translucent, low quality or labeled discs such as those shown in the illustrations. The use of such discs may damage the player, or it may be impossible to eject the disc.

- Special shaped discs

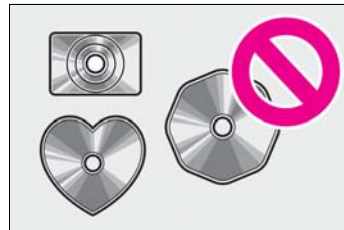

- Transparent/translucent discs

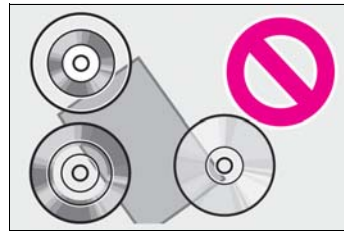

- Low quality discs

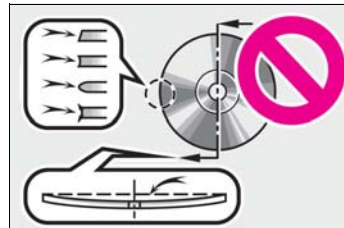

- Labeled discs





**NOTICE**

- This system is not designed for use of Dual Discs. Do not use Dual Discs because they may cause damage to the player.
- Do not use discs with a protection ring. The use of such discs may damage the player, or it may be impossible to eject the disc.
- Do not use printable discs. The use of such discs may damage the player, or it may be impossible to eject the disc.

**■ CD-R/RW and DVD-R/RW discs**

- CD-R/CD-RW discs that have not been subject to the “finalizing process” (a process that allows discs to be played on a conventional CD player) cannot be played.
- It may not be possible to play CD-R/CD-RW discs recorded on a music CD recorder or a personal computer because of disc characteristics, scratches or dirt on the disc, or dirt, condensation, etc. on the lens of the unit.
- It may not be possible to play discs recorded on a personal computer depending on the application settings and the environment. Record with the correct format. (For details, contact the appropriate application manufacturers of the applications.)
- CD-R/CD-RW discs may be damaged by direct exposure to sunlight, high temperatures or other storage conditions. The unit may be unable to play some damaged discs.
- If you insert a CD-RW disc into the player, playback will begin more

slowly than with a conventional CD or CD-R disc.

- Recordings on CD-R/CD-RW cannot be played using the DDCD (Double Density CD) system.

**■ DVD video discs**





This DVD player conforms to NTSC/PAL color TV formats. DVD video discs conforming to another format such as SECAM cannot be used.

Region codes: Some DVD video discs have the following region code indicating which countries the DVD video disc can be played in on this DVD player. If you attempt to play an inappropriate DVD video disc on this player, error message appears on the screen. Even if the DVD video disc does not have a region code, there are cases when it cannot be used.

Code	Country
ALL	All countries
1	North America

**▶ Marks shown on DVD video discs**

	Indicates NTSC/PAL format of color TV.
	Indicates the number of audio tracks.
	Indicates the number of language subtitles.

	Indicates the number of angles.
	Indicates the screen to be selected. Wide screen: 16:9 Standard: 4:3
	
	Indicates a region code by which this video disc can be played. "ALL": in all countries Number: region code
	

#### ■ DVD video disc glossary

DVD video discs: Digital Versatile Disc that holds video. DVD video discs have adopted "MPEG2", one of the world standards of digital compression technologies. The picture data is compressed by 1/40 on average and stored. Variable rate encoded technology in which the volume of data assigned to the picture is changed depending on the picture format has also been adopted. Audio data is stored using PCM and Dolby Digital, which enables higher quality of sound. Furthermore, multi-angle and multi-language features will also help users enjoy the more advanced technology of DVD video.

Viewer restrictions: This feature limits what can be viewed in conformity with a level of restrictions of the country. The level of restrictions varies depending on the DVD video disc. Some DVD

video discs cannot be played at all, or violent scenes are skipped or replaced with other scenes.

- Level 1: DVD video discs for children can be played.
- Level 2 - 7: DVD video discs for children and G-rated movie can be played.
- Level 8: All types of the DVD video discs can be played.

Multi-angle feature: The same scene can be enjoyed from different angles.

Multi-language feature: The subtitle and audio language can be selected.

Region codes: The region codes are provided on DVD players and DVD discs. If the DVD video disc does not have the same region code as the DVD player, you cannot play the disc on the DVD player. For region codes: (→P.145)

Audio: This DVD player can play linear PCM, Dolby Digital and MPEG audio format DVDs. Other decoded types cannot be played.

Title and chapter: Video and audio programs stored in DVD video discs are divided into parts by title and chapter.

Title: The largest unit of the video and audio programs stored on DVD video discs. Usually, one movie, one album, or one audio program is assigned as a title.

Chapter: A unit smaller than that of title. A title comprises of several chapters.

#### ■ Certification

- Manufactured under license from Dolby Laboratories. Dolby, Dolby Audio, Pro Logic, and the double-D symbol are trademarks of Dolby Laboratories.

#### iPod

- “Made for iPod” and “Made for iPhone” mean that an electronic accessory has been designed to connect specifically to iPod or iPhone, respectively, and has been certified by the developer to meet Apple performance standards.

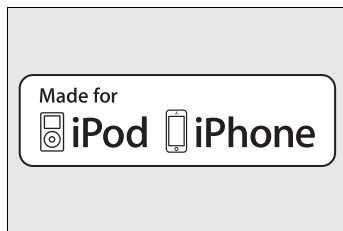

- Apple is not responsible for the operation of this device or its compliance with safety and regulatory standards. Please note that the use of this accessory with iPod or iPhone, may affect wireless performance.
- iPhone, iPod, iPod classic, iPod nano, and iPod touch are trademarks of Apple Inc., registered in the U.S. and other countries. Lightning is a trademark of Apple Inc.
- The Lightning connector works with iPhone 6s Plus, iPhone 6s, iPhone SE, iPhone 6 Plus, iPhone 6, iPhone 5s, iPhone 5c, iPhone 5, iPod touch (5th and 6th generation), and iPod nano (7th generation).

- The 30-pin connector works with iPhone 4S, iPhone 4, iPhone 3GS, iPhone 3G, iPhone, iPod touch (1st through 4th generation), iPod classic, and iPod nano (1st through 6th generation).
- USB works with iPhone 6s Plus, iPhone 6s, iPhone SE, iPhone 6 Plus, iPhone 6, iPhone 5s, iPhone 5c, iPhone 5, iPhone 4S, iPhone 4, iPhone 3GS, iPhone 3G, iPhone, iPod touch (1st through 6th generation), iPod classic, and iPod nano (1st through 7th generation).
- Bluetooth<sup>®</sup> technology works with iPhone 6s Plus, iPhone 6s, iPhone SE, iPhone 6 Plus, iPhone 6, iPhone 5s, iPhone 5c, iPhone 5, iPhone 4S, iPhone 4, iPhone 3GS, iPhone 3G, iPhone, iPod touch (2nd through 6th generation) and iPod nano (7th generation).

#### ■ Compatible models

The following iPod<sup>®</sup>, iPod nano<sup>®</sup>, iPod classic<sup>®</sup>, iPod touch<sup>®</sup> and iPhone<sup>®</sup> devices can be used with this system.

Made for

- iPod touch (6th generation)
- iPod touch (5th generation)
- iPod touch (4th generation)\*
- iPod touch (3rd generation)\*
- iPod touch (2nd generation)\*
- iPod touch (1st generation)\*
- iPod nano (7th generation)
- iPod nano (6th generation)\*
- iPod nano (5th generation)\*
- iPod nano (4th generation)\*
- iPhone SE
- iPhone 6s Plus

- iPhone 6s
- iPhone 6 Plus
- iPhone 6
- iPhone 5s
- iPhone 5c
- iPhone 5
- iPhone 4s
- iPhone 4\*
- iPhone 3GS\*
- iPhone 3G\*

\* : 10.3-inch display model

- This system only supports audio playback.
- Depending on differences between models or software versions etc., some models might be incompatible with this system.
- iPod classic
- iPod with video
- iPod nano (3rd generation)
- iPod nano (2nd generation)
- iPod nano (1st generation)
- iPhone

### High-resolution sound source

This device supports high-resolution sound sources.

The definition of high-resolution is based on the standards of groups such as the CTA (Consumer Technology Association).

Supported formats and playable media are as follows.

#### ■ Supported formats

WAV, FLAC, ALAC, OGG Vorbis

#### ■ Playable media

USB

### File information

#### Compatible USB devices

USB communication formats	USB 2.0 HS (480 Mbps)
File formats	FAT 16/32
Correspondence class	Mass storage class

#### Compatible audio format

#### Compatible compressed files

##### ■ Compatible file format (audio)

USB	DISC
MP3/WMA/AAC	MP3/WMA/AAC
WAV(LPCM)/ FLAC/ALAC/ OGG Vorbis	

##### ■ Folders in the device

USB	DISC
Maximum 3000	Maximum 192

##### ■ Files in the device

USB	DISC
Maximum 9999	Maximum 255

##### ■ Files per folder

USB	DISC
Maximum 255	—

Corresponding sampling frequency		Corresponding bit rates <sup>*1</sup>	
File type	Frequency (kHz)	File type	Bit rate (kbps)
MP3 files: MPEG 1 LAYER 3	32/44.1/48	MP3 files: MPEG 1 LAYER 3	32 - 320
MP3 files: MPEG 2 LSF LAYER 3	16/22.05/24	MP3 files: MPEG 2 LSF LAYER 3	8 - 160
WMA files: Ver. 7, 8, 9 <sup>*1</sup> (9.1/9.2)	32/44.1/48	WMA files: Ver. 7, 8	CBR 48 - 192
AAC files: MPEG4/AAC-LC	11.025/12/16/ 22.05/24/32/ 44.1/48	WMA files: Ver. 9 <sup>*2</sup> (9.1/9.2)	CBR 48 - 320
WAV (LPCM) files <sup>*2</sup>	8/11.025/12/16/ 22.05/24/32/ 44.1/48/88.2/96/ 176.4/192	AAC files: MPEG4/AAC-LC	8 - 320
FLAC <sup>*2</sup>	8/11.025/12/16/ 22.05/24/32/ 44.1/48/88.2/96/ 176.4/192	OGG Vorbis	32 - 500
ALAC <sup>*2</sup>	8/11.025/12/16/ 22.05/24/32/ 44.1/48/64/88.2/ 96	<sup>*1</sup> : Variable Bit Rate (VBR) compatible	
OGG Vorbis <sup>*2</sup>	8/11.025/16/ 22.05/32/44.1/48	<sup>*2</sup> : Only compatible with Windows Media Audio Standard	

File type	Quantization bit rate (bit)
WAV (LPCM) files	16/24
FLAC	
ALAC	

  

Compatible channel modes	
File type	Channel mode
MP3 files	Stereo, joint stereo, dual channel and monaural
WMA files	2ch
AAC files	1ch, 2ch (Dual chan- nel is not supported)
WAV (LPCM) /FLAC/ALAC/OG G Vorbis	2CH

<sup>\*1</sup>: Only compatible with Windows Media Audio Standard

<sup>\*2</sup>: Sound source of 48kHz or more is down-converted to 48kHz/24bit.

- MP3 (MPEG Audio Layer 3), WMA (Windows Media Audio) and AAC (Advanced Audio Coding) are audio compression standards.
- This system can play MP3/WMA/AAC files on CD-R/CD-RW/DVD-R/DVD-RW discs and USB memory.
- This system can play disc recordings compatible with ISO 9660 level 1 and level 2 and with the Romeo and Joliet file system and UDF (2.01 or lower).
- When naming an MP3/WMA/AAC file, add an appropriate file extension (.mp3/.wma/.m4a).
- This system plays back files with .mp3/.wma/.m4a file extensions as MP3/WMA/AAC files respectively. To prevent noise and playback errors, use the appropriate file extension.
- This system can play only the first session/border when using multi session/border compatible discs.
- MP3 files are compatible with the ID3 Tag Ver. 1.0, Ver. 1.1, Ver. 2.2 and Ver. 2.3 formats. This system cannot display disc title, track title and artist name in other formats.
- WMA/AAC files can contain a WMA/AAC tag that is used in the same way as an ID3 tag. WMA/AAC tags carry information such as track title and artist name.
- The emphasis function is available only when playing MP3 files.
- This system can play back AAC files encoded by iTunes.
- The sound quality of MP3/WMA files generally improves with higher bit rates. In order to achieve a reasonable level of sound quality, discs recorded with a bit rate of at least 128 kbps are recommended.
- m3u playlists are not compatible with the audio player.
- MP3i (MP3 interactive) and MP3-PRO formats are not compatible with the audio player.
- The player is compatible with VBR (Variable Bit Rate).
- When playing back files recorded as VBR (Variable Bit Rate) files, the play time will not be correctly displayed if the fast forward or reverse operations are used.
- It is not possible to check folders that do not include MP3/WMA/AAC files.
- MP3/WMA/AAC files in folders up to 8 levels deep can be played. However, the start of playback may be delayed when using discs containing numerous levels of folders. For this reason, we recommend creating discs with no more than 2 levels of folders.

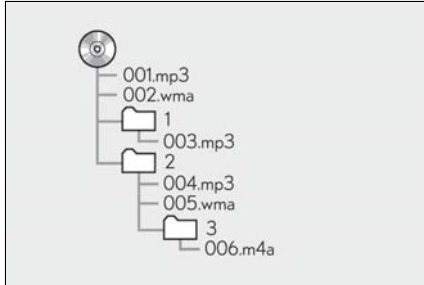

- The play order of the compact disc with the structure shown above is as follows:

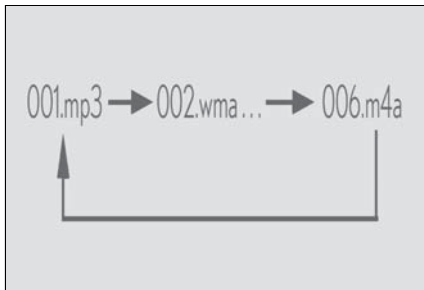

- The order changes depending on the personal computer and MP3/WMA/AAC encoding software you use.

**Compatible video format**

Format	Codec
MPEG-4	Video codec: <ul style="list-style-type: none"> <li>• H.264 MPPEG-4 AVC</li> <li>• MPEG4</li> </ul> Audio codec: <ul style="list-style-type: none"> <li>• AAC</li> <li>• MP3</li> </ul> Corresponding screen size: <ul style="list-style-type: none"> <li>• MAX 1920×1080</li> </ul> Corresponding frame rate: <ul style="list-style-type: none"> <li>• MAX 60i/30p</li> </ul>

4  
Audio/visual system

Format	Codec
AVI Container	Video codec: <ul style="list-style-type: none"> <li>• H.264/MPEG-4 AVC</li> <li>• MPEG4</li> <li>• WMV9</li> <li>• WMV9 Advanced profile</li> </ul> Audio codec: <ul style="list-style-type: none"> <li>• AAC</li> <li>• MP3</li> <li>• WMA9.2 (7,8,9,1,9.2)</li> </ul> Corresponding screen size: <ul style="list-style-type: none"> <li>• MAX 1920×1080</li> </ul> Corresponding frame rate: <ul style="list-style-type: none"> <li>• MAX 60i/30p</li> </ul>
Windows Media Video	Video codec: <ul style="list-style-type: none"> <li>• WMV9</li> <li>• WMV9 Advanced profile</li> </ul> Audio codec: <ul style="list-style-type: none"> <li>• WMA9.2 (7,8,9,1,9.2)</li> </ul> Corresponding screen size: <ul style="list-style-type: none"> <li>• MAX 1920×1080</li> </ul> Corresponding frame rate: <ul style="list-style-type: none"> <li>• MAX 60i/30p</li> </ul>

### Terms

#### ■ Packet write

- This is a general term that describes the process of writing data on-

demand to CD-R, etc., in the same way that data is written to floppy or hard discs.

#### ■ ID3 tag

- This is a method of embedding track-related information in an MP3 file. This embedded information can include the track number, track title, the artist's name, the album title, the music genre, the year of production, comments, cover art and other data. The contents can be freely edited using software with ID3 tag editing functions. Although the tags are restricted to a number of characters, the information can be viewed when the track is played back.

#### ■ WMA tag

- WMA files can contain a WMA tag that is used in the same way as an ID3 tag. WMA tags carry information such as track title and artist name.

#### ■ ISO 9660 format

- This is the international standard for the formatting of CD-ROM folders and files. For the ISO 9660 format, there are 2 levels of regulations.
- Level 1: The file name is in 8.3 format (8 character file names, with a 3 character file extension. File names must be composed of one-byte capital letters and numbers. The "\_" symbol may also be included.)
- Level 2: The file name can have up to 31 characters (including the separation mark "." and file extension). Each folder must contain fewer than



8 hierarchies.

#### ■ MP3

- MP3 is an audio compression standard determined by a working group (MPEG) of the ISO (International Standard Organization). MP3 compresses audio data to about 1/10 the size of that on conventional discs.

#### ■ WMA

- WMA (Windows Media Audio) is an audio compression format developed by Microsoft®. It compresses files into a size smaller than that of MP3 files. The decoding formats for WMA files are Ver. 7, 8 and 9.
- This product is protected by certain intellectual property rights of Microsoft Corporation and third parties. Use or distribution of such technology outside of this product is prohibited without a license from Microsoft or an authorized Microsoft subsidiary and third parties.

#### ■ AAC

- AAC is short for Advanced Audio Coding and refers to an audio compression technology standard used with MPEG2 and MPEG4.

### Error messages

#### ■ CD/DVD

Message	Explanation
"Check disc"	It indicates that the disc is dirty, damaged, or it was inserted upside down. Clean the disc or insert it correctly.  It indicates a disc which is not playable is inserted.
"DISC Error"	There is a trouble inside the system. Eject the disc.
"Region Code Error"	It indicates that the DVD region code is not set properly.

#### ■ USB

Message	Explanation
"USB Error"	This indicates a problem in the USB memory or its connection.
"No music files found."	This indicates that no MP3/WMA/AAC files are included in the USB memory.
"No video files found."	This indicates that no video files are included in the USB memory.

■ iPod

Message	Explanation
"iPod Error."	This indicates a problem in the iPod or its connection.
"No music files found."	This indicates that there is no music data in the iPod.
"Please check the iPod firmware version."	This indicates that the software version is not compatible. Perform the iPod firmware updates and try again.
"iPod authorization failed."	This indicates that it failed to authorize the iPod. Please check your iPod.

■ Bluetooth® Audio

Message	Explanation
"Music tracks not supported. Please check your portable player."	This indicates a problem in the Bluetooth® device.

- If the malfunction is not rectified: Take your vehicle to your Lexus dealer.

Voice command system

5

155

5-1. Voice command system operation

Voice command system..... 156

Natural language understanding ..... 159

Command list ..... 159

5-2. Mobile Assistant operation

Mobile Assistant..... 164

5

Voice command system

## Voice command system

The voice command system enables the radio, phone dialing, etc. to be operated using voice commands. Refer to the command list for samples of voice commands. (→P.159)

## Using the voice command system

### ■ Talk switch

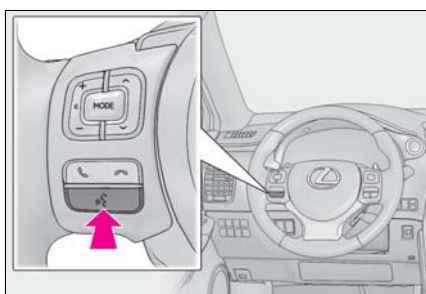

- Press the talk switch to start the voice command system.
- To cancel voice command, press and hold the talk switch.

### ■ Microphone

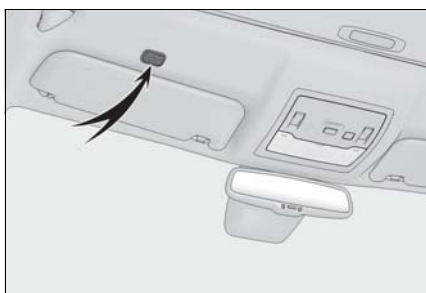

- It is unnecessary to speak directly into the microphone when giving a command.

- Voice commands may not be recognized if:
  - Spoken too quickly.
  - Spoken at a low or high volume.
  - The roof or windows are open.
  - Passengers are talking while voice commands are spoken.
  - The fan speed of the air conditioning system is set at high.
  - The air conditioning vents are turned towards the microphone.
- In the following conditions, the system may not recognize the command properly and using voice commands may not be possible:
  - The command is incorrect or unclear. Note that certain words, accents or speech patterns may be difficult for the system to recognize.
  - There is excessive background noise, such as wind noise.
- Normally, it is necessary to wait for a beep before saying a command. To enable the ability to talk over prompts and say commands before the beep, enable the voice prompt interrupt function. (→P.56)
- This system may not operate immediately after the engine switch <power switch> is in ACCESSORY or IGNITION ON mode <ON mode>.

### ⚠ NOTICE

- Do not touch and put a sharp object to the microphone. It may cause failure.

## Voice command system operation

The voice command system is operated by saying commands which correspond to a supported function. To display examples of commands for supported functions, select a function button on the screen after starting the voice command system.

### Operation from the main menu

- 1 Press the talk switch.

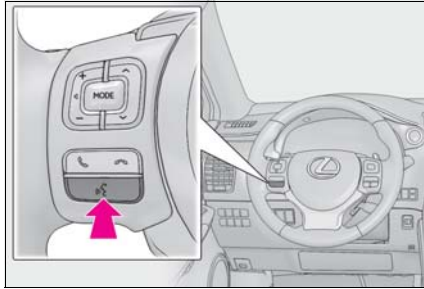

- Voice guidance for the voice command system can be skipped by pressing the talk switch.
- 2 If "Getting Started with Voice" screen is displayed, select "OK" or press the talk switch.
  - 3 After hearing a beep, say a supported command.
    - To display sample commands of the desired function, say the desired function or select the desired function button. To display more commands, select "More Commands".
    - Selecting "Help" or saying "Help" prompts the voice command system to offer examples of commands and operation methods.
    - Registered POIs, registered names in the contacts list etc., can be said in the place of the "<>" next to the commands. (→P.159)

For example: Say "Find a restaurant", "Call John Smith" etc.

- If a desired outcome is not shown, or if no selections are available, say "Go back" to return to the previous

screen.

- To cancel voice recognition, select , say "Cancel", or press and hold the talk switch.
  - To perform the voice command operation again, select "Start Over" or say "Start over".
  - To suspend voice command operation, select "Pause". To resume the voice command operation, select "Resume" or press the talk switch.
- 
- If the system does not respond or the confirmation screen does not disappear, press the talk switch and try again.
  - If a voice command cannot be recognized, voice guidance will say "Sorry, could you repeat that?" and voice command reception will restart.
  - If a voice command cannot be recognized 3 consecutive times, voice recognition will be canceled.
  - The amount of spoken feedback received from the system while using the voice command system (voice recognition prompts) can be changed on the voice settings screen. (→P.56)
  - Some voice guidance can be canceled by setting voice prompts to off. Use this setting when it is desirable to say a command immediately after pressing the talk switch and hearing a beep.

### Increasing the voice recognition performance

To increase voice recognition performance, use the "Tutorials" and "Voice Training" functions on the "Getting Started with Voice" screen. These functions are only available when the vehicle is not moving.

The "Tutorials" and "Voice Training"

functions can also be started on the voice settings screen. (→P.56)

- 1 Press the talk switch.
- 2 Select the desired item.

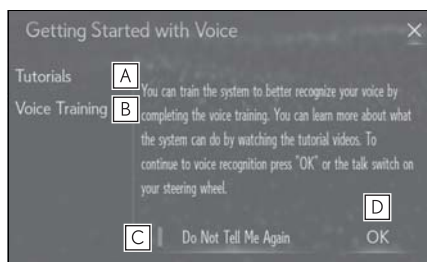

- A** Select to display the voice command tutorials.
- B** Select to train the voice command system.  
The user will be asked to say 10 sample phrases. This will help the voice command system adapt to the user's accent.
- C** Select to prevent the screen from being displayed again.
- D** Select to proceed to the voice command screen.

**Dictation function (English only)\***

\*: 10.3-inch display model

Text messages can be written using the dictation function.

To use the dictation function, a subscription to the Lexus Enform is necessary. Contact your Lexus dealer for details.

- 1 Select .



- 2 Speak to the system.

- Words recognized through your speech will be displayed. To confirm the entered text, select "OK".
- A keyboard screen will not be displayed when the vehicle is being driven.
- Text message reply with the dictation function may not be available depending on the type of cellular phone.

## Natural language understanding\*

\*: 10.3-inch display model

Due to natural language speech recognition technology, this system recognizes commands when spoken naturally. (If a Lexus Enform subscription has been entered, the system will be able to connect to the Lexus Enform center and the range of naturally spoken English which can be recognized will be increased.) However, the system cannot recognize every variation of each command. In some situations, it is possible to omit the command for the procedure and directly state the desired operation. Not all voice commands are displayed in the function menu.

To use this function, a subscription to the Lexus Enform is necessary. Contact your Lexus dealer for details.

## Command list

### Command list overview

Recognizable voice commands and their actions are shown below.

- Frequently used commands are listed in the following tables.
- For devices that are not installed to the vehicle, commands relating to that device may not be displayed on the screen. Also, depending on other conditions, such as compatibility, some commands may not be displayed on the screen.
- The functions available may vary according to the system installed.
- Voice recognition language can be changed. (→P.53)

### Command list

#### ■ Common

Command	Action
"Help"	Displays examples of some of the available commands
"Go Back"	Returns to the previous screen
"Cancel"	Cancels the voice command system

Command	Action
"Start over"	Returns to top menu screen
"Pause"	Temporarily pauses a voice session until it is resumed by pressing the talk switch again.

### ■ Top menu

Command	Action
"Show command examples for <menu>"	Displays the command list of the selected menu
"More Commands"	Displays more commonly used commands
"Voice Settings"	Displays Voice Setting screen
"Train my voice"	Displays Train Voice Recognition screen *

\*: Vehicle must be parked

### ■ Navigation \*1

Command	Action
"Get directions to <house #, street, city, state>"*2	Enables setting a destination by saying the address *3,4
"Find a <POI category/POI name>"	Displays a list of <POI category *5/POI name *6> near the current position
"Find a <POI> near my destination"	Displays a list of <POI> near the destination

Command	Action
"Find a <POI category> in a city"*2	Displays a list of <POI> in a specified city and state *4
"Go Home"	Displays the route to home
"Go to Favorite <1-5>"	Sets the location registered to the corresponding favorite number as the destination
"Show Recent Destinations"	Displays recent destinations. Selecting a number from the list will start navigation to the selected recent destination.
"Cancel Route"	Cancels the route guidance
"Delete destinations"	Displays a list of destination to delete *7
"Show <POI category> icons"	Displays the specified point of interest category *5 icons on the map
"Destination Assist"	Connects the system to the Lexus response center

\*1: 10.3-inch display model

\*2: English and French only

\*3: Best recognition results occur when saying the full address without the zip code

\*4: When the language is set to french, the supported area is only Quebec Province in Canada

\*5: For example; "Gas stations", "Restaurants", etc.



\*6: Major national brands are always supported. Local brands are also supported with a subscription to the Lexus Enform. Contact your Lexus dealer for details.

\*7: Used when multiple destinations are set on a route

#### ■ Phone

Command	Action
"Call <contact>"*	Places a call to the specified contact from the phone book
"Call <contact> <phonetype>"*	Places a call to the specified phone type of the contact from the phone book
"Dial <phone number>"	Places a call to the specified phone number
"Redial"	Places a call to the phone number of the latest outgoing call
"Call Back"	Places a call to the phone number of latest incoming call
"Show Recent Calls"	Displays the call history screen
"Send a message to <contacts>"	Sends a text message to specified contact from the phone book

\*: If the system does not recognize the name of a contact, create a voice tag. (→P.239) The name of a contact can also be recognized by adding a voice tag.

#### ■ While in a phone call

Command	Action
"Send <digits>"	Sends DTMF tones has specified
"Mute"	Mutes the microphone (far side cannot hear the conversation)
"Unmute"	Unmutes the microphone

#### ■ While incoming message notification is displayed

Command	Action
"Read Message"	Reads the incoming message over the vehicle speakers
"Ignore"	Ignores the incoming message notification
"Reply"	Initiates sending a reply to the incoming message
"Call"	Places a call to the phone number of incoming message

#### ■ Radio

Command	Action
"Tune to <frequency> AM"	Changes the radio to the specified AM frequency
"Tune to <frequency> FM"	Changes the radio to the specified FM frequency
"Play a <genre> station"	Changes the radio to an FM station of the specified genre*1

Command	Action
"Tune to preset <1-36>"	Changes the radio to the specified preset radio station
"Tune to a <genre> satellite station"	Changes the radio to a satellite radio channel of the specified genre <sup>*2</sup>
"Tune to <satellite channel name>"	Changes the radio to the satellite radio channel with the specified name <sup>*2</sup>
"Tune to channel <number> on XM"	Changes the radio to a satellite radio channel of the specified number <sup>*2</sup>

\*1: A station list must be built first using the radio screen (→P.111)

\*2: Requires a satellite radio subscription

#### ■ Audio<sup>\*</sup>

Command	Action
"Play Playlist <name>"	Plays tracks from the selected playlist
"Play Artist <name>"	Plays tracks from the selected artist
"Play Song <name>"	Plays the selected track
"Play Album <name>"	Plays tracks from the selected album
"Play Genre <name>"	Plays tracks from the selected genre
"Play Composer <name>"	Plays tracks from the selected composer
"Play Podcast <name>"	Plays tracks from the selected podcast

Command	Action
"Play Audiobook <name>"	Plays tracks from the selected audiobook
"Audio On"	Turns the audio system on
"Audio Off"	Turns the audio system off
"Change the audio source to <source name>"	Sets the source to the specified audio mode

\*: The audio device must be connected via a USB cable to use the functionality in this section

#### ■ Information<sup>\*1</sup>

Command	Action
"Get the Forecast"	Displays weather information
"Get the Forecast for <city>" <sup>*2</sup>	Displays weather for the specified city
"Show Traffic"	Displays traffic information
"Show Traffic near here"	Displays traffic information near your current location
"Show Traffic along route"	Displays traffic information along your current route
"Show Traffic on this street"	Displays traffic information along road you are currently driving on
"Show Traffic for saved route"	Displays traffic information for a saved route
"Show Predictive Traffic"	Displays the predictive traffic map

\*1: This function is not made available in some countries, areas, or on some models.

\*2: Only major US cities are supported by voice

#### ■ Apps \*

Command	Action
"Launch <apps>"	Activates the Lexus Enform App Suite 2.0 application

\*: When an application is opened and is in full screen mode, pressing the talk switch will start the voice command system and commands for the currently displayed application will be available.

#### ■ Air conditioning

Command	Action
"Turn the AC on/Turn the AC off"	Turns air conditioning system on or off
"Change the Fan speed to <#>"	Changes the set fan speed of the air conditioning system to <#>
"Set temperature to <#> degrees"	Changes the set temperature of the air conditioning system to <#> degrees *
"Increase Temperature/ Decrease Temperature"	Increases or decreases the temperature of the air conditioning system
"Increase Fan speed/Decrease Fan Speed"	Increases or decreases the fan speed of the air conditioning system

\*: Only within the possible temperature range of the air conditioning system

- Commands relating to operation of the audio/visual system can only be performed when the audio/visual system is turned on.

## Mobile Assistant

The Mobile Assistant function is a voice input assist function. Mobile Assist supports the Siri Eyes Free Mode and Google App. Instructions can be spoken into the vehicle microphone as if speaking a command to the phone. The content of the request is then interpreted by the phone and the result is output from the vehicle speakers. To operate the Mobile Assistant, a compatible device must be registered and connected to this system via Bluetooth®. (→P.39)

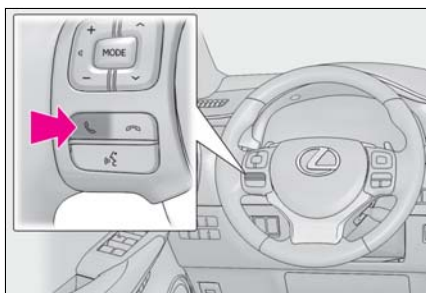

## Mobile Assistant operation

- 1 Press and hold this switch until the Mobile Assistant screen is displayed.

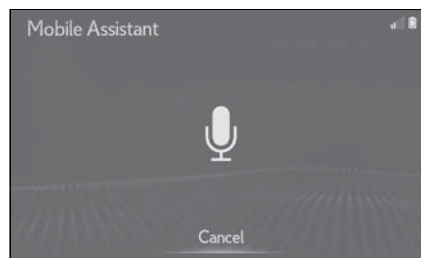

- 2 Say the desired command when the following screen is displayed.



- To cancel the Mobile Assistant, select "Cancel" or press and hold the  switch on the steering wheel.
  - To restart the Mobile Assistant for additional commands, press the  switch on the steering wheel.
  - Mobile Assistant can only be restarted after the system responds to a voice command.
  - After some phone and music commands, the Mobile Assistant feature will automatically end to complete the requested action.
  - The volume of the Mobile Assistant can be adjusted using the "PWR·VOL" knob or steering wheel volume control switches. The Mobile Assistant and phone call volumes are synchronized.
- 
- The available features and functions may vary based on the iOS/Android OS version installed on the connected device.
  - While a phone call is active, the Mobile Assistant cannot be used.
  - If using the navigation feature of the cellular phone, ensure the active audio source is Bluetooth® audio or iPod in order to hear turn by turn direction prompts.

- Wait for the listening beeps before using the Mobile Assistant.
- The Mobile Assistant may not recognize commands in the following situations:
  - Spoken too quickly.
  - Spoken at a low or high volume.
  - The roof or windows are open.
  - Passengers are talking while the Mobile Assistant is being used.
  - The fan speed of the air conditioning system is set at high.
  - The air conditioning vents are turned toward the microphone.



Information

6

167

6-1. Information display

- Information screen ..... 168
- Weather information ..... 169
- Data services settings ..... 170

6

Information

**Information screen**

Useful information, such as the fuel consumption, traffic information, weather information, etc., is available on the information screen.

**Displaying the information screen**

- 1 Press the "MENU" button on the Remote Touch.

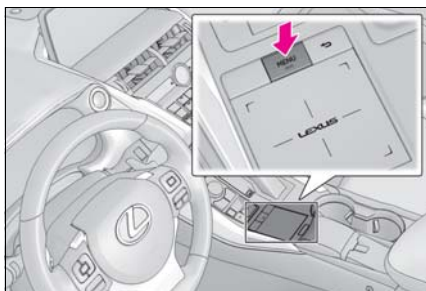

- 2 Select "Info".
  - 3 Select the desired item on the sub menu.
- The sub menu is displayed when the cursor is moved over the sub menu icon on the left side of screen.

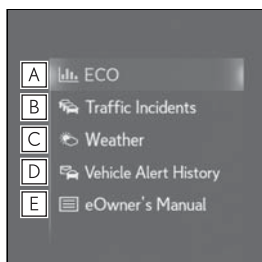

- A Select to display the energy monitor or fuel consumption screen.<sup>\*1</sup>
- B Select to display traffic informa-

tion.<sup>\*2</sup> (→P.70)

- C Select to display weather information.<sup>\*2</sup> (→P.169)
- D Select to display the vehicle alert history.<sup>\*2</sup>
- E Select to display the "eOwner's Manual".<sup>\*3</sup>

<sup>\*1</sup>: Refer to the "OWNER'S MANUAL"

<sup>\*2</sup>: This function is not made available in some countries, areas, or on some models.

<sup>\*3</sup>: For details, refer to the "eOwner's Manual" brochure included in the "OWNER'S MANUAL".



## Weather information\*

\*: This function is not made available in some countries, areas, or on some models.

Weather information can be received via HD Radio broadcast or via DCM (Data Communication Module).

### Displaying weather screen

- 1 Press the "MENU" button on the Remote Touch.

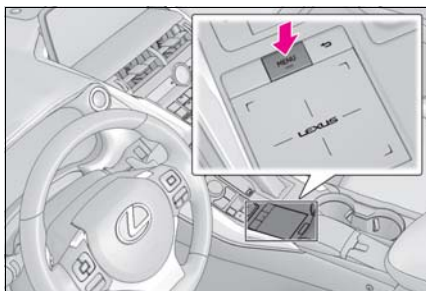

- 2 Select "Info".
- 3 Select  "Weather" on the sub menu.
- 4 Select the desired item to be displayed.

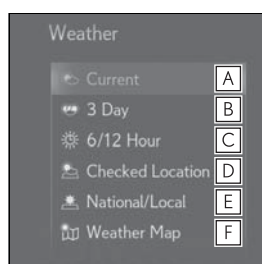

- A Select to display the current weather information.
- B Select to display a 3-day weather

forecast for the currently displayed location.

To view the details of a specific day, select the date.

- C Select to display the weather information for the next 6 hours and 12 hours. (This button is not displayed when a location is selected from the "National Cities" list of "National/Local".)
- D Select to display the weather of a desired location in the recently checked locations list.
- E Select to change the displayed weather location. A location can be selected from two different lists: a list of national cities and a list of local cities.
- F Select to display Doppler weather radar information over the map.

### Weather guidance service

When weather information for areas around the current position, destination, or along the set route is available, important information will be output through the speakers and a pop-up message asking if you would like to view the full weather information will be displayed.

- 1 Select "Yes" when the pop-up message appears.
  - 2 Check that the weather information is displayed.
- The time since the information was last updated is displayed.

- When detailed audio weather information is available, an icon will be displayed on the weather map. Select the icon to listen to the weather information.

### Data services settings\*

\*: This function is not made available in some countries, areas, or on some models.

Data service information, which is comprised of traffic information and weather information, can be received via HD Radio broadcast or DCM (Data Communication Module). The receiving method can be set to both or only via HD Radio broadcast.

### Setting download methods

- 1 Press the "MENU" button on the Remote Touch.

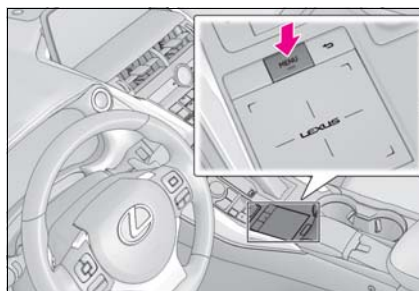

- 2 Select "Setup".
- 3 Select  "Data Services" on the sub menu.
- 4 Select "Data Download Source".

- 5 Select the desired item to be set.

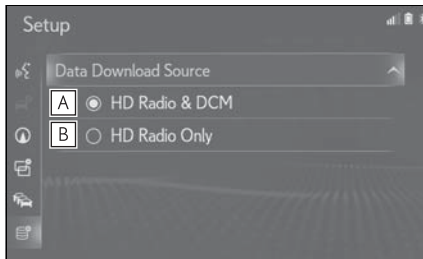

- A** Select to receive data service information via both HD Radio broadcast and the DCM. When both methods are available, HD Radio broadcast will be selected.
- B** Select to receive data only via HD Radio broadcast.



## Peripheral monitoring system

## 7

## 7-1. Lexus parking assist monitor

Lexus parking assist monitor. **174**

Guide lines displayed on the screen ..... **176**

Lexus parking assist monitor precautions ..... **179**

Things you should know ..... **184**

## 7-2. Panoramic view monitor

Panoramic view monitor ..... **186**

Checking around the vehicle **189**

Checking the front and around the vehicle ..... **191**

Checking the sides and around the vehicle ..... **194**

Checking the rear and around the vehicle ..... **196**

When folding the outside rear view mirrors ..... **201**

Magnifying function ..... **202**

Panoramic view monitor precautions ..... **203**

Things you should know ..... **213**

Product license ..... **215**

### Lexus parking assist monitor\*

\*: If equipped

The parking assist monitor assists the driver by displaying an image of the view behind the vehicle while backing up, for example while parking.

When the display is changed to the wide rear view mode, a wider lateral view behind the vehicle will be displayed.

● The screen illustrations used in this text are intended as examples, and may differ from the image that is actually displayed on the screen.

#### WARNING

- Always make sure to check all around the vehicle with your own eyes when driving.
- The camera uses a special lens. The distances between objects and pedestrians that appear in the image displayed on the screen will differ from the actual distances.

### Screen display

Each time the display mode switching button is selected, the mode will change as follows:

- ▶ Rear view

Displays the rear view of the vehicle.

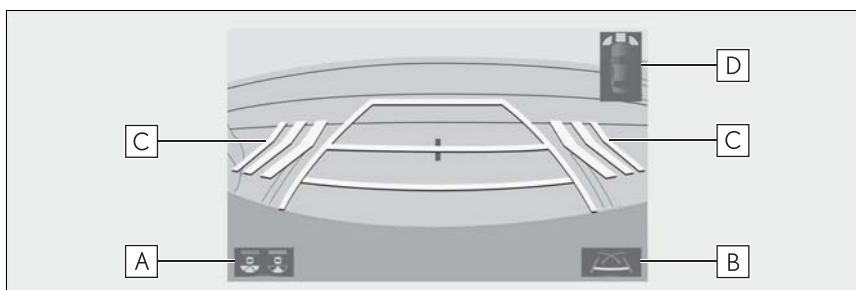

- ▶ Wide rear view

Displays a near 180° image from the rear view camera.

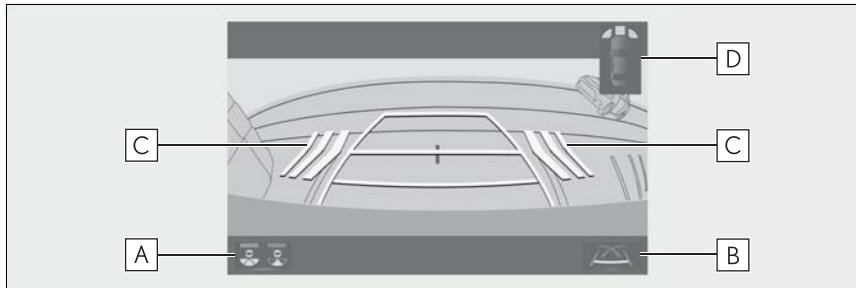

**A** Display mode switching button

Each time the button is selected, the rear view mode and the wide rear view mode are switched.

**B** Guide line switching button

Select to switch the guide line mode. (→P.176)

Each time the button is selected, the display mode will change as follows:

- Estimated course line display mode
- Parking assist guide line display mode
- Distance guide line display mode

**C** Rear Cross Traffic Alert

When a sensor detects an obstacle, the direction of obstacle is displayed and the buzzer sounds.

**D** Intuitive parking assist

When a sensor detects an obstacle, the direction of and the approximate distance to the obstacle are displayed and the buzzer sounds.

- The parking assist monitor is canceled when the shift position is shifted into any position other than the "R".
- For details about the Rear Cross Traffic Alert function and intuitive parking assist, refer to the "OWNER'S MANUAL".

**⚠ WARNING**

- As the Rear Cross Traffic Alert display is displayed over the camera view, it may be difficult to see the Rear Cross Traffic Alert display depending on the color and brightness of the surrounding area.

**Guide lines displayed on the screen**

**Estimated course line display mode**

Estimated course lines are displayed which move in accordance with the operation of the steering wheel.

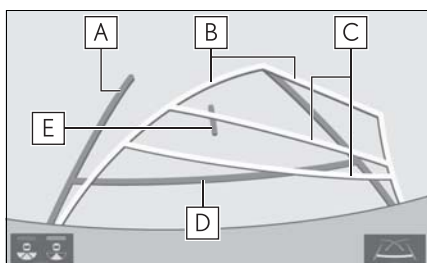

**A** Vehicle width guide line

Displays a guide path when the vehicle is being backed straight up.

**B** Estimated course lines

Show an estimated course when the steering wheel is turned.

**C** Distance guide lines

Show distance behind the vehicle when the steering wheel is turned.

- The guide lines move in conjunction with the estimated course lines.
- The guide lines display points approximately 1.5 ft. (0.5 m) (red) and approximately 3 ft. (1 m) (yellow) from the center of the edge of the bumper.

**D** Distance guide line

Shows distance behind the vehicle.

- Displays a point approximately 1.5 ft. (0.5 m) (blue) from the edge of the bumper.

**E** Vehicle center guide line

This line indicates the estimated vehicle center on the ground.

**Parking**

When parking in a space which is in the reverse direction to the space described in the procedure below, the steering directions will be reversed.

- 1 Shift the shift lever to the "R" position.
- 2 Turn the steering wheel so that the estimated course lines are within the parking space, and back up slowly.

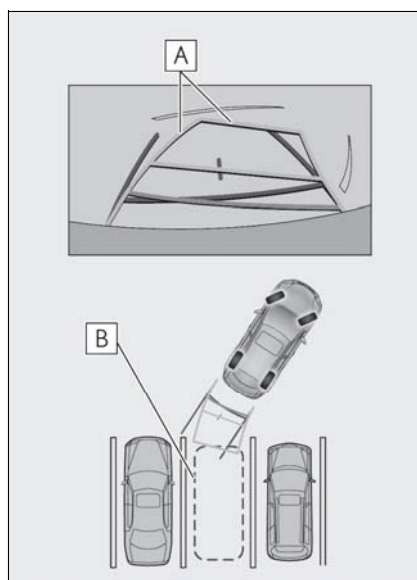

**A** Estimated course lines

**B** Parking space

- 3 When the rear position of the vehicle has entered the parking space, turn the steering wheel so that the vehicle width guide lines are within



the left and right dividing lines of the parking space.

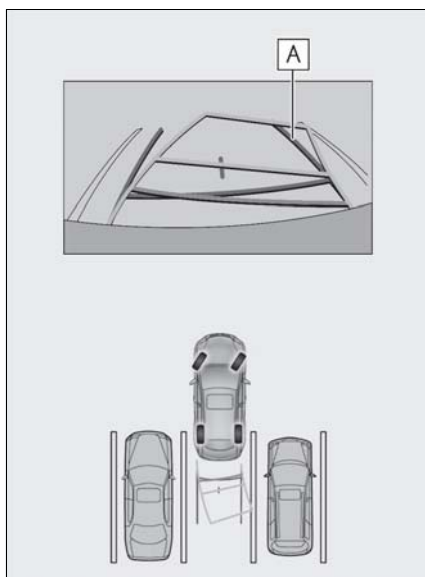

**A** Vehicle width guide line

- 4 Once the vehicle width guide lines and the parking space lines are parallel, straighten the steering wheel and back up slowly until the vehicle has completely entered the parking space.
- 5 Stop the vehicle in an appropriate place, and finish parking.

**⚠ WARNING**

● If the steering wheel is straight and the vehicle width guide lines and the estimated course lines are not in alignment, have the vehicle inspected by your Lexus dealer.

**Parking assist guide line display mode**

The steering wheel return points (parking assist guide lines) are displayed.

This mode is recommended for those who are comfortable with parking the vehicle without the aid of the estimated course lines.

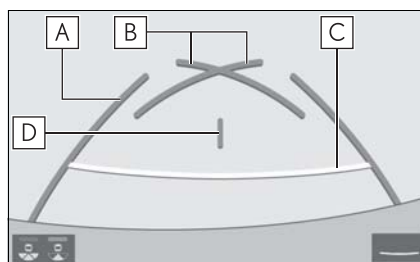

**A** Vehicle width guide line

Displays a guide path when the vehicle is being backed straight up.

- The displayed width is wider than the actual vehicle width.

**B** Parking assist guide lines

Show the path of the smallest turn possible behind the vehicle.

**C** Distance guide line

Shows distance behind the vehicle.

- Displays points approximately 1.5 ft. (0.5 m) (red) from the edge of the bumper.

**D** Vehicle center guide line

This line indicates the estimated vehicle center on the ground.

**Parking**

When parking in a space which is in the reverse direction to the space described in the procedure below, the steering directions will be reversed.

- 1 Shift the shift lever to the “R” position.
- 2 Back up until the parking assist guide line meets the edge of the

left-hand dividing line of the parking space.

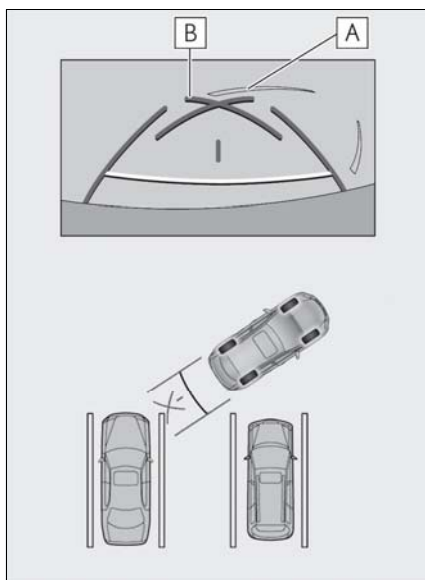

**A** Parking space dividing line

**B** Parking assist guide line

- 3** Turn the steering wheel all the way to the right, and back up slowly.
- 4** Once the vehicle is parallel with the parking space, straighten the steering wheel and back up slowly until the vehicle has completely entered the parking space.
- 5** Stop the vehicle in an appropriate place, and finish parking.

### Distance guide line display mode

Distance guide lines only are displayed. This mode is recommended for those who are comfortable with parking the vehicle without the aid of the guide lines.

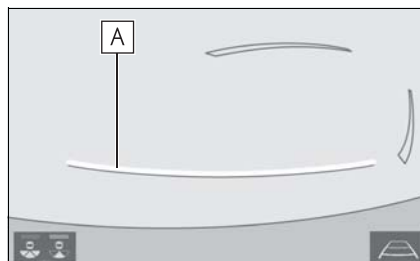

**A** Distance guide lines

Show distance behind the vehicle.

- Display points approximately 1.5 ft. (0.5m) (red) from the edge of the bumper.

## Lexus parking assist monitor precautions

### Driving precautions

The parking assist monitor is a supplemental device intended to assist the driver when backing up. When backing up, be sure to visually check all around the vehicle both directly and using the mirrors before proceeding. If you do not, you may hit another vehicle, and could possibly cause an accident.

Pay attention to the following precautions when using the parking assist monitor.

#### WARNING

- Never depend on the parking assist monitor entirely when backing up. The image and the position of the guide lines displayed on the screen may differ from the actual state. Use caution, just as you would when backing up any vehicle.
- Be sure to back up slowly, depressing the brake pedal to control vehicle speed.
- If you seem likely to hit nearby vehicles, obstacles, people or mount the shoulder, depress the brake pedal to stop the vehicle.
- The instructions given are only guidelines. When and how much to turn the steering wheel will vary according to traffic conditions, road surface conditions, vehicle condition, etc. when parking. It is necessary to be fully aware of this before using the parking assist system.

- When parking, be sure to check that the parking space will accommodate your vehicle before maneuvering into it.

- Do not use the parking assist monitor in the following cases:

- On icy or slick road surfaces, or in snow
- When using tire chains or emergency tires
- When the back door is not closed completely
- On roads that are not flat or straight, such as curves or slopes
- If the suspension has been modified or tires of a size other than specified are installed

- In low temperatures, the screen may darken or the image may become faint. The image could distort when the vehicle is moving, or you may become unable to see the image on the screen. Be sure to visually check all around the vehicle both directly and using the mirrors before proceeding.

- If the tire sizes are changed, the position of the guide lines displayed on the screen may change.

- The camera uses a special lens. The distances between objects and pedestrians that appear in the image displayed on the screen will differ from the actual distances. (→P.181)

### Area displayed on screen

The parking assist monitor displays an image of the view from the bumper of the rear area of the vehicle.

▶ Rear view

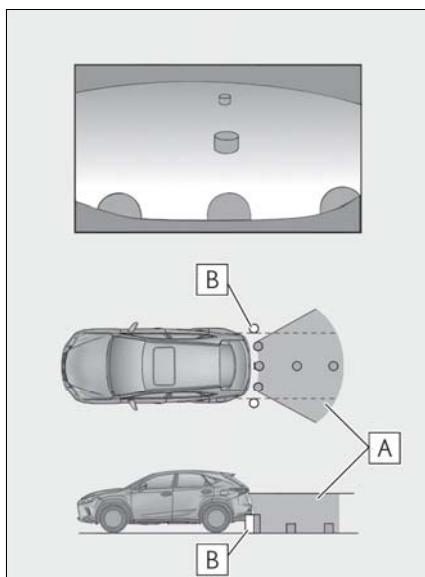

▶ Wide rear view

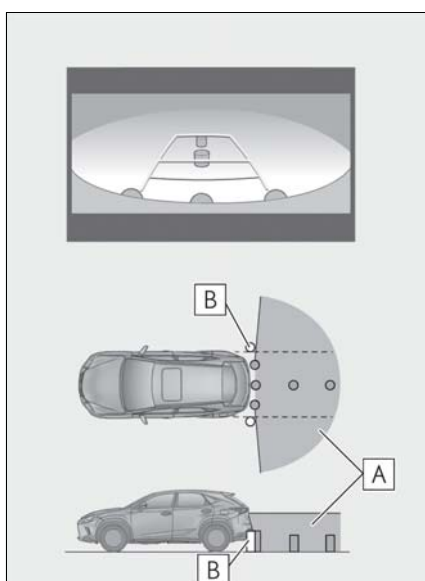

**A** The area displayed on the screen

**B** The objects not displayed on the screen

- The image adjustment procedure for the parking assist monitor screen is the same as the procedure for adjusting the screen display. (→P.36)
- The area displayed on the screen may vary according to vehicle orientation conditions.
- Objects which are close to either corner of the bumper or under the bumper cannot be displayed.
- The camera uses a special lens. The distance of the image that appears on the screen differs from the actual distance.
- Items which are located higher than the camera may not be displayed on the monitor.

**The camera**

The camera for the parking assist monitor is located as shown in the illustration.

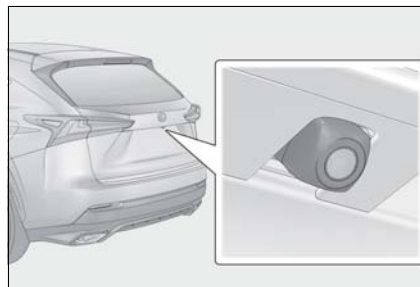

■ Using the camera

If dirt or foreign matter (such as water droplets, snow, mud etc.) is adhering to the camera, it cannot transmit a clear image. In this case, flush it with a large quantity of water and wipe the camera lens clean with a soft and wet cloth.

 NOTICE

- The parking assist monitor may not operate properly in the following cases.
  - If the back of the vehicle is hit, the position and mounting angle of the camera may change.
  - As the camera has a water proof construction, do not detach, disassemble or modify it. This may cause incorrect operation.
  - When cleaning the camera lens, flush the camera with a large quantity of water and wipe it with a soft and wet cloth. Strongly rubbing the camera lens may cause the camera lens to be scratched and unable to transmit a clear image.
  - Do not allow organic solvent, car wax, window cleaner or a glass coating to adhere to the camera. If this happens, wipe it off as soon as possible.
  - If the temperature changes rapidly, such as when hot water is poured on the vehicle in cold weather, the system may not operate normally.
  - When washing the vehicle, do not apply intensive bursts of water to the camera or camera area. Doing so may result in the camera malfunctioning.
- Do not expose the camera to strong impact as this could cause a malfunction. If this happens, have the vehicle inspected by your Lexus dealer as soon as possible.

**Differences between the screen and the actual road**

- The distance guide lines and the vehicle width guide lines may not actually be parallel with the dividing lines of the parking space, even when they appear to be so. Be sure to check visually.

- The distances between the vehicle width guide lines and the left and right dividing lines of the parking space may not be equal, even when they appear to be so. Be sure to check visually.
- The distance guide lines give a distance guide for flat road surfaces. In any of the following situations, there is a margin of error between the guide lines on the screen and the actual distance/course on the road.
  - **When the ground behind the vehicle slopes up sharply**

The distance guide lines will appear to be closer to the vehicle than the actual distance. Because of this, objects will appear to be farther away than they actually are. In the same way, there will be a margin of error between the guidelines and the actual distance/course on the road.

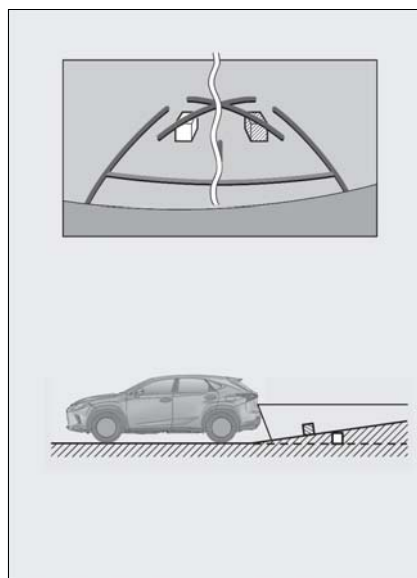

■ **When the ground behind the vehicle slopes down sharply**

The distance guide lines will appear to be farther from the vehicle than the actual distance. Because of this, objects will appear to be closer than they actually are. In the same way, there will be a margin of error between the guidelines and the actual distance/course on the road.

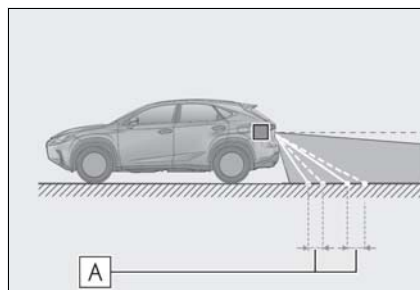

A A margin of error

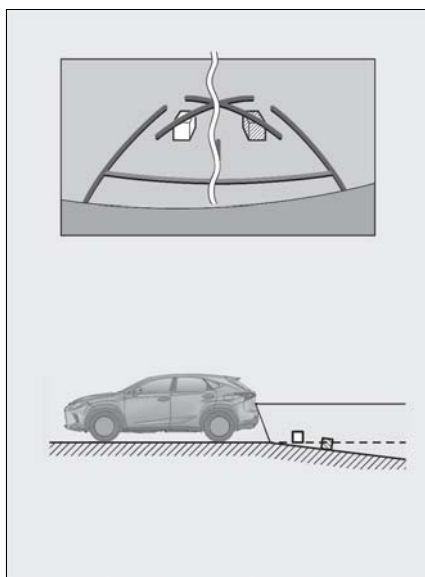

■ **When any part of the vehicle sags**

When any part of the vehicle sags due to the number of passengers or the distribution of the load, there is a margin of error between the guide lines on the screen and the actual distance/course on the road.

**When approaching three-dimensional objects**

The estimated course lines target flat surfaced objects (such as the road). It is not possible to determine the position of three-dimensional objects (such as vehicles) using the estimated course lines and distance guide lines. When approaching a three-dimensional object that extends outward (such as the flatbed of a truck), be careful of the following.

■ **Estimated course lines**

Visually check the surroundings and the area behind the vehicle. In the case shown below, the truck appears to be outside of the estimated course lines and the vehicle does not look as if it hits the truck. However, the rear body of the truck may actually cross over the estimated course lines. In reality if you back up as guided by the estimated course lines, the vehicle may hit the truck.

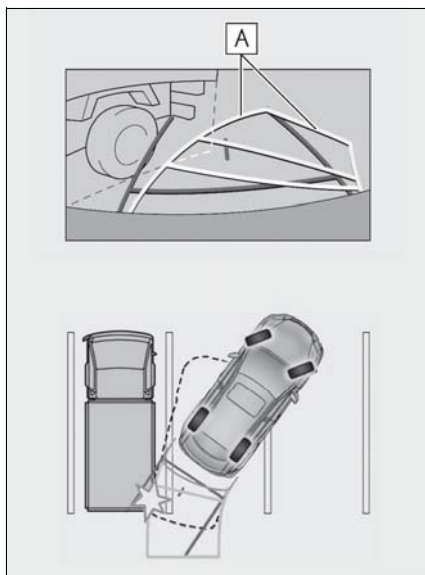

**A** Estimated course lines

■ **Distance guide lines**

Visually check the surroundings and the area behind the vehicle. On the screen, it appears that a truck is parking at point **B**. However, in reality if you back up to point **A**, you will hit the truck. On the screen, it appears that **A** is closest and **C** is farthest away. However, in reality, the distance to **A** and **C** is the same, and **B** is farther than **A** and **C**.

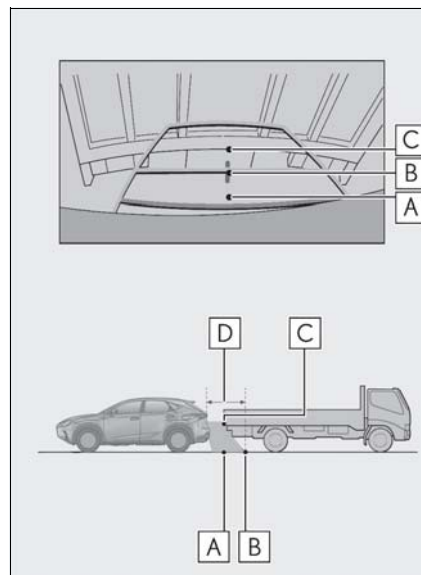

**D** Approx. 3 ft. (1m)

**Things you should know**

**If you notice any symptoms**

If you notice any of the following symptoms, refer to the likely cause and the solution, and re-check.

If the symptom is not resolved by the solution, have the vehicle inspected by your Lexus dealer.

Symptom	Likely cause	Solution
The image is difficult to see	<ul style="list-style-type: none"> <li>• The vehicle is in a dark area</li> <li>• The temperature around the lens is either high or low</li> <li>• The outside temperature is low</li> <li>• There are water droplets on the camera</li> <li>• It is raining or humid</li> <li>• Foreign matter (mud etc.) is adhering to the camera</li> <li>• Sunlight or headlights are shining directly into the camera</li> <li>• The vehicle is under fluorescent lights, sodium lights, mercury lights etc.</li> </ul>	<p>Back up while visually checking the vehicle's surroundings. (Use the monitor again once conditions have been improved.)</p> <p>The procedure for adjusting the picture quality of the parking assist monitor is the same as the procedure for adjusting the screen display. (→P.36)</p>
The image is blurry	Dirt or foreign matter (such as water droplets, snow, mud etc.) is adhering to the camera.	Flush the camera with a large quantity of water and wipe the camera lens clean with a soft and wet cloth.
The image is out of alignment	The camera or surrounding area has received a strong impact.	Have the vehicle inspected by your Lexus dealer.
The guide lines are very far out of alignment	The camera position is out of alignment.	Have the vehicle inspected by your Lexus dealer.
	<ul style="list-style-type: none"> <li>• The vehicle is tilted (there is a heavy load on the vehicle, tire pressure is low due to a tire puncture, etc.)</li> <li>• The vehicle is used on an incline.</li> </ul>	<p>If this happens due to these causes, it does not indicate a malfunction.</p> <p>Back up while visually checking the vehicle's surroundings.</p>



Symptom	Likely cause	Solution
The estimated course lines move even though the steering wheel is straight	There is a malfunction in the signals being output by the steering sensor.	Have the vehicle inspected by your Lexus dealer.
Guide lines are not displayed	The back door is open.	Close the back door. If this does not resolve the symptom, have the vehicle inspected by your Lexus dealer.
The estimated course lines are not displayed	<ul style="list-style-type: none"> <li>• 12-volt battery has been reinstalled.</li> <li>• The steering wheel has been moved while the 12-volt battery was being reinstalled.</li> <li>• 12-volt battery power is low.</li> <li>• The steering sensor has been reinstalled.</li> <li>• There is a malfunction in the signals being output by the steering sensor.</li> </ul>	<p>Stop the vehicle, and turn the steering wheel as far as it will go to the left and right.</p> <p>If this does not resolve the symptom, have the vehicle inspected by your Lexus dealer.</p>

### Panoramic view monitor\*

\*: If equipped

Panoramic view monitor assists the driver in viewing the surroundings, when operating at low speeds, by combining the front, side and rear cameras and displaying a complete vehicle overhead image on the screen.

- The screen illustrations used in this text are intended as examples, and may differ from the image that is actually displayed on the screen.

#### WARNING

- Always make sure to check all around the vehicle with your own eyes when driving.

- The camera uses a special lens. The distances between objects and pedestrians that appear in the image displayed on the screen will differ from the actual distances.

### Camera switch

The camera switch is located as shown in the illustration.

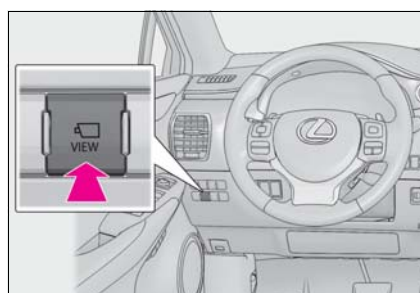

### How to switch the display

When you press the camera switch or shift the shift lever to the "R" position while the engine <power> switch is in IGNITION ON <ON> mode, the panoramic view monitor operates. (The following is an example)

- ▶ When the shift lever is in the "P" position

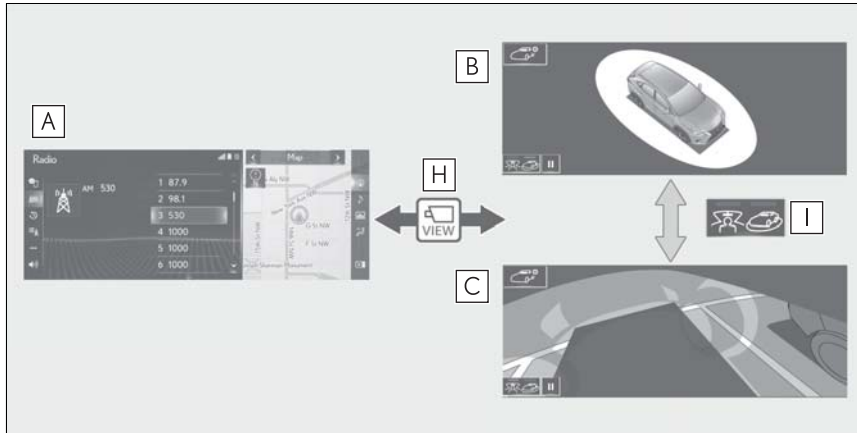

- ▶ When the shift lever is in the "D" or "N" position

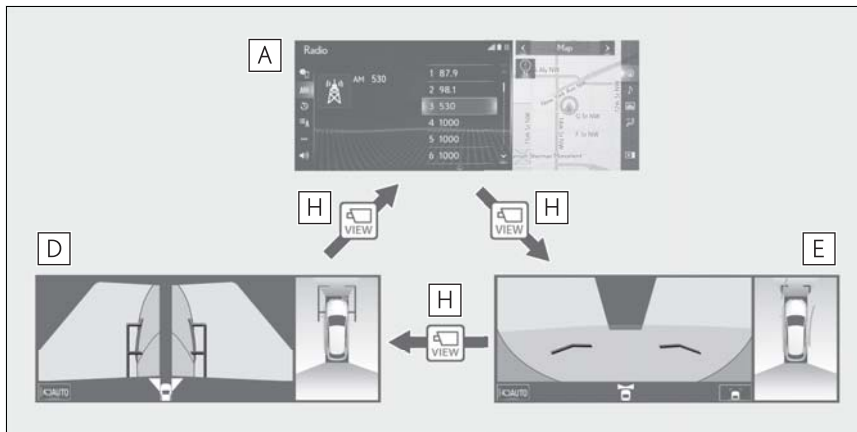

- ▶ When the shift lever is in the "R" position

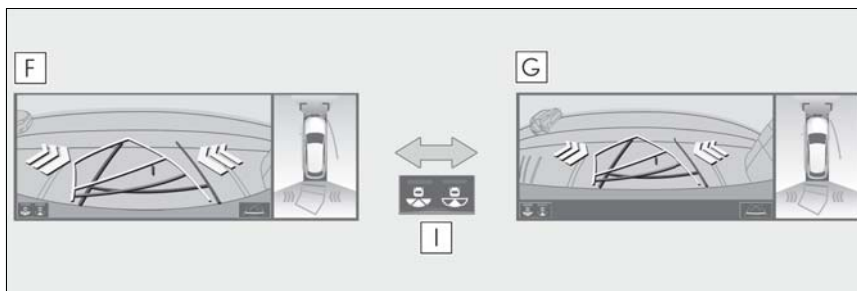

- A** Map screen, audio screen, etc.
- B** Moving view

- C** See-through view
- D** Side views & panoramic view
- E** Wide front view & panoramic view
- F** Rear view & panoramic view
- G** Wide rear view & panoramic view
- H** Pressing the camera switch
- I** Selecting the display mode switching button

- 
- The panoramic view monitor is displayed by operating the camera switch when vehicle speed is approximately 7 mph (12 km/h) or less.

## Checking around the vehicle

The moving view screen and the see-through view screen provide support when checking the areas of around the vehicle while parking. These screens display an image of the vicinity of the vehicle combined from the 4 cameras. The screen will display a 360° view around the vehicle from either inside the vehicle or from a birds-eye view at an angle.

To display the moving view/see-through view screen, press the camera switch when the shift lever is in the "P" position and the intuitive parking assist is enabled.

## Screen display

### ► Moving view

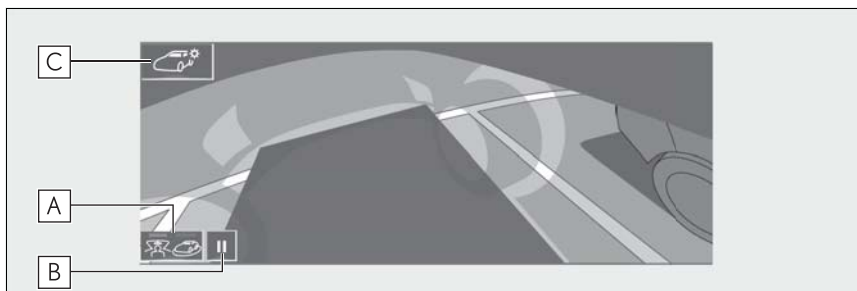

### ► See-through view

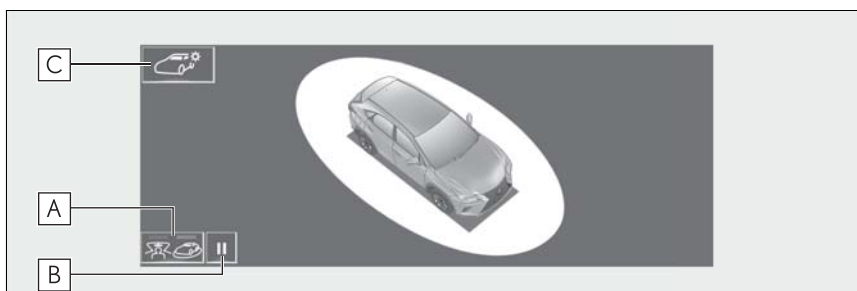

#### **A** Display mode switching button

Select to change the display mode between the moving view and the see-through view.

#### **B** Rotation pause switch

Select to pause the rotation of the screen.

To resume rotation, select .

**C** Body color setting switch

Select to display the body color setting screen and change the color of the vehicle displayed on the panoramic view monitor. (→P.190)

- Pressing the camera switch again changes the screen back to the previously displayed screen, such as the navigation screen.

### Changing the body color displayed in the panoramic view monitor

- 1 Select .
- 2 Select the desired color.

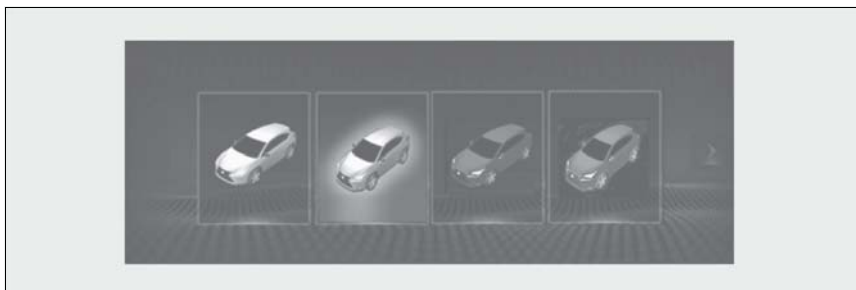

## Checking the front and around the vehicle

The wide front view & panoramic view screen provides support when checking the areas in front of the vehicle and around the vehicle when taking-off at T-intersections or other intersections during poor visibility.

To display the screen, press the camera switch when the shift lever is in the "N" or "D" position with the vehicle moving approximately 7 mph (12 km/h) or less.

This screen will be displayed if the intuitive parking assist detects an object in front of your vehicle when the vehicle is moving. (intuitive parking assist linked display)

## Screen display

### ► Wide front view & panoramic view

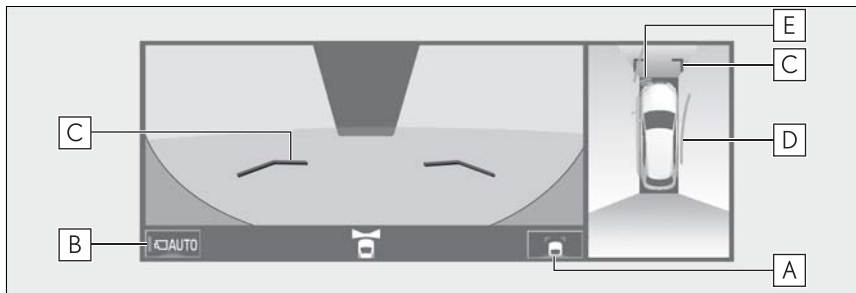

#### **A** Guide line switching button

Select to change the guide line mode between the distance guide line display mode and the estimated course line display mode. (→P.192)

#### **B** Automatic display button

Select to turn automatic display mode on/off. The indicator on the button illuminates during automatic display mode. (→P.192)

#### **C** Distance guide lines

Shows distance in front of the vehicle.

- Display points approximately 3 ft. (1 m) from the edge of the bumper.

#### **D** Estimated course lines

Shows an estimated course when the steering wheel is turned.

- This line will be displayed when the steering wheel is turned more than 90° from the center.

#### **E** Intuitive parking assist

When a sensor detects an obstacle, the direction of and the approximate distance to the

obstacle are displayed and the buzzer sounds.

- Pressing the camera switch changes the screen to the side views & panoramic view screen or previously displayed screen, such as the navigation screen.
- The intuitive parking assist linked display will disappear when the vehicle is stopped or if the intuitive parking assist no longer detects the object.

**Switching the guide line mode**

Each time the guide line switching button is selected, the mode will change as follows:

- ▶ Distance guide line

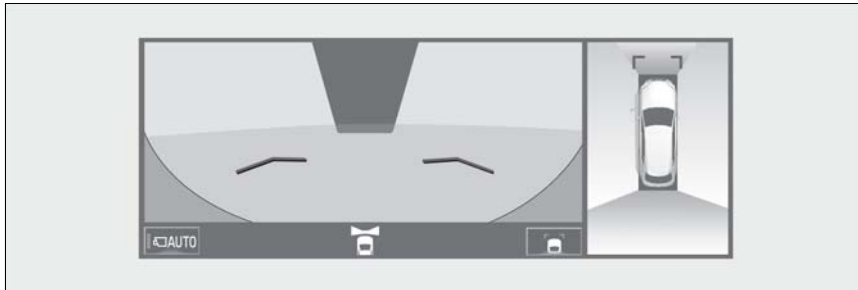

- Only the distance guide lines are displayed.

- ▶ Estimated course line

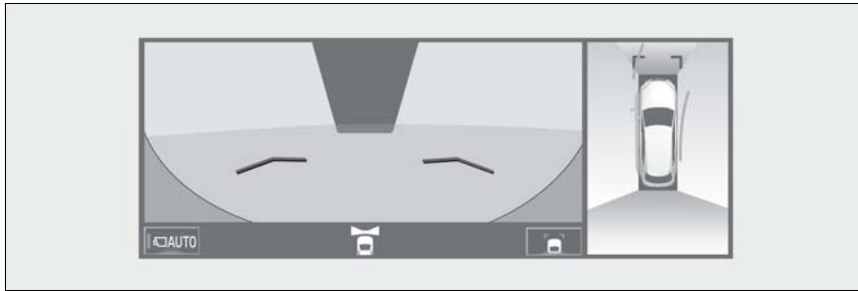

- Estimated course lines will be added to the distance guide lines.

**Automatic display mode**

In addition to screen switching by operating the camera switch, automatic display mode is available. In this mode, the screen is switched automatically in response to vehicle speed.

In automatic mode, the monitor will automatically display images in the following situations:

- When the shift lever is shifted to "N" or "D" position.
- When vehicle speed is reduced to



approximately 6 mph (10 km/h) or less.

## Checking the sides and around the vehicle

The side views & panoramic view screen displays images from around the vehicle. This screen is designed to support the driver with safe driving in situations, such as when driving on a narrow road, by allowing them to check the areas around the sides of the vehicle.

To display the screen, press the camera switch when the shift lever is in the "N" or "D" position, the intuitive parking assist is enabled, and the outside rear view mirrors are extended.

### Screen display

- ▶ Side views & panoramic view

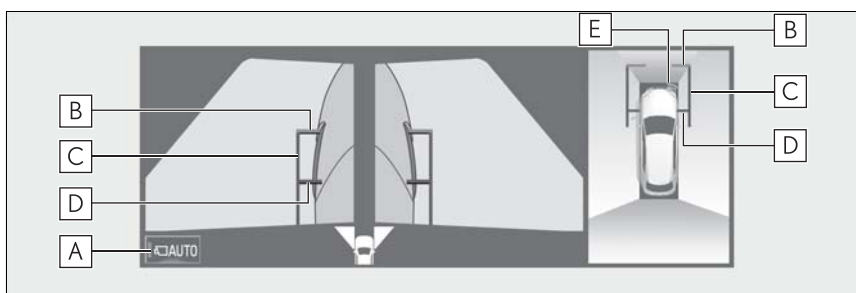

#### **A** Automatic display button

Select to turn automatic display mode on/off. The indicator on the button illuminates during automatic display mode. (→P.195)

#### **B** Distance guide lines

Show distance in front of the vehicle.

- Display points approximately 1.5 ft. (0.5 m) from the edge of the bumper.

#### **C** Vehicle width guide lines

Shows guide lines of the vehicle's width including the outside rear view mirrors.

#### **D** Front tire guide lines

Shows guide lines of where the front tire touches the ground.

#### **E** Intuitive parking assist

When a sensor detects an obstacle, the direction of and the approximate distance to the obstacle are displayed and the buzzer sounds.

- Pressing the camera switch changes the screen to previously displayed screen, such as the navigation screen.

 **WARNING**

- When a sensor indicator on the intuitive parking assist display illuminates in red or a buzzer sounds continuously, be sure to check the area around the vehicle immediately and do not proceed any further until safety has been ensured, otherwise an unexpected accident may occur.

**Automatic display mode**

In addition to screen switching by operating the camera switch, automatic display mode is available. In this mode, the screen is switched automatically in response to vehicle speed.

In automatic mode, the monitor will automatically display images in the following situations:

- When the shift lever is shifted to “N” or “D” position.
- When vehicle speed is reduced to approximately 6 mph (10 km/h) or less.

### Checking the rear and around the vehicle

The rear view & panoramic view/wide rear view & panoramic view screen provide support when checking the areas of behind the vehicle and around the vehicle while backing up, for example while parking.

The screens will be displayed when the shift lever is in the “R” position.

### Screen display

Each time the display mode switching button is selected, the mode will change as follows:

- ▶ Rear view & panoramic view

Displays the rear view and overhead view of the vehicle at same time.

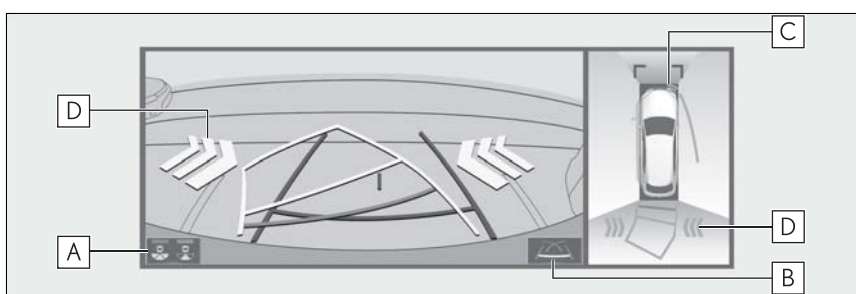

- ▶ Wide rear view & panoramic view

Displays the wide rear view and overhead view of the vehicle at same time.

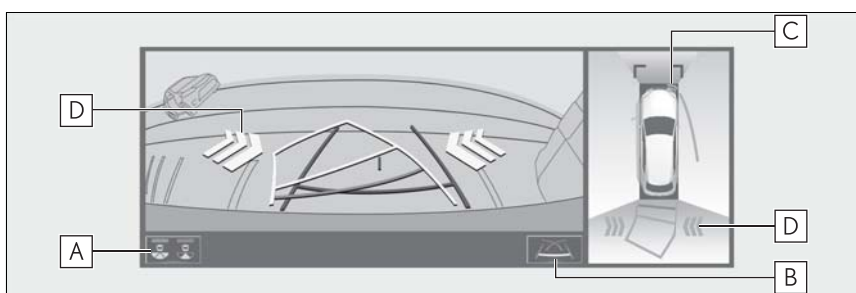

- A** Display mode switching button

Each time the button is selected, the display mode will change as follows:

- Rear view & panoramic view
- Wide rear view & panoramic view

- B** Guide line switching button

Select to switch the guide line mode. (→P.197)

**C** Intuitive parking assist

When a sensor detects an obstacle, the direction of and the approximate distance to the obstacle are displayed and the buzzer sounds.

**D** Rear Cross Traffic Alert

When a sensor detects an obstacle, the direction of obstacle is displayed and the buzzer sounds.

- The monitor is cancelled when the shift lever is shifted into any position other than the “R” position.
- For details about the Rear Cross Traffic Alert function and intuitive parking assist, refer to the “OWNER’S MANUAL”.

**⚠ WARNING**

- When a sensor indicator on the intuitive parking assist display illuminates in red or a buzzer sounds continuously, be sure to check the area around the vehicle immediately and do not proceed any further until safety has been ensured, otherwise an unexpected accident may occur.
- As the Rear Cross Traffic Alert display is displayed over the camera view, it may be difficult to see the Rear Cross Traffic Alert display depending on the color and brightness of the surrounding area.

**Guide lines displayed on the screen**

Each time the guide line switching button is selected, the mode will change as follows:

▶ Estimated course line

Estimated course lines are displayed which move in accordance with the operation of the steering wheel.

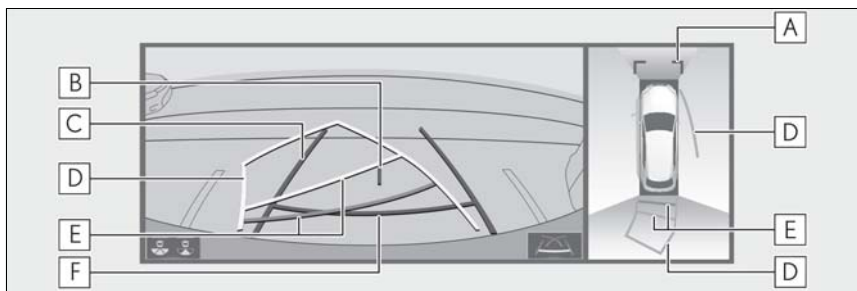

▶ Parking assist guide line

The steering wheel return points (parking assist guide lines) are displayed.

This mode is recommended for those who are comfortable with parking the vehicle without the aid of the estimated course lines.

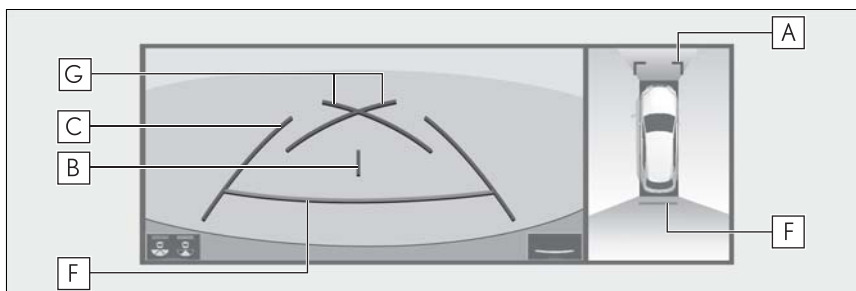

► Distance guide line

Only distance guide line is displayed.

This mode is recommended for those who are comfortable with parking the vehicle without the aid of the guide lines.

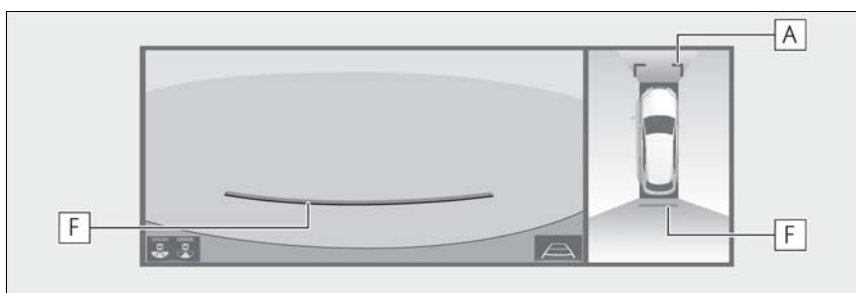

**A** Distance guide lines

Shows distance in front of the vehicle.

- Display points approximately 3 ft. (1 m) from the edge of the bumper.

**B** Vehicle center guide line

The line indicates the estimated vehicle center on the ground.

**C** Vehicle width guide lines

Displays a guide path when the vehicle is being backed straight up.

**D** Estimated course lines

Shows an estimated course when the steering wheel is turned.

**E** Distance guide lines

Shows the distance behind the vehicle when the steering wheel is turned.

- The guide lines move in conjunction with the estimated course lines.
- The guide lines display points approximately 1.5 ft. (0.5 m) (red) and approximately 3 ft. (1 m) (yellow) from the center of the edge of the bumper.

**F** Distance guide line

Shows the distance behind the vehicle.

- Displays a point approximately 1.5 ft. (0.5 m) (red/blue) from the edge of the bumper.

#### **G** Parking assist guide lines

Shows the path of the smallest turn possible behind the vehicle.

#### **!** WARNING

- Depending on the circumstances of the vehicle (number of passengers, amount of luggage, etc.), the position of the guide lines displayed on the screen may change. Be sure to check visually around the vehicle before proceeding.
- If the steering wheel is straight and the vehicle width guide lines and the estimated course lines are not in alignment, have the vehicle inspected by your Lexus dealer.
- Do not use the system if the display is incorrect due to an uneven (hilly) road or a non-straight (curvy) road.

### Parking

#### Using the estimated course line

When parking in a space which is in the reverse direction to the space described in the procedure below, the steering directions will be reversed.

- 1 Shift the shift lever to the "R" position.
- 2 Turn the steering wheel so that the estimated course lines are within

the parking space, and back up slowly.

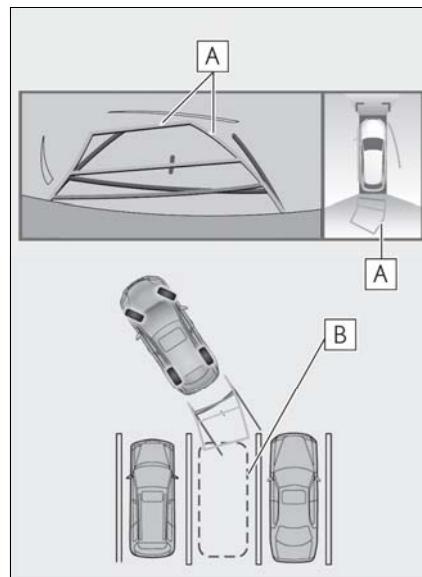

**A** Estimated course lines

**B** Parking space

- 3 When the rear position of the vehicle has entered the parking space, turn the steering wheel so that the vehicle width guide lines are within

the left and right dividing lines of the parking space.

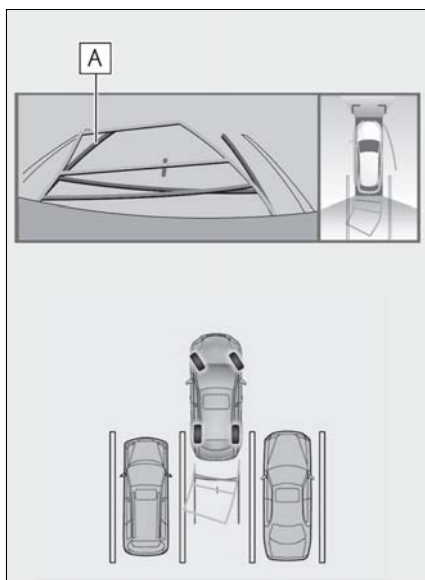

**A** Vehicle width guide line

- 4 Once the vehicle width guide lines and the parking space lines are parallel, straighten the steering wheel and back up slowly until the vehicle has completely entered the parking space.
- 5 Stop the vehicle in an appropriate place, and finish parking.

#### Using parking assist guide line

When parking in a space which is in the reverse direction to the space described in the procedure below, the steering directions will be reversed.

- 1 Shift the shift lever to the "R" position.
- 2 Back up until the parking assist guide line meets the edge of the

left-hand dividing line of the parking space.

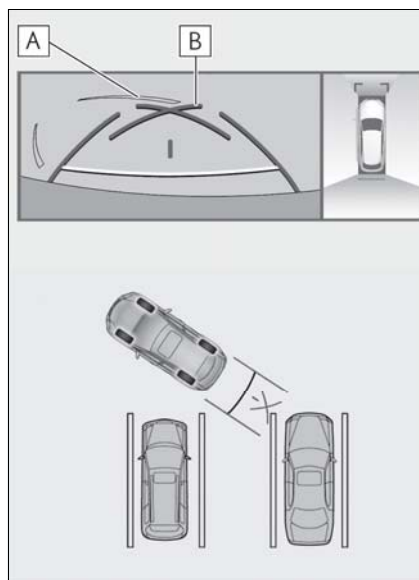

**A** Parking space dividing line

**B** Parking assist guide line

- 3 Turn the steering wheel all the way to the right, and back up slowly.
- 4 Once the vehicle is parallel with the parking space, straighten the steering wheel and back up slowly until the vehicle has completely entered the parking space.
- 5 Stop the vehicle in an appropriate place, and finish parking.



### When folding the outside rear view mirrors

Even when outside rear view mirrors are stored, the monitor can display various images of the vicinity of the vehicle and assist the operation in the confirming safe conditions in a narrow places, parking, etc.

### Screen display

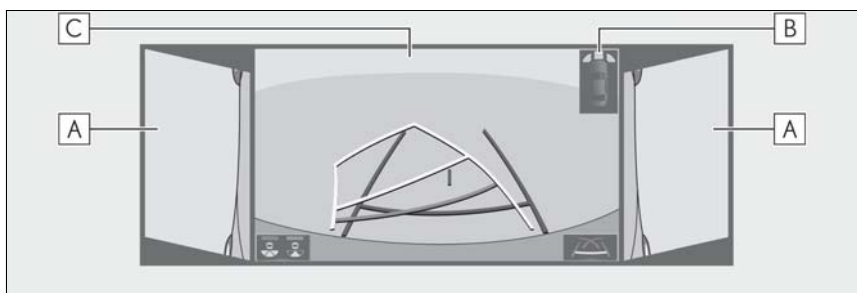

**A** Side views

**B** Intuitive parking assist

When a sensor detects an obstacle, the direction of and the approximate distance to the obstacle are displayed and the buzzer sounds.

**C** Wide front view/Rear view/Wide rear view

● For details about the front view and the rear view: →P.191, 196

#### **⚠ WARNING**

- When a sensor indicator on the intuitive parking assist display illuminates in red or a buzzer sounds continuously, be sure to check the area around the vehicle immediately and do not proceed any further until safety has been ensured, otherwise an unexpected accident may occur.

### Magnifying function

If displayed objects are too small to see clearly when the panoramic view is displayed, the area around the corners of the vehicle can be magnified.

### Magnifying the display

- 1 Select the area on the panoramic view display you wish to magnify.

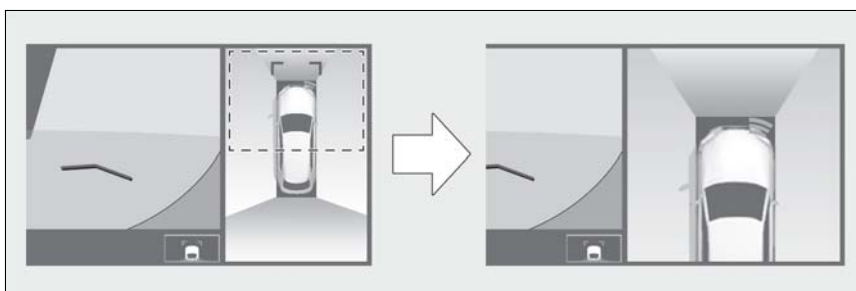

- Selected area on the panoramic view display will magnify.
  - To return to the normal view, select the panoramic view display again.
- 
- The magnifying function is enabled when all of the following conditions are met:
    - The vehicle speed is below approximately 7 mph (12 km/h).
    - The intuitive parking assist is on.
  - In the following situations, the magnified display will be canceled automatically:
    - The vehicle speed is approximately 7 mph (12 km/h) or higher.
    - The intuitive parking assist is turned off.
  - When the display is magnified, the guide lines will not be displayed.

## Panoramic view monitor precautions

### Driving precautions

The panoramic view monitor is a supplemental device intended to assist the driver when checking around the vehicle. When using, be sure to visually check all around the vehicle both directly and using the mirrors before proceeding. If you do not, you may hit another vehicle or possibly cause an accident.

Pay attention to the following precautions when using the panoramic view monitor.

#### WARNING

- Never depend on the panoramic view monitor entirely. The image and the position of the guide lines displayed on the screen may differ from the actual state. Use caution just as you would when driving any other vehicle.
- Always make sure to check all around the vehicle with your own eyes when driving.
- Never drive while looking only at the screen as the image on the screen is different from actual conditions. If you are driving while looking only at the screen, you may hit a person or an object, resulting in an accident. When driving, be sure to check the vehicle's surroundings with your own eyes and the vehicle's mirrors.
- Depending on the circumstances of the vehicle (number of passengers, amount of luggage, etc.), the position of the guide lines displayed on the screen may change. Be sure to check visually around the vehicle before proceeding.

- Do not use the panoramic view monitor system in the following cases:

- On icy or slick road surfaces, or in snow
- When using tire chains or emergency tires
- When the front door or back door is not closed completely
- On roads that are not flat or straight, such as curves or slopes
- If the suspension has been modified or tires of a size other than specified are installed

- In low temperatures, the screen may darken or the image may become faint. The image could distort when the vehicle is moving, or you may become unable to see the image on the screen. Be sure to visually check all around the vehicle both directly and using the mirrors before proceeding.

- If the tire sizes are changed, the position of the guide lines displayed on the screen may change.

- The camera uses a special lens. The distances between objects and pedestrians that appear in the image displayed on the screen will differ from the actual distances. (→P.208)

#### NOTICE

- In panoramic view/moving view/see-through view, the system combines images taken from the front, back, left and right side cameras into a single image. There are limits to the range and content that can be displayed. Familiarize yourself with the characteristics of the panoramic view monitor system before using it.



## NOTICE

- Image clarity may decline at the four corners of the panoramic view/moving view/see-through view. However, this is not a malfunction, as these are the regions along the border of each camera image where the images are combined.
  - Depending on lighting conditions near each of the cameras, bright and dark patches may appear on the panoramic view/moving view/see-through view.
  - The panoramic view/moving view/see-through view display does not extend higher than the installation position and image capture range of each camera.
  - There are blind spots around the vehicle. Accordingly, there are regions not displayed in panoramic view/moving view/see-through view.
  - Three-dimensional objects displayed in side view, wide front view or rear view may not be displayed in panoramic view/moving view/see-through view.
  - People and other three-dimensional obstacles may appear differently when displayed on the panoramic view monitor. (These differences include, among others, cases in which displayed objects appear to have fallen over, disappear near image processing areas, appear from image processing areas, or when the actual distance to an object differs from the displayed position.)
  - When the back door, which is equipped with the back camera, or front doors, which are equipped with door mirrors that have built-in side cameras, are open, images will not be displayed properly on the panoramic view monitor.
- The vehicle icon displayed in panoramic view/moving view/see-through view is a computer generated image. Accordingly, properties such as the color, shape and size will differ from the actual vehicle. For this reason, nearby three-dimensional objects may appear to be touching the vehicle, and actual distances to three-dimensional objects may differ from those displayed.

**Area displayed on screen**

**Area of image of panoramic view**

The panoramic view monitor displays an image of the surrounding view of the vehicle.

Since the panoramic view processes and displays images based on flat road surfaces, it cannot depict the position of three-dimension objects (such as vehicle bumpers, etc.) that are in positions higher than the surface of the road. Even if there is room between the bumpers of the vehicles and it seems not likely to collide in the image, in reality, the both vehicles are on a collision course.

Check the safety of the surroundings directly.

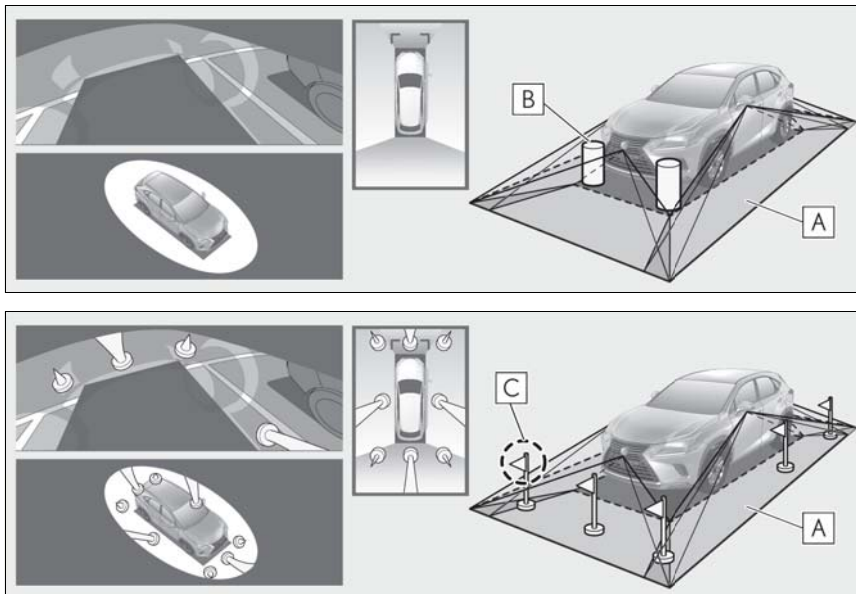

**A** The area displayed on the screen

**B** The objects not displayed on the screen

- Objects located in the shaded areas will not be displayed on the screen.

**C** The parts of objects not displayed on the screen

- Parts of objects which extend above a certain height cannot be displayed on the screen.

● As the images obtained from four cameras are processed and displayed on the standard of a flat road surface; the panoramic view/moving view/see-through

view may be displayed as follows.

- Objects may look collapsed; thinner or bigger than usual.
- An object with a higher position than the road surface may look farther away than

- it actually is or may not appear at all.
- Tall objects may appear protruding from the non-displayed areas of the image.
- Variations in the brightness of the image may appear for every camera.
- The displayed image may be shifted by inclination of the vehicle body, change in vehicle height, etc., depending on the number of passengers, amount of luggage, fuel quantity, etc.
- If the front doors or back door are not completely closed; neither the image nor the guide lines are displayed.
- The position relations of the vehicle icon and the road surface or obstacle may differ from the actual positions.
- The black areas of the vicinity of the vehicle icon are areas that are not captured by the camera.
- Images like the following are combined, thus some areas may be difficult to view.

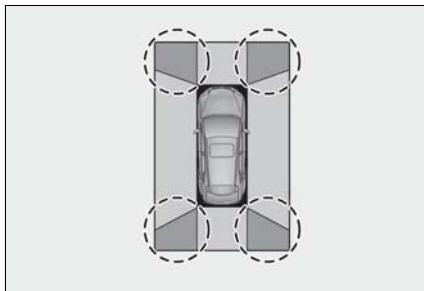

**Area of the image captured by the camera**

► Wide front view

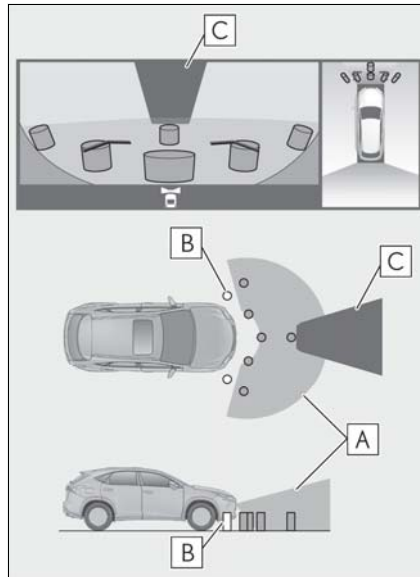

► Side views

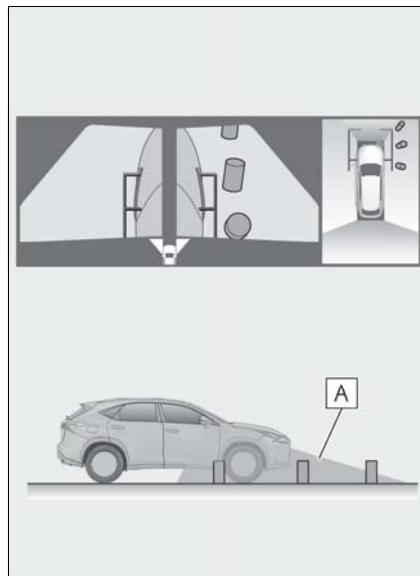

▶ Side view (when folding the outside rear view mirrors)

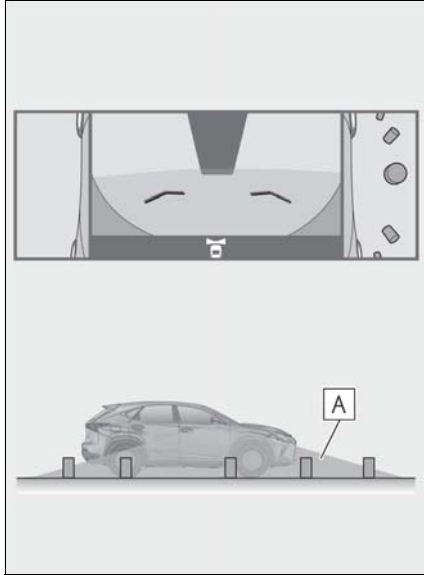

▶ Rear view

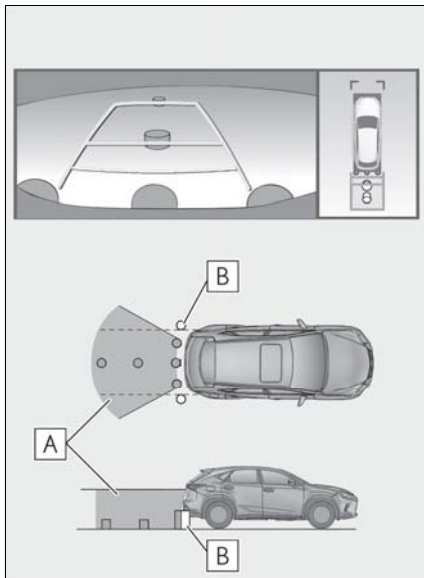

▶ Wide rear view

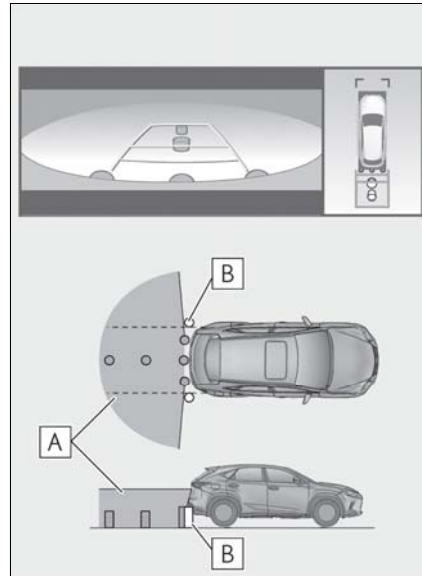

**A** The area displayed on the screen

**B** The objects not displayed on the screen

**C** Black masking

- Black masking is done for distance detection differences to the front of the vehicle.
- The area covered by the camera is limited. Objects which are close to either corner of the bumper or under the bumper cannot be seen on the screen.
- The area displayed on the screen may vary depending on vehicle orientation or road conditions.
- The camera uses a special lens. The distance in the image displayed on the screen will differ from the actual distance.

**The camera**

The cameras for the panoramic view monitor are located as shown in the illustration.

▶ Front camera

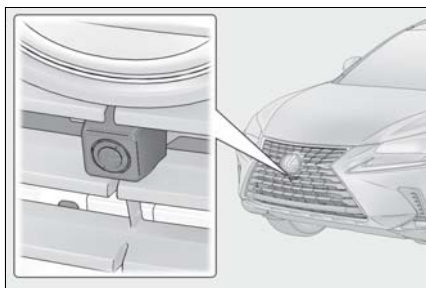

▶ Side cameras

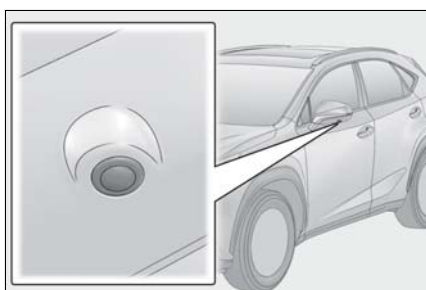

▶ Rear camera

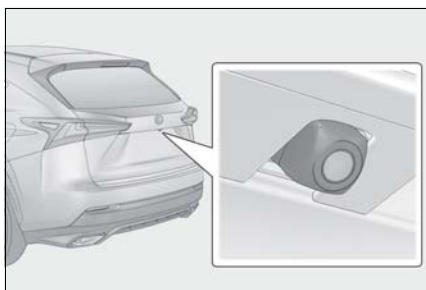

■ Using the camera

If dirt or foreign matter (such as water droplets, snow, mud etc.) is adhering to the camera, it cannot transmit a clear image. In this case, flush it with a large quantity of water and wipe the camera lens clean with a soft and wet cloth.

 NOTICE

- The panoramic view monitor may not operate properly in the following cases.
  - If the camera is hit, the position and mounting angle of the camera may change.
  - As the camera has a water proof construction, do not detach, disassemble or modify it. This may cause incorrect operation.
  - When cleaning the camera lens, flush the camera with a large quantity of water and wipe it with a soft and wet cloth. Strongly rubbing the camera lens may cause the camera lens to be scratched and unable to transmit a clear image.
  - Do not allow an organic solvent, car wax, window cleaner or a glass coating to adhere to the camera. If this happens, wipe it off as soon as possible.
  - If the temperature changes rapidly, such as when hot water is poured on the vehicle in cold weather, the system may not operate normally.
  - When washing the vehicle, do not apply intensive bursts of water to the camera or camera area. Doing so may result in the camera malfunctioning.
- Do not expose the camera to strong impacts as this could cause a malfunction. If this happens, have the vehicle inspected by your Lexus dealer as soon as possible.

**Differences between the screen and the actual road**

- The distance guide lines and the vehicle width guide lines may not actually be parallel with the dividing lines of the parking space, even when they appear to be so. Be sure to check visually.



- The distances between the vehicle width guide lines and the left and right dividing lines of the parking space may not be equal, even when they appear to be so. Be sure to check visually.
- The distance guide lines give a distance guide for flat road surfaces. In any of the following situations, there is a margin of error between the guide lines on the screen and the actual distance/course on the road.

■ **When the ground behind the vehicle slopes up sharply**

The distance guide lines will appear to be closer to the vehicle than the actual distance. Because of this, objects will appear to be farther away than they actually are. In the same way, there will be a margin of error between the guidelines and the actual distance/course on the road.

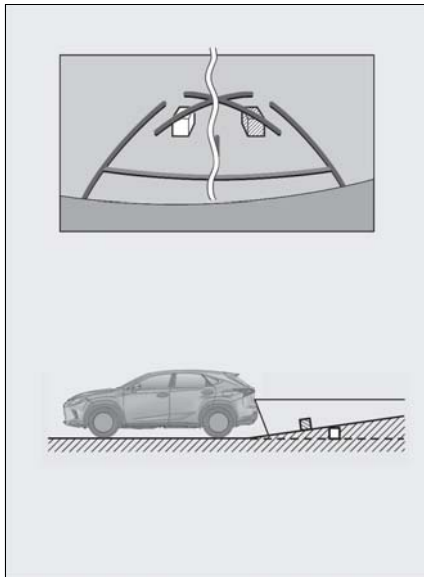

■ **When the ground behind the vehicle slopes down sharply**

The distance guide lines will appear to be farther from the vehicle than the actual distance. Because of this, objects will appear to be closer than they actually are. In the same way, there will be a margin of error between the guidelines and the actual distance/course on the road.

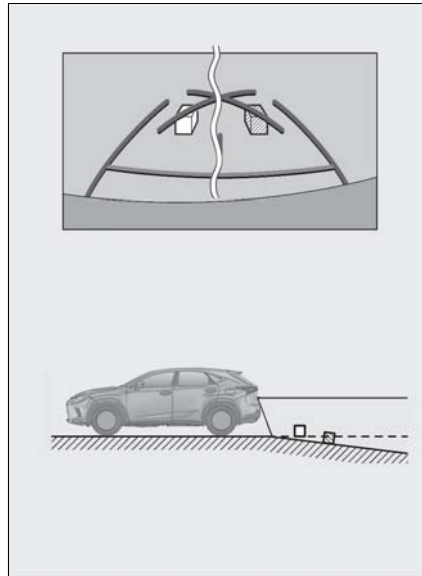

■ **When any part of the vehicle sags**

When any part of the vehicle sags due to the number of passengers or the distribution of the load, there is a margin of error between the guide lines on the screen and the actual distance/course on the road.

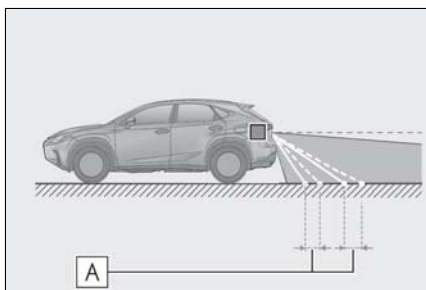

**A** A margin of error

**When approaching three-dimensional objects**

When there are three-dimensional objects (such as vehicle bumpers, etc.) nearby in positions higher than the surface of the road, take extra care when using the following.

**⚠ WARNING**

- When a sensor indicator on the intuitive parking assist display illuminates in red or a buzzer sounds continuously, be sure to check the area around the vehicle immediately and do not proceed any further until safety has been ensured, otherwise an unexpected accident may occur.

**Panoramic view display**

Since the panoramic view processes and displays images based on flat road surfaces, it cannot depict the position of three-dimension objects (such as vehicle bumpers, etc.) that are in positions higher than the surface of the road. For example, even though it appears that there is space between the bumpers of the two vehicles in the illustration below and they are not likely to collide, in reality, a collision is about

to occur.



**Estimated course lines**

- Since the estimated course line is displayed for a flat road surface, it can not depict the position of three-dimensional objects (such as vehicle bumpers, etc.) that are in positions higher than the surface of the road. Even if the bumpers of the vehicle is on the outside of the estimated course line in the image, in reality, the vehicles are on a collision course.

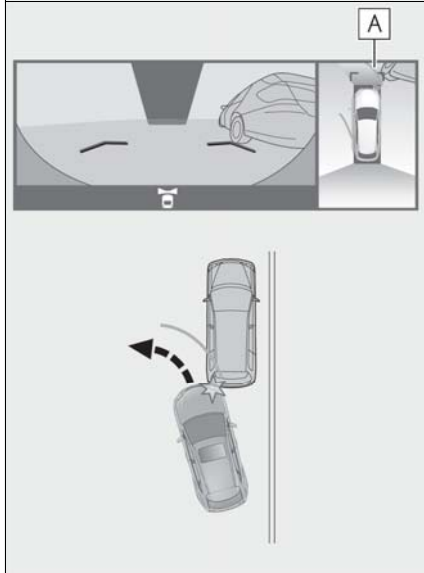

**A** The overhang of a wall

- Visually check the surroundings and the area behind the vehicle. In the case shown below, the truck appears to be outside of the estimated course lines and the vehicle does not look as if it hits the truck. However, the rear body of the truck may actually cross over the estimated course lines. In reality if you back up as guided by the estimated course lines, the vehicle may hit the truck.

**A** Estimated course line

- Three-dimensional objects (such as the overhang of a wall or loading platform of a truck) in high positions may not be projected on the screen. Check the safety of the surroundings directly.

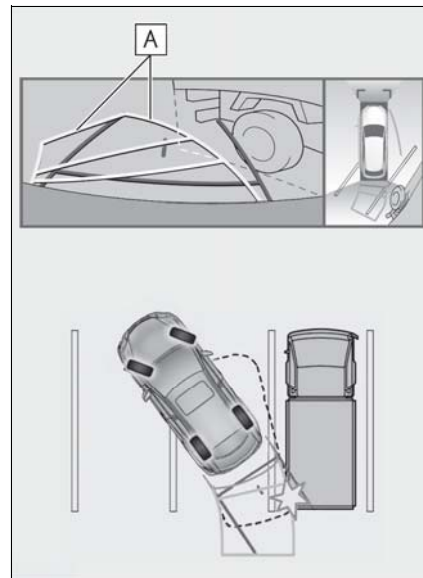
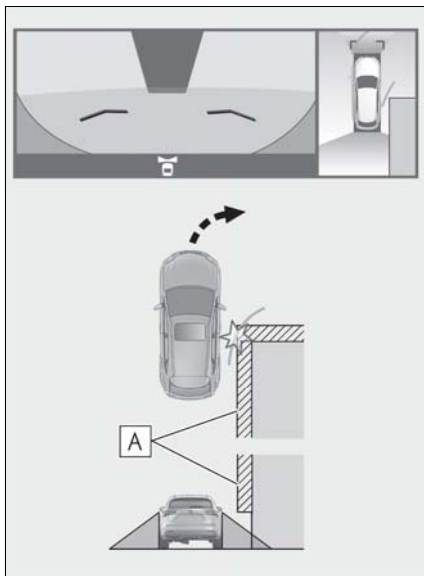

**A** Estimated course lines

**Distance guide lines**

Visually check the surroundings and the area behind the vehicle. On the screen, it appears that a truck is parking at point **B**. However, in reality if you back up to point **A**, you will hit the

truck. On the screen, it appears that **A** is closest and **C** is farthest away. However, in reality, the distance to **A** and **C** is the same, and **B** is farther than **A** and **C**.

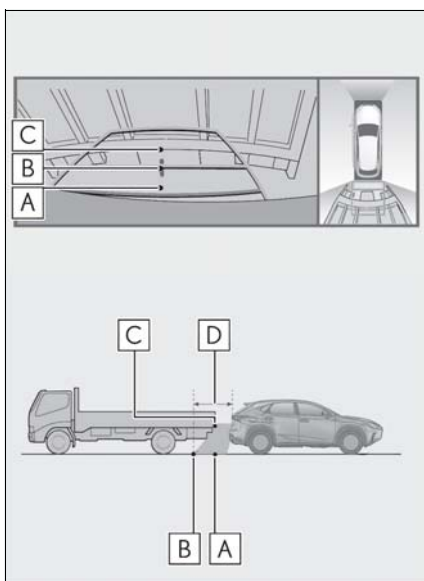

**D** Approx. 3 ft. (1 m)

## Things you should know

### If you notice any symptoms

If you notice any of the following symptoms, refer to the likely cause and the solution, and re-check.

If the symptom is not resolved by the solution, have the vehicle inspected by your Lexus dealer.

Symptom	Likely cause	Solution
The image is difficult to see	<ul style="list-style-type: none"> <li>• The vehicle is in a dark area</li> <li>• The temperature around the lens is either high or low</li> <li>• The outside temperature is low</li> <li>• There are water droplets on the camera</li> <li>• It is raining or humid</li> <li>• Foreign matter (mud etc.) is adhering to the camera</li> <li>• Sunlight or headlights are shining directly into the camera</li> <li>• The vehicle is under fluorescent lights, sodium lights, mercury lights etc.</li> </ul>	<p>Back up while visually checking the vehicle's surroundings. (Use the monitor again once conditions have been improved.)</p> <p>The procedure for adjusting the picture quality of the panoramic view monitor system is the same as the procedure for adjusting the navigation screen. (→P.36)</p>
The image is blurry	Dirt or foreign matter (such as water droplets, snow, mud etc.) is adhering to the camera.	Flush the camera with a large quantity of water and wipe the camera lens clean with a soft and wet cloth.
The image is out of alignment	The camera or surrounding area has received a strong impact.	Have the vehicle inspected by your Lexus dealer.

Symptom	Likely cause	Solution
The guide lines are very far out of alignment	The camera position is out of alignment.	Have the vehicle inspected by your Lexus dealer.
	<ul style="list-style-type: none"> <li>The vehicle is tilted. (There is a heavy load on the vehicle, tire pressure is low due to a tire puncture, etc.)</li> <li>The vehicle is used on an incline.</li> </ul>	<p>If this happens due to these causes, it does not indicate a malfunction.</p> <p>Back up while visually checking the vehicle's surroundings.</p>
The estimated course lines move even though the steering wheel is straight	There is a malfunction in the signals being output by the steering sensor.	Have the vehicle inspected by your Lexus dealer.
Guide lines are not displayed	The back door is open.	Close the back door. If this does not resolve the symptom, have the vehicle inspected by your Lexus dealer.
The estimated course lines are not displayed	<ul style="list-style-type: none"> <li>12-volt battery has been reinstalled.</li> <li>The steering wheel has been moved while the 12-volt battery was being reinstalled.</li> <li>12-volt battery power is low.</li> <li>The steering sensor has been reinstalled.</li> <li>There is a malfunction in the signals being output by the steering sensor.</li> </ul>	Have the vehicle inspected by your Lexus dealer.
The panoramic view display cannot be magnified	The Intuitive parking assist may be malfunctioning or dirty.	Follow the correction procedures for malfunctions of the Intuitive parking assist. (Refer to "OWNER'S MANUAL")
The See-through view/Moving view cannot be displayed		

## Product license

This product contains eT-Kernel Multi-Core Edition™ real-time OS of eSOL Co.,Ltd.  
Copyright (c) 2017 eSOL Co.,Ltd.  
eT-Kernel Multi-Core Edition™ is a trademark of eSOL Co.,Ltd in Japan.

### T-Kernel

This Product uses the Source Code of T-Kernel under T-License granted by the  
T-Engine Forum ([www.t-engine.org](http://www.t-engine.org)).





- 8-1. Phone operation (Hands-free system for cellular phones)**
  - Quick reference..... 218
  - Some basics..... 219
  - Placing a call using the Bluetooth® hands-free system.. 222
  - Receiving a call using the Bluetooth® hands-free system.. 225
  - Talking on the Bluetooth® hands-free system..... 226
  - Bluetooth® phone message function..... 228
- 8-2. Setup**
  - Phone settings ..... 232
- 8-3. What to do if...**
  - Troubleshooting ..... 241

**Quick reference**

**Displaying the phone screen**

▶ From the steering switch

- 1 Press  switch on the steering wheel.

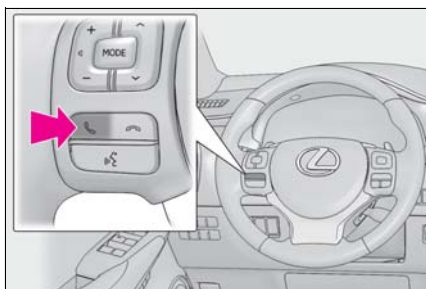

▶ From the menu button

- 1 Press the "MENU" button on the Remote Touch.

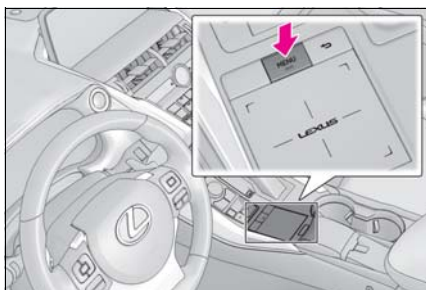

- 2 Select "Phone".

**Phone menu screen**

The sub menu is displayed when the cursor is moved over the sub menu icon on the left side of screen.

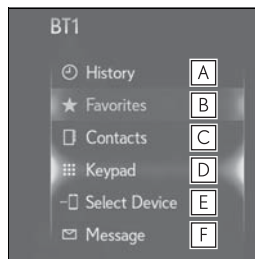

- A** Select to display the "History" screen. (→P.222)
- B** Select to display the "Favorites" screen. (→P.222)
- C** Select to display the "Contacts" screen. (→P.223)
- D** Select to display the "Keypad" screen. (→P.224)
- E** Select to choose the device to be connected, if more than 1 Bluetooth® phone is registered.
- F** Select to display the "Message" screen. (→P.228)

■ **Bluetooth® hands-free system operation**

- Registering/connecting a Bluetooth® device (→P.39)
- Placing a call using the Bluetooth® hands-free system (→P.222)
- Receiving a call using the Bluetooth® hands-free system (→P.225)
- Talking on the Bluetooth® hands-free system (→P.226)

■ **Message function**

- Using the Bluetooth® phone message function (→P.228)

■ **Setting up a phone**

- Phone settings (→P.232)
- Bluetooth® settings (→P.43)

### Some basics

The hands-free system enables calls to be made and received without having to take your hands off the steering wheel.

This system supports Bluetooth®. Bluetooth® is a wireless data system that enables cellular phones to be used without being connected by a cable or placed in a cradle.

The operating procedure of the phone is explained here.

- If your cellular phone does not support Bluetooth®, this system cannot function.
- In the following conditions, the system may not function:
  - The cellular phone is turned off.
  - The current position is outside the communication area.
  - The cellular phone is not connected.
  - The cellular phone has a low battery.
- When using the hands-free system or Bluetooth® audio and Wi-Fi® Hotspot functions at the same time, the following problems may occur:
  - The Bluetooth® connection may be cut.
  - Noise may be heard on the Bluetooth® audio playback.
  - A noise may be heard during phone calls.

#### WARNING

- While driving, do not operate a cellular phone.

- Your audio unit is fitted with Bluetooth® antennas. People with implantable cardiac pacemakers, cardiac resynchronization therapy-pacemakers or implantable cardioverter defibrillators should maintain a reasonable distance between themselves and the Bluetooth® antennas. The radio waves may affect the operation of such devices.

- Before using Bluetooth® devices, users of any electrical medical device other than implantable cardiac pacemakers, cardiac resynchronization therapy-pacemakers or implantable cardioverter defibrillators should consult the manufacturer of the device for information about its operation under the influence of radio waves. Radio waves could have unexpected effects on the operation of such medical devices.



#### NOTICE

- Do not leave your cellular phone in the vehicle. The temperature inside may rise to a level that could damage the phone.

### Registering/Connecting a Bluetooth® phone

To use the hands-free system for cellular phones, it is necessary to register a cellular phone with the system.

- ▶ Registering a Bluetooth® phone for the first time (→P.39)
  - ▶ Registering an additional Bluetooth® phone
- 1 Press the "MENU" button on the Remote Touch.
  - 2 Select "Phone".

- 3 Select  "Select Device" on the sub menu.
  - 4 Select "Add Device".
  - When another Bluetooth® device is connected, a confirmation screen will be displayed. To disconnect the Bluetooth® device, select "Yes".
  - 5 Follow the steps in "Registering a Bluetooth® phone for the first time" from step 5. (→P.39)
- ▶ Selecting a registered Bluetooth® phone
- 1 Press the "MENU" button on the Remote Touch.
  - 2 Select "Phone".
  - 3 Select  "Select Device" on the sub menu.
  - 4 Select the desired device to be connected.
  - 5 Check that a confirmation screen is displayed when the connection is complete.
  - If an error message is displayed, follow the guidance on the screen to try again.

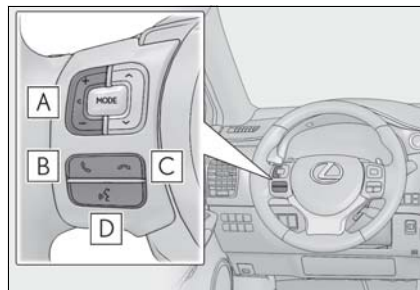

- A** Volume control switch  
Press to adjust the volume.
- B** Off hook switch  
Press to start talking.
- C** On hook switch  
Press to end talking/dialing.
- D** Talk switch  
Press to start the voice command system.  
• Voice command list (→P.159)

■ **Microphone**

The microphone is used when talking on the phone.

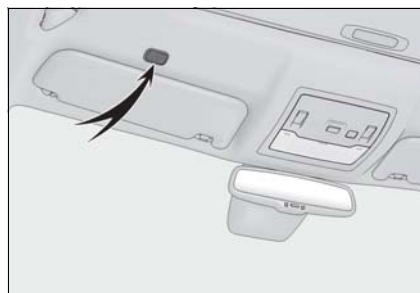

**Using the phone switch/microphone**

■ **Steering switch**

By pressing the phone switch, a call can be received or ended without taking your hands off the steering wheel.

- The other party's voice will be heard from the front speakers. The audio/visual system will be muted during phone calls or when hands-free voice commands are used.
- Talk alternately with the other party on the phone. If both parties speak at the same time, the other party may not hear what has been said. (This is not a malfunction.)
- Keep call volume down. Otherwise, the

other party's voice may be audible outside the vehicle and voice echo may increase. When talking on the phone, speak clearly towards the microphone.

- The other party may not hear you clearly when:
  - Driving on an unpaved road. (Making excessive traffic noise.)
  - Driving at high speeds.
  - The roof or windows are open.
  - The air conditioning vents are pointed towards the microphone.
  - The sound of the air conditioning fan is loud.
  - There is a negative effect on sound quality due to the phone and/or network being used.



#### NOTICE

- Do not touch and put a sharp object to the microphone. It may cause failure.

### About the contacts in the contact list

The following data is stored for every registered phone. When another phone is connected, the following registered data cannot be read:

- Contact data
- Call history data
- Favorites data
- Image data
- All phone settings
- Message settings

- When a phone's registration is deleted, the above-mentioned data is also deleted.

### When selling or disposing of the vehicle

A lot of personal data is registered when the hands-free system is used.

When selling or disposing of the vehicle, initialize the data. (→P.55)

The following data in the system can be initialized:

- Contact data
- Call history data
- Favorites data
- Image data
- All phone settings
- Message settings

- Once initialized, the data and settings will be erased. Pay much attention when initializing the data.

### Placing a call using the Bluetooth® hands-free system

After a Bluetooth® phone has been registered, a call can be made using the hands-free system. There are several methods by which a call can be made, as described below.

#### Displaying phone screen

► From the steering switch



- 1 Press  switch on the steering wheel.
- 2 Select the desired item on the sub menu.

► From the menu button

- 1 Press the "MENU" button on the Remote Touch.
- 2 Select "Phone".
- 3 Select the desired item on the sub menu.

#### By call history

Up to 30 of the latest call history items (missed, incoming and outgoing) can be selected from the "History".

- 1 Display the phone screen by either operation:
  -  switch on the steering wheel
  - "MENU" button → "Phone"
- 2 Select the  "History" on the sub menu and select the desired contact.
  - If the contact which is not registered

on the contact list is selected, the name is displayed as "Unknown Contact". In this case, follow the guidance on the screen to make a call properly.

- 3 Check that the call screen is displayed.

- The icons of call type are displayed.

 : Missed call

 : Incoming call

 : Outgoing call

- When making a call to the same number continuously, only the most recent call is listed in call history.
- When a phone number registered in the contact list is received, the name is displayed.
- Number-withheld calls are also memorized in the system.
- International phone calls may not be made depending on the type of cellular phone you have.
- The list should group together consecutive entries with the same phone number and same call type. For example, two calls from John's mobile would be displayed as follows: John (2)
- By pressing the  switch on the steering wheel, a call to the latest history item can be made.

#### By favorites list

Calls can be made using registered contacts which can be selected from a contact list. (→P.223)

- 1 Display the phone screen by either operation:
  -  switch on the steering wheel



- “MENU” button → “Phone”
- 2 Select the ★ “Favorites” on the sub menu and select the desired contact.
- 3 Select the desired number.
- 4 Check that the call screen is displayed.

### By contacts list

Calls can be made by using contact data which is transferred from a registered cellular phone. (→P.223)

Up to 5000 contacts (maximum of 4 phone numbers, e-mail addresses and addresses per contact) can be registered in the contact list.

#### ■ Calling from contacts list

- 1 Display the phone screen by either operation:
  -  switch on the steering wheel
  - “MENU” button → “Phone”
- 2 Select the  “Contacts” on the sub menu and select the desired contact.
 

“E-mail Addresses”: Select to display all registered e-mail addresses for the contact.
- 3 Select the desired number.
- 4 Check that the call screen is displayed.

### When the contact list is empty

- For PBAP compatible Bluetooth® phones when “Automatic Transfer” is set to on (→P.234)

- Contacts are transferred automatically.

- For PBAP compatible Bluetooth® phones when “Automatic Transfer” is set to off (→P.234)

- 1 Select the desired item.

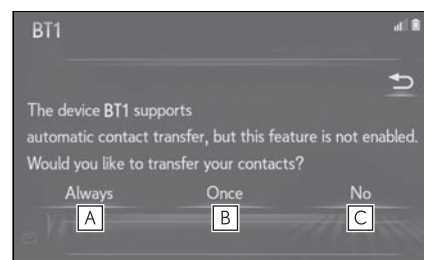

- A Select to always transfer all the contacts from a connected cellular phone automatically.
  - B Select to transfer all the contacts from a connected cellular phone only once.
  - C Select to cancel transferring.
- 2 Check that a confirmation screen is displayed when the operation is complete.

■ For PBAP incompatible but OPP compatible Bluetooth® phones

1 Select the desired item.

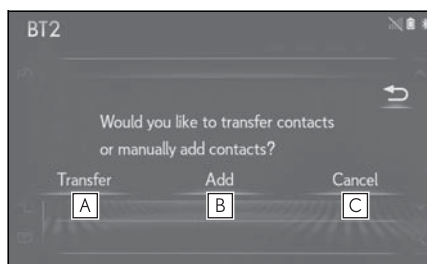

- A** Select to transfer the contacts from the connected cellular phone. Transfer the contact data to the system using a Bluetooth® phone.
- B** Select to add a new contact manually. Follow the steps in “Registering a new contact to the contacts list” from step 2. (→P.237)
- C** Select to cancel transferring.

- If your cellular phone is neither PBAP nor OPP compatible, the contacts cannot be transferred using Bluetooth®. But the contacts can be transferred from USB device. (→P.236)
- Depending on the type of Bluetooth® phone:
  - It may be necessary to perform additional steps on the phone when transferring contact data.
  - The registered image in the contact list may not transfer depending on the type of Bluetooth® phone connected.

**By keypad**

1 Display the phone screen by either operation:

- switch on the steering wheel

- “MENU” button → “Phone”

2 Select the “Keypad” on the sub menu and enter the phone number.

3 Select or press the switch on the steering wheel.

4 Check that the call screen is displayed.

- Depending on the type of Bluetooth® phone being connected, it may be necessary to perform additional steps on the phone.



## Receiving a call using the Bluetooth® hands-free system

When a call is received, the following screen is displayed with a sound.

**10.3-inch display model:** This screen can also be displayed on the side display.

### Incoming calls

- 1 Select "Answer" or press the  switch on the steering wheel to talk on the phone.

#### ► Main display

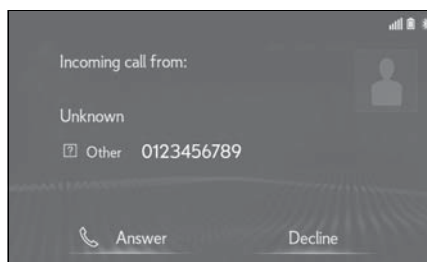

#### ► Side display\*

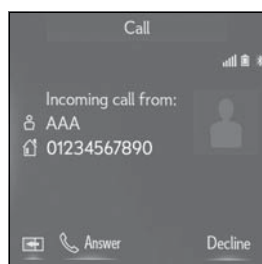

- To refuse to receive the call, select "Decline".
- To adjust the volume of a received call, turn the "PWR·VOL" knob, or

use the volume control switch on the steering wheel.

\* : 10.3-inch display model

- The contact image picture can be displayed only when the vehicle is not moving.
- During international phone calls, the other party's name or number may not be displayed correctly depending on the type of cellular phone you have.
- The ringtone that has been set in the sound settings screen can be heard when there is an incoming call. Depending on the type of Bluetooth® phone, both the system and Bluetooth® phone may ring simultaneously when there is an incoming call. (→P.232)
- 10.3-inch display model: The incoming call display mode can be set to the main display or side display. (→P.233)

### Talking on the Bluetooth® hands-free system

While talking on the phone the following screen is displayed. The operations outlined below can be performed on this screen.

10.3-inch display model: This screen can also be displayed on the side display.

### Call screen operation

#### ► Main display

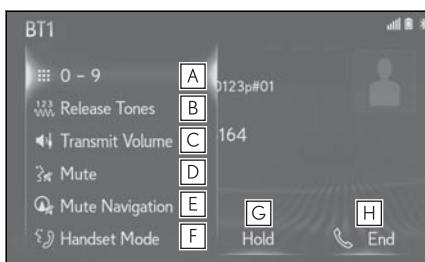

- A** Select to display the keypad to send tones. (→P.227)
- B** Select to send tones. This button only appears when a number that contains a (w) is dialed in hands-free mode. (→P.227)
- C** Select to adjust the volume of the other party's voice.
- D** Select to mute your voice to the other party.
- E** Select to mute the navigation route guidance during a phone call.\*1
- F** Select to change handset modes between hands-free and cellular phone.

- G** Select to start talking/holding with the other party.\*2 (→P.227)

- H** Select to hang up the phone.

\*1: 10.3-inch display model

\*2: This function may not be available depending on the type of Bluetooth® phone.

#### ► Side display\*1

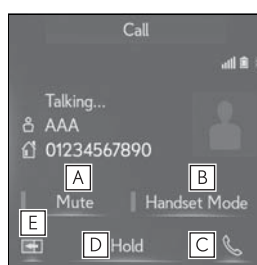

- A** Select to mute your voice to the other party.

- B** Select to change handset modes between hands-free and cellular phone.

- C** Select to hang up the phone.

- D** Select to start talking/holding with the other party.\*2 (→P.227)

- E** Select to switch the displayed current screen to the main display.

\*1: 10.3-inch display model

\*2: This function may not be available depending on the type of Bluetooth® phone.

- Only when the vehicle is not moving, the contact image can be displayed.
- When cellular phone call is changed to hands-free call, the hands-free screen will be displayed and its functions can be operated on the screen.
- Changing between cellular phone call and hands-free call can be performed by

operating the cellular phone directly.

- Transferring methods and operations will be different depending on the type of cellular phone you have.
- For the operation of the cellular phone, see the manual that comes with it.
- 10.3-inch display model: This screen can be displayed on the main display or side display. (→P.233)

### Sending tones

#### ■ By keypad

This operation cannot be performed while driving.

- 1 Select  "0-9" on the sub menu.
- 2 Enter the desired number.



#### ■ By selecting "Release Tones"

"Release Tones" appear when a continuous tone signal(s) containing a (w) is registered in the contact list.

- 1 Select  "Release Tones" on the sub menu.

- A continuous tone signal is a character string that consists of numbers and the characters p or w. (e.g. 056133w0123p#1\*)
- When the "p" pause tone is used, the tone data up until the next pause tone will be automatically sent after 2 seconds have elapsed. When the "w" pause tone is used, the tone data up until the next pause tone will be automatically sent after a user operation is performed.
- Release tones can be used when automated operation of a phone based service such as an answering machine or bank phone service is desired. A phone number with continuous tone signals can be registered in the contact list.
- Tone data after a "w" pause tone can be operated by voice command during a call.

### Transmit volume setting

- 1 Select  "Transmit Volume" on the sub menu.
- 2 Select the desired level for the transmit volume.
- 3 Press the  button on the Remote Touch to display previous screen.

- The sound quality of the voice heard from the other party's speaker may be negatively impacted.
- "Transmit Volume" is dimmed when mute is on.

### Incoming call waiting

When a call is interrupted by a third party while talking, the incoming screen is displayed.

- 1 Select "Answer" or press the  switch on the steering wheel to start talking with the other party.
- To refuse to receive the call, select "Decline".
- Each time "Swap Calls" is selected, the party who is on hold will be switched.

- This function may not be available depending on the type of cellular phone.

### Switching calls while a call is in progress

- When there are no calls on hold during a call: "Hold" is displayed. When selected, the current call is

placed on hold.

- When there is no current call, but there is a call on hold: "Activate" is displayed. When selected, the system switches to the call that was on hold.
  - When there is another call on hold during a call: "Swap Calls" is displayed. When selected, the current call is placed on hold, and the system switches to the call that was on hold.
- 
- This function may not be available depending on the type of cellular phone.
  - 10.3-inch display model: This screen can be displayed on the main display or side display.



### Bluetooth® phone message function

Received messages can be forwarded from the connected Bluetooth® phone, enabling checking and replying using the system.

Depending on the type of Bluetooth® phone connected, received messages may not be transferred to the message inbox.

If the phone does not support the message function, this function cannot be used. Even when the supported phone is used, reply function may not be used.

### Displaying the message inbox screen

- ▶ From the steering switch
  - 1 Press  switch on the steering wheel.
  - 2 Select  "Message" on the sub menu.
  - 3 Select the account name.
    - Account names are the names of the accounts that exist on the currently connected phone.
  - 4 Check that the message inbox screen is displayed.
- ▶ From the menu button
  - 1 Press the "MENU" button on the Remote Touch.
  - 2 Select "Phone".

- 3 Select  "Message" on the sub menu.
- 4 Select the account name.
  - Account names are the names of the accounts that exist on the currently connected phone.
- 5 Check that the message inbox screen is displayed.

- To change to the phone mode, select "Phone".

### Receiving a message

When an e-mail/SMS/MMS is received, the incoming message screen pops up with sound and is ready to be operated on the screen.

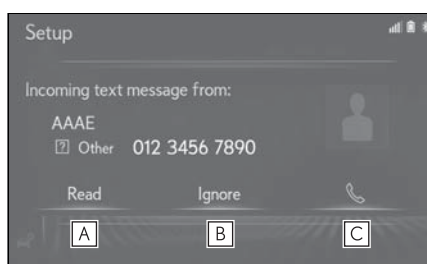

- A** Select to check the message.
- B** Select to not open the message.
- C** Select to call the message sender.

- To display the above screen, it needs to be set to "Full Screen" on "Incoming SMS/MMS Display" and "Incoming E-mail Display". (→P.233) Default setting is "Drop-down".
- Depending on the cellular phone used for receiving messages, or its registration status with the system, some information may not be displayed.
- The pop-up screen is separately available for incoming e-mail and SMS/MMS

messages under the following conditions:



E-mail:

- "E-mail Notification Pop-up" is set to on. (→P.233)

SMS/MMS:

- "SMS/MMS Notification Pop-up" is set to on. (→P.233)
- Depending on the type of Bluetooth<sup>®</sup> phone being connected, E-Mail function cannot be used via Bluetooth<sup>®</sup>.

### Checking received messages

- 1 Display the message inbox screen by either operation:
  -  switch on the steering wheel →  "Message" on the sub menu
  - "MENU" button → "Phone" →  "Message" on the sub menu
- 2 Select a desired account name.
- 3 Select the desired message from the list.
- 4 Check that the message is displayed.

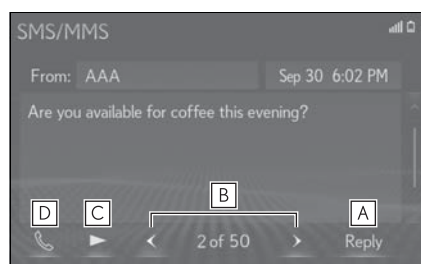

- A** Select to reply to the message. (→P.230)
- B** Select to display the previous or next message.
- C** Select to have messages read out. To cancel this function, select . When "Automatic Message Read-

out” is set to on, messages will be automatically read out. (→P.240)

**D** Select to call the message sender.

- Depending on the type of Bluetooth® phone being connected, this function cannot be used.
- Depending on the type of Bluetooth® phone being connected, it may be necessary to perform additional steps on the phone.
- Messages are displayed in the appropriate connected Bluetooth® phone’s registered mail address folder. Select the desired folder to be displayed.
- Only received messages on the connected Bluetooth® phone can be displayed.
- The text of the message is not displayed while driving.
- Turn the “PWR·VOL” knob, or use the volume control switch on the steering wheel to adjust the message read out volume.
- “Subject:” field is not shown on SMS case.

**Replying to a message (dictation reply)**

- 1 Select “Reply”.
- 2 Select “Dictation”.
- 3 When the “Say Your Message” screen is displayed, speak message that you want to send.
- 4 Select “Send” to send message.

“Cancel”: Select to cancel sending the message.

“Retry”: Select to retry speaking message that you want to send.

- While the message is being sent, a sending message screen is displayed.

- 5 Check that a confirmation screen is displayed when the operation is complete.

- If an error message is displayed, follow the guidance on the screen to try again.

**Replying to a message (quick reply)**

15 messages have already been stored.

- 1 Select “Reply”.
- 2 Select “Quick Message”.
- 3 Select the desired message.
- 4 Select “Send”.

“Cancel”: Select to cancel sending the message.

- While the message is being sent, a sending message screen is displayed.
- 5 Check that a confirmation screen is displayed when the operation is complete.
- If an error message is displayed, follow the guidance on the screen to try again.

**Editing quick reply messages**

This operation cannot be performed while driving.

- 1 Select “Reply”.
- 2 Select  corresponding to the desired message to edit.
- 3 Select “OK” when editing is completed.

- To reset the edited quick reply messages, select “Default”.



- 10.3-inch display model: Quick message #1 ("I am driving and will arrive in approximately [##] minutes.") This message cannot be edited and will automatically fill in [##] with the navigation calculated estimated time of arrival on the confirm message screen. If there are waypoints set, [##] to the next waypoint will be shown. If there is no route currently set in the navigation system, Quick message #1 cannot be selected.

#### Calling the message sender

Calls can be made to an e-mail/SMS/MMS message sender's phone number.

This operation can be performed while driving.

#### ■ Calling from e-mail/SMS/MMS message display

- 1 Select  or press the  switch on the steering wheel.
- If there are 2 or more phone numbers, select the desired number.
- 2 Check that the call screen is displayed.

#### ■ Calling from a number within a message

Calls can be made to a number identified in a message's text area in blue font.

This operation cannot be performed while driving.

- 1 Select the text area.

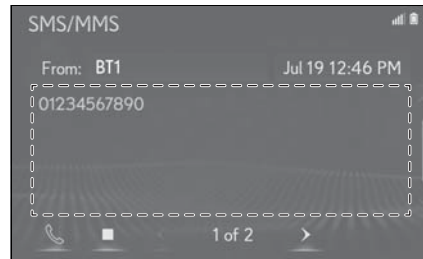

- 2 Select the desired number.

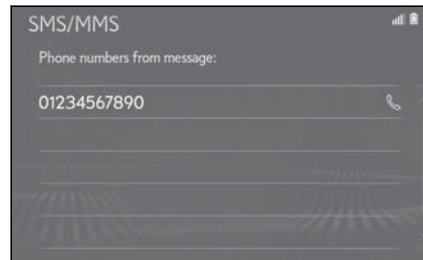



- Identified phone numbers contained in the message are displayed.
- 3 Check that the call screen is displayed.
- A series of numbers may be recognized as a phone number. Additionally, some phone numbers may not be recognized, such as those for other countries.

## Phone settings

### Displaying the phone settings screen

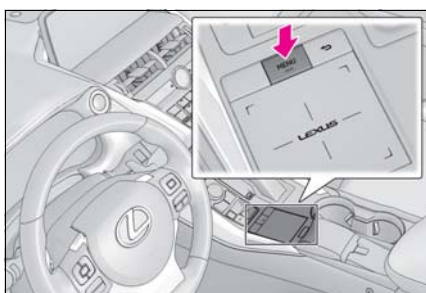
- 1 Press the "MENU" button on the Remote Touch.



- 2 Select "Setup".
- 3 Select  "Phone" on the sub menu.
- 4 Select the desired item to be set.

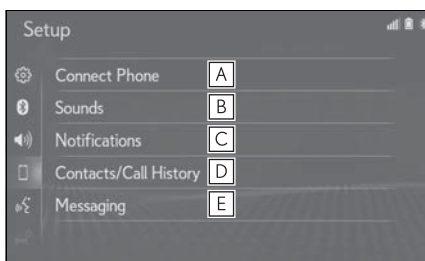

- A** Connecting a Bluetooth<sup>®</sup> device and editing the Bluetooth<sup>®</sup> device information (→P.44)
- B** Sound settings\* (→P.232)
- C** Notification settings\* (→P.233)
- D** Contact/call history settings\* (→P.234)
- E** Message settings\* (→P.240)

\*: This operation cannot be performed

while driving.

### "Sounds" screen

The call and ringtone volume can be adjusted. A ringtone can be selected.

- 1 Display the phone settings screen:
  - "MENU" button → "Setup" →  "Phone" on the sub menu
- 2 Select "Sounds".
- 3 Select the desired item to be set.

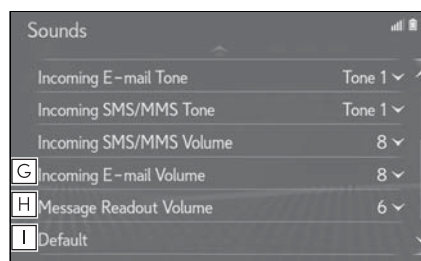
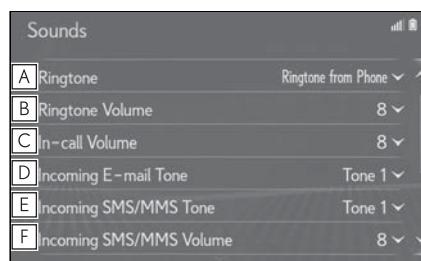

- A** Select to set the desired ringtone.
- B** Select "-" or "+" to adjust the ringtone volume.
- C** Select "-" or "+" to adjust the default volume of the other party's voice.
- D** Select to set the desired incoming e-mail tone.
- E** Select to set the desired incoming SMS/MMS tone.
- F** Select "-" or "+" to adjust the incoming SMS/MMS tone volume.



- G** Select “-” or “+” to adjust the incoming e-mail tone volume.
  - H** Select “-” or “+” to adjust the message readout volume.
  - I** Select to reset all setup items.
- Depending on the type of phone, certain functions may not be available.

**“Notifications” screen**

- 1 Display the phone settings screen:
  - “MENU” button → “Setup” →  “Phone” on the sub menu
- 2 Select “Notifications”.
- 3 Select the desired item to be set.

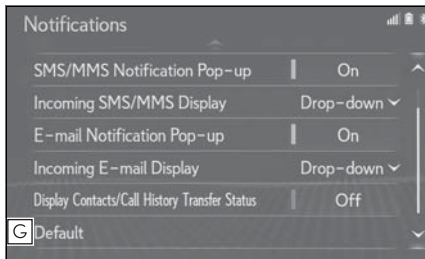
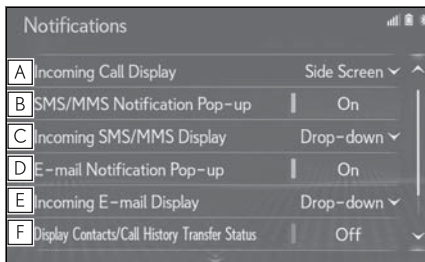

- A** Select to change the incoming call display.
  - 10.3-inch display model:
    - “Main Screen”: Select to display and operate the screen on the main display.
    - “Side Screen”: Select to display and

- operate the screen on the side display. For details of the screen: →P.225
- 8-inch display model:
  - “Full Screen”: When a call is received, the hands-free screen is displayed and can be operated on the screen.
  - “Drop-Down”: A message is displayed on the upper side of the screen and can only be operated via the steering wheel switches.

- B** Select to set the SMS/MMS notification pop-up on/off.
- C** Select to change the incoming SMS/MMS display.
  - “Full Screen”: When an SMS/MMS message is received, the incoming SMS/MMS display screen is displayed and can be operated on the screen.
  - “Drop-down”: When an SMS/MMS message is received, a message is displayed at the top of the screen.
- D** Select to set the e-mail notification pop-up on/off.
- E** Select to change the incoming e-mail display.
  - “Full Screen”: When an e-mail is received, the incoming e-mail display screen is the displayed and can be operated on the screen.
  - “Drop-down”: When an e-mail is received, a message is displayed at the top of the screen.
- F** Select to set display of the contact/history transfer completion message on/off.
- G** Select to reset all setup items.

8 Phone

- Depending on the phone, these functions may not be available.

**“Contacts/Call History” screen**

Contacts can be transferred from a Bluetooth® phone to this system. Contacts and favorites can be added, edited and deleted. Also, the call history can be deleted.

1 Display the phone settings screen:

- “MENU” button → “Setup” →  “Phone” on the sub menu
- 2 Select “Contacts/Call History”.
- 3 Select the desired item to be set.

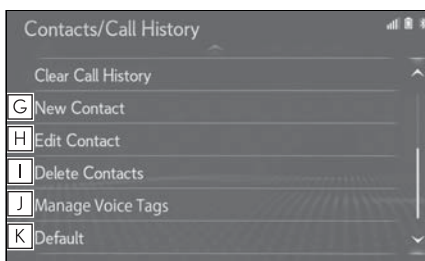
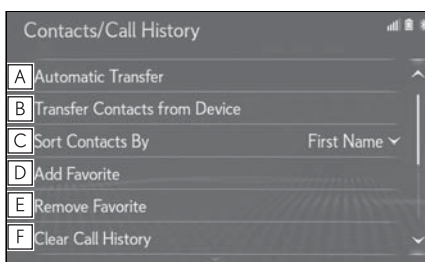

- A For PBAP compatible Bluetooth® phones: Select to change the contact/history transfer settings. (→P.234)
- B Select to update contacts from the connected device. (→P.235)
- C Select to sort contacts by the first

name or last name field.

- D Select to add contacts to the favorites list. (→P.238)
- E Select to delete contacts from the favorites list. (→P.238)
- F Select to clear the call history.\*
- G Select to add new contacts to the contact list.\* (→P.237)
- H Select to edit contacts in the contact list.\* (→P.237)
- I Select to delete contacts from the contact list.\* (→P.237)
- J Select to set the voice tags. (→P.239)
- K Select to reset all setup items.

\*: For PBAP compatible Bluetooth® phones, this function is available when “Automatic Transfer” is set to off. (→P.234)

- Depending on the type of phone, certain functions may not be available.
- Contact data is managed independently for every registered phone. When one phone is connected, another phone’s registered data cannot be read.

**Setting automatic contact/history transfer**

The automatic contact/history function is available for PBAP compatible Bluetooth® phones only.

- 1 Select “Automatic Transfer”.

**2** Select the desired item to be set.

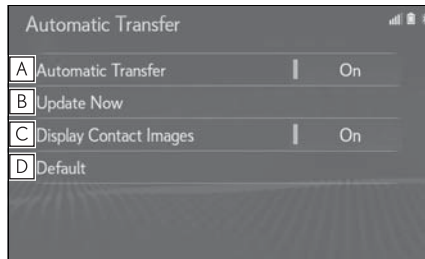

- A** Select to set automatic contact/history transfer on/off. When set to on, the phone's contact data and history are automatically transferred.
- B** Select to update contacts from the connected phone. (→P.235)
- C** Select to set the transferred contact image display on/off. Only when the vehicle is not moving, the contact image can be displayed.
- D** Select to reset all setup items.

#### ■ Updating contacts from phone

- 1** Select "Update Now".
  - Contacts are transferred automatically.
- 2** Check that a confirmation screen is displayed when the operation is complete.
  - This operation may be unnecessary depending on the type of cellular phone.
  - If another Bluetooth® device is connected when transferring contact data, depending on the phone, the connected Bluetooth® device may need to be disconnected.
  - Depending on the type of Blue-

tooth® phone being connected, it may be necessary to perform additional steps on the phone.

#### Transfer contacts from device

##### From phone

- ▶ When the contact is not registered
  - 1** Select "Transfer Contacts from Device".
  - 2** Select "From Phone (Bluetooth)".
  - 3** Transfer the contact data to the system using a Bluetooth® phone.
    - This operation may be unnecessary depending on the type of cellular phone.
    - To cancel this function, select "Cancel".
  - 4** Check that a confirmation screen is displayed when the operation is complete.
    - This function is only for OPP compatible Bluetooth® phone.
- ▶ When the contact is registered
  - 1** Select "Transfer Contacts from Device".
  - 2** Select "From Phone (Bluetooth)".
  - 3** Select "Replace Contacts" or "Add Contact".
 

"Replace Contacts": Select to transfer the contact from the connected cellular phone and replace the current one.

"Add Contact": Select to transfer the desired contact data from the connected cellular phone to add to the current one.

4 Transfer the contact data to the system using a Bluetooth® phone.

- This operation may be unnecessary depending on the type of cellular phone.

- To cancel this function, select “Cancel”.

5 Check that a confirmation screen is displayed when the operation is complete.

- This function is only for OPP compatible Bluetooth® phone.

■ **Updating the contacts in a different way (From the “Call History” screen)\***

1 Press the “MENU” button on the Remote Touch.

2 Select “Phone”.

3 Select the  “History” on the sub menu and select a contact not yet registered in the contact list.

4 Select “Update Contact”.

5 Select the desired contact.

6 Select a phone type for the phone number.

\* : For PBAP compatible Bluetooth® phones, this function is available when “Automatic Transfer” is set to off. (→P.234)

#### From USB device

Backed-up contact data (“vCard” formatted) can be transferred from USB device or Bluetooth® phone to this system.

1 Press the button to release the lock and lift the armrest.

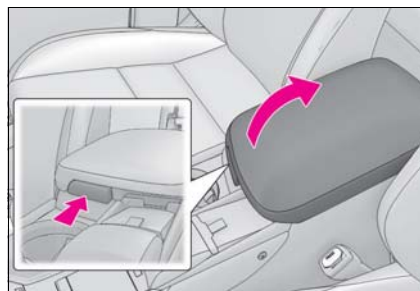

2 Open the cover and connect a device.

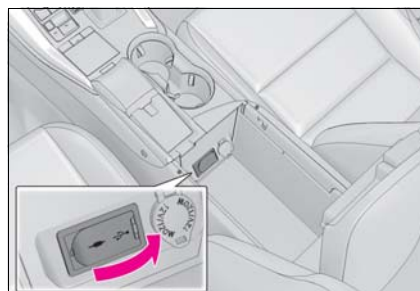

- Turn on the power of the USB device or Bluetooth® phone if it is not turned on.

3 Select “Transfer Contacts from Device”.

4 Select “From USB”.

5 Select “USB 1” or “USB 2” when the multiple USB devices are connected. If a USB device is connected, skip this procedure.

▶ When the contact is not registered

6 Select a desired file from vCard file list.

7 Check that a confirmation screen is displayed when the operation is complete.

- ▶ When the contact is registered
- 6** Select "Replace Contacts" or "Add Contact". If the contact is already registered, skip this procedure.

"Replace Contacts": Select to transfer the contact from the connected USB device or Bluetooth® phone and replace the current one.

"Add Contact": Select to transfer the desired contact data from the connected USB device or Bluetooth® phone to add to the current one.

- 7** Select a desired file from vCard file list.
- 8** Check that a confirmation screen is displayed when the operation is complete.

- Depending on the type of phone used and number of files, it may take time to display vCard file lists and download contacts.
- Downloading may not complete correctly in the following cases:
  - If the engine switch <power switch> is turned off during downloading.
  - If the USB device or Bluetooth® phone is removed before downloading is complete.

#### Registering a new contact to the contacts list

New contact data can be registered.

Up to 4 numbers per person can be registered.

- 1** Select "New Contact".
- 2** Enter the name and select "OK".
- 3** Enter the phone number and select "OK".
- 4** Select the phone type for the phone number.

- 5** To add another number to this contact, select "Yes".

#### Registering a new contact in a different way (From the "Call History" screen)

- 1** Press the "MENU" button on the Remote Touch.
- 2** Select "Phone".
- 3** Select the  "History" on the sub menu and select a contact not yet registered in the contact list.
- 4** Select "Add to Contacts".
- 5** Enter the name and select "OK".
- 6** Enter the phone number and select "OK".
- 7** Select the phone type for the phone number.
- 8** To add another number to this contact, select "Yes".

#### Editing the contact data

- 1** Select "Edit Contact".
- 2** Select the desired contact.
- 3** Select  next to the name or desired number.
- 4** Enter the name or the phone number and select "OK".

#### Deleting the contact data

- 1** Select "Delete Contacts".
- 2** Select the desired contact and press the  button on the Remote Touch.

"Select All": Select all items in the list.  
 "Unselect All": Unselect all items in the list.  
 "Delete": Delete selected items in the list.

- 3 Select "Delete".
- 4 Select "Yes" when the confirmation screen appears.

- Multiple data can be selected and deleted at the same time.
- When a Bluetooth<sup>®</sup> phone is deleted, the contact data will be deleted at the same time.

#### Favorites list setting

Up to 15 contacts (maximum of 4 numbers per contact) can be registered in the favorites list.

##### ■ Registering the contacts in the favorites list

- 1 Select "Add Favorite".
- 2 Select the desired contact to add to the favorites list.
- Dimmed contacts are already stored as a favorite.
- 3 Check that a confirmation screen is displayed when the operation is complete.
  - ▶ When 15 contacts have already been registered to the favorites list
- 1 When 15 contacts have already been registered to the favorites list, a registered contact needs to be replaced.  
 Select "Yes" when the confirmation screen appears to replace a contact.
- 2 Select the contact to be replaced.

- 3 Check that a confirmation screen is displayed when the operation is complete.

▶ Registering contacts in the favorites list in a different way (from the "Contact Details" screen)



- 1 Press the "MENU" button on the Remote Touch.
- 2 Select "Phone".
- 3 Select  "Contacts" on the sub menu and select the desired contact.
- 4 Select "Add Favorite".
- 5 Check that a confirmation screen is displayed when the operation is complete.

##### ■ Deleting the contacts in the favorites list

- 1 Select "Remove Favorite".
- 2 Select the desired contacts and press the  button on the Remote Touch.

"Select All": Select all items in the list.  
 "Unselect All": Unselect all items in the list.  
 "Remove": Remove selected items in the list.

- 3 Select "Remove".
- 4 Select "Yes" when the confirmation screen appears.
- 5 Check that a confirmation screen is displayed when the operation is complete.

- ▶ Deleting contacts in the favorites list in a different way (from the “Contact Details” screen)
  - 1 Press the “MENU” button on the Remote Touch.
  - 2 Select “Phone”.
  - 3 Select the  “Contacts” or  “Favorites” on the sub menu and select the desired contact to delete.
  - 4 Select “Remove Favorite”.
  - 5 Select “Yes” when the confirmation screen appears.
  - 6 Check that a confirmation screen is displayed when the operation is complete.

### Setting voice tags

Calls can be made by saying the voice tag of a registered contact in the contact list. (→P.156)

- 1 Select “Manage Voice Tags”.
- 2 Select the desired item to be set.



- A** Select to register a new voice tag. (→P.239)
- B** Select to edit a voice tag.(→P.239)
- C** Select to delete a voice tag.(→P.239)

### Registering a voice tag

Up to 50 voice tags can be registered.

- 1 Select “New”.
- 2 Select the desired contact to register a voice tag for.
- 3 Select “REC” and record a voice tag.
  - When recording a voice tag, do so in a quiet area.
- “Play”: Select to play the voice tag.
- 4 Select “OK” when voice tag registration is complete.

### Editing a voice tag

- 1 Select “Edit”.
- 2 Select the desired contact to edit.
- 3 Select “REC” and record a voice tag.
  - When recording a voice tag, do so in a quiet area.
- “Play”: Select to play the voice tag.
- 4 Select “OK” when voice tag registration is complete.

### Deleting the voice tag

- 1 Select “Delete”.
- 2 Select the desired contact and select “Delete”.
- 3 Select “Yes” when the confirmation screen appears.
  - Multiple data can be selected and deleted at the same time.
  - Voice tags are deleted when the set language of the system is changed. (→P.53)

**“Messaging” screen**

- 1 Display the phone settings screen:
  - “MENU” button → “Setup” →  “Phone” on the sub menu
- 2 Select “Messaging”.
- 3 Select the desired item to be set.

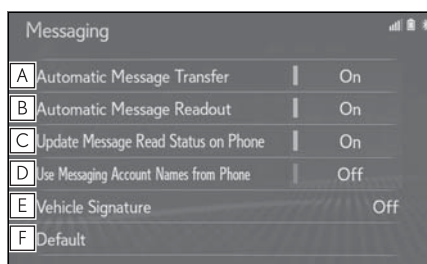

- A** Select to set automatic message transfer on/off.
- B** Select to set automatic message readout on/off.
- C** Select to set updating message read status on phone on/off.
- D** Select to set display of messaging account names on the inbox on/off. When set to on, messaging account names used on the cellular phone will be displayed.
- E** Select to set adding the vehicle signature to outgoing messages on/off.
- F** Select to reset all setup items.

● Depending on the phone, these functions may not be available.

**Vehicle signature settings**

- 1 Select “Vehicle Signature”.

- 2 Select the desired item to be set.

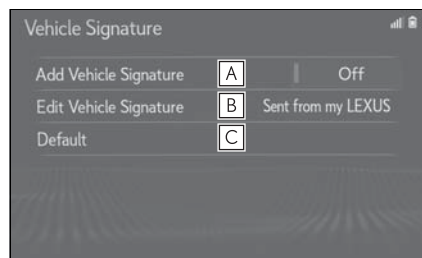

- A** Select to set adding the vehicle signature to outgoing messages on/off.
- B** Select to edit the vehicle signature (→P.240)
- C** Select to reset all setup items.

■ **Editing vehicle signature**

- 1 Select “Edit Vehicle Signature”.
- 2 Enter desired signature with using keyboard.
- 3 Select “OK”.
- 4 Select “OK” on the confirmation screen, or select “Edit Again” when it needs to amend.



**Troubleshooting**

**If there is a problem with the hands-free system or a Bluetooth® device, first check the table below.**

- ▶ When using the hands-free system with a Bluetooth® device

Symptom	Likely cause	Solution
The hands-free system or Bluetooth® device does not work.	The connected device may not be a compatible Bluetooth® cellular phone.	For a list of specific devices which operation has been confirmed on this system, check with your Lexus dealer or the following website: <a href="http://www.lexus.com/MobileLink">http://www.lexus.com/MobileLink</a>
	The Bluetooth® version of the connected cellular phone may be older than the specified version.	Use a cellular phone with Bluetooth® version 2.0 or higher (recommended: Ver. 4.1+EDR or higher). (→P.42)



- ▶ When registering/connecting a cellular phone

Symptom	Likely cause	Solution
A cellular phone cannot be registered.	An incorrect passcode was entered on the cellular phone.	Enter the correct passcode on the cellular phone.
	The registration operation has not been completed on the cellular phone side.	Complete the registration operation on the cellular phone (approve registration on the phone).
	Old registration information remains on either this system or the cellular phone.	Delete the existing registration information from both this system and the cellular phone, then register the cellular phone you wish to connect to this system. (→P.43)

8  
Phone

Symptom	Likely cause	Solution
A Bluetooth® connection cannot be made.	Another Bluetooth® device is already connected.	Manually connect the cellular phone you wish to use to this system. (→P.44)
	Bluetooth® function is not enabled on the cellular phone.	Enable the Bluetooth® function on the cellular phone.
	Automatic Bluetooth® connection on this system is set to off.	Set automatic Bluetooth® connection on this system to on when the engine <power> switch is in ACCESSORY or IGNITION ON <ON> mode. (→P.47)

► When making/receiving a call

Symptom	Likely cause	Solution
A call cannot be made/received.	Your vehicle is in a  area.	Move to where  no longer appears on the display.

► When using the phonebook

Symptom	Likely cause	Solution
Phonebook data cannot be transferred manually/ automatically.	The profile version of the connected cellular phone may not be compatible with transferring phonebook data.	For a list of specific devices which operation has been confirmed on this system, check with your Lexus dealer or the following website: <a href="http://www.lexus.com/MobileLink">http://www.lexus.com/MobileLink</a>
	Automatic contact transfer function on this system is set to off.	Set automatic contact transfer function on this system to on. (→P.234)
	Passcode has not been entered on the cellular phone.	Enter the passcode on the cellular phone if requested (default passcode: 1234).
	Transfer operation on the cellular phone has not completed.	Complete transfer operation on the cellular phone (approve transfer operation on the phone).
Phonebook data cannot be edited.	Automatic contact transfer function on this system is set to on.	Set automatic contact transfer function on this system to off. (→P.234)

► When using the Bluetooth® message function

Symptom	Likely cause	Solution
Messages cannot be viewed.	Message transfer is not enabled on the cellular phone.	Enable message transfer on the cellular phone (approve message transfer on the phone).
	Automatic transfer function on this system is set to off.	Set automatic transfer function on this system to on. (→P.234)
New message notifications are not displayed.	Notification of SMS/MMS/E-mail reception on this system is set to off.	Set notification of SMS/MMS/E-mail reception on this system to on. (→P.233)
	Automatic message transfer function is not enabled on the cellular phone.	Enable automatic transfer function on the cellular phone.

► In other situations

Symptom	Likely cause	Solution	
The Bluetooth® connection status is displayed at the top of the screen each time the engine <power> switch is in ACCESSORY or IGNITION ON <ON> mode.	Connection confirmation display on this system is set to on.	To turn off the display, set connection confirmation display on this system to off. (→P.48)	
Even though all conceivable measures have been taken, the symptom status does not change.	The cellular phone is not close enough to this system.	Bring the cellular phone closer to this system.	
	Radio interference has occurred.	Turn off Wi-Fi® devices or other devices that may emit radio waves.	
	The cellular phone is the most likely cause of the symptom.		Turn the cellular phone off, remove and reinstall the battery pack, and then restart the cellular phone.
			Enable the cellular phone's Bluetooth® connection.
			Disable the Wi-Fi® connection of the cellular phone.
			Stop the cellular phone's security software and close all applications.
		Before using an application installed on the cellular phone, carefully check its source and how its operation might affect this system.	

**9-1. Lexus Enform overview**

Lexus Enform..... 246

Type A: Function achieved by  
using a smart phone or DCM  
..... 247Type B: Function achieved by  
using DCM and the naviga-  
tion/multimedia system ..... 249Type C: Function achieved by  
using DCM ..... 250Type D: Function achieved by  
using DCM and a smart phone  
..... 253**9-2. Lexus Enform operation**

Lexus Enform App Suite 2.0 255

Lexus Enform Destinations... 258

**9-3. Setup**Lexus Enform App Suite 2.0 set-  
tings..... 260

### Lexus Enform

Lexus Enform is a service that includes Safety Connect, Service Connect, Remote, Destinations, Dynamic Navigation, Wi-Fi<sup>®</sup> Hotspot and App Suite.

### Functional overview

The functions included in Lexus Enform are classified into the following four types.

- Type A: Function achieved by using a smart phone or an embedded cellular device in the vehicle (DCM: Data Communication Module) and the navigation/multimedia system
- Type B: Function achieved by using DCM and the navigation/multimedia system
- Type C: Function achieved by using DCM
- Type D: Function achieved by using DCM and a smart phone

Function	Type
App Suite	Type A
Destinations (Destination Assist), Dynamic Navigation, Wi-Fi <sup>®</sup> Hotspot	Type B
Safety Connect	Type C
Remote, Service Connect	Type D

- These functions are not made available in some countries, areas, or on some mod-

els.

- Availability of functions of the Lexus Enform service is dependent on network reception level.

**Type A: Function achieved by using a smart phone or DCM**

Of the functions included with Lexus Enform, the App Suite relies on the use of a smart phone or DCM.

- Using a smart phone
  - App Suite enables applicable apps installed on a smart phone to be displayed on and operated from the screen via a Bluetooth®.
  - App Suite enables applicable apps installed on the system to be displayed on and operated from the screen.
- Via DCM
  - App Suite enables applicable apps installed on the system to be displayed on and operated from the screen.

A few settings must be performed before App Suite can be used. (→P.248)

**By using a smart phone or DCM**

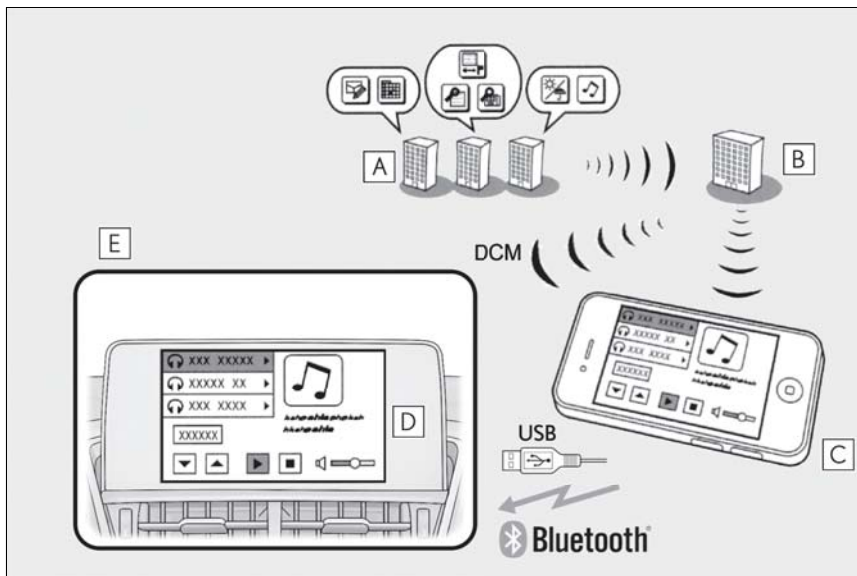

- A** Content provider  
Provides contents to the application server.
- B** Application server  
Provides applications to the navigation/multimedia system or a smart phone.

**C** Smart phone\*

Using the App Suite, communication is relayed between the navigation/multimedia system, application server and contents provider. The smart phone can be opened while communication, though the phone will display the Enform HS App lock screen. The smart phone cannot be operated while communicating.

**D** Applications

Display usable content from the content providers on the screen using the data connection of the connected smart phone or DCM.

**E** Navigation/multimedia system

Content received, via a smart phone or DCM, from content provider servers is displayed on the screen. The navigation/multimedia system is equipped with an application player to run applications.

\* : For known compatible phones, refer to <http://www.lexus.com/MobileLink>.

**Before using the function**

■ **Subscription**

- App Suite does not require an activation fee or monthly recurring fees.
- Services requiring a separate contract can also be used.\*

\* : For details, refer to <http://www.lexus.com/enform/> or call 1-800-255-3987.

■ **Availability of function**

- This function is not made available in some countries or areas.

● Data usage fees may apply while using App Suite function. Confirm data usage fees before using this function.

● The required operations to activate applications and connect a smart phone to the navigation/multimedia system, and the registration steps for the App Suite are explained in this section. For details regarding operation of the App Suite and the applications, refer to <http://www.lexus.com/enform/>.

● Availability of functions of the Lexus Enform service is dependent on network

reception level.

■ **Initializing personal data**

The personal data used in applications can be reset. (→P.55)

- The following personal data can be deleted and returned to their default settings:

- Downloaded contents
- Radio stations that were listened to

● Once initialized, the data and settings will be erased. Pay much attention when initializing the data.

**Preparation before using Lexus Enform App Suite 2.0**

■ **Settings required to use Lexus Enform App Suite 2.0**

Perform the settings in the following order.

- 1 Download the App Suite application to your smart phone or the navigation/multimedia system.



- 2 Register the smart phone with the navigation/multimedia system.

In order to use App Suite, the following must first be performed:

- Download the App Suite application onto your smart phone or the navigation/multimedia system, and login to the application. (→P.249)
- Register the smart phone, on which the App Suite application was installed, with the system. (→P.249)
- Register a Bluetooth® phone with the hands-free system. (→P.39)

#### ■ Registering the Lexus Enform App Suite 2.0 application

- Registration is optional.
- 1 Download the App Suite application to your smart phone or the navigation/multimedia system.
  - 2 Run the App Suite application on your smart phone or the system.
  - 3 Enter the information required into the application. Login to the application.

- 
- Applications can only be used when the App Suite application has been downloaded to your smart phone or the navigation/multimedia system, and the application is running.
  - App Suite operational procedures can also be confirmed by visiting <http://www.lexus.com/enform/>.
  - If a App Suite application is used while iPod audio is being played back, system operation may become unstable.

### Type B: Function achieved by using DCM and the navigation/multimedia system

The functionality of Lexus Enform Destinations, Dynamic Navigation, and Wi-Fi® Hotspot is made possible through the shared work of the DCM and the navigation/multimedia system.

These are subscription-based telematics services that use Global Positioning System (GPS) data and embedded cellular technology to provide safety and security as well as convenience features.

These services are available by subscription on select, telematics hardware-equipped vehicles and supported by Lexus' designated response center, which operates 24 hours a day, 7 days a week.

For details about:

- Dynamic Navigation →P.74, 83, 104
- Wi-Fi® Hotspot →P.49

### Before using the function

#### ■ Subscription

- After you have signed the Telematics Subscription Service Agreement and are enrolled, you can begin receiving services. A variety of subscription terms are available. Contact your Lexus dealer, or call 1-800-25-LEXUS (1-800-255-3987), for further subscription

details. (→P.258)

■ **Availability of functions**

- These functions are not made available in some countries, areas, or on some models.

**Type C: Function achieved by using DCM**

The functionality of Lexus Enform Safety Connect is made possible by the use of a DCM.

For details, refer to “OWNER’S MANUAL”.

- **Free/Open Source Software Information** This product contains Free/Open Source Software (FOSS). The license information and/or the source code of such FOSS can be found at the following URL.  
<https://www.denso.com/global/en/opensource/dcm/toyota/>
- **Exposure to radio frequency signals:** The Lexus Enform system installed in your vehicle includes a low power radio transmitter and receiver. The system receives and also sends out radio frequency (RF) signals.
- In August 1996, the Federal Communications Commission (FCC) adopted RF exposure guidelines with safety levels for mobile wireless phones. Those guidelines are consistent with the safety standards previously set by both U.S. and international standards bodies.
  - ANSI (American National Standards Institute) C95.1 [1992]
  - NCRP (National Council on Radiation Protection and Measurement) Report 86 [1986]
  - ICNIRP (International Commission on Non-Ionizing Radiation Protection) [1996]
- These standards are based on comprehensive and periodic evaluations of the relevant scientific literature. Over 120 scientists, engineers, and physicians from universities, government health agencies, and industry reviewed the available body of research to develop the ANSI Standard (C95.1).
- The design of Lexus Enform system complies with the FCC guidelines in addition

to those standards.

- Contact with the Lexus response center is dependent upon the telematics device being in operative condition, cellular connection availability, navigation map data, and GPS satellite signal reception, which can limit the ability to reach the response center or receive support. Enrollment and Telematics Subscription Service Agreement required. A variety of subscription terms are available; charges vary by subscription term selected.
- The Lexus response center offers support in multiple languages.
- Select Lexus Enform Safety Connect-subscribed vehicles are capable of communicating vehicle information. Please see the terms and conditions for additional details. Owners who do not wish to have their vehicle transmit this information can opt out at the time of enrollment or by calling 1-800-255-3987 and following the prompts for Lexus Enform Safety Connect.
- For further details about the service, contact your Lexus dealer.
- Lexus Enform functions are not subject to section 255 of the Telecommunications Act and the system is not TTY compatible.
- Certification
  - ▶ For vehicles sold in the U.S.A., Canada and Puerto Rico

**FCC ID: LHJ-TVN**

**FCC ID: JOYJ79**

**IC: 2870E-TVN**

**IC: 574B-J79**

**FCC/IC WARNING:**

Changes or modifications not expressly approved by the manufacture could void the user's authority to operate the equipment.

This device complies with Part 15 of the FCC Rules and Industry Canada license-exempt RSS standards. Operation is subject to the following two conditions:

- (1) this device may not cause harmful interference, and
- (2) this device must accept any interference, including interference that may cause undesired operation of the device.

This equipment complies with IC RSS-102 radiation exposure limits set forth for uncontrolled environment.

The antennas used for this transmitter must be installed to provide a separation distance of least 20cm from all persons.

**FCC/IC AVERTISSEMENT:**

L'utilisateur est averti que les changements ou modifications non expressément approuvés par le fabricant pourraient annuler l'autorité de l'utilisateur à utiliser l'équipement.

Cet appareil est compatible avec la Partie 15 du règlement FCC et de la Licence de l'industrie canadienne et des normes exemptes de RSS. Opération soumise aux deux conditions suivantes :

- (1) ce appareil ne doit pas causer des interférences nuisibles, et
- (2) cet appareil doit accepter toutes les interférences, y compris les interférences qui peuvent entraîner un fonctionnement indésirable de l'appareil.

Cet appareil est compatible aux limites d'exposition aux radiations IC RSS-102 définies pour un environnement non contrôlé.

Les antennes utilisées pour cet émetteur doivent être installées à une distance d'au moins 20 cm de toutes les personnes.

### Type D: Function achieved by using DCM and a smart phone

The functionality of Lexus Enform Remote and Lexus Enform Service Connect are made possible by the use of a DCM and a smart phone.

For details about these services, refer to <http://www.lexus.com/enform/>.

### Lexus Enform Remote

Lexus Enform Remote is a smart phone application that lets you view and remotely control certain aspects of your vehicle.

#### ■ Subscription

- After you sign the Telematics Subscription Service Agreement (see the Lexus Enform Safety Connect section in "OWNER'S MANUAL"), download the Lexus Enform Remote app from your smart phone's app store, and register within the app (or enroll and complete registration at the dealer), you can begin using these services.
- A variety of subscription terms are available. Contact your Lexus dealer, or call 1-800-25-LEXUS (1-800-255-3987) for further subscription details.

#### ■ Availability of function

- This function is not made available in some countries or areas.

- Availability of functions of the Lexus Enform Remote is dependent on network reception level.
- Lexus Enform Remote should only be used by authorized users.
- Laws in some communities may require that the vehicle be within view of the user when operating Lexus Enform Remote. In some states, use of Lexus Enform Remote may violate state or local laws. Before using Lexus Enform Remote, check your state and local laws.
- Any malfunction of the vehicle should be repaired by your Lexus dealer.
- Lexus Enform Remote is designed to work at temperatures above approximately -22 °F (-30 °C). This specification is related to the Lexus Enform Remote operation, but is dependent on the vehicle's operating temperature range which may be different.
- Content is subject to change without notice.
- Some Lexus Enform Remote features may not be available on some models.
- Additional information can be found at [www.lexus.com/enform/](http://www.lexus.com/enform/).

#### ⚠ WARNING

- Operating Lexus Enform Remote incorrectly may lead to unforeseen accidents or malfunctions. Check the vehicle condition and assume full responsibility before using.

### Lexus Enform Service Connect

Lexus Enform Service Connect uses DCM to collect and transmit vehicle data that allows Lexus to provide:

- Vehicle Health Report (VHR) (Safety Recalls, Service Campaigns, Current Vehicle Alerts, Required Maintenance, and Vehicle Condition Status)

- Maintenance Notifications
  - Vehicle Alert Notifications
  - **Availability of function**
  - This function is not made available in some countries or areas.
- 
- Availability of functions of the Lexus Enform Service Connect is dependent on network reception level.

## Lexus Enform App Suite 2.0

App Suite is a function that enables certain apps installed on a smart phone or the system to be displayed on and operated from the navigation/multimedia system screen. Before the Lexus Enform App Suite 2.0 can be used, some setup needs to be performed. (→P.248)

For details about the functions and services provided by each application, refer to <http://www.lexus.com/enform/>.

## Using Lexus Enform App Suite 2.0

- 1 Press the "MENU" button on the Remote Touch.

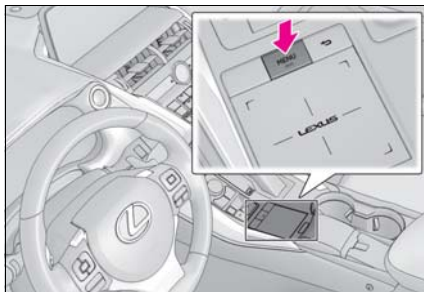

- 2 Select "Apps".
- 3 Select the desired application screen button.

**APP1**: Select to activate an application.

"Update": Select to update the applications. (→P.255)

"App Catalog": Select to change the order of the applications. (→P.256)

**2**: Displays the number of new notifications for the application

## Updating an application

When the App Suite is activated, an application may need to be updated. To update an application, it is necessary to download update data and install it.

### ■ Downloading update

If an update is available, "Update" can be selected.

- 1 Select "Update" on the "Enform App Suite" screen.
- 2 Check that downloading starts.

"Download in Background": Select to operate other functions while downloading.

"Cancel": Select to cancel updating.

- 3 Check that downloading is complete.

"Later": Select to install later. When this screen button is selected, the screen will return to the last displayed screen. To install the update data: (→P.255)

"See Detail": Select to display detailed information on the update data.

"Install": Select to install the update data. Follow the steps "Installing the update data" from step 4. (→P.255)

### ■ Installing the update data

After the downloading is complete, "Update" will be changed to "Install".

- 1 Press the "MENU" button on the Remote Touch.
- 2 Select "Apps".
- 3 Select "Install".
- 4 Select "Continue".

"Later": Select to postpone the installation of the update data and go back to the previous screen.

- 5 Check that installing is started.  
"Install in Background": Select to operate other functions while installing.
- 6 Select "OK" after the installing is complete.

- The App Suite function cannot be operated while installing.

**Reordering the applications**

Order of the applications can be changed.

- 1 Press the "MENU" button on the Remote Touch.
- 2 Select "Apps".
- 3 Select "App Catalog".
- 4 Select the desired application to be moved.
- 5 Select ◀ or ▶ to move the application, and then select the done button.

**If a message appears on the screen**

When problems occur with starting the application player, a message will appear on the screen. Referring to the table below, identify the problem and take the suggested corrective action.

- "When it is safe and legal to do so, please ensure your Enform App Suite application is running and logged in on your phone."

The Lexus Enform App Suite 2.0 application cannot be connected to Bluetooth® SPP.

Refer to

<http://www.lexus.com/enform/> to confirm if the phone is Bluetooth® SPP compatible or not, and then activate the App Suite application.

- "Installation failed, please try again"

Installation can be attempted again by changing to the "Entune App Suite" screen and pressing the "Install" switch.

- "Application download error. Please try again later."

Downloading can be attempted again by checking the communication status, changing to the "Entune App Suite" screen and pressing the "Download" switch again.

- "Download error, some Enform App Suite functions may not work as expected. Please reinitiate the download process."

The Lexus Enform App Suite 2.0 application cannot be connected to Bluetooth® SPP.

Refer to <http://www.lexus.com/enform/> to confirm if the phone is Bluetooth® SPP compatible or not, and then activate the App Suite application.

Please ensure your Enform App Suite application is running and logged in on your phone while vehicle is not moving.

- "To use the services, Enform App Suite 2.0 application needs to be running on your phone. For more information, please visit [lexus.com](http://www.lexus.com) or call 1-800-255-3987."

The Lexus Enform App Suite 2.0 application cannot be connected to Bluetooth® SPP.

Refer to <http://www.lexus.com/enform/> to confirm if the phone is Bluetooth® SPP compatible or not, and then activate the App Suite application.



- “Communication unsuccessful.  
Please try again.”

Communication was disconnected.  
After a few moments, retry the operation.

### Entering keyword operation

A keyword can be entered to an application by the software keyboard or voice recognition function. For details about the functions and services provided by each application, refer to <http://www.lexus.com/enform/>.

- The keyboard layout can be changed. (→P.53)

### Entering a keyword using the software keyboard

- 1 Press the “MENU” button on the Remote Touch.
  - 2 Select “Apps”.
  - 3 Select the desired application screen button.
  - 4 Select the character entering space.
  - 5 Enter a search term, and then select “OK”.
  - 6 Entering characters will be reflected on the character entering space.
- For details on operating the keyboard: →P.33

### Entering a keyword using the voice recognition function

- 1 Press the “MENU” button on the Remote Touch.
  - 2 Select “Apps”.
  - 3 Select the desired application screen button.
  - 4 Press the talk switch. (→P.156)
  - 5 Say the desired keyword.
- Completion of the keyword will be detected automatically.
- 6 Search results will be displayed on the screen.

## Lexus Enform Destinations

### Destination Assist

Destinations provide you with live assistance for finding destinations via the Lexus response center. You can request either a specific business, address, or ask for help locating your desired destination by category, such as restaurants, gas stations, shopping centers or other Points of Interest (POI).

After you tell the agent your choice of destination, its coordinates are sent wirelessly to the navigation system.

- The hands-free system cannot be used while Destination Assist is being used.

### Make a call with Destination Assist

#### ■ From the map screen

- 1 Press the "MAP" button on the Remote Touch.

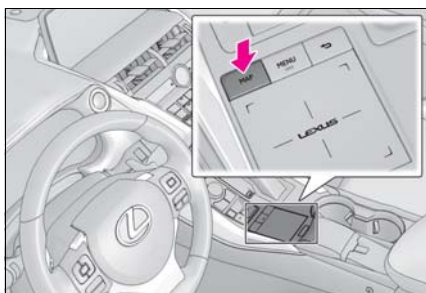

- 2 Select .
- 3 Follow the steps in "From the menu screen" from step 3. (→P.258)

#### ■ From the menu screen

- 1 Press the "MENU" button on the Remote Touch.

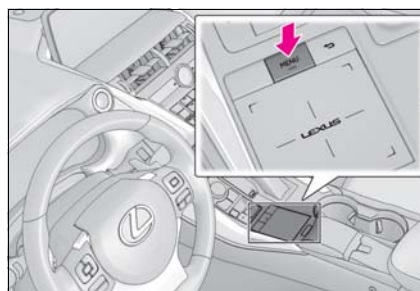

- 2 Select "Destination".
- 3 Select "Dest Assist".
- 4 When an agent comes on the line, tell the agent the address, business name, or the type of POI or service.
- To adjust the call volume, select "-" or "+", or use the volume switch on the steering wheel during the call.
- To hang up the phone, select "Disconnect" or press the  switch on the steering wheel.
- 5 After the agent helps you determine your location of choice, this screen is displayed. Select the screen button of the desired action.

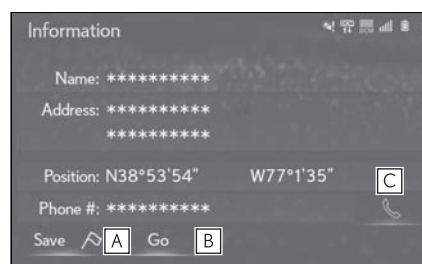

- A Select to register as a memory point.
- B Select to set as a destination.

- Select to call the registered number.

### Lexus Enform App Suite 2.0 settings

The settings of App Suite can be changed.

### Displaying the Lexus Enform App Suite 2.0 settings screen

- 1 Press the "MENU" button on the Remote Touch.

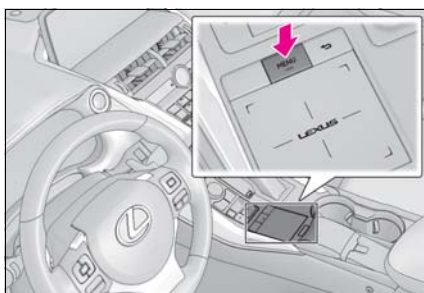

- 2 Select "Setup".
- 3 Select  "Enform App Suite" on the sub menu.
- 4 Select the desired items to be set.

### Lexus Enform App Suite 2.0 settings screen

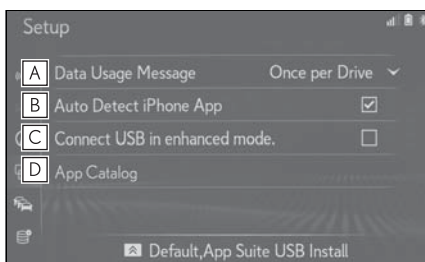

- A Select to set the pop up reminder for smart phone data usage. (→P.260)

- B Select to detect iPhone app automatically on/off.
- C Select to set the enhanced mode with connecting USB device on/off.
- D Select to configure the Enform Apps menu layout (e.g. app order, which applications are activated, etc.). This updates a setting file stored on the Lexus Enform App Suite 2.0 Server, this settings file can also be updated from the system, smartphone app and by web portal.

- By pressing the  button on the Remote Touch, following buttons can be displayed.

"Default": Select to reset all setup items.  
 "App Suite USB Install": Select to install the Apps via a USB memory device. For details, contact your Lexus dealer.

### Data use notification pop-up settings

The data use notification pop-up, which indicates that the system will use an internet connection, can be enabled/disabled.

- 1 Press the "MENU" button on the Remote Touch.
- 2 Select "Setup".
- 3 Select "Enform App Suite" on the sub menu.
- 4 Select "Data Usage Message".
- 5 Change the setting as desired.

**Index**

**261**

Alphabetical Index..... 262

## Alphabetical Index

### A

- AM/FM/SiriusXM (SXM) radio..... 111
  - Audio control switches..... 111
  - Available HD Radio™ technology..... 115
  - Control screen..... 111
  - Displaying the radio control screen..... 111
  - Displaying the radio ID..... 117
  - How to subscribe to SiriusXM Satellite Radio ..... 115
  - If the satellite radio tuner malfunctions..... 118
  - Presetting a station..... 111
  - Radio broadcast data system..... 114
  - Smart favorites ..... 117
  - Sub menu..... 112
  - Troubleshooting guide..... 115
  - Using HD Radio™ technology ..... 114
- “Apps” button (Menu screen)..... 16
- “Audio” button (“Setup” screen).... 24, 136
- Audio settings ..... 136
  - Displaying the audio settings screen..... 136
  - Language codes list ..... 139
- Audio/visual remote controls ..... 135
- AUX..... 133
  - Control screen..... 134
  - Displaying the AUX control screen..... 133
  - Sub menu..... 134

### B

- Back button (Remote Touch)..... 14, 31
- Basic function..... 12
- Basic information before operation..... 30
- Basic operation ..... 62, 106
- “Bluetooth” button (“Setup” screen)24, 43
- Bluetooth® audio ..... 130
  - Audio control switches ..... 132
  - Connecting a Bluetooth® device..... 132
  - Control screen ..... 131
  - Displaying the Bluetooth® audio control screen ..... 130
  - Sub menu ..... 132
- Bluetooth® phone message function. 228
  - Calling the message sender ..... 231
  - Checking received messages ..... 229
  - Displaying the message inbox screen ..... 228
  - Receiving a message ..... 229
  - Replying to a message..... 230

### C

- CD ..... 120
  - Audio control switches ..... 121
  - Control screen ..... 120
  - Displaying the CD control screen ..... 120
  - Sub menu ..... 121
- Checking around the vehicle..... 189
  - Changing the body color displayed in the panoramic view monitor..... 190
  - Screen display ..... 189
- Checking the front and around the vehicle ..... 191
  - Screen display ..... 191

Checking the rear and around the vehicle .....196  
     Guide lines displayed on the screen.197  
     Parking.....199  
     Screen display.....196  
 Checking the sides and around the vehicle .....194  
     Screen display.....194  
 "Climate" button (Menu screen) .....16  
 Command list.....159  
     Command list.....159  
     Command list overview.....159  
 Connectivity settings ..... 39

**D**

"Data Service" button ("Setup" screen)24, 170  
 Data services settings.....170  
     Setting download methods.....170  
 "Destination" button (Menu screen) 16, 73  
 Destination search .....73  
 Destination search operation.....73  
     Destination search screen .....73  
     Displaying the destination search screen .....73  
     One-touch setting home/favorite as a destination.....78  
     Searching by address.....75  
     Searching by contact.....78  
     Searching by Destination Assist .....74  
     Searching by emergency.....78  
     Searching by favorites list.....74  
     Searching by keyword.....74  
     Searching by point of interest .....76  
     Searching from recent destinations...76  
     Selecting search area.....74  
     Setting home as destination.....73

Detailed navigation settings..... 95  
     Displaying the detailed navigation settings screen .....95  
 Display and operation switches.....12  
     Software licence for the 10.3-inch display.....13  
     System components.....12  
 Display settings (screen adjustment) ....36  
     Display settings screen .....37  
     Displaying the display settings screen36  
 DVD.....122  
     Audio control switches .....123  
     Control screen.....123  
     Displaying the DVD control screen ..122  
     DVD options.....124  
     Sub menu.....123

**E**

"ECO" button ("Information" screen) . 168  
 Editing route .....88  
     Displaying the edit route screen .....88  
 Eject button.....108  
 "Enform App Suite" button ("Setup" screen)..... 24  
 Entering letters and numbers/list screen operation .....33  
     Entering letters and numbers .....33  
     List screen operation .....35  
 "eOwner's Manual" button (Information screen)..... 168

**G**

“General” button (“Setup” screen)..... 24, 53  
 General settings ..... 53  
     Displaying the general settings screen  
         ..... 53  
 GPS (Global Positioning System) .....102  
     Limitations of the navigation system..102  
**Guide lines displayed on the screen** ..... 176  
     Distance guide line display mode.....178  
     Estimated course line display mode..176  
     Parking assist guide line display mode  
         ..... 177  
**Guiding the route**..... 26  
     Deleting destinations ..... 26  
     Setting the destination..... 26

**H**

“HOME” button (Remote Touch).... 14, 20  
 Home screen..... 20  
     Home screen operation.....20  
**How to use the Remote Touch**.....31  
     Touchpad gestures.....32  
     Touchpad operation.....31

**I**

“Info” button (Menu screen).....16, 168  
 Information display ..... 168  
**Information screen**..... 168  
     Displaying the information screen .... 168  
**Initial screen**.....30  
     Caution screen .....30  
     Maintenance information.....30  
     Restarting the system.....30  
**Internet radio**..... 119  
     Listening to internet radio..... 119  
**iPod** .....128  
     Audio control switches .....129  
     Control screen ..... 128  
     Displaying the iPod control screen ... 128  
     Sub menu.....129

**L**

**Lexus Enform** ..... 246  
     Functional overview .....246  
**Lexus Enform App Suite 2.0**..... 255  
     Entering keyword operation..... 257  
     Using Lexus Enform App Suite 2.0.255  
**Lexus Enform App Suite 2.0 settings**. 260  
     Displaying the Lexus Enform App Suite  
         2.0 settings screen ..... 260  
     Lexus Enform App Suite 2.0 settings  
         screen..... 260  
**Lexus Enform Destinations** .....258  
     Destination Assist ..... 258  
**Lexus Enform operation**.....255  
**Lexus Enform overview** ..... 246  
**Lexus parking assist monitor** ..... 174, 174  
     Screen display .....174



Lexus parking assist monitor precautions ..... 179  
     Area displayed on screen ..... 179  
     Differences between the screen and the actual road ..... 181  
     Driving precautions ..... 179  
     The camera ..... 180  
     When approaching three-dimensional objects ..... 182  
 Linking multi-information display and navigation/multimedia system ..... 38

**M**

Magnifying function ..... 202  
     Magnifying the display ..... 202  
 "MAP" button (Remote Touch). 14, 62, 64  
 Map database version and covered area ..... 104  
     Map information ..... 104  
     Temporary updates of the map ..... 104  
 Map screen information ..... 67  
     Displaying information about the icon where the cursor is set ..... 69  
     Displaying the map options screen ..... 67  
     Standard map icons ..... 70  
     Switching the map mode on the side display ..... 68  
 Map screen operation ..... 64  
     Adjusting location in small increments ..... 66  
     Current position display ..... 64  
     Map orientation ..... 65  
     Map scale ..... 64  
     Map scroll operation ..... 65

"MEDIA" button (Audio control switch) ..... 107  
 "Media" button (Menu screen) ..... 16, 106  
 Media operation ..... 120  
 "MENU" button (Remote Touch) ..... 14, 16  
 Menu screen ..... 16  
     Menu screen operation ..... 16  
 Mobile Assistant ..... 164  
     Mobile Assistant operation ..... 164  
 Mobile Assistant operation ..... 164

**N**

Natural language understanding ..... 159  
 Navigation ..... 62  
     Map screen overview ..... 62  
 "Navigation" button ("Setup" screen).. 24, 95  
 Navigation operation ..... 25  
 Navigation settings ..... 90  
     Displaying navigation settings screen ..... 90  
     Setting up areas to avoid ..... 93  
     Setting up favorites list ..... 91  
     Setting up home ..... 90

**O**

Operating information ..... 142  
     CD/DVD player and disc ..... 143  
     Error messages ..... 153  
     File information ..... 148  
     High-resolution sound source ..... 148  
     iPod ..... 147  
     Radio ..... 142  
     Terms ..... 152  
 Operating the map screen ..... 25  
     Displaying the current position of the vehicle on the map screen ..... 25  
     Moving the map screen ..... 25  
     Zooming in /out the map ..... 25  
 Other settings ..... 53

P

- Panoramic view monitor ..... 186
  - Camera switch..... 186
  - How to switch the display ..... 186
- Panoramic view monitor precautions. 203
  - Area displayed on screen ..... 205
  - Area of the image captured by the camera ..... 206
  - Differences between the screen and the actual road..... 208
  - Driving precautions..... 203
  - The camera..... 207
  - When approaching three-dimensional objects..... 210
- “Phone” button (Menu screen)..... 16, 218
- “Phone” button (“Setup” screen) .. 24, 232
- Phone operation (Hands-free system for cellular phones)..... 218
- Phone settings ..... 232
  - “Contacts/Call History” screen..... 234
  - Displaying the phone settings screen ..... 232
  - “Messaging” screen ..... 240
  - “Notifications” screen..... 233
  - “Sounds” screen..... 232
- Placing a call using the Bluetooth® hands-free system ..... 222
  - By call history..... 222
  - By contacts list ..... 223
  - By favorites list ..... 222
  - By keypad..... 224
  - Displaying phone screen..... 222
- Product license..... 215
- “PWR-VOL” knob (Audio control switch) ..... 107

Q

- Quick reference ..... 106, 218
  - Controls..... 106
  - Displaying the phone screen ..... 218
  - Phone menu screen ..... 218

R

- “RADIO” button (Audio control switch) ..... 107
- “Radio” button (Menu screen)..... 16, 106
- Radio operation ..... 111
- Receiving a call using the Bluetooth® hands-free system..... 225
  - Incoming calls..... 225
- Receiving weather information ..... 169
- Registering home ..... 27
  - Registering home ..... 27
  - Setting home as the destination ..... 27
- Registering/Connecting a Bluetooth® device ..... 39
  - Registering a Bluetooth® audio player for the first time ..... 41
  - Registering a Bluetooth® phone for the first time ..... 39
  - Supported Bluetooth® profiles and services..... 42
- Remote Touch ..... 14
  - System components..... 14
- Route guidance ..... 84
- Route guidance screen..... 84
  - During freeway driving ..... 85
  - Screen for route guidance ..... 84
  - Turn list screen ..... 87
  - Turn-by-turn arrow screen..... 87
  - When approaching intersection..... 86

**S**

“SEEK/TRACK” switch (Audio control switch)  
 AM/FM/SiriusXM (SXM) radio..... 111  
 Bluetooth® audio..... 132  
 CD .....121  
 DVD.....123  
 iPod.....129  
 USB memory.....127  
**Setting Bluetooth® details..... 43**  
 Connecting a Bluetooth® device..... 44  
 Deleting a Bluetooth® device..... 43  
 “Detailed Settings” screen.....47  
 Displaying the Bluetooth® setup screen  
 ..... 43  
 Editing the Bluetooth® device informa-  
 tion ..... 46  
 Registering a Bluetooth® device..... 43  
**Setup..... 90, 136, 232, 260**  
 “Setup” button (Menu screen).....16, 24  
 “Setup” screen ..... 24  
 Displaying the “Setup” screen.....24  
**Some basics.....107, 219**  
 About the contacts in the contact list 221  
 Disc slot .....108  
 Registering/Connecting a Bluetooth®  
 phone .....219  
 Reordering the audio source .....108  
 Selecting an audio source.....107  
 Sound settings.....109  
 Turning the system on and off.....107  
 USB/AUX port.....108  
 Using the phone switch/microphone  
 .....220  
 Voice command system..... 110  
 When selling or disposing of the vehicle  
 ..... 221

**Split-screen.....18**  
 Display overview..... 18  
 Side display .....19  
**Starting route guidance.....80**  
 A route from the Lexus Enform center  
 .....83  
 Confirm destination screen.....80  
 Route overview screen..... 81  
 Starting route guidance.....80  
**Status icon .....22**  
 Status icon explanation..... 22  
**Steering switch**  
 “^ v” switch .....135  
 “MODE” switch.....135  
 Talk switch.....156, 220  
 TEL switch .....220  
 Volume control switch.....135, 220  
**Steering switches .....135**  
 Steering switch operation.....135  
**Sub function button (Remote Touch) .....14**  
**Sub menu .....21**  
 Displaying the sub menu.....21

**T**

Talking on the Bluetooth® hands-free system..... 226  
     Call screen operation..... 226  
     Incoming call waiting ..... 227  
     Sending tones..... 227  
     Transmit volume setting ..... 227  
 Things you should know ..... 184, 213  
     If you notice any symptoms..... 184, 213  
 Tips for operating the audio/visual system ..... 142  
 Tips for the navigation system ..... 102  
 Touchpad (Remote Touch)..... 14, 31  
 "Traffic" button ("Setup" screen)..... 24, 98  
 "Traffic Incidents" button (Information screen)..... 70, 168  
 Traffic information ..... 70  
     Displaying the traffic screen ..... 70  
     Displaying traffic information on the map ..... 72  
 Traffic settings..... 98  
     Displaying the traffic settings screen .. 98  
 Troubleshooting..... 241  
 "TUNE" knob (Audio control switch)  
     AM/FM/SiriusXM (SXM) radio..... 111  
     Bluetooth® audio..... 132  
     CD ..... 121  
     DVD ..... 123  
     iPod..... 129  
     USB memory..... 127  
 Typical voice guidance prompts..... 87

**U**

USB memory..... 125  
     Audio control switches ..... 127  
     Control screen ..... 126  
     Displaying the USB memory control screen ..... 125  
     Sub menu ..... 127  
 Using the sub function button (Remote Touch)..... 15

**V**

"Vehicle Alert History" button (Information screen)..... 168  
 "Vehicle" button ("Setup" screen)... 24, 57  
 Vehicle settings ..... 57  
     Displaying the vehicle settings screen 57  
     Maintenance..... 57  
     Setting dealer information ..... 59  
     Setting the valet mode..... 59  
 "Voice" button ("Setup" screen) ..... 24, 56  
 Voice command system ..... 156  
     Using the voice command system .... 156  
     Voice command system operation... 156  
 Voice command system operation..... 156  
 Voice settings ..... 56  
     Displaying the voice settings screen... 56

## W

"Weather" button (Information screen)	168
Weather information .....	169
Displaying weather screen .....	169
Weather guidance service .....	169
What to do if .....	241
When folding the outside rear view mirrors .....	201
Screen display .....	201
"Wi-Fi" button ("Setup" screen) .....	24
Wi-Fi® Hotspot .....	49
Connecting a device to the invehicle access point .....	50
Setting Wi-Fi® details .....	50

---

---

**For more information about the following items, see the "OWNER'S MANUAL".**

- Air conditioning
- Energy monitor (NX300h)
- Fuel consumption
- Vehicle customization
- Drive Mode customization
- Blind Spot Monitor
- Intuitive parking assist

## Map database information and updates

### END USER LICENSE AGREEMENT

#### END USER TERM

The content provided by HERE ( "Data" ) is licensed, not sold. By opening this package, or installing, copying, or otherwise using the Data, you agree to be bound by the terms of this agreement.

The Data is provided for your personal, internal use only and may not be resold. It is protected by copyright, and is subject to the following terms (this "End User License Agreement" ) and conditions which are agreed to by you, on the one hand, and HERE and its licensors (including their licensors and suppliers) on the other hand. For purposes of these terms, "HERE" shall mean (a) HERE North America, LLC with respect to Data for the Americas and/or the Asia Pacific region and (b) HERE Europe B.V. for Data for Europe, the Middle East and/or Africa.

The Data includes certain information and related content provided under license to HERE from third parties and is subject to the applicable supplier terms and copyright notices set forth at the following URL:[http://corporate.navteq.com/supplier\\_terms.html](http://corporate.navteq.com/supplier_terms.html).

#### TERMS AND CONDITIONS

**License Limitations on Use:** You agree that your license to use this Data is limited to and conditioned on use for solely personal, noncommercial purposes, and not for service bureau, timesharing or other similar purposes. Except as otherwise set forth herein, you agree not to otherwise reproduce, copy, modify, decompile, disassemble or reverse engineer any portion of this Data, and may not transfer or distribute it in any form, for any purpose, except to the extent permitted by mandatory laws.

**License Limitations on Transfer:** Your limited license does not allow transfer or resale of the Data, except on the condition that you may transfer the Data and all accompanying materials on a permanent basis if: (a) you retain no copies of the Data; (b) the recipient agrees to the terms of this End User License Agreement; and (c) you transfer the Data in the exact same form as you purchased it by physically transferring the original media (e.g., the CD-ROM or DVD you purchased), all original packaging, all Manuals and other documentation. Specifically, Multidisc sets may only be transferred or sold as a complete set as provided to you and not as a subset thereof.

**Additional License Limitations:** Except where you have been specifically licensed to do so by HERE in a separate written agreement, and without limiting the preceding paragraph, your license is conditioned on use of the Data as prescribed in this agreement, and you may not (a) use this Data with any products, systems, or applications installed or otherwise connected to or in communication with vehicles capable of vehicle navigation, positioning, dispatch, real time route guidance, fleet management or similar applications; or (b) with, or in communication with, including without limitation, cellular phones, palmtop and handheld computers, pagers, and personal digital assistants or PDAs.

**Warning:** This Data may contain inaccurate or incomplete information due to the passage of time, changing circumstances, sources used and the nature of collecting comprehensive geographic Data, any of which may lead to incorrect results.

**No Warranty:** This Data is provided to you “as is” , and you agree to use it at your own risk. HERE and its licensors (and their licensors and suppliers) make no guarantees, representations or warranties of any kind, express or implied, arising by law or otherwise, including but not limited to, content, quality, accuracy, completeness, effectiveness, reliability, fitness for a particular purpose, usefulness, use or results to be obtained from this Data, or that the Data or server will be uninterrupted or error free.

**Disclaimer of Warranty:** HERE AND ITS LICENSORS (INCLUDING THEIR LICENSORS AND SUPPLIERS) DISCLAIM ANY WARRANTIES, EXPRESS OR IMPLIED, OF QUALITY, PERFORMANCE, MERCHANTABILITY, FITNESS FOR A PARTICULAR PURPOSE OR NON-INFRINGEMENT. Some States, Territories and Countries do not allow certain warranty exclusions, so to that extent the above exclusion may not apply to you.

**Disclaimer of Liability:** HERE AND ITS LICENSORS (INCLUDING THEIR LICENSORS AND SUPPLIERS) SHALL NOT BE LIABLE TO YOU IN RESPECT OF ANY CLAIM, DEMAND OR ACTION, IRRESPECTIVE OF THE NATURE OF THE CAUSE OF THE CLAIM, DEMAND OR ACTION ALLEGING ANY LOSS, INJURY OR DAMAGES, DIRECT OR INDIRECT, WHICH MAY RESULT FROM THE USE OR POSSESSION OF THIS DATA; OR FOR ANY LOSS OF PROFIT, REVENUE, CONTRACTS OR SAVINGS, OR ANY OTHER DIRECT, INDIRECT, INCIDENTAL, SPECIAL OR CONSEQUENTIAL DAMAGES ARISING OUT OF YOUR USE OF OR INABILITY TO USE THIS DATA, ANY DEFECT IN THIS DATA, OR THE BREACH OF THESE TERMS OR CONDITIONS, WHETHER IN AN ACTION IN CONTRACT OR TORT OR BASED ON A WARRANTY, EVEN IF HERE OR ITS LICENSORS HAVE BEEN ADVISED OF THE POSSIBILITY OF SUCH DAMAGES. Some States, Territories and Countries do not allow certain liability exclusions or damages limitations, so to that extent the above may not apply to you.



**Export Control:** You agree not to export from anywhere any part of the Data or any direct product thereof except in compliance with, and with all licenses and approvals required under, applicable export laws, rules and regulations, including but not limited to the laws, rules and regulations administered by the Office of Foreign Assets Control of the U.S. Department of Commerce and the Bureau of Industry and Security of the U.S. Department of Commerce. To the extent that any such export laws, rules or regulations prohibit HERE from complying with any of its obligations hereunder to deliver or distribute Data, such failure shall be excused and shall not constitute a breach of this Agreement.

**Entire Agreement:** These terms and conditions constitute the entire agreement between HERE (and its licensors, including their licensors and suppliers) and you pertaining to the subject matter hereof, and supersedes in their entirety any and all written or oral agreements previously existing between us with respect to such subject matter.

**Severability:** You and HERE agree that if any portion of this agreement is found illegal or unenforceable, that portion shall be severed and the remainder of the Agreement shall be given full force and effect.

**Governing Law:** The above terms and conditions shall be governed by the laws of the State of Illinois (for Data for the Americas and/or the Asia Pacific region) or The Netherlands (for Data for Europe, the Middle East and Africa), without giving effect to (i) its conflict of laws provisions, or (ii) the United Nations Convention for Contracts for the International Sale of Goods, which is explicitly excluded. For any and all disputes, claims and actions arising from or in connection with the Data ( "Claims" ), you agree to submit to the personal jurisdiction of (a) the State of Illinois for Claims related to Data for the Americas and/or the Asia Pacific region provided to you hereunder, and (b) The Netherlands for Data for Europe, the Middle East and/or Africa provided to you hereunder.

**Government End Users:** If the Data is being acquired by or on behalf of the United States government or any other entity seeking or applying rights similar to those customarily claimed by the United States government, this Data is a “commercial item” as that term is defined at 48 C.F.R. ( “FAR” ) 2.101, is licensed in accordance with this End User License Agreement, and each copy of Data delivered or otherwise furnished shall be marked and embedded as appropriate with the following “Notice of Use” , and be treated in accordance with such Notice:

**NOTICE OF USE**

CONTRACTOR (MANUFACTURER/ SUPPLIER) NAME:

**HERE**

CONTRACTOR (MANUFACTURER/SUPPLIER) ADDRESS:

**425 West Randolph Street, Chicago, IL 60606.**

This Data is a commercial item as defined in FAR 2.101 and is subject to the End User License Agreement under which this Data was provided.

© 1987-2017\* HERE. All rights reserved. \*original publication date

If the Contracting Officer, federal government agency, or any federal official refuses to use the legend provided herein, the Contracting Officer, federal government agency, or any federal official must notify HERE prior to seeking additional or alternative rights in the Data.

© 1987-2017\* HERE. All rights reserved. \*original publication date

**END OF TERMS AND CONDITIONS**  
**EXHIBIT A END USER TERMS**

A. General Terms. Prior to the delivery of any Data to a user, Licensee shall obtain the user's agreement to terms and conditions of use substantially similar to, but no less protective of TCS, its licensors or VISA than the following terms:

"1. Personal Use Only. You agree to use this information for solely personal, non-commercial purposes, and not for service bureau, time-sharing or other similar purposes. You may not modify the information or remove any copyright notices that appear on the information in any way. You may not decompile, disassemble or reverse engineer any portion of this information, and may not transfer or distribute it in any form, for any purpose. Without limiting the foregoing, except for the in vehicle navigation system this information appears in, you may not use this information with any products, systems, or applications installed or otherwise connected to or in communication with vehicles, capable of vehicle navigation positioning, dispatch, real time route guidance, fleet management or similar applications.

2. No Warranty. This information is provided to you "as is," and you agree to use it at your own risk. AISIN AW CO, LTD, Inc. and its licensors (and their licensors and suppliers, collectively, "AISIN") make no guarantees, representations or warranties of any kind, express or implied, arising by law or otherwise, including but not limited to, and AISIN expressly disclaims any warranties regarding, content, quality, accuracy, completeness, effectiveness, reliability, fitness for a particular purpose, non-infringement, usefulness, use or results to be obtained from this information, or that the information or server will be uninterrupted or error free. Some states, territories and countries do not allow certain warranty exclusions, so to that extent, the above exclusion may not apply to you.

3. Disclaimer of Liability. AISIN SHALL NOT BE LIABLE TO YOU FOR ANY CLAIM, DEMAND OR ACTION, IRRESPECTIVE OF ITS NATURE, ALLEGING ANY LOSS, INJURY OR DAMAGES, WHETHER DIRECT, INDIRECT, INCIDENTAL, SPECIAL OR CONSEQUENTIAL DAMAGES, INCLUDING ANY LOSS OF PROFIT, REVENUE OR CONTRACTS ARISING OUT OF YOUR POSSESSION, USE OF OR INABILITY TO USE THIS INFORMATION, ANY DEFECT IN THE INFORMATION, OR THE BREACH OF THESE TERMS OR CONDITIONS, WHETHER IN AN ACTION IN CONTRACT OR TORT OR BASED ON A WARRANTY, EVEN IF AISIN OR ITS LICENSORS HAVE BEEN ADVISED OF THE POSSIBILITY OF SUCH DAMAGES. Some states, territories and countries do not allow certain liability exclusions or damages limitations, so to that extent the above may not apply to you.

4. Indemnity. You agree to indemnify, defend and hold AISIN and its licensors (including their respective licensors, suppliers, assignees, subsidiaries, affiliated companies, and the respective officers, directors, employees, shareholders, agents and representatives of each of them) free and harmless from and against any liability, loss, injury (including injuries resulting in death), demand, action, cost, expense, or claim of any kind or character, including but not limited to attorney's fees, arising out of or in connection with any use or possession by you of this information."

B. VISA. With respect to any VISA data, VISA specifically requires the following:

1. Licensee shall provide the Attribution to VISA with respect to the VISA data.
2. Licensee shall not allow data mining or downloading of the Information except in strictly limited quantities (a maximum of nine (9) locations per end-user search. An **end-user search** is a request by an end-user for a search of listings in a specific geographic area meeting certain criteria (for example, nearest listing to a waypoint or listings along a route segment). Any individual listing may be selected manually by the end-user for storage in a personal electronic address book or other form of memory in the navigation system. The personal electronic address book in the navigation system may be synchronized (not copied, reproduced, republished, uploaded, posted, transmitted, stored or distributed) with other devices operated by the end-user.
3. Licensee shall incorporate updates to the Data as soon as commercially feasible.
4. In addition to the general minimum terms included above, Licensee shall agree to require end-users to accept the following VISA-standard end user terms as a condition of access to the Data:
  - i.) All materials are the copyrighted property of AISIN and/or TELECOMMUNICATION SYSTEMS, INC. and its licensors. No material from this site may be copied, reproduced, republished, uploaded, posted, transmitted, stored, or distributed in any way, except that end user may download one listing (a location's name and address) on an individual non-automated basis per visiting session to the Licensee site or application, into end user's personal electronic address book. A personal electronic address book may not be shared by end user with other end users, nor may it be copied, reproduced, republished, uploaded, posted, transmitted, stored or distributed in any way. Use of the personal electronic address book must be for end user's personal, noncommercial use only.
  - ii.) End user may not use any material from AISIN's site or application for the purpose of compiling, enhancing, verifying, supplementing, or otherwise modifying VISA databases, lists, or directories of any kind, including, but not limited to, location databases, mailing lists, contact lists, marketing lists, geographic directories, or any other compilation or collation of information which is sold, rented, published, distributed, or in any manner supplied to a third party.

---

Certain business data provided by Infogroup © 2016, All Rights Reserved.



## Certification

- ▶ For vehicles sold in the U.S.A., Hawaii, Puerto Rico and Guam

FCC ID: AJDK097

[For 2.4 GHz Radio Transmitters]

This equipment complies with FCC/ISED radiation exposure limits set forth for an uncontrolled environment and meets the FCC radio frequency (RF) Exposure Guidelines and RSS-102 of the IC radio frequency (RF) Exposure rules. This equipment should be installed and operated keeping the radiator at least 20 cm or more away from person's body.

This transmitter must not be co-located or operated in conjunction with any other antenna or transmitter.

This device complies with Part 15 of FCC Rules and Innovation, Science, and Economic Development Canada licence-exempt RSS standard(s). Operation is subject to the following two conditions: (1) this device may not cause interference, and (2) this device must accept any interference, including interference that may cause undesired operation of this device.

Information to User - Alteration or modifications carried out without appropriate authorization may invalidate the user's right to operate the equipment.

**CAUTION:** Use of controls or adjustments or performance of procedures other than those specified herein may result in hazardous radiation exposure.

**CAUTION:** The use of optical instruments with this product will increase eye hazard.

**FCC ID: ACJ932AT1607****NOTE:**

<§15.19(a)(3)> This device complies with part 15 of the FCC Rules. Operation is subject to the following two conditions: (1) This device may not cause harmful interference, and (2) this device must accept any interference received, including interference that may cause undesired operation.

**FCC WARNING:**

<§15.21> Changes or modifications not expressly approved by the party responsible for compliance could void the user's authority to operate the equipment.

**CAUTION:**

<§2.1091> Radio frequency radiation exposure information:

This equipment complies with FCC radiation exposure limits set forth for an uncontrolled environment. This equipment should be installed and operated with minimum distance of 20cm between the radiator and your body. This transmitter must not be co-located or operated in conjunction with any other antenna or transmitter.

**FCC Warning :**

Any unauthorized changes or modifications to this equipment would void the user's authority to operate this device.

This device complies with part 15 of the FCC Rules. Operation is subject to the following two conditions: (1) This device may not cause harmful interference, and (2) this device must accept any interference received, including interference that may cause undesired operation.

Information to User - Alteration or modifications carried out without appropriate authorization may invalidate the user's right to operate the equipment.

- ▶ For vehicles sold in Canada

IC: 775E-K097

[For 2.4 GHz Radio Transmitters]

This equipment complies with FCC/ISED radiation exposure limits set forth for an uncontrolled environment and meets the FCC radio frequency (RF) Exposure Guidelines and RSS-102 of the ISED radio frequency (RF) Exposure rules. This equipment should be installed and operated keeping the radiator at least 20 cm or more away from person's body.

[Pour 2,4 GHz émetteurs radio]

Cet équipement est conforme aux limites d'exposition aux rayonnements énoncées pour un environnement non contrôlé et respecte les règles les radioélectriques (RF) de la FCC lignes directrices d'exposition et d'exposition aux fréquences radioélectriques (RF) CNR-102 de l'ISDE. Cet équipement doit être installé et utilisé en gardant une distance de 20 cm ou plus entre le radiateur et le corps humain.

This device complies with Part 15 of FCC Rules and Innovation, Science, and Economic Development Canada licence-exempt RSSs. Operation is subject to the following two conditions: (1) This device may not cause interference; and (2) This device must accept any interference, including interference that may cause undesired operation of the device.

Le présent appareil est conforme aux la partie 15 des règles de la FCC et CNR d'Innovation, Sciences et Développement économique Canada applicables aux appareils radio exempts de licence. L'exploitation est autorisée aux deux conditions suivantes: (1) l'appareil ne doit pas produire de brouillage; (2) l'utilisateur de l'appareil doit accepter tout brouillage radioélectrique subi, même si le brouillage est susceptible d'en compromettre le fonctionnement.



**NOTE:**

This device complies with Industry Canada licence-exempt RSS standard(s). Operation is subject to the following two conditions: (1) this device may not cause interference, and (2) this device must accept any interference, including interference that may cause undesired operation of the device.

Le présent appareil est conforme aux CNR d'Industrie Canada applicables aux appareils radio exempts de licence. L'exploitation est autorisée aux deux conditions suivantes: (1) l'appareil ne doit pas produire de brouillage, et (2) l'utilisateur de l'appareil doit accepter tout brouillage radioélectrique subi, même si le brouillage est susceptible d'en compromettre le fonctionnement.

**NOTE:**

This radio transmitter (identify the device by certification number, or model number if Category II) has been approved by Industry Canada to operate with the antenna types listed below with the maximum permissible gain and required antenna impedance for each antenna type indicated. Antenna types not included in this list, having a gain greater than the maximum gain indicated for that type, are strictly prohibited for use with this device.

Le présent émetteur radio (identifier le dispositif par son numéro de certification ou son numéro de modèle s'il fait partie du matériel de catégorie II) a été approuvé par Industrie Canada pour fonctionner avec les types d'antenne énumérés ci-dessous et ayant un gain admissible maximal et l'impédance requise pour chaque type d'antenne. Les types d'antenne non inclus dans cette liste, ou dont le gain est supérieur au gain maximal indiqué, sont strictement interdits pour l'exploitation de l'émetteur.

**CAUTION:**

This equipment complies with IC radiation exposure limits set forth for an uncontrolled environment and meets RSS-102 of the IC radio frequency (RF) Exposure rules. This equipment should be installed and operated keeping the radiator at least 20cm or more away from person's body.

Cet équipement est conforme aux limites d'exposition aux rayonnements énoncés pour un environnement non contrôlé et respecte les règles d'exposition aux fréquences radioélectriques (RF) CNR-102 de l'IC. Cet équipement doit être installé et utilisé en gardant une distance de 20 cm ou plus entre le radiateur et le corps humain.

- Gracenote, the Gracenote logo and logotype, "Powered by Gracenote", MusicID, Playlist Plus and MediaVOCS are either registered trademarks or trademarks of Gracenote, Inc. in the United States and/or other countries



#### Gracenote<sup>®</sup> End User License Agreement - Music

This application or device contains software from Gracenote, Inc. of Emeryville, California ("Gracenote"). The software from Gracenote (the "Gracenote Software") enables this application to perform disc and/or file identification and obtain music-related information, including name, artist, track, and title information ("Gracenote Data") from online servers or embedded databases (collectively, "Gracenote Servers") and to perform other functions. You may use Gracenote Data only by means of the intended End-User functions of this application or device.

This application or device may contain content belonging to Gracenote's providers. If so, all of the restrictions set forth herein with respect to Gracenote Data shall also apply to such content and such content providers shall be entitled to all of the benefits and protections set forth herein that are available to Gracenote.

You agree that you will use Gracenote Data, the Gracenote Software, and Gracenote Servers for your own personal non-commercial use only. You agree not to assign, copy, transfer or transmit the Gracenote Software or any Gracenote Data to any third party. **YOU AGREE NOT TO USE OR EXPLOIT GRACENOTE DATA, THE GRACENOTE SOFTWARE, OR GRACENOTE SERVERS, EXCEPT AS EXPRESSLY PERMITTED HEREIN.**

You agree that your non-exclusive license to use the Gracenote Data, the Gracenote Software, and Gracenote Servers will terminate if you violate these restrictions. If your license terminates, you agree to cease any and all use of the Gracenote Data, the Gracenote Software, and Gracenote Servers. Gracenote reserves all rights in Gracenote Data, the Gracenote Software, and the Gracenote Servers, including all ownership rights. Under no circumstances will Gracenote become liable for any payment to you for any information that you provide. You agree that Gracenote, Inc. may enforce its rights under this Agreement against you directly in its own name.

The Gracenote service uses a unique identifier to track queries for statistical purposes. The purpose of a randomly assigned numeric identifier is to allow the Gracenote service to count queries without knowing anything about who you are. For more information, see the web page for the Gracenote Privacy Policy for the Gracenote service.

The Gracenote Software and each item of Gracenote Data are licensed to you "AS IS." Gracenote makes no representations or warranties, express or implied, regarding the accuracy of any Gracenote Data from the Gracenote Servers. Gracenote reserves the right to delete data from the Gracenote Servers or to change data categories for any cause that Gracenote deems sufficient. No warranty is made that the Gracenote Software or Gracenote Servers are error-free or that functioning of Gracenote Software or Gracenote Servers will be uninterrupted. Gracenote is not obligated to provide you with new enhanced or additional data types or categories that Gracenote may provide in the future and is free to discontinue its services at any time.

GRACENOTE DISCLAIMS ALL WARRANTIES EXPRESS OR IMPLIED, INCLUDING, BUT NOT LIMITED TO, IMPLIED WARRANTIES OF MERCHANTABILITY, FITNESS FOR A PARTICULAR PURPOSE, TITLE, AND NON-INFRINGEMENT. GRACENOTE DOES NOT WARRANT THE RESULTS THAT WILL BE OBTAINED BY YOUR USE OF THE GRACENOTE SOFTWARE OR ANY GRACENOTE SERVER. IN NO CASE WILL GRACENOTE BE LIABLE FOR ANY CONSEQUENTIAL OR INCIDENTAL DAMAGES OR FOR ANY LOST PROFITS OR LOST REVENUES.

copyright © 2000 to present Gracenote

► For U.S. owners

Total Traffic and Weather Network, a division of TTWN Media Networks, LLC ("TTWN"), owns or holds the rights to the traffic, news, sports, weather, stocks and other data (the "TTWN Data") and network through which it is delivered, together the "TTN Service". Use of the TTN Service is subject to the terms of these Device End User Terms.

THE TTWN SERVICE IS INFORMATIONAL ONLY. YOUR USE OF TTWN SERVICE IS AT YOUR SOLE RISK. TTWN DATA IS PROVIDED "AS IS", "WHERE IS", AND "WHERE AVAILABLE". TTWN AND ITS SUPPLIERS AND LICENSORS EXPRESSLY DISCLAIM ALL WARRANTIES WITH RESPECT TO THE TTWN SERVICE (INCLUDING, WITHOUT LIMITATION, THAT THE TTWN DATA WILL BE ERROR-FREE, THAT THE TTWN SERVICE WILL OPERATE WITHOUT INTERRUPTION OR THAT THE TTWN DATA WILL BE ACCURATE), EXPRESS, IMPLIED OR STATUTORY, INCLUDING, WITHOUT LIMITATION, THE IMPLIED WARRANTIES OF MERCHANTABILITY, NON-INFRINGEMENT, FITNESS FOR A PARTICULAR PURPOSE, OR THOSE ARISING FROM A COURSE OF DEALING OR USAGE OF TRADE.

TTWN AND ITS SUPPLIERS AND LICENSORS WILL NOT BE LIABLE TO YOU UNDER ANY LEGAL THEORY, INCLUDING CONTRACT, TORT, NEGLIGENCE OR STRICT LIABILITY, FOR ANY DIRECT, INDIRECT, INCIDENTAL, SPECIAL, PUNITIVE, CONSEQUENTIAL OR EXEMPLARY DAMAGES, INCLUDING BUT NOT LIMITED TO, DAMAGES FOR LOSS OF PROFITS, GOODWILL, USE, DATA OR OTHER INTANGIBLE LOSSES (EVEN IF TTWN, ITS SUPPLIERS OR LICENSORS HAS BEEN ADVISED OF THE POSSIBILITY OF SUCH DAMAGES), RESULTING FROM OR ARISING OUT OF YOUR USE OF, OR YOUR INABILITY TO USE, THE TTWN SERVICE, THIS AGREEMENT, OR ANY OTHER MATTER RELATING TO THE TTWN SERVICE.

SOME JURISDICTIONS DO NOT ALLOW THE EXCLUSION OF CERTAIN WARRANTIES OR THE LIMITATION OR EXCLUSION OF LIABILITY FOR INCIDENTAL OR CONSEQUENTIAL DAMAGES. ACCORDINGLY, SOME OF THE ABOVE LIMITATIONS MAY NOT APPLY TO YOU.

