

Kelp Farming Manual

A Guide to the

**Processes, Techniques, and Equipment
for Farming Kelp in New England Waters**

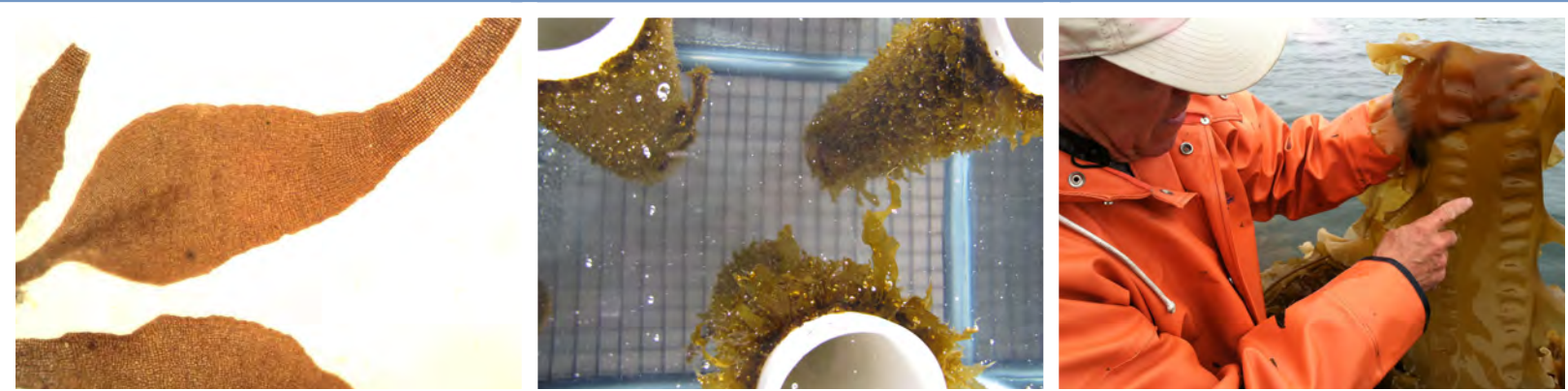

**Katie Flavin
Nick Flavin
Bill Flahive, PhD**

Ocean

APPROVED

FARMING THE NORTH ATLANTIC

Kelp Farming Manual *A Guide to the*

**Processes, Techniques, and Equipment
for Farming Kelp in New England Waters**

**Katie Flavin
Nick Flavin
Bill Flahive, PhD**

Ocean
APPROVED
FARMING THE NORTH ATLANTIC

Copyright © 2013 by Ocean Approved

All rights reserved.

This manual contains general information about farming kelp in New England waters. The information is based on Ocean Approved's experiences with learning how to farm and is not to be considered the definitive resource. You must not rely solely on the information contained in this manual as an alternative to advice and direction from your State or Federal regulating agencies. If you have any specific questions about any regulatory matter you should consult the appropriate regulating agency. The technical information in this manual is provided "as is" without any representations or warranties, express or implied. Ocean Approved, LLC makes no representations or warranties in relation to the technical information in this manual.

Acknowledgments

The three year process of learning how to farm kelp in New England waters was a collaborative effort led by Ocean Approved, the University of Connecticut and the Bridgeport Regional Aquaculture Science and Technology Education Center. We thank the following organizations and individuals that generously supported this research:

Funding Support

The U.S. Department of Commerce/National Oceanic and Atmospheric Agency
The Maine Technology Institute
Coastal Enterprises Inc.

Research Support

Organizations

The University of Connecticut
The Gulf of Maine Research Institute
Kennebec River Biosciences
Northeast Laboratories
The Bigelow Laboratory for Ocean Sciences
Woods Hole Oceanographic Institute
The Maine Department of Marine Resources
BioArchitecture Laboratories
Dr. Hyung Geun, Gangneung-Wonju, National University of South Korea
Bridgeport Regional Aquaculture Science and Technology Education Center
(BRASTECC)
Maine Sea Grant
The University of New Hampshire
The Aquaculture Research Institute at the University of Maine, Orono
The Maine Aquaculture Association
Bodega Algae, LLC

Individuals

Gary Arnold	Jang Kim, PhD
Seth Barker	Jon Lewis
Chris Barlett	Scott Lindsey, PhD
Michael Chambers, PhD	Art Mathieson, PhD
John Curtis	Dana Morse
Paul Fischer	Sarah Redmond
Bill Flahive, PhD	Diantha Robinson
Katie Flavin	Eric Tamigneaux, PhD
Nick Flavin/Lucia Flavin	Holly Turner
Elin Haugen	Robert Vadas, PhD
Chris Higgins	Charlie Yarish, PhD

Finally, we would like to thank John Forster, who encouraged Ocean Approved and introduced us to Charlie Yarish. Without John's continued encouragement and Charlie's encyclopedic knowledge of all things kelp, we would still be picking kelp off of rocks.

Contents

Chapter 1: Farming Kelp	1
Overview	1
Farm Site Selection	2
Site Selection	2
Avoiding Conflicts with Existing Use	3
The Farming Calendar and Species Selection	4
Farm System Construction	5
Farm Design	5
Configuration vs. Capacity	5
Materials	6
Construction Overview	8
Safety	9
Construction Process	9
Time and Labor Estimates	10
Lease Site Application	11
Process	11
Contact Information for New England States	36
Chapter 2: Nursery	37
Overview	37
Essential Capabilities	38
Temperature	38
Light	38
Fresh Water	38
Seawater	38
Aquaria	38
pH	38
Microscope	39
Aeration	39
Sterilization and Contamination Control	39
Advanced Capabilities	39
Equipment and Supplies	41
Aquaria	41
Nursery Spools	41
Settling Tubes	41
Water Chiller	41
Fluorescent Lighting	41
Air Pump	41
Water-Filtering Device	42
Water Filters	42
Refrigerator	42
Nutrient Media	42
Microscope	42
Cell-Counting Chamber	42
Laboratory Glassware	43
Thermometer	43
pH Meter	43
Light-Measuring Meter	43
Ultraviolet (UV) Radiation Sterilization Device	43
Carbon Dioxide (CO ₂) Supply	43
Nursery Setup	44
Temperature	44
Light	44
Seawater	45
Production Aquaria	47
Nursery Setup	47
Spools and Settling Tubes	48
Chapter 3: Isolation and Maintenance of Cultures	51
Overview	51
Life Cycle	52
Process	52
Collection and Timing	52
Sorus Preparation	54
Counting of Zoospores and Calculating Stocking Density	64
Inoculating Spools in Settling Tubes	70
Transfer of Spools to Aquaria	74
Process Step-by-Step Guide	77

Chapter 4: Nursery Husbandry and Grow-Out	82	Chapter 5: Farm Site Operation	93
Overview	82	Overview	93
Management of Environmental Parameters	85	Out-Planting of Sporophytes	93
Seawater	85	Preparation for Transfer of Sporophytes	93
Nutrients	86	Transporting of Sporophytes	
Light	86	Inside Settling Tubes	94
Temperature	87	Maintenance of Temperature	94
pH	87	Process of Transferring	
Aeration	87	Sporophytes to Long Lines	94
Contamination	87	Maintenance of Farm Site	96
Daily Nursery Tasks	88	Frequency of Farm Visits	96
Checking Nursery Air and Aquaria		Monitoring Water Conditions and Growth Rate	97
Water Temperatures	88	Determining When to Harvest	98
Overall Sound and Smell Inspection	88	Harvesting	99
Checking for Leaks in Plumbing	89	Timing	99
Visual Health Inspection of Spools	89	Harvesting Equipment and Process	99
Visual Inspection of Aquaria Water Visibility	89	Transport to Market	100
Checking all Lights and Timers	89	Off Season Farm Site Maintenance	102
Rotating Spools	89	Chapter 6: Gametophyte Cloning	103
pH Readings	90	Overview	103
Cleaning and Disinfecting Nursery		Appendices	105
Equipment and Aquaria	90	A. Glossary	105
Cleaning Plexiglass Aquarium Lids	91	B. Nutrient Formulations	111
Weekly Maintenance	91	C. Light Bank Setup Plan	113
Filling Holding Tank or Jugs with Seawater.	91	D. Measuring Light Bulb Intensity Diagram	114
Water Changes	91	E. Equipment and Supplies Resources	115
Cleaning Aquaria and Systems After		F. Release of Zoospores Worksheet	116
Water Changes	91	G. Counting Zoospores & Calculating	
Observe growth under the microscope		Stocking Density Worksheet	117
and take photos	92	H. Nursery Daily Maintenance Checklist	118
		I. Units of Measure & Conversion Table	119
		J. References	121

Chapter 1

Farming Kelp



Overview

Kelp farming, as well as the farming of various other seaweeds, is a significant and growing industry worldwide as seaweeds, especially kelp, are used for food, medicinal products, additives and bioremediation. Although the farming and use of seaweeds has a long history in many Asian and European countries, much of the rest of the world is only now recognizing the unique nutritional and health values of seaweeds. In addition to increased worldwide consumption, a recent development is the growing and harvesting of kelp for conversion to biofuels. A great deal of research is currently underway to evaluate the economics of these activities, project future demand for these algal products and to determine how best to meet increased global demand.

As the demand for kelp increases, however, relying solely on wild harvest may lead to severe declines of the natural populations such as happened in the fin fish

and shellfish harvesting industries. Increased cultivation of kelp will be required to provide a consistent and traceable supply of biomass to industries that process the kelp for food or functional products. This increase in the number and size of farm sites may lead to more conflicts with fishermen, recreational boaters and waterfront land owners. These conflicts may be mitigated by an appreciation of the beneficial aspects that kelp and other seaweed aquaculture farms frequently provide such as habitat and water quality improvements.

The natural life cycle of kelp plants produces one harvestable sporophyte (adult) population per year. An advantage of farming kelp is the potential for growing more than one harvestable crop per year as well as providing the opportunity for selection of species that exhibit desired taste, vigor and resistance to biofouling.

What follows in this manual is an introduction to the processes, equipment and techniques for growing kelp from spores to harvest. Although there is significant farming of kelp worldwide, farming kelp in the Gulf of Maine has been very limited. This manual describes the techniques developed and used successfully by Ocean Approved, LLC in conjunction with Dr. Charles Yarish and Dr. Jang Kim of the University of Connecticut to farm kelp in New England waters.

Farm Site Selection

Site Selection

Unlike land-based farms, sea farms are located in state waters that are owned in common by all citizens of the state. Good farm site selection will result in lower costs, reduce the potential for generating controversy during the application process, and result in a high-yield farm that is easy to access. Farm site selection is dependent on many criteria. Selection criteria are driven by the needs of the kelp, by regulations designed to properly manage and protect the environment, and the common ownership of state waters.

Farm sites are generally leased from the state for a set period of time. Both the state and the Army Corp of Engineers must approve the farm site and design. For the purpose of this manual, Maine state regulations will be used when discussing the regulatory criteria for selecting a site. Regulations for other New England states can be found on the websites of the appropriate state agencies.

Site selection will be a compromise between meeting state requirements and having the ideal site for growth and access. You will need to access the site often. A site that is a significant distance from your business or from your water access point may make that site economically unfeasible.

Look for a potential site that has the following characteristics:

- Adequate current (one to two knots during peak ebb and flood).
- Sufficient nutrients. This is generally not an issue in the Gulf of Maine coastal waters where they tend to exist in excess.
- A protected lee from winter storms and ice flows. This will reduce wear and tear on the gear.
- Limited use for existing fisheries. For our inshore waters this is generally lobstering.
- Good holding ground for your moorings. Mud holes are preferred as they hold the ground tackle well, and are generally not heavily fished.
- A depth in excess of 18 feet at mean low water (MLW). This will reduce the chance of kelp touching bottom, helping to keep it clean and reducing the amount of

biofouling on long lines.

- Not in an area of essential habitat or endangered species and an appropriate distance from protected shore birds. In Maine this is 1,000 feet. It is best to pick sites that are at least 1,320 feet (¼ mile) away.
- No significant flora and fauna, such as eelgrass, on the bottom. Another reason why mud bottoms are preferred.
- Is at least 1,000 feet from any state- or municipally-owned pier, beach, etc.
- While not a requirement, sites at least 1,000 feet from the nearest riparian owner may help to minimize conflicts. A riparian owner is a shorefront property owner, and some may object to having a kelp farm close to their shorefront property.

Sites that are in waters open to harvesting shellfish will help to assure customers that the kelp being raised for food is grown in clean waters.

Figure 1.1 illustrates the site selection process for a farm site located near Chebeague Island in Casco Bay, Maine. This site was chosen because it has good current, is out of the navigable channel, and is not heavily trafficked by recreational boaters. In addition, it has good depth, a mud bottom, and is not heavily fished. It is ¼-mile distant from the low water mark at its SW end and ¼-mile distant from a small community yacht club at its NE end.

The site is not located in an area where ice is typically a problem. Seal Ledge to the NE and a reef to the SW protect the site from ice flows should they form and move up and down the bay with the current.

The site also allowed the design of a farm system that is rectangular in shape. This farm is 1,100 feet long by 125 feet wide. In our experience long narrow farms are easier to work, less costly to construct, and easier to seed and maintain throughout the growing season.

The Maine Department of Marine Resources publishes maps showing areas closed to harvesting shellfish. The one that covers Casco Bay (Figure 1.2) illustrates that the Chebeague site is not located in an area closed to harvesting shellfish.

Avoiding Conflicts with Existing Use

New England waters are heavily utilized by many constituencies. The applicant for an aquaculture lease site will have a far better chance of success if they choose a site that avoids conflicts with existing use to the greatest extent possible. Constituencies to consider when

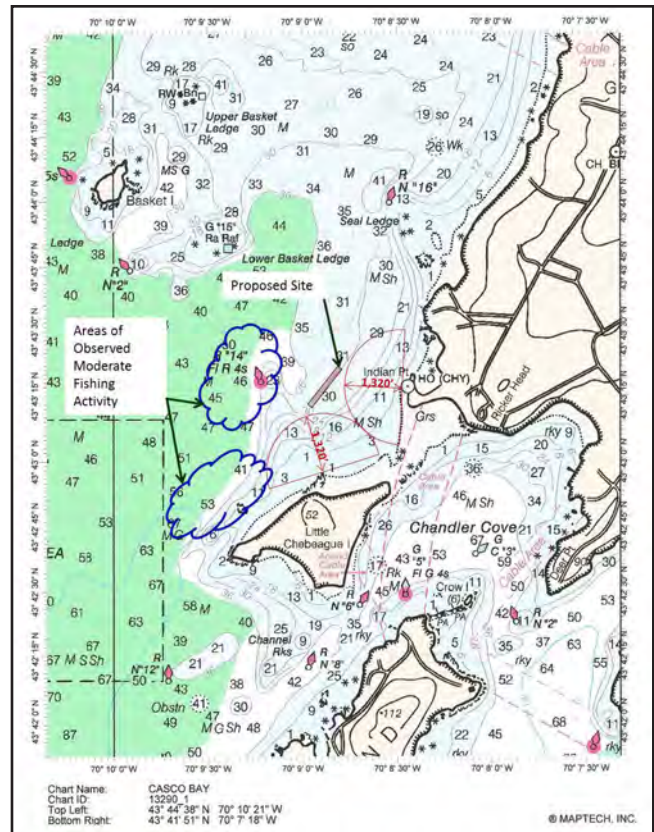

Figure 1.1 Chart used to illustrate site selection process

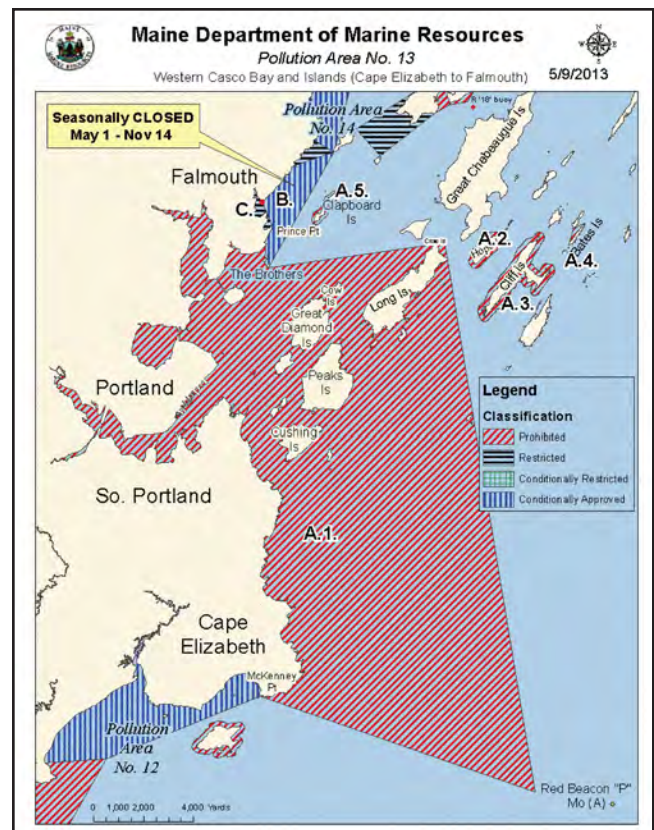

Figure 1.2 Department of Marine Resources closed shellfish area map

choosing a site are lobstermen, draggers, and recreational fishermen. In addition, if the site is near land, riparian “shorefront” owners are also an important constituency. Communicating early and frequently in the process with riparian owners, fishermen, and recreational boaters is important to understanding and addressing concerns of existing use constituencies.

Sites situated over featureless mud bottom are preferred. In addition to being excellent holding ground for moorings, there is usually little habitat that would be appealing to lobsters. As a result there is generally a low level of lobstering activity in these areas. Because lobsters change location with the seasons, it is wise to collect data on lobstering activity throughout the course of a year. Dated digital photos of the potential site taken on a periodic basis are an excellent way to record this data. Also avoid a site where draggers fish for ground fish or scallops.

During the summer months any recreational fishing activity observed at the potential site or nearby waters should be recorded. Once a kelp farm has been established, recreational fishing activity tends to increase in the surrounding waters. The structure of the farm and kelp provide significant habitat in what was once an empty water column. The recreational fishing community may greatly appreciate the introduction of a kelp farm.

Riparian owners may have concerns about having a kelp farm in view of their property, and may see it as a hazard to navigation. Ocean Approved farm sites are at least ¼ mile from shore and away from navigable channels or customary use passages. A kelp farm does not have much in the way of structure on the surface; however, there are sure to be concerns from riparian owners that their view of the water will be altered. Utilizing traditional mooring balls and lobster buoys on the surface may reduce these concerns.

The Farming Calendar and Species Selection

The farming calendar is dictated by the species one desires to cultivate, the weather, and the local water conditions. In general, nursery work takes place September through November, seeding takes place late October through November, and harvesting takes place March through May. A rule of thumb is to have the kelp farm seeded before December and then have it harvested before the water temperature rises to the point where biofouling starts to degrade the quality of the kelp, and phytoplankton starts to compete with the kelp for nutrients.

This manual will discuss the three species of kelp that OA currently farms:

Saccharina latissima (sugar kelp)—A single-blade kelp with a long, thick stipe. The blade tastes a little like an early green bean; the stipe is slightly bitter. Generally found in areas of moderate current and low wave energy.

Laminaria digitata (horsetail)—A multi-blade kelp that resembles a horse tail when held upside down. Very mild in taste and a vibrant green color when cooked. Generally found in areas of high current and/or moderate wave energy.

Alaria esculenta (winged kelp)—A single-blade kelp with reproductive areas shaped like small wings attached to the stipe area just below the large main blade. The reproductive blades resemble dragonfly wings when viewed underwater. Nutty in taste, this kelp is generally found in high wave energy zones and moderate to high current.

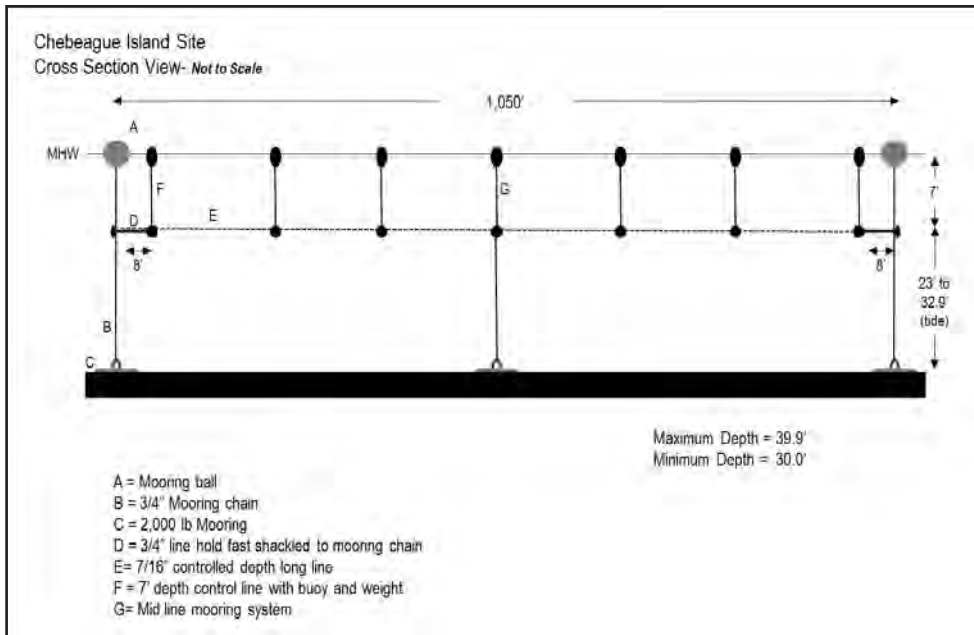

Figure 1.3 Farm design cross section view

Farm System Construction

Farm Design

There are many ways to design a kelp farm. In some countries the farm consists of vertical ropes suspended from a buoy/long line system. In others, it consists of submerged parallel long lines. The designs reflect the farm environment, the technology available for seeding and harvesting, and the need to fit into the existing use and regulatory environment.

The farm system design illustrated in Figure 1.3 is derived from a series of design experiments carried out over a period of four growing seasons. Each season the current design was modified to either improve functionality or reduce material and construction costs.

This design consists of parallel long lines suspended below the surface and moored at each end and in the middle of their run. The long lines are suspended seven feet below the surface utilizing a series of buoys tied into weights to maintain this depth.

Configuration vs. Capacity

OA's farms are configured as narrow rectangles from 1,000 to 1,500 feet in length. A long, narrow farm design reduces the amount of material required, simplifies construction, and speeds seeding and harvesting. In addition, data collected over the 2013–2014 farming season suggests that narrower farms will have higher yield for a given amount of long line, most likely due to improved nutrient availability for the kelp in the center of the farm.

An important consideration in farm design is the separation distance between the parallel long lines. While closely spaced long lines will allow for more long line for a given farm size, the issues of crossed long lines due to wave action and current and nutrient deficiency due to proximity should be considered in spacing decisions.

As an example, Ocean Approved operated three farms during the winter of 2012–2013. One farm had long lines spaced 15 feet apart. The two remaining farms' surface area was divided equally, with half the area containing long lines 10 feet apart

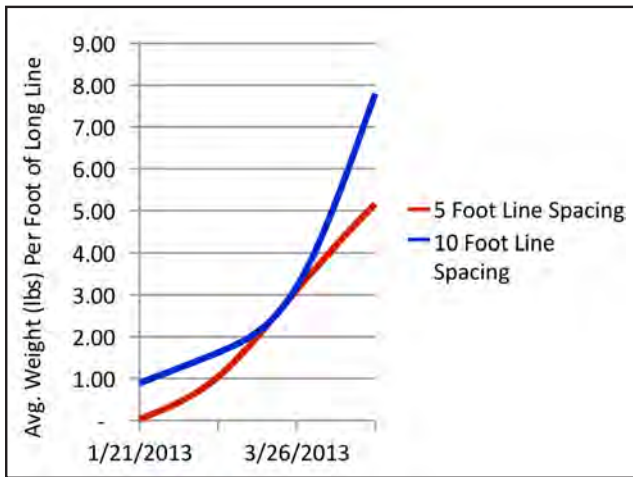

Figure 1.4 Comparison of average weight per foot of long line

area with 5-foot spacing (Figure 1.4). In addition, the 5-foot-spaced lines produced smaller plants, perhaps due to nutrient deficiency, though additional studies are needed to determine this conclusively. Depending on its use, the larger kelp grown with 10-foot spacing may be more desirable to the farmer.

Materials

The farm design is made up of three components:

1. Moorings and ground tackle
2. Long lines
3. Depth maintenance systems (droppers)

Some assembly of components can take place on land, and some on the site by necessity. Note that if farming in Maine, all buoys associated with the farm must have “Sea Farm” painted on them in 3-inch letters.

Moorings

A mooring system is deployed at each end of a long line. For long line runs of 1,000 to 1,500 feet, current, bottom, and wave conditions at the site may make it necessary to deploy a mooring at the center of the long line to ease the strain on the moorings at the ends of the long line.



Figure 1.5 Concrete block moorings

and half with long lines 5 feet apart.

The 15-foot separation of long lines resulted in no crossed or tangled lines due to wave action or currents.

The 10-foot separation of long lines resulted in some (although minimal) crossing or tangling of lines.

For the sections of the two farms with 5-foot separation, there were crossed line issues that complicated harvesting. In addition, there was some biomass loss due to the kelp being abraded off of the lines at the point where they crossed.

Analysis of the data accumulated over the season suggests that the 51% increase in biomass yield for 10-foot-spaced long lines (larger kelp on average) is more beneficial than the 67% increase in long line per given

Mooring systems consist of 2,000-lb. high density concrete blocks with a 1.5-inch chain holdfast set in the concrete (Figure 1.5). Money may be saved on the moorings by purchasing “over pour” that is returned to the cement plant and by purchasing chain from metal scrap yards. This takes planning and coordination with the cement plant but significant dollars may be saved. A shackle and $\frac{3}{4}$ -inch mooring chain was attached to the holdfast in the concrete. To the other end of the mooring chain a 200-lb. (or greater) displacement buoy was attached. The deeper the site, the larger the buoy required to support the chain and weight of long line and depth control systems. Also shackled to the mooring chain was a length of $\frac{3}{4}$ -inch line with an eye splice at the end to act as a holdfast for the long line. The length of the holdfast should be at least equal to the depth at which it is shackled to the mooring chain. This will allow for attaching the long line to the mooring system from the surface. For example, if the long lines are set at a 7-foot depth, the holdfasts should be 8 to 10 feet long.

Long Lines

To construct its long lines, OA utilizes $\frac{7}{16}$ -inch poly line cut into 200-foot lengths. The 200-foot length was dictated by the amount of seed string wound on each nursery spool. For a description of nursery spools and their purpose see Chapter 2, Nursery Equipment, and Chapter 6, Seeding Lines. The ends of the long lines are melted so that the lines may be quickly fastened together during the seeding process (Figure 1.6) Once cut and the ends melted, the lines are either flaked into a tote or line basket, or wound onto a reel or large spool for easy transport and deployment during seeding.



Figure 1.6
Quick line splice

Depth Maintenance Systems (Droppers)

For each 200-foot long line section, a depth control dropper is built. In this description the long line is set at a 7-foot depth. The buoy holds the line at the desired depth when the kelp is small. When the kelp grows larger, the stipes fill with gas and become buoyant. The weight then holds the long line at the proper depth. One should adjust the materials accordingly for the desired depth of the line.

The materials required for each dropper are:

- 10 feet of $\frac{5}{16}$ -inch poly line
- 14-lb. displacement lobster buoy with 1-inch ID spindle hole
- Two spindle washers
- 10-lb. weight with holdfast
- 7 feet of 1-inch PVC pipe

Figure 1.7 Dropper



To build a dropper (Figure 1.7):

- Tie a figure eight knot approximately 1.5 feet from one end of the poly line. **A**
- Thread a spindle washer and the PVC pipe over the other end of the line. **B**
- Thread the buoy onto the remaining line. **C**
- Thread the second spindle washer over the line and drop it down until it rests on top of the buoy. **D**
- Tie a loop so that the knot snugs the components together.

To build a 10-lb. weight (Figure 1.8):

1. Obtain a suitable mold. A plastic half gallon paint bucket works well.
2. Tie 2 feet of poly into a loop.
3. Place one end of loop in mold.
4. Pour in cement.
5. Remove mold once set.

Figure 1.8 10-lb. weight



Construction Overview

Constructing a farm site is fairly straightforward and is carried out in two phases. The first phase is setting the moorings and ground tackle. Moorings should be in place well in advance of the anticipated seeding date so that weather or unforeseen circumstances will not delay the deployment beyond the targeted seed date. This will ensure the sporophytes will not be in the nursery for longer than required—an important economic consideration.

The second phase of construction will take place when the sporophytes are deployed. This phase will include setting out the long lines and the depth control systems. The deployment and seeding of long lines is discussed in more detail in Chapter 5.

Here is a cross section view (Figure 1.9) of the design used by OA for its Chebeague Island site:

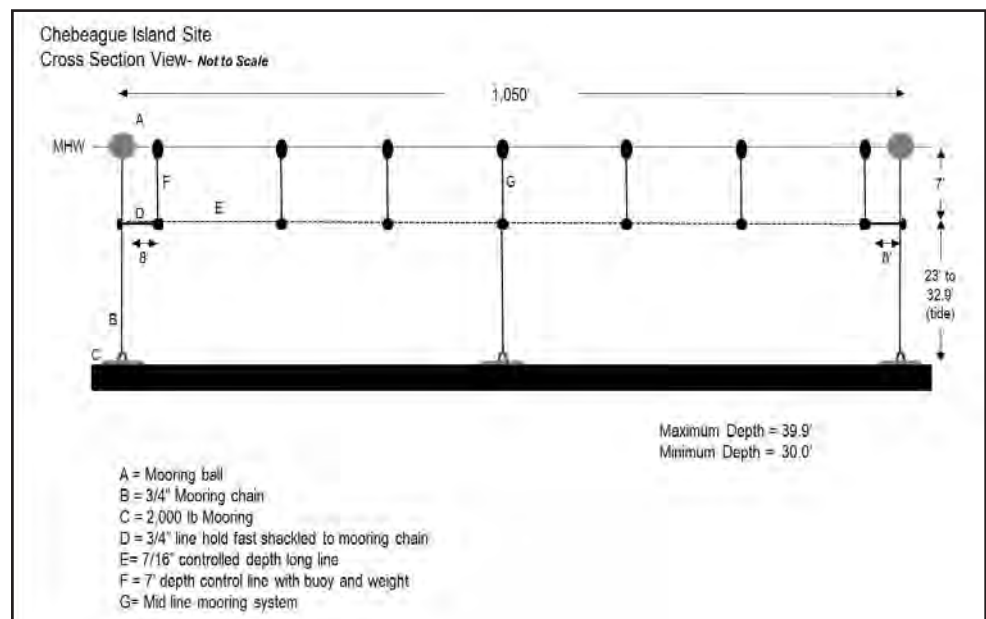

Figure 1.9 Farm site at Chebeague Island which is an example of one type of common design



Figure 1.10 A mooring being prepared to go overboard

Safety

When setting heavy moorings and ground tackle, and deploying heavy long lines, it is important to ensure that appropriate safety precautions and gear are in place. Having the appropriate equipment to lift and move the gear along with a stable work platform is important. If one does not have the experience or the appropriate gear, it is best to contract out this phase of farm construction.

Construction Process

There are two phases to constructing the farm. The first phase is setting the moorings. The second phase is setting and seeding the long lines.

Phase 1. Setting the Moorings

Moorings should be set well in advance of the planned seeding date (Figure 1.10). This will ensure they are in place when the seed twine is ready to be deployed at the site. OA's practice has been to set the moorings, then observe the mooring buoys over several tides to determine if the moorings are correctly spaced and aligned. If not, reset moorings that are mis-spaced –or not properly aligned. Once the moorings are correctly aligned, a length of chain is run along the line of moorings, shackling it to each mooring. The purpose of the chain is to add extra holding power by tying all the moorings together and to stop any one mooring from being pulled significantly out of alignment during the course of the growing season. Note that the holdfasts for each long line should be tied up to the top of the mooring buoy for ease of access when seeding.

Phase 2. Setting the Long Lines

Preparation of the lines and gear is important. Poor preparation may lead to delays or halting of the seeding process. Any delay may put the sporophyte at risk.

The long lines should be pre-cut into approximately 200-foot lengths, the ends melted, and the lines either flaked in a box or wound on a spool. The long lines will be set while seeding, which will be described in detail in Chapter 5 of this manual.

Time and Labor Estimates

The time and labor required to prepare the farm materials, set the moorings, and place and seed the long lines will be dependent on the size of the farm. Provide plenty of time to prepare the farm materials so that the farm is put together well in advance of seeding. Farm site construction delays may result in seeding delays, which will increase nursery costs and may effect overall farm yields.

Moorings

For OA's moorings, a cement plant was contacted approximately 60 days prior to needing the moorings. This allowed the cement plant to use "over pour" as it became available. The lengths of chain that were to be placed in the cement to act as holdfasts for the mooring chain shackles were provided to the cement plant (Figure 1.11).

Setting the moorings can take one to two days on the water depending on the number of moorings, the lifting gear you employ, and the weather.

Long Lines

Budget approximately 5 minutes per 200-foot section of long line. The line must be measured and cut, and the ends burned and then flaked or spooled.

Depth Maintenance Systems (Droppers)

Budget approximately 20 minutes per dropper if done in one at a time. Determine the number of droppers needed, purchase the supplies in bulk and then batch each process to increase efficiency (Figure 1.12). If you batch the processes it should average less than 10 minutes per Dropper. The processes that can be batched are:

- Painting the buoys with "Sea Farm" if required. A stencil will speed the process.
- Cutting the 7-foot PVC pipe sections to length.
- Cutting the 10-foot line that will run through the PVC pipe.
- Cutting the 2-foot line that will be placed in the cement weights.



Figure 1.11 OA 2,000lb moorings with chain holdfasts visible



Figure 1.12 Batching processes where possible will save on set up time.

- Tying the 2-foot line into loops.
- Tying a figure eight (stopper) knot 1 $\frac{3}{4}$ feet from one end of each 10-foot line.
- Threading the long end of the 10-foot line through a spindle washer.
- Making up the cement weights and placing one end of the 2-foot line loops into the cement.

Lease Site Application Process

The process of applying for and obtaining a farm lease site is the most time consuming part of starting a kelp farm. Each state has a different permitting process, and, regardless of the state, you must also receive a permit from the U.S. Army Corp of Engineers.

Most New England states have the following resources that you can contact for information about the leasing process:

- The state government agency responsible for aquaculture permitting
- A state aquaculture association
- Sea Grant extension services

In addition, aquaculturalists are a collegial group and many will be willing to lend advice or guidance as you start the process.

The process for Maine is described in this chapter. While each state is different, the goal of the application process is the same: ensure appropriate use of the commons and protection of the environment.

A first step is to visit the Department of Marine Resources (DMR) aquaculture website to download the appropriate application materials. The Maine site address is: <http://www.maine.gov/dmr/aquaculture/index.htm>

There are two types of leases—experimental and standard. The experimental is limited in size to four acres and expires at the end of three years. At the end of the lease the site must be given up, or you must apply for a standard lease. A standard lease is good for 10 years, is renewable, and can be up to 100 acres in size.

The following excerpt is from the DMR website and does a good job of describing the process:

1. **Pre-application meeting.** Prior to completing your application, contact the department to set up a pre-application meeting. Applications submitted without a pre-application meeting will not be considered complete.

2. **Pre-application scoping session.** Prior to submitting your application, you are required to hold a public scoping session. This will be an informal public meeting intended to familiarize the public with the proposal, allow you to receive information from the public prior to submitting your application, and provide the department with information prior to the site review.

3. **Application submission.** Applicant submits application to Department of Marine Resources. DMR will make a determination as to whether or not your application is complete. If incomplete, you will receive a letter asking for further information. If complete, DMR will forward your application to other regulatory agencies, the municipality, and riparian landowners.

4. **DMR site review.** You will be contacted to schedule a site review of your proposed lease area. This review will be an on-site inspection of the proposed lease area. A number of environmental measurements and a scuba dive will be made on the site. Your presence at the site review will be requested. DMR staff will develop a report of the site review.

5. **Public hearing.** An adjudicatory aquaculture lease hearing is a requirement for all applicants under the MDMR Aquaculture Lease Regulations. MDMR 12 M.R.S.A. §6072(6).

6. **Public notice.** The department will issue public notice of the hearing. At least 30 days prior to the public hearing, the applicant shall place visible markers which delineate the area proposed to be leased.

7. **Decision.** The DMR hearings officer will prepare a report including proposed findings of fact, conclusions of law, and if requested by the commissioner, a recommended decision to grant or deny the lease. The hearing officer's proposed decision will be sent to all legal parties, who will have ten days to comment on the proposed decision. The commissioner will make a final decision to grant or deny the lease within 120 days of the public hearing.

As you begin this process, it is very important to choose your proposed site carefully so that it will meet all of the state's criteria. In addition, it is also very important to know your riparian owner (whose property boundaries are within 1,000 feet of the proposed lease site) and on-the-water neighbors. Communicate with them about your future plans to apply for a lease site and determine their concerns early in the process. You may be able to modify your plans to address their concerns, or, through gathering data about the site, demonstrate that the issue of concern is unjustified.

It is important to be able to adequately address all of the state's criteria and the concerns of the public. At times lease hearings can become emotional events, with participants passionately expressing their concerns. The best advice is to have data to present that supports your contention that the lease site will not unreasonably interfere with others.

A copy of an Ocean Approved lease application for an experimental farm lease and the Maine Department of Marine Resources site report follows.

C: APPLICATION COVER SHEET FOR AN EXPERIMENTAL LEASE

Name: Ocean Approved, LLC
 Address: 188 Presumpscot Street
 City: Portland
 County: Cumberland

State, zip Maine, 04103

Telephone: business 207-671-7946 home 207-799-2022 cell 207-671-7946

Email address: tolson@oceanapproved.com

Location of lease site:

<u>town</u>	<u>county</u>	<u>waterbody</u>
Chebeague Island	Cumberland	Casco Bay

Additional description West South West of Indian Pt, North of Little Chebeague Island

Total acreage requested (4-acre maximum): 3.03 Acres

Growing Area # 13 Water Quality Classification Unrestricted (DMR Water Quality Map Included with Application)

Type of culture (circle): Bottom (no gear) Suspended (gear in the water and/or on the bottom) Net Pen (finfish)

Name of species to be cultivated, common and scientific names:

Sugar Kelp (*Saccharina latissima*), Horsetail Kelp (*Laminaria digitata*), Winged Kelp (*Alaria esculenta*)

Name and address of the source of seed stock, juveniles, smolts, etc., to be cultivated:

Ocean Approved, LLC nursery- 188 Presumpscot Street, Portland, ME 04103

Amount of application fee enclosed: \$100.00

(\$100 payable to: Treasurer, State of Maine)

I hereby state that the information included in this application is true and correct and that I have read and understand the requirements of the Department's rules governing aquaculture.

Signature: _____ Date: 6/10/11

18 U.S.C. Section 1001 provides that: Whoever, in any manner within the jurisdiction of any department or agency of the United States knowingly and willfully falsifies, conceals, or covers up any trick, scheme, or disguises a material fact or makes any false, fictitious or fraudulent statements or representations or makes or uses any false writing or document knowing same to contain any false, fictitious or fraudulent statements or entry, shall be fined not more than \$10,000 or imprisoned not more than five years or both.

PART D. EXPERIMENTAL LEASE APPLICATION INFORMATION

1. Location of proposed lease

A. Vicinity Map

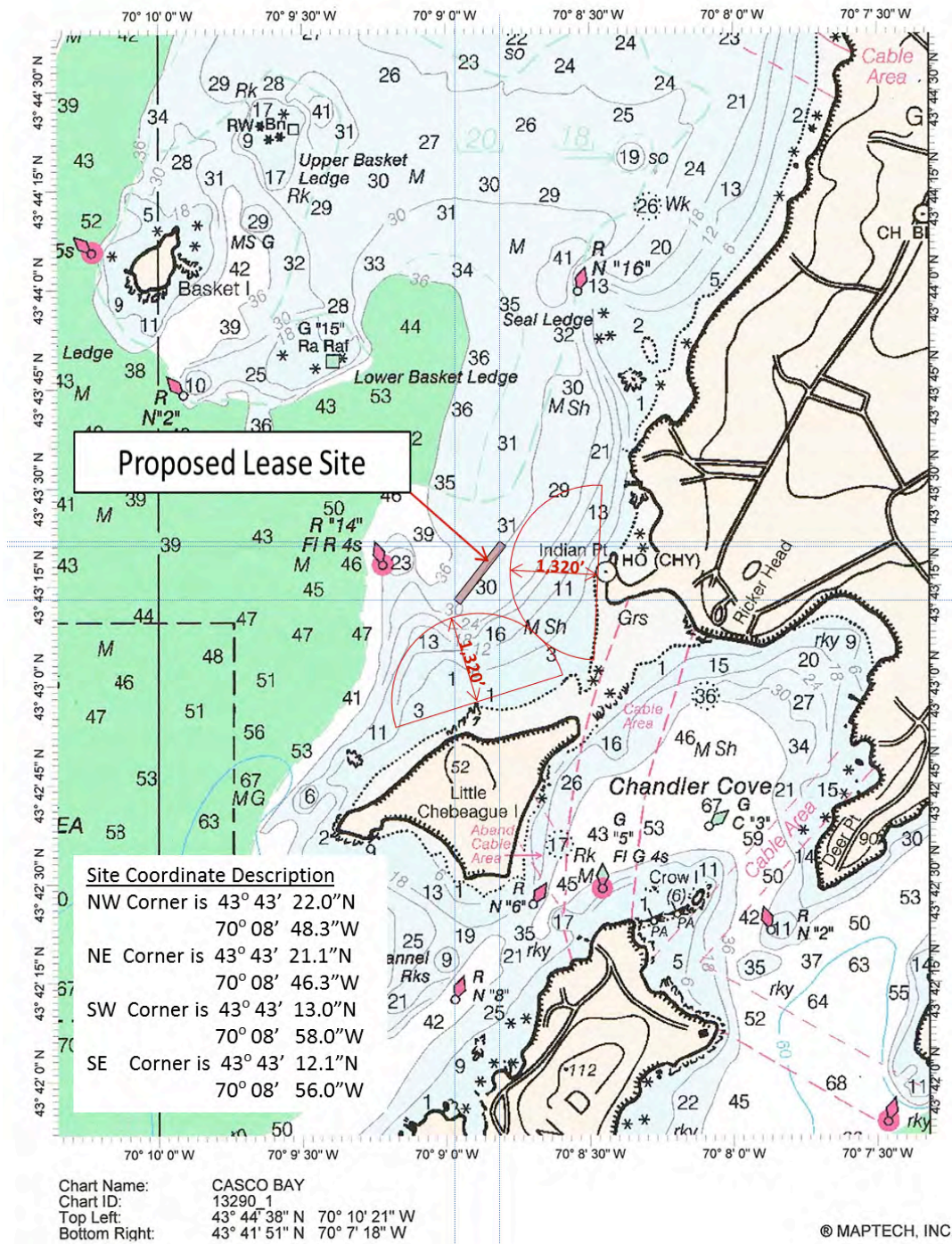

B. Boundary Description

This proposed lease site is 1,100 feet in length and 120 feet in width. The location description was developed using NOAA chart number 13290 (datum coordinates WGS) and MapTech, Inc. charting software. The northern end of the site is west of Indian Point, Chebeague Island. The southern end of the site is north of Little Chebeague Island. The proposed lease site is in subtidal waters. These waters are unrestricted (Figure 1.).

1. Site Coordinate Description

- NW Corner is 43° 43' 22.0"N
70° 08' 48.3"W
- NE Corner is 43° 43' 21.1"N
70° 08' 46.3"W
- SW Corner is 43° 43' 13.0"N
70° 08' 58.0"W
- SE Corner is 43° 43' 12.1"N
70° 08' 56.0"W

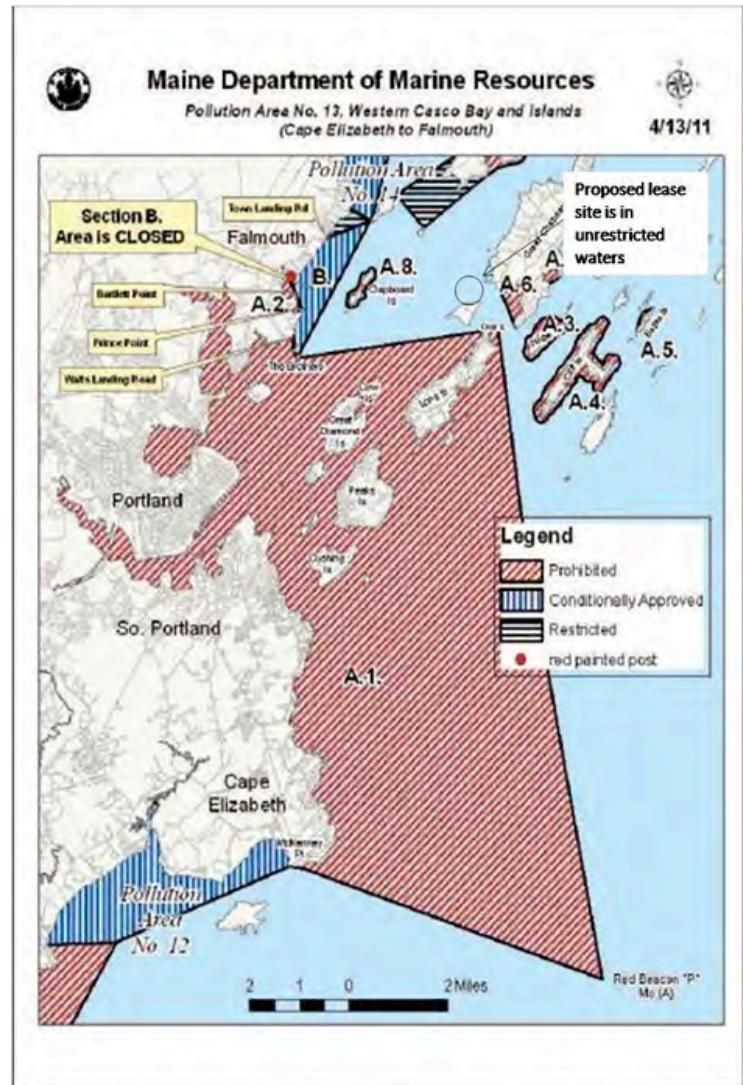

Figure 1. Maine Department of Marine Resources Water Quality Map

2. Land Owners

The proposed lease site is located between two islands- Little Chebeague Island, a small undeveloped island owned by the state of Maine, Bureau of Parks and Land and Chebeague Island, a town located in Cumberland County Maine. There are no riparian owners- defined as owning land within 1,000 feet of the proposed lease site. The closest land owner is Parcel 16 of Cumberland tax map I05 (Figure 2), owned by the Indian Island Company (c/o Ted Morse, 507 Askin Road, St. Davids, PA 19087). The proposed site is in excess of 1,320 feet from the low tide mark of the portion of the parcel 16 closest to the proposed lease site. Figure 3 describes the State of Maine as owner of Little Chebeague Island.

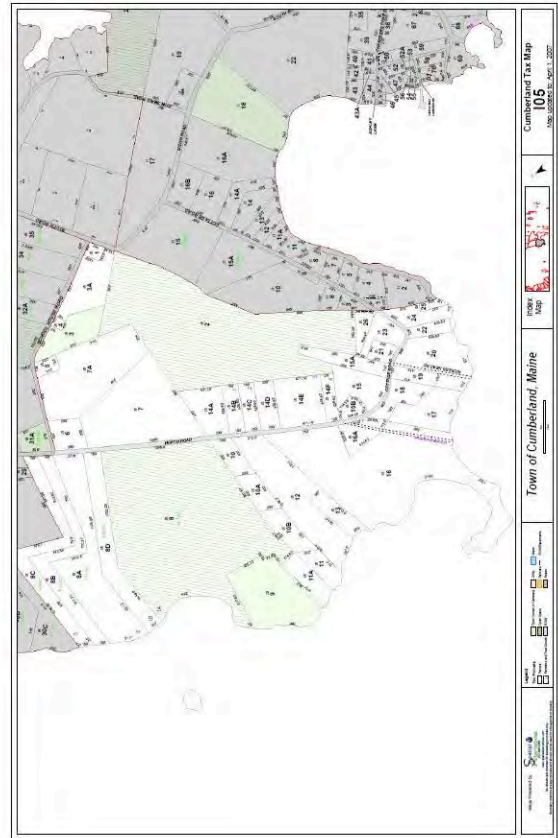

Figure 2. Chebeague Tax Map for Parcel 16

The criteria MDMR uses to determine the suitability of an aquaculture operation to a particular area (DMR Regulations Chapter 2.37(1) (A)) are discussed, with respect to the application, below:

1) Riparian Owners Ingress and Egress

The State of Maine, Bureau of Parks and Land is the only riparian landowner within 1,000 feet of the proposed lease. Little Chebeague Island is an undeveloped island adjacent to the northwest corner of the more populated Long Island. On January 31, 2011 no docks or moorings were observed within the

Figure 3. Portion of DMR Site Report #2011-02 that states Little Chebeague Island is owned by the State. Note that the comment “within 1,000 feet” does not apply to the proposed site application, but to the site applied for in report #2011-02.

3. Research Program and Application

A. The purpose and design of the study.

The purpose of this study is to determine the optimum growth environment and seeding and harvest periods through measurement of yields for native to Maine species of kelp to aid in selecting a permanent kelp aquaculture site. Long lines will be seeded during late spring and fall. Growth rates will be monitored and wet weight yield per meter of long line will be calculated at harvest. Data from spring and fall plantings will be compared over a 3 year period.

B. The species, amount and proposed source of the organisms to be grown.

Sugar Kelp (*Saccharina latissima*), Horsetail Kelp (*Laminaria digitata*), Winged Kelp (*Alaria esculenta*). The amount to be grown will be the expected outcome of this three year study. The source of the organisms will be spores harvested from native plants collected in the wild. The spores will be grown to 2.5mm sporelings in Ocean Approved's laboratory prior to being placed at the site. This technology was developed by Ocean Approved in 2010 and funded by NOAA.

C. A description of the culture and harvesting techniques to be used.

1. The company will isolate and maintain native cultures of Sugar Kelp (*Saccharina latissima*), Horsetail Kelp (*Laminaria digitata*), Winged Kelp (*Alaria esculenta*) to be used as "seed stock" for the production of young plants (Figure 4).
2. Sporophyte will be transferred to the site once they achieve 2.5 mm in length. Seed string with sporelings will be applied to long lines. (Figure 5).
3. The kelp will be harvested by lifting the long line to the surface and cutting the kelp at the intersection of the hold fast and the stipe, stripping the kelp from the line (Figure 6).
4. Yield wet weight per meter of seed string will be measured and compared to yields from other sites grown using identical rigs and techniques.

D. The expected length of the study.

The expected length of this study is 3 years. This will allow for up to 6 growing cycles.

E. Specify whether the research is for scientific OR commercial research and Development.

This research is commercial research.

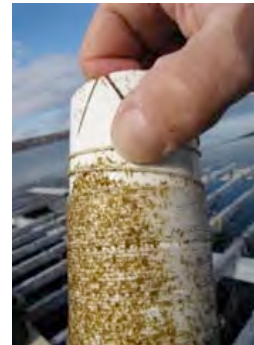

Fig. 4. Nursery Spool with Young *Saccharina latissima* Visible on Seed String and PVC Tube



Fig. 5. Kelp Seed String Deployed on Long Line



Fig. 6 Kelp Harvest

4 Existing Uses

The closest marked navigation channel is approximately 1,100 feet west of the proposed lease site and marked by red buoy #14 (NOAA Chart 13290 (Figure 7)).

Little Chebeague Island is a state owned recreation area accessible by boat at high tide and by foot at low tide via the bar connecting Little Chebeague to Chebeague Island. As such, there is seasonal recreational boating in the area to access the island. The proposed site is in excess of 1,320 feet from the closest low water mark (Figure 7) and should not unreasonably impede recreational access to the island due to its distance from the island and the submerged nature of the structure

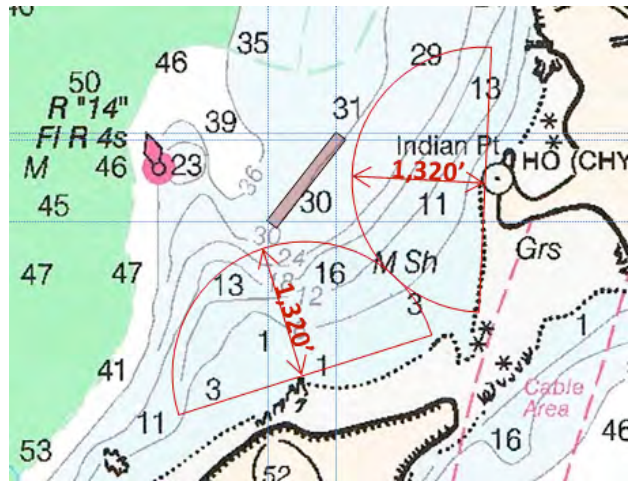

Fig. 7. Detail of NOAA Chart 13290

Indian Point on Chebeague Island has a dock on the northeast corner of the point (Figure 8) owned by the Indian Island Company that is approx 1,320 feet from the proposed lease site.

There were approximately 10 seasonal moorings observed in proximity to the dock on 6/10/11. Given the distance from the dock and mooring field, and the submerged nature of the structure, the proposed site should not unreasonably impede access to the mooring field or dock.



Fig. 8. Indian Point Dock Location

No lobster gear was observed on 6/10/11 in or in close proximity to the proposed site. Lobster gear was observed on 6/10/11 off the SW tip of Little Chebeague Island- approximately 2,000 feet from the proposed lease site.

There are four Limited Production Aquaculture sites licensed for Blue Mussels (*Mytilus edulis*) located approximately 4,000 feet SW of the proposed lease site. These sites are PST01, PST02, PST03, and PST04 licensed to Peter J. Stocks, 98 Colchester Drive, S. Portland, ME 04106 (Figure 9). We understand that Peter Stocks is in the process of applying for 10 year leases at these sites.

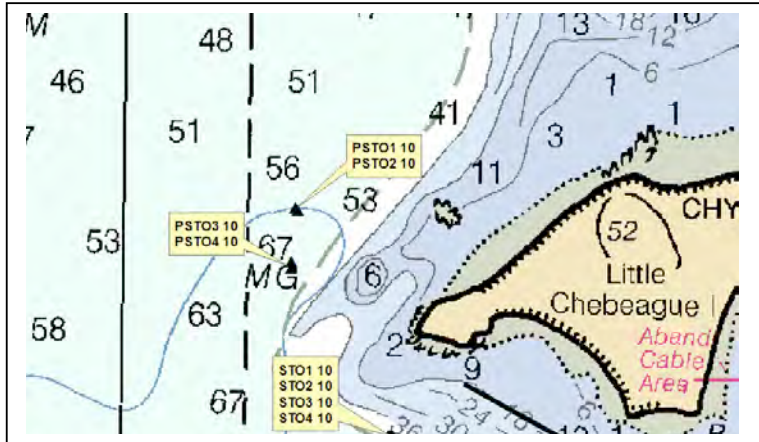

Fig. 9 Limited Production Aquaculture Sites

There are four Limited Production Aquaculture sites licensed for Blue Mussels (*Mytilus edulis*) located around the SW corner of Little Chebeague island. These sites are STO1, STO2, STO3 and STO4 licensed to Lynda Richards-Stocks, 98 Colchester Drive, S. Portland, ME 04106 (Figure 9).

There are two Limited Purpose Aquaculture sites licensed for American Oysters (*Crassostrea virginica*) located off Basket Island, approximately 1 mile northwest of the proposed site. These sites are GRE105 and GRE206, licensed to Mark Green, 5 Willow Street, Peaks Island, ME 04108

There is one experimental lease licensed for various seaweeds located off the south side of Little Chebeague Island. This lease site CAS LCI 1 is licensed to Aquafarms, LLC, Tollef Olson, 188 Presumpscot Street, Portland, ME 04103

5. Exclusive Use

The site structure design (illustrated in section 7 Structures) will allow for recreational boaters to transit the site. We request that fishing both lobster and dragging be restricted from the site to minimize the risk of gear entanglement.

6. Description of Proposed Lease Site

A. Environmental Characterization

1. Bottom Characteristics- The bottom in the proposed site area is mud.
2. Approximate Depths- Approximate depth at low tide is 30 feet. The approximate depth at high tide is 39.9 feet.
3. Topography- Flat topography. The lease site follows the 30 foot contour line.
4. Flora and Fauna- A dive site report dated June 14th, 2011, prepared by Paul Fisher observes that the bottom is featureless and composed of soft mud. There were no observed worms, seaweed or sea anemones. There was little observed lobster activity (Appendix 1. Ocean Approved Dive Site Report).
The presence of seaweed cultivation in this area will provide additional structure and shade for a diverse array of species including juvenile fish, small invertebrates, diving birds, etc. Seaweeds provide excellent shelter and juvenile habitat.
5. Approximate Current Speed and Direction- The current in the proposed lease site area runs in several directions during both ebb and flow due to the nature of the bar between Chebeague Island and Little Chebeague Island. Prior to the bar being exposed on the ebb, the current runs SW along the shore of Chebeague and separates prior to reaching Little Chebeague, with one portion continuing SW, and the other continuing SE across the bar. Once the bar is exposed, the current runs SW along the shore of Chebeague/Little Chebeague.
During flow, the current runs ENE along Little Chebeague. Once the bar is covered, the current also runs NW across the bar and merges with the NE flow. The current runs at approximately 0 to 1.5 knots depending on the state of the tide.
6. The General Shoreline and Upland Characteristics- The proposed site is located west of Indian Point, Chebeague Island and north of Little Chebeague Island. Indian Point, a lightly developed 22.6 acre parcel has a gently sloping beach of sand and mud with occasional rock outcroppings. The upland side of the beach rises gradually with low vegetation. There is a bar (primarily sand with a few rocks between Chebeague Island and Little Chebeague Island that is exposed at low tide. Little Chebeague Island, a small undeveloped island has a gently sloping beach of sand with a rocky outcrop in the middle that is exposed at low tide. The upland side of the beach rises rapidly and is covered with low vegetation giving way to trees.
7. Presence and Extent of Submerged Aquatic Vegetation- No observed aquatic vegetation (Appendix 1. Ocean Approved Dive Site Report).

B. Environmental Impact

Kelp cultivation can have a positive impact on the environment. As a sea plant, kelp consumes excess nitrogen and CO₂ in the water and expresses O₂, improving the water quality of the surrounding environment. The Town of Chebeague's Draft Comprehensive Report, March 2011, Volume 2, page 30-31 identifies excess nitrogen as an issue affecting the quality of the water surrounding the island and affecting the clam flats by increasing the prevalence of green algae (Figure 10).

In addition to improving the quality of the surrounding waters, kelp provides structure and shade for many marine organisms. It is an important habitat for juvenile fish and small invertebrates.

Kelp farm operations are low impact on the environment. Seeding is a relatively quick process accomplished from small skiffs. Based on our experience seeding should require not more than 2 days each planting season for the proposed site (wind dependent). Seeding takes place in fall, winter, and spring. Harvest is quick and efficient, and takes place in late fall and spring. It consists of bringing the long line onto the boat and removing the kelp with a small knife as the boat moves down the line. Husbandry for the site will include weekly or bi monthly trips to the site (season dependent) for plant sampling, data capture, and structure inspection/maintenance.

There are no Essential Wildlife Habitats, such as bald eagle nests surrounding Little Chebeague and Chebeague Islands, however the shoreline of these islands, and surrounding islands is designated a Significant Habitat for Tidal Waterfowl and Wading Birds (Figure 11). The proposed lease site should not interfere with this habitat as it is located in subtidal waters and is more than 1,320 feet from the shore.



Fig. 10. Green Algae on Chebeague Island. The Town of Chebeague's Draft Comprehensive Report, March 2011, Volume 2, page 30-31

The proposed lease site is located in unrestricted shellfish waters (Figure 11).

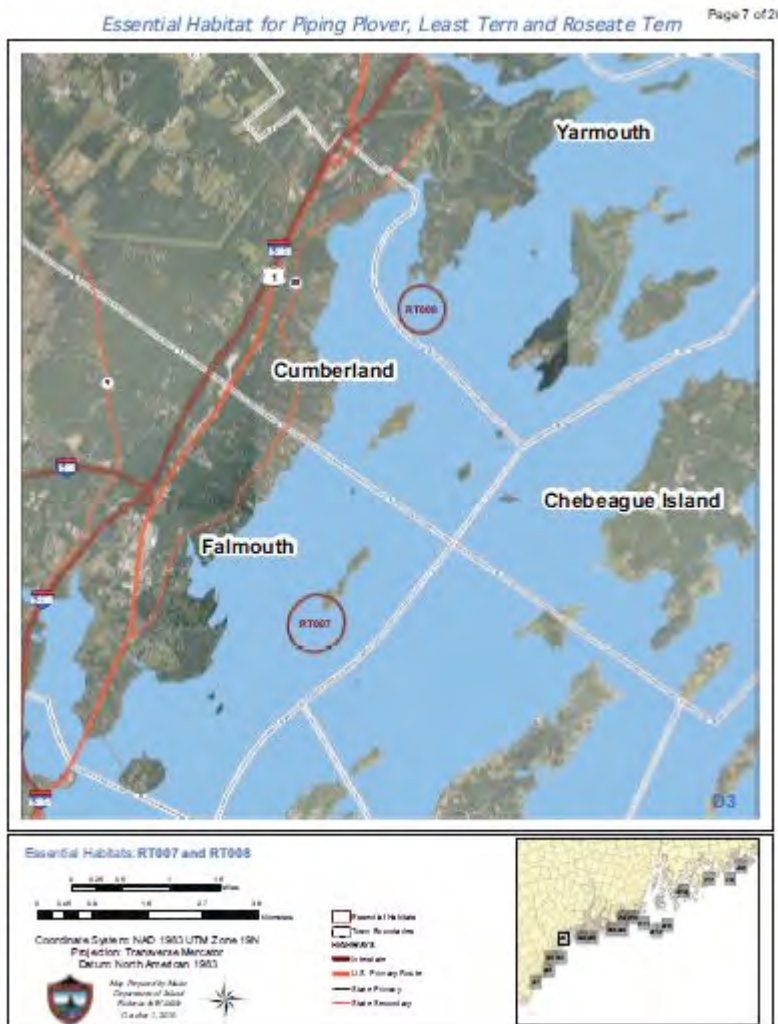
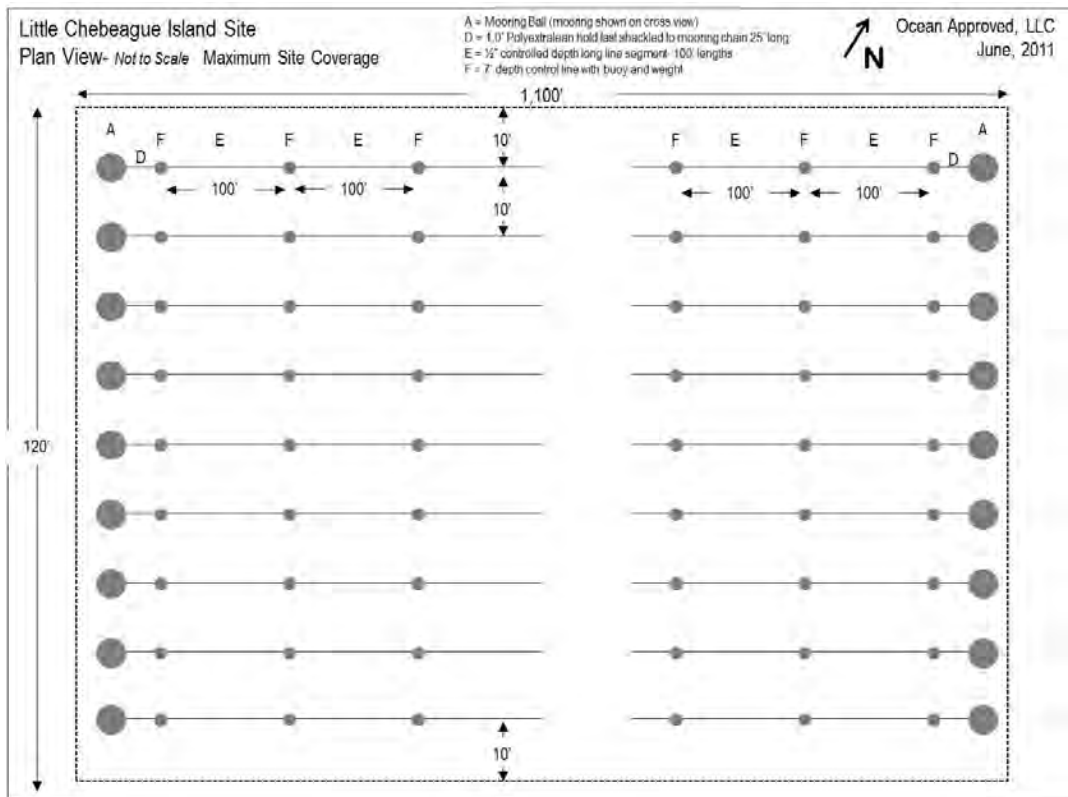
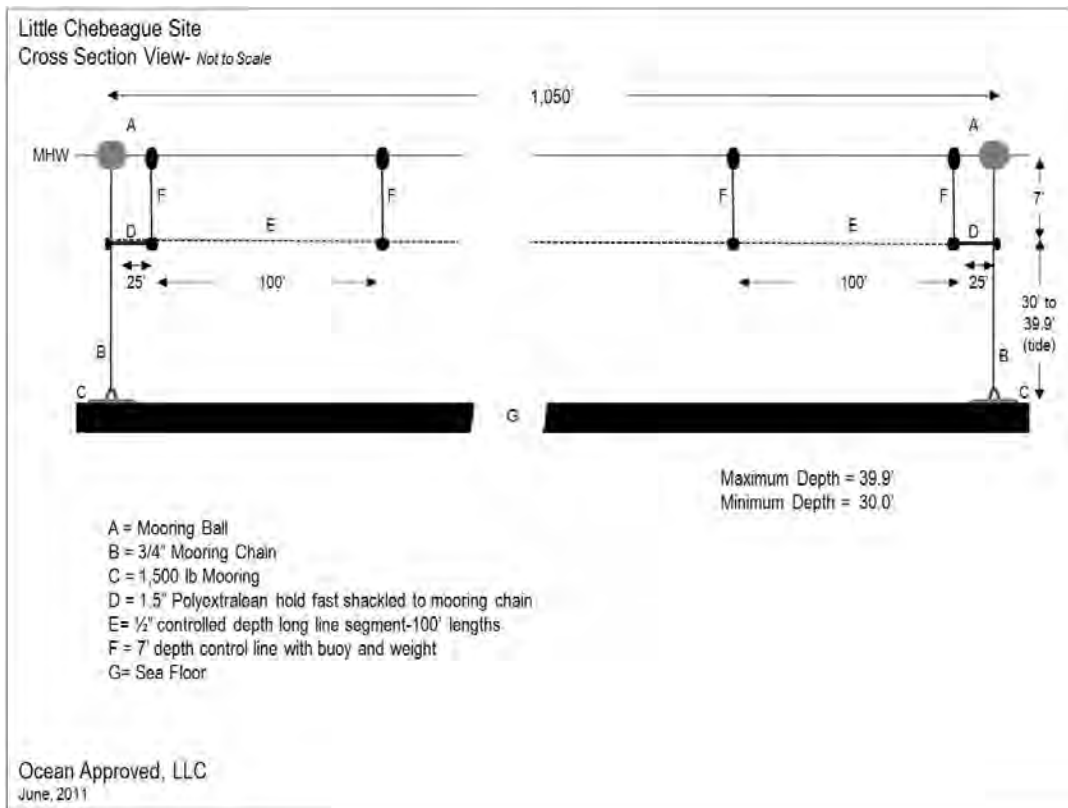

Fig. 11. Essential Habitat Map Provided by the State of Maine

7. Structures

Cross Section and plan view full page prints are included in appendix 3 and 4.



8. Discharge

Not Applicable

9. Marking

The proposed site will be marked as described in DMR Rule 2.803 Subsection (2)



PAUL R. LEPAGE
GOVERNOR

STATE OF MAINE
DEPARTMENT OF MARINE RESOURCES
MARINE RESOURCES LABORATORY
P.O. BOX 8, 194 MCKOWN POINT RD
W. BOOTHBAY HARBOR, MAINE
04575-0008

Appendix 1.

NORMAN H. OLSEN
COMMISSIONER

June 28, 2011

Ocean Approved, LLC
188 Presumpscot Street
Portland, Maine 04103

Dear Tollef:

During the month of June, I had the opportunity to review the activity in and around the lease sites that you are trying to have approved for use as kelp farms. I took care to examine the lanes of traffic as it may impede both your sites and the boating and fishing communities that surround the areas. I also checked to see what impact there was currently on each site, this included fixed gear fishing, transient boating and recreational use. My findings are as follows.

1. **Jewel Island.** These coordinates are located on the SW end of the island. The proposed site is very close to shore and is well inside of the usual channel used by the boating community to access Cocktail Cove and the campsites on this end of the island. I did see four lobster buoys on the edges of this site. Due to the location of this site and the shoal water, those factors make it unfavorable for larger draft vessels. There were no lobster boats working on June 19th when I did my inspection, nor were there any kayaks or small boats recreating in the area. This site I think would be acceptable for your use as an aquaculture site.
2. **Little Chebeague Island.** The coordinates for this site are shore side of the position of the USCG R14 navigational aid marking Indian Point on the SW side Great Chebeague Island. The area described by the coordinates almost bridges an area between both Little and Great Chebeague Islands. The area described, does have some fixed lobster gear on the edges at the time of my survey on June 21, 2011 but I did not see that as an issue. There were four buoys that were visible on that day. The area directly behind the proposed site is a land bridge between the islands at low tide and an impassable water covered sand bar at high tide. Only the smallest draft vessels may try to pass through that area. That area should be exempt from almost all boat traffic except for the lobster fishermen who may set more gear around the area as the summer continues. I believe this site would also be acceptable for your proposed use.

PHONE: (207) 633-9500

<http://www.Maine.gov/dmr>

FAX: (207) 633-9579

In closing it is my opinion that both sites would not impact any of the three areas adversely. Primary to my evaluation is the safety of the boating community while they operate any type of craft at any hour of the day or night. Each of these sites appear to be removed from any foreseeable hazard of vessels colliding with the equipment marking and used within the site. I do feel that there may be tension between the fixed gear fishermen in any of the areas, but that is expected.

Respectfully submitted,



Officer Thomas C. Hale, Maine Marine Patrol

Appendix 2.

June 14, 2011

422 Mitchell Road

Cape Elizabeth, ME

Re: Ocean Approved Site Dive Report

Chebeague Island Proposed Lease Site

Site Coordinate Description

NW Corner is 43° 43' 22.0"N

70° 08' 48.3"W

NE Corner is 43° 43' 21.1"N

70° 08' 46.3"W

SW Corner is 43° 43' 13.0"N

70° 08' 58.0"W

SE Corner is 43° 43' 12.1"N

70° 08' 56.0"W

Throughout the dive on June 13, 2011 I made the following observations:

1. Featureless soft mud bottom throughout the site.
2. No observed worms, seaweed or sea anemonies observed.
3. Little observed lobster activity observed.

Thank you for contracting my services,



Paul Fischer

Appendix 3.

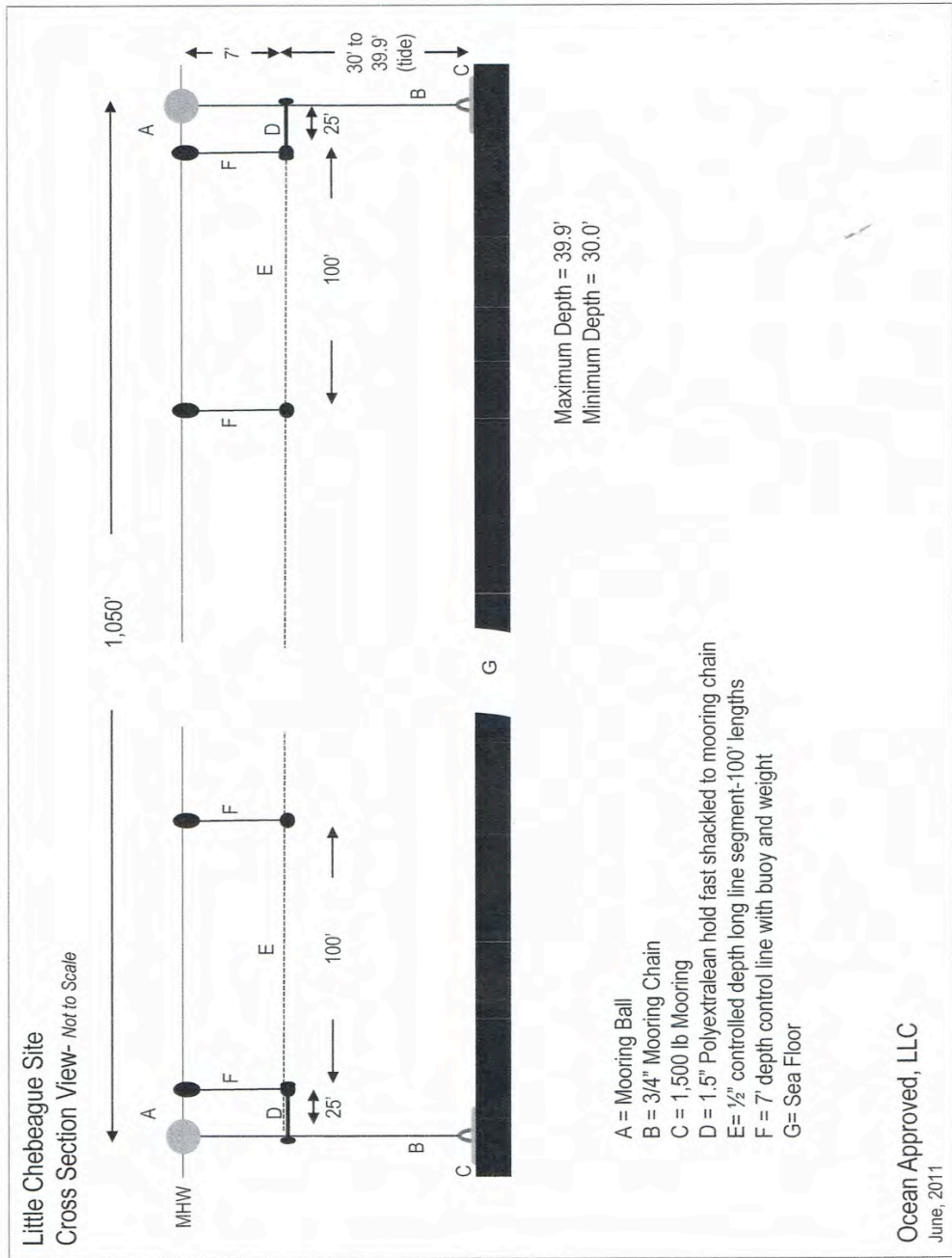

Department of Marine Resources
Site Review #2011-19E

Ocean Approved, LLC
188 Presumpscot Street
Portland, ME 04103
207-671-7946

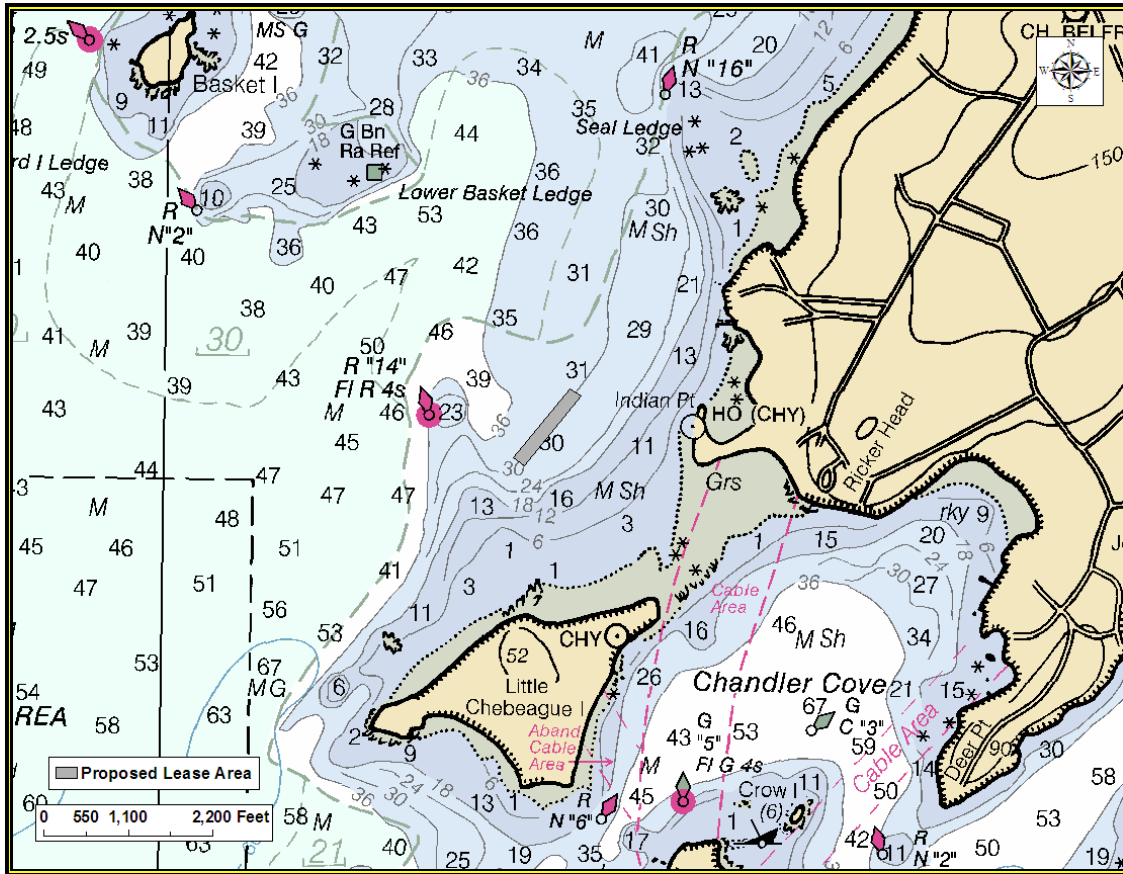

Figure 1: Area map created in ArcMap version 9.3 using NOAA Chart #13290.

Location: West Southwest of Indian Point, Great Chebeague Island, in Casco Bay, Chebeague, Maine

Purpose: Experimental long-line culture of Sugar Kelp (*Saccharina latissima*), Horsetail Kelp (*Laminaria digitata*), and Winged Kelp (*Alaria esculenta*).

Site Review by: Jon Lewis and Marcy Nelson
Report Preparation by: Jon Lewis and Marcy Nelson

November 4, 2011



Figure 2: Vicinity map created in ArcMap version 9.2 using geo-referenced aerial photographs taken at low tide (2001) and provided by The Maine Office of GIS.

On October 3, 2011 we visited the proposed experimental aquaculture lease located off the southwestern side of Great Chebeague Island in Casco Bay in the town of Chebeague, Maine. We arrived on site at 11:50 a.m.

Long Island, Casco Bay, Maine

3 October 2011

43.6900° N, 70.1700° W

04:15 EDT	9.33 feet	High Tide
10:13 EDT	0.56 feet	Low Tide
16:32 EDT	10.22 feet	High Tide
23:01 EDT	-0.07 feet	Low Tide

The applicant is requesting 3.03 acres (120 feet by 1,100 feet) for the culture of three species of indigenous seaweed. Structures would consist of up to nine 1,050 foot long-lines strung parallel to one another across the length of the lease area (see application for details).

The proposed lease is bounded to the southeast by Little Chebeague Island and to the northeast by Great Chebeague Island. To

the east lies a sand bar connecting the two islands at low water. To the west is the main navigational channel as defined by USCG navigational aids.

Water depths within the proposed lease area were collected via depth sounder on October 3, 2011. Depths were collected through the center of the site at 11:50 a.m, 1 hour and 37 minutes post slack low water. A relatively uniform depth of 23 feet was measured across the length of the site. Correcting to mean low water (0.0'), depths within the area range from ~21.5 to 23.5 feet. Mean tidal range within the area is 9.1 feet. Ocean Approved, LLC is requesting to place long-lines for kelp culture at a controlled depth of 7'. The location provides adequate depth for the proposed activities.

Position and Distances to Shore

A WASS enabled Global Positioning System (GPS) was used to navigate to each corner of the proposed lease, as described in the application. On October 3, 2011, a single buoy depicting "Sea Farm" designated each corner of the proposal. A fifth buoy that reportedly had been set too short to be visible at high water had been dragged and relocated nearby the SE corner of the proposed lease site. This buoy was removed from the water on October 3, 2011, leaving four accurately placed corner markers. POSAID Positioning Software was used to verify distances and bearings between corners. Distances to shore were determined using the measuring tool in ArcMap version 9.3, geo-referenced aerial photographs taken at low tide in 2008, and the application coordinates listed below.

Page 3 of the application described a site of 120-feet by 1,100 feet which describes the 3.03 acres stated in the application cover sheet. Using the application coordinates, we used POSAID positioning software to derive the metes and bounds as described below describing an area of 4.56 acres. The maximal acreage allowed under the application is 4.0 acres. The Department has the ability to decrease the size of the site to 4.0 acres by developing corrected coordinates to describe such an area. Alternatively, the Department, in consultation with the applicant, has the ability to develop corrected coordinates describing a 120 foot wide by 1,100 foot long area (3.03 acres). In either case, the area described by the coordinates in the application would need to be reduced. Which alternative is preferred by the applicant will need to be determined.

Application Coordinates – 4.56 acres (Figure 2)

<u>Corner</u>	<u>Latitude</u>	<u>Longitude</u>	
NW	43° 43' 22.0"N	70° 08' 48.3"W	<i>then 172.8 feet at 121.8° True to</i>
NE	43° 43' 21.1"N	70° 08' 46.3"W	<i>then 1156.7 feet at 218.0° True to</i>
SE	43° 43' 12.1"N	70° 08' 56.0"W	<i>then 172.8 feet at 301.8° True to</i>
SW	43° 43' 13.0"N	70° 08' 58.0"W	<i>then 1156.7 feet at 38.0° True to NW.</i>

Distances to Shore

NE Corner to nearest MLW – Indian Point	~1,312 feet @ 102°T
NE Corner to dock at Indian Point	~1,330 feet @ 098°T
East Boundary to nearest sandbar (N end L. Chebeague)	~1,876 feet @ 129°T

SE Corner to nearest sandbar (N end L. Chebeague)	~1,495 feet @ 173°T
SE Corner to 12' depth contour (MLW)	~669 feet @ 178°T
SW Corner to Nun "14"	~1,167 feet @ 308°T
NW Corner to Daymark "15"	~3,936 feet @ 317°T

The criteria MDMR uses to determine the suitability of an experimental aquaculture operation to a particular area (DMR Regulations Chapter 2.64(7) (A)) are discussed, with respect to the proposal, below:

(1) Riparian Owners Ingress and Egress

On October 3, 2011 there were no nearby docks or moorings with which the proposed activities might interfere. The nearest mooring associated with Indian Point was approximately 1,000 to the east of the proposed northeastern corner. Access to the Indian Point dock, located 1,300 feet from the proposed lease would not be restricted as there is more than adequate room to approach the dock from the north and the south.

(2) Navigation

The east side of the main navigational between Lower Basket Island and Great Chebeague and Little Chebeague Islands is defined by buoys 12, 14, and 16. The southwestern corner of the proposed lease is located approximately 1,100 feet from this channel. Navigation in the vicinity of the proposed lease would likely consist of vessels travelling to the Indian Point dock, to the sandbar between the islands, and nearshore recreational boaters. Adequate room exists on all sides of the proposed lease to accommodate these activities.

(3) Fishing

On October 3, 2011, no fishing activities (including the presence of lobster buoys) were observed within the boundaries, or nearby the proposed lease site. Most lobster buoys were placed in proximity to, and beyond, the 36-foot depth contour approximately 400 feet to the west. Additional buoys (approximately 20-25) were scattered between the eastern boundary of the proposed lease site and the tidally exposed sand bar extending between Great Chebeague Island and Little Chebeague Island. NOAA charting describes the proposed lease area as relatively flat with a bottom composition of mud/sand and mud/shell. When removing the fifth buoy and its associated mooring tackle (see page 3, Position and Distances to Shore) on October 3, 2011, the concrete block was clearly stained by the anoxic mud, and mud remained attached to the block at the surface. It is likely that lobsters would move over this bottom at certain times of year, however, little structure is present that would tend to "hold" lobsters in this area.

Recreational hook and line fishing may also occur in the areas adjacent to the proposed lease.

(4) Other Aquaculture Uses

The names and distances to the MDMR leases nearest the proposal are listed below. Distances were measured, straight-line, in ArcMap 9.3.

The applicant (Ocean Approved, LLC.) has a .86 acre experimental aquaculture lease for the long-line culture of seaweeds located off the southern side of Little Chebeague Island (CAS LCI), approximately 3,900 feet to the south.

Aqua Farms, LLC. operates a 2 acre aquaculture lease for the raft culture of blue mussels (*Mytilus edulis*) off the west side of Bangs Island (CAS BA2), approximately 2.6 miles to the east.

Trundy Point, LLC. operates a 1.74 acre experimental aquaculture lease for the raft culture of blue mussels and located to the south of Little Chebeague Island (CAS LONG), approximately 4,500 feet to the southwest.

The applicant (Ocean Approved, LLC.) has a pending 3 acre experimental aquaculture lease for the long-line culture of seaweeds located off the western side of Jewell Island, approximately 3.7 miles to the southeast.

The proposed activities will not interfere with existing aquaculture operations in the region. Other shellfish farms are present in Casco Bay in the neighboring towns of Cumberland, Falmouth, Yarmouth, Harpswell and Freeport. For more information on these and other aquaculture leases please visit:

<http://www.maine.gov/dmr/aquaculture/leaseinventory/index.htm>.

(5) Existing System Support

According to records available at MDMR, there are no documented eelgrass (*Zostera marina*) beds within the proposed area. The nearest eel grass bed is located along the western shores of Great Chebeague Island and Little Chebeague Island; approximately 975 feet from the proposed NE corner, 685 feet from the proposed SE corner and 900 feet from the eastern boundary. Water depths and substrate in the area of the proposed lease likely preclude the spread of eel grass into that area.

According to Maine Department of Environmental Protection and Inland Fisheries and Wildlife habitat mapping, the western shores of the two islands are designated Tidal Wading Waterfowl Habits. These habitats overlap with the aforementioned eel grass distribution; therefore distances to this habitat are the same as in the previous paragraph.

Wildlife

According to Scott Lindsay, Regional Biologist at The Maine Department of Inland Fisheries and Wildlife (MDIF&W), “The only habitat of management concern is the mapped eelgrass beds closer to the island, but it appears as though these will not be impacted by the location and type of lease.”

(6) Interference with Public Facilities

No publicly owned facilities are located within 1,000 feet of the proposed lease.

(7) Water Quality Classification

The proposed lease is in an area currently classified by the Department of Marine Resources Public Health Division as “Open” for the harvest of shellfish. This classification, however would not affect the harvest of algae from the proposed lease site. Likewise, biotoxin, or PSP closures, would not affect the proposed lease activities.

Contact Information for New England States

Massachusetts

State Government Website

<http://www.mass.gov/eea/agencies/agr/about/divisions/aquaculture-program-generic.html>

Army Corps of Engineers

U.S. Army Corps of Engineers

Concord Park

696 Virginia Road

Concord, MA 01742

(978) 318-8491

Sea Grant

<http://www.who.edu/seagrant/page.do?pid=34015>

Aquaculture Association

<http://massaquaculture.org>

New Hampshire

State Government Website

Army Corp of Engineers

U.S. Army Corps of Engineers

Concord Park

696 Virginia Road

Concord, MA 01742-2718

Sea Grant

<http://www.seagrant.unh.edu>

Aquaculture Association

<http://nhaquaculture.com/>

Rhode Island

State Government Aquaculture Website

<http://www.crmc.ri.gov/aquaculture.html>

Army Corp of Engineers

U.S. Army Corps of Engineers

Concord Park

696 Virginia Road

Concord, MA 01742-2718

Sea Grant

<http://seagrant.gso.uri.edu>

Aquaculture Association

Ocean State Aquaculture Association [OSAA]

C/O Spatco, Ltd

P.O. Box 2031

Kingston, RI 02881

President: Bill Silkes

Connecticut

State Government Website

<http://www.ct.gov/deep/cwp/view.asp?A=2705&Q=431902>

Army Corp of Engineers

U.S. Army Corps of Engineers

Concord Park

696 Virginia Road

Concord, MA 01742-2718

Sea Grant

<http://www.seagrant.uconn.edu>

Aquaculture Association

Connecticut Aquaculture Association

C/O Connecticut Seafood Council

129 Ardmore Road

West Hartford, CT 06119

Tel. (860) 523-8705

Fax. 860.523.8960

Email: ctseafoodcouncil@aol.com

Maine

State Government Website

<http://www.maine.gov/dmr/aquaculture/index.htm>

Army Corp of Engineers

U. S. Army Corp of Engineers

U.S. Army Corps of Engineers, Maine Project Office

675 Western Avenue #3

Manchester, ME 04351

Sea Grant

<http://www.seagrant.umaine.edu/>

Aquaculture Association

Maine Aquaculture Association

P.O. Box 148

103 Water St., 4th Floor

Hallowell, ME 04347

Tel. (207) 622-0136

Email: info@maineaquaculture.com

Chapter 2

Nursery



Overview

The nursery or laboratory is an area that is used for isolating kelp spores and supporting the early growth of young kelp plants (e.g., sporophytes) for later out-placement to sea. Regardless of the size or goals of the nursery, each nursery designed to grow kelp must aim to replicate the essential environmental conditions (water temperature, light, salinity, nutrient levels) found in their native habitat. One key advantage of a nursery setup is the ability to control these conditions for optimal growth and increased survival. As such, the function of every nursery is threefold: 1) support the growth of kelp from spores through sporophytes, 2) replicate the environmental conditions found naturally, and 3) control contamination. The purpose of this section is to provide a general overview of the essential capabilities a nursery must support, a comparison of water sterilization techniques, and a suggested list of equipment.

Operation of the nursery requires the understanding and use of basic laboratory equipment, attention to detail, and the ability to monitor and control the environmental conditions to support growth of the kelp. A variety of nursery designs and procedures are available for private and commercial seaweed growers; however, each of these are specifically tailored for the goals and capabilities of that particular

nursery. For instance, factors such as cost can vary dramatically depending on the nursery design and equipment purchased to meet these requirements.

The definitions, equipment, and procedures described in this chapter are those found to be successful and were utilized by Ocean Approved (OA) following more than four years of experimentation and trials. They do not represent the most inexpensive or costly setup that may be used. Depending on one's background, fisherman or scientist, these nursery processes may be considered a relatively easy stage or difficult stage in the farming process. However, if an interested kelp grower, no matter what background he or she has, follows these procedures and maintains the described conditions, the spores from reproductive kelp plants may be isolated and grown in the nursery. In a matter of four to six weeks' time the young sporophytes will be ready for out-placement to ocean farm sites.

Essential Capabilities

Temperature

Kelp grows in water between 41 and 59°F (5 and 15°C, respectively). The nursery must have the capability of controlling water temperature within this range through either the use of cold rooms or water chillers.

Light

Light intensity, wavelength, and light hours per day (photoperiod) must also be controlled. This may be accomplished by the use of environmentally controlled growth chambers or by external light fixtures. A photoperiod of 12 hours "lights on"/12 hours "lights off" was used in the OA lab.

Fresh Water

Distilled or deionized water must be readily available for cleaning glassware and equipment and mixing reagents. The volume needed will depend on the scale of the operation.

Seawater

A reliable source of seawater will be necessary for isolation and grow-out of the kelp spores and plants. Depending on location, this may be directly piped in or carried in. Culture nutrients are added to the seawater for optimal kelp growth. Contaminants must be removed from the seawater (i.e., the seawater must be disinfected or sterilized) prior to use. Synthetic seawater may be used, but was found by OA to be less productive. Table 2.1 (on page 40) describes and compares various methods for cleaning seawater.

Aquaria

(Also referred to as production aquaria or growth tanks.) A great deal of flexibility is possible here. Aquaria ranging in size from 5 to 50 gallons (or larger) may be used, but the environmental parameters mentioned here must be maintained.

pH

The acidity/alkalinity range must be monitored and controlled. Kelp spores and plants grow best between a pH of 7.0 and 9.0. The pH must be measured regularly and adjusted with the addition of carbon dioxide (CO₂) gas as needed.

Microscope

A compound microscope and counting chamber is required. The reproductive spore cells that are released and captured for culture are very small and can only be seen with the use of a microscope. A counting chamber is necessary to determine the number of spores released so that the proper density of spores can be established for each culture.

Aeration

Adding air, or “bubbling air,” into the production aquaria is also essential to maintaining pH. This is typically done by the use of small aquaria or laboratory air pumps with the use of air filters to remove airborne contaminants. OA recommends using HEPA air filters to eliminate potential contaminants.

Sterilization and Contamination Control

A process for sterilization or removing contaminants is mandatory. As shown on page 40 in Table 2.1, standard sterilization techniques include autoclaving, tyndalization, pasteurization, filtration, and ultraviolet (UV) irradiation. There are numerous considerations (e.g., cost, time, effectiveness) to be aware of when choosing the most effective technique that meets the needs of the nursery. The pros and cons of each of these processes are listed in Table 2.1.

After experimenting with most of the procedures described in Table 2.1, OA adopted the protocol illustrated in Figure 2.1. This protocol was able to remove almost all contaminants at a cost and time much less than transporting autoclaved seawater prior to use.

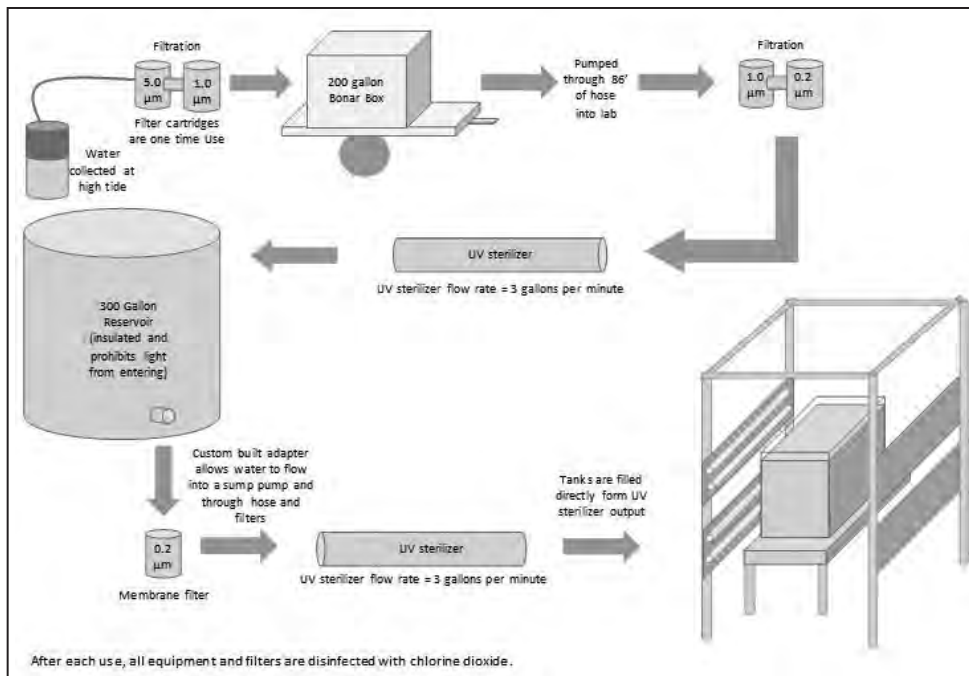

Figure 2.1 Process used by OA to collect seawater from the ocean and sterilize it for use in the nursery aquaria

Advanced Capabilities

Large universities, research institutes, or aquaculture facilities may have the resources, space, and capabilities to have flowing treated seawater, large walk-in autoclaves, and large-scale environmentally controlled growth chambers. While

these facilities are expensive to build and maintain, they do provide opportunities for much greater control of all phases of nursery operations. These facilities also allow for more advanced nursery operations, such as the cloning and growth of gametophytes, to allow for year round inoculation of spools.

Table 2.1 Seawater Treatment Methods to Control Contaminants

Tech- nique	Definition	Example Duration	Equipment Needed	Pros/Cons	Comments
Autoclaving	Sterilization using steam (water) under high pressure.	15 minutes at 121°C	Autoclave	Pros: • 100% effective • Minimum manpower Cons: • Expensive • Time consuming with large volumes	Autoclaving is very expensive for large volumes of seawater and may alter the chemistry of the water. All living organisms are destroyed. It takes only a few hours with little supervision.
Pasteurization	Partial decontamination of a substance at a specific temperature and a duration that kills most organisms without major chemical alteration of the substance.	30 minutes at 61.7°C	Standard stove	Pros: • 80% effective Cons: • Labor intensive	This is relatively inexpensive, can be done quite quickly, but only partially destroys living organisms in the liquid. Pasteurization has been used effectively to control contaminants in some algal nurseries.
Tyndallization	Sterilization by heating a substance (seawater) for several minutes on three or four successive occasions.	5 minutes at 90°C-100°C Once per day for three days (24 hours between heating)	Standard stove	Pros: • >99% effective Cons: • Moderate manpower • Labor intensive with large volumes	This is effective in destroying most living organisms but requires 24 to 72 hours of time and is more labor intensive.
Filtration	The process of passing the seawater through filters.	Varies depending on filter pore or membrane size. Also depends on number of uses.	Polypropylene and Membrane Filters 5.0, 1.0, 0.2 µm	Pros: • 80% effective • Filter large amounts of water in a short time Cons: • Filtration begins fast, but increased amounts of debris will cause the filter to clog and water flow will decrease.	Relatively inexpensive, takes little time and removes most living organism in the seawater. Effectiveness and cost may vary extensively depending on the quality and type of filter used. For example, 0.2 µm membrane filter cartridges cost more and take more time to filter than a 5.0µm filter.
Ultra-violet (UV) Radiation/ Sterilization	The process of passing the seawater past a closed UV light system.	3 gallons per minute	UV apparatus	Pros: • >99% effective Cons: • Moderately expensive	Relatively inexpensive, takes little time, but requires management of flow rates and exposure times to maximize effectiveness.
Chlorine Dioxide (ClO ₂)	Sterilization by adding (ClO ₂) into the seawater.	3-20 parts per million & 18-24 hours for ClO ₂ dissipate into the air.	ClO ₂ ; Personal protective equipment (respirator); Refrigerator & approved containers (storage)	Pros: • >99% effective • Inexpensive • Minimum effort Cons: • Toxic substance, protective equipment required	Relatively inexpensive but requires contact time in the range of 18-24 hours for complete dissipation into air. Also requires safe handling and storage practices and measurement equipment to monitor concentrations and residuals.

Equipment and Supplies

Aquaria

(Also referred to as production aquaria or growth tanks.) Aquaria ranging from 5 to 50 gallons (or larger) may be used depending on the scale of the nursery. The aquaria are used to hold and grow the spools of kelp in the nursery. OA used 20-gallon production aquaria that hosted between 8-10 nursery spools at a time.



Nursery Spools

Made of 2-inch PVC pipe, the nursery spools are cut to fit the height of the aquaria being used. Nylon twine is wrapped around the PVC and fastened with rubber bands. The spools provide the surface area needed for the spores to attach to and grow in the nursery.



Settling Tubes

Made from 4-inch PVC pipe, settling tubes are cut to fit the height of the spools and capped at the bottom to prevent water from leaking out the bottom. Settling tubes are used during inoculation of spools with spores and for transporting the spools with young sporophytes to the ocean site.

Water Chiller

A refrigeration unit used to cool individual aquaria or can be plumbed to cool numerous aquaria simultaneously. It is essential throughout the kelp culturing process to have water temperatures regulated at approximately 50°F (10°C).



Fluorescent Lighting

Light bulbs, fixtures, and timers are required to provide the 12 hours of lights ("lights on") and 12 hours of darkness ("lights off") that the growing sporophytes require. Many different configurations are available for purchase. OA used 4-foot T12 fluorescent lights in a standard light bank fixture. A series of mesh screens were used to regulate the amount of light penetrating the production aquaria.



Air Pump

Air is administered by use of air pumps, tubing, sterile pipette, or air stone, all of which can be found in a local pet supply store. Aeration is essential for proper sporophyte growth in the production aquaria. Air filters can be placed in line with the air tubing to reduce the risk of introducing airborne contaminants.



Water-Filtering Device

Any configuration of pumps, filters, and tubing used to purify the seawater for use in the nursery.



Water Filters

Various size mesh filter cartridges are used in line with the pumping system to purify the seawater. Filters can be purchased in a wide range of pore and membrane sizes. 5.0, 1.0, and 0.2 micron (μm) filters can be used together to obtain relatively low bacterial counts in the water. Some varieties are meant for single use, while others can be cleaned or autoclaved for multiple uses.

Refrigerator

An appliance that is used to cool its contents. The refrigerator is necessary for storing culture nutrients and sorus tissue, as well as chilling small quantities of seawater. OA recommends storing several gallons of filtered seawater for releases and as emergency backup water if a water chiller fails. Stored seawater, however, should be used within one week of collection to prevent growth of bacteria.



Nutrient Media

(Also referred to as culture nutrients or culture media.) Provasoli's Enriched Seawater (PES) and vitamins are the components added to the seawater to accelerate kelp growth. Germanium dioxide (GeO_2) is added to suppress diatom growth. See Appendix B for nutrient media composition and preparation that OA found most effective.



Microscope

An instrument used to magnify the reproductive spore cells, or “zoospores,” during a release. Zoospores that are released and captured for culture can only be seen with the use of a microscope. A compound microscope or similar having a 40x and 100x magnification is recommended to observe and count these spores to properly calculate the stocking density.



Cell-Counting Chamber

(Also referred to as a hemocytometer.) A microscope slide that is specifically used for counting the zoospores during release. A counting chamber is necessary to determine both the number of spores released, and to calculate the proper density of spores to add to the settling tubes. Grids are etched into the glass to allow for easier counting.

Laboratory Glassware

Beakers, graduated cylinders, and flasks are used most often during spore release, measuring culture media, preparing aquaria, and establishing gametophyte cultures.



Thermometer

An instrument that is used for measuring the temperature of both the air and water. Digital thermometers are used during the spore releases and inside production aquaria to monitor the water temperature. Thermometers are also useful to monitor the air temperature in the nursery and refrigerator.



pH Meter

An instrument that measures the acidity or alkalinity of the water. Many different models are on the market that allow for easy monitoring of seawater pH level. A digital interface makes readings more precise.



Light-Measuring Meter

An instrument used to measure and monitor the intensity of light the nursery spools receive. The light wavelengths are measured in micromoles per square meter per second ($\mu\text{mol m}^{-2} \text{s}^{-1}$). The measuring probe can be submerged in the aquaria to gain an accurate reading. It is important to use a meter that is submersible and measures in micromoles.



Ultraviolet (UV) Radiation Sterilization Device

An instrument used to sterilize filtered seawater by exposing it to UV radiation, which is used in many aspects of nursery production. OA's unit recommended a flow rate of three gallons per minute to eliminate most contaminants in the seawater. If necessary, small individual units can be added to the aquaria to reduce or prevent bacterial contamination.



Carbon Dioxide (CO₂) Supply

An air tank containing carbon dioxide gas may be used to lower the pH inside the production aquaria. As the kelp plants grow in the nursery, the pH may slowly rise to 9.0 or higher. Slowly introducing CO₂ through tubing and an air stone will lower the pH to the more preferred range of 7.0–9.0.

Nursery Setup Temperature

The air temperature in the nursery was maintained at 65°F–70°F (18°C–21°C, respectively). The temperature of the seawater in the aquaria was maintained at 50°F (10°C) through the use of external chillers (Figure 2.2). Seawater was continuously circulated through ½-inch silicon hoses that were custom fit to each individual system. Gray PVC pipes, elbows, and adapters were inserted into the intake and outflow hose ends and fastened using hose clamps to prevent leaks.

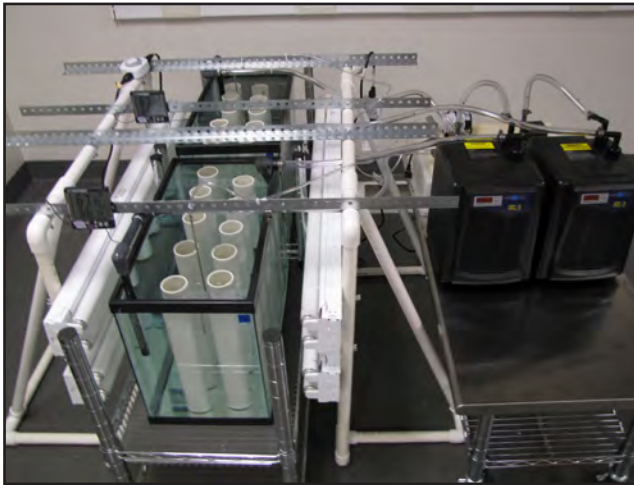

Figure 2.2 A two-aquaria setup including light bank, two chillers (one for each aquaria), and one air pump with separate tubing for each aquaria



Figure 2.3 The light bank setup fabricated by OA to administer light to the growing spools

Light

The light intensity and photoperiod must be controlled and monitored. This may be accomplished through the use of external light banks, screens, and timers. This lighting system was designed to allow for flexibility in light levels. As seen in Figure 2.3, light banks were created out of PVC, nuts, bolts, and counterweights (placed on opposite side of lights to counteract the weight of the lights). The light banks stood alone and could be modified to fit side by side with another light bank or next to a wall.

The 4-foot T12 fluorescent lighting fixtures were attached directly to the light banks. Mesh screens were fabricated using PVC pipe, pet screen (for fine mesh), plastic hardware net (for wide openings), and zip-ties. All supplies were purchased from a local hardware store. Plans for building the light banks can be found in Appendix C.

A light meter was used to measure the distance needed between the aquaria and light bank to achieve the 100 micromoles per square meter per second intensity ($\mu\text{mol m}^{-2} \text{s}^{-1}$) that the spools would receive at maximum intensity. Fine mesh screens (Figure 2.4) allowed light levels in the aquaria of approximately $20 \mu\text{mol m}^{-2} \text{s}^{-1}$, which is suitable for the beginning growth. These fine mesh screens were used for the first two weeks of growth in the nursery. The wide mesh screens (Figure 2.5) created light levels in the aquaria of approximately $55 \mu\text{mol m}^{-2} \text{s}^{-1}$. These screens were used between weeks 2 and 4. The screens were easily hung between the tank and the light source with zip-ties, to create the appropriate light levels. The screens diffuse the light and spread it evenly across the surface of the aquaria. By week 4 (or sometimes earlier), the screens can be removed, providing full light from the light banks (approximately $100 \mu\text{mol m}^{-2} \text{s}^{-1}$). Table 2.2 shows the light intensity, photoperiod and duration that have been successfully used by OA.



Figure 2.4 Fine mesh screen used to create light levels of $20 \mu\text{mol m}^{-2} \text{s}^{-1}$

Figure 2.5 Wide mesh screen used to create light levels of $55 \mu\text{mol m}^{-2} \text{s}^{-1}$



Table 2.2 Light Level Measurements in Ocean Approved Production Aquaria

Zoospore Release Date (Fine Mesh Screen) ^a	Number of Days Using Fine Mesh Screen ^a	Increase Light Intensity (Wide Mesh Screen) ^b	Number of Days Using Wide Mesh Screen ^b	Increase Light Intensity (No Screen) ^c	Number of Days Using No Screen ^c	Out-planting to Farm Site	Total Days in Nursery
9/26/10	19	10/15/10	19	11/3/10	3	11/6/10	41
9/26/10	19	10/15/10	19	11/3/10	9	11/12/10	47
11/16/10	14	11/30/10	14	12/14/10	16	12/30/10	44
11/16/10	14	11/30/10	14	12/14/10	17	12/31/10	45
11/16/10	14	11/30/10	14	12/14/10	24	1/7/11	52
11/17/10	13	11/30/10	14	12/14/10	31	1/14/11	58
11/17/10	13	11/30/10	14	12/14/10	15	12/29/10	42
12/9/10	12	12/21/10	17	1/7/11	7	1/14/11	36
12/9/10	12	12/21/10	17	1/7/11	8	1/15/11	37

^aFine mesh screen: $20 \mu\text{mol m}^{-2} \text{s}^{-1}$ ^bWide mesh screen: $55 \mu\text{mol m}^{-2} \text{s}^{-1}$ ^cNo screen: $100 \mu\text{mol m}^{-2} \text{s}^{-1}$

Seawater

Seawater was collected at high tide from open-ocean sites and stored in the nursery until utilized. Water in each aquaria was changed every seven days. This was accomplished by transferring the spools to another aquarium with fresh, filtered, and sterilized seawater and culture nutrients.

The sterilization or the removal of contaminants (e.g., unwanted algae, protozoa, and bacteria) from the collected seawater is one of the most important and challenging activities in the growth process. As outlined earlier in Table 2.1 there are a number of ways this may be accomplished. The availability of running seawater, the volume of seawater being used, and the equipment on site all play a role in deciding which process may be utilized.

The protocol for the collection and storage of seawater was dependent upon the amount of seawater that was needed for the nursery. For instance, for smaller operations (<10 aquaria), OA transferred seawater to the nursery in 5-gallon plastic jugs (Figure 2.6) However, for a larger-scale operation (≥ 10 aquaria), OA transferred seawater to the nursery using a 200-gallon Bonar Box on a trailer. The seawater was then placed in a sterile, 300-gallon, insulated storage tank (Figure 2.7). until needed. Regardless of the amount of seawater brought into the lab, all seawater was filtered (5.0, 1.0, 0.2 μm filters) and exposed to UV sterilization to remove contaminants prior to use.

Figure 2.6 Water filtration process used by OA when less than 10 aquaria in the nursery.

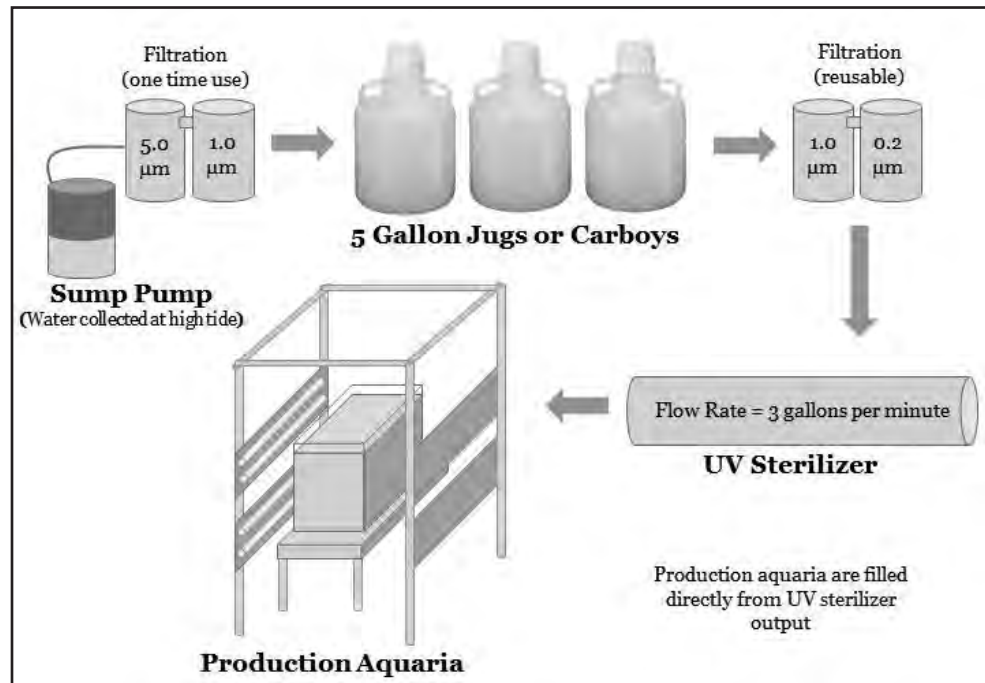

Figure 2.7 300-gallon holding tank and filtration system used in the nursery to fill the aquaria





Figure 2.8 Aquaria setup with lighting, chilling, and aeration system in place



Figure 2.9 Large cutting board used to anchor the chiller and air pumps

Production Aquaria

OA used standard 20-gallon glass tanks or aquaria to hold the spools. Each aquarium was fitted with a plexiglass lid to minimize evaporation and reduce contamination. Light banks were constructed to allow two aquaria to fit end to end (Figure 2.8). Each aquarium had a separate pump that circulated water through the chiller. Two aquaria shared an air pump. The air pump and two pumps that fed the chillers were fastened to a large cutting board and placed on the cart to provide stability (Figure 2.9).



Figure 2.10 Nursery spool used as substrate for spores to attach and grow

Spools and Settling Tubes

Various techniques and materials are used successfully worldwide to hold the 1-mm twine. OA adopted a method that was effective in the nursery as well as when transferring to the lines at the farm site. The OA method used 2-inch PVC pipe as the base of the nursery spools (Figure 2.10). The PVC pipe may be cut to the appropriate length for the size of the aquaria or growth tank being used. Since the OA nursery uses 20-gallon aquaria, the PVC pipe was cut to 15.25 inches in length. These dimensions allowed for approximately 200 feet of the 1-mm twine to be wound on each section of pipe.

Once the pipe is cut, the next step is to wind the twine onto the pipe. Winding the twine on the PVC pipe may be done manually, which is very time consuming, or mechanically. OA created a jig to spin the twine onto the pipe using a sewing machine motor (Figure 2.11). The advantage of this jig is that speed can be controlled with the sewing machine motor foot pedal, allowing the use of both hands to guide the twine onto the PVC pipe.

Regardless of the technique used, it is important that the seed twine does not overlap itself throughout the winding process and that the sides of the twine are tightly touching. Exam gloves are recommended while handling twine to minimize exposing the twine to oils and dirt that may be on one's hands.

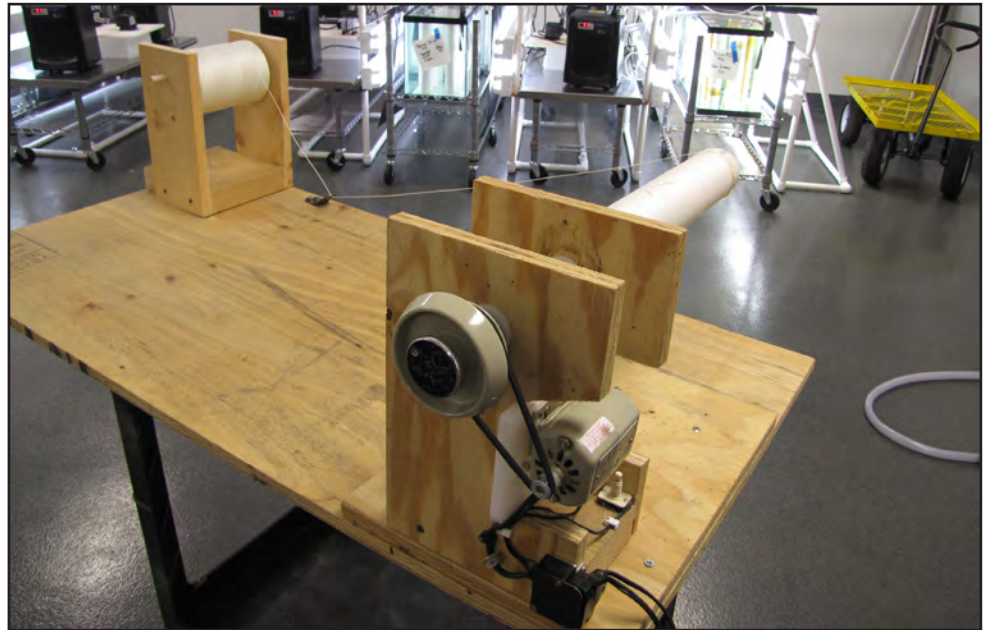

Figure 2.11 A handmade spool winder, using a sewing machine motor as the power source

Process to Construct Spools

Step 1. Cut the PVC pipe to the desired length. Ensure that the cuts are at 90 degrees. A cut that is not 90 degrees may result in the spool leaning or falling over in the aquaria.

Step 2. With a fine file and sandpaper, round the outside edge of each end of the pipe. This minimizes sporophyte damage when seed twine is deployed from the tube to the long line at the farm site.

Step 3. Boil pipes to remove deposits, wash with soap (e.g., gentle dish detergent) and water, rinse, and then soak in deionized water for 72 hours to remove any other contaminants.

Step 4. Clean, dry pipes are then stored in clean plastic bags.

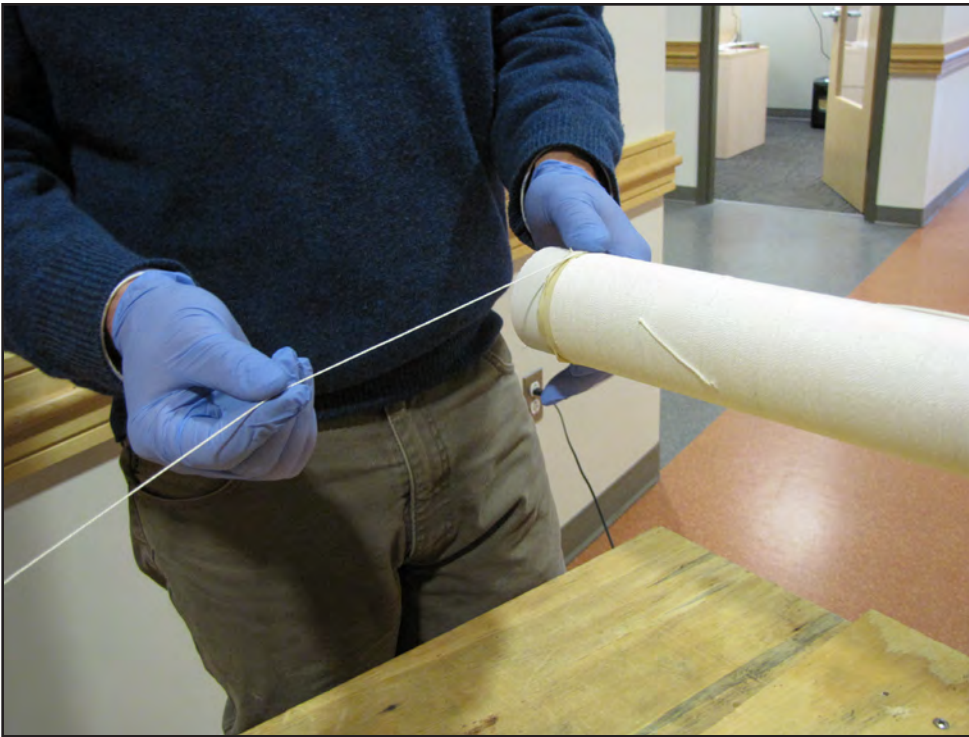

Figure 2.12 Wrapping twine around PVC pipe to create spools

Process to Attach Seed Twine to PVC Pipe

Step 1. Wearing exam gloves, wrap a rubber band around one end of the pipe about $\frac{1}{4}$ inch from the end.

Step 2. Insert the end of the seed twine under the rubber band, so that the end of the twine is pointing to the end of the pipe.

Step 3. Tie an overhand knot at the end of the seed twine to ensure that the twine does not pull under the rubber band.

Step 4. Wind the seed twine tightly around the pipe away from the rubber band either manually or using an automated device like OA's "jig." Wrap the twine tightly and do not overlap (Figure 2.12).

Step 5. After wrapping approximately 3 inches away from the rubber band, a separate 2-inch piece of twine should be inserted under one of the winds, sticking out away from the tube. This 2-inch piece of twine will allow for the monitoring of early sporophyte growth under the microscope (Figure 2.13). Small sections of these pieces can be cut off the spool throughout nursery production, without disturbing the entire length of twine.

Step 6. Continue winding until within 3 inches of the end of the pipe and then insert another piece of 2-inch sample twine.

Step 7. Continue winding until there is approximately $\frac{3}{8}$ inch of exposed PVC pipe remaining. Place a rubber band over the PVC pipe and the end of the seed twine. As before, tie an overhand knot to keep the twine from pulling under the end of the rubber band.

Step 8. Nursery spools may be kept in a clean plastic bag in the freezer until ready to use (Figure 2.14).

Figure 2.13 Sample twine viewed under the microscope used to monitor growth of sporophytes

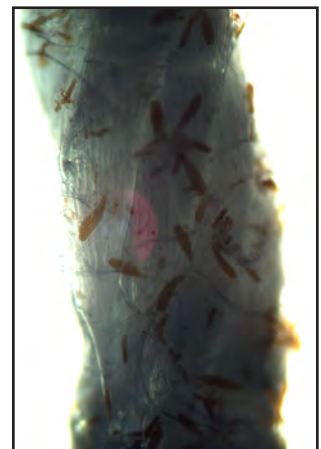

Figure 2.14 Nursery spools are stored in plastic bags in the freezer until needed.



Process To Construct Settling Tubes

The steps used to construct and clean the 4-inch-wide PVC pipe used for settling tubes (Figure 2.15) are the same as the steps used to construct the 2-inch PVC spools that hold the twine, with the exception of the need to sand and file the ends. The PVC pipe is cut to 15.75 inches in length in order to hold the 15.25 inch spools. One end must have a cap glued on so that it is watertight. These tubes must be washed and leached using the same process employed for the nursery spools. In addition to being used to hold the spools with twine for spore settling, these same tubes are used to transfer the spools to the farm sites as described in Chapter 5, page 94.

Figure 2.15 Settling tube used when inoculating spools and transferring spools out to farm sites

Chapter 3

Isolation and Maintenance of Cultures

Overview

The isolation of zoospores (i.e., “spores”) from mature kelp plants (sporophytes) is a first step in establishing cultures in the nursery. The spores are contained in the reproductive sori that are present in quantity only a few months each year. These reproductive sori mature primarily in response to temperature and light. It is important to understand the life cycle (Figure 3.1) of the kelp species that is being utilized in order to maximize efforts to isolate and grow the spores.

OA nursery activities have primarily focused on isolating spores and facilitating the settlement of spores onto nylon twine wrapped around PVC pipe (spools). Once settlement has occurred, 24 to 36 hours, the spools are placed in aquaria under controlled conditions to complete the microscopic gametophyte stage of growth. The gametophyte stage is quickly replaced by the young sporophytes, which are ready to be transferred to the farm sea site after four to six weeks of growth in the nursery.

Some nursery setups with more advanced facilities and controls are now maintaining the gametophyte stages (male and female) for extended periods of time. Maintaining these cultures in a non-reproductive phase for a number of months or years in a nursery requires more advanced equipment and skills. There is an advantage of being able to initiate the young sporophyte stage at times of the year when fertile sori may be unavailable in the ocean.

This chapter, based on the work performed in the OA nursery and current available information, describes best practices followed by OA starting with the collection of sorus tissue and concludes with the transfer of spools to production aquaria in a small-scale kelp aquaculture nursery. These OA best practices were developed from a review of the literature, proven successful techniques, and best professional judgment to recommend a practical and successful methodology for culturing kelp.

After the description of the kelp life cycle, this chapter is organized into the following sections:

1. Field collection of sorus tissue
2. Preparing sorus for zoospore release
3. Zoospore release
4. Counting zoospores and calculating stocking density
5. Inoculating spools with zoospores
6. Transferring inoculated spools into production aquaria

Figure 3.1 Life cycle of *Saccharina latissima*

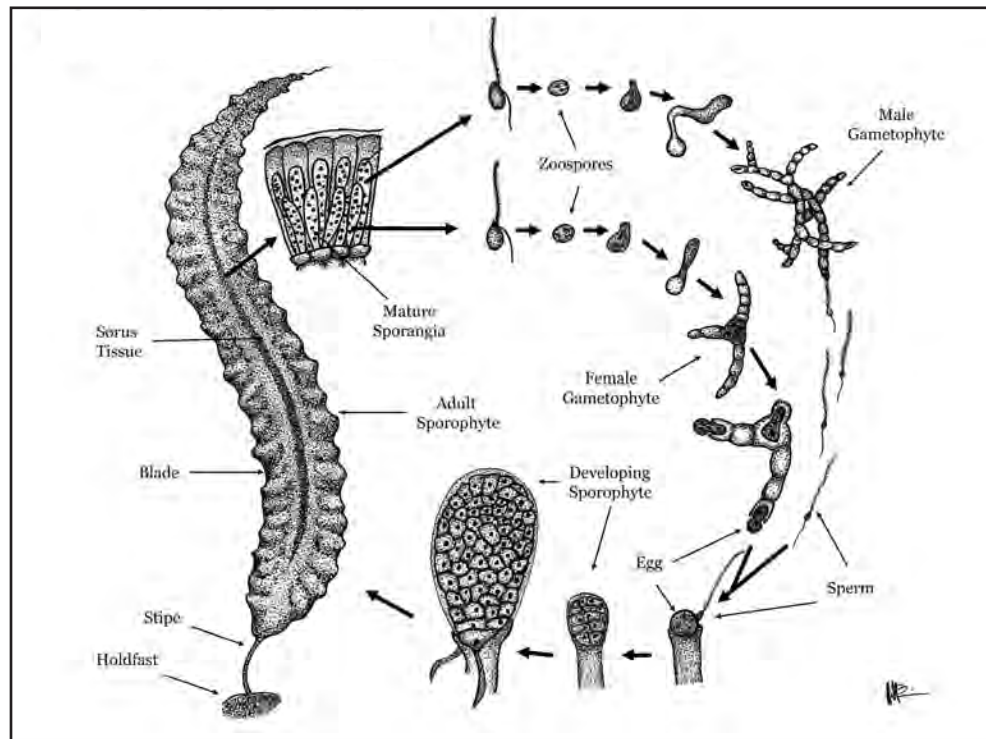

Life Cycle

Figure 3.1 illustrates the life cycle of *Saccharina latissima* (i.e., sugar kelp), which is frequently grown by kelp farmers. It shows a heteromorphic (different forms) alternation of generations between a macroscopic sporophyte plant and a microscopic gametophyte plant. Sugar kelp, along with *Laminaria digitata* (i.e., horsetail kelp), and *Alaria Esculenta* (i.e., winged kelp) are the primary species that have been cultured and grown by OA. These three algae are members of the order Laminariales, and all exhibit a similar life cycle that includes a heteromorphic alternation of generations.

Figure 3.2 Cross section of sorus tissue (440x) showing mature sporangia with spores

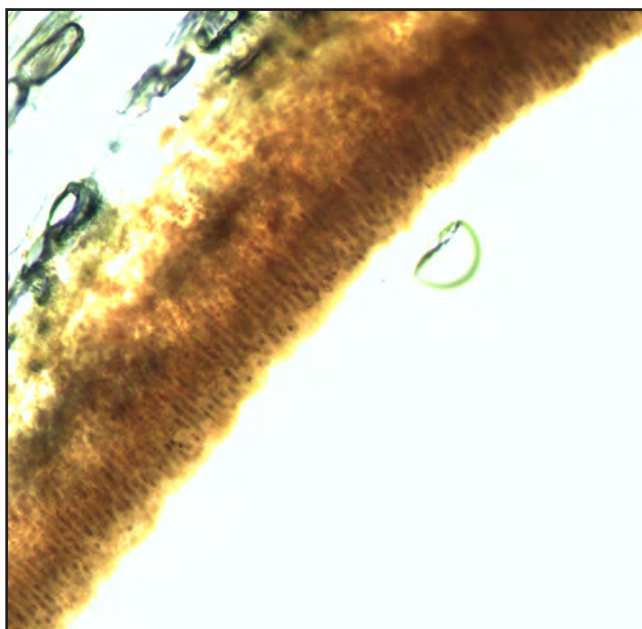

Process

Collection and Timing

The collection of healthy and mature sorus tissue is the first step when initiating cultures of kelp in the nursery. Sorus tissue (sori is plural) is the reproductive area on the kelp blade that contains the sporangia, or the cells that produce and house the spores. Figure 3.2 shows a magnified piece of sorus under the microscope, where the sporangia and spores are visible. Understanding the seasonal peaks of sorus formation and properly identifying mature sori are essential. With the goal of collecting sorus tissue for spore release in the nursery, OA identified and monitored potential harvest sites for *Saccharina latissima*. Sites with abundant mature *Saccharina latissima* sorus tissue had several characteristics in common. This kelp is often found in sheltered locations with rapidly moving currents just below mean low water.

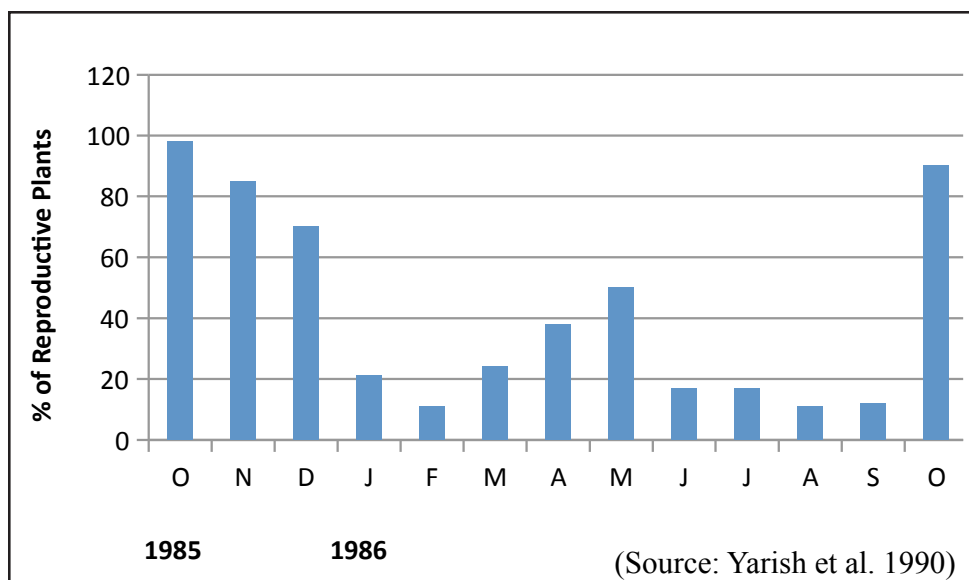

Figure 3.3 Percent of *Saccharina latissima* sporophytes with sorus tissue. Data derived from tagged populations in Long Island Sound. (Yarish et al, 1990)

Saccharina latissima, *Laminaria digitata*, and *Alaria esculenta* will often be attached to some form of substrate, such as cobble, and found in areas with a rocky bottom.

Timing of Mature Sorus

Saccharina latissima, *Laminaria digitata*, and *Alaria esculenta* follow similar patterns of growth throughout the year. The winter months and first half of the year are usually characterized by blade growth, then this growth slows during the summer months and is followed by sorus formation in the fall. Although sorus formation has its main peak in the fall months of October and November, there is a second peak in the spring months of April and May (Figure 3.3).

Identifying Sorus Tissue for Collection

In *Saccharina latissima*, mature sorus tissue is typically found near the center of the kelp blade, and can be identified as being darker and slightly raised compared to the surrounding blade tissue (Figure 3.4). Individual kelp plants, as well as sorus tissue, can vary in appearance and structure. Typically, the sorus can be found running down the entire length of the blade as a solid strip. It can also appear on only a portion of the blade or as broken-up patches.

Sorus showing signs that it has already released spores is a good indicator of maturity. In Figure 3.5, the top arrow points to the area within the sorus strip that has released spores and is lighter in coloration than the rest of the sorus. The bottom arrow is pointing to the dark-colored mature sorus that has not yet released spores. This section of sorus, below the released area, is a great candidate for zoospore release in the nursery.

Kelp blades with heavy amounts of mucilage

Figure 3.4
Mature sorus tissue of
Saccharina latissima



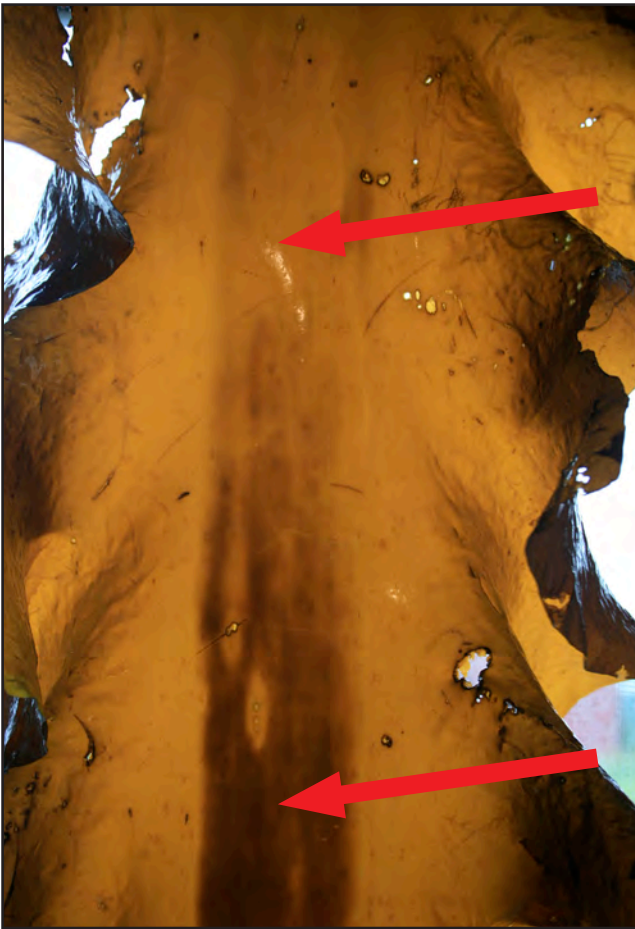

Figure 3.5 The top arrow is pointing to an area of sorus that has released its spores. The bottom arrow is pointing to an area of mature sorus that has not yet released spores.

Field Collection of Sori

Before collecting sori from the ocean, it is important to refer to the state's harvesting and licensing guidelines. In Maine, the Department of Marine Resource website provides the information on obtaining a seaweed harvesting license and can be found at: <http://www.maine.gov/dmr/license/fees.htm>. A report must be submitted regularly including total amounts harvested, species and uses. Collection must be done manually, not mechanically. It is always important to collect only the amount of kelp that is needed for spore release and to minimize any impact to the habitat.

Obtaining a tide chart and understanding the currents and topography of the collection area is important. The tide and depth of the collection area will determine what type of gear will be needed. Snorkel or dive gear, a cooler, and ice packs are a few essentials. Once the sorus is collected, it is recommended to keep it cooled to about 50°F/10°C and should be transported immediately to be prepared.

Sorus Preparation

There are two objectives to consider when preparing sorus tissue for the successful release of spores: 1) identifying and isolating healthy sorus tissue and 2) reducing the presence of contaminants (e.g., bacterial, viral, and biofouling). The purpose of this section is to provide an overview of OA-recommended preparation techniques for successfully achieving the objectives above.

As outlined on page 52 collecting kelp specimens should be done with careful consideration of the habitat, and proper identification of healthy and mature sorus



Figure 3.6 *Saccharina latissima* sorus tissue with bryozoans growing on the surface

(feeling slippery to the touch), a dark strip of sorus with a raised texture, and areas of sorus that had already released spores, usually provided successful releases in the nursery.

It is important to collect sorus tissue hosting the least amount of biofouling and blemishes. This is one step to reduce the amount of contamination entering the nursery. Sorus found with large amounts of biofouling, such as bryozoans (Figure 3.6) and other species of algae, should be avoided if possible.

tissue (Figure 3.7). To ensure reliable results, OA recommends processing the sorus within hours after collection to keep it healthy and viable. It is important to keep the sorus tissue at a cool temperature (approximately 50°F/10°C) and out of direct sunlight throughout the whole process. If large volumes of sori are being prepared, a cooler with ice packs will be needed to store the blades waiting to be processed. Once the tissue has been thoroughly cleaned and prepared, OA had the best results with and recommends allowing the tissue to dehydrate in a dark refrigerator (50°F/10°C) for approximately 14-24 hours.

Identifying Healthy Sorus Tissue

Sori is the reproductive area on the kelp blade that contains the sporangia, or the cells that produce and house the spores. In sugar kelp, mature sorus tissue is typically found near the center of the kelp blade, and can be identified as being darker and slightly raised compared to the surrounding blade tissue (Figure 3.7). Individual kelp plants as well as sorus tissue can vary in appearance and structure. Typically, the sorus can be found running down the entire length of the blade as a solid strip, appearing on only a portion of the blade, or even appearing as broken-up patches.

Reducing Contamination

The goal is to separate out the mature sorus tissue with minimal fouling organisms attached to its surface. Kelp oftentimes hosts a large amount of fouling organisms such as bryozoans (Figure 3.8), microorganisms and other species of algae.



Figure 3.7 Mature sorus tissue of *Saccharina latissima*

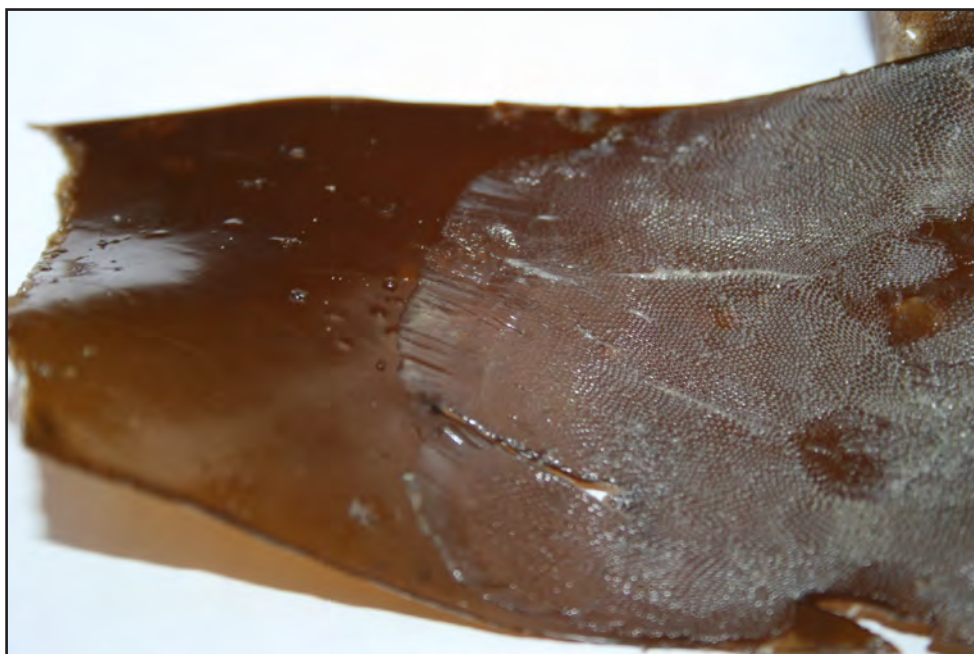

Figure 3.8 Bryozoans cover the surface of *Saccharina latissima*.

These sources of contamination can potentially outcompete the kelp and consume growing gametophytes, which would decrease the overall yield. To reduce contamination in the nursery, OA recommends preparing the sorus tissue outside or away from the nursery or production area. The use of exam gloves is also recommended throughout the entire process.

There are several steps that are intended to disinfect the sorus tissue (e.g., iodine baths and scraping the tissue with a razor blade). These processes should be done with care. Repeating these disinfection techniques more than recommended may affect both the health and productivity of the sorus tissue. OA recommends avoiding or discarding pieces that are heavily fouled, blemished, or discolored. For example, the right half of the sorus pictured in Figure 3.8 would not be used for spore release because the entire surface is covered with bryozoans. Depending on how much kelp is collected and how abundant the sorus is, it may be unavoidable to use sori with biofouling. In that case, scraping the surface with a razor to remove the attached organisms is very important.

Preparing the Settling Tubes

After the sorus has been prepped, it is essential to prepare the settling tubes in anticipation of spore release. The 14–24 hour window when the prepared sorus is refrigerated is enough time to allow for the filtered seawater inside the settling tubes to cool to 50°F/10°C. In the OA lab, settling tubes were chilled by either placing them directly in a refrigerator or by circulating chilled deionized water around them in the production aquaria (Figure 3.9). This was known as the “water bath” method. The tubes should be covered with aluminum foil and or a plexiglass lid during the chilling stage to keep the seawater free of contaminants (Figure 3.10). It is not necessary to add the culture nutrients at this time. Nutrients can be added to the settling tubes once the spores are evaluated and counted, to reduce wasting nutrients if a successful release does not occur.

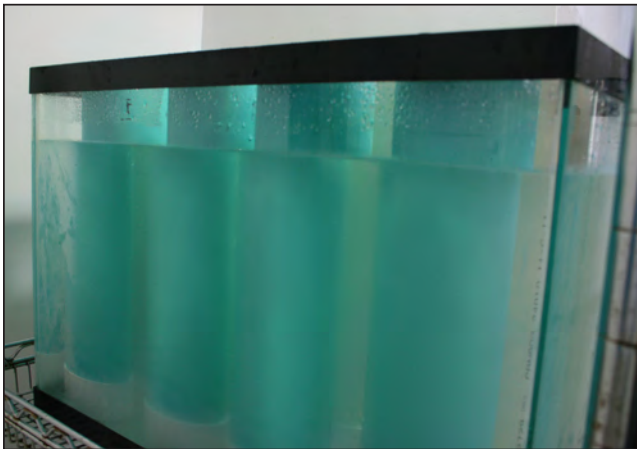

Figure 3.9 Water bath method to cool seawater in settling tubes.

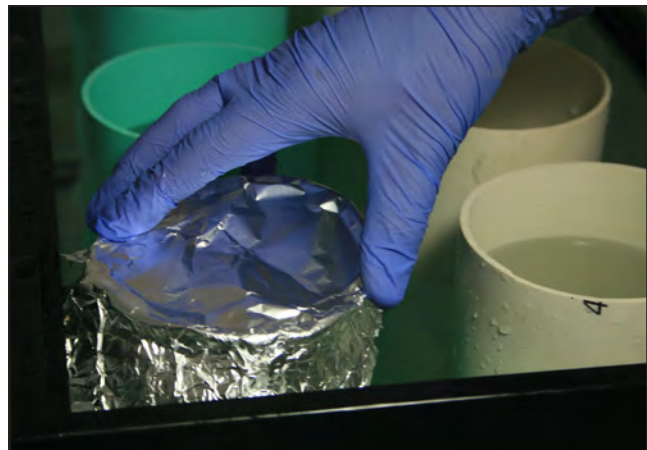

Figure 3.10 Covering the settling tubes with aluminum foil during the chilling period.

Procedure

Materials

- Freshly collected mature sorus tissue
- Cooler
- Ice packs
- Several containers and trays
- Cutting board
- Clean razors or scalpels
- Chilled filtered seawater (50°F/10°C)
- Squirt bottle
- Refrigerator
- Deionized water
- Production aquaria with chiller
- 3% iodine solution
- Tongs/tweezers
- Paper towels
- Exam gloves
- Clorox bleach
- 70% isopropyl alcohol
- Aluminum foil
- Settling tubes

Step 1. Collect Healthy Kelp and Transport for Preparation

Collect kelp blades with healthy and mature sorus tissue following the collection procedures outlined on page 52. Transport the kelp blades in coolers at a temperature near 50°F/10°C.

Step 2. Identify and Isolate Sorus Tissue

Using a clean razor or knife, cut out healthy sorus tissue, removing and discarding all the non-reproductive tissue, as well as all blemishes and biofouling. A large cutting board provides a great surface for cutting sorus tissue. Set the tissue aside. OA recommends cutting several kelp blades before moving to the next step. Promptness is crucial, so using an “assembly line style” will accelerate the process if large volumes of sori are being prepared. It is also easier to keep the sorus pieces large at this stage. If needed, the pieces can be cut to a smaller size before putting them into the beakers for release.

Step 3. Remove Excessive Biofouling

ONLY if the sorus has an excessive amount of attached organisms, gently scrape its surface with a razor blade. Extensive scraping of the tissue may damage the sorus, resulting in limited (if any) spore release. If the sorus is free from attached organisms, skip this step.

Step 4. Clean and Remove Mucilage

The sorus tissue will be damp and slimy to the touch. This slime, or mucilage, is thought to act as a protective barrier for the kelp. OA recommends removing this layer and any debris on the surface by firmly wiping the front and back 3-4 times

with a dry paper towel. Discard paper towels after each piece of sorus is cleaned to avoid cross contamination.

Step 5. Disinfect Tissue

Fill a beaker with 3% iodine solution. Using tweezers to pick up the sorus tissue, gently dip each piece into the iodine solution and hold for about 30 seconds. The iodine will kill bacteria and most contaminants on the sorus tissue. Using an iodine dip is less damaging to the sorus than other disinfectants (e.g., isopropyl alcohol, bleach).

Step 6. Rinse

Remove sorus from the iodine bath and using a squirt bottle, rinse it with chilled filtered seawater. Continue rinsing until the water drips clear and the iodine is completely removed.

Step 7. Dry

Using a clean paper towel, gently rub the front and back until each piece of sorus is dry. To avoid cross contamination, discard paper towels after each piece is dried.

Step 8. Prepare for Overnight Storage

Place pieces of sorus on dry paper towels and cover with additional sheets of paper towels. Multiple layers of prepped sorus can be stacked on top of one another, but in order to allow for proper drying, it is important not to let sorus pieces touch.

Step 9. Refrigerate

Set prepped sorus in dark refrigerator that is set at 50°F/10°C for 14–24 hours. A digital thermometer inside the refrigerator can be used to monitor that the correct temperature is maintained.

Step 10. Prepare Settling Tubes

The 14–24 hour window, when the prepared sorus is refrigerated, is enough time to allow for the filtered seawater inside the settling tubes to cool to 50°F/10°C. Fill with 2300 mL of filtered seawater. In the OA nursery, settling tubes were chilled by either: 1) placing them directly in a refrigerator or 2) circulating chilled deionized water around them in a production aquarium (Figure 3.9).

Settling tubes should be covered with aluminum foil and or plexiglass lid during the chilling stage to keep the seawater free of contaminants. It is not necessary to add the culture nutrients at this time. Nutrients will be added to the settling tubes once the spores are evaluated and counted. This will reduce the waste of the culture nutrients if a successful release does not occur.

Step 11. Clean Equipment

The cleaning method that OA used in the nursery began with soaking the equipment in a bleach solution overnight. Dilute bleach to the concentration recommended on the manufacturer's label. After soaking, rinse thoroughly until there is no bleach smell left on the equipment and it no longer has a slippery feel. Then wash with gentle dish soap and thoroughly rinse again. Glassware, cutting tools, plexiglass aquarium lids, etc., can be sprayed with 70% isopropyl alcohol and wiped dry with a

paper towel. When completely dry, aluminum foil or parafilm can be used as a cover to prevent contamination from reattaching to the surfaces. Counter spaces can be wiped down with isopropyl alcohol to reduce contamination.

Materials
 Freshly Collected Mature Sorus Tissue
 Cooler
 Ice Packs
 Several Containers & Trays
 Cutting Board
 Clean Razors or Scalpels
 Chilled Filtered Seawater (50°F/10°C)
 Squir Bottle
 Refrigerator
 Deionized Water
 Production Aquaria with Chiller
 3% Iodine
 Tongs/Tweezers
 Paper Towels
 Exam Gloves
 Clorox® Regular-Bleach
 70% Isopropyl Alcohol
 Aluminum Foil
 Settling Tubes

- 1 Collect Healthy Kelp**
 Collect mature sorus tissue with minimally attached algae and organisms (biofouling). Transport to the nursery.
- 2 Identify & Isolate Sorus Tissue**
 Cut out healthy sorus tissue and discard tissue that has biofouling or blemishes.
- 3 Remove Excess Biofouling**
 ONLY if the sorus has excessive biofouling, gently scrape the surface with a razor blade.
- 4 Clean & Remove Mucilage**
 Firmly wipe the front and back 3-4 times with a paper towel. Discard paper towels after each use.
- 5 Disinfect Tissue**
 Dip the sorus in 3% iodine solution for 30 seconds.
- 6 Rinse**
 Rinse the sorus with chilled filtered seawater until iodine is removed and water drips clear.
- 7 Dry**
 Dry the sorus by gently rubbing front and back with a paper towel. Discard paper towels after each use.
- 8 Prepare for Overnight Storage**
 Place pieces of sorus on dry paper towels and cover with additional sheets of paper towel.
- 9 Refrigerate**
 Set prepped sorus in dark refrigerator that is set at 50°F/10°C for 14 – 24 hours.
- 10 Prepare Settling Tubes**
 Chill 2300 mL chilled filtered seawater in each settling tube. Place the tank lid on top of the settling tubes to prevent contamination.

Figure 3.11 Sorus Preparation
 (See full sized step-by-step guide at the end of this chapter.)

Release of Zoospores

The purpose of this section is to provide guidance on creating the ideal conditions in the nursery for the spontaneous release of spores that will lead to the setup of a successful culture. By rehydrating the dehydrated sorus tissue prepared 14–24 hours earlier, spores are released from the sporangia into the water column. At this stage of the life cycle, the spores are propelled through the water with flagella, or whip-like appendages. The spores travel freely through the water and will settle upon a suitable substrate. In the ocean, this is oftentimes a habitat that consists of rocks and cobble. In the nursery, the nylon twine on the PVC spools provides a suitable substrate that promotes successful settling.

Page 54 outlines the procedure for preparing sorus tissue for release. Rehydrating the sorus tissue that was previously set in paper towels and refrigerated for 14–24 hours will trigger the release of spores (Figure 3.11 provides a summary of the steps). Successful release, however, is dependent on replicating the environmental conditions or cues that would occur naturally in the ocean. It is important to note that while sorus tissue can be collected throughout the year, each species of kelp releases spores at different times (see Figure 3.3, page 53).

While many environmental factors are beyond the scope of nursery control,

two considerations that aid spore release and culture are reduced contamination and chilled, filtered, or sterilized seawater (approximately 50°F/10°C) that is nutrient rich.

Culture Nutrients

Culture nutrients (i.e., culture media) are essential for “feeding” the kelp cultures and were added to every container, which held growing kelp cultures from zoo-spore release up until sporophyte transfer to the ocean site. There are many different culture nutrient variations on the market. The four components that were added to all OA release beakers, settling tubes, and production aquaria were:

- 1) Chilled, filtered, and sterilized seawater
- 2) Provasoli’s Enriched Seawater (PES) culture nutrients
- 3) Vitamins
- 4) Germanium dioxide (GeO_2) to prevent contamination from diatoms

See Appendix B for culture nutrients composition and preparation that OA found most effective.

Table 3.1 below outlines the proportions of each component used in the OA lab.

Table 3.1 Summary of nutrient concentrations used in the Ocean Approved Laboratory.		
Release Beaker	Set Tubes	Aquaria
1000 mL Seawater	2300 mL Seawater	20 gallons (76,000 mL) Seawater
9 mL PES	21 mL PES	700 mL PES
0.9 mL Vitamins	2 mL Vitamins	70 mL Vitamins
0.8 mL GeO_2	2 mL GeO_2	60 mL GeO_2
PES: Provasoli’s Enriched Seawater; GeO_2 : Germanium dioxide		

Settling tubes and spools should be ready at the time of release for inoculation with spores. See page 56 for preparing the settling tubes. Inoculation follows directly after the released spores are counted and the stocking density is calculated.

Procedure

Materials

- Prepped sori refrigerated for 14–24 hours
- Submersible thermometer
- 1000mL (1 L) beakers
- Chilled and filtered seawater, 50°F/10°C
- Culture nutrients: PES, Vitamins, GeO_2
- Graduated cylinder
- Pipettes
- Spatula
- Paper towels
- Exam gloves
- Clorox bleach
- 70% isopropyl alcohol

Health & Safety

When working with potentially hazardous materials, follow OSHA or corporate health and safety procedures. Current material safety data sheets (MSDS) for all chemicals are available at www.msds.com and should be maintained in the nursery. Gloves should always be worn while handling chemicals and any part of the production aquarium and its systems. Gloves prevent contamination from hands entering the aquarium and prevent hands from coming into contact with the culture media or chemicals that were added to the seawater.

Step 1. Begin Setup

Remove spools from the freezer to allow for defrosting. It is important to have the settling tubes filled with chilled, filtered seawater (50°F/10°C). Culture nutrients can be added to the settling tubes once spores are evaluated and counted.

Step 2. Prepare the Release Beaker(s)

In the OA lab, 1000mL (1 L) beakers were used during spore release. Fill beaker(s) with 1000mL (1 L) chilled (50°F/10°C), filtered seawater, 9 mL PES, 0.9 mL vitamins, 0.8 mL GeO₂.

Step 3. Monitor Water Temperature

Use a digital thermometer to monitor water temperature in the beaker(s). The starting water temperature should be approximately 50°F/10°C, or the same temperature as the sorus tissue.

Step 4. Add Sori to Beaker(s)

Retrieve the prepared sorus tissue from the refrigerator. Remove pieces of sorus tissue from the paper towels. If there is a brownish residue left underneath, this is evidence of prior spore release (Figure 3.12). This is a good sign and was usually followed by a productive release in the OA nursery. Add prepped sori to the beakers. The pieces should be completely submerged. Cut the sorus tissue into smaller pieces if necessary to fit into the beaker. If a large quantity of sorus is being prepared, multiple beakers can be used to prevent overcrowding. About 10–15 pieces of sorus per beaker were frequently used in the OA nursery. Record release data on the Release of Zoospores Worksheet (found in Appendix F), including: species, when and where collected, starting temperature, and time.

Step 5. Monitor Beaker(s)

Occasionally stir sori gently in the beakers (every couple of minutes) with a sterile spatula. A cloudy plume emerging from the sori signifies the start of a spore release. A very large release may turn the beaker water a murky brown color. This may happen instantly upon being submerged in the beakers, or it could take

Figure 3.12 Evidence of spore release on paper towels



up to an hour or more as the water temperature in the beakers warms. Some releases in the OA nursery occurred at beaker temperatures close to 60°F/16°C (See Table 3.2). It is important to monitor the beaker temperature because temperatures rising over 60°F/16°C can damage the newly released spores. It is recommended to write down the time, temperature, and release activity notes on the worksheet every few minutes to keep track of the progression.

Table 3.2 Summary of Release Beaker Spore Densities (spores/mL) Observed in Ocean Approved's Nursery

Release Date	Approx. Time Until Initial Signs of Release (minutes)	Water Temperature at First Sign of Release (°F)	Observed Spore Concentration (spores/mL)	Volume of Release Water Inoculated in Settling Tubes (mL) ^a
<i>Laminaria digitata</i> (Horsetail kelp)				
6/05/12	58	57	450,000	38
11/13/12	4	53	200,000	86
11/14/12	15	56	100,000	173
<i>Saccharina latissima</i> (Sugar kelp)				
9/20/12	25	56	115,000	150
9/26/12	56	59	60,000	287
9/27/12	5	51	115,000	150
9/28/12	1	54	55,000	314
10/01/12	1	51	200,000	86
10/01/12	1	51	500,000	35
11/13/12	4	53	960,000	18
11/21/12	3	51	250,000	69

^aVolume was calculated using the equation explained in Section 4.

Spores do not always release simultaneously or uniformly in the beakers. Figure 3.13 illustrates this. For example, the two beakers in Figure 3.13 were prepared using the same methods and sorus was added at exactly the same time. The beaker on the right had a successful release and the beaker on the left did not. It is hard to explain why this happens, which is why OA recommends collecting ample sorus tissue for release. There is never a guarantee that healthy spores, which are suitable for culture, will be released. More than one release may be required to inoculate the total

Figure 3.13 Comparison of release beakers



number of spools intended for production. See Figure 3.14 for a summary of this process.

Step 6. Count and Assess Viability of Spores

Once the beaker water starts to become cloudy, it is time to assess the viability and numbers of released zoospores. See page 64 for counting zoospores and calculating the stocking density.

Materials
 Prepped Sori Refrigerated for 14-24 hours
 Submersible Thermometer
 1000 mL (1 L) Beakers
 Chilled & Filtered Seawater (50°F/10°C)
 Culture Nutrients: PES, Vitamins, GeO₂
 Graduated Cylinder
 Pipettes
 Spatula
 Paper Towels
 Exam Gloves
 Clorox® Regular-Bleach
 70% Isopropyl Alcohol



1 Begin Setup
 Remove spools from freezer and make sure settling tubes are prepared with chilled filtered seawater.



2 Prepare the Release Beaker(s)
 Fill 1000 mL (1L) beakers with: 1000 mL (1 L) chilled filtered seawater, 9 mL PES, 0.9 mL vitamins, 0.8 mL GeO₂.

3 Monitor Water Temperature
 Use a digital thermometer to monitor water temperature. Starting water temperature should be approximately 50°F/10°C, or the temperature sori was stored in.



4 Add Sori to Beaker(s)
 Add sori pieces to the beakers. Cut sori into smaller pieces (if needed) to submerge everything.

5 Monitor Beaker(s)
 Occasionally stir beakers. Monitor for initial signs of the spore release. Record data on worksheet.



6 Count & Assess Viability of Spores
 As sori begin to release spores the beaker water will become cloudy. Start counting the zoospores and calculating the stocking density.



Figure 3.14
Release of Zoospores
 (See full sized step-by-step guide at the end of this chapter.)

Counting of Zoospores and Calculating Stocking Density

This section, based on the work performed in the OA nursery and current available information, provides best practices used by OA for the counting of spores during a release as well as calculating the stocking density for inoculating settling tubes in a small-scale kelp aquaculture nursery.

Spores can be counted using commercially available automatic or manual cell-counting chambers. While automated cell-counting systems are precise, these systems may not be practical for small-scale operations. Manual counting chambers are less expensive, and, with experience, have proven to be accurate and successful for counting spores. Although there are numerous types of manual counting chambers available, not all cell-counting chambers are applicable for counting kelp spores. For instance, both Sedgewick-Rafter (S-R) and hemocytometer¹ cell-counting chambers have historically been used for counting cells. While S-R counting chambers are designed for counting larger and less dense cell populations (e.g., algal and phytoplankton cells)², smaller and more dense concentrations of cells (e.g., spores), are more accurately counted using a hemocytometer-type cell-counting chamber.

Hemocytometer counting chambers were originally designed for counting blood cells, and are widely available commercially. These counting chambers are made of glass or plastic and have an etched grid pattern at the base of the counting chamber(s) to assist in the counting of cell populations. While the etched grid pattern can vary

¹Hemocytometer is also spelled haemocytometer.

²Due to the scale of the counting chambers, however, the S-R chambers are not practical for counting smaller cells such as the algal spores or when cell density is in the range of 100,000 or greater.

by type of hemocytometer, the most commonly used (and globally recognized for reliability) grid pattern is known as the “Improved Neubauer Ruling”. This grid is comprised of nine large squares (1 mm²) that are further divided into smaller squares (Figure 3.15).

OA recommends using a hemocytometer counting chamber that has an Improved Neubauer grid pattern. These glass or plastic hemocytometers consist of two counting chambers with the Improved Neubauer Ruling grid lines (Figure 3.16). Each chamber is filled using a micropipette, and when filled, the volume contained under each large square is 1/10,000 mL (or 0.0001 mL).

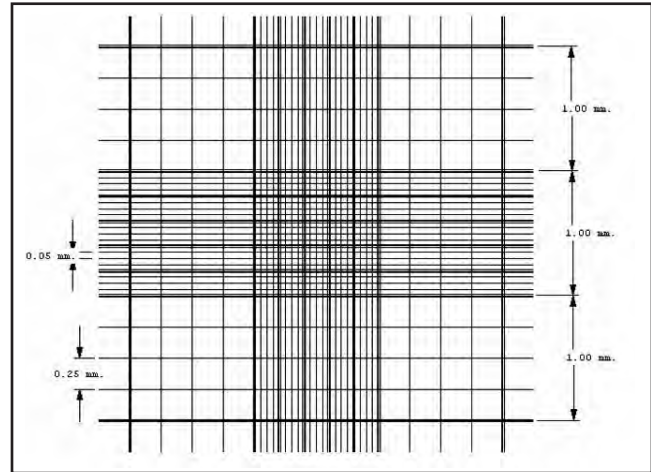
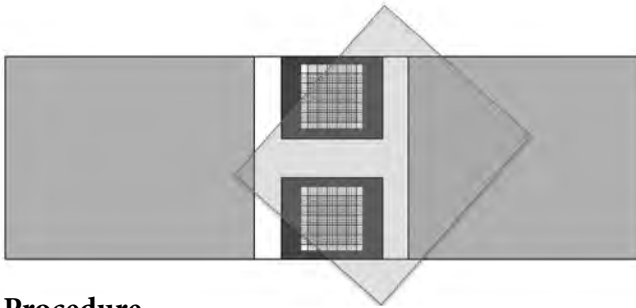

Figure 3.15 Example of the Improved Neubauer Ruling grid

Figure 3.16 Hemocytometer cell-counting chamber

Procedure

Materials

- Hemocytometer cell-counting chamber
- Lens paper
- Micropipettes
- Microscope (40x/100x magnification)
- Calculator
- Pen and paper
- Paper towels
- Exam gloves
- Clorox bleach
- 70% isopropyl alcohol
- Counting Zoospores and Calculating Stocking Density Worksheet

Step 1. Prepare Work Station

Set up the microscope and have all equipment ready for use. It is recommended that the empty hemocytometer be placed under the microscope to focus on the counting chamber grid. Spore cells were most frequently counted using the 40x or 100x power of the microscope.

Step 2. Prepare the Hemocytometer

Gently clean the hemocytometer and glass cover slip with lens paper and 70% isopropyl alcohol. Allow to air dry or wipe dry with lens paper prior to adding water from the release beaker.

Step 3. Add Release Water into Hemocytometer

As soon as beaker release water starts to become cloudy, it is time to begin

counting spores. An abundant release of spores from mature sori in the release beakers will turn the seawater a cloudy brown. The photos in Figures 3.17 and 3.18 show the appearance of the seawater solution with an abundant number of spores released. Using the micropipette, add the appropriate volume of water from the release beaker into the hemocytometer filling chamber (follow the manufacturer's recommendations specific to the counting chamber being used).

Figure 3.17 Beaker with a high concentration of spores released

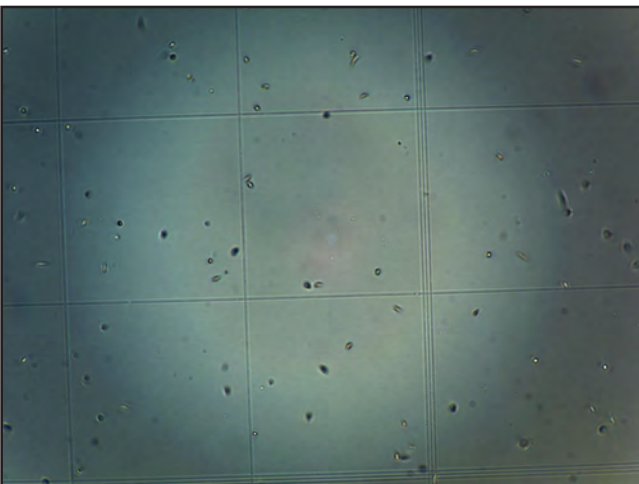

Figure 3.18 View from above, a beaker containing a high concentration of spores released

Step 4. Preliminary Evaluation

Examine spores within the grid to assess the general health and number of spores. Healthy spores, suitable for culture, will generally be moving in a straight direction. Spores that are moving in a fast circular motion or not moving at all may not be suitable for culture. Those spores should not be included in the cell count. Figure 3.19 shows spores observed under 100x magnification on a hemocytometer slide. The spores may be “fixed” with Lugol’s fixative or a similar reagent prior to counting or counted live. Fixing kills the cells, stopping movement, and allows for a more accurate determination of the number of spores. However, the rapid movement of the live spores has been found to be a good indication of their viability and health. Although counting live may make precise spore counts more difficult to achieve, OA has used live counts to determine stocking density with very good results.

Figure 3.19 Spores observed on a hemocytometer counting chamber using 100x magnification of the microscope



Step 5. Counting Spores

As mentioned previously, OA used a reusable glass hemocytometer with an Improved Neubauer grid to count the spores per mL observed during the release.³ This was accomplished by applying the following two counting techniques:

³It should be noted that each respective cell counting chamber has procedures for the filling and counting of cells and those should be followed. A number of different procedures are acceptable for counting and calculating spore density. Which procedure to use may depend on the density and activity of the spores. For accuracy, observing between 40-70 spores in the chamber is recommended.

Method 1: Count the number of spores in the four corner squares, divide the sum of the four corners by four, and multiply by 10,000.

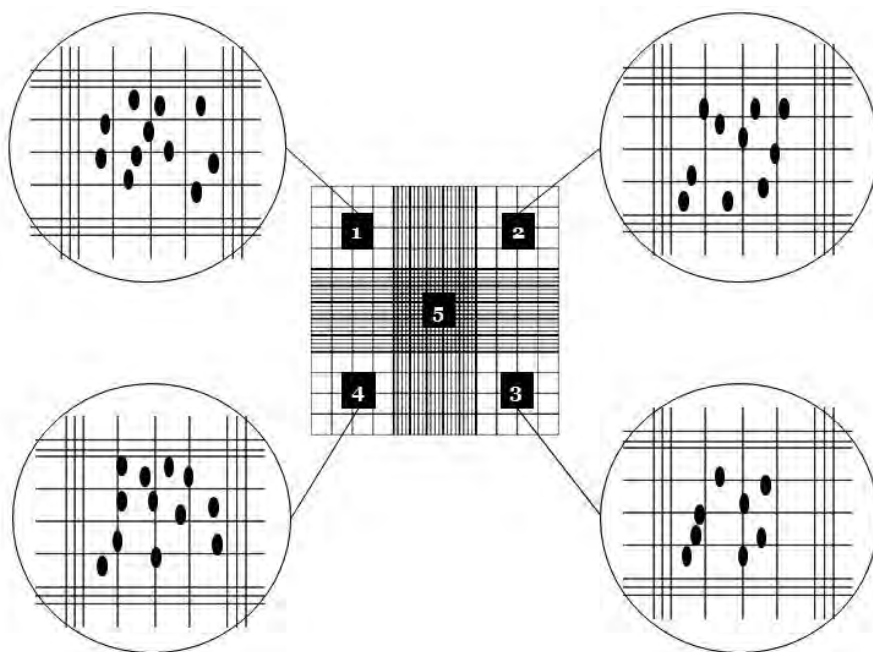

Example 1. Count the number of spores in the four corner squares, divide by four and multiply by 10,000.

Square 1 = 11 spores

Square 2 = 10 spores

Square 3 = 8 spores

Square 4 = 12 spores

Total Counted = 41 spores

Spores per mL = $[(41/4) \times 10,000]$

Spores per mL = 102,500

Method 2. If spore density is high, then only the large center square may be counted, and the total number of spores counted in the center square is multiplied by 10,000 to determine the total number of spores per mL.

By applying these two counting techniques, OA was able to calculate the stocking densities necessary for successful inoculations. Use the Counting Zoospores and Calculating Stocking Density Worksheet, found on page 69 and in Appendix G, as an aid when counting spores.

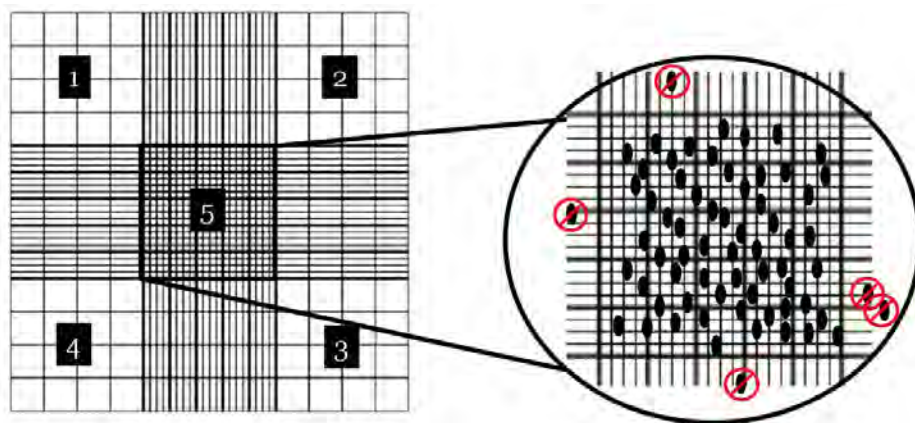

Example 2. Count the number of spores in the large center square and multiply by 10,000.

Square 5 = 62 spores

Total Counted = 62 spores

Spores per mL = $[62 \times 10,000]$

Spores per mL = 620,000

Step 6. Calculate Stocking Density

Depending on the species, the health of the sorus tissue, the time of year (different species release during different months), and the nursery environment, the concentration or density of spores that are released will vary. For example, OA observed spore densities in release beakers that ranged from 55,000 to 960,000 spores per mL (see Table 3.3).

Research has demonstrated that a stocking density in the range of 5,000 to 10,000 (average=7,500) spores per mL should be used to inoculate the settling tubes.

The formula that OA used to calculate the volume (mL) of water from the release beaker to inoculate the settling tubes is:

$$\text{Volume of Release Water (mL) to Inoculate Settling Tubes} = \frac{\text{Desired Stocking Density (Spores/mL in Settling Tubes)}}{\left(\frac{\text{Number of Spores/mL in Release Water}}{\text{Volume of Seawater (mL) in Settling Tubes}} \right)}$$

For example, the three known components are:

- 1) Recommended stocking density = 5,000 to 10,000 (average = 7,500) Spores/mL
- 2) Settling tubes = 2,300 mL seawater (Volume OA filled settling tubes)
- 3) Number of spores per mL in the release beaker = 102,500 spores (based on count from Example 1 above)

$$\text{Volume of Release Water (mL) to Inoculate Settling Tubes} = \frac{7,500 \text{ Spores/mL}}{\left(\frac{102,500 \text{ Spores/mL}}{2,300 \text{ ml Seawater}} \right)} = 168.3\text{mL}$$

Based on these calculations, **168 mL from the release beaker** would be added to each settling tube.

In a second example, the three components are:

- 1) Desired stocking density = 10,000 spores/mL
- 2) Settling tubes = 2,300 mL seawater
- 3) Number of spores per mL in the release beaker = 620,000 spores

$$\text{Volume of Release Water (mL) to Inoculate Settling Tubes} = \frac{10,000 \text{ Spores/mL}}{\left(\frac{620,000 \text{ Spores/mL}}{2,300 \text{ ml Seawater}} \right)} = 37.09\text{mL}$$

Table 3.3 Summary of Release Beaker Spore Densities (Spores per mL) Observed in Ocean Approved’s Nursery.

Release Date	Water Temperature at First Sign of Release (°F)	Observed Spore Concentration (spores/mL)	Volume of Release Water Inoculated in Settling Tubes (mL) ^a
<i>Laminaria digitata</i> (Horsetail kelp)			
6/05/12	57	450,000	38
11/13/12	53	200,000	86
11/14/12	56	100,000	173
<i>Saccharina latissima</i> (Sugar kelp)			
9/20/12	56	115,000	150
9/26/12	59	60,000	287
9/27/12	51	115,000	150
9/28/12	54	55,000	314
10/01/12	51	200,000	86
10/01/12	51	500,000	35
11/13/12	53	960,000	18
11/21/12	51	250,000	69

^aVolume was calculated using the equation explained below with the following parameters: 1)Desired stocking density of spores for settling tubes=7,500;2) volume of seawater in settling tubes=2,300 mL.

Counting Zoospores & Calculating Stocking Density Worksheet

Date: _____

Species: _____

Method 1.

1 Count = _____	[Microscopic Grid]	2 Count = _____
4 Count = _____	[Microscopic Grid]	3 Count = _____

$$\text{Zoospore Density (Spores/mL)} = \left(\frac{\text{Sq. 1} + \text{Sq. 2} + \text{Sq. 3} + \text{Sq. 4}}{4} \right) \times 10,000$$

$$\text{Zoospore Density (Spores/mL)} = \left(\frac{\text{_____}}{4} \right) \times 10,000$$

$$\text{Zoospore Density (Spores/mL)} = \underline{\hspace{2cm}}$$

Method 2.

5 Count =

$$\text{Zoospore Density (Spores/mL)} = \text{Square 5} \times 10,000$$

$$\text{Zoospore Density (Spores/mL)} = \underline{\hspace{2cm}}$$

Calculating Stocking Density

$$\text{Volume of Release Water (mL) to Inoculate Settling Tubes} = \frac{\text{Desired Stocking Density (Spores/mL) in Settling Tubes}}{\left(\frac{\text{Number of Spores/mL Release Water}}{\text{Volume of Seawater (mL) in Settling Tubes}} \right)}$$

$$\text{Volume of Release Water (mL) to Inoculate Settling Tubes} = \frac{\text{Spores/mL}}{\left(\frac{\text{Spores/mL}}{\text{mL/Seawater}} \right)}$$

$$\text{Volume of Release Water (mL) to Inoculate Settling Tubes} = \underline{\hspace{2cm}} \text{ mL}$$

Based on the calculations, 37 mL from the release beaker would be added to each settling tube. Use the Counting Zoospores and Calculating Stocking Density Worksheet, found in Appendix G, as an aid when calculating stocking densities. Figure 3.20 provides a summary of the steps.

Materials
 Hemocytometer Cell Counting Chamber
 Lens Paper
 Micropipettes
 Microscope (40x & 100x)
 Calculator
 Pen & Paper
 Paper Towels
 Exam Gloves
 Clorox® Regular-Bleach
 70% Isopropyl Alcohol



1 Prepare Workstation
 Set up the microscope and focus on the empty hemocytometer counting chamber slide.



2 Prepare the Hemocytometer
 Clean hemocytometer and cover slip with lens paper and 70% isopropyl alcohol.



3 Add Release Water into Hemocytometer
 Using the micropipette, add the appropriate volume of water from the release beaker into the hemocytometer filling chamber.*



4 Preliminary Evaluation
 Place the hemocytometer under the microscope under 40X or 100X and assess the overall health and number of spores.

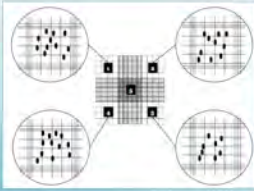

5 Counting Spores
Method 1: Count the number of cells in the four corner squares, divide the sum of the four corners by four, and multiply by 10,000.
Method 2: If spore density is high, then only the large center square is counted, and the total number of spores counted in the center square is multiplied by 10,000 to determine the total number of spores per mL.
 See text for additional information.

6 Calculating Stocking Density
 There are three components that you will need to calculate the stocking density:
 1) Desired stocking density (recommended=5,000 to 10,000 spores, or an average of 7,500 spores)
 2) Volume of seawater (mL) in the settling tubes
 3) Concentration of spores in the release beaker (spores per mL)
 Stocking densities are calculated using the equation below. See manual for additional information.

$$\frac{\text{Volume of Release Water (mL)}}{\text{Water (mL)}} = \left(\frac{\text{Desired Stocking Density (Spores/mL)}}{\text{Release Water (Spores/mL)}} \right) \times \text{Seawater in Settling Tubes (mL)}$$

*It should be noted that each respective cell counting chamber has procedures for the filling and counting of cells and those should be followed. See the manufacturer's guidelines for the recommended filling procedures.

Figure 3.20 Counting Zoospores and Calculating Stocking Density
 (See full sized step-by-step guide at the end of this chapter.)

Inoculating Spools in Settling Tubes

The first 24 hours after release is the most critical time for zoospore survival. The settling tubes contain the spools where the mobile spores will settle and attach to the nylon twine. By creating a very controlled environment within the settling tubes, the spores are encouraged to settle on the twine.

Settling tubes should already be filled with chilled, filtered seawater. Once the spores have been evaluated and the stocking density calculated (see page 64), culture nutrients are added to the number of settling tubes being inoculated. Table 3.4 below outlines the proportions of each component used in the OA nursery to promote kelp growth.

Table 3.4 Summary of Nutrient Concentrations Used in the Ocean Approved Nursery		
Release Beaker	Settling Tubes	Aquarium
1000 mL seawater	2300 mL seawater	20 gal (76,000 mL) seawater
9 mL PES	21 mL PES	700 mL PES
0.9 mL vitamins	2 mL vitamins	70 mL vitamins
0.8 mL GeO ₂	2 mL GeO ₂	60 mL GeO ₂

PES: Provasoli's Enriched Seawater; GeO₂: germanium dioxide;

Reducing Contamination

The OA nursery used and experimented with different techniques to reduce contamination while transferring spores from the release beakers to the settling tubes. If there is observable debris, the contents of the release beaker may be poured through a coarse filter or canning mesh to remove the potential contaminants. The filter should allow the spores to pass through easily. While this method may not prevent all contamination from entering into the settling tubes, it was usually effective.

Settling Tubes Control of Temperature, Light, and Aeration

For maximum recruitment, the temperature, light, and aeration must be regulated during the time the spools are inside the settling tubes. The temperature inside the tubes should be a constant 50°F/10°C and the seawater should remain chilled for the duration of the settling process of 24 hours. OA recommends employing a water bath technique using fresh water (Figure 3.21). By placing the settling tubes in an aquarium with constantly-circulating, chilled, deionized water, the water in the settling tubes will also remain chilled. It is important to note that caution should be exercised not to cross-contaminate the settling tubes with the circulating water. Aluminum foil and a Plexiglass lid are used to cover the top of the settling tubes to eliminate light and contamination from penetrating into the settling tubes. Aeration can be administered through a pipette bubbling gently in the settling tube. After several trials of using the aeration, OA did not find that it provided better spore attachment, so it has discontinued its use at this stage.



Figure 3.21 Water bath method used to chill seawater inside settling tubes

Preparing Production Aquaria

The production aquaria must be prepared to accept spools prior to transferring them from the settling tubes. OA recommends setting up production aquaria 24 hours in advance, or while the spools are in the settling tubes, to allow the seawater to chill. Fill the 20-gallon aquaria with filtered seawater about an inch from the top of tank. Turn on chiller and set it for 50°F/10°C. Cover with Plexiglass lid. Set up fine mesh screens in front of the light banks. In the absence of spools there is no need to turn on the lights. It is recommended to check that all light bulbs are working. Timers can be set for a 12-hour on/12-hour off light cycle.

Procedure

Health & Safety

When working with potentially hazardous materials, follow OSHA or corporate health and safety procedures. Current material safety data sheets for all chemicals are available at www.msds.com and should be maintained in the nursery. Gloves should always be worn while handling chemicals and any part of the production

aquarium and its systems. Gloves prevent contamination from hands entering the aquarium and prevent hands from coming into contact with the culture media or chemicals that are added to the seawater.

Materials

- 1000 mL (1L) beakers
- Chilled and filtered seawater (50°F/10°C)
- Culture nutrients: PES, vitamins, GeO_2
- Graduated cylinders
- Pipettes
- Spatula
- Cheese cloth or canning mesh
- Tweezers
- Prepared spools (nylon wound)
- Production aquaria equipment and supplies
- Paper towels
- Exam gloves
- Clorox bleach
- 70% isopropyl alcohol

Step 1. Add Nutrients to the Settling Tubes

Settling tubes should previously have been filled with chilled filtered seawater to 50°F/10°C. Add the culture nutrients to the number of settling tubes being inoculated with spores: 21 mL PES, 2 mL vitamins, 2 mL GeO_2 . Amounts are based on 2300mL of filtered seawater in the settling tubes.

Step 2. Place Spools in Settling Tubes

Place each spool into the center of a settling tube, making sure that it is not touching the sides of the tube.

Step 3. Remove Sori from Beakers

Discard sorus tissue from the release beakers that have successfully released. Sorus tissue that did not release the first time can be dehydrated more and saved for a second release attempt: dry the sorus, repackage the tissue in paper towels, and place back in the refrigerator. It is recommended to wait another 12-24 hours before attempting a second release. After the second attempt, OA recommends discarding it and collecting new sorus.

Step 4. Gently Stir and Decant

Swirl beaker or gently stir release water with a sterile spatula to ensure spores are suspended in the water column. Decant the number of mL (previously calculated in Section 4) needed to stock one settling tube into a clean measuring container.

Step 5. Add Spores to Settling Tubes

Pour the water containing spores into the settling tubes around the outside of the spool to allow for maximum attachment to the twine.

Step 6. Adjust Water Level in Settling Tubes

Ideally, the water level will be just above the top of the twine on the spool (i.e., the twine will be completely submerged). Either remove or add chilled seawater so the level is above the twine.

Step 7. Cover Settling Tubes

Cover each settling tube with aluminum foil to prevent light from penetrating inside. Place plexiglass aquarium lid on top of covered settling tubes to hold them securely.

Step 8. Ensure System is Working Properly

Check that chiller is set to 50°F/10°C and that water is circulating properly around the settling tubes. The spools will remain in settling tubes for 24 hours to allow for maximum zoospore attachment to the twine.

Step 9. Set up Production Aquaria

OA recommends setting up aquaria 24 hours in advance to allow the seawater to chill. Fill the 20-gallon aquaria with filtered seawater about an inch from the top of the aquaria. Turn on chiller and set it for 50°F/10°C. Cover with plexiglass lid. Set up fine mesh screens in front of the light banks. In the absence of spools there is no need to turn on the lights. It is recommended to check that all light bank bulbs are working. Figure 3.22 provides a summary of the steps.

Figure 3.22 Inoculating Spools in Settling Tubes
(See full sized step-by-step guide at the end of this chapter.)

Materials
 1000 mL (1 L) Beakers
 Chilled & Filtered Seawater (50°F/10°C)
 Culture Nutrients: PES, Vitamins, GeO₂
 Graduated Cylinders
 Pipettes
 Spatula
 Cheese Cloth or Canning Mesh
 Tweezers
 Prepared Spools (nylon wound, thawed)
 Aluminum Foil
 Production Aquaria Equipment & Supplies
 Paper Towels
 Exam Gloves
 Clorox® Regular-Bleach
 70% Isopropyl Alcohol



1 Add Nutrients to Settling Tubes
 Add culture nutrients to the settling tubes being inoculated with spores: 21 mL PES, 2 mL vitamins, 2 mL GeO₂ (based on 2300 mL of filtered seawater in each settling tube).



2 Place Spools in Settling Tubes
 Place spool into the center of the settling tube making sure that it is not touching the sides of the tube.



3 Remove Sori from the Beakers
 Discard sorus tissue from the release beaker. Sorus tissue that did not release the first time can be dehydrated more and saved for a second release attempt.



4 Gently Stir & Decant
 Gently stir release water to ensure spores are suspended in the water column. Decant the number of mL (previously calculated in Section 4) needed to stock one set tube into a clean measuring container.



5 Add Spores to Settling Tubes
 Pour the water containing spores water into the settling tube around the outside of the spool.



6 Adjust Water Level in Settling Tubes
 Either remove or add chilled seawater so the level is just above twine.



7 Cover Settling Tubes
 Cover each settling tube with aluminum foil and place Plexiglass lid on top.



8 Ensure System is Working Properly
 Water chillers should be set to 50°F/10°C. Water should be circulating around the outside of the settling tubes. The spools will remain in settling tubes for 24 hours.



9 Set up Production Aquaria
 Fill a 20 gallon production aquaria with filtered seawater. Turn on the water chiller and set it for 50°F/10°C. Cover with the Plexiglass lid. Hang fine mesh screens in front of the light banks. Make sure all light banks (bulbs and timers) are working properly.

Step 10. Clean Equipment

The cleaning method that OA used in the nursery started with soaking the equipment in a bleach solution overnight. Dilute bleach to the concentration recommended on the manufacturer's label. After soaking, rinse thoroughly until there is no bleach smell left on the equipment and it no longer has a slippery feel. Then wash with gentle dish soap and thoroughly rinse again. Glassware, cutting tools, plexiglass aquarium lids, etc., can be sprayed with 70% isopropyl alcohol and wiped dry with a paper towel. When completely dry, aluminum or Parafilm can be used as a cover to prevent contamination from reattaching to the surfaces. Counter spaces can be wiped down with isopropyl alcohol to reduce contamination.

Transfer of Spools to Aquaria

After the initial 24 hours in the settling tubes, the spools are ready to be transferred to the aquaria.

The production aquaria must be prepared to accept spools prior to transferring spools from settling tubes. OA recommends setting up aquaria 24 hours in advance, while the spools are in the settling tubes, to allow the seawater to chill. Culture media should be added prior to transfer, with enough time to allow for complete mixing. The water quality conditions in the aquaria should be similar to that of the settling tube water the spools are being removed from (see Table 3.4, page 70 for further information).

Procedure

Health & Safety

When working with potentially hazardous materials, follow OSHA or corporate health and safety procedures. Current material safety data sheets for all chemicals are available at www.msds.com and should be maintained in the nursery. Gloves should always be worn while handling chemicals and any part of the production aquaria and its systems. Gloves prevent contamination from hands entering the aquaria and prevent hands from coming into contact with the culture media or chemicals that are added to the seawater.

Materials

- Culture nutrients: PES, vitamins, GeO_2
- Pipettes
- Chilled production aquaria (50°F/10°C)
- Production aquaria equipment and supplies
- Aluminum foil
- Paper towels
- Exam gloves
- Clorox bleach
- 70% isopropyl alcohol

Step 1. Add Nutrients to Production Aquaria

Add culture nutrients to the production aquaria: 700 mL PES, 70 mL vitamins, 60 mL GeO_2 (based on 20 gallons of filtered seawater in production aquaria). Allow culture nutrients and seawater to mix for at least 15 minutes in the aquaria before adding spools.

Step 2. Remove Spools from Settling Tubes

Remove plexiglass lid and aluminum foil covering settling tubes. Gently pick up the spool by the PVC top, trying not to touch the twine and being careful not to let the spool scrape the sides of the tube when removing. Hold spool at an angle for a few seconds to allow the water to run off.

Step 3. Place Spools into Production Aquaria

Gently place the spool into the prepped aquaria. See Figure 3.23 for spool placement in aquaria. Up to 10 spools can be placed into a 20-gallon production aquarium, but eight are ideal due to space and nutrient limitations. Cover with a clean plexiglass lid, adjusting the chiller inflow and outflow tubes if necessary.

OA recommends transferring the spools as gently and quickly as possible to prevent the spores from damage and contamination when exposed to the air. The spores are very fragile and it is important not to allow the spools to bump into anything outside or inside the tank (e.g., other spools, the tank walls, etc.).



Figure 3.23 Spool placement in 20-gallon aquarium

Step 4. Adjust Aquaria Environmental Conditions and Check System

Attach a new sterile pipette to air tubing, turn on the air pump, and adjust the air flow rate to aerate the aquaria accordingly. Flow rate should be high enough to distribute adequate air, but not so high that it pushes the spools around. Cover with a Plexiglass lid. Set up the fine mesh screens in front of the light banks, if not already done. Set the light timers for a 12 hours on/12 hours off photoperiod.

Step 5. Label Release Details

Label aquaria with release details: species, source of sorus, release date, number of spools, culture media amounts, water changes, pH readings, notes, etc.

Step 6. Clean Equipment and Store Settling Tubes

Discard the remaining water in the settling tubes. The cleaning method that OA used in the nursery started with soaking the equipment in a bleach solution overnight. Dilute bleach to the concentration recommended on the manufacturer's label. After soaking, rinse thoroughly until there is no bleach smell left on the equipment and it no longer has a slippery feel. Then wash with gentle dish soap and thoroughly rinse again. Glassware, cutting tools, plexiglass aquarium lids, etc., can be sprayed with 70% isopropyl alcohol and wiped dry with a paper towel. When completely dry, aluminum or parafilm can be used as a cover to prevent contamination from reattaching to the surfaces. Counter spaces can be wiped down with isopropyl alcohol to reduce contamination. Figure 3.24 (following page) provides a summary of the steps.

Materials

Culture Nutrients: PES, Vitamins, GeO₂
 Pipettes
 Chilled Production Aquaria (50°F/10°C)
 Production Aquaria Equipment & Supplies
 Aluminum Foil
 Paper Towels
 Exam Gloves
 Clorox® Regular-Bleach
 70% Isopropyl Alcohol

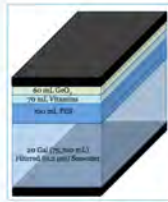

1 Add Nutrients to Production Aquaria

Add culture nutrients to the production aquaria: 700 mL PES, 70 mL vitamins, 60 mL GeO₂ (based on 20 gallons of filtered seawater in production aquaria). Allow culture nutrients and seawater to mix for at least 15 minutes in the production aquaria before adding spools.



2 Remove Spools from Settling Tubes

Gently pick up the spool by the PVC top and hold spool at an angle for a few seconds to allow the water to run off.



3 Place Spools into Production Aquaria

Quickly transfer spools into the prepped production aquaria. Position spools as seen in the picture to the left. Do not allow the spools to touch each other or the walls of the production aquaria.



4 Adjust Aquaria Environmental Conditions & Check System

Attach a new sterile pipette to air tubing, turn on the air, and adjust the air flow rate to aerate the production aquaria accordingly. Cover with Plexiglass lid. Set the light timers for a 12 hours on/12 hours off photoperiod. Check all components to ensure system is working properly.



5 Label Release Details

Label the production aquaria with the following release details: release date, species, source of sorus, number of spools in production aquaria, and the dates of water changes. Other important identifying information should also be added.



6 Clean Equipment & Store Settling Tubes

Discard remaining water in the settling tubes. Clean the settling tubes and allow them to air dry. Once dry, cover the opening with aluminum foil. This will help keep them clean until the next use.

Figure 3.24 Transfer Spools to Aquarium

(See full sized step-by-step guide at the end of this chapter.)

Sorus Preparation

Materials

Freshly Collected Mature Sorus Tissue
Cooler
Ice Packs
Several Containers & Trays
Cutting Board
Clean Razors or Scalpels
Chilled Filtered Seawater (50°F/10°C)
Squirt Bottle
Refrigerator
Deionized Water
Production Aquaria with Chiller
3% Iodine
Tongs/Tweezers
Paper Towels
Exam Gloves
Clorox® Regular-Bleach
70% Isopropyl Alcohol
Aluminum Foil
Settling Tubes

1 Collect Healthy Kelp

Collect mature sorus tissue with minimally attached algae and organisms (biofouling). Transport to the nursery.

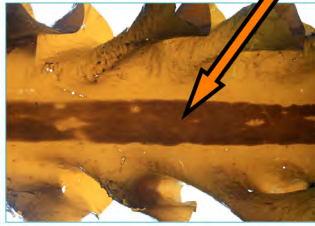

2 Identify & Isolate Sorus Tissue

Cut out healthy sorus tissue and discard tissue that has biofouling or blemishes.

3 Remove Excess Biofouling

ONLY if the sorus has excessive biofouling, gently scrape the surface with a razor blade.

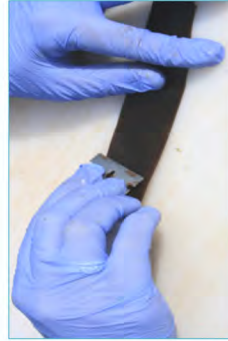

4 Clean & Remove Mucilage

Firmly wipe the front and back 3-4 times with a paper towel. Discard paper towels after each use.



5 Disinfect Tissue

Dip the sorus in 3% iodine solution for 30 seconds.



6 Rinse

Rinse the sorus with chilled filtered seawater until iodine is removed and water drips clear.



7 Dry

Dry the sorus by gently rubbing front and back with a paper towel. Discard paper towels after each use.



8 Prepare for Overnight Storage

Place pieces of sorus on dry paper towels and cover with additional sheets of paper towel.



9 Refrigerate

Set prepped sorus in dark refrigerator that is set at 50°F/10°C for 14 – 24 hours.



10 Prepare Settling Tubes

Chill 2300 mL chilled filtered seawater in each settling tube. Place the tank lid on top of the settling tubes to prevent contamination.



Release of Zoospores

Materials

- Prepped Sori Refrigerated for 14-24 hours
- Submersible Thermometer
- 1000 mL (1 L) Beakers
- Chilled & Filtered Seawater (50°F/10°C)
- Culture Nutrients: PES, Vitamins, GeO₂
- Graduated Cylinder
- Pipettes
- Spatula
- Paper Towels
- Exam Gloves
- Clorox® Regular-Bleach
- 70% Isopropyl Alcohol



1 Begin Setup

Remove spools from freezer and make sure settling tubes are prepared with chilled filtered seawater.

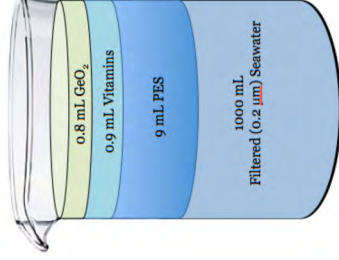

2 Prepare the Release Beaker(s)

Fill 1000 mL (1L) beakers with: 1000 mL (1 L) chilled filtered seawater, 9 mL PES, 0.9 mL vitamins, 0.8 mL GeO₂.

3 Monitor Water Temperature

Use a digital thermometer to monitor water temperature. Starting water temperature should be approximately 50°F/10°C, or the temperature sorus was stored in.



4 Add Sori to Beaker(s)

Add sorus pieces to the beakers. Cut sorus into smaller pieces (if needed) to submerge everything.



5 Monitor Beaker(s)

Occasionally stir beakers. Monitor for initial signs of the spore release. Record data on worksheet.

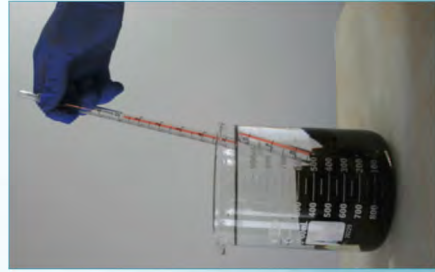

6 Count & Assess Viability of Spores

As sori begin to release spores the beaker water will become cloudy. Start counting the zoospores and calculating the stocking density.

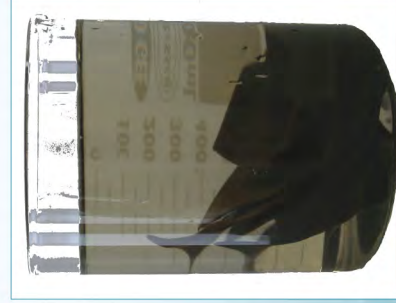

Counting Zoospores and Calculating Stocking Density

Materials

- Hemocytometer Cell Counting Chamber
- Lens Paper
- Micropipettes
- Microscope (40x & 100x)
- Calculator
- Pen & Paper
- Paper Towels
- Exam Gloves
- Clorox® Regular-Bleach
- 70% Isopropyl Alcohol



1 Prepare Workstation

Set up the microscope and focus on the empty hemocytometer counting chamber slide.



2 Prepare the Hemocytometer

Clean hemocytometer and cover slip with lens paper and 70% isopropyl alcohol.

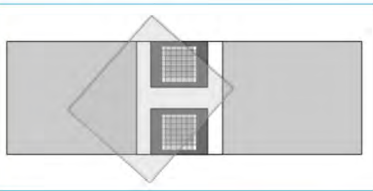

3 Add Release Water into Hemocytometer

Using the micropipette, add the appropriate volume of water from the release beaker into the hemocytometer filling chamber.*

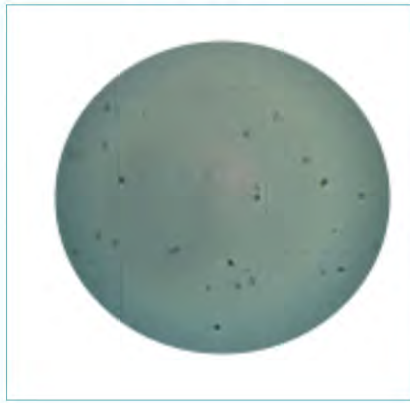

4 Preliminary Evaluation

Place the hemocytometer under the microscope under 40X or 100X and assess the overall health and number of spores.

5 Counting Spores

Method 1: Count the number of cells in the four corner squares, divide the sum of the four corners by four, and multiply by 10,000.

Method 2: If spore density is high, then only the large center square is counted, and the total number of spores counted in the center square is multiplied by 10,000 to determine the total number of spores per mL.

See text for additional information.

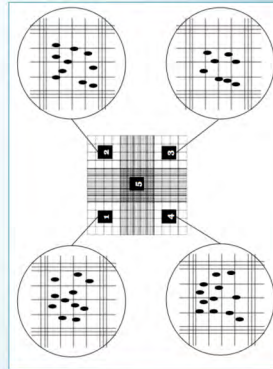

6 Calculating Stocking Density

There are three components that you will need to calculate the stocking density:

- 1) Desired stocking density (recommended=5,000 to 10,000 spores, or an average of 7,500 spores)
- 2) Volume of seawater (mL) in the settling tubes
- 3) Concentration of spores in the release beaker (spores per mL)

Stocking densities are calculated using the equation below. See manual for additional information.

$$\text{Volume of Release Water (mL)} = \left(\frac{\text{Desired Stocking Density (Spores/mL)}}{\text{Release Water (Spores/mL)}} \right) \times \text{Seawater in Settling Tubes (mL)}$$

*It should be noted that each respective cell counting chamber has procedures for the filling and counting of cells and those should be followed. See the manufacturer's guidelines for the recommended filling procedures.

Inoculating Spools in Settling Tubes

Materials

- 1000 mL (1 L) Beakers
- Chilled & Filtered Seawater (50°F/10°C)
- Culture Nutrients: PES, Vitamins, GeO₂
- Graduated Cylinders
- Pipettes
- Spatula
- Cheese Cloth or Canning Mesh
- Tweezers
- Prepared Spools (nylon wound, thawed)
- Aluminum Foil
- Production Aquaria Equipment & Supplies
- Paper Towels
- Exam Gloves
- Clorox® Regular-Bleach
- 70% Isopropyl Alcohol

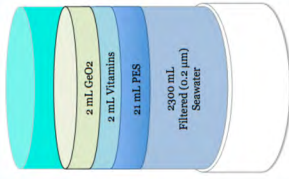

1 Add Nutrients to Settling Tubes
Add culture nutrients to the settling tubes being inoculated with spores: 21 mL PES, 2 mL vitamins, 2 mL GeO₂ (based on 2300 mL of filtered seawater in each settling tube).



2 Place Spools in Settling Tubes
Place spool into the center of the settling tube making sure that it is not touching the sides of the tube.

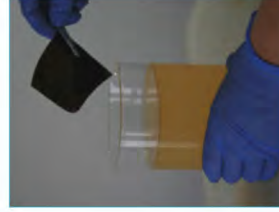

3 Remove Spori from the Beakers
Discard sorus tissue from the release beaker. Sorus tissue that did not release the first time can be dehydrated more and saved for a second release attempt.



4 Gently Stir & Decant
Gently stir release water to ensure spores are suspended in the water column. Decant the number of mL (previously calculated in Section 4) needed to stock one set tube into a clean measuring container.



5 Add Spores to Settling Tubes
Pour the water containing spores water into the settling tube around the outside of the spool.



6 Adjust Water Level in Settling Tubes
Either remove or add chilled seawater so the level is just above twine.

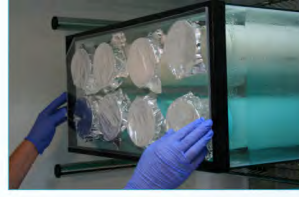

7 Cover Settling Tubes
Cover each settling tube with aluminum foil and place Plexiglass lid on top.



8 Ensure System is Working Properly
Water chillers should be set to 50°F/10°C. Water should be circulating around the outside of the settling tubes. The spools will remain in settling tubes for 24 hours.



9 Set up Production Aquaria
Fill a 20 gallon production aquaria with filtered seawater. Turn on the water chiller and set it for 50°F/10°C. Cover with the Plexiglass lid. Hang fine mesh screens in front of the light banks. Make sure all light banks (bulbs and timers) are working properly.

Transfer Spools to Aquarium

Materials

Culture Nutrients: PES, Vitamins, GeO_2
Pipettes
Chilled Production Aquaria (50°F/10°C)
Production Aquaria Equipment & Supplies
Aluminum Foil
Paper Towels
Exam Gloves
Clorox® Regular-Bleach
70% Isopropyl Alcohol

1 Add Nutrients to Production Aquaria

Add culture nutrients to the production aquaria: 700 mL PES, 70 mL vitamins, 60 mL GeO_2 (based on 20 gallons of filtered seawater in production aquaria). Allow culture nutrients and seawater to mix for at least 15 minutes in the production aquaria before adding spools.

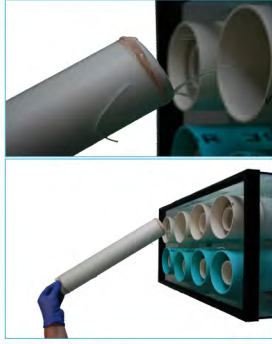
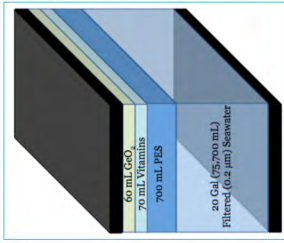

2 Remove Spools from Settling Tubes

Gently pick up the spool by the PVC top and hold spool at an angle for a few seconds to allow the water to run off.

3 Place Spools into Production Aquaria

Quickly transfer spools into the prepped production aquaria. Position spools as seen in the picture to the left. Do not allow the spools to touch each other or the walls of the production aquaria.



4 Adjust Aquaria Environmental Conditions & Check System

Attach a new sterile pipette to air tubing, turn on the air, and adjust the air flow rate to aerate the production aquaria accordingly. Cover with Plexiglass lid. Set the light timers for a 12 hours on/12 hours off photoperiod. Check all components to ensure system is working properly.



5 Label Release Details

Label the production aquaria with the following release details: release date, species, source of sorus, number of spools in production aquaria, and the dates of water changes. Other important identifying information should also be added.

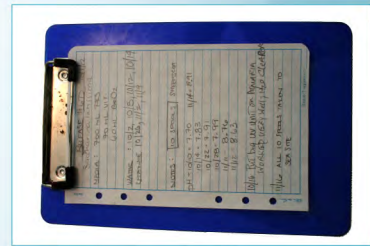

6 Clean Equipment & Store Settling Tubes

Discard remaining water in the settling tubes. Clean the settling tubes and allow them to air dry. Once dry, cover the opening with aluminum foil. This will help keep them clean until the next use.



Chapter 4

Nursery Husbandry and Grow-Out

Overview

The nursery grow-out process begins once the spores have attached to the nylon twine on the spools. This phase usually takes four to six weeks, and is primarily a management period when temperature, light, pH, nutrients, aeration, and contamination must be monitored and controlled. Table 4.1 (on page 83) shows a sample calendar timeline in the OA production nursery.

The purpose of this chapter is to:

1. Provide an overview of the environmental parameters that must be maintained in the nursery during the grow-out period, and
2. Take an in-depth look at the daily and weekly tasks of running the production nursery.

During the first two weeks, the young kelp plants, or sporophytes, are too small to be seen with the naked eye. The sporophytes, however, can be periodically checked using the microscope. Typically, 40x and 100x magnification was used to see how well the growth on the sample twine was progressing. Observing growth is also discussed later in this chapter as part of weekly maintenance tasks. By the third week a brown color should be visible on the spools as the cells divide and grow into multicellular young kelp plants. Figures 4.1 through 4.10 (on pages 84 and 85) show a typical progression of growth from 48 hours post-inoculation through 40 days of growth in the nursery.

Table 4.1 Sample timeline of the OA nursery grow-out process.

Preparation: Purchase equipment, setup laboratory & establish seawater protocol	Dry & wind spools. Bag spools & place in the freezer	Collect & clean (e.g., filter) seawater
Cut PVC pipes for spools and settling tubes, boil, wash, rinse & soak for 72 hours in deionized water		

SAMPLE NURSERY SCHEDULE

1	2	3	4	5	6	7
Collect & prep spores for release - refrigerate overnight; chill set tubes to 50°F	Release, count spores and inoculate settling tubes; set up production aquaria	Transfer spools to production aquaria; add nutrients; soak equipment in bleach water	Daily nursery maintenance	Daily nursery maintenance	Daily nursery maintenance	Daily nursery maintenance
8	9	10	11	12	13	14
Daily nursery maintenance	Prepare for water change	Weekly nursery maintenance	Daily nursery maintenance	Daily nursery maintenance	Daily nursery maintenance	Daily nursery maintenance
15	16	17	18	19	20	21
Daily nursery maintenance	Prepare for water change	Weekly nursery maintenance	Daily nursery maintenance	Daily nursery maintenance	Daily nursery maintenance	Daily nursery maintenance
22	23	24	25	26	27	28
Daily nursery maintenance	Prepare for water change	Weekly nursery maintenance	Daily nursery maintenance	Daily nursery maintenance	Daily nursery maintenance	Daily nursery maintenance
29	30	31	32	33	34	35
Daily nursery maintenance	Prepare for water change	Weekly nursery maintenance	Daily nursery maintenance	Daily nursery maintenance	Daily nursery maintenance	Transfer to Ocean Site

Daily Nursery Maintenance	Weekly Nursery	Prepare for Water Change	Transfer to Ocean Site
	Maintenance		
Rotate spools, check pH, air and water temp, visually inspect lab & equipment, pH readings, clean used equipment See Section C for further information	Complete daily maintenance tasks after the water change See Section D for further information	Complete daily maintenance tasks prior to preparing for the water change. See Section D for further information	See Chapter 6 for further information



Figure 4.1 Gametophyte 48 hours post inoculation (400x)



Figure 4.2 Day 5 gametophytes on nylon twine (100x)

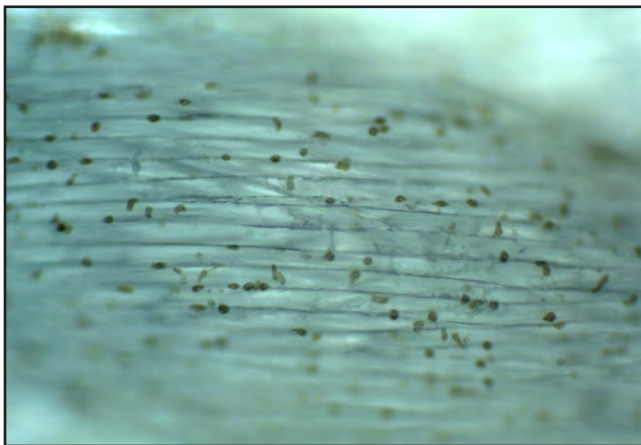

Figure 4.3 Day 9 gametophytes (100x)

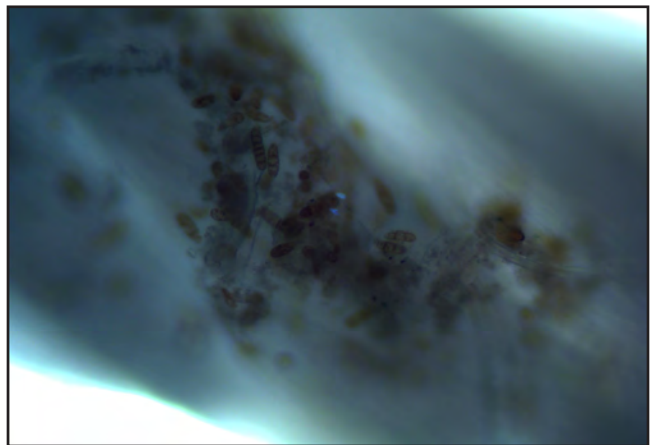

Figure 4.4 Day 14 developing sporophytes (40x)



Figure 4.5 Day 19 sporophytes (100x)

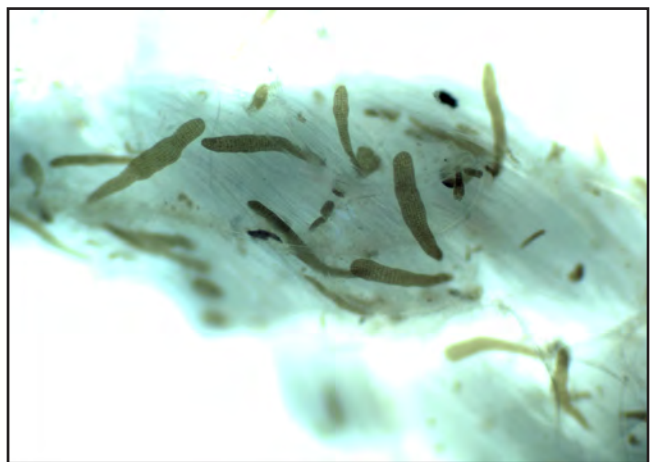

Figure 4.6 Day 23 sporophytes (40x)

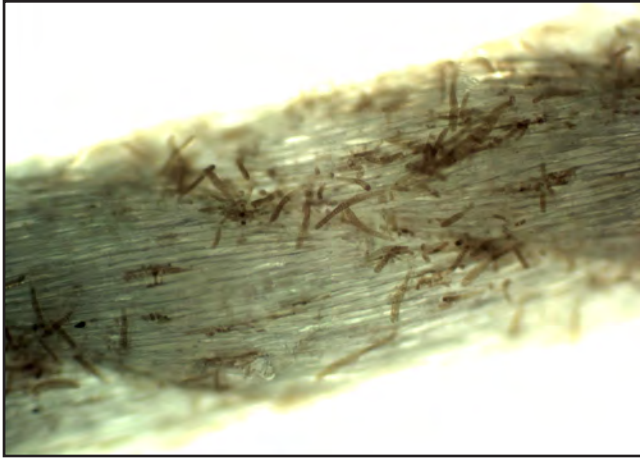

Figure 4.7 Day 26 sporophytes (40x)

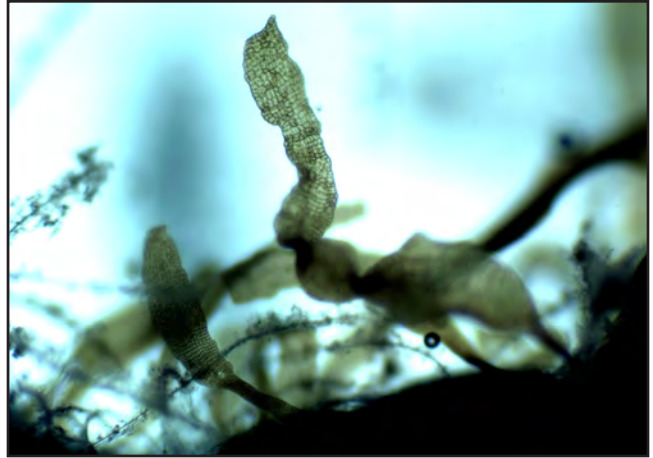

Figure 4.8 Day 31 sporophytes (40x)

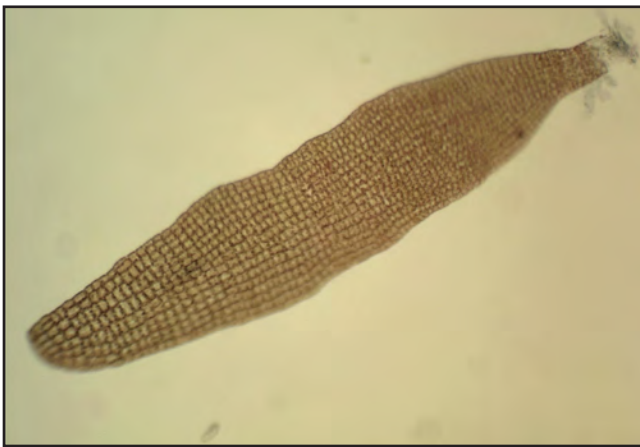

Figure 4.9 Day 37 sporophytes (40x)

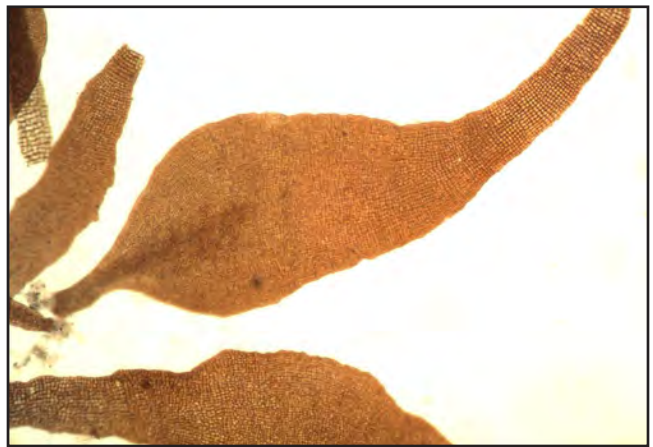

Figure 4.10 Day 40 sporophytes (40x)

Management of Environmental Parameters

Similar to a garden needing specific soil, light, and nutrients for a particular plant, the kelp nursery also needs several key environmental factors to grow. By paying close attention to specific environmental conditions, OA has successfully grown kelp in a nursery for the last four years. Table 4.2 summarizes the environmental parameters: temperature, salinity, pH, and light intensity, among others maintained in the OA nursery. These conditions are essential for the optimal growth, health, and survival of the kelp culture. Kelp can withstand some fluctuation in salinity, but are more sensitive to slight changes in the water temperature and pH.

Seawater

OA changed the seawater in each aquarium on a weekly basis. The replacement seawater must be filtered and sterilized prior to use. It is critical to remove unwanted contaminants by one or more of the techniques (i.e., autoclaving, filtration, and/or UV sterilization) discussed in Table 2.1, page 40. Salinity does not need to be tested on a daily basis if collected from a clean and relatively stable ocean source.

Table 4.2 Parameter Ranges in OA Nursery

Parameter	Recommended Value or Range	
Water Temperature	50°F/10°C	
Salinity	28-34 ppt	
pH	7.0-9.0	
Light		
Days 1-14	20 $\mu\text{mol}\cdot\text{m}^{-2}\cdot\text{s}^{-1}$	(Fine mesh screen)
Days 15-28	55 $\mu\text{mol}\cdot\text{m}^{-2}\cdot\text{s}^{-1}$	(Wide mesh screen)
Days 29+	100 $\mu\text{mol}\cdot\text{m}^{-2}\cdot\text{s}^{-1}$	(No screen)

Nutrients

At the time of each weekly water change, the culture nutrients, vitamins and germanium dioxide (GeO₂) were replenished. Formulas for the media concentrations used in the OA lab, as well as sources for purchasing premade and sterilized media are listed in Appendix B and E.

Light

The light intensity and the photoperiod (12 hours “lights on”/12 hours “lights off”) were regulated through the use of timers on the lights and fine mesh and wide mesh screens. The screens should be hung between the aquarium and the light source to create the appropriate light levels. OA used plastic zip-ties to secure the screens in front of the light banks. The screens diffuse the light and spread it evenly across the surface of the aquarium. The fine mesh screens (Figure 4.11) created light levels in the aquaria of 20 micromoles per square meter per second ($\mu\text{mol m}^{-2} \text{s}^{-1}$), which is suitable for the beginning growth. The wide mesh screens (Figure 4.12) created light levels in the aquaria of 55 $\mu\text{mol m}^{-2} \text{s}^{-1}$.

Figure 4.11 (Below) Fine mesh screen used to create light levels of 20 $\mu\text{mol m}^{-2} \text{s}^{-1}$

Figure 4.12 (Right) Wide mesh screen used to create light levels of 55 $\mu\text{mol m}^{-2} \text{s}^{-1}$

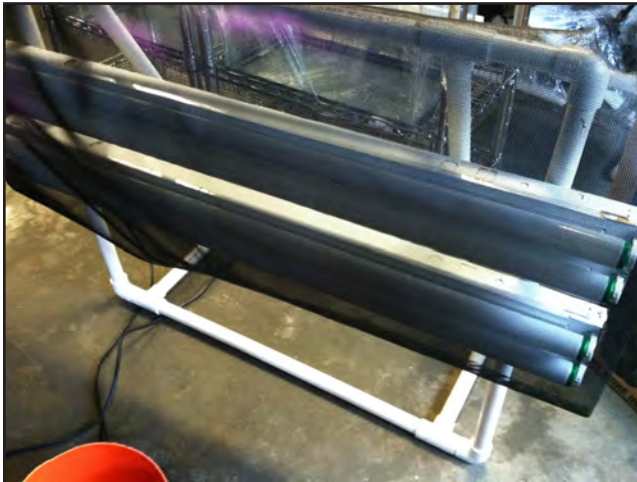

Table 4.3 contains data from the 2010 growth season where light levels and

Table 4.3 Light Level Measurements in Ocean Approved’s Production Aquaria

Zoospore Release Date (Fine Mesh Screen) ^a	Number of Days Using Fine Mesh Screen ^a	Increase Light Intensity— (Wide Mesh Screen) ^b	Number of Days Using Wide Mesh Screen ^b	Increase Light Intensity — (No Screen) ^c	Number of Days Using No Screen ^c	Out-planting to Farm Site	Total Days in Nursery
9/26/10	19	10/15/10	19	11/3/10	3	11/6/10	41
9/26/10	19	10/15/10	19	11/3/10	9	11/12/10	47
11/16/10	14	11/30/10	14	12/14/10	16	12/30/10	44
11/16/10	14	11/30/10	14	12/14/10	17	12/31/10	45
11/16/10	14	11/30/10	14	12/14/10	24	1/7/11	52
11/17/10	13	11/30/10	14	12/14/10	31	1/14/11	58
11/17/10	13	11/30/10	14	12/14/10	15	12/29/10	42
12/9/10	12	12/21/10	17	1/7/11	7	1/14/11	36
12/9/10	12	12/21/10	17	1/7/11	8	1/15/11	37

^aFine mesh screen: 20 micromoles per square meter per second ($\mu\text{mol m}^{-2} \text{s}^{-1}$) ^bWide mesh screen: 55 micromoles per square meter per second ($\mu\text{mol m}^{-2} \text{s}^{-1}$) ^cNo screen: 100 micromoles per square meter per second ($\mu\text{mol m}^{-2} \text{s}^{-1}$)

time spent in the nursery were varied by design. Based on these experiments, and additional work performed during the 2011 and 2012 seasons, OA adopted the protocol of using the fine mesh screens for days 2 through 14 in the nursery, and the wide mesh screens from day 15 through day 28. By week 4 (or sometimes earlier), the screens can be removed, providing full light of $100 \mu\text{mol m}^{-2} \text{s}^{-1}$. It should be noted that these are general guidelines. Decisions on when to change from fine mesh to wide mesh should be based on the overall appearance and growth of the sporophytes.

Temperature

Kelp plants grow best in water that remains at or near 50°F (or 10°C). This temperature was most frequently used in the nursery using commercially available water chillers for each aquarium. Nurseries that have a constant supply of natural running seawater may not have to cool the water, but still must prevent unwanted contaminants from entering the aquaria. Figure 4.13 shows the setup of aquaria and chillers that were used by OA to maintain a constant tank temperature of 50°F (10°C) in a room maintained at a temperature of 68°F (20°C).

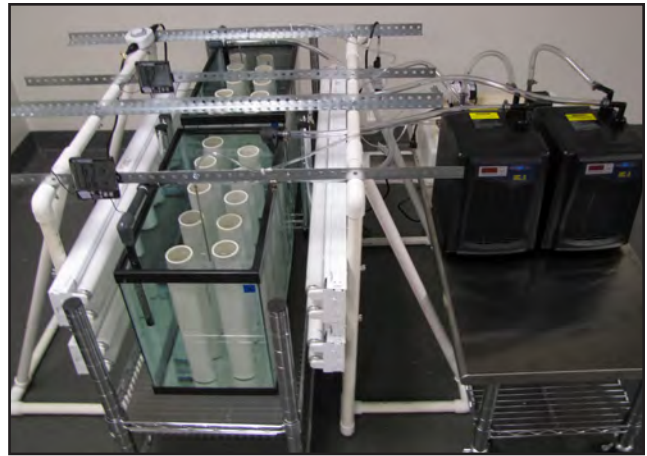

Figure 4.13 Nursery setup with the ability to sustain two production aquaria

pH

The acidity/alkalinity index must be monitored and maintained. Kelp grows best in the pH range of 7.0–9.0 on the pH scale of 0–14 (Figure 4.14). The pH may be measured using aquarium or pool test kit “dip sticks” or electronic handheld meters. The pH of natural seawater is in the range of 7.8 to 8.2. As the kelp plants grow in the aquaria, the pH will slowly increase. This is normal. The pH may be controlled and lowered by bubbling CO_2 gas through the water for short periods of time to maintain a pH close to 8.0.

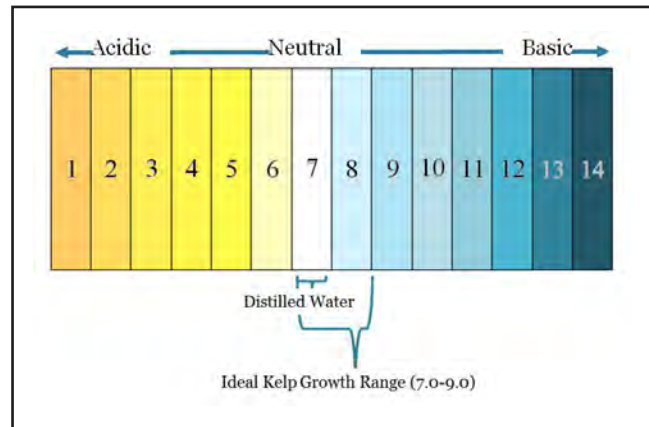

Figure 4.14 On the pH scale of 0–14, distilled water is neutral with a pH of 7.0, and kelp grows at a pH between 7.0–9.0

Aeration

Air is introduced into the aquaria using air pumps, tubing, sterile pipettes, and air filters. An air pump provides the seawater with dissolved oxygen and water movement. It is important to provide an ample supply of air bubbles to the growing sporophytes for healthy growth and for promoting strong holdfasts. The air flow rate should be high enough that it circulates the water in the aquaria, but not so high that it moves the spools around (Figure 4.15).

Contamination

For this manual, a contaminant refers to any organism (e.g., bacteria, protozoans, other species of algae) that negatively affects the growth of the kelp. Contaminants typically compete with the kelp for light, nutrients or space. It is very important to remove as many of these contaminants as early as possible. Techniques for reducing contamination in the seawater are discussed in Chapter 2. Additionally, frequent water changes are also effective in minimizing competition from these organisms. It is possible to see contamination with regular visual observations of the aquaria. Oftentimes, if contamination is

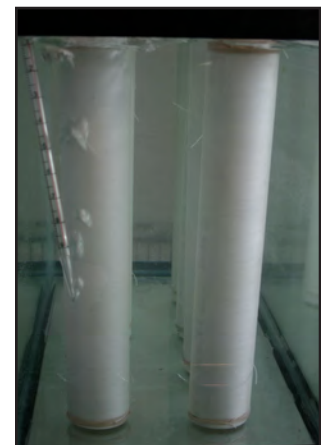

Figure 4.15 Adjust air flow so it does not move spools around

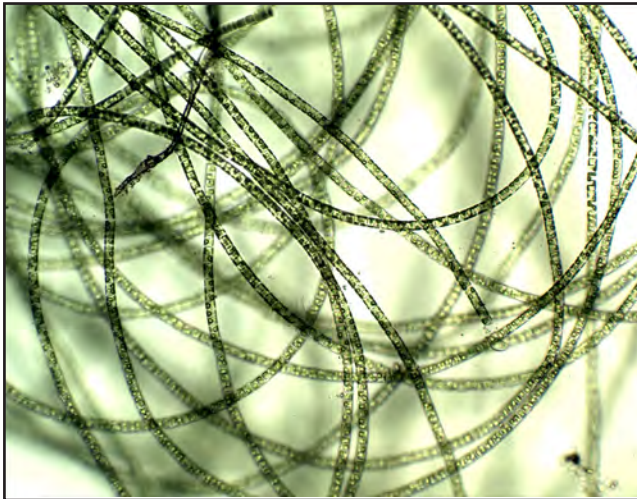

Figure 4.16 Green filamentous algae

present, the visibility in the aquaria will rapidly deteriorate and the aquaria will become cloudy. Figure 4.16 shows a microscopic view of a green filamentous algae observed in a production aquarium. Possible contamination may also be evaluated by observing in a small water sample under the microscope. For a more accurate analysis, samples can be sent to a laboratory specializing in the counting and identification of these types of organisms. Completely eliminating contaminants in the aquaria may be difficult. When needed, OA used a small ultraviolet (UV) sterilization device on individual aquaria. These systems are relatively inexpensive, easy to install, and continually treat the seawater with UV radiation as it circulates through the system.

Daily Nursery Tasks

Daily checklists are used for both efficiency and consistency in the OA nursery (Figure 4.17). This checklist can also be found in Appendix H. The checklist helps with recognizing problems when they first arise. OA recommends being proactive about maintaining the nursery and its systems.

Checking Nursery Air and Aquaria Water Temperatures.

The temperature of the seawater in the aquaria is a vital part of culture success. It is recommended to check the temperature of the aquaria frequently. It is important to note that the warmer the room temperature in the nursery, the harder chillers have to work to keep the aquaria at temperature.

If the temperature in the aquaria rises by a few degrees for a short period of time, it most likely will not affect the sporophytes, but if the temperature rises over 60°F (or

15.5°C), this could be damaging. In the OA nursery, production took place throughout the year to support our research. During the summer months, with increased outside temperatures, poor air circulation in the nursery, and increased number of production aquaria, the chillers at times could not keep the seawater chilled to 50°F (10°C). A large temperature difference between air and seawater, may also cause condensation to build up on the outside of the aquaria. Heavy amounts of condensation reduce the light that the spools receive. At one point it was necessary to install a small air conditioning unit in the nursery to lower the nursery’s air temperature, reduce the strain on the chillers, and reduce condensation. Taking steps to correct this situation early will prevent chillers and equipment from burning out and failing in the future.

Figure 4.17 Checklist used by OA to assist with maintaining daily tasks in the nursery

Nursery Daily Maintenance Checklist							
Task	Sun	Mon	Tues	Wed	Thurs	Fri	Sat
Check nursery air temperature							
Check aquaria water temperature							
Overall sound inspection							
Overall smell inspection							
Check for leaks in plumbing							
Visual health inspection of spools							
Visual inspection of aquaria water visibility							
Check all lights and timers							
Rotate spools							
pH readings							
Clean/disinfect nursery equipment and aquaria							
Clean plexi glass aquaria lids							
Notes:							

Overall Sound and Smell Inspection

Getting into the habit of recognizing what a properly functioning nursery sounds and smells like will

help prevent a number of malfunctions from occurring. For instance, knowing how loud the nursery is with the systems and pumps running may help to diagnose any faulty equipment. Before a pump burns out, a high-pitched hum or a rattling may be heard that was not there before. The smell of the nursery is key to preventing burn-out as well. If the room has a “hot” smell, this could signify a pump is overheating, or if there is a slight scent of melting plastic, it is critical to look into the problem right away.

Checking for Leaks in Plumbing

The OA nursery experienced leaks in pipes and pumps infrequently, but they could have caused problems if left unfixed. Most often leaks were small drips caused by a hose clamp that was too loose or a pump hose incorrectly positioned. Puddles on the floor or under pumps are easily recognized with a quick walk through the nursery or when performing everyday maintenance on the aquaria. In the OA nursery, power strips and cords were hung from the ceiling to prevent any water from coming in contact with electricity sources.

Visual Health Inspection of Spools

When the spools are placed into the aquaria, they are white in color (or the color of the twine used). As the weeks progress, a light brown mottled coloration is noticeable, followed by a more uniform light brown. The spools continue to get darker and more “fuzzy-looking” as the sporophytes grow. If the darkening of the brown coloration stops, or if other colors such as green are noticed, it is recommended to examine a piece of the sample twine. Look for signs of contamination by other organisms or algae. During the summer months, numerous species of green and brown algae (e.g., *Enteromorpha* and *Ectocarpus*) grow prolifically in the Gulf of Maine, and can make their way into the production aquaria when performing water changes. Figure 4.18 shows dots of green algae, which have contaminated the twine.



Figure 4.18 Green algae contamination present on the twine

Visual Inspection of Aquaria Water Visibility

Looking at the visibility of the seawater in the aquaria is also a very important task. If contamination does take hold in the aquaria, the visibility will very rapidly decline and clear water will turn cloudy. Over the course of the week, a small amount of cloudiness may occur as the time to change the water approaches. In this case, slight cloudiness is normal. If an entire aquaria becomes cloudy overnight, significant contamination (usually bacteria) may be present. OA occasionally placed small UV sterilizers in aquaria to control growth of potential contaminants. These individual units can clear cloudy aquaria in less than a day and can be purchased at pet stores or online.

Checking all Lights and Timers

Another vital component of kelp growth in the nursery is providing the correct intensity and duration of light. Power outages and turning a power strip off (that has a timer plugged into it), may disrupt the time on the timers, resulting in incorrect light/dark cycles. It is recommended to check the timers frequently.

Rotating Spools

The one very essential task in the nursery to complete every day is “rotating the spools” or turning each spool 180 degrees in the aquaria. This process ensures that

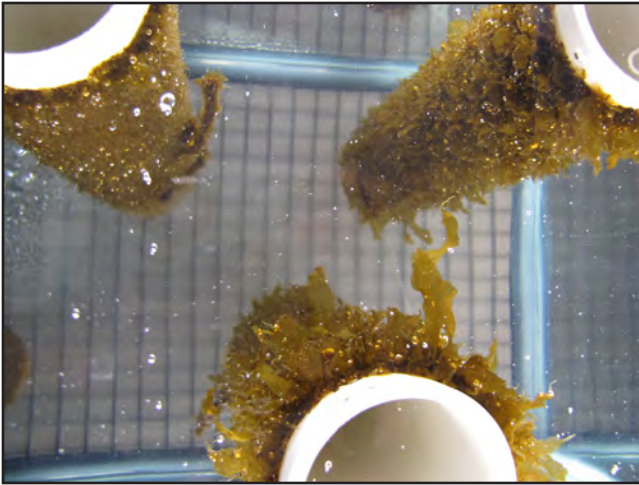

Figure 4.19 Oxygen bubbles rising from maturing sporophytes in week 6 in the nursery



Figure 4.20 Equipment soaking overnight in bleach and deionized water solution

every part of the spool is exposed to light. It is important to wear gloves while rotating the spools to prevent contamination from hands entering the aquaria and coming into contact with the culture media added to the seawater. Gloves should always be worn when handling any part of the aquaria and their systems.

pH Readings

As the sporophytes grow and photosynthesize, they utilize more carbon dioxide dissolved in the water and release more oxygen into the aquaria. In the last week(s) of growth in the nursery, oxygen bubbles can be seen coming off the sporophytes and rising to the surface (Figure 4.19). At this stage, testing the pH of the seawater in the aquaria is an important task, as the pH may begin to approach 9.0 or higher. In the OA nursery, the pH was monitored once a week for the first two weeks, followed by every three days, and then almost every day in the last week of nursery culture. To bring the pH back down to approximately 8.0, CO₂ was slowly bubbled into the aquaria that exhibited high pH readings.

Cleaning and Disinfecting Nursery Equipment and Aquaria

If the space and equipment being used for culture is kept clean, then there is less risk of introducing contamination into the systems. Cleanliness is a key attribute of a successful kelp nursery. Prepare sori and clean coolers outside of the nursery production area. Clean glassware, containers, and equipment used for sorus preparation after use. Remove the trash from the nursery often. The cleaning method that OA used in the nursery started with soaking the equipment in a bleach solution overnight (Figure 4.20). Use the bleach concentration recommended on the manufacturer's label. After soaking, rinse thoroughly until there is no bleach smell left on the equipment and it no longer has a slippery feel. Then wash with gentle dish soap and thoroughly rinse again. Glassware, cutting tools, plexiglass aquarium lids, etc., can be sprayed with 70% isopropyl alcohol and wiped dry with a paper towel. When completely dry, aluminum foil (Figure 4.21) or parafilm can be used as a cover to prevent contamination from reattaching to the surfaces. Counter spaces can be wiped down with 70% isopropyl alcohol after sorus preparation and spore release and throughout the grow-out period in the nursery.

Figure 4.21 Glassware with an aluminum foil cover to prevent contamination



Cleaning Plexiglass Aquarium Lids

Plexiglass aquarium lids will frequently need to be cleaned of salt buildup. While this does not need to be done daily, it is good practice to clean the lids every couple of days and soak them in bleach during weekly water changes.

Weekly Maintenance

Four tasks were completed on a weekly basis in the OA nursery. These included: 1) filling the holding tank or jugs with seawater, 2) water changes, 3) cleaning the aquaria and systems after water changes, and 4) observing growth under the microscope and taking photos.

Filling Holding Tank or Jugs with Seawater.

Depending on how many aquaria are in production, collecting water may need to be done more or less frequently. It is recommended to replenish the seawater supply at least once a week to prevent any contamination in the jugs. Disinfecting the holding container weekly or biweekly with bleach or chlorine dioxide (ClO_2) reduces the chance of contamination.

Water Changes

The weekly water change is a 100% change of the seawater in the aquaria. Spools are removed from each aquarium and transferred into aquaria that were previously prepared to receive the spools. OA found that having extra aquaria set up with active systems (i.e., chillers, air, light banks, etc.) allowed for a quick transfer of spools from the old seawater to the new. OA accomplished this by filling the new aquaria with fresh filtered seawater the day before the water change and covering with a plexiglass lid. The chiller was turned on to allow the water to cool ahead of the transfer of spools. Nutrients were added either the night before or a few hours earlier to allow for thorough mixing. At the time of water change, the new water temperature must be cooled to 50°F (or 10°C). Use the same guidelines for transferring spools into the aquaria from Chapter 3, page 74. Transfer the data record, or clipboard shown in Figure 4.22, to the new aquaria after moving the spools.

Cleaning Aquaria and Systems After Water Changes

After the spools are transferred, the old aquaria and systems, now without spools, should be disinfected and cleaned. Depending on the amount of contamination, a specific amount of stock solution of 3,000 ppm commercial grade ClO_2 was added to each 20 gallon aquarium. Final concentrations of 3 to 10 ppm ClO_2 were most frequently used. Follow manufacturers guide lines for use and dilution of ClO_2 . The 3 to 10ppm ClO_2 solution was circulated through pumps and chillers for 24 hours. Aquaria were then drained using an inexpensive siphon (similar to one used for siphoning fuel), rinsed with deionized water, scrubbed thoroughly with dish soap, and rinsed thoroughly with deionized water. It is important to rinse away all traces of soap residue from the aquaria before using for culture again. Aquaria were set upside down to dry and then covered until next use. If plastic tubing appeared to be cloudy or if residue started to build up, they were cleaned or replaced.

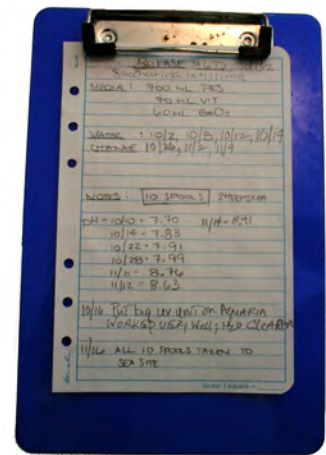

Figure 4.22 Release details on a movable clipboard follow the spools with every water change

Figure 4.23 The red arrow is pointing to the piece of sample twine that can be used to observe growth under the microscope. The blue arrow points to the rubber band holding the twine in place.

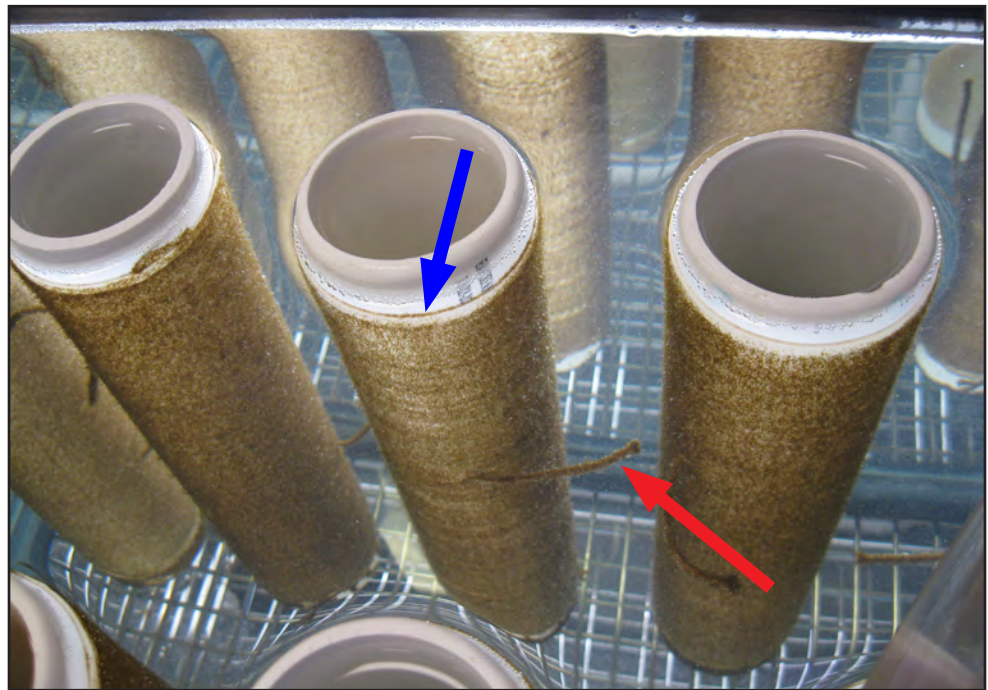
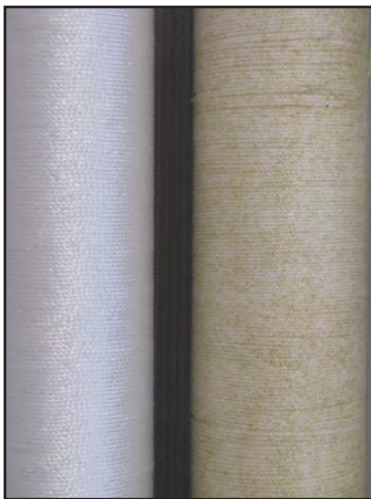

Figure 4.24 Spool at week 1 (left); spool at the end of week 2 (right)



Observe growth under the microscope and take photos

OA cut small pieces of sample twine (Figure 4.23) off the spools as they were lifted out of the aquaria during water changes. The kelp’s growth on the twine was observed under 40x and 100x magnification of the microscope. When looking at the spools during the first two weeks in the nursery, there is little visual evidence that any growth is occurring. Looking closer at the sample twine under the microscope is a reassurance that the proper growth is taking place. Observing growth on a weekly basis also makes it possible to track the progression from the zoospore to the gametophyte stage and then to the sporophyte stage. If the microscope is equipped with a camera, taking photos will allow for comparing growth at a later date. Taking photos of the spools in the aquaria at regular intervals is another way to ensure that the kelp is growing, as it is possible to see the spools becoming darker and the growth more dense. Figures 4.24–4.26 show spool growth and color change over time in the nursery. These photos were captured out of the water during a water change.

Figure 4.25 Spool at week 1 (left); spool at the end of week 3 (right)



Figure 4.26 Spools at week 4 before transport to the ocean farm site

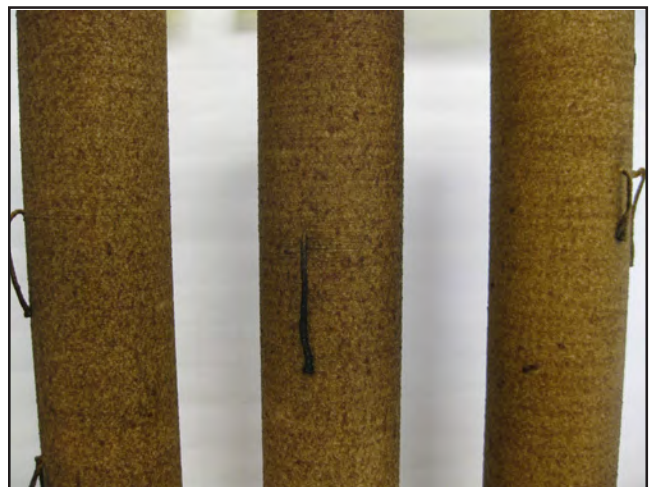

Chapter 5

Farm Site Operation

Overview

The operation of the kelp farm is similar to any farmer or fisherman's work. Each phase of the operation has unique requirements which vary over time. Once the lines have been set and the sporophytes transferred to the site, the frequency of visits may drop to once every two weeks. However, as the kelp plants grow, the visits must be more frequent, up to once a week to weight any lines that may have become buoyant due to the increasing amount of gas contained in the stipes of the kelp.

The first phase of farm site operation is out-planting the sporophytes. The most important consideration when choosing an out-planting date is the weather. The ideal weather conditions are:

- 52°F or cooler
- Cloud cover
- Calm
- Approaching low tide

The temperature and cloud cover are important in maintaining the sporophytes while they are exposed to the air. Calm winds and seas are important for safety, efficiency, and ease of work. In addition, calm conditions will greatly lessen the chance of crossing lines during the process of seeding.

Out-Planting of Sporophytes

Preparation for Transfer of Sporophytes

Before mature spools with sporophytes can be brought from the nursery out to the farm site, a few preparations must be made for the transfer, such as chilling filtered seawater and gathering supplies. Supplies that will be needed for the transport include: chilled filtered seawater, settling tubes, Styrofoam rings (Figure 5.1), aluminum foil, rubber bands, cooler/tote, ice, and cardboard or other packing material.

Figure 5.1 Styrofoam ring cut to fit around spools inside of settling tubes for transport to farm site





Figure 5.2 Styrofoam ring keeps spool from moving inside settling tube during transport.

Transporting of Sporophytes Inside Settling Tubes

The spools will be transported inside the same settling tubes that were used when inoculating the spools with spores. Settling tubes are filled with chilled seawater and a Styrofoam ring is added to keep the spools situated in an upright position and prevent them from rubbing against the sides of the tube (Figure 5.2). The tubes are covered with aluminum foil, which is fastened by rubber bands. The number of spools being transported determines the size of the cooler or tote to use for packing (Figure 5.3).

Maintenance of Temperature

The temperature is an important factor to consider when transporting spools. To prevent the spools from undergoing too much stress, the water temperature should remain as close to the temperature in the production aquaria as possible. This can be achieved during warm days by packing ice around the settling tubes in the cooler. On cool days with temperatures at 50°F/10°C or colder, packing with ice is less important and may not be needed. The less time the spools sit in the settling tubes the better. Transport to the farm site should take place immediately after packing to ensure sporophytes survival.



Figure 5.3 Settling tubes and spools packed for transport before ice is added around tubes

Process of Transferring Sporophytes to Long Lines

Step 1. Choose the upwind or up-current side of the farm. If the wind and current are not moving in the same direction, choose based on which one is stronger.

Step 2. Remove a seed spool from its transport tube and thread one end of



Figure 5.4 Boat slowly backing away from mooring

a 200-foot section of long line through the spool. While a crew member holds the spool, tie the end of the long line to the holdfast that is attached to the mooring chain.

Step 3. Remove the rubber band from the end of the spool that is facing the mooring/holdfast.

Step 4. Tie the end of the seed twine securely to the long line at the point where it meets the holdfast.

Step 5. While one member holds the end of the seed spool securely and parallel to the long line, a second crew member should slowly back the boat away from the mooring towards the corresponding mooring at the far end of the farm (Figure 5.4).

Step 6. The crew member holding the seed spool should tension the long line as it passes through the spool (Figure 5.5).

Step 7. When the seed twine on the seed spool is expended, it should be tied securely to the long line. Ideally this should be within a few feet of the end of the 200-foot section of long line. If not, cut the long line so that two or more feet are remaining.

Step 8. The empty seed spool should be slid off the long line.

Step 9. The end of another 200-foot-long section of long line should be threaded through a full seed spool. This end should then be fastened to the seeded long line (Figure 5.6).

Figure 5.5 Long line threaded through spool; crew tensioning long line

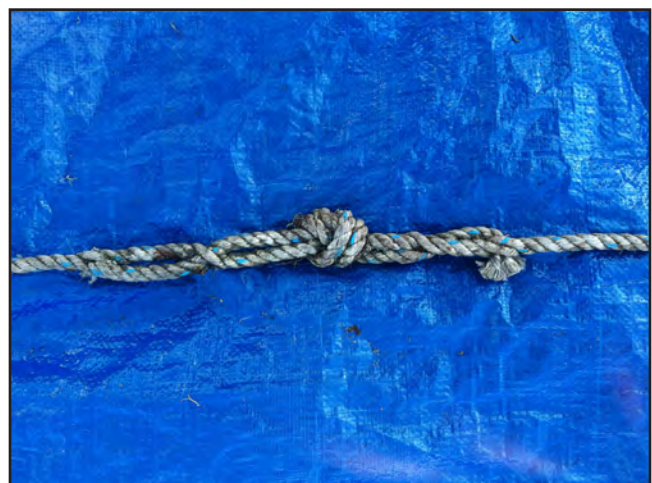

Figure 5.6 Two 200-foot sections of long line joined together

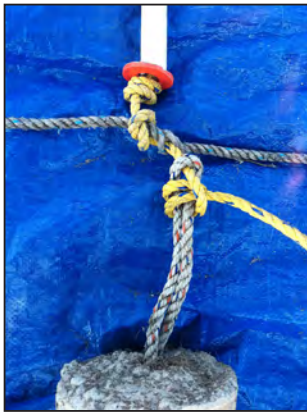

Figure 5.7 Dropper spliced into long line near where two 200-foot sections meet

Step 10. A dropper should be spliced into the long line on one side of the point where the two long lines meet (Figure 5.7).

Step 11. Steps 3–8 should be repeated.

Step 12. Repeat process until far mooring buoy and holdfast are reached.

Once all lines have been seeded, the lines should be adjusted so that the tension on each is roughly the same as its neighbors (Figure 5.8). This is most easily accomplished at low tide/slack water on a calm day.



Figure 5.8 Tensioning the line once seeded

Maintenance of Farm Site

Frequency of Farm Visits

Throughout the growing season, there are two important maintenance tasks. Observing and correcting crossed lines, adding additional weights to the lines as the kelp grows and develops positive buoyancy.

Figure 5.9 A buoyant long line



Plan on visiting the farm site every two weeks to check the growth of the kelp, address buoyant or crossed lines, and perform other maintenance as required. It is a good idea to visit the site after every significant storm or wind event to check for damaged gear.

Buoyant Lines

Kelp will develop positive buoyancy as the stipe matures. It becomes hollow and fills with gas. This gas raises the kelp plant. At some point there will be enough buoyancy to raise the long line (Figure 5.9). As soon as this is observed, additional weight should be added to sink the long line to the desired depth.

Crossed Lines

Crossed lines are to be avoided and corrected as soon as observed. The best way to avoid crossed lines is to:

1. Ensure that the lines are tensioned equally.
2. Avoid lifting up the lines for inspection on days when wind and current would cause your boat to drift over an adjacent line.
3. Add additional weights to lines as soon as positive buoyancy is observed.

If one or more lines crossed, attempt to separate the lines as soon as possible. Leaving the lines crossed increases the risk of damage to the kelp from abrasion as two or more lines rub against each other. In addition to potential damage to the kelp and biomass loss, crossed lines are difficult to harvest efficiently, adding to the cost and time it takes to harvest.

Monitoring Water Conditions and Growth Rate

While not required to farm kelp, monitoring water conditions throughout the growing season will provide useful data that may inform farming decisions in the future (Figure 5.10). Parameters to consider monitoring:

- Water temperature
- Salinity
- Turbidity
- Nitrogen levels

Measuring growth rate (in both biomass and size) of kelp may also provide valuable data. One method to measure biomass growth is to strip a representative meter of line on a periodic basis and weigh the kelp. A method for measuring size is to take five representative plants from the meter and measure their length.



Figure 5.10 Monitoring water conditions mid-season

To measure growth rate of a specific plant:

1. Tag the plant so that it can be found again.
2. Punch a small hole 10 cm above the stipe in the center of the blade.
3. Return to the plant on a periodic basis and measure distance from hole to stipe.

Determining When to Harvest

Determining when to harvest will depend on:

1. The intended use of the kelp
2. The constraints of the processor
3. The quality of kelp desired

Intended Use

Depending on the use of the kelp, harvesting a farm may take place over several days or several months. If the kelp is going to be processed for extracts or other industrial use, it may be harvested in a matter of a day (or days), depending on the size of the farm. If the kelp is going to be used for a purpose requiring specific size plants, the lines may be harvested multiple times over the last part of the growing season, taking only the plants that have met the specified size. This allows the smaller plants that have been shaded to grow to sufficient size. Employing this process, OA harvested one farm five times before pulling in the lines, allowing two weeks between each harvest.

Constraints of the Processor

OA farms have generated up to 33,000 lbs. of kelp per acre. Since there is significant biomass, the capacity of the processor or drying facility needs to be taken into consideration.

The Quality of Kelp Desired

As the water warms in the spring, organisms start to grow on the kelp (Figure 5.11). Depending on the use of the kelp, it may be beneficial to harvest prior to these



Figure 5.11 Examining kelp for evidence of biofouling growth

organisms developing in sufficient quantity (Figure 5.12). In quantity, they may degrade the quality of the kelp to the point where it cannot be processed for its intended use.

Some of the organisms that are typically observed on kelp in the Gulf of Maine are:

- Algal epiphytes
- Bryozoans
- Small snails

Figure 5.12 Bryozoans growing on kelp



In addition, you may notice sorus tissue developing at the end of the blades (Figure 5.13). There are some food products in which sorus tissue may not be desired due to the texture on the palate.

Harvesting

Harvesting kelp is not difficult, though proper equipment is required to handle the weight if the farm is large or the harvest is being done all at once. A section of long line is lifted out of the water onto a boat or harvest barge. The higher the long line is lifted, the easier it is to cut. Having the long line just about head height is most efficient. Next, the kelp is cut either at the point where the meristem joins the stipe or at the stipe just above the holdfast, where the stipe begins. The kelp is then either placed or dropped into coolers or net bags. Once the section of line has been harvested, the boat or barge is moved down the line to the next section to be harvested.

Timing

Depending on growth rates and intended use of the kelp, farm harvests may begin as early as March and may finish in April or May. This avoids some of the issues surrounding warmer water and organisms growing on the kelp. Attempt to schedule the harvest during a period of relative weather stability. The perfect conditions for harvest are:

- **Tide ebbing and close to low water**—This provides slack in the lines allowing them to be lifted with less effort.
- **Calm wind and waves**—This lessens the likelihood of crossing lines while lifting a line to harvest. It also makes the job safer and more efficient, and requires fewer labor hours per given quality of kelp (Figure 5.14).
- **Cloudy**—This helps maintain the quality of the kelp.
- **Below 50°F and above 32°F**—This helps maintain the quality of the kelp.

Harvesting Equipment and Process

The basic equipment for harvesting kelp from a small farm:

- A sharp knife.
- Totes, coolers, or large fish boxes to keep the kelp at the appropriate temperature required by the processor. These can either keep the kelp from freezing on cold days or keep it from getting too warm on warm days.



Figure 5.13 Sorus tissue

Figure 5.14 A calm, cool, cloudy day, perfect for harvesting kelp





Figure 5.15 Net bags each containing approximately 1,000 lbs. of kelp

- Net bags if the harvest is large or if the kelp is to be stored in the water prior to transport to the processing facility (Figure 5.15). A frame can be fabricated to hold the net bag open underneath the long line (Figure 5.16).

Figure 5.16 Frame holding net bag under long line

If the harvests are larger, a harvest platform such as a small barge (Figure 5.17) and power lifting equipment (Figure 5.18) should be considered.



Transport to Market

How the harvest is transported to the buyer is dependent on the use of the kelp and the purchaser's specification. Kelp for non-dried food product that is being delivered to a processing plant must arrive chilled and covered. It is important to note that if fresh water accumulates in the bottom of the transport container, the kelp blades will bubble due to absorbing some of this water. Storage containers must be properly drained. Work with the buyer or processor to determine the best mode of transportation for the kelp.



Figure 5.17 Small harvest barge

Figure 5.18 Lift equipment for larger harvests



Off Season Farm Site Maintenance

After the farm is harvested, the long lines should be stripped of kelp holdfasts and other marine organisms and brought ashore. Once ashore, the seed twine should be cut off the lines. The simplest way to accomplish this is to lay the lines out and walk along them with a small pair of scissors, cutting sections as you move along the line. After the seed twine is removed and any organic material has dried and been stripped off, the lines can be wound on a spool or flaked for storage (Figure 5.19).

Clean off organic material from the droppers and weights with a power washer and stack so as to be ready for next season.

During the off-season it may be appropriate to inspect the moorings and tackle and replace any material that needs replacing.



Figure 5.19 Drying of Long Lines After Harvest

Chapter 6

Gametophyte Cloning

Overview

The natural life cycle of these kelp plants exhibits an alternation of generations between the small microscopic male and female gametophyte plants and the large macroscopic sporophyte stage plants that are found growing just below mean low water. Figure 3.1, page 52 illustrates the life cycle of these three kelp species.

The procedures and techniques in this manual describe the collection and processing of reproductive structures (sori) in situ, when available. The reproductive spores from the sori are then provided appropriate conditions and substrate to support the growth of gametophytes and young sporophytes in the nursery. These methods have proven to be effective for OA and other kelp farmers worldwide.

There are, however, limitations when using these methods. Some of the limitations when utilizing wild collected plants are: availability of mature sori, the inability to selectively breed and work with plants showing the most vigor, and cost and time in the nursery. A review of the nursery techniques utilized by OA to grow and seed the young kelp plants illustrates that much time and attention is needed to control contaminants, maintain environmental conditions and to provide the appropriate media to stimulate growth. The young kelp is typically maintained in the nursery for four to six weeks before transferring to the farm site. Reducing the time that kelp spend in the nursery can lower costs, increase survival, and decrease the risk of contamination.

A great deal of research has been done with numerous kelp species to understand and manipulate the life cycle to obtain more than one harvestable crop per year and select genomes that have the desired characteristics such as taste, size and resistance to biofouling. The cloning and maintenance of male and female gametophyte colonies is now widespread and well-documented. Since these gametophytes are microscopic, a large number of cells may be grown in small containers in a nursery and when needed the normal reproductive sequence can be initiated by the use of colored light.

Although the control and monitoring of culture conditions is necessary, these clonal cultures have been maintained for months and years with minimal effort. The advantages of having the gametophytes in culture are significant. Desired species can more easily be developed, the gametophytes are available at any time of the year, and the time in the nursery to develop young sporophytes is reduced.

Working with researchers at the University of Connecticut, OA utilized

gametophytes of *S. latissima* and *A. esculenta* to seed some spools. The male and female gametophytes were cultured in a nursery setting and, when needed, the production of gametes (egg and sperm cells) was induced. The gametes were then sprayed onto the nylon twine on nursery spools. Seeding the spools with this process reduced the time the spools were kept in the nursery from four weeks to less than two weeks.

Appendices

A. Glossary

Aeration: a process where air is circulated through, mixed with, or dissolved in a liquid or substance.

Alaria: *Alaria esculenta* is a species of kelp plant commonly known as “winged kelp” that is found in temperate coastal water growing below mean low water. It has been successfully grown in the nursery and at the farm site of OA.

Alternation of generations: a term used to describe the life cycle of algae (and other plants) that alternate between two phases of growth: a multicellular gametophyte (1n) and a multicellular sporophyte (2n) plant. In the kelp grown in OA’s nursery and farm sites the sporophyte and gametophyte are of different size and appearance.

Aquaculture: farming of aquatic organisms such as fish, mollusks, and algae.

Autoclaving: a process of sterilizing utensils or liquids by subjecting them to high-pressure saturated steam at 121°C for 15 to 20 minutes.

Bacteria: a large group of microorganisms, typically a few microns in size that have various shapes and exist in water, soil, and air. An mL of water may have a bacterial count of over one million individuals.

Biofouling: accumulation of microorganisms, plants, algae, or animals on wetted surfaces such as boat hulls, rope, pilings, or other organisms.

Blade: the part of the kelp plant that is flattened and expanded.

Bryozoans: a group of aquatic invertebrate animals typically about 0.5 mm in size that live in colonies in marine waters and may form large deposits of colonies on marine plants such as kelp.

Carbon dioxide (CO₂): a chemical compound naturally occurring in water and air and utilized by plants in photosynthesis. CO₂ is also the byproduct of respiration (breakdown of sugars) by plants and animals. Concentrated CO₂ gas may be

introduced into aquaria or other culture tanks to adjust and regulate the acidity/alkalinity (pH) of the seawater.

Cell-counting chambers: glass or plastic slides that contain a chamber designed to hold an exact volume of liquid. Grid patterns are etched on the slides to allow for accurately counting the number of cells or zoospores in the liquid.

Chiller: a refrigeration unit that may be used to control the temperature of water or other liquids that is circulated through it. Chillers have been used in the OA nursery to maintain the aquaria at desired temperatures.

Chlorine dioxide (ClO₂): a chemical compound that is a useful and potent disinfecting agent. It may be used to disinfect water and other materials. One should follow the manufacturer's instructions for the proper concentrations and handling in the various uses.

Clorox: a commercially available cleaning and disinfecting product containing approximately 5.5% Sodium hypochlorite (NaOCl) as the active ingredient. Clorox may be used to treat water, equipment, and surfaces. One should follow the manufacturer's instructions for the proper concentrations and handling in the various uses.

Decant: a process that can be used to separate a solid from a liquid when the solid material does not stay in solution and settles to the bottom. The solid is allowed to settle to the bottom of the beaker or container and then the liquid is carefully poured off without disturbing the solid on the bottom.

Deionized water: water that has been "softened" by passing it through cylinders with resins that exchange the "hard ions" of magnesium, calcium, and iron with "soft" sodium ions.

Diatoms: a large and diverse group of microscopic algae (phytoplankton) found in abundance in many aquatic habitats. Although mostly microscopic they may grow in colonies to a large size.

Dropper (depth control system): depth maintenance buoys used on long lines at the farm sites to keep the lines at a desired depth throughout the kelp growth period.

Ectocarpus: a genus of small filamentous brown algae that frequently grow attached to kelp.

Enteromorpha: a genus of filamentous and tubular green algae that are very prevalent in the intertidal zone during the warmer months. Occasionally species of enteromorpha may be introduced into the nursery aquaria and outcompete the young kelp.

Exam gloves: disposable gloves made of latex, vinyl, or other materials and are widely used in medical, scientific, and other industries to protect the hands from chemicals or contaminants and to eliminate the transfer of materials from one's hands to the materials being worked with.

Filtration: the process of separating solids from liquids. Filtration in this manual describes the passing of seawater through a polypropylene or membrane filter to remove potential contaminants such as bacteria, protozoa, and plankton.

Fish boxes: watertight boxes frequently used in the marine industries to transport fish, water, and other substances. A Bonar box is one type of fish box.

Fixative: a solution used to preserve or stabilize cells for observation under the microscope.

Flagella: a thin, whip-like structure extruding from some microscopic algae cells which quickly sway back and forth providing motility to the cells.

Gametophyte: the phase in the kelp life cycle that is microscopic and produces male and female sex cells (gametes) that merge to produce the macroscopic sporophyte phase.

Germanium dioxide (GeO₂): a chemical compound that is added in small concentrations to culture media to prevent the growth of diatoms.

Graduated cylinder: laboratory and nursery glassware used to measure liquids in milliliters (1/1000 liter).

Hemocytometer: a cell-counting chamber holding a known volume of liquid and used under the microscope to count and/or observe very small cells and zoospores.

Heteromorphic: having two different phases in the life cycle, each having a different appearance.

Iodine: weak solutions of elemental iodine that are frequently used as antiseptics. OA frequently used over-the-counter providone iodine diluted to 3% to destroy organisms attached to the kelp blades and sori prior to attempting to induce the release of spores.

Kelp: the common name of a group of brown algae of the order laminariales that are common in temperate marine environments and are grown in many aquaculture operations.

Laminaria: *Laminaria digitata* is a species of kelp known as “horsetail kelp” and is commonly found in temperate coastal waters growing below mean low water. It has been successfully grown in the nursery and farm sites of OA.

Lease site: a farm location leased from the state.

Long line: rope used at the farm sites for the attachment and growth of kelp. OA's sites used 7/16 inch line.

Lugol's solution: a solution of elemental iodine and potassium iodide in water often used as an antiseptic and disinfectant or as a fixative for cells in laboratory procedures.

Macroscopic: the scale of objects which are large enough to be seen without magnification.

Mean low water: the average level of low tides over a period of time—usually many years.

Meristem: a region of cells at the base of the kelp blade where cells are actively dividing, causing the blade to grow.

Micropipettes: laboratory and nursery glassware used for accurately measuring small volumes (milliliters) of liquid.

Microscope: an instrument used to magnify organisms that are too small to be seen with the naked eye.

Microscopic: the scale of objects smaller than those that can be seen with the naked eye and that therefore require a lens or microscope to see them clearly.

Milliliter (mL): one thousandth of a liter (1/1000). One quart of liquid contains 946 milliliters.

MSDS (Material Safety Data Sheets): Intended to provide worker and emergency personnel with procedures for handling or working with a potentially hazardous substance in a safe manner.

Mucilage: a term used to describe the slimy carbohydrate complex that is found on the surface and cell walls of many algae, especially kelp.

Nursery spools: two-inch diameter PVC pipe used to hold the twine on which the young kelp spores set and grow.

OSHA (Occupational Safety and Health Administration): the federal agency that regulates workplace safety and health.

Pasteurization: the process of heating a food or liquid to a specific temperature for a predetermined time (61.7°C for 30 minutes) and then cooling it quickly. Unlike sterilization, it does not kill all microorganisms but significantly reduces their numbers and does not cause major chemical alteration of the substance.

PES: Provasoli's Enriched Seawater. A defined culture media containing a complex of compounds found to be beneficial to the growth of many marine organisms.

pH: the measure of the acidity or basicity of a solution. Solutions with a pH less than 7.0 are acidic and solutions with a pH greater than 7.0 are basic (or alkaline). A pH of 7.0 is neutral. Pure water has a pH of approximately 7.0. Kelp grows best at a pH of 7.0 to 9.0.

Phytoplankton: photosynthesizing microscopic organisms that inhabit the upper,

sunlit layer of oceans and bodies of fresh water.

Protozoans: a diverse group of unicellular animal-like microorganisms, many being motile, found in almost all environments.

Saccharina: *Saccharina latissima* is a species of kelp known as “sugar kelp” and is commonly found in temperate coastal waters growing below mean low water. It has been successfully grown in the nursery and farm sites of OA and is one of the most frequently grown varieties of kelp in aquaculture around the world.

Sedgewick-rafter cell (S-R): a glass slide that has a cell designed to hold 1 mL of liquid. The cell is frequently used with a microscope for counting plankton. It is a relatively inexpensive and accurate method but has been replaced in many applications by automated counters. OA utilized the S-R type of cell on a limited basis because of the small size and abundance of the kelp spores. These small spores were more accurately counted using the cellometer or Neubauer type cell, which hold smaller volumes and allow for higher magnification under the microscope.

Sorus: an area of a kelp blade containing a grouping of reproductive cells distinguished in the kelp as a darker and raised area of the blade.

Species: a unit of classification (naming) within a genus.

Sporangium: a cell which produces spores on the kelp blade within the sorus tissue. (Plural: sporangia)

Spore: single-celled reproductive entities that may join with another cell or may grow into a new plant without fusion.

Sporeling: in this manual a sporeling refers to a young kelp plant growing on twine on a nursery spool.

Sporophyte: in this manual a sporophyte refers to a both young kelp plant growing on twine on a nursery spool and adult plant in the ocean this is final stage of the kelp lifecycle.

Stipe: the erect, stem-like portion of kelp that connects the holdfast to the blade.

Stocking density: the number of reproductive spores used to inoculate a settling tube to establish the young gametophyte and sporophyte phase on the twine.

Twine: the 1mm nylon thread that is wound around the nursery spools to provide the substrate for young kelp to grow.

Tyndallization: destruction of microorganisms (contaminants) by heating a substance (seawater) at the boiling point for 15 minutes three days in a row. This process may be used where steam heat (autoclaving) is not possible and will normally sterilize the substance. Heating seawater to 80 degrees centigrade for ten minutes

will eliminate most micro-organisms and has been successfully used in some algal culture operations.

UV light sterilization: the process of passing a liquid (seawater) through a closed UV light system designed to destroy microorganisms.

Vitamins: supplements to nursery culture media to encourage and support the growth of young kelp plants.

Zoospores: motile reproductive cells bearing flagella. In kelp, zoospores normally develop into male or female gametophytes.

B. Nutrient Formulations

Provasoli's Enriched Seawater (PES) Culture Media

PES Culture Media

Solution I: Base Solution

1000 mL quantity

Deionized water	1,000 mL (total) (1 L)
NaNO ₃	2,800 mg (2.8g)
Na ₂ glycerophosphate	400 mg (0.4 g)
Thiamine-HCl (Vit. B1)	4 mg (.004g)
Tris Buffer	4,000 mg (4g)

(tris(hydroxymethyl)amino-methane; 2-amino-2[hydroxymethyl]1,3-propanediol)

Specialty solutions normally made up in 2000 mL volumes:

Solution II: Fe (as EDTA complex; 1:1 molar)

Deionized water	250 mL (total)
Fe (NH ₄) ₂ (SO ₄) ₂ · 6H ₂ O	175 mg
Na ₂ EDTA	150 mg

1 mL of this solution = 0.1 mg Fe. We have recently found that we can substitute 403 mg FeNaEDTA (=C₁₀H₁₂FeN₂NaO₈; molecular weight 367.05)

Solution III: P II metals P II metals as one solution which should be kept refrigerated

Deionized water	200 mL (total)
H ₃ BO ₃ (Boric Acid)	228 mg
FeCl ₃ ·6H ₂ O (Ferric Chloride)	9.8 mg
MnSO ₄ ·4H ₂ O	32.8 mg

OR

MnSO₄·H₂O (Manganese sulfate monohydrate) 26.0 mg

OR

MnSO ₄ ·7H ₂ O	37.4 mg
Na ₂ EDTA	200 mg
(Disodium Ethylenediamine Tetraacetate)	
CoSO ₄ ·7H ₂ O	1.0 mg
(Cobaltous sulfate heptahydrate)	
ZnSO ₄ ·7H ₂ O	4.4 mg
(Zinc sulfate, 7-Hydrate)	

Solution IV: Vitamins

Vitamin B12 and Biotin solution should be made up as follows in 25 ml volumetric flasks to give final concentrations of 80 µg and 40 µg, respectively, per 1000 of original stock solution:

vitamin B12	2.0 mg
biotin	1.0 mg

To the base solution (I), add the following amounts of prepared solutions II, III, & IV.

Solution I: Base Solution	1000 mL quantity
Solution II: Fe (as EDTA complex; 1:1 molar)	20 mg = 200 mL
Solution III: P II metals	200 mL
Solution IV: Vitamins Vitamin B12, Biotin	1 mL

Notes:

Enrichment media need to be sterilized. Since pH needs to be adjusted after the media are prepared, it is easiest to mix the solutions, adjust pH with HCl, then filter sterilize the finished media, though solutions II and III can be autoclaved separately after they are made up. Vitamins (in solutions I and IV) should not be heat sterilized. The media should be refrigerated, and all vitamins should be stored in the refrigerator.

Nutrient Concentrations Table

Nutrient concentrations used in the OA nursery		
Release Beakers	Settling Tubes	Aquaria
1000 mL Seawater	2300 mL Seawater	20 gallons/ 75,700 mL Seawater
9 mL PES	21 mL PES	700 mL PES
.9 mL Vitamins	2 mL Vitamins	70 mL Vitamins
.8 mL GeO ₂	2 mL GeO ₂	60 mL GeO ₂

C. Light Bank Setup Plan

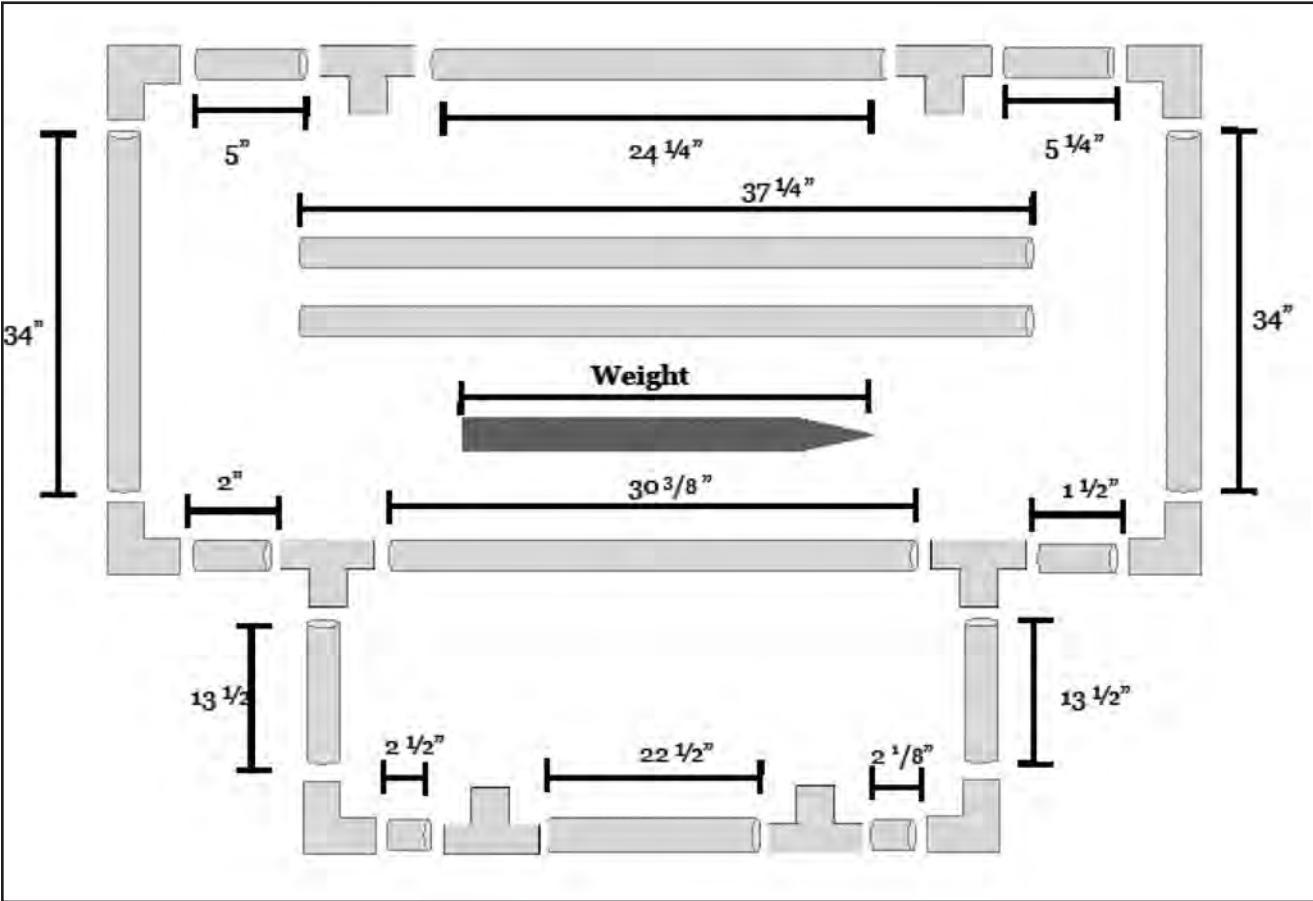

D. Measuring Light Bulb Intensity Diagram

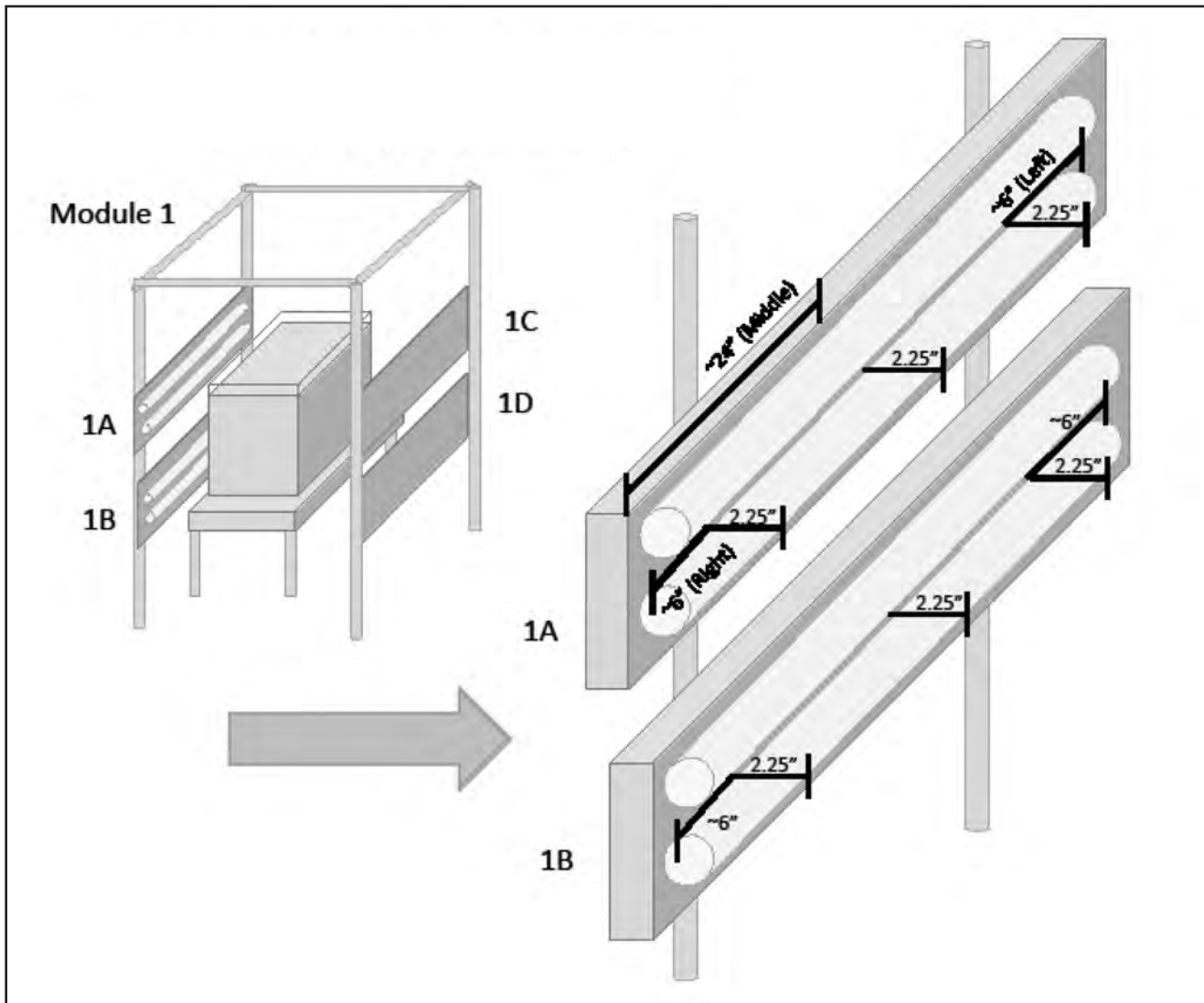

E. Equipment and Supplies Resources

Listed are a few of the many suppliers of equipment that OA found helpful in equipping its nursery.

Culture Nutrients

Kennebec River Biosciences
41 Main Street
Richmond, Maine 04357
(207) 737-2637
<http://www.microtechnologies.biz>

Bigelow Laboratory for Ocean Sciences
60 Bigelow Drive
P.O. Box 380
East Boothbay, Maine 04544
(207) 315-2567
www.bigelow.org

Deionized Water

Culligan Water Conditioning of Yarmouth, ME
915 US Route One
Yarmouth, ME 04096
(207) 846-5061
www.yarmouth.culliganman.com

Filters and Filtration

The Strainrite Companies
65 First Flight Drive
Auburn, ME 04211-1970
(207) 376-1600
www.strainrite.com

Chillers and Aquarium Supplies

Fish Tanks Direct.com
www.fishtanksdirect.com

Laboratory Supplies

American Science Supply and Surplus
www.sciplus.com
Fisher Scientific
www.fishersci.com

Microscope Maintenance and Repair

Q.C. Services Inc.
PO Box 68
8 Smith Street
Harrison, ME 04040
(207) 583-2980
www.qcservices-maine.com

Laboratory Testing

Kennebec River Biosciences
41 Main Street
Richmond, Maine 04357
(207) 737-2637
<http://www.microtechnologies.biz>

G. Counting Zoospores & Calculating Stocking Density Worksheet

Counting Zoospores & Calculating Stocking Density Worksheet

Date: _____

Species: _____

Method 1.

1 Count = _____	[Grid]	2 Count = _____
4 Count = _____	[Grid]	3 Count = _____

$$\text{Zoospore Density (Spores/mL)} = \left(\frac{\text{Sq. 1} + \text{Sq. 2} + \text{Sq. 3} + \text{Sq. 4}}{4} \right) \times 10,000$$

$$\text{Zoospore Density (Spores/mL)} = \left(\frac{\text{_____}}{4} \right) \times 10,000$$

$$\text{Zoospore Density (Spores/mL)} = \underline{\hspace{2cm}}$$

Method 2.

[Grid]
5 Count = _____

$$\text{Zoospore Density (Spores/mL)} = \text{Square 5} \times 10,000$$

$$\text{Zoospore Density (Spores/mL)} = \underline{\hspace{2cm}}$$

Calculating Stocking Density

$$\text{Volume of Release Water (mL) to Inoculate Settling Tubes} = \frac{\text{Desired Stocking Density (Spores/mL) in Settling Tubes}}{\left(\frac{\text{Number of Spores/mL Release Water}}{\text{Volume of Seawater (mL) in Settling Tubes}} \right)}$$

$$\text{Volume of Release Water (mL) to Inoculate Settling Tubes} = \frac{\text{Spores/mL}}{\left(\frac{\text{Spores/mL}}{\text{mL/Seawater}} \right)}$$

$$\text{Volume of Release Water (mL) to Inoculate Settling Tubes} = \underline{\hspace{2cm}} \text{ mL}$$

H. Nursery Daily Maintenance Checklist

Nursery Daily Maintenance Checklist							
Task	Sun	Mon	Tues	Wed	Thurs	Fri	Sat
Check nursery air temperature							
Check aquaria water temperature							
Overall sound inspection							
Overall smell inspection							
Check for leaks in plumbing							
Visual health inspection of spools							
Visual inspection of aquaria water visibility							
Check all lights and timers							
Rotate spools							
pH readings							
Clean/disinfect nursery equipment and aquaria							
Clean plexi glass aquaria lids							
Notes:							

I. Units of Measure & Conversion Table

°C	degrees Celsius
°F	degrees Fahrenheit
cm	centimeter(s)
dm	decimeter(s)
ft	foot (feet)
g	gram(s)
gal	gallon(s)
in	inch(es)
lb	pound
L	liter
hm	hectometer
km	kilometer
m	meter(s)
mL	milliliter(s)
mm	millimeter(s)
oz	ounce(s)
ppm	parts per million
μm	micrometer(s) or micron(s)
μmol m ⁻² sec ⁻¹	micromole per square meter per second

American		
Units of Length	Units of Capacity	Units of Weight
1 mile = 1760 yards 1 mile = 8 furlong 1 furlong = 10 chains 1 chain = 4 rods 1 rod = 5 1/2 yards 1 yard = 3 feet 1 foot = 12 inches	1 gallon = 4 quarts 1 quart = 2 pints 1 pint = 4 gills 1 pint = 34.6774 inches ³ 1 gill = 5 fl. oz. 1 fl. oz. = 8 fl. drachms 1 US gal = 0.8327 gallons 1 US pint = 0.8327 pint 1 US pint = 16 fl. oz. 1 yard ³ = 27 feet ³ 1 foot ³ = 1728 inches ³	1 ton = 20 cwt 1 ton = 2240 lb. 1 cwt = 4 quarters 1 quarter = 2 stone. 1 stone = 14 lb. 1 lb. = 16 oz. 1 oz. = 16 drams 1 oz. = 437.5 grains 1 US ton = 2000 lb.
Metric		
Units of Length	Units of Capacity	Units of Weight
Conversions		
Units of Length	Units of Capacity	Units of Weight
1 mile = 1.609 km 1 yard = 0.9144 meters 1 foot = 0.3048 meters 1 inch = 25.4 mm	1 gallon = 4.5461 liters 1 gallon = 3.785 liters 1 pint = 0.5683 liters 1 cubic inch = 16.3871 cm ³	1 ton = 1.016 metric tonnes 1 lb. = 0.4536 kg 1 oz. = 28.3495 grams 1 US ton = 0.9072 metric tonnes
Temperature		
degrees Celsius to degrees Fahrenheit		degrees Fahrenheit to degrees Celsius
$^{\circ}\text{C} \times (9/5) + 32 = ^{\circ}\text{F}$		$(^{\circ}\text{F} - 32) \times (5/9) = ^{\circ}\text{C}$

J. References

- Agrawal, S.C. (2012). Factors controlling induction of reproduction in algae – review: the text. *Folia. Microbiol.* 57: 387-407.
- Asensi, A., Ar Gall, E., Marie, D., Billot, C., Dion, C., Kloareg, B. (2001). Clonal propagation of *Laminaria digitata* (Phaeophyceae) sporophytes through a diploid cell-filament suspension. *J. Phycology.* 37(3): 411-417.
- Blasco, N. (2012). Kelp culture in integrated multi-trophic aquaculture: expanding the temporal limitations. Masters Thesis. Department of Geography, University of Victoria.
- Bolton, J.J. and Luning, K. (1982). Optimal growth and maximal survival temperatures of Atlantic species (Phaeophyta) in culture. *J. Marine Biol.* 66(1): 89-94.
- Broch, O.J. and Slagstad, D. (2012). Modelling seasonal growth and composition of the kelp *Saccharina latissima*. *J. Appl. Phycology.* 24: 759-776.
- Buchholz, C. and Luning, K. (1999). Isolated, distal blade discs of the brown alga *Laminaria digitata* from sorus, but not discs, near to the meristematic transition zone. *J. Appl. Phycology.* 16: 579-584.
- Chopin, T., Buschmann, A.H., Halling, C., Troell, M., Kautky, N., Neori, A., Kraemer, G.P., Zertuche-Gonzalez, J.A., Yarish, C., Neefus, C. (2001). Integrating seaweeds into marine aquaculture systems: A key toward sustainability. *J. Phycol.* 37: 975-986.
- Dapeng, L., Zhou, Z.-G., Liu, H., Wu, C. (1999). A method of *Laminaria japonica* strain selection and sporeling raising by the use of gametophyte clones. *Hydrobiologia.* 398/399: 473-476.
- Denny, M., Roberson, L. (2002). Blade motion and nutrient flux to the Kelp, *Eisenia arborea*. *Bio. Bull.* 203: 1-13.
- Edwards, M. and Watson, L. (2011). Aquaculture explained. Cultivating *Laminaria digitata*. No. 26. Bord Iascaigh Mhara, Irish Sea Fisheries Board.
- Egan, B. and Yarish, C. (1988). The distribution of the genus *Laminaria* (Phaeophyta) at its southern limit in the western Atlantic Ocean. *Botanica Mar.* 31: 155-161.
- Egan, B., Vlasto, A., Yarish, C. (1989). Seasonal acclimation to temperature and light in *Laminaria longicruris* de la Pyl. (Phaeophyta). *J. of Exp. Mar. Biol. and Ecol.* 129: 1-16.
- Egan, B., Garcia-Esquivel, Z., Brinkhuis, B.H., Yarish, C. (1990) Editors. Genetics of morphology and growth in *Laminaria* from the North and G.R. South (Evolutionary Biogeography of the Marine Algae of the North Atlantic. NATO ASI Vol. 22. Springer-Verlag, Berlin, pp. 147-172.
- Egan, B. and Yarish, C. (1990). Productivity and life history of *Laminaria longicruris* de la Pyl. at its southern limit in the Western Atlantic Ocean. *Marine Ecology-Progress Series* 76: 263-273.
- Forbord, S., Skjermo, J., Arff, J., Handa, A., Reitan, K.I., Bjerregaard, R., Luning, K. (2012). Development of *Saccharina latissima* (Phaeophyceae) kelp hatcheries with year-round production of zoospores and juvenile sporophytes on culture ropes for kelp aquaculture. *J. Appl. Phycology.* 24:393-399.
- Fork, D.C. and Ames, J. (1967). Light induced shifts in the absorption spectrum of carotenoids in red and brown algae. *Photochemistry and Photobiology.* 6 (12): 913-918.

- Fowler-Walker, M.J., Wernberg, T., Connell S.D. (2006). Differences in kelp morphology between wave sheltered and exposed localities: morphologically plastic or fixed traits? *Marine Biology*. 148:755-767.
- Gendron, L., and Tamigneaux, É. (2008). *Expériences de culture de l'algue brune Saccharina longicuris en 2007: essais en bassin en mer au large de Paspébiac et de Grande-Rivière (Québec)*. Direction régionale des Sciences, Pêches et Océans Canada, Institut Maurice-Lamontagne.
- Kai, T., Nimura, K., Yasui, H., Mizuta, H. (2006). Regulation of sorus formation by auxin in *Laminariales* sporophyte. *J. Appl. Phycology*. 18(1): 95-101.
- Koehl, M.A.R., Alberte, R.S. (1988). Flow, flapping and photosynthesis of *Nereocystis luetkeana*: a functional comparison of undulate and flat blade morphologies. *Marine Biology*. 99: 435-444.
- Koehl, M.A.R., Silk, W. K., Liang, H., & Mahadevan, L. (2008). How kelp produce blade shapes suited to different flow regimes: A new wrinkle. *Integrative and Comparative Biology*, 48(6), 834-851.
- Kraan, S. (2010). Mass-cultivation of carbohydrate rich macroalgae, a possible solution for sustainable biofuel production. *Mitig. Strateg. Glob. Change*. 18: 27-46.
- Lignell, Å., Ekman, P., Pedersén, M. (1987). Cultivation technique for marine seaweeds allowing controlled and optimized conditions in the laboratory and on a pilotscale. *Botanica marina*, 30(5), 417-424.
- Lüning, K. and Dring, M.J. (1972). Reproduction induced by blue light in female gametophytes of *Laminaria saccharina*. *Planta* 104:252-256.
- Lüning, K. and Pang, S. (2003). Mass cultivation of seaweeds: current aspects and approaches. *J. Appl. Phycology*. 15: 115-119.
- Mathieson, A.C. and Penniman, C.A. (1986). A phytogeographic interpretation of the marine flora from the Isles of Shoals, U.S.A. *Botanica Marina*. 29(5): 413-434.
- Mathieson, A.C. (1989). Phenological patterns of northern New England seaweeds. *Botanica Marina*. 32: 419-438.
- Mathieson, A.C., Hehre, E.J., Hambrook, J., Gerweck, J. (1996). A comparison of insular seaweed floras from Penobscot Bay, Maine, and other northwest Atlantic Islands. *Rhodora*. 98 (896): 369-418.
- Mathieson, A.C., Dawes, C.J., Hehre, E.J. (1998). Floristic and zonation studies of seaweeds from Mount Desert Island, Maine: an historical comparison. *Rhodora*. 100(904): 333-379.
- Mathieson, A.C., Hehre, E.J., Dawes, C.J., Neefus, C.D. (2008). An historical comparison of seaweed populations from Casco Bay, Maine. *Rhodora*. 110 (941): 1-102.
- Mathieson, A.C., Dawes, C.J., Hehre, E.J., Harris, L.G. (2010). Floristic studies of seaweeds from Cobscook Bay, Maine. 2010. *Northeastern Naturalist*. 16 (5): 1-48.
- Merrill, J. E. and Gillingham, D. M. (1991). Bull Kelp Cultivation Handbook. National Coastal Research and Development Institute, 91(11). NCRI Publication No. NCRI-T-91-011.
- Mizuta, H., Nimura, K., Yamamoto, H. (1999). Sorus development on median and marginal parts of the sporophyte of *Laminaria japonica* Areschoug (Phaeophyceae). *J. Appl. Phycology*. 11:585-591.
- Nimura, K., and Mizuta, H. (2002). Inducible effects of abscisic acid on sporophyte discs from *Laminaria japonica* Areschoug (*Laminariales*, *Phaeophyceae*). *Jour. Appl. Phycology*. 14(3): 159 -163.

- Pang, S.J., and Lüning, K. (2004). Breaking seasonal limitation: year-round sporogenesis in the brown alga *Laminaria saccharina* by blocking the transport of putative sporulation inhibitors. *Aquaculture*. 240: 531-541.
- Peteiro, C. and Freire, O. (2009). Effect of outplanting time on commercial cultivation of kelp *Laminaria saccharina* at the southern limit in the Atlantic coast, N.W. Spain. *J. Ocean. Limnol.* 27 (1): 54-60.
- Provasoli, L. (1968). Media and prospects for the cultivation of marine algae. In: A. Watanabe, and A. Hatttori (ed), Cultures and Collections of Algae. Proc. U.S. - Japan Conf. Hakone, September 1966. *Jap. Soc. Plant Physiol.*, 63-75.
- Tamigneaux, E., Gendron, L., Benfey, T., Reid, G. K. (2011). Seaweed farming in Chaleurs Bay (Québec): results from 4 years of research and development activities. In *Aquaculture Canada and Cold Harvest 2010, proceedings of contributed papers, St. John's, Newfoundland and Labrador, Canada, 16-19 May 2010*. (pp. 67-69). Aquaculture Association of Canada.
- U.S. Department of Energy (U.S. DOE). (2011). Macroalgae analysis: A National GIS-based analysis of macroalgae production potential summary report and project plan. U.S. DOE contract No: DE-AC05-76RL01830.
- Westermeier, R., Patin, D., Ines Piel, M., Maier, I., Mueller, D.G. (2006). A new approach to kelp mariculture in Chile: production of free-floating sporophyte seedlings from gametophyte cultures of *Lessonia trabeculata* and *Macrocystis pyrifera*. *Aquaculture Research*. 37, 164-171.
- Xu, B., Zheng, Q.S., Qu, S.C., Cong, Y.Z., Tang, X.X. (2009). Introduction of a seedling production method using vegetative gametophytes to the commercial farming of *Laminaria* in China. *J. Appl. Phycology*. 21: 171-178.
- Yarish, C. and Egan, P.F. (1989). The Biology of *Laminaria longicruris* and its potential for mariculture in Long Island Sound. In: Kanungo, K., Brousseau, K., Singletary, R., and Liscek, L. (Editors) *The Second Conference on the Aquatic Environment: Problems and Perspectives*. Western Connecticut State University, Danbury, CT. pp. 55-89.
- Yarish, C., Brinkhuis, B.H., Egan, B., Garcia-Esquivel, Z. (1990). Morphological and physiological bases for *Laminaria* selection protocols in Long Island sound. In: Yarish, C., C.A. Penniman, and M. van Patten (Editors). *Economically Important Marine Plants of the Atlantic: Their Biology and Cultivation*. The Connecticut Sea Grant College, Groton, CT, pp. 53-94.
- Yarish, C., Penniman, C.A., Egan, B. (1990). Growth and reproductive responses of *Laminaria longicruris* de la Pyl. to nutrient enrichment. Proc. of the 13th International Seaweed Symposium. *Hydrobiologia* 204/205: 505-511.
- Zhang, Q.S., Qu, S.C., Cong, Y.Z., Luo, S.J., Tang, X.X. (2008). High throughput culture and gametogenesis induction of *Laminaria japonica* gametophyte clones. *J. Appl. Phycology*. 20: 205-211.



Farming the clean, cold waters of the Gulf of Maine, Ocean Approved creates 100% natural seaweed products that are high in nutrition, sustainably harvested, and easy to incorporate into your menus or products.

Our open-ocean kelp farms are the first in the nation and allow us to provide our customers with a local alternative to imported seaweeds.

We create seed in our nurseries using processes developed through our research, and culture the seaweed to maturity on our farms. This ensures the highest quality domestically produced seaweed available to the market.

Ocean Approved's fresh-frozen seaweed products are the first of their kind. Nature has designed Maine seaweeds to be the perfect frozen vegetable, and even we cannot tell the difference between our fresh-frozen and fresh seaweed.

This allows us to create blanched products that are mild in flavor, have a pleasing texture on the palate, are vibrant in color, and free of dyes and preservatives.

Ocean Approved, LLC

188 Presumpscot Street
Portland, ME 04103

www.oceanapproved.com

www.facebook.com/oceanapproved

