

OLYMPUS[®]

INSTRUCTIONS



EVIS EXERA II VIDEO SYSTEM CENTER
OLYMPUS CV-180

USA: CAUTION: Federal law restricts this device to sale by or on the order of a physician.

Contents

Labels and Symbols	1
Important Information — Please Read Before Use	3
Intended use	3
Instruction manual	3
User qualifications	5
Instrument compatibility	5
Repair and modification	6
Signal words	6
Dangers, warnings and cautions.....	7
Cardiac applications.....	11
Summary of Equipment Functions	12
Chapter 1 Checking the Package Contents	14
Chapter 2 Nomenclature and Functions	15
2.1 Front panel.....	15
2.2 Rear panel	19
2.3 Keyboard.....	22
2.4 Side panels	27
2.5 Videoscope cable EXERA II (MAJ-1430).....	27
2.6 Set-up of screen options	28
2.7 Monitor	29
2.8 Pointer.....	33
Chapter 3 Inspection	34
3.1 Inspection of the power supply	35
3.2 Inspection of the examination light.....	36
3.3 Inspection of the automatic brightness control function.....	37
3.4 Inspection of the monitor display	38
3.5 Inspection of the freeze function	39
3.6 Inspection of the release function	39
3.7 Inspection of the PinP (picture in picture) function.....	39
3.8 Inspection of the orientation function	39
3.9 Inspection of the special light observation function.....	40
3.10 Inspection of the scope switches and foot switches	40

3.11	Power OFF	40
Chapter 4	Operation.....	41
4.1	Operation flow	44
4.2	Connection of an endoscope	46
4.3	Turning the video system center ON.....	50
4.4	Recall of user preset data	51
4.5	White balance adjustment.....	52
4.6	Patient data	57
4.7	Observation of the endoscopic image.....	59
4.8	Recording of the observation image	59
4.9	Termination of the operation	60
Chapter 5	Functions.....	62
5.1	Front panel.....	62
	Image source buttons.....	62
	PinP (picture in picture) display.....	64
	Image enhancement mode (ENH.).....	67
	Iris mode.....	69
	White balance.....	70
	Brightness adjustment (Exposure)	71
	STOP button and PC card indicator	75
	PC card slot and eject button	76
	RESET button	80
5.2	Keyboard.....	81
	Domepoint	81
	Clearing characters from the screen ("F1")	82
	System setup ("Shift" + "F1").....	84
	Scope information ("F2")	84
	User preset ("Shift" + "F2").....	85
	Cursor ("F3").....	85
	Patient data ("Shift" + F3).....	86
	Freeze mode ("F4")	86
	Browse ("Shift" + "F4").....	87
	Stopwatch ("F5").....	88
	Automatic gain control (AGC) ("F6").....	89
	Contrast mode ("Shift" + "F6")	90
	Image zooming ("F7").....	91
	Color bar ("Shift" + "F7").....	93
	Image size ("F8")	94
	Printer lock ("Shift" + "F8").....	95
	Image enhancement ("F9").....	96
	White balance adjustment ("Shift" + "F9")	97
	Color tone adjustment ("COLOR").....	98
	Freeze ("FREEZE")	99
	Release ("RELEASE").....	101
	Arrow pointer ("Shift" + arrow keys and domepoint).....	102

	Color mode (“Shift” + “Alt” + “1”, “2”, “3”, “4”).....	104
	Ending examination (“EXAM END”).....	105
5.3	Image recording and playback (PC card)	106
	Storage level of the PC card.....	106
	Recording the frozen image on a PC card.....	108
	PC card menu.....	110
	Basic operation of the PC card menu.....	111
	Formatting of the PC card.....	114
	Playback images from the PC card	115
	Deleting images from a PC card.....	117
	Deleting folder from PC card	118
	Annotation of images.....	119
	Playback image annotation.....	122
	Playback the images using the personal computer	124
	Image files and folders.....	125
5.4	Image recording and playback (other than PC card)	127
	Image filing system.....	127
	Videocassette recorder (VCR).....	129
5.5	Printing images	131
	Video printer	131
5.6	Pre-entry of patient data	136
	Basic operation in the patient menu	136
	Entering new patient data.....	137
	Displaying patient data	140
	Editing previously entered patient data.....	141
	Deleting previously entered patient data	142
	Clearing all patient data previously entered.....	143
	Recording patient data into PC card.....	144
	Loading patient data from PC card	146
5.7	Scope information	148
	Displaying and entering scope information.....	149
5.8	Special light observation.....	151
	NBI (narrow band imaging).....	151
Chapter 6 Fuse replacement.....		153
Chapter 7 Care, Storage and Disposal.....		155
7.1	Care	155
7.2	Storage	156
7.3	Disposal	156

Chapter 8	Installation and Connection.....	157
8.1	Installation work flow.....	158
8.2	Installation of the equipment.....	159
8.3	Fitting of accessories.....	162
8.4	Light source.....	164
8.5	Monitor.....	170
8.6	Keyboard.....	178
8.7	Videocassette recorder (VCR).....	179
8.8	Video printer.....	181
8.9	OLYMPUS flushing pump (OFP).....	183
8.10	Foot switch.....	184
8.11	Ultrasound center.....	185
8.12	Connection to the AC mains power supply.....	189
Chapter 9	Function setup.....	193
9.1	Turning power ON.....	193
9.2	System setup.....	194
	Basic operation of the system setup.....	194
	System.....	197
	Printer.....	201
	Image filing system.....	206
	Monitor.....	208
	Videocassette recorder.....	211
	Saving the system setup.....	213
	Summary of settings.....	214
9.3	User preset.....	216
	Basic operation of the user preset.....	216
	Remote switch and foot switch (EXERA and VISERA).....	219
	Release function.....	223
	Recording format for PC card.....	224
	Freeze function.....	225
	Image enhancement (normal observation).....	226
	Color mode.....	228
	Image size.....	229
	Iris.....	232
	Iris speed.....	235
	Auto gain control (AGC).....	237
	Contrast.....	238
	Exposure area.....	239
	Electronic shutter.....	240
	Patient data display.....	241
	Scope nickname.....	242
	Release index time.....	243
	Indication of the special light observation.....	244
	Monitor orientation function.....	245

PinP (picture in picture) function.....	246
Special light observation.....	250
Image enhancement (NBI observation).....	250
Saving the user preset.....	251
Resetting the user preset data to the factory defaults	252
Deleting user preset data.....	253
Summary of settings.....	255
Chapter 10 Troubleshooting	259
10.1 Troubleshooting guide	259
10.2 Returning the video system center for repair	268
Appendix	269
System chart	269
Transportation, storage, and operation environment	276
Specifications	276
EMC information	282

Contents

Labels and Symbols

Safety-related labels and symbols are attached on the locations shown below. If labels or symbols are missing or illegible, contact OLYMPUS.

○ Rear panel

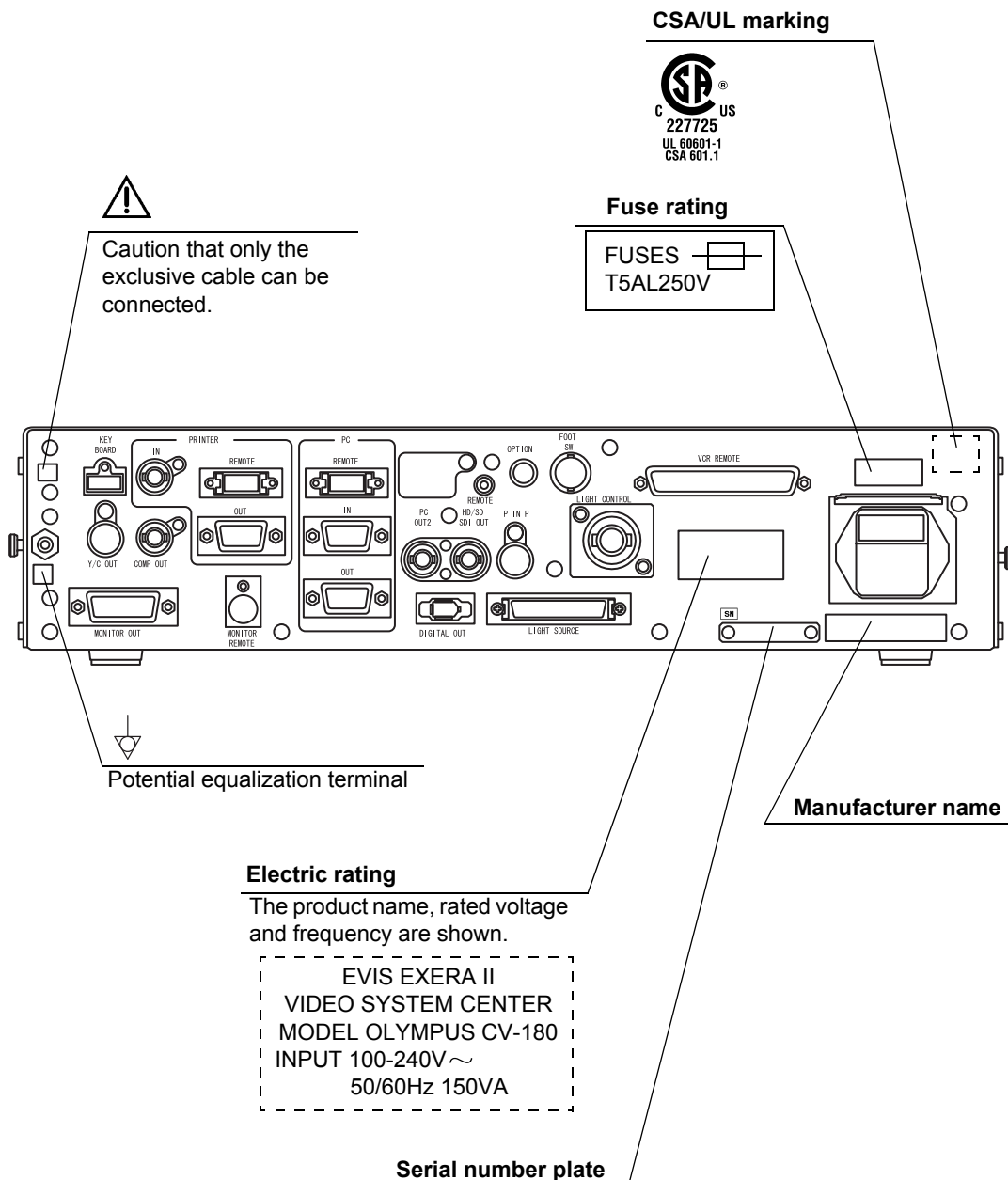

○ **Back cover of this instruction manual**



Manufacturer



Authorized representative in the European Community

Important Information — Please Read Before Use

Intended use

This video system center has been designed to be used with OLYMPUS camera heads, endoscopes, light sources, monitors, endo-therapy accessories and other ancillary equipment for endoscopic diagnosis, treatment and video observation. Do not use this video system center for any purpose other than its intended use.

Instruction manual

This instruction manual contains essential information on using this video system center safely and effectively. Before use, thoroughly review this manual and the manuals of all equipment which will be used during the procedure and use the equipment as instructed.

Keep this and all related instruction manuals in a safe, accessible location. If you have any questions or comments about any information in this manual, please contact Olympus.

○ Terms used in this manual

Light source:

The light source provides light and electrical signals to the endoscope. It also provides electrical signals to the video system center.

Video printer:

The video printer is a device that prints the frozen video image.

Wall mains outlet:

The wall mains outlet is a wall AC mains power outlet socket having the exclusive terminal for grounding.

Isolation transformer:

The isolation transformer is a safety device that is used to isolate non-insulated equipment with potentially high leakage currents to decrease the possibility of electric shock.

Image sensor (CCD):

Image sensor (CCD) is a device that converts light into electrical signals.

Automatic brightness control:

The automatic brightness control automatically adjusts the intensity of the light emitted from the light source so that the endoscopic image will be maintained at constant brightness even if the distance between the distal end of the endoscope's insertion tube and the subject changes.

Color adjustment:

Color adjustment adjusts the color balance on the video monitor.

Iris:

The iris function is used to electrically measure the brightness of an endoscopic image to obtain a control signal for the purpose of automatic light adjustment.

Freeze:

The freeze function creates a stationary view of the moving image.

Release:

The release function is used to capture and record an endoscopic image.

Edge enhancement:

Edge enhancement is an image processing technique that electronically sharpens the edges of an image.

Structure enhancement:

Structure enhancement is an image processing technique that electronically emphasizes the detailed patterns and edges of an image to increase sharpness.

PinP (Picture in picture):

PinP function displays both the image of the endoscopic live image and the image of an external device on the monitor simultaneously.

PC card:

A digital medium for storage of images, etc.

Wash out:

Wash out is the inability to see details in the endoscopic image due to excessive brightness.

HDTV:

High Definition Television. This is a format for high resolution video transmission featuring higher definition than the standard SDTV format.

SDTV:

Standard Definition Television. It is the format used in standard video systems.

Special light observation:

This is a observation using filtered light.

NBI (narrow band imaging):

This is one of the special light observations using the narrow band observation light.

User qualifications

If there is an official standard on user qualifications to perform endoscopy and endoscopic treatment that is defined by the medical administration or other official institutions, such as academic societies on endoscopy, follow that standard. If there is no official qualification standard, the operator of this instrument must be a physician approved by the medical safety manager of the hospital or person in charge of the department (department of internal medicine, etc.).

The physician should be capable of safely performing the planned endoscopy and endoscopic treatment following guidelines set by the academic societies on endoscopy, etc., and considering the difficulty of endoscopy and endoscopic treatment. This manual does not explain or discuss endoscopic procedures.

Instrument compatibility

Refer to the “System chart” in the Appendix to confirm that this video system center is compatible with the ancillary equipment being used. Using incompatible equipment can result in patient injury or equipment damage and makes it impossible to obtain the expected functionality.

This instrument complies with the EMC standard for medical electrical equipment; edition 2 (IEC 60601-1-2: 2001). However, when connecting to an instrument that complies with the EMC standard for medical electrical equipment; edition 1 (IEC 60601-1-2: 1993), the whole system complies with edition 1.

Repair and modification

This video system center does not contain any user-serviceable parts. Do not disassemble, modify or attempt to repair it; patient or operator injury, equipment damage and/or the impossibility to obtain the expected functionality can result. Some problems that appear to be malfunctions may be correctable by referring to Chapter 10, "Troubleshooting". If the problem cannot be resolved using the information in Chapter 10, contact Olympus. This instrument is to be repaired by Olympus technicians only.

Signal words

The following signal words are used throughout this manual:

DANGER

Indicates an imminently hazardous situation which, if not avoided, will result in death or serious injury.

WARNING

Indicates a potentially hazardous situation which, if not avoided, could result in death or serious injury.

CAUTION

Indicates a potentially hazardous situation which, if not avoided, may result in minor or moderate injury. It may also be used to alert against unsafe practices or potential equipment damage.

NOTE

Indicates additional helpful information.

Dangers, warnings and cautions

Follow the dangers and cautions given below when handling this video system center. This information is to be supplemented by the dangers and cautions given in each chapter.

DANGER

- Strictly observe the following precautions. Failure to do so may place the patient and medical personnel in danger of electric shock.
 - When this video system center is used to examine a patient, do not allow metal parts of the endoscope or its accessories to touch metal parts of other system components. Such contact may cause unintended current flow to the patient.
 - Keep fluids away from all electrical equipment. If fluids are spilled on or into the unit, stop operation of the video system center immediately and contact Olympus.
 - Do not prepare, inspect or use this video system center with wet hands.
- Never install and operate the video system center in locations where:
 - the concentration of oxygen is high;
 - oxidizing agents (such as nitrous oxide (N₂O)) are present in the atmosphere;
 - flammable gases are present in the atmosphere;
 - flammable liquids are near.

Otherwise, explosion or fire may result because this video system center is not explosion-proof.

WARNING

- In case of instrument failure or malfunction, always keep another video system center in the room ready for use.
- Never insert anything into the ventilation grills of the video system center. It can cause an electric shock and/or fire.
- Although the illumination light emitted from the endoscope's distal end is required for endoscopic observation and treatment, it may also cause alteration of living tissues such as protein denaturation of liver tissue and perforation of the intestines by inappropriate use.

Observe the following warnings on the illumination.

- Always set the minimum required brightness. The brightness of the image on a video monitor may differ from the actual brightness at the distal end of an endoscope. Especially in combination with endoscopes using an electrical shutter function, pay attention to the brightness level setting of the light source. When this instrument is used with a light source compatible with automatic brightness control function, be sure to use this function. The automatic brightness control function can keep the illumination light properly. Refer to the instruction manual of the light source for details.
- Do not continue observation in the proximity to tissue or keep the distal end of the endoscope in contact with living tissue for a long time. It may cause patient burns.
- When discontinuing the use of the endoscope, be sure to turn the light source OFF so that the endoscope does not irradiate unnecessary light.
- This product may interfere with other medical electronic equipment used in combination with it. Before use, refer to the Appendix to confirm the compatibility of this instrument with all equipment to be used.
- Do not use this product in any place where it may be subject to strong electromagnetic radiation (for example, in the vicinity of a microwave therapeutic device, MRI, wireless set, short-wave therapeutic device, cellular/portable phone, etc.). This may impair the performance of the product.

- If the endoscopic image dims during use, blood, mucus or debris may adhere to the light guide on the distal end of the endoscope. Carefully withdraw the endoscope from the patient and remove the blood or mucus in order to obtain optimum illumination and to ensure the safety of the examination. If you continue to use the endoscope in such a condition, the distal end temperature may rise and cause mucosal burns. It may also cause patient and/or operator injury.
- Do not rely on the special light observation method alone for primary detection of lesions or for a decision regarding any potential diagnostic or therapeutic intervention.
- For reasons described below, do not rely on the NBI imaging modality alone for primary detection of lesions or to make a decision regarding any potential diagnostic or therapeutic intervention.
 - It has not been demonstrated to increase the yield or sensitivity of finding any specific mucosal lesion including colonic polyps or Barrett's esophagus.
- To display observation images, connect the output terminal of the video system center directly to the monitor. Do not make the connection via any ancillary equipment. Images may disappear during observation depending on the condition of ancillary equipment.

CAUTION



- Do not use a pointed or hard object to press the buttons on the front panel and/or keyboard. This may damage the buttons.
- Do not touch the electrical contacts inside the video system center's connectors.
- Do not apply excessive force to this video system center and/or other instruments connected. Otherwise, damage and/or malfunction can occur.
- Do not connect or disconnect the endoscope connector while this video system center is turned ON. Connecting or disconnecting the endoscope while this video system center is ON may destroy the CCD. Turn the video system center OFF before connecting or disconnecting the endoscope.
- Clean and vacuum dust the ventilation grills using a vacuum cleaner, when necessary. Otherwise, the video system center may break down and gets damaged from overheating.

- Be sure that this instrument is not used adjacent to or stacked with other equipment (other than the components of this instrument or system) to avoid electromagnetic interference.
- Electromagnetic interference may occur to this instrument when it is placed near equipment marked with the following symbol or other portable and mobile RF communications equipment such as cellular phones. If radio interference occurs, mitigation measures may be necessary, such as reorienting or relocating this instrument or shielding the location.



NOTE

As defined by the international safety standard (IEC 60601-1), medical electrical equipment is classified into the following types: TYPE CF applied part (the instrument can safely be applied to any part of the body, including the heart), and TYPE B/BF applied part (the instrument can safely be applied to any organ except the heart). The part of the body that an endoscope or electrosurgical accessory can safely be applied to depends on the classification of the equipment to which the instruments are connected. Before beginning the procedure, check the current leakage classification type of each instrument to be used for the procedure. Classification types are clearly specified in the instruments' instruction manuals.

Symbol	Classification
	TYPE CF applied part
	TYPE BF applied part
	TYPE B applied part

Cardiac applications

DANGER

- Use only the devices listed in the “System chart” in the Appendix for endoscopic observation or treatment of the heart or areas near the heart. Other combinations of equipment may cause ventricular fibrillation or seriously affect the cardiac function of the patient.
- For cardiac applications, never support the endoscope with a metal surgical arm which is not electrically isolated from the ground. If not isolated, the endoscope will be connected to the ground through the surgical arm and bed, and will conduct unexpected leakage current which may seriously affect the cardiac function of the patient.
- The use of medical devices not specifically designed for cardiac applications may cause ventricular fibrillation or seriously affect the cardiac function of the patient. As specified by the international standard IEC 60601-1, any applied part used for observation or treatment of the heart or areas near the heart must meet “TYPE CF applied part” requirements for low electrical leakage current. When using endoscopes for endoscopic cardiac applications, the applied part requirements include all devices directly connected to the endoscope, such as the light guide cable, camera head and telescope holder. Each of these devices must individually meet the “TYPE CF applied part” requirements for leakage current limits if they are to be used for cardiac applications.

NOTE

The OLYMPUS light guide cables and camera heads listed in the “System chart” in the Appendix (TYPE CF applied part) which are suitable for cardiac applications bear a  mark.

Summary of Equipment Functions

This instrument is a system controller of the endoscopic image observation system that displays, records and prints the endoscopic images. Some of the functions of this instrument described below are enabled only when the required equipment are connected to this instrument. For more details, refer to the instruction manuals for this instrument and the other instruments connected.

Displaying the endoscopic images on the monitor

- The endoscopic live image and the other images of, for example, the ultrasonic endoscope connected to this instrument can be displayed on the monitor.
- The endoscopic image and other external images can be displayed on the same monitor at the same time (PinP function).
→ “PinP (picture in picture) display” on page 64
- Either a standard-definition (SDTV) monitor or high-definition (HDTV) monitor can be used.

Special light observation

Endoscopic observation using filtered light is available.
→ Section 5.8, “Special light observation” on page 151

Adjusting the endoscopic images

Images can be adjusted to enable clear and convenient observation.

- Adjustment of the image color
→ “Color tone adjustment (“COLOR”)” on page 98
- Adjustment of the image brightness
→ “Brightness adjustment (Exposure)” on page 71
- Changing the iris mode
→ “Iris mode” on page 69
- Changing the contrast mode
→ “Contrast mode (“Shift” + “F6”)” on page 90
- Enhancement of edge lines and patterns of the images
→ “Image enhancement mode (ENH.)” on page 67
- Changing the image size
→ “Image size (“F8”)” on page 94

- Enlargement of the images
→ “Image zooming (“F7”)” on page 91

Entering patient data

- The patient data such as name, sex, etc. can be entered and displayed on the monitor with the endoscopic live image.
→ Section 4.6, “Patient data” on page 57 and Section 5.6, “Pre-entry of patient data” on page 136.)
- Up to 40 sets of patients data can be stored on the PC card. These patient data can be copied to the other CV-180.
→ “Recording patient data into PC card” on page 144

Customizing the operations

Up to 20 remote switch settings and other functions such as iris mode, image enhancement, etc., can be stored.

→ Section 9.3, “User preset” on page 216

Recording images

- The endoscopic image can be recorded on the PC card.
→ Section 5.3, “Image recording and playback (PC card)” on page 106
- The endoscopic image can be recorded on the image-recording device connected to this instrument, and the recorded images can be played back.
→ Section 5.4, “Image recording and playback (other than PC card)” on page 127
- The endoscopic image can be printed from the printer connected to this instrument.
→ Section 5.5, “Printing images” on page 131

Operation of ancillary equipment

- Video cassette recorder
→ “Videocassette recorder (VCR)” on page 129
- Video printer
→ Section 5.5, “Printing images” on page 131
- Image filing system
→ “Image filing system” on page 127

Chapter 1 Checking the Package Contents

Match all items in the package with the components shown below. Inspect each item for damage. If the instrument is damaged, a component is missing or you have any questions, do not use the instrument; immediately contact Olympus.

Video system center (CV-180)

Keyboard (MAJ-1428)

Power cord

Videoscope cable EXERA II (MAJ-1430)

HDTV/SDTV monitor cable (MAJ-1462)

White cap (MH-155)

White cap holder (MAJ-960)

Foot holder (MAJ-1433, 4 pcs.)

White cap set (MAJ-941)

Water container (MAJ-901)

Scope cable holder (MAJ-1466)

Keyboard cover (MAJ-1557)

Spare fuse (MAJ-1432, 2 pcs.)

Instruction manual

Cable color sheet

Chapter 2 Nomenclature and Functions

2.1 Front panel

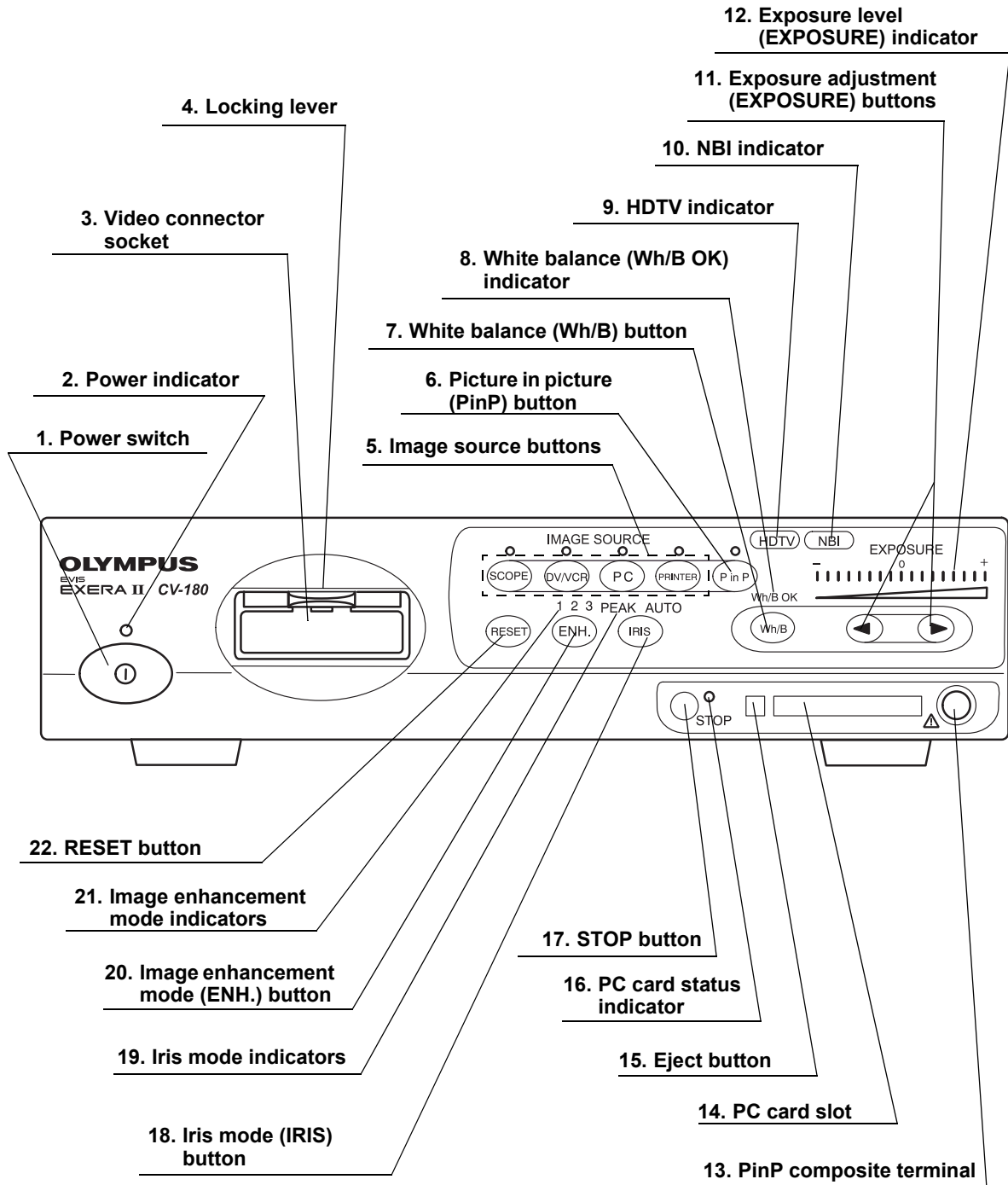

1. Power switch

Press to turn the video system center ON or OFF.

2. Power indicator

Lights up when the video system center is ON.

3. Video connector socket

The video plug of the videoscope cable, videoscope or camera head are connected to this socket.

4. Locking lever

Press down to disconnect the video plug of the videoscope cable, videoscope or camera head.

5. Image source buttons

Press these buttons to select the image sources to be displayed on the monitor. Press and hold the buttons to change (except "SCOPE").

→ "Image source buttons" on page 62

Button	The image on the monitor
SCOPE	The endoscopic live image
DV/VCR	The image of the videocassette recorder, etc.
PC	The image of the image filing system
PRINTER	The image of the video printer

6. Picture in picture (PinP) button

Press to display an image of the connected ancillary equipment and the endoscopic live image together on the monitor.

- Setting of the PinP function
→ "PinP (picture in picture) function" on page 246
- Operation of the PinP function
→ "PinP (picture in picture) display" on page 64

7. White balance (Wh/B) button

Press to perform the white balance adjustment.

→ Section 4.5, "White balance adjustment" on page 52

8. White balance (Wh/B OK) indicator

The indicator lights up when the white balance adjustment is completed.

9. HDTV indicator

Lights up green when the instrument is turned ON, and turns white when the HDTV compatible endoscope is connected to this instrument.

10. NBI indicator

Lights up green when the NBI compatible endoscope is connected to this instrument, and turns white during NBI observation. This indicator works only when the light source CLV-180 is used.

→ "NBI (narrow band imaging)" on page 151

11. Exposure adjustment (EXPOSURE) buttons

Press to adjust the brightness of the observation light. When CLV-180 is used, this button is interlocked with the "BRIGHTNESS" on CLV-180.

→ "Brightness adjustment (Exposure)" on page 71

12. Exposure level (EXPOSURE) indicator

Indicates the brightness level of the observation light.

→ "Brightness adjustment (Exposure)" on page 71

13. PinP composite terminal

The ultrasound center (EUS), endoscope position detecting unit (UPD) etc. can be connected to this connector to input the images to be displayed together with the endoscopic observation image. The PinP function can also be used with the PinP Y/C terminal on the rear panel. However, the PinP composite terminal takes priority over the PinP Y/C terminal.

14. PC card slot

Insert the PC card adapter (optional) in this slot. The xD picture card can be used as the storage media.

→ "PC card slot and eject button" on page 76

15. Eject button

Press to remove the PC card from the PC card slot.

→ "PC card slot and eject button" on page 76

16. PC card status indicator

This indicator lights up green when the PC card is inserted into the PC card slot, and blinks orange while accessing the PC card.

→ "PC card slot and eject button" on page 76

17. STOP button

Press to stop accessing the PC card. Be sure to press this button before removing the PC card from the PC card slot.

→ "PC card slot and eject button" on page 76

18. Iris mode (IRIS) button

Press to switch the iris mode (brightness adjustment method) of the endoscopic image. Either "AUTO" or "PEAK" mode can be selected.

- Presetting
→ "Iris" on page 232
- Switching operation
→ "Iris mode" on page 69

19. Iris mode indicators

Indicates the iris mode being selected.

20. Image enhancement mode (ENH.) button

“Image enhancement” refers to facilitate observation of edges and patterns of the endoscopic image by electronic treatment. Press this button to change the modes of the enhancement methods.

- Presetting
→ “Image enhancement (normal observation)” on page 226
or “Image enhancement (NBI observation)” on page 250
- Operation
→ “Image enhancement mode (ENH.)” on page 67

21. Image enhancement mode indicators

One of these indicators light up and indicates the image enhancement mode being selected. The indicator goes off when the image enhancement is not used.

22. RESET button

Press and hold the switch to return the settings changed during operation to the default settings.

→ “RESET button” on page 80

2.2 Rear panel

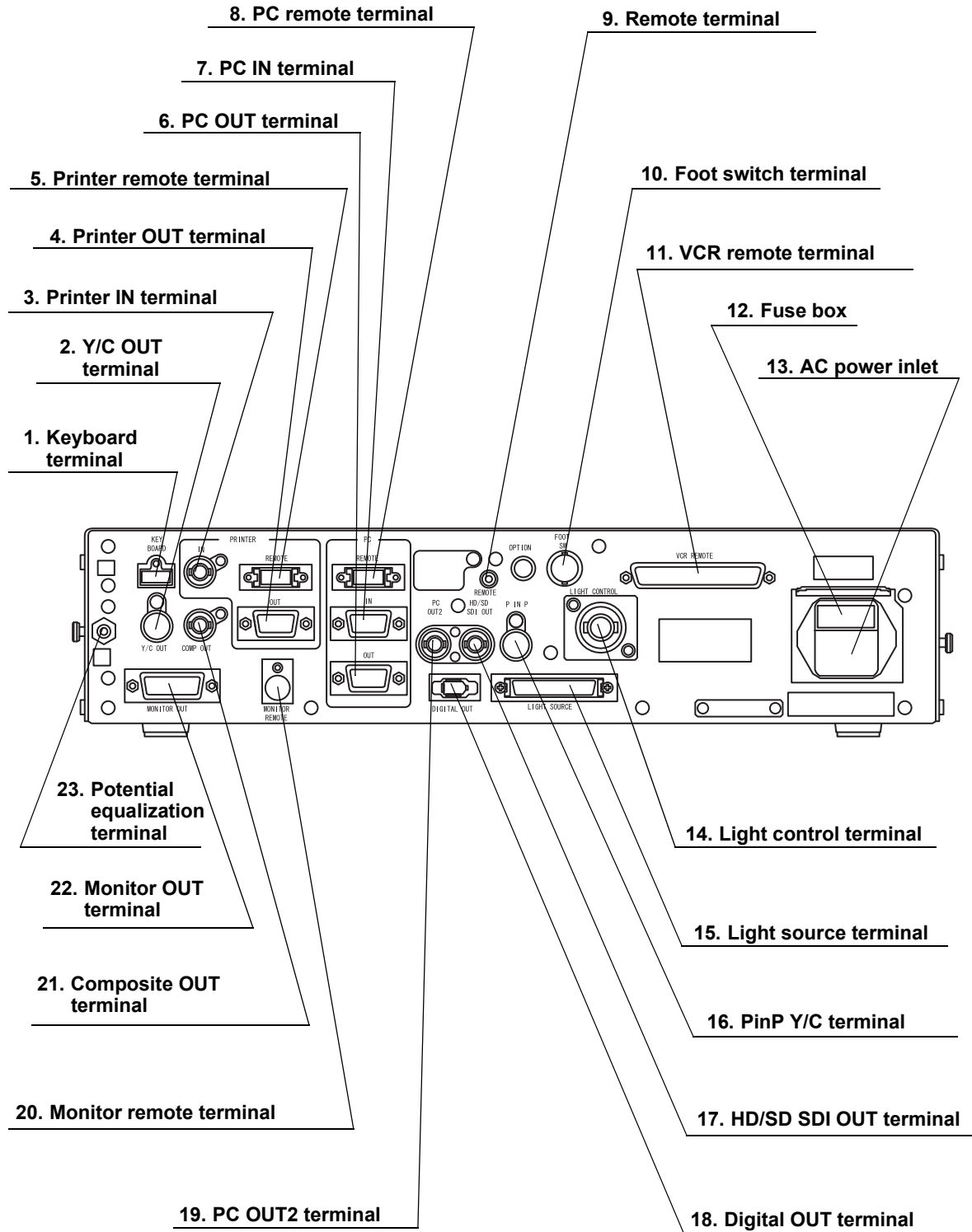

- 1. Keyboard terminal**
Connect the keyboard.
- 2. Y/C OUT terminal**
Outputs a Y/C video signals.
- 3. Printer IN terminal**
Connect the video printer. Inputs the analog video signal from the video printer.
- 4. Printer OUT terminal**
Connect the video printer. Outputs the analog video signal to the video printer.
- 5. Printer remote terminal**
Connect the video printer. Establishes communication with the video printer.
- 6. PC OUT terminal**
Connect the image filing system. Outputs the analog video signal to the image filing system.
- 7. PC IN terminal**
Connect the image filing system. Inputs the analog video signal from the image filing system.
- 8. PC remote terminal**
Connect the image filing system. Establishes communication with the image filing system.
- 9. Remote terminal**
Outputs the signal synchronizing the release and VCR (Rec/Pause) operation.
- 10. Foot switch terminal**
Connect the foot switch.
- 11. VCR remote terminal**
Connect an Olympus-recommended VCR. Outputs the analog video signal and the remote signals to the VCR.
- 12. Fuse box**
Stores the fuses that protect the instrument from electrical surges.
- 13. AC power inlet**
Connect the provided power cord to supply the AC power via this inlet.
- 14. Light control terminal**
Connect a light source that supports the analog interface.
- 15. Light source terminal**
Connect a light source CLV-180 that supports the digital interface.

16. PinP Y/C terminal

The ultrasound center (EUS), endoscope position detecting unit (UPD) etc. can be connected to this connector to input the image to be displayed together with the endoscopic observation image. The PinP function can also be used with the PinP composite terminal on the front panel. However, the PinP composite terminal takes priority over the PinP Y/C terminal.

17. HD/SD SDI OUT terminal

Connect a monitor compatible with the serial digital interface (SDI). Outputs the SDI signal.

18. Digital OUT terminal

Connect an Olympus-recommended digital video recorder to output and input the digital video signal to the digital video recorder, using IEEE1394 cable.

19. PC OUT2 terminal

Connect the image filing system. Outputs an SDI signal to the image filing system.

20. Monitor remote terminal

Connect the monitor. Outputs the monitor control signal to the monitor.

21. Composite OUT terminal

Outputs the composite video signal.

22. Monitor OUT terminal

Connect the monitor. Outputs analog video signals to the monitor. HDTV signal is output when the HDTV compatible endoscope is connected. This connector can output a 180° rotated image (see "Monitor orientation function" on page 245).

23. Potential equalization terminal

This terminal is connected to a potential equalization terminal of the other equipment connected to this instrument. The electric potential of their equipment are made equal.

2.3 Keyboard

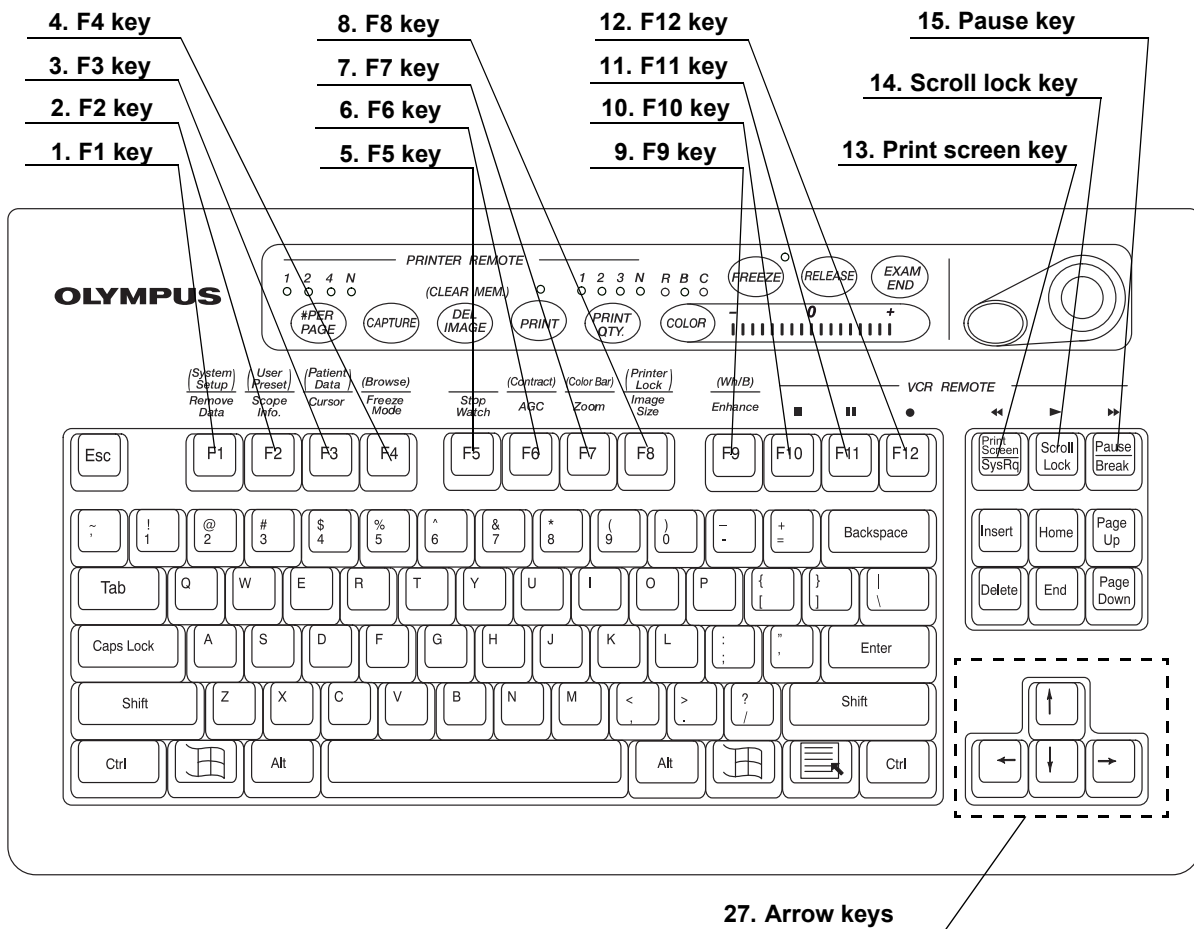
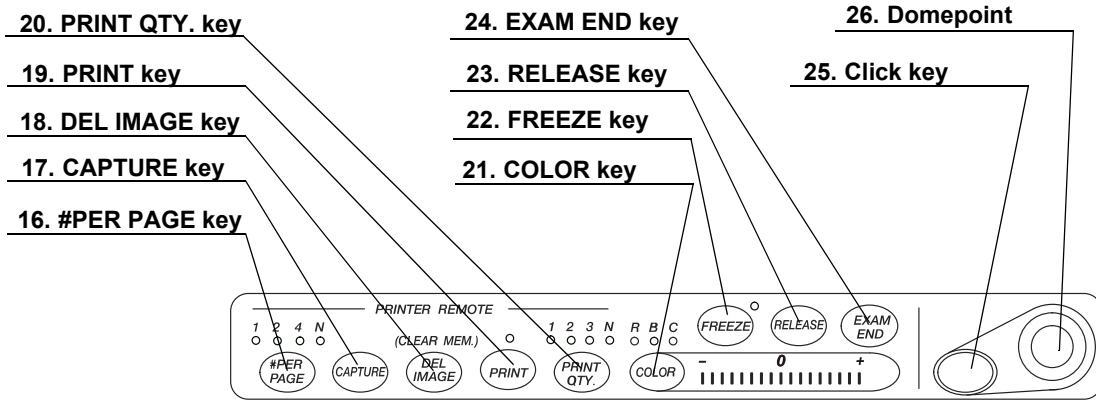

1. F1 key

Press to clear or re-display the patient data on the monitor step by step.

→ “Clearing characters from the screen (“F1”)” on page 82

Press together with the “Shift” key to display the system setup menu to set the basic functions of this instrument.

→ “System setup (“Shift” + “F1”)” on page 84

2. F2 key

Press to display the scope information window when using an endoscope with the endoscope information memory function. While the window is still open, press this key again to display the scope information menu that shows the information about the connected endoscope.

→ “Scope information (“F2”)” on page 84

Press together with the “Shift” key to display the user preset menu to set and call up the observation condition of the endoscopic image.

→ See “User preset (“Shift” + “F2”)” on page 85

3. F3 key

Press to switch the display of the cursor on screen ON and OFF.

→ “Cursor (“F3”)” on page 85

Press together with the “Shift” key to display the patient data menu to enter or call up the patient data onto the monitor.

→ “Patient data (“Shift” + F3)” on page 86

4. F4 key

Press to change the freeze mode.

→ “Freeze mode (“F4”)” on page 86

Press together with the “Shift” key to display the PC card menu to store or call up the image data or the patient data from the PC card.

→ “Browse (“Shift” + “F4”)” on page 87

5. F5 key

Press to change the clock on the monitor to a stopwatch, and to start time counting.

→ “Stopwatch (“F5”)” on page 88

6. F6 key

Press to switch the auto gain control (AGC) function ON and OFF.

→ “Automatic gain control (AGC) (“F6”)” on page 89

Press together with the “Shift” key to switch between the three steps of the observation image contrast.

→ “Contrast mode (“Shift” + “F6”)” on page 90

7. F7 key

Press to change the zoom ratio of the observation image in three steps (x1; x1.2; x1.5).

→ “Image zooming (“F7”)” on page 91

Press together with the “Shift” key to display the color bar for checking the color of the monitor.

→ “Color bar (“Shift” + “F7”)” on page 93

8. F8 key

Press to change the image area size on the monitor.

→ “Image size (“F8”)” on page 94

Press together with the “Shift” key to disable the functions of the following 5 keys for video printer operation: #PER Page, CAPTURE, DEL IMAGE, PRINT, PRINT QTY.

→ “Printer lock (“Shift” + “F8”)” on page 95

9. F9 key

Press to switch the image enhancement mode.

→ “Image enhancement (“F9”)” on page 96

Press together with the “Shift” key to perform the white balance adjustment.

→ “White balance adjustment (“Shift” + “F9”)” on page 97

10. F10 key

Press to stop (■) the VCR.

→ “Videocassette recorder (VCR)” on page 129

11. F11 key

Press to pause (▬) the VCR. Press the Scroll (▶) key to resume play.

→ “Videocassette recorder (VCR)” on page 129

12. F12 key

Press to start (●) VCR recording.

→ “Videocassette recorder (VCR)” on page 129

13. Print screen key

Press to fast-rewind (◀◀) the VCR.

→ “Videocassette recorder (VCR)” on page 129

14. Scroll lock key

Press to playback (▶) the VCR.

→ “Videocassette recorder (VCR)” on page 129

15. Pause key

Press to fast-forward (▶▶) the VCR.

→ “Videocassette recorder (VCR)” on page 129

16. #PER PAGE key

Press to set the number of images per video print sheet. The indicator corresponding to the number lights up. An arbitrary number “N” on the keyboard depends on the printer.

→ Section 5.5, “Printing images” on page 131

17. CAPTURE key

Press to capture the image in the video printer.

→ Section 5.5, “Printing images” on page 131

18. DEL IMAGE key

Press to set the printer cursor back on the print sheet by one. Press together with the "Shift" key to delete a captured image at the position of the cursor.
→ Section 5.5, "Printing images" on page 131

19. PRINT key

Press to print the images captured in the video printer.
→ Section 5.5, "Printing images" on page 131

20. PRINT QTY. key

Press to specify the number of video print sheets to print simultaneously. The indicator corresponding to the number lights up. An arbitrary number "N" on the keyboard can be specified in the system setup menu.
→ Section 5.5, "Printing images" on page 131

21. COLOR key

Press to select R (Red), B (Blue) or C (Chroma) to adjust the color of the endoscopic image. The lamp corresponding to the selected tone above the key lights up. Adjust the selected color tone using the "right" or "left" arrow keys. The indicator on the right side of the "COLOR" key shows the adjustment status.
→ "Color tone adjustment ("COLOR")" on page 98

22. FREEZE key

Press to freeze the live endoscopic image. Press the key again to return to the live image.
→ "Freeze ("FREEZE")" on page 99

23. RELEASE key

Press to record the image into the video printer, image filing system and PC card. The recording devices to operate should be set in advance.
→ "Release ("RELEASE")" on page 101

24. EXAM END key

Press to execute the examination end processing.
→ "Ending examination ("EXAM END")" on page 105

25. Click key

Press this key to enter an item after selecting the item using the domepoint.
→ "Domepoint" on page 81

26. Domepoint

Moves the arrow pointer. Selects an item in the menu or puts a marking in the endoscopic image.
→ "Domepoint" on page 81

27. Arrow keys

Moves the cursor.

Press one of these keys together with the “Shift” key to display the arrow pointer on the endoscopic image.

→ “Arrow pointer (“Shift” + arrow keys and dome point)” on page 102

28. Other keyboard keys

- Esc
Cancels the selection or returns to the previous screen.
- Tab
Goes to the next input area, or returns to the previous input area.
- Enter
Fixes entry and goes to the next text box or screen.
- Shift, Alt
Executes functions together with other keys.
- Back space
Clears the character left of the cursor.
- Delete
Clears the character right of the cursor.

2.4 Side panels

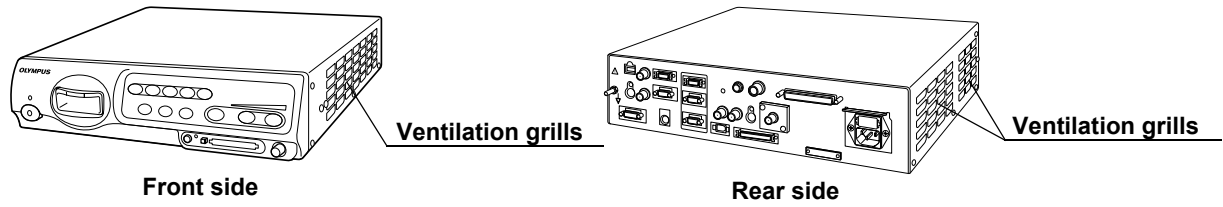

2.5 Videoscope cable EXERA II (MAJ-1430)

"UP" mark

Connect to the video system center "UP" side up.

Video plug

Connect to the video connector socket of the video system center.

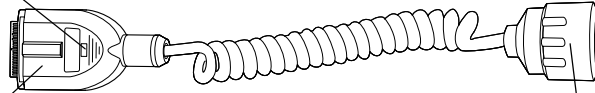

Scope side connector

Connect to the scope connector of the endoscope.

2.6 Set-up of screen options

The software of this instrument has the following functions.

- **The screen of the endoscopic live image and the images of the external instruments connected to this instrument**

This is the basic screen of the instrument. This instrument starts the endoscopic live image when it is turned ON.

→ Section 3.4, “Inspection of the monitor display” on page 38

- **System setup screen**

This screen is used for setting the basic functions to operate this instrument and the other instruments connected to it correctly.

→ Section 9.2, “System setup” on page 194

- **User preset screen**

Up to 20 user presets are available to save individual user settings. The factory default settings are set before shipment.

→ Section 9.3, “User preset” on page 216

- **Patient data screen**

Patient name, sex, age, etc. can be entered for up to 40 patients in advance. Existing patient data can be accessed and displayed on the monitor together with the endoscopic image, and can be stored on the PC card.

→ Section 5.6, “Pre-entry of patient data” on page 136

- **PC card menu screen**

This screen is used to browse endoscopic images on the PC card.

→ “PC card menu” on page 110

- **Scope information screen**

This screen is used to display and/or enter endoscope information such as the type of endoscope, etc.

→ Section 5.7, “Scope information” on page 148

- **Color bar screen**

This screen is used to check the display color.

→ “Color bar (“Shift” + “F7”)” on page 93

2.7 Monitor

Endoscopic image display

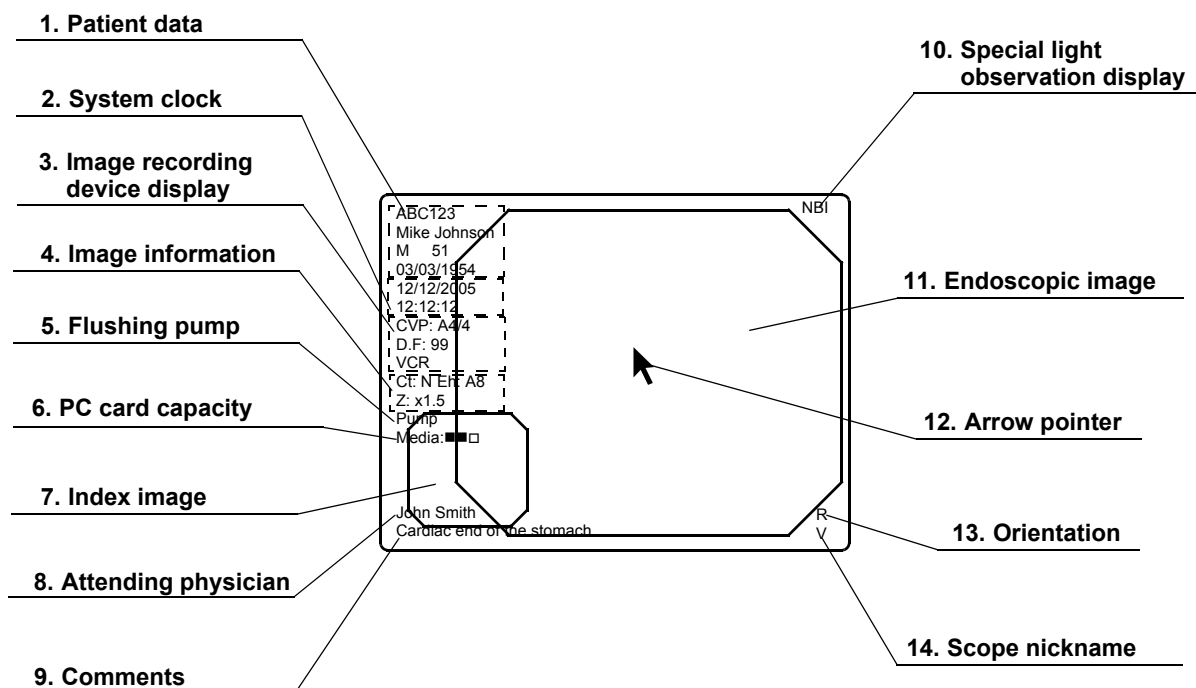

1. Patient data

Patient data such as name sex, etc. can be entered and displayed in this area.

→ Section 4.6, “Patient data” on page 57

2. System clock

Date and time are displayed. The date format can be set.

→ “Date and time” on page 197

The clock has the stopwatch function.

→ “Stopwatch (“F5”)” on page 88

3. Image recording device display

The status of the image recording devices that record and print the image are displayed only when the recording devices are activated.

Indication	Device	Details
CVP	Video printer	page 131
D.F	Digital filing system	page 127
VCR	Videocassette recorder	page 129

4. Image information

Displays image information on the monitor. The indications are displayed only when these function are operated.

Indication	Meaning	Details
Ct	Contrast	page 90
Eh	Enhancement mode	page 67
Z	Zoom ratio	page 91

5. Flushing pump

Displayed only when the Olympus flushing pump (OFP) is processing.

6. PC card capacity

Indicates the remaining memory level of the PC card when the PC card is inserted in the PC card slot.

→ "Storage level of the PC card" on page 106

7. Index image

Displays the reference image of the image taken by "RELEASE".

→ "Release index time" on page 243

8. Attending physician

The physician's name can be entered and displayed together with the patient data.

9. Comments

Comments can be entered and displayed together with the patient data.

10. Special light observation display

Indicates the name of the special observation function during the observation.

→ Section 5.8, "Special light observation" on page 151

11. Endoscopic image

The live endoscopic image is displayed in this area. The size and shape of the image depends on the type of endoscope used.

→ "Image size" on page 229

12. Arrow pointer

The arrow pointer is used for pointing out a part of the endoscopic image and for entering data in the menus.

- Displaying
→ "Arrow pointer ("Shift" + arrow keys and domepoint)" on page 102
- Operation
→ "Domepoint" on page 81

13. Orientation

"R" mark appears when a 180° reverse image is displayed.

→ "Monitor orientation function" on page 245

14. Scope nickname

The scope nickname is displayed when an endoscope with a scope nickname function is connected.

→ “Scope nickname” on page 242

Data input menu

Function button

Saves data, terminates the menu, etc.

Menu name

Text box

For entering and displaying data.

Highlight

Indicates in blue that the function button is selected.

Cursor

Used for entering data.

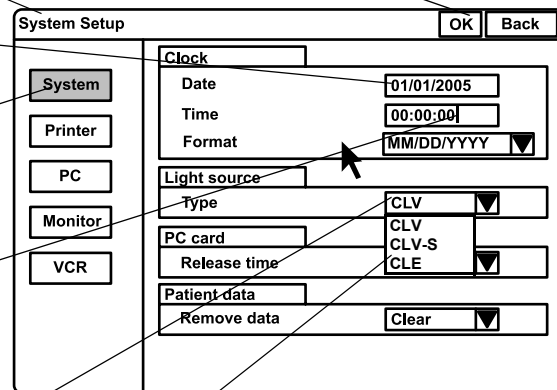

List box

Opens the pull down menu and selects the setting values.

Pull down menu

Click "▼" to show the setting values in the pull down menu.

Scroll bar

Shows all setting values not being displayed in the list box.

Arrow pointer

Moves the cursor, selects the function buttons, displays the pull down menus.

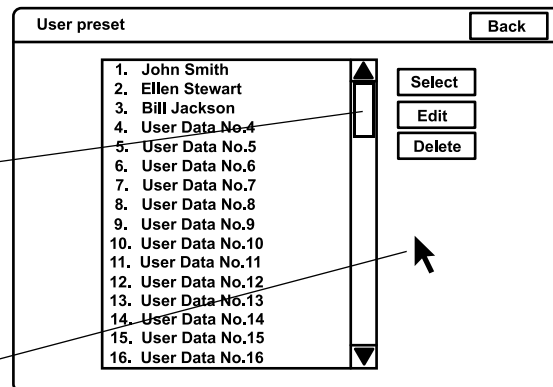

2.8 Pointer

Highlight, cursor and arrow pointer are available as pointing devices for the endoscopic image and menus on the monitor.

Pointer	Function	Screen	Displaying and operation
Highlight	Indicates the button selected.	<ul style="list-style-type: none"> • System setup menu • User preset menu • Patient data menu • Scope information menu • PC card information menu 	<p>Always displayed.</p> <p>Movable by pressing the arrow, "Tab", or "Shift" + "Tab" keys.</p>
Cursor	Indicates the position to enter data.	<ul style="list-style-type: none"> • System setup menu • User preset menu • Patient data menu • Scope information menu • PC card information menu • Endoscopic image screen 	<p>Always displayed.</p> <p>Movable by pressing the arrow, "Home", or "End" keys.</p>
Arrow pointer	Moves the cursor and focus or points out a specific portion of the image.	<ul style="list-style-type: none"> • System setup menu • User preset menu • Patient data menu • Scope information menu 	<p>Always displayed.</p> <p>Movable by the domepoint.</p>
		<ul style="list-style-type: none"> • PC card menu • Endoscopic image screen 	<p>Always displayed on image screen (unless full image screen selected). Press "Shift" and any arrow key in the full image screen to display/remove the arrow pointer.</p> <p>Press "Shift" and any arrow key.</p>

Chapter 3 Inspection

WARNING

- Review Chapter 8, “Installation and Connection” thoroughly, and prepare the instruments properly before inspection. If the equipment is not properly prepared before each use, equipment damage, patient and operator injury and/or fire can occur.
- Before each procedure, inspect the video system center as instructed below. Inspect other equipment to be used with this video system center as instructed in their respective instruction manuals. Should any irregularity be observed, do not use the video system center and see Chapter 10, “Troubleshooting”. If the irregularity is still observed after consulting Chapter 10, contact Olympus. Damage or irregularity may compromise patient or user safety and may result in more severe equipment damage.

Prepare the video system center and other ancillary equipment before each particular case. Refer to the respective instruction manual for each piece of equipment.

3.1 Inspection of the power supply

1. Confirm that the videoscope cable, camera head and/or endoscope is connected to the videoscope cable socket of the instrument.

NOTE

For the connection of the endoscope or scope cable, refer to Section 4.2, "Connection of an endoscope" on page 46.

2. Press the power switch of the instrument (see Figure 3.1). The indicator lamp above the power switch lights up.

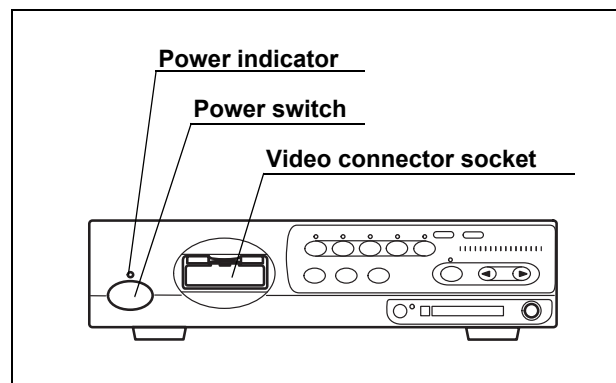

Figure 3.1

○ If the power fails to come ON

When the power fails to come ON, turn the video system center OFF. Then check the video system center referring to Chapter 10, "Troubleshooting". If the power still fails to come ON, contact Olympus.

3.2 Inspection of the examination light

WARNING

Do not stare directly into the light beam. This may result in eye injury.

Turn ON the light source and confirm that examination light is emitted from the distal end of the endoscope (see Figure 3.2). For operation of the light source, refer to its instruction manual.

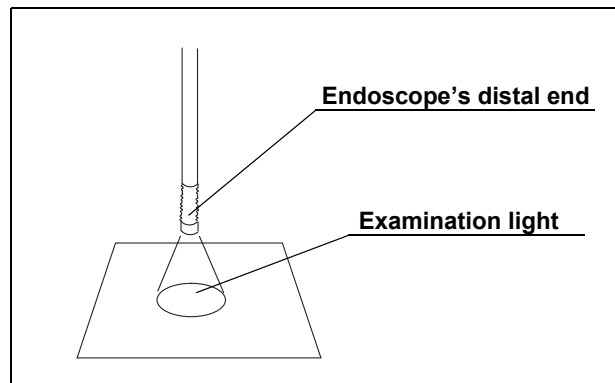

Figure 3.2

3.3 Inspection of the automatic brightness control function

1. Confirm that this instrument is connected to the light source using the light source cable or light control cable (see Section 8.4, "Light source" on page 164).
2. According to the directions given in the light source's instruction manual, confirm that the light source's brightness control is set to "AUTO" and that the brightness level is in the center of the adjustable range.
3. Move the distal end of the endoscope between 1 and 3 cm from your palm. Confirm that the brightness of the image on the monitor remains constant. Confirm that the light emitted from the distal end of the endoscope changes in your palm.
4. Hold the distal end of the endoscope 3 cm from your palm. Use a piece of gauze, etc. to prevent the endoscope's distal end and your palm from being exposed to extraneous light. View the image on the monitor.
5. Confirm that the brightness of the image on the monitor changes when the light source's brightness level is changed.

NOTE

- In combination with some endoscope models, the space between the distal end of the endoscope and your palm in which the automatic brightness control function is available will be smaller than 1 - 3 cm. Please refer to the instruction manual of the endoscope used.
- Depending on the light source connected, the exposure level indicator on the video system center goes off. Control the brightness on the light source referring to "Brightness adjustment (Exposure)" on page 71.

3.4 Inspection of the monitor display

CAUTION

Be sure to perform white balance adjustment before inspecting the color on the monitor display. See Section 4.5, "White balance adjustment" on page 52.

1. Turn the instrument ON. Then the endoscopic image appears on the screen (see Figure 3.3).

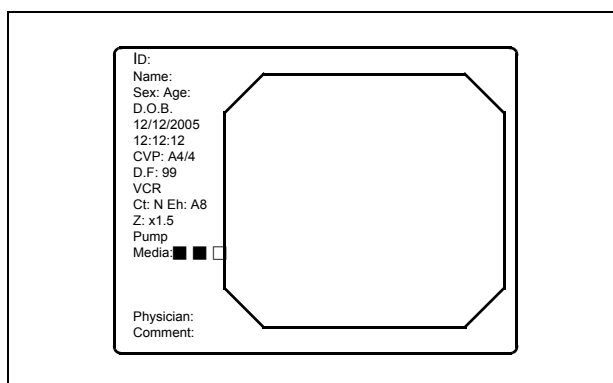

Figure 3.3

2. Confirm that the endoscopic image is normal by observing any object such as the palm of your hand.
3. Confirm that the date and time are correct.
4. Confirm that the "CVP" counter and "D.F" counter are displayed on the screen when the video printer and digital filing system are connected.
5. Confirm that enough space is available on the PC card to store endoscopic images.

NOTE

- The display layout is variable according to the connected endoscope and user preset.
- For setting the date or time, refer to "Date and time" on page 197.

3.5 Inspection of the freeze function

WARNING

Do not use this instrument when the live image cannot be observed. Otherwise, patient injury may occur.

1. Press the "FREEZE" key on the keyboard, and confirm that the live endoscopic image freezes and a short beep is heard.
2. Press the "FREEZE" key again and confirm that the frozen image returns to the live image.
3. Confirm the function of the scope switches and/or foot switches, when the freeze function is assigned to these switches.

3.6 Inspection of the release function

1. Press the "RELEASE" key on the keyboard.
2. Confirm that the live image freezes for a short time and a beep is heard.
3. Confirm that the selected recording device is activated.
4. Confirm that the counter for the recording devices, which are displayed on the monitor, increments by one.
5. Confirm the function of the scope switches and/or foot switches, when the release function is assigned to these switches.

3.7 Inspection of the PinP (picture in picture) function

According to the "PinP (picture in picture) display" on page 64, confirm that the PinP indication can be performed correctly.

3.8 Inspection of the orientation function

If the orientation function is activated, confirm that the indication on the monitor is an endoscopic image rotated by 180° (refer to "Monitor orientation function" on page 245).

3.9 Inspection of the special light observation function

According to Section 5.8, "Special light observation" on page 151, confirm that the image of the special light observation can be displayed correctly.

3.10 Inspection of the scope switches and foot switches

If any function is assigned to the scope's remote switches and/or foot switches, confirm the proper function of these switches.

3.11 Power OFF

Press the power switch of the instrument (see Figure 3.1) to turn the instrument OFF. The indicator above the switch goes off.

Chapter 4 Operation

This chapter explains the work flow of endoscopic observation using the video system center. For information on how to use the functions that are not explained in this chapter, refer to the reference pages.

The operator of the video system center must be a physician or medical personnel under the supervision of a physician and must have received sufficient training in clinical endoscopic techniques. This manual, therefore, does not explain or discuss clinical endoscopic procedures. It only describes basic operation and precautions related to the operation of the video system center.

WARNING

- Be sure to wear protective equipment such as eye wear, face mask, moisture-resistant clothing and chemical-resistant gloves that fit properly and are long enough so that your skin is not exposed. Otherwise, dangerous chemicals and/or potentially infectious material such as blood and/or mucus of the patient may cause an infection.
- Should any irregularity is observed, do not use the video system center. Damage or irregularity may compromise patient or user safety and may result in more severe equipment damage.
- Anytime you observe an abnormality in a video system center function, stop the examination immediately and take action according to the following procedures. Using a defective video system center may cause patient and/or operator injury.
 - If the endoscopic image disappears or if the image freezes and cannot be restored, press the “RESET” button or temporarily turn the video system center OFF and wait for about 10 seconds. Then turn it back ON again.
For ancillary equipment used in conjunction with the video system center, also turn the power OFF and then ON again as directed in their respective instruction manuals. If this fails to correct the problem, immediately stop using the equipment and turn the video system center and light source OFF. Then, gently withdraw the endoscope from the patient as described in the endoscope's instruction manual.

- If any other abnormality occurs or is suspected, immediately stop using the equipment, turn OFF all equipment, and gently withdraw the endoscope from the patient as described in the endoscope's instruction manual. Then refer to the instructions in Chapter 10, "Troubleshooting". If the problems cannot be resolved by the remedial action described in Chapter 10, do not use the equipment and contact Olympus.
- Combination with other equipment
 - Do not use the video system center in locations exposed to direct strong electromagnetic radiations (for example, microwave treatment device, short wave treatment device, MRI or radio equipment). Electromagnetic radiation can interfere with the monitor display.
 - Use only Olympus high-frequency electrosurgical equipment with this unit. Non-Olympus equipment can cause interference on the monitor display or a loss of the endoscopic image.
 - Before using high-frequency electrosurgical equipment, be sure to install and connect the equipment according to its instruction manual and make sure that the noise does not affect the observation and surgical procedures. If high-frequency electrosurgical equipment is used without such confirmation, patient injury may result.
- To activate the auto brightness control function of the light source, the video system center should be turned ON. If it is not turned ON, the auto brightness control function is not activated and the light intensity is set to maximum. In this case, the endoscope distal end would become hot and could cause burns to the operator and physician (if a light source model other than CLV-180 is used).
- When using spray-type medical agents such as lubricant, anesthetic, or alcohol, use them away from the video system center so that the medical agents do not contact the video system center. Medical agents might enter the video system center through the ventilation grills and may cause equipment damage.
- Do not use a humidifier near the video system center as dew condensation possibly might occur and it may cause equipment failure.

NOTE

- High-frequency electrosurgical equipment can cause slight interference on the monitor display.
- Sometimes horizontal line noise appears when a slim endoscope is used. To reduce the horizontal line noise, select “Edge enhancement” for the enhancement setting.

4.1 Operation flow

Please see the operation work flow in Figure 4.1 below. Follow each step of the work flow for using the video system center.

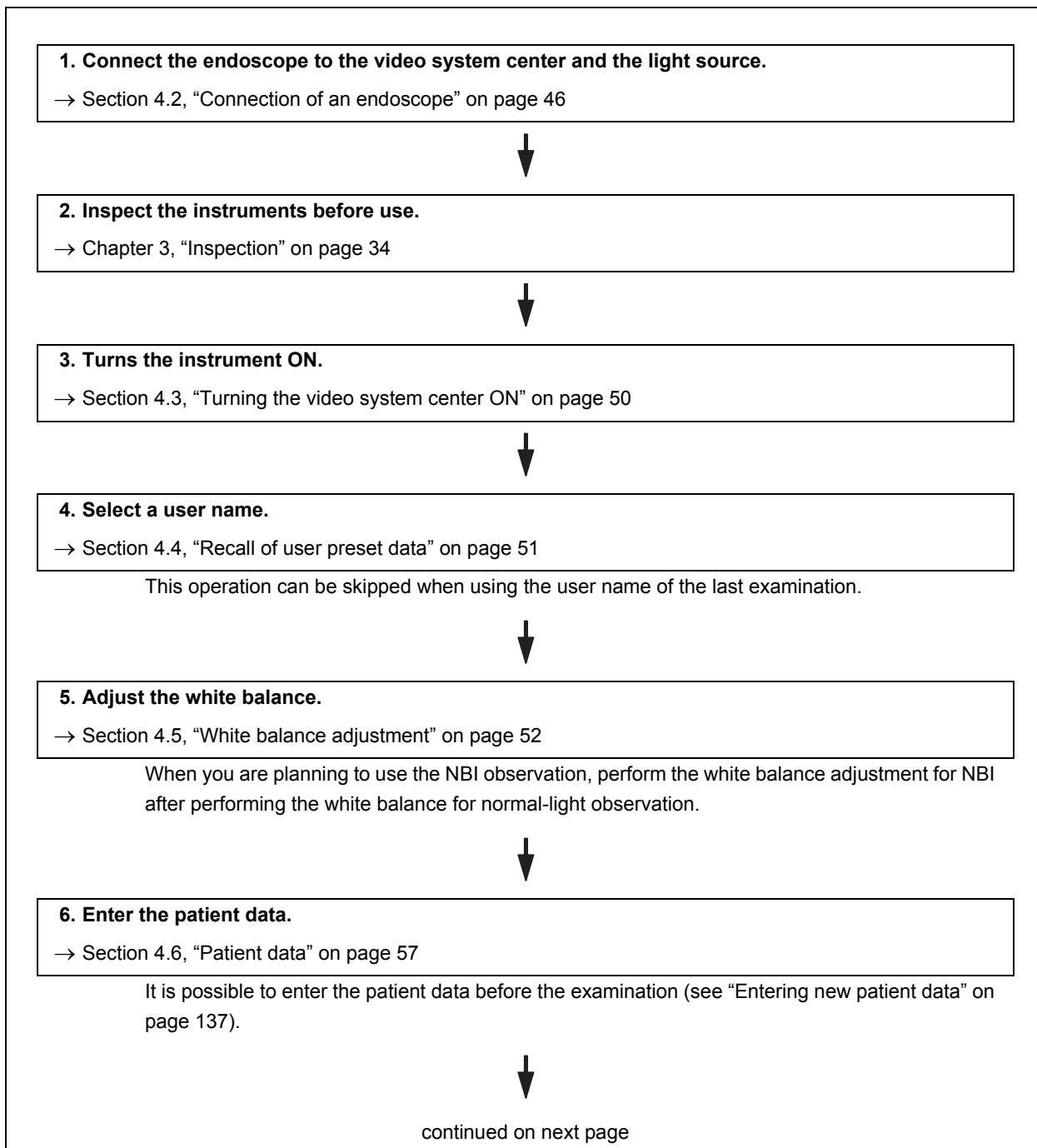

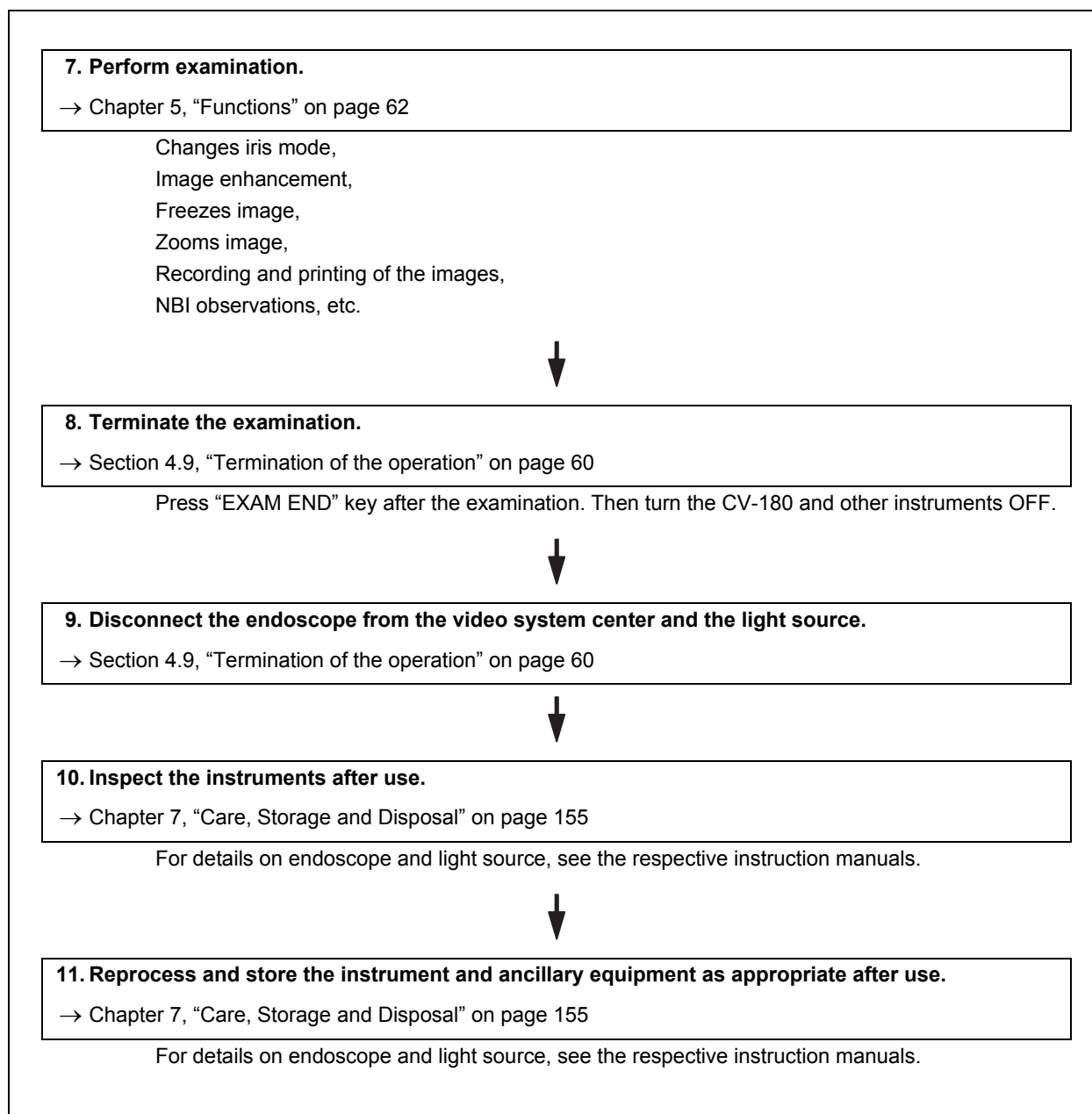

Figure 4.1

4.2 Connection of an endoscope

Connect the endoscope to the video system center and the light source. The connection may require special cables. Refer to the instruction manuals of ancillary equipment for details on the cables to be used.

WARNING

- Make sure that the video plug and its electrical contacts are completely dry before connecting the plug to the video system center (see Figure 4.2). Wet equipment could cause the image to flicker or disappear.

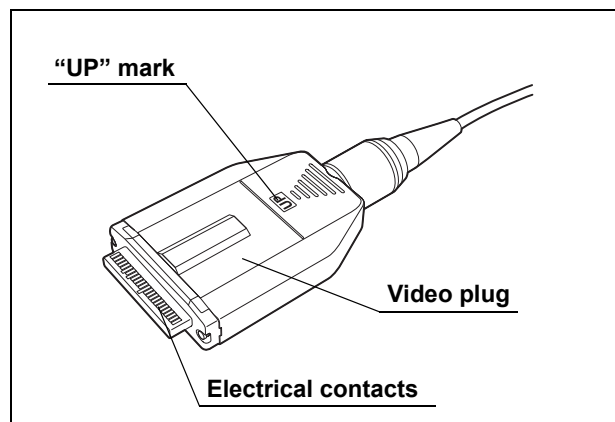

Figure 4.2

- Do not apply excessive force to the camera cable of the camera head by bending, stretching or crushing it. Also do not pull a bundle of camera cables, as this may cause internal wire disconnection.

CAUTION

- Do not connect or disconnect the endoscope connector while this video system center is turned ON. Connecting or disconnecting the endoscope while this video system center is ON may destroy the CCD. Turn the video system center OFF before connecting or disconnecting the endoscope.
- Connect the video plug all the way into the socket. The improper connection may increase image noise or may cause disappearance of the endoscopic image during operation
- Be sure to refer to the instruction manuals of the ancillary equipment including the endoscope and camera cable.

VISERA series videoscope

1. Ensure that this instrument and all connected devices are turned OFF.
2. Connect the endoscope connector of the videoscope to the light source, referring to the instruction manual for the light source.
3. Push the video plug into the video connector socket of the instrument all the way until it clicks, holding this instrument with a hand so that it will not move. Confirm that the "UP" mark points upwards (see Figure 4.3).

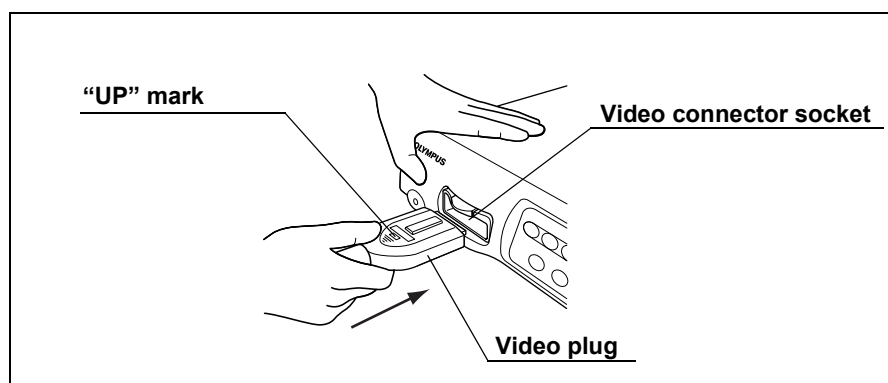

Figure 4.3

EVIS series videoscope and ultrasonic videoscope

1. Ensure that this instrument and all connected devices are turned OFF.
2. Connect the endoscope connector of the fiberscope to the light source referring to the instruction manual for the light source.
3. Push the video plug of the scope cable EXERA II into the video connector socket of the instrument all the way until it clicks, holding this instrument with a hand so that it will not move. Confirm that the "UP" mark points upwards (see Figure 4.3).
4. Connect the scope side connector of the scope cable EXERA II to the endoscope, referring to the instruction manual of the endoscope.

Fiberscope and camera head

1. Ensure that this instrument and all connected devices are turned OFF.
2. Connect the endoscope connector of the fiberscope to the light source, referring to the instruction manual for the light source.
3. Push the video plug of the camera head into the video connector socket of the instrument all the way until it clicks, holding this instrument with a hand so that it will not move. Confirm that the "UP" mark points upwards (see Figure 4.3).
4. Connect the video adapter and camera head to the eyepiece section of the fiberscope, referring to the instruction manuals for the video adapter and camera head.

Rigidscope and camera head

1. Ensure that this instrument and all connected devices are turned OFF.
2. Connect the light guide cable to the light source, referring to the instruction manual for the light source.
3. Push the video plug of the camera head into the video connector socket of the instrument all the way until it clicks, holding this instrument with a hand so that it will not move. Confirm that the "UP" mark points upwards (see Figure 4.3).
4. Attach the light guide cable, video adapter and camera head to the rigidscope, referring to the instruction manuals for the light guide cable, video adapter and camera head.

Summary of connection

This diagram gives an overview of all connections. For further details of the connection, refer to the instruction manuals of the ancillary equipment being used.

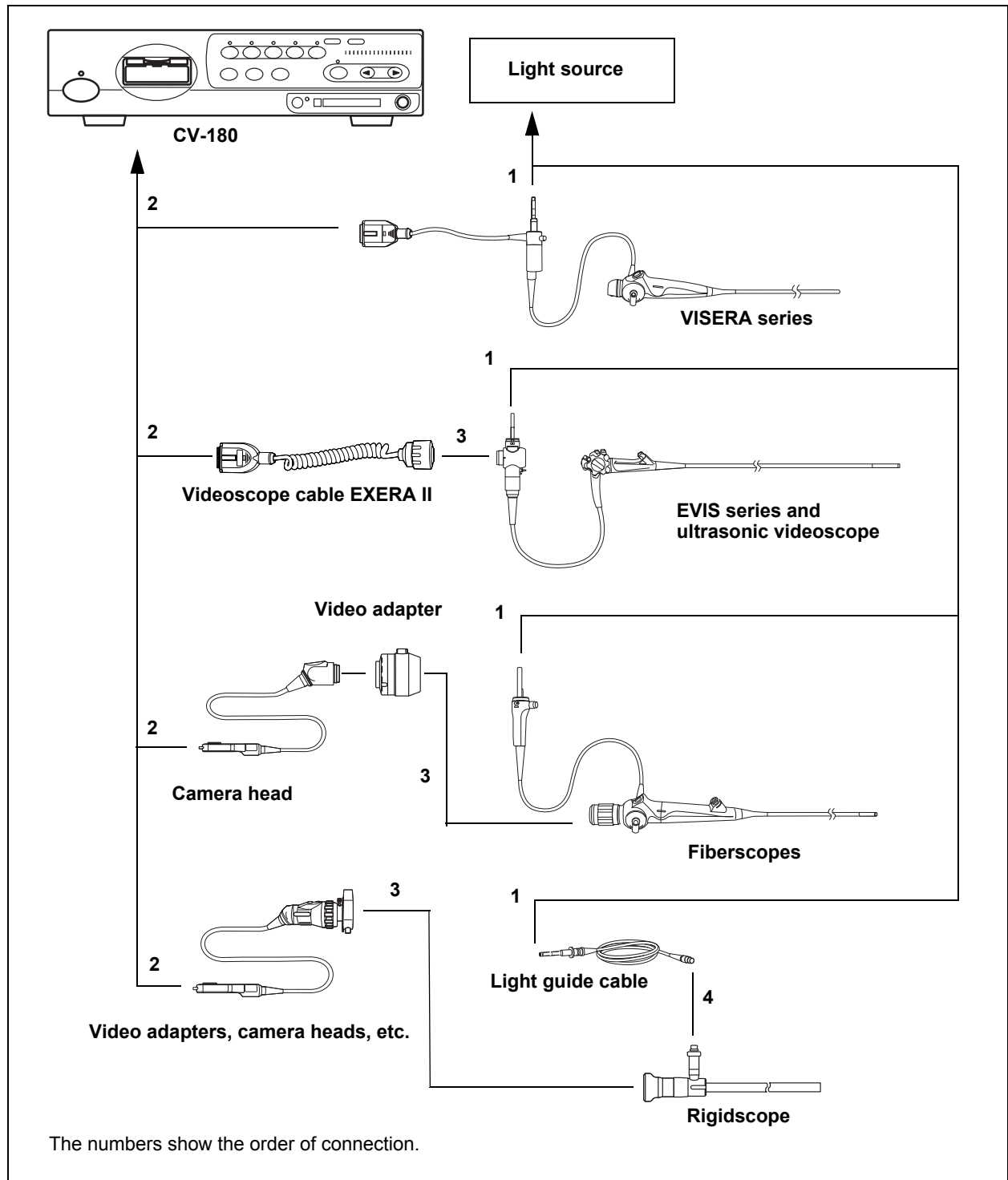

Figure 4.4

4.3 Turning the video system center ON

1. Turn the ancillary equipment ON.
2. Turn the instrument ON by pressing the power switch (see Figure 4.5). The indicator above the power switch lights up.

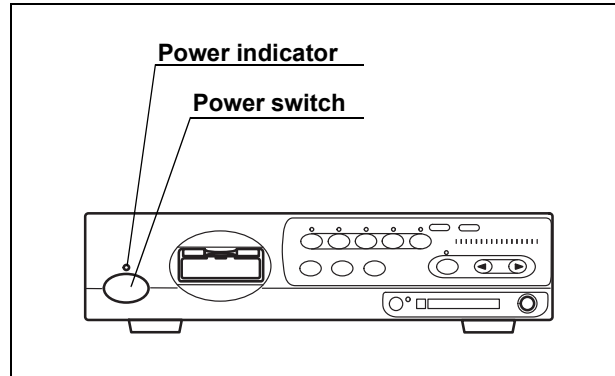

Figure 4.5

3. The endoscopic image appears on the monitor (see Figure 4.6).

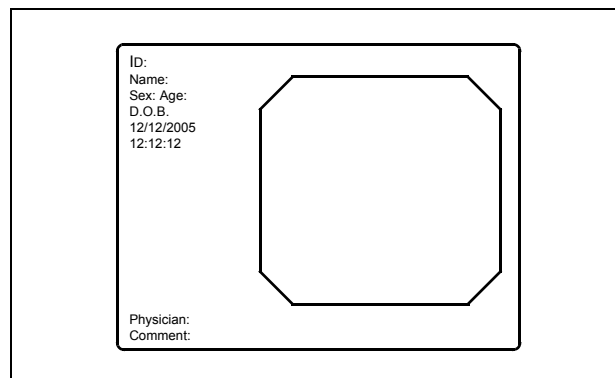

Figure 4.6

NOTE

For the procedure of turning the ancillary equipment ON, refer to each instrument's instruction manual.

4.4 Recall of user preset data

The operating conditions for each user (operator) can be recalled from the “User preset” menu (see Section 9.3, “User preset” on page 216).

CAUTION

Confirm that the required user preset data is selected before starting the observation. If different user preset data is used, unintended operations may occur.

1. Press the “Shift” and “F2” keys together. The “User preset” menu appears on the monitor (see Figure 4.7).

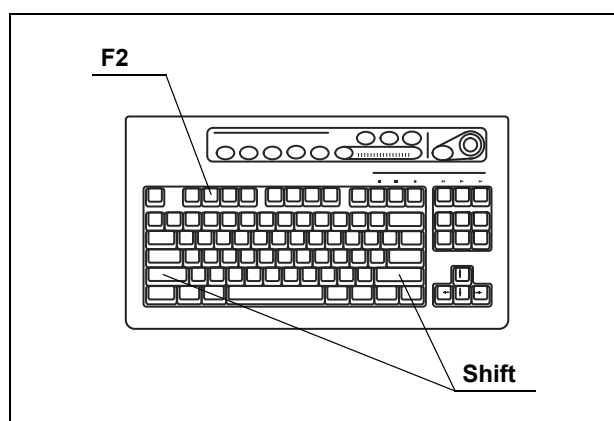

Figure 4.7

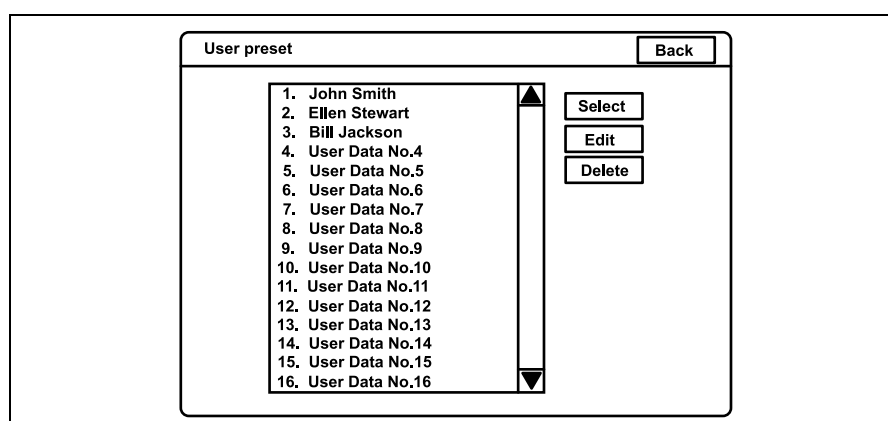

Figure 4.8

2. Click the desired user name in the user name dialog box. The selected user name is highlighted.
3. Check if the correct user name is selected, then click “Select”. The endoscopic image appears on the monitor and the user preset data is loaded to the video system center.

NOTE

The user preset data used in the last operation before turning the video system center OFF comes up initially after turning the instrument ON.

4.5 White balance adjustment

This adjustment procedure is used to display the correct image color on the monitor. There are two white balance adjustments for the normal observation and the NBI observation. Be sure to always adjust the white balance in the following cases:

- Before observation.
- After exchange of the light source.
- When any abnormality can be seen on the color of the image even if white balance adjustment has been completed.

WARNING

- When adjusting the white balance of the endoscope to be used in the sterilized zone, do not use the white cap (MH-155) as described in this part, but use a white object such as a piece of gauze without bringing it in contact with the endoscope. Contact of the endoscope with a non-sterilized object may result in cross-contamination.
- Make sure that the endoscope and white cap (MH-155) are clean before adjusting the white balance. Otherwise, cross-contamination may result.
- Always control the color tone and/or enhancement of the image appropriately before observation. Setting an inappropriate color tone or enhancement condition may result in overlooking or wrong diagnosis.

CAUTION

- Do not turn the video system center OFF or disconnect the videoscope while the white balance button is being pressed or the “Wh/B OK” indicator is blinking. Otherwise, the data stored on the memory chip of the endoscope may be destroyed.
- When adjusting the white balance, always turn the light source ON and take care not to expose the distal end of the endoscope to external light. Otherwise, it may cause an incorrect white balance adjustment.
- Always use the white cap when setting the white balance for the videoscope used in a non sterilized zone.
- Set the brightness level of the light source to “3” or the center of the adjustment range before adjusting the white balance.
- When the color tone is not proper, white color cannot be displayed properly on the monitor even if the white balance is set. Adjust the color tone to the center of the adjustable range.

For normal light observation

1. Confirm the lighting status of the “Wh/B OK” (Wh/B = White balance) indicator on the front panel (see Figure 4.9 and Table 4.1).

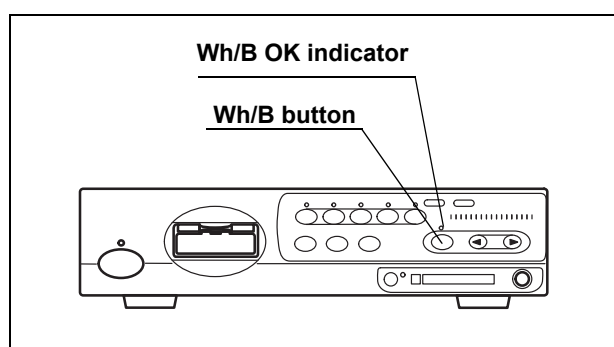

Figure 4.9

“Wh/B OK” indicator	Status of white balance adjustment
OFF	Before adjustment or if adjustment failed.
ON	Completed.

Table 4.1

2. Proceed as follows according to the use of the endoscope.

○ **When using an endoscope for the non-sterilized zone**

1. Insert the endoscope's distal end into the white cap and hold the white cap and endoscope stable to avoid wash-out of the monitor image (see Figure 4.10).

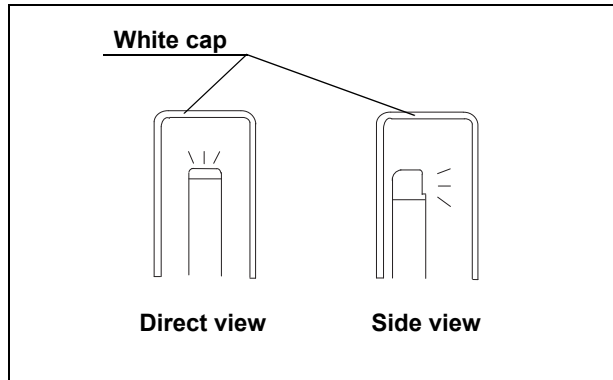

Figure 4.10

2. Maintaining the stable condition in step 1., press the “Wh/B” button until a short beep is generated. The result of the adjustment will be displayed on the monitor for a few seconds (see Table 4.2).

Result	Message
Completed successfully	“White balance complete!” “Check NBI white balance.” (When using NBI compatible endoscope.)
Failed	“White balance incomplete! Perform again!”

Table 4.2

3. Confirm that the “Wh/B OK” indicator is ON (see Table 4.1). If it is OFF, go back to step 1. again.

CAUTION

When performing white balance adjustment keep an appropriate distance between distal end and white cap. Otherwise, the white balance might not be adjusted properly.

○ When using an endoscope for the sterilized zone

1. Hold the endoscope stable to avoid wash-out of the monitor image, and enlarge the image to the full monitor, monitoring a white object such as a piece of gauze in such a way that it does not contact the endoscope.
2. Maintaining the stable condition in step 1., press the “Wh/B” button until a short beep is generated. The result of white balance adjustment will be displayed on the monitor for a few seconds (see Table 4.3).

Result	Message
Completed successfully	“White balance complete!” “Check NBI white balance.” (When using NBI compatible endoscope.)
Failed	“White balance incomplete! Perform again!”

Table 4.3

3. Confirm that the “Wh/B OK” indicator is ON (see Table 4.1). If it is OFF, go back to step 1. again.

For NBI observation

When connecting an NBI compatible endoscope, perform the white balance adjustment for NBI observation after the white balance adjustment for normal light observation has been performed.

1. Adjust the white balance for normal light observation according to “For normal light observation” on page 53.
2. Switch to the NBI mode by operating the mode button of the light source. Refer to the instruction manual of the light source.
3. Confirm that “NBI” appears on the monitor, and that the “NBI” indicator on the front panel of the video system center turns from green to white.
4. Hold the endoscope as shown in step 1. of “When using an endoscope for the non-sterilized zone” on page 54 or step 1. of “When using an endoscope for the sterilized zone” on page 55 according to the use of it.

5. Maintaining the stable condition in step 4., press the “Wh/B” button until a short beep is generated. The result of the adjustment will be displayed on the monitor for a few seconds (see Table 4.4).

Result	Message
Completed successfully	“NBI White Balance Complete!”
Failed	“NBI White Balance Incomplete!”

Table 4.4

6. If the adjustment failed, perform the operation of steps 4. and 5. again.
7. Switch to the normal mode by operating the mode button of the light source. Refer to the instruction manual of the light source.
8. Confirm that “NBI” disappears on the monitor, and that the “NBI” indicator on the front panel of the video system center turns from green to white.

NOTE

- The white balance adjustment can also be initiated by pressing the “Shift” and “F9” keys on the keyboard together instead of the “Wh/B” button.
- When the white balance adjustment cannot be completed, check if the color tone and/or brightness are correct and the white cap is clean.
- Once the white balance adjustment is completed, the “Wh/B OK” indicator keeps on lighting until the video system center is turned OFF.
- The white balance adjustment can also be initiated from the endoscope's remote switches and/or foot switches. For how to set up the remote switches and foot switches, see “Remote switch and foot switch (EXERA and VISERA)” on page 219

4.6 Patient data

Before the observation, enter the patient data into the endoscopic image.

There are two methods to enter the patient data:

- Patient data can be entered immediately before the examination.
- A list of several patient data can be entered in advance.

This section explains how to enter patient data immediately before the examination. To enter a list of several patient data in advance, see Section 5.6, “Pre-entry of patient data” on page 136.

CAUTION

- Before entering patient data, press the “EXAM END” key to clear the previous patient data. Otherwise, different patient data can be mixed on one print sheet and/or normal functioning of the digital filing system cannot be guaranteed.
- When recording the images, be sure to record the images together with the patient data. Otherwise distinction between different observations may become difficult.
- Be sure to enter the patient ID when entering patient data. Also be sure to enter a different patient ID for each patient. Otherwise, the image data for some patients may mix in the same image folder.

1. Press the “F1” key to change the monitor display full-patient-data display.
2. Press the “EXAM END” key to clear the previous patient data.

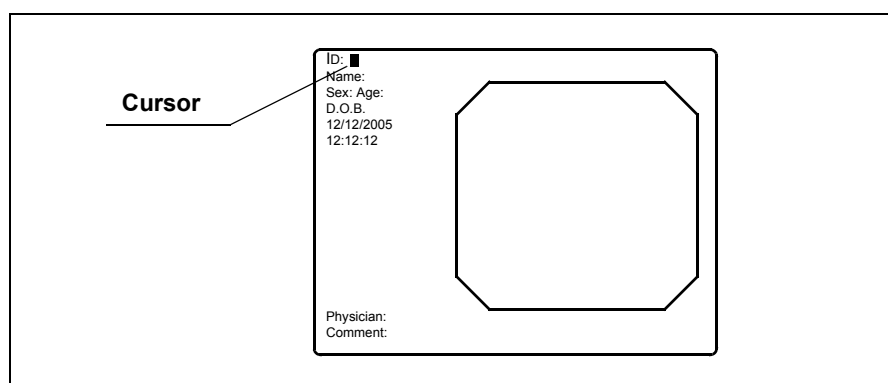

Figure 4.11

3. Enter data.

Data	data input condition	Entry example
ID No.	Up to 15 characters	ABC123
Name	Up to 20 characters	Mike Johnson
Sex	1 character	M
Age	Up to 3 characters. Automatically calculated after entering D.O.B.	51
D.O.B.	8 characters. Enter the numbers according to the format (see page 197).	03031954
Physician	Up to 20 characters	John Smith
Comment	Up to 37 characters	Cardiac end of the stomach

Table 4.5

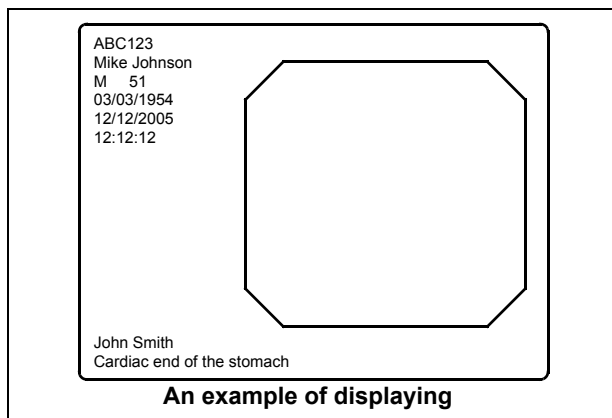

Figure 4.12

4. When modifying data, press the arrow key to move the cursor to the input position and edit the data.
5. When deleting all patient data displayed on the monitor, press the "EXAM END" key on the keyboard (see Figure 4.13).

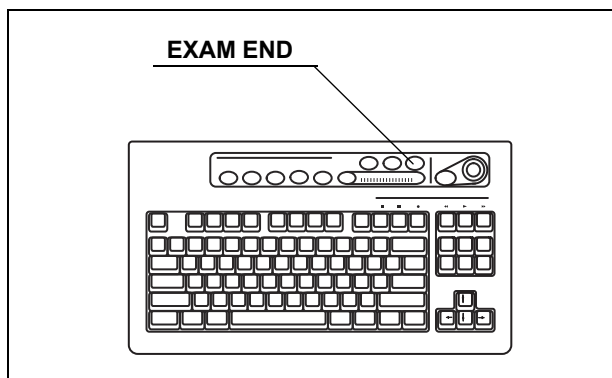

Figure 4.13

4.7 Observation of the endoscopic image

Observe the endoscopic image using the various functions provided with the video system center. For details of the functions, see Chapter 5, "Functions".

4.8 Recording of the observation image

Table 4.6 shows the devices that can record and/or print endoscopic images. These devices can be controlled by the keyboard, scope switches, etc. For the operation of these devices, see Chapter 5, "Functions".

Recording device	Details
PC card	Section 5.3, "Image recording and playback (PC card)" on page 106
Digital file system	"Image filing system" on page 127
Videocassette recorder	"Videocassette recorder (VCR)" on page 129
Video printer	Section 5.5, "Printing images" on page 131

Table 4.6

4.9 Termination of the operation

CAUTION

Do not disconnect the video connector before turning the video system center OFF. Otherwise, the endoscope or camera head may be damaged.

1. Press the "EXAM END" key (see Figure 4.14) to execute the following process;
 - clearing patient data on the monitor;
 - completing printing of un-printed images;
 - closing the digital file system.

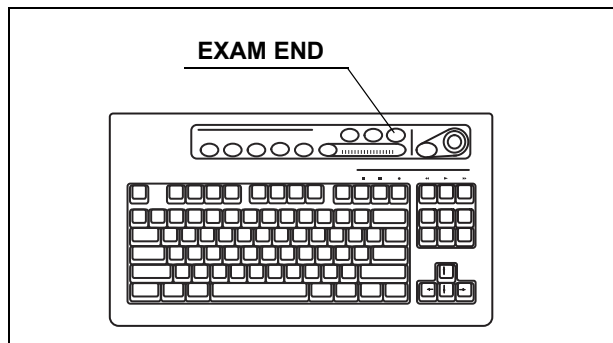

Figure 4.14

2. Turn the instrument and ancillary equipment OFF.
3. When an EVIS series endoscope is used:
Disconnect the scope side connector of the videoscope cable, and place it on the scope cable holder (A in Figure 4.15). For disconnecting the video plug, see B in Figure 4.15.

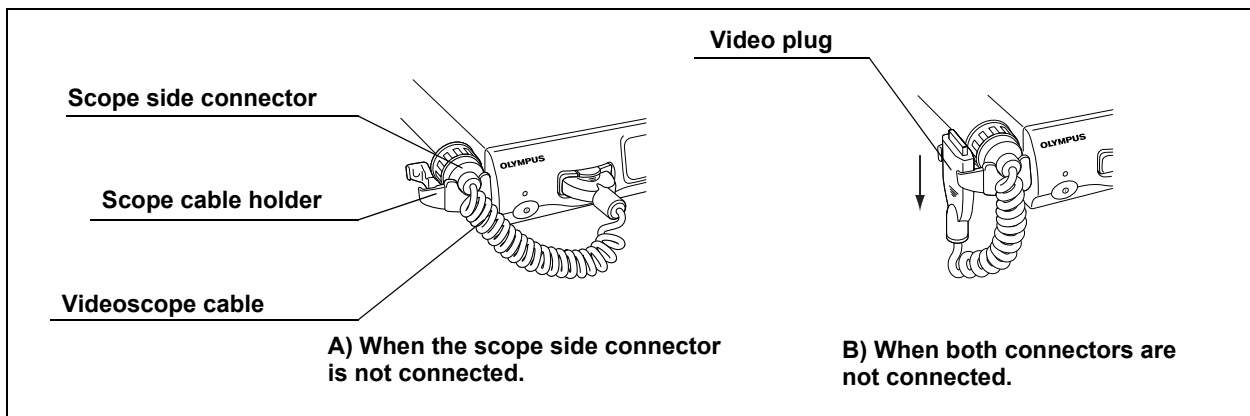

Figure 4.15

NOTE

In B in Figure 4.15, insert the video plug to the scope cable holder in the direction of the arrow.

4. When a VISERA series endoscope or camera head is used:
Disconnect the video plug of the videoscope cable from the instrument, holding the instrument with a hand so that it will not move and push the locking lever down (see Figure 4.16).

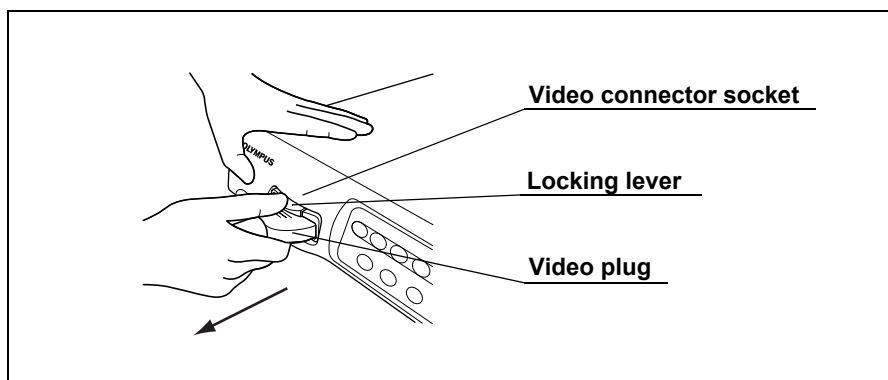

Figure 4.16

Chapter 5 Functions

This chapter explains the functions of the buttons and keys on the video system center. See the “System setup” menu and “User preset” menu in Chapter 9, “Function setup” for presetting.

5.1 Front panel

Image source buttons

Used to select the image source displayed on the monitor. The buttons other than the “SCOPE” button has to be pressed for more than 1 second to activate.

1. The Image source buttons select the images to be displayed on the monitor (see Figure 5.1). The indicator above the active button lights up.
2. Confirm that the desired image appears on the monitor.

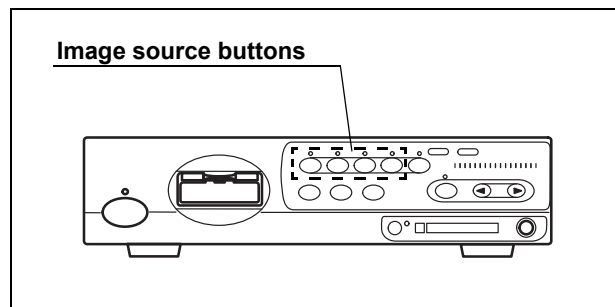

Figure 5.1

Button	Images on the monitor	Terminal and image sources	
		Front panel	Rear panel
SCOPE	Endoscope's live image	Scope connector	-
DV/VCR	VCR, video recorder	-	VCR REMOTE or DIGITAL OUT
PC	Digital filing system	-	PC IN
PRINTER	Video printer	-	PRINTER IN

Table 5.1

CAUTION

When performing endoscopic observation, select the "SCOPE" image source. Images may disappear during observation depending on the condition of ancillary equipment.

NOTE

When pressing an image source button except PC button to which no device is connected, the lamp above the button blinks and the previous image appears on the monitor. When pressing PC button, the image input from PC IN terminal is selected, regardless of the PC's connection.

PinP (picture in picture) display

The image of an external device connected to the following connectors can be displayed on the monitor together with the endoscopic live image.

- PinP composite terminal on the front panel (prior to the PinP Y/C terminal on the rear panel.)
- PinP Y/C terminal on the rear panel

The PinP function has two modes, “ON/OFF mode” and “Mode Change mode”. The two modes display images in different ways. Presetting of PinP in the “User preset” menu is needed. See “PinP (picture in picture) function” on page 246.

1. Confirm that the external device is connected to either the PinP composite terminal on the front panel or the PinP Y/C terminal on the rear panel (see Figure 5.2).

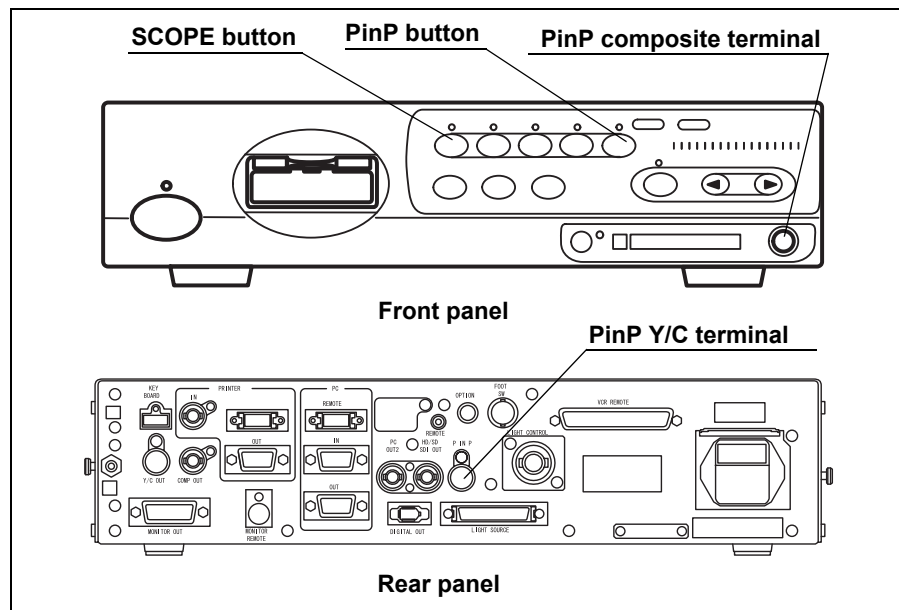

Figure 5.2

2. Press the “SCOPE” button to display the endoscopic live image.

3. Press the “PinP” button. The sub image appears on the monitor (see Figure 5.3).

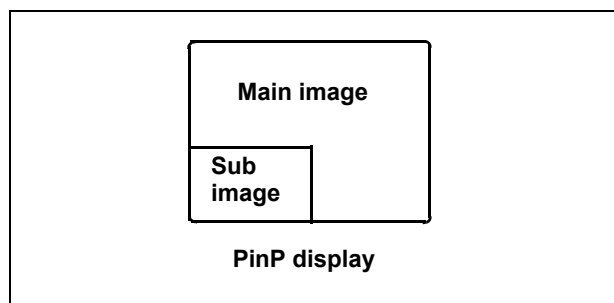

Figure 5.3

4. Press the “PinP” button to change the display. The transitions of the displays are different according to the settings in “User preset” menu (see Figure 5.4 and Figure 5.5) (refer to “PinP (picture in picture) function” on page 246 for the setting method).

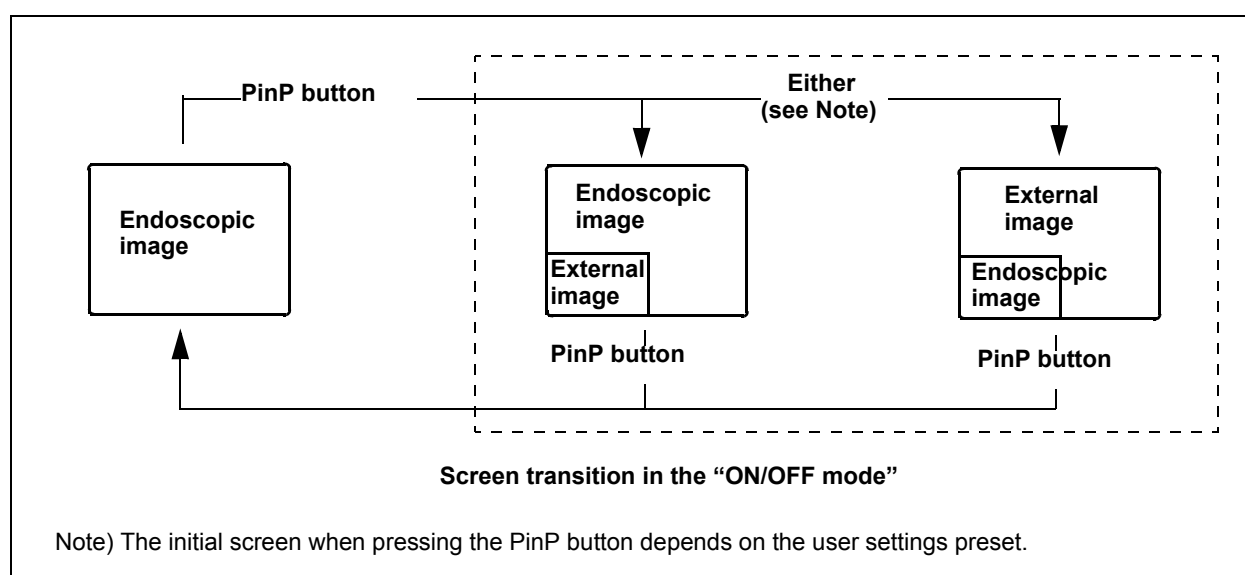

Figure 5.4

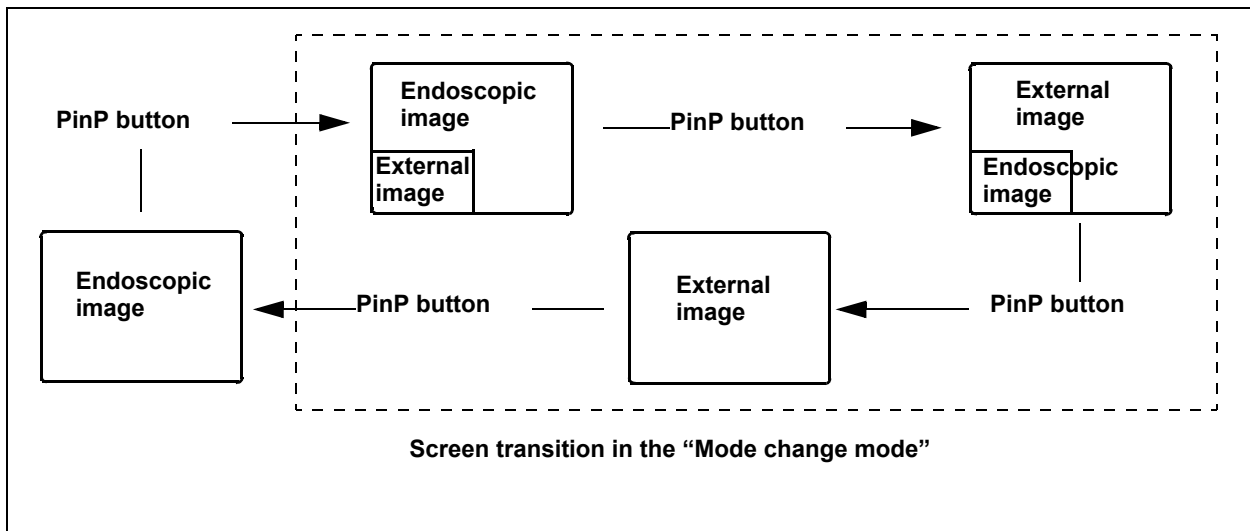

Figure 5.5

NOTE

- All patient data disappears in the PinP display. Press the "F1" key to display the data.
- The index image does not appear in the PinP display (see "Release index time" on page 243).
- It takes a few seconds before the PinP display appears depending on the devices connected.
- The PinP function is also controlled from the scope switches and/or foot switches. For how to set up the scope switches and foot switches. See "Remote switch and foot switch (EXERA and VISERA)" on page 219.
- The output signal is just SDTV in PinP display.
- Before activating the PinP function make sure that an endoscope is connected to this instrument. If no endoscope is connected it might not be possible to use the PinP function and image recording of an external device may not work.

Image enhancement mode (ENH.)

The image enhancement function electrically increases the sharpness of the endoscopic live image. Three enhancement modes and normal modes are available. The type and level of image enhancement should be set in advance. See “Image enhancement (normal observation)” on page 226 and “Image enhancement (NBI observation)” on page 250.

1. Press the “ENH.” button to change the enhancement mode (see Figure 5.6). The indicator above the button lights up and the selected mode is displayed on the monitor for a few seconds.

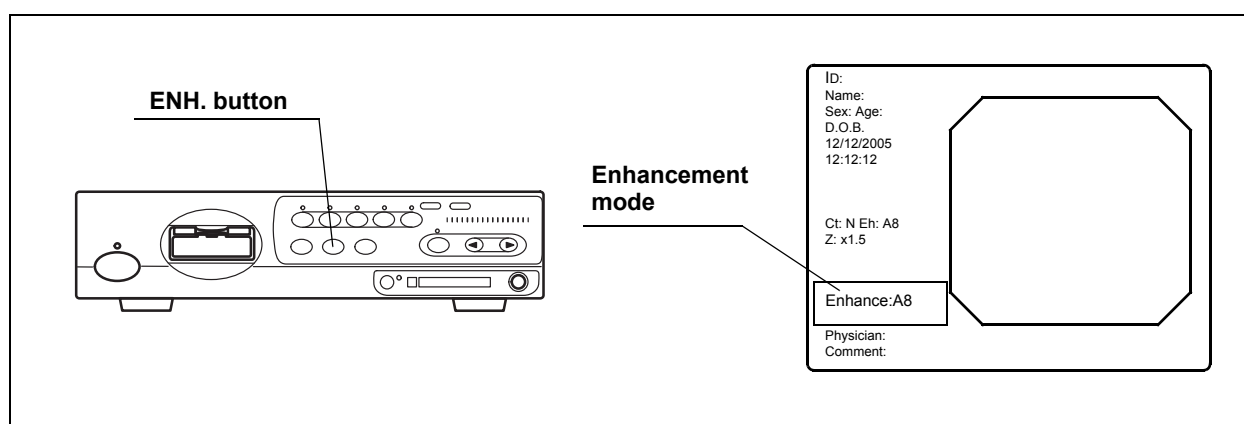

Figure 5.6

2. To switch OFF the image enhancement at any mode, press and hold the “ENH.” button. The indicator above the button goes OFF.

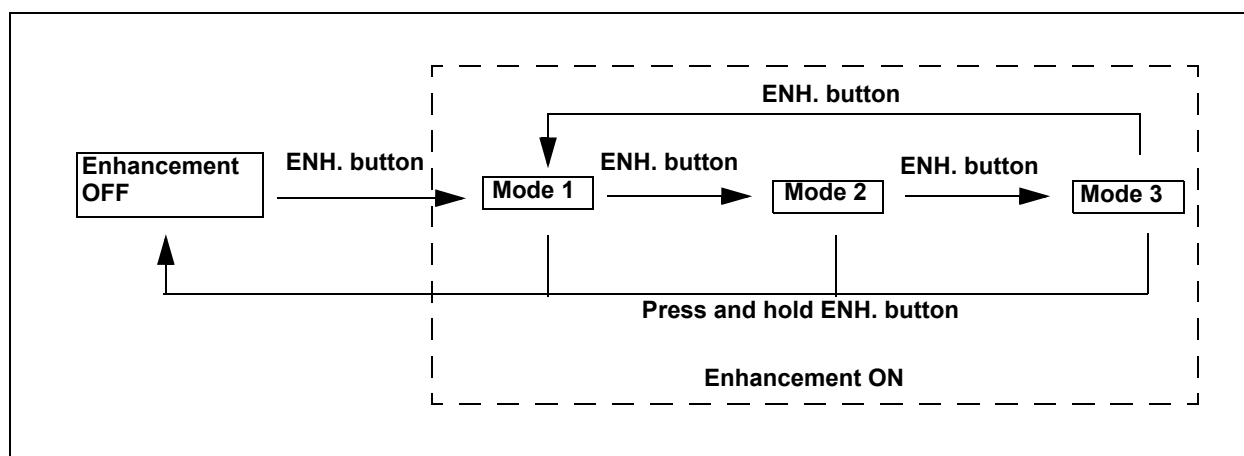

Figure 5.7

NOTE

- Mesh-like noise may be observed in the image when the image enhancement function is ON during use of a fiberscope or hybrid endoscope. In this case, use the recommended camera head, or switch the image enhancement OFF.
 - OTV-S7H-1N, OTV-S7H-1D, OTV-S7H-1NA
- The image enhancement mode used in the last operation before turning the video system center OFF comes up when the instrument is turned ON.
- The image enhancement function can also be controlled from the scope switches and/or foot switches. For how to set up the scope switches and foot switches, see “Remote switch and foot switch (EXERA and VISERA)” on page 219.

Iris mode

This operation selects the method to measure the brightness of the object of the observation. Two iris modes, peak mode and auto mode, are available. For details on the iris mode, see “Iris” on page 232.

1. Press the “IRIS” button on the front panel to switch between auto mode and peak mode alternately. The indicator above the iris mode button lights up.

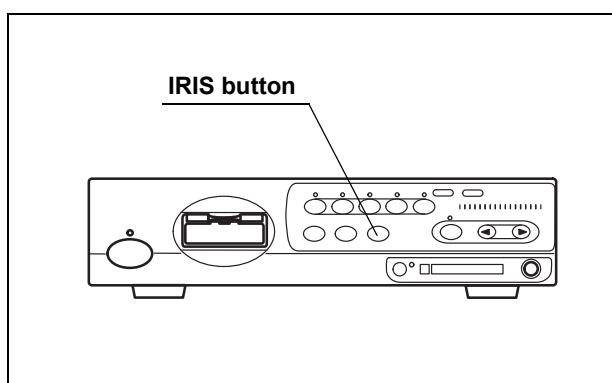

Figure 5.8

NOTE

- The iris mode used in the last operation before the video system center is turned OFF comes up when the instrument is turned ON.
- The iris mode can also be controlled from the scope switches and/or foot switches. For how to set up the scope switches and foot switches, see “Remote switch and foot switch (EXERA and VISERA)” on page 219.

White balance

The “Wh/B” button performs the white balance adjustment to reproduce colors in their original tones. The “Wh/B OK” indicator indicates if the white balance adjustment is completed or not. For details of the operation, see Section 4.5, “White balance adjustment” on page 52.

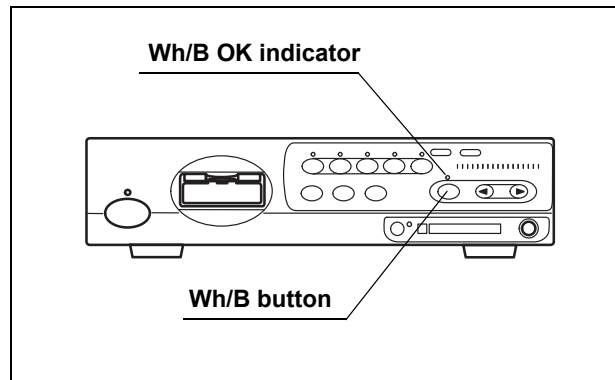

Figure 5.9

NOTE

- The white balance adjustment can also be activated by pressing the “Shift” and “F9” keys on the keyboard.
- The white balance adjustment can also be controlled from the scope switches and/or foot switches. For how to set up the scope switches and foot switches, see “Remote switch and foot switch (EXERA and VISERA)” on page 219.

Brightness adjustment (Exposure)

The brightness of the live images can be adjusted. The lamp brightness is automatically adjusted to keep the brightness of the image constant when the light source is set to "AUTO". The lamp brightness is manually adjusted to keep the lamp brightness constant at the setting value when the light source is set to "MAN.". The function differs depending on the following conditions:

- The light source and its settings.
- The setting of the electric shutter function (refer to "Electronic shutter" on page 240)

Light source	Light source mode	Endoscope's electronic shutter	Brightness adjustment	Brightness level indication	
CLV-180	AUTO	Independent of ON/OFF of the electronic shutter function.	Adjust the brightness using the "EXPOSURE" buttons on the front panel. The lamp brightness is automatically adjusted to keep the image brightness constant.	<ul style="list-style-type: none"> • The level indicators of the video system center and light source are interlocked. • The "EXPOSURE" indicator is a dot display. 	
	MAN.	Automatically becomes OFF.	Adjust the brightness using the "EXPOSURE" buttons on the front panel. The lamp brightness remains constant.	<ul style="list-style-type: none"> • The level indicators of the video system center and light source are interlocked. • The "EXPOSURE" indicator is a bar display. 	
Other than above	AUTO	ON	<ul style="list-style-type: none"> • Set the light intensity of the light source to the center of the adjustable range. • Adjust the brightness using the "EXPOSURE" buttons on the front panel. The lamp brightness is automatically adjusted to keep the image brightness constant. 	<ul style="list-style-type: none"> • The level indicators of this instrument and light source are not interlocked. • The "EXPOSURE" indicator is a dot display. 	
		OFF	Adjust the brightness using the brightness adjustment buttons on the light source. The lamp brightness is automatically adjusted to keep the image brightness constant.	The "EXPOSURE" indicator goes OFF.	
	MAN.	ON	Do not use this setting (see page 74). The light intensity reaches its greatest value, and excessive heat of the endoscope's distal end may occur.		
		OFF		Adjust the brightness using the brightness adjustment buttons on the light source.	The "EXPOSURE" indicator goes OFF.

Table 5.2

WARNING

- Always use the minimum level of illumination necessary for adequate viewing. Whenever possible, avoid close, stationary viewing of mucous membranes for a long time. Intense endoscopic illumination may cause mucosal burns.
- Do not bring the metal plug of the light guide and the distal end of the endoscope immediately after use in contact with the body and flammable objects because the parts will be extremely hot.
- Be sure to set the brightness control mode of the light source to manual mode or turn the examination lamp OFF before disconnecting the camera head from the endoscope or disconnecting the videoscope from the video system center. Disconnecting them can increase the light intensity to the maximum and may cause burns or eye injury.

NOTE

Refer to the instruction manual of the endoscope for details of the electric shutter function.

○ CLV-180

The video system center can adjust the brightness of the light source.

1. Set the brightness control of the light source to "AUTO" or "MAN." according to the instruction manual of the light source.
2. Set the brightness, using the "EXPOSURE" buttons on the front panel (see Figure 5.10). The brightness level is displayed on the "EXPOSURE" indicator.

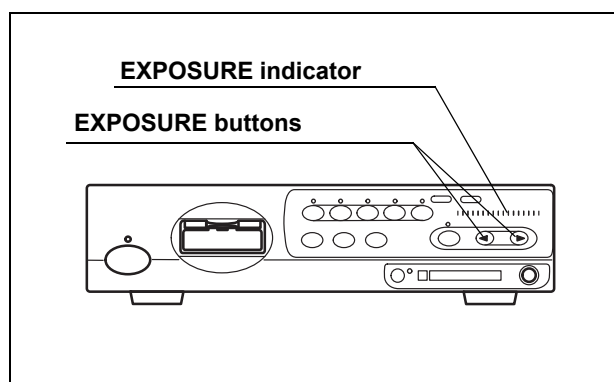

Figure 5.10

NOTE

- Each time the "EXPOSURE" button is pressed the indicator changes by 1 level. Pressing and holding the button, changes the indicator continuously.
- The "EXPOSURE" indication is interlocked with the brightness level indication of the connected CLV-180. When the brightness adjustment buttons on the CLV-180 are pressed, the "EXPOSURE" indication on the video system center varies in an interlocked operation.

○ Other than CLV-180 in AUTO mode

The operation differs depending on the setting of the electronic shutter function of the endoscope (refer to “Electronic shutter” on page 240).

When the electronic shutter function is ON:

1. Set the brightness level of the light source to the center of the adjustable range.
2. Set the brightness using the “EXPOSURE” buttons on the front panel of the video system center. The brightness level is displayed on the “EXPOSURE” indicator.

WARNING

When the brightness level of the light source is not in the center of the adjustable range, intense light, which is not recognized clearly, may cause burns and/or appropriate brightness may not be obtained.

When the electronic shutter function is OFF:

Set the brightness as required, using the brightness adjustment buttons of the light source. The brightness level is displayed on the light source.

NOTE

The “EXPOSURE” buttons of the video system center is invalid, and the “EXPOSURE” indicator goes OFF.

○ Other than CLV-180 in MANUAL mode

WARNING

Never set the electronic shutter function to ON in the user preset menu (refer to “Electronic shutter” on page 240). Intense light, which is not recognized clearly, may cause burns.

Set the brightness as required, using the brightness adjustment buttons of the light source. The brightness level is displayed on the light source.

NOTE

The “EXPOSURE” buttons of the video system center is invalid, and the “EXPOSURE” indicator goes OFF.

STOP button and PC card indicator

This button stops accessing the PC card. Press the button before ejecting the PC card from the PC card slot.

CAUTION

Be sure to press the "STOP" button and confirm that the PC card status indicator goes OFF before ejecting the PC card from the PC card slot. Otherwise, the PC card and/or data stored may be destroyed.

1. Press the "STOP" button before removing the PC card. The PC card status indicator goes OFF.

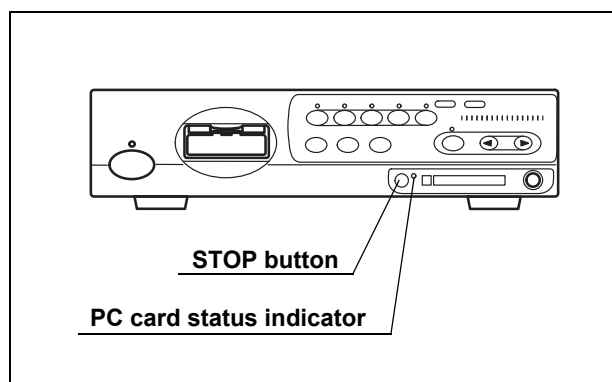

Figure 5.11

The PC card indicator shows the status as shown below.

PC card indicator	Status
OFF	No PC card in the slot, or the video system center does not recognize the PC card.
Green	The PC card is in the slot, and the video system indicator has recognized the PC card.
Orange (blinking)	The video system indicator is accessing the PC card.

Table 5.3

NOTE

The images cannot be recorded when the PC card is not ejected after pressing the "STOP" button. Press the eject button to eject the PC card after a few seconds, then insert the PC card again to let the video system center recognize the PC card.

PC card slot and eject button

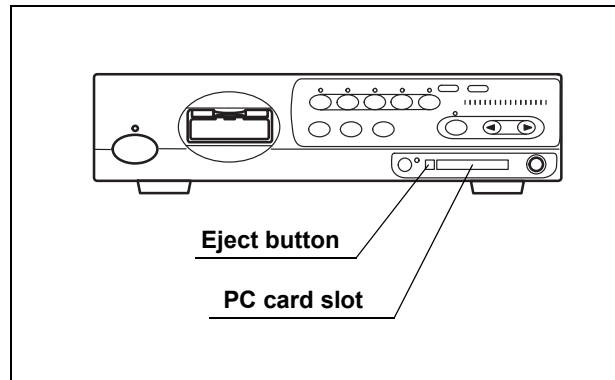

Figure 5.12

Table 5.4 shows the applicable PC card adapter and Memory Card.

Applicable device	Specification
PC card adopter	MAPC-10 (Olympus)
Memory Card	xD picture card M-XD32P, M-XD64P, M-XD128P, M-XD256P, M-XD512P, M-XD1GM, M-XD1GMA, M-XD2GMA (Olympus)

Table 5.4

CAUTION

- Be sure to confirm the followings. Otherwise, recording or playing back images on the PC card may not be possible.
 - Format the PC card before the first use as described in “Formatting of the PC card” on page 114.
 - Use the CV-180 for formatting the PC card. Do not use a personal computer, etc.
- Be sure to confirm the followings. Otherwise, the PC card and the data in the PC card may be destroyed.
 - Do not press the “STOP” button while the PC card status indicator is blinking.
 - Do not press the “STOP” button while formatting the PC card.
 - Press the “STOP” button and confirm if the PC card status indicator goes OFF before ejecting the PC card from the PC card slot.
 - Handle the PC card with care and avoid subjecting them to sudden or severe impact.
 - Do not place the PC card in a place subject to strong static electricity, electricity or magnetism.

- Do not leave the PC card under high temperatures, high humidity or in a corrosive atmosphere.
- Do not allow a foreign object to penetrate the inside of the PC card slot. Otherwise, the equipment may be damaged.
- Do not touch the PC card with wet hands. The video system center and/or data stored may be destroyed.

NOTE

- See the following pages for details on how to record the PC card.
 - Images:
Section 5.3, “Image recording and playback (PC card)” on page 106.
 - Patient data:
“Recording patient data into PC card” on page 144.
“Loading patient data from PC card” on page 146.
- Please use only the PC card adapter and Memory Card from Olympus. Other cards might not work properly.
- The PC card of CardBus type and Smart Media are not available.

○ Insertion of PC card into the PC card slot

1. Insert the xD picture card into the PC card adapter.
2. Push the PC card adapter all the way into the PC card slot.

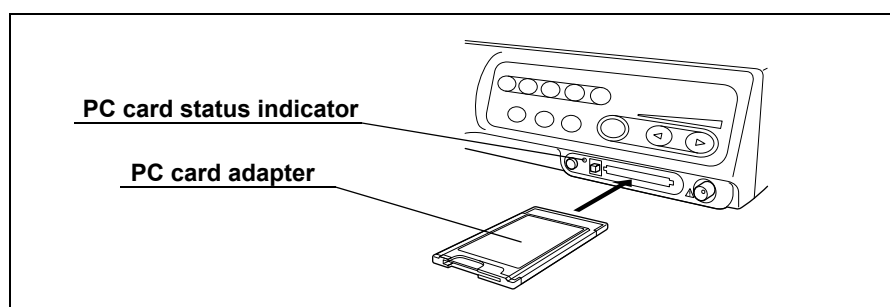

Figure 5.13

3. The video system center recognizes the PC card, and the PC card status indicator lights up green.

NOTE

- If the video system center does not recognize the PC card, eject and reinsert the PC card adapter, or turn the video system center OFF then ON again, leaving the PC card adapter inserted.
- Always prepare spare PC cards for use when the currently used card becomes full.
- It is recommended to back up the image data on the PC card into a personal computer regularly.

○ Ejection of PC card from the PC card slot

CAUTION

Be sure to press the “STOP” button and confirm that the PC card status indicator goes OFF before ejecting the PC card from the PC card slot. Otherwise, the PC card and/or data stored may be destroyed.

1. Press the “STOP” button. The PC card status indicator goes OFF (see Figure 5.14).

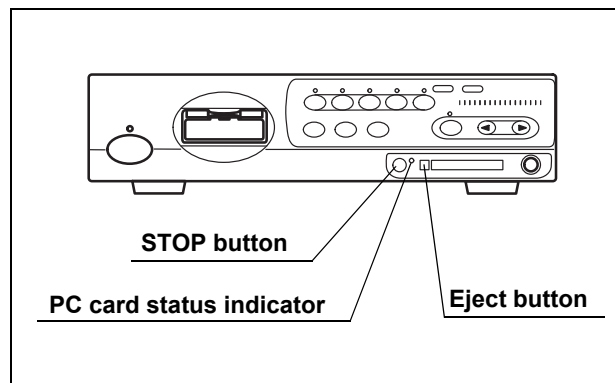

Figure 5.14

2. Press the eject button.

3. Press the eject button again. The PC card adapter comes out slightly (see Figure 5.15).

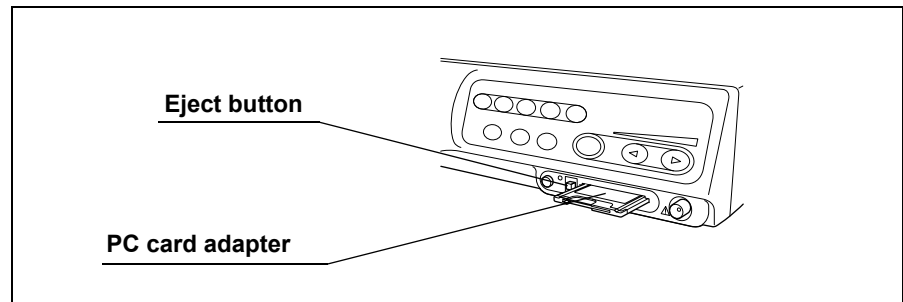

Figure 5.15

4. Pull the PC card adapter straight out.

RESET button

The “RESET” button resets the settings modified during use of the video system center to the original values. The settings to be reset are the following items:

- User preset data: To be reset to their original settings.
- Items shown in Table 5.5: To be reset to the factory defaults.

Function	Default setting	
Image source	Scope	
Color tone	R	[0]
	G	[0]
	C	[0]
Freeze	Live image	
Release index	4 sec	
Zoom	x1.0	
Special light observation	Normal observation	
Arrow pointer	OFF	
Stop watch	OFF	
Characters on screen	Full display	
Exposure	Center	
PinP	OFF	

Table 5.5

1. Press and hold the “RESET” button on the front panel (see Figure 5.16). All front panel indicators should blink for about 1 second, then the settings are reset.

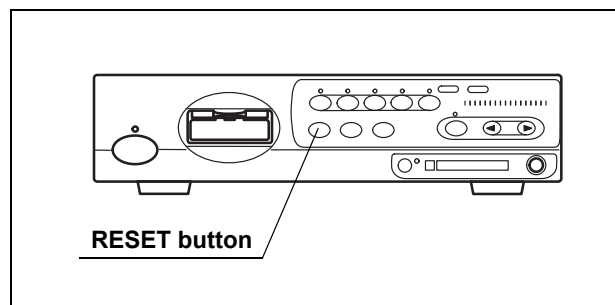

Figure 5.16

5.2 Keyboard

Domepoint

The domepoint is used to move the arrow pointer, and execute the function on the screen or move the cursor on the screen. It refers as “clicking” to press the “Click” key one time, placing the arrow pointer at the desired area.

1. Press the domepoint using your finger tip. The arrow pointer on the screen moves to the direction corresponding to the pressed part of the domepoint.

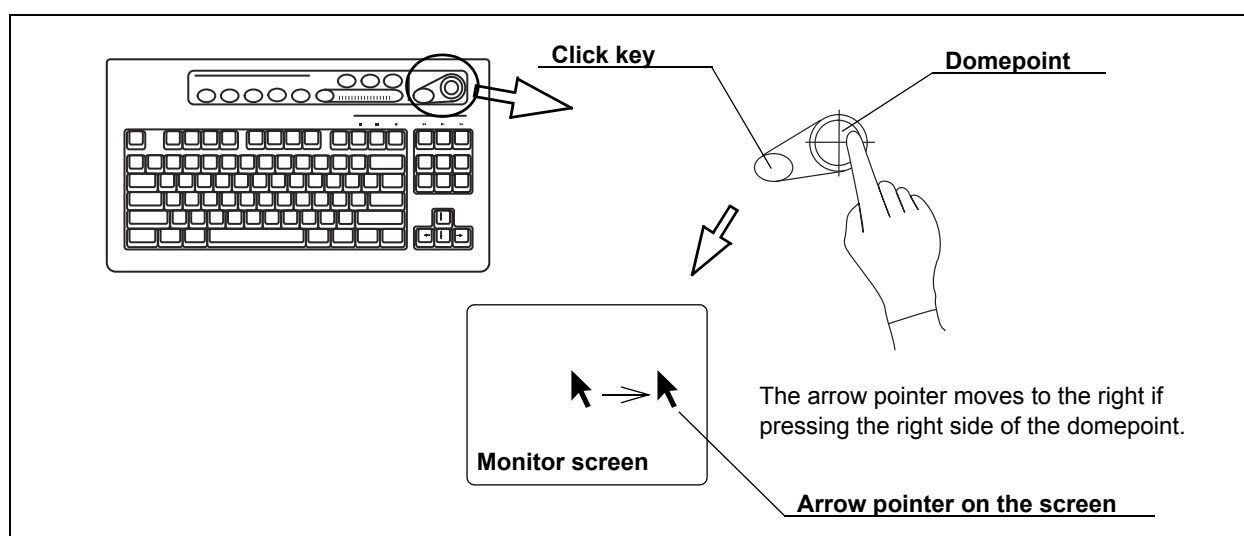

Figure 5.17

2. Move the arrow pointer to a text box area. Click the text box to place the cursor.

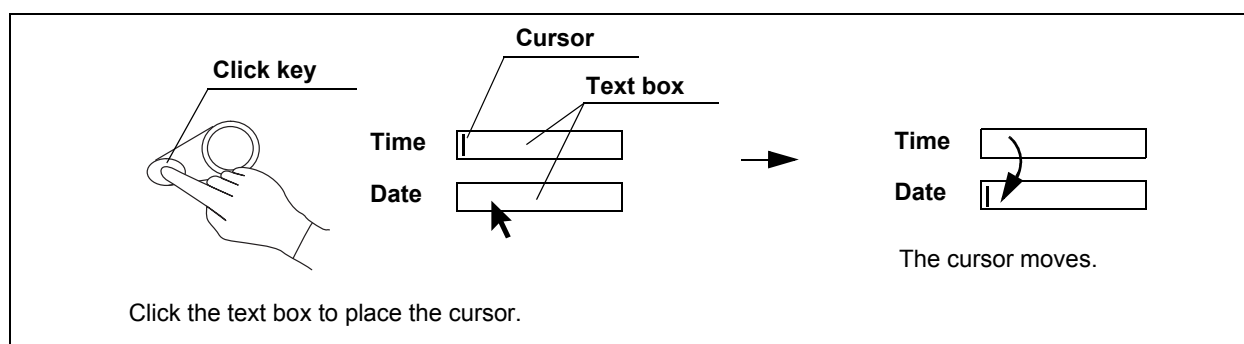

Figure 5.18

3. Click a button on the menu to move the highlight, or perform the function of the button.

NOTE

Also refer to Section 2.8, "Pointer" on page 33 for the operation of cursor and highlight.

Clearing characters from the screen ("F1")

This operation clears and redisplayes the text information such as patient data on the monitor screen.

Part of the patient data disappears from the monitor screen each time the "F1" key is pressed. The fourth press redisplayes the initial display showing all patient data (see Figure 5.20 for the transition of the display).

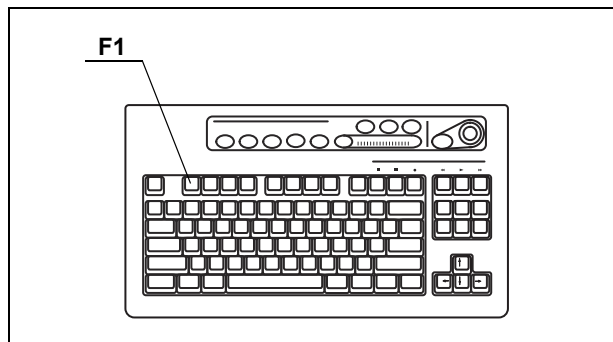

Figure 5.19

NOTE

- The zoom ratio of the image except "x1.0" is always displayed on the monitor even when the text information is cleared.
- Only when all text data are displayed on the monitor, the patient data can be entered.
- The image size and layout may differ from those shown in Figure 5.20 depending on the connected endoscope.
- The patient data can also be cleared using the scope switches and/or foot switches. For how to set up the scope switches and foot switches, see "Remote switch and foot switch (EXERA and VISERA)" on page 219.

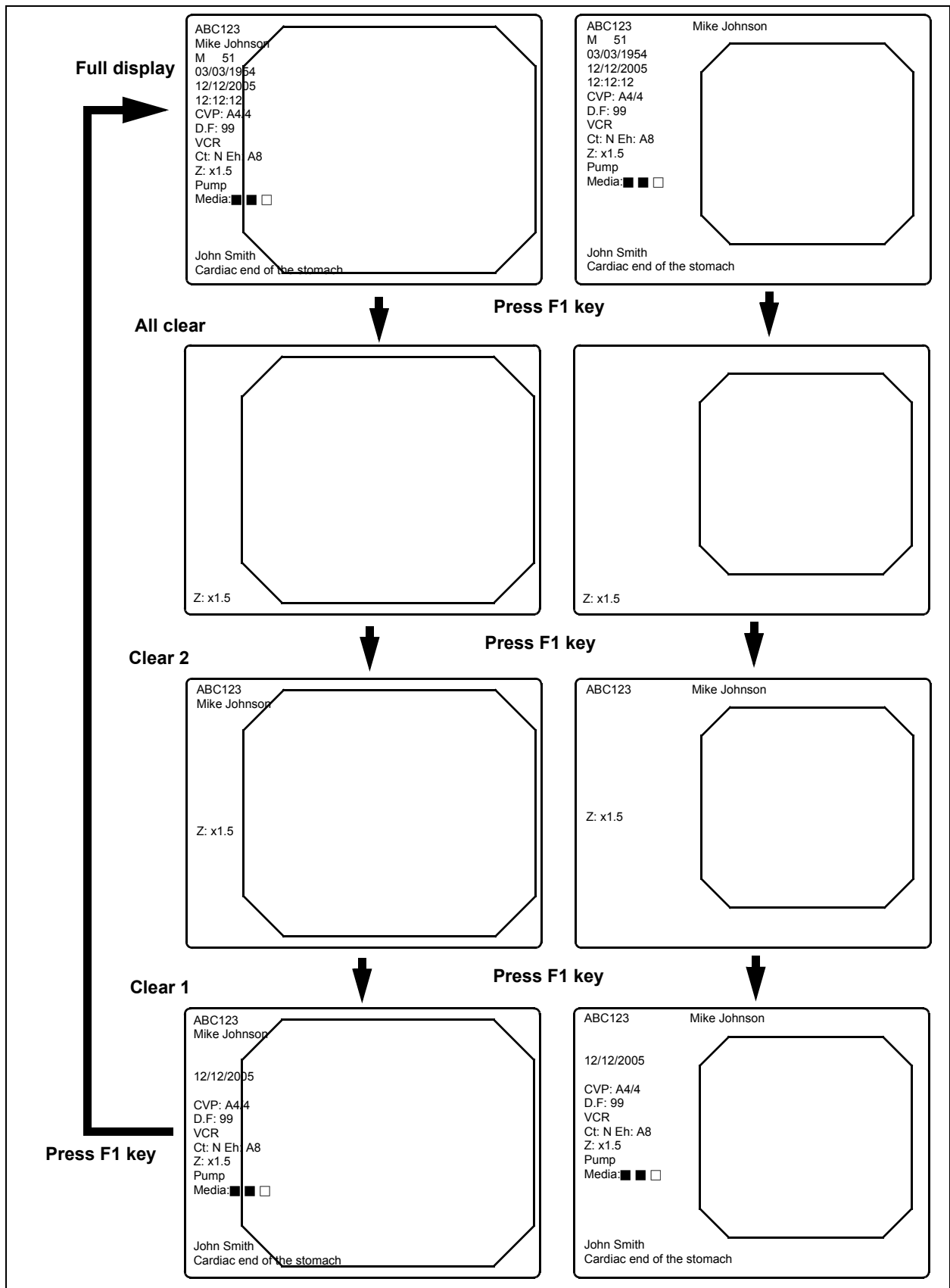

Figure 5.20

System setup (“Shift” + “F1”)

Press these keys to open the system setup menu that enables the proper use of the video system center and ancillary equipment. For details on the system setup menu, see Section 9.2, “System setup” on page 194.

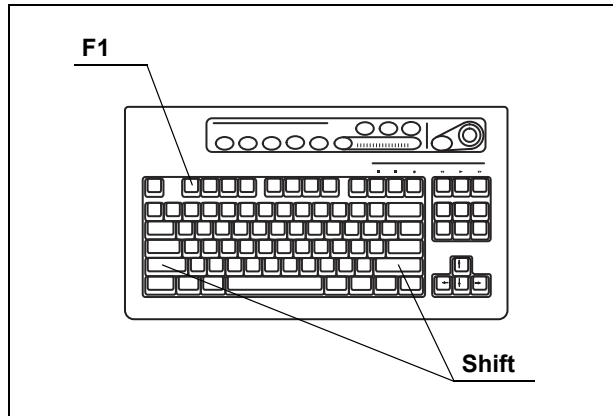

Figure 5.21

Scope information (“F2”)

Press this key to open the scope information window. For details, see Section 5.7, “Scope information” on page 148.

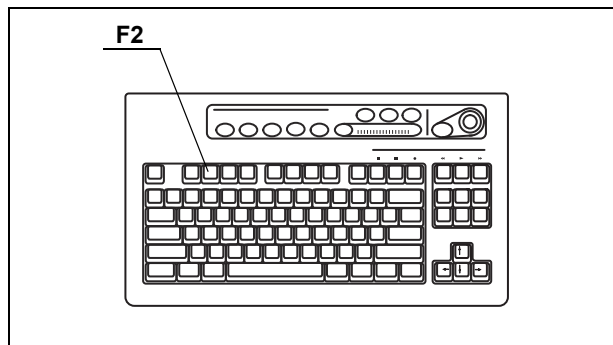

Figure 5.22

User preset (“Shift” + “F2”)

Press these keys to open the user preset menu that sets up the observation conditions for each user (operator). For details on the user preset menu, see Section 9.3, “User preset” on page 216.

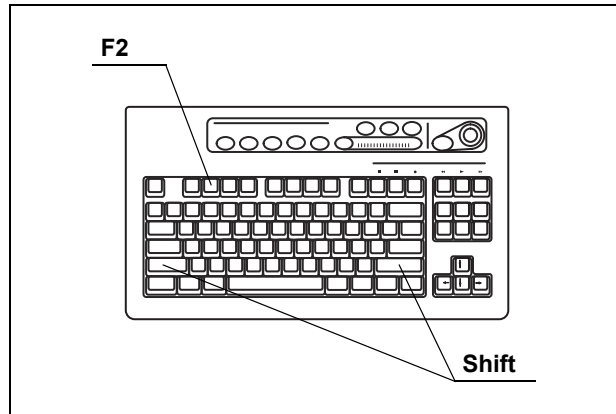

Figure 5.23

Cursor (“F3”)

Press to switch the display of the cursor on the screen between ON and OFF.

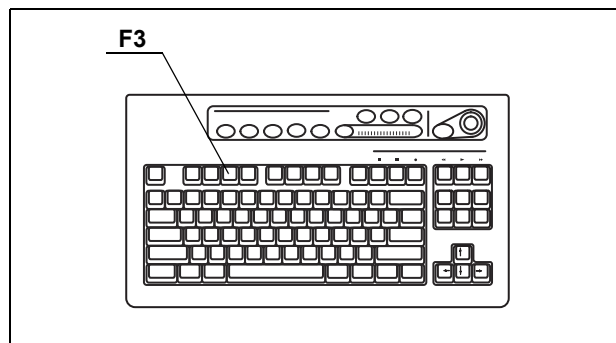

Figure 5.24

Patient data (“Shift” + F3)

Press these keys to open “Patient Data” menu to enter the patient data. For details on the patient data menu, see “Entering new patient data” on page 137.

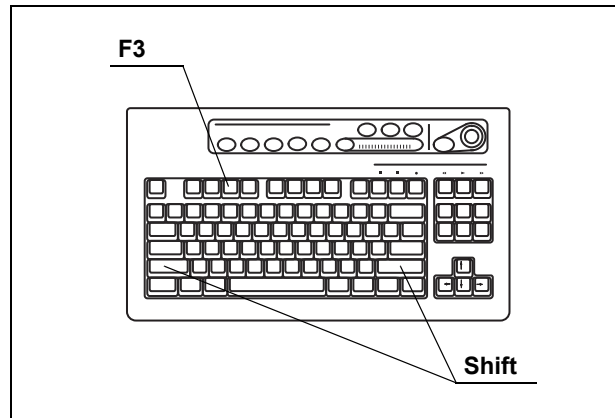

Figure 5.25

Freeze mode (“F4”)

This key switches between the two different freeze modes that pause the endoscopic live image.

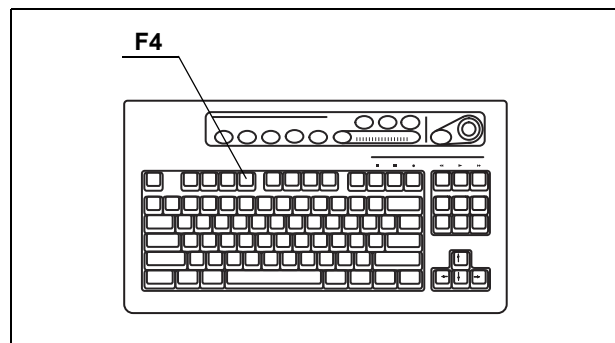

Figure 5.26

The freeze mode switches between “frame” and “field” each time the “F4” key is pressed. For more information of the freeze mode, see “Freeze function” on page 225.

Browse (“Shift” + “F4”)

Press these keys to open the PC card menu. The PC card displays the endoscopic images and patient data stored on the PC card. See “PC card menu” on page 110.

Press the “Shift” and “F4” keys together to open the PC card menu.

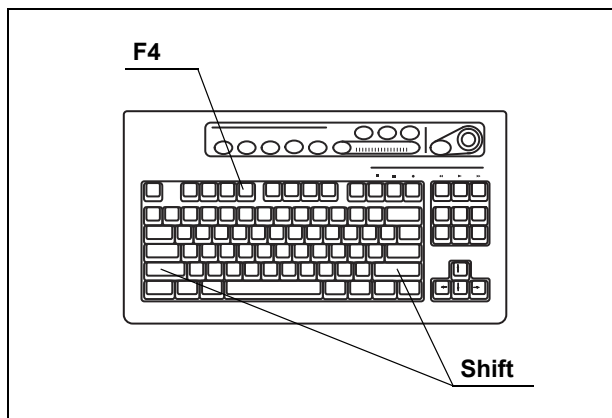

Figure 5.27

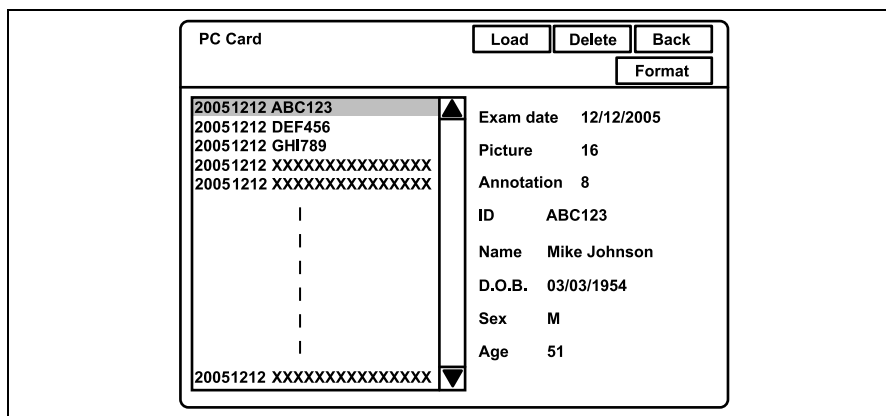

Figure 5.28

Stopwatch ("F5")

Press the "F5" key to change the clock on the monitor screen to a stopwatch. Use the "F5" key also to start and stop counting (see Figure 5.30).

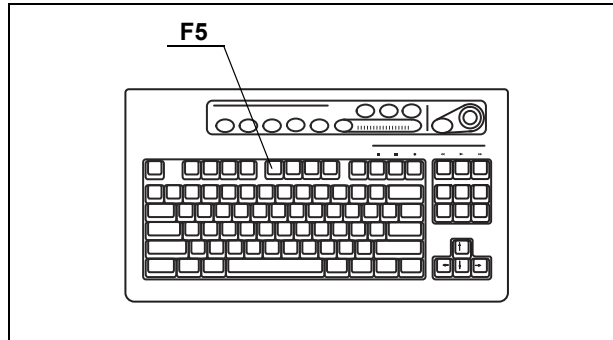

Figure 5.29

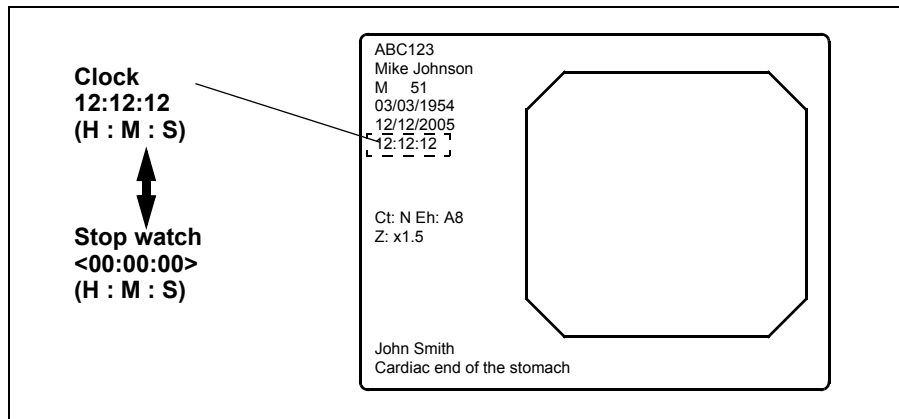

Figure 5.30

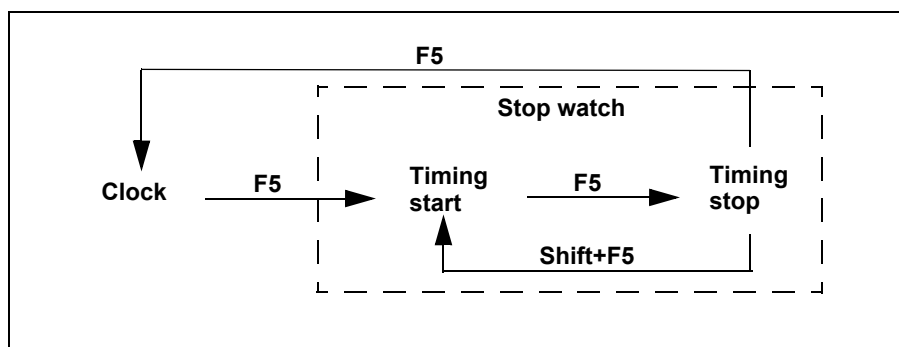

Figure 5.31

NOTE

The stopwatch operation can also be controlled from the scope switches and/or foot switches. For how to set up the scope switches and foot switches, see "Remote switch and foot switch (EXERA and VISERA)" on page 219.

Automatic gain control (AGC) (“F6”)

If necessary set up the AGC function in advance. See “Auto gain control (AGC)” on page 237.

1. The AGC function is turned ON and OFF alternately each time the “F6” key is pressed. The AGC status, ON or OFF, is displayed on the monitor for about 2 seconds (see Figure 5.33).

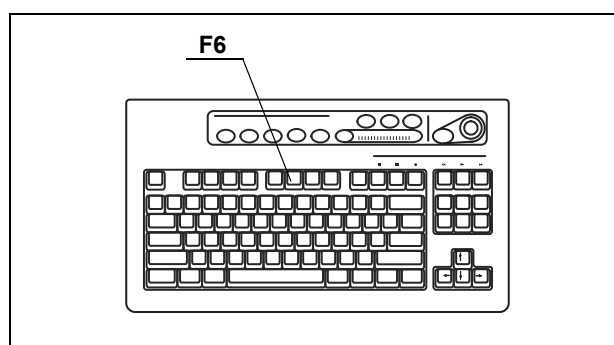

Figure 5.32

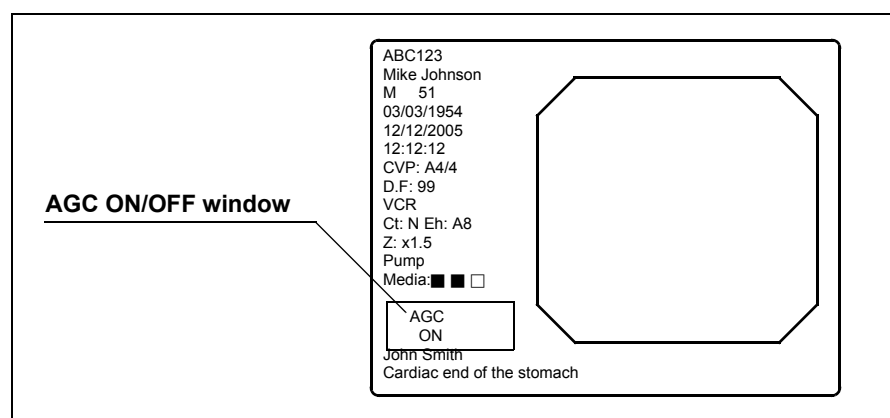

Figure 5.33

NOTE

- Image noise may appear when AGC is ON.
- The AGC function cannot be switched ON or OFF while the image is frozen.
- The AGC function used in the last operation before turning the instrument OFF comes up, when the instrument is turned ON.
- The AGC switching operation can also be controlled from the scope switches and/or foot switches. For how to set up the scope switches and foot switches, see “Remote switch and foot switch (EXERA and VISERA)” on page 219.

Contrast mode (“Shift” + “F6”)

Pressing these keys changes the contrast of the endoscopic image.

Mode	Explanation
Normal	Standard setting
High	Darkens the dark part and brightens the bright part compared to the normal observation.
Low	Brightens the dark part and darkens the bright part compared to the normal observation.

Table 5.6

1. Press the “Shift” and “F6” keys together. Every time the two keys are pressed, the contrast mode changes. The selected mode is displayed on the monitor (see Figure 5.35).

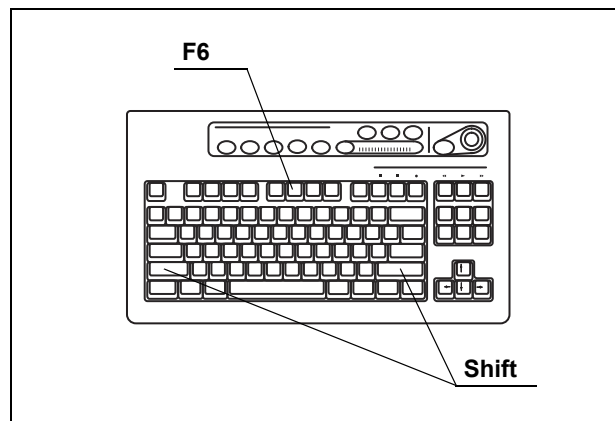

Figure 5.34

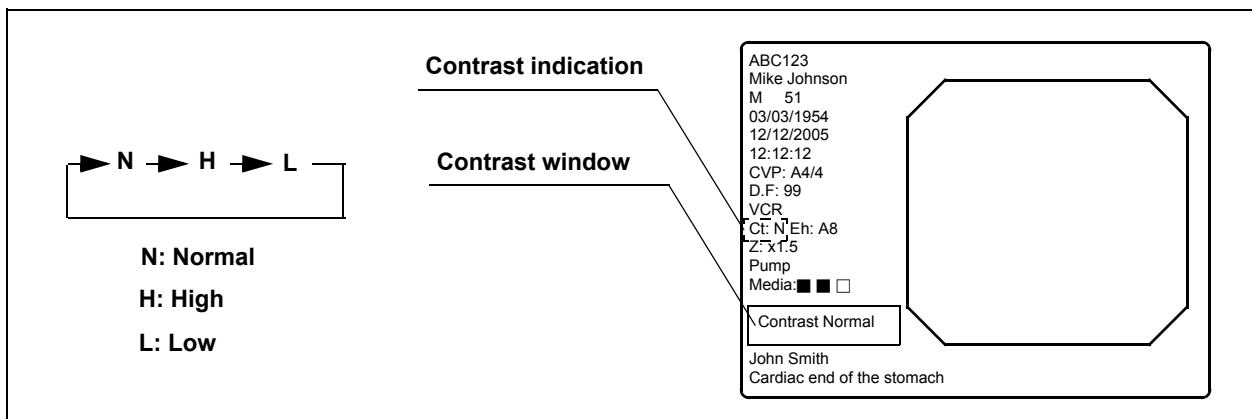

Figure 5.35

NOTE

- The contrast mode function does not work during the special light observation.

- The contrast mode can also be controlled from the scope switches and foot switches. For how to set up the scope switches and foot switches, “Remote switch and foot switch (EXERA and VISERA)” on page 219.

Image zooming (“F7”)

The endoscopic image can electrically be magnified, when using the endoscope compatible with the electronic zooming function (Scope 1, Scope 4, and Scope 5 in Table 9.30 on page 229). Three zoom ratios, x1, x1.2, x1.5, are available. The image area size does not change.

Press the “F7” key to change the zoom ratio. The zoom ratio is displayed on the monitor for about 2 seconds (see Figure 5.37).

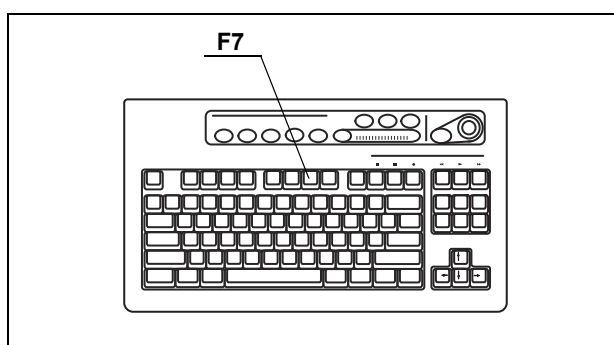

Figure 5.36

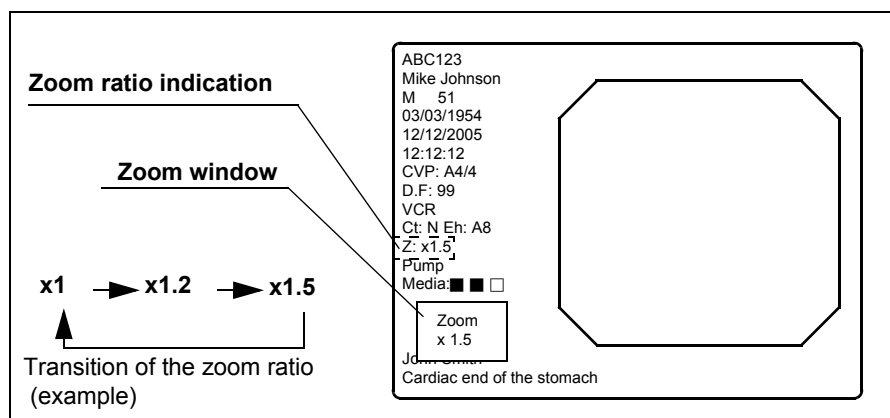

Figure 5.37

NOTE

- The image area size can be changed during zooming (see “Image size (“F8”)” on page 94). When the zoom ratio returns to x1, the image area size also returns to the original size.
- While the image is frozen, the zoom function is not active.
- When the zoom ratio is x1, the zoom ratio is not displayed on the monitor.
- This instrument always starts with zoom ratio x1.
- The zoom ratio is displayed at the lower left on the monitor when the text information is cleared on the monitor.
- The zoom ratio can also be controlled from the scope switches and/or foot switches. For how to set up the scope switches and foot switches, see “Remote switch and foot switch (EXERA and VISERA)” on page 219.

Color bar (“Shift” + “F7”)

The color bar is used to check the color tones of the monitor. The color bar can be displayed when the monitor displays the endoscopic image.

1. Turn the video system center and the monitor ON (see Figure 5.38).

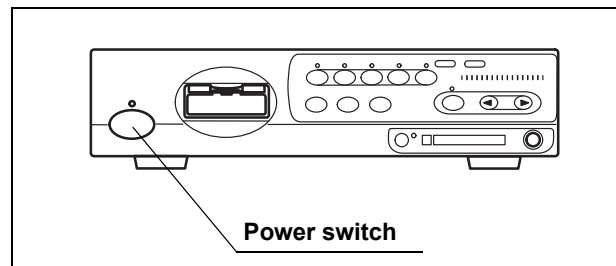

Figure 5.38

2. Press the “Shift” and “F7” keys together (see Figure 5.39). The color bar appears on the monitor (see Figure 5.40).

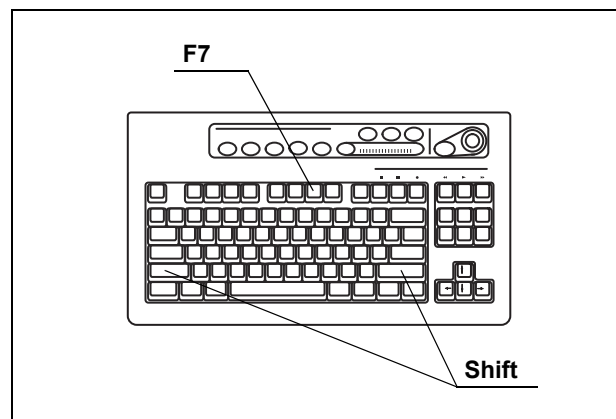

Figure 5.39

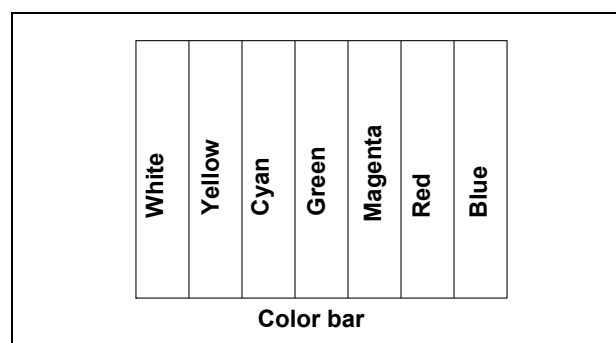

Figure 5.40

3. Confirm that all colors of the color chart are displayed properly.

4. If the colors do not appear properly, adjust them according to the instruction manual of the monitor.
5. Press the “Shift” and “F7” keys together (see Figure 5.39) to return to the endoscopic image screen.

Image size (“F8”)

The size of the observation image on the monitor can be changed (see Table 9.31 in “Image size” on page 229). The available image sizes are variable depending on the endoscope.

The image size changes each time the “F8” key is pressed.

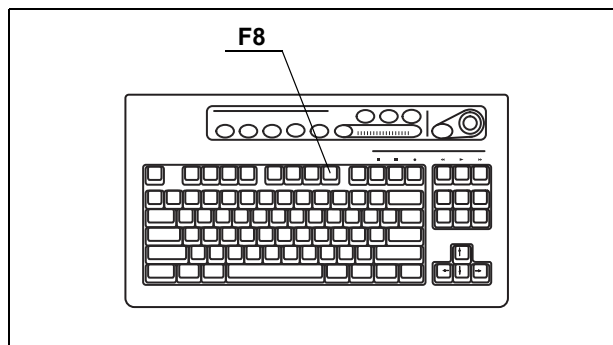

Figure 5.41

NOTE

- When the video system center is turned ON, the image size used in the last operation before the instrument is turned OFF comes up when the instrument is turned ON.
- The image size selection operation can also be controlled from the scope switches and/or foot switches. For how to set up the scope switches and foot switches, see “Remote switch and foot switch (EXERA and VISERA)” on page 219.

Printer lock (“Shift” + “F8”)

All keys of the “PRINTER REMOTE” on the keyboard can be locked. During this time, the video printer can be operated using the keys on the printer.

1. Press the “Shift” and “F8” keys together to lock the “PRINTER REMOTE” keys.

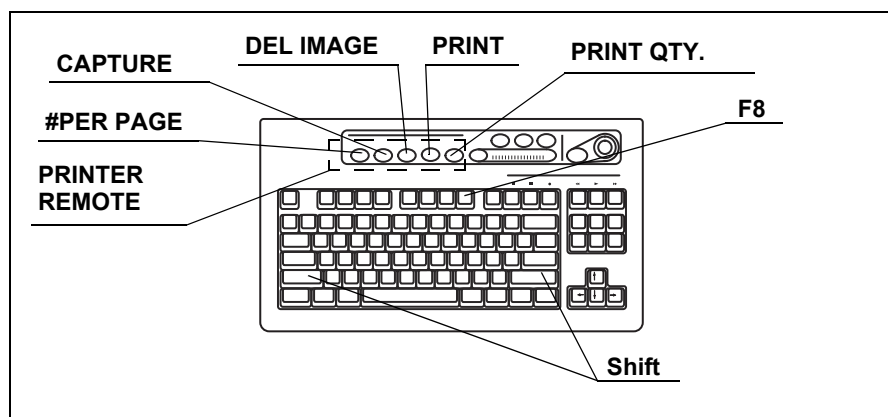

Figure 5.42

2. To unlock the keys, press the “Shift” and “F8” keys together again.

Image enhancement (“F9”)

This key changes the image enhancement modes. The three types and level of the image enhancement should be set in advance. For the setup procedure, see “Image enhancement (normal observation)” on page 226 and “Image enhancement (NBI observation)” on page 250.

1. Press the “F9” key to display the current enhancement mode for a few seconds.
2. During displaying the mode on the monitor, press the “F9” key to change the enhancement mode (ex. A1, A3, etc.). The display window appears for a few seconds.

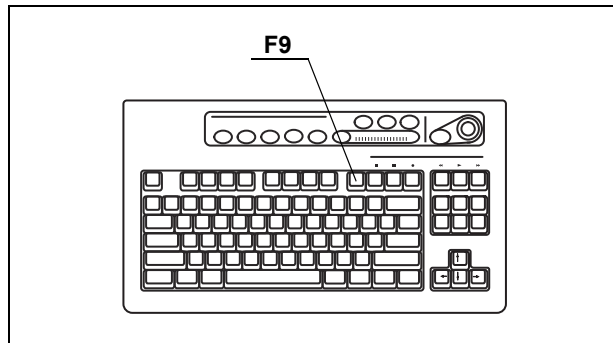

Figure 5.43

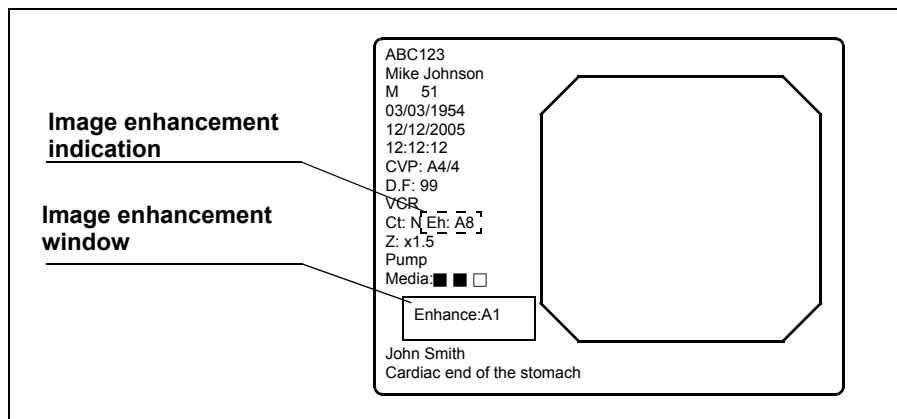

Figure 5.44

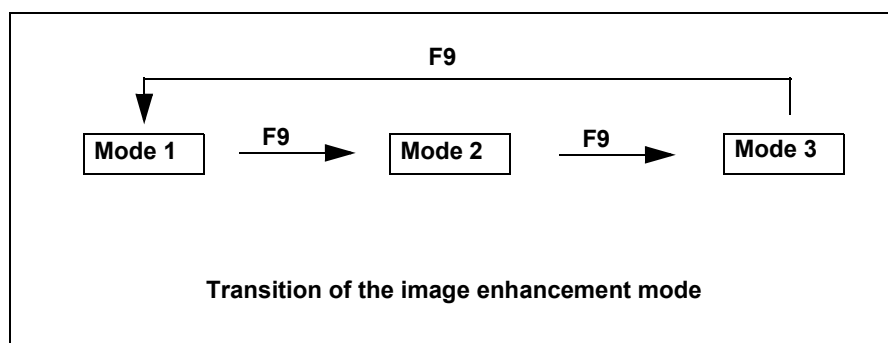

Figure 5.45

NOTE

- When this instrument is turned ON, the enhancement mode used in the last operation before the instrument is turned OFF comes up when the instrument is turned ON.
- The image enhancement mode selection operation can also be controlled from the scope switches and/or foot switches. For how to set up the scope switches and foot switches, see “Remote switch and foot switch (EXERA and VISERA)” on page 219.

White balance adjustment (“Shift” + “F9”)

White balance is an adjustment function to display the appropriate color of the image on the monitor. The operation of these two keys is the same as the “Wh/B” button on the front panel. See Section 4.5, “White balance adjustment” on page 52.

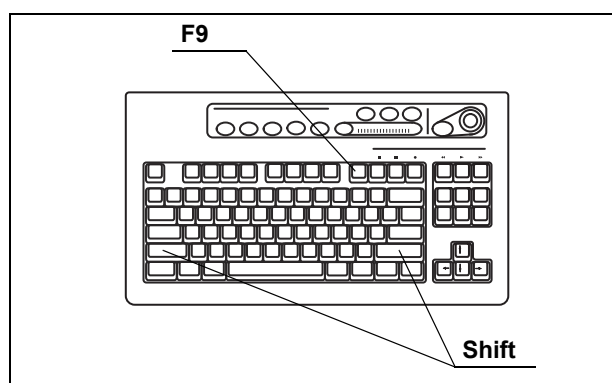

Figure 5.46

NOTE

The white balance adjustment can also be initiated from the scope switches and/or foot switches. For how to set up the scope switches and foot switches, see “Remote switch and foot switch (EXERA and VISERA)” on page 219.

Color tone adjustment (“COLOR”)

This key is used for the adjustment of R (red), B (blue) and C (chroma) of the observation image on the monitor. The adjustment level is displayed by the color level indicator on the keyboard (see Figure 5.47).

This adjustment is effective for the normal observation and NBI observation. The normal observation has the common setting of R, B and C. NBI observation has its own setting.

CAUTION

Complete the white balance adjustment before the color tone adjustment. Otherwise, the color tone is not adjusted properly.

1. Press the “COLOR” key to select R (red), B (blue) or C (chroma) to adjust. The indicator above the key lights up to show the tone selected.

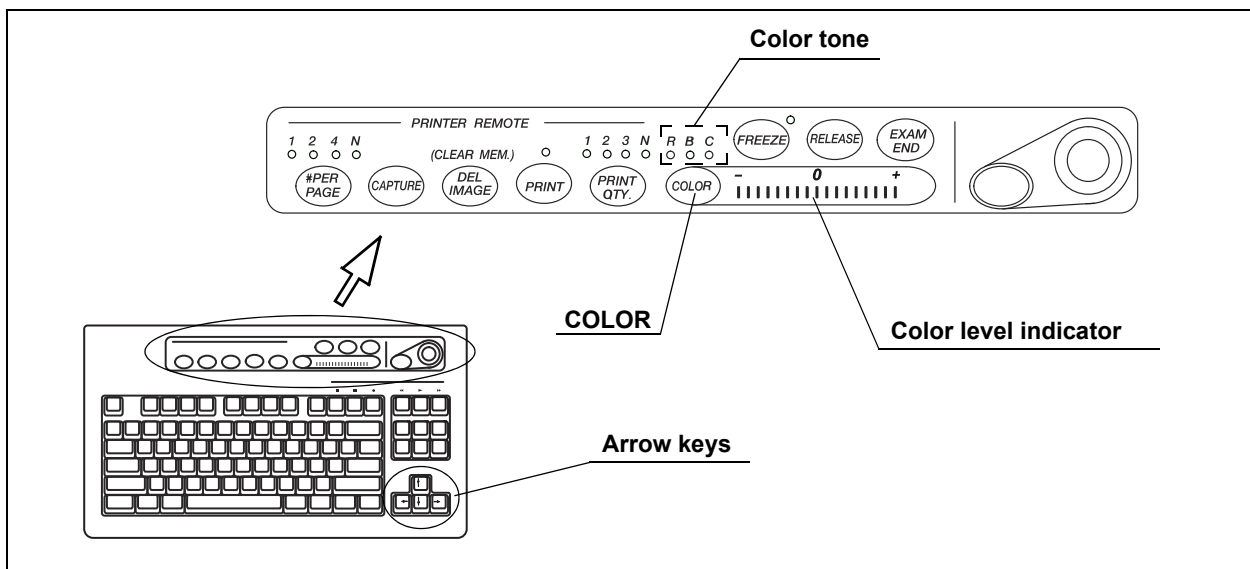

Figure 5.47

2. Press the arrow keys to adjust the level of the selected tone.
3. Press the “COLOR” key to select the next tone and adjust it the same way.

NOTE

- When the keyboard is left untouched for more than 10 seconds after selecting the tone, the selection is canceled automatically and the indicator goes OFF.
- When the video system center is turned ON, the color tone used in the last operation before the instrument is turned OFF comes up when the instrument is turned ON.

Freeze (“FREEZE”)

This key pauses the endoscopic live image for recording or observation. There are two types of freeze function: “field freeze” and “frame freeze”. The type of freeze function to start with can be set in advance in the user preset menu. See “Freeze function” on page 225.

WARNING

If the frozen image does not return to the live image, turn this instrument OFF then ON again. Also turn the ancillary equipment OFF then ON again by referring to the respective instruction manual. If the image is still frozen, immediately stop using this instrument and withdraw the endoscope gently from the patient’s body by referring to the instruction manual of the endoscope.

1. Press the “FREEZE” key (see Figure 5.48) to freeze the endoscopic image.
2. Press the “FREEZE” key again and the frozen image returns to the live image.

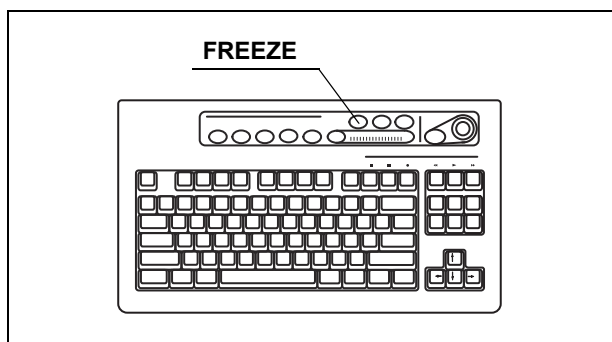

Figure 5.48

NOTE

- The frozen image also returns to the live image by pressing any key on the keyboard, except for the following keys. “F1”, “F4”, “F5”, “F8”, “F9”, “Shift” + arrow keys.
- The frozen image might be blurred, when a fast motion has been captured.
- A frozen image in the frame freeze mode is more easily blurred than in the field freeze mode.
- During freezing, the size of the image area and image enhancement can be changed.

- The image freeze operation can also be controlled from the scope switches and/or foot switches. For how to set up the scope switches and foot switches, see “Remote switch and foot switch (EXERA and VISERA)” on page 219.

Release (“RELEASE”)

The key is used for image recording of the devices listed below. The device to be controlled by this key has to be set in advance in the user preset menu (Release1 in the user preset menu). See “Release function” on page 223.

- Video printer, PC card, Image filing system

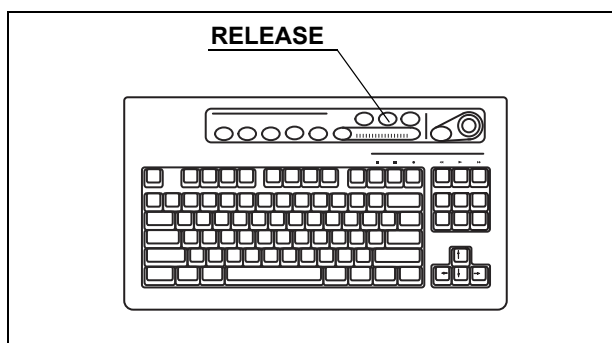

Figure 5.49

1. Press the “RELEASE” key to record the endoscopic image on the recording devices assigned. The live image pauses for a few seconds.
2. The counter of the recording devices on the monitor changes.
 - Video printer: Increments the counter.
 - Image filing system: Increments the counter.
 - PC card: Displays the storage level. (see “Storage level of the PC card” on page 106).

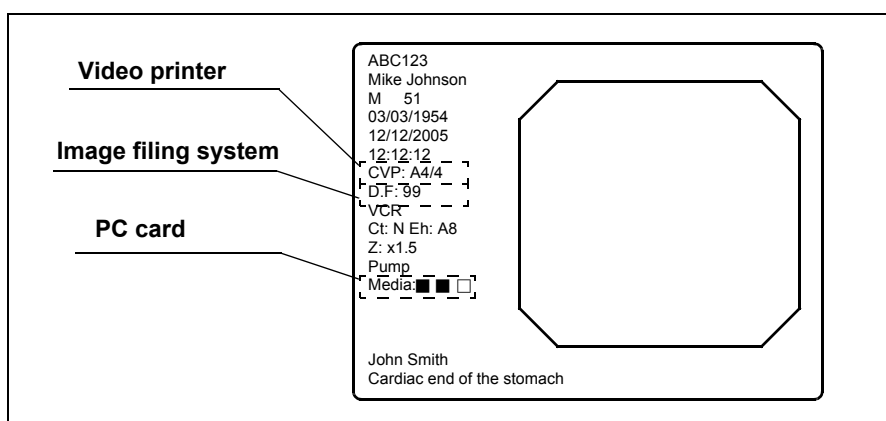

Figure 5.50

NOTE

- The release operation can also be controlled from the scope switches and/or foot switches. For how to set up the scope switches and foot switches, see “Remote switch and foot switch (EXERA and VISERA)” on page 219.
- Before activating the PinP function make sure that an endoscope is connected to this instrument. If no endoscope is connected it might not be possible to use the PinP function and image recording of an external device may not work.

Arrow pointer (“Shift” + arrow keys and domepoint)

The arrow pointer can be displayed on the monitor. The arrow pointer is used to mark a desired position in the endoscopic image, or to click the menus. The display of the arrow pointer depends on each screen.

Screen	Display of the arrow pointer
Endoscopic image screen	Press “Shift” and any arrow key.
System setup menu	Always displayed
User preset menu	
Patient data menu	
Scope information menu	
PC card menu	Always displayed on the other than full image screen Press “Shift” and any arrow key in the full image screen.

Table 5.7

1. Press the “Shift” and any arrow key (see Figure 5.51). The arrow pointer appears in the center of the endoscopic image (see Figure 5.52).

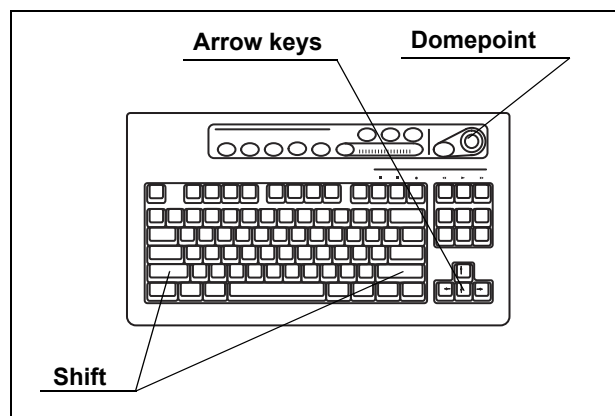

Figure 5.51

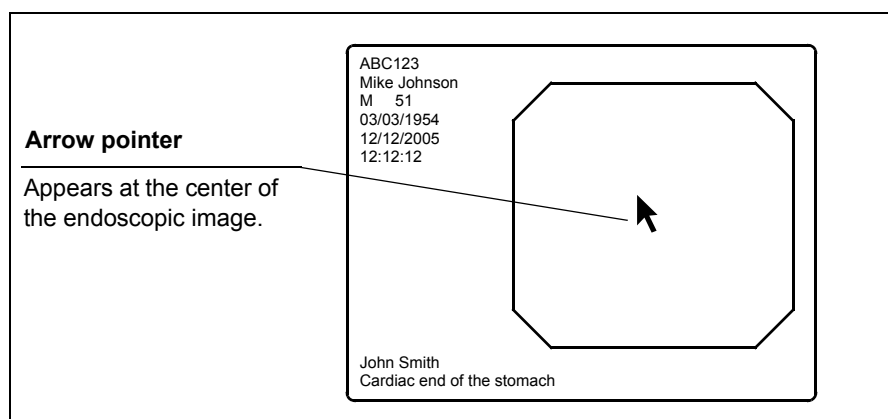

Figure 5.52

2. Move the arrow pointer using the domepoint on the keyboard.
3. To delete the arrow pointer, press the “Shift” and any arrow key.

NOTE

- The arrow pointer disappears when the endoscopic image screen once changes to the other menu and returns to the endoscopic image screen.
- The arrow pointer can also be displayed and cleared from the scope switches and/or foot switches. For how to set up the scope switches and foot switches, see “Remote switch and foot switch (EXERA and VISERA)” on page 219.

Color mode (“Shift” + “Alt” + “1”, “2”, “3”, “4”)

These keys change the color tone of the monitor. This function is valid only for Scope B, C, and D in Table 9.33 on page 233. This function is not active for NBI observation because NBI observation uses the default setting for each endoscope. See “Color mode” on page 228 for the initial mode.

Press “Shift”, “Alt”, and one of the “1”, “2”, “3”, or “4” keys together. The color mode changes.

Key	Color mode	Color tone of the display
Shift + Alt + 1	Mode 1	Same as the color mode 1 of VISERA video system center OTV-S7V
Shift + Alt + 2	Mode 2	Less reddish color than the Mode 1
Shift + Alt + 3	Mode 3	More yellowish color than the Mode 1
Shift + Alt + 4	Mode 4	Standard color mode

Table 5.8

Ending examination (“EXAM END”)

The following steps are executed at the end of each examination procedure using this key;

- Clearing the displayed patient data on the monitor;
- Completing printing un-printed printer image;
- Close processing of image filing system.

CAUTION

Do not disconnect the video connector before turning the video system center OFF. Otherwise, the endoscope or camera head may be damaged.

Press the “EXAM END” key. The patient data on the monitor disappears and the data processing (e.g. to the PC card) is stopped.

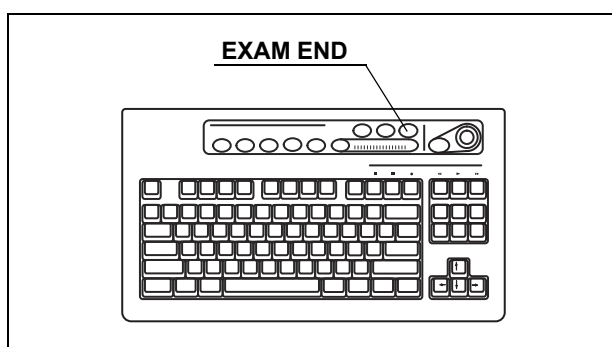

Figure 5.53

NOTE

The patient name that is once displayed in the endoscopic image turns gray in the patient list after finishing the observation by pressing the “EXAM END” key.

5.3 Image recording and playback (PC card)

This section explains how to record and playback images from the PC card. See “STOP button and PC card indicator” on page 75 and “PC card slot and eject button” on page 76 for the operation of the PC card slot.

CAUTION

- Be sure to format the PC card before recording images. Otherwise, recording cannot be performed properly. See “Formatting of the PC card” on page 114.
- Be sure to format the PC card using the CV-180. The PC card that is formatted by a personal computer may cause malfunction in recording or playback.

Storage level of the PC card

The storage level of the PC card is displayed on the monitor when the PC card is inserted into the PC card slot. A warning message appears on the monitor when the storage level runs out the space.

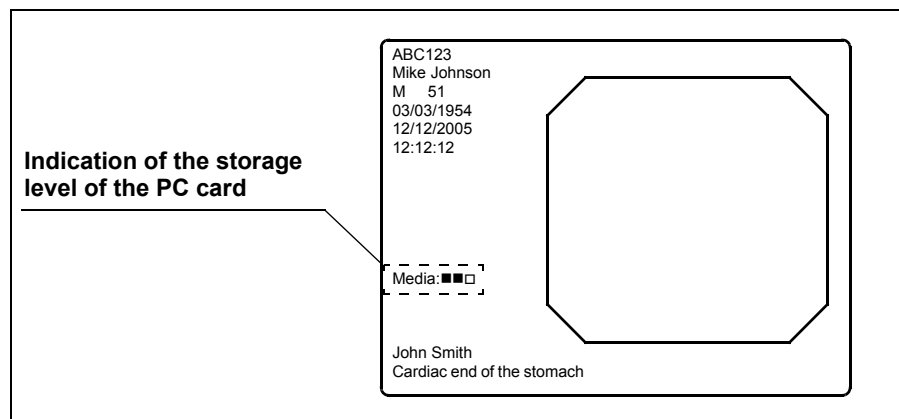

Figure 5.54

Display	Rough number of recordable images
Media: ■ ■ ■	50 or more images
Media: ■ ■ □	Less than 50 images
Media: ■ □ □	Less than 30 images
Media: □ □ □	Less than 20 images
Media: Full	Storage device is full.

Table 5.9

NOTE

- The storage level is a rough estimation based on the recording format (refer to “Recording format for PC card” on page 224). Prepare spare PC cards before the storage device runs out the space.
- If the storage level becomes less than 30 images during the examination or if the first release operation is done after turning the video system center ON when the storage level is less than 30 images, a message appears on the screen (see Figure 5.55).

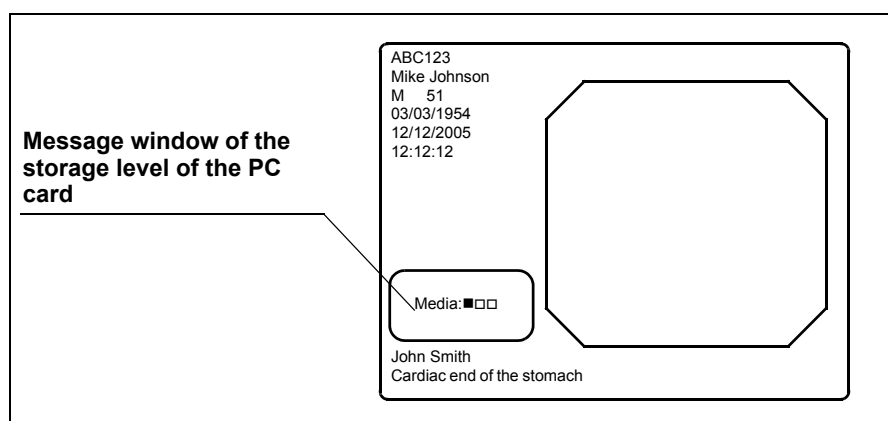

Figure 5.55

Recording the frozen image on a PC card

Assign the "PC Card" to "RELEASE 1" or "RELEASE 2" in the user preset menu in advance. See "Remote switch and foot switch (EXERA and VISERA)" on page 219.

1. Insert the PC card into the PC card slot. The PC card status indicator lights up green (see Figure 5.56).

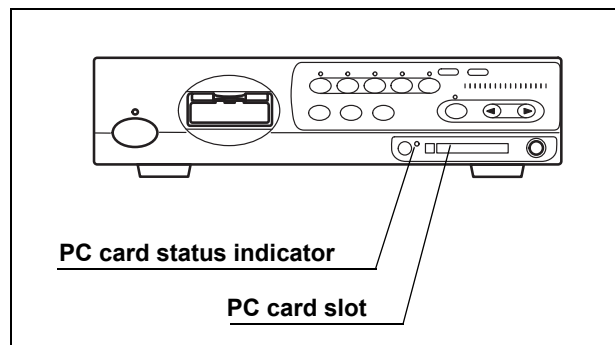

Figure 5.56

2. Press the "FREEZE" key to pause the endoscopic image (see Figure 5.57).
3. Check the frozen image if it is suitable to record. If not, press the "FREEZE" key again to return to the live image and repeat steps 2. and 3.

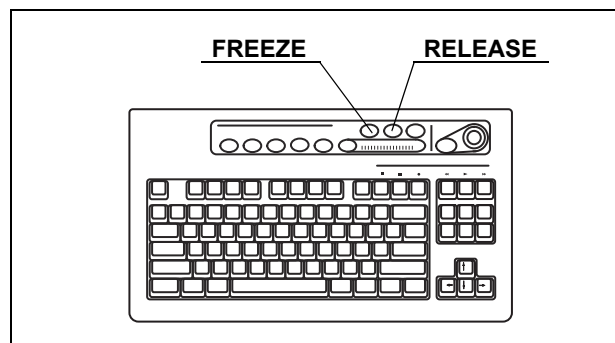

Figure 5.57

4. Press the "RELEASE" key (see Figure 5.57) to record the image. It may take around several seconds to record the images.
5. During recording, the PC card status indicator blinks orange, and the endoscopic image returns to the live image.

CAUTION

- If the video system center is turned OFF or the "STOP" button is pressed during recording, the images on the video system center will be lost.

- Up to 5 serial images can be recorded. The serial release action over 5 (3 in PinP) displays the message “Please wait.” and cannot record the images.

NOTE

- It takes several seconds to record the images depending on endoscope, recording format and object. Usually, HDTV images take longer than SDTV images.
- The freeze and release operations can also be controlled from the scope switches and foot switches. For how to set up the scope switches and foot switches, see “Remote switch and foot switch (EXERA and VISERA)” on page 219.
- The main and sub images of PinP are recorded on the PC card as the separated files that have the same time stamp.

PC card menu

The images on the PC card can be displayed, cleared, etc., on the PC card menu. Figure 5.58 shows the menu tree of the PC card menu.

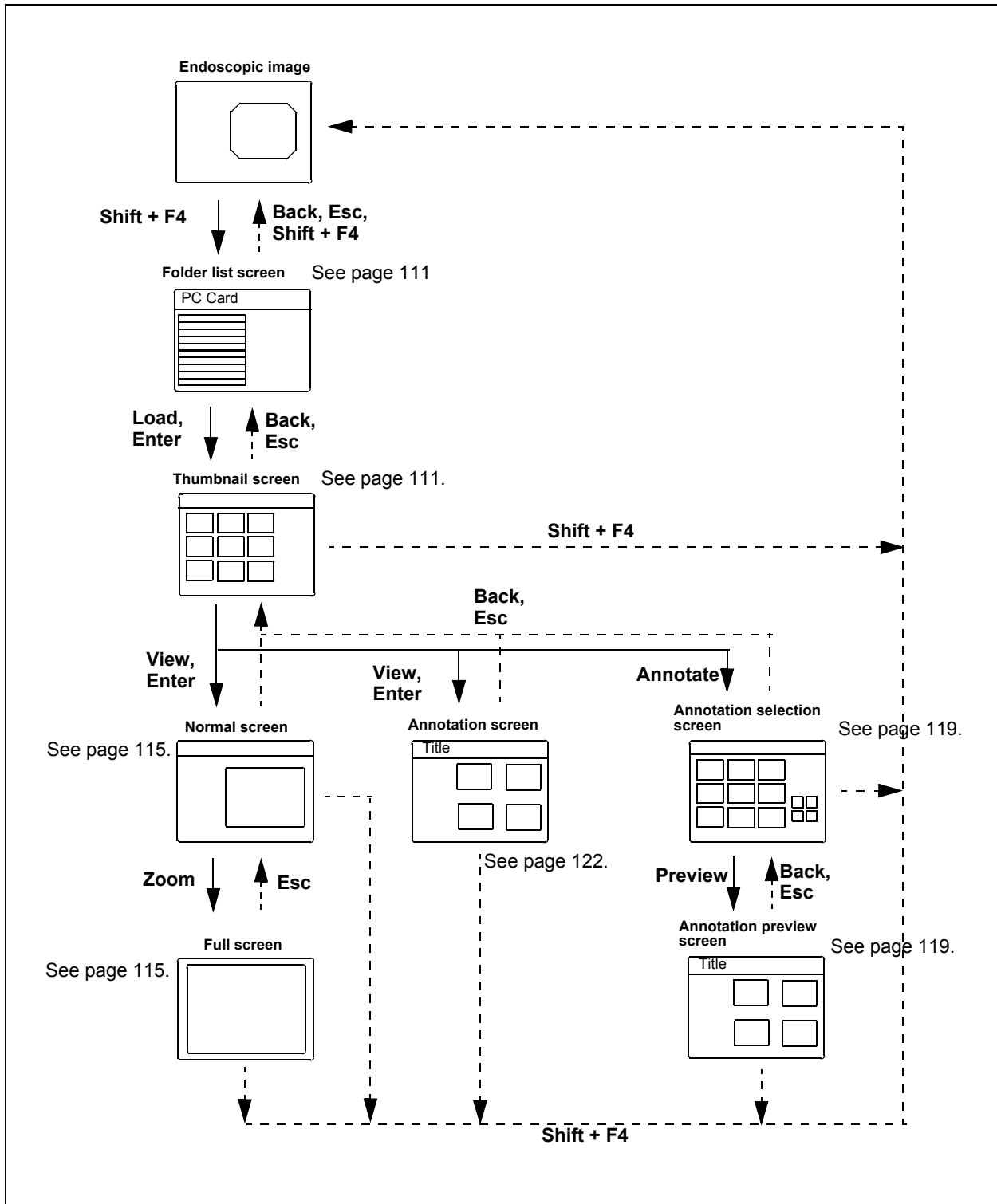

Figure 5.58

Basic operation of the PC card menu

1. Insert the PC card into the PC card slot. The PC card status indicator lights up green (see Figure 5.59).

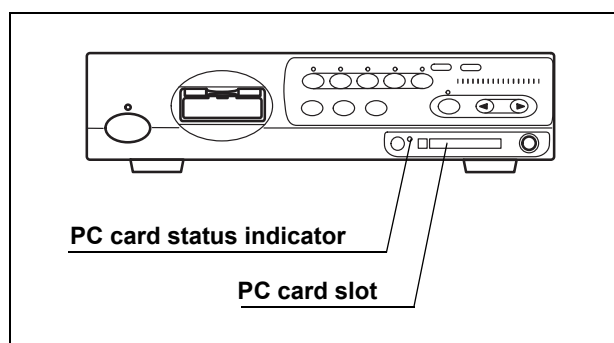

Figure 5.59

NOTE

For details on the PC card and PC card slot, see “STOP button and PC card indicator” on page 75 and “PC card slot and eject button” on page 76.

2. Press the “Shift” and “F4” keys together (see Figure 5.60). The message “Please wait” is displayed on the monitor, then the folder list screen appears (see Figure 5.61).

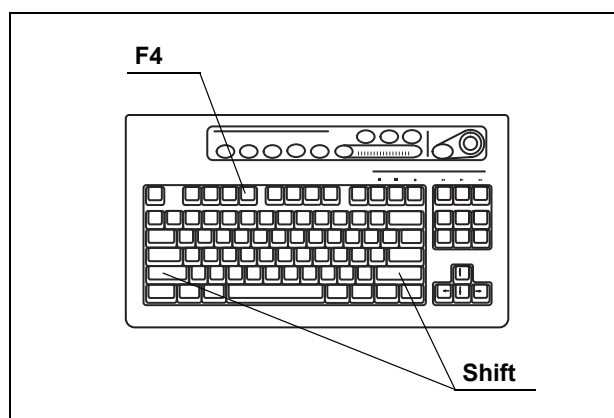

Figure 5.60

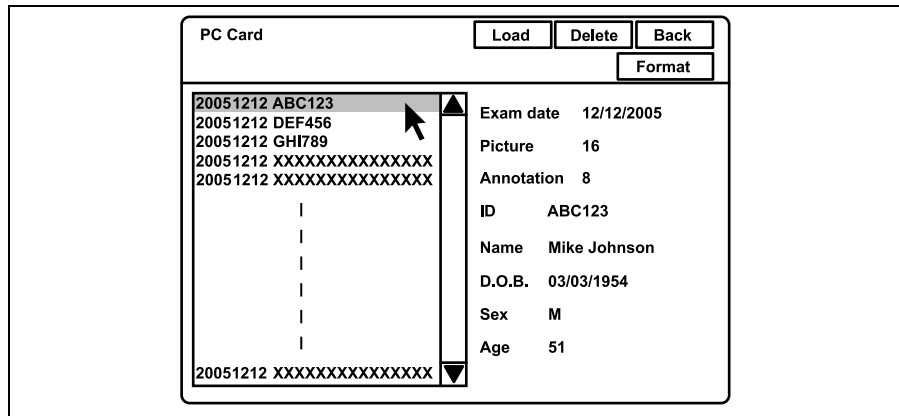

Figure 5.61

Button	Function	Details
Load	Displays the thumbnail index of the data folder selected.	page 111
Delete	Deletes the data folder selected.	page 118
Back	Returns to the endoscopic live image.	page 111
Format	Formats the PC card.	page 114

Table 5.10

- Click an image folder in the folder list. The patient data is displayed on the right side of the window.
- Click “Load” or press the “Enter” key. The message “Please wait” is displayed on the monitor, then the thumbnail screen appears (see Figure 5.62). The thumbnail-sized images for the annotation image is not an image but an icon.

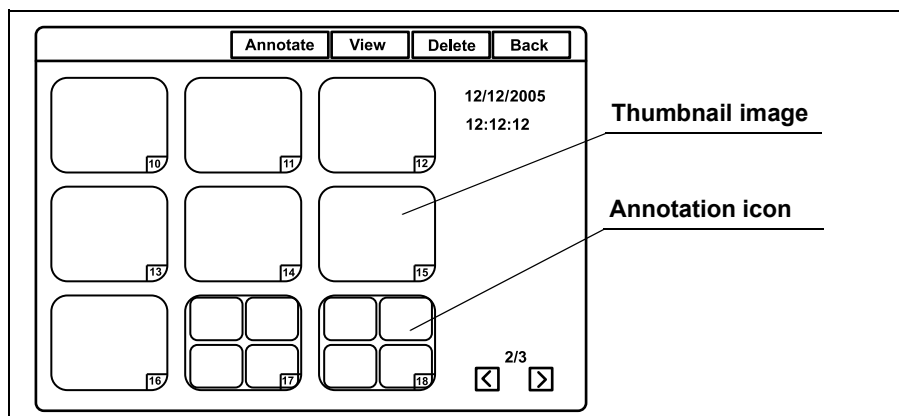

Figure 5.62

- Perform file operation such as playback and deletion of images, etc.

6. Click “Back” or press the “Esc” key to return to the previous screen. Or press the “Shift” and “F4” keys together to return to the endoscopic image.

NOTE

- The aspects ratio of a thumbnail image depends on the endoscope used.
- Refer to “Image files and folders” on page 125 for the details of the folder names shown in the folder list screen.

Formatting of the PC card

CAUTION

- Be sure to format the PC card using the CV-180. If it is formatted by an other instrument such as a personal computer, it may not be possible to record or playback images from the PC card.
 - Do not press the “STOP” button during formatting the PC card.
 - Formatting a PC card deletes all data saved on the PC card.
1. Display the folder list screen (refer to “Basic operation of the PC card menu” on page 111).
 2. Click “Format” (see Figure 5.63). A confirmation message is displayed to ask if the card can be formatted.

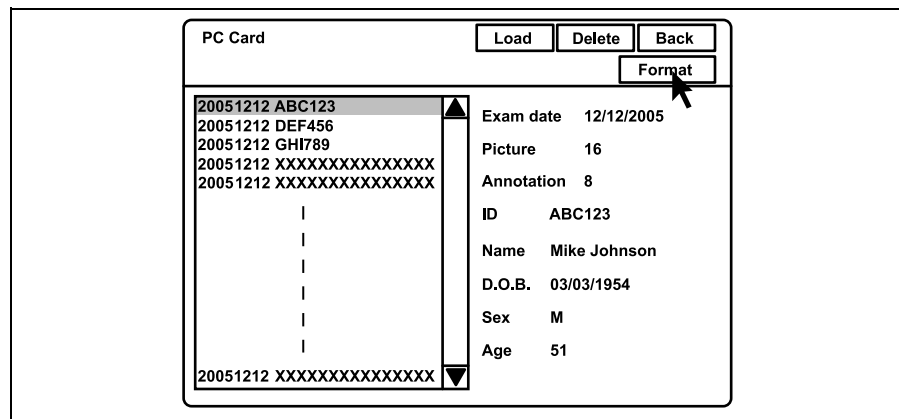

Figure 5.63

3. Click “No” to go back to the folder list screen instead of formatting. Click “Yes” to start formatting. During formatting, the message “Please wait” appears on the screen and the PC card status indicator of the video system center blinks orange.
4. The PC card status indicator lights up green after formatting has been completed and the message “Complete” appears on screen. A notification of normal or abnormal completion appears on the monitor.

NOTE

If formatting failed, the message “Failed in format” appears on screen. In this case, the PC card is not working properly. Use a new one.

Playback images from the PC card

1. Display the thumbnail screen (refer to “Basic operation of the PC card menu” on page 111).
2. Click a thumbnail image to playback. The selected image should be edged with a thick frame. The shooting date and time of the image are displayed on the right side of the window.

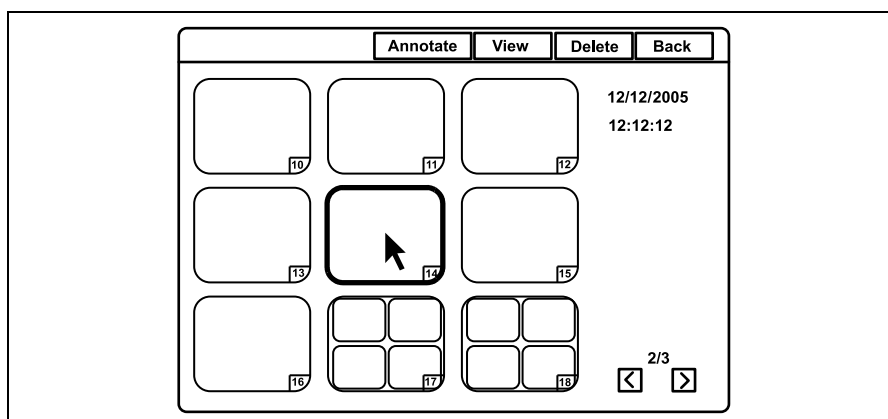

Figure 5.64

3. Click “View” or press the “Enter” key. The message “Please wait” is displayed on the monitor, then the normal screen image selected appears (see Figure 5.65).

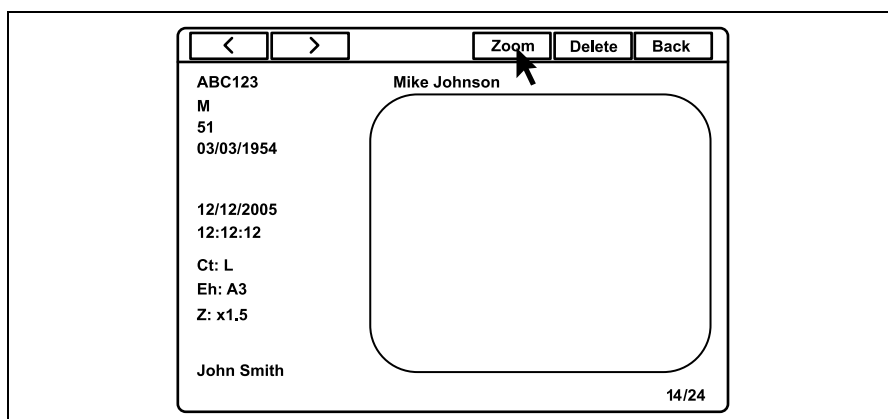

Figure 5.65

4. Click “<” or “>” to playback the images before and after the image currently being played back.

5. Click "Zoom". The message "Please wait" is displayed on the monitor, then the full screen image appears (see Figure 5.66).

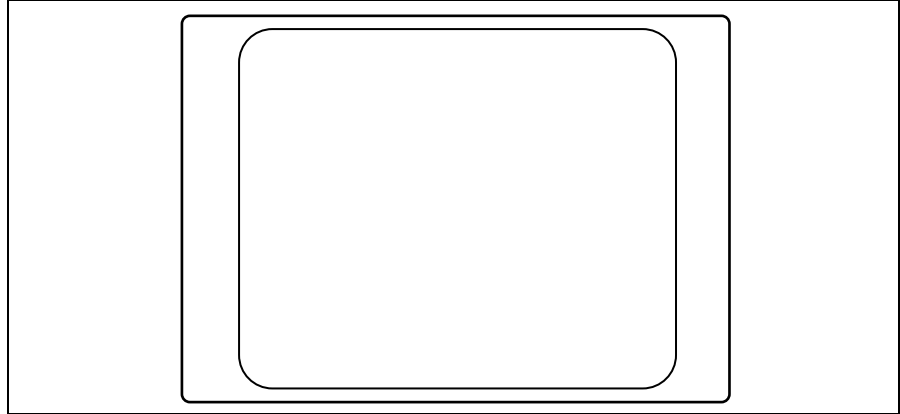

Figure 5.66

6. Press the "Esc" key to return to the normal sized playback screen.
Or press the "Shift" and "F4" keys together to return to the endoscopic image screen.

NOTE

- The images recorded by an instrument other than the CV-180 cannot be played back.
- The images edited by a personal computer or an instrument other than the CV-180 may be unable to be played back.
- The endoscopic image and the patient data is displayed together on the same screen when using the CV-180 for playing back, but cannot be displayed together on a personal computer.
- In the normal screen, all images recorded in the full-height or full size are scaled down and displayed on the constant display area are shown in Figure 5.65.
- The two images of the PinP are displayed separately in the thumbnail screen, which has the same time stamps but different file names.
- The sub image of the PinP is displayed with the same patient data as the main image.
- Playback in PinP mode is not available.
- "R" is not displayed on the monitor when the rotated image of the orientation function is played back (refer to "Monitor orientation function" on page 245).

- The images in the thumbnail screen and the normal screen are displayed in SDTV format. The full screen is displayed in the original format (HDTV or SDTV).

Deleting images from a PC card

1. Display the thumbnail screen (refer to “Basic operation of the PC card menu” on page 111).
2. Click a thumbnail image to be deleted. The selected thumbnail is edged with a thick frame. The shooting date and time of the image are displayed on the right side of the window.

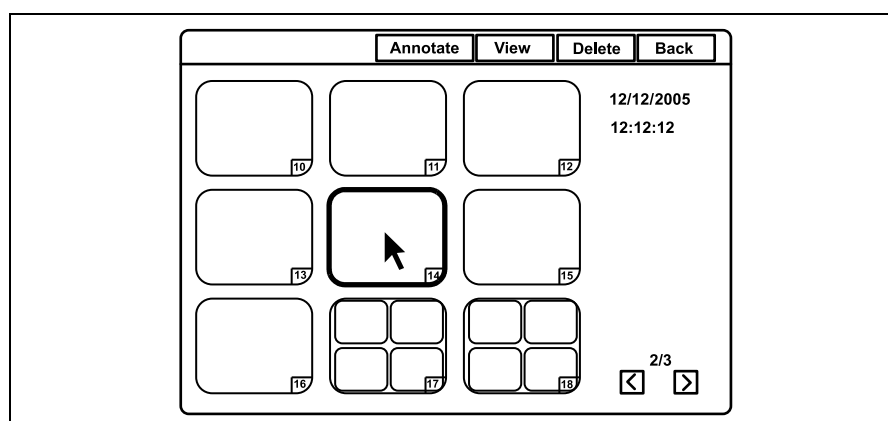

Figure 5.67

3. Click “Delete”. A confirmation message appears on the monitor.
4. Click “No” to go back to the thumbnail screen instead of deleting. Click “Yes” to delete the selected image.
5. Click “Back” or press the “Esc” key to return to the folder list screen. Or press the “Shift” and “F4” keys together to return to the endoscopic image.

NOTE

It is also possible to delete the image by displaying the image in the normal screen in step 2. and then clicking “Delete”.

Deleting folder from PC card

This operation deletes the image files from the PC card. The selected folder and all image files in this folder are deleted.

NOTE

Confirm in advance if the selected folder shall be deleted.
The deleted folder cannot be restored.

1. Display the folder list screen (refer to “Basic operation of the PC card menu” on page 111).
2. Click the image folder to be deleted. The patient data is displayed on the right side of the window (see Figure 5.68).

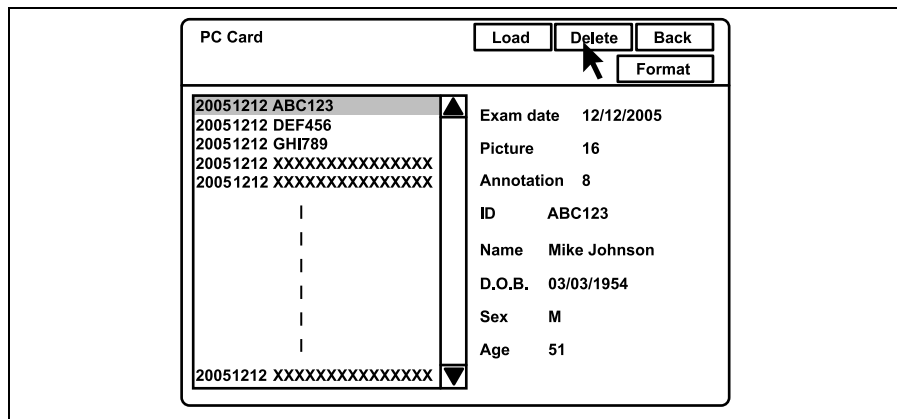

Figure 5.68

3. Click “Delete”. A confirmation message appears on the monitor.
4. Click “No” to go back to the folder list screen instead of deleting.
Click “Yes” to delete the selected folder.
5. Click “Back”, press the “Esc” key, or press the “Shift” and “F4” keys together to return to the endoscopic image.

Annotation of images

This function selects and arranges four frozen endoscopic images from a PC card onto a sheet with comments and stores it as a file in the same folder.

○ Selection of images

1. Display the thumbnail screen (refer to “Basic operation of the PC card menu” on page 111).
2. Click “Annotate” (see Figure 5.69).

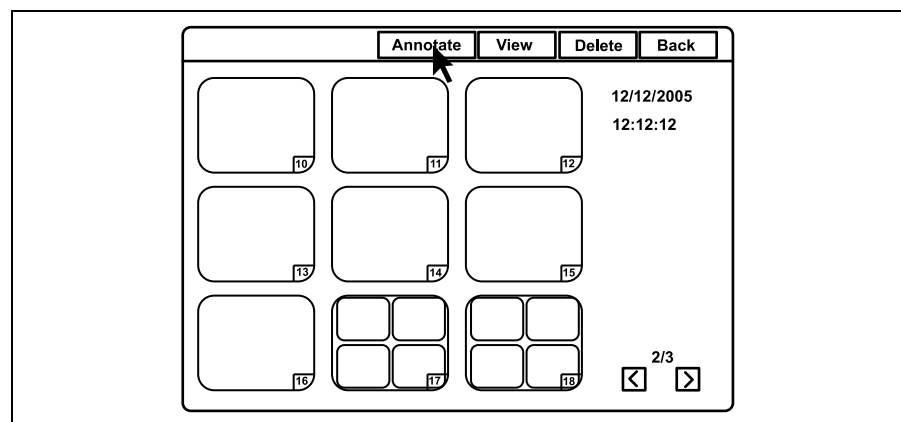

Figure 5.69

3. The annotation selection screen appears (see Figure 5.70).

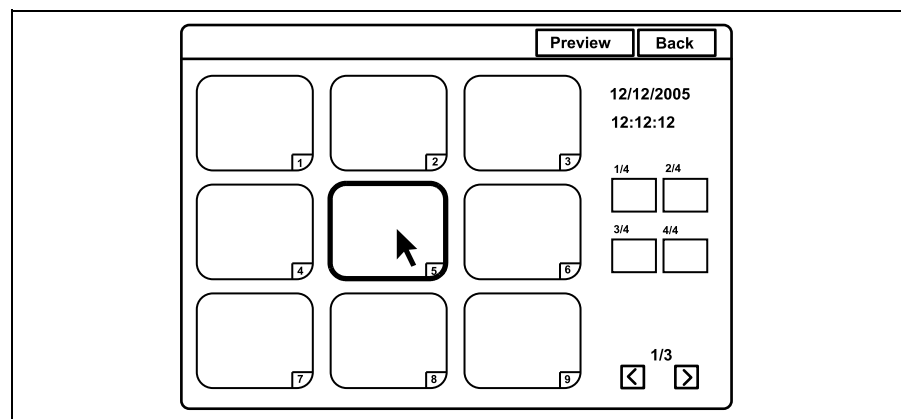

Figure 5.70

4. Click “<” or “>” to scroll the thumbnail images if necessary.
5. Click the required thumbnail image. The selected image is edged with a thick frame. The shooting date and time of the image are displayed on the right side of the window (see Figure 5.70).

- Click one of the position buttons on the screen. The number of the selected image appears at the position button and the selected image is edged with a thick frame in the color of the position button (see Figure 5.71).

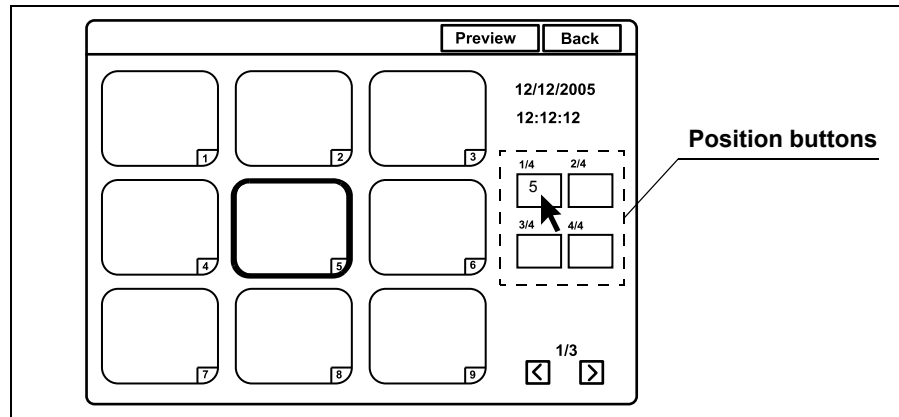

Figure 5.71

- Select up to 4 images repeating steps 4. to 6., and then proceed with “Annotating” on page 121.

NOTE

- If you click the position button that is already assigned with an image, the assignment is cleared.
- If you click an image and then click a position button that is already assigned with another image, the assigned image changes.
- The images that are assigned with the position buttons are edged with a thick frame in the following colors:
 - “1/4”: Pink
 - “2/4”: Blue
 - “3/4”: Green
 - “4/4”: Yellow

○ Annotating

1. Click "Preview" on the annotation selection screen after selecting the images (see Figure 5.71). The message "Please wait" is displayed on the monitor, then the annotation preview screen appears (see Figure 5.72).

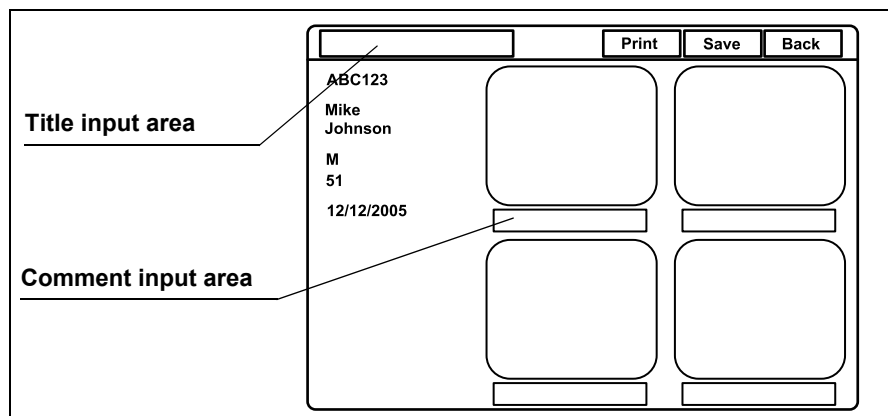

Figure 5.72

2. Click the title input area to place the cursor, and enter the title.
 - Up to 25 alphanumeric and symbol characters can be entered.
3. Click the comment input area under each image to place the cursor, and enter the title or comments.
 - Up to 15 alphanumeric and symbol characters can be entered.
4. Click "Save". The selected images, title and comments are recorded as an annotation image file on the PC card.
5. Click "Back" or press the "Esc" key to return to the annotation selection screen.
Or press the "Shift" and "F4" keys together to return to the endoscopic image.

NOTE

All annotation images including HDTV images are displayed and saved in SDTV format.

Playback image annotation

1. Display the thumbnail screen (refer to “Basic operation of the PC card menu” on page 111).
2. Click an annotation icon to be played back. The selected icon is edged with a thick frame (see Figure 5.73).

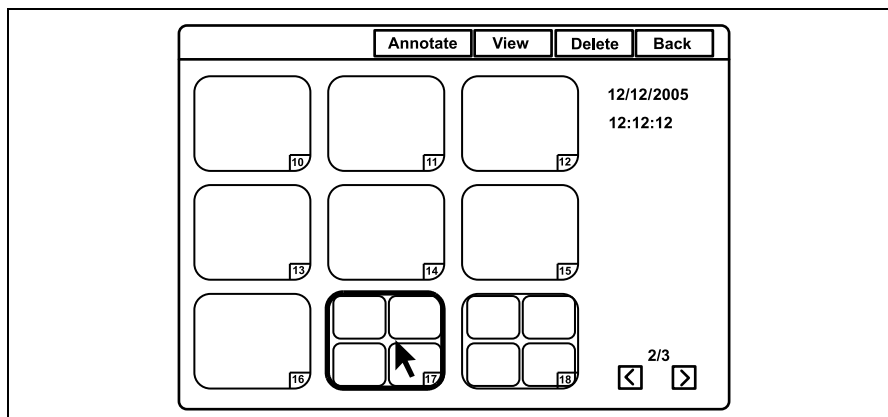

Figure 5.73

3. Click “View” or press the “Enter” key. The annotation screen appears on the monitor (see Figure 5.74).

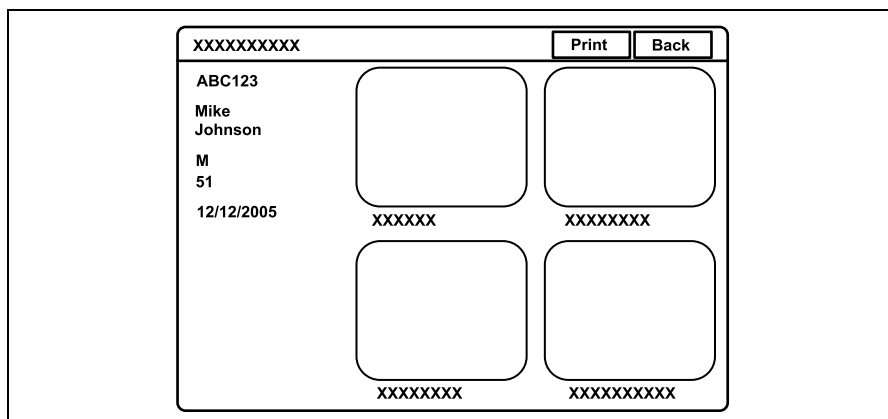

Figure 5.74

4. Click “Print” to print out the images on the video printer. A confirmation message appears on the monitor.
5. Click “No” to go back to the annotation screen instead of printing. Click “Yes” to print the images with the patient data and the comment.
6. Click “Back” or press the “Esc” key to return to the thumbnail screen. Or press the “Shift” and “F4” keys together to return to the endoscopic image.

NOTE

- When the type of printer is “Foot switch” in Table 9.8 on page 202, the “Print” function does not work.
- When “Yes” is selected in step 5., the un-printed images in the memory of the printer are cleared.

Playback the images using the personal computer

The images on the PC card can be played back on the personal computer. Hardware requirements are the followings:

- Windows® 2000 or later
- Internet Explorer ver.5.0 or later

CAUTION

Do not delete or move data on the PC card using the personal computer. The data may be damaged or it may not be possible to playback images from the PC card.

1. Insert the PC card into the PC card slot of the personal computer. Refer to the instruction manual of the personal computer.

2. Select the drive in which the PC card is inserted.

Figure 5.75 shows an example of the image files/folders structure on the PC card.

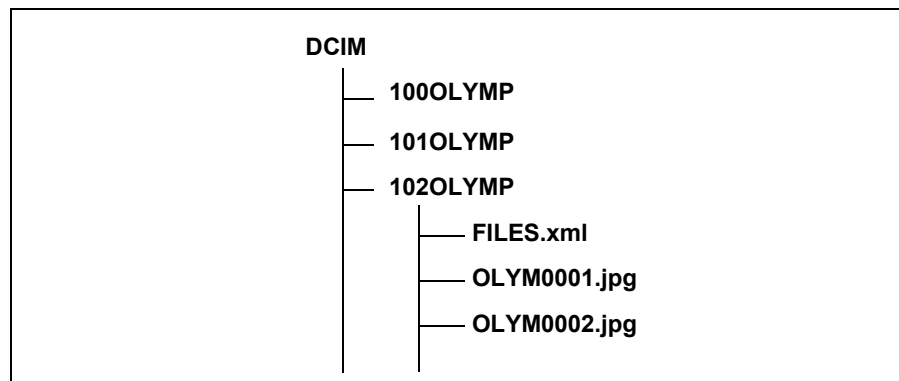

Figure 5.75

3. Open the desired folder.

4. Open the file "FILES.xml". The list of image files saved in the folder is shown in an Internet Explorer window.

5. Click the desired file of the list to display the image.

NOTE

- If you open the image file not using the xml. file, the endoscopic image and the data cannot be displayed in one image. The file names that are displayed by other than the xml. file are different from those in Figure 5.75.
- The images cannot be displayed in the PinP style.

Image files and folders

The data files of the endoscopic images are stored in the image folder, which is generated by the video system center, on the PC card.

○ Files

The video system center numbers the endoscopic image files sequentially. The names of each image file becomes like the following, and is numbered sequentially in order of photographing.

- OLYMnnnn.jpg:
("nnnn" is a four-digit number.)

○ Folders

The folder in which image files are stored either newly generated or previously generated ones are used according to the conditions such as turning ON or OFF the system, with or without the patient ID, etc. (see Table 5.11). The folder names are as follows.

- When the patient ID was entered: "8-digit date" + "max.15-digit patient ID"
ex. 20050512 ABC123 ("2005, May, 12th" and "ABC123")
- When no patient ID was entered: "8-digit date" + "15-digit X"
ex. 20050512 XXXXXXXXXXXXXXXXX

Resume function of patient data display *1	ON		OFF	
	Entered	Not entered	Entered	Not entered
Patient ID in the last observation				
Patient ID was NOT entered after the system was turned ON.	The image files are stored in the previous folder.*2	New folder is generated.		
Folder name	-	8-digit date +15-digit X		
Patient ID was entered after the system was turned ON.	New folder is generated.			
Folder name	8-digit date + Max.15-digit ID			

*1 For the resume function, see "Patient data display" on page 241.

*2 The shaded region is used for recording the images into the same folder after swapping the endoscope during the observation.

Table 5.11

CAUTION

Be sure to enter the patient ID each time when entering the patient data. Also, be sure to enter the different patient ID for each patient. Otherwise, the image data for some patients may mix in the same image folder.

NOTE

- When entering the same patient ID on the same date twice, a new folder with the same ID and date will be created, if an observation has taken place in between the two observation.
- The maximum number of image files recorded in a folder is 9999. The maximum number of folders on a PC card is 900. The total volume of the image data cannot exceed the amount of memory of the PC card.
- The recording speed decelerates when the number of images in a folder exceeds 100, or when the number of folders on a PC card exceeds 100.

5.4 Image recording and playback (other than PC card)

The recordable area of the image is variable depending on the recording devices. Refer to the respective instruction manual of the recording device.

Image filing system

Assign the "Digital file" to "RELEASE 1" or "RELEASE 2" in the "User preset" menu in advance. See "Release function" on page 223.

1. Press the "FREEZE" key (see Figure 5.76) to freeze the endoscopic live image.
2. Check the frozen image if it is suitable for recording. If not, press the "FREEZE" key again to return to the live image and repeat steps 1. and 2.

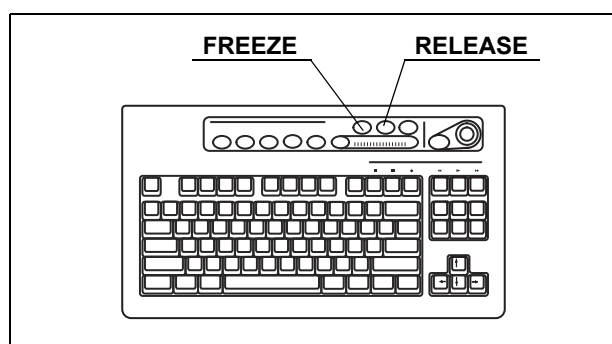

Figure 5.76

3. Press the "RELEASE" key (see Figure 5.76) to record the image. The frozen endoscopic image returns to the live image. The D.F. counter on the monitor increments by one (see Figure 5.77).
When the index image setting is ON, the index image is displayed at the lower left corner on the monitor.

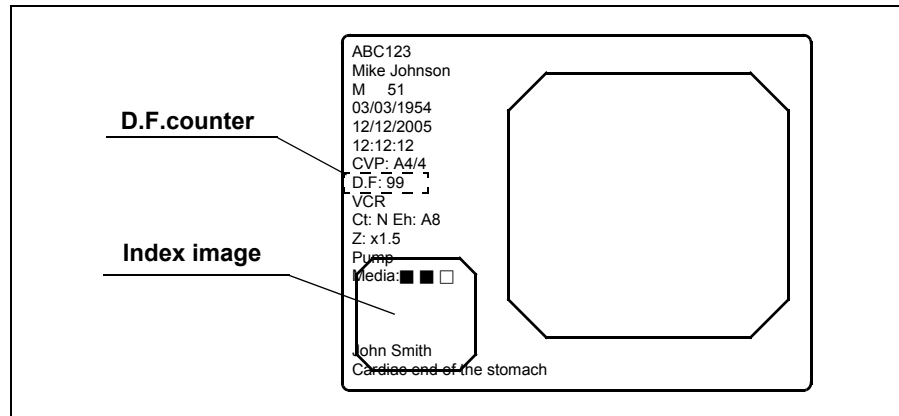

Figure 5.77

NOTE

- Press the “RELEASE” key (see step 3.) to record the image without checking the image. In this case, the live image is frozen for the release time, and then returns to the live image. See “Image filing system” on page 206 for the release time.
- Maintain intervals of 1 second or more between each press of the “RELEASE” key, when not using the “FREEZE” key. If the intervals are shorter than 1 second, it may not be possible to record images.
- Keep the endoscope as stationary as possible to record blurless images when pressing the “RELEASE” key.
- D.F. counter does not appear on the monitor when the user data are clear.
- The freeze and release operations can also be controlled from the scope switches and/or foot switches. For how to set up the scope switches and foot switches, see “Remote switch and foot switch (EXERA and VISERA)” on page 219.

Videocassette recorder (VCR)

VCR can be operated using the keyboard. The following table shows the function and the keys to operate.

Key	Function
F10 (■)	Stops recording or playback.
F11 ()	Pauses playback.
F12 (●)	Starts recording.
Print. screen (◀◀)	Fast-rewinds the tape.
Scroll Lock (▶)	Starts playback.
Pause (▶▶)	Fast-forwards the tape.

Table 5.12

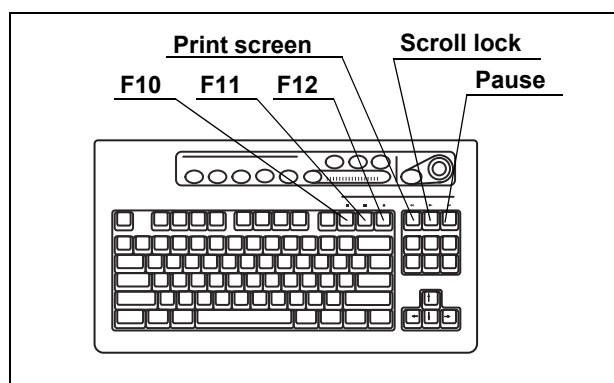

Figure 5.78

1. Press the Image source button to change the image source.
 - Press the “SCOPE” button to record the image.
 - Press the “DV/VCR” button to playback the image.
2. Perform the VCR operation of recording or playback using the keys on the keyboard (see Figure 5.78). “VCR” appears on the monitor during VCR recording (see Figure 5.79).

CAUTION

After turning the DVO-1000MD ON and right after disk insertion “Now Loading ...” is displayed. During this initialization process images cannot be recorded.

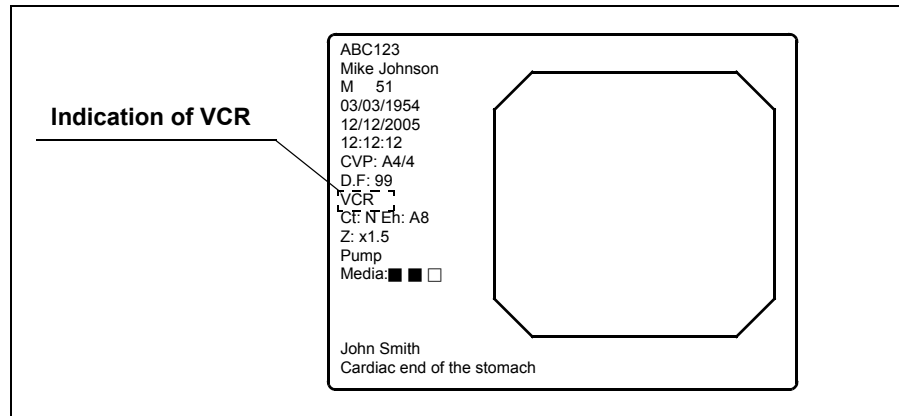

Figure 5.79

NOTE

- When the VCR is connected using the VTR remote cable (MH-992), only the recording and pause operations can be operated.
- When “DVD (IEEE1394) of the VCR type is selected, only the recording and pause operations can be operated (“Videocassette recorder” on page 211).
- The fast forward and rewind operations can be operated only when the VCR is set to RS-232C and IEEE1394.
- The “VCR” does not appear when the patient data are cleared from the monitor.
- Also refer to the instruction manual for the VCR.
- The recording and pause operations can also be controlled from the scope switches and/or foot switches. For how to set up the scope switches and foot switches, see “Remote switch and foot switch (EXERA and VISERA)” on page 219.

5.5 Printing images

The video printer captures images, and starts printing them when the number of images reached the selected number of images to be printed per sheet.

Video printer

The video printer can be operated using the “PRINTER REMOTE” or “RELEASE” key on the keyboard. The “RELEASE” key needs to be preset. See “Release function” on page 223.

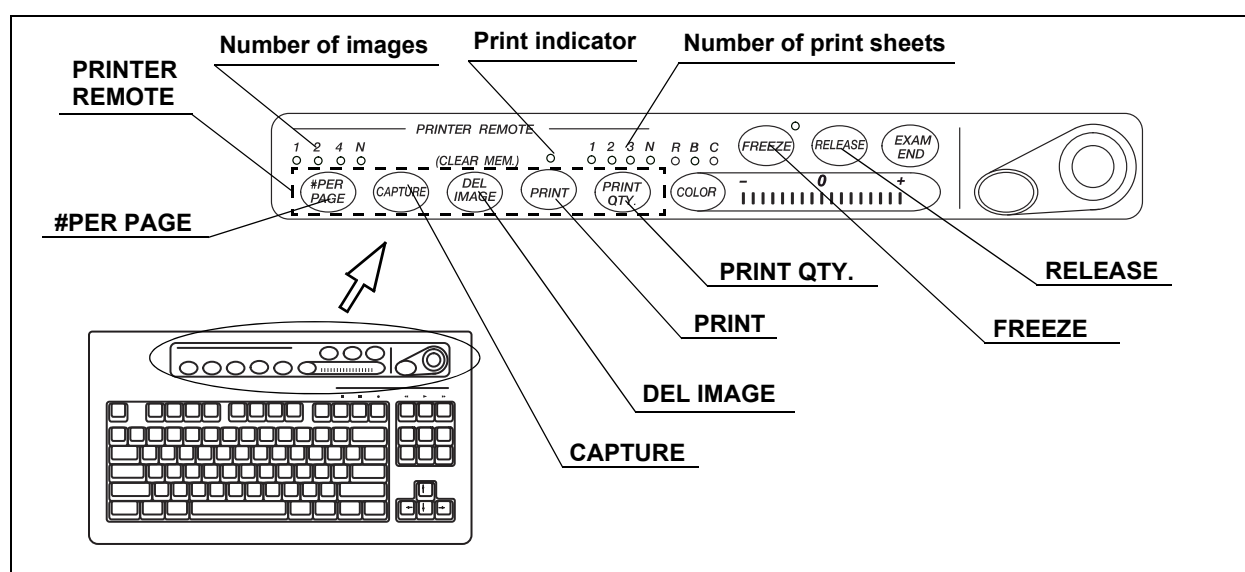

Figure 5.80

Key	Function
#PER PAGE	Sets the number of images to be printed per sheet.
CAPTURE or RELEASE	Captures images into the memory of the video printer.
DEL IMAGE	Deletes the last image stored in the memory of the printer.
Shift + DEL IMAGE	Deletes images on the position showed by the CVP counter.
PRINT	Prints the images captured by the video printer.
PRINT QTY.	Sets the number of sheets to be printed.
Shift + F8 (Printer lock)	Locks the 5 printer remote keys and allows the video printer to be operated by using the keys on the video printer.

Table 5.13

The following images can be loaded using “CAPTURE” and “RELEASE”.

Image	CAPTURE	RELEASE
Endoscopic live image, PinP, special light observation	○	○
Normal size playback screen, full size playback screen, annotation screen of the PC card menu,	○	—

○ available, — not available

Table 5.14

CAUTION

- Confirm that the necessary images have been printed before deleting the images.
- Always delete all images in the video printer at the end of an examination when the number of images per sheet is more than one. If not, the images of a previous examination and a new examination may be mixed on one print sheet.
- If you move to another menu before printing the images, the images disappear.

○ **Number of images on the print form**

1. Press the “#PER PAGE” key to display the number of images to be printed on the print sheet.
2. While the window opens, press the “#PER PAGE” key to change the number of images to be printed on the print sheet. The indicator above the “#PER PAGE” key indicates the number.

○ **Printing**

1. Press the “PRINT QTY.” key to select the number of print sheets to be printed. The indicator above the “PRINT QTY.” key indicates the number.
2. Press the “FREEZE” key to freeze the endoscopic live image.
3. Check the frozen image if it is suitable for recording. If not, press the “FREEZE” key again to return to the live image and repeat steps 2. and 3.

- Press the "CAPTURE" key or "RELEASE" key to capture the endoscopic image into the memory of the video printer. The CVP counter on the monitor increments by one (see Figure 5.81).

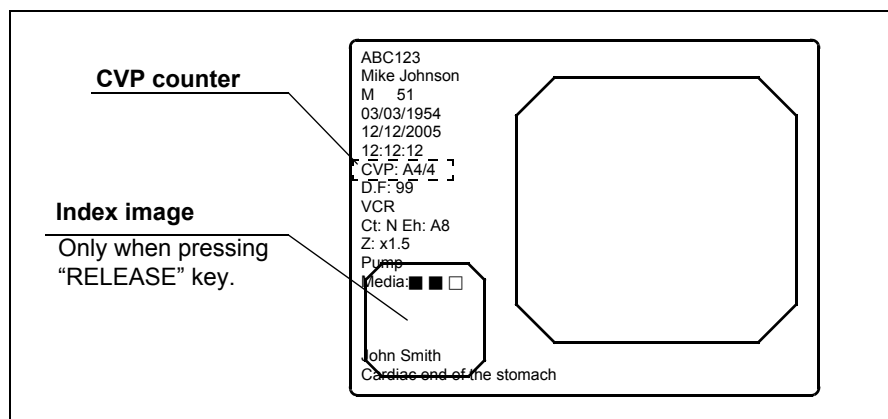

Figure 5.81

- When the number of images captured reaches the number of images to print on a print sheet, printing starts automatically. The indicator above the "PRINT" key lights up during printing.
- To start printing before the number of images captured reaches the number of images to be printed on a print sheet, press the "PRINT" key anytime. The indicator above the "PRINT" key lights up during printing.

○ Overwriting pre-recorded images

- Press the "DEL IMAGE" key a number of times until the CVP counter shows the image number to be overwritten.

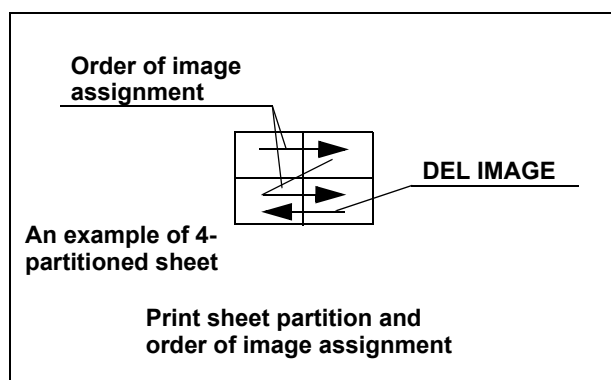

Figure 5.82

- Press the "CAPTURE" key or "RELEASE" key to overwrite the new image on the previous image. The CVP counter on the monitor increments by one (see Figure 5.81).

NOTE

- Press the “CAPTURE” key or “RELEASE” key to record the image without checking the image. In this case, the live image is frozen for the release time.
- Maintain the endoscope as stationary as possible when pressing the keys to record the blurless images.
- The maximum number of images per page is variable depending on the printer model. See Table 5.15 for details.
- Depending on the video printer or the number of images on a print sheet, the “CAPTURE” key may not be operated during printing.
- HDTV images can be printed only when using the OEP-4 with “Mode1”. See “Output signal to OEP-4” on page 204.
- The CVP counter does not appear when the patient data are cleared from the monitor.
- When pressing the “RELEASE” key, the images captured are displayed at the lower left on the monitor depending on the settings. When pressing the “CAPTURE” key the images taken in are displayed in full-screen on the monitor.
- A caption can be printed in the margin on the print sheet. See “Caption” on page 203.
- The CAPTURE and RELEASE operations can also be controlled from the scope switches and/or foot switches. For how to set up the scope switches and foot switches, see “Remote switch and foot switch (EXERA and VISERA)” on page 219.























Printer	Details					
OEP (OLYMPUS) OEP-3 (OLYMPUS)	Indication of number of images	[1]	[2]	[4]	[N]	[N]
	Sheet partition					
	Full size	2	4	8	16	
OEP-4 (OLYMPUS)	Indication of number of images	[1]	[2]	[4]	[N]	-
	Sheet partition					-
	Full size	2	4	8	-	
UP-1800 (SONY) UP-1850 (SONY) UP-2900MD (SONY)	Indication of number of images	[1]	[4]	[N]	-	-
	Sheet partition				-	-
	Full size	4	16	-	-	
UP-2950MD (SONY)	Indication of number of images	[1]	[2]	[4]	[N]	-
	Sheet partition					-
	Full size	2	4	16	-	
UP-5000MD (SONY) UP-5200MD (SONY) UP-5250MD (SONY)	Indication of number of images	[1]	[4]	[N]	-	-
	Sheet partition				-	-
	Full size	4	9	-	-	
UP-21MD (SONY)	Indication of number of images	[1]	[2]	[4]	-	-
	Sheet partition				-	-
	Full size	2	4	-	-	

Table 5.15

5.6 Pre-entry of patient data

In the patient menu, patient data can be entered in the video system center prior to examination and called up before the examination. The following patient data for up to 40 patients can be entered in advance.

ID	Max. 15 alphanumeric and symbol characters
Name	Max. 20 alphanumeric and symbol characters
Sex	M or F
D.O.B.	Max. 8 alphanumeric and symbol characters
Age	Max. 3 numeric characters
Physician name	Max. 20 alphanumeric and symbol characters

Table 5.16

Basic operation in the patient menu

1. Press the "Shift" and "F3" keys together. The "Patient Data" menu appears on the monitor (see Figure 5.84).

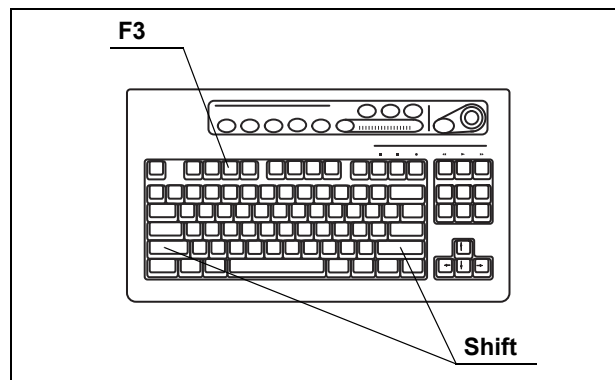

Figure 5.83

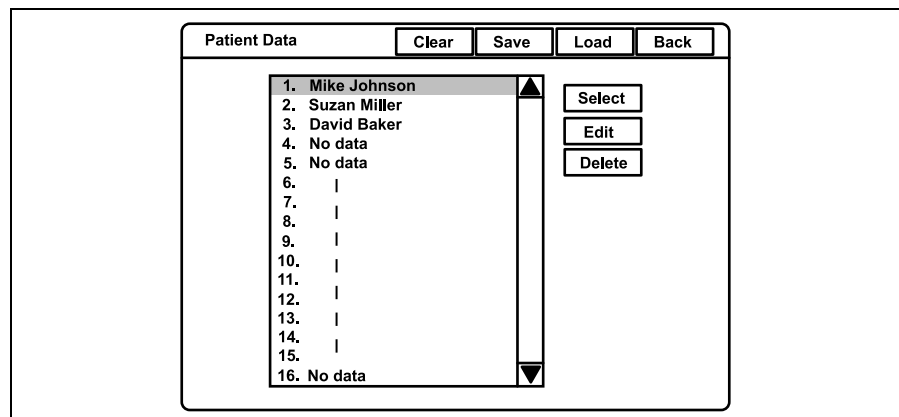

Figure 5.84

- Click the buttons with the arrow pointer to operate the menu.

Button	Function
Clear	Clears all previously registered patient data.
Save	Saves the registered 40 patient data on the PC card.
Load	Loads the 40 patient data from the PC card onto the video system center.
Back	Closes the patient menu and returns to the endoscopic image.
Call	Returns to the endoscopic live image and displays the patient data selected.
Edit	Opens the patient data input screen.
Delete	Deletes selected patient data.

Table 5.17

- Click "Back" to return to the endoscopic image.

Entering new patient data

- Press the "Shift" and "F3" keys together to display "Patient Data" menu (see Figure 5.85).

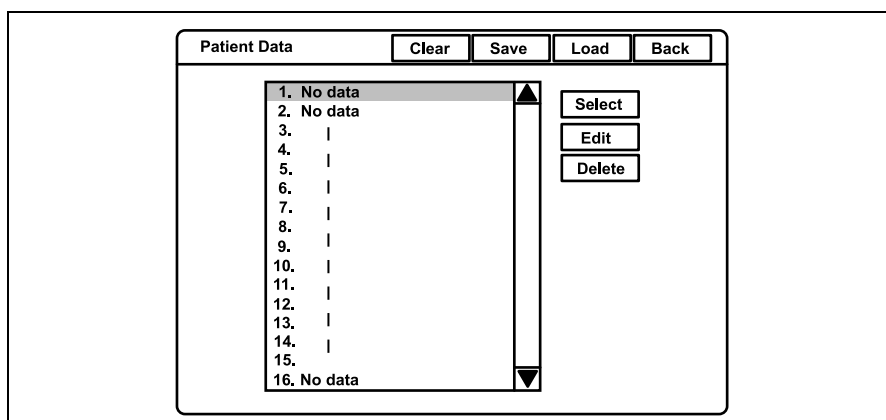

Figure 5.85

- Click "No data" in the patient name list (see Figure 5.85).

3. Click "Edit". The patient data input screen appears on the monitor (see Figure 5.86).

Patient Data 1		OK	Back
ID	<input type="text"/>		
Patient name	<input type="text"/>		
Sex	<input type="text"/>		
D. O. B.	<input type="text"/>		
Age	<input type="text"/>		
Physician name	<input type="text"/>		

Figure 5.86

4. Click each text box to place the cursor.
5. Enter the data in the text boxes (see Figure 5.87).

Patient Data 1		OK	Back
ID	<input type="text" value="ABC123"/>		
Patient name	<input type="text" value="Mike Johnson"/>		
Sex	<input type="text" value="M"/>		
D. O. B.	<input type="text" value="03/03/1954"/>		
Age	<input type="text" value="51"/>		
Physician name	<input type="text" value="John Smith"/>		

Figure 5.87

6. Click "OK" to register the entered data. The next patient data input screen appears.

7. After finishing entering the data, click "Back" to return to the patient name list (see Figure 5.88).

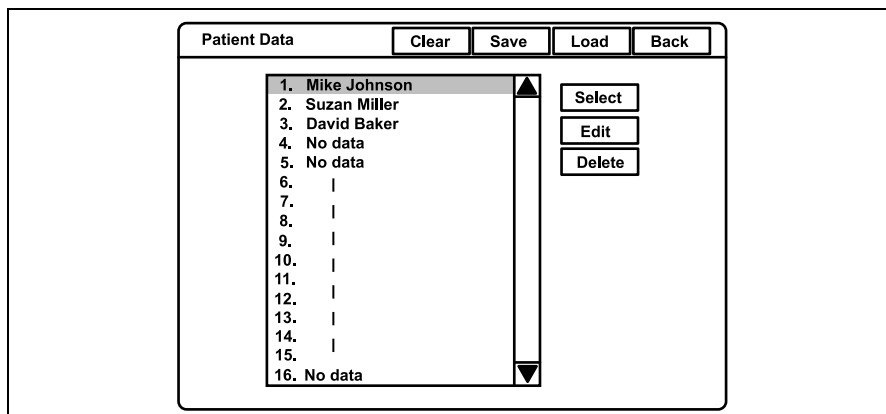

Figure 5.88

8. Click again "Back" to return to the endoscopic image.

NOTE

- To cancel and stop the input operation, click "Back" instead of "OK". The entries typed in until then are canceled and the display returns to the endoscopic image.
- If an error message is displayed, check if the entered data is correct.
- To enter the patient data at the time of examination, see Section 4.6, "Patient data" on page 57.

Displaying patient data

Call up the previously registered patient data and display it on the endoscopic image.

1. Press the “Shift” and “F3” keys together to display the “Patient Data” menu (see Figure 5.89).

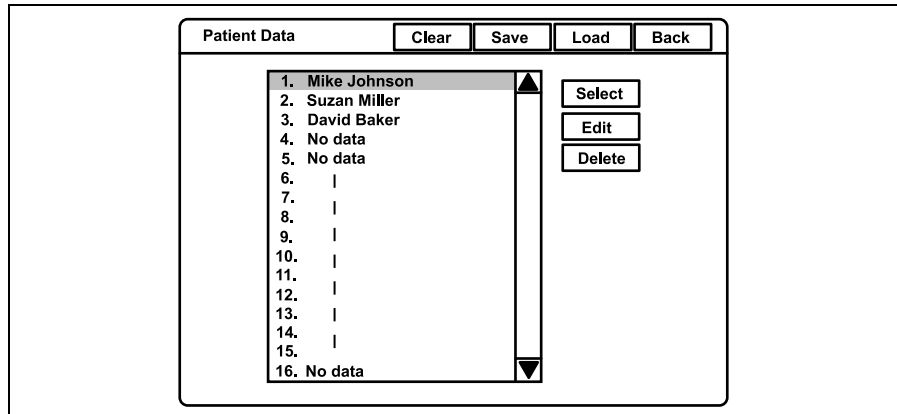

Figure 5.89

2. Click the desired patient name in the patient name list.
3. Click “Select”. The selected patient data is displayed on the endoscopic image.

NOTE

The patient name that is once displayed in the endoscopic image turns gray in the patient name dialog box after finishing observation by pressing the “EXAM END” key.

Editing previously entered patient data

1. Press the “Shift” and “F3” keys together to display the “Patient Data” menu (see Figure 5.90).

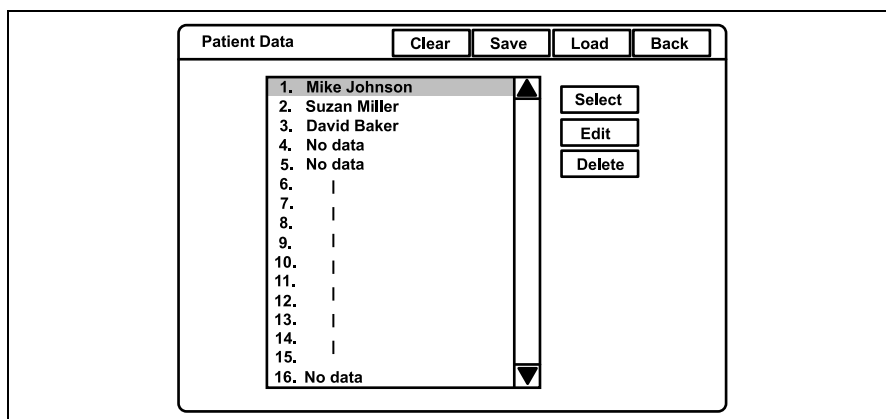

Figure 5.90

2. Click the desired patient name in the patient name list. The selected patient name is highlighted.
3. Click “Edit”. The patient data input screen appears (see Figure 5.91).

Patient Data 1		OK	Back
ID	<input type="text" value="ABC123"/>		
Patient name	<input type="text" value="Mike Johnson"/>		
Sex	<input type="text" value="M"/>		
D. O. B.	<input type="text" value="03/03/1954"/>		
Age	<input type="text" value="51"/>		
Physician name	<input type="text" value="John Smith"/>		

Figure 5.91

4. Click the data to be modified and place the cursor in the data area.
5. Enter the data in the text boxes.
6. Click “OK” to register the entered data.
7. Click “Back” to return to the endoscopic image.

Deleting previously entered patient data

1. Press the “Shift” and “F3” keys together to display the “Patient Data” menu (see Figure 5.92).

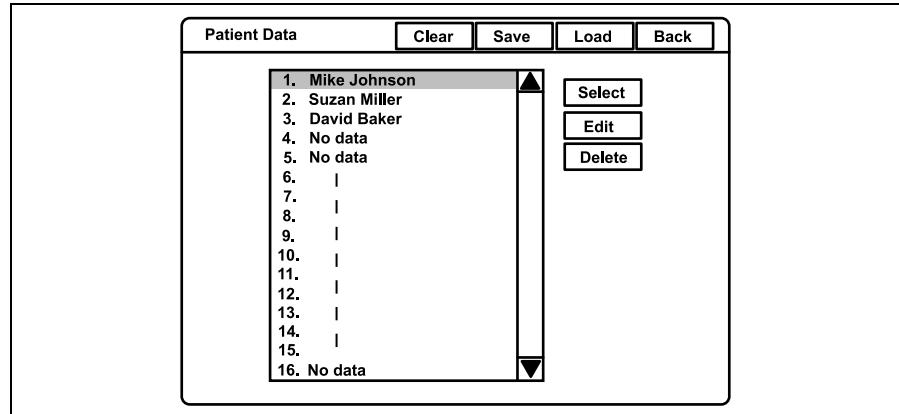

Figure 5.92

2. Click the desired patient name in the patient name list. The selected patient name is highlighted.
3. Click “Delete”. A confirmation message appears on the monitor.
4. Click “No” to return to step 1.
Click “Yes” to delete the selected patient data. The patient name selected in the patient name dialog box changes to “No data” (see Figure 5.93).

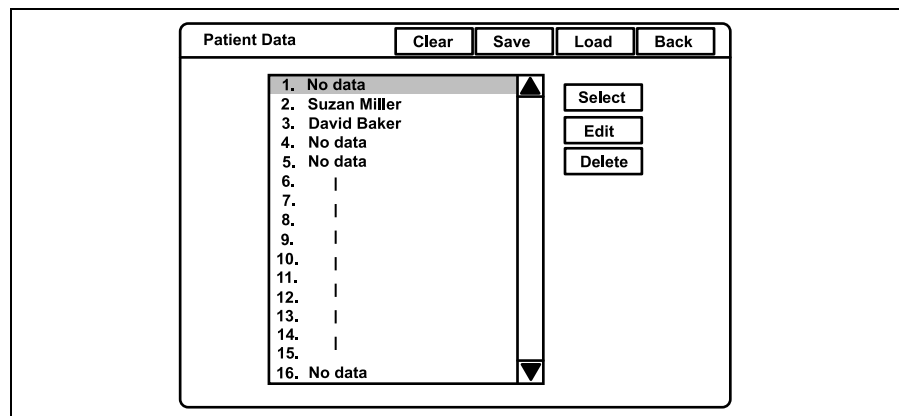

Figure 5.93

5. Click “Back” to return to the endoscopic image.

Clearing all patient data previously entered

1. Press the “Shift” and “F3” keys together to display the “Patient Data” menu (see Figure 5.94).

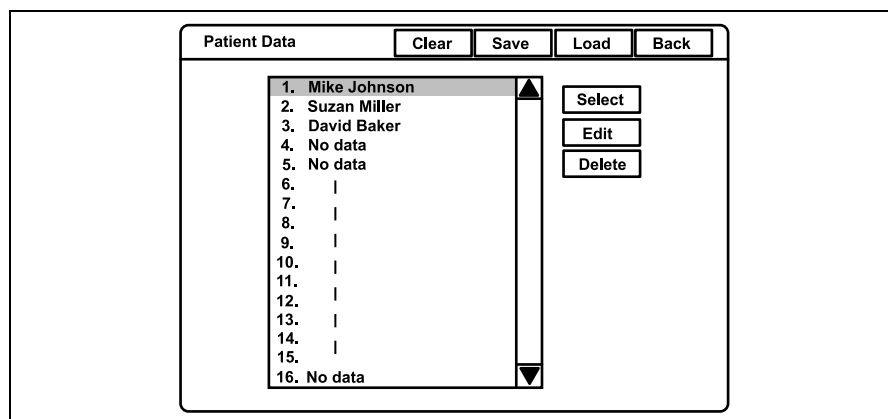

Figure 5.94

2. Click “Clear”. A confirmation message appears on the monitor.
3. Click “No” to go back to step 1.
Click “Yes” to delete all patient data, and all names in the patient name dialog box changes to “No data” (see Figure 5.95).

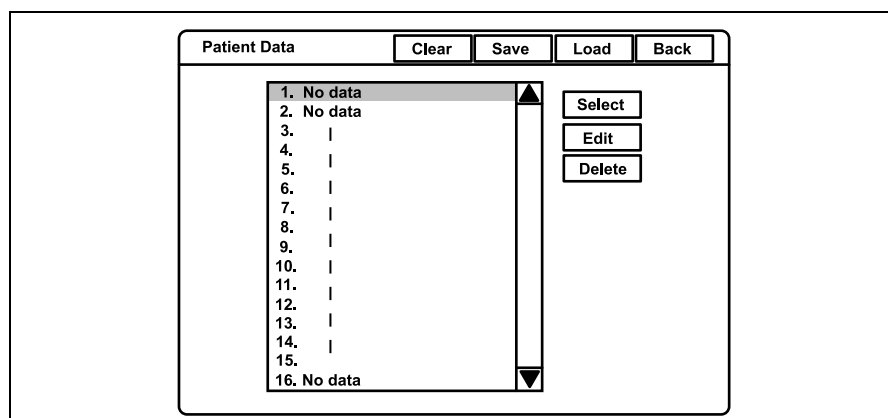

Figure 5.95

4. Click “Back” to return to the endoscopic image.

Recording patient data into PC card

The patient data that is entered in the video system center can be saved on the PC card. The recorded patient data can be transferred to another CV-180 using the PC card.

CAUTION

Be sure to confirm that there is no necessary patient data on the PC card which needs to be saved. The patient data on the PC card will be deleted when new patient data is stored.

1. Insert the PC card into the PC card slot. The PC card status indicator lights up in green.

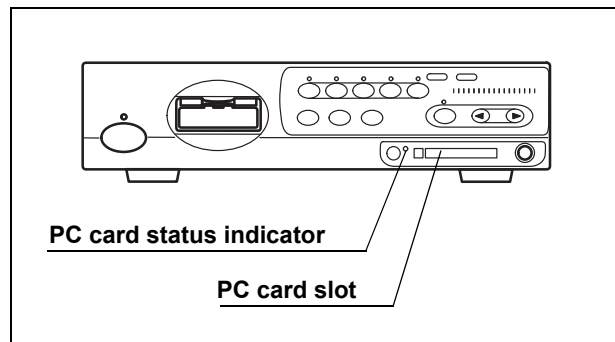

Figure 5.96

2. Press the "Shift" and "F3" keys together to display "Patient Data" menu (see Figure 5.97).

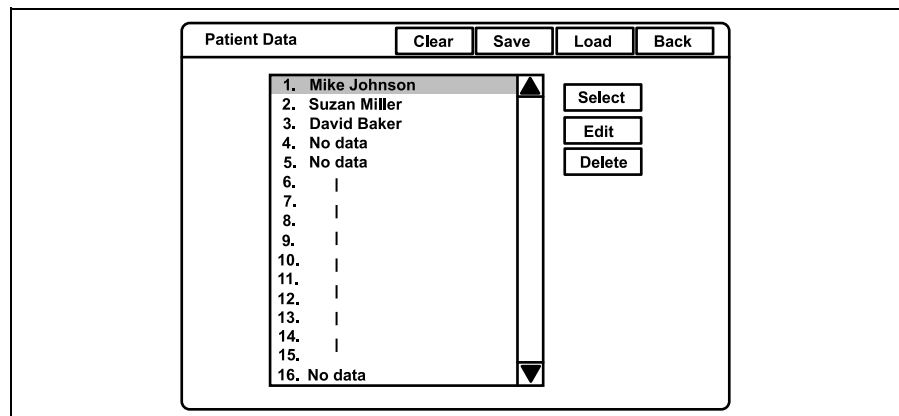

Figure 5.97

3. Click "Save" to record all patient data on the PC card.

4. When patient data is stored on the PC card, a confirmation message appears on the monitor.
Click "Yes" to overwrite the data. The PC card status indicator on the front panel blinks in amber during patient data recording.
Click "No" to return to step 2.
5. Click "Back" to return to the endoscopic image.

NOTE

All 40 patient data on the PC card are overwritten.

Loading patient data from PC card

Patient data on the PC card can be overwritten on the video system center.

CAUTION

Be sure to confirm that there are no necessary patient data in the video system center. The patient data in the video system center will be overwritten.

1. Insert the PC card into the PC card slot. The PC card status indicator lights up green (see Figure 5.98).

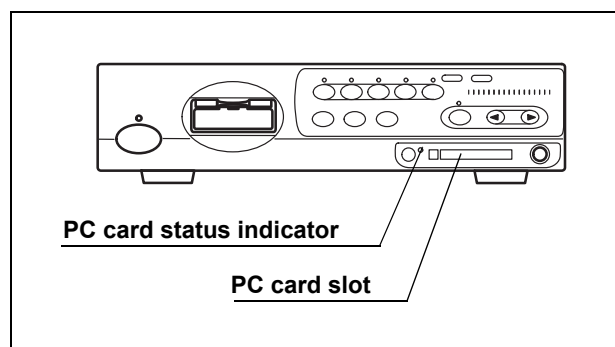

Figure 5.98

2. Press the "Shift" and "F3" keys together to display the PC card menu on the monitor (see Figure 5.99).

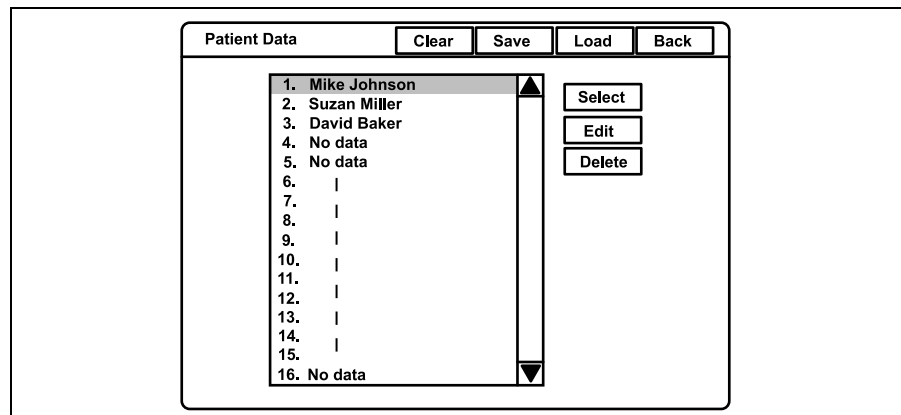

Figure 5.99

3. Click "Load" (see Figure 5.99). A confirmation message appears on the monitor.

4. Click "No" to return to step 2.

Click "Yes" to register the patient data into the video system center. The patient name in the patient name list changes to the new patient name on the PC card. The PC card status indicator on the front panel blinks amber during recording.

5. Click "Back" to return to the endoscopic image.

NOTE

All 40 patients data are registered into the video system center. Previous data disappear.

5.7 Scope information

Endoscopes equipped with the scope ID function incorporate a memory chip. The memory chip stores data of the endoscope, and the data can be displayed on the monitor. Some of the data can also be input from the video system center. Table 5.18 shows the details of data stored in the memory chip.

Data item	Details	Input
Scope model	Model name of the endoscope	No
Serial number	Serial number of the endoscope	No
Comment	Up to 20 characters can be entered.	Yes
Cumulative uses	Cumulated number of uses	No
Checkup period	Times of inspections User can enter a number of 0 - 4095.	Yes
Service contract	With or without a service contract	No
Warranty date	Warranty expiration date of the endoscope	No
Customer name	Person or hospital owning the endoscope Up to 20 characters can be entered.	Yes
Customer ID	ID number of the customer User can enter up to 20 characters.	Yes
ID version	The version number of the memory chip	No
Channel diameter*1	Diameter of the endoscope channel	No
Distal end diameter*1	Outer diameter of the endoscope's distal end	No
Insertion tube diameter*1	Outer diameter of the endoscope's insertion tube	No
Cumulative time*1	Cumulated time of uses	No

Table 5.18

NOTE

- The memory chip is built with durability but may still be damaged. If a memory chip is damaged, it becomes incapable of backing up data. In such a case, please contact Olympus.
- The following endoscopes are equipped with the scope ID function;
 - EVIS EXERA II series endoscopes
 - EVIS EXERA 160 series or later endoscopes (*1 The items are not supported.)
 - Some endoscopes of the VISERA series

Displaying and entering scope information

1. Press the "F2" key (see Figure 5.100). The scope information window appears on the monitor for about 6 seconds (see Figure 5.101).

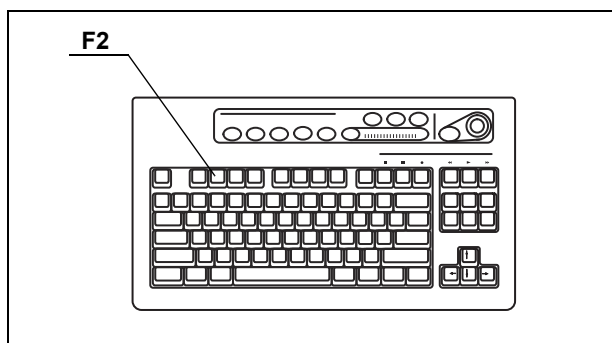

Figure 5.100

Forceps channel diameter
Displays the position to see the forceps and the diameter of the instrument channel.

Scope switch assignment
Displays the functions assigned to the scope switches.

Endoscope's information
Displays serial no., forceps channel diameter, distal end diameter and insertion part diameter.

ABC123
Mike Johnson
M 51
03/03/1954
12/12/2005
12:12:12
CVP: A4/4

<p>2.8</p> <p>Pump</p> <p>1:Freeze 2:iris 3:Enhance 4:Release</p>	<table border="1" style="width: 100%; border-collapse: collapse;"> <tr> <td>Scope Name</td> <td>GIF-H180</td> </tr> <tr> <td>Serial No.</td> <td>:2500001</td> </tr> <tr> <td>Channel</td> <td>:2.8</td> </tr> <tr> <td>Distal End</td> <td>:9.8</td> </tr> <tr> <td>Insertion Tube</td> <td>:9.8</td> </tr> </table>	Scope Name	GIF-H180	Serial No.	:2500001	Channel	:2.8	Distal End	:9.8	Insertion Tube	:9.8
Scope Name	GIF-H180										
Serial No.	:2500001										
Channel	:2.8										
Distal End	:9.8										
Insertion Tube	:9.8										

Figure 5.101

2. While the window opens, press the “F2” key again to show the scope information screen on the monitor (see Figure 5.102).

The screenshot shows a window titled "Scope Information" with "OK" and "Back" buttons in the top right corner. The window contains the following fields:

- Scope model
- Serial number
- Comment (with a text input field)
- Cumulative uses (with a text input field)
- Checkup period (with a text input field)
- Service contract
- Warranty date
- Customer name (with a text input field)
- Customer ID (with a text input field)
- ID version
- Channel diameter
- Distal end diameter
- Insertion tube diameter
- Cumulative time (with a text input field)

Figure 5.102

3. Click each input area to modify.
4. Modify the data using the keyboard.
5. Click “OK” to store the entered data into the scope ID chip in the endoscope. While the data is being stored, the message “Please wait” appears on the monitor.
6. Click “Back” to return to the endoscopic image.

CAUTION

While the message “Please wait” is displayed, do not turn OFF the video system center.

NOTE

To cancel the input, click “Back” to return to the endoscopic image display.

5.8 Special light observation

WARNING

Do not rely on the special light observation method alone for primary detection of lesions or for a decision regarding any potential diagnostic or therapeutic intervention.

NBI (narrow band imaging)

WARNING

If the endoscopic image seems to be dark in the NBI observation, change to the normal observation. Otherwise, the examination might not be performed safely.

CAUTION

Perform the white balance adjustment for NBI observation after completion of the white balance adjustment for the normal observation. Otherwise, NBI observation cannot be performed with a correct color tone.

NBI is an observation method that employs filtered light as examination light. NBI requires the following equipment;

- CLV-180 light source
- NBI compatible endoscope:
GIF-H180, CF-H180AL/I, GIF-Q180, CF-Q180AL/I, PCF-Q180AL/I,
GIF-N180, BF-Q180, BF-P180, BF-1T180, ENF-V2/VQ, CYF-V2,
CYF-VA2, OTV-S7ProH-HD-L08E, LTF-VH, WA5001*A/L

Normal observation and NBI observation can be changed during use.

All mucosal areas are to be viewed using traditional white light.

NBI imaging should not be used as a substitute for a thorough traditional examination of the mucosa.

1. Select the NBI mode on the light source using the mode button, and confirm the NBI indicator of the light source, referring to the instruction manual of the light source.
2. Confirm that the NBI indicator on the front panel of the video system center turns from green to white (see Figure 5.103).

NOTE

- “NBI” may appear on the monitor by the user preset.
- During NBI observation, bile and residual debris may appear dark and reddish.

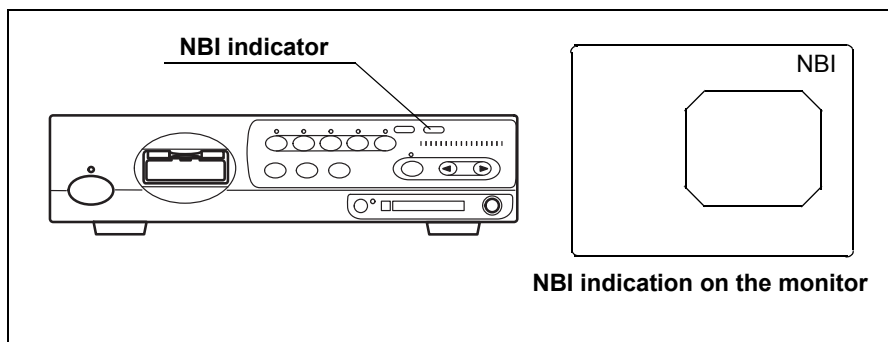

Figure 5.103

3. Perform the white balance adjustment (see page 52).
4. Perform the NBI observation.
5. Return to the normal observation using the mode button on the light source, referring to the instruction manual of the light source.
6. Confirm that the NBI indicator on the front panel of the video system center lights up green, and that “NBI” disappears on the monitor.

NOTE

- If the “NBI” mode is selected when a non NBI compatible light source and/or endoscope is used, the NBI indicator does not change to green, and a warning message appears on the monitor.
- Enter and button operations cannot be operated for several seconds while the light source turns into NBI mode.
- Contrast (“Shift” + “F6”) and color mode (“Shift” + “Alt” + “1”, “2”, “3”, “4”) cannot be operated during the NBI observation.
- The NBI mode selection operation can also be controlled from the scope switches and/or foot switches. For how to set up the scope switches and foot switches, see “Remote switch and foot switch (EXERA and VISERA)” on page 219.
- The color tones of NBI observation slightly vary with products.
- Contact Olympus for further information about the NBI observation.

Chapter 6 Fuse replacement

Always use the fuses designated below. To order new fuses, please contact Olympus.

- Spare fuses MAJ-1432

WARNING

- Never use a fuse other than the fuse model designated by Olympus. Otherwise, malfunction or failure of the video system center may cause a fire or electric shock hazard.
- Be sure to turn the video system center OFF and unplug the power cord before removing the fuse box from the video system center. Otherwise, fire or electric shock may result.
- If the power fails to come on after replacing the fuses, unplug the power cord immediately from the AC mains power inlet and then contact Olympus. Otherwise, electric shock may result.

1. Turn the video system center OFF and disconnect the power cord from the wall mains outlet.
2. Pull the fuse box straight out, squeezing the tabs projected on both sides of the fuse box using a pair of tweezers (see Figure 6.1).

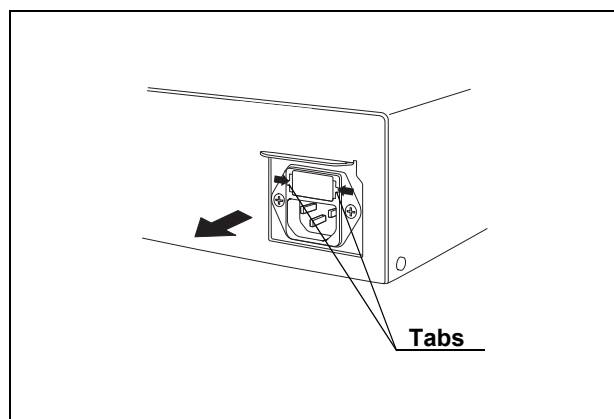

Figure 6.1

3. Replace both fuses (see Figure 6.2).

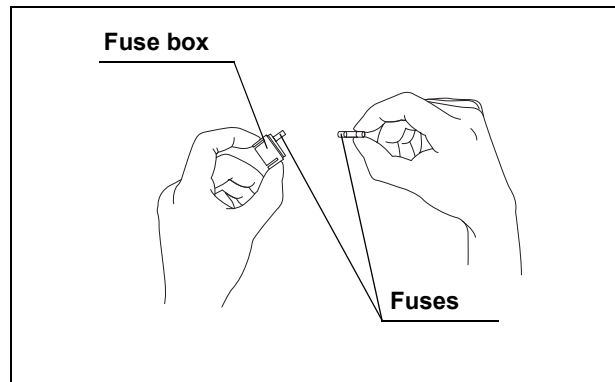

Figure 6.2

WARNING

Insert the fuse box into this instrument until it clicks into position. If the fuse box is inserted incompletely, the power may fail to come ON or a power failure may occur during operation.

4. Insert the fuse box into the video system center until it clicks into position.
5. Plug the power cord and turn the video system center ON and confirm the power output.

Chapter 7 Care, Storage and Disposal

7.1 Care

WARNING

- After wiping with a piece of moistened gauze, dry the video system center thoroughly before using it again. If it is used while still wet, there is the risk of an electric shock.
- When cleaning the video system center, always wear appropriate personal protection equipment such as eye wear, face mask, moisture-resistant clothing and chemical-resistant gloves that fit properly and are long enough to that your skin is not exposed. Blood, mucus and other potentially infectious material adhering to the video system center could pose an infection control risk.
- Do not apply spray-type medical agents such as rubbing alcohol directly to the video system center. Medical agents might enter the video system center through the ventilation grills and may cause equipment damage.

CAUTION

- Do not clean the videoscope cable socket, the terminals and the AC mains power inlet. Cleaning them can deform or corrode the contacts, which could damage the video system center.
- Do not soak in water, autoclave or gas sterilize the video system center. These methods will damage it.
- Do not wipe the external surface with hard or abrasive wiping material, the surface will be scratched.

After using the video system center, immediately perform the following cleaning procedure. If cleaning is delayed, residual organic debris will begin to solidify, and it may be difficult to effectively clean the video system center. Always remove debris routinely.

1. Turn the video system center OFF and disconnect the power cord from the wall mains outlet.
2. If the video system center is soiled with blood or other potentially infectious materials, wipe off all debris using a piece of gauze moistened with neutral detergent.

3. Remove dust, dirt and other stains on the surface by wiping with a piece of gauze moistened with 70% ethyl or isopropyl alcohol.
4. Make sure to dry the video system center after wiping with 70% ethyl or isopropyl alcohol.

7.2 Storage

CAUTION

Do not store the video system center in a location exposed to direct sunlight, X-rays, radio activity or strong electromagnetic radiation (e.g. near microwave medical treatment equipment, short-wave medical treatment equipment, MRI equipment, radio or mobile phones). Damage to the video system center may result.

1. Turn the video system center OFF and disconnect the power cord from the wall mains outlet.
2. Disconnect the ancillary equipment connected to the video system center.
3. Store the equipment in the level position in a clean, dry and stable location.

7.3 Disposal

CAUTION

When disposing of this instrument or any of its components (such as fuses), follow all applicable national and local laws and guidelines.

1. For security reasons, clear all patient data in the instrument (see “Clearing all patient data previously entered” on page 143).
2. Clear the image data and patient data in the PC card, or format the PC card (see “Formatting of the PC card” on page 114).

Chapter 8 Installation and Connection

WARNING

- Review this chapter thoroughly, and prepare the instruments properly before use. If the equipment is not properly prepared before each use, equipment damage, patient and operator injury and/or fire can occur.
- When non-medical electrical ancillary equipment is used, connect its power cord via an isolation transformer prior to connecting it to this video system center. Failure to do so can cause electric shock, burns and/or fire.

CAUTION

- Turn OFF all system components before connecting them. Otherwise, equipment damage or malfunction can result.
- Use appropriate cables only. Otherwise, equipment damage or malfunction can result.
- Properly and securely connect all cables. Otherwise, equipment damage or malfunction can result.
- The cables should not be sharply bent, pulled, twisted or crushed. Cable damage can result.
- Never apply excessive force to connectors. This could damage the connectors.
- Use this instrument only under the conditions described in “Transportation, storage, and operation environment” and “Specifications” in the Appendix. Otherwise, improper performance, compromised safety and/or equipment damage may result.

Prepare this video system center and compatible equipment (shown in the “System chart” in the Appendix) before each use. Referring to the instruction manuals of each system component, install and connect the equipment according to the procedure described in this chapter.

8.1 Installation work flow

Please see the installation work flow in Figure 8.1 below. Follow each step of the work flow before using the video system center and the ancillary equipment.

CAUTION

Connect the power cord to the power source after connecting all cables. Otherwise, equipment damage or malfunction can result.

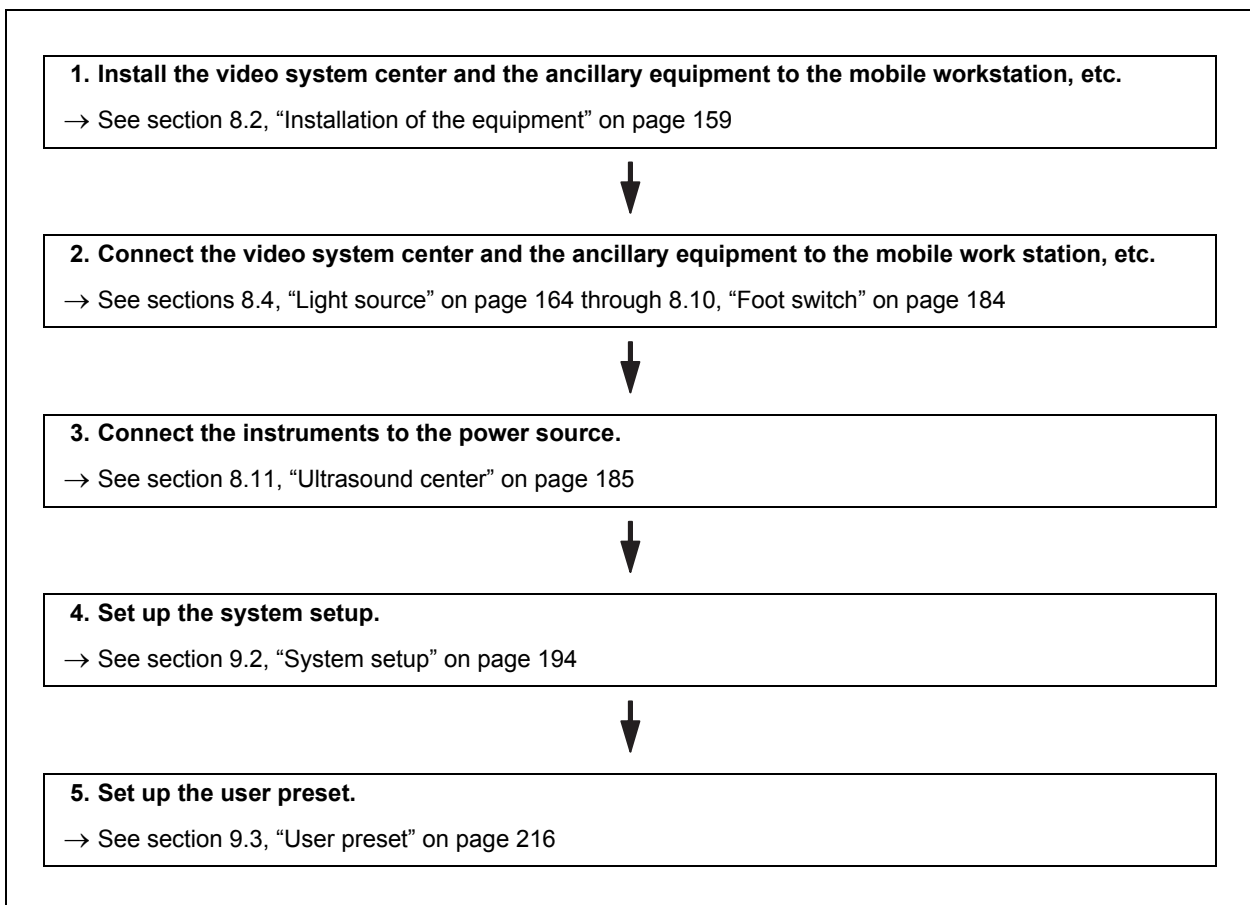

Figure 8.1

8.2 Installation of the equipment

CAUTION

- Do not place any object on the top of the video system center. Otherwise, equipment deformation and damage can result.
- Keep the ventilation grills of the video system center clear. The ventilation grills are located on the side panels. Blockage can cause overheating and equipment damage.
- Clean and vacuum dust the ventilation grills using a vacuum cleaner. Otherwise, the video system center may break down from over heating.
- Place the video system center on a stable, level surface using the foot holders (MAJ-1433). Otherwise, the video system center may topple down or drop, and user or patient injury may occur, or equipment damage can result.
- If a trolley other than the mobile workstation (WM-NP1 or WM-WP1) is used, confirm that the trolley can withstand the weight of the equipment installed on it.
- Do not install the video system center near a source of strong magnetic wave (microwave treatment device, short wave treatment device, MRI, radio equipment, etc.). Otherwise, the video system center may malfunction.

Installation on the mobile workstation (WM-NP1, WM-WP1)

1. Place the mobile workstation on a level and flat floor. Lock the caster brakes by pushing them down (see Figure 8.2).

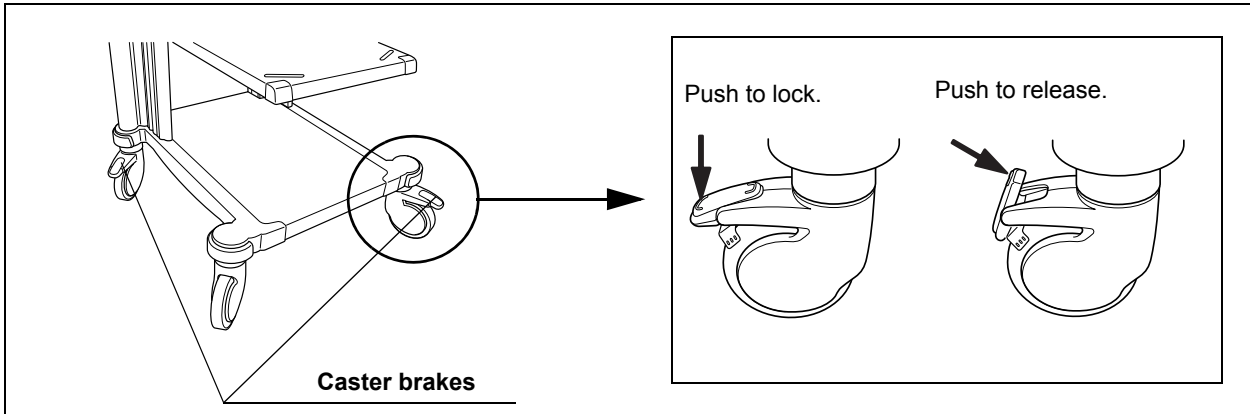

Figure 8.2

2. Install the mobile shelf of the mobile workstation according to the configuration of the equipment installed on it as described in the mobile workstation's instruction manual.
3. Place the pattern sheet on the light source. The pattern sheet is packed with the foot holder (MAJ-1433).
4. Peel the paper from the back of the foot holders and attach them firmly at the right position on the light source using the pattern sheet (see Figure 8.3).

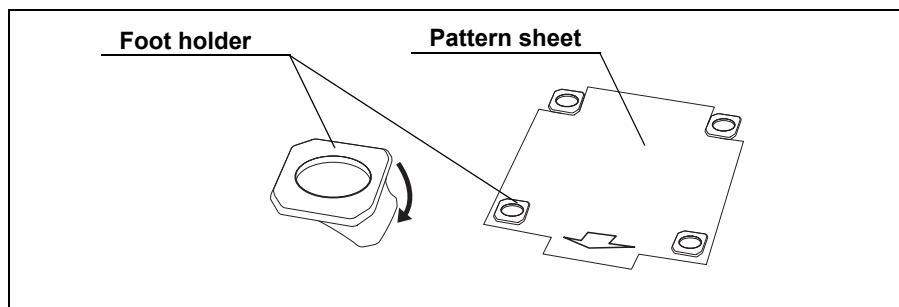

Figure 8.3

5. Remove the pattern sheet.
6. Place the light source on the mobile shelf of the mobile workstation as described in the light source's instruction manual.

CAUTION

When using a light source that is smaller than the video system center, such as CLV-S40, place the light source on the video system center. Otherwise, the video system center may not be kept level and fall down.

7. Place the video system center on the light source so that the feet of the video system center fit into the foot holders.

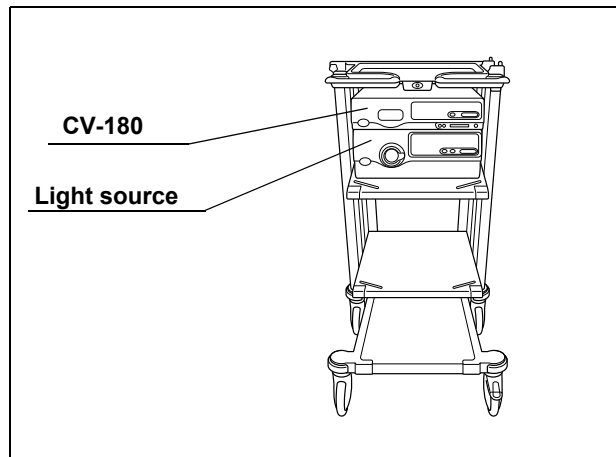

Figure 8.4

Installation in another location

When installing the video system center in another location, adhere the foot holders as described on the previous page, and place the video system center on them.

8.3 Fitting of accessories

Videoscope cable holder (MAJ-1466)

The videoscope cable holder (MAJ-1466) is used to temporarily hang the connector on the endoscope end of the videoscope cable. The holder is attached to the video system center by ditches A or ditches B (see Figure 8.5).

CAUTION

Do not hook anything other than the videoscope cable on the videoscope cable holder.

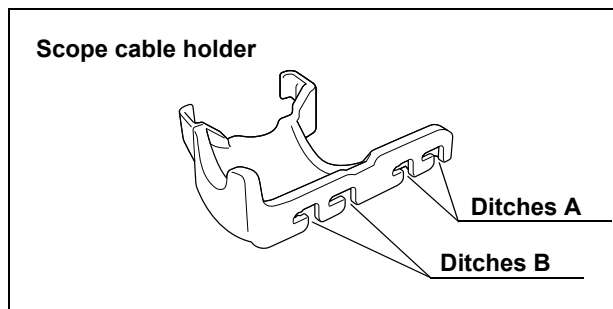

Figure 8.5

Ditch	Remark
A	The scope cable holder projects forward from the front panel. (When the water container is mounted on the light source.)
B	The scope cable holder does not project forward from the front panel.

Table 8.1

1. Fit ditches A or B to the projections on the left side of the instrument.
2. Push the videoscope cable holder backward until it clicks.

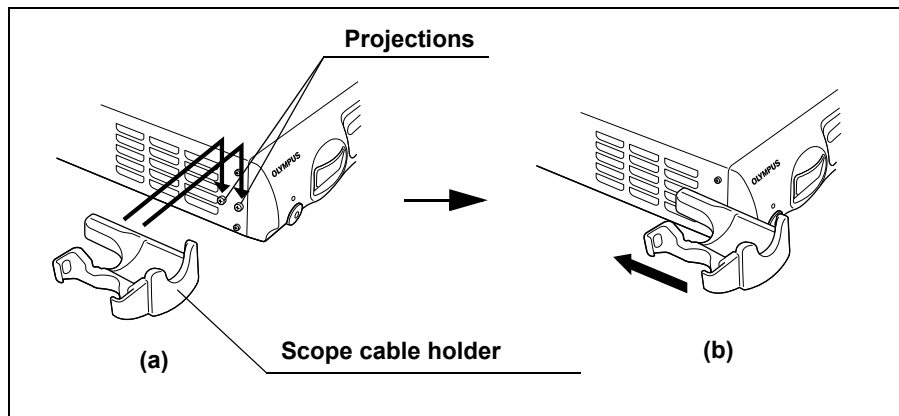

Figure 8.6

White cap set (MAJ-941)

The white cap (MH-155) is used for the white balance adjustment. The white cap is attached to the video system center by the white cap holder (MAJ-960).

CAUTION

Do not hang any object other than the white cap on the white cap holder.

1. Fit ditches A or B on the projections on the left side of the instrument (see Figure 8.7).

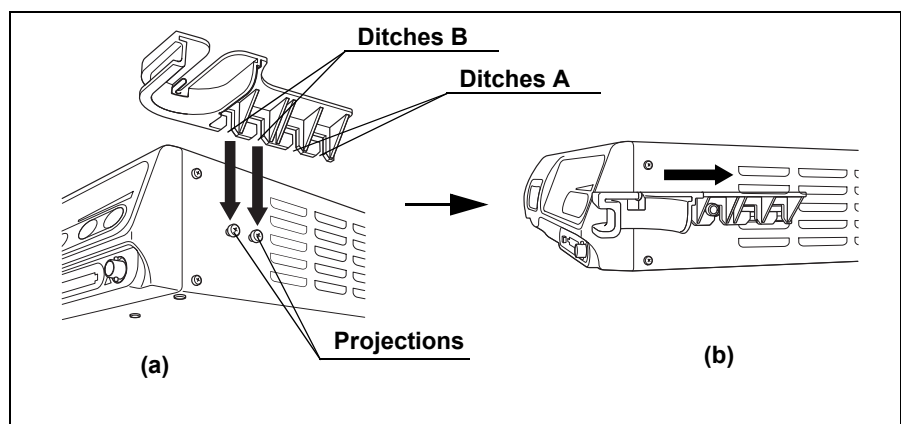

Figure 8.7

Ditch	Remark
A	The white cap projects forward from the front panel.
B	The white cap does not project forward from the front panel.

Table 8.2

2. Push the white cap holder backward until it clicks.
3. Insert the disk part at the top of the white cap into the ditches on the opening of the white cap holder until it clicks (see Figure 8.8).

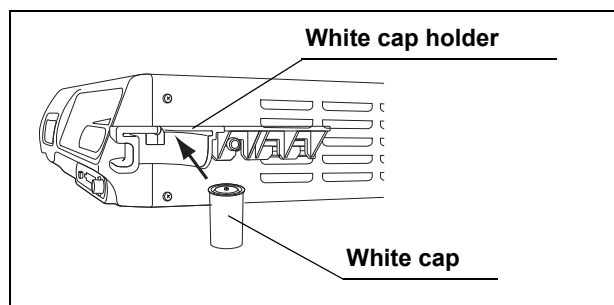

Figure 8.8

8.4 Light source

Compatible light sources

For compatible light sources, see the table below.

Model	Product name
CLV-180	EVIS EXERA II xenon light source
CLV-160	EVIS EXERA xenon light source
CLV-U40	EVIS universal light source
CLV-S40	VISERA xenon light source

Table 8.3

When a light source other than CLV-180 is used, the operations are restricted as follows.

Brightness	The brightness adjustment function interlocked with the light source does not work.
Special light observation	Special light observation function is not available.

Table 8.4

CLV-180

For connecting the light source (CLV-180) to the video system center, use the cable listed below.

Model	Product name	note
MAJ-1411	Light source cable	-

Table 8.5

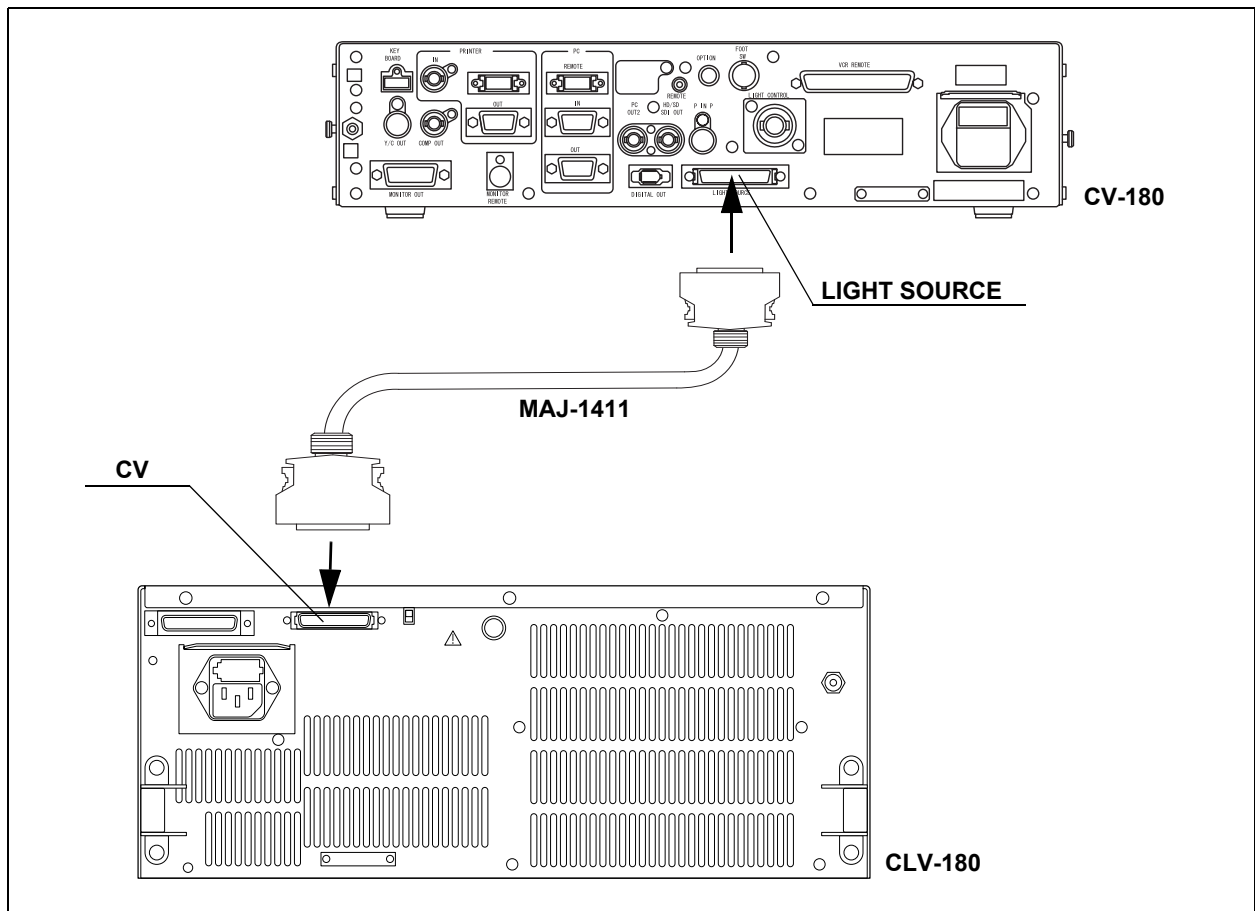

Figure 8.9

CLV-160

For connecting the light source (CLV-160) to the video system center, use the cable listed below.

Model	Product name	note
MH-966	Light control cable	-

Table 8.6

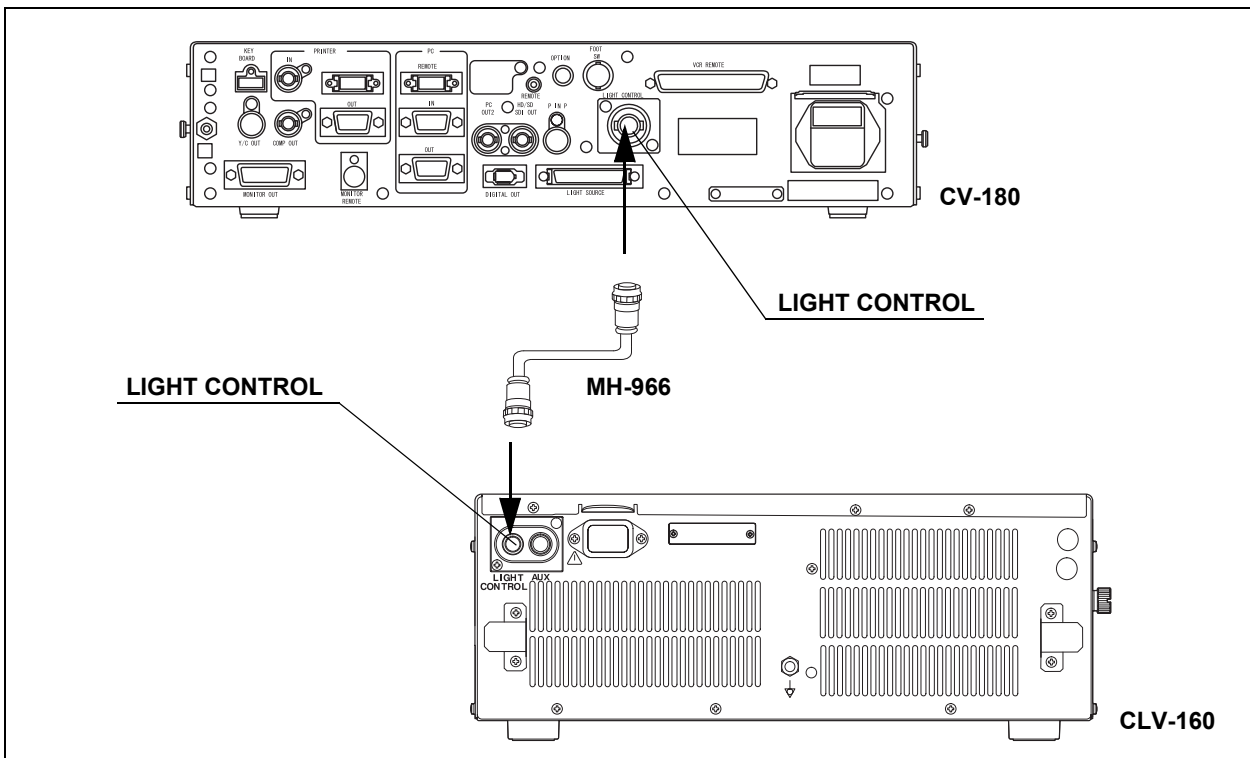

Figure 8.10

CLV-U40

○ When connecting to the rear panel of the CLV-U40

For connecting the light source (CLV-U40) to the video system center, use the cable listed below.

Model	Product name	note
MH-966	Light control cable	-

Table 8.7

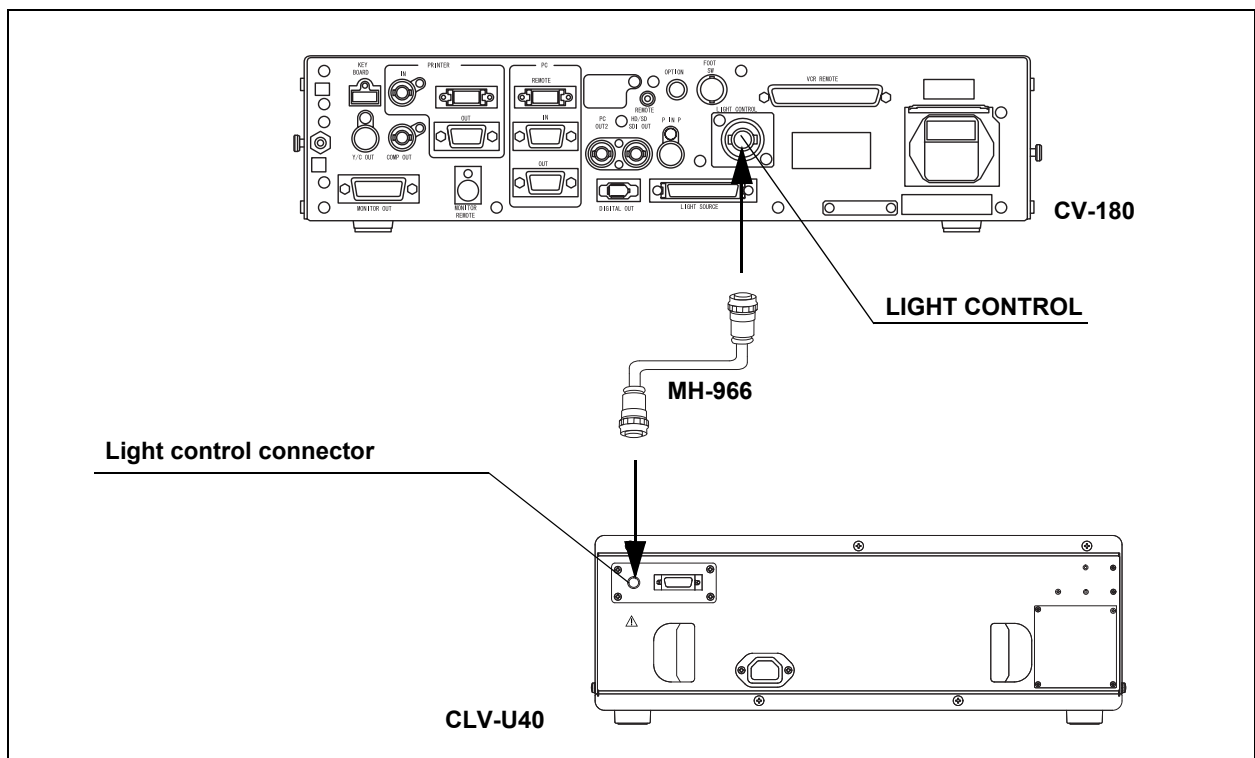

Figure 8.11

○ **When connecting to the front panel of the CLV-U40**

For connecting the light source (CLV-U40) to the video system center, use the cable listed below.

Model	Product name	note
MH-993 or MAJ-1567	Light control cable	-

Table 8.8

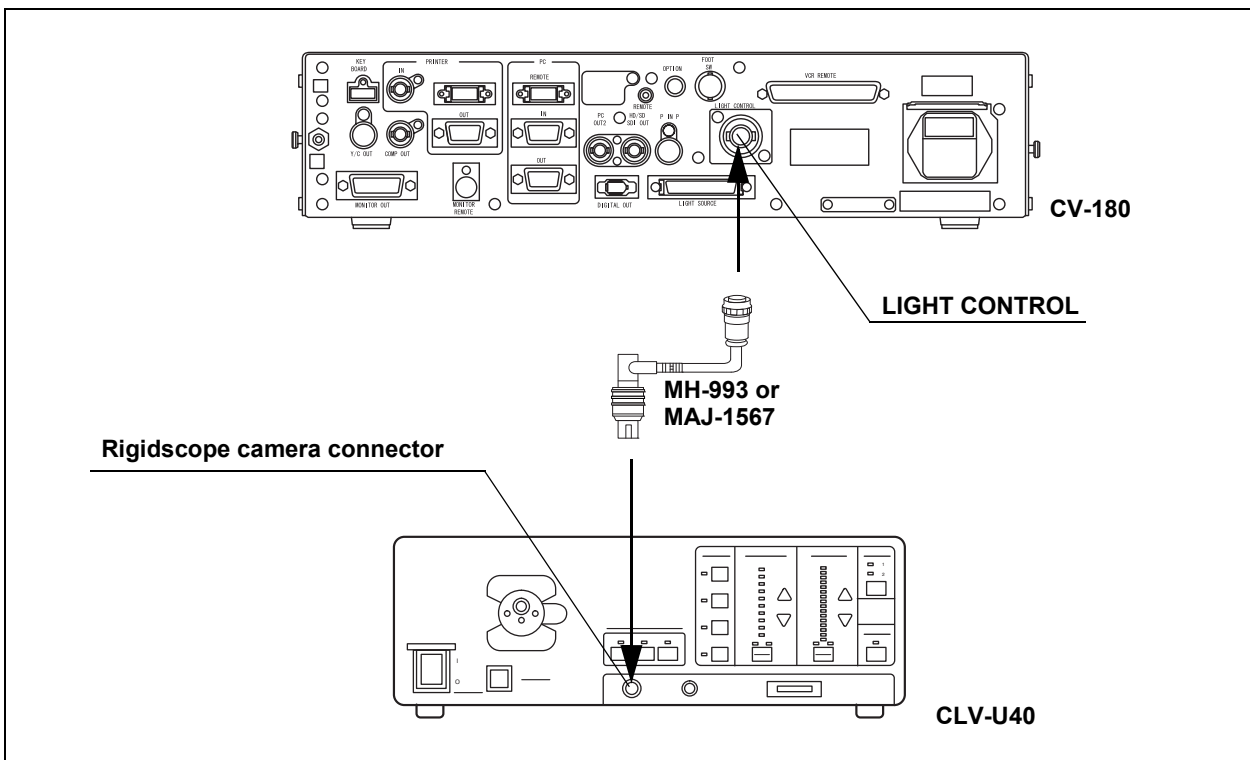

Figure 8.12

CLV-S40

For connecting the light source (CLV-S40) to the video system center, use the cable listed below.

Model	Product name	Note
MAJ-1567	Light control cable	-

Table 8.9

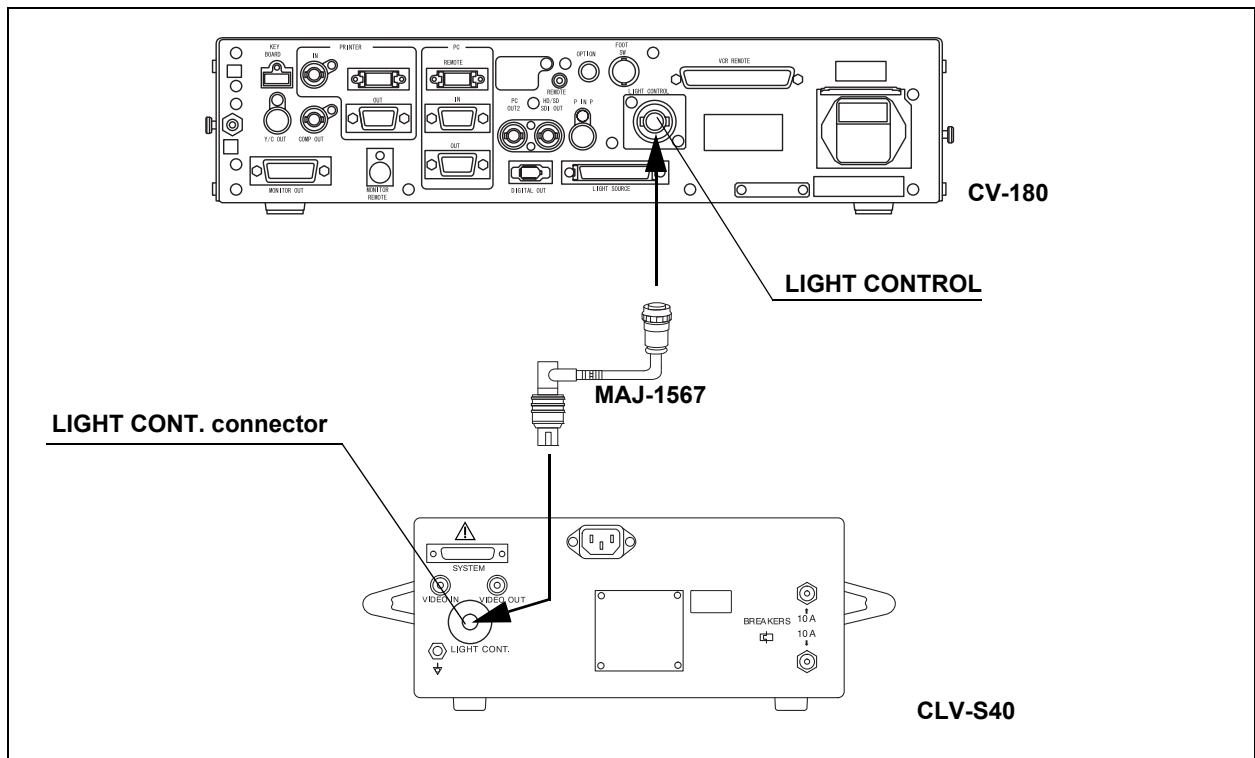

Figure 8.13

8.5 Monitor

Compatible monitors

For compatible monitors, see the table below.

Model	Product name
OEV143, OEV203	Color video monitor
OEV191	LCD monitor
OEV181H	High definition monitor
OEV191H	High definition LCD monitor

Table 8.10

OEV143 or OEV203

For connecting the monitors (OEV143 or OEV203) to the video system center, use the cables listed below.

For easy cable connection, attach the cable color sheet to the cables (see Figure 8.14).

Model (length)	Product name
Use any one of the following cables.	
MAJ-846 (7 m)	Monitor cable
MAJ-921 (1.5 m)	
MAJ-970 (4 m)	
MAJ-971 (15 m)	
MAJ-1462 (7 m)	
MAJ-1584 (15 m)	
MAJ-1586 (2 m)	
MAJ-227 (7 m)	Monitor remote cable

Table 8.11

NOTE

- Connect the R/G/B/S connectors of the monitor cable to the RGB component A terminals of the monitor. If those connectors are connected to the RGB component B terminals, remote control of the monitor is deactivated.
- When the monitor remote cable is connected to the monitor, the "SPLIT", "RESET", "UNDERSCAN", "OVERSCAN" switches on the front panel of the monitor are deactivated.

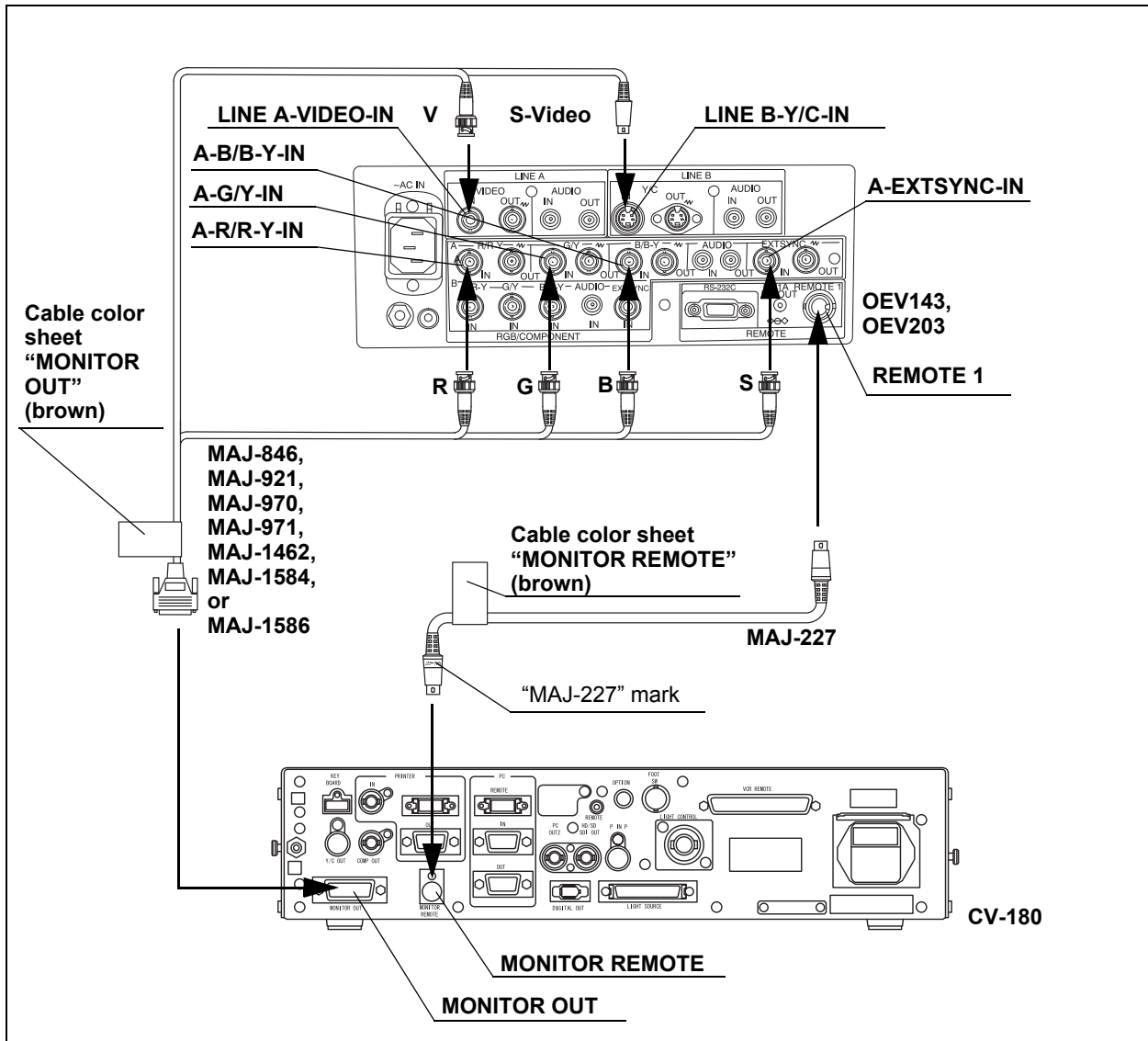

Figure 8.14

OEV181H

For connecting the monitor (OEV181H) to the video system center, use the cables listed below.

For easy cable connection, attach the cable color sheet to the cables (see Figure 8.15).

Model (length)	Product name
Use any one of the following cables.	
MAJ-921 (1.5 m)	Monitor cable
MAJ-970 (4 m)	
MAJ-1462 (7 m)	
MAJ-1584 (15 m)	
MAJ-1586 (2 m)	
Use either one of the following cables.	
MAJ-1161 (4 m)	HDTV monitor remote cable
MAJ-1230 (7 m)	
MAJ-1465 (15 m)	

Table 8.12

NOTE

Set the factory default "FACTORY" of the monitor to "FACTORY1", according to the instruction manual of the monitor. Otherwise, the monitor remote function may not operate correctly.

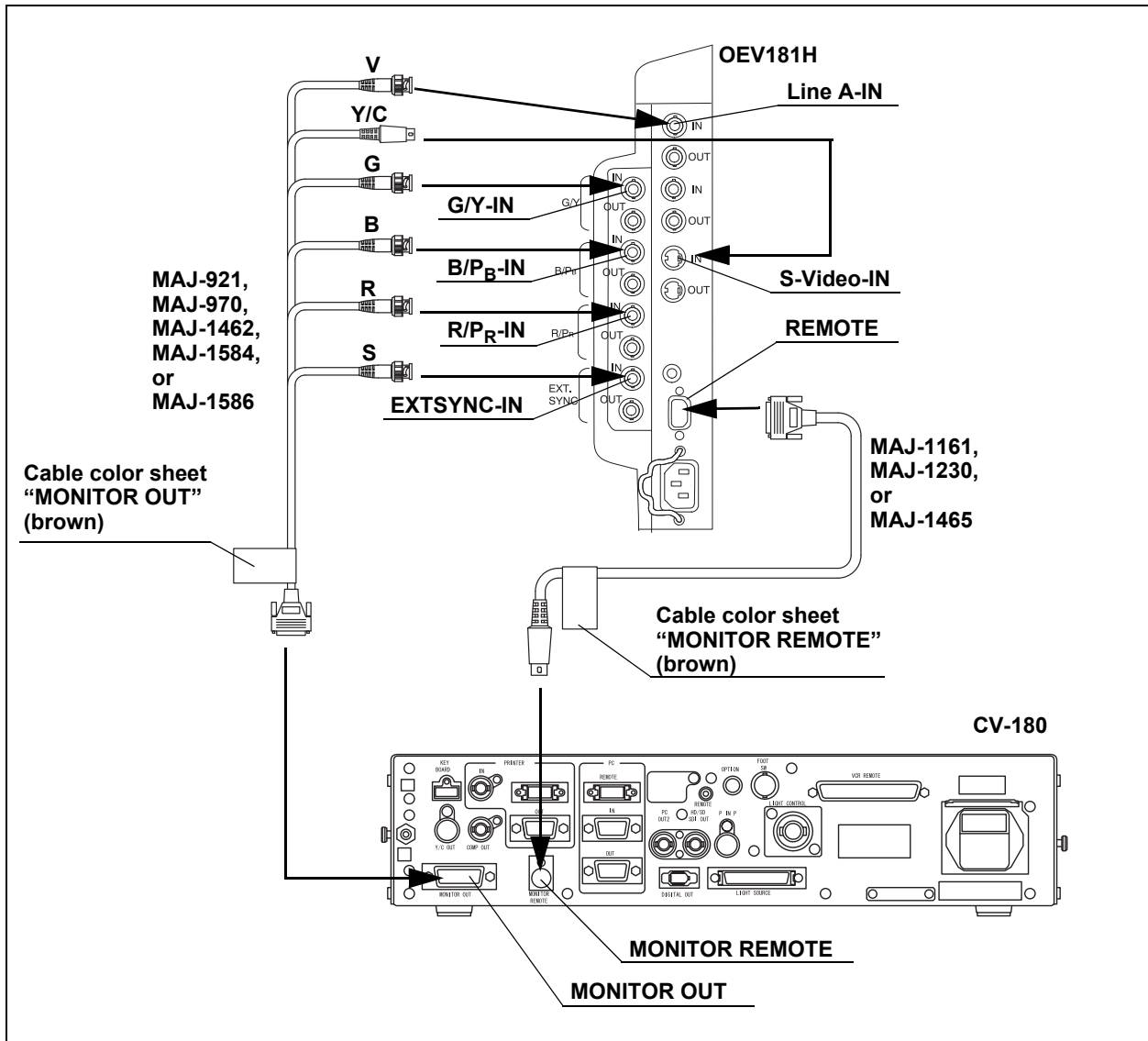

Figure 8.15

OEV191H, OEV191**○ When using RGB or YPbPr video signal**

For connecting the monitors (OEV191H or OEV191) to the video system center, use the cables listed below.

For easy cable connection, attach the cable color sheet to the cables (see Figure 8.16).

Model (length)	Product name
Use any one of the following cables.	
MAJ-921 (1.5 m)	Monitor cable
MAJ-970 (4 m)	
MAJ-1462 (7 m)	
MAJ-1584 (15 m)	
MAJ-1586 (2 m)	
MAJ-846* ¹ (7 m)	
MAJ-971* ¹ (15 m)	
Use either one of the following cables.	
MAJ-1161 (4 m)	HDTV monitor remote cable
MAJ-1230 (7 m)	
MAJ-1465 (15 m)	

*1 These cables are not compatible with the OEV191H.

Table 8.13

NOTE

- To display an endoscopic image, set the factory default "FACTORY" of the monitor to "FACTORY4", according to the instruction manual of the monitor. Otherwise, the monitor remote function may not operate correctly.
- Setting the monitor to "FACTORY4" may make an ultrasound image in the PinP display fuzzy. Set the monitor to "FACTORY6" to sharpen it.

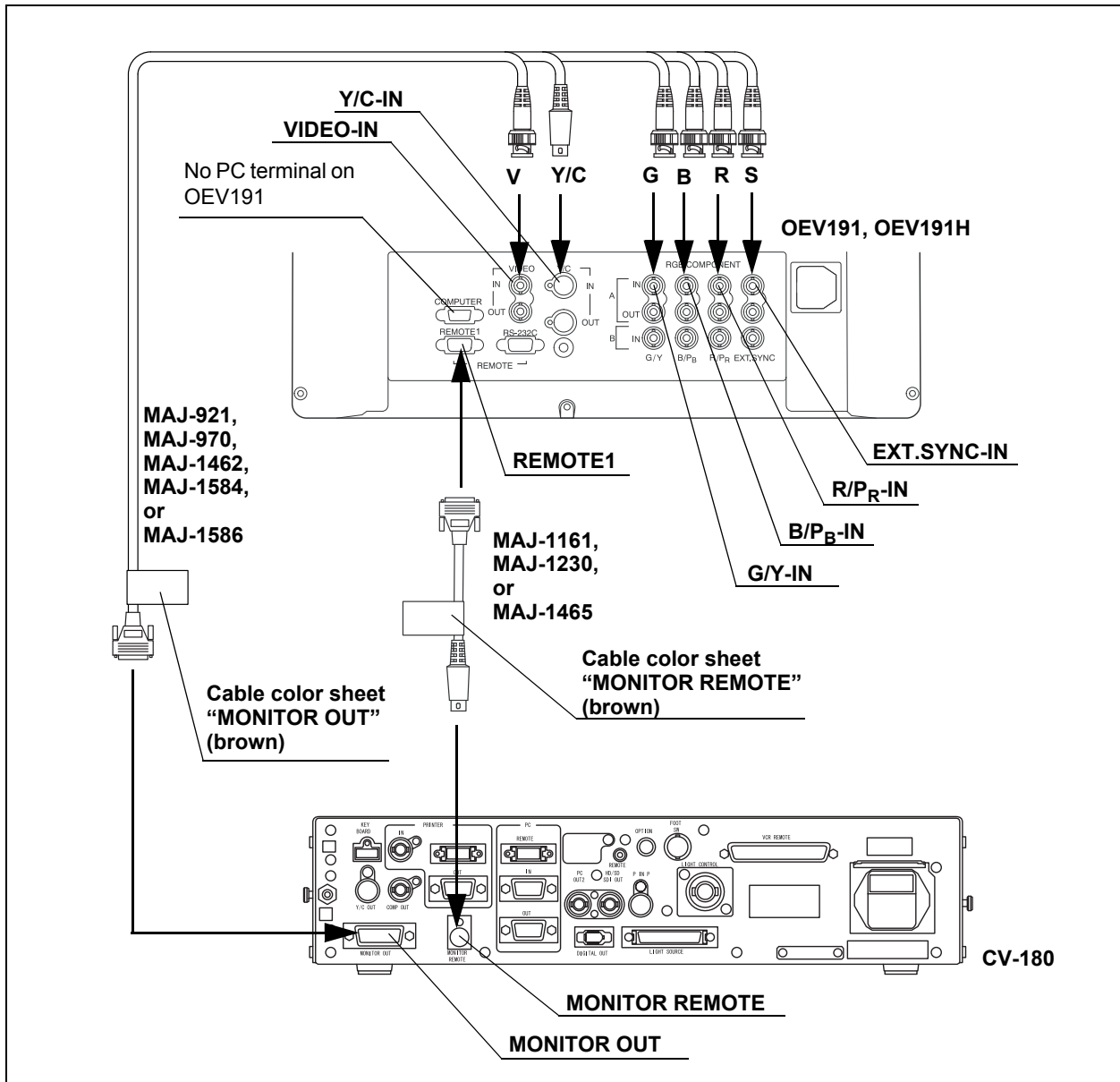

Figure 8.16

○ When using SDI video signal

For connecting the monitors (OEV191H or OEV191) to the video system center, use the cables listed below.

For easy cable connection, attach the cable color sheet to the cable (see Figure 8.17).

Model	Product name	Note
MAJ-1464	SDI cable	22 m
MAJ-1431	HD/SD-SDI adapter	Attach to OEV191H

Table 8.14

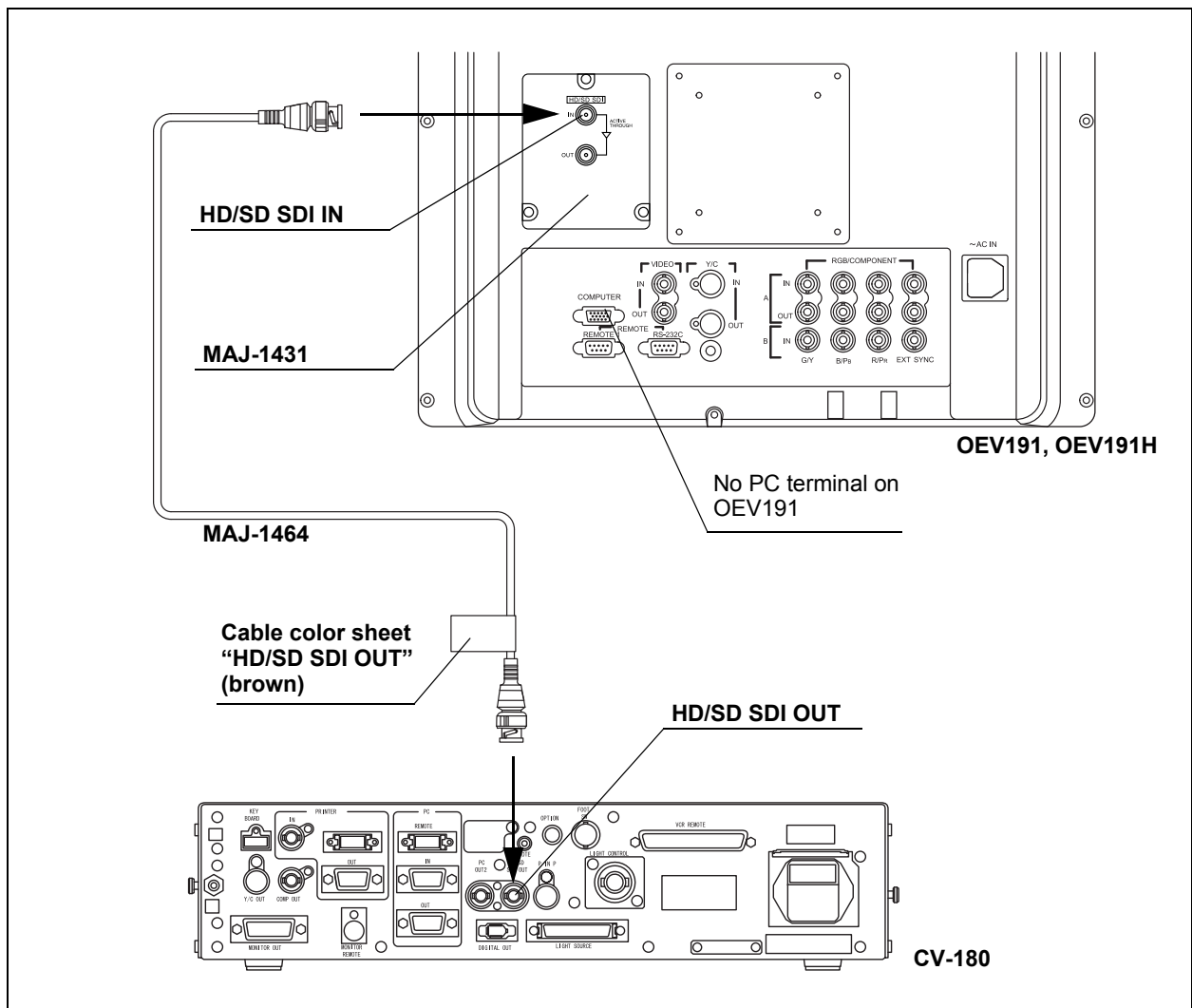

Figure 8.17

8.6 Keyboard

For a compatible keyboard, see the table below.

Model	Product name	Note
MAJ-1428	Keyboard	-

Table 8.15

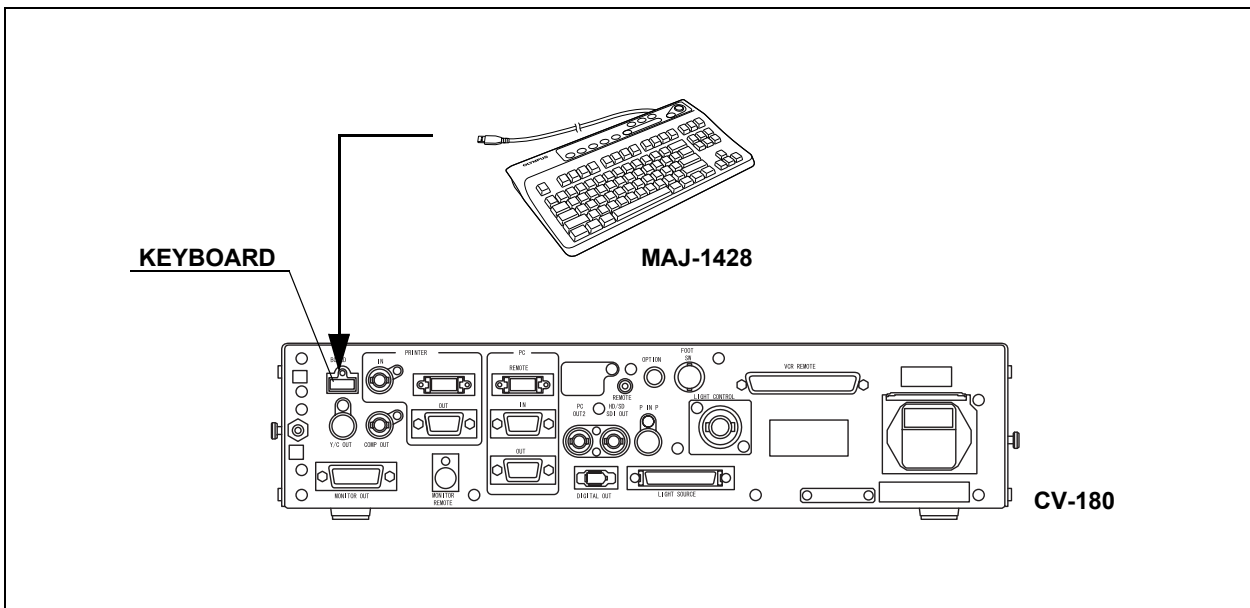

Figure 8.18

8.7 Videocassette recorder (VCR)

○ When using the VCR remote terminal

For compatible video cassette recorders and cables to be used, see the table below.

VCR	Cable			
	MH-989	MH-992	MAJ-906	MAJ-1568
DVO-1000MD (SONY)	–	–	○	–
DSR-20MD (SONY)	–	–	○	–
SVO-9500MD (SONY)	○	○	–	–
PDW-70MD (SONY)	–	–	–	○
PDW-75MD (SONY)	–	–	–	○

○ compatible, – incompatible

Table 8.16

NOTE

- When the SVO-9500MD is used together with the VTR remote cable (MH-989), the SVO-9500MD has to be equipped with the RS-232C interface board (SVBK-120). For details, refer to the instruction manual for the interface board.
- When the SVO-9500MD is used together with the VTR remote cable (MH-992), remote control is restricted to the [Record] and [Pause] functions.
- For details, refer to the instruction manuals for the videotape recorder and VTR remote cable.
- When the PDW-70MD or the PDW-75MD is used, SDI image cable (MAJ-1464) is necessary with VTR remote cable (MAJ-1568).

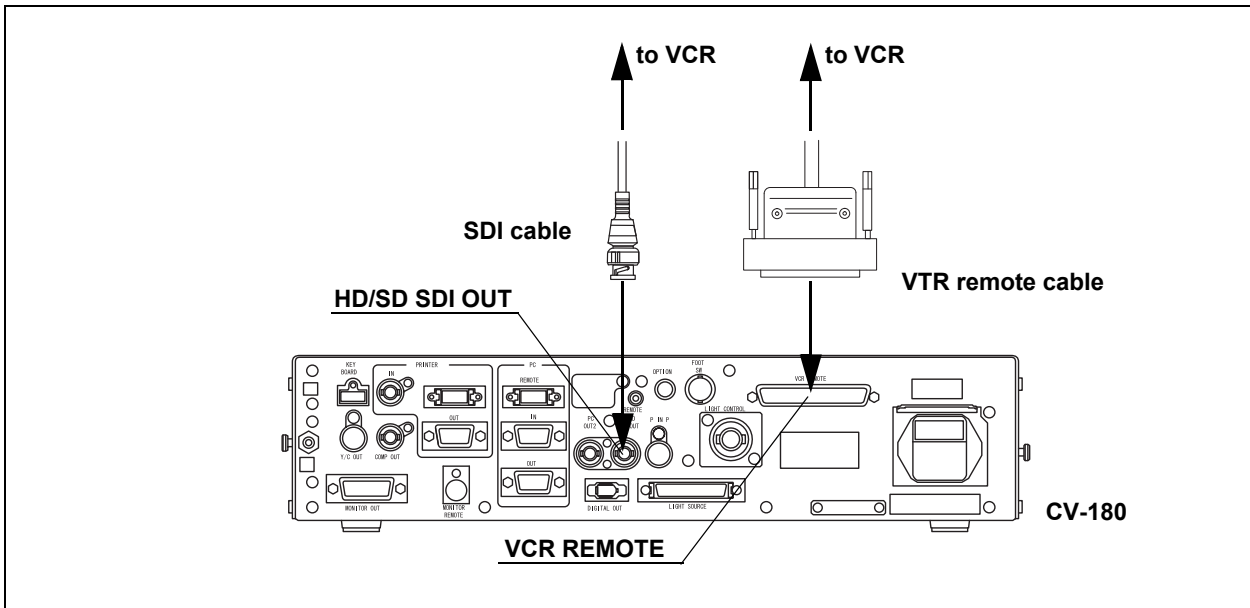

Figure 8.19

○ **When using the digital out terminal**

For connecting the video cassette recorder to the video system center, use a commercially available DV cable.

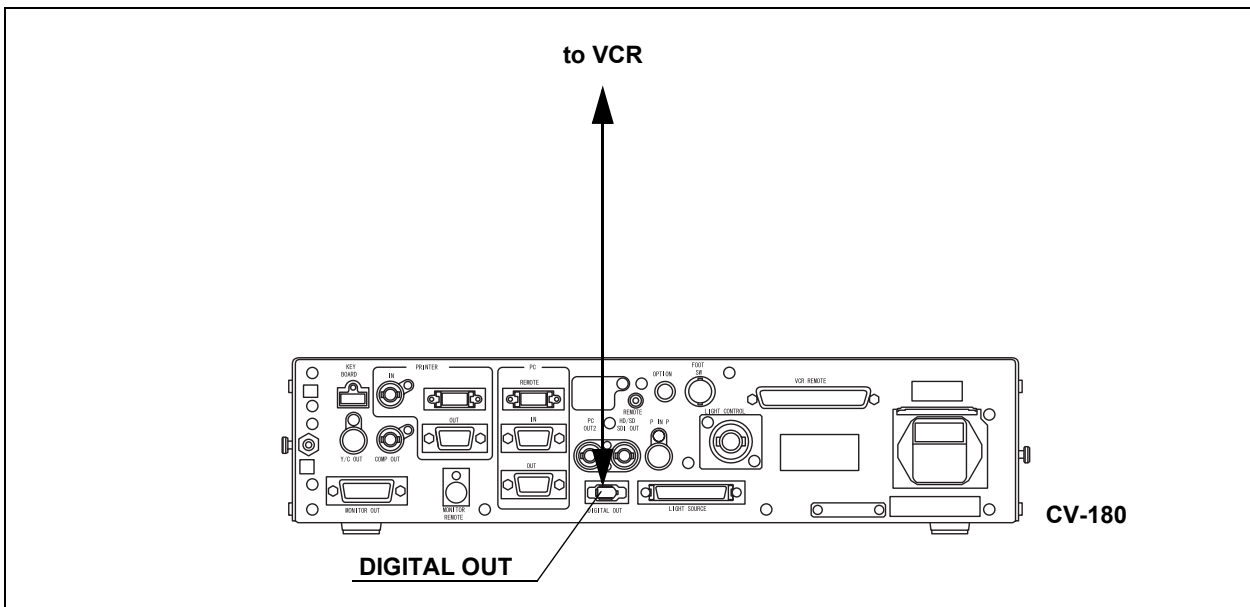

Figure 8.20

8.8 Video printer

For compatible video printers see the table below.

Model	Product name	Note
OEP, OEP-3, OEP-4	Color video printer	OLYMPUS
UP-1800, UP-1850	Color video printer	SONY
UP-2900MD, UP-2950MD	Color video printer	SONY
UP-5200MD, UP-5250MD	Color video printer	SONY
UP-21MD, YP-22MD	Color video printer	SONY

Table 8.17

For connecting a video printer to the video system center, use the cables listed below.

For easy cable connection, attach the cable color sheet to the cables (see Figure 8.21).

Model	Product name	Note
MH-984, or MD-445 and MAJ-849	Monitor cable (MH-984), SCV cable (MD-445), Printer adapter (MAJ-849)	-
MH-995	Remote cable	-
MB-677	BNC cable	-

Table 8.18

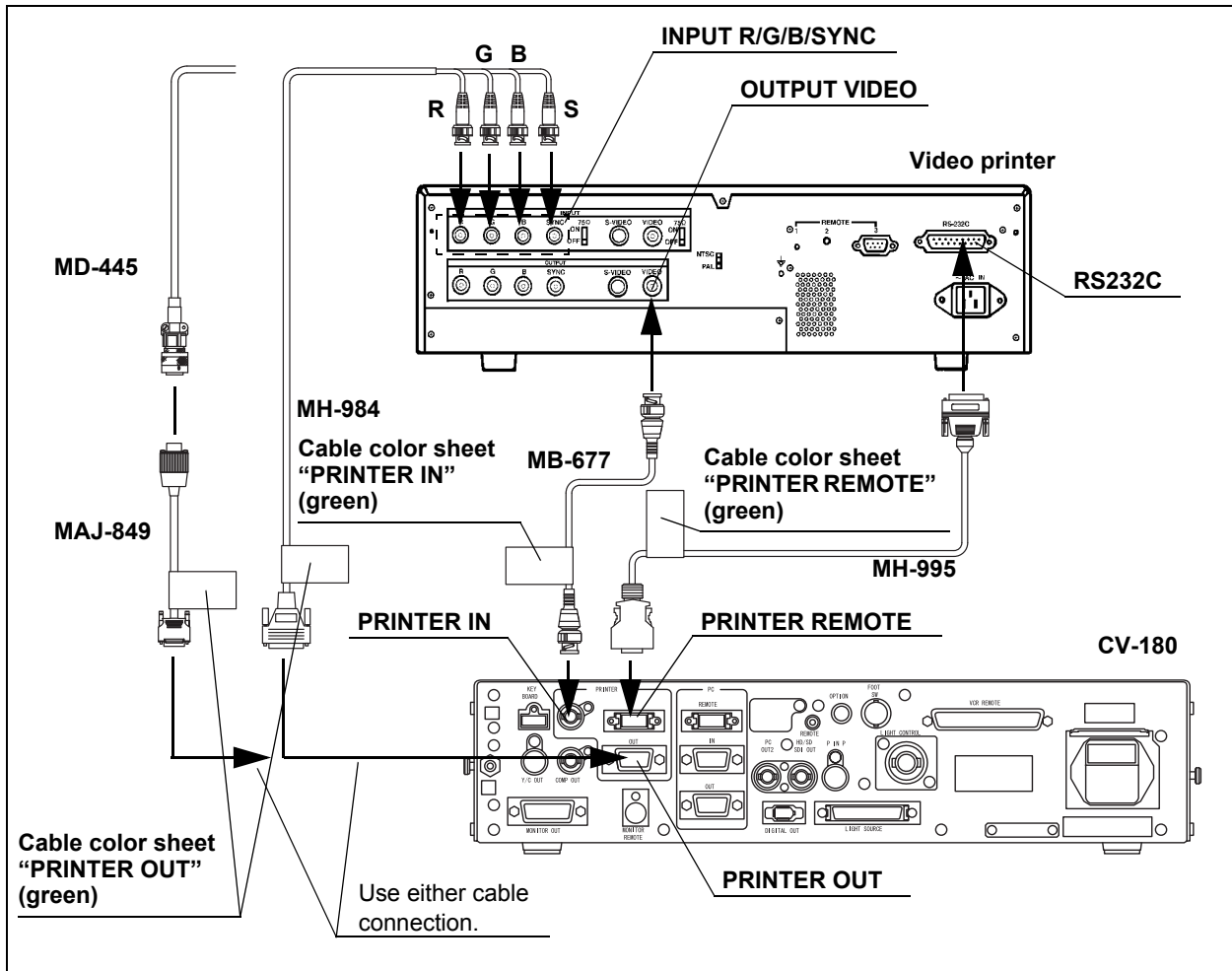

Figure 8.21

8.9 OLYMPUS flushing pump (OFP)

For connecting the Olympus flushing pump, use the cable listed below.
 For easy cable connection, attach the cable color sheet to the cable (see Figure 8.22).

Model	Product name	Note
MAJ-920	Pump remote cable	-

Table 8.19

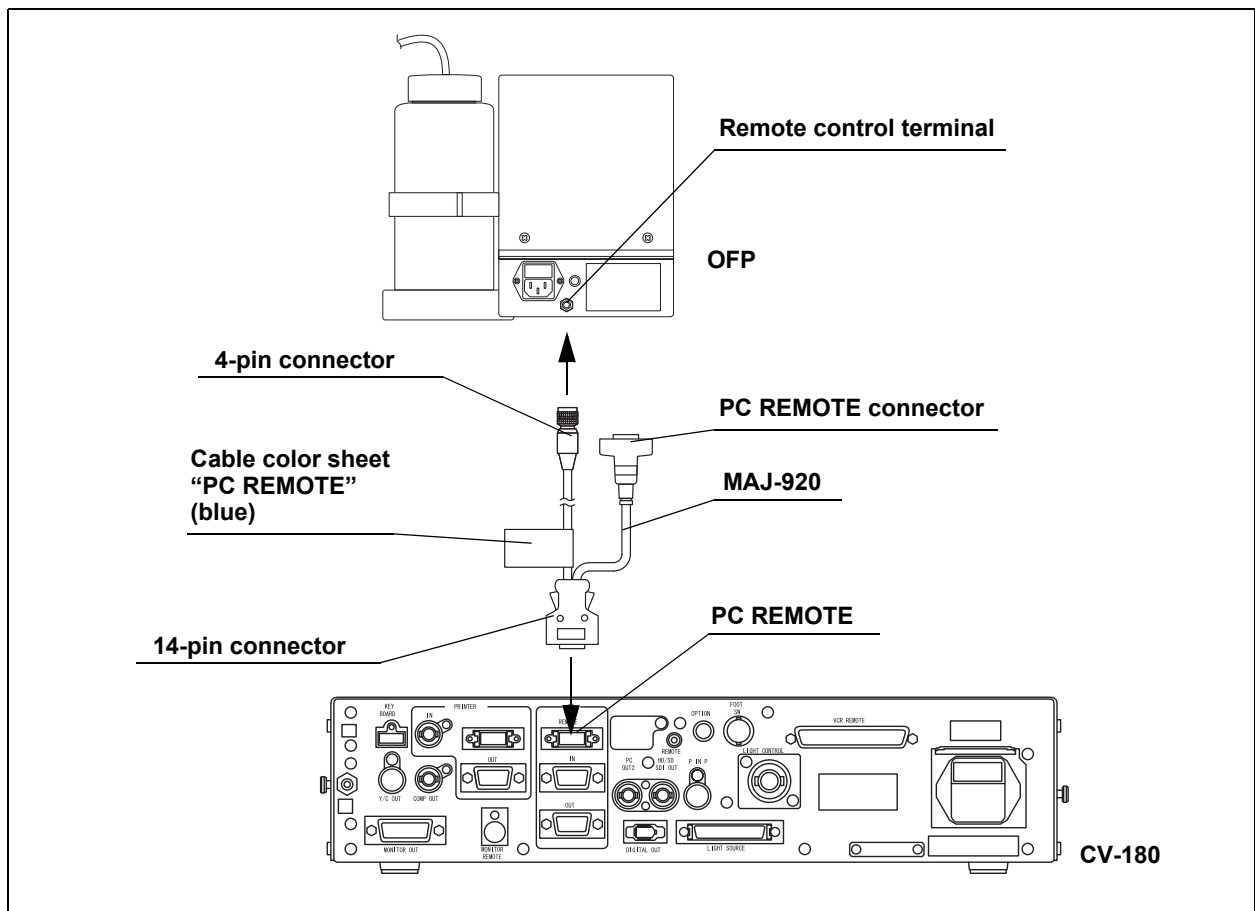

Figure 8.22

8.10 Foot switch

For a compatible foot switch, see the table below.

Model	Product name	Note
MAJ-1391	Foot switch	-

Table 8.20

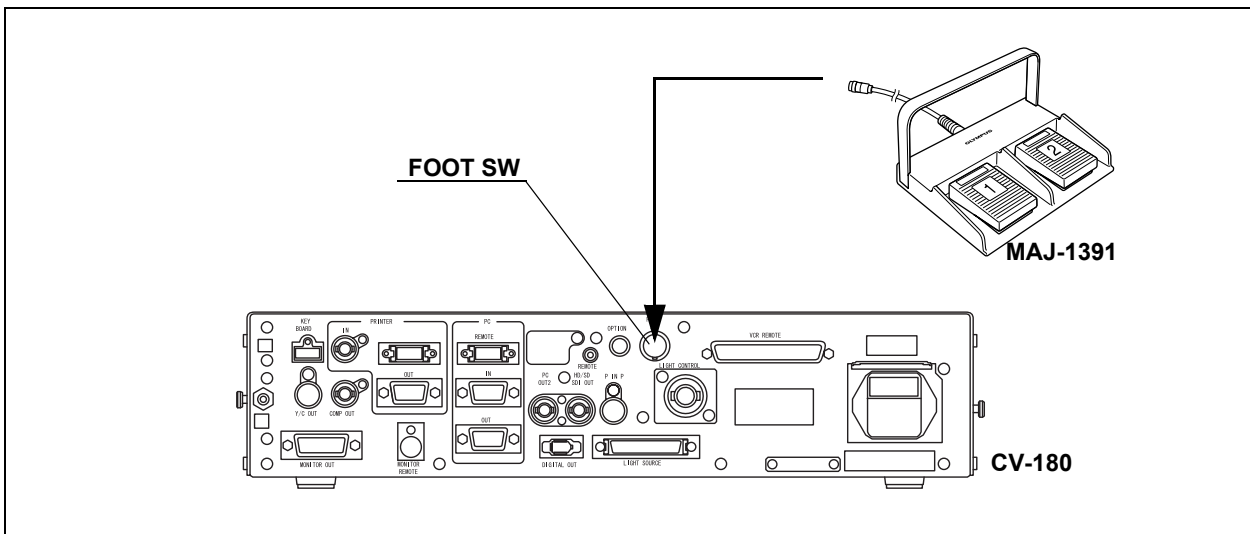

Figure 8.23

8.11 Ultrasound center

Compatible ultrasound centers

For compatible ultrasound centers, see the table below.

Model	Product name
EU-C60	Compact endoscopic ultrasound center
EU-M30	Endoscopic ultrasound center
EU-M60	Endoscopic ultrasound center
EU-MA	Endoscopic ultrasound center

Table 8.21

EU-C60

For connecting the ultrasound center (EU-C60) to the video system center, use the cable listed below.

Model	Product name	Note
MB-677	BNC cable	-

Table 8.22

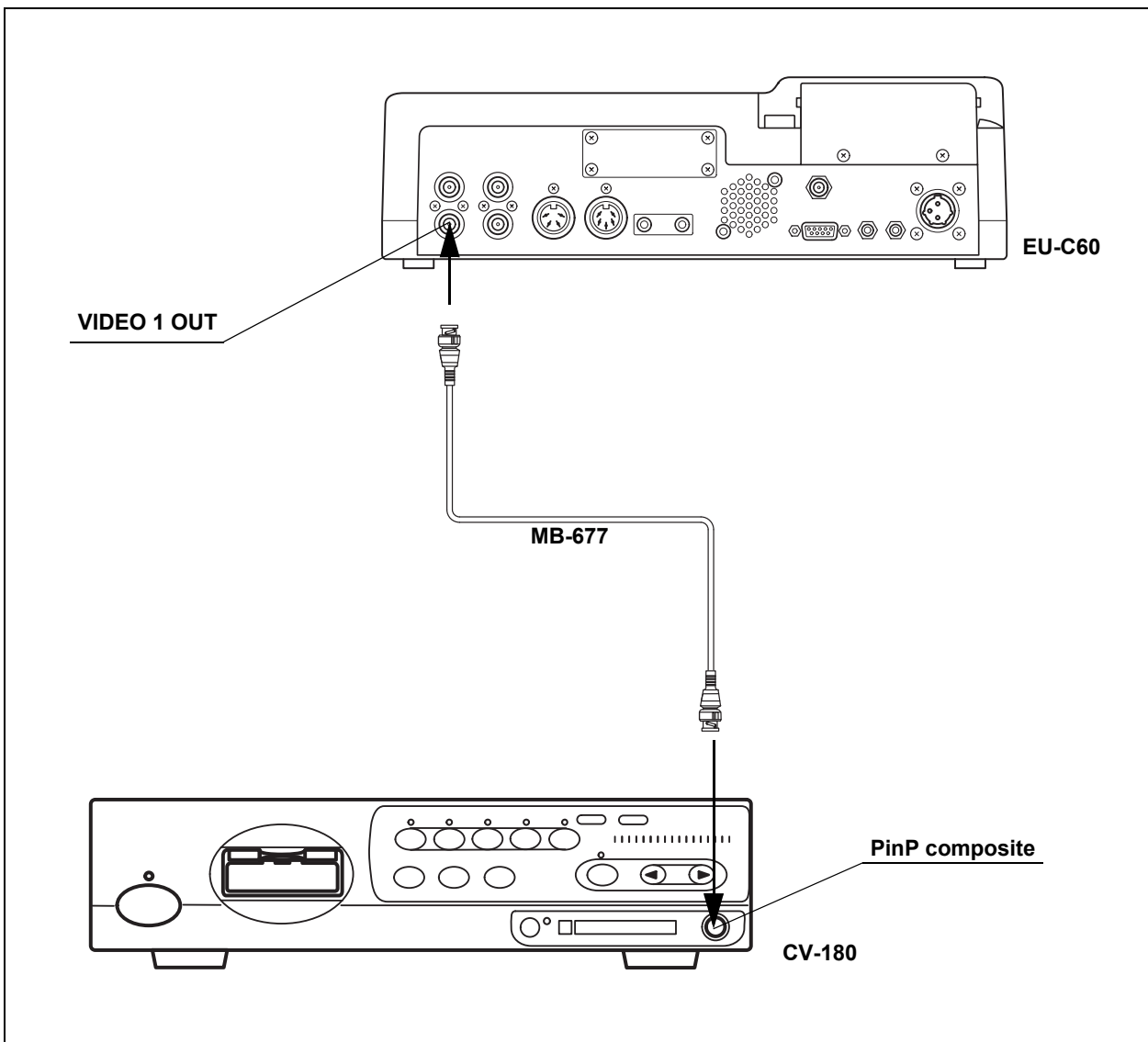

Figure 8.24

EU-M30

For connecting the ultrasound center (EU-M30) to the video system center, use the cable listed below.

Model	Product name	Note
MH-909	Monitor cable	-

Table 8.23

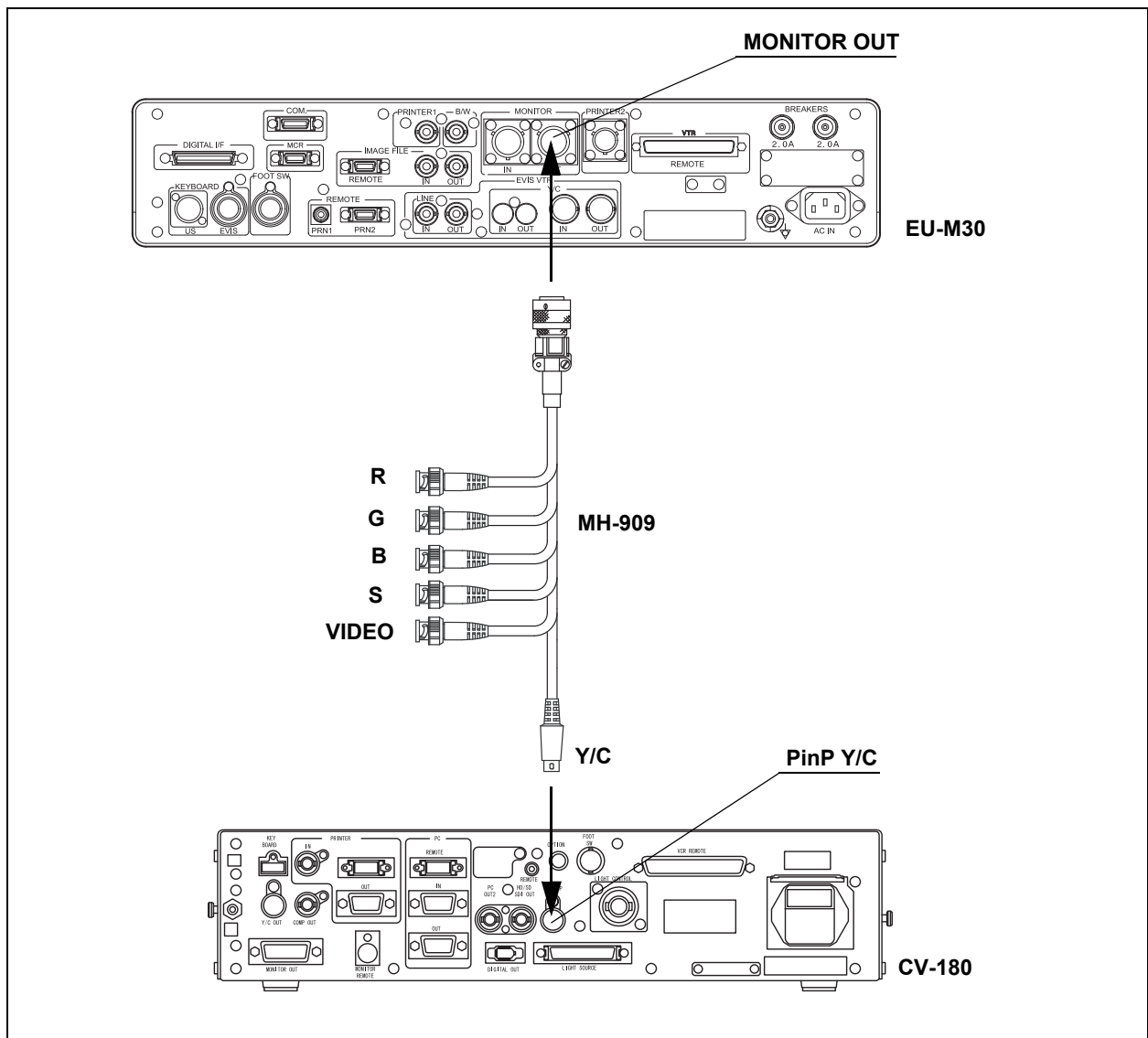

Figure 8.25

NOTE

Do not connect the video output and B/W output of the EU-M30 to the CV-180. An ultrasonic image in the PinP display may be distorted.

EU-M60, EU-MA

For connecting the ultrasound center (EU-M60 or EU-MA) to the video system center, use the cable listed below.

Model	Product name	Note
MH-985 or MAJ-987	S cable	-

Table 8.24

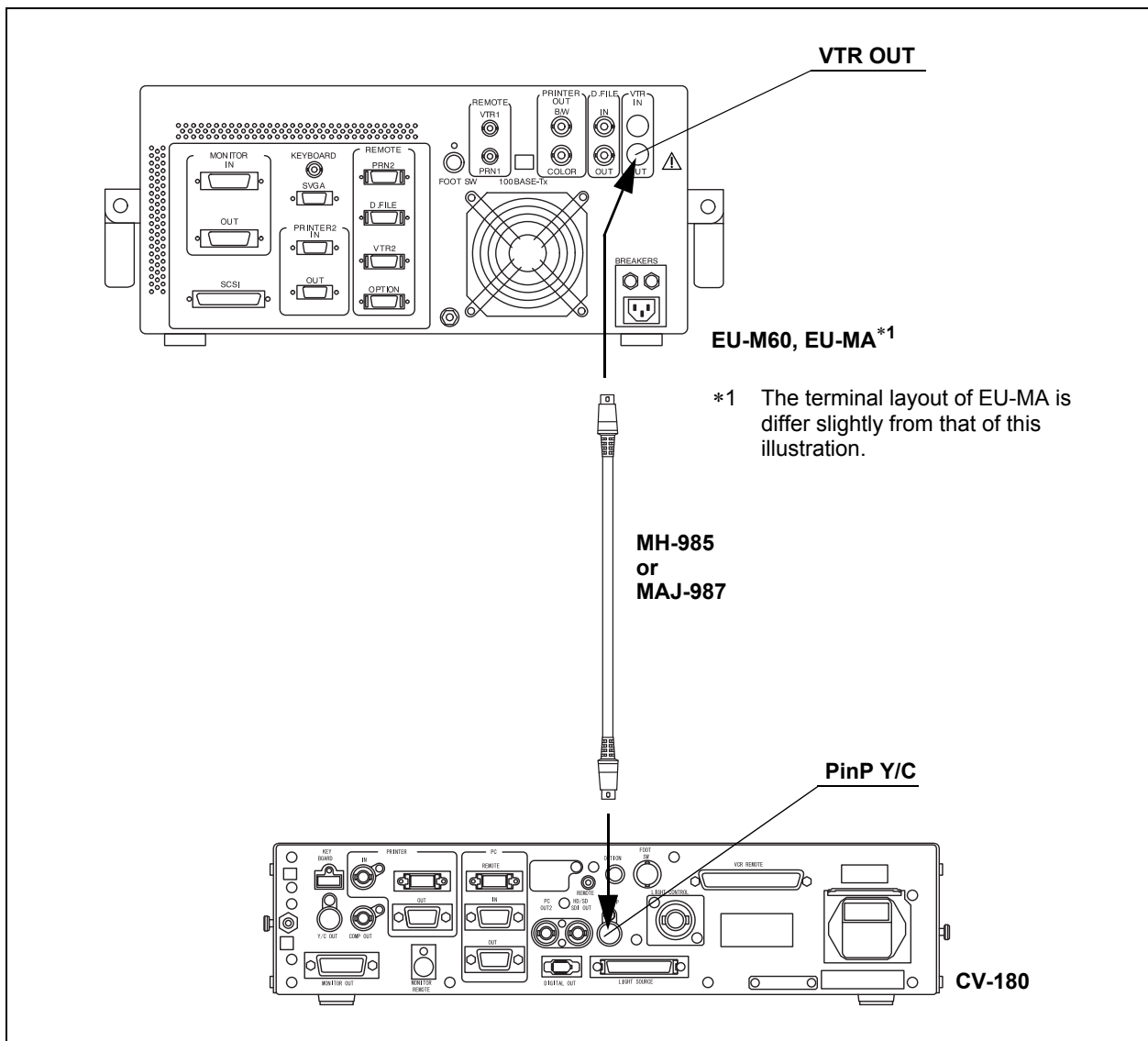

Figure 8.26

NOTE

Do not connect the video output and B/W output of the EU-M60 to the CV-180. An ultrasonic image in the PinP display may be distorted.

8.12 Connection to the AC mains power supply

DANGER

- Be sure to connect the power plug of the power cord directly to a grounded wall mains outlet. If the video system center is not grounded properly, it can cause an electric shock and/or fire.
- Do not connect the power plug to the 2-pole power circuit with a 3-pole to 2-pole adapter. It can prevent proper grounding and cause an electric shock.

WARNING

- Always keep the power plug dry. A wet power plug may cause electric shocks.
- Confirm that the hospital-grade wall mains outlet to which this instrument is connected has adequate electrical capacity that is larger than the total power consumption of all connected equipment. If the capacity is insufficient, fire can result or circuit breaker may trip and turn OFF this instrument and all other equipment connected to the same power circuit.
- When using the mobile workstation (WM-NP1, WM-WP1), confirm that the mobile workstation has adequate electrical capacity that is larger than the total power consumption of all connected equipment. If the capacity is insufficient, drop in the supply voltage can result or the electric protective device may trip and turn OFF all the equipment connected to the mobile workstation.
- When non-medical ancillary electrical equipment is used, always connect the equipment to a wall mains outlet via an isolation transformer. Otherwise, electric shock can result.
- The total power consumption of all connected equipment to the isolation transformer should not exceed the rating of the isolation transformer. If it exceeds, add another isolation transformer. Otherwise, the equipment may not work correctly.
- Do not bend, pull or twist the power cord. Equipment damage including separation of the power plug and disconnection of the cord wire as well as fire or electric shock can result.
- Be sure to connect the power plug securely to prevent erroneous unplugging during use. Otherwise, the equipment will not function.

- Do not extend a single wall mains outlet into multiple outlets for connecting the power cords of both the electrosurgical unit and light source. Otherwise, malfunction of the equipment may result.

○ **When the mobile workstation (WM-NP1, WM-WP1) is used**

1. Confirm that the video system center is OFF.
2. Connect the power cord provided with the mobile workstation to the AC power inlet of the video system center and the AC mains outlet of the mobile workstation (see Figure 8.27).

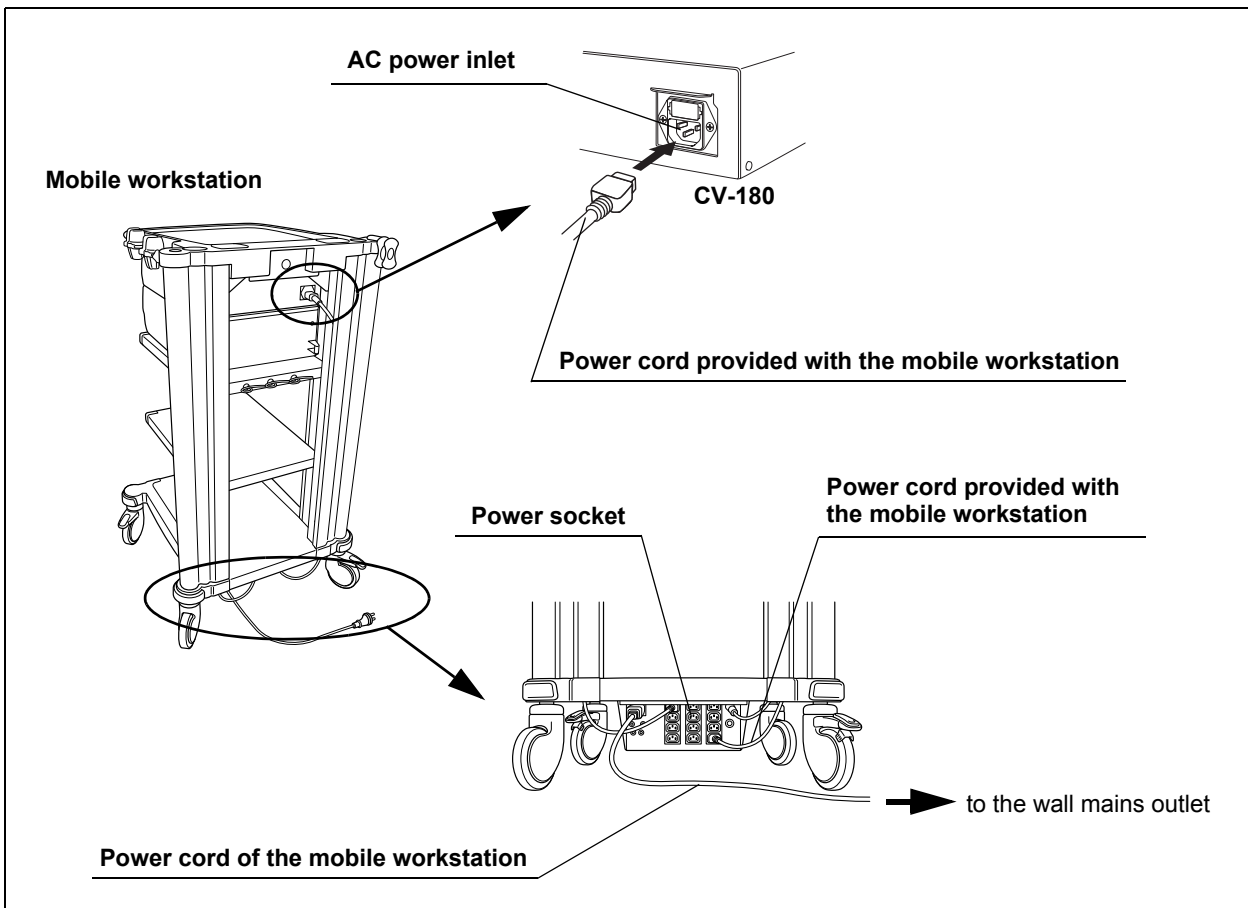

Figure 8.27

3. Connect the power cords provided with the mobile workstation to the AC power inlets of the ancillary equipment and the AC mains outlets of the mobile workstation.
4. Connect the power cord of the mobile workstation to the wall mains outlet.

○ **When a mobile workstation other than the WM-NP1 and WM-WP1 is used or when no mobile workstation is used**

1. Confirm that the video system center is OFF.
2. Connect the power cord provided with the video system center first to its AC power inlet, then to the wall mains outlet.
3. Connect the instruments listed in Table 8.25 to the wall mains outlet.
4. Connect the instruments listed in Table 8.26 to the isolation transformer.
5. Connect the power cord of the isolation transformer to the wall mains outlet.

Model	Product name
CLV-180, CLV-160, CLV-U40, CLV-S40,	Light source
OEV monitors (OEV143, OEV203, OEV181H, OEV191, OEV191H)	Monitor
OEP printers	Video printer

Table 8.25 The devices to be connected directly to the wall mains outlet

Model	Product name
DVO-1000MD, DSR-20MD, SVO-9500MD	VCR
Other than OEP video printers (UP-1800, UP-1850, UP-2900MD, UP-2950MD, UP-5200MD, UP-5250MD, UP-21MD)	Video printer
Other than OEV video monitors	Monitor

Table 8.26 The devices to be connected to the isolation transformer

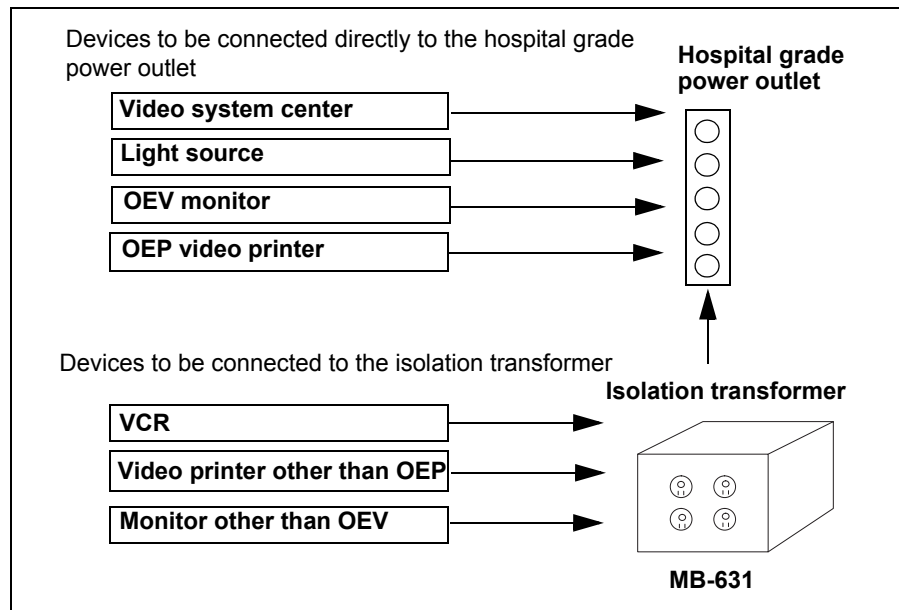

Figure 8.28

Chapter 9 Function setup

This chapter shows basic settings for appropriate use of the video system center and other equipment connected to the video system center.

Menu	Function
System setup	Sets the basic settings of the video system center and the ancillary instruments. See page 214 for the items to set.
User preset	Sets the functions for observation. See page 255 for the items to set.

Table 9.1

9.1 Turning power ON

1. Push the power switch of the video system center. The power indicator above the switch lights up.
2. Confirm that the endoscopic image appears on the monitor (see Figure 9.1).

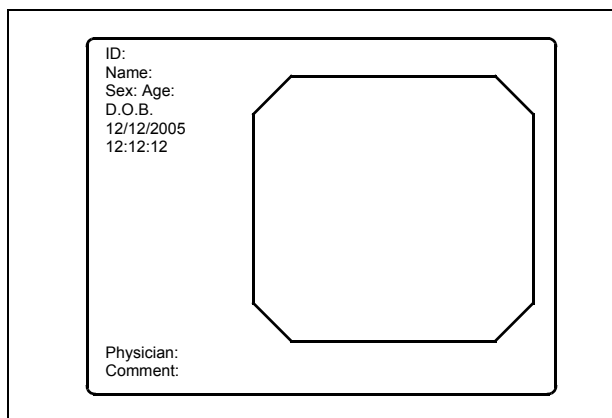

Figure 9.1

NOTE

No endoscope is required for the settings. If no endoscope is connected, the color bar appears on the monitor instead of the endoscopic image.

9.2 System setup

Basic operation of the system setup

1. Press the “Shift” and “F1” keys together (see Figure 9.2). The “System setup” menu appears on the monitor (see Figure 9.3).

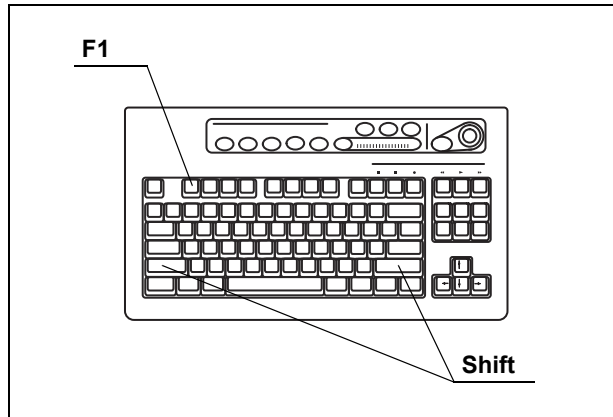

Figure 9.2

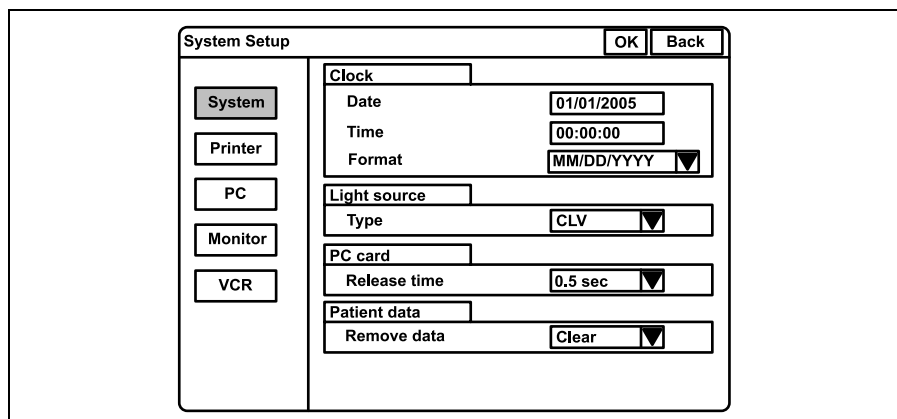

Figure 9.3

Buttons	Functions
OK	Determines the entered data. Used to move back to the endoscopic image.
Back	Cancels the entered data. Used to move back to the endoscopic image.

Table 9.2

2. Click “System”, “Printer”, etc., on the left side of the menu. The applicable setting items appear on the right side of the window.
3. Click the desired text box to place the cursor and enter the data.

4. Click “ ▼ ” of the list box to open the pull down menu, and click the data in the pull down menu.
5. Click “Back” or “Esc” to cancel the input data and to go back to the endoscopic image.
6. Click “OK” after completing input operation. A confirmation message appears on the monitor.
7. Click “Y” or press “Enter” to store the input data and to go back to the endoscopic image.
Click “N” to go back to step 2.

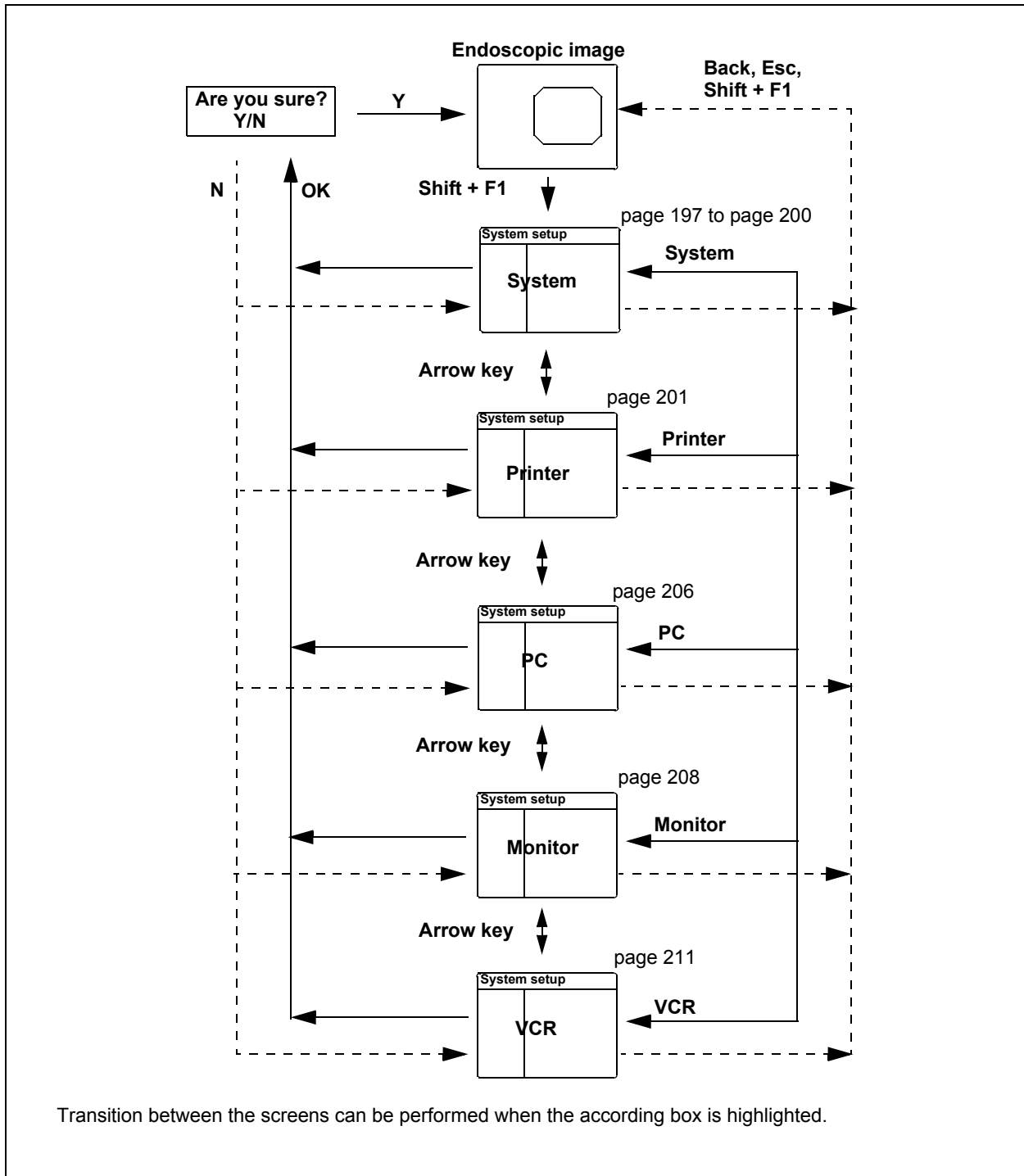

Figure 9.4

System

This operation sets the current date and time, the type of the connected light source, the release time when an endoscopic image is stored to the PC card, and the display type of the patient data with an endoscopic image.

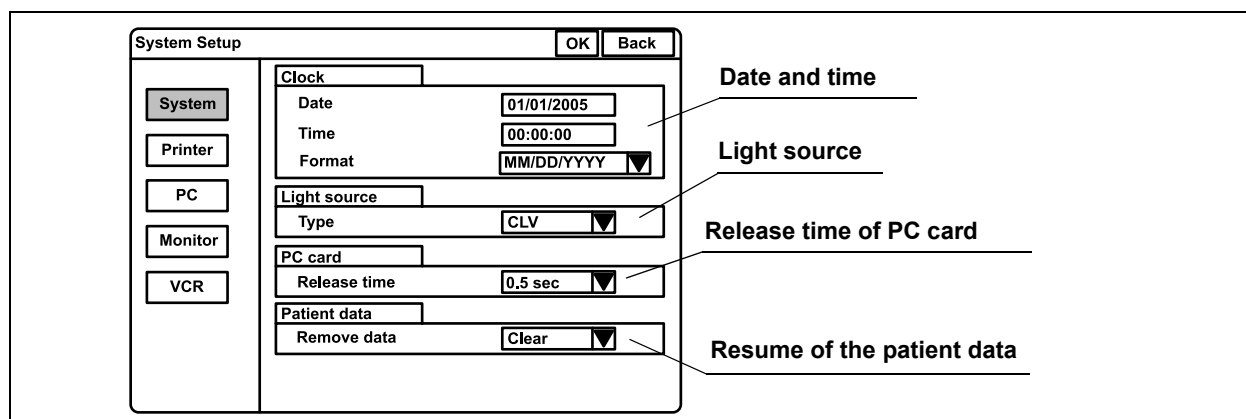

Figure 9.5

Click "System" on the system setup menu. The setting screen appears on the right part of the window (see Figure 9.5).

○ Date and time

This operation sets the current date and time, and the display format of the date.

1. Click the text box of "Date" and enter numeric characters for month, date and year.
2. Click the text box of "Time" and enter hour, minute and second.
3. Click "▼" of "Format". The date formats appear in the pull-down menu.

Format			Explanation
• MM/DD/YYYY	• DD/MM/YYYY	• YYYY/MM/DD	YYYY: year MM: month DD: day
• MM-DD-YYYY	• DD-MM-YYYY	• YYYY-MM-DD	
• MM.DD.YYYY	• DD.MM.YYYY	• YYYY.MM.DD	
• MM DD YYYY	• DD MM YYYY	• YYYY MM DD	

Table 9.3

4. Click the format to use. The format is selected and displayed in the dialog box.

○ Light sources

This operation sets the type of light source connected.

CAUTION

Other settings of the light source may cause improper color and/or brightness in the image.

1. Click “▼” of the list box “Type”. The following light sources appear in the pull-down menu.

Setting value	Connected light source
CLV	CLV-160, CLV-U40
CLV-S	CLV-S40
CLE	Halogen light source

Table 9.4

2. Click the setting value corresponding to the connected light source. The selected setting value is displayed.

NOTE

- When the CLV-180 is used, the setting is not necessary.
- When a light source other than CLV-180 is used, set up the light source according to the table below. Please refer to the instruction manual of the light source.

Setting items	Settings
Brightness adjustment mode	AUTO
BRIGHTNESS	Center of the adjustable range

Table 9.5

○ Release Time of PC card

The endoscopic live image pauses when the “RELEASE” button is pressed to record the image on the PC card. This operation sets the length of time to pause.

1. Click “▼” of the list box “Release Time”. The available release times appear in the pull-down menu.

Setting values	Release time
0.5 sec	0.5 second
1 sec	1 second
1.5 sec	1.5 seconds
2 sec	2 seconds

Table 9.6

2. Click the desired release time. The selected time is displayed.

NOTE

The actual release time is the longest one among all release time settings of instruments.

○ Display of Patient data

All or a part of the text data such as the patient data can be cleared from the monitor (refer to “Clearing characters from the screen (“F1”)” on page 82). The following operation sets whether the display status when turning the video system center OFF is saved or not. In case “Save” is set, the same display status appears on the monitor when the instrument is turned ON as it was when the instrument has been turned OFF.

1. Click “ ▼ ” of the list box “Remove data”. “Clear” and “Save” appear in the pull-down menu.
2. Click “Save” or “Clear”. The value selected is displayed.

Setting value	Explanation
Clear	Displays all text data when the instrument is turned ON.
Save	Displays same status as when the instrument is turned OFF.

Table 9.7

Printer

This operation sets the type of video printer, number of print sheets, caption to be printed on the print sheets, and release time of the video printer.

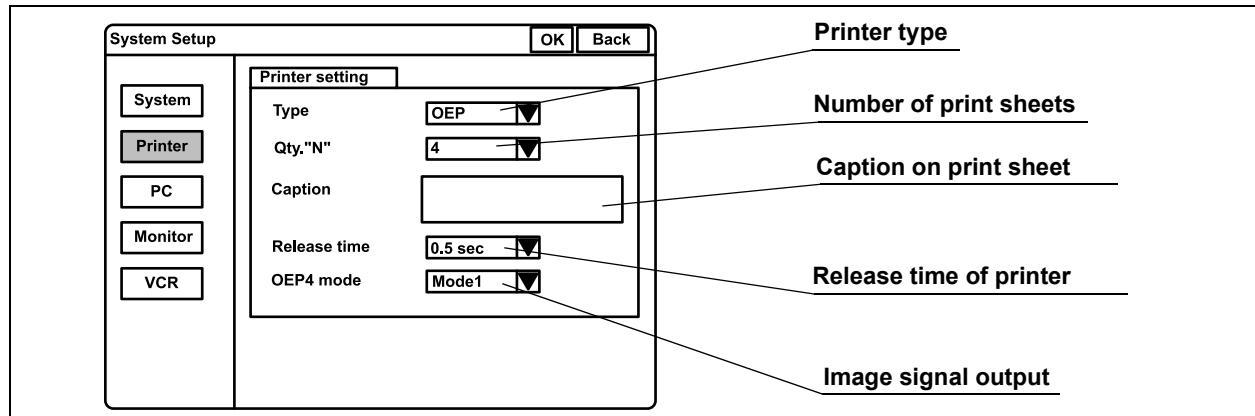

Figure 9.6

Click "Printer" on the system setup menu. The setting items appear on the right part of the window (see Figure 9.6).

NOTE

When the video printer of HDTV non-correspondence is used, the HDTV image can only be printed in SDTV quality.

○ Printer type

1. Click “ ▼ ” of the “Type”. The video printer types appear in the pull-down menu.

Setting value	Applicable video printer model	HDTV printing
OEP	OEP (OLYMPUS)	NO
OEP4	OEP-4 (OLYMPUS)	YES
OEP3	OEP-3 (OLYMPUS)	NO
2900	UP-2900MD (SONY)	NO
2950	UP-2950MD (SONY)	NO
5200	UP-5200MD (SONY)	NO
5250	UP-5250MD (SONY)	NO
5000	UP-5000MD (SONY)	NO
1800	UP-1800 (SONY)	NO
1850	UP-1850 (SONY)	NO
UP21	UP-21MD (SONY)	NO
YP22	function not available	NO
Foot switch		NO

Table 9.8

2. Click the video printer type to be used. The selected printer type is displayed.

○ Number of print sheets

1. Click “ ▼ ” of the “Qty.“N””. The numbers of the print sheet (4, 5, 6, 7, 8 and 9) appear in the pull-down menu (see Figure 9.6). These numbers are assigned to “N” of the “PRINT QTY.” key on the keyboard.
2. Click the desired number. The selected number is displayed.

NOTE

- The number 1, 2 or 3 are selected with the “PRINT QTY.” key on the keyboard.
- When “Foot switch” of the printer type is selected, “Qty.“N”” cannot be set.

○ Caption

1. Click the text box of "Caption". The cursor moves into the dialog box.
2. Enter the caption in the dialog box.
 - Max. 32 alphanumeric and symbol characters can be entered.

Figure 9.7 shows an example of a print sheet with caption.

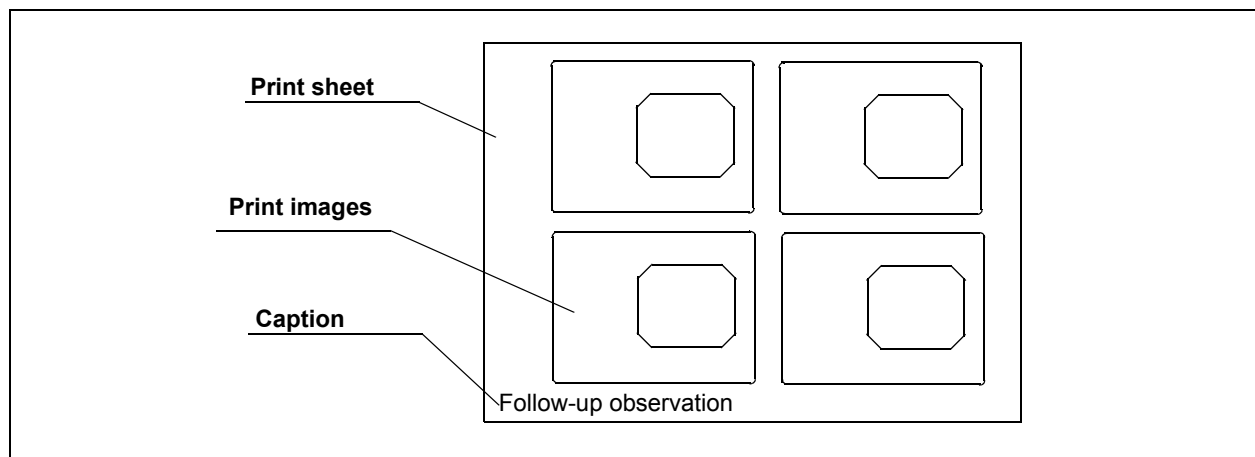

Figure 9.7

NOTE

- When OEP is used, set "TIMER" of the OEP printer OFF. For details, refer to the instruction manual of the OEP printer.
- When "Foot switch" of the printer type is used, "Caption" cannot be set.
- When the UP-1800/1850 is used, set the "LIVE MODE" option of the printer OFF. For details, refer to the instruction manual for the UP-1800/1850.
- When the UP-1800/1850 is used and "MODE" is set to "1", set "Separate" of the printer OFF. The remote operation from the CV-180 becomes disabled. For details, refer to the instruction manual for the UP-1800/1850.
- Set the baud rate of the RS-232C printer, referring to its instruction manual.
 - Baud rate: 4800 bps

○ Release time

The endoscopic live image pauses when the “RELEASE” button is pressed to record the image onto the PC card. This operation sets the length of time to pause.

1. Click “▼” of the “Release time (see Figure 9.6 on page 201). The release times appear in the pull-down menu.

Setting value	Release time
0.5 sec	0.5 second
1 sec	1 second
1.5 sec	1.5 seconds
2 sec	2 seconds

Table 9.9

2. Click the desired release time. The selected time is displayed.

NOTE

The actual release time is the longest one among all release time settings of the instruments.

○ Output signal to OEP-4

1. Click “▼” of the “OEP4 mode” (see Figure 9.6 on page 201). The output signal appear in the pull-down menu.

Setting value	Explanation
Mode 1	The video signal (HDTV or SDTV) compatible with the endoscope type is output. In the mode1, HDTV images and SDTV images cannot be printed on the same print sheet. In this case, HDTV images and SDTV images are printed on the separate print sheets.
Mode 2	The SDTV signal is output regardless of the endoscope type. However, the HDTV signal is output only when the number of images on the print form is one.

Table 9.10

2. Click the desired mode. The selected mode is displayed.

NOTE

- During displaying in PinP in mode1, the image output is always SDTV format without reference to the endoscope.
- OEP-4 cannot print HDTV and SDTV images on the same page. If HDTV images follow SDTV images, the Printing Forcibly message will appear and the HDTV images will be

printed first. After the HDTV images are printed, SDTV images can be captured and printed as usual. The Printing Forcibly message does not indicate a malfunction.

Image filing system

This operation sets the type of image filing system that is connected to the “PC” terminal on the rear panel and the release time of the image filing system.

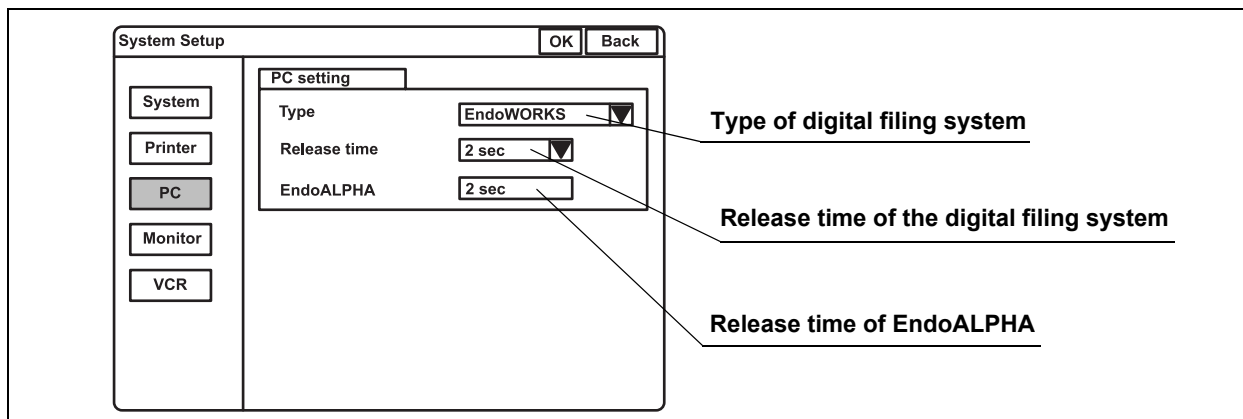

Figure 9.8

Click “PC” on the system setup menu. The setting items appear on the right side of the window (see Figure 9.8).

○ Type of image filing system

1. Click “▼” of the “Type”. The types of image filing system appear in the pull-down menu.

Setting value	Explanation
EndoWORKS	The images can be recorded on the EndoWORKS system.
EndoALPHA	The images can be recorded on the EndoALPHA system.
EndoBASE	The images can be recorded on the EndoBASE system.
OFF	The images cannot be recorded on any image filing system.

Table 9.11

2. Click the system to use. The selected system is displayed.

○ Release time

The endoscopic live image pauses when the “RELEASE” button is pressed to record the images into the image filing system. This operation sets the length of time to pause.

1. Click “▼” of the “Release time (see Figure 9.8). The release times appear in the pull-down menu.

Setting value	Release time
0.5 sec	0.5 second
1 sec	1 second
1.5 sec	1.5 seconds
2 sec	2 seconds

Table 9.12

2. Click the desired release time. The selected release time is displayed.

NOTE

The actual release time is the longest one among all release time settings of instruments.

○ EndoALPHA

The release time set by EndoALPHA is displayed. The setting value cannot be changed on this screen.

Monitor

This operation sets the monitor type, video signal, aspect ratio of the HDTV (horizontal and vertical ratio of the display area) and the terminal to be activated by the monitor for video output.

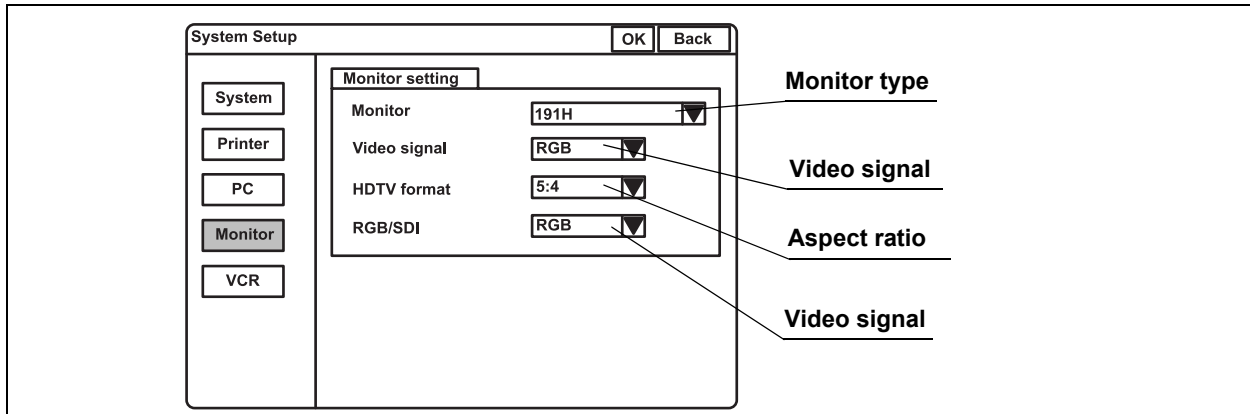

Figure 9.9

Click “Monitor Setting” on the system setup menu. The setting items appear on the right side of the window (see Figure 9.9).

○ Monitor type

1. Click “▼” of “Monitor”. The monitor types appear in the pull-down menu.

Setting value	Video signal	Applicable monitor model
141/201	SDTV	OEV141, OEV201
142/143/202/203	SDTV	OEV142, OEV143, OEV202, OEV203
181H	HDTV	OEV181H
191H	HDTV	OEV191H
191	SDTV	OEV191
Remote OFF (HD)	HDTV	
Remote OFF (SD)	SDTV	

Table 9.13

2. Click the desired monitor type. The selected monitor type is displayed.

○ Video signal format

CAUTION

Improper setting of the video signal may displays abnormal images.

1. Click “▼” of the “Video signal”. The video signals appear in the pull-down menu.

Setting value	Explanation
RGB	For RGB compatible monitors
YPbPr	For analog component signal compatible monitors

Table 9.14

2. Click the desired video signal. The selected video signal is displayed.

○ Aspect ratio

1. Click “▼” of “HDTV format”. The aspect ratios appear in the pull-down menu.

Setting value	Explanation
5:4	For the monitors whose horizontal to vertical ratio is 5:4.
4:3	For the monitors whose horizontal to vertical ratio is 4:3.

Table 9.15

2. Click the desired aspect ratio. The selected aspect ratio is displayed.

NOTE

- When the aspect ratio settings of the monitor and CV-180 are not the same, the top and bottom or right and left of the image may not be displayed properly on the monitor. It is recommended to use the default settings of the aspect ratio and to use the remote control cable described in Section 8.5, “Monitor” on page 170
- A common aspect ratio of HDTV is 16:9, but this instrument displays only the central part of the image in the ratio 5:4 or 4:3.

○ The video signal output

This operation sets the type of video signal output to the monitor.

1. Click “▼” of “RGB/SDI”. The video signals appear in the pull-down menu.

Setting value	Explanation
RGB	Output RGB video signal to the monitor.
SDI	Outputs SDI video signal to the monitor.

Table 9.16

2. Click the desired video signal. The selected video signal is displayed.

NOTE

CV-180 does not have an SDI input and is therefore not capable of transferring images from external devices to the monitor via SDI.

Videocassette recorder

This operation sets the type of videocassette recorder (VCR) and the video signal to the VCR.

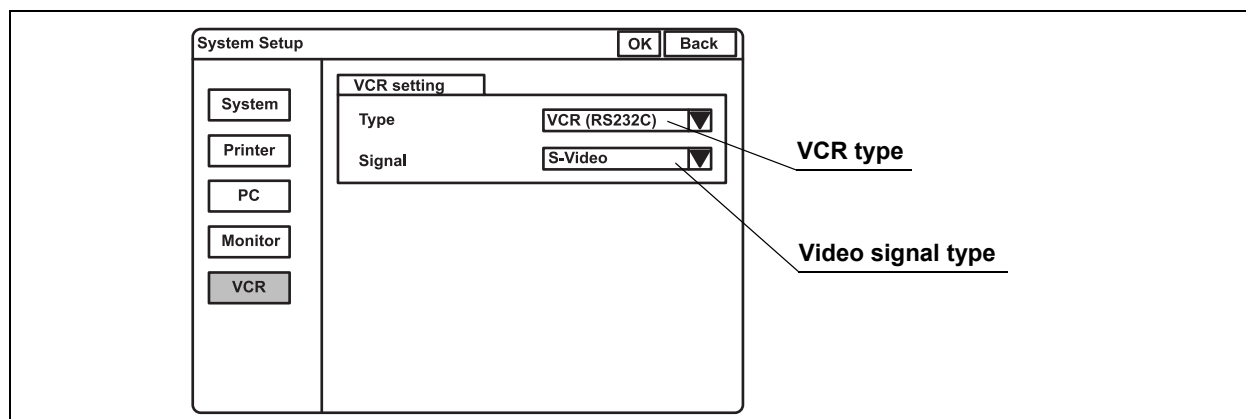

Figure 9.10

Click “VCR” on the system setup menu. The setting items appear on the right side of the window (see Figure 9.10).

○ VCR type

1. Click “▼” of “Type”. The VCR types appear in the pull-down menu.

Setting value	VCR
VCR (RS232C)	SVO-9500MD (SONY), DSR-20MD (SONY)
VCR (IEEE 1394)	DSR-20MD (SONY)
Foot switch	SVO-9500MD (SONY)
HD-VCR (RS232C)	PDW-70MD (SONY), PDW-75MD (SONY)
DVD (RS232C)	DVO-1000MD (SONY)
DVD (IEEE1394)	DVO-1000MD (SONY)
Option	Reserved for future system expansion.

Table 9.17

NOTE

When “DVD (IEEE1394)” of the VCR type is selected, only the recording and pause operations can be operated.

2. Click the desired type. The selected VCR type is displayed.

○ Video signal type

1. Click “ ▼ ” of “Signal”. The video signals appear in the pull-down menu.

Setting value	Explanation
S-Video	The type of input signal when playing back is S-video.
Composite	The type of input signal when playing back is composite.

Table 9.18

2. Click the desired video signal. The selected video signal is displayed.

NOTE

- When using the VTR remote cable MH-989 or MAJ-906, set the RS-232C transfer rate of the videocassette recorder as shown below following the instructions given in the instruction manual for the VTR remote cable.
 - Baud rate: 9600 bps
- When using the VTR remote cable MH-922, set the videocassette recorder’s foot switch control mode in “Low level trigger mode” following the instructions given in the instruction manual for the videocassette recorder (SVO-9500MD).
- For further information, refer to the instruction manual for the VTR remote cable.

Saving the system setup

This operation finalizes and saves the settings of the system setup.

1. Click "OK" of the system setup menu (see Figure 9.11). All settings are saved in the video system center.

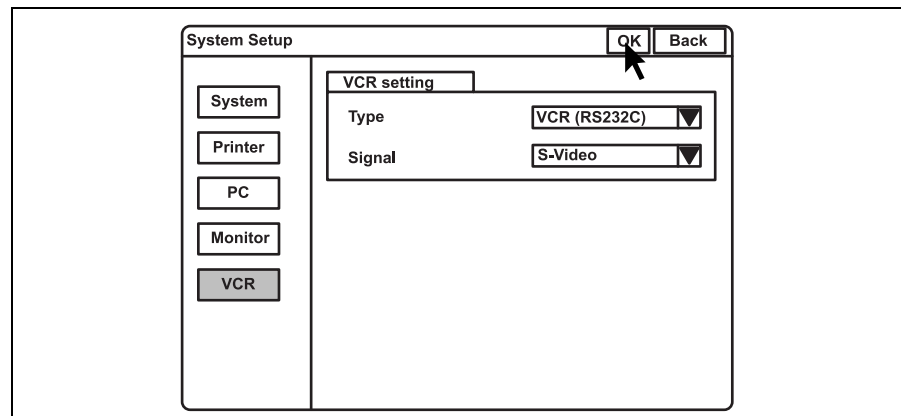

Figure 9.11

2. Click "Back" to go back to the endoscopic image.

NOTE

To cancel the settings, click "Back" instead of "OK". The input values are canceled and the display returns to the endoscopic image.

Summary of settings

Table 9.19 shows the options of the system setup menu. The bold and underscored options listed are the factory default settings.

Setup item		Setting value	Note	
System	Clock	Date	Display format is according to the type of format selected below.	
		Time	Display format is [HH:MM:SS] HH: hour MM: minute SS: second	
		Format	[YYYY/MM/DD], [YYYY.MM.DD], [YYYY-MM-DD], [YYYY MM DD], [MM/DD/YYYY] , [MM-DD-YYYY], [MM.DD.YYYY], [MM DD YYYY], [DD/MM/YYYY], [DD-MM-YYYY], [DD.MM.YYYY], [DD MM YYYY]	Display format for the system date YYYY: year MM: month DD: day
	Light source	Type	[CLV] , [CLV-S], [CLE]	Type of light source or lamp bulb
	PC card	Release time	[0.5 sec] , [1 sec], [1.5 sec], [2 sec]	Length of time to pause the image for recording
Patient data	Remove data	[Clear] , [Save]	The display status of text data such as patient data is saved or not saved.	
Printer	Printer setting	Type	[OEP] , [OEP3], [OEP4], [2900], [2950], [5200], [5250], [5000], [1800], [1850], [UP21], [YP22], [Foot switch]	Printer types to connect to "Printer Remote" terminal
		Qty. "N"	[4] , [5], [6], [7], [8], [9]	The number of sheet assigned to "N"
		Caption	-	-
		Release time	[0.5 sec] , [1 sec], [1.5 sec], [2 sec]	Length of time to pause the live image
		OEP4 mode	[Mode 1] , [Mode 2]	Video signal out put to OEP4
PC	PC setting	Type	[EndoWORKS] , [EndoBASE], [EndoALPHA], [OFF]	Image filing systems
		Release time	[0.5 sec], [1 sec], [1.5 sec], [2 sec]	Length of time to pause the live image
		EndoALPHA	[0.5 sec], [1 sec], [1.5 sec], [2 sec]	

Table 9.19

Setup item		Setting value	Note	
Monitor	Monitor setting	Monitor	[141/201], [142/143/202/203], [181H], [191H], [191], [Remote OFF (HD)], [Remote OFF (SD)]	Monitor type to connected to "Monitor OUT"
		Video signal	[RGB], [YPbPr]	Video signal format to monitor
		HDTV format	[5:4], [4:3]	Aspect ratio of HDTV
		RGB/SDI	[RGB], [SDI]	Terminal to be activated by the monitor for video output
VCR	VCR setting	Type	[VCR (RS232C)], [VCR (IEEE1394)], [Foot switch], [HD-VCR (RS232C)], [DVD (RS232C)], [DVD (IEEE1394)], [Option]	VCR type
		Signal	[S-Video], [Composite]	VCR signal type

Table 9.19

9.3 User preset

The user preset menu sets the functions of this instrument for each individual user, endoscope, etc., for up to 20 users. Each preset data has been set to the factory defaults.

Basic operation of the user preset

1. Press the “Shift” and “F2” key together (see Figure 9.12). The “User preset” menu appears on the monitor (see Figure 9.13).

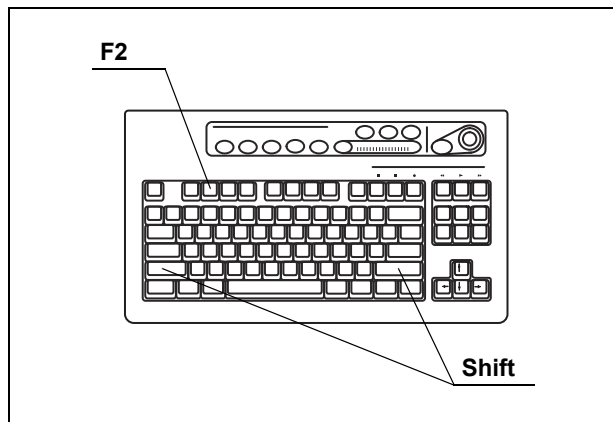

Figure 9.12

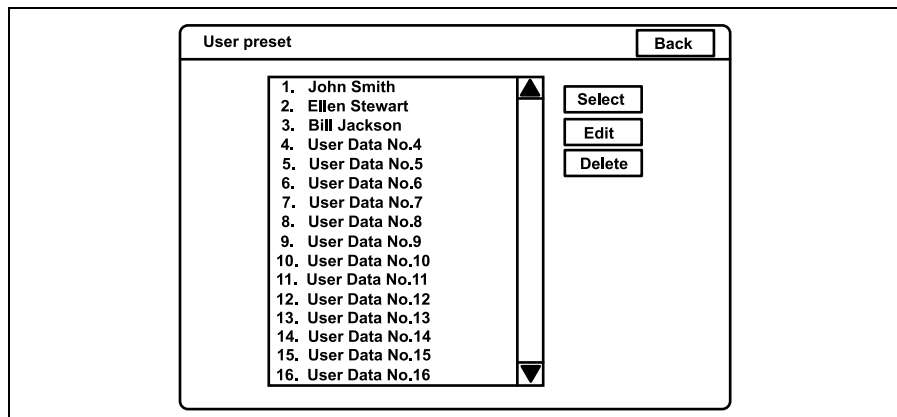

Figure 9.13

Button	Function
Back	Cancels the inputs, and returns to the endoscopic image.
Select	Loads the selected user preset data on the video system center, then returns to the endoscopic image.
Edit	Edits the user preset data in the video system center.
Delete	Deletes the user name and its data from the user name list.

Table 9.20

2. Click “User Data No. #” in the user name list, in which no user is registered. The background of the selected user name is blue.
3. Click “EDIT” on the right side of the screen (see Figure 9.13). The edit screen of the user preset menu appears (see Figure 9.14).

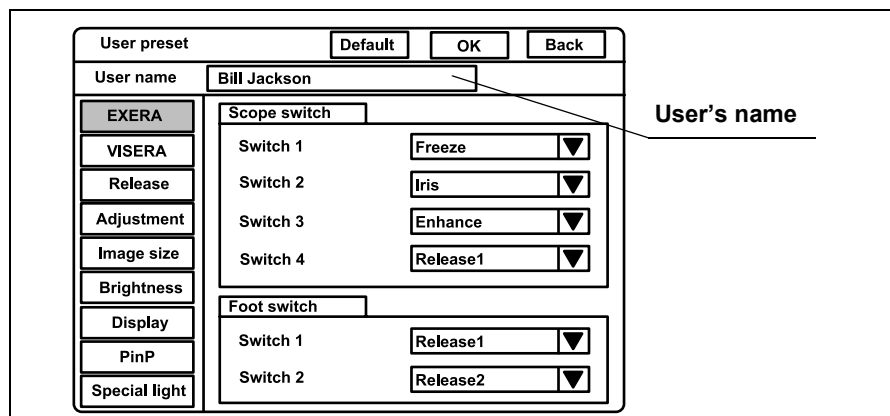

Figure 9.14

Button	Function
Back	Returns to the endoscopic image.
OK	Determines and saves the input data (returns to the endoscopic image).
Default	Resets the user preset data to the factory default settings.

Table 9.21

4. Enter the user name in the text box of “User name”. Otherwise, entered data cannot be saved.
 - Max. 20 alphanumeric and symbol characters can be entered.
5. Click “▼” of the dialog box of the setting values to open the pull down menu, and click the data on the pull down.
6. To cancel the input, click “Back” or “Esc”. The input values are canceled and the display returns to the user list menu.
7. After completing data input, click “OK”. A confirmation message appears on the monitor.
8. Click “N” to return to step 2.
Click “Y” or press “Enter” to save the input values and return to the endoscopic image.

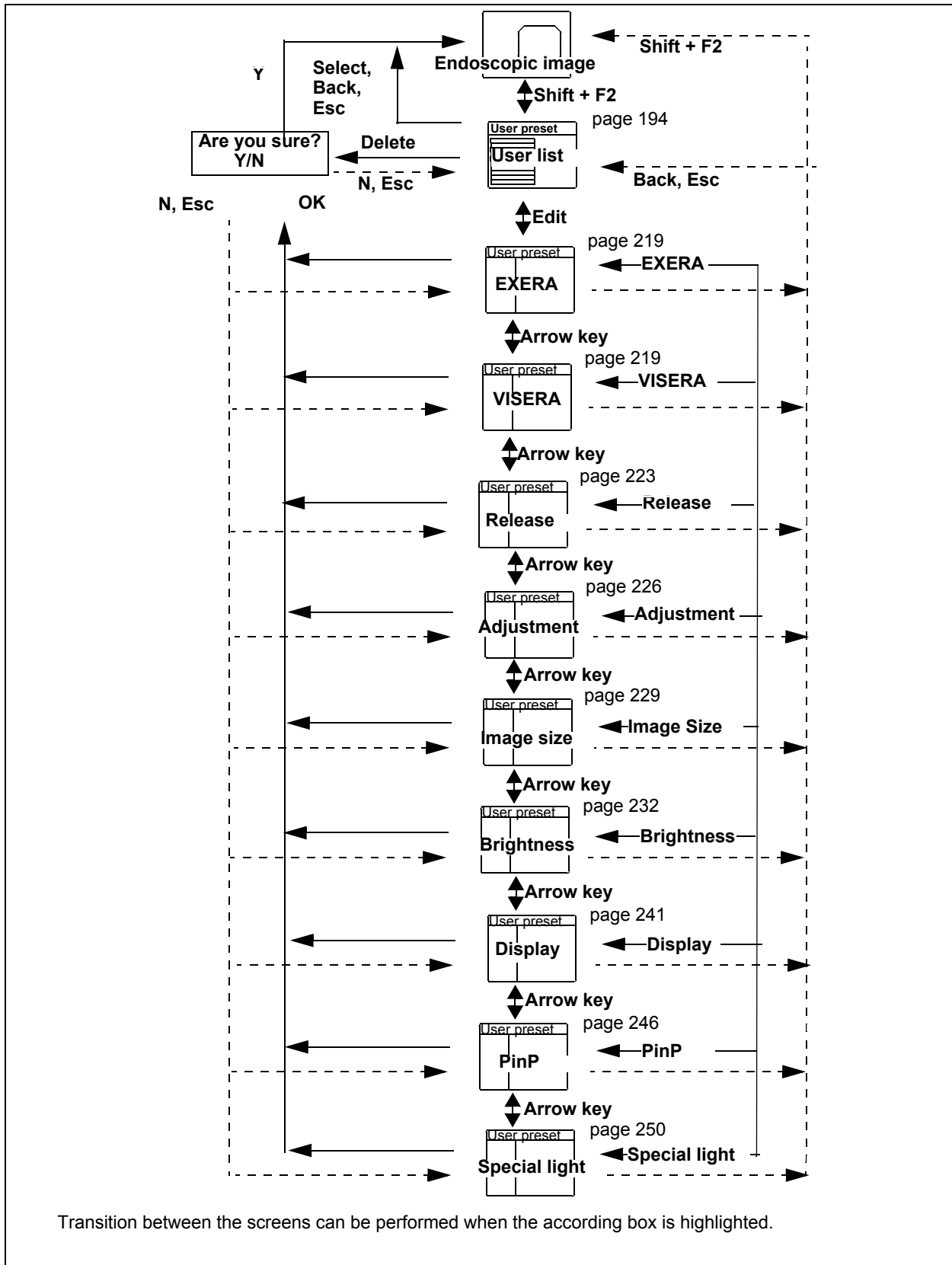

Figure 9.15

Remote switch and foot switch (EXERA and VISERA)

This operation assigns the functions to the remote switches on the endoscope and the foot switch.

CAUTION

Use the “EXERA” menu to assign the functions for the EVIS series endoscopes and use the “VISERA” menu for the VISERA series endoscopes and the camera heads. Otherwise the functions are invalid.

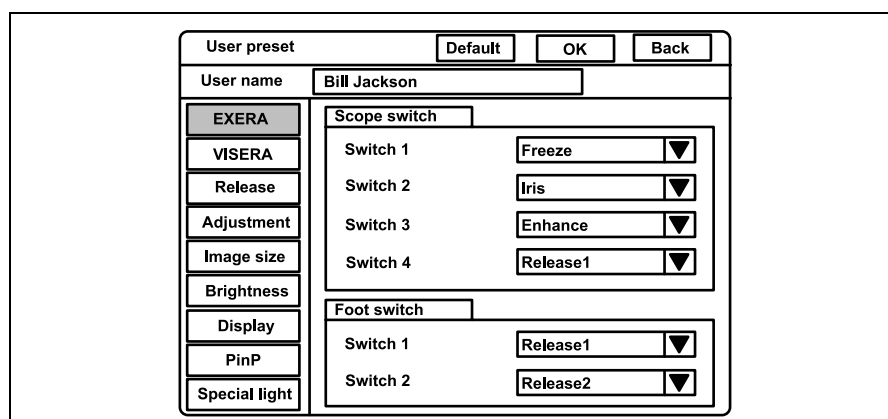

Figure 9.16

1. Click “EXERA” or “VISERA” on the user preset menu. The setting items appear on the right side of the window.
2. Click “▼” of “Scope switch” or “Foot switch” (see Figure 9.16). The available functions appear in the pull-down menu.
3. Click the desired function. The selected function is displayed.
4. Follow steps 1. to 3. to assign the functions to all the scope and foot switches in the same way.

NOTE

- It is possible to assign the same function to all the remote switches and foot switches.
- The positions and shapes of the scope switches are different depending on the endoscope model as shown in Figure 9.17. For details, refer to the instruction manual of the endoscope.

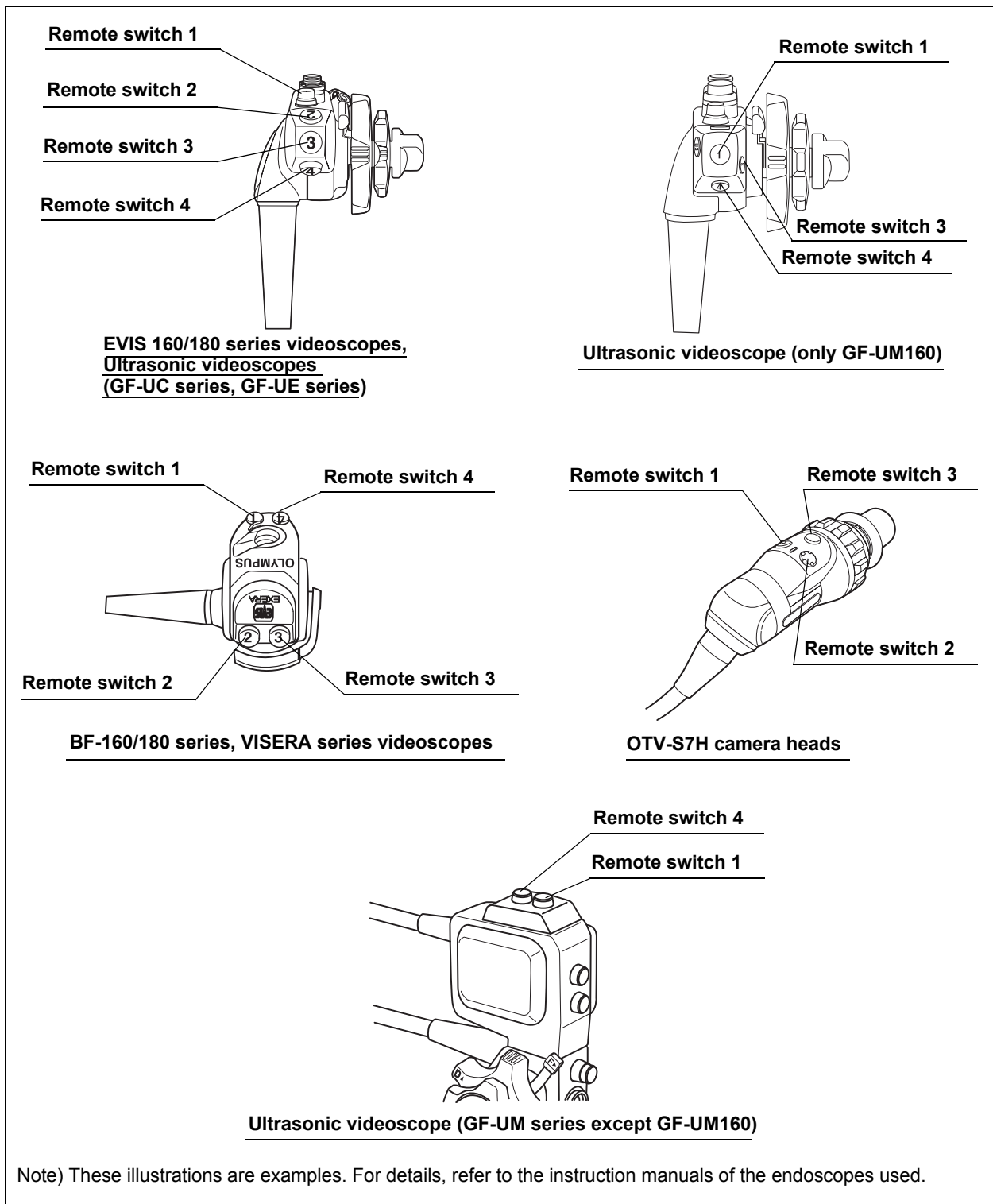

Figure 9.17

Function	Outline
Freeze	Toggles back and forth between live image and frozen image of the endoscopic image. Same function as "FREEZE" on the keyboard. See "Freeze ("FREEZE")" on page 99.
Release 1	Records the images on the monitor into the recording devices. Same function as "RELEASE" on the keyboard. See "Release ("RELEASE")" on page 101.
Release 2	Records the images on the monitor into the recording devices. See "Release function" on page 223.
Iris	Switches to the iris mode (type of optical measurement). Same function as the "Iris mode switch" on the front panel. See "Iris mode" on page 69.
Enhance	Switches the image enhancement mode (OFF/1/2/3). Same function as the "Image enhancement button" on the front panel. See "Image enhancement mode (ENH.)" on page 67.
Contrast	Switches the contrast of the endoscopic image. Same function as the "Shift"+"F6" keys on the keyboard. See "Contrast mode ("Shift" + "F6")" on page 90.
AGC	Toggles back and forth the AGC function between ON and OFF. Same function as the "F6" key on the keyboard. See "Automatic gain control (AGC) ("F6")" on page 89.
Image size	Changes the image size. Same function as the "F8" key on the keyboard. See "Image size ("F8")" on page 94.
VCR	Operates either VCR recording or pause. See "Videocassette recorder (VCR)" on page 129.
Capture	Takes in the image into the video printer. Same function as the "CAPTURE" key on the keyboard. See "Video printer" on page 131.
Stop watch	Uses the clock on the monitor as a stopwatch. Same function as the "F5" key on the keyboard. See "Stopwatch ("F5")" on page 88.
Remove data	Erases and displays the patient data on the monitor. Same function as the "F1" key on the keyboard. See "Clearing characters from the screen ("F1")" on page 82.
Zoom	Enlarges the image. Same function as the "F7" key on the keyboard. See "Image zooming ("F7")" on page 91.
White balance	Press and hold to execute the white balance adjustment. Same function as the "Shift" + "F9" keys on the keyboard and "White balance button" on the front panel. See Section 4.5, "White balance adjustment" on page 52.
Exposure area	Changes the exposure area of the auto brightness control. See "Exposure area" on page 239.
Exposure (up)	Increases the brightness of the image. Same function as "▶" of the brightness adjustment button on the front panel. See "Brightness adjustment (Exposure)" on page 71.
Exposure (down)	Decreases the brightness of the image. Same function as "◀" of the brightness adjustment button on the front panel. See "Brightness adjustment (Exposure)" on page 71.
NBI	Activates the NBI observation mode. See "NBI (narrow band imaging)" on page 151.
PDD mode	This function is not available.
PDD gain	This function is not available.
OP.2	Reserved for future system expansion. Currently not used.

Table 9.22

Function	Outline
OFFP	Turns the OLYMPUS flushing pump (OFFP) ON and OFF. This function is available only on the remote switches and foot switches.
Light	Turns the light source ON and OFF. This function is active only when the CLV-180 is used. Press to light up. Press and hold to light OFF.
Arrow	Displays or erases the arrow pointer. Same function as the "Shift" and any arrow key on the keyboard. See "Arrow pointer ("Shift" + arrow keys and domepoint)" on page 102.
PinP	Toggles back and forth the display between the normal display and PinP. Same function as the "PinP" button on the front panel. See "PinP (picture in picture) display" on page 64 or "PinP (picture in picture) function" on page 246.
Shutter	Turns the electronic shutter function ON and OFF. This function is available only on the remote switches and foot switches.
US freeze	Reserved for future system expansion. Currently not used.
Freeze mode	Toggles back and forth between frame and field of the freeze mode. Same function as "F4" key on the keyboard.
Option	Operates functions of the image filing system such as EndoWORKS, etc.
None	No function

Table 9.22

Release function

Release is a function to take pictures or start recording the endoscopic image. This operation assigns the recording devices to “Release 1” and “Release 2” that is assigned to the remote switches and foot switches. The setting of “Release 1” is assigned to the “RELEASE” key on the keyboard, too.

1. Click “Release” on the system setup menu. The setting items appear on the right side of the window (see Figure 9.18).

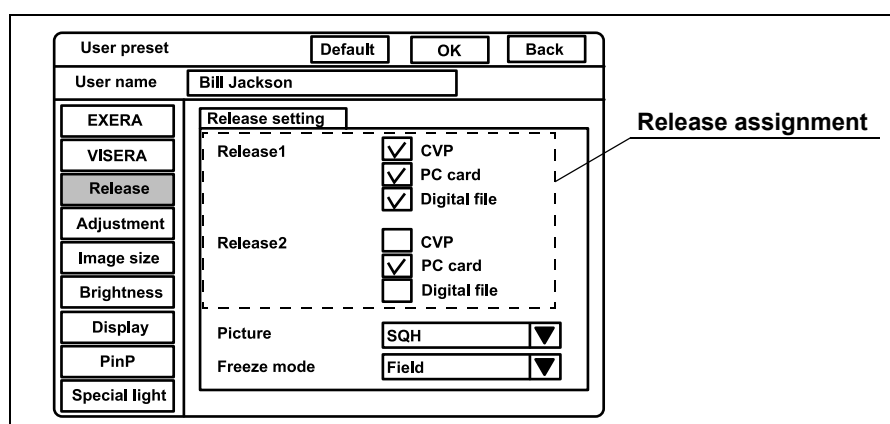

Figure 9.18

2. Click the check box of the device to be used. The selected check box is highlighted (see Figure 9.18). It is possible to select multiple devices.

Setting value	Device
CVP	Color video printer
PC card	PC card slot of this instrument
Digital file	Image filing system

Table 9.23

3. Follow steps 1. and 2. to assign the instruments to “Release 2” in the same way.

Recording format for PC card

This operation sets the recording format of the frozen image to be recorded on the PC card.

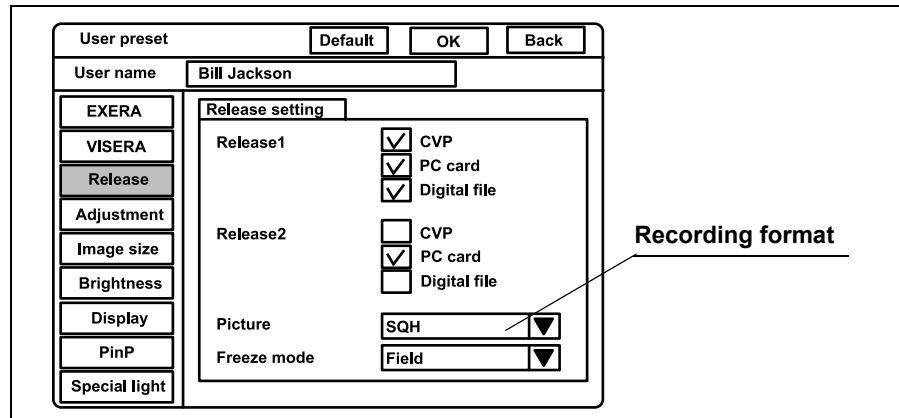

Figure 9.19

Click “ ▼ ” of “Picture” (see Figure 9.19). The recording formats appear in the pull-down menu.

Setting value	Number of full-screen images that can be stored in 32 MB PC card	
	SDTV	HDTV
SHQ	Approx. 310 images	Approx. 110 images
HQ	Approx. 2000 images	Approx. 760 images
SQ	Approx. 2570 images	Approx. 970 images
Tiff	Approx. 30 images	Approx. 6 images

Table 9.24

NOTE

- The PinP function is OFF in Table 9.24.
- Even the approximate number of recordable images can vary significantly depending on different factors.

Freeze function

This function sets the method of “FREEZE” to pause the endoscopic image.

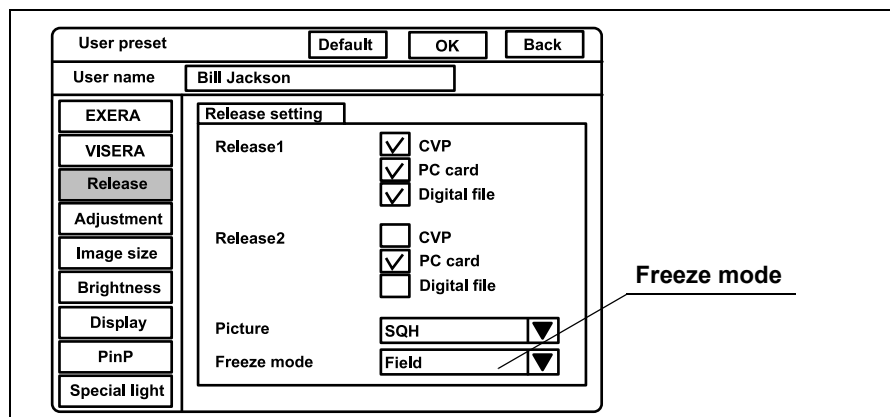

Figure 9.20

1. Click “▼” of “Freeze mode” (see Figure 9.20). The freeze modes appear in the pull-down menu.

Setting value	Explanation
Field	Less blur image can be obtained than frame freeze when the object moves fast. (Use this mode for routine use.)
Frame	Clearer image can be obtained than field freeze when the object does not move.

Table 9.25

2. Click the desired freeze mode. The selected mode is displayed.

Image enhancement (normal observation)

This function electrically increases the sharpness of the endoscopic image. The three kinds of enhancement types can be set by combining desired enhancement types and levels (see Table 9.26). These modes can be selected during observation, and the selected mode is indicated by indicators 1, 2 or 3 above the “Image enhance button” on the front panel. This menu sets the three enhancement modes and the initial mode when the user preset is called up. Refer to “Image enhancement (NBI observation)” on page 250 for setting the image enhancement for NBI observation.

Enhancement method	Function	Level
A: Structural enhancement A	Enhancement of contrast of the fine patterns in the image.	A1, A2, A3, A4, A5, A6, A7, A8
B: Structural enhancement B	Enhancement of contrast of more finer patterns than A in the image.	B1, B2, B3, B4, B5, B6, B7, B8
E: Edge enhancement	Enhancement of edges of the endoscopic image.	E1, E2, E3, E4, E5, E6, E7, E8

Table 9.26

1. Click “Adjustment” on the system setup menu. The setting items appear on the right side of the window (see Figure 9.21).

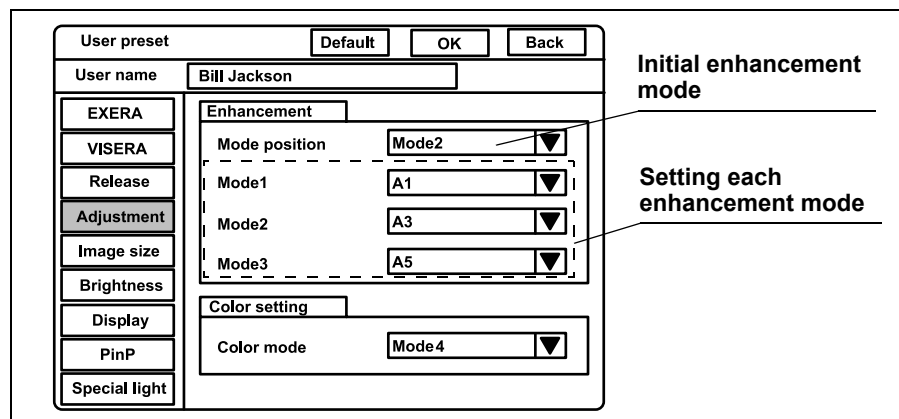

Figure 9.21

○ Initial enhancement mode

1. Click “▼” of “Mode position” (see Figure 9.21). The numbers of enhancement mode appear in the pull-down menu.

Setting value	Explanation
Mode 1	Corresponds to Mode 1 in “Enhancement modes” below.
Mode 2	Corresponds to Mode 2 in “Enhancement modes” below.
Mode 3	Corresponds to Mode 3 in “Enhancement modes” below.
OFF	No enhancement

Table 9.27

2. Click the enhancement mode number to use. The selected number is displayed.

○ Enhancement modes

1. Click “▼” of “Mode 1” (see Figure 9.21). The enhancement types appear in the pull-down menu.
 - A1 to A8, B1 to B8 and E1 to E8, 24 kinds are displayed.
The larger the number, the higher the enhancement.
2. Click the desired enhancement type. The selected type is displayed.
3. Follow steps 1. and 2. to assign the enhancement type to “Mode 2” and “Mode 3” in the same way.

NOTE

- The image enhancement mode used before the video system center OFF comes up when the instrument is turned ON. The setting set in “Mode position” comes up when the user preset is called up.
- B1 to B8 is valid for Scope 1, Scope 4, and Scope 5 shown in Table 9.30 on page 229. When an endoscope other than these endoscopes is used, the enhancement automatically becomes A1 to A8.
- Mesh-like noise may be observed in the image, when the image enhancement function is on during use of a fiberscope or hybrid scope. Switch the image enhancement OFF, or use the recommended camera head below:
 - OTV-S7H-1N
 - OTV-S7H-1D

Color mode

This menu sets the color tone of the monitor from four modes. The color mode can be changed during observation. See “Color mode (“Shift” + “Alt” + “1”, “2”, “3”, “4”)” on page 104 The setting of “Color Mode” is valid only to “Scopes B”, “Scopes C” and “Scopes D” in Table 9.33 on page 233.

The color mode in this menu is not valid for NBI observation, because NBI observation uses the exclusive color mode for each endoscope.

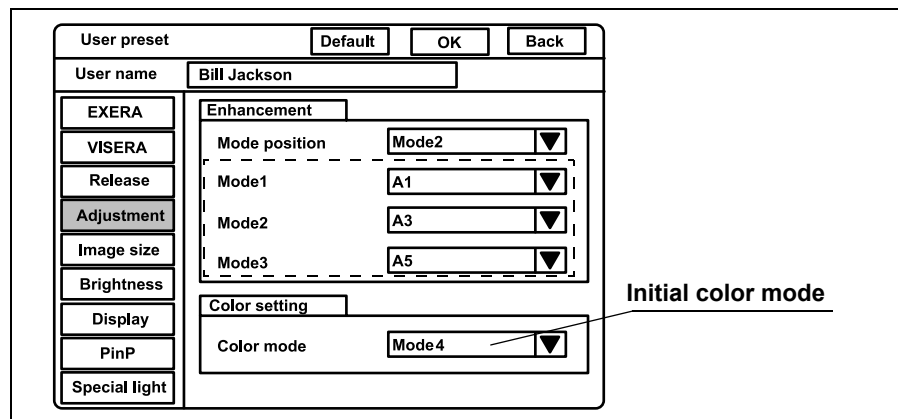

Figure 9.22

1. Click “Enhancement” on the system setup menu. The setting items appear on the right side of the window (see Figure 9.22).
2. Click “ ▼ ” of “Color mode” (see Figure 9.22). The color modes appear in the pull-down menu.

Setting value	Explanation
Mode 1	Same as the color mode 1 of VISERA video system center OTV-S7V
Mode 2	Less reddish color than the Mode 1
Mode 3	More yellowish color than the Mode1
Mode 4	Standard color mode

Table 9.28

3. Click the desired color mode. The selected mode is displayed.

Image size

This menu sets the image size on the monitor when the user preset menu is called up. The available image sizes (see Table 9.29) depend on the endoscope models (see Table 9.30). Refer to Figure 9.24 on page 231 for a rough comparison of the image sizes.

Type of Endoscope	Image size				
	Small	Medium	Semi-Full	Full-Height	Full
Scope 1	–	○	–	○	–
Scope 2	○	○	–	–	–
Scope 3	–	○	–	○	–
Scope 4	–	○	–	○	–
Scope 5	–	–	–	–	○

○: applicable, –: not applicable

Table 9.29

Type of Endoscope	Model
Scope 1	EVIS Q series
Scope 2	GIF-XP160, BF-P160, BF-3C160, BF-XT160, LF-V, HYF-V
Scope 3	<ul style="list-style-type: none"> • EVIS series other than Scope 1, Scope 2 and Scope 4 • ENF-V/V2, CYF-V/VA/V2/VA2, PEF-V • Ultrasonic videoscopes
Scope 4	EVIS H series
Scope 5	Other than above

Table 9.30

1. Click "Image size" on the system setup menu. The setting items appear on the right side of the window (see Figure 9.23).

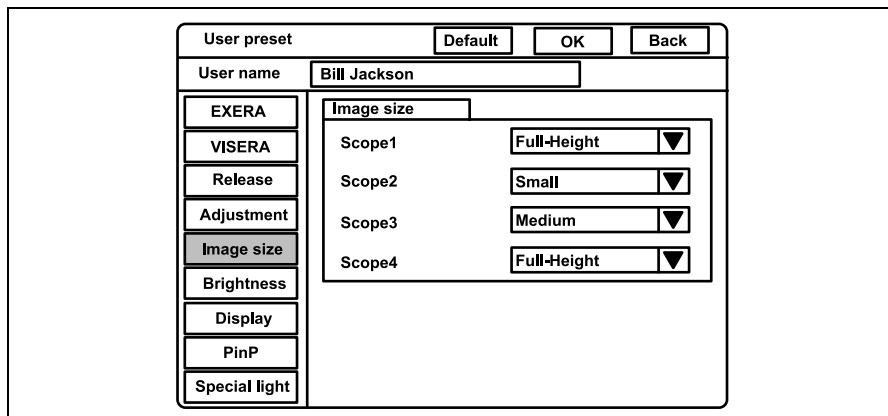

Figure 9.23

2. Click "▼" of the scope type to use (see Figure 9.23). The image sizes appear in the pull-down menu.
3. Click the desired image size. The selected image size is displayed.
4. Follow steps 1. to 3. to set the image size of all endoscopes to be used.

NOTE

- The image size can be changed during observation. For details, see "Image size ("F8")" on page 94
- When this instrument is turned ON, the image size before turning the video system center OFF comes up when turning the instrument ON. When the user preset is called up, the image size set in this menu comes up.
- "Scope 5" is not displayed on this menu because the endoscopes of "Scope 5" are compatible only with "Full" size.

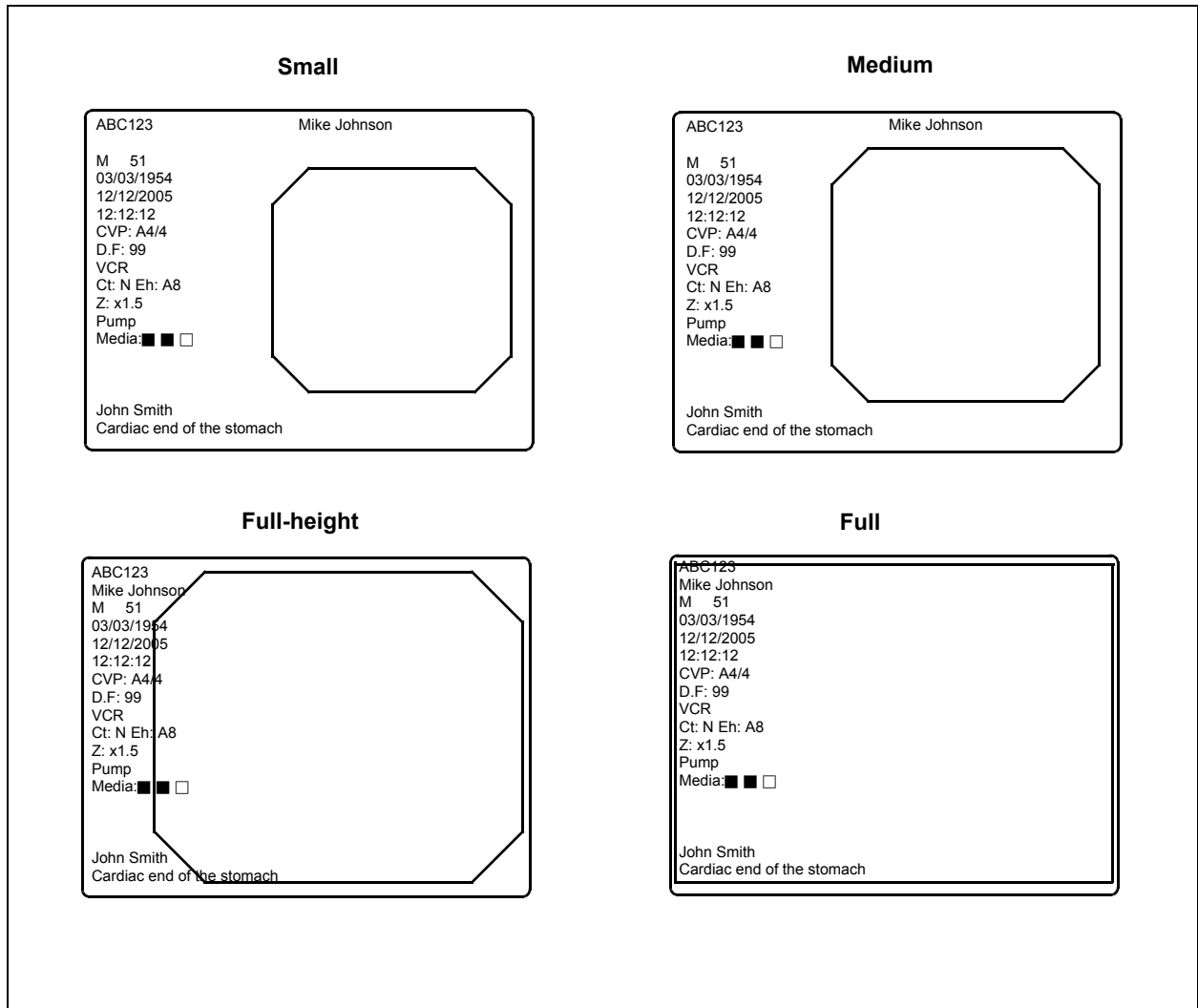

Figure 9.24

Iris

This video system center automatically measures the brightness of objects, and displays live images with proper brightness on the monitor. There are two methods, "Auto" and "Peak". The functions slightly differ depending on the endoscope type (see Table 9.33) even with the same methods. The methods can be changed during use (see "Iris mode" on page 69).

This menu sets the measuring method that measures the image brightness.

Setting value	Explanation
Auto	<p>The methods to measure the brightness of the central and peripheral part of the image. One of the following three measuring methods can be used. They differ in how the measuring results are combined. Select "AUTO 1" or "AUTO 2" when white wash is observed on the image.</p> <p>1) AVE.: The brightness is adjusted based on the average brightness of the two parts.</p> <p>2) AUTO 1: The brightness is adjusted based on the brightest part of the central part and the average brightness of the periphery part.</p> <p>3) AUTO 2: The entire image is brighter than "AUTO 1".</p>
Peak	The brightness is adjusted based on the brightest part of the image.

Table 9.31 Method of photometry for endoscopes of "Scope A" (see Table 9.33)

Setting value	Explanation
Auto	<p>The image brightness is adjusted based on the average brightness of the exposure area set in the image. The three exposure areas can be selected. Select "Full" or "Center" when white wash is observed, or the image becomes dark.</p> <p>1) Mask: The exposure area is set automatically to obtain optimum brightness for the subject. (This exposure area become the same with "Full" for scope D.)</p> <p>2) Center: Center-weighted measuring.</p> <p>3) Full: The brightness of the whole image is measured.</p>
Peak	The same measuring method as the "Auto" but slightly darker.

Table 9.32 Method of photometry for endoscopes of "Scope B", "Scope C", and "Scope D" (see Table 9.33)

Endoscope type	Endoscope model
Scope A	GIF-N180/H180/Q180, CF-H180AL/I, CF-Q180AL/I, PCF-Q180AL/I, BF-P180/Q180/1T180, EVIS EXERA160 series, EVIS140/130/100 series, Ultrasonic videoscopes
Scope B	ENF-V/V2, LF-V, HYF-V/V2, CYF-V/VA/VA2, PEF-V
Scope C	OTV-SP1H-N-12E/12Q, OTV-SP1H-NA-12E/12Q, OTV-S7H-N/1N/1D/NA/1NA, OTV-S7H-1D-F08E/L08E/1MD/D-L08E, OTV-S7H-NA-10E/1NA-10E, OTV-S7H-NA-12E/1NA-12E, OTV-S7H-NA-10Q/NA-12Q, OTV-S7H-1NA-12Q, OTV-S7H-FA-E/1FA-E/FA-Q, OTV-S7H-VA, OTV-SP1H-NA-12E/12Q, OTV-SP1H-N-12E/12Q, OTV-S7ProH-HD-10E/10Q/12E/12Q, OTV-S7ProH-HD-L08E
Scope D	LTF-V3/VP, A50001A, A50003A, A50021A, A50023A, WA50003L, WA50005L, WA50011A, WA50013A, WA50013L, WA50015L, WA50121A, WA50201A, ENF-VQ

Table 9.33 Types of the endoscope

1. Click "Brightness" on the system setup menu. The "Brightness setting" appears on the right side of the window (see Figure 9.25).

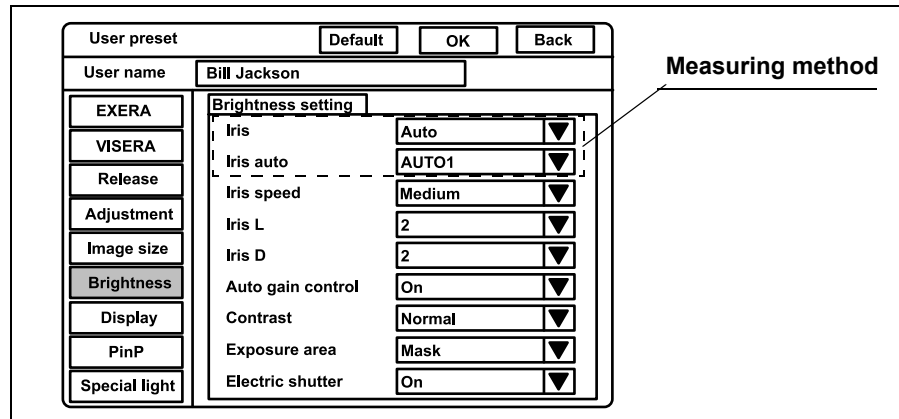

Figure 9.25

2. Click "▼" of "Iris" (see Figure 9.25). The measuring methods appear in the pull-down menu.

Setting value	Explanation
Auto	See Table 9.31 and Table 9.32 on page 232.
Peak	

Table 9.34

3. Click the desired method. The selected mode is displayed.
4. Click "▼" of "Iris auto" (see Figure 9.25). The measuring methods of "Auto" appear in the pull-down menu.

Setting value	Explanation
AUTO 1	See Table 9.31 on page 232.
AUTO 2	
AVE.	

Table 9.35

5. Click the desired method. The selected method is displayed.

NOTE

When this instrument is turned ON, the latest iris mode before the video system center is turned OFF comes up when the instrument is turned ON. When the user preset is called up, the iris mode that is set in this menu comes up.

Iris speed

This menu sets the speed to adjust the brightness of the image according to the result of the measuring method. The setting in this menu is effective only for the endoscopes of “Scope A” in see Table 9.33 on page 233.

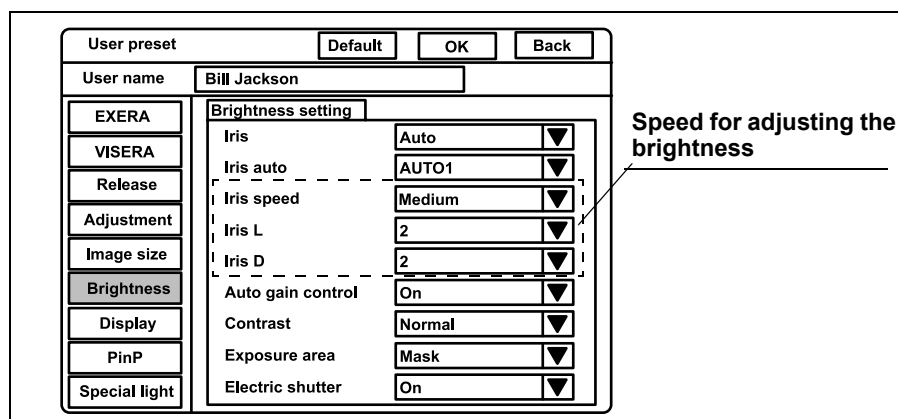

Figure 9.26

Setting value	Explanation
Iris speed	Changes the brightness adjustment speed from three speeds.
Iris L	Fine-tunes the darkening speed in the each settings of “Iris speed”.
Iris D	Fine-tunes the brightening speed in the each settings of “Iris speed”.

Table 9.36

1. Click “▼” of “Iris speed” (see Figure 9.26). The iris speeds appear in the pull-down menu.

Setting value	Explanation
Low	The brightness adjustment speed is low.
Medium	The brightness adjustment speed is medium.
High	The brightness adjustment speed is high.

Table 9.37

2. Click the desired iris speed. The selected iris speed is displayed.

3. Click “ ▼ ” of “Iris L (Iris D)” (see Figure 9.26). The fine-tuning speeds appear in the pull-down menu.

Setting value	Explanation
1	The fine-tuning of the brightness adjustment is low.
2	The fine-tuning of the brightness adjustment is medium.
3	The fine-tuning of the brightness adjustment is high.

Table 9.38

4. Click the desired speed. The selected speed is displayed.

Auto gain control (AGC)

The AGC (Automatic Gain Control) is used to increase the brightness of an endoscopic image electrically, when the brightness of the image is dark because the distance between the endoscope's distal end and the object is too long. This menu sets if the AGC function is used. When the AGC function is set, the function can be switched ON and OFF from the keyboard and remote switch during observation (see “Automatic gain control (AGC) (“F6)” on page 89).

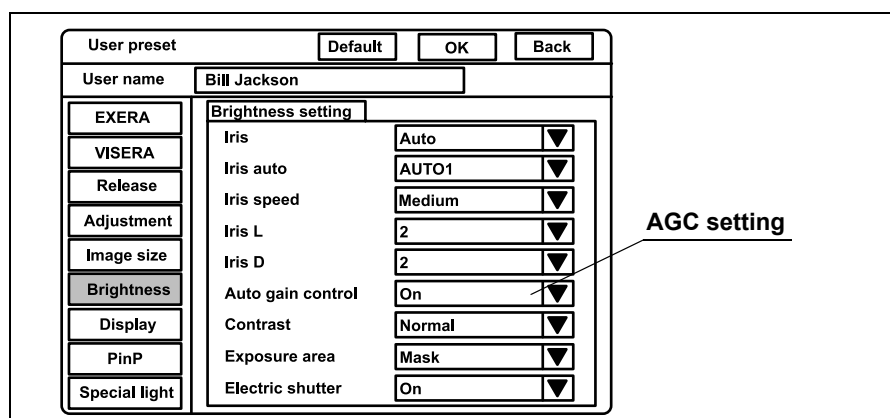

Figure 9.27

1. Click “▼” of “Auto gain control” (see Figure 9.27). The setting values ON and OFF appear in the pull-down menu.

Setting value	Explanation
On	AGC function is ON.
Off	AGC function is OFF.

Table 9.39

2. Click “ON” or “OFF”. The selected status is displayed.

NOTE

Image noises may appear in the image when the AGC function is ON.

Contrast

The contrast modes widen or narrow the difference between brightness and darkness of the endoscopic image. This operation sets the contrast mode when the video system center is turned ON. Three contrast modes are available and can be changed by the keyboard during observation (refer to “Contrast mode (“Shift” + “F6”)” on page 90). The setting is invalid during special light observation (refer to “Special light observation” on page 250).

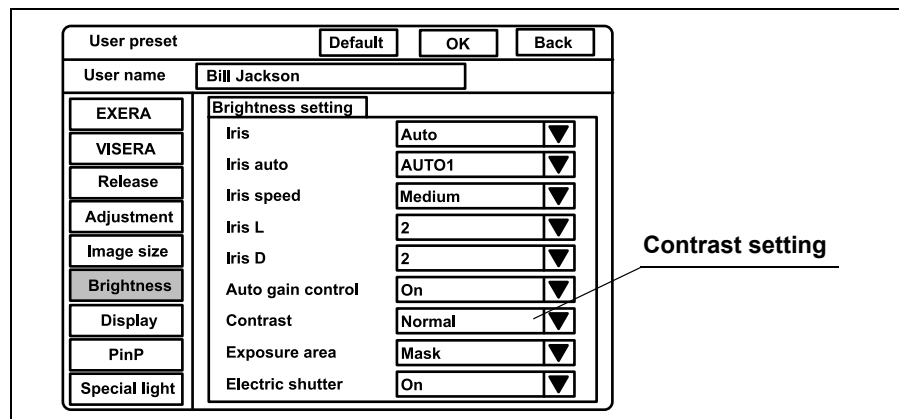

Figure 9.28

1. Click “ ▼ ” of “Contrast” (see Figure 9.28). The exposure areas appear in the pull-down menu.

Setting value	Explanation
Normal	Standard setting
Low	Darkens the bright part, and brightens the dark part.
High	Brightens the bright part, and darkens the dark part.

Table 9.40

2. Click the desired contrast mode. The selected mode is displayed.

Exposure area

This menu sets the exposure area for endoscopes of “Scope B”, “Scope C” and “Scope D” in see Table 9.33 on page 233.

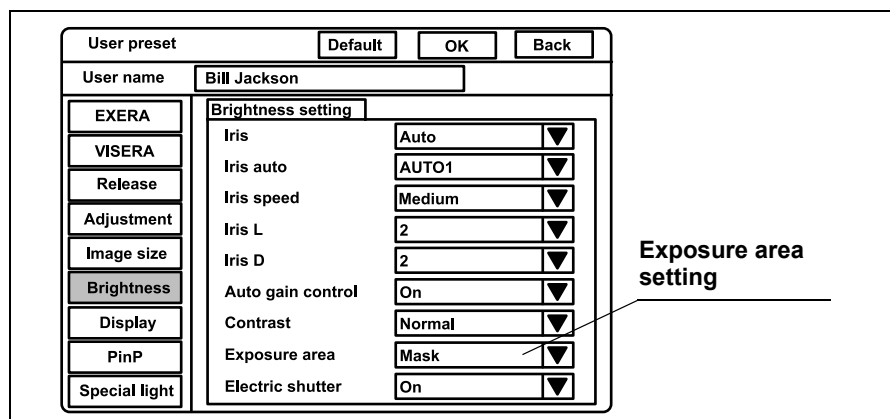

Figure 9.29

1. Click “▼” of “Exposure area” (see Figure 9.29). The exposure areas appear in the pull-down menu.

Setting value	Explanation
Mask	
Center	See Table 9.32 on page 232.
Full	

Table 9.41

2. Click the desired exposure area. The selected exposure area is displayed.

Electronic shutter

This menu sets whether the electronic shutter function of the endoscope is ON or OFF. The applicable endoscopes are EVIS H series endoscopes, camera heads, LTF endoscopes. When using an endoscope compatible with the electronic shutter function, the light exposure is automatically adjusted using the electronic shutter function of the endoscope.

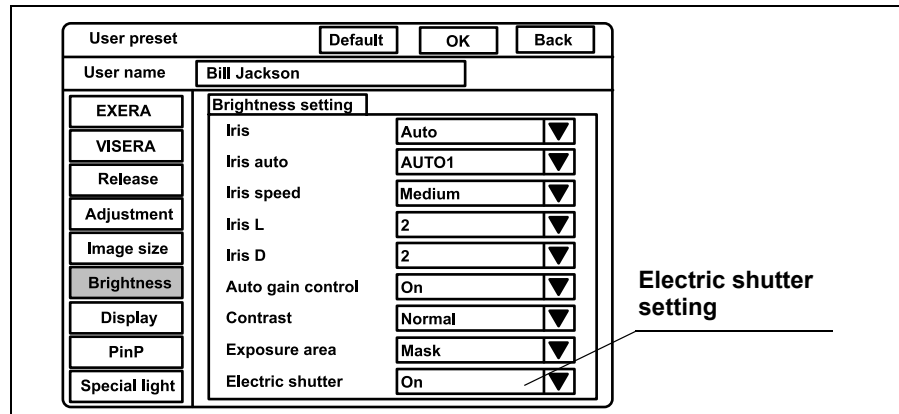

Figure 9.30

1. Click “ ▼ ” of “Electric shutter” (see Figure 9.30). The setting values ON and OFF appear in the pull-down menu.

Setting value	Explanation
On	Activates the electronic shutter function.
Off	De-activates the electronic shutter function.

Table 9.42

2. Click “ON” or “OFF”. The selected option is displayed.

NOTE

When using an endoscope not compatible with the electronic shutter function of the video system center, the electronic shutter function does not work even if “ON” is selected.

Patient data display

This menu sets whether the patient data, which had been displayed right before the video system center has been turned OFF, is displayed on the monitor or not when the video system center is turned ON.

WARNING

When “Save data” is set to YES, confirm that the name on the monitor is identical to the name of the patient to be observed before observation.

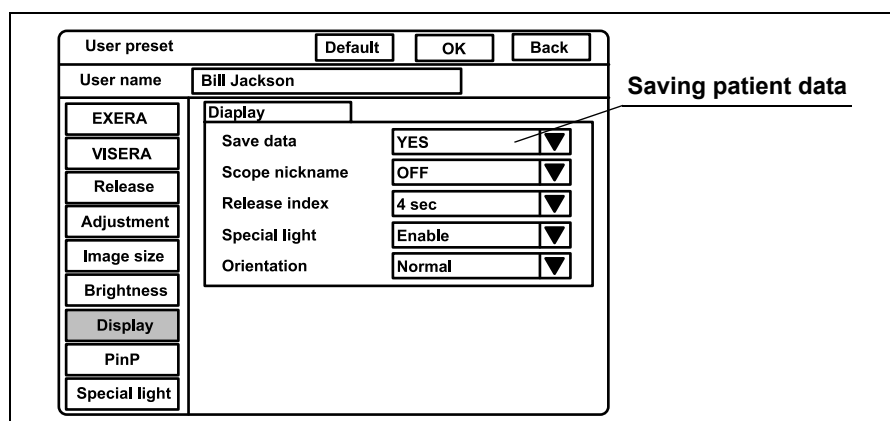

Figure 9.31

1. Click “Display” on the system setup menu. The setting items appear on the right side of the window (see Figure 9.31).
2. Click “ ▼ ” of “Save data” (see Figure 9.31). The setting values of “Yes” and “No” appear in the pull-down menu.

Setting value	Explanation
Yes	Displays the patient data that had been displayed right before the video system center has been turned OFF.
No	No display of last patient data.

Table 9.43

3. Click “Yes” or “No”. The selected option is displayed.

Scope nickname

The scope nickname is displayed on the monitor, when the endoscope with the scope nickname function is connected. This menu sets whether the nickname is displayed on the monitor or not. For the V-scope, “V” is displayed on the monitor.

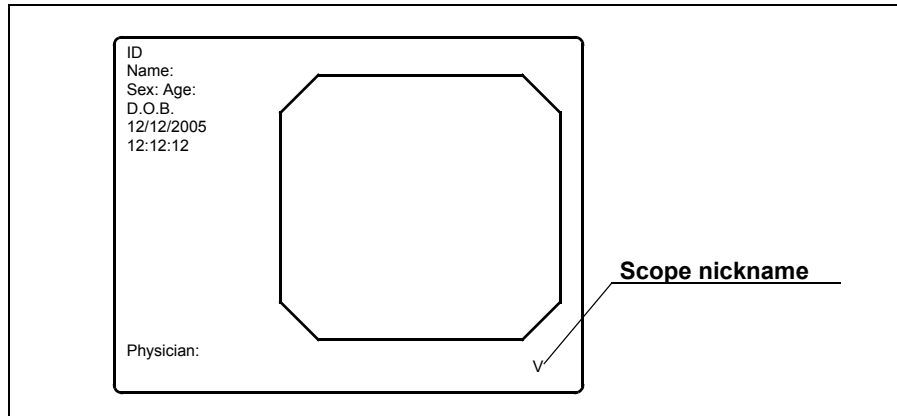

Figure 9.32

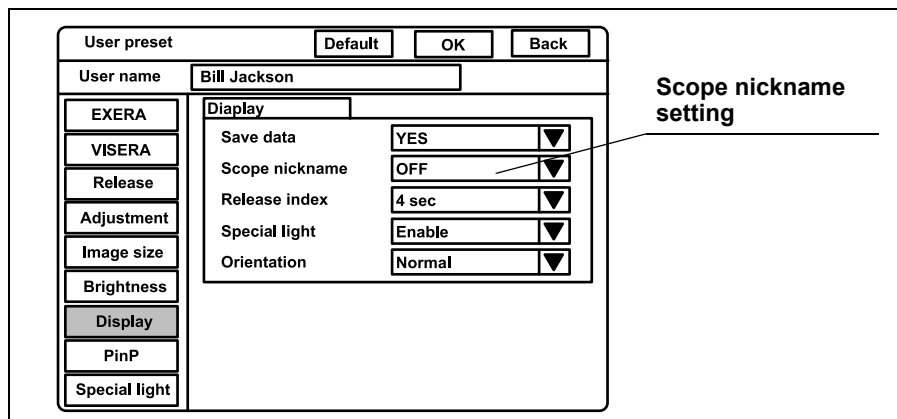

Figure 9.33

1. Click “ ▼ ” of “Scope nickname” (see Figure 9.33). The settings “Enable” and “OFF” appear in the pull-down menu.

Setting value	Explanation
Enable	Displays the scope nickname.
OFF	No display of the scope nickname

Table 9.44

2. Click the desired setting. The selected setting is displayed.

Release index time

The image taken using the release function can be displayed in the lower-left of the monitor. This image is called index image. This menu sets the time an index image is displayed.

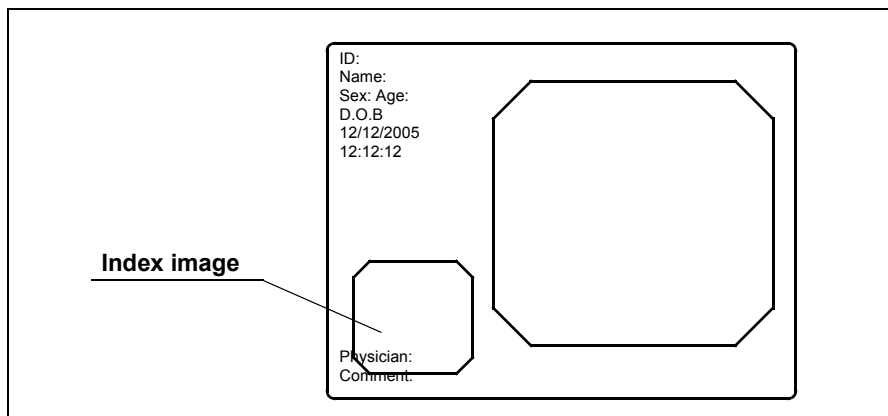

Figure 9.34

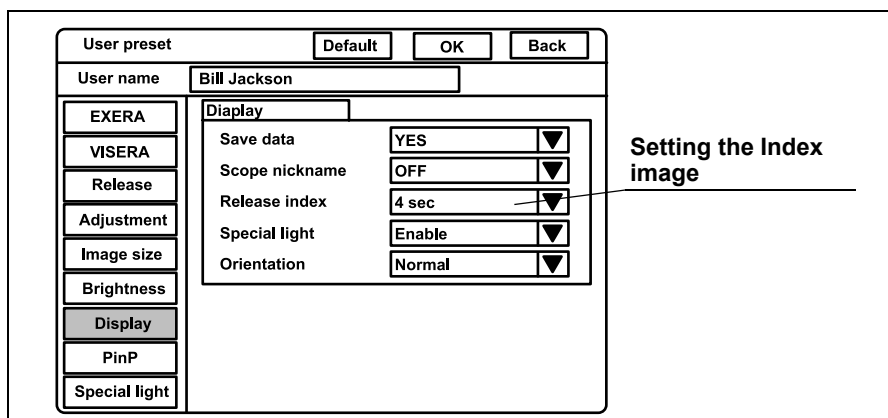

Figure 9.35

1. Click “ ▼ ” of “Release index” (see Figure 9.35). The display times appear in the pull-down menu.

Setting value	Explanation
Off	No display of the index image
2 sec	Displays the index image for 2 seconds.
4 sec	Displays the index image for 4 seconds.
Always	Displays the index image all the time.

Table 9.45

2. Click the desired display time. The selected time is displayed.

NOTE

- The index image may overlap the characters such as the patient data.
- Index image does not appear in the PinP screen (see “PinP (picture in picture) display” on page 64).

Indication of the special light observation

This menu sets whether the indication of the special light observation is shown on the monitor or not (see Figure 9.36).

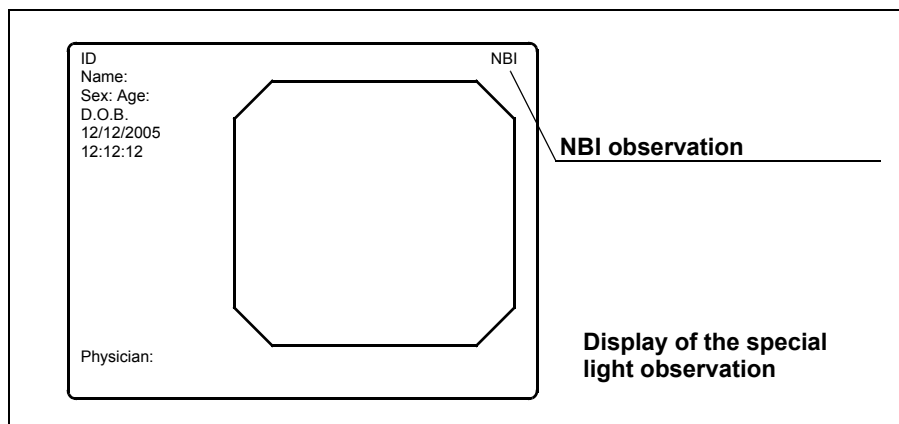

Figure 9.36

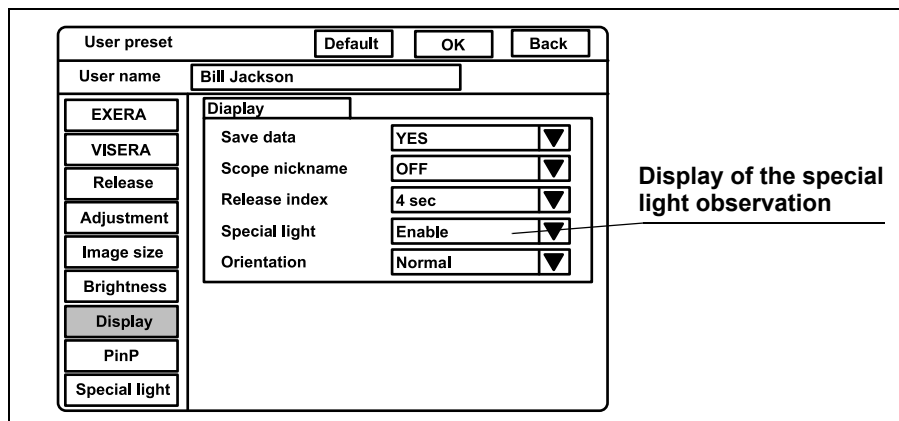

Figure 9.37

1. Click “▼” of “Special light” (see Figure 9.37). The settings “Enable” and “Disable” appear in the pull-down menu.

Setting value	Explanation
Enable	Display
Disable	No display

Table 9.46

- Click "OFF" or "ON". The selected option is displayed.

Monitor orientation function

The orientation function rotates the monitor image into a 180° reverse image. The following operation sets whether or not the orientation function is activated (see Figure 9.38).

CAUTION

Please note that during image rotation a time delay of the image display might occur. Please deal appropriately.

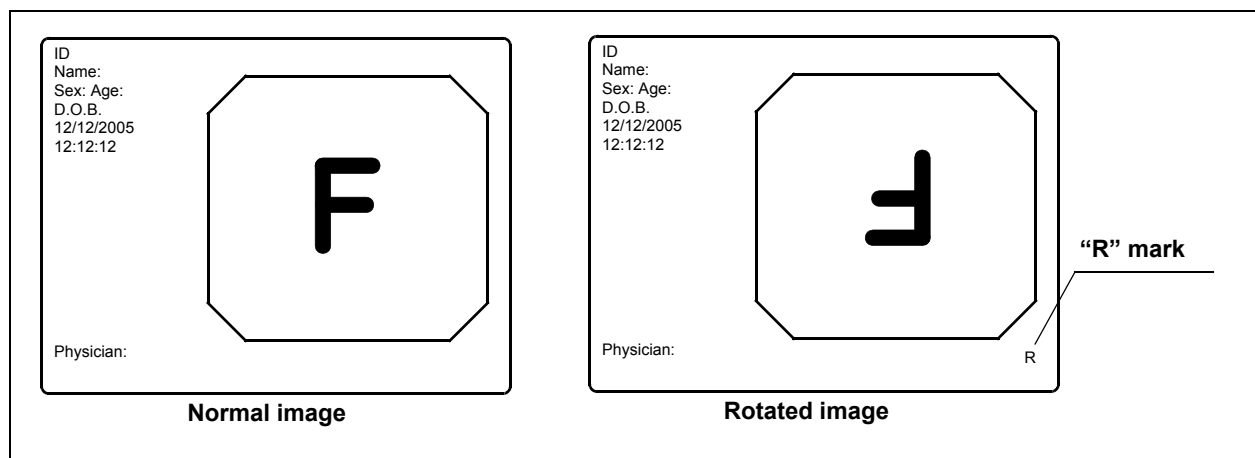

Figure 9.38

The orientation setup affects all video outputs as well as the monitor output. The recorded images are also reversed. The external PinP image does not reverse.

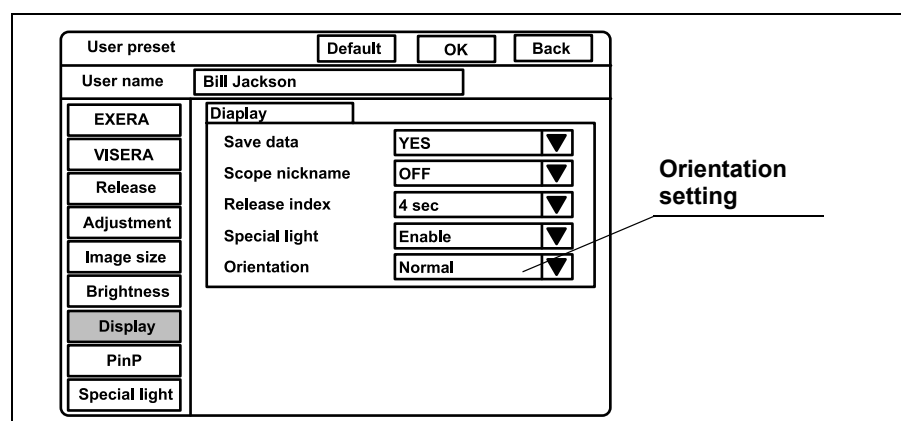

Figure 9.39

1. Click “▼” of “Orientation” (see Figure 9.39). The settings of “Normal” and “Rotation” appear in the pull-down menu.

Setting value	Explanation
Normal	Displays the endoscopic image on the monitor normally.
Rotation	Displays the endoscopic image rotated by 180° on the monitor.

Table 9.47

2. Click “Normal” or “Rotation”. The selected option is displayed.

NOTE

“R” mark is always displayed at the bottom right of the display when the orientation function and PinP function are ON.

PinP (picture in picture) function

The PinP function displays an image of an external device (such as an ultrasonic observation unit) connected to the video system center, as a sub or main image on the monitor together with the endoscopic image (see Figure 9.40). The images from one of the devices connected to the following connectors can be displayed as the PinP image.

- PinP composite terminal on the front panel
(has priority to the PinP Y/C terminal on the rear panel)
- PinP Y/C terminal on the rear panel

CAUTION

Please note that during PinP is displayed a time delay of the image display might occur. Please deal appropriately.

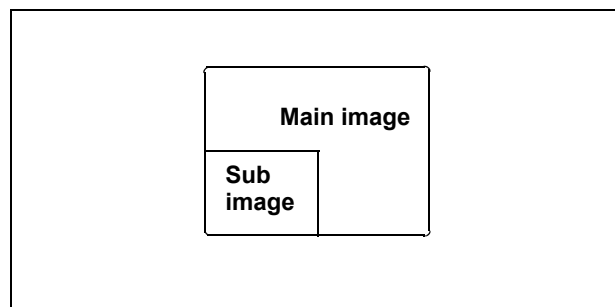

Figure 9.40

Click “PinP” on the system setup menu. The setting items appear on the right side of the window (see Figure 9.41).

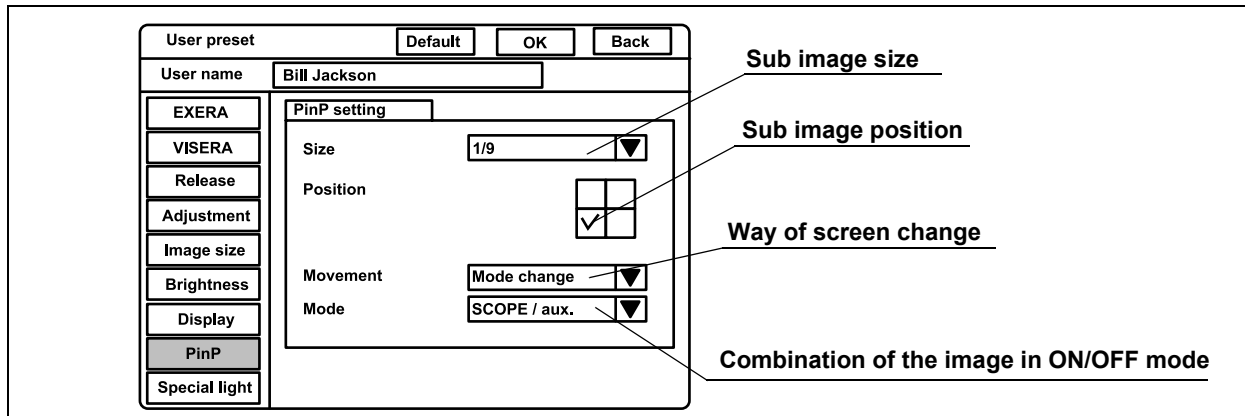

Figure 9.41

○ Image size of PinP

1. Click “▼” of “Size” (see Figure 9.41). The PinP sub image sizes appear in the pull-down menu (see Figure 9.42).

Setting value	Explanation
1/4	The size of sub image is about one-fourth that of the main image.
1/9	The size of sub image is about one-ninth that of the main image.

Table 9.48

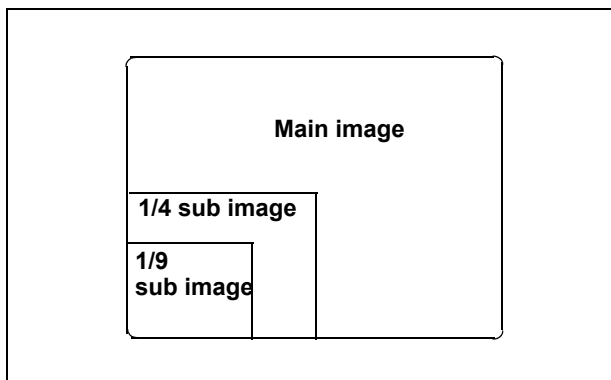

Figure 9.42

2. Click the desired sub image size. The selected size is displayed.

○ Position of the PinP sub image

Click the check box for the position to display the PinP sub image. The selected check box turns black.

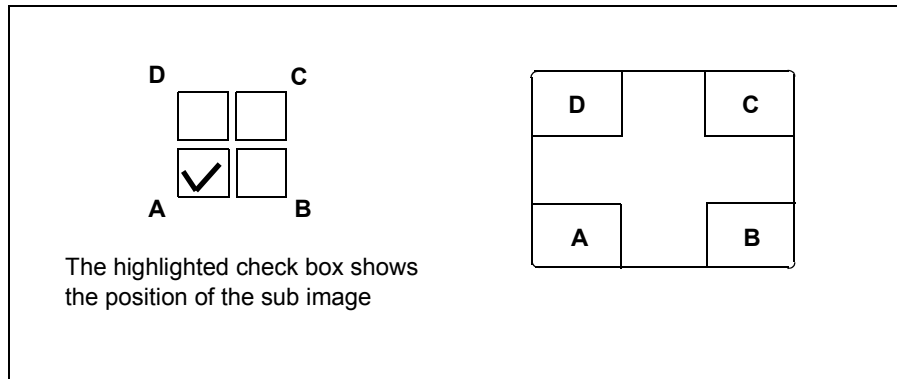

Figure 9.43

○ Display mode of PinP

1. Click “ ▼ ” of “Movement” (see Figure 9.41). The PinP modes appear in the pull-down menu.

Setting value	Explanation (see “PinP (picture in picture) display” on page 64.)
On/Off	The PinP button toggles back and forth between the non-PinP mode and the PinP mode.
Mode change	The PinP button switches between the PinP mode, endoscopic image and external image.

Table 9.49

2. Click the desired PinP mode. The selected PinP mode is displayed.
3. Click “ ▼ ” of “Mode” if “ON/OFF” of “Movement” is selected (see Figure 9.41). The display modes appear in the pull-down menu.

Setting value	Explanation
SCOPE/aux.	The endoscopic image is the main image and the external image is the sub image.
AUX./scope	The external image is the main image and the endoscopic image is the sub image.

Table 9.50

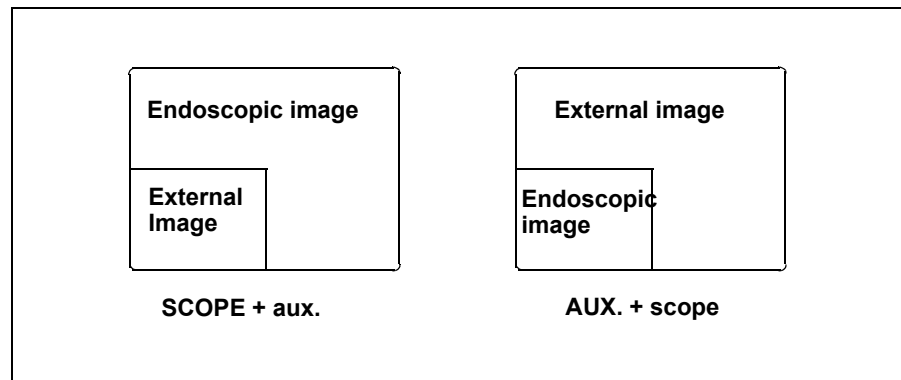

Figure 9.44

NOTE

If "Mode change" of "Movement" is selected, the mode setting is invalid.

4. Click the desired display mode. This selected mode is displayed.

Special light observation

The following special light observation function is available on the video system center.

Observation	Outline
NBI (narrow band imaging)	Uses filtered light of a specific wavelength.

Table 9.51

For these observations, use the endoscopes and the light source indicated below.

	CV-180	Light source	Compatible endoscope
NBI	No change	CLV-180	Refer to "NBI (narrow band imaging)" on page 151.

Table 9.52

Image enhancement (NBI observation)

This menu sets the image enhancement mode of NBI observation in the same way as normal observation. Refer to the "Image enhancement (normal observation)" on page 226 for the procedure.

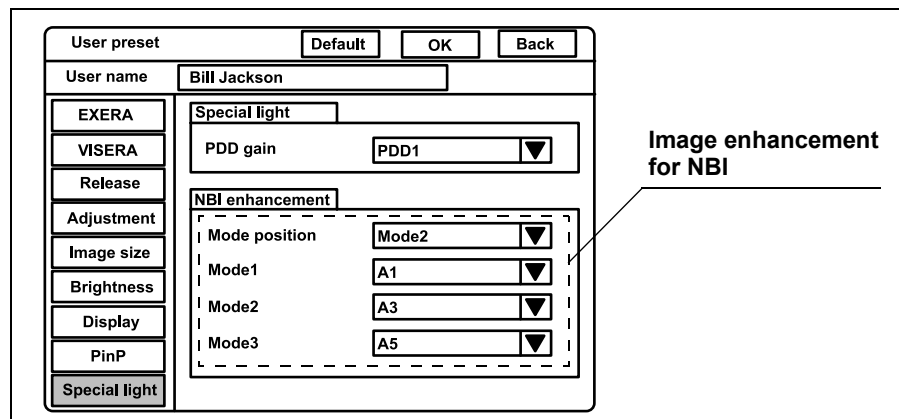

Figure 9.45

NOTE

"PDD gain" is reserved for future system expansion. Currently not used.

Saving the user preset

This procedure finalizes and saves the user preset data.

Figure 9.46

1. Click “OK” in the user preset menu (see Figure 9.46). A confirmation message appears on the monitor.
2. Click “N” to return to the user preset menu.
Click “Y” or press “Enter” to finalize and save the settings in the video system center. The endoscopic image appears (see Figure 9.47).

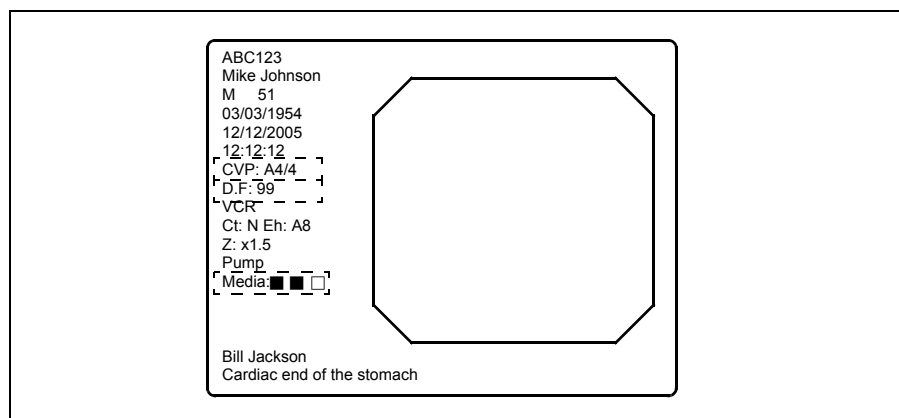

Figure 9.47

NOTE

- To cancel the data entered, click “Back” instead of “OK”. The data entered are canceled and the display returns to the user list menu.
- The functions are activated immediately after saving the user preset data.

Resetting the user preset data to the factory defaults

This operation resets the settings of the user preset to the factory default setting. The user name is not reset in this operation. See Table 9.53 on page 255 for the default settings.

1. Press the “Shift” and “F2” keys together (see Figure 9.48). The user name list of the user preset menu appears on the monitor (see Figure 9.49).

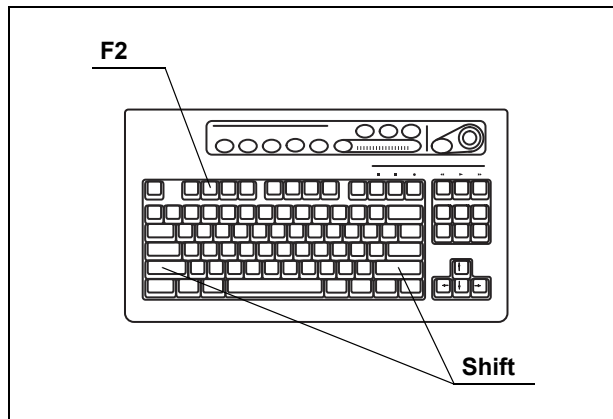

Figure 9.48

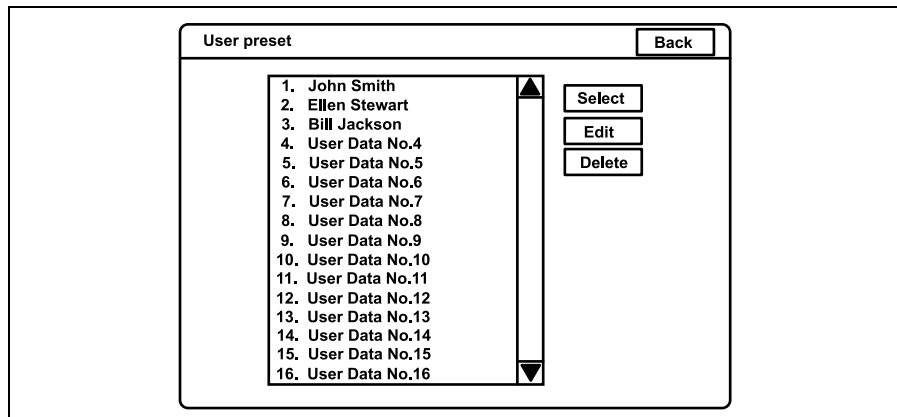

Figure 9.49

2. Click the user name in the user name dialog box to be reset to the factory default setting. The user name is highlighted.
3. Click “Edit”. The user preset menu appears.
4. Click “Default” on top of the menu. A confirmation message appears on the monitor.
5. Click “No” to return to the user preset menu.
Click “Yes” to reset the settings of the selected user to the factory default setting.

6. Click "Back" to return to the user name list.
7. To reset the settings of other registered users, repeat steps 2. to 6.
8. Click "Back" to return to the endoscopic image.

Deleting user preset data

This operation deletes the user preset data with the user name.

1. Press the "Shift" and "F2" keys together (see Figure 9.50). The user name list of the user preset menu appears on the monitor (see Figure 9.51).

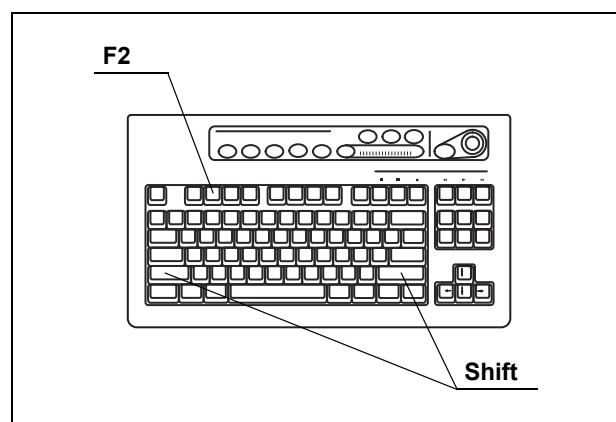

Figure 9.50

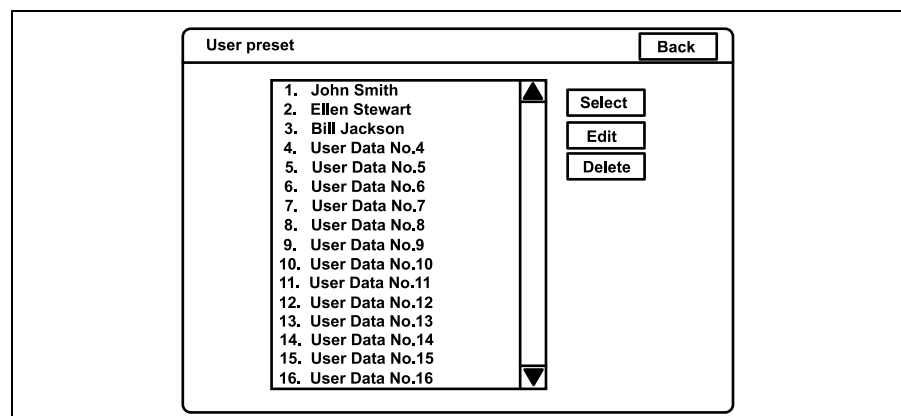

Figure 9.51

2. Click the user name in the user name dialog box to be deleted. The user name is highlighted.
3. Click "Delete" to delete the user preset data. A confirmation message appears on the monitor.

4. Click "No" to return to step 2.
Click "Yes" to delete the user being selected. The user name changes to "User Data No. #".
5. To delete the settings of other registered users, repeat steps 2. to 4.
6. Click "Back" to return to the endoscopic image.

Summary of settings

The following table shows the options of the user preset menu. The bold and underscored options listed are the factory default settings.

	Setup item		Setting value	Note
EXERA	Scope switch	Switch 1	[Freeze], [Release 1], [Release 2],	The same functions can be assigned to more than one switch.
		Switch 2	[Iris], [Enhance], [Contrast], [AGC],	
Switch 3		[Image size], [VCR], [Capture],	The default settings are: Switch 1: <u>Freeze</u> Switch 2: <u>Iris</u> Switch 3: <u>Enhance</u> Switch 4: <u>Release 1</u>	
Switch 4		[Stop watch], [Remove data], [Zoom],		
	[White balance], [Exposure area],			
	[Exposure (up)], [Exposure (down)],			
			[NBI], [OP.2], [OFP], [Light], [Arrow],	
			[PinP], [Shutter], [US freeze],	
	Foot switch	Switch 1	[Freeze mode], [Option], [None]	The same functions can be assigned to more than one switch. The default settings are: Switch 1: <u>Release 1</u> Switch 2: <u>Release 2</u>
		Switch 2		
VISERA	Scope switch	Switch 1	[Freeze], [Release 1], [Release 2],	The same functions can be assigned to more than one switch.
		Switch 2	[Iris], [Enhance], [Contrast], [AGC],	
Switch 3		[Image size], [VCR], [Capture],	The default settings are: Switch 1: <u>Release 1</u> Switch 2: <u>Enhance</u> Switch 3: <u>VCR</u> Switch 4: <u>Freeze</u>	
Switch 4		[Stop watch], [Remove data], [Zoom],		
	[White balance], [Exposure area],			
	[Exposure (up)], [Exposure (down)],			
			[NBI], [OP.2], [OFP], [Light], [Arrow],	
			[PinP], [Shutter], [US freeze],	
	Foot switch	Switch 1	[Freeze mode], [Option], [None]	The same functions can be assigned to more than one switch. The default settings are: Switch 1: <u>Release 1</u> Switch 2: <u>Release 2</u>
		Switch 2		
Release	Release setting	Release 1	<u>CVP</u> , <u>PC card</u> , <u>Digital file</u>	Devices to be operated by “Release1” and “Release 2”.
		Release 2	[CVP], <u>PC card</u> , [Digital file]	
		Picture	<u>SHQ</u> , [HQ], [SQ], [TIFF]	Recording format for PC card
		Freeze mode	<u>Field</u> , [Frame]	Freeze method

Table 9.53

Setup item		Setting value	Note
Adjustment	Enhancement	Mode position	[Mode1], [Mode2], [Mode3], [OFF] Initial mode of enhancement
		Mode 1 Mode 2 Mode 3	[A1] - [A8], [B1] - [B8], [E1] - [E8] Setting of each enhancement mode The default settings are: Mode 1: A1 Mode 2: A3 Mode 3: A5
	Color setting	Color mode	[Mode 1], [Mode 2], [Mode 3], [Mode 4] Color tone of the monitor
Image size	Image size	Scope 1	[Medium], [Full-height]
		Scope 2	[Small], [Medium]
		Scope 3	[Medium], [Full-height]
		Scope 4	[Medium], [Full-height]
Brightness	Brightness setting	Iris	[Auto], [Peak] Initial method of metering
		Iris auto	[AUTO 1], [AUTO 2], [AVE] Metering method for "Auto"
		Iris speed	[High], [Medium], [Low] Speed of the automatic brightness control
		Iris L	[1], [2], [3] Fine-tuning of "Iris Speed"
		Iris D	[1], [2], [3] Fine-tuning of "Iris Speed"
		AGC	[ON], [OFF] AGC function ON or OFF
		Contrast	[Normal], [Low], [High] Initial setting of contrast
		Exposure area	[Mask], [Center], [Full] Setting of the metering area
		Electronic shutter	[ON], [OFF] Electric shutter function ON or OFF
Display	Display	Save data	[YES], [NO]
		Scope nickname	[Enable], [OFF] The display function of the scope nickname is ON or OFF.
		Release index time	[OFF], [2 sec], [4 sec], [Always] Setting of display time of the index image
		Special light	[Enable], [Disable] The display function of the special light observation is ON or OFF.
		Orientation	[Normal], [Rotation] Setting of the orientation of the image

Table 9.53

Setup item		Setting value	Note	
PinP	PinP setting	Size	[1/4], [1/9]	Image size of the sub image
		Position	[Upper-left], [Upper-right], [Lower-left], [Lower-right]	Position of the sub image
		Movement	[ON/OFF], [Mode change]	
		Mode	[SCOPE/aux.], [AUX./scope]	Setting of main and sub image
Special Light	PDD setting	PDD gain	[PDD1], [PDD2]	Initial method of PDD
	NBI enhancement	Mode	[Mode 1], [Mode 2], [Mode 3], [OFF]	Initial mode of enhancement
		Mode 1	[A1] - [A8], [B1] - [B8], [E1] - [E8]	Setting of each enhancement mode
		Mode 2 Mode 3		The default settings are: Mode 1: A1 Mode 2: A3 Mode 3: A5

Table 9.53

Chapter 10 Troubleshooting

If the video system center is visibly damaged, does not function as expected, or is found to have irregularities during the inspection described in Chapter 3, "Inspection" and Chapter 8, "Installation and Connection", or the use described in Chapter 4, "Operation", do not use the video system center and contact Olympus. Some problems that appear to be malfunctions may be correctable by referring to Section 10.1, "Troubleshooting guide". If the problem cannot be resolved by the described remedial action, stop using the video system center and contact Olympus.

DANGER

Never use the video system center if an abnormality is suspected. Damage or irregularity in the instrument may compromise patient or user safety and may result in more severe equipment damage.

10.1 Troubleshooting guide

The following table shows the possible causes of and countermeasures against troubles that may occur due to equipment setting errors or deterioration of consumable.

Troubles or failures other than those listed in the following table need repair. As repair performed by persons who are not qualified by Olympus could cause patient or user injury and/or equipment damage, be sure to contact Olympus for repair.

WARNING

If an abnormality is suspected, turn the light source OFF once and turn it ON again. If the abnormality cannot be solved, turn the light source OFF and disconnect the power cord to stop the flow of electricity completely.

Irregularity description	Possible cause	Solution
The endoscope cannot be connected to the video system center.	The endoscope is not compatible with the video system center.	Use one of the endoscopes shown in the "System chart" in the Appendix.
The power fails to come on.	The power switch of the video system center is set to OFF.	Set the power switch to ON.
	The power cord is not connected.	Connect to a wall mains outlet as described in Chapter 8, "Installation and Connection".
	The power switch of the mobile workstation is set to OFF.	Set the power switch to ON.
	The fuses are blown.	Replace the fuses as described in Chapter 6, "Fuse replacement".
The endoscopic image does not appear on the monitor.	The switches on the rear and/or front of the monitor are not set correctly.	Set them correctly by referring to the monitor's instruction manual.
	The monitor output setting is incorrect.	Select the "SCOPE" output on the front panel as described in "Image source buttons" on page 62.
	The color bar image has been displayed.	Press the "Esc" key on the keyboard to restore the endoscopic image.
	The "System setup" menu appears.	Press the "Esc" key on the keyboard to restore the endoscopic image.
	The endoscope or camera head is not connected correctly.	Connect the endoscope or camera head as described in its instruction manual. (See also Section 4.2, "Connection of an endoscope" on page 46.)
	The monitor cable is not connected.	Connect the monitor cable as described in Section 8.5, "Monitor" on page 170.
	The videoscope cable EXERA II is not connected.	Connect the videoscope cable EXERA II as described in Section 4.2, "Connection of an endoscope" on page 46.

Irregularity description	Possible cause	Solution
The endoscopic image is too dark.	The iris mode selection is incorrect.	Set it properly as described in "Iris mode" on page 69.
	The exposure setting is incorrect.	Set it properly as described in "Brightness adjustment (Exposure)" on page 71.
	The monitor brightness setting is improper.	Set a proper brightness as described in the monitor's instruction manual.
	The monitor contrast setting is improper.	Set a proper contrast as described in the monitor's instruction manual.
	The following problems may be due to the light source. Refer to the light source's instruction manual for further details.	
	<ul style="list-style-type: none"> • The lamp is not installed correctly. • The lamp is broken. • The lamp is not ignited. • The brightness level is improper. • The filter is improper. 	Reinstall the lamp correctly. Replace it with a new lamp. Press the lamp ignition button on the light source. Set to a proper level. Set to a proper filter setting.
The endoscopic image is too bright.	The iris mode selection is incorrect.	Set it properly as described in "Iris mode" on page 69.
	The exposure setting is incorrect.	Set it properly as described in "Brightness adjustment (Exposure)" on page 71.
	The light control cable is not connected.	Connect the light control cable as described in Section 4.2, "Connection of an endoscope" on page 46.
	The light source brightness level is improper.	Set a proper brightness as described in the light source's instruction manual.
	The monitor brightness setting is improper.	Set a proper brightness as described in the monitor's instruction manual.
	The monitor contrast setting is improper.	Set a proper contrast as described in the monitor's instruction manual.

Irregularity description	Possible cause	Solution
The color tone of the endoscopic image is unusual.	The color tone is set improperly.	Set it properly as described in "Color tone adjustment ("COLOR")" on page 98.
	The color mode is set improperly.	Set it properly as described in "Color mode" on page 228.
	The white balance is incorrect.	Adjust it properly as described in Section 4.5, "White balance adjustment" on page 52.
	NBI mode is selected.	Set the light source to normal mode as described in the instruction manual of the light source or Section 5.8, "Special light observation" on page 151.
	The monitor cable is connected incorrectly.	Connect the monitor cable properly as described in Section 8.5, "Monitor" on page 170.
	The following problems may be due to the monitor. Refer to the monitor's instruction manual for further details.	
	• PHASE setting is improper.	Set a proper PHASE setting.
	• CHROMA setting is improper.	Set a proper CHROMA setting.
	• Color temperature setting is improper.	Set a correct color temperature.
The endoscopic image remains frozen.	The freeze switch is still set.	Press the freeze switch to restore the real-time image.
The endoscopic image is drifting.	The monitor cable is connected incorrectly.	Connect the monitor cable correctly as described in Section 8.5, "Monitor" on page 170.
	The monitor is set incorrectly.	Initialize the monitor.
The endoscopic image is vibrating.	There is a strong magnetic field near the monitor.	Move the source of the magnetic field away from the monitor.

Irregularity description	Possible cause	Solution
Characters do not appear on the screen.	The color bar image is displayed.	Press the "Shift"+"F7" keys on the keyboard to display the endoscopic image.
	The screen is in "All clear mode".	Press the "F1" key on the keyboard to display characters.
	PinP display is ON.	Press the "SCOPE" button to change to the endoscopic image.
Patient data cannot be entered.	The keyboard is not connected securely.	Connect the keyboard securely as described in Section 8.10, "Foot switch" on page 184.
The release destination device cannot be selected.	The ancillary equipment settings are incorrect.	Set the ancillary equipment correctly as described in its instruction manual.
Recording and playback of the videotape recorder cannot be performed.	The VTR remote cable is not connected.	Connect the VTR remote cable properly as described in Section 8.7, "Videocassette recorder (VCR)" on page 179.
	The monitor output setting is incorrect.	Select the "VTR" output on the front panel as described in "Image source buttons" on page 62.
	The monitor remote control setting is incorrect.	Set it properly as described in "Monitor" on page 208.
	The remote cable is not connected to the monitor.	Connect the optional monitor remote cable.
	The monitor brightness setting is improper.	Set a proper brightness as described in the monitor's instruction manual.
	The VCR remote control setup is incorrect.	Set it properly as described in "Videocassette recorder" on page 211.

Irregularity description	Possible cause	Solution
Image capturing and display with the video printer cannot be performed.	The remote cable is not connected.	Connect the remote cable correctly as described in "Printer" on page 201.
	The monitor output setting is incorrect.	Select the "Printer" output on the front panel as described in "Image source buttons" on page 62.
	The monitor remote control setting is incorrect.	Set it correctly as described in "Monitor" on page 208.
	The remote cable is not connected to the monitor.	Connect the optional monitor remote cable.
	The monitor brightness setting is improper.	Set a proper brightness as described in the monitor's instruction manual.
	The printer setup in the system setup is incorrect.	Set it properly as described in "Printer" on page 201.
The image cannot be stored with the PC card.	The PC card adapter is not inserted into the PC card slot of the video system center properly.	Insert the PC card adapter properly.
	The PC card is not inserted into the PC card adapter properly.	Insert the PC card properly.
	Available space of the PC card is low.	Delete unnecessary images or use a new PC card.
The image stored with the PC card cannot be played back.	The PC card adapter is not inserted into the PC card slot of the video system center properly.	Insert the PC card adapter properly.
	The PC card is not inserted into the PC card adapter properly.	Insert the PC card properly.
	The image was edited on a personal computer or another equipment.	The image cannot be played back.

Irregularity description	Possible cause	Solution
The endoscope's remote switches are inoperative.	The endoscope or videoscope cable EXERA II is not connected.	Connect the endoscope or scope cable EXERA II as described in Section 4.2, "Connection of an endoscope" on page 46.
	The user preset for the endoscope's remote switches are incorrect.	Set them properly as described in "Remote switch and foot switch (EXERA and VISERA)" on page 219.
The data is not displayed on the scope information menu.	The endoscope is not connected or a videoscope other than that with the scope information function is connected.	Connect an videoscope with scope information function as described in its instruction manual. (Also see Section 5.7, "Scope information" on page 148.
The endoscope information data cannot be entered.	The endoscope is not connected or a videoscope other than that with the scope information function is connected.	Connect an videoscope with scope information function as described in its instruction manual. (Also see Section 5.7, "Scope information" on page 148.
The sub image is not displayed.	The external equipment is not connected properly.	Connect the external equipment is properly.
The internal clock shows the wrong time and/or data.	The internal clock is not set correctly.	Set it properly as described in "Date and time" on page 197.
NBI observation is not enabled.	The light source (CLV-180) is not connected.	Connect the CLV-180.
	An endoscope incompatible with NBI is connected.	Connect an NBI compatible endoscope.
	The light source is OFF.	Turn the light source ON.
	The NBI mode is not selected.	Select the NBI mode and confirm that the color of the "NBI" indicator is changed from green to white.

○ Error messages

Message	Possible cause	Solution
No connect PC!	The image filing system and/or the cable is not connected.	Connect the image filing system and the cable.
No connect DV/VCR!	The DV/VCR and/or the cable is not connected.	Connect the DV/VCR and the cable.
No connect CVP!	The video printer and/or the cable is not connected.	Connect the video printer and the cable.
No input for PinP	Only external image or no image is inputted.	Input both endoscopic and external image.
Not available with this scope.	The zoom operation is performed using an incompatible endoscope.	Use an endoscope compatible with the zoom function.
White balance incomplete! Perform again!	The white balance adjustment is not completed normally.	Adjust the white balance again.
NBI white balance incomplete! Perform again!	The white balance adjustment for the NBI observation is not completed normally.	Adjust the white balance for the NBI observation again.
Check PC card!	No PC card is inserted.	Insert a PC card to the PC card slot.
Media full	The storage capacity of the PC card is insufficient. It was attempted to create over 900 folders on the PC card or attempted to save over 9999 files in a folder.	Delete unnecessary folders or files. Or use a new PC card.
No data!	There is no data in the PC card.	Use a card that the data is stored on.
Failed in format	Failed to format PC card	Use a new PC card.
File down!	The communication with the image filing system is not available.	Check the setting of the image filing system.
Light source mismatch!	The light source is not compatible with the special light observation.	Use the light source compatible with the special light observation.
Scope mismatch!	The endoscope is not compatible with the special light observation.	Use the endoscope compatible with the special light observation.
Data NG!	Invalid data is inputted.	Input the valid data.

Message	Possible cause	Solution
VCR error 1	The VCR remote cable is not connected correctly.	Connect the VCR remote cable correctly.
VCR error 2	Incompatible format of media	Use a compatible media referring to the instruction manual for the media.

When the following messages appear, contact Olympus.

Message	Possible cause
PC Card Error 01	Failure to call on the image from the PC card
PC Card Error 02	The number of releases for a folder exceeds 9999
PC Card Error 03	Failure to delete the image
PC Card Error 04	Failure to call on the image management file
PC Card Error 05	Failure to write to the image management file
PC Card Error 06	Failure to call on the folder
PC Card Error 07	The number of releases for the PC card exceeds 900
PC Card Error 08	Failure to delete the folder
PC Card Error 09	Failure to call on the annotation file
PC Card Error 10	Failure to create the annotation file
PC Card Error 11	Failure to delete the annotation file
PC Card Error 12	Failure to call on the image attached to the annotation file
PC Card Error 13	Failure to write the image to the annotation file
PC Card Error 14	Failure to call on the patient data
PC Card Error 15	Failure to create the patient data
PC Card Error 16	Failure to call on the setting file
PC Card Error 17	Failure to create the setting file
PC Card Error 18	Failure to create the log file
PC Card Error 19	Failure to compress the file
PC Card Error 20	Failure to decompress the file
PC Card Error 21	Released with full media

10.2 Returning the video system center for repair

CAUTION

- Olympus is not liable for any injury or damage which occurs as a result of repairs attempted by non-Olympus personnel.
- Before returning the video system center for repair, delete the patient data from the instrument (refer to “Clearing all patient data previously entered” on page 143) and remove the PC card from the instrument.

When returning the video system center for repair, contact Olympus. With the video system center, include a description of the malfunction or damage and the name and telephone number of the individual at your location who is most familiar with the problem. Include a repair purchase order.

NOTE

If an accessory of the instrument (keyboard, power cord, scope cable EXERA II, HDTV/SDTV monitor cable, foot holder, spare fuse, white cap, scope cable holder, cable color sheet) needs to be replaced, contact Olympus to purchase a replacement.

Appendix

System chart

The recommended combinations of equipment that can be used with this video system center are listed below. New products released after the introduction of the video system center may also be compatible for use in combination with it. For further details, contact Olympus.

WARNING

If combinations of equipment other than those shown below are used, the full responsibility should be assumed by the medical treatment facility. Such combinations do not only allow the equipment to manifest their full functionality but may also imperil the safety of the patient and medical personnel. In addition, the endurance of the video system center and ancillary equipment is not guaranteed. Troubles caused in this case are not covered by free-of-charge repair. Be sure to use the equipment in one of the recommended combinations.

For combination with the camera head for microsurgery OTV-S7H-1MD, refer to the instruction manual for the OTV-S7H-1MD.

○ System chart for non-ultrasonic endoscopes

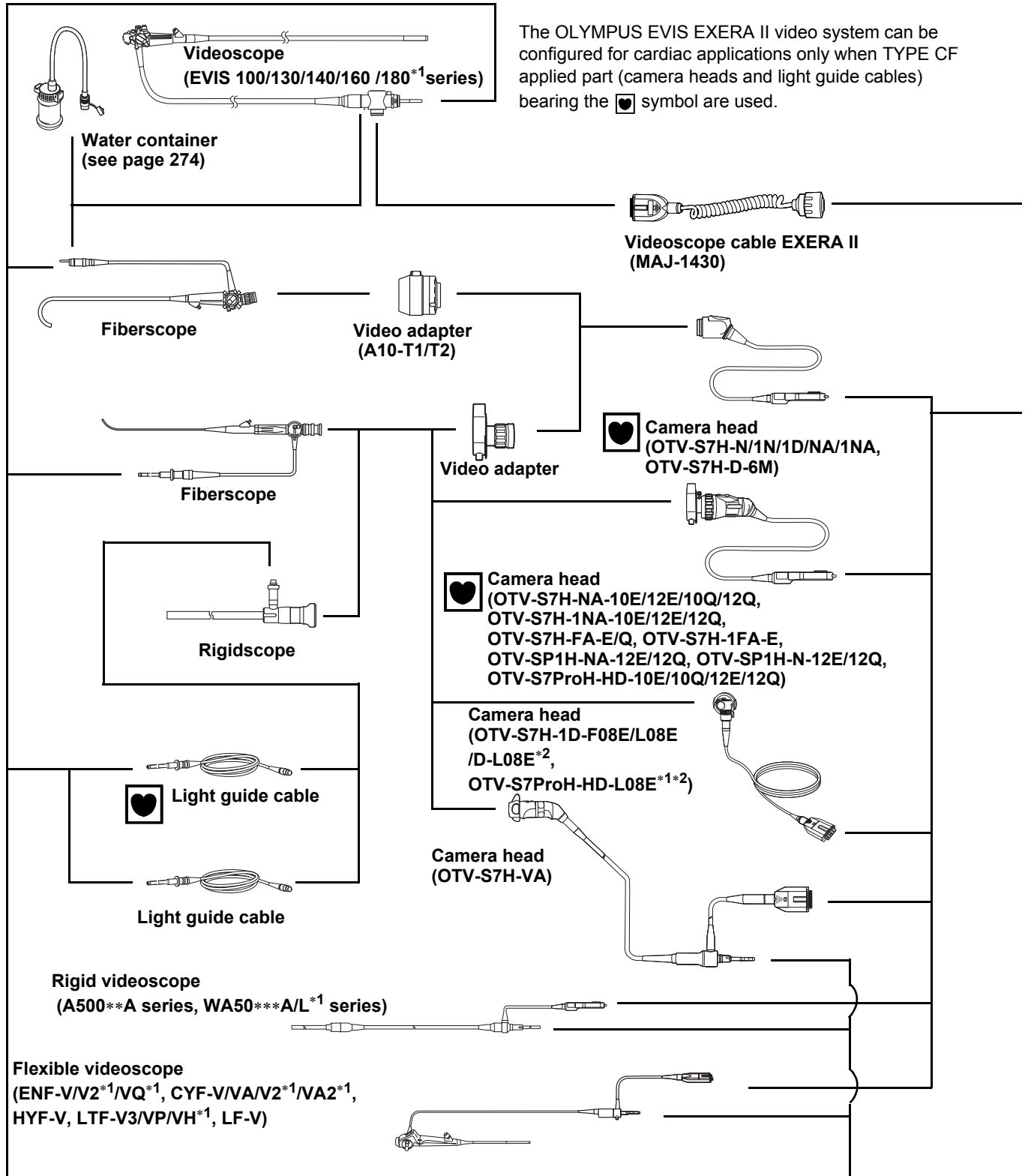

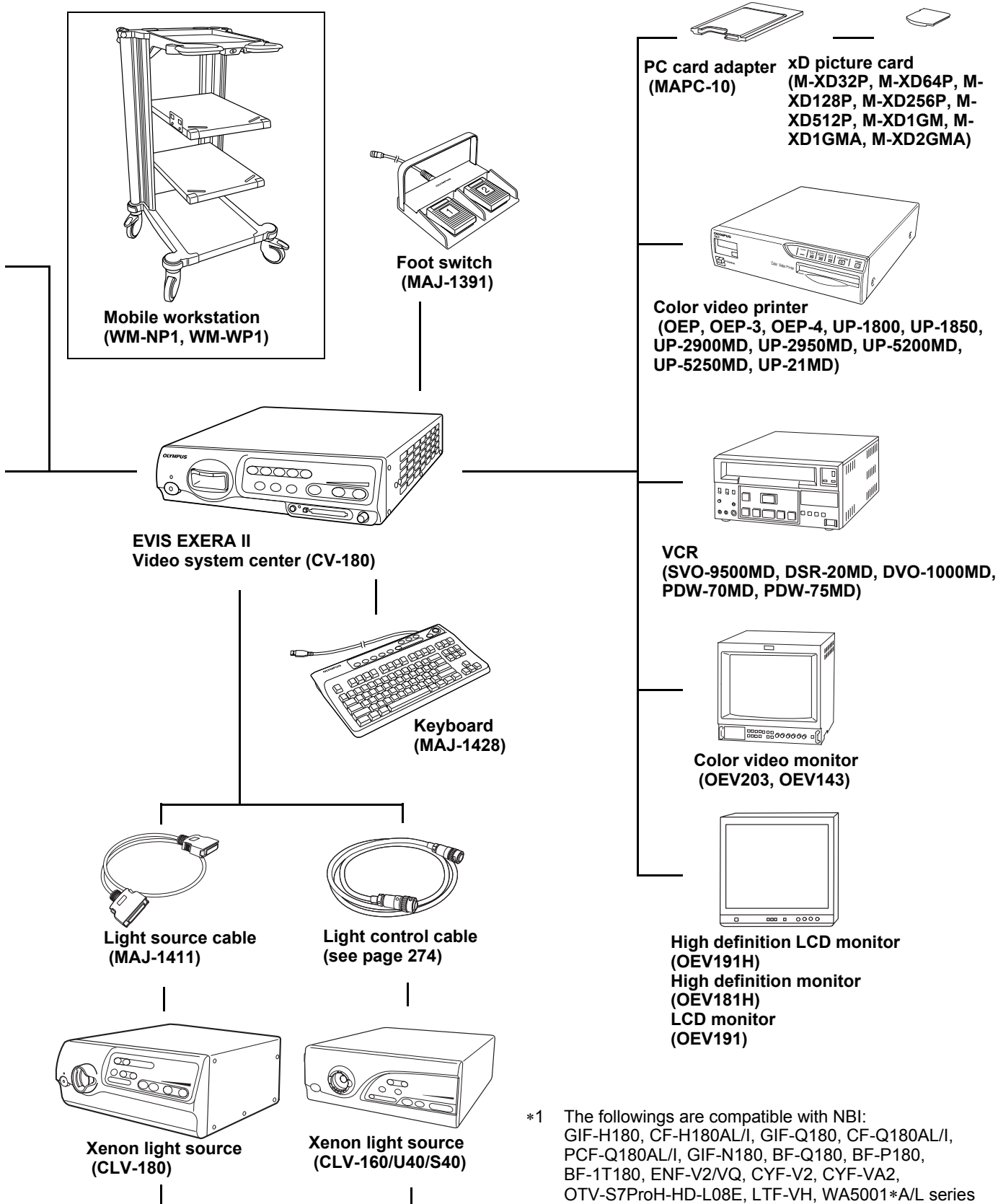

*1 The followings are compatible with NBI:
GIF-H180, CF-H180AL/I, GIF-Q180, CF-Q180AL/I,
PCF-Q180AL/I, GIF-N180, BF-Q180, BF-P180,
BF-1T180, ENF-V2/VQ, CYF-V2, CYF-VA2,
OTV-S7ProH-HD-L08E, LTF-VH, WA5001*A/L series

*2 This product is not available in some areas.

○ System chart for ultrasonic endoscopes

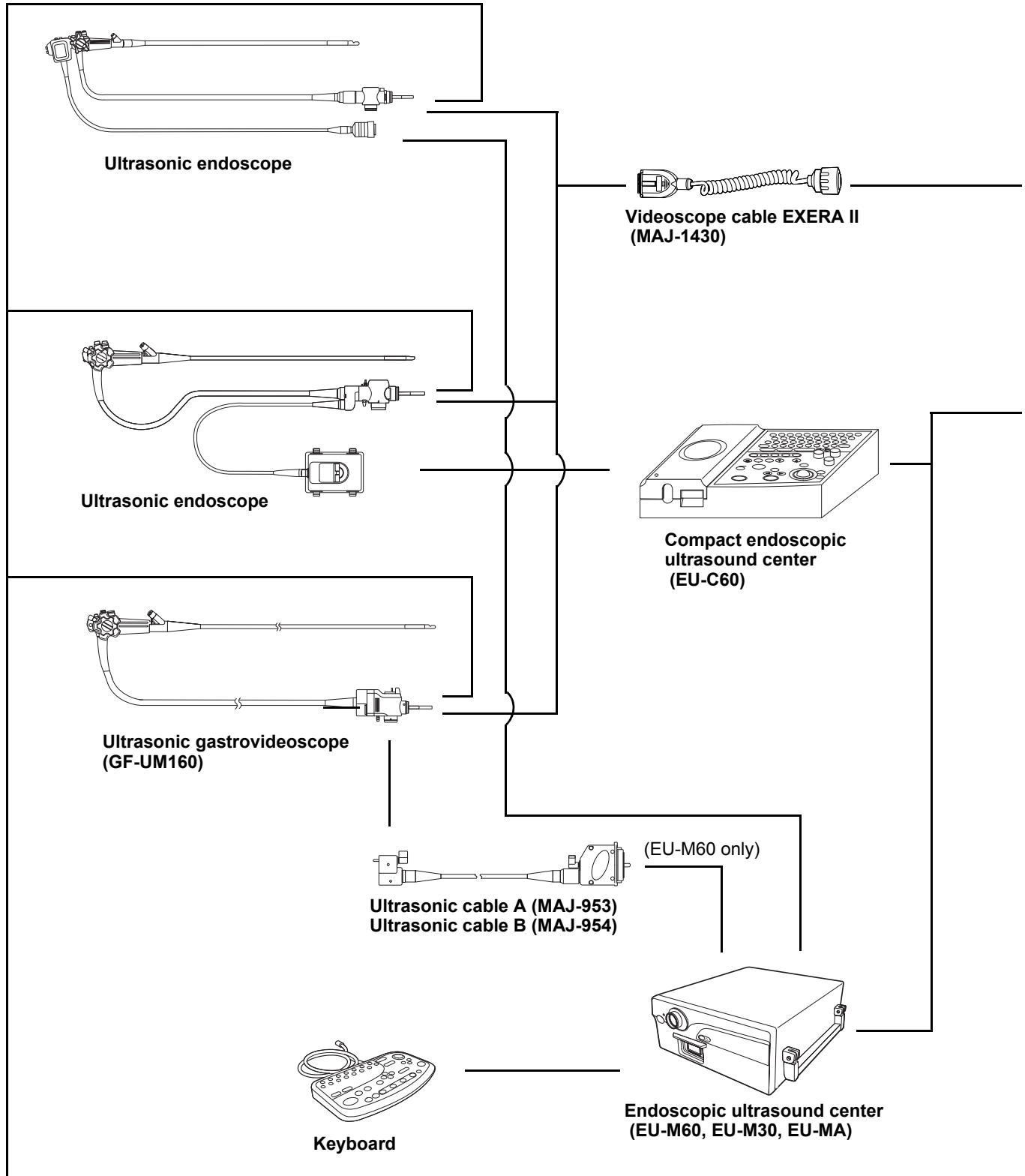

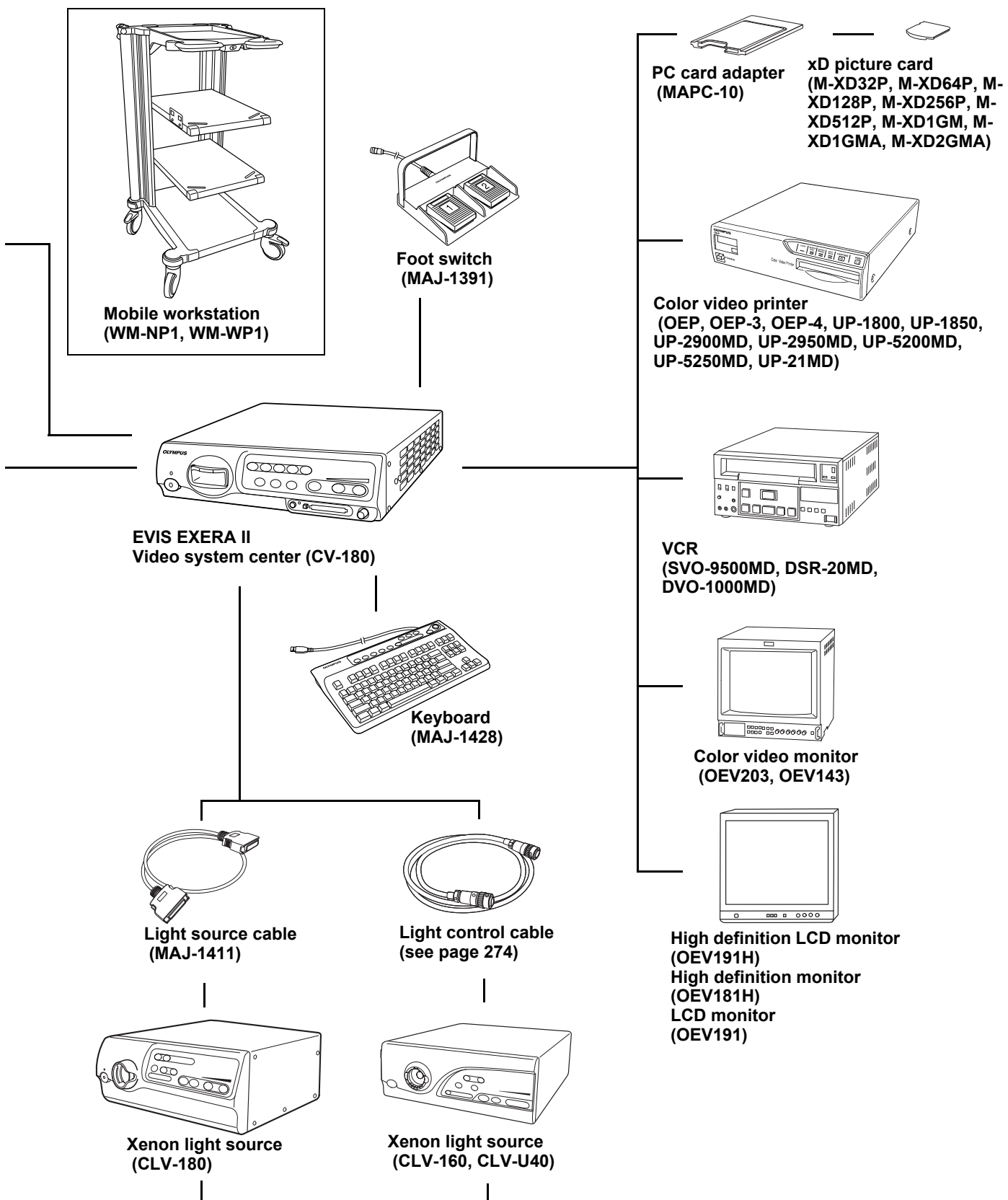

○ **Water container**

BF endoscopes do not use the water container.

Endoscope	Water container		
	MD-431	MH-884	MAJ-901
EVIS EXERA II 180 series	-	○	○
EVIS EXERA 160 series, Ultrasonic videoscope 160 series	-	○	○
EVIS 140 series, Ultrasonic videoscope 140 series	-	○	○
EVIS 100 and 130 series, Ultrasonic videoscope 130 series	○	-	-
OES 40 series	-	○	○
OES 10, 20, 30, E and E3 series*1, Ultrasonic fiberscope	○	-	-

○ compatible, - incompatible

*1 The OES E and E3 series are not available in some areas.

○ **Connection cable (light source)**

Light source	Light source cable	Light control cables		
	MAJ-1411	MH-966	MAJ-1567	MH-993
CLV-180	○	-	-	-
CLV-160	-	○	-	-
CLV-U40	-	○	○	○
CLV-S40	-	-	○	-

○ compatible, - incompatible

○ Connection cable (OEV143, OEV203, OEV191, OEV181H, OEV191H)

		Length	Monitor				
			OEV143	OEV203	OEV191	OEV181H	OEV191H
Monitor cable	MAJ-921	1.5 m	○	○	○	○	○
	MAJ-970	4 m	○	○	○	○	○
	MAJ-1462	7 m	○	○	○	○	○
	MAJ-1584	15 m	○	○	○	○	○
	MAJ-1586	2 m	○	○	○	○	○
	MAJ-846	7 m	○	○	○	-	-
	MAJ-971	15 m	○	○	○	-	-
Monitor remote cable	MAJ-227	4 m	○	○	-	-	-
	MAJ-1161	7 m	-	-	○	○	○
	MAJ-1230	4 m	-	-	○	○	○
	MAJ-1465	15 m	-	-	○	○	○

○ compatible, - incompatible

○ Connection cables (color video printer)

Video cable (print)		Video cable (display)	Remote cable
MH-984 (3 m)	MD-445 (7 m) with MAJ-1165	MB-677 (3 m)	MH-995 (2.8 m)

Transportation, storage, and operation environment

Transportation and storage environment	Ambient temperature	-25 to +70°C (-13 to +158°F)
	Relative humidity	10 - 90%
	Atmospheric pressure	700 - 1060 hPa
Operation environment	Ambient temperature	10 - 40°C (50 - 104°F)
	Relative humidity	30 - 85% (without condensation)
	Atmospheric pressure	700 - 1060 hPa (0.7 - 1.1 kgf/cm ²) (10.2 - 15.4 psia)

Specifications

Item	Specifications	
Power supply	Voltage	100 - 240 V AC
	Voltage fluctuation	Within $\pm 10\%$
	Frequency	50/60 Hz
	Frequency fluctuation	Within ± 1 Hz
	Consumption electric power	150 VA
	Fuse rating	5 A, 250 V
	Fuse size	$\varnothing 5 \times 20$ mm
Size	Dimensions	382 (W) \times 91 (H) \times 490 (D) mm (maximum)
	Weight	10 kg
Classification (medical electrical equipment)	Type of protection against electric shock	Class I
	Degree of protection against electric shock of applied part	Depend on applied part See also applied part (camera head or videoscope).
	Degree of protection against explosion	This instrument should be kept away from flammable gases.

Item	Specifications
Observation	
HDTV signal output	Either RGB or YPbPr output can be selected.
SDTV signal output	VBS composite (NTSC), Y/C and RGB; simultaneous outputs possible.
White balance adjustment	White balance adjustment is possible using the white balance button on the front panel.
Standard color chart output	A color bar chart can be displayed by pressing the "Shift" + "F7" keys on the keyboard.
Color tone adjustment	<p>The following color tone adjustments are possible using the "COLOR" key and arrow keys on the keyboard.</p> <ul style="list-style-type: none"> • Red adjustment: ± 8 steps • Blue adjustment: ± 8 steps • Chroma adjustment: ± 8 steps
Automatic gain control (AGC)	The image can be electrically amplified when the light is inadequate due to the distal end of the endoscope being too far from the object.
Contrast	<p>The image contrast can be set to one of the following three modes (N, H, L) using the "Shift"+ "F6" key on the keyboard.</p> <ul style="list-style-type: none"> • N (normal): Normal image • H (high): The dark areas are darker and the bright areas are brighter than in the normal image. • L (low): The dark areas are brighter and bright areas are darker than in the normal image.

Item	Specifications
Observation (continued)	<p data-bbox="726 324 774 347">Iris</p> <p data-bbox="997 324 1388 425">The auto iris modes can be selected using the “Iris mode” button on the front panel.</p> <ul data-bbox="997 436 1388 593" style="list-style-type: none"> • Peak: For use when observing by focusing on a small bright area. • Auto: For use when observing by focusing on the image center.
	<p data-bbox="726 604 973 660">Image enhancement setting</p> <p data-bbox="997 604 1388 884">Fine patterns or edges in the endoscopic images can be enhanced electrically to increase the image sharpness. Either the structural enhancement or edge enhancement can be selected according to the user setup.</p>
	<p data-bbox="726 896 901 996">Switching the enhancement modes</p> <p data-bbox="997 896 1388 1075">The enhancement level can be selected from 4 levels (OFF, 1, 2 and 3) using the image enhancement button on the front panel.</p>
	<p data-bbox="726 1086 973 1120">Image size selection</p> <p data-bbox="997 1086 1388 1198">The size of the endoscopic image can be changed using the “Shift” + “F8” key on the keyboard.</p>
	<p data-bbox="726 1209 933 1232">Reset to defaults</p> <p data-bbox="997 1209 1388 1310">The following settings can be reset to their defaults using the rest button on the front panel.</p> <ul data-bbox="997 1321 1388 1836" style="list-style-type: none"> • User preset • Image source • Color tone • Freeze • Release index • Zoom • Special light observation • Arrow pointer • Stop watch • Characters on screen • Exposure • PinP
	<p data-bbox="726 1848 821 1870">Freeze</p> <p data-bbox="997 1848 1388 1960">An endoscopic image is frozen using an endoscope or the “FREEZE” key on the keyboard.</p>

Item	Specifications
Documentation	<p data-bbox="1038 327 1412 499">The following ancillary equipment can be controlled from the front panel, keyboard or endoscope's remote switches (specified models only).</p> <ul data-bbox="1038 510 1390 707" style="list-style-type: none"> <li data-bbox="1038 510 1114 539">• VCR <li data-bbox="1038 555 1203 584">• Video printer <li data-bbox="1038 600 1273 629">• Image filing system <li data-bbox="1038 645 1390 707">• Endoscopic ultrasound center, etc.
	<p data-bbox="774 723 911 752">Patient data</p> <p data-bbox="1038 723 1422 786">The following data can be displayed on the monitor using the keyboard.</p> <ul data-bbox="1038 797 1337 1267" style="list-style-type: none"> <li data-bbox="1038 797 1214 826">• Patient ID No. <li data-bbox="1038 842 1203 871">• Patient name <li data-bbox="1038 887 1198 916">• Sex and age <li data-bbox="1038 931 1198 960">• Date of birth <li data-bbox="1038 976 1315 1039">• Date of recording (time, stopwatch) <li data-bbox="1038 1055 1241 1084">• Image frame No. <li data-bbox="1038 1099 1337 1128">• Videotape recorder mode <li data-bbox="1038 1144 1294 1173">• Display image setting <li data-bbox="1038 1189 1235 1218">• Physician name <li data-bbox="1038 1234 1182 1263">• Comments
	<p data-bbox="774 1279 938 1379">Advance registration of patient data</p> <p data-bbox="1038 1279 1374 1379">The following data of up to 40 patients can be entered prior to surgery using the keyboard.</p> <ul data-bbox="1038 1391 1214 1603" style="list-style-type: none"> <li data-bbox="1038 1391 1214 1420">• Patient ID No. <li data-bbox="1038 1435 1203 1464">• Patient name <li data-bbox="1038 1480 1198 1509">• Sex and age <li data-bbox="1038 1525 1198 1554">• Date of birth <li data-bbox="1038 1570 1166 1599">• Physician

Item		Specifications
PC card	Media	xD-Picture Card (2/1 GB, 512/256/128/64/32 MB), specified by Olympus. MAPC-10 can be used as PC card adapter.
	Recording format	TIFF: no compression SHQ: approx. 1/5 HQ: approx. 1/7 SQ: approx. 1/10
	Number of Recording images	in 32 MB, SDTV / HDTV TIFF: approx. 30 / 6 images SHQ: approx. 310 / 110 images HQ: approx. 2000 / 760 images SQ: approx. 2570 / 970 images
Image storage and retrieval	Monitor output	Using the monitor out switches on the front panel, it is possible to select an image from the endoscope or ancillary equipment for display on the monitor.
Memory backup	Memorization of selected setting	The following settings are held in memory even after the video system center is turned OFF. <ul style="list-style-type: none"> • White balance • Iris mode • Enhancement • Image size • Color tone
	Lithium battery	Life: 5 years

EMC	Applied standards; IEC 60601-1-2: 2001	This instrument complies with the standards listed in the left column.
		CISPR 11 of emission: Group 1, Class B
		This instrument complies with the EMC standard for medical electrical equipment; edition 2 (IEC 60601-1-2: 2001). However, when connecting to an instrument that complies with the EMC standard for medical electrical equipment; edition 1 (IEC 60601-1-2: 1993), the whole system complies with edition 1.
Year of manufacture	7612345 ↑	The last digit of the year of manufacture is the second digit of the serial number.

EMC information

This model is intended for use in the electromagnetic environments specified below. The user and the medical staff should ensure that it is used only in these environments.

○ Magnetic emission compliance information and recommended electromagnetic environments

Emission standard	Compliance	Guidance
RF emissions CISPR 11	Group 1	This instrument uses RF (Radio Frequency) energy only for its internal function. Therefore, its RF emissions are very low and are not likely to cause any interference in nearby electronic equipment.
RF emissions CISPR 11	Class B	This instrument's RF emissions are very low and are not likely to cause any interference in nearby electronic equipment.
Main terminal conducted emissions CISPR 11		
Harmonic emissions IEC 61000-3-2	Class A	This instrument's harmonic emissions are low and are not likely to cause any problem in the typical commercial power supply connected to this instrument.
Voltage fluctuations/flicker emissions IEC 61000-3-3	Complies	This instrument stabilizes own radio variability and has no affect such as flicker of a lighting apparatus.

○ Electromagnetic immunity compliance information and recommended electromagnetic environments

Immunity test	IEC 60601-1-2 test level	Compliance level	Guidance
Electrostatic discharge (ESD) IEC 61000-4-2	Contact: $\pm 2, \pm 4, \pm 6$ kV Air: $\pm 2, \pm 4, \pm 8$ kV	Same as left	Floors should be made of wood, concrete, or ceramic tile that hardly produces static. If floors are covered with synthetic material that tends to produce static, the relative humidity should be at least 30%.
Electrical fast transient/burst IEC 61000-4-4	± 2 kV for power supply lines ± 1 kV for input/output lines	Same as left	Mains power quality should be that of a typical commercial (original condition feeding the facilities) or hospital environment.
Surge IEC 61000-4-5	Differential mode: $\pm 0.5, \pm 1$ kV Common mode: $\pm 0.5, \pm 1, \pm 2$ kV	Same as left	Mains power quality should be that of a typical commercial or hospital environment.
Voltage dips, short interruptions and voltage variations on power supply input lines IEC 61000-4-11	$< 5\% U_T$ ($>95\%$ dip in U_T) for 0.5 cycle <hr/> $40\% U_T$ (60% dip in U_T) for 5 cycles <hr/> $70\% U_T$ (30% dip in U_T) for 25 cycles <hr/> $< 5\% U_T$ ($>95\%$ dip in U_T) for 5 seconds	Same as left	Mains power quality should be that of a typical commercial or hospital environment. If the user of this instrument required continued operation during power mains interruptions, it is recommended that this instrument be powered from an uninterruptible power supply or a battery.
Power frequency (50/60 Hz) magnetic field IEC 61000-4-8	3 A/m	Same as left	It is recommended to use this instrument by maintaining enough distance from any equipment that operates with high current.

NOTE

U_T is the a.c. mains power supply prior to application of the test level.

○ Cautions and recommended electromagnetic environment regarding portable and mobile RF communications equipment such as a cellular phones

Immunity test	IEC 60601-1-2 test level	Compliance level	Guidance
Conducted RF IEC 61000-4-6	3 V _{rms} (150 kHz - 80 MHz)	3 V (V ₁)	Formula for recommended separation distance (V ₁ =3 according to the compliance level) $d = \left[\frac{3.5}{V_1} \right] \sqrt{P}$
Radiated RF IEC 61000-4-3	3 V/m (80 MHz - 2.5 GHz)	3 V/m (E ₁)	Formula for recommended separation distance (E ₁ =3 according to the compliance level) $d = \left[\frac{3.5}{E_1} \right] \sqrt{P} \quad 80 \text{ MHz to } 800 \text{ MHz}$ $d = \left[\frac{7}{E_1} \right] \sqrt{P} \quad 800 \text{ MHz to } 2.5 \text{ GHz}$

NOTE

- Where “P” is the maximum output power rating of the transmitter in watts (W) according to the transmitter manufacturer and “d” is the recommended separation distance in meters (m).
- This instrument complies with the requirements of IEC 60601-1-2: 2001. However, under electromagnetic environment that exceeds its noise level, electromagnetic interference may occur on this instrument.
- Electromagnetic interference may occur on this instrument near a high-frequency electrosurgical equipment and/or other equipment marked with the following symbol:



○ **Recommended separation distance between portable and mobile RF communications equipment and this instrument**

Rated maximum output power of transmitter P (W)	Separation distance according to frequency of transmitter (m) (calculated as $V_1=3$ and $E_1=3$)		
	150 kHz - 80 MHz	80 MHz - 800 MHz	800 MHz - 2.5 GHz
	$d = 1.2\sqrt{P}$	$d = 1.2\sqrt{P}$	$d = 2.3\sqrt{P}$
0.01	0.12	0.12	0.23
0.1	0.38	0.38	0.73
1	1.2	1.2	2.3
10	3.8	3.8	7.3
100	12	12	23

NOTE

The guidance may not apply in some situations. Electromagnetic propagation is affected by absorption and reflection from structures, objects and people. Portable and mobile RF communications equipment such as cellular phones should be used no closer to any part of this instrument, including cables than the recommended separation distance calculated from the equation applicable to the frequency of the transmitter.



©2006 OLYMPUS MEDICAL SYSTEMS CORP. All rights reserved.
No part of this publication may be reproduced or distributed without the
express written permission of OLYMPUS MEDICAL SYSTEMS CORP.

OLYMPUS is a registered trademark of OLYMPUS CORPORATION.

Microsoft, Windows, Windows NT, PowerPoint, and MS-DOS are
either registered trademarks or trademarks of Microsoft Corporation in
the United States and/or other countries.

Other trademarks, product names, logos, or trade names used in this
document are generally registered trademarks or trademarks of each
company.



OLYMPUS®

Manufactured by



OLYMPUS MEDICAL SYSTEMS CORP.

2951 Ishikawa-cho, Hachioji-shi, Tokyo 192-8507, Japan
Fax: (042)646-2429 Telephone: (042)642-2111

Distributed by

OLYMPUS AMERICA INC.

3500 Corporate Parkway, P.O. Box 610, Center Valley, PA
18034-0610, U.S.A.
Fax: (484)896-7128 Telephone: (484)896-5000

OLYMPUS LATIN AMERICA, INC.

5301 Blue Lagoon Drive, Suite 290 Miami, FL 33126-2097, U.S.A.
Fax: (305)261-4421 Telephone: (305)266-2332



OLYMPUS EUROPA HOLDING GMBH

(Premises/Goods delivery) Wendenstrasse 14-18, 20097 Hamburg, Germany
(Letters) Postfach 10 49 08, 20034 Hamburg, Germany
Fax: (040)23773-4656 Telephone: (040)23773-0

KEYMED LTD.

KeyMed House, Stock Road, Southend-on-Sea, Essex SS2 5QH, United Kingdom
Fax: (01702)465677 Telephone: (01702)616333

OLYMPUS MOSCOW LIMITED LIABILITY COMPANY

117071, Moscow, Malaya Kaluzhskaya 19, bld. 1, fl.2, Russia
Fax: (095)958-2277 Telephone: (095)958-2245

OLYMPUS (BEIJING) SALES & SERVICE CO., LTD.

A8F, Ping An International Financial Center, No. 1-3, Xinyuan South Road,
Chaoyang District, Beijing, 100027 P.R.C.
Fax: (86)10-5976-1299 Telephone: (86)10-5819-9000

OLYMPUS KOREA CO., LTD.

Olympus-Tower, 114-9 Samseong-Dong, Gangnam-Gu, Seoul 135-090 Korea
Fax: (02)6255-3494 Telephone: (02)6255-3210

OLYMPUS SINGAPORE PTE LTD.

491B, River Valley Road #12-01/04, Valley Point Office Tower, Singapore 248373
Fax: 6834-2438 Telephone: 6834-0010

OLYMPUS AUSTRALIA PTY. LTD.

31 Gilby Road, Mount Waverley, VIC., 3149, Australia
Fax: (03)9543-1350 Telephone: (03)9265-5400

