



P-500 Digital Photo Printer



User Guide

Table of Contents

Kit Contents	1
Things You Should Know	2
Printer Features	3
Control buttons	3
Display panel	3
Side panel	3
Inserting the Shoulder Strap	4
Loading the Film Pack	4
Printing Digital Photos	6
Inserting the memory card	6
Setting the Print Queue	6
Tagging Images	8
Editing the Print Queue	10
Clearing the Print Queue	10
Troubleshooting	11
Printer does not function at all	11
Printer does not print when I press Print	11
Some images printed, but then the printer stopped	11
There is a problem with the memory card	12
There is a problem with the print queue	12
The printer is inoperable	12
Display Panel Messages	13
General	13
Memory Card	13
Film Errors	14
FCC Notice	15
Precautions	16
Printer Precautions	16
Film Precautions	16
Polaroid Customer Support	17
One Year Limited Warranty	17
EMC Statement (Europe)	17
Specifications	18

Kit Contents

The **Polaroid P-500 Digital Photo Printer** prints photos taken with your digital camera.

- a **P-500** Digital Photo Printer
- b Shoulder Strap
- c User's Guide, Quick Reference/Label, Registration Card
- d Polaroid 500 Instant Film

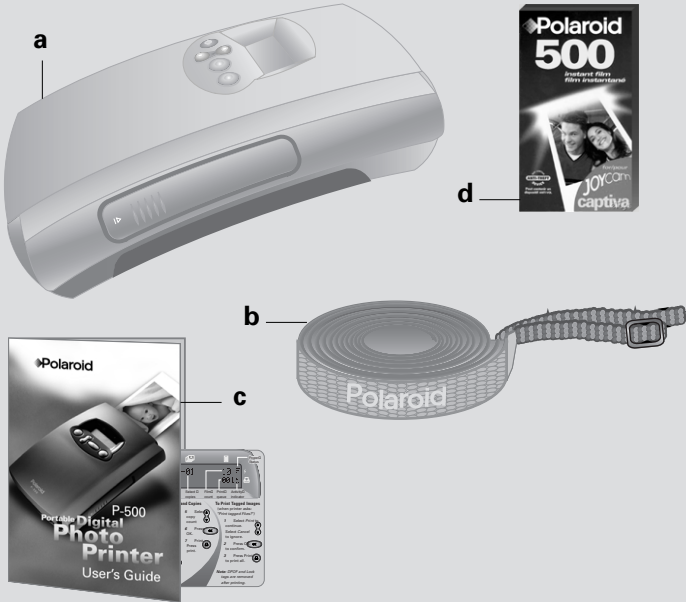

Things You Should Know

- **About removable memory cards.** The P-500 prints photos taken with most digital cameras using CompactFlash Type II & III or SmartMedia memory cards. The P-500 supports JPEG image files created by most digital cameras.
- **About the print queue.** The print queue is the sequence of images you select for printing.
- **About DPOF.** Your digital camera may have an advanced feature that allows you to tag selected images for printing. When you transfer the memory card to the P-500, you can print the tagged images without having to set the print queue. This guide refers to this feature as **DPOF** (digital print order format). Your camera manual may use another term such as *print set* or *direct print select*. See  **Tagging Images** on (page 8).
- **About Lock.** Your digital camera may have a lock feature that allows you to protect images from being deleted. When using **Lock**, an icon such as a key or check mark identifies these images. You may use the lock feature to tag images for printing with the P-500. If both DPOF and locked images are on the memory card, locked tags are ignored. See  **Tagging Images** on (page 8).
- For best quality photos, set your camera to the highest resolution when taking pictures.
- For best results, use the printer at temperatures above **55°F (13°C)**.
- Fill out and mail in your registration card. Sign up for a free online account to create and store images at: **www.PolaroidDigital.com**.

Printer Features

Control buttons

- a On/Off
- b Arrows/Select
- c OK/Confirm
- d Print

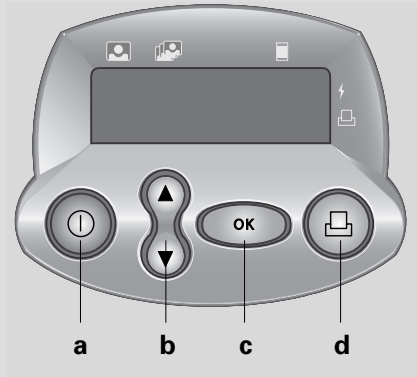

Display panel

The display panel indicates printer status.

- e Image number
- f Copy count
- g Film count
- h Power indicator
- i Print queue

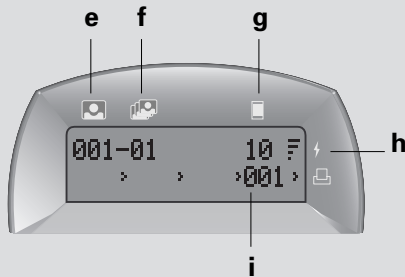

Side panel

- j Card eject button
- k Memory card slot
- l Film compartment door

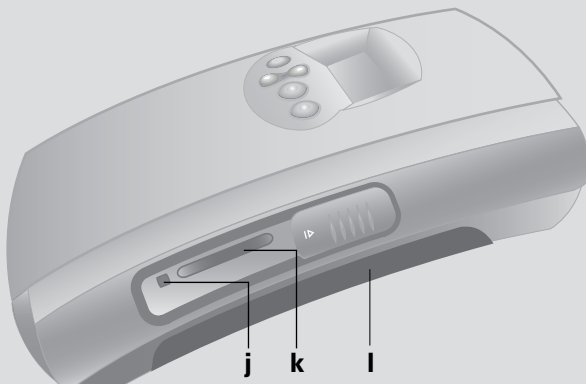

Inserting the Shoulder Strap

1 Insert strap as shown.

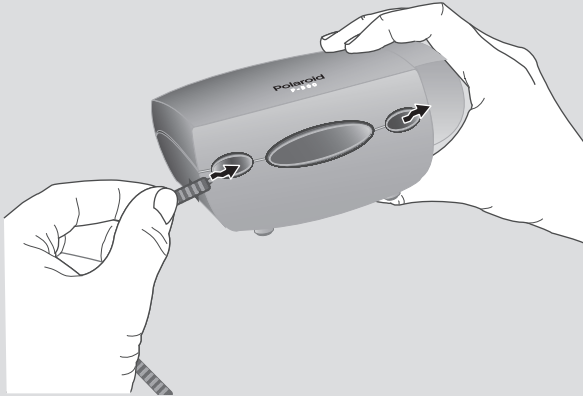

2 Push through and attach to other end.

Loading the Film Pack

Your printer uses Polaroid 500 instant film. The film pack contains the battery power for the printer.

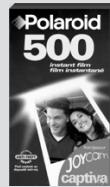

1 Open the film compartment as shown.

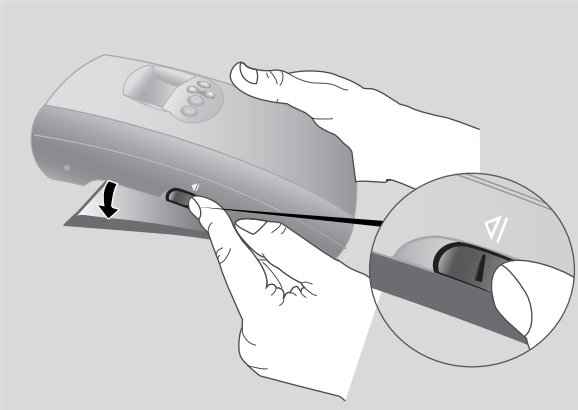

- 2** Slide the film pack carefully, film-side up, within the metal guides as shown.

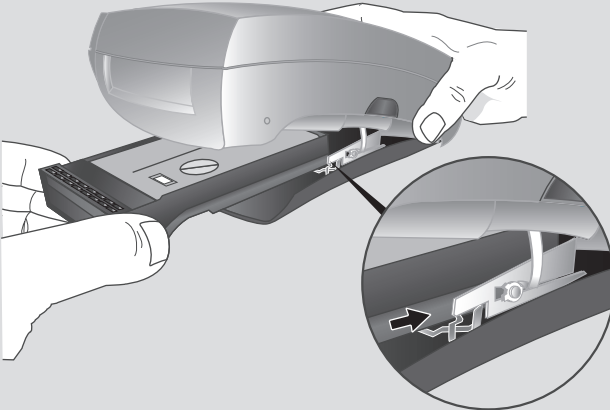

- 3** Close the film compartment door.

- 4** Press and hold . The film cover ejects.



Each time the film door opens, the film count resets to 10. If you insert a partially used film pack, the count will be inaccurate.

You should have enough battery power to print a full film pack. When the power level shows only the two smallest bars  you have a limited time to print your images.



To conserve battery life, the printer shuts down after several seconds of inactivity. To reactivate the printer press and hold . The printer retains your selections.

Printing Digital Photos

Inserting the memory card

Use the printer display panel to select images and that you want to print before or after inserting the memory card.

- 1 Slide open the memory card slot door. Insert the card, label-side up, into the slot.

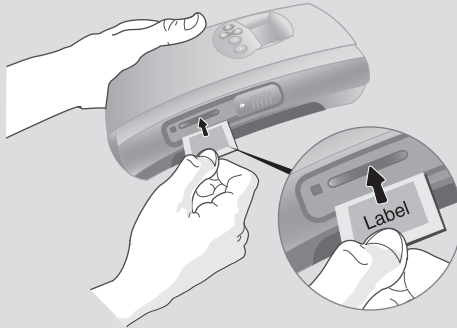

Note: SmartMedia requires an adapter. Insert the card into the adapter, and then the adapter into the printer.

Setting the Print Queue



- 1 Press and hold .

Note: The printer detects DPOF or Locked images, if any are present, and sets the print queue. To ignore this feature select **Cancel**. For more information see  **Tagging Images on page 8**.

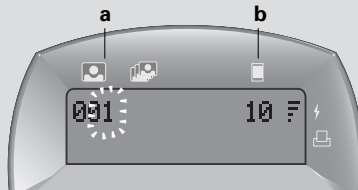
The Image Number (a) displays 000.





The film count (**b**) displays the frames available. You can program as many images as there are frames.

- 2 Select  the image number you want.
- 3 Press .

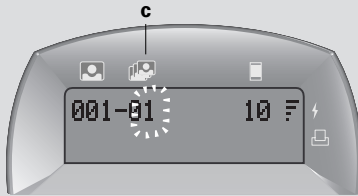
The Copies (**c**) field becomes active.



- 4 Choose  the number of copies you want.
The default number is 1.

- 5 Press .

The print queue (**d**) displays the image number. As you select more images, the film count shows the remaining frames available. You can queue more than four images, however the print queue displays the last images entered.



- 6 Press .

Each photo prints in several seconds.

Printing continues until the queue or the film pack is empty.

Tagging Images

You can select images for printing without setting the print queue using your digital camera's DPOF or Lock feature. Refer to your camera manual for details.

Note: If you want multiple copies of a locked image, set the print queue.

- 1 Using your camera's LCD (liquid crystal display), tag the images you want to print with either the DPOF or Lock feature.
- 2 Remove the memory card from your camera.
- 3 Slide open the memory card slot door. Insert the card, label-side up, into the slot.

Note: SmartMedia requires an adapter. Insert the card into the adapter, and then the adapter into the printer.

- 4 Press and hold .

The printer detects tagged image files.

The P-500 alerts you that it detects DPOF or Locked images. You may continue with, or ignore, this method of printing. The default setting is to continue to print tagged images.

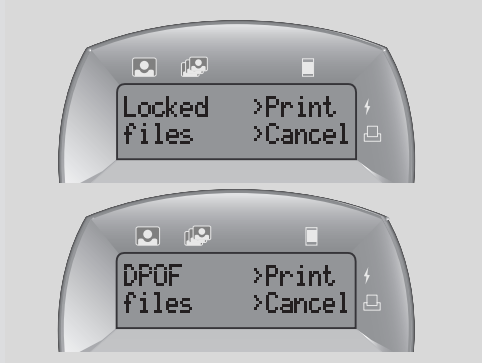



5 To print, press .

A message *Printing (#) of (#)* appears. Each photo prints in several seconds.

If the number of tagged files exceeds the number of frames available, a message such as: ***Print 10 of 15?*** indicates the total number of frames available (10) and the number of tagged files detected on your memory card (15).

6 Press  to continue.

Note: To ignore, select  **Cancel**. If you cancel, press  and see  **Editing the Print Queue** (page 10).



All tags are removed after printing.

Editing the Print Queue

If you are not printing tagged images you can edit the print queue before you press print to adjust your selections.

1 Select  the image number requiring adjustment.

2 Press .

The copies field becomes active and indicates the current number of selected copies.

3 Adjust  the number of copies.

4 Press .

Note: To clear an image number from the print queue, set the copy count to zero and press .

Clearing the Print Queue

You can clear the queue any time. If you have pressed Print, the current photo will finish printing before the P-500 shuts down.

- Press .

Troubleshooting

Printer does not function at all.

The film pack is not in the printer.

- Load the film pack into the printer.

The battery in the film pack is too low or dead.

- Replace the film pack.

Environment is very cold, causing reduced performance.

- If using the printer at temperatures below $55^{\circ}\text{F}(13^{\circ}\text{C})$, keep film packs warm, then load just before use.

Printer does not print when I press Print .

The default image number is "000."

- Select an image to print.

The film pack is jammed.

- Open the film compartment, clear the jam, and turn the printer on. The exposed frame ejects.

The film pack is empty.

- Insert a new film pack.

The battery in the film pack is too low or dead.

- Replace the film pack.

Some images printed, but then the printer stopped.

A partially used film pack was loaded which defaults the film count to 10. Although the printer allowed you to program 10 images, the film ran out.

- Insert a new film pack.

The battery in the film pack is too low.

- Replace the film pack.

▣▣▣▣ **There is a problem with the memory card.**

The card is in the printer, but it still will not print.

- The printer is compatible with Type II and III CompactFlash and SmartMedia cards only. Check your memory card for compatibility.
- Remove the memory card, and check the images in your camera. Reinsert the card into the printer if the image files you want to print are on the card.

The card is unreadable.

- Stored images may have been corrupted. Remove the card and reformat it, or use another card.
- Images may not be in JPEG format. Check the file format.

▣▣▣▣ **There is a problem with the print queue.**

The print queue displays a number of frames remaining, however, the photos will not print.

- The default setting for all film-packs loaded into the camera is 10. It's possible that a partially used film pack was inserted into the printer and less than 10 frames were available. Insert a new film pack.

The print queue will not accept all my images.

- The printer will allow you to queue as many images as there is film available. Insert a new film pack.

The wrong print came out.

- Recheck the image number using your camera's LCD. Certain digital cameras create image files in a method not supported by the P-500. If you encounter a conflict, go to online support at **PolaroidDigital.com**; or call Polaroid Customer Support at **1.800.897.0356**.

▣▣▣▣ **The printer is inoperable .**

- If you encounter problems operating the printer, open the film door and restart the printer. For help go to online support at **PolaroidDigital.com**; or call Polaroid Customer Support at **1.800.897.0356** for further assistance.

Display Panel Messages

To clear any message on the display, Press OK to continue.

General

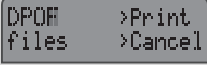
<i>Message</i>	<i>Explanation</i>	<i>Resolution</i>
	The printer detects Locked or DPOF files when you turn on the printer. The default selection is Print.	To Print, press OK; to ignore and manually set the print queue, select Cancel, then press OK.
		
<i>Press Print</i>	Queue is full. You can print as many photos as there is film available up to a maximum of 10.	To continue, press Print.
<i>Select Image #</i>	Default image number is 0, printer needs information.	Select image numbers then press Print.
<i>Temp error</i>	Printer operates best at temperatures above 55 °F.	Warm film.

Memory Card

<i>Message</i>	<i>Explanation</i>	<i>Resolution</i>
<i>No card</i>	Memory card has not been transferred to the printer.	Insert memory card.

Memory Card *(continued)*

Message	Explanation	Resolution
<i>Card error</i>	An unrecognized memory card has been inserted into the printer.	Use only Compact-Flash Type II & III (2-128 megabyte) or SmartMedia removable memory cards with this printer.
<i>### invalid</i>	Queue entry for image number not found.	Printer will skip invalid image # and move on to next image in queue.
<i>Q #_ Bad fread error???</i>	Unreadable files (corrupted, non-JPEG format), prevent the printer from operating.	Remove the card and if possible, view the contents in your computer. Remove non-JPEG files and try printing again. If the problem continues, try using another card. If problem continues, contact customer service.
<i>jbuffer overflow</i>	There may be a discrepancy between image numbering in your camera and the P-500.	

Film Errors

Message	Explanation	Resolution
<i>Insert Film</i>	All available frames have been printed.	Insert new film pack

FCC Notice

This equipment has been tested and found to comply with the limits for a Class B digital device, pursuant to part 15 of the FCC Rules.

WARNING: Changes or modifications to this unit not expressly approved by the party responsible for compliance could void the user's authority to operate the equipment. Note: This equipment has been tested and found to comply with the limits for a Class B digital device, pursuant to Part 15 of the FCC rules. These limits are designed to provide reasonable protection against harmful interference when the equipment is operated in a residential installation. This equipment generates, uses, and can radiate radio frequency energy and, if not installed and used in accordance with the instruction manual, may cause harmful interference to radio communications. However, there is no guarantee that interference will not occur in a particular installation. If this equipment does cause harmful interference to radio or television reception, which can be determined by turning the equipment off and on, the user is encouraged to try to correct the interference by one or more of the following measures:

- Reorient or relocate the receiving antenna.
- Increase the separation between the equipment and receiver.
- Connect the equipment into an outlet on a circuit different from that to which the receiver is connected.
- Consult the dealer or an experienced radio TV technician for help.

Precautions

Printer Precautions

Observe the following precautions when using the Polaroid Digital Photo Printer:

- Do not open the printer case or attempt your own repairs. High-voltage internal components create the risk of electrical shock when exposed. Contact **Polaroid Customer Service** for repair information.

Film Precautions

This printer is powered by batteries contained within the film pack. Supervise children when printer is operated by them or used in their presence. To avoid electrical shock, do not expose to or immerse in water or other fluids, disassemble, or operate if dropped or damaged. Contact **Polaroid Customer Service** for repair information.

This film uses a caustic paste. Avoid contacting skin, eyes, or mouth with the paste. **If you get some paste on your skin, eyes, or mouth, wipe it off immediately, wash with water to avoid an alkali burn and consult a doctor.** Do not cut or take apart photos or battery. Do not burn battery or allow metal to touch its terminals. Keep discarded materials, or paste away from children, animals, clothing, and furniture.

Polaroid Customer Support

Internet: www.PolaroidDigital.com

Telephone: 1-800-897-0356, (U.S.A.)

You can call Polaroid toll-free within the U.S.A., 7 days a week, 8 A.M. to 8 P.M. Eastern Standard Time. Please identify the Polaroid product and if possible, its serial number.

We offer a variety of Customer Support Services. Call us for details and applicable fees.

Outside the U.S.A., contact the Polaroid office nearest you.

One Year Limited Warranty

Polaroid will, at our option, repair or replace any unit found defective in manufacture within the warranty period. The warranty period is determined by the date of purchase. Keep the receipt as proof of purchase. Otherwise, the warranty period is determined by the date of manufacture.

This warranty does not apply to damage caused by accident, misuse or tampering, and excludes all consequential damages except in jurisdictions not allowing such exclusions or limitations.

EMC Statement (Europe)

Polaroid Corporation certifies that this product conforms to the following standards:

EMC

89/336/EEC EMC Directive

EN 55022, Class B

EN 50082-1

Specifications

- No PC required
- No batteries required
- No cables required
- Image format: JPEG
- On-board alpha-numeric and text (English only) status display
- Supports DPOF and image lock
- Print quality: Full color continuous tone prints
- Automatic image enhancement
- Film type: Polaroid 500 Instant film
- Image size: 2.15" x 2.86" (54.6mm x 72.6mm)
- Print time: < 20 seconds
- Prints multiple copies of a single image
- Compatibility: all digital cameras using CompactFlash Association (CFA) certified TYPE II & III (2-128 megabyte) or SmartMedia (requires adapter) removable memory cards.
- Size: 4.75" x 7.25"H x 2.35"H (121mm x 184mm x 60mm)
- Weight: 18 oz. (.55kg)
- Optimal operating temperature range: 55°F to 104°F

Polaroid

©2000 Polaroid Corporation, Cambridge, MA 02139, U.S.A., owner of the trademark "Polaroid". All other product names may be the property of their respective owners. All rights reserved.
Printed in the U.S.A. PU-21674M-0