

Service Service Service



Service Manual

TABLE OF CONTENTS

	Chapter
Technical Specification and Service hints.....	1
Safety Instructions.....	2
Instructions for Use.....	3
Mechanical Instructions.....	4
Exploded view and Service parts list.....	5
Troubleshooting flow.....	6
Overall Block diagram.....	7
Overall Electrical diagram.....	8
Revision list.....	9

©Copyright 2005 Philips Consumer Electronics B.V. Eindhoven, The Netherlands
All rights reserved. No part of this publication may be reproduced, stored in a retrieval system or transmitted, in any form or by any means, electronics, mechanical, photocopying, or otherwise without the prior permission of Philips

3141 785 30701

1.0 TECHNICAL SPECIFICATION and SERVICE HINTS

General

Dimensions (WxHxD) :	53.7 X 86.0 X 16.3 mm (2.11 x 3.39 x 0.64 inch)
Weight :	87 g
Output power :	2 x 5 mW (16 Ohm)
Frequency response :	20 – 16 000 Hs
Equalizer :	5-bands
Hard disk :	
Capacity :	4GB – 6GB
Display :	128 x 128 pixels, 65K color
Backlight :	White
Battery :	630 mAh Li-Ion rechargeable battery
Battery life time:	>16hrs
File transfer rate using USB2.0 :	>4Mbyte
Battery charging current	450mA
Maximum charging time :	4hr
Battery cutoff voltage:	3.7V
Connections:	Headphone Line Out Jack Power Connector

Battery level detection

Detection Level	Typ.
4-step to 3-step voltage	3.6 – 3.7V
3-step to 2-step voltage	3.53 – 3.6V
2-step to 1-step voltage	3.48 – 3.53V
Force Power Off voltage	<3.5V

Current consumption

DC-IN SUPPLY (4.5V)	
Battery Charging Current	450mA
BATT. SUPPLY (3.7V)	
Power Off	300uA
Idle	30mA
Playback without HDD reading	30mA
Playback with HDD reading	345mA
File transfer using USB2.0	350mA

Headphone out (headphone output load 2x16 ohm)

Maximum output power :	10 mW
Frequency response :	45Hz – 16kHz (16Ω load) 20Hz – 16kHz (15kΩ load)
SNR (A-wght) :	85dB
THD (1kHz) :	0.1%
Left-Right Channel	45dB typ. (1k Hz)
Separation :	40dB typ. (20Hz – 16kHz)
Left-Right Channel	<1.0dB (1k Hz)
Balance :	<2.0dB (20Hz – 16kHz)

Supported playback format

MP3 :	8 - 320 Kbps and VBR
WMA :	32 - 192 Kbps
Sample rates :	8, 11.025, 16, 22.050 32, 44.1, 48

ID3-tag support : Yes
 PC Connectivity : USB
 File Transfer
 via **Windows Media Player 10** for music and picture playback or Windows Explorer for general data (music playback disabled)

Firmware and software upgrades

1. If you have not already installed the Device Manager download the latest version of the Device Manager from <http://www.philips.com/support>. You may need to enter your language preference and the model number e.g.HDD1630, to access the Device/Firmware Manager upgrade file.
2. Download the zip file into a temp folder in your computer. Unzip the file and then double click the Setup.exe file to start the installation of the Device Manager.
3. Once the installation is complete, connect the GoGear to the power supply with the AC/DC adapter.
4. Make sure all other applications such as Philips Device plug-in, Windows Media Player or Windows Explorer that accessing the device are closed or else Device Manager will not recognize the device. Launch the **Philips Device Manager** at **Start->Programs->Philips Device Manager->Philips Device Manager** on your PC.
5. Click **Update** in the dialogue box



the **Philips Device Manager** will detect the connection of your GoGear and the application will automatically check on the server to see if an update is available and prompt user to download the updated firmware. Click **YES** to start the downloading.

1.0 TECHNICAL SPECIFICATION and SERVICE HINTS



6. A status bar will show the downloading progress of the firmware. Once the downloading is complete the application will prompt you to install the update onto your GoGear. Click **YES** to confirm

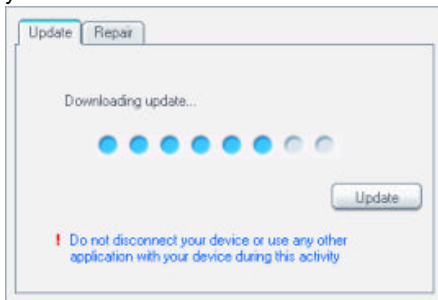

7. The application will show the status of updating and at the end you need to click OK to complete the update.

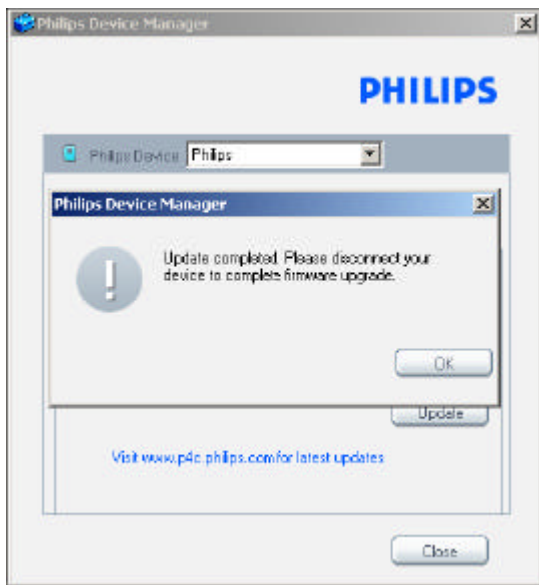

(Please do not disconnect the jukebox during the upgrading process as this interruption may damage the firmware!)

8. Follow all screen instructions to complete the firmware

upgrade.

9. The Device Manager will close automatically once the success message is displayed. Close all opened application and then unplug your GoGear.
10. Once the GoGear micro jukebox is disconnected from the computer, the display will show "Firmware Upgrading" for a couple of seconds and then start up as usual. If the message does not disappear after 2 minutes, do a soft reset by pressing and holding the Power on/off key and the volume + key for a couple of seconds.

Repair the firmware with Device Manager

1. If you have not already installed the Device Manager download the latest version of the Device Manager from <http://www.philips.com/support>. You may need to enter your language preference and the model number e.g.HDD1630, to access the Device/Firmware Manager upgrade file.
2. Download the zip file into a temp folder in your computer. Unzip the file and then double click the Setup.exe file to start the installation of the Device Manager.
3. Once the installation is complete, connect the GoGear to the power supply with the AC/DC adapter.
4. Make sure all other applications such as Philips Device plug-in, Windows Media Player or Windows Explorer that accessing the device are closed or else Device Manager will not recognize the device. Launch the **Philips Device Manager** at **Start->Programs->Philips Device Manager->Philips Device Manager** on your PC.



1.0 TECHNICAL SPECIFICATION and SERVICE HINTS



5. Click YES to start the downloading. A status bar will show the downloading progress of the firmware. Once the downloading is complete the application will prompt you to install the update onto your GoGear.

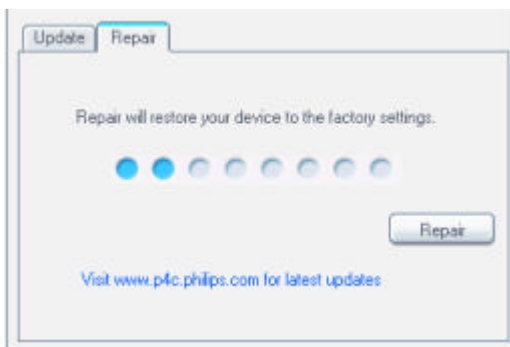

6. Once the repair is complete a dialogue box will pop up; click OK and unplug the GoGear from the computer.

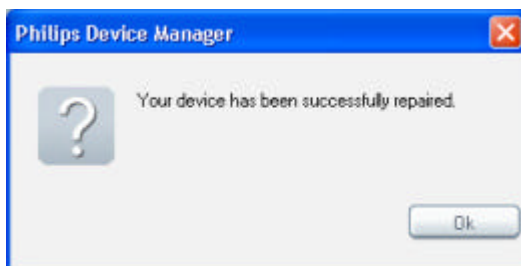

IMPORTANT: All music & content of your micro jukebox will be erased once the factory setting is restored.

7. Follow all screen instructions to complete the repair.
8. The Device Manager will close automatically once the success message is displayed. Close all opened application and then unplug your micro jukebox.
9. Once the GoGear micro jukebox is disconnected from the computer, the display will show "Firmware Upgrading" for a couple of seconds and then start up as usual.

Service Hints

Re Build database, firmware and Microsoft (Plays For Sure) copy protection key after replacement of hard disk or PCBA

IMPORTANT: All devices having the hard disk or PCBA replaced must have the firmware image, database and the Plays For Sure key rebuilt before returning to customers.

1. Connect the GoGear to the power supply and the computer with the combined charger and USB cable.
2. Reset the device by pressing and holding down the Volume + and the power on/off slider switch until the display turns off.
3. While the device restart, press and hold the volume - key until the Philips splash screen disappear and showing the connection icon to put the device in USB Mass Storage Device mode.

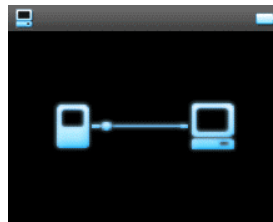

4. The device will be listed as a new drive named GOGEAR or MDJUKEBOX in Windows Explorer.



5. Launch Windows Explorer and then quick format the new drive to the file system FAT32.

1.0 TECHNICAL SPECIFICATION and SERVICE HINTS

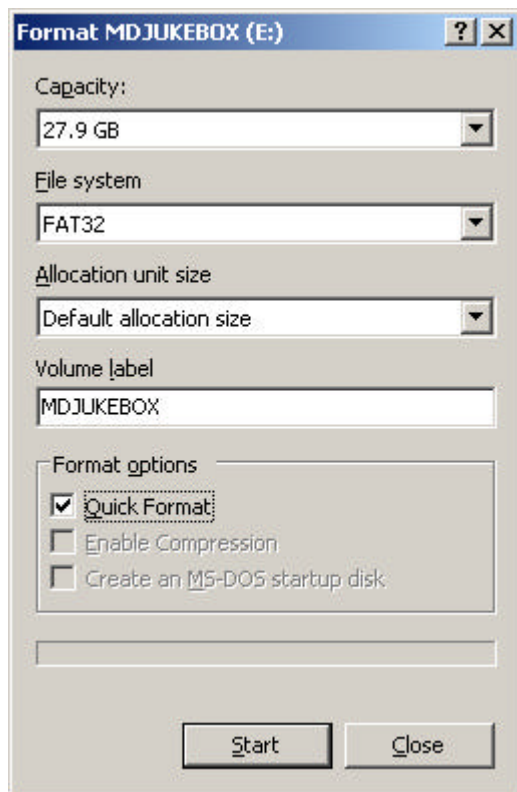

IMPORTANT: All music & content of your micro jukebox will be erased once the device is formatted.

6. Unzip and copy all the content of the shipment ui files of the corresponding model version into the root directory of the device. **(CD ROM with the Shipment ui files will be provided to repair workshops.)**
7. Disconnect the GoGear from the computer by clicking on the safely remove hardware  icon on the task tray.
8. Wait until the display shows "Burn success".
9. Reset the device again by pressing and holding down the Volume + and the power on/off slider switch until the display turns off.
10. Upgrade the firmware of the device to the latest version by following the procedure as mentioned under "Firmware software upgrades"

2.0 SAFETY INSTRUCTIONS

GB WARNING

All ICs and many other semi-conductors are susceptible to electrostatic discharges (ESD). Careless handling during repair can reduce life drastically. When repairing, make sure that you are connected with the same potential as the mass of the set via a wrist wrap with resistance. Keep components and tools also at this potential.

F ATTENTION

Tous les IC et beaucoup d'autres semi-conducteurs sont sensibles aux décharges statiques (ESD). Leur longévité pourrait être considérablement écourtée par le fait qu'aucune précaution n'est prise à leur manipulation. Lors de réparations, s'assurer de bien être relié au même potentiel que la masse de l'appareil et enfilez le bracelet serti d'une résistance de sécurité. Veiller à ce que les composants ainsi que les outils que l'on utilise soient également à ce potentiel.

D WARNUNG

Alle ICs und viele andere Halbleiter sind empfindlich gegenüber elektrostatischen Entladungen (ESD). Unsorgfältige Behandlung im Reparaturfall kann die Lebensdauer drastisch reduzieren. Veranlassen Sie, dass Sie im Reparaturfall über ein Pulsarmband mit Widerstand verbunden sind mit dem gleichen Potential wie die Masse des Gerätes. Bauteile und Hilfsmittel auch auf dieses gleiche Potential halten.

ESD



NL WAARSCHUWING

Alle IC's en vele andere halfgeleiders zijn gevoelig voor electrostatische ontladingen (ESD). Onzorgvuldig behandelen tijdens reparatie kan de levensduur drastisch doen verminderen. Zorg ervoor dat u tijdens reparatie via een polsband met weerstand verbonden bent met hetzelfde potentiaal als de massa van het apparaat. Houd componenten en hulpmiddelen ook op ditzelfde potentiaal.

I AVVERTIMENTO

Tutti IC e parecchi semi-conduttori sono sensibili alle scariche statiche (ESD). La loro longevità potrebbe essere fortemente ridotta in caso di non osservazione della più grande cauzione alla loro manipolazione. Durante le riparazioni occorre quindi essere collegato allo stesso potenziale che quello della massa dell'apparecchio tramite un braccialetto a resistenza. Assicurarsi che i componenti e anche gli utensili con quali si lavora siano anche a questo potenziale.

GB

Safety regulations require that the set be restored to its original condition and that parts which are identical with those specified, be used.

"Pour votre sécurité, ces documents doivent être utilisés par des spécialistes agréés, seuls habilités à réparer votre appareil en panne".

NL

Veiligheidsbepalingen vereisen, dat het apparaat bij reparatie in zijn oorspronkelijke toestand wordt teruggebracht en dat onderdelen, identiek aan de gespecificeerde, worden toegepast.



F

Les normes de sécurité exigent que l'appareil soit remis à l'état d'origine et que soient utilisés les pièces de rechange identiques à celles spécifiées.

GB Warning !

Invisible laser radiation when open. Avoid direct exposure to beam.

D

Bei jeder Reparatur sind die geltenden Sicherheitsvorschriften zu beachten. Der Originalzustand des Geräts darf nicht verändert werden; für Reparaturen sind Original-Ersatzteile zu verwenden.

S Varning !

Osynlig laserstrålning när apparaten är öppnad och spärrar är urkopplad. Beträkta ej strålen.

I

Le norme di sicurezza esigono che l'apparecchio venga rimesso nelle condizioni originali e che siano utilizzati i pezzi di ricambio identici a quelli specificati.

SF Varoitus !

Avatussa laitteessa ja suojalukituksen ohitettaessa olet alltiina näkymättömälle laserisäteilylle. Älä katso säteeseen!

DK Advarse !

Usynlig laserstrålning ved åbning når sikkerhedsafbrydere er ude af funktion. Undgå udsættelse for strålning.

"After servicing and before returning set to customer perform a leakage current measurement test from all exposed metal parts to earth ground to assure no shock hazard exist. The leakage current must not exceed 0.5mA."

3.0 INSTRUCTION FOR USE

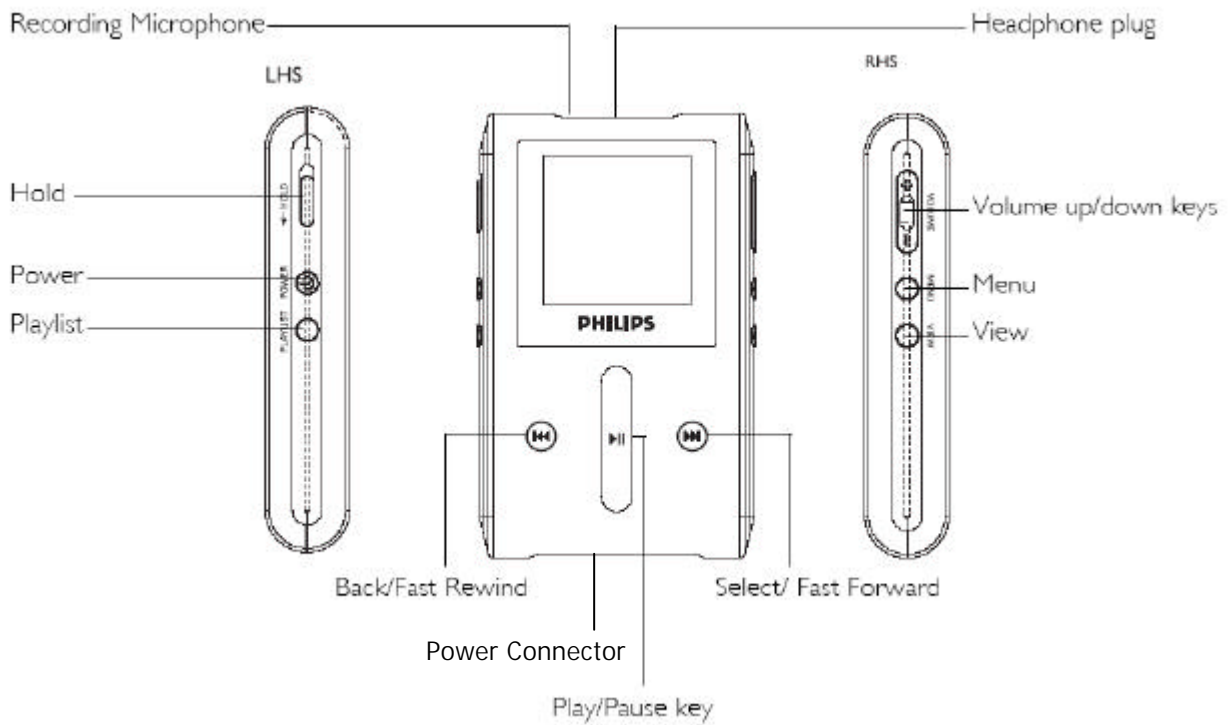

Press this	To
⏻ POWER (about 3 seconds)	Power on / off
HOLD	Lock all touch control keys
▶	Play / Pause songs
◀◀	Back / Fast rewind
▶▶	Select / Fast forward
+ VOLUME -	Control volume
VERTICAL TOUCH STRIP	Scroll through lists
MENU	Access list of menu options
VIEW	Switch between library and play screen
PLAYLIST	Add song to "Playlist on the go"

4.0 MECHANICAL INTRUCTIONS

Set Disassembly



1. Remove the cosmetic screw on the back cover by Allen Key.



2. Finger inset the gap of the top cover assy and the housing, and then carefully lift up the top cover.



3. Generally remove the housing.



4. Remove the 4 screws on four corners. See pointed arrows.

4.0 MECHANICAL INTRUCTIONS



5. Carefully pull out the mainboard assy, which include the HDD drive, LCD, battery and PCBA board.

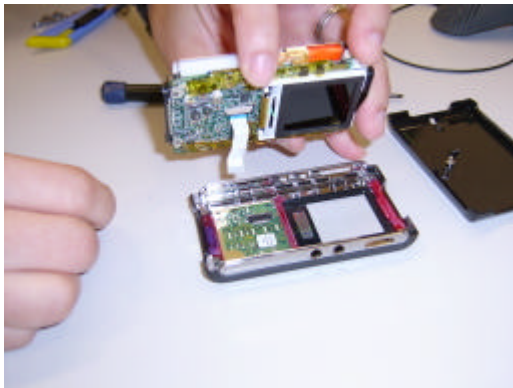

6. Disconnect the flex cable from the front touch screen module carefully, then free the top cover assy.

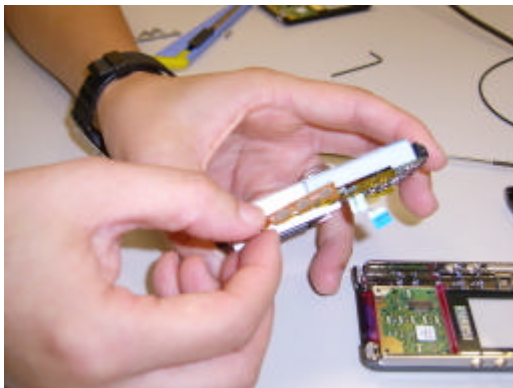

7. Lift up the double side tape of the side buttons.

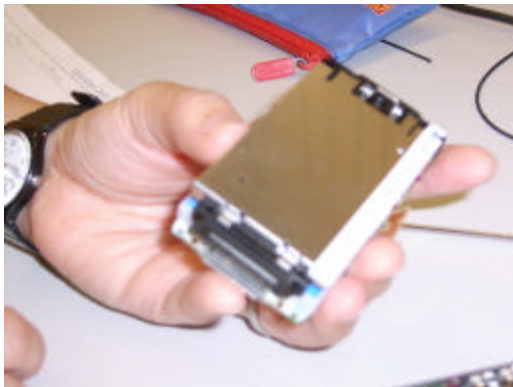

8. Turn to the bottom side.

4.0 MECHANICAL INTRUCTIONS



9. Open up the metal shielding and disconnect the cable connected to the battery. Carefully disassemble the mini mic as circled in the picture from the plastic audio jack holder.



10. Remove the battery part form PCBA.



11. Lift up the hard disk and disconnect the flex cable underneath from the PCBA.



12. After remove both battery and hard disk.

5.0 EXPLODED VIEW AND SERVICE PARTS LIST

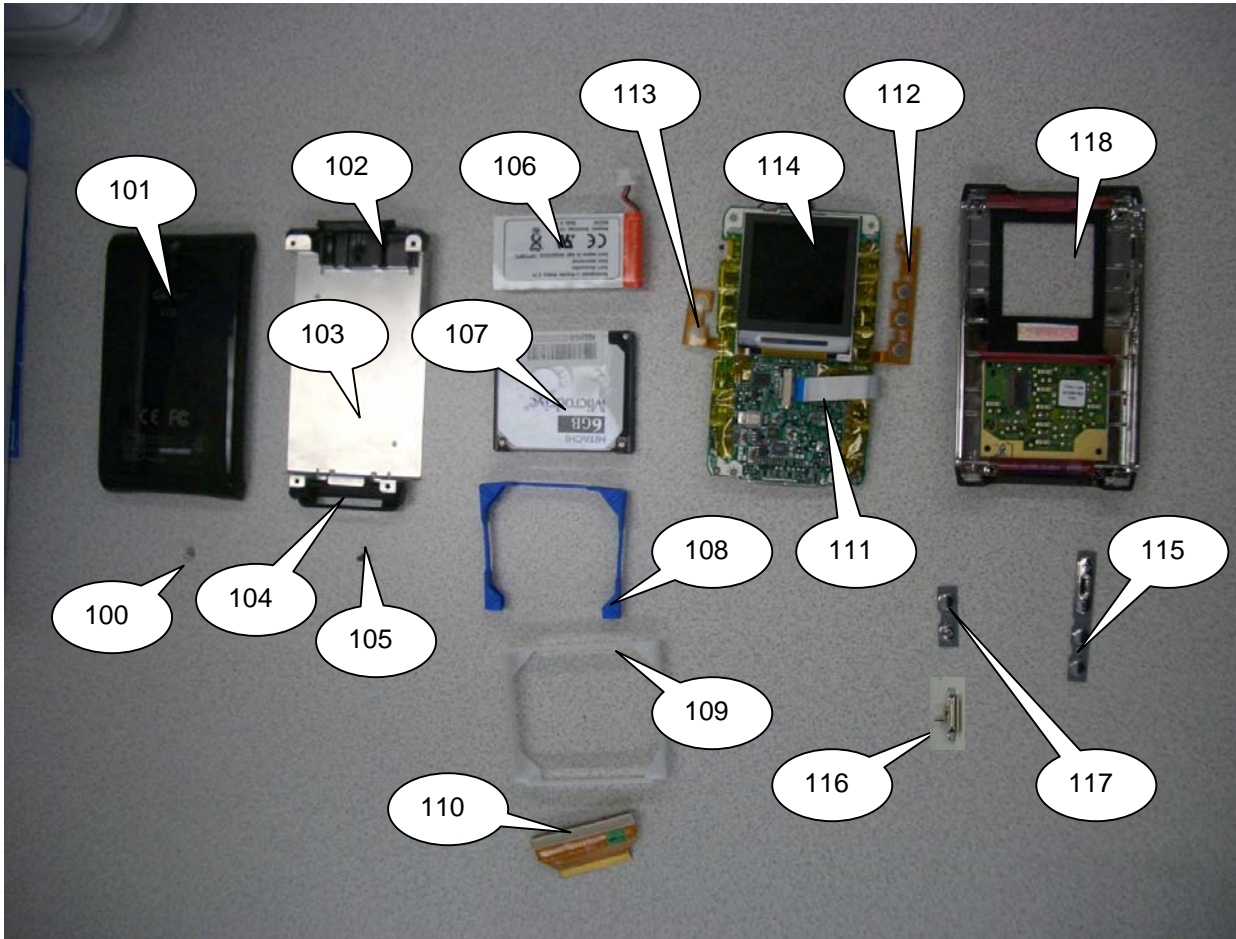

MECHANICAL PARTS

100	994000003554	COSMETIC SREW PHOENIX
101	994000003555	BACK CABINET PHOENIX
102	994000003559	AUDIO JACK HOLDER ASSY
103	994000003556	SHIELDING PHOENIX
104	994000003572	CRADLE HOLDER PHOENIX
105	994000003558	SCREW 1.7X5 PHOENIX
106	994000003557	BATTERY PACK PHOENIX
107	282206200084	HDD 4GB (HDD1420/00)
	282206200079	HDD 6GB (HDD1620/00/05, HDD1630/17 & HDD1635/17)
108	994000003563	HDD DAMPER PHOENIX
109	994000003564	HDD HOLDER PHOENIX
110	994000003568	HD FPC PHOENIX
111	994000003565	FFC PHOENIX
112	994000003566	KEY FPC 1 PHOENIX
113	994000003567	KEY FPC 2 PHOENIX
114	994000003569	PCBA W/Z RADIO LCD PHOENIX (HDD1630/17 & HDD1635/17)
	994000003571	PCBA W/O RADIO LCE PHOENIX (HDD1420/00 & HDD1620/00/05)
115	994000003573	RIGHT SIDE KEYPAD PHOENIX
116	994000003574	HOLD KEY PHOENIX
117	994000003575	LEFT SIDE KEYPAD PHOENIX
118	994000003576	HOUSING TOUCHPAD PHOENIX

MISCELLLENEOUS

994000003527	EARPHONE SHE9500
994000003577	AC ADAPTOR AD7150/00
994000003578	AC ADAPTOR AD7153/17
994000003579	AC ADAPTOR AD715B/05
994000003791	CRADLE ASSY PHOENIX (HDD1635/17)

5.0 EXPLODED VIEW AND SERVICE PARTS LIST

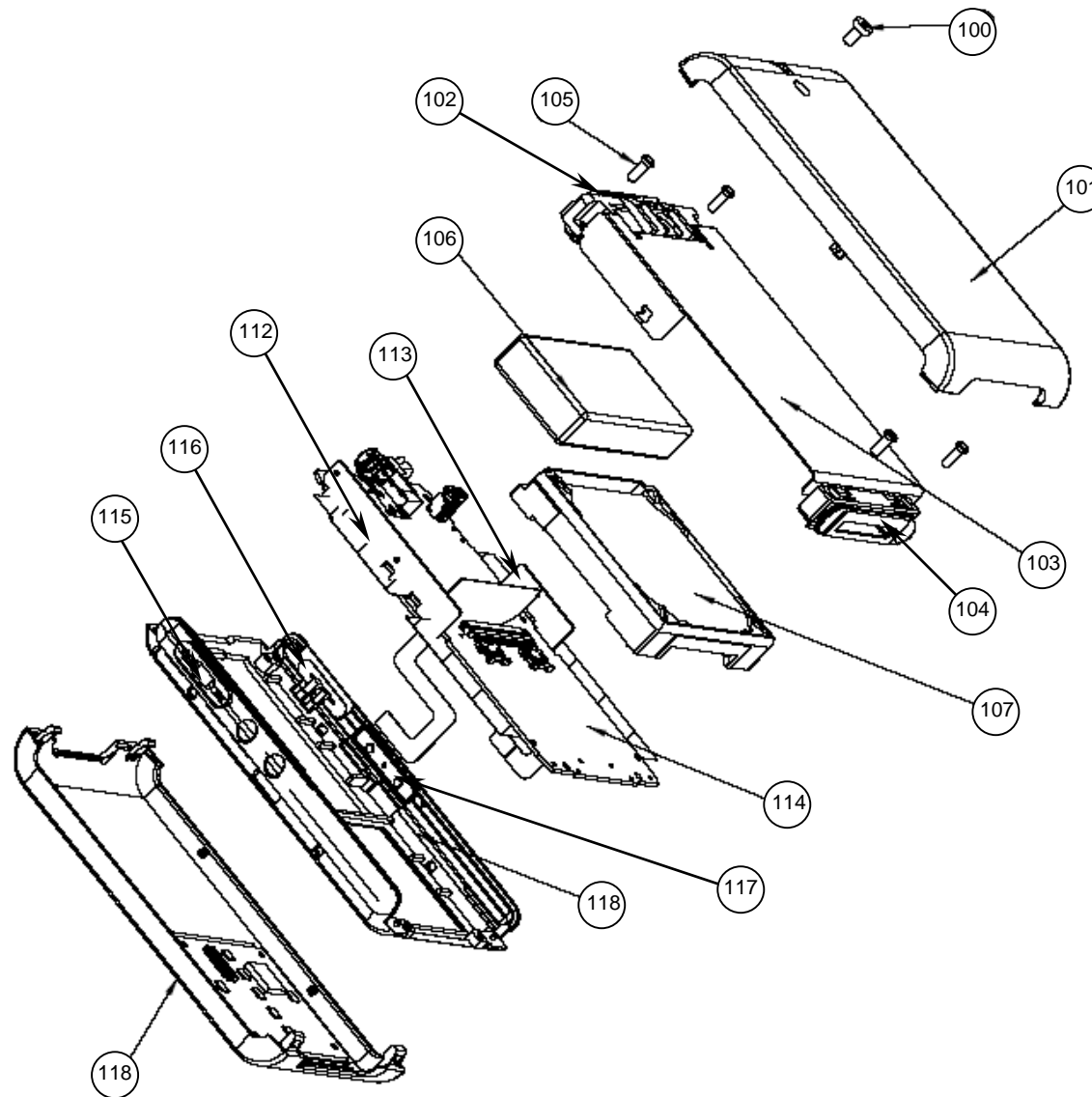

MECHANICAL PARTS

100	994000003554	COSMETIC SREW PHOENIX
101	994000003555	BACK CABINET PHOENIX
102	994000003559	AUDIO JACK HOLDER ASSY
103	994000003556	SHIELDING PHOENIX
104	994000003572	CRADLE HOLDER PHOENIX
105	994000003558	SCREW 1.7X5 PHOENIX
106	994000003557	BATTERY PACK PHOENIX
107	282206200084	HDD 4GB (HDD1420/00)
	282206200079	HDD 6GB (HDD1620/00/05, HDD1630/17 & HDD1635/17)
108	994000003563	HDD DAMPER PHOENIX
109	994000003564	HDD HOLDER PHOENIX
110	994000003568	HD FPC PHOENIX
111	994000003565	FFC PHOENIX
112	994000003566	KEY FPC 1 PHOENIX
113	994000003567	KEY FPC 2 PHOENIX
114	994000003569	PCBA W/Z RADIO LCD PHOENIX (HDD1630/17 & HDD1635/17)
	994000003571	PCBA W/O RADIO LCE PHOENIX (HDD1420/00 & HDD1620/00/05)
115	994000003573	RIGHT SIDE KEYPAD PHOENIX
116	994000003574	HOLD KEY PHOENIX
117	994000003575	LEFT SIDE KEYPAD PHOENIX
118	994000003576	HOUSING TOUCHPAD PHOENIX

MISCELLNEOUS

994000003527	EARPHONE SHE9500
994000003577	AC ADAPTOR AD7150/00
994000003578	AC ADAPTOR AD7153/17
994000003579	AC ADAPTOR AD715B/05
994000003791	CRADLE ASSY PHOENIX (HDD1635/17)

6.0 TROUBLESHOOTING FLOW

SYMPTOM 1: NO POWER

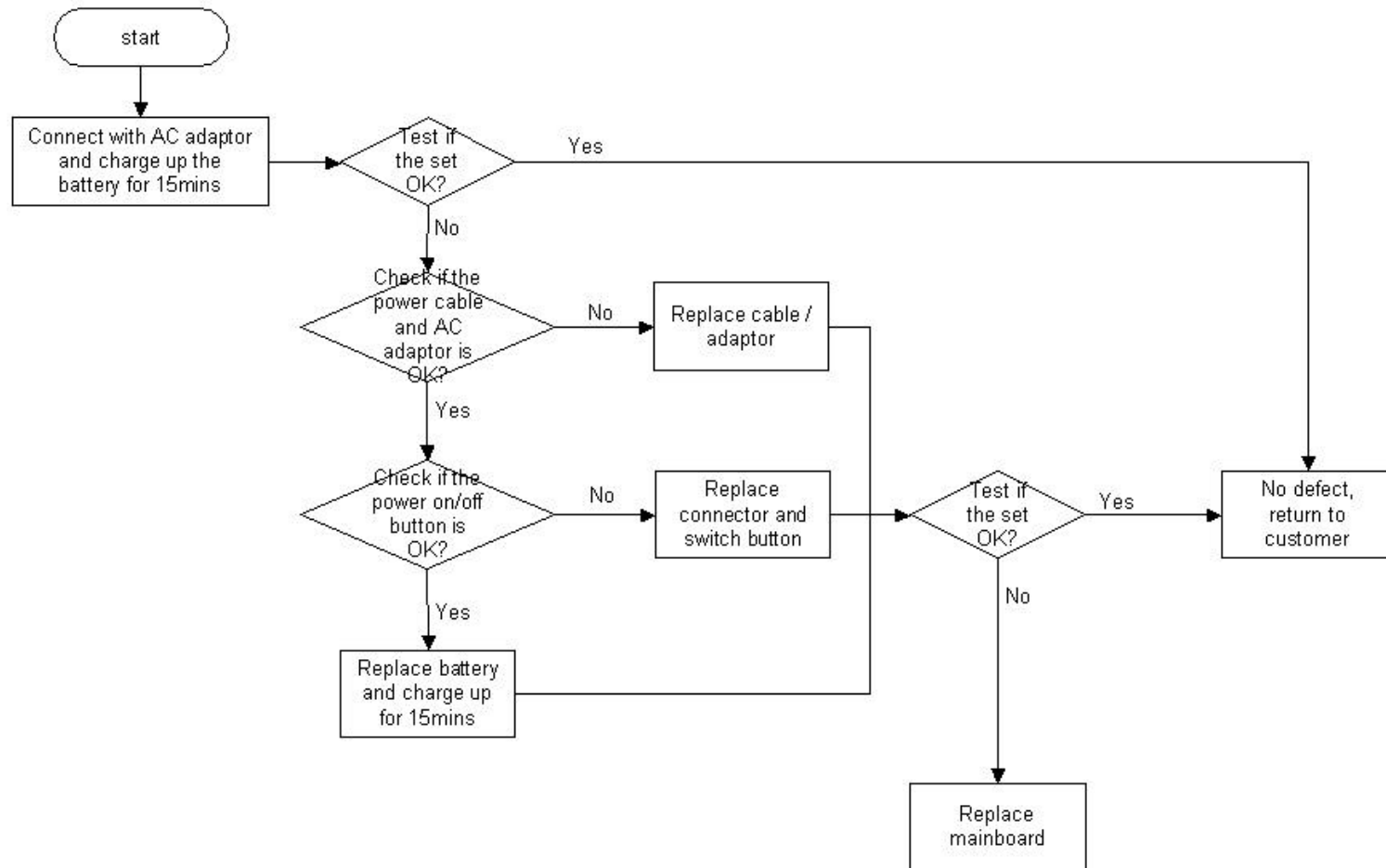

6.0 TROUBLESHOOTING FLOW

SYMPTOM 2: JUKEBOX FREEZES / HANGS UP

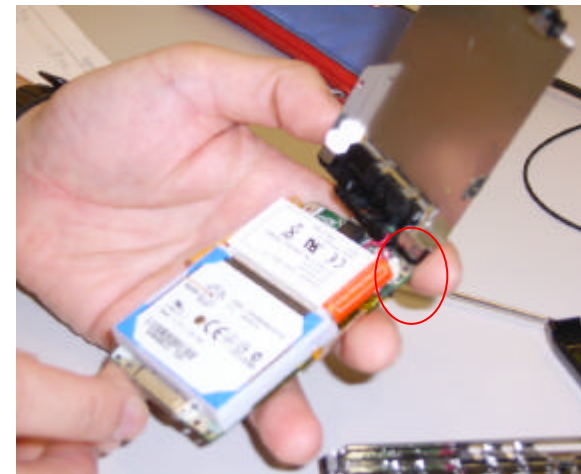
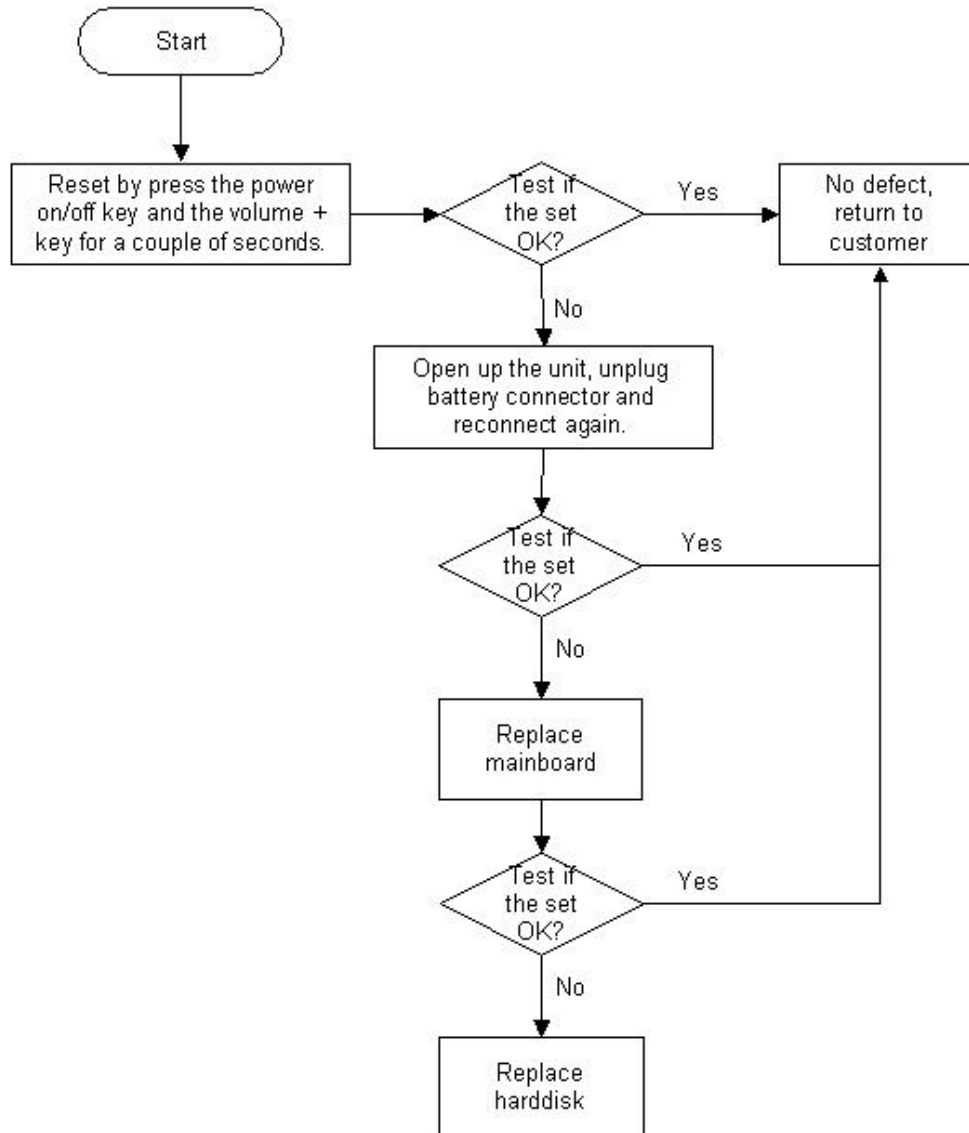

Open up the unit, unplug battery connector and reconnect again

6.0 TROUBLESHOOTING FLOW

SYMPTOM 3: ERROR MESSAGE SCROLLS ON THE DISPLAY

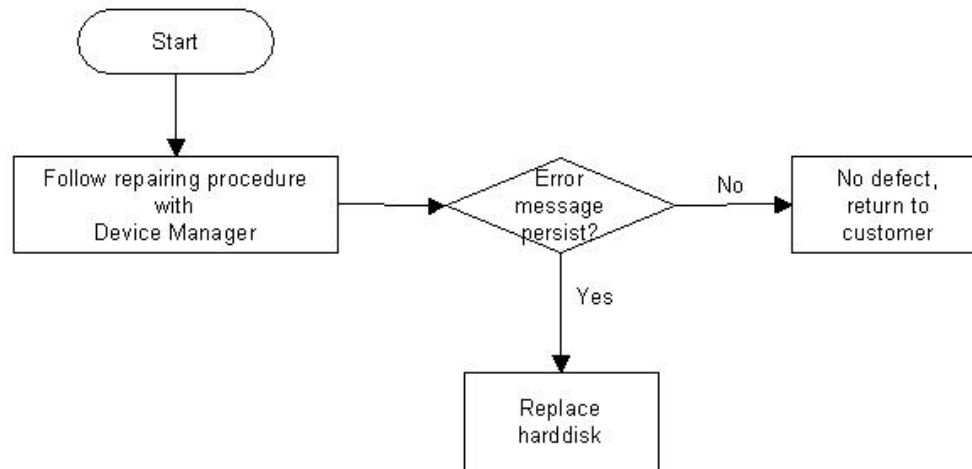

6.0 TROUBLESHOOTING FLOW

SYMPTOM 4: NO SOUND

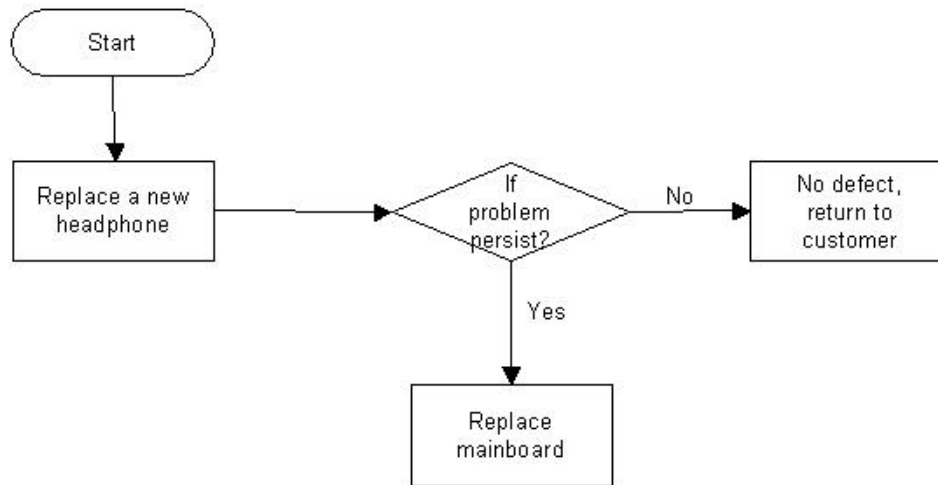

7.0 Overall Block Diagram

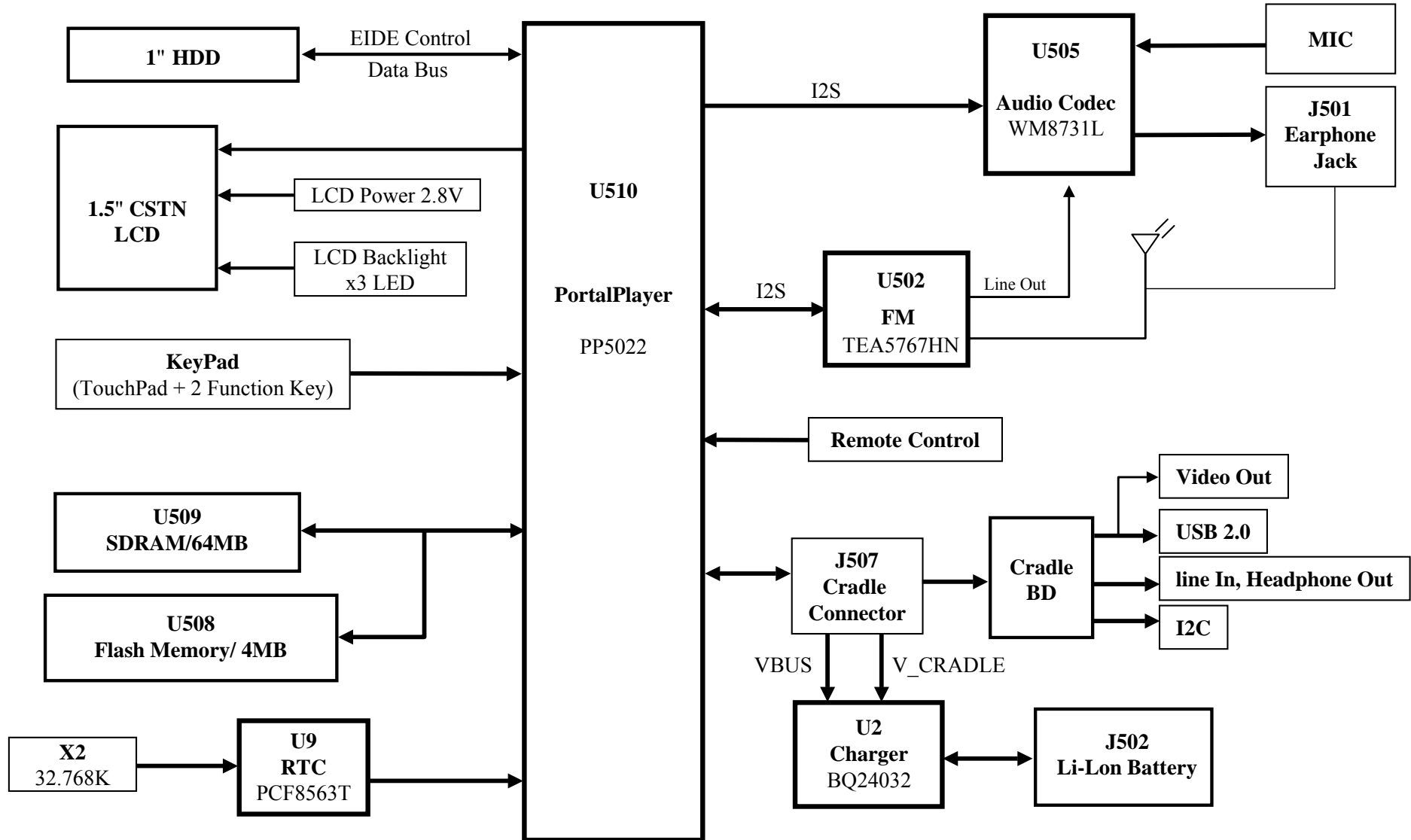

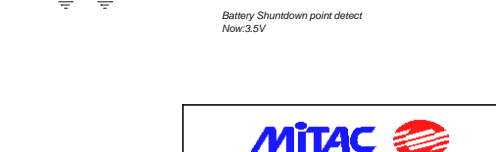
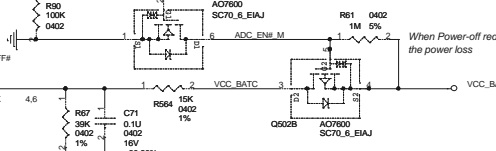
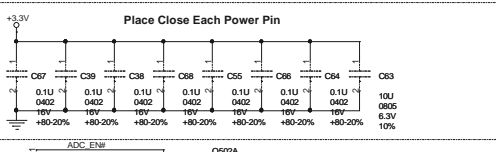
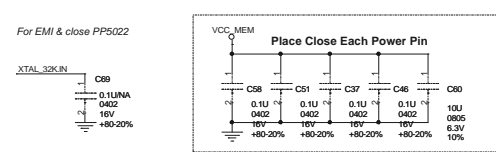
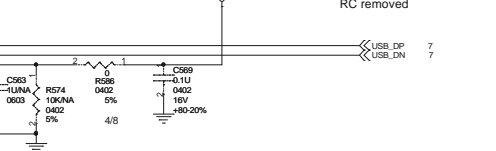
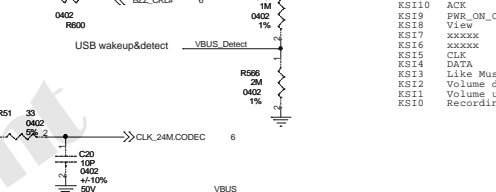
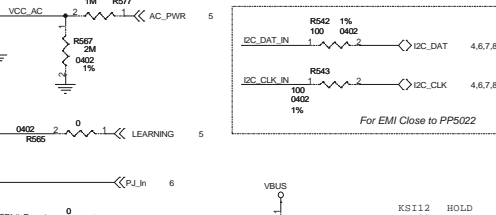
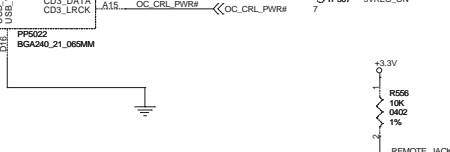
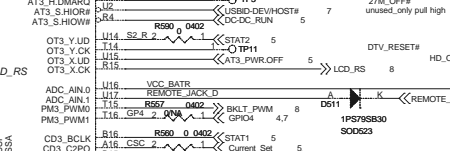
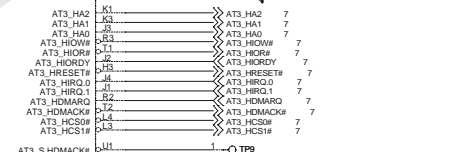
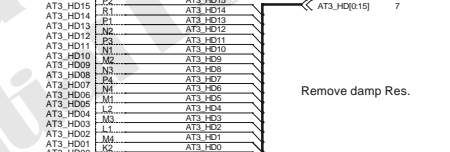
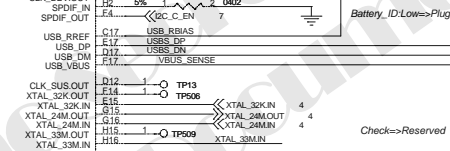
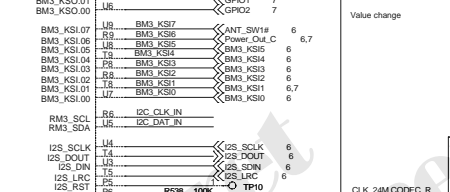
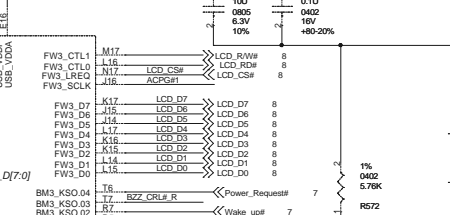
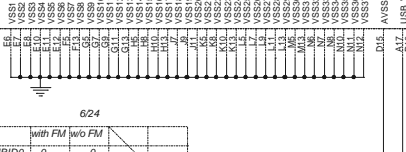
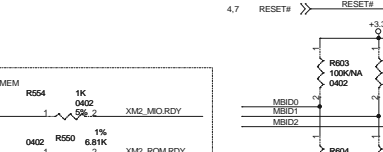
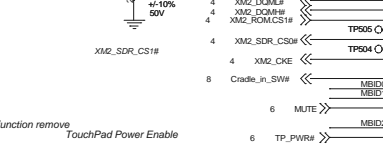
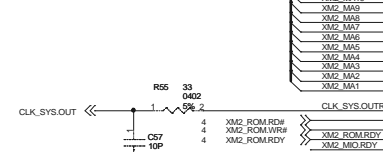
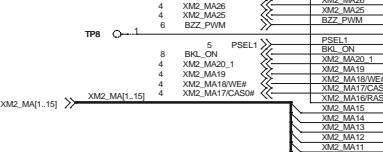
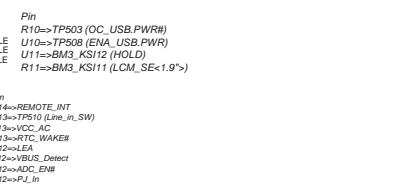
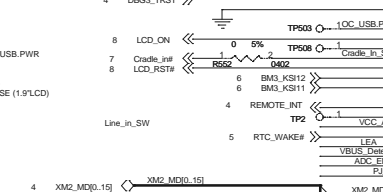
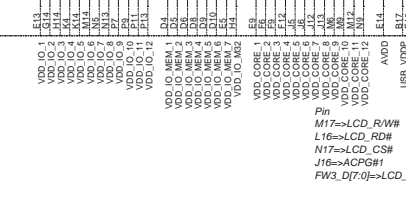
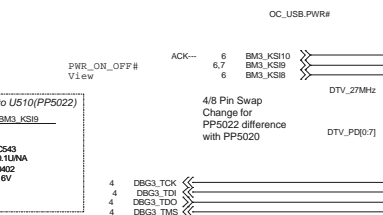
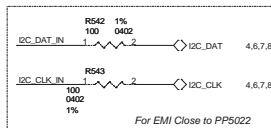
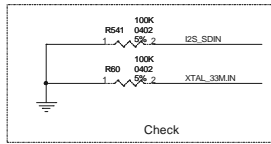
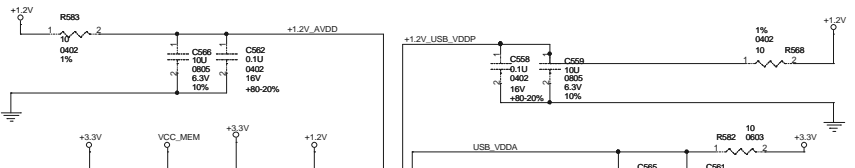
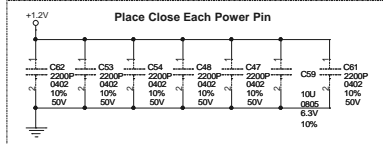

pin R15=>LCD_RS

MBID0	MBID1	MBID2
0	0	0
0	0	1
0	1	0
0	1	1

Only For PP5022 Ver.B CKE reset Issue
Can be eliminate

Power Supply Voltage:1.65V~1.95V
BANK 0 FLASH MEMORY
512Kx16Bits => 1MByte

RAM TYPE/WIDTH (UPPER 2 BITS ARE FIRMWARE SELECT)				
ADDRESS	DESCRIPTION	DEFAULT		
A7 A6 A5	SRAM 16-BIT	0	X	0
0	SRAM 32-BIT	0	X	1
1	SRAM 16-BIT	1	X	0
1	SRAM 32-BIT	1	X	1

BOOT VECTOR LOCATION (HARDWARE SELECT)	
ADDRESS	DESCRIPTION
A15 A14	EXT ROM0 (0000:0000) (DEFAULT)
0	EXT ROM1 (0000:0000)
1	BOOTROM USER
1	BOOTROM OTHER

BOOT CLOCK SOURCE (HARDWARE SELECT)	
ADDRESS	DESCRIPTION
A17 A16	24.000MHz (DEFAULT)
0	24.576MHz
1	48.000MHz
1	RESERVED

BOOT OPTION	
ADDRESS	DESCRIPTION
A19	0 = IDE0 (DEFAULT)
0	1 = IDE 1

JTAG CONFIG (HARDWARE SELECT)	
ADDRESS	DESCRIPTION
A18 A17	00 = Serial (CPU->COP) (DEFAULT)
0	01 = CPU only (CPU)
1	10 = COP only (COP)
1	11 = Parallel (CPU COP)

FLASH BUS WIDTH	
ADDRESS	DESCRIPTION
A1	0 = 16 BIT
1	1 = 8 BIT

Power Supply Voltage:1.65V~1.95V

16Mx16(256Mbit) Infineon=283780190001
Samsung=283780190002

4/12 Change R & C value for PP5022

These net length must be equivalent

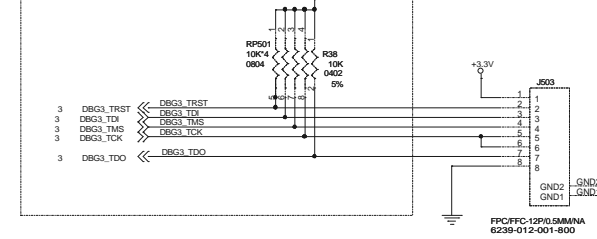

For EMI & close U505 (RTC)

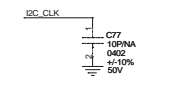

MITAC

File: Phoenix DVT R0D
Size: C Document
Number: FLASH / SDRAM / RTC
Rev: R00
Date: 2006/11/04
Sheet: 4 of 8

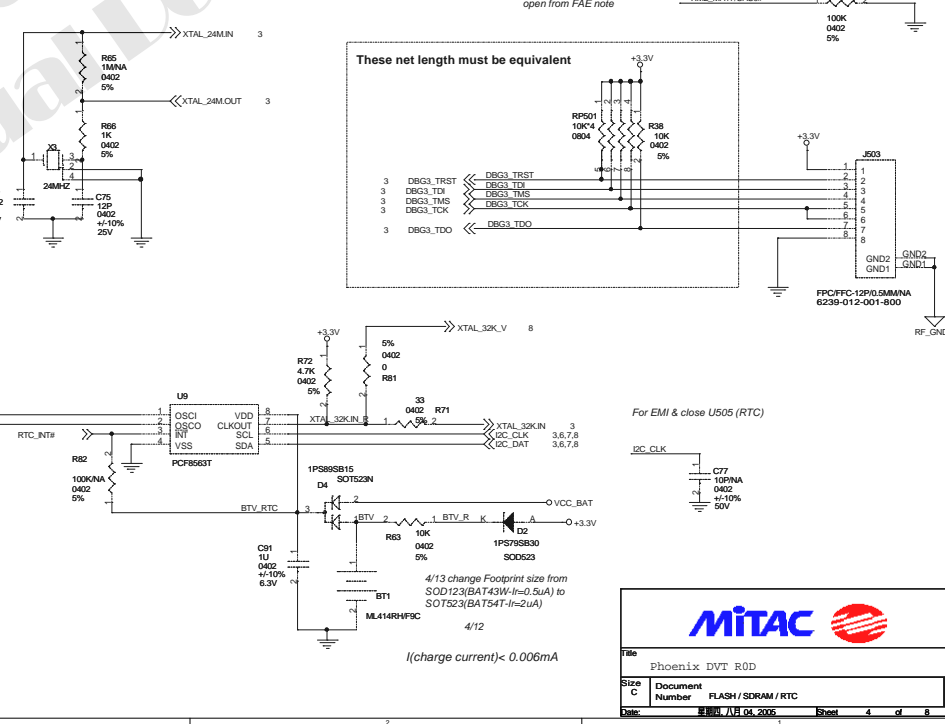
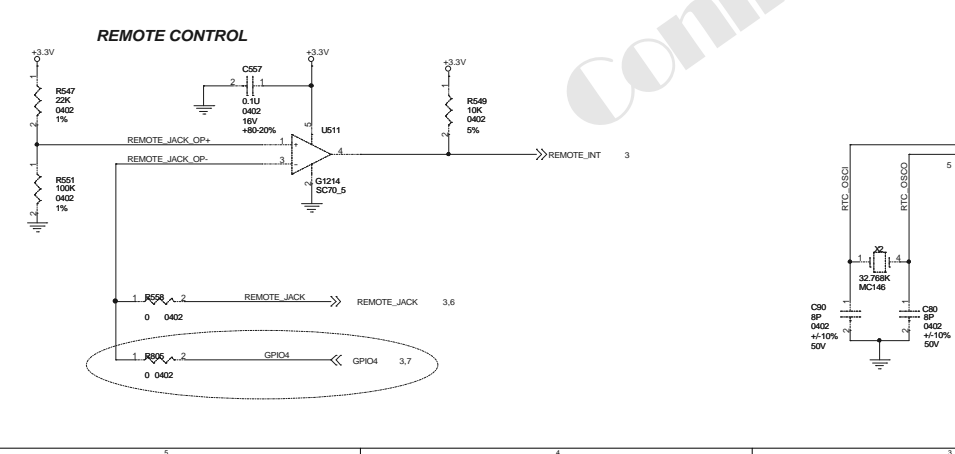
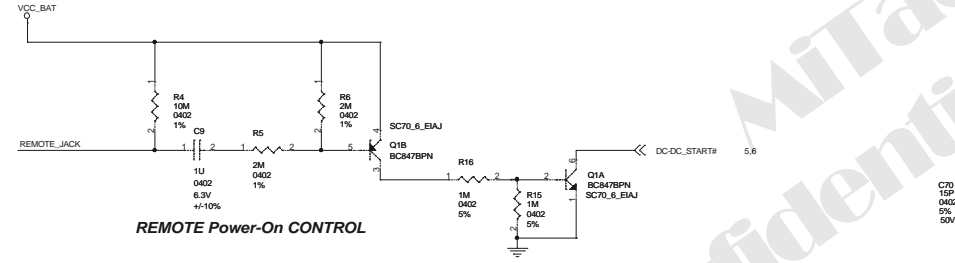
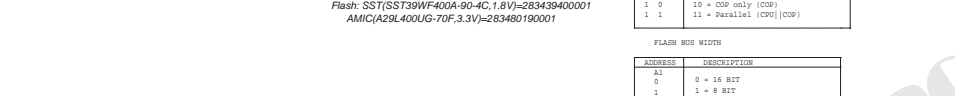
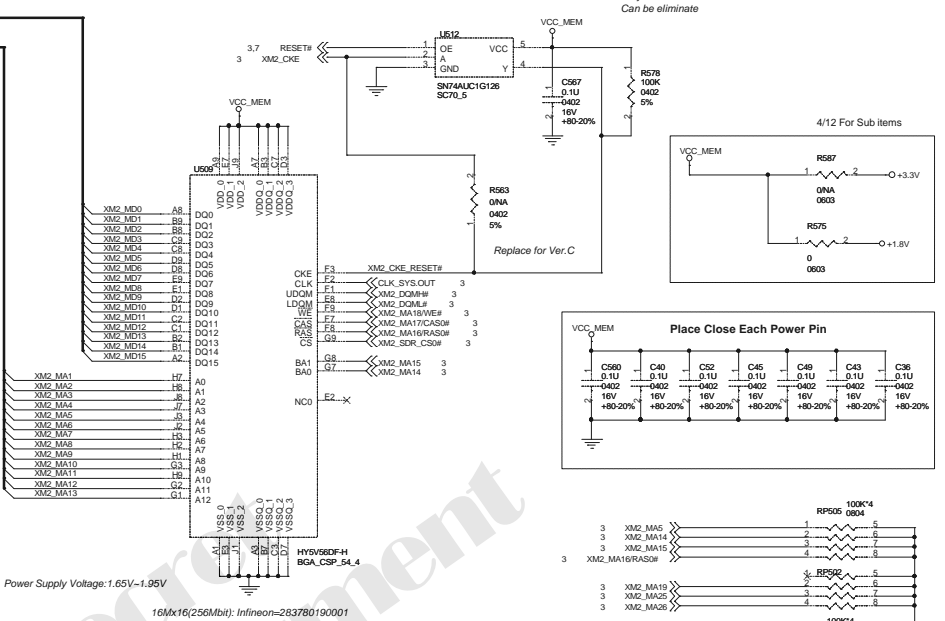
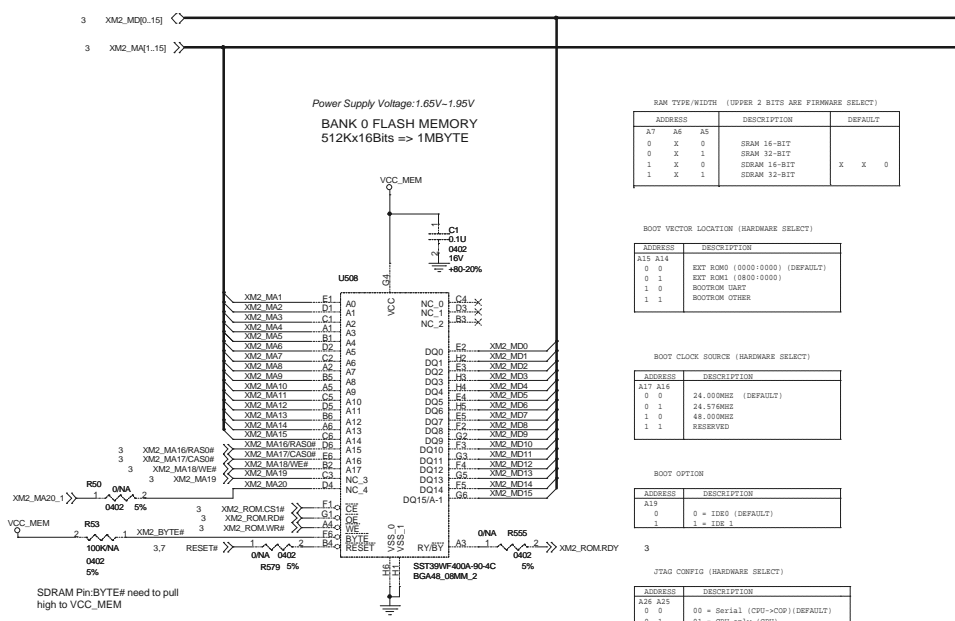

$$dI = Vo * (1 - Vo / V) / (L * I)$$

$$I_{max} = I_{omax} + (dI / 2)$$

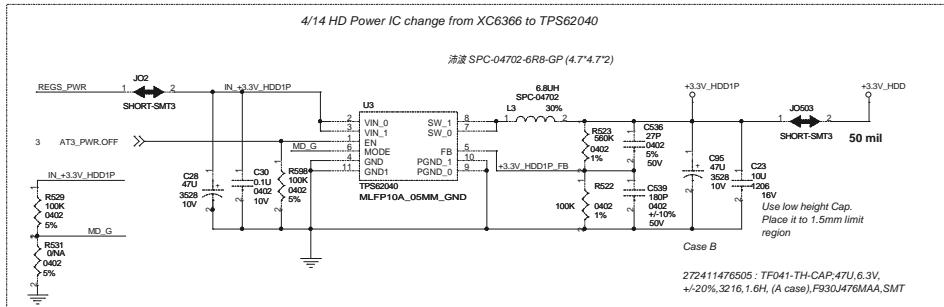

4/14 Colayout two select one

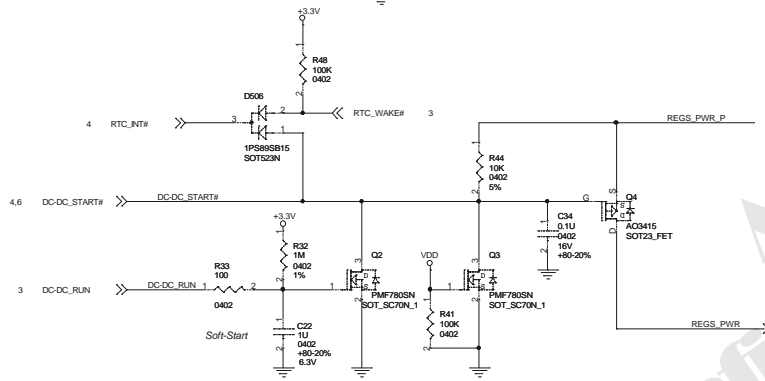
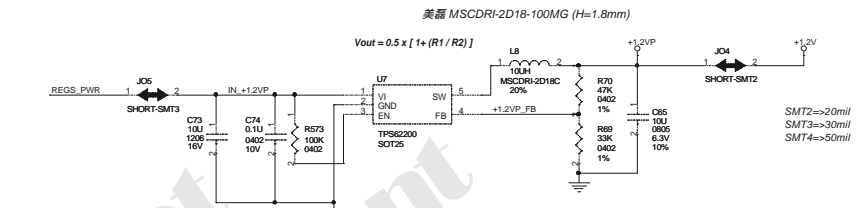
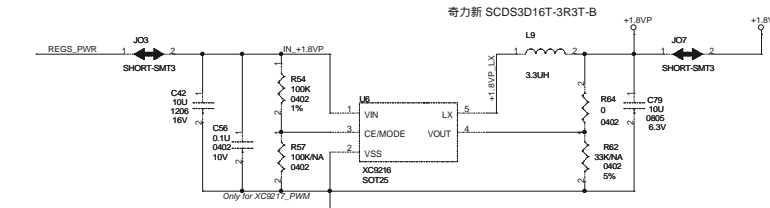
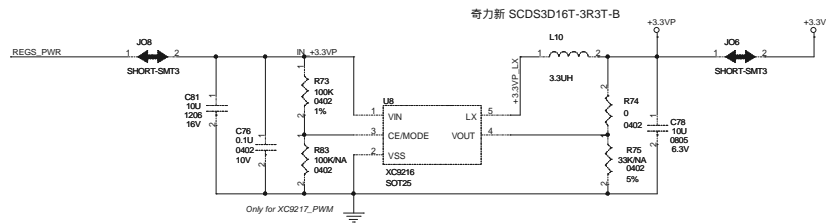

For Only AC or USB Input to Auto-Power-On To show the Battery charge status

To set Battery Charge Current when Plug-in non-high power PC.

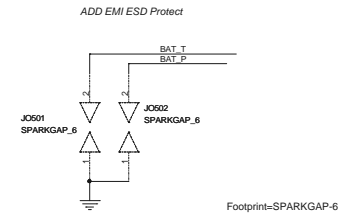
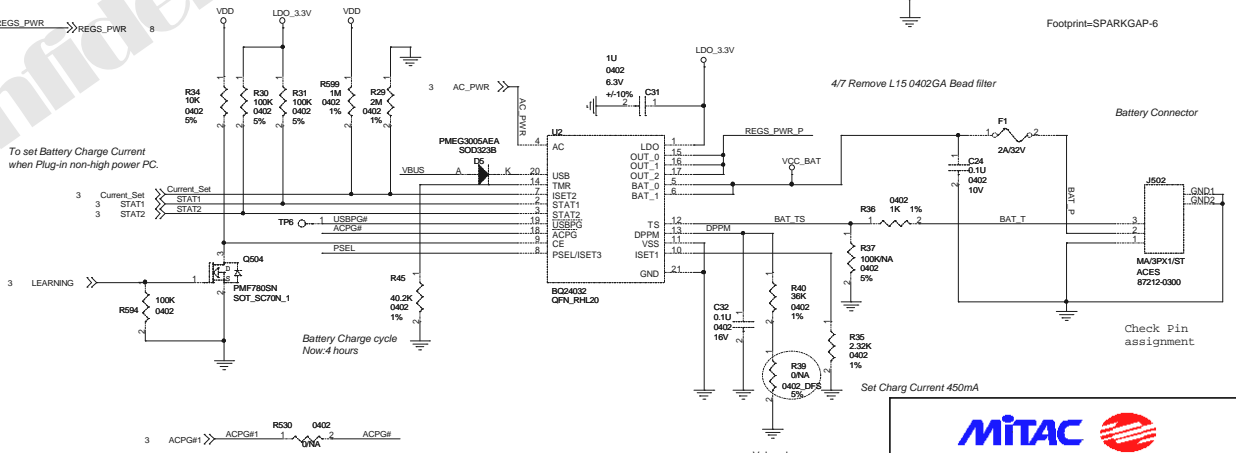
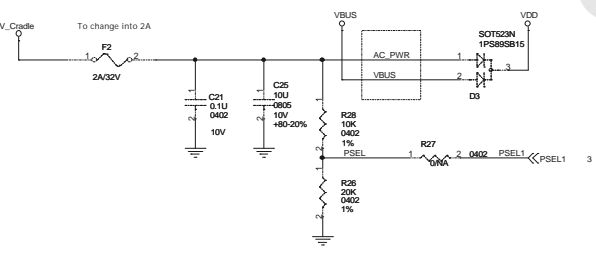

4/7 Remove L15 0402GA Bead filter

MITAC	
Phoenix DVT R0D	
File	Phoenix DVT R0D
Size	Document
C	Number
Number	SYSTEM POWER / RESET
Date	2006/11/04 2006
Sheet	6 of 8
Rev	R00

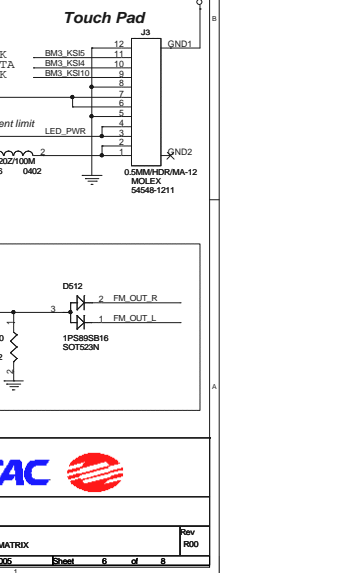
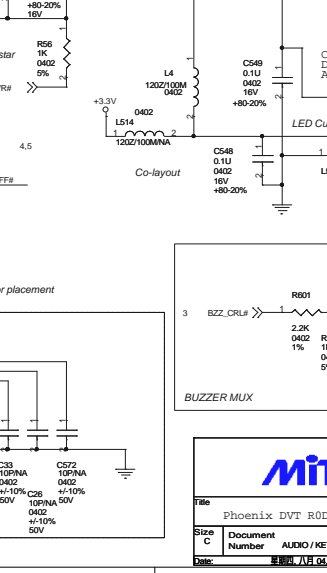
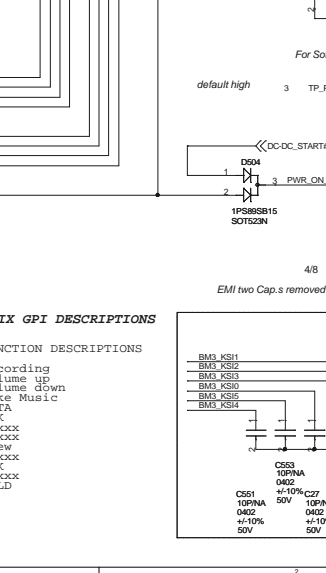
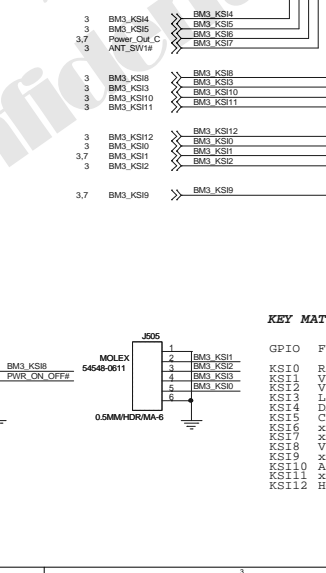
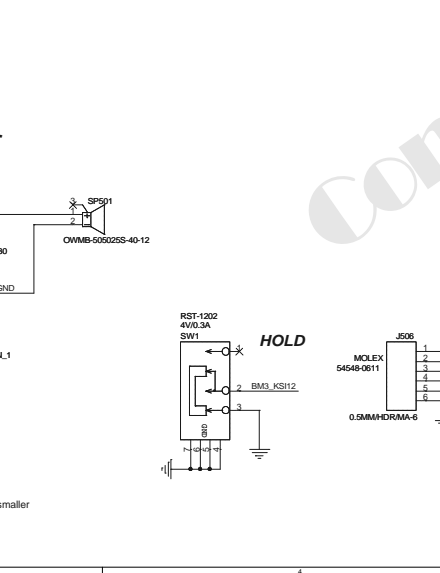
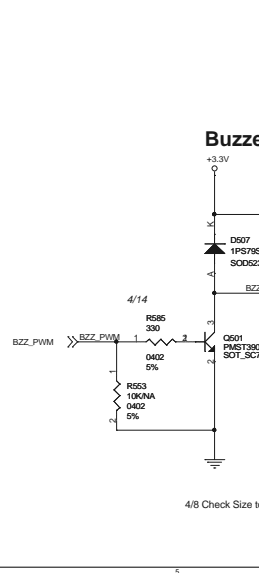
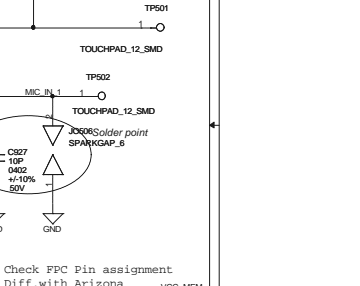
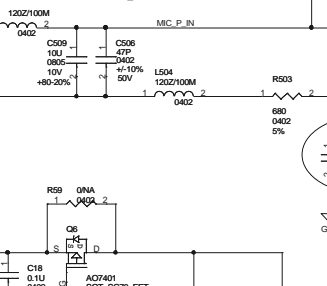
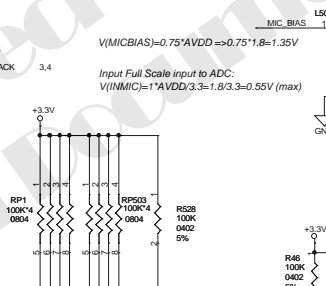
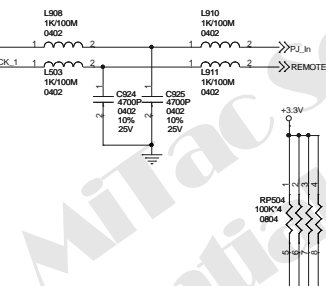
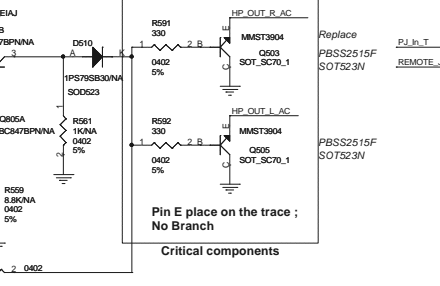
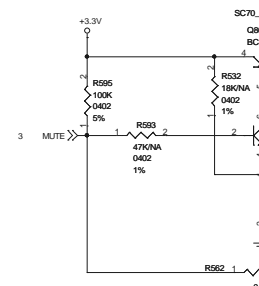
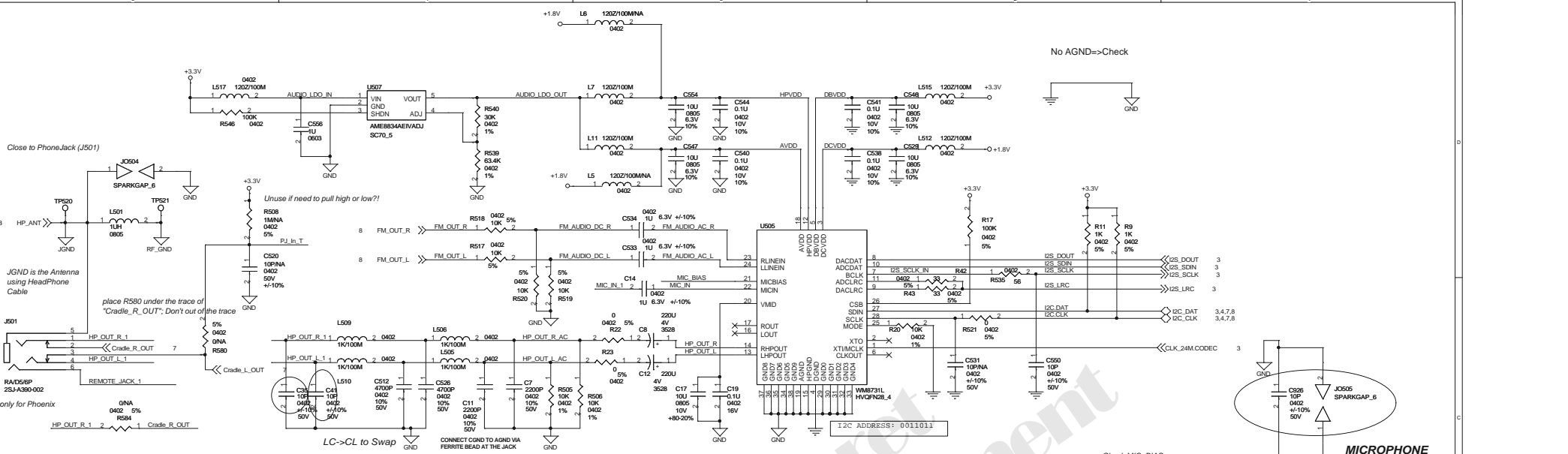

Cradle POWER SWITCH

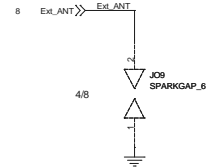
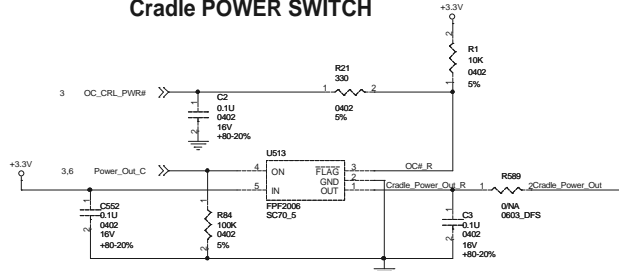

1" HDD FPC Connector

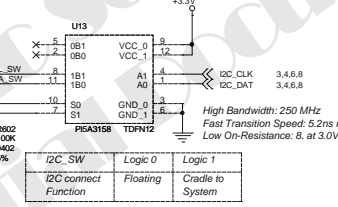
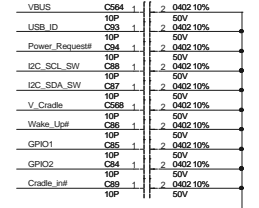
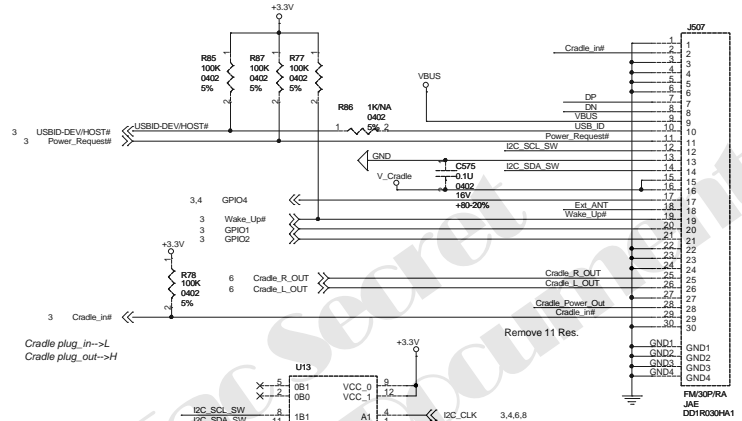
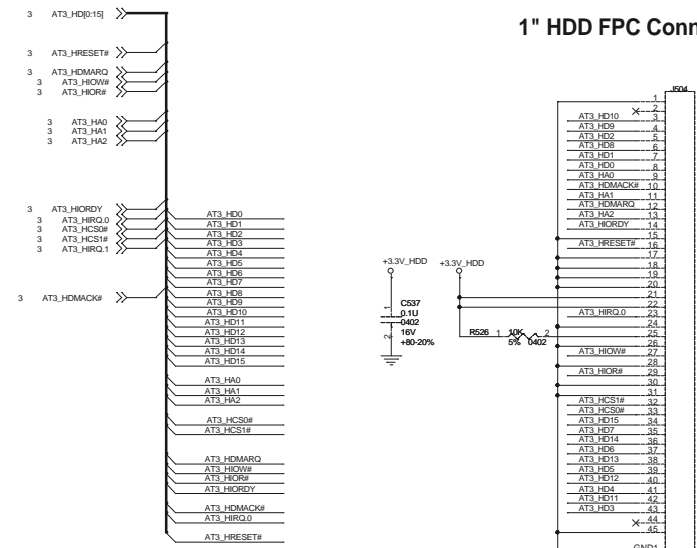

CoLayout

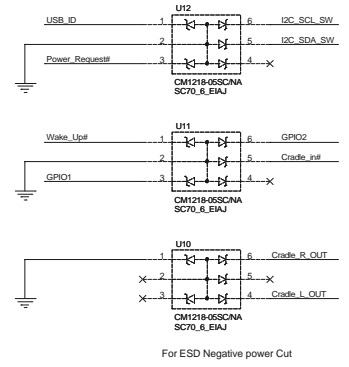
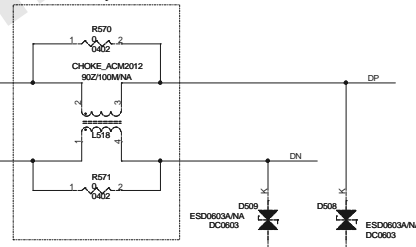

For ESD Negative power Cut

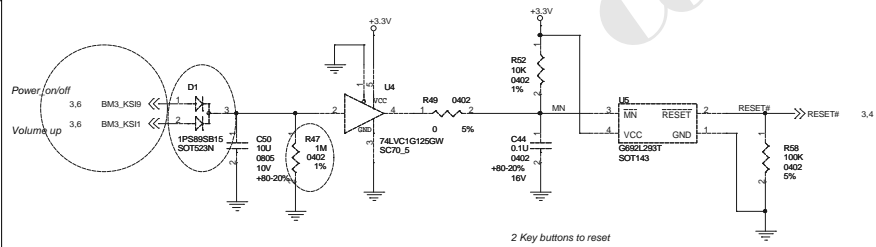
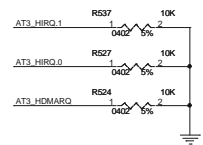
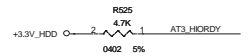
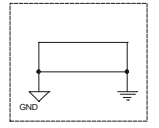

2 Key buttons to reset

RC Delay Time:
 $t = C \cdot dV/dt$
 $= C \cdot V$
 $(dV \text{ is both sides voltage of Res. ; } dt \text{ is the time of charge Cap.)}$

File: Phoenix DVT R0D

Size C	Document Number	BATTERY / HDD	Rev R00
--------	-----------------	---------------	---------

Spec: 11/11/04 2006 Sheet 7 of 8

1.5" CSTN PANEL

美磊 MSCDRI-2D18-4R7MG (H=1.8mm)

Ip=400mA+Vin100ns/L
=402.27mA

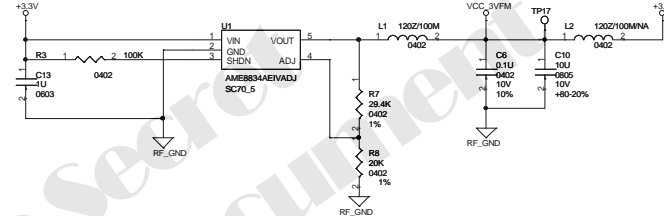
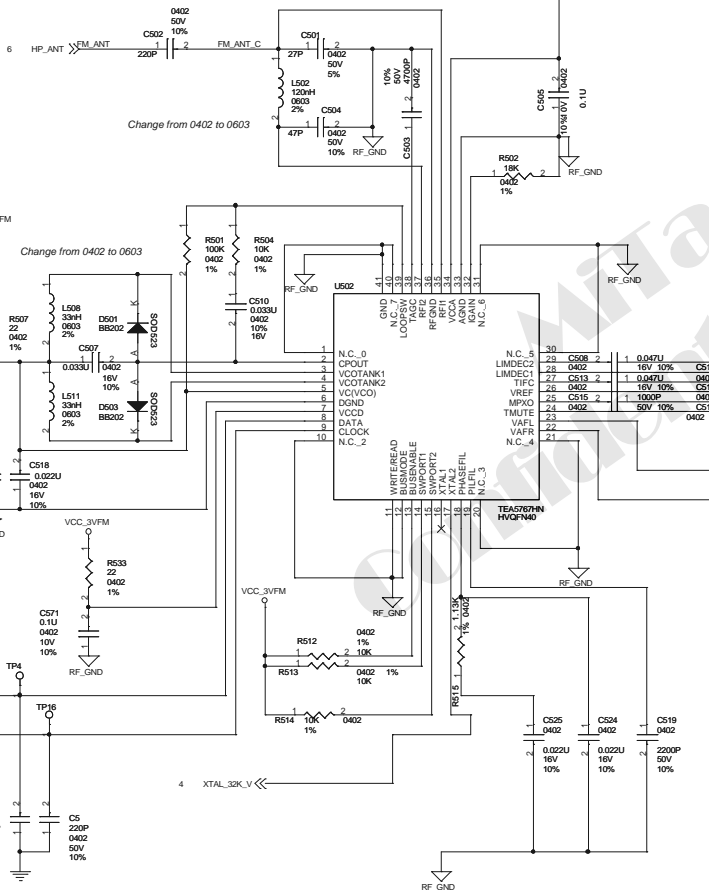
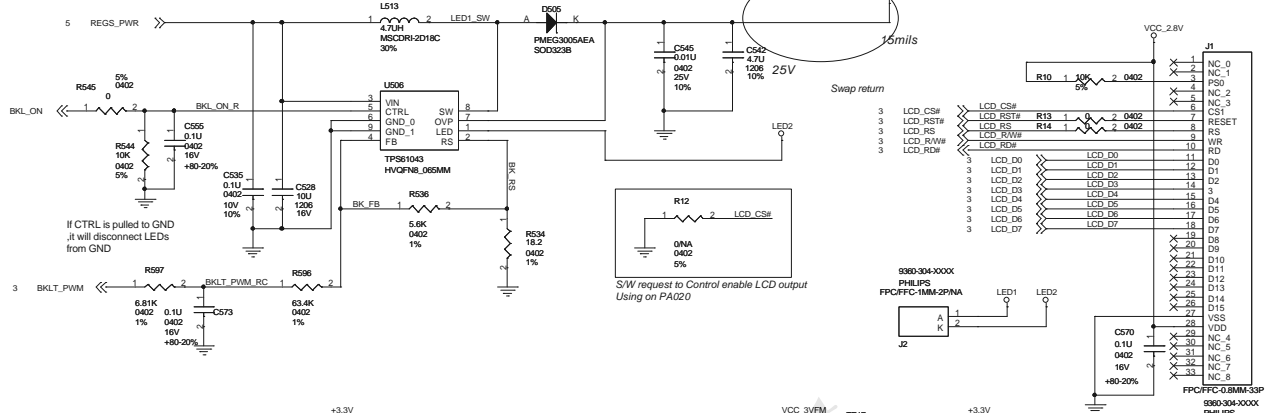
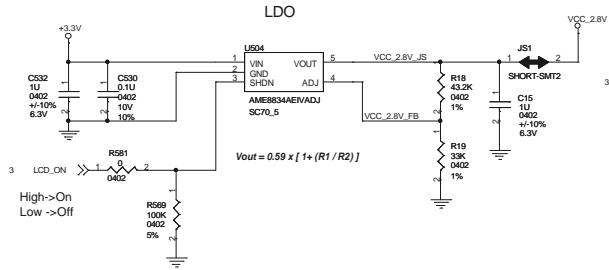

ANTENNA SWITCH

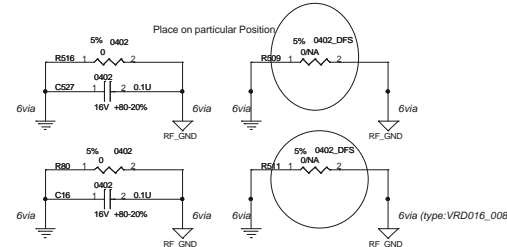
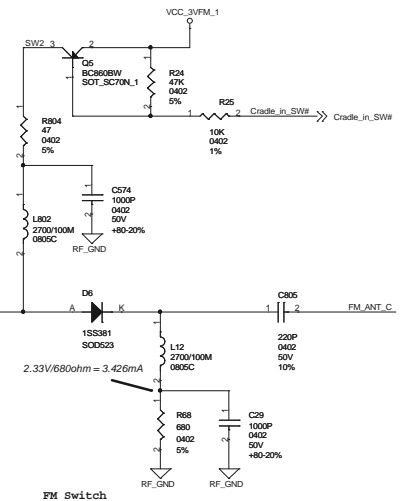

MITAC

File: Phoenix DVT R0D
 Size: C Document
 Number: FM TUNER / LCM
 Date: 2006/04/04 Sheet: 8 of 8
 Rev: R00

9.0 REVISION LIST

Version 1.0 (3141 785 30700)

- Initial release HDD1420/HDD1620/HDD1630/DD1635

Version 1.1 (3141 785 30701)

Chapter 5 – Service part list revised service 12NC as listed below

- Added the new part cradle assy for HDD1635/17 (994000003791)