

Pioneer

DJ controller

DDJ-SZ

serato || **serato**  **DJ**

<http://pioneerdj.com/support/>

The Pioneer DJ support site shown above offers FAQs, information on software and various other types of information and services to allow you to use your product in greater comfort.

<http://serato.com/>

For the latest version of the Serato DJ software, access Serato.com and download the software from there.

Operating Instructions

Contents

How to read this manual

- Thank you for buying this Pioneer product.
Be sure to read this booklet and the "Operating Instructions (Basic Edition)" included with this unit. Both include important information that should be fully understood before using this product.
For instructions on obtaining the Serato DJ software's manual, see *Acquiring the manual* (p.34).
- In this manual, names of screens and menus displayed on the product and on the computer screen, as well as names of buttons and terminals, etc., are indicated within brackets. (e.g.: [CUE] button, [Files] panel, [MIC1] terminal)
- Please note that the screens and specifications of the software described in this manual as well as the external appearance and specifications of the hardware are currently under development and may differ from the final specifications.
- Please note that depending on the operating system version, web browser settings, etc., operation may differ from the procedures described in this manual.

This manual consists mainly of explanations of functions of this unit as hardware. For detailed instructions on operating the Serato DJ software, see the Serato DJ software manual.

- The Serato DJ software manual can be downloaded from "Serato.com". For details, see *Downloading the Serato DJ software manual* (p. 34).
- The latest version of these operating instructions can be downloaded from the Pioneer support site. For details, see *Downloading the latest version of these operating instructions* (p.34).

01 Before start

Features	3
What's in the box	4
Installing the software	4

02 Connections and part names

Connections	6
Part names and functions	8

03 Basic Operation

Connections	13
Starting the system	14
Quitting the system	16

04 Advanced Operation

Using the performance pads	17
Using the slip mode	18
Using the fader start function	19
Using the sampler velocity mode	19
Adjusting the crossfader's operating load	20
Analyzing tracks	20
Using effects	20
Using the SOUND COLOR FX function	21
Using the oscillator function	21
Types of effects	22
Using external inputs	22

05 Changing the settings

Launching utilities mode	24
Utilities modes	24
About the setting utility software	26

06 Using the DVS system

Before controlling the Serato DJ software	28
Controlling the Serato DJ software	29

07 Additional information

Troubleshooting	32
Signal flow	33
Acquiring the manual	34
Using as a controller for other DJ software	34
About trademarks and registered trademarks	35
Cautions on copyrights	35

Before start

Features

This unit features carefully arranged interfaces for various operations including "BIG JOG", which gives you total control over scratch play, "PERFORMANCE PADS", which can be used to add arrangements to music with beats, rolling and other dynamic actions produced using HOT CUE, SAMPLER and other functions, and "4-CHANNEL MIXER", which supports multi-track mixing with the 4-deck function, providing unique DJ performance tools when using "Serato DJ". Also, the unit provides "SOUND COLOR FX" and "OSCILLATOR" functions so that original arrangements can be added to the music being played back. Furthermore, numerous input and output terminals support a variety of DJ styles. Featuring aluminum material for the top panel, the design makes the unit look high quality, which is appropriate in a variety of scenes such as nightclubs, home parties, etc.

BIG JOG

We have achieved the shortest time required from when jog is operated until when the control signal is transferred to the software. Additionally, "BIG JOG", a large sized jog, allows the DJ to play scratches as they wish with smooth operability. At the center of the jog, the "ON JOG DISPLAY" displays the playback status of music and the current playback position so that the DJ can perform scratching more accurately. Also, the unit is equipped with "JOG FEELING ADJUST", which is popular in the CDJ Series. It is possible to adjust the operation load and back spin continuous time during scratch play to match particular tastes.

MULTI-COLOR PERFORMANCE PADS

"PERFORMANCE PADS", a large rubber pad used to assign and operate functions such as HOT CUE and SAMPLER, is positioned at the front of the unit. Music can be arranged by dynamic actions such as beating and rolling and the volume can be stronger or weaker depending on the strength of the beat. Also, each pad has built-in multi-color illumination that can be used to instantaneously understand the selected pad mode and playing status of each pad through illumination colors and lit condition.

4-CHANNEL MIXER

The unit includes "4-CHANNEL MIXER", which allows the DJ to independently operate songs being played back with four decks. Four songs can be mixed to create a highly individualistic DJ mix. Level meters are located near the master unit and the operation interface of each channel, so that input and output levels can be understood instantly. This unit retains the control panel layout of the Pioneer DJM series, the world standard in DJ mixers. The simple, easy-to-understand control panel layout not only facilitates DJ performances but also makes it easy for DJs using the unit for the first time to operate it without hesitation, so it can be used without worry as a permanently installed mixer in the club.

OSCILLATOR

The unit is equipped with an "OSCILLATOR" function that generates four types of sound (NOISE, CYMBAL, SIREN, and HORN). Operation is simple. Just press the button of the sound type you wish to output. You can create original music by superimposing oscillator sound over the music you are playing back or further emphasize the climax of music. Also, you can change the tone by simply turning the [OSCILLATOR PARAMETER] control, making it possible to generate oscillator sound that is matched to the music.

SOUND COLOR FX

The unit is equipped with four "SOUND COLOR FX" functions (ECHO, JET, PITCH, and FILTER), achieving a wide range of musical arrangements. By simply turning the control, it is possible to create the effect you want, and a variety of remix can be achieved such as adding original arrangements to the music. Also, BPM information can be obtained from "Serato DJ", making it possible to add the ECHO effect linked with the BPM of the song being played back.

PLUG AND PLAY DUAL USB PORT

Two USB sound cards are provided to connect the unit to up to two computers at the same time.

The sound cards of the unit and all buttons and controls are set to be linked with "Serato DJ" beforehand so that the DJ can begin playing using "Serato DJ" without going through the need to make troublesome settings.

The USB selector located at the top side can be used to switch between the two sound cards with a single action. When one DJ takes over from another, this function provides a smooth transition between the two computers without sound being interrupted.

Flexible Connectivity

Four external input systems and two MIC input systems are provided to connect to a CD player or analog turntable.

Mixing is possible without going through a computer, so the unit can be used as a single DJ mixer as well.

In addition, two MASTER OUT systems and one BOOTH OUT system are provided to handle professional PA device output.

All kinds of party scenes and DJ playing styles are supported.

DVS Supported

The sound cards of the unit are compatible with the DVS (Digital Vinyl System) function of "Serato DJ".

Signals from the control tone disk (an optional dedicated disk used to operate "Serato DJ") played back by the player connected to an external input terminal is output to a computer via the sound card of the unit to operate the decks of "Serato DJ".

DURABLE FADER

A slide structure is used for the crossfader and channel fader, in which the fader knob is supported by two metal shafts.

This achieves smooth operability without wobble and also high durability.

Also, effects on inside the faders caused by liquid and dust are minimized.

An independently developed "MAGVEL FADER" magnetic system is equipped for the crossfader to support scratch play, which provides high durability of more than 10 000 000 operations, and fine operability.

The channel fader has about three times better operation durability than the previous model (DJM-800).

HIGH SOUND QUALITY

Leveraging the audio circuit of Pioneer audio devices for clubs, the unit provides powerful sound quality faithful to the original. It also reduces contact resistance through use of an AC inlet having a wide contact area with the power cable, and achieves stable and powerful sound even in the DJ booth in a loud environment. By adopting a high performance D/A converter and low jitter crystal oscillator made by Wolfson Microelectronics, the unit reproduces clear and powerful club sound faithful to the original.

Professional Quality Design

Aluminum material on the top panel and jog plate provides a sense of high quality design.

This unit is an essential part of DJ performance in clubs and home party scenes.

SLIP MODE

This unit is equipped with a Slip Mode function by which the sound continues in the background while such operations as looping, scratching and hot cueing are being performed. This allows DJ performances without changing the original track's development after such playback operations as looping, scratching and hot cueing are completed.

NEEDLE SEARCH

Points can be searched for simply by touching the touch pad with a finger. This makes for intuitive, speedy searching with the sense of touching the music directly.

What's in the box

- CD-ROM (Installation Disc)
- Power cord
- USB cable^[1]
- Warranty (for some regions only)^[2]
- Operating Instructions (Basic Edition)

[1] Only one USB cable is included with this unit.

To connect two units, use a cable conforming to USB 2.0 standards.

[2] Japanese and European models only. (For the North American region, the corresponding information is provided on the last page of both the English and French versions of the "Operating Instructions (Basic Edition)".)

Installing the software

Before installing the software

For the latest version of the Serato DJ software, access Serato.com and download the software from there. A software download link is also provided on the included CD-ROM.

- For details, refer to *Installation procedure (Windows)* or *Installation procedure (Mac OS X)*.
- The user is responsible for preparing the computer, network devices and other elements of the Internet usage environment required for a connection to the Internet.

About the driver software

This driver software is an exclusive driver for outputting audio signals from a computer.

- First read the *Software end user license agreement* on page 34 carefully.

Checking the latest information on the driver software

For detailed information on this unit's designated driver software, see the Pioneer DJ support site below.

<http://pioneerdj.com/support/>

About the Serato DJ software

Serato DJ is a DJ software application by Serato. DJ performances are possible by connecting the computer on which this software is installed to this unit.

Minimum operating environment

Supported operating systems	CPU and required memory
Mac OS X: 10.9, 10.8, 10.7 and 10.6	32-bit version Intel® processor, Core™ i3, i5 and i7 1.07 GHz or better, Intel® processor, Core™ 2 Duo 2.0 GHz or better 2 GB or more of RAM
	64-bit version Intel® processor, Core™ i3, i5 and i7 1.07 GHz or better, Intel® processor, Core™ 2 Duo 2.4 GHz or better 4 GB or more of RAM
Windows: Windows 7	32-bit version Intel® processor, Core™ i3, i5 and i7 1.07 GHz or better, Intel® processor, Core™ 2 Duo 2.0 GHz or better 2 GB or more of RAM
	64-bit version Intel® processor, Core™ i3, i5 and i7 1.07 GHz or better, Intel® processor, Core™ 2 Duo 2.4 GHz or better 4 GB or more of RAM

Others

Optical drive	Optical disc drive on which the CD-ROM can be read
USB port	A USB 2.0 port is required to connect the computer with this unit.
Display resolution	Resolution of 1 280 x 720 or greater
Internet connection	An Internet connection is required for registering the "Serato.com" user account and downloading the software.

- For the latest information on the required operating environment and compatibility as well as to acquire the latest operating system, refer to "Software Info" under "DDJ-SZ" on the Pioneer DJ support site below.
<http://pioneerdj.com/support/>
- Operating System support assumes you are using the latest point release for that version.
- Operation is not guaranteed on all computers, even if all the required operating environment conditions indicated here are fulfilled.
- Depending on the computer's power-saving settings, etc., the CPU and hard disk may not provide sufficient processing capabilities. For notebook computers in particular, make sure the computer is in the proper conditions to provide constant high performance (for example by keeping the AC power connected) when using Serato DJ.
- Use of the Internet requires a separate contract with a provider offering Internet services and payment of provider fees.

Installation procedure (Windows)

Do not connect this unit and the computer until installation is completed.

- Log on as the user which was set as the computer's administrator before installing.
- If any other programs are running on the computer, quit them.

1 Insert the CD-ROM into the computer's optical drive.

The CD-ROM menu is displayed.

- If the CD-ROM menu does not appear when the CD-ROM is inserted, open the optical drive from [Computer (or My Computer)] in the [Start] menu, then double-click the [CD_menu.exe] icon.

2 From the menu that appears, select [Install Driver Software], then click [Start].

3 "Download the latest version? An internet environment is required to access the site." is displayed. Click [Yes].

The web browser is launched and the Pioneer DJ support site is displayed.

4 Click [Software Download] under [DDJ-SZ] on the Pioneer DJ support site.

5 Click [Driver Software].

6 From the download page, download the driver software for Windows (DDJ-SZ_X.XXX.exe).

7 Double-click the downloaded file.

The driver installation screen appears.

8 Carefully read the *Software end user license agreement* and if you consent to the provisions, put a check mark in [I agree.] and click [OK].

If you do not consent to the provisions of the *Software end user license agreement*, click [Cancel] and stop installation.

9 Proceed with installation according to the instructions on the screen.

If [Windows Security] appears on the screen while the installation is in progress, click [Install this driver software anyway] and continue with the installation. When the installation program is completed, a completion message appears. After installing the driver software, install the Serato DJ software.

10 Select [Download Serato DJ Software.] from the CD-ROM's menu, then click [Start].

11 "An internet environment is required to access the site. Connected to the internet?" is displayed. Click [Yes].

The web browser is launched and the Pioneer DJ support site is displayed.

12 Click [Software Info] under [DDJ-SZ] on the Pioneer DJ support site.

13 Click the link to the Serato DJ download page.

The Serato DJ download page is displayed.

14 Log in to your "Serato.com" user account.

- If you have already registered a user account on "Serato.com", proceed to step 16.
- If you have not completed registering your user account, do so following the procedure below.
 - Following the instructions on the screen, input your e-mail address and the password you want to set, then select the region in which you live.
 - If you check [E-mail me Serato newsletters], newsletters providing the latest information on Serato products will be sent from Serato.
 - Once user account registration is completed, you will receive an e-mail at the e-mail address you have input. Check the contents of the e-mail sent from "Serato.com".
- Be careful not to forget the e-mail address and password specified when you performed user registration. They will be required for updating the software.
- The personal information input when registering a new user account may be collected, processed and used based on the privacy policy on the Serato website.

15 Click the link in the e-mail message sent from "Serato.com".

This takes you to the Serato DJ download page. Proceed to step 17.

16 Log in.

Input the e-mail address and password you have registered to log in to "Serato.com".

17 Download the Serato DJ software from the download page.

Unzip the downloaded file, then double-click the unzipped file to launch the installer.

18 Read the terms of the license agreement carefully, and if you agree, select [I agree to the license terms and conditions], then click [Install].



- If you do not agree to the contents of the license agreement, click [Close] to cancel installation. Installation begins.

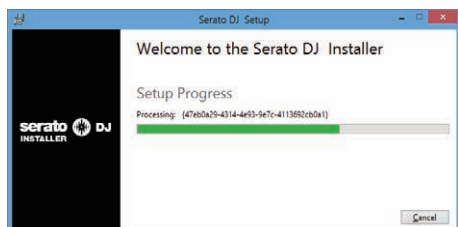

The message of successful installation appears once installation is completed.

19 Click [Close] to quit the Serato DJ installer.



Installation procedure (Mac OS X)

Do not connect this unit and the computer until installation is completed.

- If any other programs are running on the computer, quit them.

1 Insert the CD-ROM into the computer's optical drive.

The CD-ROM menu is displayed.

- If the CD-ROM menu does not appear on the screen when the CD-ROM is inserted, open the optical driver from Finder, then double-click the [CD_menu.app] icon.

2 From the menu that appears, select [Install Driver Software], then click [Start].

3 "Download the latest version? An internet environment is required to access the site." is displayed. Click [Yes].

The web browser is launched and the Pioneer DJ support site is displayed.

4 Click [Software Download] under [DDJ-SZ] on the Pioneer DJ support site.

5 Click [Driver Software].

6 From the download page, download the driver software for Mac OS (DDJ-SZ_M_X.X.X.dmg).

7 Double-click the downloaded file.

The [DDJ-SZ_AudioDriver] menu screen appears.

8 Double-click [DDJ-SZ_AudioDriver.pkg].

The driver installation screen appears.

9 Check the details on the screen and click [Continue].

10 When the end user license agreement appears, read *Software end user license agreement* carefully, then click [Continue].

11 If you consent to the provisions of the *Software end user license agreement*, click [Agree].

If you do not consent to the provisions of the *Software end user license agreement*, click [Disagree] and stop installation.

12 Proceed with installation according to the instructions on the screen.

13 Select [Download Serato DJ Software.] from the CD-ROM's menu, then click [Start].

14 "An internet environment is required to access the site. Connected to the internet?" is displayed. Click [Yes].

The web browser is launched and the Pioneer DJ support site is displayed.

15 Click [Software Info] under [DDJ-SZ] on the Pioneer DJ support site.

16 Click the link to the Serato DJ download page.

The Serato DJ download page is displayed.

17 Log in to your "Serato.com" user account.

- If you have already registered a user account on "Serato.com", proceed to step 19.
- If you have not completed registering your user account, do so following the procedure below.
 - Following the instructions on the screen, input your e-mail address and the password you want to set, then select the region in which you live.
 - If you check [E-mail me Serato newsletters], newsletters providing the latest information on Serato products will be sent from Serato.
 - Once user account registration is completed, you will receive an e-mail at the e-mail address you have input. Check the contents of the e-mail sent from "Serato.com".
- Be careful not to forget the e-mail address and password specified when you performed user registration. They will be required for updating the software.
- The personal information input when registering a new user account may be collected, processed and used based on the privacy policy on the Serato website.

18 Click the link in the e-mail message sent from "Serato.com". This takes you to the Serato DJ download page. Proceed to step 20.

19 Log in.

Input the e-mail address and password you have registered to log in to "Serato.com".

20 Download the Serato DJ software from the download page.

Unzip the downloaded file, then double-click the unzipped file to launch the installer.

21 Read the terms of the license agreement carefully, and if you agree, click [Agree].

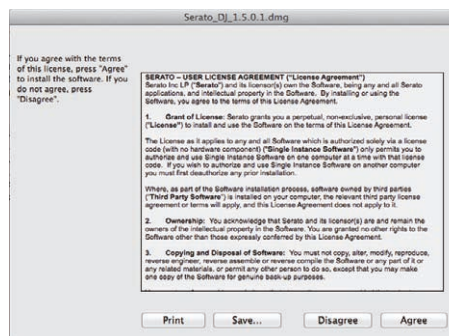

- If you do not agree to the contents of the usage agreement, click [Disagree] to cancel installation.

22 If the following screen appears, drag and drop the [Serato DJ] icon on the [Applications] folder icon.

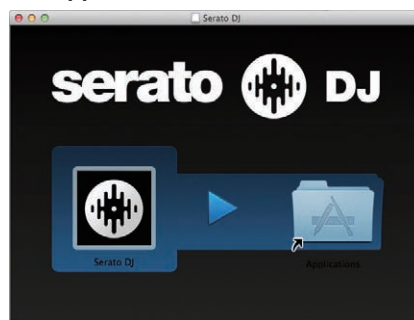

Connections and part names

Connections

- Connect the power cord after all the connections between devices have been completed. Be sure to turn off the power and unplug the power cord from the power outlet whenever making or changing connections. Refer to the operating instructions for the component to be connected.
- Be sure to use the included power cord.
- Be sure to use the USB cable included with this product or the one that conforms to USB 2.0.

Names of Parts

❖ Rear panel

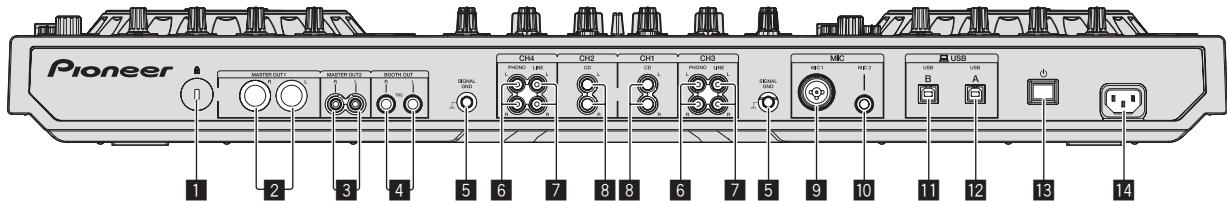

1 Kensington security slot

2 MASTER OUT 1 terminals

Connect powered speakers, etc., here.

- Compatible with XLR connector type balanced outputs.

3 MASTER OUT 2 terminals

Connect to a power amplifier, etc.

- Compatible with RCA pin-jack type unbalanced outputs.

4 BOOTH OUT terminals

Output terminals for a booth monitor, compatible with balanced or unbalanced output for a TRS connector.

The master channel sound can be output from the [BOOTH OUT] terminals regardless of the audio level set for the master channel.

The volume level can be adjusted with the [BOOTH MONITOR] control.

- The sound will be distorted if the level is raised too high when using unbalanced outputs.

5 SIGNAL GND terminal

Connects an analog player's ground wire here. This helps reduce noise when the analog player is connected.

6 PHONO terminals

Connect to a phono level (MM cartridge) output device. Do not input line level signals.

- You need to set the [LINE, PHONO, USB] selector switch on top of the unit to [PHONO] beforehand.

7 LINE terminals

Connect to a DJ player or other line level device.

- You need to set the [LINE, PHONO, USB] selector switch on top of the unit to [LINE] beforehand.

8 CD terminals

Connect to a DJ player or other line level device.

- You need to set the [CD, USB] selector switch on top of the unit to [CD] beforehand.

9 MIC1 jack

Connects a microphone here.

- Either an XLR connector or a phones plug (Ø 6.3 mm) can be used.

10 MIC2 terminal

Connects a microphone here.

11 USB-B terminal

Connect to a computer.

- Connect this unit to your computer directly via a USB cable included with this product or the one that conforms to USB 2.0.
- A USB hub cannot be used.

12 USB-A terminal

Connect to a computer.

- Connect this unit to your computer directly via a USB cable included with this product or the one that conforms to USB 2.0.
- A USB hub cannot be used.

13 ⏻ switch

This switches this unit's power between on and standby.

14 AC IN terminal

Connect the power cord after all the connections between devices have been completed.

Be sure to use the included power cord.

❖ Front panel

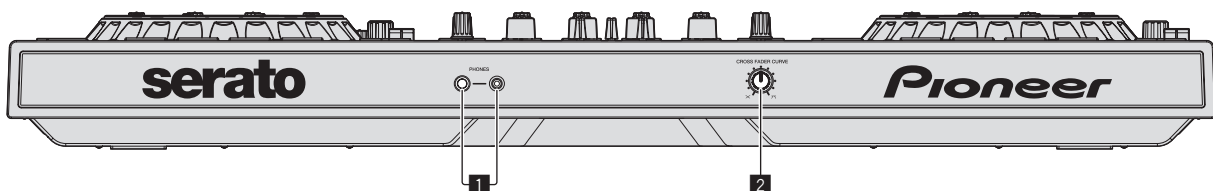

1 PHONES jacks

Connect headphones here.

Both stereo phone plugs (Ø 6.3 mm) and stereo mini phone plugs (Ø 3.5 mm) can be used.

- There are two input jacks, both a stereo phones jack and a mini phones jack, but do not use both simultaneously. If both are used simultaneously, when one is disconnected and/or connected, the volume of the other may increase or decrease suddenly.

2 CROSS FADER CURVE selector switch

This switches the crossfader curve characteristics.

- The further the control is turned clockwise, the sharper the curve rises.
- The further the control is turned counterclockwise, the more gradually the curve rises.

Connecting the input/output terminals

❖ Connecting input terminals

Rear panel

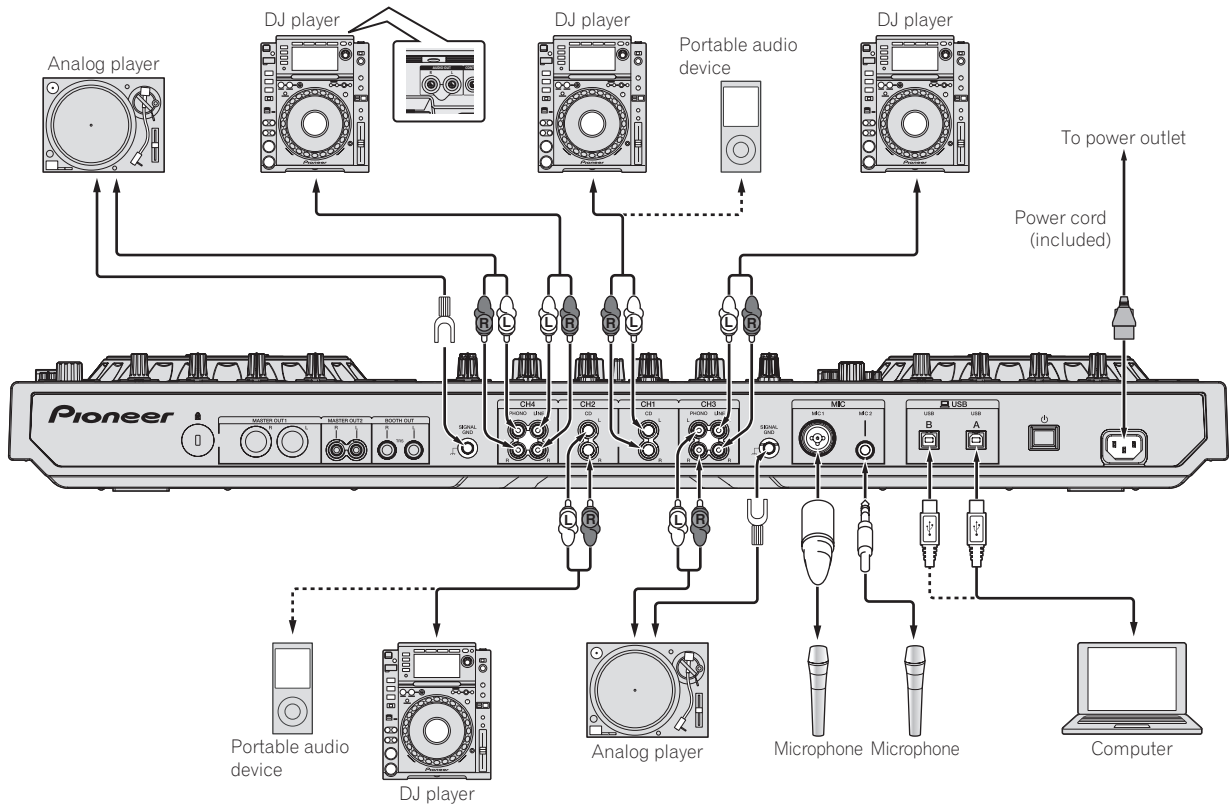

❖ Connecting output terminals

Rear panel

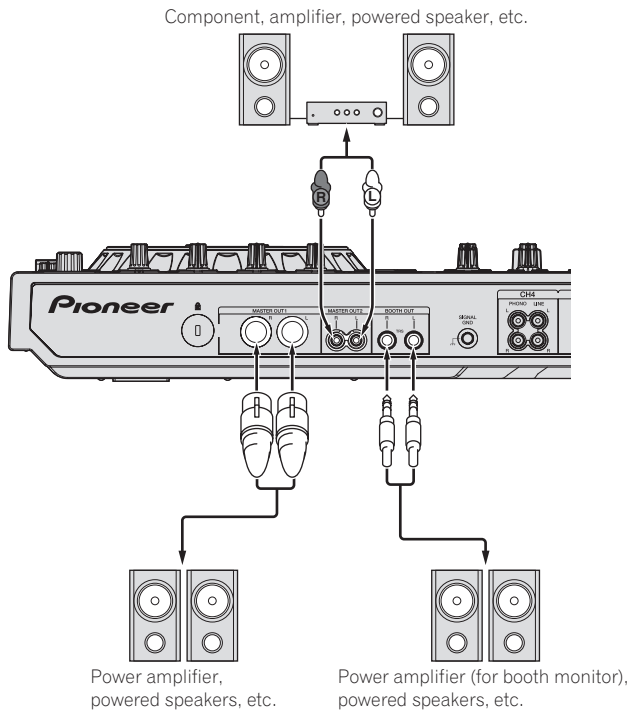

Front panel

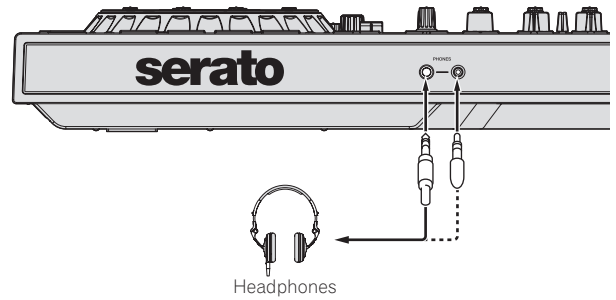

Part names and functions

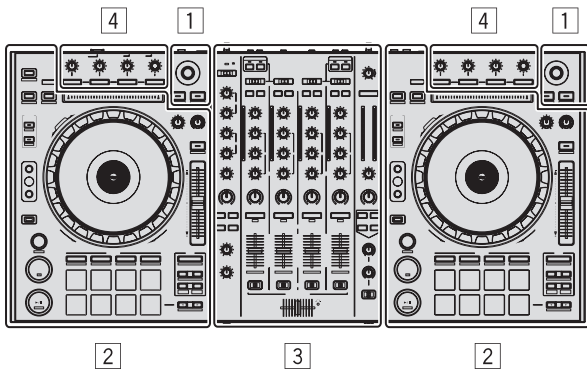

- 1 Browser section
- 2 Deck section
- 3 Mixer section
- 4 Effect section

Browser section

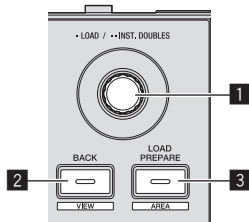

1 Rotary selector

Turn:
The cursor in the library or on the [CRATES] panel moves up and down.

Press:
The selected tracks are loaded to the respective decks.

- When the rotary selector is pressed twice, the tracks loaded in the selected deck on the opposite side are loaded into the deck whose rotary selector was pressed. When this is done while a track is playing, the track is played from the same position. (Instant Double)

2 BACK (VIEW) button

Press:
The cursor moves between the [CRATES] panel and library each time the button is pressed.

[SHIFT] + press:
Switches the Serato DJ layout.

3 LOAD PREPARE (AREA) button

Press:
Loads tracks to the [Prepare] panel.

[SHIFT] + press:
Selects and opens the [Files] panel, [Browse] panel, [Prepare] panel or [History] panel.

Deck section

This section is used to control the four decks. The buttons and controls for operating decks 1 and 3 are located on the left side of the controller, those for operating decks 2 and 4 are located on the right side of the controller.

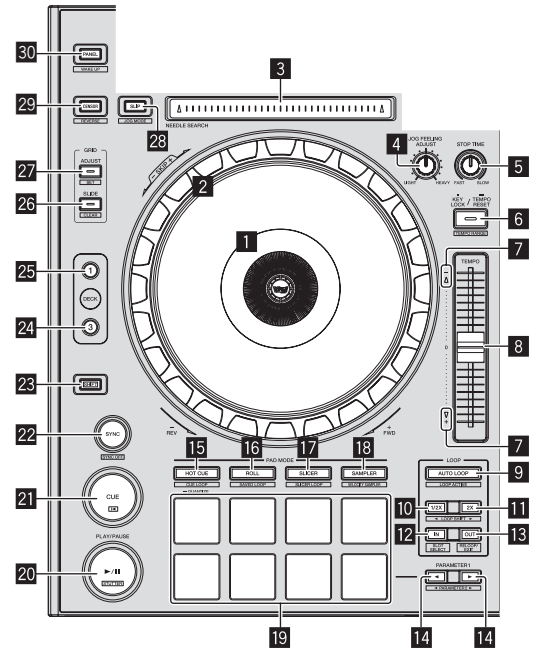

1 Jog dial display section

↪ *Jog dial display section (p.12)*

2 Jog dial

Turn top:

When the vinyl mode is on, the scratch operation is possible.

When the vinyl mode is off, the pitch bend operation (adjustment of the playing speed) is possible.

Turn outer section:

The pitch bend operation (adjustment of the playing speed) is possible.

[SHIFT] + Turn top:

The playback position skips in sync with the beat. (Skip mode)

- The skip mode cannot be used with tracks for which no beatgrid is set. For details on setting beatgrids, see the Serato DJ software manual.
- To use the skip mode, [SYNC PREFERENCES] in the Serato DJ [SETUP] menu must be switched to [Smart Sync].

3 NEEDLE SEARCH pad

By touching the pad, you can jump to the desired position in the track loaded in the deck.

4 JOG FEELING ADJUST control

This adjusts the load applied when the jog dial is spun.

The load gets heavier when turned clockwise, lighter when turned counterclockwise.

5 STOP TIME control

When the [PLAY/PAUSE▶/||] button is pressed, the speed of playback stop can be changed.

6 KEY LOCK button

Press:

Turns the key lock function on and off.

When the key lock function is on, the key does not change even when the playing speed is changed with the [TEMPO] slider.

The sound is digitally processed, so the sound quality decreases.

[SHIFT] + press:

The [TEMPO] slider's range of variation switches each time the button is pressed.

→ [±8%] → [±16%] → [±50%]

Press for over 1 second:

Sets the tempo (BPM) of the currently playing track back to its original tempo.

7 Takeover indicator

When decks are switched while the sync function is off, the position of the controller's **[TEMPO]** slider may not match the software's tempo (pitch). To regain control of the tempo from the controller, adjust using the **[TAKEOVER]** indicator as reference. Slowly move the **[TEMPO]** slider in the direction in which the **[TAKEOVER]** indicator lights. When moved to the position at which the **[TAKEOVER]** indicator turns off, the **[TEMPO]** slider's position matches the software's tempo (pitch) and the tempo can once again be controlled with the **[TEMPO]** slider.

8 TEMPO slider

Use this to adjust the track playing speed.

When the deck is switched, if the value controlled by Serato DJ and the **[TEMPO]** slider position of the unit are different, you cannot operate the **[TEMPO]** slider unless it is moved to the position controlled by Serato DJ.

- The default setting of the **[TEMPO]** slider of deck 3 and 4 of Serato DJ is $\pm 0.0\%$.

9 AUTO LOOP button

Press:

Turns the auto loop function on and off.

- During loop playback, this operation cancels looping.

[SHIFT] + press:

Switches looping between active and non-active. (Loop Active)

- Even if looping is active, if there is no playback position in that loop, loop playback is not performed.
- When the playback position enters the active loop, loop playback starts.
- During loop playback, this operation cancels looping.

10 LOOP 1/2X button

Press:

Select the auto loop beat.

During loop playback, the length of loop playback is split in half each time this button is pressed.

[SHIFT] + press:

During loop playback, moves the loop to the left by the amount equal to its length. (Loop Shift)

11 LOOP 2X button

Press:

Select the auto loop beat.

During loop playback, the length of loop playback is doubled each time this button is pressed.

[SHIFT] + press:

During loop playback, moves the loop to the right by the amount equal to its length. (Loop Shift)

12 LOOP IN button

Press:

Loop In Point is set.

When this button is pressed during loop playback, the loop in point can be fine-adjusted using the jog dial.

[SHIFT] + press:

The loop slot switches. (Loop Slot)

When loops are stored in loop slots ahead of time, they can be called out later.

- Up to eight loops can be set in the loop slots.
- When you select the number of the loop slot at which you want to store the loop then set a loop, the loop is automatically stored.
- When a new loop is set after a loop has been stored, the loop is overwritten and the slot is updated.
- When the number of the loop slot whose loop you want to call out is selected and the **[LOOP OUT]** button is pressed while pressing the **[SHIFT]** button (reloop), playback of the stored loop starts.

13 LOOP OUT button

Press:

The loop out point is set, and loop playback begins.

When this button is pressed during loop playback, the loop out point can be fine-adjusted using the jog dial.

[SHIFT] + press:

Cancels loop playback. (Loop Exit)

After loop playback is canceled, playback returns to the previously set loop in point and loop playback resumes. (Reloop)

14 PARAMETER◀ button, PARAMETER▶ button

These set the various parameters for when using the performance pads.

- ☞ *Using the performance pads* (p.17)

15 HOT CUE mode button

Press:

Sets the hot cue mode.

- ☞ *Using hot cues* (p.17)

[SHIFT] + press:

Sets the hot loop mode.

- ☞ *Using the cue loop* (p.18)

Press for over 1 second:

Turns the quantize on/off.

16 ROLL mode button

Press:

Sets the roll mode.

- ☞ *Using the Roll function* (p.17)

[SHIFT] + press:

Sets the saved loop mode.

- ☞ *Using the saved loop* (p.18)

17 SLICER mode button

Press:

Sets the slicer mode.

- To cancel the slicer mode, press one of the **[ROLL]** mode, **[SAMPLER]** mode or **[HOT CUE]** mode buttons.

[SHIFT] + press:

Sets the slicer loop mode.

18 SAMPLER mode button

Press:

Sets the sampler mode.

[SHIFT] + press:

Turns the sampler velocity mode on and off.

- For details on the sampler velocity mode, see *Using the sampler velocity mode* on page 19.

19 Performance pads

Various performances can be achieved using the pads.

- ☞ *Using the performance pads* (p.17)

20 PLAY/PAUSE ▶/II button

Press:

Use this to play/pause tracks.

- When the **[PLAY/PAUSE ▶/II]** button is pressed during cue sampling, playback continues from that point.

[SHIFT] + press:

The track returns to the temporary cue point and playback continues from there. (Stutter)

21 CUE button

Press:

This is used to set, play and call out temporary cue points.

- When the **[CUE]** button is pressed while pausing, the temporary cue point is set.
- When the **[CUE]** button is pressed during playback, the track returns to the temporary cue point and pauses. (Back Cue)
- When the **[CUE]** button is pressed and held after the track returns to the temporary cue point, playback continues as long as the button is pressed in. (Cue Sampler)
- When the **[PLAY/PAUSE ▶/II]** button is pressed during cue sampling, playback continues from that point.

[SHIFT] + press:

Loads the previous track in the track list. (Previous Track)

- If the current playback position is not the beginning of a track, the track returns to the beginning.

22 SYNC button

Press:

The tempos (pitches) and beat grids of tracks on multiple decks can be synchronized automatically.

[SHIFT] + press:

Cancels the sync mode.

23 SHIFT button

When another button is pressed while pressing the **[SHIFT]** button, a different function is called out.

24 DECK 3 button

The deck on the right side has a **[DECK 4]** button.

Switches the deck to be operated.

25 DECK 1 button

The deck on the right side has a [DECK 2] button.
Switches the deck to be operated.

26 GRID SLIDE button

Press:
When the jog dial is turned while pressing the [GRID SLIDE] button, the overall beat grid can be slid to the left or right.

[SHIFT] + press:
Clears the beat markers. (Grid Clear)

27 GRID ADJUST button

Press:
When the jog dial is turned while pressing the [GRID ADJUST] button, the beat grid interval can be adjusted.

[SHIFT] + press:
Sets a beat marker. (Grid Set)

- Beat markers can be set at multiple points.

28 SLIP button

Turns the slip mode on and off.
➡ *Using the slip mode* (p.18)

[SHIFT] + press:
This switches the vinyl mode on/off.

29 CENSOR button

Press:
The track is played in the reverse direction while the [CENSOR] button is pressed, and normal playback resumes when the button is released.

- Even during playback in the reverse direction, normal playback continues in the background. When the button is released, playback resumes from the point reached in the background.

[SHIFT] + press:
The track is played in the reverse direction. When the [SHIFT] and [CENSOR] buttons are pressed again, reverse playback is canceled and normal playback resumes.

30 PANEL button

Press:
(During normal operation)
The panel display switches in the order below each time the button is pressed.
Panel display off ➔ [REC] panel ➔ [FX] panel ➔ [SP-6] panel ➔ Panel display off ...

- When Serato-Video is installed and enabled at the [SETUP] menu, a key for switching to the [VIDEO] panel is displayed on the Serato DJ software screen. To display the [VIDEO] panel, use the mouse to click this key for switching to the [VIDEO] panel.

(During standby status)
The standby mode is canceled.

[SHIFT] + press:
The panel display switches in the order below each time the button is pressed.
Panel display off ➔ [SP-6] panel ➔ [FX] panel ➔ [REC] panel ➔ Panel display off ...

- When Serato-Video is installed and enabled at the [SETUP] menu, a key for switching to the [VIDEO] panel is displayed on the Serato DJ software screen. To display the [VIDEO] panel, use the mouse to click this key for switching to the [VIDEO] panel.

Mixer section

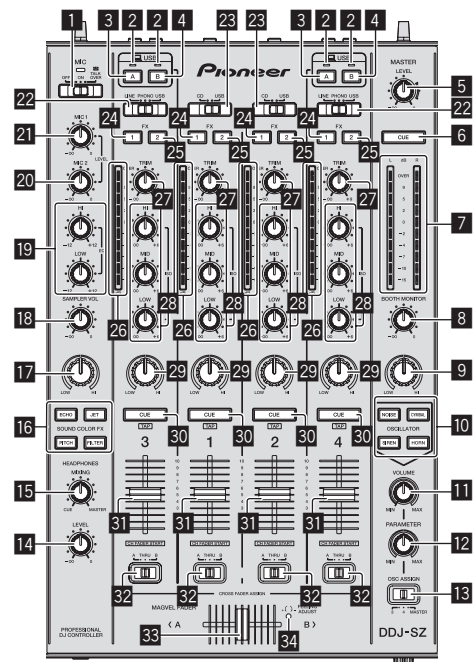

1 OFF, ON, TALK OVER selector switch

Turns the microphone on/off.

2 USB connection indicator

Displays the connection status between the **USB-A** terminal and **USB-B** terminal.

Lights: When communication with Serato DJ is normal

Flashes: When the driver is not installed in the computer

Lights out: When the computer is not connected to the terminal

3 USB (A) button

When lights, the **USB-A** terminal is used in communication with the computer.

- The [USB (A)] button and [USB (B)] button located at the left side are used to control the USB communication for deck 1 or deck 3. The [USB (A)] button and [USB (B)] button located at the right side are used to control USB communication for deck 2 or deck 4.
- When the [USB (A)] button or [USB (B)] button located on the left side is flashing, it means the deck 1 or deck 3 audio is on air. Flashing stops when the channel fader of deck 1 or deck 3 is moved to the frontmost position. When the [USB (A)] button or [USB (B)] button located on the right side is flashing, it means deck 2 or deck 4 audio is on air. Flashing stops when the channel fader of deck 2 or deck 4 is moved to the frontmost position. (When the USB terminal is switched, sound is also switched instantaneously. Therefore, when the button is flashing, before switching the USB terminal, make sure that the deck is not used by another user.)

4 USB (B) button

When lights, the **USB-B** terminal is used in communication with the computer.

- The [USB (A)] button and [USB (B)] button located at the left side are used to control the USB communication for deck 1 or deck 3. The [USB (A)] button and [USB (B)] button located at the right side are used to control USB communication for deck 2 or deck 4.
- When the [USB (A)] button or [USB (B)] button located on the left side is flashing, it means the deck 1 or deck 3 audio is on air. Flashing stops when the channel fader of deck 1 or deck 3 is moved to the frontmost position. When the [USB (A)] button or [USB (B)] button located on the right side is flashing, it means deck 2 or deck 4 audio is on air. Flashing stops when the channel fader of deck 2 or deck 4 is moved to the frontmost position. (When the USB terminal is switched, sound is also switched instantaneously. Therefore, when the button is flashing, before switching the USB terminal, make sure that the deck is not used by another user.)

5 MASTER LEVEL control

Adjusts the master sound level output.

6 MASTER CUE button

Turns monitoring of the master output's sound on and off.

7 Master level indicator

Displays the master output's audio level.

8 BOOTH MONITOR control

Adjusts the level of audio signals output from the [BOOTH OUT] terminal.

9 MASTER OUT COLOR control

Changes the SOUND COLOR FX parameter applied to the master output sound.

- 10 OSCILLATOR SELECT buttons**
Generates oscillator sound (NOISE, CYMBAL, SIREN, and HORN).
➔ *Using the oscillator function* (p.21)
- 11 OSCILLATOR VOLUME control**
Adjusts the sound level of oscillator sound.
- 12 OSCILLATOR PARAMETER control**
Adjusts the quantitative parameters of oscillator sound.
- 13 OSC ASSIGN selector switch**
Selects the channel to output oscillator sound.
- 14 HEADPHONES LEVEL control**
Adjusts the sound level output from the headphones.
- 15 HEADPHONES MIXING control**
Adjusts the balance of the monitor volume between the sound of the channels for which the headphones [CUE] button is pressed and the sound of the master channel.
- 16 SOUND COLOR FX buttons**
These turn the SOUND COLOR FX effects on/off.
- 17 SAMPLER, MIC COLOR control**
Changes the SOUND COLOR FX parameter applied to sampler sound and microphone sound.
- 18 SAMPLER VOL control**
Adjusts the sound level of sampler.
- 19 EQ (HI, LOW) controls**
These adjust the tone quality of the [MIC1] and [MIC2] channels.
- 20 MIC2 control**
Adjusts the sound level output from the [MIC2] channel.
- 21 MIC1 control**
Adjusts the sound level output from the [MIC1] channel.
- 22 LINE, PHONO, USB selector switch**
Selects the input source of each channel from the components connected to this unit.
- [LINE]: Select this to use a line level output device (DJ player, etc.) connected to the [LINE] input terminals.
— When [PHONO] is selected, sound is muted momentarily.
 - [PHONO]: Select this to use a phono level (for MM cartridges) output device (analog player, etc.) connected to the [PHONO] input terminals.
 - [USB]: Select this to use the track loaded in the Serato DJ software's deck.
- 23 CD, USB selector switch**
Selects the input source of each channel from the components connected to this unit.
- [CD]: Select this to use a line level output device (DJ player, etc.) connected to the [CD] terminals.
 - [USB]: Select this to use the track loaded in the Serato DJ software's deck.
- 24 FX 1 assign button**
Turns effect unit FX1 on and off for the respective channel.
- 25 FX 2 assign button**
Turns effect unit FX2 on and off for the respective channel.
- 26 Channel Level Indicator**
Displays the sound level of the respective channels before passing through the channel faders.
- 27 TRIM control**
Adjusts the level of audio signals input in each channel.
- 28 ISO (HI, MID, LOW) controls**
Boosts or cuts frequencies for the different channels.
- 29 COLOR control**
This changes the parameters of the SOUND COLOR FX of the different channels.
- 30 Headphones CUE button**
Press:
The sound of channels for which the headphones [CUE] button is pressed is output to the headphones.
- When the headphones [CUE] button is pressed again, monitoring is canceled.
- [SHIFT] + press:
The track's tempo can be set by tapping the button. (Tap function)
- When the tap function is used, the deck section's display on the computer's screen switches to the [Beatgrid Editor] display. To switch the deck section's display back to how it was before, click [Edit Grid] on the computer's screen.

- 31 Channel fader**
Move:
Adjusts the level of audio signals output in each channel.

[SHIFT] + move:
Use the channel fader start function.
➔ *Using the channel fader start function* (p.19)

- 32 Crossfader assign selector switch**
Assigns the channel output to the crossfader.
- [A]: Assigns to [A] (left) of the crossfader.
[B]: Assigns to [B] (right) of the crossfader.
[THRU]: Selects this when you do not want to use the crossfader. (The signals do not pass through the crossfader.)

- 33 Crossfader**
Outputs the sound assigned with the crossfader assign switch.

[SHIFT] + move:
Uses the crossfader start function.
➔ *Using the crossfader start function* (p.19)

- 34 FEELING ADJUST adjustment hole**
This can be used to adjust the crossfader's operating load.
➔ *Adjusting the crossfader's operating load* (p.20)

Effect section

This section is used to control the two effect units (FX1 and FX2). Controls and buttons to operate the FX1 unit are located on the left side of the controller, those to operate the FX2 unit are located on the right side of the controller. The channels to which the effect is to be applied are set using the effect assign buttons.

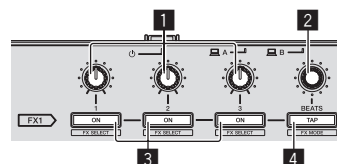

- 1 Effect parameter controls**
These adjust the effects' parameters.
- 2 FX BEATS control**
Adjusts the effect time.
- 3 Effect parameter buttons**
Press:
Turns the effect on and off or switches the parameter.
- [SHIFT] + press:
Switches the effect type.
- 4 TAP button**
Press:
The BPM used as the base value for the effect is calculated by the interval at which the button is tapped with a finger.
When the button is pressed and held, the effect time is reset.
- [SHIFT] + press:
Switches the effect mode.

Front panel

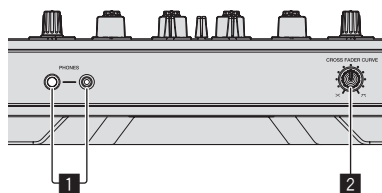

1 PHONES jacks

2 CROSS FADER CURVE selector switch

This switches the crossfader curve characteristics.

- The further the control is turned clockwise, the sharper the curve rises.
- The further the control is turned counterclockwise, the more gradually the curve rises.

Jog dial display section

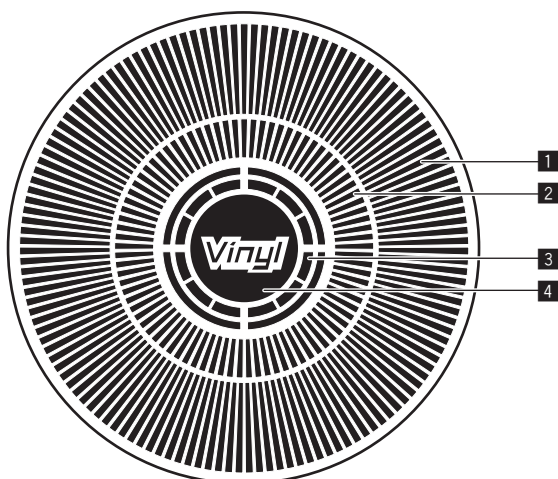

1 Operation display

It works in synchronization with the rotation display of the Serato DJ deck.

2 Hot cue point display

3 Jog touch detection display

The display lights when the jog dial top is pressed when VINYL mode is on.

4 VINYL

The display lights when VINYL mode is on.

Basic Operation

Connections

1 Connect headphones to one of the [PHONES] terminals.

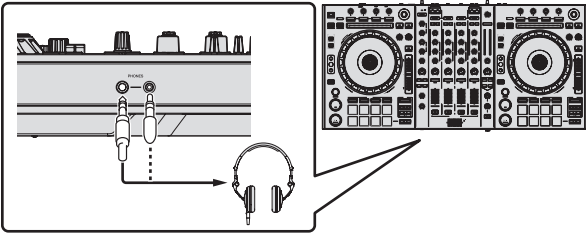

2 Connect powered speakers, a power amplifier, components, etc., to the [MASTER OUT 1] or [MASTER OUT 2] terminals.

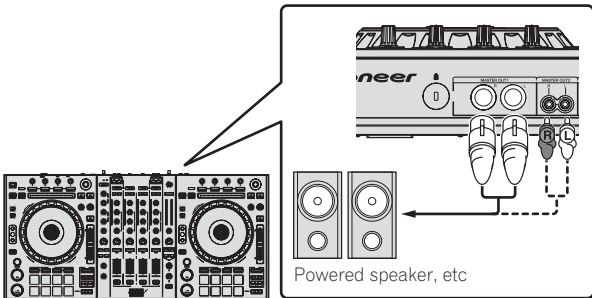

- To output the sound from the [BOOTH OUT] terminals, connect speakers or other devices to the [BOOTH OUT] terminals.
- For details on the connections of the input/output terminals, see *Connections* (p.6).

3 Connect this unit to your computer via a USB cable.

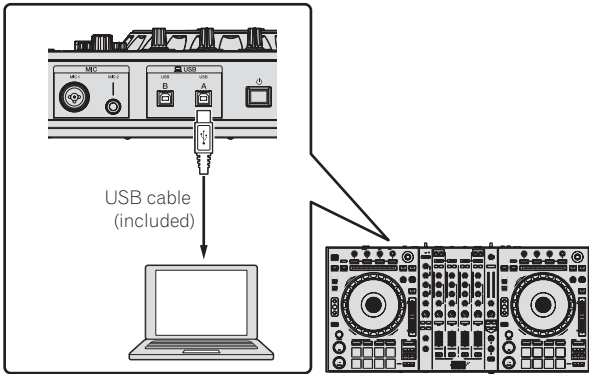

This product satisfies electromagnetic noise regulations when it is connected to other equipment through shielded cables and connectors. Use only the furnished accessory connecting cables.

D44-8-2_A1_En

4 Turn on the computer's power.

5 Connect the power cord.

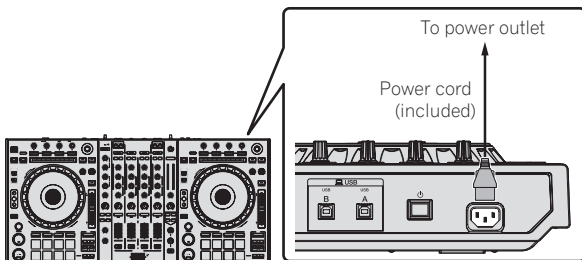

6 Press the [⏻] switch on this unit's rear panel to turn this unit's power on.

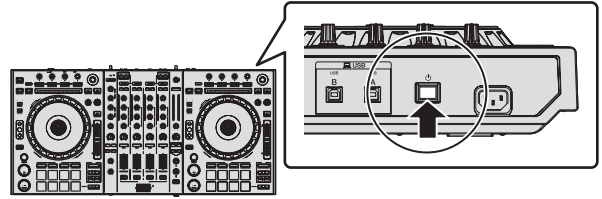

Turn on the power of this unit.

- For Windows users
The message [Installing device driver software] may appear when this unit is first connected to the computer or when it is connected to a different USB port on the computer. Wait a while until the message [Your devices are ready for use] appears.

7 Turn on the power of the devices connected to the output terminals (powered speakers, power amplifier, components, etc.).

- When a microphone, DJ player or other external device is connected to input terminals, the power of that device also turns on.

Starting the system

Launching Serato DJ

For Windows

From the Windows **[Start]** menu, click the **[Serato DJ]** icon under **[All Programs] > [Serato] > [Serato DJ]**.

For Mac OS X

In Finder, open the **[Applications]** folder, then click the **[Serato DJ]** icon.

Computer screen directly after the Serato DJ software is launched

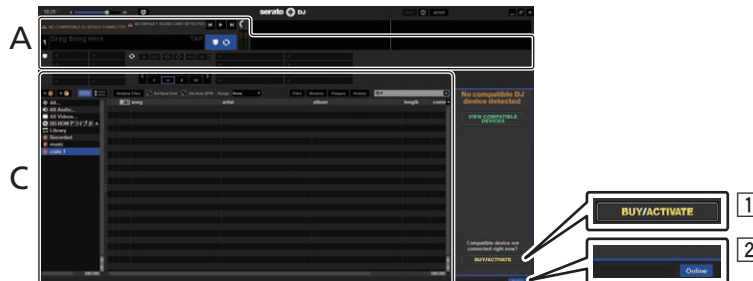

- 1 The **[BUY/ACTIVATE]** icon may appear on the right side of the screen that is displayed when Serato DJ is launched the first time, but there is no need to activate or purchase a license for those using **DDJ-SZ**.
- 2 Click **[Online]** to use the unit as is.

To operate the beat grid

With Serato DJ, **[SYNC PREFERENCES]** is set to **[Simple Sync]** by default, but this must be switched to **[Smart Sync]** in order to perform beat grid operations.

SETUP—DJ Preference—SYNC PREFERENCES

For instructions on displaying the settings screen and details on the beat grid, see the Serato DJ manual.

Computer screen when a track is loaded in the Serato DJ software

Click **[Library]** at the upper left of the computer screen, then select **[Vertical]** or **[Horizontal]** from the pull-down menu to switch the Serato DJ screen.

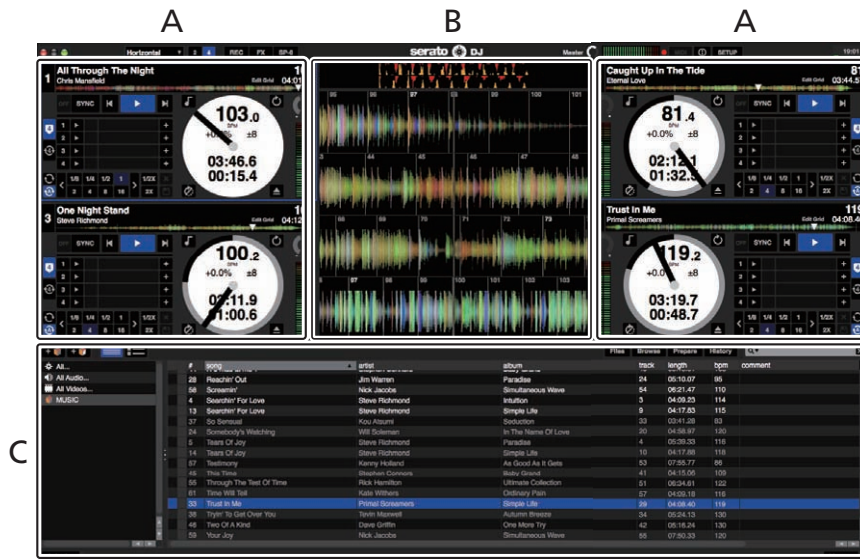

A Deck section

The track information (the name of the loaded track, artist name, BPM, etc.), the overall waveform and other information is displayed here.

B Waveform display

The loaded track's waveform is displayed here.

C Browser section

Crates in which tracks in the library or sets of multiple tracks are stored are displayed here.

This manual consists mainly of explanations of functions of this unit as hardware. For detailed instructions on operating the Serato DJ software, see the Serato DJ software manual.

Importing tracks

The following describes the typical procedure for importing tracks.

- There are various ways to import tracks with the Serato DJ software. For details, see the Serato DJ software manual.
- If you are already using Serato DJ software (Scratch Live, ITCH or Serato DJ Intro) and have already created track libraries, the track libraries you have previously created can be used as such.
- If you are using Serato DJ Intro and have already created track libraries, you may have to reanalyze the tracks.

1 Click the [Files] key on the Serato DJ software screen to open the [Files] panel.

The contents of your computer or the peripheral connected to the computer are displayed in the [Files] panel.

2 Click the folder on the [Files] panel containing the tracks you want to add to the library to select it.

3 On the Serato DJ software screen, drag and drop the selected folder to the crates panel.

A crate is created and the tracks are added to the library.



a [Files] panel
b Crates panel

Loading tracks and playing them

The following describes the procedure for loading tracks into deck [1] as an example.

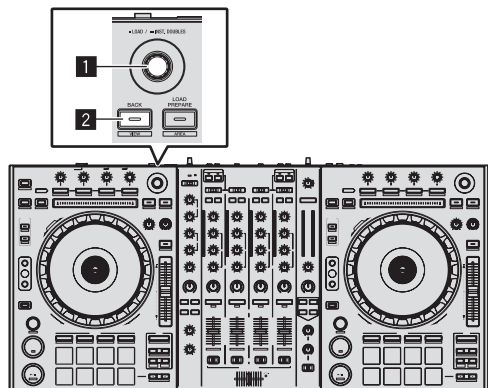

1 Rotary selector
2 BACK (VIEW) button

1 Press this unit's [BACK (VIEW)] button, move the cursor to the crates panel on the computer's screen, then turn the rotary selector to select the crate, etc.

2 Press the rotary selector, move the cursor to the library on the computer's screen, then turn the rotary selector and select the track.

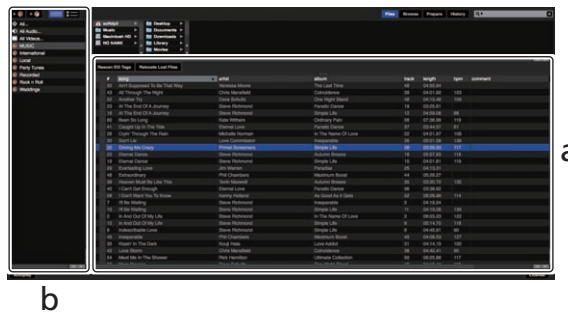

a Library
b Crates panel

3 Press the [DECK1] button.

4 Press the rotary selector to load the selected track onto the deck.

Playing tracks and outputting the sound

The following describes the procedure for outputting the channel 1 sound as an example.

- Set the volume of the devices (power amplifier, powered speakers, etc.) connected to the [MASTER OUT 1] and [MASTER OUT 2] terminals to an appropriate level. Note that loud sound will be output if the volume is set too high.

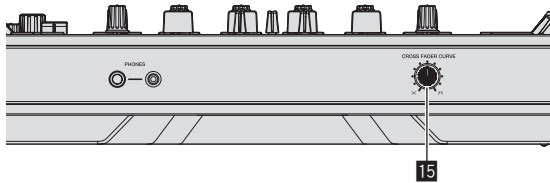
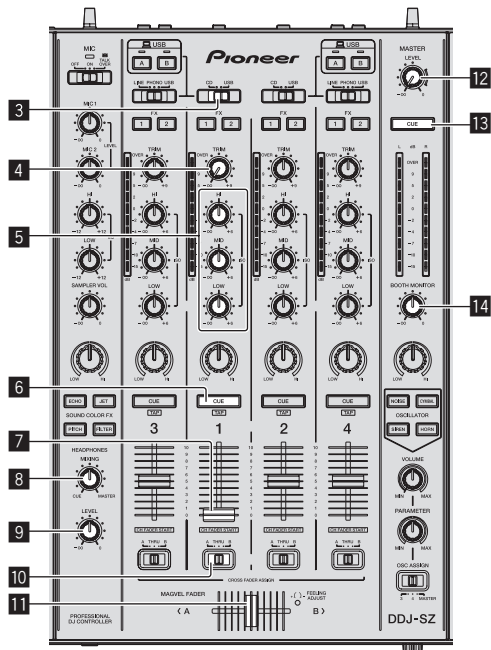

- 3 CD, USB selector switch
- 4 TRIM control
- 5 ISO (HI, MID, LOW) controls
- 6 Headphones CUE button
- 7 Channel fader
- 8 HEADPHONES MIXING control
- 9 HEADPHONES LEVEL control
- 10 Crossfader assign selector switch
- 11 Crossfader
- 12 MASTER LEVEL control
- 13 MASTER CUE button
- 14 BOOTH MONITOR control
- 15 CROSS FADER CURVE selector switch

1 Set the positions of the controls, etc., as shown below.

Names of controls, etc.	Position
MASTER LEVEL control	Turned fully counterclockwise
CD, USB selector switch	[USB] position
TRIM control	Turned fully counterclockwise
ISO (HI, MID, LOW) controls	Center
Channel fader	Moved forward
Crossfader assign selector switch	[THRU] position

2 Press the [▶/II] button to play the track.

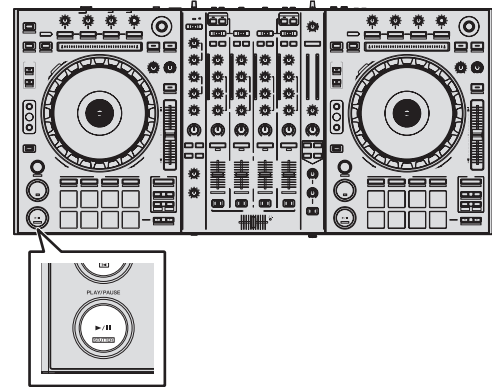

3 Turn the [TRIM] control.

Adjust the [TRIM] control so that the channel level indicator's orange indicator lights at peak level.

4 Move the channel fader away from you.

5 Turn the [MASTER LEVEL] control to adjust the audio level of the speakers.

Adjust the sound level output from the [MASTER OUT 1] and [MASTER OUT 2] terminals to an appropriate level.

Monitoring sound with headphones

Set the positions of the controls, etc., as shown below.

Names of controls, etc.	Position
HEADPHONES MIXING control	Center
HEADPHONES LEVEL control	Turned fully counterclockwise

1 Press the headphones [CUE] button for the channel 1.

2 Turn the [HEADPHONES LEVEL] control.

Adjust the sound level output from the headphones to an appropriate level.

Note

This unit and the Serato DJ software include a variety of functions enabling individualistic DJ performances. For details on the respective functions, see the Serato DJ software manual.

- The Serato DJ software manual can be downloaded from "Serato.com". For details, see *Downloading the Serato DJ software manual* (p. 34).

Quitting the system

1 Quit [Serato DJ].

When the software is closed, a message for confirming that you want to close it appears on the computer's screen. Click [Yes] to close.

2 Press the [⏻] switch on this unit's rear panel to set this unit's power to standby.

3 Disconnect the USB cable from your computer.

Advanced Operation

The descriptions from this point on are for functions not described in the Serato DJ software manual that are specifically for when this unit and Serato DJ are used in combination.

Using the performance pads

These functions are switched using the respective pad mode buttons (the [HOT CUE] mode button, [ROLL] mode button, [SLICER] mode button and [SAMPLER] mode button).

Using hot cues

With this function, playback can be started instantaneously from the position at which a hot cue is set.

- Up to eight hot cue points can be set and saved per track.

1 Press the [HOT CUE] mode button.

The [HOT CUE] mode button lights and the mode switches to the hot cue mode.

2 In the play or pause mode, press a performance pad to set the hot cue point.

The hot cue points are assigned to the respective performance pads as shown below.

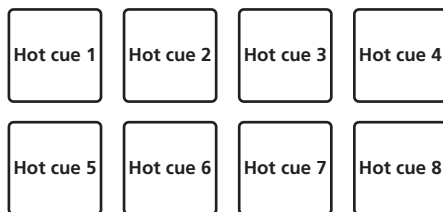

3 Press the performance pad at which the hot cue point was set.

Playback starts from the hot cue point.

- Set hot cue points can be cleared by pressing a performance pad while pressing the [SHIFT] button.

Using the Roll function

When a performance pad is pressed, a loop with the number of beats assigned to that pad is set and loop playback continues as long as the pad is being pressed. During loop roll playback, normal playback with the original rhythm continues in the background. When loop roll playback is canceled, playback resumes from the position reached in the background at the point loop roll playback was canceled.

1 Press the [ROLL] mode button.

The [ROLL] mode button lights and the mode switches to the roll mode.

2 Press the [PARAMETER◀] or [PARAMETER▶] button.

The loop roll beats assigned to the performance pads switch each time one of the buttons is pressed.

The following four settings can be made:

- 4 beats from 1/32
- 8 beats from 1/16
- 16 beats from 1/8
- 32 beats from 1/4

For example, when set to "8 beats from 1/16", the pad's setting is as shown below.



The range of beats set for the loop roll is displayed on the computer's screen.



3 Press and hold one of the performance pads.

A loop roll with the number of beats assigned to the pad that was pressed is played. Playback continues in the background during loop roll playback.

- The number of beats of the currently playing loop roll can be changed by pressing the [LOOP 1/2X] or [LOOP 2X] button during loop roll playback.

4 Release the performance pad.

Loop roll playback is canceled, and playback resumes from the position reached in the background.

Using the Slicer function

The specified range is divided into eight equal sections, and these eight sliced sections are assigned to the respective performance pads. While one of the performance pads is pressed, the sound for the section assigned to that pad is played in a loop.

During loop playback of the pad's sound, normal playback with the original rhythm continues in the background. When the pad is released and loop playback ends, playback resumes from the position reached at that point.

- The slicer function cannot be used with tracks for which no beatgrid is set. For details on setting beatgrids, see the Serato DJ software manual.
 - Beatgrids can also be set using this unit's [GRID ADJUST] and [GRID SLIDE] buttons. (p.10)

1 Press the [SLICER] mode button.

The [SLICER] mode button lights and the mode switches to slicer mode.

- While pressing the [SHIFT] button, pressing the [SLICER] mode button switches the mode to slicer loop mode.
- For details, see *About slicer mode and slicer loop mode* on page 18.

2 Press the [PARAMETER◀] or [PARAMETER▶] button while pressing the [SHIFT] button.

Set the domain for the slicer function. The value set for the domain switches each time one of the buttons is pressed while pressing the [SHIFT] button.

The domain can be set to one of six settings: 2 beats, 4 beats, 8 beats, 16 beats, 32 beats or 64 beats.

The eight equal sections into which the range specified with the domain setting have been sliced are assigned to the respective performance pads as shown below.

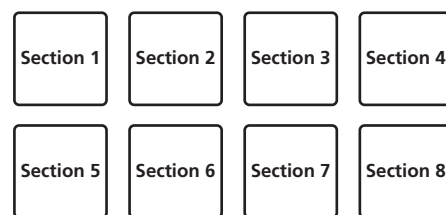
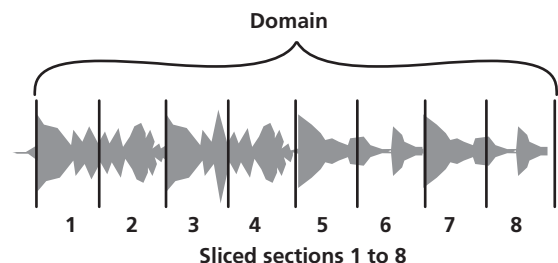

3 Press the [PARAMETER◀] or [PARAMETER▶] button.

Set the quantization for the slicer function. The value set for the quantization switches each time one of the buttons is pressed.

The quantization can be set in four ways: 1/8, 1/4, 1/2 and 1.

The length of the loop which is played while the pad is being pressed can be changed with the "QUANTIZATION" setting. For example, when "QUANTIZATION" is set to "1", the entire section assigned to the pad is played in a loop, and when "QUANTIZATION" is set to "1/2", only the first half of the section assigned to the pad is played in a loop.

4 Press and hold one of the performance pads.

When the pad is pressed and held, the sound is played in a loop.

- The length of loop playback differs depending on the quantization setting.

When the pad is released, the track returns to the position that is playing in the background.

❖ About slicer mode and slicer loop mode

Slicer mode

When the playback position advances to the end of the range that has been sliced into eight equal sections, the range shown on the display switches to the next eight sliced sections, and these sliced sections are assigned to the respective pads, replacing the previously assigned sections.

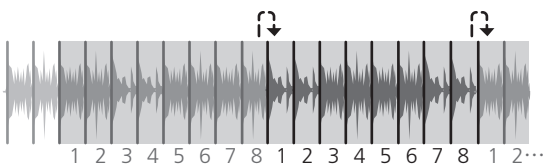

Slicer loop mode

When the playback position advances to the end of the range that was sliced into eight equal parts, the playback position returns to the beginning of the range that was sliced into eight equal parts.

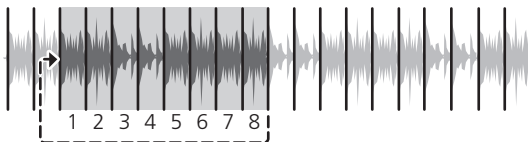

Using the sampler function

Tracks loaded in the sampler slots of the sampler (SP-6) can be played with the performance pads.

1 Press the [PANEL] button to open the [SP-6] panel on the computer's screen.

2 Press the [SAMPLER] mode button.

The [SAMPLER] mode button lights and the mode switches to the sampler mode.

3 Press the [PARAMETER◀] or [PARAMETER▶] button.

Switch the sampler (SP-6) bank. The sampler has four banks, A, B, C and D, and each bank has six slots.

4 Operating the mouse on the computer's screen, drag and drop tracks to load them into the [SP-6] panel's slots.

The sampler settings and loaded tracks are saved.

5 Press a performance pad.

The sound for the slot assigned to the pad that was pressed is played.

- Playback method differs depending on the Serato DJ sampler mode. For details, see the Serato DJ software manual.

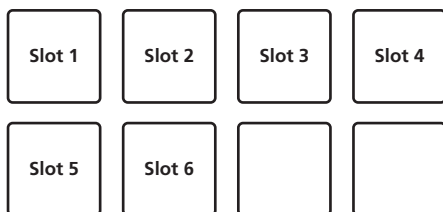

- When a performance pad is pressed while pressing the [SHIFT] button, the sound of the slot that is currently playing stops.

Using the cue loop

1 Press the [HOT CUE] mode button while pressing the [SHIFT] button.

The mode switches to cue loop mode.

2 During playback, press a performance pad.

The loop in point is set at the hot cue slot and loop playback starts.

- The length of the loop at this time is the number of beats set for auto looping. The loop in points are assigned to the performance pads as shown below.

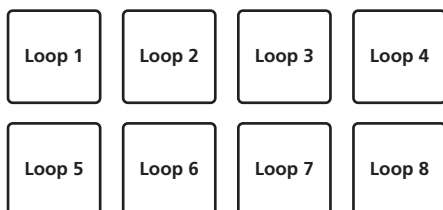

- With the cue loop function, the hot cue point is used as the loop-in point. If a performance pad at which a hot cue point is already set is pressed, loop playback starts from that hot cue point.

3 During loop playback, press the [PARAMETER◀] button.

The loop length is cut in half.

Pressing the [LOOP 1/2X] button obtains the same effect.

4 During loop playback, press the [PARAMETER▶] button.

The loop length is doubled.

Pressing the [LOOP 2X] button obtains the same effect.

5 During loop playback, press the [PARAMETER◀] or [PARAMETER▶] button while pressing the [SHIFT] button.

The loop moves, remaining the same length (loop shift).

- This function (Loop Shift) cannot be used with Serato DJ Ver. 1.6.0. It is scheduled to be supported in future upgrades.

6 While pressing the [SHIFT] button, press the same performance pad.

The track returns to the set loop in point and loop playback continues.

7 Press the same performance pad again.

Loop playback is canceled.

Using the saved loop

With this function, loop is saved in a loop slot of Serato DJ or a saved loop is called.

1 Press the [ROLL] mode button while pressing the [SHIFT] button.

The mode switches to saved loop mode.

2 During loop playback, press a performance pad.

A loop is assigned to the loop slot of Serato DJ.

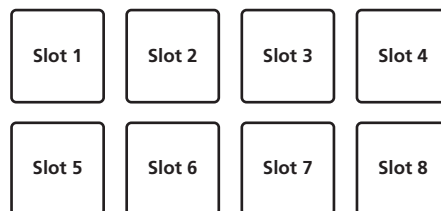

3 Press the performance pad while pressing the [SHIFT] button.

Playback continues by returning to the beginning of the loop.

4 Press the same performance pad again.

Loop playback is canceled.

5 During loop playback, press the [PARAMETER◀] button.

The loop length is cut in half.

6 During loop playback, press the [PARAMETER▶] button.

The loop length is doubled.

7 During loop playback, press the [PARAMETER◀] or [PARAMETER▶] button while pressing the [SHIFT] button.

The loop moves, remaining the same length (loop shift).

- This function (Loop Shift) cannot be used with Serato DJ Ver. 1.6.0. It is scheduled to be supported in future upgrades.

Using the slip mode

When the slip mode is turned on, normal playback with the original rhythm continues in the background during scratching, looping and hot cue playback. When scratching, looping or hot cue playback is canceled, normal playback resumes from the position reached up to the point at which the operation was canceled.

Various performances can be achieved without breaking the rhythm.

- The [SLIP] button lights when the slip mode is set and flashes while the sound is being played in the background.

Slip scratching

1 While pressing the [SHIFT] button, press the [SLIP] button.

The unit switches to VINYL mode.

2 During playback, operate the top of the jog dial to scratch.

Normal playback continues in the background even while scratching.

3 Release your hand from the top of the jog dial.

Playback starts from the position reached in the background.

- To cancel the slip mode, press the [SLIP] button again.

Slip hot cue

1 Press the [HOT CUE] mode button.

Set the hot cue mode.

2 Set the hot cue.

Press a performance pad to set the hot cue.

3 Press the [SLIP] button.

The mode switches to the slip mode.

4 During playback, press and hold a performance pad.

Playback starts from the position at which the hot cue was set. Playback continues as long as the performance pad is pressed.

Normal playback continues in the background while the hot cue is playing.

5 Release your finger from the performance pad.

Playback starts from the position reached in the background.

- To cancel the slip mode, press the [SLIP] button again.

Slip braking

1 Adjust the [STOP TIME] control

The **STOP TIME** setting adjusts the speed at which the track stops from the play mode.

When using slip braking, adjust the [STOP TIME] control to around the 9 o'clock position so that playback stops slowly.

2 Press the [SLIP] button.

The mode switches to the slip mode.

3 During playback, press the [PLAY/PAUSE ►/II] button.

Playback slowly stops while the button is being pressed. Normal playback continues in the background while playback is slowly stopping.

4 Press the [PLAY/PAUSE ►/II] button again.

Playback starts from the position reached in the background.

- To cancel the slip mode, press the [SLIP] button again.

Auto slip looping

1 Press the [SLIP] button.

The mode switches to the slip mode.

2 Press the [LOOP 1/2X] or [LOOP 2X] button.

Select the auto loop beat.

3 Press the [AUTO LOOP] button.

A loop with the specified number of beats is set and loop playback starts. Normal playback continues in the background during loop playback.

4 Press the [AUTO LOOP] button again.

Looping is canceled and playback starts from the position reached in the background.

- To cancel the slip mode, press the [SLIP] button again.

Manual slip looping

❖ Creating a loop and slipping it

1 Press the [SLIP] button.

The mode switches to the slip mode.

2 Press the [LOOP IN] button, then press [LOOP OUT] button.

Loop playback starts.

Normal playback continues in the background even during loop playback.

3 Press the [LOOP OUT] button while pressing the [SHIFT] button.

Looping is canceled and playback starts from the position reached in the background.

- To cancel the slip mode, press the [SLIP] button again.

Using the fader start function

- When the DVS system is used, the fader start function cannot be used if Serato DJ is set to [ABS] mode.

Using the channel fader start function

- To use the channel fader start function, set the crossfader assign selector switch to [THRU].

1 Set the cue.

Pause at the position from which you want to start playback, then press the [CUE] button for the corresponding deck.

- Cues can also be set by moving the channel fader from the back to the position nearest you while pressing the [SHIFT] button in the pause mode.

2 While pressing the [SHIFT] button, move the channel fader from the position nearest you towards the back.

Playback of the track starts from the set cue point.

- When the channel fader is moved back to the position nearest you while pressing the [SHIFT] button during playback, the track moves instantaneously back to the set cue point and the pause mode is set. (Back Cue)

If no cue is set, playback starts from the beginning of the track.

It is also possible to change the setting in the utility settings so that the sync mode is set simultaneously when playback is started with the channel fader start function.

When the channel fader is moved from the back to the position nearest you while pressing the [SHIFT] button when standing by at a cue, track playback starts from the set cue.

Using the crossfader start function

To use the crossfader start function, set the crossfader assign selector switch of the channel you want to move to [A] or [B].

1 Set the cue.

Pause at the position from which you want to start playback, then press the [CUE] button for the corresponding deck.

- Cues can also be set by moving the crossfader to the left edge or the right edge while pressing the [SHIFT] button in the pause mode.

2 Move the crossfader to the left edge or right edge position.

Set to the edge opposite the side on which the channel you want to use with the fader start function is set.

3 While pressing the [SHIFT] button, move the crossfader in the opposite direction from the left edge or right edge.

Playback of the track starts from the set cue point.

- When the crossfader is returned to the original position while pressing the [SHIFT] button during playback, the track moves instantaneously back to the set cue point and the pause mode is set (Back Cue).

If no cue is set, playback starts from the beginning of the track.

When the crossfader is moved from the left edge to the right edge (or from the right edge to the left edge) while pressing the [SHIFT] button when standing by at a cue, track playback starts from the set cue point.

Using the sampler velocity mode

When the sampler velocity mode is on, the sample volume level changes according to the strength with which the performance pads are tapped. The volume level increases when the performance pads are tapped strongly, decreases when they are tapped weakly.

When the sampler velocity mode is off, the sound is triggered at the volume level set with the Serato DJ software, regardless of the strength with which the performance pads are tapped.

Turning the sampler velocity mode on

When the [SAMPLER] mode button is pressed while pressing the [SHIFT] button, the sampler velocity mode is turned on.

Turning the sampler velocity mode off

When the [SAMPLER] mode button is pressed, the mode is changed to the usual sampler mode (sampler velocity mode is turned off).

- In the utilities mode, the velocity curve and after-touch function can be set. When after-touch is enabled, the sample's volume level changes while the performance pad is pressed according to the strength at which the pad is pressed. Also, in the utilities mode, the method for entering the sampler velocity mode can be changed.

For details, see *Changing the sampler velocity mode's velocity curve setting* on page 25.

Adjusting the crossfader's operating load

The load (resistance) when the crossfader is operated can be adjusted using a flathead screwdriver.

- You can adjust the play (cut lag) on both edges of the crossfader. For details, see *Adjusting the crossfader cut lag* on page 26.

1 Move the crossfader to the right edge.

2 Insert the flathead screwdriver into the [FEELING ADJUST] adjustment hole and turn it.

- Turn clockwise: The load decreases (the resistance of fader movement gets weaker).
- Turn counterclockwise: The load increases (the resistance of fader movement gets stronger).

Analyzing tracks

When loading tracks onto the deck by pressing the rotary selector, the tracks are analyzed, but it may take time to display the BPM and waveform until analysis is completed.

When the Serato DJ software is used as an offline player, tracks can be analyzed ahead of time. For tracks whose analysis has been completed, the BPM and waveform are displayed immediately when the tracks are loaded onto the decks.

For details on using the Serato DJ software as an offline player and instructions on analyzing tracks, see the Serato DJ software manual.

- Depending on the number of tracks, some time may be required for analysis.

Using effects

Serato DJ has two effect units, FX1 and FX2. Those effects can be applied to the selected deck or sampler sound (AUX). The following describes how to operate this unit to assign an effect unit to channel 1.

Serato DJ effects unit screen display

Multi FX mode: Up to three effects can be selected per effect unit, and each effect has one adjustable parameter.

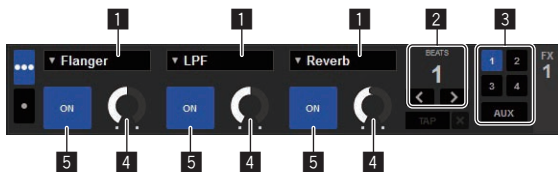

Single FX mode: One effect can be selected per effect unit and there are multiple adjustable parameters.

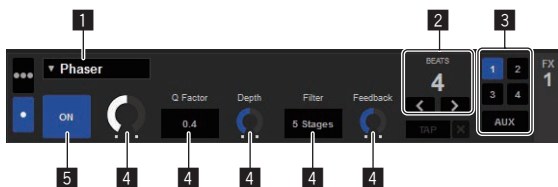

- This displays the effect type.
- This displays the effect time.
- This displays the number of the deck to which the effect unit is assigned.
- This displays the effect parameter status.
- This displays whether the effect is on or off.

Operating in the multi FX mode

1 Press the [TAP] button while pressing the [SHIFT] button to switch Serato DJ's DJ-FX mode to the multi FX mode.

The mode switches between the multi FX mode and single FX mode each time the buttons are operated.

2 Press the [FX1] button or [FX2] button of channel 1 to select the effect unit to assign.

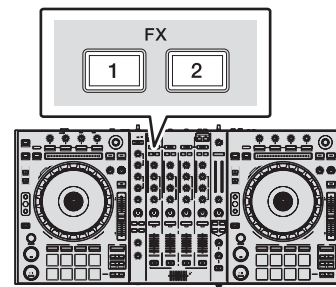

The number of the deck to which the effect is assigned is highlighted on the Serato DJ screen.

3 Press the effect parameter 1 button while pressing the [SHIFT] button to select the first effect type.

To select the second effect type, press the effect parameter 2 button while pressing the [SHIFT] button.

To select the third effect type, press the effect parameter 3 button while pressing the [SHIFT] button.

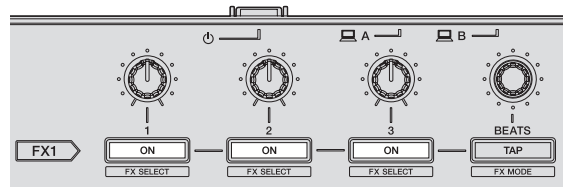

The currently selected effect type is displayed on the Serato DJ screen.

4 Press the effect parameter 1 button to turn the first effect on.

Press the effect parameter 2 button to turn the second effect on.

Press the effect parameter 3 button to turn the third effect on.

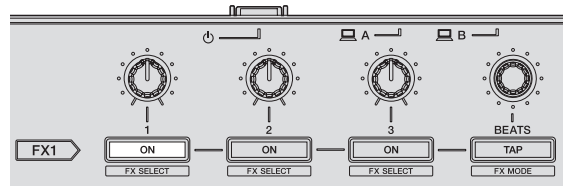

The [ON] key for the corresponding effect is highlighted on the Serato DJ screen.

5 Operate the effect parameter 1 control to adjust the parameter of the first effect.

Operate the effect parameter 2 control to adjust the parameter of the second effect. Operate the effect parameter 3 control to adjust the parameter of the third effect.

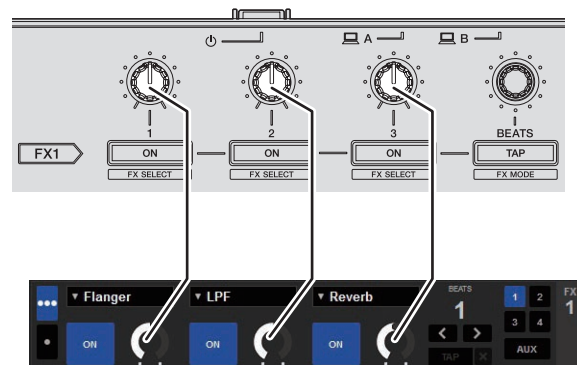

6 Turn the [FX BEATS] control to adjust the effect time.

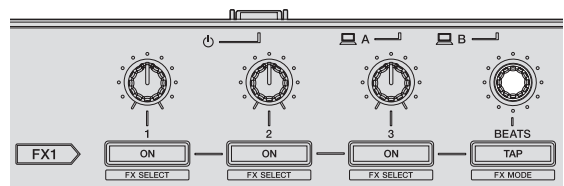

- It is also possible to set the BPM value to be used as the basis for the effect time from the interval at which the [TAP] button is tapped. For details, see *Switching the effect's tempo mode* on page 21.

Operating in the single FX mode

1 Press the [TAP] button while pressing the [SHIFT] button to switch Serato DJ's DJ-FX mode to the single FX mode.

The mode switches between the multi FX mode and single FX mode each time the buttons are operated.

2 Press the [FX1] button or [FX2] button of channel 1 to select the effect unit to assign.

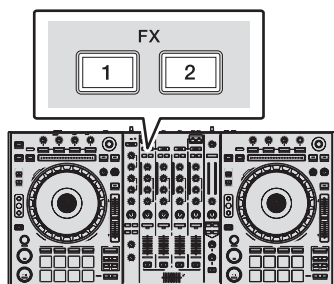

The number of the deck to which the effect is assigned is highlighted on the Serato DJ screen.

3 Press one of the effect parameter buttons while pressing the [SHIFT] button to select the effect type.

The selected effect is displayed on the Serato DJ screen.

4 Press the effect parameter 1 button to turn the effect on.

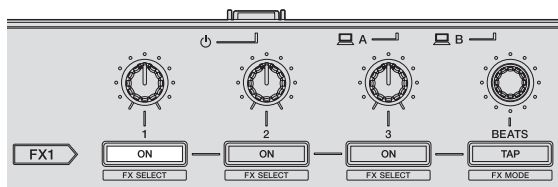

The effect switches between on and off each time the button is pressed.

- The effect's [ON] key is highlighted on the Serato DJ screen.

5 Operate the effect parameter 2 button or the effect parameter 3 button to switch the effect's parameter.

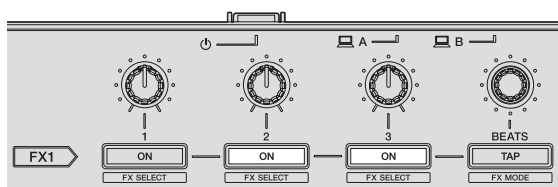

- Depending on the type of effect, the button may not light when it is operated.

6 Operate the effect parameter control(s) to adjust the effect's parameter(s).

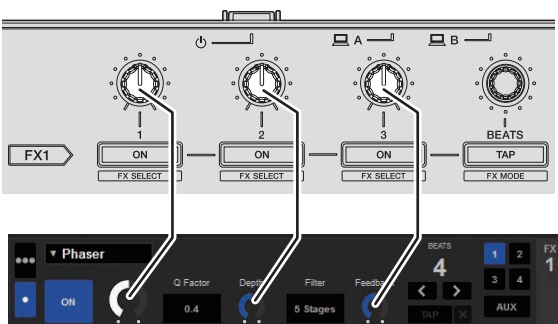

7 Turn the [FX BEATS] control to adjust the effect time.

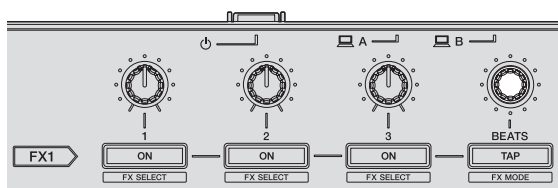

- It is also possible to set the BPM value to be used as the basis for the effect time from the interval at which the [TAP] button is tapped.
For details, see *Switching the effect's tempo mode* on page 21.

Switching the effect's tempo mode

With Serato DJ effects, there are two ways to set the effect's tempo: with the "auto tempo mode" and the "manual tempo mode".

- By default, the auto tempo mode is set.

❖ Auto tempo mode

The track's BPM value is used as the basis for the effect's tempo.

❖ Manual tempo mode

The BPM value used as the effect's basis is calculated from the interval at which the [TAP] button is tapped.

❖ Switching to the manual tempo mode

While in the auto tempo mode, press the [TAP] button three times.

- When the [TAP] button is pressed for over 1 second while in the manual-tempo mode, the mode switches to the auto tempo mode.

Using the SOUND COLOR FX function

These are effects that change in association with the [COLOR] control.

1 Press one of the [SOUND COLOR FX] buttons.

This selects the type of effect.

The button that was pressed flashes.

- Even when one of the [SOUND COLOR FX] buttons is selected, if a different [SOUND COLOR FX] button is pressed, the newly pressed button is selected.
- For the types of effects, see *Types of SOUND COLOR FX effects* on page 22.
- The same effect is set for all channels.

2 Turn the [COLOR] control.

The effect is applied to the channel(s) for which the control(s) was (were) pressed.

Canceling the SOUND COLOR FX effect

Press the flashing [SOUND COLOR FX] button.

The effect is canceled.

Using the oscillator function

You can add a noise-based built-in audio source.

1 Use the [OSC ASSIGN] switch to select the channel to which you want to apply oscillator sound.

- [CH3]: Applies oscillator sound on channel 3.
- [CH4]: Applies oscillator sound on channel 4.
- [MASTER]: Adds oscillator sound to the master output.

2 Turn the [OSCILLATOR PARAMETER] control.

Turning the control clockwise or counterclockwise adjusts the oscillator sound tone.

3 Turn the [OSCILLATOR VOLUME] control.

Adjusts the sound level of oscillator sound.

4 Press one of the [OSCILLATOR SELECT] buttons.

This selects the type of oscillator sound.

The button that was pressed flashes for a certain period of time.

- For types of oscillator sound, see *Type of oscillator sound* on page 22.
- You can select more than one oscillator sound.
- While pressing the [NOISE] button, sound output continues.

Quitting the oscillator function

Oscillator sound automatically stops after a certain period of time and the [OSCILLATOR SELECT] button changes from flashing to lighted.

Types of effects

Types of SOUND COLOR FX effects

Effect Name	Descriptions	[COLOR] control
ECHO	Applies an echo effect, with the sound delayed slightly after the original sound output several times and gradually attenuated.	Counterclockwise: The delay time of echo sound gradually becomes longer. Clockwise: The delay time of echo sound gradually becomes shorter.
JET	The flanger effect is applied.	Counterclockwise: Applies a flanger effect, which emphasizes low-pitched sound. Clockwise: Applies a flanger effect, which emphasizes high-pitched sound.
PITCH	Changes the sound pitch.	Counterclockwise: Pitch goes down. Clockwise: Pitch goes up.
FILTER	Outputs sound that has passed through a filter.	Turn counterclockwise: Gradually decreases the low-pass filter's cutoff frequency. Turn clockwise: Gradually increases the high-pass filter's cutoff frequency.

- The specification of the echo sound delay time differs depending on when the BPM value can be received from the Serato DJ software, or not.
Condition to receive the BPM value from the Serato DJ software side:
 - When there is BPM information on the deck to which music was loaded by Serato DJ
 - When the [LINE, PHONO, USB] selector switch or [CD, USB] selector switch is set to the [USB] position
 When in a condition wherein the BPM value can be received from the Serato DJ software side, the delay time of echo sound can be adjusted to the beat count. Other than that, the delay time of echo sound gradually becomes longer from 100 msec by turning the control counterclockwise and gradually becomes shorter from 125 msec by turning the control clockwise.

Type of oscillator sound

Effect Name	Descriptions	OSCILLATOR PARAMETER control
NOISE	Generates white noise.	Turn counterclockwise: The cut-off frequency of the filter through which the white noise passes gradually decreases. Turn clockwise: The cut-off frequency of the filter through which the white noise passes gradually increases.
CYMBAL	Generates a cymbal-like sound.	Counterclockwise: The pitch of the cymbal sound goes down. Clockwise: The pitch of the cymbal sound goes up.
SIREN	Generates a siren-like sound.	Counterclockwise: The pitch of the siren sound goes down. Clockwise: The pitch of the siren sound goes up.
HORN	Generates a horn-like sound.	Counterclockwise: The pitch of the horn sound goes down. Clockwise: The pitch of the horn sound goes up.

Using external inputs

This unit is equipped with four sets of external inputs for connecting CD players, analog turntables, etc. This unit's 4-channel mixer can be used to mix externally input sound without passing through a computer. The mixer functions below can be used without a computer connected.

Notes

- For details on the respective items, see *Connections* (p.6) and *Part names and functions* (p.8).
- The functions below do not work with respect to external inputs.
 - Track tempo setting (pressing the headphones [CUE] button while pressing the [SHIFT] button)
 - Fader start function (while pressing the [SHIFT] button, move the channel fader or cross fader)
 - Applying Serato DJ software effects
- The values adjusted with the various controls for the Serato DJ software differ from values adjusted for the external input.

Mixer section

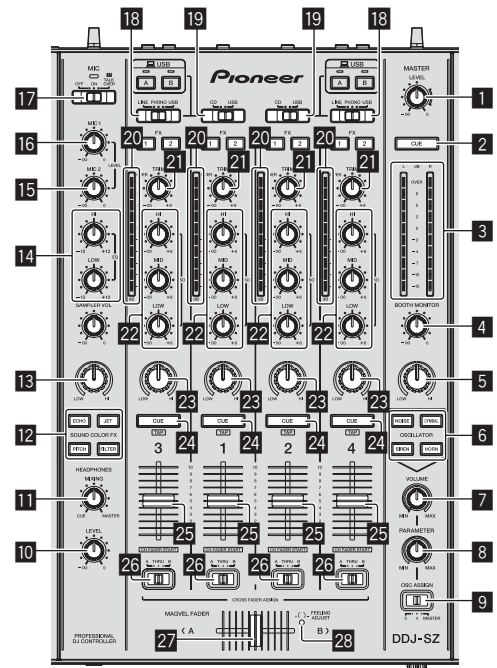

- MASTER LEVEL control
- MASTER CUE button
- Master level indicator
- BOTH MONITOR control
- MASTER OUT COLOR control
- OSCILLATOR SELECT buttons
- OSCILLATOR VOLUME control
- OSCILLATOR PARAMETER control
- OSC ASSIGN selector switch
- HEADPHONES LEVEL control
- HEADPHONES MIXING control
- SOUND COLOR FX buttons
- SAMPLER, MIC COLOR control
- EQ (HI, LOW) controls
- MIC2 control
- MIC1 control
- OFF, ON, TALK OVER selector switch
- LINE, PHONO, USB selector switch
- CD, USB selector switch
- Channel Level Indicator
- TRIM control
- ISO (HI, MID, LOW) controls
- COLOR control
- Headphones CUE button
- Channel fader
- Crossfader assign selector switch
- Crossfader
- FEELING ADJUST adjustment hole

Front panel

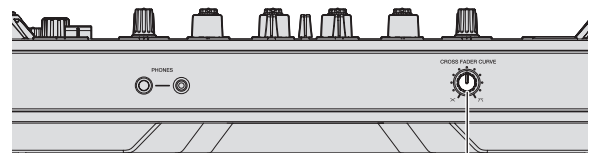

- CROSS FADER CURVE selector switch

Using a microphone

1 Connect a microphone to the [MIC1] or [MIC2] terminal.

2 Set the [OFF, ON, TALK OVER] selector switch to [ON] or [TALK OVER].

- [ON]: The indicator lights.
- [TALK OVER]: The indicator flashes.
- When set to [TALK OVER], the sound of channels other than the [MIC1] channel is attenuated by 18 dB (default) when a sound of -10 dB or greater is input to the microphone.
- The sound attenuation level while [TALK OVER] is selected can be changed in utility mode. For the method to effect that change, see *Changing the talk over function level* on page 26.
- The talk over mode can be switched to the normal mode or the advanced mode. For instructions on changing it, see *Changing the talk over function setting* on page 26.

3 Turn the [MIC1] or [MIC2] control.

Adjust the level of the sound output from the [MIC1] channel.

- Pay attention that rotating to the extreme right position outputs a very loud sound.

4 Input audio signals to the microphone.

❖ Adjusting the sound quality

Turn the [EQ (HI, LOW)] controls.

The adjustable ranges for the respective controls are as shown below.

- **HI:** -12 dB to $+12$ dB (10 kHz)
- **LOW:** -12 dB to $+12$ dB (100 Hz)

Mixing the sound of a DJ player, etc.

1 Connect the DJ player or other line level output device to the [CD] or [LINE] terminals.

2 Set the [LINE, PHONO, USB] selector switch or [CD, USB] selector switch to [LINE] or [CD].

3 Operate the [TRIM] control and channel fader to adjust the sound level output from each channel.

Mixing the sound of an analog turntable, etc.

1 Connect the analog player or other phono level (for MM cartridges) output device to the [PHONO] terminals.

2 Set the [LINE, PHONO, USB] selector switch to [PHONO].

3 Operate the [TRIM] control and the channel faders to adjust the audio level output from the respective decks.

Changing the settings

Launching utilities mode

If the utilities mode is launched while the DJ application is running, the set status may not be displayed properly.

- 1 Disconnect the USB cable from your computer.
- 2 Press the **[⏻]** switch on this unit's rear panel to set this unit's power to standby.
Set this unit's power to the standby mode.
- 3 While pressing both the **[SHIFT]** and **[PLAY/PAUSE ▶/||]** buttons on the left deck, press the **[⏻]** switch on this unit's rear panel.
Utilities mode is launched.
- 4 After setting this unit to the utility settings mode, operate the controller for the item whose settings you want to change.
See the explanations below for the settings that can be changed.
- 5 Press the **[⏻]** switch on this unit's rear panel to set this unit's power to standby.
To save the settings, set the **[⏻]** switch on this unit's rear panel to standby and quit utilities mode.

Utilities modes

The following settings can be changed:

- MIDI controller setting
- Fader start setting
- Master output attenuation level setting
- Slip mode flashing setting
- Demo mode setting
- Setting of the velocity curve in the sampler velocity mode
- Sampler velocity mode after-touch setting
- Setting for sending intervals of the jog dial's MIDI message
- Setting of the auto standby function
- Operation setting of the **[NEEDLE SEARCH]** pad
- Setting of talk over function
- Setting of talk over function level
- Cut lag setting of crossfader
- Output setting of microphone to booth monitor
- Peak limiter setting
- Brightness setting of jog ring

Forcefully using the unit as the general MIDI controller

The unit automatically changes operation as follows depending on whether Serato DJ is running.

- When Serato DJ is running, controller operation depends on the Serato DJ functions.
- When Serato DJ is not running, the unit operates as a general MIDI controller.

Even though Serato DJ is running, you can forcefully operate the unit as a general MIDI controller.

Press the **[KEY LOCK]** button on the left deck.

- **[KEY LOCK]** button off: Operation automatically changes depending on whether or not Serato DJ is running.
- **[KEY LOCK]** button lit: Regardless of whether or not Serato DJ is running, the unit is forcefully operated as a general MIDI controller.

Changing the fader start setting

The fader start function's setting can be changed.

- By default, the fader start mode functions without the sync mode set.

Press one of the effect parameter buttons for the left deck.



- Effect parameter 1 button lit: Fader start with the sync mode set (The sync function is activated simultaneously when fader starting starts.)
- Effect parameter 2 button lit: Fader start without sync mode set (The sync function is not activated simultaneously when fader starting starts.)
- Effect parameter 3 button lit: Fader start function disabled

Setting the master output's attenuation level

- The default is 0 dB.

Press one of the left deck's **[HOT CUE]** mode, **[ROLL]** mode or **[SLICER]** mode buttons.

- **[HOT CUE]** mode button lit: 0 dB (no attenuation)
- **[ROLL]** mode button lit: -3 dB
- **[SLICER]** mode button lit: -6 dB

Changing the slip mode flashing setting

When slip mode is on, buttons available in slip mode (such as the jog dial indicator, **[AUTO LOOP]** button, and **[PLAY/PAUSE ▶/||]** button) can be set to flash or not flash. The flashing method used for the **[SLIP]** button during slip mode changes depending on the setting.

- By default, slip mode flashing is set to mode 1.

Press the performance pad on the left side to select a setting.

The currently selected setting can be understood by looking at which pad lights.

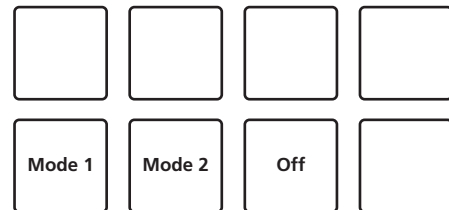

- Mode 1: When slip mode is turned on, the buttons available in slip mode flash for approximately one second. During slip mode, the **[SLIP]** button flashes only while playback continues in the background.
- Mode 2: When the slip mode is turned on, the buttons available in slip mode flash for approximately one second. During slip mode, the **[SLIP]** button continues flashing.
- Off: The buttons available in slip mode do not flash. During slip mode, the **[SLIP]** button flashes only while playback continues in the background.

Disabling the demo mode

On this unit, the demo mode is set if no operation is performed for 10 minutes under normal usage conditions. This demo mode can be changed.

- By default, demo mode starts when there is no operation for 10 minutes.
- When any control or button on this unit is operated while in the demo mode, the demo mode is canceled.

Press one of the **[SOUND COLOR FX]** buttons.

- **[ECHO]** button lights: Demo mode is disabled
- **[JET]** button lights: Demo mode starts when there is no operation for 1 minute
- **[PITCH]** button lights: Demo mode starts when there is no operation for 5 minutes
- **[FILTER]** button lights: Demo mode starts when there is no operation for 10 minutes

Changing the sampler velocity mode's velocity curve setting

Use the procedure below to set the sampler velocity mode's velocity curve. You can choose one of four types of velocity curves.

- By default, curve 3 is set.

Press one of the [AUTO LOOP] buttons on the deck whose setting you want to make.

The velocity curve setting changes each time the [AUTO LOOP] button is pressed. The currently set value is indicated by how the [LOOP 1/2X], [LOOP 2X], [LOOP IN] and [LOOP OUT] buttons light.

Curve 1

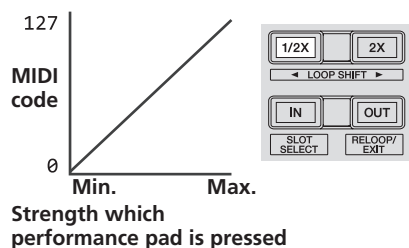

Curve 2

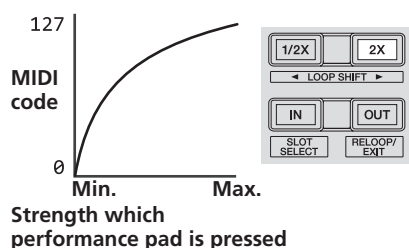

Curve 3

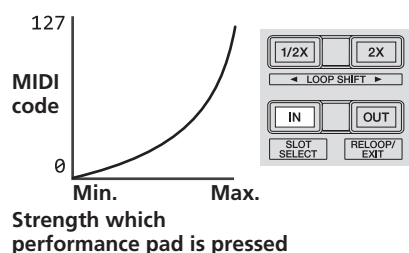

Curve 4

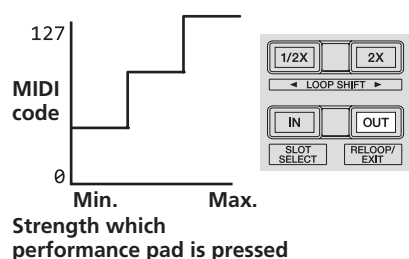

Enabling the sampler velocity mode's after touch setting

When the sampler velocity mode is turned on for this unit's performance pads, the after touch setting can be turned on and off.

After touch setting disabled: The sampler volume changes according to the strength with which the performance pad is initially pressed, but does not keep changing while the pad is held after it is initially pressed.

After touch setting enabled: The sampler volume changes according to the strength with which the performance pad is initially pressed and the strength with which the pad is held after it is initially pressed.

- By default, the after touch setting is disabled.

Press the [SAMPLER] mode button on the left deck.

- [SAMPLER] mode button lit: After touch setting enabled
- [SAMPLER] mode button off: After touch setting disabled

Adjusting the jog dial's MIDI message sending interval

This unit is equipped with a mode for adjusting the jog dial's MIDI message sending interval.

Depending on your computer's operating system and specifications, the jog dial may not operate properly if the sending interval of MIDI message for JOG dial is too short. In this case, follow the procedure below to adjust the MIDI message sending interval.

- From a short MIDI sending interval, increase the interval to a length at which no problems occur.
- The default is 4 ms.

Press the [SHIFT] button on the left deck.

The MIDI message sending interval setting changes each time the button is pressed. The currently set value is indicated by how the master level indicator is lit.

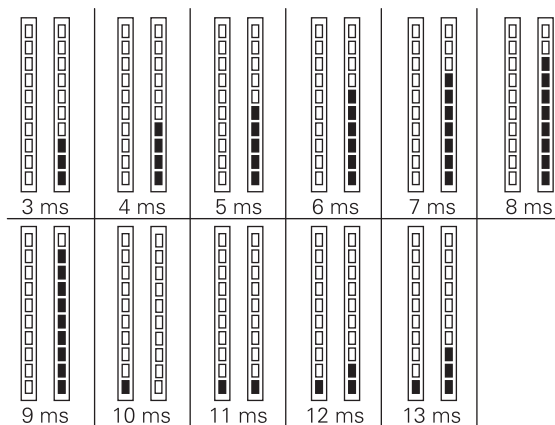

Disabling the auto standby function

- When auto standby function is set to on, if 4 hours have passed while the following conditions are all met, the unit automatically enters standby status.
 - Buttons and controls of the unit except the [MIC1] control and [MIC2] control are not operated.
 - That no audio signals of -18 dB or greater are input to this unit's input terminals.
- When the [PANEL (WAKE UP)] button is pressed, the standby mode is canceled.
- By default, the auto standby function is enabled.

Press the [GRID ADJUST] button of the left side deck.

- [GRID ADJUST] button lit: Auto standby function is enabled
- [GRID ADJUST] button off: Auto standby function is disabled

Restricting operation of the [NEEDLE SEARCH] pad

To prevent incorrect operation during playback, you can restrict operation of the [NEEDLE SEARCH] pad.

While restricted, search operation using the [NEEDLE SEARCH] pad can be performed only when you are touching the top of the jog dial or playback is stopped. By default, operation of the [NEEDLE SEARCH] pad is not restricted.

Press the [CENSOR] button of the left side deck.

- [CENSOR] button lit: [NEEDLE SEARCH] pad operation restricted
- [CENSOR] button off: [NEEDLE SEARCH] pad operation not restricted

Changing the talk over function setting

About talk over mode

The talk over function has the two modes described below.

Advanced talk over mode: Sound other than the microphone channel is output with only the midrange attenuated per the talk over level setting.

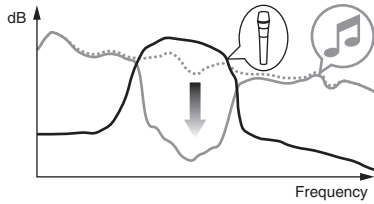

Normal talk over mode: Sound other than the microphone channel is output attenuated per the talk over level setting.

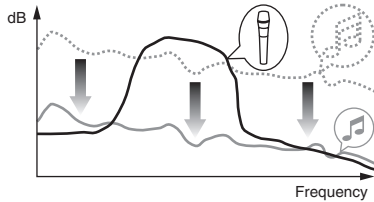

- By default, the advanced talk over mode is set.

Press the [GRID SLIDE] button of the left side deck.

- [GRID SLIDE] button lit: Advanced talk over mode
- [GRID SLIDE] button off: Normal talk over mode

Changing the talk over function level

Sets the talk over function's sound attenuation level.

- By default, the level is set to -18 dB.

Press the performance pad on the left side to select a setting.

The currently selected setting can be understood by looking at which pad lights.

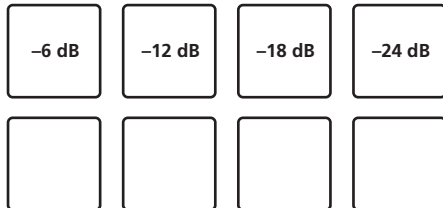

Adjusting the crossfader cut lag

Adjust the play (cut lag) on both edges of the crossfader. It can be adjusted between 0 (0.74 mm) and 52 (5.94 mm) in units of 0.1 mm.

- By default, it is set to 6 (1.34 mm).

Turn the rotary selector on the left deck.

The current setting (0 to 52) is displayed by the lit condition of the channel level indicator.

- Number of lit segments of the [CH3] channel indicator: Tens
- Number of lit segments of the [CH1] channel indicator: One's place

Setting the microphone output of the booth monitor

- By default, it is set to output microphone sound from the [BOOTH OUT] terminal.

Press the [BACK (VIEW)] button of the left side deck.

- [BACK (VIEW)] button lit: Outputs microphone sound from the [BOOTH OUT] terminal
- [BACK (VIEW)] button off: Does not output microphone sound from the [BOOTH OUT] terminal

Changing the peak limiter setting

Lessens sudden, unpleasant digital clipping of the master output.

- By default, the peak limiter is set to enabled.

Press the [LOAD PREPARE (AREA)] button of the left side deck.

- [LOAD PREPARE (AREA)] button lit: Peak limiter enabled
- [LOAD PREPARE (AREA)] button off: Peak limiter disabled

Adjusting the brightness of jog ring

You can adjust the brightness of the illumination around the jog dial.

- The same setting is applied to the jog dials on the left and right decks.
- By default, it is set to bright light.

Press the top of the jog dial.

Each time the top of the jog dial is pressed, the setting changes.

The brightness can be set in three levels: light, dark, and off. The current setting can be understood by the jog ring lit condition.

About the setting utility software

The setting utility can be used to make the checks and settings described below.

- Checking the status of this unit's input selector switches
- Setting the audio data output from this unit to the computer
- Adjusting the buffer size (when ASIO is used)
- Checking the version of the driver software

Displaying the setting utility

For Windows

Click [Start] menu > [All Programs] > [Pioneer] > [DDJ-SZ] > [DDJ-SZ Settings Utility].

For Mac OS X

Click [Macintosh HD] icon > [Application] > [Pioneer] > [DDJ-SZ] > [DDJ-SZ Settings Utility].

Checking the status of this unit's input selector switches

Display the setting utility before starting.

Click the [CONTROLLER INPUT] tab.

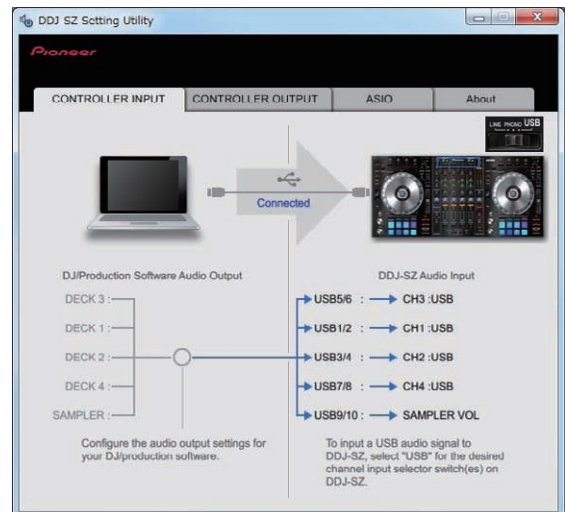

Setting the audio data output from this unit to the computer

When Serato DJ is running and using this unit as the default audio device, set the audio data output in Serato DJ. Display the setting utility before starting.

1 Click the [CONTROLLER OUTPUT] tab.

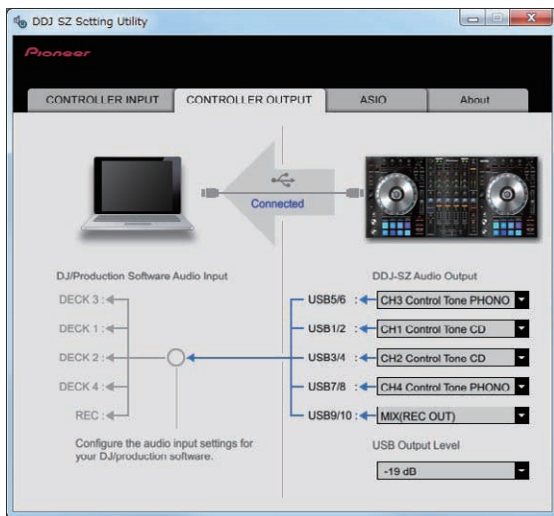

2 Click the [DDJ-SZ Audio Output] pull-down menu.

Select and set the audio data to be output to the computer from the flow of audio signals inside this unit.

CH1 (USB1/2)	CH2 (USB3/4)	CH3 (USB5/6)	CH4 (USB7/8)	CH5 (USB9/10)
—	—	CH3 Control Tone PHONO ^[1]	CH4 Control Tone PHONO ^[1]	MIX (REC OUT) ^[2]
CH1 Control Tone CD ^[1]	CH2 Control Tone CD ^[1]	CH3 Control Tone LINE ^[1]	CH4 Control Tone LINE ^[1]	Cross Fader A ^[2]
Post CH1 Fader ^[2]	Post CH2 Fader ^[2]	Post CH3 Fader ^[2]	Post CH4 Fader ^[2]	Cross Fader B ^[2]
Cross Fader A ^[2]	Cross Fader A ^[2]	Cross Fader A ^[2]	Cross Fader A ^[2]	MIC
Cross Fader B ^[2]	Cross Fader B ^[2]	Cross Fader B ^[2]	Cross Fader B ^[2]	Post CH1 Fader ^[2]
MIC	MIC	MIC	MIC	Post CH2 Fader ^[2]
—	—	—	—	Post CH3 Fader ^[2]
—	—	—	—	Post CH4 Fader ^[2]

- [1] The audio data is output with the same volume at which it is input to this unit, regardless of the [USB Output Level] setting.
- [2] When using for applications other than recording, pay attention to the DJ application's settings so that no audio loops are generated. If audio loops are generated, sound may be input or output at unintended volumes.
- When Serato DJ is connected, the CH5 setting cannot be changed to a setting other than [MIX (REC OUT)].

3 Click the [USB Output Level] pull-down menu.

Adjust the volume of the audio data output from this unit.

- The [USB Output Level] setting is applied equally to all audio data. However, when [1] on the table at step 2 is selected, the audio data is output with the same volume at which it is input to this unit.
- If not enough volume can be achieved with the DJ software's volume adjustment alone, change the [USB Output Level] setting to adjust the volume of the audio data output from this unit. Note that the sound will be distorted if the volume is raised too high.

Adjusting the buffer size (when ASIO is used)

This function can only be used by those using a Windows operating system.

If an application using this unit as the default audio device (DJ software, etc.) is running, quit that application before adjusting the buffer size. Display the setting utility before starting.

Click the [ASIO] tab.

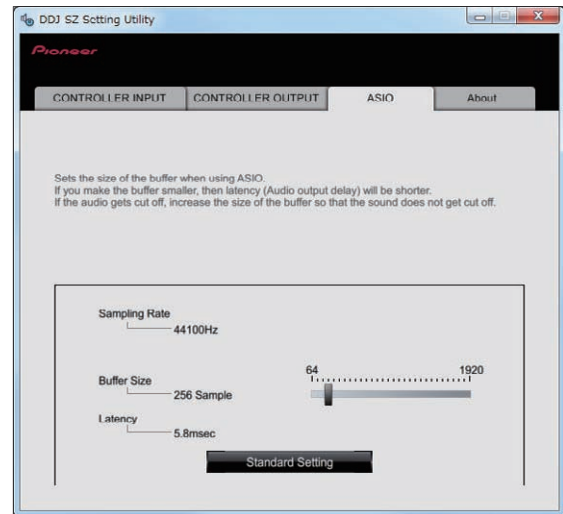

- If the buffer size is made large, drops in audio data (breaks in the sound) occur less easily, but the time lag due to the delay in the transfer of the audio data (latency) increases.

Checking the version of the driver software

Display the setting utility before starting.

Click the [About] tab.

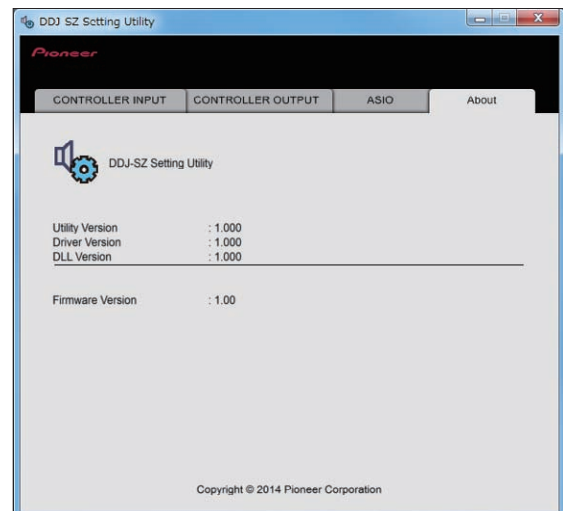

Using the DVS system

This unit allows you to use the Serato DJ software and control disc (sold separately) ¹ to operate digital music files using a familiar analog player (turntable) or DJ player.
¹ A special CD and record containing the signals necessary for operating digital music files.

Before controlling the Serato DJ software

About input channels

The signals played on the Serato DJ software's decks [DECK1] to [DECK4] are input to this unit's respective channels.

Set the positions of the controls, etc., as shown below.

Names of controls, etc.	Position
LINE, PHONO, USB selector switch	USB
CD, USB selector switch	USB
TRIM control	Turned fully counterclockwise
ISO (HI, MID, LOW) controls	Center
COLOR control	Center
Channel faders	Moved forward
Crossfader assign selector switch	[THRU] position
MASTER LEVEL control	Turned fully counterclockwise

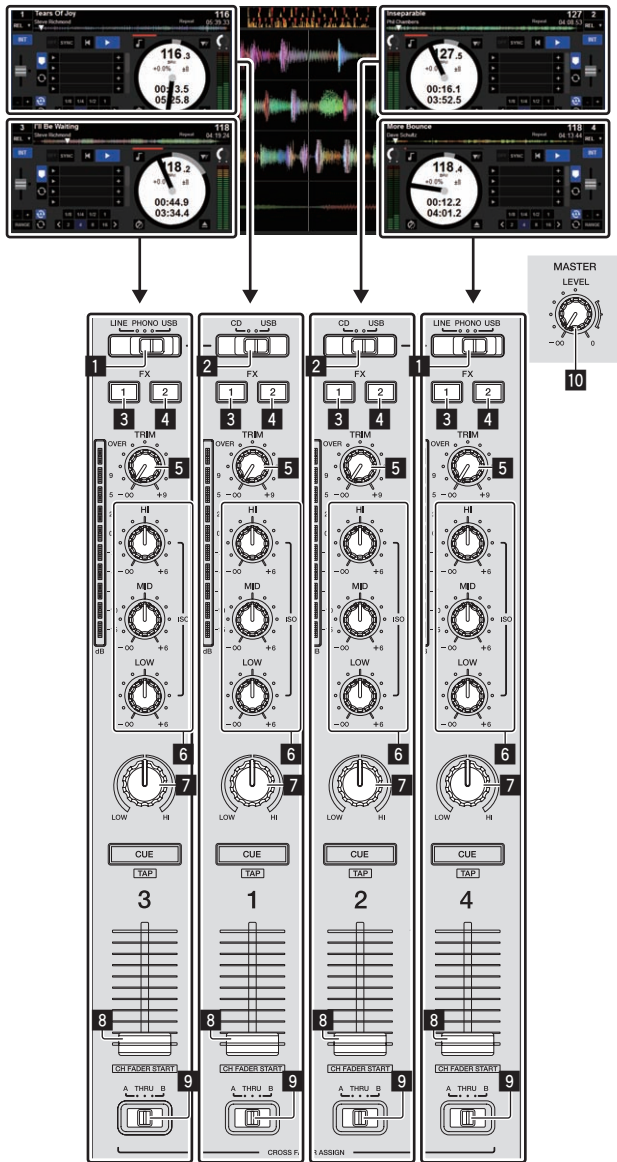

- 1 LINE, PHONO, USB selector switch
- 2 CD, USB selector switch
- 3 FX 1 assign button
- 4 FX 2 assign button
- 5 TRIM control
- 6 ISO (HI, MID, LOW) controls
- 7 COLOR control
- 8 Channel fader
- 9 Crossfader assign selector switch
- 10 MASTER LEVEL control

❖ Serato DJ setting screen

Computer screen when the Serato DJ software and this unit are connected (setup screen)

This is the Setup screen displayed when the computer and this unit are connected after installing the driver software.

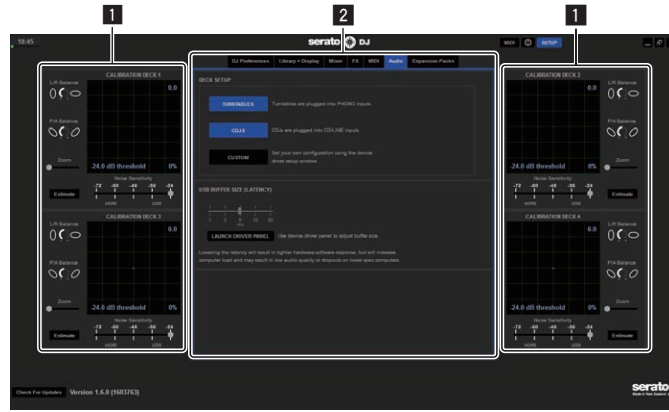

1 CALIBRATION DECK

The Serato DJ software calculates analog signals from the control disc and processes the signals of digital audio files.

Different signal levels and device statuses can be calculated for each usage environment to make the optimum settings for reading out the control signals.

- When CALIBRATION DECK is not displayed, click the [Expansion Packs] tab. Then, from the list, select [Vinyl/CDJ Control] and tick the [Enable Vinyl/CDJ control] check box.

2 Utility settings

Utility settings such as settings affecting the entire system and detailed operation settings can be made here.

Controlling the Serato DJ software

Here we explain three types of connections for different usage environments.

- When using analog players and DJ players simultaneously, proceed to page 29.
- When using DJ players only, proceed to page 29.
- When using the CUSTOM setting, proceed to page 30.
- When you finish reading the explanation for the connection appropriate for the operation environment, proceed to *Checking the control signals* (p.30).

When using analog players and DJ players simultaneously

This section explains the setting method used when operating [DECK1] and [DECK2] of the Serato DJ software with a DJ player, and [DECK3] and [DECK4] of the Serato DJ software with an analog player.

- Refer to this section only when an analog player is used.
- When three DJ players and one analog player are connected to the unit, see *When using the custom setting* on page 30.

1 Connect the DJ player that will be controlling [DECK1] to the [CH1] [CD] terminals, the DJ player that will be controlling [DECK2] to the [CH2] [CD] terminals.

- For instructions on connecting, see *Connections* on page 6.

2 Connect the analog player that will be controlling [DECK3] to the [CH3] [PHONO] terminals, the analog player that will be controlling [DECK4] to the [CH4] [PHONO] terminals.

- For instructions on connecting, see *Connections* on page 6.

3 Connect the ground wires for the respective analog players to this unit's [SIGNAL GND] terminals.

4 Load the control CDs in the DJ players.

5 Set the control vinyls on the analog players.

6 Switch the DDJ-SZ's input.

Switch the input selector switches for channels [CH1] – [CH4] to [USB].

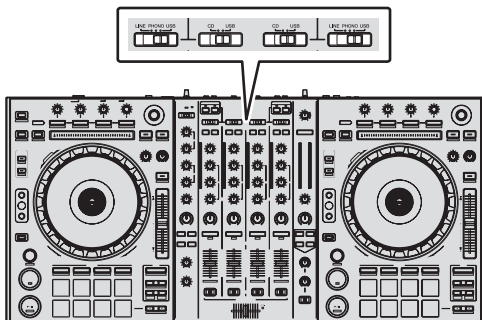

7 Select [SETUP] on the Serato DJ software's screen, then select [TURNTABLES] at the [Audio] tab in the utility settings.

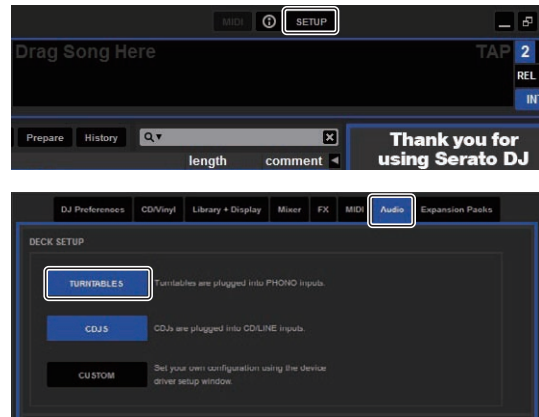

When [TURNTABLES] is selected, [CDJS] is selected as well at the same time.

When using DJ players only

This section explains the setting method used when operating [DECK1] to [DECK4] of the Serato DJ software with a DJ player.

1 Connect the DJ player that will be controlling [DECK1] to the [CH1] [CD] terminals, the DJ player that will be controlling [DECK2] to the [CH2] [CD] terminals.

- For instructions on connecting, see *Connections* on page 6.

2 Connect the DJ player that will be controlling [DECK3] to the [LINE] terminal of [CH3], and the DJ player that will be controlling [DECK4] to the [LINE] terminal of [CH4].

- For instructions on connecting, see *Connections* on page 6.

3 Load the control CDs in the DJ players.

4 Switch the DDJ-SZ's input.

Switch the input selector switches for channels [CH1] – [CH4] to [USB].

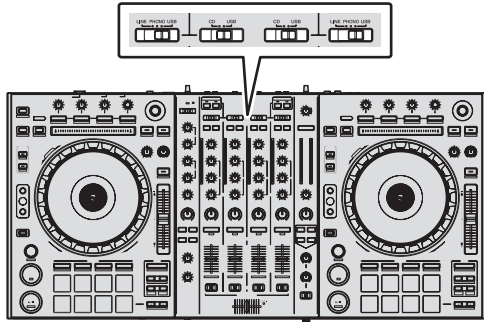

5 Select [SETUP] on the Serato DJ software's screen, then select [CDJS] at the [Audio] tab in the utility settings.

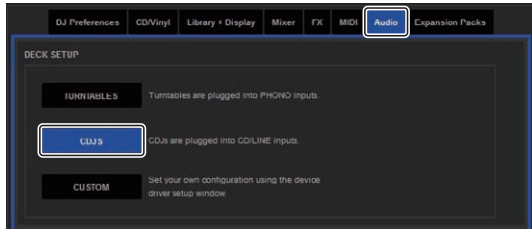

8 Select [SETUP] on the Serato DJ software's screen, then select [CUSTOM] at the [Audio] tab in the utility settings.

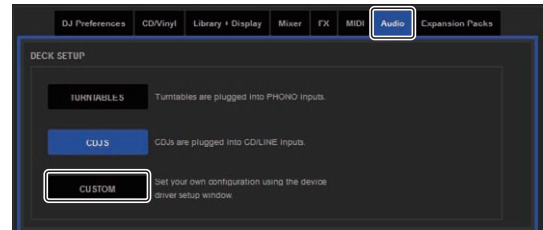

When [CUSTOM] is selected, the DDJ-SZ settings utility is displayed.

9 Select the [CONTROLLER OUTPUT] tab in the settings utility, then from the [DDJ-SZ Audio Output] pull-down menu corresponding to the connected channel, select [CH* Control Tone CD] for [USB1/2] and [USB3/4] that use a DJ player, select [CH3 Control Tone LINE] for [USB5/6], and select [CH4 Control Tone PHONO] for [USB7/8] that uses an analog player.

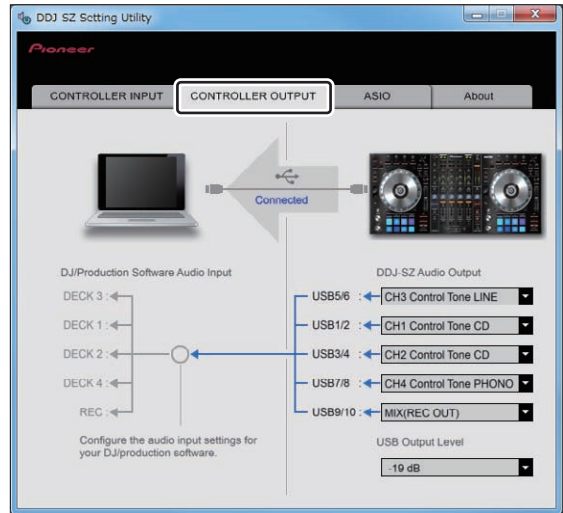

When using the custom setting

To perform DVS playback with a setting other than those described above, select the custom setting.

As an example of the custom setting, this section explains the setting method used to operate [DECK1] to [DECK3] of the Serato DJ software with a DJ player, and [DECK4] of the Serato DJ software with an analog player.

1 Connect the DJ player that will be controlling [DECK1] to the [CH1] [CD] terminals, the DJ player that will be controlling [DECK2] to the [CH2] [CD] terminals.

- For instructions on connecting, see *Connections* on page 6.

2 Connect the DJ player that will be controlling [DECK3] to the [LINE] terminal of [CH3].

- For instructions on connecting, see *Connections* on page 6.

3 Connect the analog player that will be controlling [DECK4] to the [PHONO] terminal of [CH4].

- For instructions on connecting, see *Connections* on page 6.

4 Connect the ground wires for the analog player to this unit's [SIGNAL GND] terminal.

5 Load the control CDs in the DJ players.

6 Set the control vinyls on the analog players.

7 Switch the DDJ-SZ's input.

Switch the input selector switches for channels [CH1] – [CH4] to [USB].

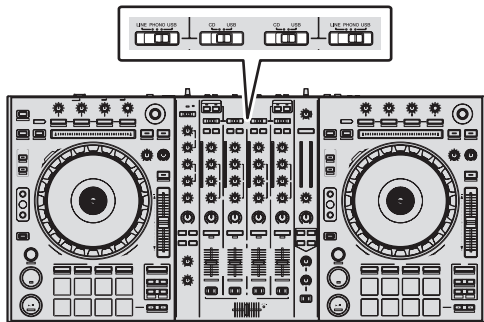

Checking the control signals

1 Select [SETUP] on the Serato DJ software screen to display the utilities setting screen.

2 Press the play button on the connected player and play track 1.

Green ring appears at [CALIBRATION DECK].

Check that the innermost ring is close to a true circle.



For details, see the Serato DJ software manual.

The Serato DJ software manual can be downloaded from the Pioneer DJ support site below.

See [Software Info] under [DDJ-SZ].

<http://pioneerdj.com/support/>

Functional restrictions when in ABS or REL mode

About functions that do not operate when in ABS or REL mode, see the following list.

Performance pad function	REL	ABS
Hot cue	✓	✓ ^[1]
Roll	✓	✗
Slicer	✓	✗
Sampler	✓	✓
Cue loop	✓	✗
Saved loop	✓	✗
Slicer loop	✓	✗
Sampler Velocity	✓	✓

Loop function	REL	ABS
Auto loop	✓	✗
Loop 1/2	✓	✗
Loop x 2	✓	✗
Loop in	✓	✗
Loop out	✓	✗

PLAY/CUE function	REL	ABS
Play/Pause	✗	✗
Cue	✓	✗

Jog function	REL	ABS
Scratch	✗	✗
Pitch bend	✓	✗

TEMPO slider function	REL	ABS
Slider	✗	✗
Key lock	✓	✓
Tempo reset	✗	✗
Stop time	✗	✗

Needle Search function	REL	ABS
Needle search	✓	✗

✓ Enabled, ✗ Disabled

[1] Only the hot cue setting is possible. (Trigger playback cannot be performed.)

Selecting the play mode

The Serato DJ software provides three play modes that can be selected according to your intended purpose.

[ABS], [REL] and [INT] can be selected on the deck unit.

Here we explain the procedure with the play mode set to [ABS] as an example.

Select [ABS] at the tab on the deck unit.

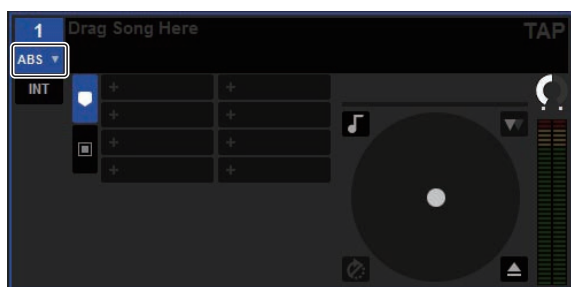

For a description of the respective play modes, see the Serato DJ software manual. The Serato DJ software manual can be downloaded from the Pioneer DJ support site below.

See [Software Info] under [DDJ-SZ].

<http://pioneerdj.com/support/>

Importing tracks

For details, see *Importing tracks* on page 15.

Playing tracks

- Set the volume of the devices (power amplifier, powered speakers, etc.) connected to the [MASTER OUT 1] and [MASTER OUT 2] terminals to an appropriate level. Note that loud sound will be output if the volume is set too high.

1 Press the play button on the connected player and play track 1.

Play a track in the Serato DJ software.

2 Turn the [TRIM] control.

Turn the [TRIM] control to adjust so that the channel level indicator's orange indicator lights at the peak level.

3 Move the channel fader away from you.

4 Turn the [MASTER LEVEL] control to adjust the audio level of the speakers.

Adjust the sound level output from the [MASTER OUT 1] and [MASTER OUT 2] terminals to an appropriate level.

Note

This unit and the Serato DJ software include a variety of functions enabling individualistic DJ performances. For details on the respective functions, see the Serato DJ software manual.

- The Serato DJ software manual can be downloaded from the Pioneer DJ support site below.

See [Software Info] under [DDJ-SZ].

<http://pioneerdj.com/support/>

Additional information

Troubleshooting

- Incorrect operation is often mistaken for trouble or malfunction. If you think that there is something wrong with this component, check the points below and the [FAQ] for the [DDJ-SZ] on the Pioneer DJ support site. Sometimes the problem may lie in another component. Inspect the other components and electrical appliances being used. If the problem cannot be rectified, ask your nearest Pioneer authorized service center or your dealer to carry out repair work.
- This unit may not operate properly due to static electricity or other external influences. In this case, proper operation may be restored by turning the power off, waiting 1 minute, then turning the power back on.

Problem	Check	Remedy
The power is not turned on.	Is the [⏻] switch of the power on?	Turn the [⏻] switch of the power on.
	Is the power cord properly connected?	Plug in the power cord to an AC outlet. (page 6)
This unit is not recognized.	Is the included USB cable properly connected?	Connect the included USB cable properly.
	Are you using a USB hub?	USB hubs cannot be used. Connect the computer and this unit directly using the included USB cable.
	Is the driver software properly set?	Set the driver software properly. (page 4)
Tracks are not displayed in the library.	Have music files been imported?	Import the music files properly. For details on importing music files, see the Serato DJ software manual.
	Is a crate or subcrate that does not contain any tracks selected?	Either select a crate or subcrate that contains any tracks or add tracks to the crate or subcrate.
iTunes tracks are not displayed in the library.	Is [Show iTunes Library] at the [Library+Display] tab in the [SETUP] menu checked?	Check [Show iTunes Library]. For details on importing music files, see the Serato DJ software manual.
	Is a crate or subcrate that does not contain any tracks selected?	Either select a crate or subcrate that contains any tracks or add tracks to the crate or subcrate.
Music files in the library cannot be edited (changing track names, etc.).	Is [Protect Library] at the [SETUP] menu's [Library+Display] tab enabled?	Disable [Protect Library].
Recording is not possible.	Is the recording level low?	Adjust the gain control on the [REC] panel in the Serato DJ software.
	Have you saved the recording after completing it?	Save the recording after completing it. For detailed instructions on recording, see the Serato DJ software manual.
No sound or small sound.	Are the [TRIM] control, channel fader, crossfader, the [LINE, PHONO, USB] selector switch (or the [CD, USB] selector switch) and the [MASTER LEVEL] control set to the correct position?	Set the [TRIM] control, channel fader, crossfader, the [LINE, PHONO, USB] selector switch (or the [CD, USB] selector switch) and the [MASTER LEVEL] control to the correct position.
	Are the connected powered speakers, etc., properly set?	Properly set the external input selection, volume, etc., on the powered speakers, etc.
	Are the connection cables properly connected?	Connect the connection cables properly.
	Are the terminals and plugs dirty?	Clean the terminals and plugs before making connections.
	Is the driver software properly set?	Set the driver software properly. (page 4)
	Is the [MASTER LEVEL] control set to the proper position?	Adjust the [MASTER LEVEL] control so that the master level indicator's orange indicator lights at the peak level.
Distorted sound.	Is the [TRIM] control set to the proper position?	Adjust the [TRIM] control so that the channel level indicator's orange indicator lights at the peak level.
	Is the driver software's latency value suitable?	Set the driver software's latency to a suitable value.
Sound being played is interrupted when using DJ software.	Is the DJ software's latency to a suitable value.	Set the DJ software's latency to a suitable value.
Cannot output the microphone sound.	Are the [OFF, ON, TALK OVER] selector switches set to the proper position?	Set the [OFF, ON, TALK OVER] selector switches to the proper position.
Cannot output the sound of the external device.	Is the [LINE, PHONO, USB] selector switch (or [CD, USB] selector switch) set to the proper position?	Set the [LINE, PHONO, USB] selector switch (or [CD, USB] selector switch) to the proper position.
Sound is interrupted when the ASIO driver is set.	Has the ASIO driver been set with Serato DJ running?	Set the ASIO driver before launching Serato DJ. (page 27)
The indicator flashes and operation is strange.	—	Normal operation can sometimes be restored by unplugging the power cord, waiting at least 1 minute, then plugging the power cord back in. If the symptom persists, unplug the power cord and request repairs.
Serato DJ operation is unstable.	Are you using the latest version of the software?	Free updates of Serato DJ can be downloaded from the website. Use the most recent version. (page 4)
	Are you using softwares other than Serato DJ at the same time?	Quit other applications to decrease the load on the computer. If operation continues to be unstable, try disabling the wireless network or other wireless connections, antivirus software, the screen saver, the low power mode, etc. (page 4)
	When other USB devices are connected to the computer.	Disconnect other USB devices from the computer. When another USB audio device is connected to the computer at the same time, it may not operate or be recognized normally.
	Are you using a USB hub?	USB hubs cannot be used. Connect the computer and this unit directly using the included USB cable.
	There is a problem with the USB port to which this unit is connected.	If your computer has multiple USB ports, try connecting this unit to a different USB port.
	Is this unit connected to a notebook computer running on its battery?	Supply power to the notebook computer from an AC power supply. (Depending on the notebook computer's settings, the low power mode may be set when the computer is running on its battery, automatically reducing the performance of the computer itself.) (page 4)
	The USB buffer size is too small.	Raise the USB buffer size. (page 27)
	Is the setting in the utilities mode wrong?	In utilities mode, check that the unit is not set to be forcefully operated as a general MIDI controller.
The jog dial illumination does not turn during playback. (It does turn when scratching.) The [TEMPO] slider does not work when the deck is switched while the sync mode is set. (The TAKEOVER indicator lights.)	Is the setting in the utilities mode wrong?	In utilities mode, check that the unit is not set to be forcefully operated as a general MIDI controller.

Problem	Check	Remedy
The fader start function does not work.	Is a cue set? Is the setting in the utilities mode wrong?	Set a cue. (page 19) In utilities mode, set the fader start setting to "Fader start with the sync mode set" or "Fader start without the sync mode set".
The BPM is not displayed. The sync and auto loop functions do not work.	Has the track been analyzed? Is [Set Auto BPM] checked in the offline player settings?	Analyze the file. Re-analyze the track with [Set Auto BPM] checked. For detailed instructions on analyzing tracks, see the Serato DJ software manual.
The BPM is displayed but not the beatgrid. The slicer function does not work. The skip mode does not work.	Are [Set Auto BPM] and [Set Beatgrid] checked in the offline player settings?	Re-analyze the track with [Set Auto BPM] and [Set Beatgrid] checked. For detailed instructions on analyzing tracks, see the Serato DJ software manual. Set the beatgrid. For detailed instructions on setting the beatgrid, see the Serato DJ software manual. Beatgrids can also be set using this unit's [GRID ADJUST] and [GRID SLIDE] buttons. (page 10)
The BPM and beatgrid are not displayed properly. The beatgrid is off beat.	Is the BPM analysis range set appropriately in the offline player settings?	Change the BPM analysis range then reanalyze the tracks. If the problem persists, set the beatgrid and BPM manually. Adjust the beatgrid. For detailed instructions on adjusting the beatgrid, see the Serato DJ software manual. The beatgrid can be adjusted using this unit's [GRID ADJUST] and [GRID SLIDE] buttons.
The USB connection indicator flashes.	Is the driver software properly set?	While the track is playing, tap the headphones [CUE] button in beat while pressing the [SHIFT] button (Tap function). The track's BPM and beat grid can be adjusted. When the tap function is used, the deck section's display on the computer's screen switches to the [Beatgrid Editor] display. To switch the deck section's display back to how it was before, click [Edit Grid] on the computer's screen. (page 10) Set the driver software properly. (page 4)

Signal flow

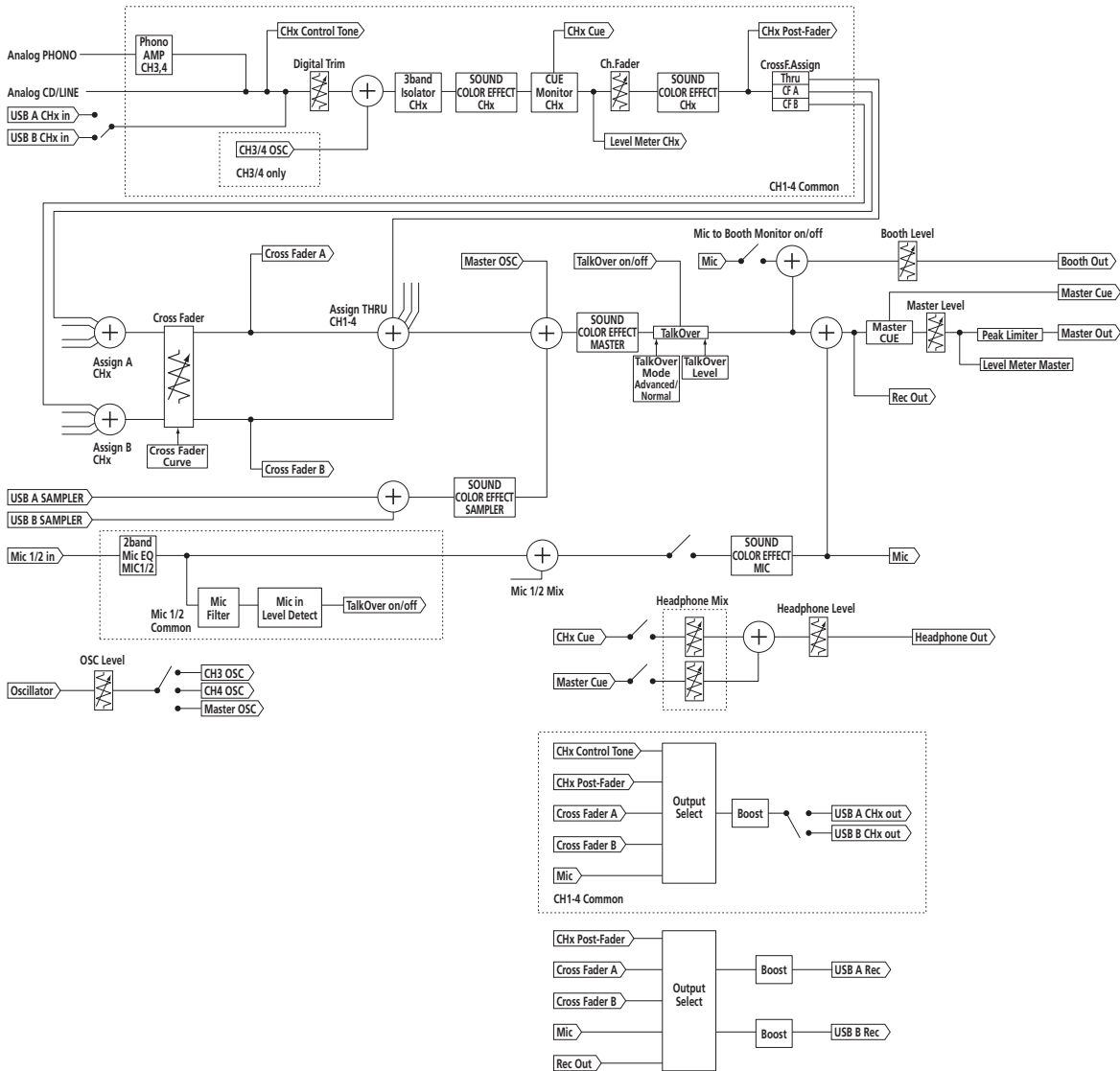

Acquiring the manual

The operating instructions may be in a file in PDF format. Adobe® Reader® must be installed to read files in PDF format. If you do not have Adobe Reader, please install it from the download link on the CD-ROM's menu screen.

Downloading the latest version of these operating instructions

1 Insert the CD-ROM into the computer's optical drive.

The CD-ROM menu is displayed.

If the CD-ROM's menu does not appear when the CD-ROM is inserted, perform the operations below.

- For Windows
Open the optical drive from [Computer (or My Computer)] in the [Start] menu, then double-click the [CD_menu.exe] icon.
- For Mac OS X
In Finder, double-click the [CD_menu.app] icon directly.

2 When the CD-ROM's menu is displayed, select [DDJ-SZ: Download the Operating Instructions (PDF file)], then click [Start].

3 "An internet environment is required to access the site. Connected to the internet?" is displayed. Click [Yes].

The web browser is launched and the Pioneer DJ support site is displayed.

4 On the Pioneer DJ support site, click "Manuals" under "DDJ-SZ".

5 Click on the required language on the download page.

Downloading of the operating instructions begins.

Downloading the Serato DJ software manual

1 Insert the CD-ROM into the computer's optical drive.

The CD-ROM menu is displayed.

If the CD-ROM's menu does not appear when the CD-ROM is inserted, perform the operations below.

- For Windows
Open the optical drive from [Computer (or My Computer)] in the [Start] menu, then double-click the [CD_menu.exe] icon.
- For Mac OS X
In Finder, double-click the [CD_menu.app] icon directly.

2 When the CD-ROM's menu is displayed, select [Serato DJ: Download the Software Manual (PDF file)], then click [Start].

3 "An internet environment is required to access the site. Connected to the internet?" is displayed. Click [Yes].

The web browser is launched and the Pioneer DJ support site is displayed.

- To close the CD-ROM menu, click [Exit].

4 Click [Software Info] under [DDJ-SZ] on the Pioneer DJ support site.

5 Click the link to the Serato DJ download page.

The Serato DJ download page is displayed.

6 Log in to your "Serato.com" user account.

Input the e-mail address and password you have registered to log in to "Serato.com".

7 From "More Downloads" on the right side of the download page, click "Serato DJ x.x.x Manual".

Downloading of the Serato DJ software manual starts.

Using as a controller for other DJ software

This unit also outputs the operating data for the buttons and controls in MIDI format. If you connect a computer with a built-in MIDI-compatible DJ software via a USB cable, you can operate the DJ software on this unit. The sound of music files being played on the computer can also be output from the DDJ-SZ.

When using this unit as a controller for operating DJ software other than Serato DJ, change the setting to use DJ software other than Serato DJ at the utilities mode.

Also, make the audio and MIDI-related settings in the DJ software.

- For details, see your DJ software's operating instructions.

About MIDI messages

For details on this unit's MIDI messages, see "List of MIDI Messages".

- "List of MIDI Messages" can be acquired from the following URL:
<http://pioneerdj.com/support/>

About the driver software

This driver software is an exclusive driver for outputting audio signals from a computer.

- First read the *Software end user license agreement* on page 34 carefully.

Operating environment

Supported operating systems	
Mac OS X 10.9 / 10.8 / 10.7 / 10.6	✓
Windows® 8/Windows® 8 Pro	32-bit version ✓
	64-bit version ✓
Windows® 7 Home Premium/Professional/Ultimate	32-bit version ✓
	64-bit version ✓
Windows Vista® Home Basic/Home Premium/Business/Ultimate	32-bit version ✓
	64-bit version ✓

Checking the latest information on the driver software

For detailed information on this unit's designated driver software, see the Pioneer DJ support site below.

<http://pioneerdj.com/support/>

❖ Software end user license agreement

This Software End User License Agreement ("Agreement") is between you (both the individual installing the Program and any single legal entity for which the individual is acting) ("You" or "Your") and PIONEER CORPORATION ("Pioneer").

TAKING ANY STEP TO SET UP OR INSTALL THE PROGRAM MEANS THAT YOU ACCEPT ALL OF THE TERMS OF THIS LICENSE AGREEMENT. PERMISSION TO DOWNLOAD AND/OR USE THE PROGRAM IS EXPRESSLY CONDITIONED ON YOUR FOLLOWING THESE TERMS. WRITTEN OR ELECTRONIC APPROVAL IS NOT REQUIRED TO MAKE THIS AGREEMENT VALID AND ENFORCEABLE. IF YOU DO NOT AGREE TO ALL OF THE TERMS OF THIS AGREEMENT, YOU ARE NOT AUTHORIZED TO USE THE PROGRAM AND MUST STOP INSTALLING IT OR UNINSTALL IT, AS APPLICABLE.

1 DEFINITIONS

- 1 "Documentation" means written documentation, specifications and help content made generally available by Pioneer to aid in installing and using the Program.
- 2 "Program" means all or any part of Pioneer's software licensed to You by Pioneer under this Agreement.

2 PROGRAM LICENSE

- 1 Limited License. Subject to this Agreement's restrictions, Pioneer grants to You a limited, non-exclusive, non-transferable, license (without the right to sublicense):
 - a To install a single copy of the Program in Your computer or mobile device, to use the Program only for Your personal purpose complying with this Agreement and the Documentation ("Authorized Use");
 - b To use the Documentation in support of Your Authorized Use; and
 - c To make one copy of the Program solely for backup purposes, provided that all titles and trademark, copyright and restricted rights notices are reproduced on the copy.
- 2 Restrictions. You will not copy or use the Program or Documentation except as expressly permitted by this Agreement. You will not transfer, sublicense, rent, lease or lend the Program, or use it for third-party training, commercial time-sharing or service bureau use. You will not Yourself or through any third party modify, reverse engineer, disassemble or decompile the Program, except to the extent expressly permitted by applicable law, and then only after You have notified Pioneer in writing of Your intended activities.
- 3 Ownership. Pioneer or its licensor retains all right, title and interest in and to all patent, copyright, trademark, trade secret and other intellectual property rights in the Program and Documentation, and any derivative works thereof. You do not acquire any other rights, express or implied, beyond the limited license set forth in this Agreement.
- 4 No Support. Pioneer has no obligation to provide support, maintenance, upgrades, modifications or new releases for the Program or Documentation under this Agreement.

3 WARRANTY DISCLAIMER

THE PROGRAM AND DOCUMENTATION ARE PROVIDED "AS IS" WITHOUT ANY REPRESENTATIONS OR WARRANTIES, AND YOU AGREE TO USE THEM AT YOUR SOLE RISK. TO THE FULLEST EXTENT PERMISSIBLE BY LAW, PIONEER EXPRESSLY DISCLAIMS ALL WARRANTIES OF ANY KIND WITH RESPECT TO THE PROGRAM AND DOCUMENTATION, WHETHER EXPRESS, IMPLIED, STATUTORY, OR ARISING OUT OF COURSE OF PERFORMANCE, COURSE OF DEALING OR USAGE OF TRADE, INCLUDING ANY WARRANTIES OF MERCHANTABILITY,

4 EXPORT CONTROL AND COMPLIANCE WITH LAWS AND REGULATIONS

You may not use or otherwise export or re-export the Program except as authorized by United States law and the laws of the jurisdiction in which the Program was obtained. In particular, but without limitation, the Program may not be exported or re-exported (a) into any U.S.-embargoed countries or (b) to anyone on the U.S. Treasury Department's Specially Designated Nationals List or the U.S. Department of Commerce Denied Persons List or Entity List. By using the Program, you represent and warrant that you are not located in any such country or on any such list. You also agree that you will not use the Program for any purposes prohibited by United States law, including, without limitation, the development, design, manufacture, or production of nuclear, missile, or chemical or biological weapons.

5 U.S. GOVERNMENT RESTRICTED RIGHTS

The Program and Documentations are "commercial computer software" and "commercial computer software documentation" as those terms are defined in 48 C.F.R. §252.227-7014 (a) (1) (2007) and 252.227-7014 (a) (5) (2007). The U.S. Government's rights with respect to the Program and Documentations are limited by this license pursuant to 48 C.F.R. § 12.212 (Computer software) (1995) and 48 C.F.R. §12.211 (Technical data) (1995) and/or 48 C.F.R. §227.7202-3, as applicable. As such, the Program and Documentations are being licensed to the U.S. Government end users: (a) only as "commercial items" as that term is defined in 48 C.F.R. §2.101 generally and as incorporated in DFAR 212.102; and (b) with only those limited rights as are granted to the public pursuant to this license. Under no circumstance will the U.S. Government or its end users be granted any greater rights than we grant to other users, as provided for in this license. Manufacturer is Pioneer Corporation, 1-1 Shin-Ogura, Saiwai-ku, Kawasaki-shi, Kanagawa-Ken, 212-0031 Japan

6 DAMAGES AND REMEDIES FOR BREACH

You agree that any breach of this Agreement's restrictions would cause Pioneer irreparable harm for which money damages alone would be inadequate. In addition to damages and any other remedies to which Pioneer may be entitled, You agree that Pioneer may seek injunctive relief to prevent the actual, threatened or continued breach of this Agreement.

7 TERMINATION

Pioneer may terminate this Agreement at any time upon Your breach of any provision. If this Agreement is terminated, You will stop using the Program, permanently delete it from your computer or mobile device where it resides, and destroy all copies of the Program and Documentation in Your possession, confirming to Pioneer in writing that You have done so. Sections 2.2, 2.3, 2.4, 3, 4, 5, 6, 7 and 8 will continue in effect after this Agreement's termination.

8 GENERAL TERMS

- 1** Limitation of Liability. In no event will Pioneer or its subsidiaries be liable in connection with this Agreement or its subject matter, under any theory of liability, for any indirect, incidental, special, consequential or punitive damages, or damages for lost profits, revenue, business, savings, data, use, or cost of substitute procurement, even if advised of the possibility of such damages or if such damages are foreseeable. In no event will Pioneer's liability for all damages exceed the amounts actually paid by You to Pioneer or its subsidiaries for the Program. The parties acknowledge that the liability limits and risk allocation in this Agreement are reflected in the Program price and are essential elements of the bargain between the parties, without which Pioneer would not have provided the Program or entered into this Agreement.
- 2** The limitations or exclusions of warranties and liability contained in this Agreement do not affect or prejudice Your statutory rights as consumer and shall apply to You only to the extent such limitations or exclusions are permitted under the laws of the jurisdiction where You are located.
- 3** Severability and Waiver. If any provision of this Agreement is held to be illegal, invalid or otherwise unenforceable, that provision will be enforced to the extent possible or, if incapable of enforcement, deemed to be severed and deleted from this Agreement, and the remainder will continue in full force and effect. The waiver by either party of any default or breach of this Agreement will not waive any other or subsequent default or breach.
- 4** No Assignment. You may not assign, sell, transfer, delegate or otherwise dispose of this Agreement or any rights or obligations under it, whether voluntarily or involuntarily, by operation of law or otherwise, without Pioneer's prior written consent. Any purported assignment, transfer or delegation by You will be null and void. Subject to the foregoing, this Agreement will be binding upon and will inure to the benefit of the parties and their respective successors and assigns.
- 5** Entire Agreement. This Agreement constitutes the entire agreement between the parties and supersedes all prior or contemporaneous agreements or representations, whether written or oral, concerning its subject matter. This Agreement may not be modified or amended without Pioneer's prior and express written consent, and no other act, document, usage or custom will be deemed to amend or modify this Agreement.
- 6** You agree that this Agreement shall be governed and construed by and under the laws of Japan.

About trademarks and registered trademarks

- Pioneer is a registered trademark of PIONEER CORPORATION.
- Microsoft, Windows and Windows Vista are either registered trademarks or trademarks of Microsoft Corporation in the United States and/or other countries.
- Mac OS, iTunes, and Finder are trademarks of Apple Inc., registered in the U.S. and other countries.
- Intel and Intel Core are trademarks of Intel Corporation in the U.S. and/or other countries.
- ASIO is a trademark of Steinberg Media Technologies GmbH.
- Serato DJ, Scratch Live, ITCH and Serato DJ Intro are registered trademarks of Serato.

The names of companies and products mentioned herein are the trademarks of their respective owners.

This product has been licensed for nonprofit use. This product has not been licensed for commercial purposes (for profit-making use), such as broadcasting (terrestrial, satellite, cable or other types of broadcasting), streaming on the Internet, Intranet (a corporate network) or other types of networks or distributing of electronic information (online digital music distribution service). You need to acquire the corresponding licenses for such uses. For details, see <http://www.mp3licensing.com>.

Cautions on copyrights

Recordings you have made are for your personal enjoyment and according to copyright laws may not be used without the consent of the copyright holder.

- Music recorded from CDs, etc., is protected by the copyright laws of individual countries and by international treaties. It is the full responsibility of the person who has recorded the music to ensure that it is used legally.
- When handling music downloaded from the Internet, etc., it is the full responsibility of the person who has downloaded the music to ensure that it is used in accordance with the contract concluded with the download site.

— The specifications and design of this product are subject to change without notice.

© 2014 PIONEER CORPORATION. All rights reserved.

PIONEER CORPORATION

1-1, Shin-ogura, Saiwai-ku, Kawasaki-shi, Kanagawa 212-0031, Japan
<DRI1219-A>