

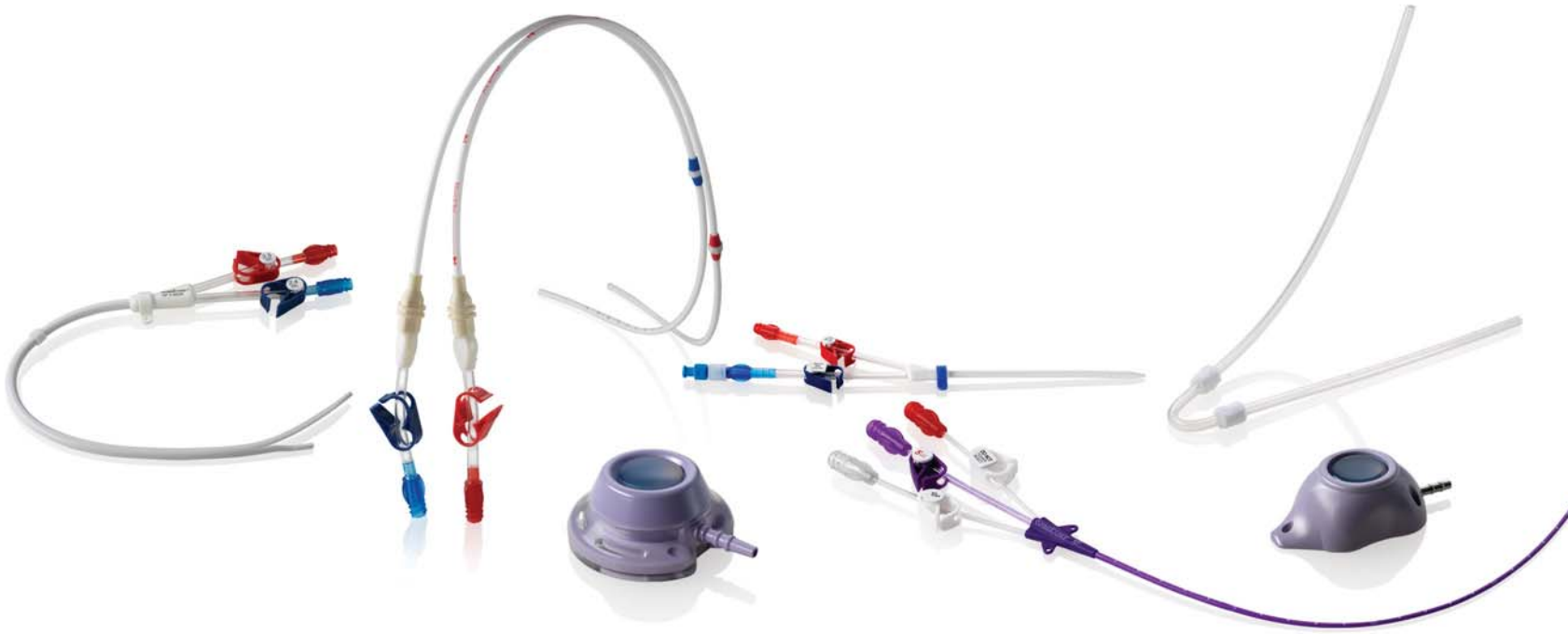

DIALYSIS & VASCULAR ACCESS PRODUCTS







DIALYSIS & VASCULAR ACCESS PRODUCTS

TABLE OF CONTENTS

Long Term	2	Central Vein	
Split Cath®	3	Infusion Catheters	22
Split Stream®	4	Pro-Picc®	23
Eschelon™	5	Vascu-Picc®	24
Bio-Flex® Tesio®	6	Midline	25
Titan HD™	7	Dignity™ CT Ports	26
Hemo-Flow®	8	Pro-Fuse® CT Ports	27
Hemo-Cath® LT	9	Titanium Ports	28
		Plastic Ports	29
Short Term	10	Pro-Line®	30
Duo-Split®	11	LT Silicone CVC	31
SLX	12	Multi-Cath	32
Hemo-Cath® ST	13	Peritoneal	34
400XL	14	V-Series	35
Duo-Flow®	15	I-Series	36
Soft-Line®	16	Accessories	38
T-3	17	Micro-Stick® Sets	39
Tri-Flow®	18	Super Sharp	
Femoral	19	Introducer Needle	39
Subclavian	20	Pro-Pierce™ Safety	
Continuous	21	Huber Needle	40
		Repair Kit	40
		Dilators	41
		Sheath Dilators	41
		Guidewires	42
		Trocars & Tunnelers	42
		Ordering Info	
		& Policies	43



About Medcomp

Medcomp® develops, manufactures, markets and supports cutting-edge vascular access devices and accessories to meet the clinical needs of the medical industry, particularly in the fields of interventional medicine and dialysis. Our company's engineering and applications expertise provides superior products whose progressive designs accommodate advances in medicine and whose quality anticipates the requirements of our professional clients and the patients they serve. Currently one of the world's largest manufacturers of dialysis and centrally terminating venous catheters, Medcomp is, and always has been, on the cutting edge of new vascular access device technologies.

Message to the Customers

In everything we do, from research and development to manufacture, packaging, delivery and support, our first consideration is you, the patient. It is vitally important to us that he or she – young or old, indigent or wealthy, chronically ill or seeking a diagnosis or one-time treatment – receives the best that Medcomp can provide. We dedicate ourselves to supplying the highest quality, innovation and customer service with every device we sell.

Our History

Medcomp was founded in 1978 to manufacture and market vascular access catheters for acute hemodialysis. At that time catheter designs were simple, consisting of a single lumen catheter for single-needle dialysis or double lumen catheters for continuous-flow dialysis. As the need for new products grew with the advent of increasingly complex procedures, Medcomp emerged as a premier developer of innovative devices using our in-house staff of engineers working in conjunction with some of the preeminent

physicians in the field of nephrology and vascular access.

Building on our pioneering Tesio®, Split Cath® and Duo-Flow® products, Medcomp continues to dominate the market in both new and proven dialysis, interventional and accessory devices. Today our contributions to the medical devices field total more than 70 product lines and thousands of distinct products, most notably and recently including the Pro-PICC® catheter and Dignity™ ports, which are both CT injectable.

In order to better support our professional clients, we began a successful transition in 2006 from a distributor-based sales system to a direct-sales force populated by highly skilled, clinically trained sales professionals. Medcomp is and will continue to be a stable, financially sound, privately held company wholly dedicated to the satisfaction of patients, its customers and its employees at every level.

Development & Production

Medcomp's reputation and growth can be attributed to our diversely disciplined group of engineers specializing in biomedical, mechanical and electrical engineering, collaboration with esteemed professionals, and readiness to listen to suggestions and comments from members of the medical community. By continually improving on existing technology, Medcomp is able to provide a catheter to suit every medical requirement while also considering the patient's comfort. Patients, physicians and nurses can rely on a Medcomp device to do its job. 



All Medcomp products are developed in accordance with all FDA Quality Systems Regulations, European Medical Device Directives (CE), Japanese GMPI and numerous other international regulations and standards to ensure safety and performance. Medcomp is ISO 13485 certified by KEMA Registered Quality, maintains certification to Annex II as defined in Medical Device Directive 93/42 EEC, and is certified by DNV, Det Norske Veritas, Norway. We are audited regularly.

LONG TERM HEMODIALYSIS CATHETERS

section

1

DIALYSIS & VASCULAR ACCESS PRODUCTS

Long Term

SPLIT CATH[®]

SPLIT STREAM[®]

ESCHELON[™]

BIO-FLEX[®] TESIO[®]

TITAN HD[™]

HEMO-FLOW[®]

HEMO-CATH[®]

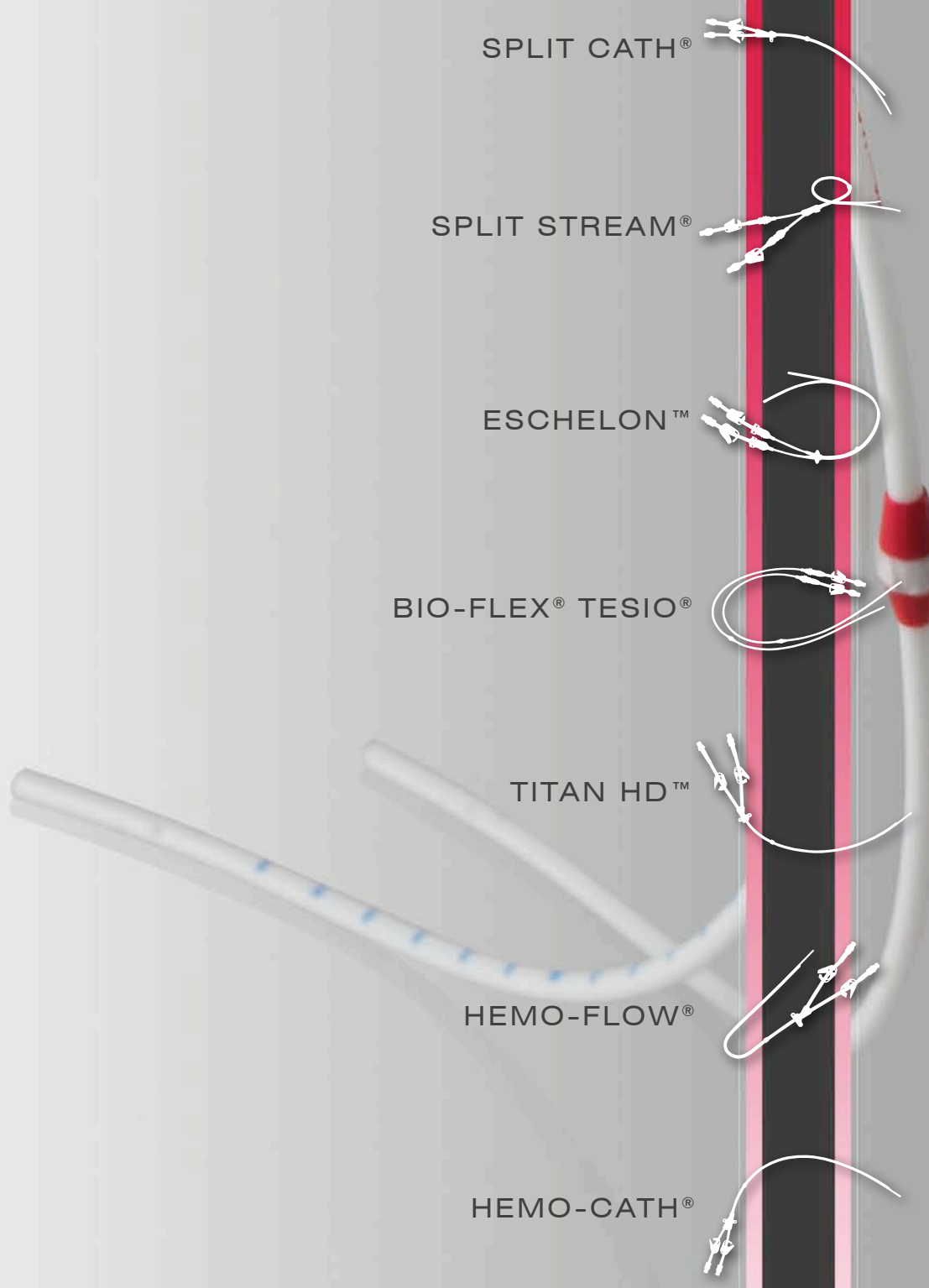

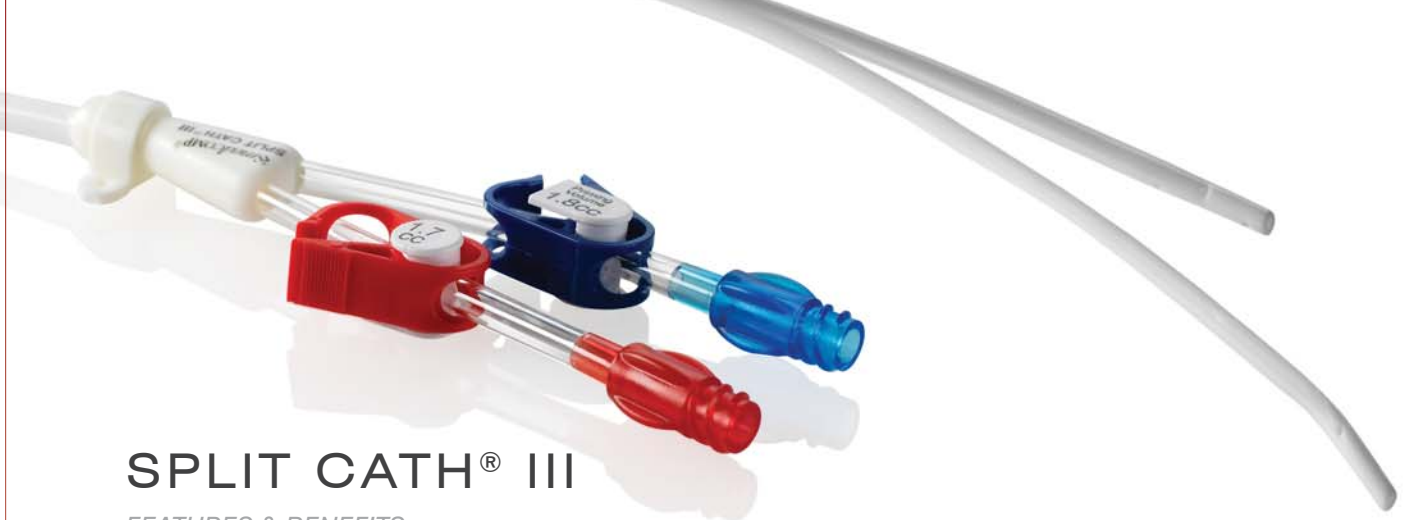

SPLIT CATH® III

FEATURES & BENEFITS

- Two free floating lumens improve patency and flow, and lowers recirculation.
- Material is both alcohol and iodine compatible, providing characteristics of strength, biocompatibility and kink resistance.
- Multiple sizes to fit patients' needs.



Catalog #	Straight	
ASPC24-3	14F x 24CM SPLIT CATH® III	5/Box
ASPC28-3	14F x 28CM SPLIT CATH® III	5/Box
ASPC32-3	14F x 32CM SPLIT CATH® III	5/Box
ASPC36-3	14F x 36CM SPLIT CATH® III	5/Box
ASPC40-3	14F x 40CM SPLIT CATH® III	5/Box
ASPC55-3	14F x 55CM SPLIT CATH® III	5/Box
ASPC2416-3	16F x 24CM SPLIT CATH® III	5/Box
ASPC2816-3	16F x 28CM SPLIT CATH® III	5/Box
ASPC3216-3	16F x 32CM SPLIT CATH® III	5/Box
ASPC3616-3	16F x 36CM SPLIT CATH® III	5/Box
ASPC4016-3	16F x 40CM SPLIT CATH® III	5/Box
ASPC5516-3	16F x 55CM SPLIT CATH® III	5/Box

Catalog #	Straight	
ASPC40-3TL	14F x 40CM TRANSLUMBAR KIT	5/Box
ASPC55-3TL	14F x 55CM TRANSLUMBAR KIT	5/Box

TRANSLUMBAR KIT CONTAINS:

(1) Catheter (3) Dilators (2) Injection Caps (1) Scalpel (1) Valved Tearaway Sheath Dilator (1) Introducer Needle (2) Guidewire (1) Adhesive Wound Dressing (1) Tunneler (1) Stiffening Stylet

Catalog #		
AST	SPLIT CATH III® TUNNELER	5/Box
ASTSG	SPLIT CATH III® SURE GRIP TUNNELER	5/Box

Catalog #	Pre-Curved	
ASPC24-3PC	14F x 24CM PC SPLIT CATH® III	5/Box
ASPC28-3PC	14F x 28CM PC SPLIT CATH® III	5/Box
ASPC32-3PC	14F x 32CM PC SPLIT CATH® III	5/Box
ASPC36-3PC	14F x 36CM PC SPLIT CATH® III	5/Box
ASPC2416-3PC	16F x 24CM PC SPLIT CATH® III	5/Box
ASPC2816-3PC	16F x 28CM PC SPLIT CATH® III	5/Box
ASPC3216-3PC	16F x 32CM PC SPLIT CATH® III	5/Box
ASPC3616-3PC	16F x 36CM PC SPLIT CATH® III	5/Box

Catalog #	Straight	
ASPC15P-XL	10F x 15CM SPLIT CATH® III	5/Box
ASPC18P-XL	10F x 18CM SPLIT CATH® III	5/Box
ASPC24P-XL	10F x 24CM SPLIT CATH® III	5/Box

BASIC SET CONTAINS:

(1) Catheter w/ Stylet (1) Introducer Needle (1) Guidewire (2) Dilators (1) Scalpel (1) Tunneler (1) Valved Tearaway Sheath Introducer (1) Adhesive Wound Dressing (2) Injection Caps

SPLIT STREAM®

FEATURES & BENEFITS

- Retrograde split tip catheter allows for more accurate placement.
- Available in 14F and 16F in multiple lengths for all patient needs.
- Removable hub aids in patient comfort.

Catalog #		
SST24	14F x 24CM RETROGRADE SPLIT STREAM®, BASIC SET	5/Box
SST28	14F x 28CM RETROGRADE SPLIT STREAM®, BASIC SET	5/Box
SST32	14F x 32CM RETROGRADE SPLIT STREAM®, BASIC SET	5/Box
SST36	14F x 36CM RETROGRADE SPLIT STREAM®, BASIC SET	5/Box
SST40	14F x 40CM RETROGRADE SPLIT STREAM®, BASIC SET	5/Box
SST2416	16F x 24CM RETROGRADE SPLIT STREAM®, BASIC SET	5/Box
SST2816	16F x 28CM RETROGRADE SPLIT STREAM®, BASIC SET	5/Box
SST3216	16F x 32CM RETROGRADE SPLIT STREAM®, BASIC SET	5/Box
SST3616	16F x 36CM RETROGRADE SPLIT STREAM®, BASIC SET	5/Box
SST4016	16F x 40CM RETROGRADE SPLIT STREAM®, BASIC SET	5/Box

SET CONTAINS:

(1) Catheter (1) Guidewire (2) Dilators (1) Arterial Extension Set (Red) (1) Venous Extension Set (Blue) (1) Scalpel (1) Valved Tearaway Sheath Dilator (1) Adhesive Wound Dressing (3) Clamps (1) Removable Hub (1) Tunneled (1) Lumen Clamp (2) Injection Caps (1) Introducer Needle

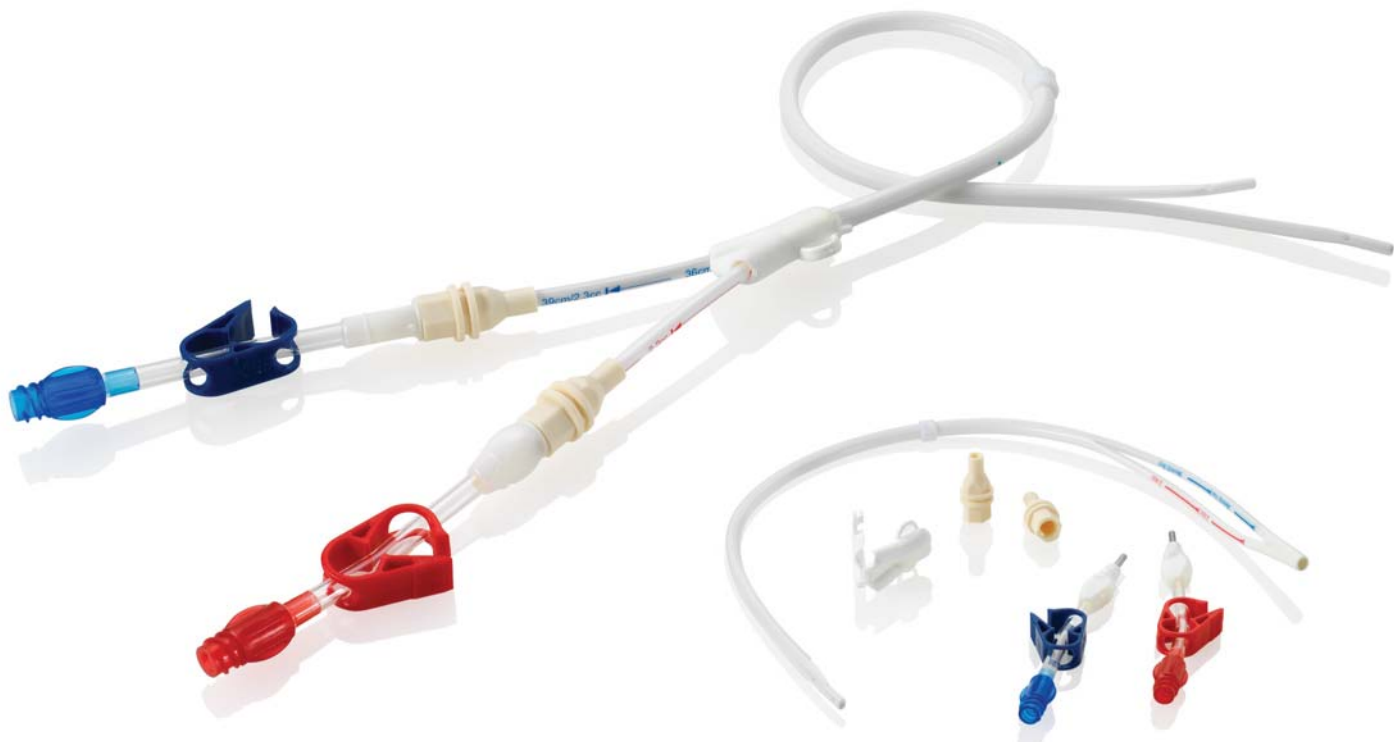

ESCHELON™

FEATURES & BENEFITS

- All the benefits of a split tip design with two round inner lumens.
- Improved kink resistance with high flow rates.
- Two piece extension design for easy replacement of extensions.

Catalog #		
JDDF1524	15F x 24CM LT DL LUMEN CATHETER W/ STYLET	5/Box
JDDF1528	15F x 28CM LT DL LUMEN CATHETER W/ STYLET	5/Box
JDDF1532	15F x 32CM LT DL LUMEN CATHETER W/ STYLET	5/Box
JDDF1536	15F x 36CM LT DL LUMEN CATHETER W/ STYLET	5/Box
JDDF1540	15F x 40CM LT DL LUMEN CATHETER W/ STYLET	5/Box

SET CONTAINS:

(1) Catheter w/ Stylet (1) Introducer Needle (1) Guidewire (2) Dilators
 (1) Scalpel (1) Tunneler (1) Tearaway Sheath Introducer (1) Adhesive
 Wound Dressing (2) Injection Caps



BIO-FLEX® TESIO® CATH

FEATURES & BENEFITS



- Two free floating lumens, independent of each other, provide increased patency, when compared to other dual lumen catheters.
- Flow rates in excess of 450ml/min.
- Retrograde insertion allows for accurate distal tip placement.



Catalog #	Standard Tesio® Sets	
PBF	6.5F x 29CM CATHETERS, CUFFS @ 12CM AND 15CM	5/Box
BFS-6	10F x 52CM CATHETERS, CUFFS @ 18CM AND 21CM	5/Box
BFR-6	10F x 52CM CATHETERS, CUFFS @ 22CM AND 25CM	5/Box
BFL-6	10F x 52CM CATHETERS, CUFFS @ 27CM AND 30CM	5/Box
BFR1070KD-A	10F x 72CM CATHETERS, CUFFS @ 46CM AND 50CM	5/Box

STANDARD SET CONTAINS:

(2) Catheters (2) Introducer Needles (2) Guidewires (1) Scalpel (2) Tunnelers (2) Football Tunnelers (1) Coaxial Introducer Sheath (2) Valved Tearaway Sheath Introducers (2) Venous and Arterial Extensions (1) Adhesive Wound Dressing (2) Clamps (2) Injection Caps

Catalog #	Tesio® Sets With Cutting Trocars	
BFS-6CTT	10F x 52CM CATHETERS, CUFFS @ 18CM AND 21CM	5/Box
BFR-6CTT	10F x 52CM CATHETERS, CUFFS @ 22CM AND 25CM	5/Box
BFL-6CTT	10F x 52CM CATHETERS, CUFFS @ 27CM AND 30CM	5/Box

BASIC SET WITH CUTTING TROCAR CONTAINS:

(2) Catheters (2) Introducer Needles (2) Guidewires (1) Scalpel (2) Cutting Trocars (2) Football Tunnelers (1) Coaxial Introducer Sheath (2) Valved Tearaway Sheath Introducers (2) Venous and Arterial Extensions (1) Adhesive Wound Dressing (2) Clamps (2) Injection Caps

Catalog #	Tesio® Single Catheter Sets	
BFSS	10F x 52CM CATHETER, CUFF @ 21CM	5/Box
BFRS	10F x 52CM CATHETER, CUFF @ 25CM	5/Box
BFLS	10F x 52CM CATHETER, CUFF @ 30CM	5/Box

SINGLE SET CONTAINS:

(1) Catheter (1) Introducer Needle (1) Guidewire (1) Scalpel (1) Tunneler (1) Football Tunneler (1) Tearaway Sheath Introducer (1) Venous Extension (1) Adhesive Wound Dressing (1) Clamp (1) Injection Cap

Catalog #	Accessories	
BTT	TESIO® BLUNT TUNNELER	5/Box
CTT	10F TESIO® CUTTING TUNNELER	5/Box
FTT10	FOOTBALL TUNNELER	5/Box
RTT	RAULERSON TUNNELER	5/Box
BF11A	10F ARTERIAL EXTENSION SET FOR TESIO® CATHETER	10/Box
BF11V	10F VENOUS EXTENSION SET FOR TESIO® CATHETER	10/Box
BF11AVS	10F ARTERIAL AND VENOUS EXTENSION SET FOR TESIO® CATHETER	10/Box

TITAN HD™

FEATURES & BENEFITS

- 90 degree angle of the arterial tip reduces risk of arterial insufficiency and improves the ability to hold locking solutions.
- High flow rates in excess of 450 ml/min.
- Unique tip design allows for easy insertion over a guidewire or through an introducer sheath.



Catalog #	Straight with Side Holes	
THD155024	15.5F x 24CM TITAN HD™ CATHETER SET	5/Box
THD155028	15.5F x 28CM TITAN HD™ CATHETER SET	5/Box
THD155032	15.5F x 32CM TITAN HD™ CATHETER SET	5/Box
THD155036	15.5F x 36CM TITAN HD™ CATHETER SET	5/Box
THD155040	15.5F x 40CM TITAN HD™ CATHETER SET	5/Box
THD155055	15.5F x 55CM TITAN HD™ CATHETER SET	5/Box

Catalog #	Pre-Curved with Side Holes	
THD155224	15.5F x 24CM PC TITAN HD™ CATHETER SET	5/Box
THD155228	15.5F x 28CM PC TITAN HD™ CATHETER SET	5/Box
THD155232	15.5F x 32CM PC TITAN HD™ CATHETER SET	5/Box
THD155236	15.5F x 36CM PC TITAN HD™ CATHETER SET	5/Box

Catalog #	Straight without Side Holes	
THD155424	15.5F x 24CM TITAN HD™ CATHETER SET	5/Box
THD155428	15.5F x 28CM TITAN HD™ CATHETER SET	5/Box
THD155432	15.5F x 32CM TITAN HD™ CATHETER SET	5/Box
THD155436	15.5F x 36CM TITAN HD™ CATHETER SET	5/Box
THD155440	15.5F x 40CM TITAN HD™ CATHETER SET	5/Box
THD155455	15.5F x 55CM TITAN HD™ CATHETER SET	5/Box

Catalog #	Pre-Curved without Side Holes	
THD155624	15.5F x 24CM PC TITAN HD™ CATHETER SET	5/Box
THD155628	15.5F x 28CM PC TITAN HD™ CATHETER SET	5/Box
THD155632	15.5F x 32CM PC TITAN HD™ CATHETER SET	5/Box
THD155636	15.5F x 36CM PC TITAN HD™ CATHETER SET	5/Box

BASIC SET CONTAINS:
 (1) Catheter w/ Stylet (1) Introducer Needle (1) Guidewire (2) Dilators (1) Scalpel (1) Tunneler
 (1) Valved Tearaway Sheath Introducer (1) Adhesive Wound Dressing (2) Injection Caps

HEMO-FLOW®

FEATURES & BENEFITS

- High flow rates in excess of 400ml/min.
- Radiopaque polyurethane material that is both alcohol and iodine compatible.
- Available in straight and pre-curved designs to accommodate patient need and comfort.

Catalog #	Straight	
HFS 24	14.5F x 24CM HEMO-FLOW® SET	5/Box
HFS 28	14.5F x 28CM HEMO-FLOW® SET	5/Box
HFS 32	14.5F x 32CM HEMO-FLOW® SET	5/Box
HFS 36	14.5F x 36CM HEMO-FLOW® SET	5/Box
HFS 40	14.5F x 40CM HEMO-FLOW® SET	5/Box
HFS 55	14.5F x 55CM HEMO-FLOW® SET	5/Box

Catalog #	Pre-Curved	
HFS24PC	14.5F x 24CM PC HEMO-FLOW® SET	5/Box
HFS28PC	14.5F x 28CM PC HEMO-FLOW® SET	5/Box
HFS32PC	14.5F x 32CM PC HEMO-FLOW® SET	5/Box
HFS36PC	14.5F x 36CM PC HEMO-FLOW® SET	5/Box

BASIC SET CONTAINS:

- (1) Catheter (1) Introducer Needle (1) Guidewire (2) Dilators (1) Scalpel
- (1) Tunneler (1) Valved Tearaway Sheath Introducer (1) Adhesive Wound Dressing (2) Injection Caps





HEMO-CATH® LT

FEATURES & BENEFITS

- Silicone material provides biocompatibility and kink resistance.
- Ideal for extracorporeal therapies: dialysis, hemofiltration, apheresis and plasmapheresis.
- Radiopaque silicone material.

Catalog #	Straight Catheter Basic Sets	
SL18P	8F x 18CM SILICONE DOUBLE LUMEN	10/Box
SL24P	8F x 24CM SILICONE DOUBLE LUMEN	10/Box

CATHETER BASIC SET CONTAINS:

- (1) Catheter (1) Dilator (1) 10cc Syringe (1) J/Flex Guidewire
- (1) Adhesive Wound Dressing (1) Hemo-Cath® Hub Clip
- (1) Introducer Needle (2) Injection Caps

Catalog #	Straight Catheter Only	
SL28C	12.5F x 28CM SILICONE DOUBLE LUMEN	10/Box
SL32C	12.5F x 32CM SILICONE DOUBLE LUMEN	10/Box
	Pre-Curved Catheter Only	
SL28CPC	12.5F x 28CM SILICONE DOUBLE LUMEN	10/Box
SL32CPC	12.5F x 32CM SILICONE DOUBLE LUMEN	10/Box

CATHETER ONLY CONTAINS:

- (1) Catheter (2) Injection Caps (1) Catheter Clip

Catalog #	Straight Catheter Basic Sets	
MC101243	12.5 x 24CM SILICONE DOUBLE LUMEN	5/Box
SL28	12.5F x 28CM SILICONE DOUBLE LUMEN	5/Box
SL32	12.5F x 32CM SILICONE DOUBLE LUMEN	5/Box
	Pre-Curved Catheter Basic Sets	
SL28PC	12.5F x 28CM SILICONE DOUBLE LUMEN CURVED	5/Box
SL32PC	12.5F x 32CM SILICONE DOUBLE LUMEN CURVED	5/Box

SET CONTAINS:

- (1) Catheter (1) Patient I.D. Card (2) Injection Caps (1) Scalpel
- (1) Tearaway Sheath Dilator (1) Introducer Needle (1) J/Flex Guidewire (1) Adhesive Wound Dressing (1) Hemo-Cath® Hub Clip
- (1) Trocar

Catalog #	Straight Catheter Full Trays	
MCDLTS28	12.5F x 28CM SILICONE DOUBLE LUMEN	5/Box
MCDLTS32	12.5F x 32CM SILICONE DOUBLE LUMEN	5/Box
	Pre-Curved Catheter Full Trays	
MCDLTS28PC	12.5F x 28CM SILICONE PC DOUBLE LUMEN	5/Box
MCDLTS32PC	12.5F x 32CM SILICONE PC DOUBLE LUMEN	5/Box

TRAY CONTAINS:

- (1) Catheter (1) Dilator (1) Tearaway Sheath Dilator (4) 4 x 4" Gauze (1) Chlorhexidine (2) 5cc Syringe (3) Safety Hypodermic Needles (1) 5cc Lidocaine HCL 1% (1) Safety Introducer Needle (1) Surgical Gloves (2) 10cc Syringe (1) Scalpel (1) J/Flex Guidewire (1) 2-0 Silk Suture with Curved Needle (1) Fenestrated Drape 24" x 38-1/2" (1) Hemostat (1) Adhesive Wound Dressing (1) Chlorhexidine IFU (1) Patient I.D. Card (2) Injection Caps (1) Tunneler (1) Hemo-Cath® Hub Clip

SHORT TERM HEMODIALYSIS CATHETERS

section

2

DIALYSIS & VASCULAR ACCESS PRODUCTS



DUO-SPLIT®



SLX



HEMO-CATH®



400XL



DUO-FLOW®



SOFT-LINE®

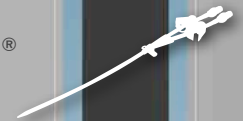

T-3



TRI-FLOW®



FEMORAL



SUBCLAVIAN



CONTINUOUS



Short Term



DUO-SPLIT®

FEATURES & BENEFITS

- The first split tip short term catheter.
- Soft, open tip design allows for greater flow and improved patency over standard tapered-tip short term catheters.
- Dual stylets facilitate standard insertion techniques.



Catalog #	Catheter Only	
DSP134C	13F x 12CM POLYURETHANE SHORT TERM DUO-SPLIT® CATHETER ONLY	10/Box
DSP136C	13F x 15CM POLYURETHANE SHORT TERM DUO-SPLIT® CATHETER ONLY	10/Box
DSP138C	13F x 20CM POLYURETHANE SHORT TERM DUO-SPLIT® CATHETER ONLY	10/Box
DSP139C	13F x 24CM POLYURETHANE SHORT TERM DUO-SPLIT® CATHETER ONLY	10/Box
DSP130C	13F x 30CM POLYURETHANE SHORT TERM DUO-SPLIT® CATHETER ONLY	10/Box
DSP134PC	13F x 12CM POLYURETHANE PRE-CURVED SHORT TERM DUO-SPLIT® CATHETER ONLY	10/Box
DSP136PC	13F x 15CM POLYURETHANE PRE-CURVED SHORT TERM DUO-SPLIT® CATHETER ONLY	10/Box
DSP138PC	13F x 20CM POLYURETHANE PRE-CURVED SHORT TERM DUO-SPLIT® CATHETER ONLY	10/Box
DSP139PC	13F x 24CM POLYURETHANE PRE-CURVED SHORT TERM DUO-SPLIT® CATHETER ONLY	10/Box
DSP134IJC	13F x 12CM POLYURETHANE RAULERSON IJ SHORT TERM DUO-SPLIT® CATHETER ONLY	10/Box
DSP136IJC	13F x 15CM POLYURETHANE RAULERSON IJ SHORT TERM DUO-SPLIT® CATHETER ONLY	10/Box
DSP138IJC	13F x 20CM POLYURETHANE RAULERSON IJ SHORT TERM DUO-SPLIT® CATHETER ONLY	10/Box
DSP139IJC	13F x 24CM POLYURETHANE RAULERSON IJ SHORT TERM DUO-SPLIT® CATHETER ONLY	10/Box

(1) Catheter (2) Injection Caps (2) Dilators (1) Patient I.D. Card

Catalog #	Basic Set	
DSP134S	13F x 12CM POLYURETHANE SHORT TERM DUO-SPLIT® BASIC SET	5/Box
DSP136S	13F x 15CM POLYURETHANE SHORT TERM DUO-SPLIT® BASIC SET	5/Box
DSP138S	13F x 20CM POLYURETHANE SHORT TERM DUO-SPLIT® BASIC SET	5/Box
DSP139S	13F x 24CM POLYURETHANE SHORT TERM DUO-SPLIT® BASIC SET	5/Box
DSP130S	13F x 30CM POLYURETHANE SHORT TERM DUO-SPLIT® BASIC SET	5/Box
DSP134PS	13F x 12CM POLYURETHANE PRE-CURVED SHORT TERM DUO-SPLIT® BASIC SET	5/Box
DSP136PS	13F x 15CM POLYURETHANE PRE-CURVED SHORT TERM DUO-SPLIT® BASIC SET	5/Box
DSP138PS	13F x 20CM POLYURETHANE PRE-CURVED SHORT TERM DUO-SPLIT® BASIC SET	5/Box
DSP139PS	13F x 24CM POLYURETHANE PRE-CURVED SHORT TERM DUO-SPLIT® BASIC SET	5/Box
DSP134IJS	13F x 12CM POLYURETHANE RAULERSON IJ SHORT TERM DUO-SPLIT® BASIC SET	5/Box
DSP136IJS	13F x 15CM POLYURETHANE RAULERSON IJ SHORT TERM DUO-SPLIT® BASIC SET	5/Box
DSP138IJS	13F x 20CM POLYURETHANE RAULERSON IJ SHORT TERM DUO-SPLIT® BASIC SET	5/Box
DSP139IJS	13F x 24CM POLYURETHANE RAULERSON IJ SHORT TERM DUO-SPLIT® BASIC SET	5/Box

(1) Catheter (2) Injection Caps (2) Dilators (1) Guidewire (1) Introducer Needle (1) Adhesive Wound Dressing (1) Patient I.D. Card

Catalog #	Full Tray	
DSP134T	13F x 12CM POLYURETHANE SHORT TERM DUO-SPLIT® FULL TRAY	5/Box
DSP136T	13F x 15CM POLYURETHANE SHORT TERM DUO-SPLIT® FULL TRAY	5/Box
DSP138T	13F x 20CM POLYURETHANE SHORT TERM DUO-SPLIT® FULL TRAY	5/Box
DSP139T	13F x 24CM POLYURETHANE SHORT TERM DUO-SPLIT® FULL TRAY	5/Box
DSP130T	13F x 30CM POLYURETHANE SHORT TERM DUO-SPLIT® FULL TRAY	5/Box
DSP134PT	13F x 12CM POLYURETHANE PRE-CURVED SHORT TERM DUO-SPLIT® FULL TRAY	5/Box
DSP136PT	13F x 15CM POLYURETHANE PRE-CURVED SHORT TERM DUO-SPLIT® FULL TRAY	5/Box
DSP138PT	13F x 20CM POLYURETHANE PRE-CURVED SHORT TERM DUO-SPLIT® FULL TRAY	5/Box
DSP139PT	13F x 24CM POLYURETHANE PRE-CURVED SHORT TERM DUO-SPLIT® FULL TRAY	5/Box
DSP134IJT	13F x 12CM POLYURETHANE RAULERSON IJ SHORT TERM DUO-SPLIT® FULL TRAY	5/Box
DSP136IJT	13F x 15CM POLYURETHANE RAULERSON IJ SHORT TERM DUO-SPLIT® FULL TRAY	5/Box
DSP138IJT	13F x 20CM POLYURETHANE RAULERSON IJ SHORT TERM DUO-SPLIT® FULL TRAY	5/Box
DSP139IJT	13F x 24CM POLYURETHANE RAULERSON IJ SHORT TERM DUO-SPLIT® FULL TRAY	5/Box

(1) Catheter (2) Injection Caps (1) Dilator (1) Guidewire (1) Safety Introducer Needle (1) Safety Scalpel (1) Adhesive Wound Dressing (1) 2-0 Silk Suture (1) 5cc Syringe (1) 10cc Syringe (3) Safety Hypodermic Needles (1) Safety Needle (1) 5cc Ampule Lidocaine HCL 1% (1) Surgical Gloves (4) 4" x 4" Gauze Sponge (1) Chlorhexidine (1) Fenestrated Drape (1) Hemostat (1) Patient I.D. Card

SLX

FEATURES & BENEFITS

- Larger 14F luminal design allows for improved flow rates.
- Silicone material provides biocompatibility and kink resistance.
- Fast Track™ Stylet and round catheter permits easier insertion and less patient discomfort.



Catalog #	Catheter Only	
MC061442	14F x 15CM SLX DOUBLE LUMEN, CATHETER ONLY	10/Box
MC061443	14F x 20CM SLX DOUBLE LUMEN, CATHETER ONLY	10/Box
MC061444	14F x 24CM SLX DOUBLE LUMEN, CATHETER ONLY	10/Box
MC061445	14F x 30CM SLX DOUBLE LUMEN, CATHETER ONLY	10/Box

CATHETER ONLY CONTAINS:

(1) Catheter w/ Stylet (2) Injection Caps (1) Catheter Clip

Catalog #	Basic Set	
MC061402	14F x 15CM SLX DOUBLE LUMEN, BASIC SET	5/Box
MC061403	14F x 20CM SLX DOUBLE LUMEN, BASIC SET	5/Box
MC061404	14F x 24CM SLX DOUBLE LUMEN, BASIC SET	5/Box
MC061405	14F x 30CM SLX DOUBLE LUMEN, BASIC SET	5/Box

BASIC SET CONTAINS:

(1) Catheter w/ Stylet (1) Introducer Needle (1) Guidewire (2) Dilators (1) Scalpel
 (1) Tearaway Sheath Introducer (1) Adhesive Wound Dressing (2) Injection Caps
 (1) Catheter Clip (1) 2-0 Suture

Catalog #	Full Tray	
MC061422	14F x 15CM SLX DOUBLE LUMEN, FULL TRAY	5/Box
MC061423	14F x 20CM SLX DOUBLE LUMEN, FULL TRAY	5/Box
MC061424	14F x 24CM SLX DOUBLE LUMEN, FULL TRAY	5/Box
MC061425	14F x 30CM SLX DOUBLE LUMEN, FULL TRAY	5/Box

FULL TRAY CONTAINS:

(1) Catheter w/ Stylet (1) Safety Introducer Needle (1) Guidewire (2) Dilators
 (1) Safety Scalpel (1) Tearaway Sheath Introducer (1) Adhesive Wound Dressing
 (2) Injection Caps (1) Catheter Clip (4) 4"x4" Gauze (2) Chlorhexidine (1) 5cc Syringe
 (2) 10cc Pre-Filled Syringes (1) 2-0 Silk Suture (3) Safety Hypodermic Needles
 (1) Hemostat (1) Fenestrated Drape (1) 5cc Lidocaine (1) Filter Straw
 (1) Surgical Gloves

HEMO-CATH® ST

FEATURES & BENEFITS

- Silicone material provides biocompatibility and kink resistance.
- Silicone catheter provides improved patient comfort.
- Fast Track™ Stylet and round catheter permits easier insertion.



Catalog #	Straight Catheter Only	
SL12P	8F x 12CM DOUBLE LUMEN CATHETER	10/Box

CATHETER ONLY CONTAINS:

(1) Catheter (1) Dilator (1) 10cc Syringe (1) J/Flex Guidewire (1) Adhesive Wound Dressing (1) Hemo-Cath® Hub Clip (1) Introducer Needle (2) Injection Caps

Catalog #	Catheter Only	
SL15C	11.5F x 15CM, SILICONE HEMO-CATH®, CATHETER ONLY	10/Box
SL20C	11.5F x 20CM, SILICONE HEMO-CATH®, CATHETER ONLY	10/Box
SL24C	11.5F x 24CM, SILICONE HEMO-CATH®, CATHETER ONLY	10/Box

CATHETER ONLY CONTAINS:

(1) Catheter w/ Stylet (2) Injection Caps (1) Catheter Clip

Catalog #	Basic Set	
SL15	11.5F x 15CM, SILICONE HEMO-CATH®, BASIC SET	5/Box
SL20	11.5F x 20CM, SILICONE HEMO-CATH®, BASIC SET	5/Box
SL24	11.5F x 24CM, SILICONE HEMO-CATH®, BASIC SET	5/Box
SL27	11.5F x 27CM, SILICONE HEMO-CATH®, BASIC SET	5/Box

BASIC SET CONTAINS:

(1) Catheter w/ Stylet (1) Introducer Needle (1) Guidewire (2) Dilators (1) Scalpel (1) Tearaway Sheath Introducer (1) Adhesive Wound Dressing (2) Injection Caps (1) Catheter Clip

Catalog #	Full Tray	
MCDLTSL15	11.5F x 15CM, SILICONE HEMO-CATH®, FULL TRAY	5/Box
MCDLTSL20	11.5F x 20CM, SILICONE HEMO-CATH®, FULL TRAY	5/Box
MCDLTSL24	11.5F x 24CM, SILICONE HEMO-CATH®, FULL TRAY	5/Box
MCDLTSL27	11.5F x 27CM, SILICONE HEMO-CATH®, FULL TRAY	5/Box

FULL TRAY CONTAINS:

(1) Catheter w/ Stylet (1) Safety Introducer Needle (1) Guidewire (2) Dilators (1) Safety Scalpel (1) Tearaway Sheath Introducer (1) Adhesive Wound Dressing (2) Injection Caps (1) Catheter Clip (4) 4"x4" Gauze (2) Chlorhexidine (1) 5cc Syringe (2) 10cc Pre-Filled Syringes (1) 2-0 Silk Suture (3) Safety Hypodermic Needles (1) Hemostat (1) Fenestrated Drape (1) 5cc Lidocaine (1) Filter Straw (1) Surgical Gloves



400XL

FEATURES & BENEFITS

- 360° arterial ports help eliminate vessel occlusion and arterial insufficiency.
- High flow catheter material eliminates kinking due to its excellent memory.
- The advantages of high flow and high efficiency dialysis with the benefits of Medcomp's patented Duo-Flow® design.



Catalog #	Catheter Only	
DFXL146CT	14F x 15CM 400XL STRAIGHT CATHETER	10/Box
DFXL148CT	14F x 20CM 400XL STRAIGHT CATHETER	10/Box
DFXL149CT	14F x 24CM 400XL STRAIGHT CATHETER	10/Box
DFXL146IJC	14F x 15CM 400XL PRE-CURVED CATHETER	10/Box
DFXL148IJC	14F x 20CM 400XL PRE-CURVED CATHETER	10/Box
DFXL149IJC	14F x 24CM 400XL PRE-CURVED CATHETER	10/Box

CATHETER ONLY CONTAINS:

(1) Catheter (2) Injection Caps (2) Dilators (1) Patient I.D. Card

Catalog #	Basic Set	
DFXL146MT	14F x 15CM 400XL STRAIGHT CATHETER	5/Box
DFXL148MT	14F x 20CM 400XL STRAIGHT CATHETER	5/Box
DFXL149MT	14F x 24CM 400XL STRAIGHT CATHETER	5/Box
DFXL146IJS	14F x 15CM 400XL PRE-CURVED CATHETER	5/Box
DFXL148IJS	14F x 20CM 400XL PRE-CURVED CATHETER	5/Box
DFXL149IJS	14F x 24CM 400XL PRE-CURVED CATHETER	5/Box

BASIC SET CONTAINS:

(1) Catheter (2) Injection Caps (2) Dilators (1) Guidewire (1) Introducer Needle
(1) Adhesive Wound Dressing (1) Patient I.D. Card

Catalog #	Full Tray	
DFXL146	14F x 15CM 400XL STRAIGHT CATHETER	5/Box
DFXL148	14F x 20CM 400XL STRAIGHT CATHETER	5/Box
DFXL149	14F x 24CM 400XL STRAIGHT CATHETER	5/Box
DFXL146IJ	14F x 15CM 400XL PRE-CURVED CATHETER	5/Box
DFXL148IJ	14F x 20CM 400XL PRE-CURVED CATHETER	5/Box
DFXL149IJ	14F x 24CM 400XL PRE-CURVED CATHETER	5/Box

FULL TRAY CONTAINS:

(1) Catheter (2) Injection Caps (2) Dilators (1) Guidewire (1) Safety Introducer Needle
(1) Safety Scalpel (1) Adhesive Wound Dressing (1) 2-0 Silk Suture (2) 5cc Syringes
(2) 10cc Syringes (3) Safety Hypodermic Needles (1) 5cc Lidocaine (1) Surgical Gloves
(4) 4" x 4" Gauze (1) Chlorhexidine (1) Fenestrated Drape
(1) Hemostat (1) Patient I.D. Card

US and Foreign Patents Pending.



DUO-FLOW®

FEATURES & BENEFITS

- Thermosensitive polyurethane material softens after insertion for increased patient safety.
- Raulerson IJ Catheter has a unique pre-formed curve that overcomes patient discomfort and significantly decreases the risk for infections, compared with straight catheters.
- Coaxial catheter design allows for improved flow rates and outcomes, when compared with standard double “D” dual lumen catheters.

Catheter Only 10/Box	Basic Set 5/Box	Full Tray 5/Box	
Catalog #			Straight Catheter
XTP94CT	XTP94MT	---	9F x 12CM STRAIGHT DUO-FLOW® CATHETER
XTP96CT	XTP96MT	---	9F x 15CM STRAIGHT DUO-FLOW® CATHETER
XTP98CT	XTP98MT	---	9F x 20CM STRAIGHT DUO-FLOW® CATHETER
			Pre-Curved Catheter
XTP94IJC	XTP94IJS	---	9F x 12CM PRE-CURVED DUO-FLOW® CATHETER
XTP96IJC	XTP96IJS	---	9F x 15CM PRE-CURVED DUO-FLOW® CATHETER
XTP98IJC	XTP98IJS	---	9F x 20CM PRE-CURVED DUO-FLOW® CATHETER
			Straight Catheter
XTP114CT	XTP114MT	MCDLT3500	11.5F x 12CM STRAIGHT DUO-FLOW® CATHETER
XTP116CT	XTP116MT	MCDLT4000	11.5F x 15CM STRAIGHT DUO-FLOW® CATHETER
XTP118CT	XTP118MT	MCDLT4400	11.5F x 20CM STRAIGHT DUO-FLOW® CATHETER
XTP119CT	XTP119MT	MCDLT4424	11.5F x 24CM STRAIGHT DUO-FLOW® CATHETER
			Raulerson IJ Catheter
XTP114IJC	XTP114IJS	MCDLT114IJ	11.5F x 12CM RAULERSON IJ DUO-FLOW® CATHETER
XTP116IJC	XTP116IJS	MCDLT116IJ	11.5F x 15CM RAULERSON IJ DUO-FLOW® CATHETER
XTP118IJC	XTP118IJS	MCDLT118IJ	11.5F x 20CM RAULERSON IJ DUO-FLOW® CATHETER
			Pre-Curved Catheter
XTP114IJC-2	XTP114IJS-2	MCDLT114IJ-2	11.5F x 12CM PRE-CURVED DUO-FLOW® CATHETER
XTP116IJC-2	XTP116IJS-2	MCDLT116IJ-2	11.5F x 15CM PRE-CURVED DUO-FLOW® CATHETER
XTP118IJC-2	XTP118IJS-2	MCDLT118IJ-2	11.5F x 20CM PRE-CURVED DUO-FLOW® CATHETER

CATHETER ONLY CONTAINS:

(1) Catheter (2) Injection Caps (1) Dilator

BASIC SET CONTAINS:

(1) Catheter (1) Introducer Needle (1) Guidewire (2) Dilators (1) Scalpel (1) Tearaway Sheath Introducer (1) Adhesive Wound Dressing (2) Injection Caps (1) Catheter Clip

FULL TRAY CONTAINS:

(1) Catheter (1) Introducer Needle (1) Guidewire (2) Dilators (1) Safety Scalpel (1) Tearaway Sheath Introducer (1) Adhesive Wound Dressing (2) Injection Caps (1) Catheter Clip (4) 4"x4" Gauze (2) Chlorhexidine (1) 5cc Syringe (2) 10cc Pre-Filled Syringes (1) 2-0 Silk Suture (3) Safety Hypodermic Needles (1) Hemostat (1) Fenestrated Drape (1) 5cc Lidocaine (1) Filter Straw (1) Surgical Gloves

US and Foreign Patents Pending.

SOFT-LINE®

FEATURES & BENEFITS

- Soft polyurethane material provides increased flow for improved outcomes.
- 360 degree venous and arterial distal ports decrease vessel turbulence and occlusion while increasing blood flows.
- Soft radiopaque tip reduces incidence of vessel damage and aids in confirming catheter tip placement.



Catheter Only 10/Box	Basic Set 5/Box	Full Tray 5/Box	
Catalog #			Straight Catheter
---	T73M	---	7F x 7CM STRAIGHT SOFT-LINE® CATHETER
---	T74M	---	7F x 10CM STRAIGHT SOFT-LINE® CATHETER
T94C	T94M	---	9F x 12CM STRAIGHT SOFT-LINE® CATHETER
T96C	T96M	---	9F x 15CM STRAIGHT SOFT-LINE® CATHETER
T98C	T98M	---	9F x 20CM STRAIGHT SOFT-LINE® CATHETER
T114C	T114M	T3500	11F x 12CM STRAIGHT SOFT-LINE® CATHETER
T116C	T116M	T4000	11F x 15CM STRAIGHT SOFT-LINE® CATHETER
T118C	T118M	T4400	11F x 20CM STRAIGHT SOFT-LINE® CATHETER
T119C	T119M	T4424	11F x 24CM STRAIGHT SOFT-LINE® CATHETER
			Pre-Curved Catheter
T114JC-2	T114JS-2	T114J-2	11F x 12CM PRE-CURVED SOFT-LINE® CATHETER
T116JC-2	T116JS-2	T116J-2	11F x 15CM PRE-CURVED SOFT-LINE® CATHETER
T118JC-2	T118JS-2	T118J-2	11F x 20CM PRE-CURVED SOFT-LINE® CATHETER

CATHETER ONLY CONTAINS:

(1) Catheter (2) Injection Caps (1) Dilator

BASIC SET CONTAINS:

(1) Catheter (1) Introducer Needle (1) Guidewire (2) Dilators (1) Scalpel (1) Tearaway Sheath Introducer (1) Adhesive Wound Dressing (2) Injection Caps (1) Catheter Clip

FULL TRAY CONTAINS:

(1) Catheter (1) Introducer Needle (1) Guidewire (2) Dilators (1) Safety Scalpel (1) Tearaway Sheath Introducer (1) Adhesive Wound Dressing (2) Injection Caps (1) Catheter Clip (4) 4"x4" Gauze (2) Chlorhexidine (1) 5cc Syringe (2) 10cc Pre-Filled Syringes (1) 2-0 Silk Suture (3) Safety Hypodermic Needles (1) Hemostat (1) Fenestrated Drape (1) 5cc Lidocaine (1) Filter Straw (1) Surgical Gloves

T-3

FEATURES & BENEFITS

- Triple lumen versatility coupled with double lumen reliability.
- Soft, biocompatible material is both alcohol and iodine compatible.
- Large lumen size allows for high flow treatments while still offering the ability to satisfy future infusion and withdrawal needs

Catalog #	Catheter Only	
MC011541	15.5F x 15CM T-3 TRIPLE LUMEN, CATHETER ONLY	10/Box
MC011542	15.5F x 20CM T-3 TRIPLE LUMEN, CATHETER ONLY	10/Box
MC011543	15.5F x 24CM T-3 TRIPLE LUMEN, CATHETER ONLY	10/Box
MC011545	15.5F x 32CM T-3 TRIPLE LUMEN, CATHETER ONLY	10/Box

CATHETER ONLY CONTAINS:
 (1) Catheter w/ Stylet (2) Dilators (3) Injection Caps

Catalog #	Basic Set	
MC011501	15.5F x 15CM T-3 TRIPLE LUMEN, BASIC SET	5/Box
MC011502	15.5F x 20CM T-3 TRIPLE LUMEN, BASIC SET	5/Box
MC011503	15.5F x 24CM T-3 TRIPLE LUMEN, BASIC SET	5/Box
MC011505	15.5F x 32CM T-3 TRIPLE LUMEN, BASIC SET	5/Box

BASIC SET CONTAINS:
 (1) Catheter w/ Stylet (1) Introducer Needle (1) Guidewire (2) Dilators (1) Scalpel
 (1) Valved Tearaway Sheath Introducer (1) Adhesive Wound Dressing (3) Injection Caps

Catalog #	Full Tray	
MC011521	15.5F x 15CM T-3 TRIPLE LUMEN, FULL TRAY	5/Box
MC011522	15.5F x 20CM T-3 TRIPLE LUMEN, FULL TRAY	5/Box
MC011523	15.5F x 24CM T-3 TRIPLE LUMEN, FULL TRAY	5/Box
MC011525	15.5F x 32CM T-3 TRIPLE LUMEN, FULL TRAY	5/Box

FULL TRAY CONTAINS:
 (1) Catheter w/ Stylet (1) Introducer Needle (1) Guidewire (2) Dilators (1) Safety Scalpel (1) Valved Tearaway Sheath Introducer (1) Adhesive Wound Dressing (3) Injection Caps (4) 4"x4" Gauze
 (2) Chlorhexidine (1) 5cc Syringe (3) 10cc Pre-Filled Syringes (1) 2-0 Silk Suture (3) Safety Hypodermic Needles
 (1) Hemostat (1) Fenestrated Drape (1) 5cc Lidocaine (1) Filter Straw (1) Surgical Gloves

AVAILABLE SEPTEMBER 1, 2009



TRI-FLOW®

FEATURES & BENEFITS

- Ideal for extracorporeal therapies: dialysis, hemofiltration, apheresis and plasmapheresis.
- Third lumen gives greater flexibility for fluid administration, vasoactive drug therapy, nutrition and blood sampling.
- Integral soft tip reduces occurrence of stenosis and erosion.

Catalog #	Catheter Only	
XTP3114CT	11.5F x 12CM, STRAIGHT TRI-FLOW™ CATHETER	10/Box
XTP3116CT	11.5F x 15CM, STRAIGHT TRI-FLOW™ CATHETER	10/Box
XTP3118CT	11.5F x 20CM, STRAIGHT TRI-FLOW™ CATHETER	10/Box
XTP3119CT	11.5F x 24CM, STRAIGHT TRI-FLOW™ CATHETER	10/Box
XTP3114CTPC	11.5F x 12CM, PRE-CURVED TRI-FLOW™ CATHETER	10/Box
XTP3116CTPC	11.5F x 15CM, PRE-CURVED TRI-FLOW™ CATHETER	10/Box
XTP3118CTPC	11.5F x 20CM, PRE-CURVED TRI-FLOW™ CATHETER	10/Box

CATHETER ONLY CONTAINS:

(1) Catheter w/ Stylet (1) Dilator (3) Injection Caps

Catalog #	Basic Set	
XTP3114MT	11.5F x 12CM, STRAIGHT TRI-FLOW™ CATHETER	5/Box
XTP3116MT	11.5F x 15CM, STRAIGHT TRI-FLOW™ CATHETER	5/Box
XTP3118MT	11.5F x 20CM, STRAIGHT TRI-FLOW™ CATHETER	5/Box
XTP3119MT	11.5F x 24CM, STRAIGHT TRI-FLOW™ CATHETER	5/Box
XTP3114MTPC	11.5F x 12CM, PRE-CURVED TRI-FLOW™ CATHETER	5/Box
XTP3116MTPC	11.5F x 15CM, PRE-CURVED TRI-FLOW™ CATHETER	5/Box
XTP3118MTPC	11.5F x 20CM, PRE-CURVED TRI-FLOW™ CATHETER	5/Box

BASIC SET CONTAINS:

(1) Catheter w/ Stylet (1) Introducer Needle (1) Guidewire (1) Dilator (1) Scalpel
 (1) Adhesive Wound Dressing (3) Injection Caps

Catalog #	Full Tray	
MCDLT3-3500	11.5F x 12CM STRAIGHT TRI-FLOW™ CATHETER	5/Box
MCDLT3-4000	11.5F x 15CM STRAIGHT TRI-FLOW™ CATHETER	5/Box
MCDLT3-4400	11.5F x 20CM STRAIGHT TRI-FLOW™ CATHETER	5/Box
MCDLT3-4424	11.5F x 24CM STRAIGHT TRI-FLOW™ CATHETER	5/Box
MCDLT3-3500PC	11.5F x 12CM PRE-CURVED TRI-FLOW™ CATHETER	5/Box
MCDLT3-4000PC	11.5F x 15CM PRE-CURVED TRI-FLOW™ CATHETER	5/Box
MCDLT3-4400PC	11.5F x 20CM PRE-CURVED TRI-FLOW™ CATHETER	5/Box

FULL TRAY CONTAINS:

(1) Catheter (1) Introducer Needle (1) Guidewire (2) Dilators (1) Safety Scalpel
 (1) Adhesive Wound Dressing (3) Injection Caps (4) 4"x4" Gauze (2) Chlorhexidine
 (1) 5cc Syringe (3) 10cc Pre-Filled Syringes (1) 2-0 Silk Suture (3) Safety Hypodermic
 Needles (1) Hemostat (1) Fenestrated Drape (1) 5cc Lidocaine (1) Filter Straw
 (1) Surgical Gloves



FEMORAL

FEATURES & BENEFITS

- Material is ideal for femoral punctures.
- Available in double or single lumen configurations.
- Useful in over-the-wire and over-the-needle insertions.



Catalog #	Catheter Only	
MCF64	7.0F x 13.5CM STRAIGHT FEMORAL CATHETER	10/Box
MCF55	8.5F x 14.0CM STRAIGHT FEMORAL CATHETER	10/Box
MCF10	8.5F x 25.0CM STRAIGHT FEMORAL CATHETER	10/Box
MCF6	8.5F x 15.0CM STRAIGHT FEMORAL CATHETER W/ "Y" HUB	10/Box

CATHETER ONLY CONTAINS:
(1) Catheter (1|2) Injection Cap(s)

Catalog #	Basic Set	
MCFK64	7.0F x 13.5CM STRAIGHT FEMORAL CATHETER SET	10/Box
MCFK100	8.5F x 25.0CM STRAIGHT FEMORAL CATHETER SET	10/Box
MCFK60	8.5F x 15.0CM STRAIGHT FEMORAL CATHETER W/ "Y" HUB	10/Box

SET CONTAINS:
(1) Catheter (1|2) Injection Cap(s) (1) Introducer Needle (1) Guidewire



SUBCLAVIAN

FEATURES & BENEFITS

- Flexi-Smooth® material softens “in situ,” conforming to vessel anatomy.
- Rotating suture wing for secure external anchoring.
- Removable “Y” adaptor and pre-loaded stylet.

Catalog #	Catheter Only	
MCY306PS	8F x 15CM SUBCLAVIAN CATHETER W/ REMOVABLE “Y” ADAPTOR	10/Box
MCY308PS	8F x 20CM SUBCLAVIAN CATHETER W/ REMOVABLE “Y” ADAPTOR	10/Box

CATHETER ONLY CONTAINS:
 (1) Catheter (1) Removable “Y” Adapter (1) Injection Cap

Catalog #	Basic Set	
MCYK306PS	8F x 15CM SUBCLAVIAN CATHETER W/ REMOVABLE “Y” ADAPTOR	5/Box
MCYK308PS	8F x 20CM SUBCLAVIAN CATHETER W/ REMOVABLE “Y” ADAPTOR	5/Box

BASIC SET CONTAINS:
 (1) Catheter (1) Removable “Y” Adaptor (1) Injection Cap (1) Introducer Needle (1) Guidewire
 (1) Adhesive Wound Dressing



CONTINUOUS/C.A.V.H.

FEATURES & BENEFITS

- Available in two lengths and French sizes.
- Zero-clearance sheath/dilator transition for ease of insertion.
- Locking dilator assures stability of catheter during insertion.

Catalog #	Basic Set	
MC5CAVH3	5F x 7.6CM STRAIGHT C.A.V.H. CATHETER	5/Box
MC8CAVH4F	8F x 11CM STRAIGHT C.A.V.H. CATHETER	5/Box
MC8CAVH6	8F x 15CM STRAIGHT C.A.V.H. CATHETER	5/Box

SET CONTAINS:

(2) Catheters w/ Dilators (2) Injection Caps (2) Introducer Needles (2) Guidewires
 (1) Scalpel (2) Adhesive Wound Dressings

Catalog #	Full Tray	
MCT-106	8F x 15CM STRAIGHT C.A.V.H. CATHETER	5/Box

FULL TRAY CONTAINS:

(2) Catheters w/ Dilators (2) Injection Caps (2) Introducer Needles (2) Guidewires
 (1) Scalpel (1) Adhesive Wound Dressing (1) Suture (3) 10cc Syringes
 (2) Hypodermic Needles (2) Lidocaine (1) Surgical Gloves (12) Gauze
 (1) Povidone Iodine Solution (1) Fenestrated Drape (2) Sterile Wraps
 (2) Prep Sponge Applicators (4) Towels



CENTRAL VEIN INFUSION CATHETERS

section

3

DIALYSIS & VASCULAR ACCESS PRODUCTS



PRO-PICC®



VASCU-PICC®



MIDLINE



DIGNITY™



PRO-FUSE®



TITANIUM PORTS



PLASTIC PORTS



PRO-LINE®

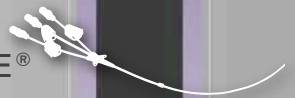

LT SILICONE CVC



MULTI-CATH



CVC



PRO-PICC®

FEATURES & BENEFITS



- Catheters are approved for both CECT Injections and Infusion Therapy.
- Design allows for CT injections for diagnostic imaging at up to 5cc/sec at 300psi.
- Thermosensitive, polyurethane material is both alcohol and iodine compatible.
- Available in single, dual, and triple lumen configurations.

Catalog #	Basic Set	
MR17034101	4F x 50CM SINGLE CT RATED PICC BASIC SET	5/Box
MR17035101	5F x 60CM SINGLE CT RATED PICC BASIC SET	5/Box
MR17035201	5F x 55CM DUAL CT RATED PICC BASIC SET	5/Box
MR17036201	6F x 60CM DUAL CT RATED PICC BASIC SET	5/Box
MR17036301	6F x 60CM TRIPLE CT RATED PICC BASIC SET	5/Box

BASIC SET CONTAINS:

(1) PICC w/ Stylet (1) PTFE Tearaway Introducer (1) Scalpel
 (1) Guidewire (1) Syringe (1) Tape Measure (1) Introducer Needle
 (1|2|3) Needle Free Valve(s) (1) Catheter Securement Device

Catalog #	Long Wire Set	
MR17034102	4F x 50CM SINGLE CT RATED PICC LONG WIRE	5/Box
MR17035102	5F x 60CM SINGLE CT RATED PICC LONG WIRE	5/Box
MR17035202	5F x 55CM DUAL CT RATED PICC LONG WIRE	5/Box
MR17036202	6F x 60CM DUAL CT RATED PICC LONG WIRE	5/Box
MR17036302	6F x 60CM TRIPLE CT RATED PICC LONG WIRE	5/Box

LONG WIRE SET CONTAINS:

(1) PICC (1) PTFE Tearaway Introducer (1) Mini Scalpel
 (1) Guidewire (1) Syringe (1) Tape Measure (1) Introducer Needle
 (1|2|3) Needle Free Valve(s) (1) Catheter Securement Device

Catalog #	Nursing Kit	
MR17034105	4F x 50CM SINGLE CT RATED PICC NURSING KIT	5/Box
MR17035105	5F x 60CM SINGLE CT RATED PICC NURSING KIT	5/Box
MR17035205	5F x 55CM DUAL CT RATED PICC NURSING KIT	5/Box
MR17036305	6F x 60CM TRIPLE CT RATED PICC NURSING KIT	5/Box

NURSING KIT CONTAINS:

(1) PICC w/ Stylet (1) PTFE Tearaway Introducer (1) Safety Scalpel
 (1) Guidewire (1) Syringe (1) Tape Measure (1) Safety Introducer
 Needle (1|2|3) Needle Free Valve(s) (1) Catheter Securement
 Device (1) Latex-Free Tourniquet

Catalog #	Full Nursing Kit	
MR17034106	4F x 50CM SINGLE CT RATED PICC FULL NURSING	5/Box
MR17035106	5F x 60CM SINGLE CT RATED PICC FULL NURSING	5/Box
MR17035206	5F x 55CM DUAL CT RATED PICC FULL NURSING	5/Box
MR17036306	6F x 60CM TRIPLE CT RATED PICC FULL NURSING	5/Box

FULL NURSING KIT CONTAINS:

(1) PICC w/ Preloaded Stylet (1) PTFE Tearaway Introducer
 (1) Safety Scalpel (1) Nitinol Guidewire (2) Syringes
 (2) Tape Measures (1) Surgical Tape (1) Safety Introducer
 Needle (1|2|3) Needle Free Valve(s) (1) Catheter Securement
 Device (1) Latex-Free Tourniquet (3) Pre-Filled Saline Syringes
 (2) Chlorhexidine (1) Lidocaine (1) Adhesive Dressing
 (1) 36" x 36" CSR Wrap (1) Needle Stick Pad (10) 4" x 4" Gauze
 (3) Surgical Gloves (1) Filter Straw (1) Scissors (1) Steri-strips
 (2) Face Masks (8) 2" x 2" Gauze (1) I.V. Catheter (1) Towel
 (1) Fenestrated Drape (1) Drape (1) Hypodermic Safety Needle
 (1) Lidocaine/Saline Stickers

Catalog #	Max Barrier Kit	
MR17034106MB	4F x 50CM SINGLE CT RATED PICC MAX BARRIER	4/Box
MR17035106MB	5F x 60CM SINGLE CT RATED PICC MAX BARRIER	4/Box
MR17035206MB	5F x 55CM DUAL CT RATED PICC MAX BARRIER	4/Box
MR17036306MB	6F x 60CM TRIPLE CT RATED PICC MAX BARRIER	4/Box

MAX BARRIER FULL NURSING KIT CONTAINS:

(1) PICC w/ Preloaded Stylet (1) PTFE Tearaway Introducer
 (1) Safety Scalpel (1) Nitinol Guidewire (2) Syringes
 (2) Tape Measures (1) Surgical Tape (1) Safety Introducer Needle
 (1|2|3) Needle Free Valve(s) (1) Catheter Securement Device
 (1) Latex-Free Tourniquet (3) Pre-Filled Saline Syringes
 (2) Chlorhexidine (1) Lidocaine (1) Adhesive Dressing (1) 36" x
 36" CSR Wrap (1) Needle Stick Pad (10) 4" x 4" Gauze
 (3) Surgical Gloves (1) Filter Straw (1) Scissors (1) Steri-strips
 (2) Face Masks (8) 2" x 2" Gauze (1) I.V. Catheter (1) Towel
 (1) Fenestrated Drape (1) Drape (1) Hypodermic Safety Needle
 (1) Lidocaine/Saline Stickers

VASCU-PICC®

FEATURES & BENEFITS

- Innovative catheter design reduces post insertion bleeding and provides improved catheter strength.
- Thermosensitive, polyurethane material is both alcohol and iodine compatible.
- Full range of catheter sizes from 1.9F to 6F.
- Available in single, dual, and triple lumen configurations.



Catalog #	OTN Set	
MR17011101	1.9F x 50CM SINGLE VASCU-PICC® BASIC SET	5/Box
MR17012601	2.6F x 50CM DUAL VASCU-PICC® BASIC SET	5/Box

OTN SET CONTAINS:

- (1) PICC w/ Stylet (1) OTN Tearaway Sheath Introducer Needle (1) 10cc Syringe (1) Needle Free Cap(s) (1) 10cc Syringe (1) Tape Measure (1) Suture Wing (1) Latex Free Tourniquet (10) 2 x 2 Gauze

Catalog #	Basic Set	
MR17013101	3F x 60CM SINGLE VASCU-PICC® BASIC SET	5/Box
MR17014101	4F x 60CM SINGLE VASCU-PICC® BASIC SET	5/Box
MR17015101	5F x 60CM SINGLE VASCU-PICC® BASIC SET	5/Box
MR17014201	4F x 60CM DUAL VASCU-PICC® BASIC SET	5/Box
MR17015201	5F x 60CM DUAL VASCU-PICC® BASIC SET	5/Box
MR17015301	5F x 60CM TRIPLE VASCU-PICC® BASIC SET	5/Box

BASIC SET CONTAINS:

- (1) PICC w/ Stylet (1) PTFE Tearaway Introducer (1) Scalpel (1) Guidewire (1) Syringe (1) Tape Measure (1) Introducer Needle (1) Needle Free Valve(s) (1) Catheter Securement Device

Catalog #	Long Wire Set	
MR17014102	4F x 60CM SINGLE VASCU-PICC® LONG WIRE	5/Box
MR17015102	5F x 60CM SINGLE VASCU-PICC® LONG WIRE	5/Box
MR17015202	5F x 60CM DUAL VASCU-PICC® LONG WIRE	5/Box
MR17015302	5F x 60CM TRIPLE VASCU-PICC® LONG WIRE	5/Box

LONG WIRE SET CONTAINS:

- (1) PICC (1) PTFE Tearaway Introducer (1) Mini Scalpel (1) Guidewire (1) Syringe (1) Tape Measure (1) Introducer Needle (1) Needle Free Valve(s) (1) Catheter Securement Device

Catalog #	Nursing Kit	
MR17013105	3F x 60CM SINGLE VASCU-PICC® BASIC NURSING	5/Box
MR17014105	4F x 60CM SINGLE VASCU-PICC® BASIC NURSING	5/Box
MR17015105	5F x 60CM SINGLE VASCU-PICC® BASIC NURSING	5/Box
MR17014205	4F x 60CM DUAL VASCU-PICC® BASIC NURSING	5/Box
MR17015205	5F x 60CM DUAL VASCU-PICC® BASIC NURSING	5/Box
MR17015305	5F x 60CM TRIPLE VASCU-PICC® BASIC NURSING	5/Box

NURSING KIT CONTAINS:

- (1) PICC w/ Stylet (1) PTFE Tearaway Introducer (1) Safety Scalpel (1) Guidewire (1) Syringe (1) Tape Measure (1) Safety Introducer Needle (1) Needle Free Valve(s) (1) Catheter Securement Device (1) Latex-Free Tourniquet

Catalog #	Full Nursing Kit	
MR17013106	3F x 60CM SINGLE VASCU-PICC® FULL NURSING	5/Box
MR17014106	4F x 60CM SINGLE VASCU-PICC® FULL NURSING	5/Box
MR17015106	5F x 60CM SINGLE VASCU-PICC® FULL NURSING	5/Box
MR17014206	4F x 60CM DUAL VASCU-PICC® FULL NURSING	5/Box
MR17015206	5F x 60CM DUAL VASCU-PICC® FULL NURSING	5/Box
MR17015306	5F x 60CM TRIPLE VASCU-PICC® FULL NURSING	5/Box

FULL NURSING CONTAINS:

- (1) PICC w/ Preloaded Stylet (1) PTFE Tearaway Introducer (1) Safety Scalpel (1) Nitinol Guidewire (2) Syringes (2) Tape Measures (1) Surgical Tape (1) Safety Introducer Needle (1) Needle Free Valve(s) (1) Catheter Securement Device (1) Latex-Free Tourniquet (3) Pre-Filled Saline Syringes (2) Chlorhexidine (1) Lidocaine (1) Adhesive Dressing (1) 36" x 36" CSR Wrap (1) Needle Stick Pad (10) 4" x 4" Gauze (3) Surgical Gloves (1) Filter Straw (1) Scissors (1) Steri-strips (2) Face Masks (8) 2" x 2" Gauze (1) I.V. Catheter (1) Towel (1) Fenestrated Drape (1) Drape (1) Hypodermic Safety Needle (1) Lidocaine/Saline Stickers

Catalog #	Max Barrier Kit	
MR17014106MB	4F x 60CM SINGLE VASCU-PICC® MAX BARRIER	4/Box
MR17015206MB	5F x 60CM DUAL VASCU-PICC® MAX BARRIER	4/Box
MR17015306MB	5F x 60CM TRIPLE VASCU-PICC® MAX BARRIER	4/Box

MAX BARRIER FULL NURSING KIT CONTAINS:

- (1) PICC w/ Stylet (1) PTFE Tearaway Introducer (1) Safety Scalpel (1) Guidewire (2) Syringes (2) Tape Measures (1) Surgical Tape (1) Safety Introducer Needle (1) Needle Free Valve(s) (1) Catheter Securement Device (1) Latex-Free Tourniquet (3) Pre-Filled Saline Syringes (2) Chlorhexidine (1) Lidocaine (1) Adhesive Dressing (1) 36" x 36" CSR Wrap (1) Needle Stick Pad (10) 4" x 4" Gauze (3) Surgical Gloves (1) Filter Straw (1) Scissors (1) Steri-strips (2) Face Masks (8) 2" x 2" Gauze (1) I.V. Catheter (1) Towel (1) Fenestrated Drape (1) Drape (1) Hypodermic Safety Needle (1) Lidocaine/Saline Stickers (1) Full Body Drape (1) XL Gown (1) Surgical Face Mask w/ Eye Shield (1) Bouffant Cap

MIDLINE

FEATURES & BENEFITS

- Clearly denoted on the I.D. tag as Midline catheter.
- Eliminates the need for a chest X-Ray.
- Thermosensitive polyurethane material is both alcohol and iodine compatible.
- Available in single and dual configurations.



Catalog #	Basic Set	
ML3S20	3F x 20CM SINGLE MIDLINE BASIC SET	5/Box
ML4S20	4F x 20CM SINGLE MIDLINE BASIC SET	5/Box
ML5S20	5F x 20CM SINGLE MIDLINE BASIC SET	5/Box
ML4D20	4F x 20CM DUAL MIDLINE BASIC SET	5/Box
ML5D20	5F x 20CM DUAL MIDLINE BASIC SET	5/Box

BASIC SET CONTAINS:

- (1) Midline PICC w/ Stylet (1) PTFE Tearaway Introducer (1) Scalpel
- (1) Guidewire (1) Syringe (1) Tape Measure (1) Introducer Needle
- (1|2|3) Needle Free Valve(s) (1) Catheter Securement Device

Catalog #	Full Nursing Tray	
ML3S20FN	3F x 20CM SINGLE MIDLINE BASIC SET	5/Box
ML4S20FN	4F x 20CM SINGLE MIDLINE BASIC SET	5/Box
ML5S20FN	5F x 20CM SINGLE MIDLINE BASIC SET	5/Box
ML4D20FN	4F x 20CM DUAL MIDLINE BASIC SET	5/Box
ML5D20FN	5F x 20CM DUAL MIDLINE BASIC SET	5/Box

FULL NURSING TRAY CONTAINS:

- (1) Midline PICC w/ Preloaded Stylet (1) PTFE Tearaway Introducer (1) Safety Scalpel
- (1) Nitinol Guidewire (2) Syringes (2) Tape Measures (1) Surgical Tape (1) Safety Introducer Needle (1|2|3) Needle Free Valve(s) (1) Catheter Securement Device
- (1) Latex-Free Tourniquet (3) Pre-Filled Saline Syringes (2) Chlorhexidine (1) Lidocaine
- (1) Adhesive Dressing (1) 36" x 36" CSR Wrap (1) Needle Stick Pad (10) 4" x 4" Gauze
- (3) Surgical Gloves (1) Filter Straw (1) Scissors (1) Steri-strips (2) Face Masks
- (8) 2" x 2" Gauze (1) I.V. Catheter (1) Towel (1) Fenestrated Drape (1) Drape
- (1) Hypodermic Safety Needle (1) Lidocaine/Saline Stickers

DIGNITY™

FEATURES & BENEFITS

- Low profile, reduced width and ergonomic shape help minimize incision size while improving aesthetics and patient comfort.
- Approved for both CECT injections and infusion therapy.
- Allows CT injections for diagnostic imaging at up to 5cc/sec at 300psi.
- Unique printing allows “CT” to be visible under X-ray.

Open Suture Holes

Catalog #	Dignity™		
MRCTI96001	9.6F Silicone Catheter	Attachable	5/Box
MRCTI80001	8.0F Trinflex® Catheter	Attachable	5/Box
MRCTI66001	6.6F Trinflex® Catheter	Attachable	5/Box
MRCTI96801	9.6F Silicone Catheter	Pre-Attached	5/Box
MRCTI80801	8.0F Trinflex® Catheter	Pre-Attached	5/Box
MRCTI66801	6.6F Trinflex® Catheter	Pre-Attached	5/Box
	Dignity™ Low Profile		
MRCTI80041	8.0F Trinflex® Catheter	Attachable	5/Box
MRCTI66041	6.6F Trinflex® Catheter	Attachable	5/Box
MRCTI80841	8.0F Trinflex® Catheter	Pre-Attached	5/Box
MRCTI66841	6.6F Trinflex® Catheter	Pre-Attached	5/Box

SET CONTAINS:

(2) Catheter Locks (1) Scalpel (1) Introducer Needle
 (1) Vein Pick (1) Guidewire (1) 10cc Syringe (1) Valved Tearaway Introducer (1) Tunneler (1) 22 Ga. Huber Needle
 (1) Blunt Tip Needle (1) Valved Tearaway Introducer IFU
 (1) Port IFU (1) Patient Information Pack (1) Patient Chart Sticker

Silicone Filled Suture Holes

Catalog #	Dignity™		
MRCTI9600S	9.6F Silicone Catheter	Attachable	5/Box
MRCTI8000S	8.0F Trinflex® Catheter	Attachable	5/Box
MRCTI6600S	6.6F Trinflex® Catheter	Attachable	5/Box
MRCTI9680S	9.6F Silicone Catheter	Pre-Attached	5/Box
MRCTI8080S	8.0F Trinflex® Catheter	Pre-Attached	5/Box
MRCTI6680S	6.6F Trinflex® Catheter	Pre-Attached	5/Box
	Dignity™ Low Profile		
MRCTI8004S	8.0F Trinflex® Catheter	Attachable	5/Box
MRCTI6604S	6.6F Trinflex® Catheter	Attachable	5/Box
MRCTI8084S	8.0F Trinflex® Catheter	Pre-Attached	5/Box
MRCTI6684S	6.6F Trinflex® Catheter	Pre-Attached	5/Box

SET CONTAINS:

(2) Catheter Locks (1) Scalpel (1) Introducer Needle
 (1) Vein Pick (1) Guidewire (1) 10cc Syringe (1) Valved Tearaway Introducer (1) Tunneler (1) 22 Ga. Huber Needle (1) Blunt Tip Needle (1) Valved Tearaway Introducer IFU (1) Port IFU
 (1) Patient Information Pack (1) Patient Chart Sticker

*Silicone filled suture holes available September 1, 2009.



MR Conditional – 3 Tesla (artifacts may present imaging problems if MRI area of interest is on or near area where device is located)



PRO-FUSE®

FEATURES & BENEFITS

- Ports are approved for both CECT injections and infusion therapy.
- Allows CT injections for diagnostic imaging at up to 5cc/sec at 300psi.
- Raised rim provides clear tactile response during palpation to assist in septum location.
- Unique printing allows “CT” to be visible under X-ray.

Open Suture Holes

Catalog #	Pro-Fuse® CT		
MRCTT96001	9.6F Silicone Catheter	Attachable	5/Box
MRCTT80001	8.0F Triniflex® Catheter	Attachable	5/Box
MRCTT96801	9.6F Silicone Catheter	Pre-Attached	5/Box
MRCTT80801	8.0F Triniflex® Catheter	Pre-Attached	5/Box
	Pro-Fuse® Low Profile		
MRCTT80041	8.0F Triniflex® Catheter	Attachable	5/Box
MRCTT66041	6.6F Triniflex® Catheter	Attachable	5/Box
MRCTT80841	8.0F Triniflex® Catheter	Pre-Attached	5/Box
MRCTT66841	6.6F Triniflex® Catheter	Pre-Attached	5/Box

SET CONTAINS:

(2) Catheter Locks (1) Scalpel (1) Introducer Needle (1) Vein Pick
 (1) Marked Guidewire (1) 10cc Syringe (1) Valved Tearaway Introducer
 (1) Tunneler (1) 22 Ga. Huber Needle (1) Blunt Tip Needle (1) Valved
 Tearaway Introducer IFU (1) Port IFU (1) Patient Information Pack
 (1) Patient Chart Sticker

Silicone Filled Suture Holes

Catalog #	Pro-Fuse® CT		
MRCTT9600S	9.6F Silicone Catheter	Attachable	5/Box
MRCTT8000S	8.0F Triniflex® Catheter	Attachable	5/Box
MRCTT9680S	9.6F Silicone Catheter	Pre-Attached	5/Box
MRCTT8080S	8.0F Triniflex® Catheter	Pre-Attached	5/Box
	Pro-Fuse® Low Profile		
MRCTT8004S	8.0F Triniflex® Catheter	Attachable	5/Box
MRCTT6604S	6.6F Triniflex® Catheter	Attachable	5/Box
MRCTT8084S	8.0F Triniflex® Catheter	Pre-Attached	5/Box
MRCTT6684S	6.6F Triniflex® Catheter	Pre-Attached	5/Box

SET CONTAINS:

(2) Catheter Locks (1) Scalpel (1) Introducer Needle (1) Vein Pick
 (1) Marked Guidewire (1) 10cc Syringe (1) Valved Tearaway Introducer
 (1) Tunneler (1) 22 Ga. Huber Needle (1) Blunt Tip Needle (1) Valved
 Tearaway Introducer IFU (1) Port IFU (1) Patient Information Pack
 (1) Patient Chart Sticker



MR Conditional – 3 Tesla (artifacts may present imaging problems if MRI area of interest is on or near area where device is located)



TITANIUM PORTS

FEATURES & BENEFITS

- Port stem is uniquely engineered to ensure security & ease of connection.
- Suture holes assure securement and stability after placement.
- MRI compatible.

Catalog #	Titanium Ports		
MR601175A	7.5F Standard Trinflex® Catheter	Attachable	5/Box
MR601190A	9.0F Standard Trinflex® Catheter	Attachable	5/Box
MR601080A	8.0F Standard Silicone Catheter	Attachable	5/Box
MR601096A	9.6F Standard Silicone Catheter	Attachable	5/Box
MR602010A	10F Dual Trinflex® Catheter	Attachable	5/Box
MR604150A	5.0F Low Profile Trinflex® Catheter	Attachable	5/Box
MR604175A	7.5F Low Profile Trinflex® Catheter	Attachable	5/Box
MR601175P	7.5F Standard Trinflex® Catheter	Pre-Attached	5/Box
MR601190P	9.0F Standard Trinflex® Catheter	Pre-Attached	5/Box
MR601080P	8.0F Standard Silicone Catheter	Pre-Attached	5/Box
MR601096P	9.6F Standard Silicone Catheter	Pre-Attached	5/Box
MR602010P	10F Dual Trinflex® Catheter	Pre-Attached	5/Box
MR604150P	5.0F Low Profile Trinflex® Catheter	Pre-Attached	5/Box
MR604175P	7.5F Low Profile Trinflex® Catheter	Pre-Attached	5/Box

SET CONTAINS:

- (2) Catheter Locks (1) Scalpel (1) Introducer Needle (1) Vein Pick (1) Marked Guidewire
 (1) 10cc Syringe (1) Valved Tearaway Introducer (1) Tunneler (1) 22 Ga. Huber Needle
 (1) Blunt Tip Needle (1) Valved Tearaway Introducer IFU (1) Port IFU (1) Patient I.D. Card



MR Conditional – 3 Tesla (artifacts may present imaging problems if MRI area of interest is on or near area where device is located)



PLASTIC PORTS

FEATURES & BENEFITS

- Tapered tip allows an easier insertion and smaller port pocket, improving aesthetics & patient comfort.
- Silicone-filled suture holes reduce risk of tissue ingrowth, allowing for easy port removal.
- MRI compatible.

Catalog #	Plastic Ports		
MR591166A	6.6F Standard Silicone Catheter	Attachable	5/Box
MR591184A	8.4F Standard Silicone Catheter	Attachable	5/Box
MR591048A	4.8F Standard Trinflex® Catheter	Attachable	5/Box
MR591066A	6.6F Standard Trinflex® Catheter	Attachable	5/Box
MR591080A	8.0F Standard Trinflex® Catheter	Attachable	5/Box
MR592090A	9.0F Standard Dual Trinflex® Catheter	Attachable	5/Box
MR594166A	6.6F Low Profile Silicone Catheter	Attachable	5/Box
MR594181A	8.4F Low Profile Silicone Catheter	Attachable	5/Box
MR594048A	4.8F Low Profile Trinflex® Catheter	Attachable	5/Box
MR594080A	8.0F Low Profile Trinflex® Catheter	Attachable	5/Box
MR591166P	6.6F Standard Silicone Catheter	Pre-Attached	5/Box
MR591184P	8.4F Standard Silicone Catheter	Pre-Attached	5/Box
MR591048P	4.8F Standard Trinflex® Catheter	Pre-Attached	5/Box
MR591066P	6.6F Standard Trinflex® Catheter	Pre-Attached	5/Box
MR591080P	8.0F Standard Trinflex® Catheter	Pre-Attached	5/Box
MR592090P	9.0F Standard Dual Trinflex® Catheter	Pre-Attached	5/Box
MR594166P	6.6F Low Profile Silicone Catheter	Pre-Attached	5/Box
MR594181P	8.4F Low Profile Silicone Catheter	Pre-Attached	5/Box
MR594048P	4.8F Low Profile Trinflex® Catheter	Pre-Attached	5/Box
MR594080P	8.0F Low Profile Trinflex® Catheter	Pre-Attached	5/Box

SET CONTAINS:

(2) Catheter Locks (1) Scalpel (1) 18 Ga. Introducer Needle (1) Vein Pick (1) .038" x 70cm "J" Marked Guidewire with Advancer (1) 10cc Syringe (1) Valved Tearaway Introducer (1) Tunneler (1) 22 Ga. Huber Needle (1) Blunt Tip Needle (1) Valved Tearaway Introducer IFU (1) Port IFU (1) Patient I.D. Card



MR Conditional – 3 Tesla (artifacts may present imaging problems if MRI area of interest is on or near area where device is located)



PRO-LINE®

FEATURES & BENEFITS

- Catheters are approved for both CECT injections and infusion therapy.
- Design allows for CT injections for diagnostic imaging at up to 5cc/sec at 300psi.
- Thermosensitive polyurethane material is both alcohol and iodine compatible.

Catalog #		
MR28035101	5F X 60CM SINGLE LUMEN PRO-LINE®, BASIC KITS	5/Box
MR28036101	6F X 60CM SINGLE LUMEN PRO-LINE®, BASIC KITS	5/Box
MR28037101	7F X 60CM SINGLE LUMEN PRO-LINE®, BASIC KITS	5/Box
MR28036201	6F X 60CM DOUBLE LUMEN PRO-LINE®, BASIC KITS	5/Box
MR28037201	7F X 60CM DOUBLE LUMEN PRO-LINE®, BASIC KITS	5/Box

BASIC KIT CONTAINS:

- (1) Catheter w/ Stylet (1) Introducer Needle (1) PTFE Tearaway Introducer
- (1) 10cc Syringe (1) Guidewire (1) Mini Scalpel (1) Tape Measure
- (2) Tunnelers (1 | 2) Needleless Cap(s)



LT SILICONE CVC

FEATURES & BENEFITS

- Soft silicone material provides biocompatibility and kink resistance, enhancing long term performance.
- Multiple sizes and lumen configurations available.
- Integral polyester cuff promotes tissue in-growth, securing the catheter and reducing infection.

Catalog #		
MR28010611	6F x 90CM SINGLE LUMEN LT CVC BASIC KIT	10/Box
MR28010711	7F x 90CM SINGLE LUMEN LT CVC BASIC KIT	10/Box
MR28010911	9F x 90CM SINGLE LUMEN LT CVC BASIC KIT	10/Box
MR28010721	7F x 90CM DOUBLE LUMEN LT CVC BASIC KIT	10/Box
MR28010921	9F x 90CM DOUBLE LUMEN LT CVC BASIC KIT	10/Box
MR28011121	11F x 90CM DOUBLE LUMEN LT CVC BASIC KIT	10/Box
MR28011421	14F x 90CM DOUBLE LUMEN LT CVC BASIC KIT	10/Box
MR28011231	12F x 90CM TRIPLE LUMEN LT CVC BASIC KIT	10/Box

SET CONTAINS:

- (1) Infusion Catheter (1) Valved Introducer (1) Tunneler (1) Mini Scalpel
 (1) .035 x 100cm J Guidewire (1|2|3) Injection Port(s) (1) Introducer Needle



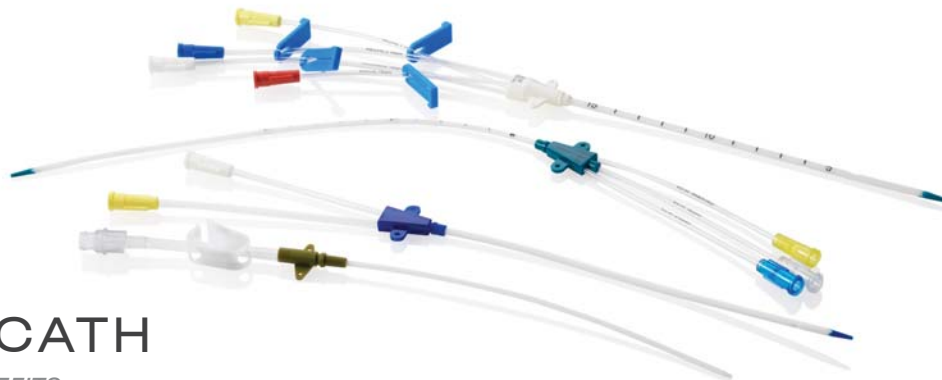

MULTI-CATH

FEATURES & BENEFITS

- Multiple sizes and lumen configurations available.
- Soft, flexible, radiopaque tips are less traumatic to the vessel and allow for clear visibility of the catheter tip.
- Attachable suture wing allows anchorage at puncture site regardless of depth of catheter, minimizing trauma and irritation to the exit site.

Catalog #	Single Lumen	
CSP-2405	24ga x 13cm Single Lumen	10/Box
CSP-2005	20ga x 13cm Single Lumen	10/Box
CSP-1812	18ga x 30cm Single Lumen	10/Box
CSP-1808	18ga x 20cm Single Lumen	10/Box
CSP-1806	18ga x 15cm Single Lumen	10/Box
CSP-1612	16ga x 30cm Single Lumen	10/Box
CSP-1608	16ga x 20cm Single Lumen	10/Box
CSP-1606	16ga x 15cm Single Lumen	10/Box
CSP-1412	14ga x 30cm Single Lumen	10/Box
CSP-1408	14ga x 20cm Single Lumen	10/Box
CSP-1406	14ga x 15cm Single Lumen	10/Box
	Double Lumen	
MC2LP-38S	4F x 5CM DOUBLE LUMEN CATHETER BASIC KIT	10/Box
MC2LP-35S	4F x 8CM DOUBLE LUMEN CATHETER BASIC KIT	10/Box
MC2LP-313S	4F x 13CM DOUBLE LUMEN CATHETER BASIC KIT	10/Box
MC2LP-330S	4F x 30CM DOUBLE LUMEN CATHETER BASIC KIT	10/Box
MC2LP-58S	5F x 8CM DOUBLE LUMEN CATHETER BASIC KIT	10/Box
MC2LP-5S	5F x 13CM DOUBLE LUMEN CATHETER BASIC KIT	10/Box
MC2LP-530S	5F x 30CM DOUBLE LUMEN CATHETER BASIC KIT	10/Box
MC2L-6S	7F x 15CM DOUBLE LUMEN CATHETER BASIC KIT	10/Box
MC2L-8S	7F x 20CM DOUBLE LUMEN CATHETER BASIC KIT	10/Box
MC2L-12S	7F x 30CM DOUBLE LUMEN CATHETER BASIC KIT	10/Box
	Triple Lumen	
MC3LP-58S	5.5F x 8CM TRIPLE LUMEN CATHETER BASIC KIT	10/Box
MC3LP-5S	5.5F x 13CM TRIPLE LUMEN CATHETER BASIC KIT	10/Box
MC3LP-530S	5F x 30CM TRIPLE LUMEN CATHETER BASIC KIT	10/Box
MC3L-6S	7F x 15CM TRIPLE LUMEN CATHETER BASIC KIT	10/Box
MC3L-8S	7F x 20CM TRIPLE LUMEN CATHETER BASIC KIT	10/Box
MC3L-12S	7F x 30CM TRIPLE LUMEN CATHETER BASIC KIT	10/Box
	Quad Lumen	
MC4L-6S	8.5F x 15CM QUAD LUMEN CATHETER BASIC KIT	10/Box
MC4L-8S	8.5F x 20CM QUAD LUMEN CATHETER BASIC KIT	10/Box

BASIC KIT CONTAINS:

(1) Catheter with Clamps (1) J/Flex Guidewire (1) Introducer Needle
 (1|2|3|4) Injection Cap(s) (1) 5cc Syringe (1) Vessel Dilator (1) Movable Wing

PERITONEAL (PD CATHS)

DIALYSIS & VASCULAR ACCESS PRODUCTS

V-SERIES

I-SERIES

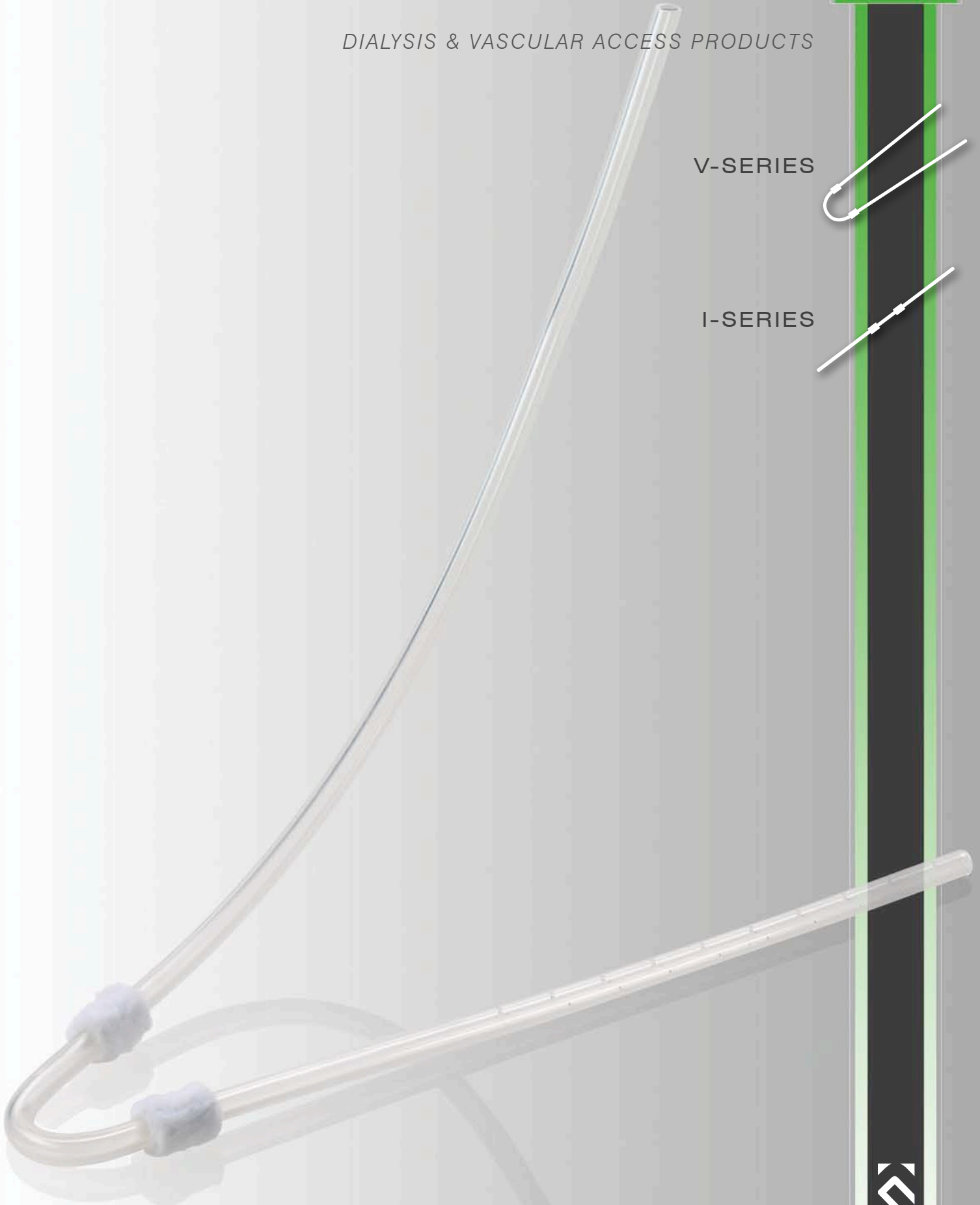



V-SERIES

FEATURES & BENEFITS

- Design positions catheter in a downward position, both internally and externally.
- Reduces stress at insertion site.
- External Segment designed for simplicity in maintenance.

Catalog #	Straight Catheter Only	
MC200301	43CM STRAIGHT CATHETER WITH DOUBLE CUFF, LEFT SIDE	5/Box
MC200302	43CM STRAIGHT CATHETER WITH DOUBLE CUFF, RIGHT SIDE	5/Box

Catalog #	Coiled Catheter Only	
MC200401	63CM COILED CATHETER WITH DOUBLE CUFF, LEFT SIDE	5/Box
MC200402	63CM COILED CATHETER WITH DOUBLE CUFF, RIGHT SIDE	5/Box

Catalog #	Straight Catheter Set	
MC200101	43CM STRAIGHT CATHETER WITH DOUBLE CUFF, LEFT SIDE	5/Box
MC200102	43CM STRAIGHT CATHETER WITH DOUBLE CUFF, RIGHT SIDE	5/Box

Catalog #	Coiled Catheter Set	
MC200201	63CM COILED CATHETER WITH DOUBLE CUFF, LEFT SIDE	5/Box
MC200202	63CM COILED CATHETER WITH DOUBLE CUFF, RIGHT SIDE	5/Box

Catalog #	Accessories	
MC50	MALE LUER LOCK END CAP	100/Box
MC51	BETA CLAMP	100/Box
MBCA	BARBED LUER LOCK CATHETER ADAPTOR	200/Box
MCS	CATHETER STYLET	5/Box
MTS	TUNNELING STYLET	10/Box

CATHETER ONLY CONTAINS:

(1) Catheter (1) Female Luer (1) Clamp (1) Injection Cap

BASIC SET CONTAINS:

(1) Catheter (1) Female Luer (1) Clamp (1) Introducer Needle (1) Guidewire (1) Scalpel
(1) Tearaway Introducer Sheath (1) Tunneler (1) 10cc Syringe (5) Gauze Pads (1) Injection Cap



I-SERIES

FEATURES & BENEFITS

- Strategically placed side holes allow for increased flow and reduction of omental occlusion.
- Wide 2.5mm radiopaque stripe maximizes visibility under X-ray.
- Multiple configurations to meet all patient needs.

Catalog #	Straight Catheter Only	
MDC31S	31CM STRAIGHT CATHETER WITH DOUBLE CUFF	5/Box
MDC32S	32CM STRAIGHT CATHETER WITH DOUBLE CUFF	5/Box
MDC37S	37CM STRAIGHT CATHETER WITH DOUBLE CUFF	5/Box
MDC42S	42CM STRAIGHT CATHETER WITH DOUBLE CUFF	5/Box
MDC47S	47CM STRAIGHT CATHETER WITH DOUBLE CUFF	5/Box
MSC31S	31CM STRAIGHT CATHETER WITH SUBCUTANEOUS SINGLE CUFF	5/Box
MSC37S	37CM STRAIGHT CATHETER WITH SUBCUTANEOUS SINGLE CUFF	5/Box
MSC42S	42CM STRAIGHT CATHETER WITH SUBCUTANEOUS SINGLE CUFF	5/Box
MSC46S	46CM STRAIGHT CATHETER WITH SUBCUTANEOUS SINGLE CUFF	5/Box
MPP41S	41CM STRAIGHT CATHETER WITH PREPERITONEAL SINGLE CUFF	5/Box
MPP46S	46CM STRAIGHT CATHETER WITH PREPERITONEAL SINGLE CUFF	5/Box

Catalog #	Coiled Catheter Only	
MDC57C	57CM COILED CATHETER WITH DOUBLE CUFF	5/Box
MDC63C	63CM COILED CATHETER WITH DOUBLE CUFF	5/Box
MPP40C	40CM COILED CATHETER WITH PREPERITONEAL SINGLE CUFF	5/Box
MPP57C	57CM COILED CATHETER WITH PREPERITONEAL SINGLE CUFF	5/Box
MPP60C	60CM COILED CATHETER WITH PREPERITONEAL SINGLE CUFF	5/Box

Catalog #	Straight Catheter Set	
MPD-242	42CM STRAIGHT CATHETER WITH DOUBLE CUFF	5/Box
MPD-146S	46CM STRAIGHT CATHETER WITH SUBCUTANEOUS SINGLE CUFF	5/Box
MPD-141	41CM STRAIGHT CATHETER WITH PREPERITONEAL SINGLE CUFF	5/Box
MPD-146	46CM STRAIGHT CATHETER WITH PREPERITONEAL SINGLE CUFF	5/Box

Catalog#	Coiled Catheter Set	
MPD-257	57CM COILED CATHETER WITH DOUBLE CUFF	5/Box
MPD-263	63CM COILED CATHETER WITH DOUBLE CUFF	5/Box
MPD-160	60CM COILED CATHETER WITH PREPERITONEAL SINGLE CUFF	5/Box

Catalog#	Accessories	
MC50	MALE LUER LOCK END CAP	100/Box
MC51	BETA CLAMP	100/Box
MBCA	BARBED LUER LOCK CATHETER ADAPTOR	200/Box
MCS	CATHETER STYLET	5/Box
MTS	TUNNELING STYLET	10/Box
MTC	TITANIUM CONNECTOR	5/Box
MP216	16F TEARAWAY INTRODUCER SHEATH	5/Box

CATHETER ONLY CONTAINS:

(1) Catheter (1) Female Luer (1) Clamp (1) Injection Cap

BASIC SET CONTAINS:

(1) Catheter (1) Female Luer (1) Clamp (1) Introducer Needle (1) Guidewire (1) Scalpel (1) Tearaway Introducer Sheath (1) Tunneler (1) 10cc Syringe (5) Gauze Pads (1) Injection Cap



ACCESSORIES

DIALYSIS & VASCULAR ACCESS PRODUCTS

MICRO-STICK® SETS

SUPER SHARP
INTRODUCER NEEDLE

PRO-PIERCE™
SAFETY HUBER NEEDLE

REPAIR KIT

DILATORS

SHEATH DILATORS

GUIDEWIRES

TROCARS & TUNNELERS

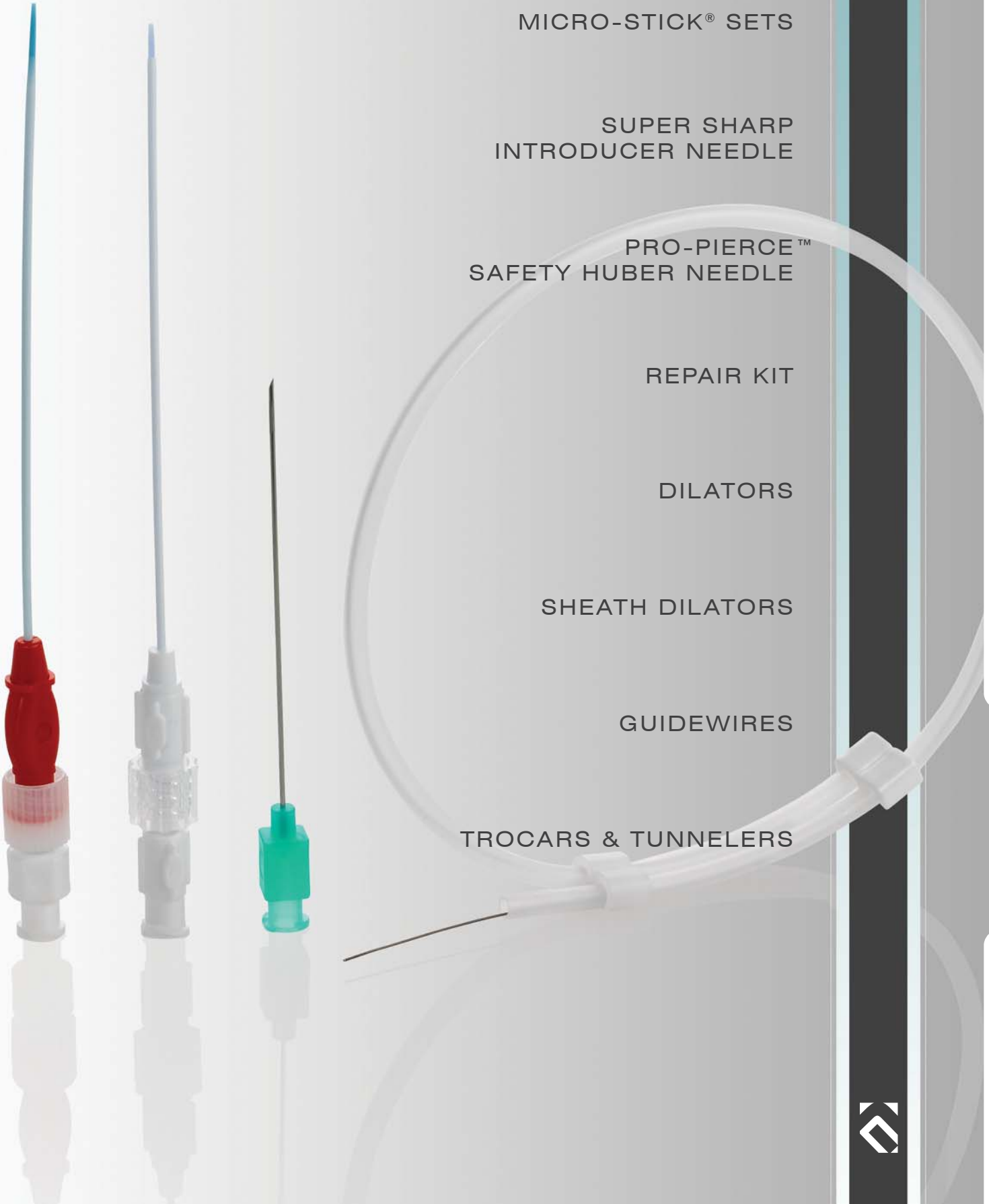

MICRO-STICK® SETS



Catalog #	Nitinol Wire Set	
MR190401	4F MICRO-STICK® INTRODUCER SET, WITH NITINOL WIRE	10/Box
MR190501	5F MICRO-STICK® INTRODUCER SET, WITH NITINOL WIRE	10/Box

Catalog #	Steel Wire Set	
MR190402	4F MICRO-STICK® INTRODUCER SET, WITH STEEL WIRE	10/Box
MR190502	5F MICRO-STICK® INTRODUCER SET, WITH STEEL WIRE	10/Box



Catalog #	Tearaway Micro Introducer Set	
	5CM Lengths	
MR190305	3.5F x 5CM TEARAWAY INTRODUCER SET	10/Box
MR190405	4.5F x 5CM TEARAWAY INTRODUCER SET	10/Box
MR190505	5.5F x 5CM TEARAWAY INTRODUCER SET	10/Box
MR190605	6.5F x 5CM TEARAWAY INTRODUCER SET	10/Box
	10CM Lengths	
MR190310	3.5F x 10CM TEARAWAY INTRODUCER SET	10/Box
MR190410	4.5F x 10CM TEARAWAY INTRODUCER SET	10/Box
MR190510	5.5F x 10CM TEARAWAY INTRODUCER SET	10/Box
MR190610	6.5F x 10CM TEARAWAY INTRODUCER SET	10/Box

SUPER SHARP INTRODUCER NEEDLE



Catalog #	Introducer	
MC217	21GA x 7CM NEEDLE	50/Box
MC215S	21GA x 5CM SAFETY NEEDLE	50/Box
MC217S	21GA x 7CM SAFETY NEEDLE	50/Box

PRO-PIERCE™ SAFETY HUBER NEEDLE

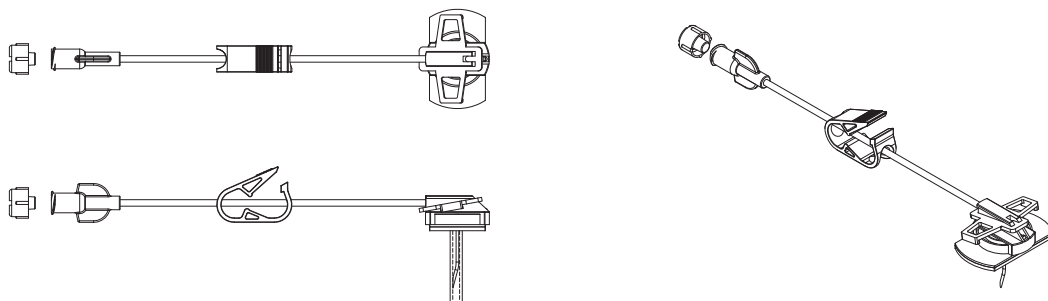

Catalog #	Without Y-Site
MR1919075	19GA x .75" CT INJECTABLE SAFETY HUBER NEEDLE
MR1919100	19GA x 1" CT INJECTABLE SAFETY HUBER NEEDLE
MR1919150	19GA x 1.5" CT INJECTABLE SAFETY HUBER NEEDLE
MR1920050	20GA x .50" CT INJECTABLE SAFETY HUBER NEEDLE
MR1920075	20GA x .75" CT INJECTABLE SAFETY HUBER NEEDLE
MR1920100	20GA x 1" CT INJECTABLE SAFETY HUBER NEEDLE
MR1920150	20GA x 1.5" CT INJECTABLE SAFETY HUBER NEEDLE
MR1922050	22GA x .50" CT INJECTABLE SAFETY HUBER NEEDLE
MR1922075	22GA x .75" CT INJECTABLE SAFETY HUBER NEEDLE
MR1922100	22GA x 1" CT INJECTABLE SAFETY HUBER NEEDLE
MR1922150	22GA x 1.5" CT INJECTABLE SAFETY HUBER NEEDLE

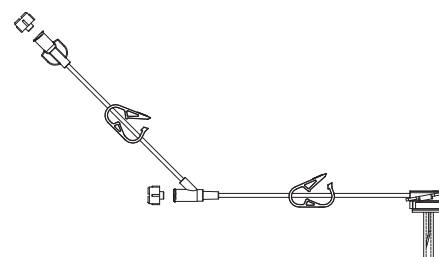

Catalog #	With Y-Site
MR1919075Y	19GA x .75" CT INJECTABLE Y-SITE SAFETY HUBER NEEDLE
MR1919100Y	19GA x 1" CT INJECTABLE Y-SITE SAFETY HUBER NEEDLE
MR1919150Y	19GA x 1.5" CT INJECTABLE Y-SITE SAFETY HUBER NEEDLE
MR1920050Y	20GA x .50" CT INJECTABLE Y-SITE SAFETY HUBER NEEDLE
MR1920075Y	20GA x .75" CT INJECTABLE Y-SITE SAFETY HUBER NEEDLE
MR1920100Y	20GA x 1" CT INJECTABLE Y-SITE SAFETY HUBER NEEDLE
MR1920150Y	20GA x 1.5" CT INJECTABLE Y-SITE SAFETY HUBER NEEDLE
MR1922050Y	22GA x .50" CT INJECTABLE Y-SITE SAFETY HUBER NEEDLE
MR1922075Y	22GA x .75" CT INJECTABLE Y-SITE SAFETY HUBER NEEDLE
MR1922100Y	22GA x 1" CT INJECTABLE Y-SITE SAFETY HUBER NEEDLE
MR1922150Y	22GA x 1.5" CT INJECTABLE Y-SITE SAFETY HUBER NEEDLE

LONG TERM DIALYSIS REPAIR KIT

Catalog #		
RPK-01	LONG TERM DIALYSIS CATHETER REPAIR KIT	5/Box

DILATORS

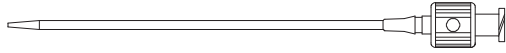

Catalog #		
MC74	4F VESSEL DILATOR	10/Box
MC75	5F VESSEL DILATOR	10/Box
MC76	6F VESSEL DILATOR	10/Box
MC77	7F VESSEL DILATOR	10/Box
MC78	8F VESSEL DILATOR	10/Box
MC79	9F VESSEL DILATOR	10/Box
MC70	10F VESSEL DILATOR	10/Box
MC71	11F VESSEL DILATOR	10/Box
MC72	12F VESSEL DILATOR	10/Box
MC73	13F VESSEL DILATOR	10/Box
MC714	14F VESSEL DILATOR	10/Box

SHEATH DILATORS

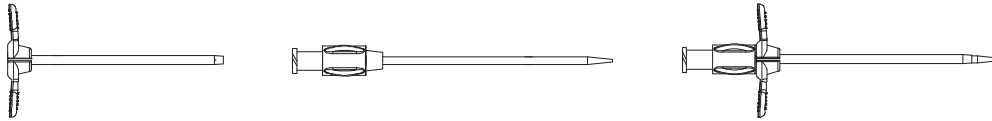

Catalog #		
MR190702	7F x 13CM VALVED TEARAWAY INTRODUCER	5/Box
MR190802	8F x 15CM VALVED TEARAWAY INTRODUCER	5/Box
MR190902	9F x 15CM VALVED TEARAWAY INTRODUCER	5/Box
MR191102	10F x 15CM VALVED TEARAWAY INTRODUCER	5/Box
MR191302	13F x 15CM VALVED TEARAWAY INTRODUCER	5/Box
MR191402	14F x 14CM VALVED TEARAWAY INTRODUCER	5/Box
MR191502	15F x 14CM VALVED TEARAWAY INTRODUCER	5/Box
MR191602	16F x 14CM VALVED TEARAWAY INTRODUCER	5/Box
MR191702	17F x 14CM VALVED TEARAWAY INTRODUCER	5/Box

Catalog #		
VS355	3.5F x 5CM TEARAWAY INTRODUCER	5/Box
VS455	4.5F x 5CM TEARAWAY INTRODUCER	5/Box
VS555	5.5F x 5CM TEARAWAY INTRODUCER	5/Box
VS655	6.5F x 5CM TEARAWAY INTRODUCER	5/Box
VS3510	3.5F x 10CM TEARAWAY INTRODUCER	5/Box
VS4510	4.5F x 10CM TEARAWAY INTRODUCER	5/Box
VS5510	5.5F x 10CM TEARAWAY INTRODUCER	5/Box
VS6510	6.5F x 10CM TEARAWAY INTRODUCER	5/Box

GUIDEWIRES



Catalog #	Mandrel Wires	
MR190045	.018 x 45CM NITINOL WIRE	10/Box
MR190065	.018 x 65CM MARKED NITINOL WIRE	10/Box
MR190080	.018 x 80CM MARKED NITINOL WIRE	10/Box
MR190130	.018 x 130CM MARKED NITINOL WIRE	10/Box
G45S	.018 x 45CM STEEL WIRE	10/Box
G65S	.018 x 65CM MARKED STEEL WIRE	10/Box
Catalog #	Spring Coiled Wires	
MC35	.035 x 70CM STRAIGHT TIP GUIDEWIRE	10/Box
MC38	.038 x 70CM STRAIGHT TIP GUIDEWIRE	10/Box
MC120	.038 x 120CM STRAIGHT TIP GUIDEWIRE	10/Box
MC35-J	.035 x 70CM J/FLEX TIP GUIDEWIRE	10/Box
MC38-J	.038 x 70CM J/FLEX TIP GUIDEWIRE	10/Box
MC150J	.035 x 150CM J/FLEX TIP GUIDEWIRE	10/Box
MR195150	.035 x 150CM STRAIGHT PTFE GUIDEWIRE	10/Box

TROCARS / TUNNELERS

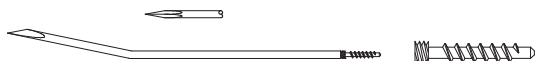

Catalog #		
PCTT	6.5F TESIO® CUTTING TROCAR	5/Box
CTT	10F TESIO® CUTTING TROCAR	5/Box



Catalog #		
RTT	RAULERSON TROCAR SET	5/Box



Catalog #		
AST	SPLIT CATH® TUNNELER	5/Box



Catalog #		
BTH	HEMO-CATH® BLUNT TUNNELER	5/Box

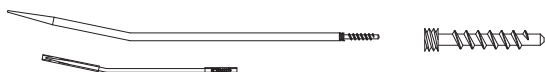

Catalog #		
BTT	TESIO® BLUNT TUNNELER	5/Box



Catalog #		
ASTSG	SURE GRIP SPLIT CATH® TUNNELER	5/Box

ORDERING INFORMATION & POLICIES

All orders should be directed to Medcomp's Customer service department. Minimum orders should be for full box quantities, accompanied with purchase order number.

Products are shipped via United Parcel Service and are F.O.B. Harleysville in the Continental United States. Express service is also available at the expense of the customer.

Export shipments are shipped air freight to maintain traceability. Should a customer wish air parcel post shipments, Medcomp® will not assume responsibility for lost shipments. All shipments outside of the Continental United States are F.O.B. Harleysville, PA.

Terms

All orders will be billed at prevailing prices at the time of shipment.

Terms are net 30 days for domestic accounts. Outside the U.S., terms are prepayment by wired funds or letter of credit at sight.

Wire funds to: Harleysville National Bank
483 Main Street
Harleysville, PA 19438
215-256-8851
Account # 01-015501

Prices are in U.S. dollars, and are subject to tax, if any. All prices are subject to change without notice.

Return Goods Policy

Return goods must be authorized by Medcomp® prior to return. Medcomp® will accept return of any standard product within 30 days, providing it is undamaged and in original sealed package, and returned prepaid. Custom products are nonreturnable.

Warranty

- Medcomp® warrants its products to be free from defects in workmanship and materials for the period up to and including the expiration date.
- Medcomp® shall not be liable for any incidental, special or consequential loss, damage or expense directly or indirectly arising from the use of its products.
- Liability is limited to replacing, at Medcomp's option, any products which shall under normal use and service appear to the company to have been defective in materials or workmanship.
- Damage to the products through misuse, neglect, or accident voids this warranty.
- No agent, employee or representative of Medcomp® has the authority to bind Medcomp® to any other warranty.
- This warranty is expressly in lieu of any other implied warranties, including any merchantability of fitness and of any other obligation on the part of the seller.
- NOTE: Because of continuing product improvement, prices, specifications, and model availability are subject to change without notice.
- Medcomp®, Split Cath®, Vasco-Sheath®, Flexi-Smooth®, Hemo-Cath®, Tesio®, Pro-PICC®, Pro-Line®, Pro-Fuse®, Duo-Split®, Duo-Flow®, Lock Right®, Bio-Flex®, Soft-Line®, Micro-Stick®, Split Stream®, Hemo-Flow® and Vasco-PICC® are registered trademarks of Medical Components, Inc.
- Multi-Cath, Tri-Flow™, Fast Track™, Dignity™ and Pro-Pierce™ are trademarks of Medical Components, Inc.

Patents

The Split Cath® is covered under the following U.S. Patent Numbers 6,190,349 and 5,947,953. U.S. and Foreign Patents Pending.

The Tesio® Catheter is covered under the following U.S. Patent Numbers 5,830,184 and 5,944,732 and 5,624,413.

The Duo-Flow® Catheter is covered under the following U.S. Patent Number 5,053,004.

Single Lumen Pro-PICC®/Pro-Line® U.S. PATENTS: D489,452; 6,823,617; D491,265; D498,299 AND D515,211

Double Lumen Pro-PICC®/Pro-Line® U.S. PATENTS: D489,452; 6,823,617; D491,265; D498,299 AND D505,202

Triple lumen Pro-PICC® U.S. PATENTS: D489,452; 6,823,617; D491,265; D498,299 AND D546, 446

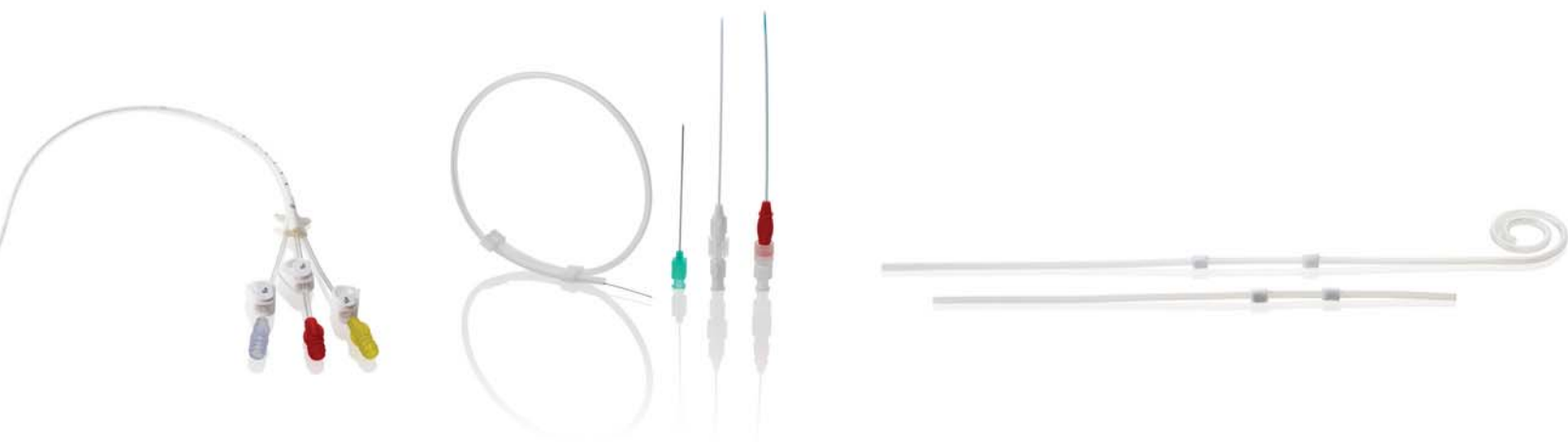

 **medCOMP**[®]

DIALYSIS & VASCULAR ACCESS PRODUCTS

