

PSB-4710EV
SOCKET 478 PENTIUM 4 with
10/100 Ethernet LAN & AGP4X VGA SBC
Manual Revision 1.0
July.1,2002

@Copyright 2002
All Rights Reserved.

The information in this document is subject to change without prior notice in order to improve reliability, design and function and does not represent a commitment on the part of the manufacturer.

In no event will the manufacturer be liable for direct, indirect, special, incidental, or consequential damages arising out of the use or inability to use the product or documentation, even if advised of the possibility of such damages.

This document contains proprietary information protected by copyright. All rights are reserved. No part of this manual may be reproduced by any mechanical, electronic, or other means in any form without prior written permission of the manufacturer.

Trademarks

PSB-4710EV is registered trademarks of ICP Electronics Inc.; IBM PC is a registered trademark of International Business Machines Corporation. Intel is a registered trademark of Intel Corporation. AMI is registered trademarks of AMI Software ,Inc.. Other product names mentioned herein are used for identification purposes only and may be trademarks and/or registered trademarks of their respective companies.

Support

Any questions regarding the content of this manual or related issues can be e-mailed to us directly at: SUPPORT@IEI.COM.TW

Contents

1. Introduction	4
1.1 Specifications	5
1.2 What You Have	7
2. Installation	8
2.1 PSB – 4710EV's Layout.....	9
2.2 Unpacking Precautions.....	10
2.3 PC/104-PLUS Power Source Setting	10
2.4 Clear CMOS Setup.....	11
2.5 Onboard Keyboard/Mouse Source Setting.....	11
2.6 COM2 RS232/RS422/RS485 Selection & Voltage Setting.....	11
3. Connection	12
3.1 Floppy Disk Drive Connector	13
3.2 PCI E-IDE Disk Drive Connector	14
3.3 Parallel Port.....	15
3.4 Serial Ports	15
3.5 Keyboard & PS/2 Mouse Connector.....	16
3.6 External Switches and Indicators	17

3.7 USB Port Connector.....	18
3.8 IrDA Infrared Interface Port.....	18
3.9 Fan Connectors.....	18
3.10 LAN RJ45 & STATE LED Connector	19
3.11 VGA Connector.....	19
3.12 AUDIO Headphone & Input Connector	19
3.13 ATX-12 Power Connector	20
3.14 Digital INPUT/OUTPUT Connector	20

4. AMI BIOS Setup

4.1 Introduction	21
4.2 Starting Setup	21
4.3 Using Setup	22
4.4 Getting Help.....	23
4.5 Main Menu	24
4.6 Standard CMOS Setup	26
4.7 Advanced CMOS Setup.....	27
4.8 Advanced Chipset Setup.....	32
4.9 Power Management Setup	34
4.10 PCI / Plug and Play Setup	35
4.11 Peripheral Setup	37
4.12 Hardware Monitor Setup	39
4.13 Change Supervisor Password	39

Appendix A. Watch-Dog Timer.....

41

Appendix B. I/O Address Map..... 43

Appendix C. ATX Power Supply..... 45

Appendix D. How to use Wake Up Function..... 47

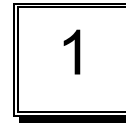

Introduction

Welcome to the PSB-4710EV SOCKET 478 PENTIUM 4 Single Board Computer. The PSB-4710EV board is an PSB form factor board, which comes equipped with high performance Processor and advanced high performance multi-mode I/O, designed for the system manufacturers, integrators, or VARs that want to provide all the performance, reliability, and quality at a reasonable price.

In addition, the PSB-4710EV Build-in AGP4X VGA(Intel 845G). The VGA controller has 3D graphics capabilities, which provides up to 2048x1536x16-color resolution. The onboard VGA shares 8MB system DDR-SDRAM .

An advanced high performance super AT I/O chip – ITE IT8712 is used in the PSB-4710EV board. Both on-chip UARTs are compatible with the NS16C550. The parallel port and IDE interface are compatible with IBM PC/AT architecture.

The PSB-4710EV has built-in(ICH4) 10/100 Fast Ethernet LAN .They are fully integrated 10BASE-T/100BASE-TX LAN solution with high performance networking functions and low power features.

The PSB-4710EV uses the advanced Intel 845G Chipsets which is 100% software compatible chipset with PCI 2.2 standard.

1.1 Specifications

CPU(PGA 478)	Intel Pentium 4 Processor, supports 400/533 MHz FSB
Bus interface	PCISA golden finger, but only PCI signal are provided
Bus speed	PCI: 33MHz
DMA channels	7
Interrupt levels	15
Chipset	INTEL 845G (GMCH)
Real-time clock	INTEL 82801DB(ICH4)
System memory	One 184-pin DIMM socket support DDR 200/266 SDRAM . The max. Memory is up to 1GB.
ATA/100 IDE interface	Up to four PCI Enhanced IDE hard drives. The ATA/100 IDE can handle data transfer up to 100MB/s. Compatible with existing ATA-2 IDE specifications its best advantage, so there is no need to do any changes for users' current accessories.
Floppy disk drive interface	Supports up to two floppy disk drives, 5.25" (360KB and 1.2MB) and/or 3.5" (720KB, 1.44MB, and 2.88MB)
Serial ports	COM1(RS-232) & COM2(RS-232/RS422/RS485) with 16C550 UART (or compatible) with 16-byte FIFO buffer. Support up to 115.2Kbps. Ports can be individually configured to COM1, COM2 or disabled.
Bi-directional parallel port	Configurable to LPT1, LPT2, LPT3 or disabled. Supports EPP/ECP/SPP
Hardware monitor	Built-in to monitor power supply voltage and fan speed status
IrDA port	Supports Serial Infrared(SIR) and Amplitude Shift Keyed IR(ASKIR) interface

USB port	Supports 2 USB2.0 ports for future expansion
Watch-dog timer	Software Programmable Reset generated when CPU does not periodically trigger the timer. Your can use BIOS INT15 to control the watchdog and generate a system reset.
VGA controller	Built-in AGP2.0 4X 3D graphics engine. Share system DDR SDRAM 8M. Screen Resolution: up to 2048x1536x16.
Ethernet	ICH4 Fast Ethernet controllers, IEEE 802.3u Auto-Negotiation support for 10BASE-T/100BASE-TX standard. One RJ45 connectors are located on the mounting bracket for easy connection.
Keyboard and PS/2 mouse connector	A 6-pin mini DIN connector is located on the mounting bracket for easy connection to a keyboard or PS/2 mouse. For alternative application, a keyboard and a PS/2 mouse pin header connector are also available on board.
Digital input/output	It provide with 4bit digital input/output (+5V level). Your can use I/O PORT 201H to control it.
Audio	AC'97 Audio CODEC
PC/104-PLUS	Expansion bus, only PCI slot are provided.
Compact flash	It can be used with a passive adapter (True IDE Mode) in a Type I/II Socket.
Power consumption	(PENTIUM 4 : 2GHz, 1GB PC133 SDRAM) +5V @ 4.46A ,+12V @ 6.55A . Recommended : 350-watt power supply or higher
Operating temperature	0° ~ 60° C (*CPU needs Cooler & silicone heatsink paste*)

- WARNING !** 1.Never run the processor without the heatsink(Cooler) properly and firmly attached.
2. Please use ATX-12V Power Connector (PW1) to provide power to the CPU.

1.2 What You Have

In addition to this *User's Manual*, the PSB-4710EV package includes the following items:

- One PSB-4710EV Single Board Computer
- One RS-232 and Printer Cable & One RS232/422/485 Cable with bracket
- One FDD cable
- One ATA/100 IDE cable.
- One ATX-12V cable.
- One 6-pin Mini-Din converts to two 6-pin mini-Din cables for keyboard and mouse connection.

If any of these items are missing or damaged, contact the dealer from whom you purchased this product. Save the shipping materials and carton in case you want to ship or store the product in the future.

2

Installation

This chapter describes how to install the PSB-4710EV. At first, the layout of PSB-4710EV is shown, and the unpacking information that you should be careful is described. The jumpers and switches setting for the PSB-4710EV's configuration, such as CPU clock setting, and watchdog timer, are also included.

2.1 PSB-4710EV's Layout

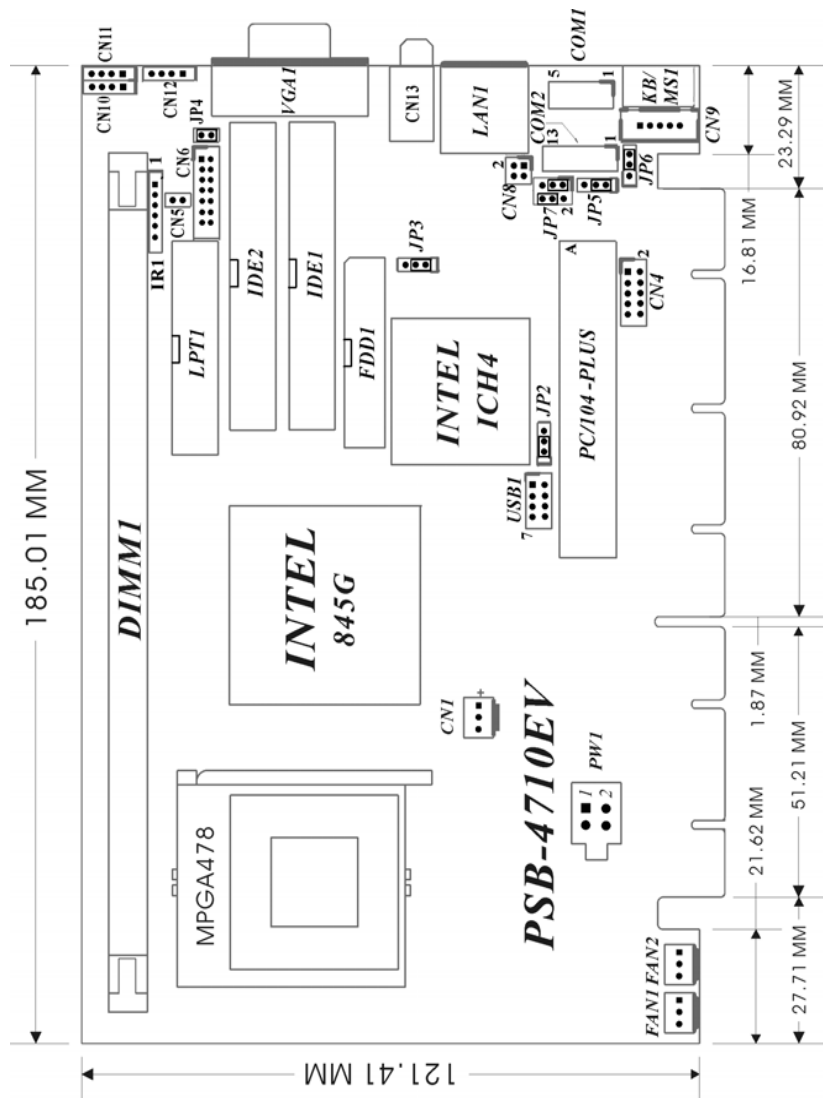

2.2 Unpacking Precautions

Some components on PSB-4710EV SBC are very sensitive to static electric charges and can be damaged by a sudden rush of power. To protect it from unintended damage, be sure to follow these precautions:

- ✓ Ground yourself to remove any static charge before touching your PSB-4710EV SBC. You can do it by using a grounded wrist strap at all times or by frequently touching any conducting materials that is connected to the ground.
- ✓ Handle your PSB-4710EV SBC by its edges. Don't touch IC chips, leads or circuitry if not necessary.
- ✓ Do not plug any connector or jumper while the power is on.

Table of Jumpers

LABEL	FUNCTION
JP2	PC/104-PLUS Power source Setting
JP3	CMOS state setting
JP4	CompactFlash Master(close)/Slave(open) Setting
JP5	COM2 RS232/RS422/RS485 select
JP6	Keyboard/Mouse power source Setting
JP7	COM2 PIN8 Voltage Output Setting

2.3 PC/104-PLUS Power source Setting

JP2	DESCRIPTION
1-2	+5V
2-3	+3.3V

Note: All shaded rows in tables of this manual are the default settings for the PSB-4710EV.

2.4 Clear CMOS Setup

If you want to clear the CMOS Setup (for example, you forgot the password, you should clear the setup and then set the password again.), you should close the JP3 (2-3) about 3 seconds, then open it again. Set back to normal operation mode, open JP3.

- **JP3 : Clear CMOS Setup (Reserve Function)**

JP3	DESCRIPTION
1-2	Normal Operation
2-3	Clear CMOS Setup

WARNING !

When you change power between ATX to AT, be sure to clear CMOS(Power ON) first. Otherwise, the CPU Board may fail to Boot up.

2.5 Onboard Keyboard/Mouse source Setting

JP6	DESCRIPTION
1-2	5VSB
2-3	+5V

2.6 COM2 RS232/RS422/RS485 mode Select & Voltage Output(PIN8) Setting

JP5 :To set the operating mode of COM2.

JP5	DESCRIPTION
1-2	RS232
2-3	RS422/485

JP7 :To set the function of pin8 at COM2, you can change this pin to provide 5V or 12V power source .

COM2 PIN8	
JP7	2-4
1-3	+5V
3-5	+12V

3

Connection

This chapter describes how to connect peripherals, switches and indicators to the ROCKY- 4782EV board.

Table of Connectors

LABEL	FUNCTION
FAN1~FAN2	Fan Connectors
PW1	ATX-12V CPU Power Source
VGA1	VGA 15-pin Female Connector
IR1	IrDA connector
USB1	USB Connectors
LPT1	Parallel Port Connector
COM1	Serial Port 10-pin Connectors
COM2	Serial Port 14-pin Connectors
CN1	Backplane to Mainboard Connectors
CN5	ATX BUTTON (Power ON) Switch
CN4	Digital INPUT/OUTPUT Connectors
CN6	External Switches and Indicators
CN8	LAN State LED Connectors
CN9	External 5-pin Header Keyboard Connector
CN10	AUDIO MIC-IN
CN11	AUDIO CD-IN
CN12	AUDIO LINE-IN
LAN1	LAN RJ45 Connectors
KB/MS1	PS/2 MOUSE & KEYBOARD Connector
FDD1	FDC Connector
IDE2/CFA1	Secondary IDE Connector
IDE1	Primary IDE Connector

3.1 Floppy Disk Drive Connector

The PSB-4710EV board is equipped with a 34-pin daisy-chain drive connector cable.

• FDD1 : FDC Connector

PIN NO.	DESCRIPTION	PIN NO.	DESCRIPTION
1	GROUND	2	REDUCE WRITE
3	GROUND	4	N/C
5	GROUND	6	N/C
7	GROUND	8	INDEX#
9	GROUND	10	MOTOR ENABLE A#
11	GROUND	12	DRIVE SELECT B#
13	GROUND	14	DRIVE SELECT A#
15	GROUND	16	MOTOR ENABLE B#
17	GROUND	18	DIRECTION#
19	GROUND	20	STEP#
21	GROUND	22	WRITE DATA#
23	GROUND	24	WRITE GATE#
25	GROUND	26	TRACK 0#
27	GROUND	28	WRITE PROTECT#
29	GROUND	30	READ DATA#
31	GROUND	32	SIDE 1 SELECT#
33	GROUND	34	DISK CHANGE#

3.2 PCI E-IDE Disk Drive Connector

You can attach four IDE(Integrated Device Electronics) hard disk drives on two channels. These connectors support Ultra-DMA100 IDE devices. Non-DMA100 devices are suggested to be connecting to the secondary IDE connector.

IDE 1 : Primary IDE Connector

IDE 2 : Secondary IDE Connector

• IDE Interface Connector

PIN NO.	DESCRIPTION	PIN NO.	DESCRIPTION
1	RESET#	2	GROUND
3	DATA 7	4	DATA 8
5	DATA 6	6	DATA 9
7	DATA 5	8	DATA 10
9	DATA 4	10	DATA 11
11	DATA 3	12	DATA 12
13	DATA 2	14	DATA 13
15	DATA 1	16	DATA 14
17	DATA 0	18	DATA 15
19	GROUND	20	N/C
21	N/C	22	GROUND
23	IOW#	24	GROUND
25	IOR#	26	GROUND
27	N/C	28	BALE – DEFAULT
29	N/C	30	GROUND – DEFAULT
31	INTERRUPT	32	IOCS16#-DEFAULT
33	SA1	34	N/C
35	SA0	36	SA2
37	HDC CS0#	38	HDC CS1#
39	HDD ACTIVE#	40	GROUND

3.3 Parallel Port

This port is usually connected to a printer. The PSB-4710EV includes an on-board parallel port, accessed through a 26-pin flat-cable connector.

• LPT1 : Parallel Port Connector

PIN NO.	DESCRIPTION	PIN NO.	DESCRIPTION
1	STROBE#	2	DATA 0
3	DATA 1	4	DATA 2
5	DATA 3	6	DATA 4
7	DATA 5	8	DATA 6
9	DATA 7	10	ACKNOWLEDGE
11	BUSY	12	PAPER EMPTY
13	PRINTER SELECT	14	AUTO FORM FEED #
15	ERROR#	16	INITIALIZE
17	PRINTER SELECT LN#	18	GROUND
19	GROUND	20	GROUND
21	GROUND	22	GROUND
23	GROUND	24	GROUND
25	GROUND		

3.4 Serial Ports

The PSB-4710EV offers two high speeds NS16C550 compatible UART.

COM1 : 10-pin header on board

COM2 : 14-pin header on board

Connector	Ports	Address	Interrupt
COM1	COM1	3F8	IRQ4
COM2	COM2	2F8	IRQ3

• Serial Port 10(14)-pin Connector

PIN NO.	DESCRIPTION
1	DATA CARRIER DETECT (DCD)
2	RECEIVE DATA (RXD)
3	TRANSMIT DATA (TXD)
4	DATA TERMINAL READY (DTR)
5	GROUND (GND)
6	DATA SET READY (DSR)
7	REQUEST TO SEND (RTS)
8	CLEAR TO SEND (CTS)
9	RING INDICATOR (RI)
10	NC
(11)	RS422/RS485 TX+
(12)	RS422/RS485 TX-
(13)	RS422/RS485 RX+
(14)	RS422/RS485 RX-

3.5 Keyboard & PS/2 Mouse Connector

A 6-pin mini DIN connector is located on the mounting bracket for easy connection to a keyboard or a PS/2 mouse. The card comes with a cable to convert from the 6-pin mini-DIN connector to two 6-pin mini-DIN connectors for keyboard and mouse connection.

• KB/MS1 : 6-pin Mini-DIN Keyboard Connector

PIN NO.	DESCRIPTION
1	KEYBOARD DATA
2	MOUSE DATA
3	GROUND
4	+5V
5	KEYBOARD CLOCK
6	MOUSE CLOCK

For alternative application, a keyboard and a PS/2 mouse pin header connector are also available on board.

• CN9 : 5-pin Header Keyboard Connector

PIN NO.	DESCRIPTION
1	KEYBOARD CLOCK
2	KEYBOARD DATA
3	N/C
4	GROUND
5	+5V

3.6 External Switches and Indicators

There are several external switches and indicators for monitoring and controlling your CPU board. All the functions are in the CN6 connector.

CN6 : External Switches and Indicators

	PIN	DESCRIPTION	PIN	DESCRIPTION	
Power LED	1	+5V	2	Speaker +	Speaker
	3	N/C	4	N/C	
	5	GND	6	N/C	
KEYLOCK	7	KEYLOCK PIN1	8	Speaker -	Reset Button
	9	KEYLOCK PIN2	10	Reset PIN1	
	11	GND	12	Reset PIN2	
HDD LED	13	HDD LED+	14	HDD LED-	HDD LED

• CN5 : 2-pin Header ATX POWER BUTTON Connector

PIN NO.	DESCRIPTION
1	BUTTON PIN1
2	BUTTON PIN2

• CN1 : Backplane to Mainboard Connector

PIN NO.	DESCRIPTION
1	5VSB
2	ATX-ON
3	GND

★ Power source from Backplane with ATX Connector (Through Power Button & +5VSB)

3.7 USB Port Connector

The RSB-4710EV provide 2 built-in USB2.0 ports for the future new I/O bus expansion.

USB1			
PIN NO.	DESCRIPTION	PIN NO.	DESCRIPTION
1	VCC	8	GROUND
2	DATA-	7	DATA+
3	DATA+	6	DATA-
4	GROUND	5	VCC

3.8 IrDA Infrared Interface Port

The PSB-4710EV has a built-in IrDA port which supports Serial Infrared (SIR) or Amplitude Shift Keyed IR (ASKIR) interface. If you want to use the IrDA port, you have to configure SIR or ASKIR model in the BIOS under Peripheral Setup COM2. Then the normal RS-232 COM 2 will be disabled.

• IR1: IrDA connector

PIN NO.	DESCRIPTION
1	VCC
2	NC
3	IR-RX
4	Ground
5	IR-TX
6	NC

3.9 Fan Connectors (FAN1~FAN2)

The PSB-4710EV provides two CPU cooling fan connectors, These connectors can supply 12V/500mA to the cooling fan. All connectors have the same pin assignments and provide a "rotation" pin to get rotation signals from fans and notice the system. So the system BIOS can recognize the fan speed. Please note that only specified fan can issue the rotation signals.

• Fan Connector

PIN NO.	DESCRIPTION
1	Rotation Signal
2	+12V
3	Ground

3.10 LAN RJ45& State LED Connectors

The PSB-4710EV is equipped with two built-in 10/100Mbps Ethernet controllers. You can connect it to your LAN through RJ45 LAN connectors. There are two LED on the connector indicating the status of LAN. The pin assignments are as following:

• LAN1 RJ45 Connector

PIN NO.	DESCRIPTION	PIN NO.	DESCRIPTION
1	TX+	5.	N/C

2	TX-	6.	RX-
3.	RX+	7.	N/C
4.	N/C	8.	N/C

• **CN8: LAN State LED Connector**

PIN NO.	DESCRIPTION
1-2	100TX
3-4	ACT/LINK

3.11 VGA Connector

The PSB-4710EV has a built-in 15-pin VGA connector directly connects to your CRT monitor.

• **VGA1 : 15-pin Female Connector**

1	RED	2	GREEN
3	BLUE	4	NC
5	GROUND	6	GROUND
7	GROUND	8	GROUND
9	NC	10	GROUND
11	NC	12	DDC DAT
13	HSYNC	14	VSYNC
15	DDCCLK		

3.12 AUDIO Headphone & Connector

The PSB-4710EV has a built-in AC'97 AUDIO CODEC; connector directly connects to your MIC-IN & CD-IN & LINE-IN.

- **CN13: AUDIO Headphone Jack (Output)**
- **CN12: AUDIO LINE-IN Connector (Input)**
- **CN11: AUDIO CD-IN Connector (Input)**
- **CN10: AUDIO MIC-IN Connector (Input)**

PIN NO.	DESCRIPTION		
	CN11	CN12	CN10
1	LEFT	LEFT	MIC-IN
2	GND	GND	GND
3	GND	GND	GND
4	RIGHT	RIGHT	NC

3.13 ATX-12V Power Connector

This connector supports the ATX power, functions such as modem Ring on, wake-up LAN and soft power off are supported by mainboard. (Power source from Mainboard)

PW1			
PIN NO.	DESCRIPTION	PIN NO.	DESCRIPTION
1	GND	2	GND
3	+12V	4	+12V

Notice: The power from PW1 should support at least 6.5A current for the use of P4 CPU. If the power is not enough, the operation of CPU could be abnormal. Be sure the power from power supply is enough, and don't share this power with other devices, such as hard disk and etc. You can use ICP's special cable for connection if your power supply doesn't have suitable cable.

3.14 Digital INPUT/OUTPUT Connector

Pin	Description	Pin	Description
1	GND	2	+5V
3	OUT3	4	OUT2
5	OUT1	6	OUT0
7	IN3	8	IN2
9	IN1	10	IN0

4

AMI BIOS SETUP

4.1 Introduction

This manual discusses AMI's Setup program built into the ROM BIOS. The Setup program allows users to modify the basic system configuration. This special information is then stored in battery-backed RAM so that it retains the Setup information when the power is turned off.

4.2 Starting Setup

The AMI BIOS is immediately activated when you first power on the computer. The BIOS reads the system information contained in the CMOS and begins the process of checking out the system and configuring it. When it finishes, the BIOS will seek an operating system on one of the disks and then launch and turn control over to the operating system.

While the BIOS is in control, the Setup program can be activated in one of two ways:

1. By pressing immediately after switching the system on, or
2. by pressing the key when the following message appears briefly at the bottom of the screen during the POST.

Press DEL to enter SETUP.

If the message disappears before you respond and you still wish to enter Setup, restart the system to try again by turning it OFF then ON or pressing the "RESET" button on the system case. You may also restart by simultaneously pressing <Ctrl>, <Alt>, and <Delete> keys. If you do not press the keys at the correct time and the system does not boot, an error message will be displayed and you will again be asked to...

PRESS F2 TO CONTINUE, DEL TO ENTER SETUP

4.3 Using Setup

In general, you use the arrow keys to highlight items, press <Enter> to select, use the PageUp and PageDown keys to change entries, press <F1> for help and press <Esc> to quit. The following table provides more detail about how to navigate in the Setup program using the keyboard.

Up arrow	Move to previous item
Down arrow	Move to next item
Left arrow	Move to the item in the left hand
Right arrow	Move to the item in the right hand
Esc key	Main Menu -- Quit and not save changes into CMOS Status Page Setup Menu and Option Page Setup Menu -- Exit current page and return to Main Menu
PgUp key	Increase the numeric value or make changes
PgDn key	Decrease the numeric value or make changes
+ key	Increase the numeric value or make changes
- key	Decrease the numeric value or make changes
F1 key	General help, only for Status Page Setup Menu and Option Page Setup Menu
F2 /F3 key	Change color from total 16 colors. F2 to select color forward, (Shift) F2 to select color backward
F4 key	Reserved
F5 key	Reserved
F6 key	Reserved
F7 key	Reserved
F8 key	Reserved
F9 key	Reserved
F10 key	Save all the CMOS changes, only for Main Menu

4.4 Getting Help

Press F1 to pop up a small help window that describes the appropriate keys to use and the possible selections for the highlighted item. To exit the Help Window press <Esc> or the **F1** key again.

If, after making and saving system changes with Setup, you discover that your computer no longer is able to boot, the AMI BIOS supports an override to the CMOS settings which resets your system to its defaults.

The best advice is to only alter settings which you thoroughly understand. To this end, we strongly recommend that you avoid making any changes to the chipset defaults. These defaults have been carefully chosen by both AMI and your systems manufacturer to provide the absolute maximum performance and reliability. Even a seemingly small change to the chipset setup has the potential for causing you to use the override.

4.5 Main Menu

Once you enter the AMIBIOS™ CMOS Setup Utility, the Main Menu will appear on the screen. The Main Menu allows you to select from several setup functions and two exit choices. Use the arrow keys to select among the items and press <Enter> to accept and enter the sub-menu. Note that a brief description of each highlighted selection appears at the bottom of the screen.



The main menu includes the following main setup categories. Recall that some systems may not include all entries.

Standard CMOS Setup

Use this menu for basic system configuration.

Advanced CMOS Setup

Use this menu to set the Advanced Features available on your system.

Advanced Chipset Setup

Use this menu to change the values in the chipset registers and optimize

your system's performance.

Power Management Setup

When Disabled, SMI will not be initialized, and complete power management functionality is removed until this option is set to Enabled.

PCI / Plug and Play Setup

This entry appears if your system supports PnP / PCI.

Peripheral Setup

Use this menu to specify your settings for integrated peripherals.

Hardware Monitor Setup

Use this menu to monitor your hardware.

Auto-detect Hard Disks

Use this menu to specify your settings for hard disks control.

Change Supervisor Password

Use this menu to set User and Supervisor Passwords.

Auto Configuration with Optimal Settings

Use this menu to load the BIOS default values that are factory settings for optimal performance system operations. While AMI has designed the custom BIOS to maximize performance, the factory has the right to change these defaults to meet their needs.

Auto Configuration with Fail-Safe Settings

Use this menu to load the BIOS default values for the minimal/stable performance for your system to operate.

Save Settings and Exit

Save CMOS value changes to CMOS and exit setup.

Exit Without Saving

Abandon all CMOS value changes and exit setup.

4.6 Standard CMOS Setup

The items in Standard CMOS Setup Menu are divided into 10 categories. Each category includes no, one or more than one setup items. Use the arrow keys to highlight the item and then use the <PgUp> or <PgDn> keys to select the value you want in each item.

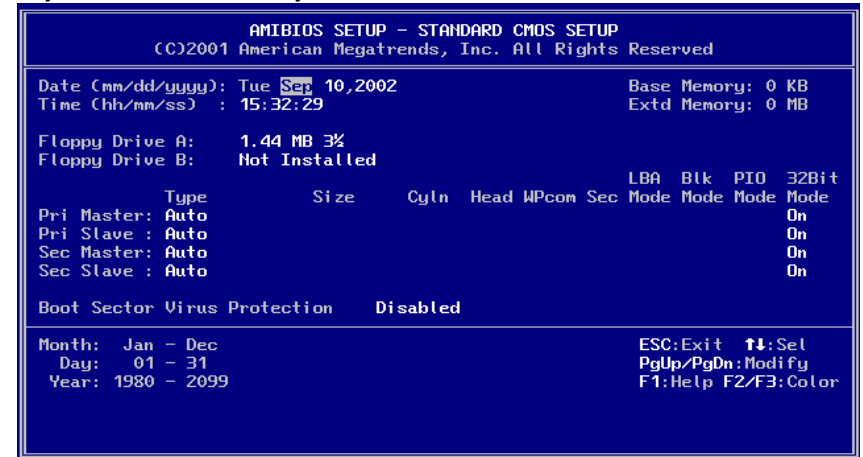

Main Menu Selections

Item	Options	Description
Date	MM DD YYYY	Set the system date.
Time	HH : MM : SS	Set the system time
IDE Primary Master	Options are in its sub menu (described in Table 3)	Press <Enter> to enter the sub menu of detailed options
IDE Primary Slave	Options are in its sub menu (described in Table 3)	Press <Enter> to enter the sub menu of detailed options
IDE Secondary Master	Options are in its sub menu (described in Table 3)	Press <Enter> to enter the sub menu of detailed options
IDE Secondary Master	Options are in its sub menu (described in Table 3)	Press <Enter> to enter the sub menu of detailed options
Drive A Drive B	None 360K, 5.25 in 1.2M, 5.25 in 720K, 3.5 in 1.44M, 3.5 in 2.88M, 3.5 in	Select the type of floppy disk drive installed in your system
Halt On	All Errors No Errors All, but Keyboard All, but Diskette All, but Disk/Key	Select the situation in which you want the BIOS to stop the POST process and notify you
Base Memory	N/A	Displays the amount of conventional memory detected during boot up
Extended Memory	N/A	Displays the amount of extended memory detected during boot up

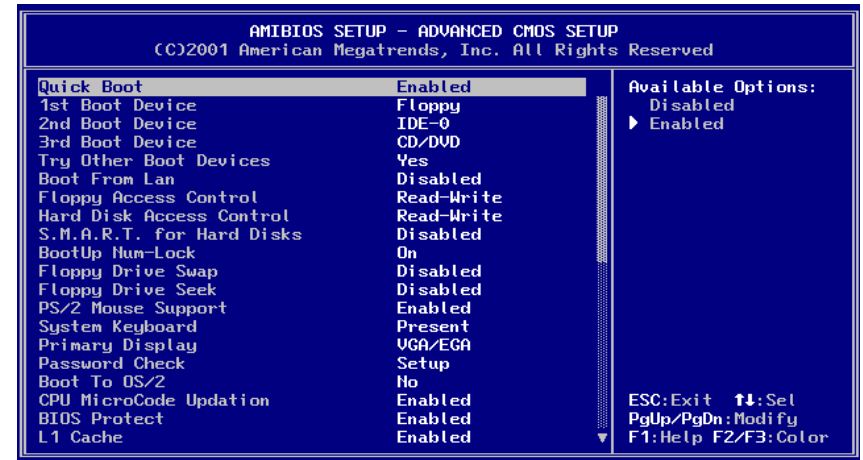

Quick Boot

When set to enable, DRAM testing function will disable. Warning

1st /2nd /3rd Boot Device

This option sets the type of device for the first boot drives that the AMIBIOS attempts to boot from after AMIBIOS POST completes. The settings are Disabled, IDE-0, IDE-1, IDE-2, IDE-3, Floppy, ARMD-FDD, ARMD-HDD, CDROM, SCSI.

Try Other Boot Devices

Set this option to Yes to instruct AMIBIOS to attempt to boot from any other drive in the system if it cannot find a boot drive among the drives specified in the 1st Boot Device, 2nd Boot Device, 3rd Boot Device, 4th Boot Device options. The settings are Yes or No.

4.7 Advanced CMOS Setup

This section allows you to configure your system for basic operation. You have the opportunity to select the system's default speed, boot-up sequence, keyboard operation, shadowing and security.

Floppy Access Control

This option specifies the read/write access that is set when booting from a floppy drive. The settings are Read/Write or Read-Only.

Hard Disk Access Control

This option specifies the read/write access that is set when booting from a hard disk drive. The settings are Read/Write or Read-Only.

S.M.A.R.T. for Hard Disks

Self-Monitoring, Analysis and Reporting Technology. This option can help BIOS to warn the user of the possible device failure and give user a chance to back up the device before actual failure happens. The settings are Disabled, Enabled.

Boot Up Num-Lock

When On, this option turns off Num Lock when the system is powered on so the end user can use the arrow keys on both the numeric keypad and the keyboard.

Floppy Drive Swap

Set this option to Enabled to permit drives A: and B: to be swapped. The settings are Enabled or Disabled.

Floppy Drive Seek

Set this option to Enabled to specify that floppy drives A: will perform a Seek operation at system boot. The settings are Enabled or Disabled.

PS/2 Mouse Support

When this option is enabled, BIOS support a PS/2- type mouse.

System Keyboard

This option does not specify if a keyboard is attached to the computer. Rather, it specifies if error messages are displayed if a keyboard is not attached. This option permits you to configure workstation with no keyboard. The settings are Absent, Present.

Primary Display

Select this option to configure the type of monitor attached to the computer. The settings are Monochrome, Color 40x25, Color 80x25, VGA/PGA/EGA ,or Not Install.

Password Check

This option enables the password check option every time the system boots or the end user runs Setup. If always is chosen a user password prompt appears every time the computer is tuned on. If setup is chosen, the password prompt appears if BIOS is executed.

Boot To OS/2

Set this option to Enabled if running OS/2 operating system and using more than 64MB of system memory on the motherboard. The settings are YES or NO.

Wait For 'F1' If Error

If this option is enabled, AMIBIOS waits for the end user to press <F1> before continuing. If this option is disabled, AMIBIOS continues the boot process without waiting for <F1> to be pressed. The settings are Disabled or Enabled.

Hit 'DEL' Message Display

Disabling this option prevents "Hit if you want to run Setup" from appearing when the system boots. The settings are Disabled or Enabled.

L1 Cache

The option enabled or disabled the internal cache memory in the processor.

L2 Cache

The option enables secondary cache memory. If Enabled is selected, external cache memory is enabled. If disabled is select, external cache memory is disabled.

System BIOS Cacheable

When this option is set to enabled, the System ROM area from F0000-FFFFF is copied (shadowed) to RAM for faster execution.

C000,32k Shadow

When this option is set to enabled, the Video ROM area from C0000-C7FFF is copied (shadowed) to RAM for faster execution.

Disabled :The contents of the video ROM are not copied to RAM.

Cached :The contents of the video ROM area from C0000h - C7FFFh are copied from ROM to RAM and can be written to or read from cache memory. Enabled :The contents of the video ROM area from C0000h - C7FFFh are copied (shadowed) from ROM to RAM for faster execution.

C800,16k Shadow

These options enable shadowing of the contents of the ROM area named in the option title. The settings are Enable Disable, Cached. The ROM area that is not used by ISA adapter cards will be allocated to PCI adapter cards.000,32k Shadow

CC00,16k Shadow

These options enable shadowing of the contents of the ROM area named in the option title. The settings are Enable Disable, Cached. The ROM area that is not used by ISA adapter cards will be allocated to PCI adapter cards.800,16k Shadow

D000,16k Shadow

These options enable shadowing of the contents of the ROM area named in the option title. The settings are Enable Disable, Cached. The ROM area that is not

used by ISA adapter cards will be allocated to PCI adapter cards.C00,16k Shadow

D400,16k Shadow

These options enable shadowing of the contents of the ROM area named in the option title. The settings are Enable Disable, Cached. The ROM area that is not used by ISA adapter cards will be allocated to PCI adapter cards.000,16k Shadow

D800,16k Shadow

These options enable shadowing of the contents of the ROM area named in the option title. The settings are Enable Disable, Cached. The ROM area that is not used by ISA adapter cards will be allocated to PCI adapter cards.400,16k Shadow

DC00,16k Shadow

These options enable shadowing of the contents of the ROM area named in the option title. The settings are Enable Disable, Cached. ISA adapter cards will be allocated to PCI adapter cards.800,16k Shadow

4.8 Advanced Chipset Setup

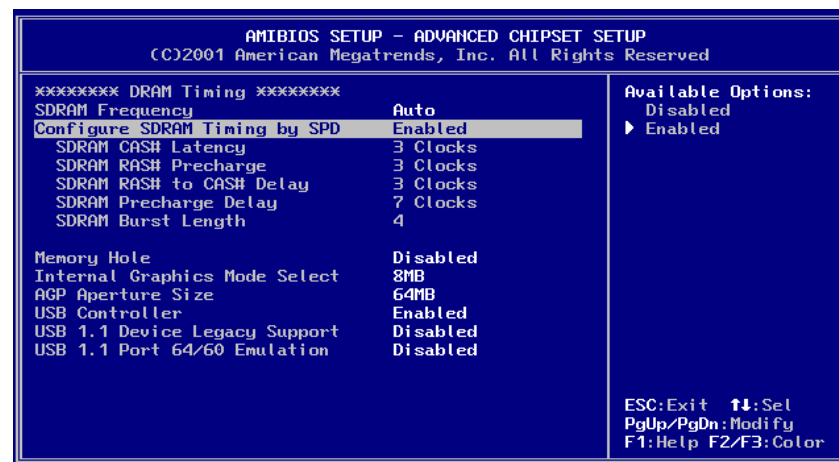

This section allows you to configure the system based on the specific features of the installed chipset. This chipset manages bus speeds and access to system memory resources, such as DRAM and the external cache. It also coordinates communications between the conventional ISA bus and the PCI bus. It must be stated that these items should never need to be altered. The default settings have been chosen because they provide the best operating conditions for your system.

SDRAM Frequency

This setting decided by Memory frequency.

Configure SDRAM Timing by SPD

This field detect the capability of the SDRAM modules that you are using ---Enabled or Disabled.

SDRAM CAS# Latency

This controls the latency between the SDRAM read command and the time that the data actually becomes available.

Memory Hole

You can reserve this area of system memory for ISA adapter ROM. When this area is reserved, it cannot be cached. The user information of peripherals that need to use this area of system memory usually discusses their memory requirements.

Internal Graphics Mode Select

This option is setting for sharing memory size from system memory to Video memory.

4.9 Power Management Setup

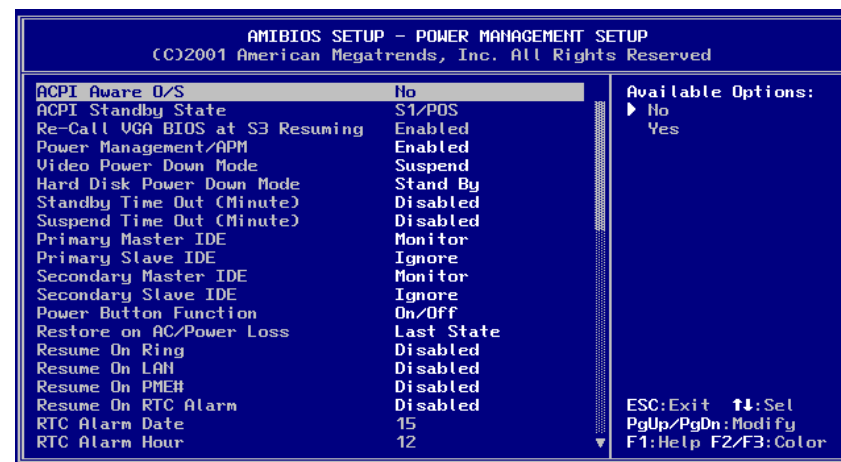

ACPI Aware O/S

This feature is switch of ACPI function. Configuration options : [No] [Yes]

ACPI Standby State

This feature is switch of STR (S3) or POS (S1) function. Configuration options : [S3/STR] [S1/POS]

Power Management/APM

When Disabled, SMI will not be initialized, and complete power management functionality is removed until this option is set to Enabled.

Suspend Time Out(Minute)

If no activity occurs during this time period, the BIOS will place the system into the suspend low power state. The "Standby Time Out" period must expire first (if enabled) before this time out period begins.

Hard Disk Time Out

If no disk activity occurs for , this time period, the BIOS will put the hard disk , device(s) into low power mode.

RTC Alarm Date,Hour

When this option is set enabled, system will according to you set time then wakeup from soft off mode.

Resume on Ring

Modem Ring Resume From Soft Off

Power Type Select

This feature is switch of Power Type function.
Configuration options : [AT] [ATX]

4.10 PCI / Plug and Play Setup

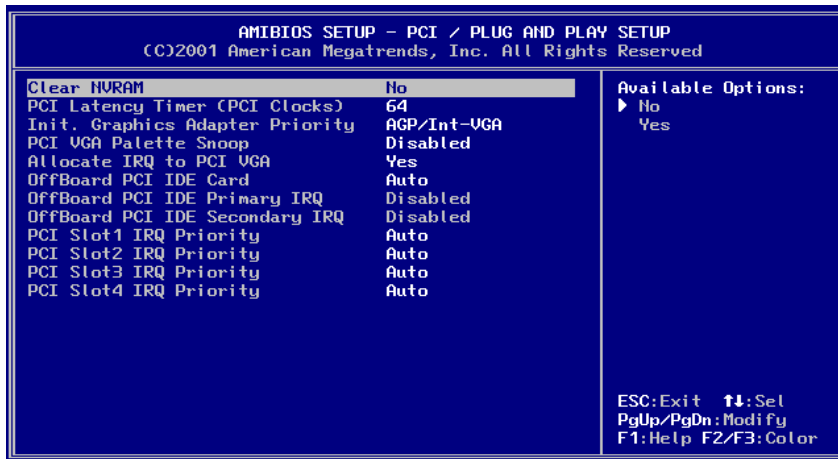

Clear NVRAM

When this option is set to Yes, system can auto clear NVRAM. The settings are No, Yes.

PCI Latency Timer (PCI Clocks)

This option specifies the latency timings(in PCI clocks) for PCI devices installed in the PCI expansion slots. The settings are 32, 64, 96, 128, 160 , 192, 224, or 248.

Allocate IRQ to PCI VGA

Set this option to Yes to allocate an IRQ to the VGA device on the PCI bus. The settings are Yes or No.

OffBoard PCI IDE Card

This question is needed for off-board non-compliant PCI IDE card. If present , BIOS needs to know which slot it is in and how the IRQ is used by the card.

OffBoard PCI IDE Primary IRQ

This option specifies the PCI interrupt used by the primary IDE channel on the offboard PCI IDE controller. The settings are Disabled, Hardwired, INTA, INTB, INTC, or INTD.

OffBoard PCI IDE Secondary IRQ

This option specifies the PCI interrupt used by the secondary IDE channel on the offboard PCI IDE controller. The settings are Disabled, Hardwired, INTA, INTB, INTC, or INTD.

PCI Slot1 / Slot2 / Slot3 / Slot4 IRQ Priority

The option specify the IRQ priority for PCI device installed in the PCI expansion slot. The settings are Auto, (IRQ) 3, 4, 5, 7, 9, 10, and 11, in priority order.

4.11 Peripheral Setup

The Peripheral Setup allows you to configure your system to most effectively save energy while operating in a manner consistent with your own style of computer use.

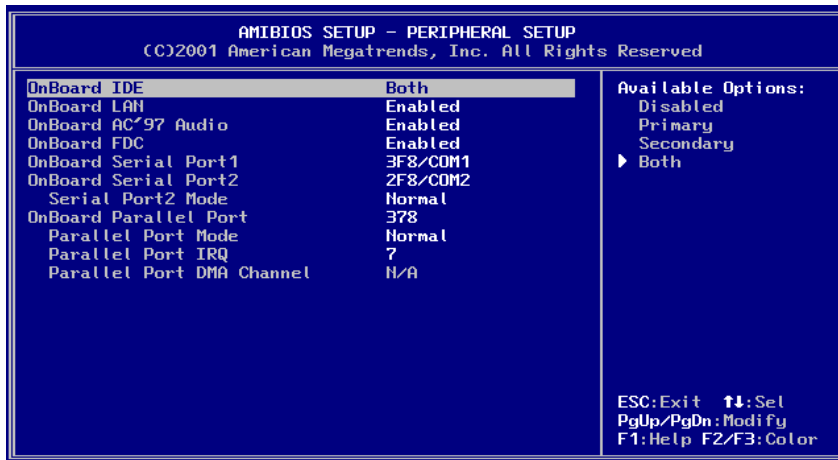

OnBoard Serial Port1 /Port2

This option specifies the base I/O port address of serial port 1. The settings are Auto (AMIBIOS automatically determines the correct base I/O port address), Disabled, 3F8h, 2F8h, 2E8h, or 3E8h.

Serial Port2 Mode

This option specifies the IR active pulse or inverting clock of serial port B.

IR Pin Select

The SINB/SOUTB pin of Serial PortB function or IRRX/IRTX pin if IR function in normal condition.

OnBoard Parallel Port

This option specifies the base I/O port address of parallel port on the motherboard. The settings are Disabled, 378h, 278h, or 3BCh.

Parallel Port Mode

This option specifies the parallel port mode. The settings are Normal, Bi-Dir, EPP, ECP. Normal :The normal parallel port mode is used. Bi-Dir :Use this setting to support bidirectional transfers on the parallel port.

EPP :The parallel port can be used with devices that adhere to the Enhanced Parallel Port(EPP) specification. EPP uses the existing parallel port signals to provide asymmetric bidirectional data transfer driven by the host device.

ECP :The parallel port can be used with devices that adhere to the Extended Capabilities Port(ECP) specification. ECP uses the DMA protocol to achieve data transfer rates up to 2.5 Megabits per second. ECP provides symmetric bidirectional communication.

EPP Version

EPP data or address read cycle 1.9 or 1.7

Parallel Port IRQ

This option specifies the IRQ used by the parallel port. The settings are Auto, (IRQ)5, (IRQ)7.

Parallel Port DMA Channel

This option is only available if the setting for the Parallel Port Mode option is ECP. This option sets the DMA channel used by the parallel port. The settings are DMA Channel 0, 1, or 3.

4.12 Hardware Monitor Setup

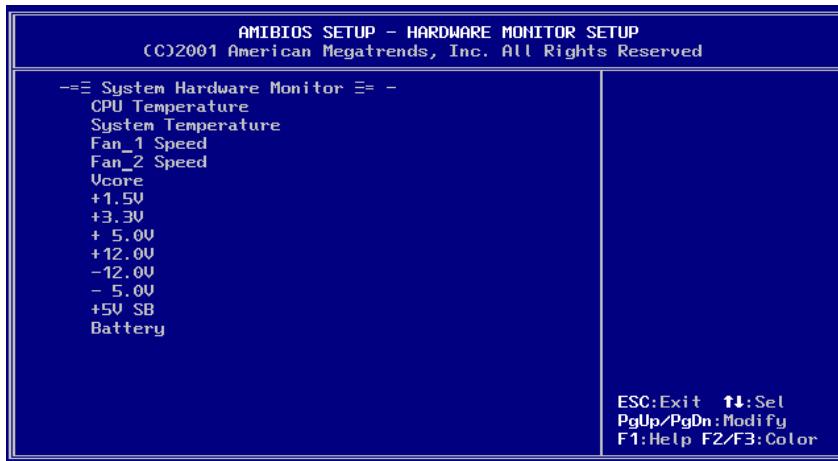

4.13 Change Supervisor Password

You can set either supervisor or user password, or both of them. The differences between are:

supervisor password :

can enter and change the options of the setup menus.

user password :

just can only enter but do not have the right to change the options of the

setup menus. When you select this function, the following message will appear at the center of the screen to assist you in creating a password.

ENTER PASSWORD:

Type the password, up to eight characters in length, and press <Enter>. The password typed now will clear any previously entered password from CMOS memory. You will be asked to confirm the password. Type the password again and press <Enter>. You may also press <Esc> to abort the selection and not enter a password.

To disable a password, just press <Enter> when you are prompted to enter the password. A message will confirm the password will be disabled. Once the password is disabled, the system will boot and you can enter Setup freely.

PASSWORD DISABLED.

When a password has been enabled, you will be prompted to enter it every time you try to enter Setup. This prevents an unauthorized person from changing any part of your system configuration.

Additionally, when a password is enabled, you can also require the BIOS to request a password every time your system is rebooted. This would prevent unauthorized use of your computer.

You determine when the password is required within the BIOS Features Setup Menu and its Security option (see Section 3). If the Security option is set to password will be required both at boot and at entry to Setup. If set to "Setup", prompting only occurs when trying to enter Setup.

Appendix A. WatchDog Timer

The WatchDog Timer is provided to ensure that standalone systems can always recover from catastrophic conditions that cause the CPU to crash. This condition may have occurred by external EMI or a software bug. When the CPU stops working correctly, hardware on the board will either perform a hardware reset (cold boot) or a Non-Maskable Interrupt (NMI) to bring the system back to a known state.

A BIOS function call (INT 15H) is used to control the WatchDog Timer:

INT 15H:

AH – 6FH
<u>Sub-function:</u>
AL – 2 : Set the Watchdog Timer's period
BL : Time-out value(Its unit--second or minute, is dependent on the item "WatchDog Timer unit select" in CMOS setup).

You have to call sub-function 2 to set the time-out period of Watchdog Timer first. If the time-out value is not zero, the Watchdog Timer will start counting down. While the timer value reaches zero, the system will reset. To ensure that this reset condition does not occur, the WatchDog Timer must be periodically refreshed by calling sub-function 2. However the Watchdog timer will be disabled if you set the time-out value to be zero.

A tolerance of at least 10% must be maintained to avoid unknown routines within the operating system (DOS), such as disk I/O that can be very time-consuming.

Note: when exiting a program it is necessary to disable the WatchDog Timer, otherwise the system will reset.

Example program:

```
; INITIAL TIMER PERIOD COUNTER
;
; W_LOOP:
;
;     MOV  AX, 6F02H      ;setting the time-out value
;     MOV  BL, 30        ;time-out value is 48 seconds
;     INT  15H
;
;
; ADD YOUR APPLICATION PROGRAM HERE
;
;     CMP  EXIT_AP, 1    ;is your application over?
;     JNE  W_LOOP        ;No, restart your application
;
;     MOV  AX, 6F02H    ;disable Watchdog Timer
;     MOV  BL, 0
;     INT  15H
;
;
; EXIT
;
```

Appendix B. I/O Address Map

• I/O Address Map

I/O Address Map	Description
000-01F	DMA Controller #1
020-021	Interrupt Controller # 1, Master
040-05F	System Timer
060-06F	Standard 101/102 keyboard Controller
070-07F	Real time Clock, NMI Controller
080-0BF	DMA Page Register
0A0-0BF	Interrupt Controller # 2
0C0-0DF	DMA Controller # 2
0F0-0F0	Clear Math Coprocessor Busy
0F1-0F1	Reset Math Coprocessor
0F8-0FF	Math Coprocessor
170-1F7	BUS Master PCI IDE Controller
278-27F	Parallel Printer Port 2
2F8-2FF	Serial Port 2
376-376	BUS Master PCI IDE Controller
378-37F	Parallel Printer Port 1
3B0-3DF	Intel 82845G/GL Graphic Adapter
3F0-3F7	Floppy Disk Controller
3F8-3FF	Serial Port 1
480-48F	PCI BUS

1 st MB Memory Address Map

Memory address	Description
00000-9FFFF	SYSTEM MEMORY
A0000-BFFFF	VGA BUFFER
C0000-CFFFF	VGA BIOS
E0000-FFFFFF	SYSTEM BIOS
100000	EXTEND MEMORY

IRQ Mapping Chart

IRQ0	System Timer	IRQ8	RTC clock
IRQ1	Keyboard	IRQ9	AC97 AUDIO
IRQ2	IRQ Controller	IRQ10	IRQ Holder for PCI steering
IRQ3	COM2	IRQ11	ICH4 USB2.0
IRQ4	COM1	IRQ12	PS/2 mouse
IRQ5	INTEL ICH4 LAN	IRQ13	FPU
IRQ6	FDC	IRQ14	Primary IDE
IRQ7	Printer	IRQ15	Secondary IDE

DMA Channel Assignment

Channel	Function
0	Available
1	Available
2	Floppy disk
3	Available
4	Cascade for DMA controller 1
5	Available
6	Available
7	Available

Appendix C. ATX Power Supply

The following notes show how to connect ATX Power Supply to the backplanes and / or the SBC card.

A. For backplanes with ATX Connector

1. Please, disconnect the AC cord of the Power Supply from the AC source to prevent sudden electric surge to the board.
2. Please, check the type of your CPU board. All CPU board listed on the next page support ATX power supply but has two types of power switch connection:

2.1. PSB-4710EV (through Power Button & GND):

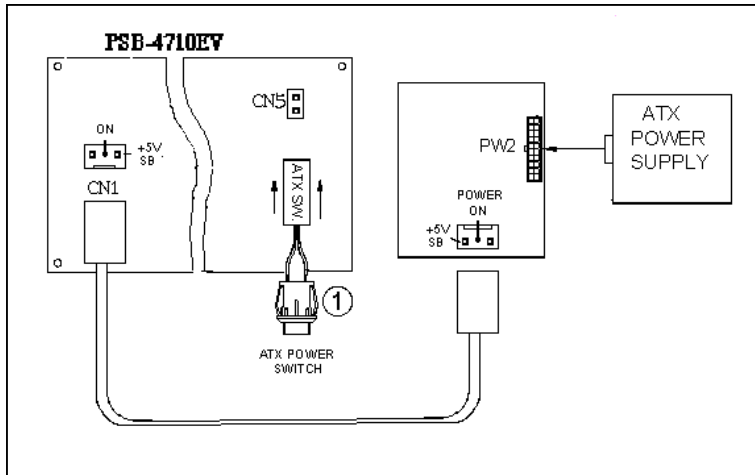

Connect the ATX power button switch to the CN5 (power button). And connect the power cable from Backplane to CN1 of CPU card.

If you want to turn ON the system, just press the button once. And if you want to turn off the power supply, please press the ATX power switch button for about 4 seconds.

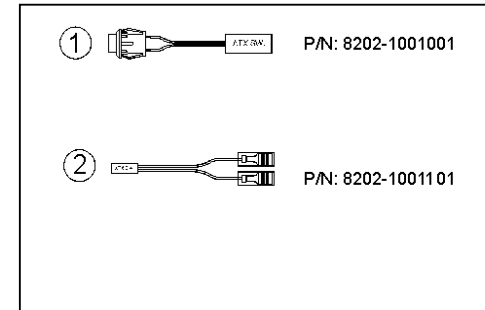

B. For the backplanes with ATX power supply connector

For some SBC without ATX power ON/OFF function, then you can control the ATX power supply through backplane's PS ON connector. Refer to the figure below: for the backplanes with ATX connector, the connection can be made simply as following:

1. Connect the ON/OFF (ordinary one) switch to Pin 2 (PS ON) and Pin 3 (GND) of connector CN2
2. You may now turn the power ON/OFF by the power switch

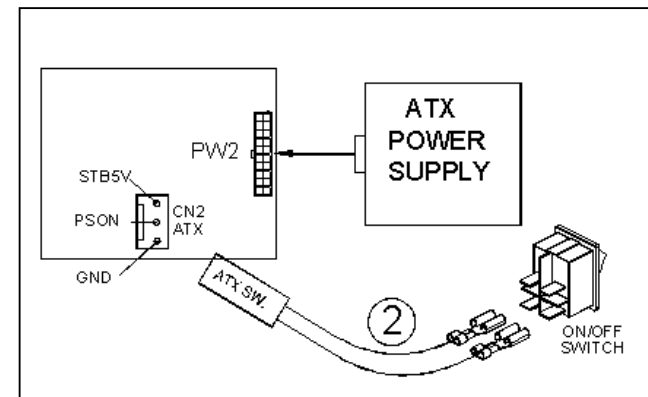

Appendix D. How to use Wake-Up Function

The PSB-4710EV provides two kind of Wake up Function. This page describes how to use Modem Wake-Up and LAN Wake-Up function.

Wake-Up function is working while you use ATX power supply,

Wake –Up On Modem(Ring) :

You must set the option **Wake-Up On LAN/Ring** of CMOS SETUP to be enabled. The ATX power supply will be switched on when there is a ring signal detected on pin “RI” of serial port.

Wake-Up On LAN:

When your computer is in power-down status, you can see LAN Link/Active LED is flashing. This status indicates that the LAN chip has entered standby mode and waits for Wake-Up signal. You can use other computers to wake up your computer by sending ID to it.

ID: ID is the address of your system LAN. Every LAN chip has a factory-set ID, which you can find it from network information in WINDOWS.

ID's format is xxxxxxxxxxxx
Example ID: 009027388320