



Congratulations on the purchase of your new Prince Table Tennis table. Our products are designed and manufactured to give you years of game playing enjoyment.

*KEEP BOX AND PACKING MATERIAL UNTIL TABLE HAS BEEN COMPLETELY ASSEMBLED.*

*ALL DAMAGE MUST BE REPORTED TO DMI WITHIN TEN DAYS OF RECEIPT.*

*If you have any problems with your new product,*  
**PLEASE DO NOT RETURN IT TO THE STORE.**

Please contact us:

**1.800.399.4402**

**FAX: 215.283.9573**

Please have your model number when inquiring about parts.

Or write to:

DMI Sports

Customer Service

375 Commerce Drive

Fort Washington PA, 19034

Please visit our web site at:

**[www.dmisports.com](http://www.dmisports.com)**

When contacting DMI Sports, please provide your model number and item number (if applicable) if requesting a replacement part. Item numbers can be found inside this owners manual.

Your Model Number PT400

**Your model number is also located on the original carton. These instructions are also available online at: [www.dmisports.com](http://www.dmisports.com).**

## **IMPORTANT!**

**Please Keep Your Instructions!** (You will need your Model number should you need to contact us.) Before attempting assembly, please read through this instruction book to familiarize yourself with all the parts and assembly steps. We recommend that two adults assemble this game. Please refer to the Parts Identifier on the following page and be sure that all parts have been included. This product is manufactured according to the ITTF standards (International Table Tennis Federation), and includes national and international patents. Be careful not to over tighten any screws, nuts or bolts.

DMI Sports Inc. warranties this product for one year from the purchase date for any manufacturing or material defect. High-density chipboard is warranted for one year from date of purchase. Although we at DMI Sports are dedicated to giving our customers the highest quality products, occasionally a part may be missing. If you are missing a part, or if you have any questions, please call our customer service department at 1.800.399.4402 Mon-Fri between the hours of 9:00am and 5:00pm E.S.T; or you can reach us at: [www.dmisports.com](http://www.dmisports.com).

Do not return the game to the store. Please contact us first at: 1.800.423.3220 or on our website at: [www.dmisports.com](http://www.dmisports.com).

## **TWO ADULTS ARE REQUIRED TO ASSEMBLE THIS TENNIS TABLE**













**TOOLS REQUIRED FOR ASSEMBLY:**

- Phillips Head Screwdriver (or Electric Screwdriver) **Not Included**
- Wrench Set - **Not Included**
- Hammer - **Not Included**

**PARTS IDENTIFIER**

**HARDWARE PARTS - Parts are NOT represented to scale)**



















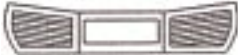

H1	Qty. 4	H2	Qty. 8	H3	Qty. 20	H4	Qty. 4
							
5/16" Large Bolt TTPH115		5/16" Small Bolt TTPH116		5/16" Washer TTPH119		5/16" Hex Nut TTPH117	
H5	Qty. 8	H6	Qty. 4	H7	Qty. 4	H8	Qty. 4
							
5/16" Wing Nut TTPH118		Large Lock Nut TTPH120		1/4" Phillips Screw TTPH107		1/4" Hex Nut TTPH114	
H9	Qty. 4	H10	Qty. 4				
							
#10 Tek Screw TTPH099		3/8" Washer TTPH130					

**NOTE:** The following parts are pre-assembled items and listed as replacement items only. Please refer to the Parts Re-Order Form on the last page of this manual should you find the need to replace these and all other parts.

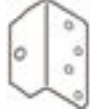
- RPPT400-TTPH112 (8) M6 x 16 screws are used to attach the Crossbar TTPM107 to the Outer Legs TTPM106
- RPPT400-TTPH122 (8) #12 x 24 screws and RPPT400-TTPH113 (8) #12 Hex Nuts are used to attach the Outer Legs TTPM105 to the TTPM11 L and TTPM111R Leg stays in addition to the TTPM110 angle bracket.

## PARTS IDENTIFIER

### ASSEMBLY PARTS

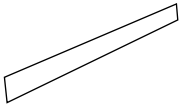
P1	Qty. 8	P2	Qty. 4	P3	Qty. 2	P4	Qty. 1
							
Plastic Wheel TTPP101		Wheel Bracket TTPP102		Table Frame TTPM102		Cross beam TTPM103	
P5	Qty. 4	P6	Qty. 2	P7	Qty. 4	P8	Qty. 4
							
Short Brace TTPM104		Plastic Ball Holder TTPP104		Safety Catch Ring TTPP107		Safety Catch TTPP108	
P9	Qty. 2	P10	Qty. 2	P11	Qty. 4	P12	Qty. 4
							
Net Holder TTPP110		Carriage Tray TTPP105		Plastic Leg Caps TTPP113		Frame Plastic Cover TTPP117	
P13	Qty. 4	P14	Qty. 1	P15	Qty. 2	P16	Qty. 12
							
Guide Plastic Cover TTPP118		Nylon Net TTPP119		1/2 Assembled Acekit RSPACEKIT-HALF		Table Bracket, Metal TTPM110	
P17	Qty. 4	P18	Qty. 2	P19	Qty. 2	P20	Qty. 2
							
Safety Catch Support TTPP111		Outer Leg TTPM105		Leg Cross Bar TTPM108		End Apron TTPM124	
P21	Qty. 4	P22	Qty. 4	P23	Qty. 2	<p><b>NOTE: P8, P23 and P16 through P21 come pre-assembled to P15. They are only listed here as replacement parts should there be a problem with them.</b></p>	
							
Side Apron TTPM125		Plastic Corner TTPP122		Edge Support TTPM129			

# Prince Match FSA - Code: PT400 - Assembly Instructions

**STEP 1.** Separate all parts according to the assembly steps.

**STEP 2.** (Fig. 2.1) Locate two (P3) carriage pieces (Tabel Frame) and attach (P2) into the base holes provided using assembly hardware parts (H6) and (H10). Attach two (P1) wheels to (P2) wheel bracket using (H1) and (H4). (If too tight, the wheels will not spin) Repeat this step for the remaining wheels. There will be four double wheels when Step 2. is complete. Washer (H11) can be found with Plastic Corners (P22) within seperate bag in packaging.

**DO NOT OVER TIGHTEN BOLTS AT PIVOT POINT (H6).**

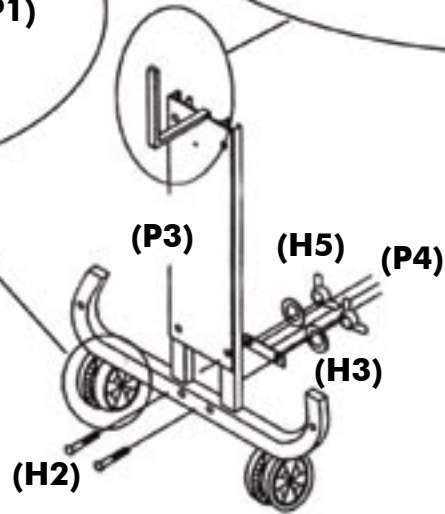
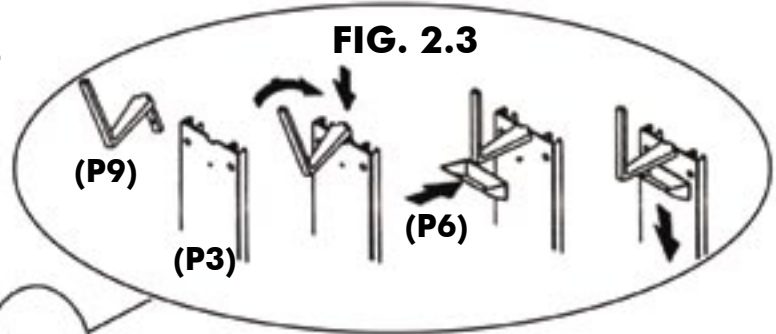
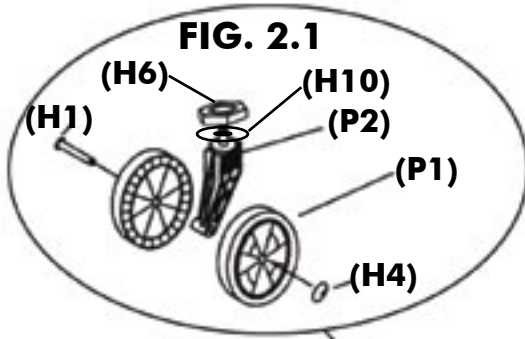

**IMPORTANT!**  
Press (Wheel Assembly) into carriage as indicated in FIG. 2.2 and bolt to carriage frame with lock nut (H6).

**FIG. 2.2**

**STEP 3.** **IF NOT PRE-ASSEMBLED** (Fig. 3.1) attach the metal ring (P7) to the end (hole) of each safety catch (P8). Make sure the safety catch works properly by pulling the metal ring.

**Attach Plastic Corners** using an (H9) screw, attach the (P22) plastic corners to the pre-assembled end and side aprons.

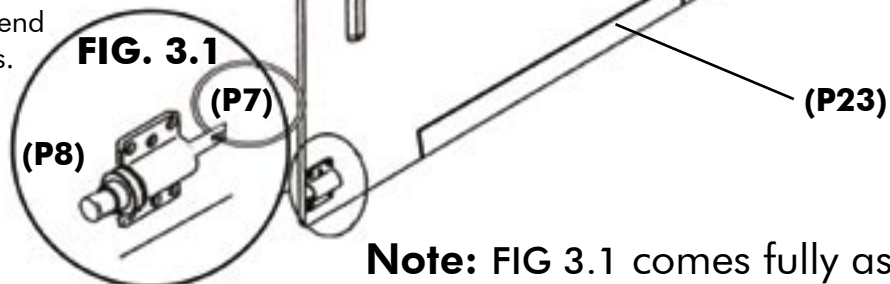

**Note:** FIG 3.1 comes fully assembled to (P15).

**Note:** Illustrations for Step 4. are on the following page.

**STEP 4.** **(Fig. 4.1)** With two adults, lift table as shown. One side at a time, fit the shoulder of the safety catch into the track of the frame **(P3)**. Lower the table as you depress the spring loaded plunger on the safety catch. Following the track, the plunger will locate in the uppermost holes. While continuing to support the table, depress the plungers again on both sides and lower the table until the plungers snap into the lower holes. Maintain a hold of the table top until both braces **(P5)** have been attached. Repeat this step for the other side.

**(Fig. 4.2)** Find the plastic tabs on the carriage tray **(P10)** and attach to carriage **(P3)**.

**(Fig. 4.3)** With bolts **(H2)**, wing nuts **(H5)** and washers **(H3)**, attach the brace **(P5)** to the carriage frame. Find screws **(H7)**, washers **(H3)** and nuts **(H8)** and fasten each brace **(P5)** to the table bracket **(P16)**. Insert plastic cap **(P12)**.  
**DO NOT OVER TIGHTEN THIS PIVOT POINT.**

**(Fig. 4.4)** Closed position.

**(Fig. 4.5)** Insert the frame guide plastic cover **(P13)** in the carriage frame channels **(P3)**.  
AFFIX BOTH SIDES OF THE NET AT THE SAME TIME GRADUALLY.

**Note:** When inserting plastic caps or covers (P11, P12 and P13) gently hammer into place.

## Care and Maintenance

### Cleaning your table

Use a soft damp (not wet) cloth only. DO NOT USE ANY CHEMICALS, ABRASIVE OR CLEANING PRODUCTS on the playing surface.

### Maintenance of you table

All moving parts must be oiled including the pivot points. This will insure ease of use and safety of your table.

This table must be stored indoors to avoid damage to the surface. The dampness and temperature changes can cause wood to warp, swell or blister.

# Prince Match FSA - Code: PT400 - Assembly Instructions

## STEP 4. Illustrations

**FIG. 4.1**

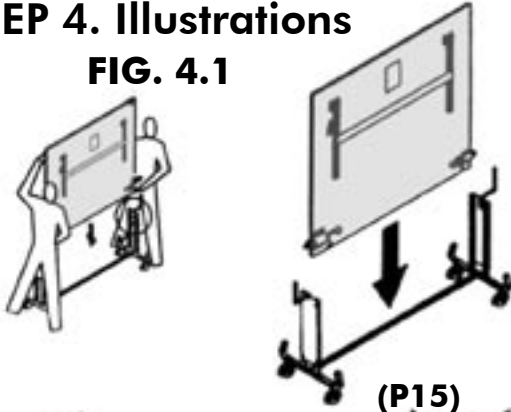

**FIG. 4.1.B**

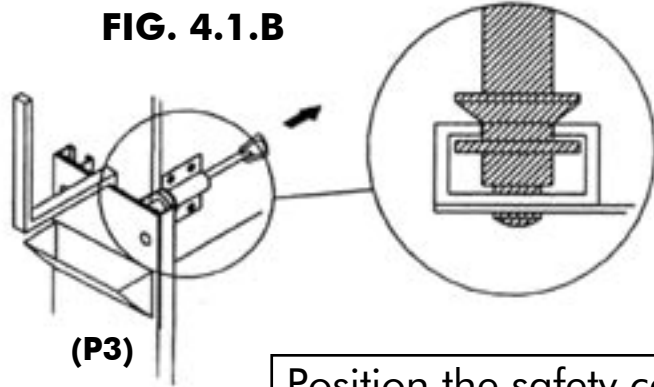

Position the safety catch device in the carriage frame channels as seen in FIG. 4.1.B

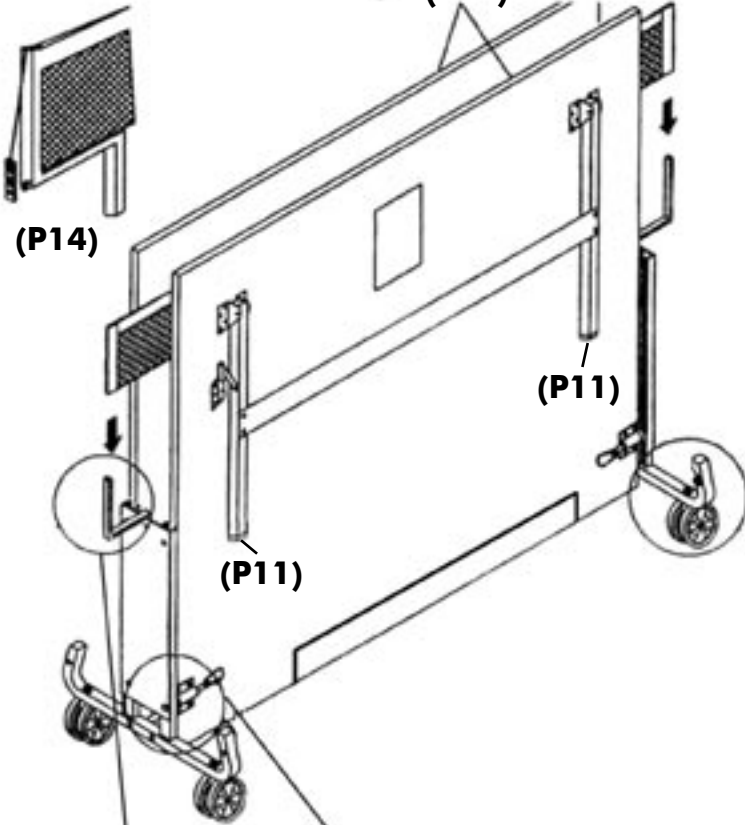

**FIG. 4.2**

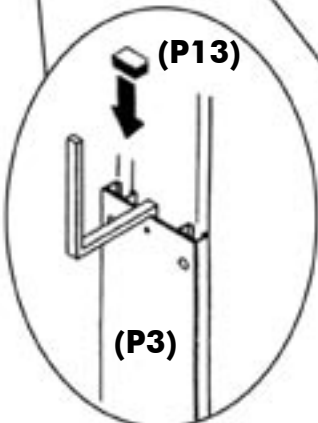
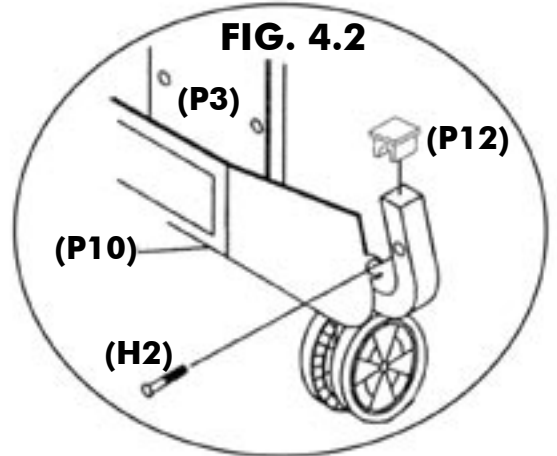

**FIG. 4.5**

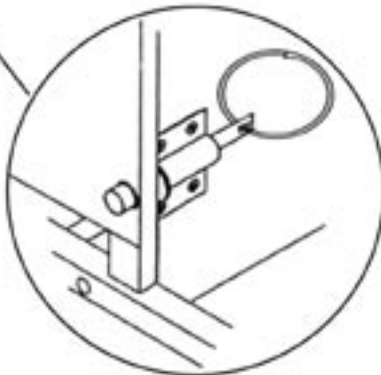

**FIG. 4.4**

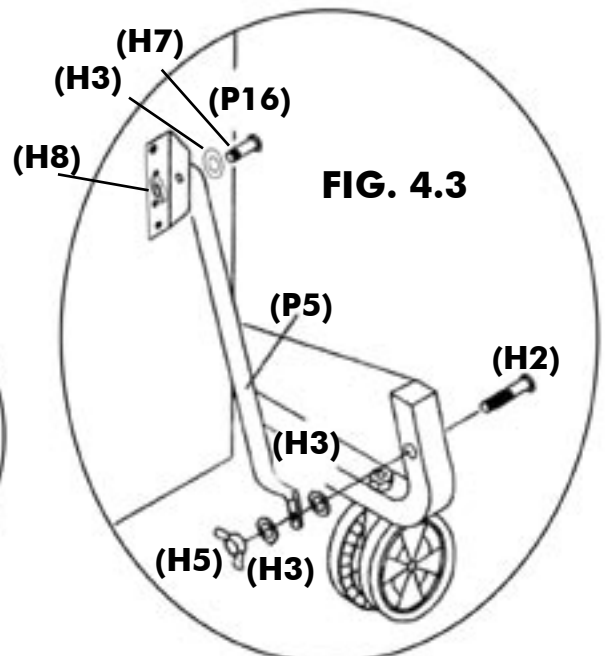

**FIG. 4.3**

**DO NOT OVER TIGHTEN BOLTS AT PIVOT POINT (H8) and (H5).**

## APPLYING LABELS

The very last step in completing the assembly of your new Prince Table Tennis table involves applying the labels to the proper locations on the table. There are four types of labels to be applied.

#1 is the Style label. There are four style labels. Each of the four labels are applied to the four corners of the tables side aprons as shown below.

#2 is the Crossbar label. There are two crossbar labels. Each crossbar label is applied to each of the two crossbars on your table as shown below.

#3 is the Carriage Tray label. There are two tray labels. One of each of these labels will be applied to each carriage tray on your table.

#4 is the Table Frame label. There are two table frame labels. Each of these labels will be applied to the two table frames as shown below.

The labels represented here are not of actual size or color.

**Note:** It is recommended that you write the model number on the under-side of this table for future reference.







## RECOMMENDATION OF USE AND PRECAUTIONS

**Anyone using or handling this table tennis table must always follow the illustrated instructions attached to the back of the board and be fully aware of the operating instructions.**

1. Handling the table, (Assembly, open, close or to store) should always be done by two adults to prevent accident or injury.
2. Be sure that no persons or objects are in the way of the boards when opening the table.
3. Do not put heavy objects on the table.
4. Do not sit on the table.
5. Do not clean the table with solvents or any other aggressive product because it could damage the paint finish.
6. Do not use sharp objects on the board or painted surface.
7. If the table is used for purposes other than playing table tennis, cover the surface to prevent any damage.
8. Request proof of purchase and keep it during the warranty period.
9. Under no circumstances is the manufacturer responsible for direct or indirect damages including loses of benefits or any other commercial damage occurred by the use of the purchased product.
10. The functioning and storage of this product should always be supervised by an adult.
11. Do not store or handle the table on an unstable floor surface.
12. If safety device malfunction occurs, secure table tops until the problem is solved.
13. To extend the life of this product, (outdoor table or indoor table) protect it from moisture or severe climate changes.

**NOTE:** Although we at DMI Sports are dedicated to giving our customers the highest quality products, occasionally a table may be damaged in shipping. If you find that it is necessary to return your table to DMI Sports, please repack the table as shown here.



**PARTS RE-ORDER FORM**

**PT400 Table Tennis Table**

Send this form along with your check or money order payable to:

**DMI SPORTS**

375 Commerce Drive  
Fort Washington, PA 19034  
[www.dmisports.com](http://www.dmisports.com)

DATE: \_\_\_\_\_

NAME: \_\_\_\_\_

ADDRESS: \_\_\_\_\_ PHONE: \_\_\_\_\_

CITY: \_\_\_\_\_ STATE: \_\_\_\_\_ ZIP CODE: \_\_\_\_\_

REF.	QTY	PART#	DESCRIPTION	UNIT PRICE	TOTAL AMOUNT
H1		TTPH115	5/16" Large Bolt (ea.)	1.00	
H2		TTPH116	5/16" Small Bolt (ea.)	1.00	
H3		TTPH119	5/16" Washer (ea.)	.50	
H4		TTPH117	5/16" Hex Nut (ea.)	.50	
H5		TTPH118	5/16" Wing Nut (ea.)	.50	
H6		TTPH120	Large Lock Nut (ea.)	.50	
H7		TTPH107	1/4" Phillips Screw (ea.)	.50	
H8		TTPH114	1/4" Hex Nut (ea.)	.50	
H9		TTPH099	#10 Tek Screw (ea.)	.50	
P1		TTPP101	Plastic Wheel (ea.)	2.50	
P2		TTPP102	Wheel Bracket (ea.)	2.50	
P3		TTPM102	Table Frame (ea.)	20.00	
P4		TTPM103	Cross beam (ea.)	20.00	
P5		TTPM104	Short Brace (ea.)	10.00	
P6		TTPP104	Plastic Ball Holder (ea.)	4.50	
P7		TTPP107	Safety Catch Ring (ea.)	1.00	
P8		TTPP108	Safety Catch (ea.)	5.00	
P9		TTPP110	Net Holder (ea.)	5.00	
P10		TTPP105	Carriage Tray (ea.)	7.50	
P11		TTPP113	Plastic Leg Caps (ea.)	1.00	
P12		TTPP117	Frame Plastic Cover (ea.)	1.00	
P13		TTPP118	Guide Plastic Cover (ea.)	1.00	
P14		TTPP119	Nylon Net (ea.)	9.50	
P15		RSPACEKIT-HALF	1/2 Assembled Acekit (ea)	175.00	
P16		TTPM110	Table Bracket, Metal (ea.)	8.00	
P17		TTPP111	Safety Catch Support (ea.)	3.00	
P18		TTPM105	Outer Leg (ea.)	15.00	
P19		TTPM108	Leg Cross Bar (ea.)	15.00	
P20		TTPM124	End Apron (ea.)	12.00	
P21		TTPM125	Side Apron (ea.)	12.00	
P22		TTPP122	Plastic Corner (ea.)	3.00	
P23		TTPM129	Edge Support (ea.)	12.00	
		TTPH112	M6 x 16 Screw (ea.)	1.00	
		TTPH122	#12 x 24 Screw (ea.)	1.00	
		TTPH113	#12 Hex Nut (ea.)	1.00	
		TT400LABELS	Match Label Sheets (1 of 2) (ea.)	4.50	
<b>SHIPPING AND HANDLNG:</b>				<b>Subtotal:</b>	
<b>Up to \$15.00 add \$2.00 for S&amp;H</b>				<b>Shipping and Handling Charges:</b>	
<b>Over \$15.00 CALL</b>				<b>(PA Residents Add 6% State Sales Tax:) TOTAL:</b>	