

YOU MUST
SUBSCRIBE TO
YOUR NETWORK'S
CALLER DISPLAY SERVICE
BEFORE YOUR BT PAPERJET 300
WILL DISPLAY CALL INFORMATION



This product is intended to be connected to analogue networks and private switching systems in the United Kingdom.

This product has not been designed for making emergency telephone calls when the power fails. Alternative arrangements should be made for access to emergency services.

PaperJet 300

Multifunctional 6 in 1 Phone, Fax,
Copier, PC Scanner, PC Faxing and Colour Printer

**User
Guide**

**Please open this page for an 'at a glance'
guide to your PaperJet 300**

Please open this page for a 'further at a glance' guide to your PaperJet 300

At a glance

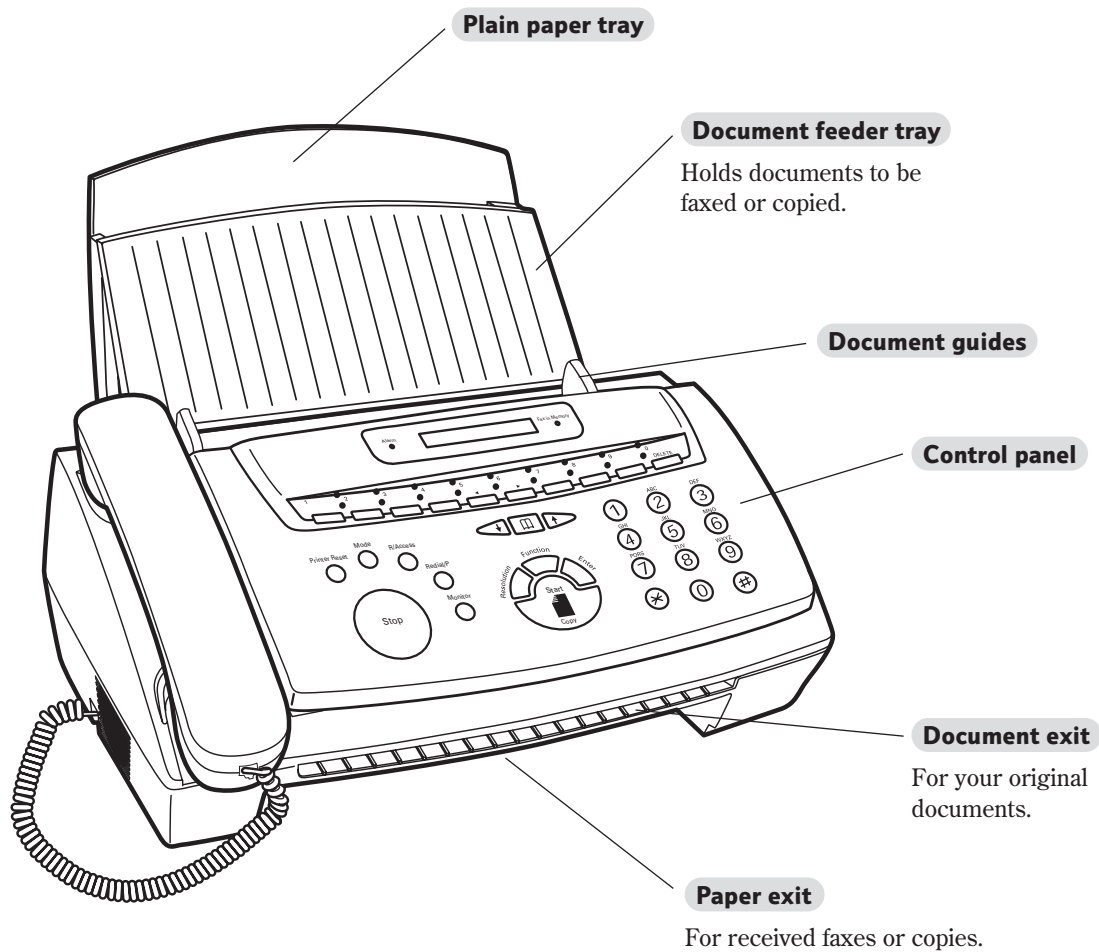

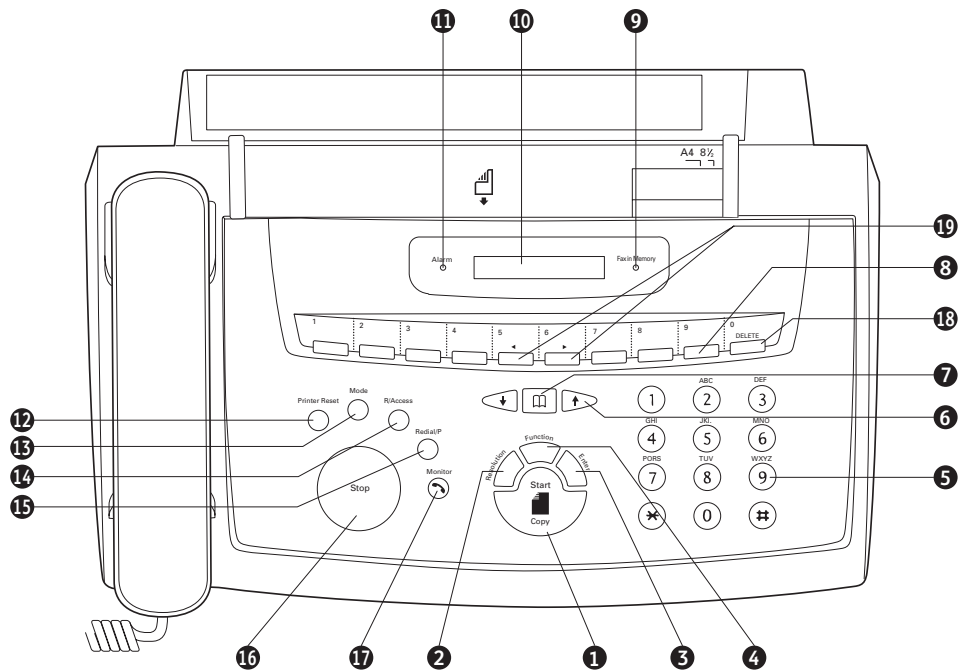
**1. Start/Copy**

Press to start sending a fax or for manual fax reception.
Press to copy a document.

2. Resolution

Selects scanner resolution.

3. Enter

Press to confirm selections.

4. Function

Used when selecting programming functions.

5. Keypad**6. ↑↓**

Scroll through names and numbers stored in the directory and Calls list. When entering names, switches between upper and lower case letters and numbers.

7. Directory

Lets you search for an entry by initial letter or by scrolling.

8. One Touch Memory Buttons

For storing names and numbers to be dialled.

9. Fax in memory

Lights up when a fax is received into the memory.

10. LCD Display

Shows date, time and operation instructions.

11. Alarm

Lights up when an error occurs.

12. Printer Reset

Press to cancel a print error message.

13. Mode

Sets the reception mode.

14. R/Access

For use when connected to a switchboard and for some exchange line features.

15. Redial/Pause

Press to redial the last number.
Inserts a pause when dialling or storing a number.

16. Stop

Stops sending or receiving a fax and copying.
Used to cancel programming operations.

17. Monitor

Lets you hear the progress of a call without lifting the handset.

18. Delete

Used to delete characters when entering/editing names and numbers.

19. Memory buttons 5 and 6

Moves the cursor left and right when entering/editing names and numbers. Also used to display calls data in the directory.

Left side view

Ringer volume

Off, Medium, High.

Monitor volume

Adjusts the speaker volume between Low, Medium and High when handsfree dialling or monitoring a call.

Handset cord socket

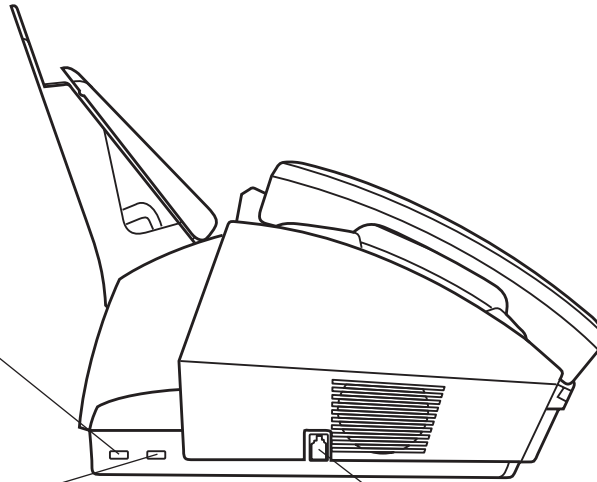

Back view

Mains power cable

Parallel printer socket

Telephone line cord socket

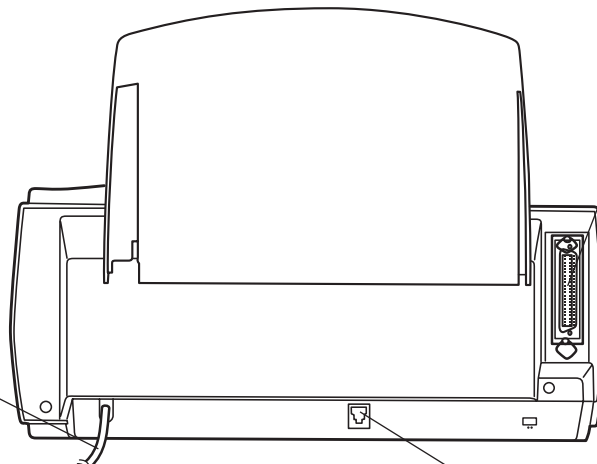

Inner view

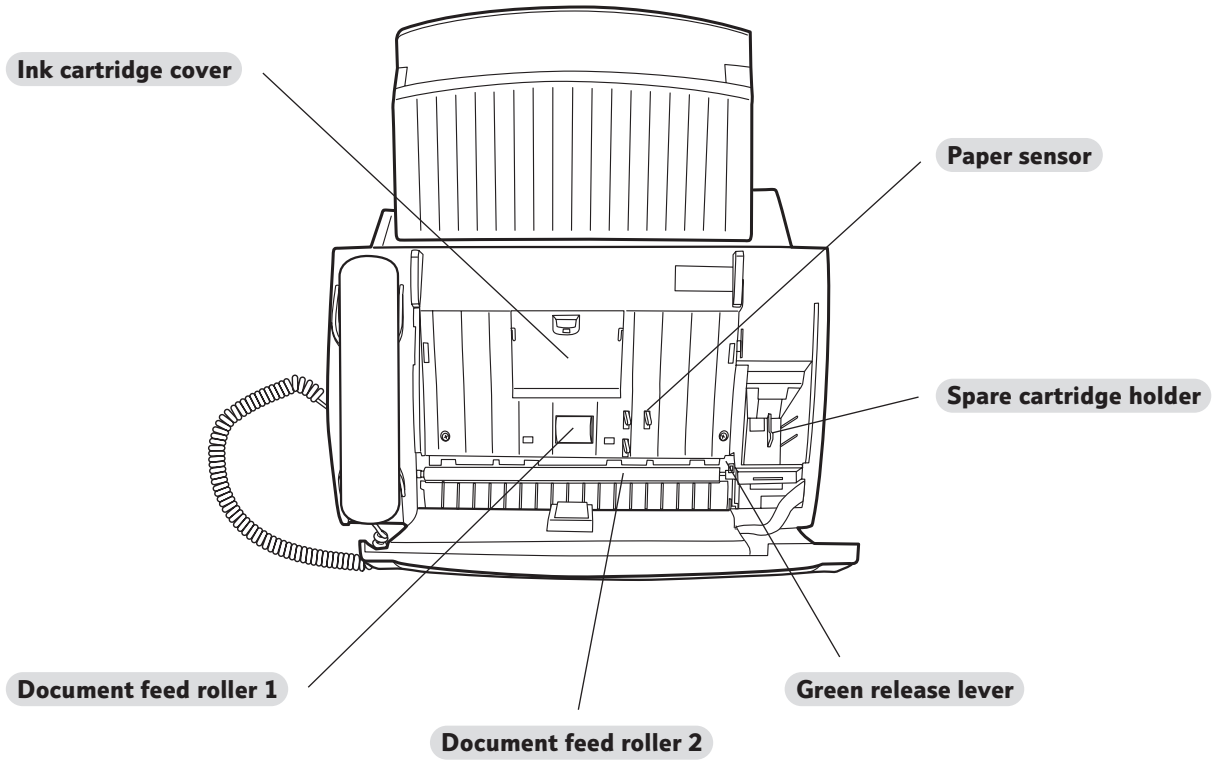

Key features

Plain paper fax, copier and phone

Send faxes to multiple destinations or set documents to be sent at a later time to take advantage of lower cost call charges. Quality ink jet printing of received faxes onto plain paper.

As a plain paper photocopier, the PaperJet 300 lets you make up to 99 copies of an original document up to 20 pages long.

Connects to a PC for faxing and printing

Send faxes direct from your computer screen and display received faxes on-screen with the option to print if desired. Easy change cartridges let you print from a PC in mono or colour.

One Touch buttons and Directory memory

Store your 10 most frequently used numbers for dialling at the touch of a single button. The Directory also holds up to 50 names and numbers making dialling easier and quicker.

Automatic redial

If a fax fails to get through (e.g. the line is busy) PaperJet 300 will make up to two automatic redial attempts every three minutes.

Memory

If the paper or ink cartridge runs out, incoming faxes can be received into the memory to be printed when you add paper.

In this guide

<i>At a glance</i>	2	<i>Connecting to a PC</i>	34
<i>Key features</i>	6	<i>PC software</i>	34
<i>Introduction</i>	8	<i>Opening the printer driver</i>	35
<i>Unpacking your PaperJet 300</i>	8	<i>Fax software</i>	36
<i>For your records</i>	8	<i>Faxing and scanning</i>	36
<i>Safety information</i>	9	<i>Switching between mono and Colour cartridges</i>	37
<i>General</i>	9	<i>Additional features</i>	39
<i>Environmental</i>	9	<i>Reports and lists</i>	39
<i>Cleaning</i>	9	<i>Printing activity reports</i>	39
<i>Customer Helpline</i>	9	<i>Delayed fax report</i>	40
<i>Setting up</i>	10	<i>Broadcast fax report</i>	40
<i>Using your PaperJet 300</i>	16	<i>Optional settings</i>	41
<i>Entering names and numbers</i>	16	<i>Connecting to a switchboard</i>	46
<i>One Touch memories</i>	17	<i>Help</i>	47
<i>Directory</i>	18	<i>Error codes</i>	49
<i>Sending faxes</i>	21	<i>Document jam</i>	50
<i>Receiving faxes</i>	24	<i>Paper jam</i>	50
<i>Delayed faxing</i>	26	<i>Replacing the ink cartridge</i>	51
<i>Broadcast faxing</i>	27	<i>Aligning the print cartridge</i>	53
<i>Polling reception</i>	28	<i>Wiping the print nozzles and contacts</i>	55
<i>Voice request</i>	28	<i>Cleaning</i>	56
<i>Using the phone</i>	29	<i>General information</i>	57
<i>Connecting an answering machine</i>	30	<i>Guarantee</i>	57
<i>Making copies</i>	31	<i>Helpline</i>	57
<i>Caller Display</i>	32	<i>Technical information</i>	58
		<i>Memory capacity</i>	60
		<i>Index</i>	61

Introduction

Unpacking your PaperJet 300

If anything is missing, please contact your place of purchase immediately

PaperJet 300 fax

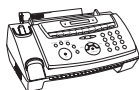

Handset



Plain paper tray

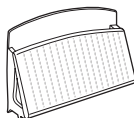

Black ink cartridge



PC cable



Telephone line cord
with piggy back socket



PC Fax and Print
software CD



For your records

Date of purchase:

Place of purchase:

Serial number:

For guarantee purposes proof of purchase is required so please keep your receipt

Safety information

General

Never put foreign bodies into the fax machine. Their accidental contact with electrical parts may cause a fire or electric shocks.

If you have a problem with the machine, do not try to repair it yourself.

Environmental

Install your machine on a stable, smooth and flat surface

Do not block or cover any of the openings on the machine.

Avoid placing your PaperJet 300 in direct sunlight, beside an air conditioner or where it is dusty or damp.

Do not step on or place anything on the mains power cable.

Do not stand your fax machine on carpets or other surfaces which generate fibres, or place it in locations preventing free flow of air over its surfaces.

Do not submerge any part of your machine in water and do not use it in damp or humid conditions such as bathrooms.

Do not expose your fax machine to fire, explosive or other hazardous conditions.

There is a slight chance that your fax machine could be damaged by an electrical storm. We recommend that you unplug the power and telephone line cord for the duration of the storm.

Cleaning

Clean the cover of control panel with a damp, not wet cloth. A mild detergent can be used. To clean the document feed rollers, see page 56.

Customer Helpline

If you have any problems with your PaperJet 300 call the BT Helpline on **0845 0500 950**.

Setting up

1 Plan the location of your PaperJet 300

Place your PaperJet 300 on a stable, flat surface. Make sure it is close enough to the telephone and mains power sockets so that cables will reach.

Remember to leave enough room at the front of the machine for documents to come out. Allow a free flow of air around the machine for ventilation.

2 Fit the plain paper tray into the two slots on the PaperJet 300

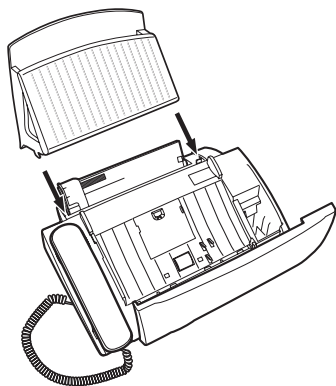

3 Connect the handset

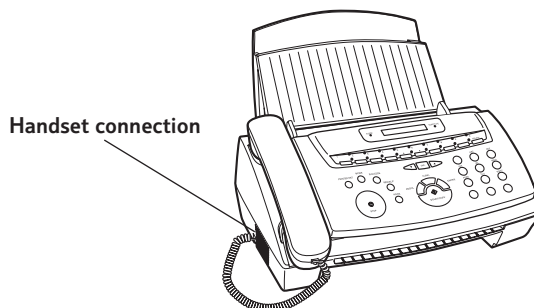

Plug the handset cord into the socket marked **HANDSET** at the side of the machine. Place the handset in the cradle.

4 Connect the telephone line cord

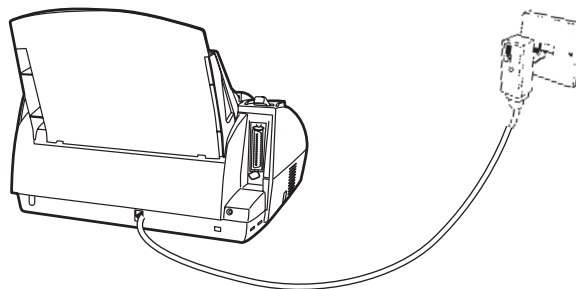

Plug the telephone line cord into the socket marked **LINE** at the back of the machine. Connect the other end to the telephone wall socket.

5 Connect the mains power

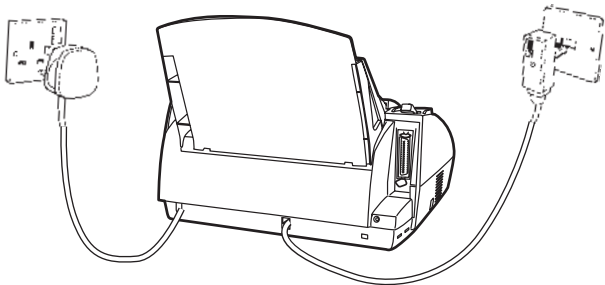

Plug into the mains power and switch on.
Your PaperJet 300 displays:



8 Load paper

The plain paper sheet feeder can hold up to 50 sheets of 80gsm paper.

NOTE

Your PaperJet 300 is set to print on A4 paper. To print exactly to fit US Letter (216 x 279mm) and US Legal (216 x 356mm) you will need to adjust the paper setting, see 'Optional Settings', page 41.

Pull open the front of paper tray.

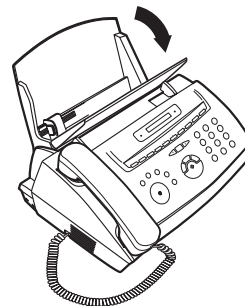

Fan the paper before loading.

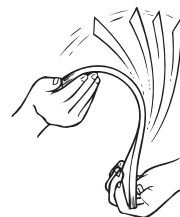

Align the paper with the right hand side of the paper tray and slide in the paper until it stops. Do not force the paper into the paper tray. Your PaperJet 300 prints on the side of the paper facing you.

Pinch the tabs on the paper guide together and move to the width of the loaded paper.

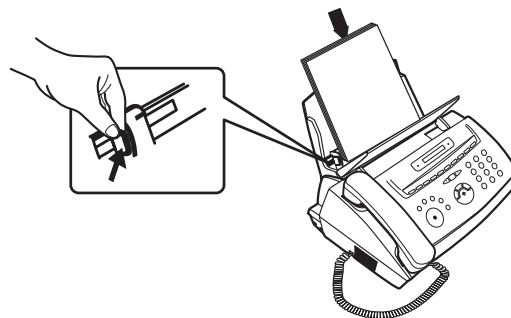

Close the paper tray.



6 Install the ink cartridge

Your PaperJet 300 is supplied with a black cartridge. You can also install a colour cartridge for colour printing from a PC.

CAUTION

Do not touch the print head on the ink cartridge. Do not rest the print head on any surface. Do not shake the ink cartridge.

Pull open the control panel.

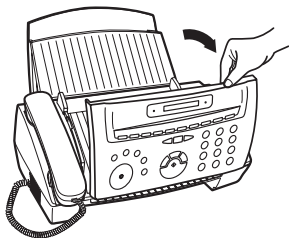

Open the cartridge cover.

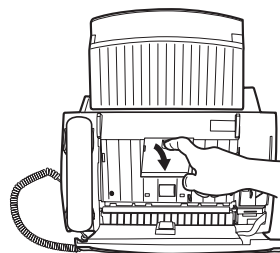

The ink cartridge carrier should have automatically moved to the centre position. If it has not moved, press the **Printer Reset** button.

Printer Reset



Holding it by the finger grip, peel the protective film from the print nozzles.

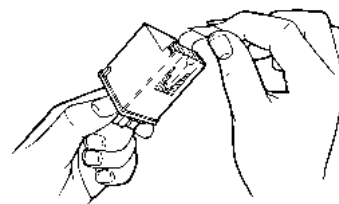

Avoid touching the nozzles and metal electrical contacts.

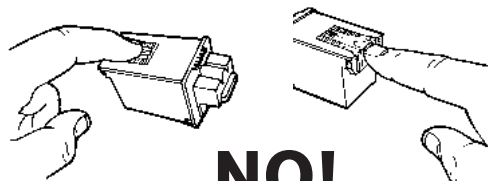

NO!

Insert the ink cartridge into the cartridge carrier with the metal contacts facing away from you.

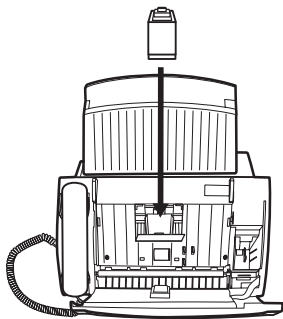

Push the ink cartridge towards the back of the machine until it clicks into place.

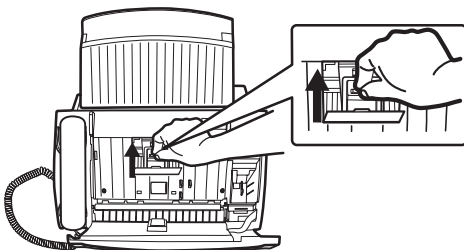

Close the cartridge cover and control panel

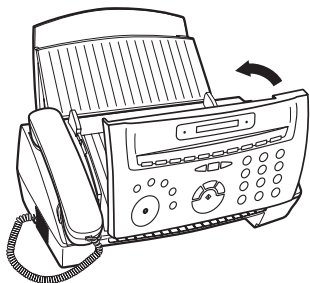

Display shows:



Function



Press **Function** to display NEW CARTRIDGE?



Press **Enter**.

Display shows ALIGN CARTRIDGE?

7 Align the new cartridge



Press **Enter**. Display shows PRINTING.
The alignment chart is printed.

00-30

Enter the 2-digit number beneath the straightest line, e.g 12. *See page 53 for full details.*



Press **Enter** to confirm. Screen shows the standby display with the date and time.

A full cartridge will print around 900 standard pages. *See page 60.*

9 Set the date and time

The current date and time will be included with every fax page you send.



Press the **Function** button until the display shows FAX SET UP?



Press **Enter**.

Display shows 1: SET CLOCK?



Press **Enter**.

Display shows the current settings.

KEYPAD

Use the keypad to enter the day, month, year and then the time using the 24 hour clock. For example, to set 4 August 2001 2.15 pm, enter **04 08 01 14 15**.



Press **Enter** to confirm.

You hear a confirmation beep.



Press **Stop** to return to standby.

NOTE

If you make a mistake, move the cursor to the position you want by pressing the ◀ and ▶ buttons, then enter the correct number.

NOTE

For connecting to a PC, see page 34.

10 Enter your name and fax number

Your name and number will be added to every fax page you send. You can set up to 20 characters and up to 20 digits.



Press the **Function** button until the display shows 5: FAX SET UP?



Press **Enter**.

Display shows 1: SET CLOCK?



Press **Function**.

Display shows 2: SENDER ID?



Press **Enter**.

Display shows SENDER NAME?

KEYPAD

Use the keypad to enter your name when the cursor appears.

For example to enter the name JOHN:



Press the **5** button until the display shows J



Press the **6** button until the display shows O



Press the **4** button until the display shows H



Press the **6** button until the display shows N



Press the **▲** or **▼** button to switch between capitals, lower case, letters and numbers.



Press the **▶** button twice to enter a space in a name.



Press **1** to enter & ' () , - .



Press the **Stop** button to cancel any instructions.



If you make a mistake entering a number or name press the **◀** and **▶** buttons to move the cursor then press the **Delete** button.





Press **Enter** to confirm.
Display shows **SENDER NUMBER**.

Enter your fax number.

When entering a number:

Press One Touch button **8** to insert a hyphen.

Press One Touch button **9** to insert a **+** as the first digit.

KEYPAD



Press **Enter** to confirm.
Display shows **PBX MODE OFF**.



Either: Press **Stop** to return to Standby.

Or: If connected to a switchboard set your switchboard access code now see *page 46*.

NOTE

Position of your fax header.

When you send a fax, your name, fax number, date and time will be shown at the top of the page inside the text area. To change this so that the header is printed outside the text area or to switch it off, see 'Optional Settings', page 41.

NOTE

Using the menu.

There are two methods to access menu options.

1. Press the **Function** button repeatedly to scroll to the option you want then press **Enter**, e.g. to begin entering the sender ID, press **Function 5** times, then **Enter**, then **Function**, then **Enter**.

or

2. Press the **Function** button then enter the number corresponding to the menu option you want e.g. to begin entering the sender ID, press **Function**, then **5**, then **Enter**, then **2**, then **Enter**.

*If you are accessing the **SETTINGS** menu, you will notice that all options have 2 digit numbers (see pages 41 to 44). To select, you must always enter both digits. e.g., for **TIMER REDIAL** enter 0 and 5.*

Using your PaperJet 300

Entering names and numbers

You can store names and numbers in the One Touch buttons and Directory.

How to use the keypad to enter a name

Use the keypad enter a name:

For example to enter the name JOHN:

JKL

5

Press the **5** button until the display shows J

MNO

6

Press the **6** button until the display shows O

GHI

4

Press the **4** button until the display shows H

MNO

6

Press the **6** button until the display shows N

1

Press **1** to enter & # ' () , - .



To move the cursor to the next space, press the **▶** button



To switch between capital letters, lower case letters and numbers, press the **▲** or **▼** button. The current setting is shown in the right hand side of the display.



If you make a mistake, press the **◀▶** buttons to move the cursor to the character you want to change, then press **Delete** and enter the correct letter.



press **Delete** and enter the correct letter.



To cancel, press **Stop**.

If you do not press any button for more than a minute, the display returns to standby.

How to use the keypad to enter a number

Use the keypad to enter numbers:



To enter a hyphen, press the **One Touch 8** button



If you make a mistake, press the **◀▶** buttons to move the cursor to the digit you want to change, then press **Delete** and enter the correct number.



To cancel, press **Stop**.

Redial/P



To enter a 3 second pause in a number, press the **Redial/Pause** button where required. A P will be shown in the display.

R/Access



If connected to a switchboard press **R/Access** to enter your access code at the start of the number. This means you won't have to press it every time you dial the number.

NOTE

You will first need to program your access code, see page 46.

NOTE

If you do not press any button for more than a minute, the display returns to standby.

One Touch memories

You can store up to 10 of your most frequently used numbers and dial them by pressing a single button. Each one touch memory can store up to 16 characters and 32 digits.

To store a One Touch entry

Press **Function**.

Display shows 1: STORE MEMORY



Press **Enter**.

Display shows MEMORY = 1?

Press the **One Touch** memory you want to use. Display shows the memory number



Press **Enter** to confirm.

KEYPAD

Enter the name.

For details, *see page 16*.



Press **Enter** to confirm.

KEYPAD

Enter the number you want.

For details, *see page 16*.



Press **Enter** to confirm. You hear a confirmation beep.

Display shows the next **One Touch** button. You can now add another entry.



Press **Stop** to return to standby.

To dial a One Touch entry

If sending a fax:

Load the document.

Press the **One Touch** button you want.

Making a phone call:

Lift handset (or press **Monitor**).

Press the **One Touch** button you want.

**To edit a One Touch entry**

Press **Function**.

Display shows 1: STORE MEMORY



Press **Enter**.

Display shows MEMORY = 1?

Press the **One Touch** button you want to change.



Press **Enter**.

Display shows the name and :CHANGE.



Press **Enter** and edit the name.



Press **Enter** to confirm and then edit the displayed number.



Press **Enter** to confirm.

You hear a confirmation beep.

You can now edit another entry by pressing another **One Touch** memory button.



Press **Stop** to return to standby.

To delete a One Touch entry



Press **Function**.

Display shows 1: STORE MEMORY



Press **Enter**.

Display shows MEMORY = 1?

Press the **One Touch** button you want to cancel.



Press **Enter**.

Display shows the name and :CHANGE.



Press **Function**.

Display shows the name and :DELETE.



Press **Enter** to confirm. You hear a confirmation beep.

You can now delete another entry by pressing another **One Touch** memory button...



Press **Stop** to return to standby.

Directory

You can store up to 50 names and numbers in the Directory.

The Directory will automatically keep a list of all outgoing phone and fax calls you make (except those already stored in the One Touch buttons), so you can store a number already called and simply add a name to it.

Unless you deliberately store a number, the Directory only keeps a list of the latest numbers dialled up to a total of 50 numbers.

If you dial the same number more than once, your PaperJet 300 will only keep a record of the last time it is dialled. Once 50 different number have been listed, any new numbers will replace the oldest previous number.

You can delete entries from the Directory list, transfer them to One Touch buttons or store them as permanent entries.

NOTE

The Caller Display memory shares the Directory memory. So we recommend that you keep 5-10 entries free in order to allow a Caller Display to give you an incoming calls list of 5-10 entries.

To store a Directory entry

You can store up to 50 names and numbers in the Directory. These will remain there until you delete them. Each entry can have up to 16 characters and 32 digits.

Press **Function** until the display shows
2:SET DIRECTORY?



Press **Enter**. Display shows ENTER NUMBER

KEYPAD

Enter the number. For full details *see page 16*.



Press **Enter** to confirm.

KEYPAD

Enter the name. For full details, *see page 16*.



Press **Enter** to confirm.



Press **Enter** to confirm. You hear a confirmation beep.

Display shows ENTER NUMBER.
You can now add another entry.



Press **Stop** to return to standby.

To dial a Directory number

If sending a fax:

Load the document.



Press **▲** or **▼** to scroll to the entry you want.



Press **Start**. The document is scanned and the number is dialed.

Making a phone call:

Lift handset (or press **Monitor**).



Press **▲** or **▼** to scroll to the entry you want.



Press **Start**. The number is dialed.

To search for a Directory entry by name



Press **Directory**.

KEYPAD

Use the keypad to enter the first letter of the name.



Press **▼** to display the first name beginning with that letter and to scroll down the list.



Press **◀** or **▶** to display the rest of the entry.



Press **Stop** to return to standby.

To view the Directory by scrolling



Press **▲** or **▼** to scroll to the entry you want.



Press **◀** or **▶** to display the rest of the entry.



Press **Stop** to return to standby.

To edit a Directory entry



Press **▲** or **▼** to scroll to the entry you want.

If a name is displayed, press **▶** to display the number.



Press **Enter**.

The cursor is set to the first digit.

KEYPAD

Edit the number if required.



Press **Enter** to confirm.

KEYPAD

Edit the name.



Press **Enter** to confirm.



Press **Stop** to return to standby.

To transfer a Directory entry to a One Touch button



Press **▲** or **▼** to scroll to the entry you want.



Press **Function**.

Display shows **TRANSFER?** then **MEMORY?**

Press the **One Touch** button you want.



Press **Enter** to confirm. You hear a confirmation beep.

You can now transfer another entry by scrolling to a new phone or fax number.

The transferred entry is cleared from the Directory.



Press **Stop** to return to standby.

Adding a name to a number in the Calls list



Press **▲** or **▼** to display the number.



Press **Enter** twice. Display shows **ENTER NAME**. When cursor appears, enter the name.



Press **Enter**. The name and number are stored in the directory.



Press **Stop** to return to standby.

To delete a Directory entry



Press **▲** or **▼** to scroll to the entry you want.



Press **Delete**.



Press **Enter** to confirm. You hear a confirmation beep.

You can now delete another entry by scrolling to a new phone or fax number.



Press **Stop** to return to standby.

To view the Calls list

Your PaperJet 300 keeps a record of the calls you have made – providing there is spare capacity in the Directory.

Entries are listed in order of call frequency – the most called numbers are listed first.



Press **▲** or **▼**. Display shows the most frequently dialled entries first by name.



Press **◀** or **▶** once to display the phone/fax number.

Press again to display the number of times dialled and the last date and time you called the number.

For example, X 5 21 Dec 12:00 = Dialled 5 times, last called on 21st December at midday.



Press **▲** or **▼** to display the next most frequently dialled number.



Press **Stop** to return to standby.

NOTE

If you have subscribed to your network's Caller Display service, your PaperJet will also display a list of incoming calls. The length of the list depends on the available Directory memory. If all 50 entries are full, you will only see details of a current incoming call.

Sending faxes

Paper sizes: Width Length

Maximum: 216mm x 1.5m

Minimum: 184mm x 148mm

Paper weight

70gsm – 90gsm

Do not use

Torn, crumpled and rolled paper.

Paper that is too thin.

Wet or moist paper.

Correction fluid.

Carbon paper.

Make sure that any paperclips or staples have been removed from documents.

Make sure any correction fluid is dry.

Inserting documents in the feeder

Gently insert documents to be faxed or copied face down into the document feeder (up to 20 pages).

Adjust the paper feeder width guide to fit.

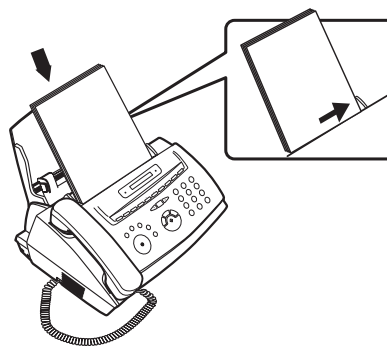

To set the resolution

You can choose different resolution settings to ensure the best quality when faxing or copying a document.

The available settings are:

STANDARD – for standard text documents.
This is also the fastest setting.

FINE – for documents with small type and drawings.

SUPER FINE – for text with very small characters and/or graphics.

PHOTO – for documents with varying shades of grey, such as photographs.

Load the document to be faxed or copied. The first page is pulled slightly into the machine. Display shows **STANDARD**.



Press the **Resolution** button to display the setting you want.

After each document, the setting automatically returns to **STANDARD** which is the default setting. You can change the default setting. See 'Optional Settings', page 41.

To set the contrast

When a document has been loaded, you can switch between

NORMAL – for normal contrast documents.

LIGHT – for very light documents which need to be sent or copied darker.

Your PaperJet 300 is pre-set to **NORMAL** and you shouldn't need to change it, but if the original document is very light or faint you can change the setting **LIGHT**.



Press **Function** until the display shows
5: FAX SET UP?



Press **Enter**.
Display shows 1: SET CLOCK?



Press **Function** until the display shows
3: SETTINGS?



Press **Enter**.
Display shows (01) PAUSE TIME

KEYPAD

Enter **28**. Display shows **CONTRAST**



Press **Enter**. Display shows the current setting **NORMAL** or **LIGHT**



Press the **Function** button to switch between **NORMAL** and **LIGHT**.



Press **Enter** to confirm the setting.



Press **Stop** to return to standby.

The setting is fixed until you change it.

To send a fax

Load the document face down.

Set the resolution and contrast if required.

Dial manually:

KEYPAD

Dial the number using the keypad.



Press **Start**. The document is scanned and the number is dialled.

One Touch number:



Press the **One Touch memory** button you want. The document is scanned and the number is dialled.

Directory number:



Press **↑** or **↓** to scroll to the entry you want.



Press **Start**. The document is scanned and the number is dialled.

To hear the progress of your call.

*If you want to hear the dialling tones and fax tones press the **Monitor** button before dialling the number. If you use this method the document will not be scanned into memory before sending.*

To stop a fax being sent

Stop

Press **Stop**. The fax is cancelled.

To redial the last number

If sending a fax:

Load the document.



Press **Redial**.

The document is scanned and sent.

Making a phone call:

Lift handset (or press **Monitor**).



Press **Redial**. The number is dialled

Automatic fax redial

If the number is engaged when sending a fax, your PaperJet 300 is set to redial two times, waiting approximately 3 minutes between tries. If you have set a delayed fax, it will redial three times.

Receiving faxes

Reception mode.

Your PaperJet 300 has three reception modes for receiving faxes and telephone calls.

To set reception mode

Mode



Press **Mode** to display the current setting. Repeated presses will switch between the options **MANUAL RECEIVE**, **AUTO RECEIVE** and **WITH ANS MACHINE**. The mode displayed is the one that is set.

Auto receive

Your PaperJet 300 answers each call after 5 rings and receives faxes automatically. If the call is a voice call, the phone will ring again for a further 5 rings (secondary ringing) and you can answer the call by picking up the handset. If you do not answer, the machine will try to receive the call as a fax. During secondary ringing the caller will hear a beep every 2 seconds to reassure them that the line is active.

You can adjust the number of rings your machine gives. See *'Optional Settings', page 41*.

If you are using your PaperJet 300 as a fax machine only, we recommend that you switch the second set of rings off. See *'Optional Settings', page 41*.

If you accidentally answer a fax call.

If you pick up the handset and you hear fax tones, simply press the **Start** button, replace the handset and the fax will be received.

Manual receive

When Manual mode is set, your PaperJet 300 rings like a normal phone until you answer it yourself.

If a voice caller wants to send a fax.

If the caller wants to send a fax after your conversation, press **START** on your PaperJet 300 and replace the handset.

If you hear fax tones.

Press **Start** to begin reception and replace the handset. The display shows **RECEIVING**.

With answer machine

Set this mode when you connect an answering machine to your PaperJet 300. Your answering machine will automatically take voice messages and PaperJet 300 will take faxes.

When your PaperJet 300 rings it will wait for the answering machine to take the call. If there are fax tones or no incoming voice message it will automatically try to receive a fax. Remember, it is advisable to say in your outgoing message that the caller can send a fax after the tone.

If the answering machine is switched off, your PaperJet 300 will answer the call after 7 rings. Your answering machine should be set to answer after less than 7 rings, see *Connecting an answering machine, page 30*.

Receiving faxes into the memory

If you run out of paper or the ink cartridge is empty, your PaperJet 300 will automatically store incoming faxes into the memory. The memory can store up to 20 pages of the standard letter, see *page 60*.

To print a fax stored in the memory

If you have received faxes into the memory the **Fax in memory** light flashes and the display shows the reason for the document not being printed normally – **PRINTER ERROR!**, **CHECK PAPER!** or **INK OUT**

Either add new paper, clear the jam or replace the ink cartridge accordingly.

Press **Printer Reset**. The fax stored in the memory will print out.

Clear a paper jam, *see page 50*.

Replace the ink cartridge, *see page 51*.

Printer Reset



Paper jam and out of ink warning:

If the plain paper jams or the ink cartridge runs out during printing, the display shows **CHECK PAPER** or **OUT OF INK**.

Clear the paper jam, *see page 50*.

Replace the ink cartridge, *see page 51*.

Then press **Printer Reset** to print out the document that has been stored in the memory.

Printer Reset



If the memory becomes full while there is paper in the paper tray:

This happens if the fax is too large for the PaperJet 300 to handle. Pages received before the memory became full will be printed but, you will need to ask the sender to re-fax the pages you have not received.

Very detailed pages or photos may need to be sent singly.

Power failure while a fax is stored in the memory:

If the power fails and a document is stored in the memory, the stored fax is lost. Your PaperJet 300 informs you with a power failure report giving details of any documents lost from memory. When the power is restored the display will show **MEMORY DATA LOST**.

Delayed faxing

Store a document of up to 20 standard pages in the memory for sending at a specific time within the next 24 hours. This lets you take advantage of lower call rates or coincide with time zone differences if sending to another country.

To send a delayed fax

Load the document face down.

Set the resolution and contrast if required.

Function



Press **Function** until the display shows
3: TIMED SEND?



Press **Enter**. Display shows START TIME:

KEYPAD

Enter the time you want the fax to be sent using the 24 hour clock, e.g. to start sending at 7.30pm, enter **19 30**.



Press **Enter**.

Display shows ENTER FAX NUMBER?

KEYPAD

Enter the fax number. You can also use **One Touch memory** buttons and **Directory** entries.



Press **Enter**. The document is scanned. Display then shows TIMED SND and the time you have set.

NOTE

If you have set the resolution to Photo and the scanning memory becomes full, try resetting with the resolution set to Standard, Fine or Superfine.

To cancel a delayed fax

Function



Press **Function** until the display shows
3: TIMED SEND?



Press **Enter**. Display shows CANCEL?



Press **Enter** to confirm. You hear a confirmation beep.

Display shows CANCELLED!

To change the time and/or number of a delayed fax

Function



Press **Function** until the display shows
3: TIMED SEND?



Press **Enter**. Display shows CANCEL?



Press **Function** until the display shows
CHANGE?



Press **Enter**. Display shows START TIME and the time currently set.

KEYPAD

Enter the new time.



Press **Enter**.

Display shows the fax destination.



Press **Delete** to delete the number.

KEYPAD

Enter the correct number. You can also use **One Touch** buttons or a **Directory** entry.



Press **Enter** to confirm. You hear a confirmation beep.

Display shows TIMED SND and the time set.

Broadcast faxing

You can store a document of up to 20 standard pages in the memory for faxing to up to 20 different numbers including One Touch and Directory entries.

To store a broadcast fax

Load the document face down.

Set the resolution and contrast if required.



Press **Function** until the display shows
4: BROADCAST?



Press **Enter**.

Display shows 0: NOW 1: LATER

0

Press **0** if sending now.

Display shows ENTER FAX NUMBER?

Or

1

Press **1** if you want to set a time for the fax to be sent. Display shows START TIME:

If sending now:

KEYPAD

Enter a number you want. You can dial the number using the keypad or enter a **One Touch** or **Directory entry**.



Press **Enter**.

Display shows ENTER FAX NUMBER?

KEYPAD

Enter the next number. Then press **Enter** and repeat up to a maximum of 20 numbers.



Press **Start**. Your PaperJet 300 scans the document and begins sending the fax to all the numbers you have set.

If sending later:

KEYPAD

Enter the time using the 24 hour clock, e.g to send at 7.30pm, enter **19 30**.



Press **Enter**.

Display shows ENTER FAX NO?

KEYPAD

Enter a number you want. You can dial the number using the keypad or enter a **One Touch** or **Directory entry**.



Press **Enter**.

KEYPAD

Enter the next number. Then press **Enter** and repeat up to a maximum of 20 numbers.



Press **Start**. Your PaperJet 300 scans the document you have set. Display shows E/CAST. and the time set for broadcasting.

NOTE

If you have set the resolution to Photo and the scanning memory becomes full, try resetting with the resolution set to Standard, Fine or Superfine.

To cancel a broadcast fax



Press **Function** until the display shows
4: BROADCAST?



Press **Enter**.

Display shows CANCEL?



Press **Enter**. Display shows CANCELLED!

Polling reception

You can set your PaperJet 300 to call another fax machine and receive a document from it. This is often known as Faxback. You may need to know the other machine's password in order to retrieve the document.

To poll a document



Press **Function** until the display shows
7: POLLING RX ?



Press **Enter**.

KEYPAD

If required, enter the other machine's password.



Press **Enter**.
Display shows ENTER FAX NUMBER?

KEYPAD

Enter the number for the other machine.



Press **Enter**. The number is dialled and the document is received. Display then returns to standby.



To cancel polling, press **Stop**.

Voice request

You can start a phone conversation after sending or receiving a fax.

To speak after sending or receiving a fax

While the fax is being sent:

Lift the handset. When the fax has finished, the other machine will beep to let the other person know you want to talk.

When the person at the other end responds, you can talk.

NOTE

If you lift the handset and replace it, the voice request is cancelled.

If the other person does not pick up their handset while the beeps are sounding – or if the other fax does not have a voice request function - the line will be disconnected.

To answer a voice request

If the person wants to talk, your PaperJet 300 beeps while the fax is being sent or received and the display shows **PHONE CALLING**.

Lift the handset and wait for the caller to respond.

Using the phone

You can use your PaperJet 300 to make and receive calls.

To make a phone call

Lift the handset

KEYPAD Use the keypad to dial the number you want.

Or

Press the **One Touch** button you want, the number is dialled.

Or



Press the **▲** or **▼** button to scroll through the Directory.



Press **Start** to dial.



To dial handsfree



Press **Monitor**. You hear the dialling tone.

KEYPAD

Use the keypad to dial the number you want.

Or

Press the **One Touch** button you want, the number is dialled.

Or



Press the **▲** or **▼** button to scroll through the Directory.



Start



Press **Start** to dial.

When the call is answered, lift the handset and talk.

To search and dial a Directory entry by name

Lift the handset.



Press **Directory** button.

KEYPAD

Use the keypad to enter the first letter of the name.



Press the **▼** button to display the first name beginning with that letter and to scroll down the list.

Start



Press **Start** to dial.

To redial a number

Lift the handset.

Redial/P



Press **Redial**. The last number called is redialled.

To receive a phone call

When the phone rings.

Lift the handset and speak.

If you hear fax tones, replace the handset after the display shows **RECEIVING**.

Connecting an answering machine

Your PaperJet 300 can work with an answering machine so that you can take voice and fax messages.

To ensure the two machines work together, the fax machine must be in **WITH ANS MACHINE** mode and the answering machine line cord must be connected into the socket on the back of the PaperJet 300's line cord doubler plug (as shown below).

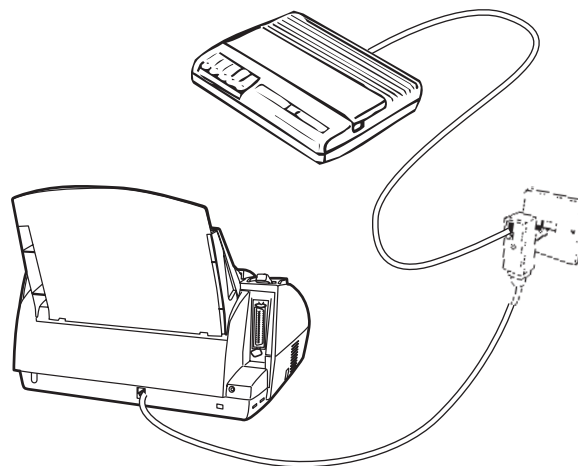

When set up like this, and a call comes in, your answer machine will always answer the call first. Your PaperJet 300 will monitor the call and take control if it detects that it is a fax call. If the answering machine fails to answer, PaperJet 300 will answer the call after 7 rings and prepare to receive a fax.

To set the receive mode

Mode



Press **Mode** to display WITH ANS MACHINE.

To set up the answering machine

You can choose the number of rings before your answering machine takes the call (refer to your answering machine's guide for instructions), it is recommended that you set the number of rings to between **2** and **4** and it must never be more than **6** rings.

For optimum performance, the outgoing message on the answering machine should be as short as possible and should not exceed the times shown below: -

No. of rings before answer m/c answers	Max length of outgoing message
2	14 seconds
4	8 seconds

Making copies

You can make up to 99 copies of an original document up to 20 pages long.

To make a single copy

Load the document face down.

Set the resolution and contrast, if required.

Press **Copy**.

Display shows NUM OF COPIES 01.



Press **Copy**. Display shows SCAN LEFT: 19.

The original is scanned and the copy printed.



To make multiple copies

Load the document face down.

Set the resolution and contrast, if required.

Press **Copy**. Display shows COPIES #01

Enter the number of copies you want.

Press **Copy**. The original is scanned and the copy printed.



KEYPAD



To copy a highly detailed original

A highly detailed document may be too much for the memory. By switching the ADF COPY setting on, you can set your PaperJet 300 to scan and copy at the same time.

This shows you how to switch ADF on and off.



Press **Function** until the display shows 5: FAX SET UP?



Press **Enter**.



Press **Function** until the display shows 3: SETTINGS.



Press **Enter**. Display shows (01) PAUSE TIME

KEYPAD

Press **Function** until display shows COPY MODE (or enter 2, 2 to go straight there).



Press **Enter**. Display shows MEMORY COPY.



Press **Function** to switch between the two options of ADF COPY and MEMORY COPY.



Press **Enter** to confirm.



Press **Stop** to return to standby.

NOTE

If there is not enough memory to scan all the original document, copy it in stages.

Copies are reduced to 97% of the original to prevent an original being copied onto two separate sheets.

Avoid using very smooth or slippery originals such as fax roll paper or transparencies as these could slip and the copy may run onto two pages.

On some types of paper the ink may take longer to dry. Be careful to ensure it does not leave marks on the original document.

Caller Display

Caller Display lets you know who's calling before you answer the telephone. Providing you have free space in the Directory, your PaperJet 300 will also show you a list of new and old calls you have received.

The number of calls in the list is limited by the number of free spaces in the 50 number Directory.

With a Caller Display service, your PaperJet 300 receives caller information which is transmitted over the telephone network.

To use this feature you will first have to subscribe to your network's Caller Display service. Ask your network provider for more information.

With Caller Display, your PaperJet 300 stores the caller's number if available, call date and time.

If you have stored the incoming number in the directory or one touch memory, the display will show the stored name.

IMPORTANT

The Caller Display memory shares the Directory memory. So we recommend that you keep 5-10 entries free in order to allow a Caller Display to give you an incoming calls list of 5-10 entries.

To view and dial from the Calls list

Details of calls received will be stored providing you have free space in the Directory memory. When you have new calls, the display shows **NEW CALL(S)**.



Press **▲** or **▼** to scroll through the Calls list. If you have new calls, these are shown first.



If the name is displayed press **▶** button:

- to display the caller's number
- the number of times the caller has rung (X2 = 2 calls)
- the date and time of the most recent call.

Press **Start** to dial the number displayed.

Or

Press **Stop** to return to standby.

**Caller information not available**

If you have subscribed to BT's Caller Display, you may see a text message if the number of your caller is not available.

The text message will be one of the following.

WITHHELD

The caller has stopped their number from being sent.

INTERNATIONAL

The call received was from outside the UK.

UNAVAILABLE

The caller's exchange/network does not offer a Caller Display Service.

OPERATOR

The call has come via the operator.

PAYPHONE

The caller is ringing from a payphone.

RINGBACK

The exchange is ringing to let you know that a previously engaged number is free.

NO CALLER INFO

If your PaperJet 300 does not recognise the information contained within the caller display message, it will not show a number.

Connecting to a PC

Your PaperJet 300 is supplied with software to enable you to manage faxes from your PC, to scan documents into your PC and to use it as a mono and colour printer. It also contains a detailed user guide for the faxing and scanning applications.

You are provided with a cable to enable you to connect your PaperJet 300 to the PC parallel printer port.

System requirements

Windows 95, 98, Me

16MB RAM, 486 processor or higher, 20Mb free space on the hard drive.

Windows 3.1

8MB RAM, 486 processor or higher, 20Mb free space on the hard drive.

Windows for Workgroups 3.11

10MB RAM (10Mb required by some applications), 486 processor or higher, 20Mb free space on the hard drive.

Loading the software

The procedures described here are written for Windows 9x and Windows Me. If you are running Windows 3.1x, there may be some differences.

Switch off your PC and PaperJet 300.

Connect the printer cable provided between your PaperJet 300 printer socket and the PC parallel printer port (LPT1)

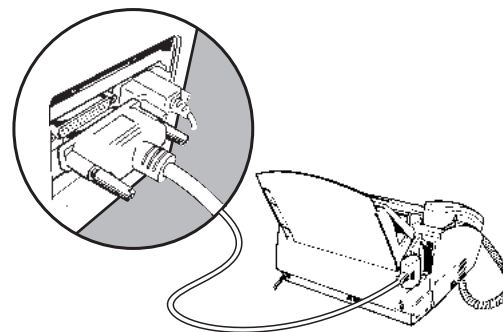

Switch on your PC and PaperJet 300

As your PC starts up, if it detects the PaperJet 300 (it will show as Colour MFP on your PC) and opens the Add New Hardware Wizard screen, you should click on Cancel to close the wizard.

Insert the PC Fax Software CD into the CD drive. The CD should auto run and present

the PaperJet 300 Software Installer screen with the options shown below.

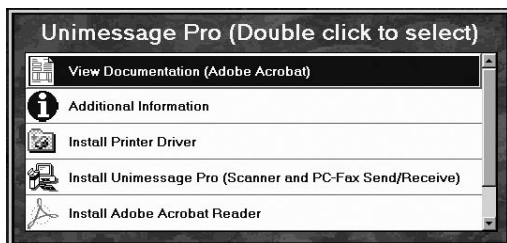

→ If your CD doesn't run automatically, select **Run** from the **Start** menu, type in **x:\Setup.exe** (where x is the letter of your CD drive) and then click on **OK**.

→ To view the user guide, double click on **View Documentation**. If you don't already have Adobe Acrobat Reader on your PC you will need to install that first. It is included on the CD, just double click on that option.

If you want to use your PaperJet 300 only as a printer then you will need to install the Printer Driver only.

If you want to use the PC faxing and scanning features, you will need to install Unimessage Pro.

You can load either the Printer Driver or Unimessage Pro or both.

→ To load the printer driver, double click on the **Printer Driver** option. The installer will load the driver and present the printer control program window when it has finished. This window enables you to adjust the printer settings, clean nozzles and align ink cartridges and print test pages.



Status: shows details of cartridges, the current print job and lets you print a test page.

Options: lets you set your preferences.

Cartridges: shows the status of the cartridges, lets you clean nozzles and align the cartridge.

DOS Printing: lets you adjust the settings for DOS printing.

About: provides program details.

You can make changes if you wish but you don't need to for most uses. When you are ready, click on Close.

→ You are now presented with a window with two option buttons: **Exit to Windows** and **Restart Windows**.

→ If you are not going to load Unimessage Pro, click on **Restart Windows**.

- If you want to load Unimessage Pro, click on **Exit to Windows** and then close any windows which are hiding the Install screen.
 - To load Unimessage Pro, double click on the **Unimessage Pro** option, the installer will load. Follow the on-screen instructions, changing the pre-set options if needed. When loading has finished you are given the option to re-start your PC or return to Windows.
 - If you have finished loading the software you must restart your PC. Select **Restart your PC** and click **OK**.
- After loading Unimessage Pro, when your PC re-starts, Unimessage Pro will start up automatically and you will need to enter some information and choose some options to complete the installation. Follow the on-screen instructions.

To print a document

- Open the document on the PC.
- Select **Print** from the file menu, when the printer dialogue box opens, ensure **Colour MFP** is the selected printer.
- Select **Properties/Options** if you want to adjust the printer settings.
- Click **OK** to print.

NOTE

When printing from the PC, if you pause a print for more than 3 minutes, your PaperJet 300 will "time out" and you will have to cancel the print and start again.

Faxing and scanning

You can fax documents from your PC via your PaperJet 300. You can also scan documents into your PC.

Sending a simple fax

- Open **Unimessage Pro** to display the Welcome screen.
- Click on **New Message** to open the fax dialogue box.
- In the **To** box, enter the telephone number of the recipient.
- Enter a brief description of the message in the **Subject** box (optional).
- Type the message you want to send in the main box.
- The type of header sheet that will be sent is shown in the footer. If you want to change it, select **Cover Sheet** from the **Insert** menu and choose a new one.
- To send the fax, click on the **Send** icon (envelope) or select **Send** from the **File** menu.

Faxing a document

- Open **Unimessage Pro** to display the **Welcome** screen. You can now minimise the **Welcome** screen.
- Open the document you want to send.
- Select **Print** from the **File** menu and ensure **Unimessage Pro** is the selected printer in the print dialogue box.
- Click **OK**. The fax dialogue box opens.
- In the **To** box, enter the telephone number of the recipient.
- Enter a brief description of the message in the **Subject** box (optional).
- If you want to add a message to the header sheet, type it in the main box.
- The type of header sheet that will be sent is shown in the footer. If you want to change it, select **Cover Sheet** from the **Insert** menu and choose a new one.
- To send the fax, click on the **Send** icon (envelope) or select **Send** from the **File** menu.

To switch between mono and colour cartridges

Pull open the control panel.

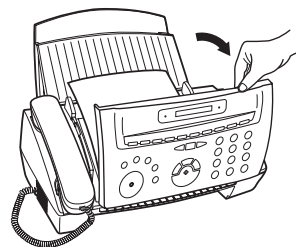

Open the cartridge cover.

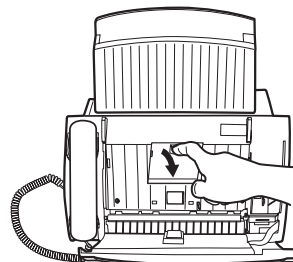

The ink cartridge carrier should have automatically moved to the centre position. If it has not moved, press the **Printer Reset** button.

Printer Reset



Remove the current cartridge.

Insert the replacement cartridge holding it by the finger grip.

Insert the cartridge with the electrical contacts facing towards the back of the machine.

Avoid touching the nozzles and metal electrical contacts.

Push the cartridge towards the back of the machine until it clicks into place.

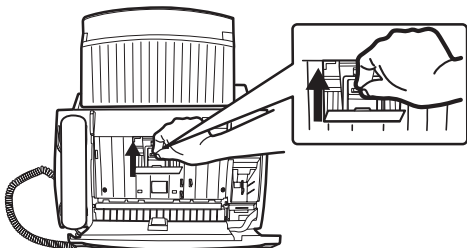

Close the cartridge cover and control panel.

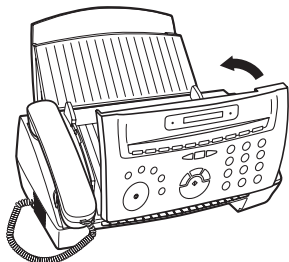

Display shows OLD CARTRIDGE?. If you have used the cartridge before press **Enter**. Display returns to standby.



If it is a new cartridge, press **Function** to display NEW CARTRIDGE?



Press **Enter**. The display shows ALIGN CARTRIDGE?



Press **Enter**. The alignment page is printed.



When prompted, enter the number which appears under the straightest line on the print out.

NOTE

It is quicker and more economical to use a mono cartridge for printing received faxes and copies.

Additional features

Reports and lists

Reports give you details of faxes sent and received.
Lists show you the various settings and stored names and numbers on your PaperJet 300.

To print a list of stored names and numbers

The list contains all One Touch and Directory entries and received calls if you subscribe to a Caller Display services.



Press **Function** until the display shows
6: PRINT OUT?



Press **Enter**.
Display shows 1: PHONE BOOK?



Press **Enter**. The list is printed.
Display shows PHONE BOOK.



Press **Stop** to return to standby.

Printing activity reports

Your PaperJet 300 has been set to print a report automatically after every 20 faxes sent or received.

You can also set it to:

Print immediately.

Once a day.

No print out ,see 'Optional settings', page 41.

The activity report may also include error codes to help you diagnose any problems quickly and accurately.
See 'Help', page 47.

To set to 'no print out' or 'print same time each day'

Press **Function** until the display shows
5: FAX SET UP?



Press **Enter**. Display shows 1: SET CLOCK?



Press **Function** until the display shows
4: ACT. REPORT?



Press **Enter**. Display shows ACT. REPORT ON.



Press **Function** to switch between ON
and OFF.



Either select OFF, press **Enter** to confirm
and then **Stop** to return to standby.



Or select ON.



Press **Enter**. Display shows PRINT TIME:

Enter the time at which you would like the
activity report printed each day.



Press **Enter** to confirm. You hear a
confirmation beep. If you press **Enter**
without entering a time your PaperJet 300
will print an activity report after every 20 fax
transactions.



Press **Stop** to return to standby.

NOTE

If you have not sent or received any faxes, an activity report will not be printed, even if you have set your PaperJet 300 to print one at the same time every day.

To print an activity report immediately



Press **Function** until the display shows
6: PRINT OUT?



Press **Enter**.
Display shows 1: PHONE BOOK?



Press **Function** until the display shows
3: ACT. REPORT?



Press **Enter**. The report is printed.



Press **Stop** to return to standby.

Delayed fax report

Your PaperJet 300 can be set to print out a report after a delayed fax has been sent. This is called a "Timed Report". The original setting is off. To switch it on, See 'Optional Settings', page 41.

Broadcast fax report

Your PaperJet 300 can be set to print out a report after a broadcast fax has been sent. The original setting is off. To switch it on, See 'Optional Settings', page 41.

To print out a list of current feature settings

The print out lets you see a complete list of the feature settings currently set on your PaperJet 300.



Press **Function** until the display shows
6: PRINT OUT?



Press **Enter**.



Press **Function** until the display shows
3: SETTINGS?



Press **Enter**. The settings list is printed.



Press **Stop** to return to standby.

To print out the current function list

You can see a list of all the functions you can set on your PaperJet 300.



Press **Function** until the display shows
6: PRINT OUT?



Press **Enter**.



Press **Function**.
Display shows 2: FUNCTION LIST?



Press **Enter**. The function list is printed.



Press **Stop** to return to standby.

Optional settings

Your PaperJet 300 lets you change settings to suit the way you work.

To change the feature settings

The settings menu lets you adjust a wide range of settings.



Press **Function** until the display shows
5: FAX SET UP?



Press **Enter**.



Press **Function** until the display shows
3: SETTINGS?



Press **Enter**.

Enter the feature number you want
,see list on page 42 to 44.



Press **Enter**.

Enter the code you want for the new setting
,see list page 42 to 44.



Press **Enter** to confirm. You can now enter another Feature number in order to change the next setting.



Press **Stop** to return to standby.

Feature Number	Name	Setting codes	Options	Explanation	Original setting
01	PAUSE TIME	03 -- 12	3 seconds --- seconds 12 seconds	Sets the length of a pause inserted into a stored number.	3 seconds
05	TIMER REDIAL	00 01 02 03	OFF once 2 times 3 times	The number of times the machine will redial the number if the fax fails (e.g. other machine is busy). This setting applies to timed jobs only.	3 times
06	AUTO REDIAL.	00 01 02 03	OFF once 2 times 3 times	The number of times the machine will redial the number if the fax fails (e.g. other machine is busy). This setting applies to non-timed jobs only.	2 times
07	No. OF RINGS	01 02 03 and up to 11	once 2 times 3 times and up to 11 times	Number of rings before your machine answers a call when set to RECEIVE MODE.	7 times
09	F/T SW. OVER	00 01 02 03 04 05	OFF 3 times 5 times 7 times 9 times 11 times	In AUTO mode, you can set the number of times the unit will ring if the incoming call is a voice call. At the end of these rings the unit prepares to receive a fax.	5 times
13	POWER SAVE	00 01	OFF ON	If power save is set on the unit will revert to an energy saving mode after 5 minutes of no use. This mode is not recommended if you have a PC connected.	Off
17	KEY TONES	00 01 02	OFF LOW HIGH	Lets you set the pitch of the beeps you hear when you press a button.	Low
20	FAX HEADER	00 01 02	OFF ON (outside) ON (inside)	This switches the fax header, that is sent with each document, on and off and determines whether it is printed inside or outside the image area.	ON (inside)
21	FAX FOOTER	00 01	OFF ON	Sets whether the caller's details are printed at the foot of received documents.	OFF

Feature Number	Name	Setting codes	Options	Explanation	Original setting
22	COPY MODE	00 01	ADF COPY MEMORY COPY	Sets whether or not the document is scanned into memory before copying. Use ADF for documents too large for the memory.	MEMORY COPY
23	PAPER SIZE	00 01 02	A4 LETTER LEGAL	Allows you to set the size of paper you want to print on.	A4
24	ECM	00 01	OFF ON	Allows you to switch error correction mode on and off. Error correction mode automatically rectifies errors caused by bad lines, etc.	ON
27	RESOLUTION	00 01 02 03	STANDARD FINE SUPER PHOTO	Sets the default scanning resolution setting.	STANDARD
28	CONTRAST	00 01	NORMAL LIGHT	Sets the default scanning contrast setting.	NORMAL
31	SEND REPORT	00 01 02	OFF ON: EACH SEND ON: ERROR	Controls printing of automatic fax transmission reports. Allows you to switch send report printing on and off. Will print for each fax sent or only when an error occurs.	ON: ERROR
32	TIMED REPORT (Delayed send report)	00 01 02	OFF ON:EACH SEND ON:ERROR	Allows you to switch delayed send report printing on and off. Will print for each delayed fax sent or only when an error occurs.	ON:ERROR
35	B/CST REPORT	00 01	OFF ON	When set to On a report is printed on completion of each broadcast fax.	OFF
36	PHOTO QUAL	00 01	STANDARD HIGH	This sets the way the unit prints halftones (greys).	HIGH
47	INK SET	00 01	SETTING A SETTING B	Controls the amount of ink applied to the paper when printing faxes and copies. Setting A applies more ink than setting B. Reduces print definition but may be useful to overcome problems with ink smudging.	SETTING A

Feature Number	Name	Setting codes	Options	Explanation	Original setting
54	AUTO SEND	00 01	OFF ON	This feature determines whether the fax starts automatically when you initiate a fax call using the handset. When set to ON, if the unit hears fax tones from the far end, it will automatically start to send. When set to OFF, you need to press START to begin sending.	OFF
55	PRINT SIZE	00 01 02	90% 84% 70%	Allows you to set the vertical reduction when printing received faxes. The horizontal reduction is constant at approx. 95% This setting does not affect the printing of copies.	90%
57	REMOTE START	00 01	OFF ON	Allows you to start up the fax from another telephone by dialling #, 7.	ON

You can print a list of the current feature settings, *see page 41*.

Power Save mode

The power save feature reduces power consumption from 6W to 2W while your PaperJet 300 is lying idle.

Power save is switched off when you receive your machine.

You can switch power save on and off by changing the feature setting 13, *see list on page 42*. The power save setting will switch on about 5 minutes after the last button has been pressed or the last call was received. The display shows **POWER SAVE**.

Power save will automatically switch off again, when a button is pressed, the handset is lifted or a new call is received.

Power save mode does not switch on if the display shows **NEW CALLS** or if you have a colour cartridge installed.

IMPORTANT

If you have connected your PaperJet 300 to a computer and it has gone into power save mode, you will not be able to print until power save is deactivated. You can only deactivate power save by pressing a button on your PaperJet 300 or by lifting the handset. Power save cannot be deactivated through a command from your computer.

To reduce the printing area

If someone is trying to send you a fax that is longer than the paper you are printing on, your PaperJet 300 will try to receive it over 2 pages. You can reduce the printing area in order to compress the fax onto a single page.

All faxes are reduced. Your PaperJet 300 has been originally set to 90% of the original size, but incoming faxes can be switched between 90%, 84% or 70%. You must re-set the reduction again to change it back.

Press **Function** until the display shows **5: FAX SET UP?**



Press **Enter**.
Display shows **1: SET CLOCK?**



Press **Function** until the display shows **3: SETTINGS?**



Press **Enter**.



KEYPAD

Press Function until display shows **PRINT SIZE** (or enter **5, 5** to go straight there).



Press **Enter**.

Set the ratio you want

00 = 90%

01 = 84%

02 = 70%

Press **Enter** to confirm.



Press **Stop** to return to standby.



ECM (Error Correction Mode)

ECM automatically reduces the possibility of damaged data when sending or receiving faxes.

ECM is switched on and we recommend that you do not change this setting.

Connecting to a switchboard

To set your switchboard access code



Press the **Function** button until the display shows 5:FAX SET UP?



Press **Enter**.
Display shows 1:SET CLOCK?



Press **Function**.
Display shows 2:SENDER ID?



Press **Enter**.
Display shows SENDER NAME

When the name you have entered previously appears, press **Enter**.
Display shows SENDER NUMBER



When the number you have entered previously appears, press **Enter**.
Display shows PBX MODE OFF



Press the **Function** button to display No. or FLASH

Select No. if you use an access code (e.g. 9) to get an outside line. Select FLASH if you use a recall to get an outside line.



Press **Enter** to confirm your choice.



If you selected FLASH press **Stop** to return to standby.

If you selected No. enter a code (this is the prefix you normally use to get an outside line) of up to 4 digits.



Press **Enter** to confirm your choice.



Press **Stop** to return to standby.

To make a call

If sending a fax:

Load the document.



Press the **R/Access** button.

Enter the number you want.



Press **Start**. The document is scanned and sent.

Making a phone call:

Lift handset (or press **Monitor**).



Press the **R/Access** button.

Enter the number you want.

NOTE

When storing numbers in a One Touch button or the Directory you can use the R/Access button to enter the access code as the first digit (it will appear in the display as "R"). This means the access code will automatically be dialled along with the number.

Help

Try these solutions to the most common problems.

Machine does not work

Check that it is plugged in and switched on at the mains.

Display shows CHECK PAPER!

Paper tray is empty.

Paper is not properly inserted in the plain paper tray.

If an error code is shown, check the error code list on *page 49*. Then press **Printer Reset** and try printing again.

Display shows CHANGE CARTRIDGE

The front cover is open. Press top corners firmly to close.

Original document is not accepted

Paper may be too thick or too thin.

Paper may already be jammed inside. Open the control panel and remove any jammed paper.

Display shows OUT OF INK

Install a new ink cartridge, *page 51*.

You can't send a fax

Check that the document is inserted properly. There may be a problem with the receiving machine.

You can't receive a fax when the machine rings

Is your machine set to Manual receive? If so, lift the handset and press **Start**.

Memory may be full and there is no paper in the plain paper tray. Check that the machine is switched on at the mains power supply.

Received fax is blank

Check that the sealing tape has been removed from the ink cartridge print head. See *'Replacing a print cartridge'*, *page 51*.

Document may have been placed upside down on the sending machine.

Can't print a document stored in the memory

Check that there is ink in the cartridge. Check that there is paper in the plain paper tray.

Printed document contains illegible or distorted characters

Phone line quality may have been poor. Ask for the document to be sent again.

Printed pages have white lines on them

Ink cartridge may not be installed properly. Reinstall the cartridge, see *page 51*.

Results	Probable cause	Solution
Smudged or blurred.	Wrong type of paper.	Try a different paper
Fading.	Print head is clogged or cartridge is out of ink.	Clean the print head nozzles, <i>page 55</i> , or replace the print cartridge <i>page 51</i> .
White streaks, dots missing, irregular dots.	Print head is clogged.	Clean the print head nozzles, <i>page 55</i> .
Straight lines are printed jaggedly.	Print cartridge is not aligned.	Align the cartridge, <i>page 53</i> .

No dial tone when you lift the handset

Check that the telephone line cord is properly connected.

Speaker tones are too quiet

Monitor volume may be set to Low. Move the monitor switch to Medium or High. *See 'At a glance', page 3.*

Cannot make a phone call

Check that your PaperJet 300 is not already sending or receiving a fax.

When connected to a PC, the display shows PRINTING and will not return to standby

Press **Printer Reset** until the display shows PRINT CANCELLED. Then try printing again.

Error light comes on

Press **Stop** to turn of the light. Print an activity report, *page 39* and check the error code shown, *see page 49.*

Several sheets of paper are drawn into the printer at the same time

Pages may be sticking together. Remove and fan out the paper before inserting again.

Check that there are not too many sheets in the paper tray. Remove some sheets if necessary.

If the paper tray contains different types of paper, try loading just one type.

Paper is printed at an angle

Make sure the paper is held straight in the paper tray by the paper guide.

Printed documents smudge easily

If you find that the ink smudges easily, there may be a compatibility problem between the ink and the paper you are using. It is recommended that you try using a different brand of paper.

If this doesn't resolve the problem, try changing the INK SET setting to setting B (47 in the SETTINGS menu). Note that the ink setting will affect copies and faxes only (not PC prints).

CUSTOMER HELPLINE

If you cannot solve the problem or need further advice, call the PaperJet Customer Helpline 0845 0500 950.

Error codes

The activity report may show error codes. The chart shows you what they mean.

Code	Meaning	Action
10	No response from the other machine.	Contact the other party to make sure the machine can receive.
12	No response.	
19	The memory became full when receive a fax.	Check that the ink or paper hasn't run out. Ask the other party to send a fax in stages.
20	Stop button pressed while fax was being sent or received.	
21	Original document jammed.	Remove and try sending again.
27	Delayed fax cancelled.	
29	Power was turned off while a fax was being sent from the memory.	
30s	Printing quality poor due to bad telephone line.	If this code appears frequently contact your network operator help line (151 for BT residential customers, 154 for BT business customers)
40's	Problem with other fax machine.	Try resending the fax later. Or ask them to try sending you the fax again.
50s	Fax stopped by other machine. Line disconnected.	Try resending the fax later. Or ask them to try sending you the fax again.
71	Other machine is not compatible.	Contact the other party.

To clear a document jam

The display shows DOCUMENT JAM.

Open the control panel.

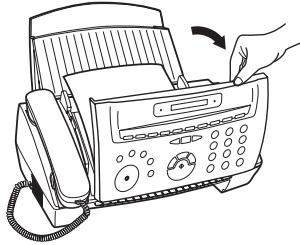

Press and hold down the **Green Release Lever** while removing the jammed paper.

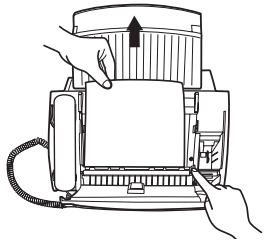

Close the control panel.

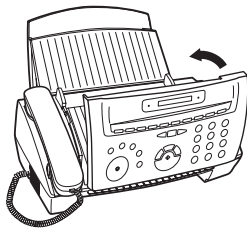

To clear a plain paper jam

The display shows CHECK PAPER.

Open the plain paper tray cover and pull out all the paper.

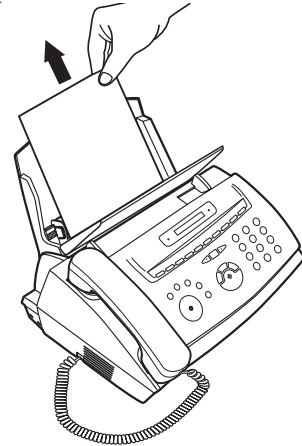

Replace the paper in the tray. Close the cover.

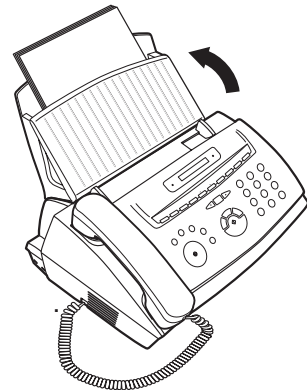

Printer Reset



Press the **Printer Reset** button.
Your machine returns to standby.

To replace an empty ink cartridge

This is different to swapping cartridges. If you want to swap between mono and colour cartridges, see *"Printing from a PC"* on page 36.

Pull open the control panel.

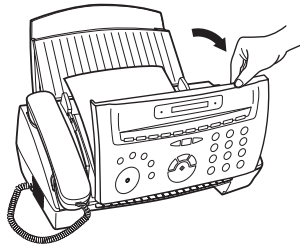

Open the cartridge cover.

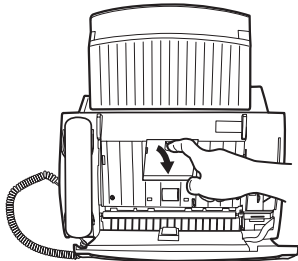

The ink cartridge carrier should have automatically moved to the centre position. If it has not moved, press the **Printer Reset** button.

Printer Reset



Remove the old cartridge.

Remove the new print cartridge from its packaging. Holding it by the finger grip, peel the protective film from the print nozzles.

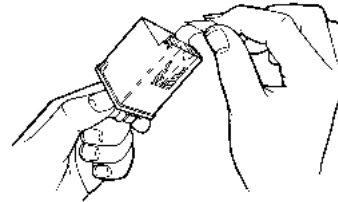

Avoid touching the nozzles and metal electrical contacts.

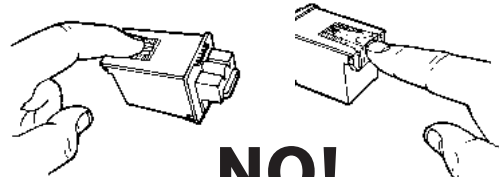

NO!

Insert the new cartridge holding it by the finger grip.

Insert the cartridge with the electrical contacts facing towards the back of the machine.

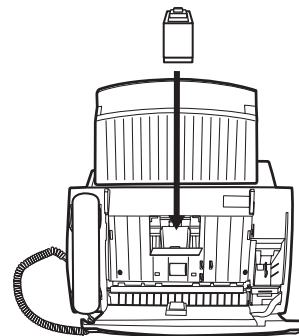

Push the cartridge towards the back of the machine until it clicks into place.

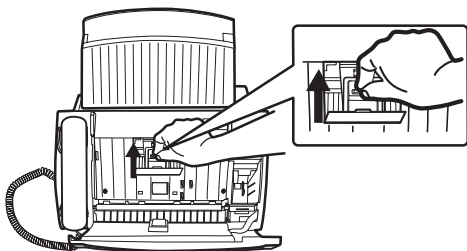

Close the cartridge cover and control panel.

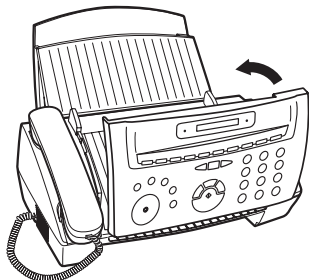

Display shows OLD CARTRIDGE.

Press **Function** to display NEW CARTRIDGE.

Press **Enter**.

Display shows ALIGN CARTRIDGE.

Press **Enter**. The alignment page is printed.

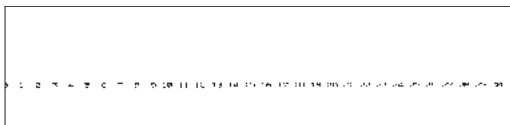

Select the vertical line that is closest to being a straight line.

Enter the number under the straightest line, e.g. 12.



Press **Enter** to confirm. You hear a confirmation beep.



Press **Stop** to return to standby.

To store a spare ink cartridge

If swapping between mono and colour cartridges you can store the spare one in the compartment under the control panel.

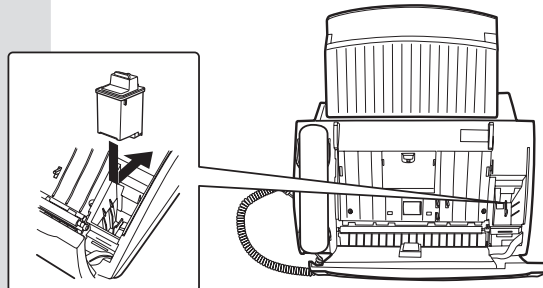

Function



Enter



Enter



Enter

Aligning the print cartridge

If the print quality should deteriorate at any time you might want to check the cartridge alignment.

To align the cartridge from a PC

- Open the printer Control Program.
- Click Cartridges tab.
- Click Align Cartridges. The Align Cartridges box appears on screen. Your PaperJet 300 prints the alignment page. Select the vertical line that is closest to being a straight line.
- Enter the number under the straightest line in the Alignment Cartridge box, e.g. 12.
- Click OK.

To align the cartridge at the machine

Aligning the cartridge ensures the best print quality.



Press **Function** until the display shows 8: PRINTER?



Press **Enter**.
Display shows 1: CLEAN NOZZLES?



Press **Function**. Display shows 2: ALIGN?



Press **Enter**. The alignment page is printed.

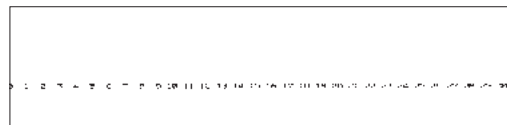

Select the vertical line that is closest to being a straight line.

KEYPAD

Enter the number under the straightest line, e.g. 12.



Press **Enter** to confirm. You hear a confirmation beep.



Press **Stop** to return to standby.

Cleaning the print nozzles and contacts

If your documents are not being printed completely, the ink cartridge nozzles may be clogged. You can set your PaperJet 300 to clean them.

To purge the print nozzles at the machine

Make sure there is paper in the plain paper tray.



Press **Function** until the display shows
8: PRINTER?



Press **Enter**.

Display shows 1: CLEAN NOZZLES?



Press **Enter**. Display shows PRINTING and the nozzle test pattern is printed. This shows a test pattern of nozzles working correctly.



Compare the diagonal line above the bars to the diagonal line below the bars. If there is a broken line, the nozzles are clogged. If the bottom line has fewer breaks, or is of better print quality than the top line, run the test again.

If the print quality is not satisfactory after running the test three times, remove the cartridge and carefully wipe the nozzle plate with a damp soft tissue. Reinstall the cartridge and repeat the clean nozzle routine.

To purge the print nozzles from a PC

Make sure there is paper in the plain paper tray.

Open the printer Control Program.

Click the Cartridges tab.

Click Clean Print Nozzles. Your PaperJet 300 starts the nozzle cleaning test.

Examine the test pattern as shown above in *'Cleaning the print nozzles at the machine'*.

Compare the diagonal line above the bars to the diagonal line below the bars. If there is a broken line, the nozzles are clogged. If the bottom line has fewer breaks, or is of better print quality than the top line, run the test again.

If the print quality is not satisfactory after running the test three times, remove the cartridge and carefully wipe the nozzle plate with a damp soft tissue. Reinstall the cartridge and repeat the clean nozzle routine.

Wiping the print nozzles and contacts

If the print quality does not improve after purging the nozzles, the contacts may be dirty or there may be dried ink on the nozzles.

Wiping the print nozzles

Remove the print cartridge from the machine, see *"To replace an empty ink cartridge"* on page 51.

Dampen a clean cloth with water. To dissolve any dried ink, hold a damp cloth against the nozzles for about 3 seconds and wipe gently. To avoid mixing colours, wipe from one side to the other, in one direction as shown.

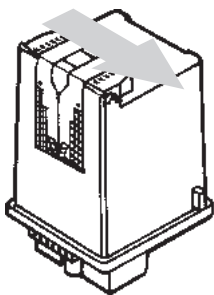

Allow the nozzles to dry.

Wiping the contacts

Using a clean damp area of the cloth, gently wipe the entire gold covered area, on the back of the cartridge, from one side to the other, as shown.

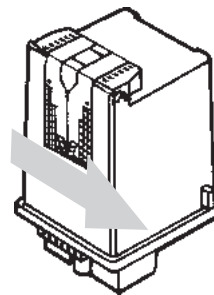

Gently wipe dry.

Ensure cartridge is dry before replacing in the machine.

Cleaning

To clean the casing

Gently wipe the case with a soft, clean cloth dampened with a mild detergent. Do not use abrasive cleaning agents.

To clean the document feeder rollers

If a streaky or dirty pattern appears on a copy or fax you have sent, clean the two document feeder rollers with a soft, clean cloth dampened with a mild detergent.

Open the control panel.

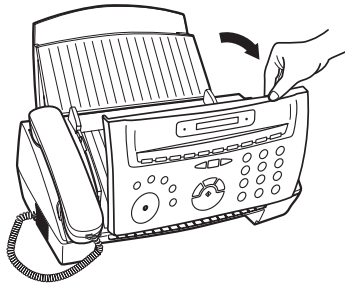

Press the document sensor to rotate the feeder rollers.

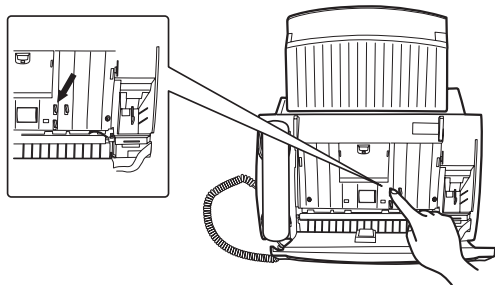

Clean the document feeder rollers, then use a dry cloth to dry them thoroughly.

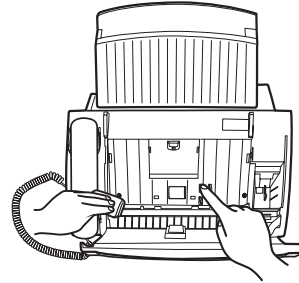

Close the control panel.

General information

Guarantee information

Subject to the terms listed below the guarantee will provide for the repair of, or at BT's or its agent's discretion the option to replace the PaperJet 300, or any component thereof, which is identified as faulty or below standard, or as a result of inferior workmanship or materials. Products over 28 days old from the date of purchase may be replaced with a refurbished product.

The conditions of the guarantee are:

- The guarantee shall only apply to defects that occur within 12 months from the date of purchase, provided that the equipment is sent to the repair address within this period.
- This guarantee does not cover any faults or defects caused by accidents, misuse, fair wear and tear, neglect, tampering with the equipment, or any attempt at adjustment or repair other than through approved agents.
- This guarantee does not affect your statutory rights.

Helpline support and returns back to point of sale

Within the 12 month guarantee period:

Prior to returning your product, first read the '*Help section*' beginning on *page 47* or contact the Helpline for assistance.

Helpline: **0845 0500 950**. Lines open Monday to Friday from 09:00 to 17:30 excluding bank holidays.

Outside the 12 month guarantee period:

If your product needs repair after the guarantee period has ended, the repair must meet the approval requirements for connection to the telephone network. We recommend that you call the Helpline and ask for details of our recommended repairers.

Returning the product:

If the Helpline is unable to remedy the problem they will ask you to return your PaperJet 300. Remove the ink cartridge from the machine and place it in a black plastic bag. Where possible, pack it in its original packaging. Please remember to include all parts, including line cords and mains power plug. (Please note we cannot take responsibility for products damaged in transit.)

Please obtain and keep proof of posting or delivery.

A copy of the proof of purchase such as your receipt must be returned with your product.

Technical information

Paper handling:	Automatic feed
Paper tray capacity:	50 sheets max of 75gsm. Maximum thickness of stacked paper 10mm
Paper size:	A4 – 210 x 297mm Letter – 8.5 x 11 inches Legal – 8.5 x 14 inches
Paper weight:	64 to 90gsm
Paper type:	Plain paper. Transparency film.
PC Interface:	Parallel port
Ink cartridge:	Black: 1250 pages (5% coverage), Colour: 200 pages (15% coverage)
Document handling:	20 page, auto document feed.
Document size:	A4, letter, legal.
Document weight:	70 to 90gsm

Type:	Desk top type transceiver
Effective scanning width:	208mm
Effective recording width:	203mm
Transmission speed:	14400/12000/9600/7200/4800/2400/bps
Transmission time:	8 sec, standard mode, ITU-T #1, Memory to Memory (MR codes)
Horizontal resolution:	8 pels/200 dpi.
Vertical resolution:	Standard mode: 3.85lines/mm, Photo: 7.7 lines/mm with 64 grey scales Fine mode: 7.7 lines/mm Super fine mode: 15.4 lines/mm
Photo:	77 lines/mm, 64 grey scales.
Compression method:	MH/MR
Scanning method:	Flat-bed by Contact Image Sensor
Printing method:	Ink jet
Power supply:	AC 230V, 50/60Hz
Power consumption:	Stand-by: 6W, Transmission: 18W Stand-by (with Power save):2W, Reception:23W,Copy:35W.
Overall dimensions:	366(W) x 279(D) x 179(H)mm (excluding trays) 366(W) x 322(D) x 261(H)mm (with trays)
Weight;	Approx. 3.6kg (no accessories)
Ambient temperature:	5°C-35°C(41°F-95°F)

R&TTE

This product is intended to be connected to analogue networks and private switching systems in the United Kingdom.

PaperJet 300 Fax Machine

This equipment complies with the essential requirements of the Radio Equipment and Telecommunications Terminal Equipment Directive, 1999/5/EC.

If you require a copy of the original manufacturer's Declaration of Conformance, then please contact the BT PaperJet Helpline on **0845 0500 950**.

Memory capacity

The memory can store up to 20 pages of the standard letter at A4 size.



THE SLEREXE COMPANY LIMITED

SAPORS LANE · BOOLE · DORSET · BH 25 8 ER

TELEPHONE BOOLE (945 13) 51617 · TELEX 123456

Our Ref. 350/PJC/EAC

4th April, 1984

Dr. P. N. Cundall,
Mining Surveys Ltd.,
Holroyd Road,
Reading,
Berks.

Dear Pete,

Permit me to introduce you to the facility of facsimile transmission.

In facsimile a photocell is caused to perform a raster scan over the subject copy. The variations of print density on the document cause the photocell to generate an analogous electrical video signal. This signal is used to modulate a carrier, which is transmitted to a remote destination over a radio or cable communications link.

At the remote terminal, demodulation reconstructs the video signal, which is used to modulate the density of print produced by a printing device. This device is scanning in a raster scan synchronised with that at the transmitting terminal. As a result, a facsimile copy of the subject document is produced.

Probably you have uses for this facility in your organisation.

Yours sincerely,

P. J. CROSS
Group Leader - Facsimile Research

Index

A dditional features	39	Delayed faxing	
Activity report	39	send	26
Align ink cartridge	53	cancel	26
Answering machine	30	change time	26
At a glance	2	Delete	
B roadcast faxing	27	one touch numbers	18
store	27	directory numbers	20
cancel	27	Dialling	
C aller display	32	one touch numbers	17
caller information not available	33	directory numbers	19
calls list	33	faxes	23
Cartridge		phone calls	29
align from a PC	53	Directory	18
align at the machine	53	add name to number in calls list	20
clean nozzles	53	delete	20
replace	51	dial	19
store spare cartridge	52	edit	20
swap colour and mono cartridges	37	search	19
Cleaning		store	19
machine and paper rollers	56	transfer entry to One Touch button	20
print nozzles	55	view directory	19
Contrast	22	view outgoing calls	21
Copying	31	Document jam	50
single copies	31	E nter	
multiple copies	31	a fax number	14
detailed original	32	a name	14
D ate set	14	Error codes	49
		Error correction mode (ECM)	45

F ax		O ne Touch memories	17
broadcasting	27	delete	18
delayed send	26	dial	17
header	14	edit	17
print from memory	25	store	17
receiving	24	Optional settings	41
redial	23	change features	41
send	23	features list	42
send via switchboard	46	P aper	
stop	23	fit paper tray	10
Features, list of	42	jams	50
G uarantee	57	load	11
H andset-connect	10	sizes	21
Header, name and number	14	PC	
Help	47	connecting	34
Helpline	9	fax software	34
I nk cartridge		faxing and scanning	36
align	53	print documents	36
clean nozzles	53	printer software	34
replace	51	Phone	
store	52	make call	29
Installation		handsfree	29
PC software	34	receive a call	30
fax software	34	redial	30
J ams	50	search and dial	29
L ists		Polling reception	28
current settings	41	Power, connect to mains	11
functions	41	Power save mode	45
stored names and numbers	39	Print area-reduce	45
M emory capacity	60	Printer driver	34
Memory full	25	Printer error codes	49
Monitor volume	3	Print from memory	25
		R eceiving phone calls	30
		Receiving faxes	24

Reception mode	24	T echnical information	58
Redial phone call	23	Telephone line connect	10
Redial fax call	30	Time set	14
Replace ink cartridge	51	U npacking	8
Reports and lists		V oice request	28
activity	39	Volume	
broadcast fax	39	loudspeaker	3
delayed fax	40	ringer	3
no print out	40	W indows	
Resolution	22	Open printer control panel in 95/98	34
Returning the product	57	Open printer control panel in 3.1/3.11	34
Ringer volume	3	Open printer control panel in Me	34
S afety information	9		
Setting up	10		
Sending faxes	21		
Set			
date	14		
time	14		
Stop			
broadcast fax	27		
delayed fax	26		
fax	23		
Speak			
after sending a fax	28		
before receiving a fax	28		
Store			
directory entry	19		
entering a name & number	14		
One Touch entry	17		
Swap ink cartridge	37		
Switchboard	46		
make call	46		
send fax	46		
set access code	46		



Offices worldwide

The telecommunications services described in this publication are subject to availability and may be modified from time to time. Services and equipment are provided subject to British Telecommunications plc's respective standard conditions of contract. Nothing in this publication forms any part of any contract.

Touchtone[™] is a registered trade mark of British Telecommunications plc in the UK.

© British Telecommunications plc 2001.
Registered Office: 81 Newgate Street, London EC1A 7AJ.
Registered in England No. 1800000.
PaperJet 300 user guide (7/01) 3
Designed by The Art & Design Partnership Limited.
Printed in China.

