



Paradigm REAL-Time™  
**Revel**  
MINIMED



User Guide

**Paradigm<sup>®</sup> REAL-Time  
Revel<sup>™</sup> Insulin Pump**

**User Guide**

©2009 Medtronic MiniMed, Inc. All rights reserved.

This product is covered by U.S. Patents. Other U.S. and/or foreign patents may be pending. Please visit <http://www.medtronicdiabetes.com/patents> for a listing of patents covering this product.

Bolus Wizard<sup>®</sup>, CareLink<sup>®</sup>, Dual Wave<sup>®</sup>, Guardian<sup>®</sup>, Guardian RT<sup>®</sup>, MiniLink<sup>®</sup>, Paradigm<sup>®</sup>, Paradigm Link<sup>®</sup>, Quick-serter<sup>®</sup>, Quick-set<sup>®</sup>, Sen-serter<sup>®</sup>, Silhouette<sup>®</sup>, Sof-set<sup>®</sup>, and Square Wave<sup>®</sup> are registered trademarks of Medtronic MiniMed, Inc.

Easy Bolus<sup>™</sup> and Revel<sup>™</sup> are trademarks of Medtronic MiniMed, Inc.

CONTOUR<sup>®</sup> is a registered trademark of Bayer.

Energizer<sup>®</sup> is a registered trademark of Eveready Battery Company.

Glucagon Emergency Kit<sup>®</sup> is a registered trademark of Eli Lilly and Company.

YSI 2300 STAT Plus<sup>™</sup> is a trademark of YSI Inc.

OneTouch<sup>®</sup>, OneTouch<sup>®</sup> Ultra<sup>®</sup>, and OneTouch<sup>®</sup> UltraLink<sup>®</sup> are registered trademarks of LifeScan, Inc.



**Medtronic**



**Medtronic MiniMed**  
18000 Devonshire Street  
Northridge, CA 91325  
USA  
800 646 4633  
818 576 5555  
[www.medtronicdiabetes.com](http://www.medtronicdiabetes.com)

R<sub>x</sub> Only



6025306-019\_a

REF MMT-523 MMT-723 MMT-523K MMT-723K

**Contacts:****Africa:**

Medtronic Africa (Pty) Ltd.

Tel: +27 (0) 11 677 4800

**Australia:**

Medtronic Australasia Pty. Ltd.

Tel: 1800 668 670 (product orders)

Tel: 1800 777 808 (customer help)

**Azerbaijan:**

Albatros Health Care

Tel: +994 12 498 9537

**Bangladesh**

Sonargaon Healthcare Pvt Ltd.

Mobile: (+91)-9903995417

or (+880)-1714217131

**Belarus:**

Badgin Ltd

Tel: +375 (172) 665128

**België/Belgique:**

N.V. Medtronic Belgium S.A.

Tel: 0800-90805

**Bosnia and Herzegovina**

Intermedical

Tel: +387 33 202 183

Fax: +387 33 202 183

**Brasil:**

Medtronic Comercial Ltda.

Tel: +(11) 3707-3707

**Bulgaria**

Interagro-90 Ltd

Tel: +359 888 636 033

**Canada:**

Medtronic of Canada Ltd.

Tel: 1-800-284-4416 (toll free/sans-frais)

**China:**

Medtronic (Shanghai) Ltd.

24 Hour Help (Cell): +86

400-820-1981

24 Hour Help (Landline): +86

800-820-1981

**Croatia**

Oktal Pharma

Tel: +385 1 659 57 77

Fax: +385 1 659 57 01

**Croatia**

Medtronic B.V.

Tel: +385 1 488 11 20

Fax: +385 1 484 40 60

**Danmark:**

Medtronic Danmark A/S

Tel: +45 32 48 18 00

**Deutschland:**

Medtronic GmbH

Geschäftsbereich Diabetes

Telefon: +49 2159 8149-370

Telefax: +49 2159 8149-110

24-Std-Hotline: 0800 6464633

**Eire:**

Accu-Science LTD.

Tel: +353 45 433000

**España:**

Medtronic Ibérica S.A.

Tel: +34 91 625 05 42

Fax: +34 91 625 03 90

24 horas: +34 901 120 335

**Europe:**

Medtronic Europe S.A. Europe,

Middle East and Africa Headquarters

Tel: +41 (0) 21-802-7000

**France:**

Medtronic France S.A.S.

Tel: +33 (0) 1 55 38 17 00

**Hellas:**

Medtronic Hellas S.A.

Tel: +30 210677-9099

**Hong Kong:**

Medtronic International Ltd.

Tel: +852 2919-1300

To order supplies: +852 2919-1322

24-hour helpline: +852 2919-6441

**India:**

India Medtronic Pvt. Ltd

Tel: (+91)-80-22112245 / 32972359

Mobile: (+91)-9611633007

**Indonesia:**

Medtronic International Ltd.

Tel: +65 6436 5090

or +65 6436 5000

**Israel:**

Agentek

Tel: +972 3649 3111

**Italia:**

Medtronic Italia S.p.A.

Tel: +39 02 24137 261

Fax: +39 02 24138 210

Servizio assistenza tecnica: N° verde

24h: 800 712 712

**Japan:**

Medtronic Japan Co. Ltd.

Tel: +81-3-6430-2019

**Kazakhstan:**

Medtronic Kazakhstan B.V.

Tel: +77273110580

**Latin America:**

Medtronic, Inc.

Tel: 1(305) 500-9328

Fax: 1(786) 709-4244

**Latvija:**

Ravemma Ltd.

Tel: +371 7273780

**Macedonia:**

Kemofarm  
Tel: +389 2 260 36 03  
Fax: +389 2 260 36 49

**Magyarország:**

Medtronic Hungária Kft.  
Tel: +36 1 889 0688

**Malaysia:**

Medtronic International Ltd.  
Tel: +603 7946 9000

**Middle East and North Africa:**

Regional Office  
Tel: +961-1-370 670

**Montenegro:**

Glosarij  
Tel: +382 20 642 495  
Fax: +382 20 642 540

**Nederland, Luxembourg:**

Medtronic B.V.  
Tel: +31 (0) 45-566-8291  
Gratis: 0800-3422338

**New Zealand:**

Medica Pacifica  
Phone: 64 9 414 0318  
Free Phone: 0800 106 100

**Norge:**

Medtronic Norge A/S  
Tel: +47 67 10 32 00  
Fax: +47 67 10 32 10

**РОССИЯ:**

Medtronic B. V.  
Tel: +7 495 580 73 77  
24h: 8-800-200-76-36

**Philippines:**

Medtronic International Ltd.  
Tel: +65 6436 5090  
or +65 6436 5000

**Polska:**

Medtronic Poland Sp. Z.o.o.  
Tel: +48 22 465 6934

**Portugal:**

Medtronic Portugal Lda  
Tel: +351 21 7245100  
Fax: +351 21 7245199

**Puerto Rico:**

Medtronic Puerto Rico  
Tel: 787-753-5270

**Republic of Korea:**

Medtronic Korea, Co., Ltd.  
Tel: +82.2.3404.3600

**Romania:**

Trustmed SRL  
Tel: +40 (0) 21 220 6477

**Schweiz:**

Medtronic (Schweiz) AG  
Tel: +41 (0)31 868 0160  
24-Stunden-Hotline: 0800 633333  
Fax Allgemein: +41 (0)318680199

**Serbia**

Epsilon  
Tel: +381 11 311 5554  
Fax: +381 11 311 5554

**Singapore:**

Medtronic International Ltd.  
Tel: +65 6436 5090  
or +65 6436 5000

**Slovenija:**

Zaloker & Zaloker d.o.o.  
Tel: +386 1 542 51 11  
Fax: +386 1 542 43 32

**Slovenská republika:**

Medtronic Slovakia o.z.  
Tel: +421 26820 6986  
Fax: +421 268 206 999

**Sri Lanka**

Swiss Biogenics Ltd.  
Mobile: (+91)-9003077499  
or (+94)-777256760

**Suomi:**

Medtronic Finland Oy  
Tel: +358 20 7281 200  
Help line: +358 400 100 313

**Sverige:**

Medtronic AB  
Tel: +46 8 568 585 10  
Fax: +46 8 568 585 11

**Taiwan:**

Medtronic-Taiwan Ltd.  
Tel: +886.2.2183.6068  
Toll Free: +886.0800.005.285

**Thailand:**

Medtronic (Thailand) Ltd.  
Tel: +662 232 7400

**Turkiye:**

Medtronic Medikal Teknoloji  
Ticaret Ltd. Sirketi.  
Tel: +90 216 4694330

**USA:**

Medtronic Diabetes Global  
Headquarters  
Tel: +1-800-826-2099  
24 Hour HelpLine: +1-818-576-5555  
To order supplies: +1-800-843-6687

**Ukraine:**

Med EK Service Ltd.  
Tel: +380445457705

**United Kingdom:**

Medtronic Ltd.  
Tel: +44 1923-205167

**Österreich:**

Medtronic Österreich GmbH  
Tel: +43 (0) 1 240 44-0  
24 - Stunden - Hotline: 0820 820 190

**Česká republika:**

Medtronic Czechia s.r.o.

Tel: +420 233 059 401

Non-stop help line:

+420 233 059 059



# Important Safety Information Regarding Your Paradigm Insulin Pump (includes all models)

## Avoid Immersing Your Pump In Water

The pump was tested and met requirements for IPX7 at time of manufacture. For more information about IPX7, see the *Glossary* on *page 229*. Be aware that drops and bumps that occur over time will affect the integrity of the pump case and make it more vulnerable to damage from water. Lotions, sunscreens and insect repellent can also damage the pump case. It is not known how much water is needed to damage your pump. **You should avoid getting your pump wet. To shower, bathe, swim, or participate in water activities, always disconnect from your pump and reconnect after you are out of the water.**

If you inadvertently submerge your pump in water, dry the pump quickly using a soft, clean towel and verify that it is working properly by selecting **Selftest** from the pump's Utilities Menu. If you believe that water has entered your pump or you observe any other possible pump malfunction, please check your blood glucose, treat high blood glucose (if necessary) with an injection and contact our 24 Hour HelpLine at 1 800 646 4633 for further assistance. Symptoms of high blood glucose include fatigue, excessive thirst and nausea. Always contact your healthcare professional if you experience excessively high or low blood glucose levels, or if you have any questions about your care.

## Electrostatic Discharge

Although your Paradigm pump is designed to be unaffected by typical levels of electrostatic discharge (ESD), very high levels of ESD can result in a reset of the pump's software with an associated pump error alarm. In most cases, exposure to high levels of ESD will trigger the pump's A-13 alarm although, under certain circumstances, high level ESD exposure can cause A-44, Bolus Stopped or Max Delivery alarms. High levels of ESD are more likely in situations where the relative humidity is very low, such as inside a heated building during the winter in areas where it is cold outside.

If your pump experiences an A-13 or other error alarm, press the **ESC** and **ACT** buttons to clear the alarm. If you are unable to clear the alarm by pressing **ESC** and **ACT**, you may need to remove and replace the pump's battery to clear the alarm. After clearing the alarm, you should always verify that your pump is set to the correct date and time and that all other settings (basal rate, max basal and bolus limits, etc.) are programmed to the desired values, since the software reset could erase your previously programmed settings. Please see the Alarms and Alerts section of this User Guide for more details regarding what to do if your pump displays an error alarm or other alert message.

*Please contact our 24 Hour HelpLine at 1-800-646-4633 to report any error alarms or other problems that occur with your pump.*



## Warranty

Medtronic Diabetes warrants the Medtronic MiniMed Insulin Pump against defects in materials and workmanship for a period of 4 years from the date of purchase.

During the warranty period, Medtronic Diabetes will, at its discretion, either repair or replace (with a new or recertified pump, at Medtronic Diabetes' discretion) any defective pump or motor, subject to the conditions and exclusions stated herein. In the event that a pump is repaired or replaced, the warranty period will not be extended.

This warranty is valid only if the Medtronic MiniMed Insulin Pump is used in accordance with the manufacturer's instructions. This warranty will not apply:

- If damage results from changes or modifications made to the pump by the user or third persons after the date of manufacture.
- If damage results from use of non-Medtronic reservoirs and/or infusion sets.
- If damage results from service or repairs performed by any person or entity other than the manufacturer.
- If damage results from a *Force Majeure* or other event beyond the control of the manufacturer.
- If damage results from negligence or improper use, including but not limited to: improper storage, submersion in water or physical abuse, such as dropping or otherwise.

This warranty shall be personal to the original user. Any sale, rental or other transfer or use of the product covered by this warranty to or by a user other than the original user shall cause this warranty to immediately terminate. This warranty does not apply to batteries, infusion sets, reservoirs, and other accessories.

**The remedies provided for in this warranty are the exclusive remedies available for any breach hereof. Neither Medtronic Diabetes nor its suppliers or distributors shall be liable for any incidental, consequential, or special damage of any nature or kind caused by or arising out of a defect in the product.**

**Pumps purchased through our Pathway Program will assume the warranty stated in our Pathway Program agreement.**

**All other warranties, expressed or implied, are excluded, including the warranties of merchantability and fitness for a particular purpose.**

# Contents

<b>Chapter 1: Introduction .....</b>	<b>1</b>
Assistance .....	1
Emergency kit .....	2
Consumables .....	2
Accessories .....	3
How to wear your pump .....	3
How to use this guide .....	4
User safety .....	5
Indications .....	5
Paradigm REAL-Time Revel insulin pump .....	5
Meter .....	6
Contraindications .....	6
Warnings .....	6
Pump .....	6
Reservoir and infusion sets .....	7
Sensor .....	7
Transmitter .....	7
Tubing Connector .....	8
Magnetic fields .....	8
X-rays, MRIs and CT scans .....	9
Precautions .....	9
Avoid extreme temperatures .....	9
Infusion sets and sites .....	9
Sensor .....	9
Adverse reactions .....	9
Notice .....	10
Insulin pump and RF accessories .....	10
RF interference from other devices .....	11

<b>Chapter 2: The basics .....</b>	<b>13</b>
Your pump .....	13
Install battery .....	14
Pump buttons .....	15
The pump screen .....	17
HOME screen .....	17
Screen icons .....	17
Battery .....	17
Time display .....	18
Reservoir volume .....	18
Alert and alarm icons .....	18
Sensor icons .....	18
Scroll bar .....	19
Screen backlight .....	19
Beep/vibrate .....	19
Operating modes .....	19
Normal mode .....	20
Special mode .....	20
Attention mode .....	20
Menus .....	21
MAIN MENU .....	21
BOLUS MENU .....	21
SUSPEND .....	21
SENSOR .....	21
CAPTURE EVENT .....	22
BASAL MENU .....	22
RESERVOIR + SET .....	22
UTILITIES MENU .....	22
STATUS screen .....	22
If you remove your pump .....	23
 <b>Chapter 3: Basic programming .....</b>	 <b>25</b>
Setting the time and date .....	25
Selecting the language .....	27
Bolus .....	27
Setting the Normal bolus .....	27
Normal meal bolus using the exchange system .....	29

Bolus practice: .....	29
Normal meal bolus practice using exchanges .....	30
Normal meal bolus using carbohydrate counting .....	30
Normal meal bolus practice using carbohydrates .....	31
Meal bolus, correction bolus and insulin sensitivity .....	31
Practice: Meal bolus .....	32
Review your bolus deliveries .....	32
Bolus details .....	33
Maximum bolus limit .....	35
Example 1: Max bolus .....	35
Example 2: Max bolus .....	35
Scroll rate .....	35
Example: Scroll rate .....	36
BG Reminder .....	36
Capturing Events .....	37
Turning on the Capture Event feature .....	38
Entering BG measurements .....	38
Entering insulin injection information .....	39
Entering carbohydrate information .....	40
Entering exercise information .....	41
Entering Other markers .....	41
Viewing Capture Event history .....	42
Basal .....	42
Start and stop times .....	42
Your basal settings .....	44
Basal programming and delivery .....	44
Current basal delivery .....	45
Daily basal rate(s) .....	45
Setting the Max basal rate .....	46
Example 1: Max basal .....	46
Example 2: Max basal .....	47
Stopping your pump .....	47
Resume pump delivery .....	48
Example: Suspend function .....	48
Practice: Suspend function .....	49
Practice: Resume basal delivery after a suspend .....	49

<b>Chapter 4: Starting on insulin .....</b>	<b>51</b>
Prepare your pump for use .....	51
Setting up the reservoir .....	52
Filling the reservoir .....	52
Changing your infusion set .....	54
Removing the reservoir .....	54
Rewinding your pump .....	55
Inserting the reservoir in your pump .....	55
Filling the tubing .....	56
Inserting the infusion set .....	57
Quick-set infusion set (with Quick-serter®) .....	59
Filling the cannula .....	60
Disconnecting Quick-set .....	60
Reconnecting Quick-set .....	61
Record keeping for diabetes management .....	61
Determining your pump settings .....	62
 <b>Chapter 5: Using the Bolus Wizard feature .....</b>	 <b>63</b>
What is it? .....	63
Carbohydrate counting .....	63
Your blood glucose reading .....	63
Your personal Bolus Wizard feature settings .....	63
How the Bolus Wizard feature works .....	66
Bolus Wizard warnings .....	67
HIGH BG .....	67
LOW BG .....	67
MAX BOLUS EXCEEDED .....	67
How to program the Bolus Wizard feature .....	67
Turning on the Bolus Wizard feature .....	68
Selecting the Carb units .....	68
Setting the Carb/Exch ratios .....	69
Setting the BG units .....	70
Insulin sensitivity .....	70
Setting the BG Targets .....	71
About active insulin .....	72
Active insulin time .....	73
Review your Bolus Wizard feature settings .....	74

Normal bolus using Bolus Wizard feature .....	74
Bolus Wizard feature examples .....	75
Example 1: Blood glucose on target (normal blood glucose) and no active insulin .....	76
Example 2: Blood glucose above target (high blood glucose) and no active insulin .....	77
Example 3: Blood glucose below target (low blood glucose) and no active insulin .....	78
Example 4: Blood glucose above target (high blood glucose) with active insulin .....	79
Example 5: Blood glucose below target (low blood glucose) with active insulin .....	80
<b>Chapter 6: Optimizing pump therapy .....</b>	<b>81</b>
Square Wave and Dual Wave bolus .....	81
Turning on the Dual Wave/Square Wave option .....	82
Square Wave or Dual Wave bolus without Bolus Wizard feature .....	82
Square Wave bolus practice .....	84
Dual Wave bolus practice .....	85
Using the Bolus Wizard feature for a Square Wave or Dual Wave bolus .....	85
Easy bolus .....	87
Easy bolus setup .....	88
Step value setup .....	88
Delivering Easy Bolus .....	89
Example 1: Easy bolus .....	90
Your turn: Easy bolus practice .....	90
Missed Bolus Reminder .....	91
Add, delete, and review bolus reminders .....	91
Add .....	91
Delete .....	91
Review .....	91
Basal patterns .....	92
Turning on the patterns .....	92
Programming a pattern .....	92
Select a pattern .....	93
Example 1: Basal patterns .....	94
Example 2: Basal patterns .....	94
Your turn: .....	94
Temp basal rates .....	95
How does temp basal work? .....	95
Temp basal types .....	95
Insulin rate (U/H) .....	95

Percent of basal ..... 97

**Chapter 7: Sensor features ..... 103**

Entering your sensor settings ..... 103

- Turning on the sensor ..... 103
- Turning on the Glucose Alerts ..... 104
- Setting the Glucose Limits ..... 104
- Selecting the BG units ..... 105
- Setting the Glucose Limits start time ..... 105
- Setting the High Repeat ..... 107
- Setting the Low Repeat ..... 107
- Setting the Predictive glucose alert ..... 108
- Setting the Rate of Change Alerts ..... 109
- Setting the Cal Repeat ..... 110
- Setting the Cal Reminder ..... 110
- Entering the transmitter ID ..... 111
- Setting up the Weak Signal feature ..... 111
- Setting the sensor glucose graph timeout ..... 112
- Reviewing your settings ..... 112
  - Using the Sensor Demo ..... 113
- The transmitter ..... 114
- Starting the sensor ..... 114
- Inserting the sensor ..... 114
- Removing the sensor ..... 114
- Preparing the sensor for communication ..... 114
- Calibrating the sensor ..... 115
- Entering meter BG for calibration ..... 116

**Chapter 8: Using your sensor ..... 119**

Status screens ..... 119

Reading the sensor glucose graphs ..... 120

- Opening and viewing the graphs ..... 121
- The graphs ..... 121
- Examples of real-time sensor glucose graphs ..... 123
  - 3-hour graph ..... 123
  - 6-hour graph ..... 123
  - 12-hour graph ..... 124

24-hour graph .....	124
How to check for rapid changes in sensor glucose .....	125
The rapid change arrows .....	125
How to make glucose alerts silent .....	126
Calibration history .....	127
Sensor alert history .....	127
Using your system in water .....	128
<b>Chapter 9: Utilities .....</b>	<b>129</b>
Alarm review .....	129
Setting your alert type .....	129
Auto-off .....	130
LOW RESV WARNING (Low reservoir warning) .....	130
Review daily insulin totals .....	131
Pump data management .....	132
Insulin delivery information .....	132
Sensor glucose information .....	133
Meter blood glucose information .....	134
AUC calculation .....	136
Personal reminders .....	138
Alarm clock .....	138
PC connect for change settings .....	138
Remote control option .....	138
Turn on remote control option .....	139
Add, delete, review remote control IDs .....	139
Other Devices option .....	140
Block feature .....	140
Turning block on .....	140
Example 1: Block .....	140
Example 2: Block .....	141
Lock keypad feature .....	141
Locking the keypad .....	141
Unlocking the keypad .....	141
Selftest .....	141
User settings .....	142
Saving the settings .....	143
Restoring the settings .....	143



Clearing the settings .....	144
History .....	144
<b>Chapter 10: Meter option .....</b>	<b>147</b>
About meters .....	147
Meter rules .....	147
Add, delete, review meter IDs .....	148
<b>Chapter 11: Therapy management software .....</b>	<b>149</b>
CareLink® Personal Software .....	149
Reports .....	149
Logbook .....	150
<b>Chapter 12: Insulin pump therapy follow-up .....</b>	<b>151</b>
Recommended follow-up .....	151
Everyday .....	151
Every month .....	151
Every three months .....	151
Laboratory tests .....	152
Every visit .....	152
Annually .....	152
<b>Chapter 13: Troubleshooting, alerts and alarms .....</b>	<b>153</b>
My pump has a NO DELIVERY alarm .....	153
What happens if I leave the pump battery out too long? .....	154
Why doesn't my pump battery last very long? .....	154
What is a CHECK SETTINGS alarm? .....	155
My screen appears distorted .....	155
The pump is asking me to rewind .....	155
My bolus stopped .....	155
My pump buttons are not acting right during a bolus .....	156
My pump will not display my blood glucose reading from my meter .....	156
I dropped my pump .....	156
I submerged my pump in water .....	157
I cannot get to the USER SETTINGS screen .....	157
Alerts .....	157
Example: .....	158

What to do .....	158
Pump alert conditions .....	159
LOW RESERVOIR .....	159
LOW BATTERY .....	159
Sensor alert conditions .....	159
WEAK SIGNAL .....	159
ALERT SILENCE .....	159
MISSED BOLUS .....	160
LOST SENSOR .....	160
LOW TRANSMTR .....	161
CHARGE TRANSMTR .....	161
CHANGE SENSOR .....	161
SENSOR END .....	161
CAL ERROR .....	162
METER BG NOW .....	162
METER BG BY .....	162
LOW XX MG/DL (XX = SG measurement) .....	162
HIGH XXX MG/DL (XXX = SG measurement) .....	163
LOW PREDICTED .....	163
HIGH PREDICTED .....	163
RISE RATE .....	163
FALL RATE .....	163
SENSOR ERROR .....	164
Alarms .....	164
What to do .....	165
Alarm conditions .....	165
A (ALARM) .....	165
AUTO OFF .....	165
BATT OUT LIMIT .....	165
BOLUS STOPPED .....	166
BUTTON ERROR .....	166
CHECK SETTINGS .....	166
E (ERROR) .....	166
EMPTY RESERVOIR .....	166
FAILED BATT TEST .....	166
FINISH LOADING .....	166
MAX FILL REACHED .....	167

MAX DELIVERY .....	168
MOTOR ERROR .....	168
NO DELIVERY .....	168
NO RESERVOIR .....	168
OFF NO POWER .....	168
RESET .....	168
WEAK BATTERY .....	169
Testing the transmitter .....	169
Connecting the tester .....	169
Disconnecting the tester .....	170
Troubleshooting sensor features .....	170
Reconnect old sensor .....	170
Find lost sensor .....	171
<b>Chapter 14: Maintenance .....</b>	<b>173</b>
Battery .....	173
Storage .....	174
Cleaning your pump .....	174
Cleaning the transmitter .....	174
Cleaning the Sen-serter .....	175
<b>Chapter 15: Pump specifications .....</b>	<b>177</b>
Alarms and error messages .....	177
Alarm history .....	177
Audio frequency .....	177
Backlight .....	178
Basal .....	178
BG Target .....	178
Bolus delivery .....	178
Maximum bolus .....	178
Bolus history .....	178
Bolus units .....	179
Bolus Wizard feature .....	179
Carb ratios .....	179
Carb units .....	179
Daily totals .....	179
Default screen .....	179

Delivery accuracy .....	180
Pump motor .....	180
Dual Wave bolus .....	181
Easy bolus .....	181
Filling the infusion set .....	181
Infusion pressure .....	181
Insulin sensitivity .....	181
Low resv (reservoir) warning .....	182
Meter value .....	182
Normal bolus .....	182
Occlusion detection .....	182
Percent temp basal .....	182
Power supply .....	183
Reservoir + Set history .....	183
Program safety checks .....	183
Pump size .....	183
Pump weight .....	183
Remote control .....	183
Reservoir .....	183
Square Wave bolus .....	184
Temporary (temp) basal rate .....	184
Time and date screen .....	184
Environmental conditions .....	184
Radio frequency (RF) communication specifications .....	184
Quality of service .....	184
Data security .....	184
Status screen .....	185
Bolus Wizard feature specifications .....	187
Bolus Wizard feature examples .....	190
Insulin delivery default settings .....	192
Bolus Wizard feature default settings .....	194
Sensor features default settings .....	194
Guidance and manufacturer's declaration .....	198
Icon table .....	204
<b>Appendix A: Sensor accuracy .....</b>	<b>207</b>
Performance results in adults .....	208

Accuracy of Guardian RT readings .....	209
Precision of Guardian RT readings .....	213
Low and High alerts in adults .....	214
The Low Glucose alert .....	214
The High Glucose alert .....	215
Guardian RT sensor performance and calibration stability as a function of time .....	216
Effects of calibration frequency .....	219
Time-elapsed plots .....	220
Performance results in children and adolescents .....	223
Accuracy of Guardian RT readings .....	223
Low and High alerts in children and adolescents .....	227
The Low Glucose alert .....	227
The High Glucose alert .....	228
<b>Glossary .....</b>	<b>229</b>
<b>Index .....</b>	<b>237</b>

# Introduction

Thank you for choosing Medtronic Diabetes (legally known as Medtronic MiniMed, Inc.) as your partner in helping you gain better control of your diabetes. Whether you are beginning pump therapy for the first time or upgrading from a previous model, we believe that the combination of state-of-the-art technology and the simple, menu-driven programming of the pump will provide many benefits.

This user guide is designed to help you to understand pump therapy and the operation of your Medtronic MiniMed Paradigm® REAL-Time Revel™ insulin pump. We strongly recommend that you work closely with your healthcare professional for a safe and complete pump start.

## Assistance

Medtronic Diabetes provides a 24 Hour HelpLine for assistance. The HelpLine is staffed with representatives who are trained in the set-up and operation of the pump and are able to answer pump-related questions. When calling the HelpLine or your local Medtronic Diabetes office, please have your pump and serial number available. The phone number for the 24 Hour HelpLine is also on the back of your pump.

Department	Telephone number
24 Hour HelpLine (calls within the United States)	800.646.4633
24 Hour HelpLine (calls outside the United States)	+1.818.576.5555
Web site	<a href="http://www.medtronicdiabetes.com">www.medtronicdiabetes.com</a>

## Emergency kit

Keep an emergency kit with you at all times to make sure that you always have necessary supplies. Inform a family member, co-worker, and/or friend where this emergency kit is kept. Please refer to the *User safety* section in this chapter for more information on pump safety. Your emergency kit should include these items:

- Fast-acting glucose tablets
- Blood glucose monitoring supplies
- Urine ketone monitoring supplies
- Extra Paradigm® compatible infusion set and Paradigm reservoir
- Insulin syringe and fast-acting insulin (with dosage instructions from your healthcare professional)
- Wallet card
- Dressing and adhesive
- Glucagon Emergency Kit®
- Extra AAA alkaline batteries (Energizer® brand is recommended)

---

**CAUTION: If you give yourself insulin by using a syringe, the Bolus Wizard feature will not be able to correctly determine the active insulin in your system. Consult with your healthcare professional on how long you need to wait after a manual injection before you can rely on the active insulin calculation of your Bolus Wizard feature.**

---

## Consumables

The pumps use disposable reservoirs and infusion sets for insulin delivery. Installation instructions for Paradigm reservoir and Paradigm compatible infusion sets are provided in the *Starting on insulin* chapter.

- **Reservoirs** — The 523 and 523K pumps are only used with the 176-unit Paradigm reservoir (MMT-326A). The 723 and 723K pumps can be used with either the 300-unit Paradigm reservoir (MMT-332A) or the 176-unit reservoir, depending on your insulin needs.
- **Infusion sets** — Medtronic Diabetes provides a variety of Paradigm-compatible infusion sets to fit your needs. Contact your healthcare professional for help in choosing an infusion set that fits your needs. Change your infusion set every two to three days.

---

**WARNING:** For your protection the pump has undergone extensive testing to confirm appropriate operation when used with Paradigm reservoirs and Paradigm compatible infusion sets manufactured or distributed by Medtronic Diabetes. We recommend using Medtronic Diabetes infusion sets and reservoirs as we cannot guarantee appropriate operation if the pump is used with reservoirs or infusion sets offered by third-parties and therefore we are not responsible for any injury or malfunctioning of the pump that may occur in association with such use.

---

## Accessories

- **Meter** – Your pump can be used with an optional blood glucose meter powered by MWT1 technology (where or if available). MWT1 is the wireless Radio Frequency (RF) technology that is used to transmit information from the meter to the pump. You can program your pump to automatically receive your BG reading from this meter. All meters referenced in this user guide are blood glucose meters supported by MWT1 technology.
- **Remote control** – The optional Paradigm remote control can be used with the pump to deliver normal boluses and suspend/resume the pump from a distant location. (This user guide provides programming instructions for the remote control. Refer to the remote control user guide for operating instructions.)
- **Medtronic MiniLink® Transmitter** – The transmitter (MMT-7703) is a small device that connects to the sensor. It comes with a tester and a charger. When connected to a sensor that is inserted in the body, the transmitter automatically initializes the sensor and begins to periodically send glucose data to the pump using a radio signal.
- **Sensor** – The sensor (MMT-7002/MMT-7003) continuously converts tiny amounts of glucose from your fatty layer under the skin into an electronic signal. This signal is sent to the transmitter.
- **CareLink USB Upload Device** – The Medtronic Diabetes CareLink USB (MMT-7305) is used to download the Paradigm 523, 723, 523K or 723K pump data to the diabetes management software using a USB port on your computer.

To order supplies, call 800-646-4633, +1-818-362-5958 (outside U.S.), refer to the contacts list at the beginning of this user guide, or visit our web site at [www.medtronicdiabetes.com](http://www.medtronicdiabetes.com).

## How to wear your pump

There are different ways to wear your pump. Medtronic Diabetes has optional accessories that can hide, protect, and add to the convenience of wearing a pump. Refer to the accessories catalog or the website ([www.medtronicdiabetes.com](http://www.medtronicdiabetes.com)) for more information.

- **Holster** – To wear the pump on your belt.
- **Pump clip** – To wear the pump underneath your clothing.







- **Activity guard** – If you are active in sports, or you are a child, use the guard to protect the pump from disconnecting.
- **Leather case** – Fine leather lined with nylon. Styling complements business and formal wear. Velcro flap provides easy access for programming. Wear it vertically with the built-in belt clip.

## How to use this guide

*NOTE: This user guide shows sample screens only. Your pump screens may be slightly different.*

For step-by-step instructions, refer to the appropriate sections in this guide. Refer to the Glossary for definitions of terms and functions. The terms and symbols used in this guide are in the table below.

<b>Conventions</b>	<b>Meaning</b>
Press	to push and release the button
Hold	to push and keep pressure on the button
Select	to press  or  to highlight a screen item you want to select
Exit the menus	press <b>ESC</b> until the <b>HOME</b> screen appears
Pump buttons	always bold and uppercase; for example, <b>ESC</b> , <b>ACT</b>
Screen and menu names	always uppercase; for example, <b>MAIN MENU</b> , <b>REWIND</b> screen
Menu selections	always bold; for example, <b>24-Hour Setup</b> , <b>On</b> , <b>Off</b>
Flashing (blinking) screen item	you can change the value for that item with the  or  buttons
<b>NOTE</b> and <b>TIP</b>	additional helpful information
<b>CAUTION</b>	warns of a potential hazard which, if not avoided, may result in minor or moderate injury to the equipment
<b>WARNING</b>	notifies you of a potential hazard which, if not avoided, could result in death or serious injury. It may also describe potential serious adverse reactions and safety hazards

Conventions	Meaning
Go to the...screen.	<p>when a step instructs you to go to a certain screen, the path to that screen is shown. For example: Go to the ALARM MENU.</p> <p><b>Main &gt; Utilities &gt; Alarm</b></p> <ol style="list-style-type: none"> <li>1 From the MAIN MENU, select <b>Utilities</b> and press <b>ACT</b>.</li> <li>2 In the UTILITIES MENU, select <b>Alarm</b> and press <b>ACT</b>.</li> <li>3 The ALARM MENU appears.</li> </ol>

## User safety

### Indications

#### Paradigm REAL-Time Reveal insulin pump

The Paradigm REAL-Time Reveal insulin pumps (523/723/523K/723K) are indicated for the continuous delivery of insulin, at set and variable rates, for the management of diabetes mellitus in persons requiring insulin.

The Paradigm REAL-Time system consists of the Paradigm MMT-523/723 insulin pumps, or the MMT-523K/723K pediatric versions of the insulin pumps, the MMT-7002/ MMT-7003 glucose sensor, and the MMT-7703 transmitter. Use of the MMT-523/723 insulin pumps with the optional sensor and transmitter components is indicated for continuous or periodic monitoring of glucose levels in the fluid under the skin, and possible low and high blood glucose episodes in adults (ages 18 and older). Use of the MMT-523K/723K insulin pumps with the optional sensor and transmitter components is indicated for continuous or periodic monitoring of glucose levels in the fluid under the skin, and possible low and high blood glucose episodes in children and adolescents (ages 7 through 17). The pediatric system provides an alert if glucose levels fall below or rise above preset values. Glucose values provided by the Paradigm 523/723/523K/723K systems are not intended to be used directly for making therapy adjustments, but rather to provide an indication of when a fingerstick may be required. All therapy adjustments should be based on measurements obtained using a home glucose monitor and not on the sensor glucose readings provided by the Paradigm 523/723/523K/723K systems.

## Meter

The Paradigm pump can be programmed to receive fingerstick blood glucose values transmitted from Bayer's CONTOUR® NEXT LINK Wireless Meter, Bayer's CONTOUR® LINK Wireless Meter, a OneTouch® UltraLink® meter, or a BD Paradigm Link® glucose meter for use in the Bolus Wizard calculator and for use as calibration values for the glucose sensor. Glucose values from other glucose meters must be manually entered into the pump.

## Contraindications

Pump therapy is not recommended for people who are unwilling or unable to perform a minimum of four blood glucose tests per day and to maintain contact with their healthcare professional. Successful insulin pump therapy requires sufficient vision or hearing to allow recognition of the pump signals and alarms.

Do not expose your insulin pump to MRI equipment or other devices that generate very strong magnetic fields. The magnetic fields in the immediate vicinity of these devices can damage the part of the pump's motor that regulates insulin delivery, possibly resulting in over-delivery and severe hypoglycemia.

**Your pump must be removed and kept outside the room during magnetic resonance imaging (MRI) procedures.**

If your pump is inadvertently exposed to a strong magnetic field, discontinue use and contact the 24 Hour HelpLine for further assistance.

## Warnings

### Pump

The pump is not suitable for use in the presence of a flammable anaesthetic mixture with air, oxygen or nitrous oxide.

The drive support cap should appear slightly indented at all times (as shown in the image). If you notice that the cap is loose, or sticking out, discontinue use of the pump and contact our 24 Hour HelpLine at 1 800 646 4633 to arrange for your pump to be replaced. **Do not press on the drive support cap if it is sticking out. Pushing on the drive support cap may result in unintended delivery of insulin, which can cause hypoglycemia.**



## **Reservoir and infusion sets**

Standard Luer sets are not compatible with the Medtronic MiniMed Paradigm pump. Medtronic Diabetes Paradigm reservoirs and Paradigm-compatible infusion sets are specifically designed for use with the pump. Do not modify your Paradigm reservoir or Paradigm-compatible infusion set.

Do not put any other drugs/medications inside your reservoir to use with this pump. Only insulin that has been prescribed by your physician can be used in this pump.

## **Sensor**

Bleeding, swelling, irritation and/or infection at the insertion site are possible risks associated with inserting the sensor and sometimes result from improper insertion and maintenance of insertion site.

## **Transmitter**

Product contains small parts and may pose a choking hazard for young children.

Optional occlusive dressing should be removed if irritation or reaction to this develops.

## Tubing Connector

If insulin, or any liquid, gets inside the tubing connector, it can temporarily block the vents that allow the pump to properly prime the infusion set. This may result in the delivery of too little or too much insulin, which can cause hypoglycemia or hyperglycemia. To prevent liquid from getting inside the tubing connector, after you fill the reservoir make sure you hold the insulin vial upright when you remove the reservoir from the transfer guard. If you do not hold the insulin vial upright, insulin can get on the top of the reservoir and could transfer liquid into the tubing connector. If any liquid gets on the top of the reservoir or inside the tubing connector when you change your infusion set, start over with a new reservoir and infusion set. For instructions on setting up your reservoir, see *Setting up the reservoir, on page 52*. For instructions on changing your infusion set, see *Changing your infusion set, on page 54*.

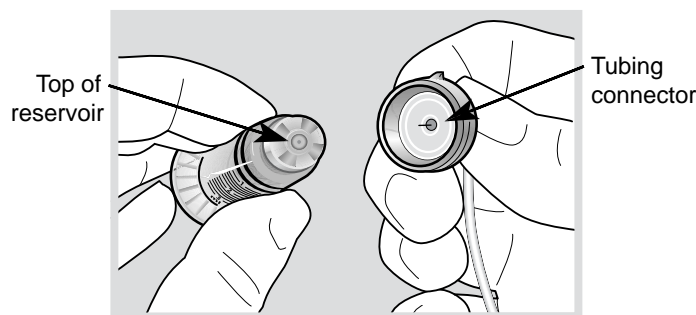

## Magnetic fields

Do not use pump cases that have a magnetic clasp.

Do not expose your insulin pump to MRI equipment or other devices that generate very strong magnetic fields. The magnetic fields in the immediate vicinity of these devices can damage the part of the pump's motor that regulates insulin delivery, possibly resulting in over-delivery and severe hypoglycemia.

**Your pump must be removed and kept outside the room during magnetic resonance imaging (MRI) procedures.**

If your pump is inadvertently exposed to a strong magnetic field, discontinue use and contact our 24 Hour HelpLine for further assistance.

## X-rays, MRIs and CT scans

If you are going to have an X-ray, CT scan, MRI or other type of exposure to radiation, **take off your pump, sensor, transmitter, meter and remote control** before entering a room containing any of these equipment.

The Paradigm pump is designed to withstand common electromagnetic interference, including airport security systems. Be sure to carry the Emergency Card provided, when you are traveling. This card provides airport information.

## Precautions

Although the pump has multiple safety alarms, it cannot notify you if the set is leaking or the insulin has lost its potency. It is essential, therefore, that you test your blood glucose levels at least four times per day. If your blood glucose is out of range, check the pump and the infusion set to ensure that the necessary amount of insulin is being delivered.

### Avoid extreme temperatures

- 1 Avoid exposure of your pump and remote control to temperatures above 108°F (42°C) or below 34°F (1°C).
- 2 Insulin solutions freeze near 32°F (0°C) and degrade at high temperatures. If you are outside in cold weather, wear your pump close to your body and cover it with warm clothing. If you are in a warm environment, take measures to keep your pump and insulin cool.
- 3 Do not steam, sterilize or autoclave your pump or remote control.

### Infusion sets and sites

Avoid using an infusion set insertion site that will be irritated by clothing and accessories, or by rigorous stretching and exercise.

### Sensor

Prior to exercising, make sure the sensor is firmly attached.

## Adverse reactions

Operation of the sensor feature requires the insertion of a glucose sensor into the skin. Bleeding, swelling, bruising, or infection at the sensor insertion site are possible risks of sensor use. The sensor should be removed if redness, pain, tenderness or swelling develop at the insertion site. The optional occlusive dressing should be removed if irritation or a reaction to this develops. Contact your doctor and our 24 Hour HelpLine in the event of any adverse reaction.

## Notice

---

**CAUTION: Any changes or modifications to the devices not expressly approved by Medtronic Diabetes could void your ability to operate the equipment.**

---

### Insulin pump and RF accessories

The pump, meter, transmitter and remote control comply with the United States Federal Communications Commission and international standards for electromagnetic compatibility.

Do not use the RF meter to send your blood glucose reading to the pump while on an aircraft. Manually enter your blood glucose.

These devices comply with Part 15 of the FCC Rules. Operation is subject to the following two conditions: (1) This device may not cause harmful interference, and (2) this device must accept any interference received, including interference that may cause undesirable operation. It does not interfere with any RF signals transmitted from outside sources.

These standards are designed to provide reasonable protection against excessive radio frequency interference and prevent undesirable operation of the device from unwanted electromagnetic interference. Operation is subject to the following two conditions:

- 1 This device has been tested and found to comply with the regulations governing such devices in your area. For the specific regulation and test results for your area, please contact our 24 Hour HelpLine.
- 2 This device generates, uses, and can radiate radio frequency energy and, if installed and used in accordance with the instruction, may cause harmful interference to radio communications. If the device does cause interference to radio or television reception, you are encouraged to try to correct the interference by one or more of the following measures:
  - Reorient or relocate the insulin pump/remote control/transmitter/meter
  - Increase the separation between the insulin pump/remote control/transmitter/meter and the device that is receiving/emitting interference

The meter and the transmitter send information to the pump using radio frequency. If other devices that use radio frequency are in use, such as cell phones, cordless phones and wireless networks, they may prevent communication between the pump and the meter. This interference will not cause any incorrect data to be sent and will not cause any harm to your pump or meter. Moving away from or turning off these other devices may allow communication. Refer to the *Troubleshooting, alerts and alarms* chapter to correct interference problems you may have.

Wireless transmission between the pump and transmitter within the 6 feet (1.8 meters) operating range may be interrupted due to the transmitter orientation and the pump position on the body. Move the pump closer to the transmitter or to another position. If a Lost Sensor alarm has occurred retry:

**Main > Sensor > Link to Sensor > Find Lost Sensor**

If you have questions, please contact the 24 Hour HelpLine.

## RF interference from other devices

Common consumer electronic devices that transmit in the same frequency band used by the MMT-7703 MiniLink transmitter may prevent the pump from receiving the glucose information sent by the transmitter. Most cellular (mobile) phones and 900 MHz cordless phones, when transmitting or receiving, may cause significant interruption of transmitter-receiver communication. It is likely that other devices operating in similar frequency ranges will have a similar effect. This interference, however, will not cause any incorrect data to be sent and will not cause any harm to your transmitter.

The pump includes a programmable WEAK SIGNAL alert that notifies you when one or more expected transmissions were not received as expected by the pump. (The pump will also issue a LOST SENSOR alert if communication is interrupted for an extended period of time.)

Communication problems can usually be resolved by:

- ensuring that there is less than 6 feet (1.8 meters) between the receiving device and transmitter, to include RF glucose meters;
- turning off or moving away from other RF transmitting devices; or
- reorienting or relocating the transmitter or receiving device, or both.

Communications problems may also occur due to cellular telephone interference. Testing conducted with several different cellular telephones indicates that, while a glucose value is being transmitted, using a cell phone within 12 inches (31 cm) of receiving devices, transmitters or RF glucose meters can interfere with reception of the transmitted values. In the event of such interference, normal communication can be re-established by:

- turning the cell phone off; or
- keeping the cell phone at least 12 inches (31 cm) away from the receiving device, transmitter or glucose meter when a glucose measurement is being transmitted.

If you have questions, please contact the 24 Hour HelpLine.





# The basics

## Your pump

**CAUTION:** Never use sharp objects to press the buttons on your Paradigm pump as this can damage the buttons or compromise the seal of the pump. Some examples of sharp objects that may damage your keypad are fingernail files, pens or pencils, paper clips, knives, scissors, and keys.

Take a look at your pump. The reservoir window allows you to view the insulin in the reservoir. The reservoir, with the tubing connector attached, is inserted into the reservoir compartment of the pump.

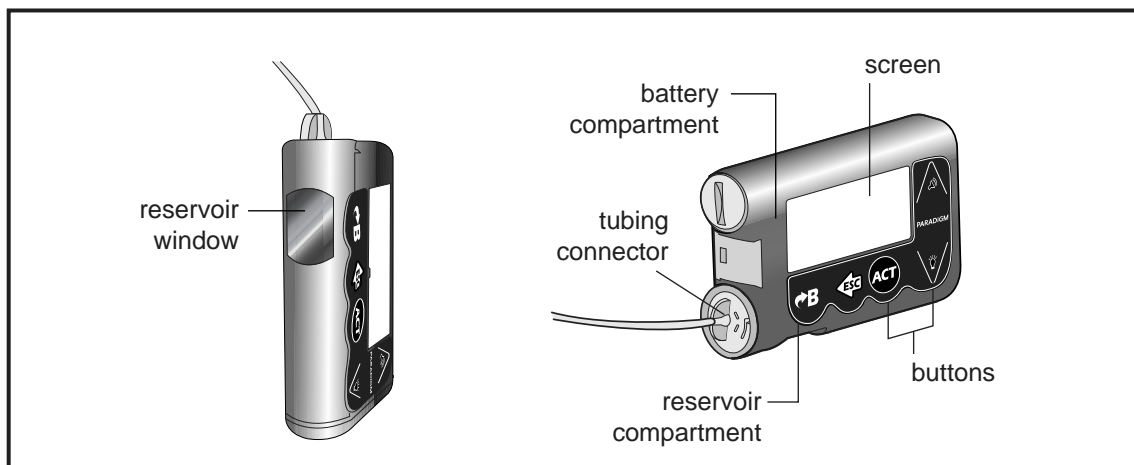

# Install battery

---

**CAUTION: Do not use a rechargeable or carbon zinc battery in your pump. For best results use a new Energizer AAA alkaline battery, size E92, type LR03.**

---

Medtronic Diabetes designed the pump to only accept a new battery. As a safety measure, if you install a battery that does not have full power, the WEAK BATTERY or FAILED BATT TEST alarm may sound. If you receive a WEAK BATTERY alarm, respond to the alarm and continue. The pump will still operate normally, but with a decreased battery life. The pump uses one AAA alkaline battery.

- 1 Make sure all the following apply:
  - Clear (ESC, ACT) any alarms and/or alerts before removing and replacing the battery.
  - Make sure the pump is at the HOME (idle) screen when you remove the battery.
  - Do NOT remove the battery during a bolus or Fill Cannula delivery.
- 2 Use the edge of a coin to remove the battery cap. Turn the cap in a counter-clockwise direction.
- 3 Remove the old battery and dispose of it per the disposable requirements of your state or country. Put the new battery in the pump with the negative end [(-) symbol] going in first. Check the label on the back of the pump to make sure the battery is inserted correctly.

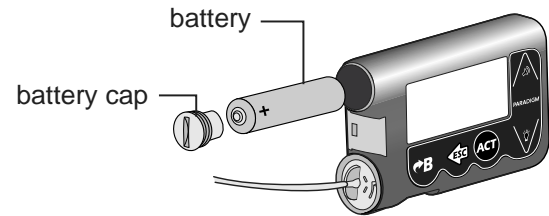

**NOTE:** Do not use batteries that have been in cold storage, such as in the refrigerator or in your car during winter in cold climates.

- 4 Place the battery cap in the pump and tighten so the slot is aligned horizontally with the pump as shown here:

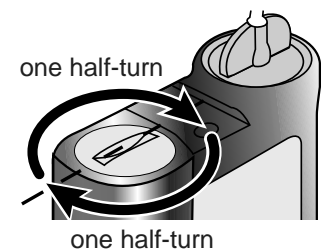

---

**CAUTION: Do NOT over-tighten the battery cap. You should not turn the cap more than four half turns. If you over-tighten the cap you may not be able to remove it, and you can damage your pump.**

---

- 5 While the pump turns on, it will show one or more screens until the HOME screen appears.  
If the HOME screen does not appear, do these steps:
  - a. Check that the battery is inserted correctly. If the battery has been installed backwards, remove the battery and install it properly.
  - b. If your pump still does not turn on or you get a FAILED BATT TEST alarm, remove and replace the battery with a new one.
  - c. If the pump is still not on, call our 24 Hour HelpLine.
- 6 Check to make sure the time and date are correct. If more than five minutes have passed since you removed the battery, you will be prompted to check the time and date. Refer to the *Setting the time and date* section in the *Basic programming* chapter for programming instructions.
- 7 Press **ESC** to view the STATUS screen, making sure no alarms are active. If an alarm is active, follow the instructions on the screen.





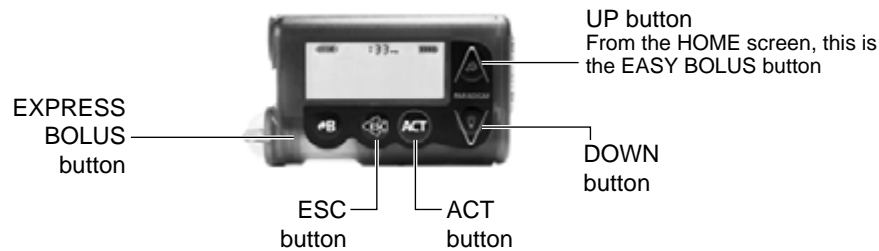

HOME screen

## Pump buttons





The buttons on the pump are used to navigate through the menus and screens, and to program the features of the pump.



The following table describes how to use the buttons on your pump from the **HOME** screen:

Button	Description
	<b>EASY BOLUS™</b> button - Shortcut to set and deliver an Easy Bolus.
	Turns the backlight on or off.
	Opens the MAIN MENU.
	<ul style="list-style-type: none"> <li>• Opens the pump STATUS screen if the sensor feature is turned off.</li> <li>• Opens the following screens and graphs from the HOME screen if the sensor feature is turned on: <ul style="list-style-type: none"> <li>• 1 press opens the last sensor graph selected.</li> <li>• 2 presses open the pump STATUS screen.</li> <li>• 3 presses open the SENSOR STATUS screen.</li> </ul> </li> </ul>
	<b>EXPRESS BOLUS</b> button - Shortcut to set any bolus.

The following table describes how to use the buttons on your pump from the **menus and programming screens**:

Button	Description
	Increases or decreases the value of a flashing item. Scrolls up or down the items in a list.
	Accepts a selected menu item or activates a selected setting.
	<ul style="list-style-type: none"> <li>• Returns to previous screen or exits the menu.</li> <li>• Backs out of unintentional menu selections if the <b>ACT</b> button has not been pressed yet.</li> </ul>
	<ul style="list-style-type: none"> <li>• Press simultaneously with  to turn on backlight when in the menus.</li> <li>• Use as a Shift button by pressing it in combination with another button to access certain features.</li> </ul>

## The pump screen

The screen shows five lines of text at one time. The first is the operating mode. The second is the current open menu or function. The last three lines show either information or text that you can select for the current function.

**NOTE:** The screen text in the examples used in this guide might not exactly match the text on your pump screen. Please follow your pump screen instructions. If you have any questions, contact our 24 Hour HelpLine.

## HOME screen

The HOME screen serves as the starting point to access the programming screens. When no buttons are pressed for about 30 seconds, the pump returns to this screen.

When you press **ACT** from the HOME screen, the **MAIN MENU** will appear.

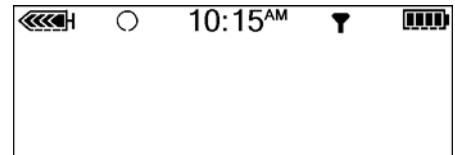

When the pump is on, the following icons always appear across the top of the screen: reservoir volume icon, the time (12- or 24-hr), and the battery icon. If these do not appear, the pump is not operating.

## Screen icons

There are various icons that appear at the top of your pump screen, like the time, battery and reservoir icons mentioned above. The next sections describe what the icons mean.

### Battery

The battery icon tells you how much usable life is left in your battery. There are four segments in the icon. Each segment represents approximately 25 percent of the usable battery life you have left until you reach Low Battery point. So if you only have one segment left, make sure you have a new battery available.



At least 75% left



Low battery

## Time display

The current time of day is displayed across the top of the pump screen in the format you select—12-hour or 24-hour. The AM or PM is only displayed for the 12-hour format. For instructions on setting the time on your pump, see the *Setting the time and date* section in the *Basic programming* chapter.

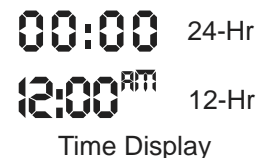

## Reservoir volume

The reservoir volume icon tells you how much insulin is in your pump. This icon is also divided into four segments. Each segment represents approximately 25 percent of the reservoir volume you have left. This allows you to be aware of how much insulin you have left in your pump. Refer to your STATUS screen to view the number of units left in the reservoir.

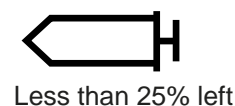

**NOTE:** For the Paradigm 723/723K pump, your reservoir icon will only appear full if using a filled 300-unit Paradigm reservoir. The icon will not appear full if you use the 176-unit Paradigm reservoir.

## Alert and alarm icons

An open circle (alert) or a solid circle (alarm) are displayed in the upper part of your pump screen only when there is an alert or alarm condition on your pump. For alarm and alert information, see the *Troubleshooting, alerts and alarms* chapter.

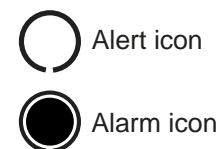

## Sensor icons

A dark sensor icon means that the sensor is on and the pump is receiving sensor data. A light-colored sensor icon with a dark circle around it means that the sensor is on, but the pump is not receiving sensor data. For information about the sensor, see the *Sensor features* chapter.

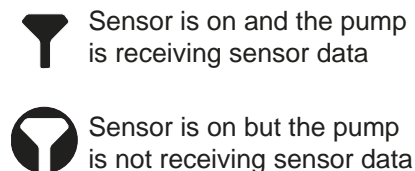



## Scroll bar

If there is more text than the screen can show, a scroll bar appears on the right side of the screen. Press  to view any additional text.



## Screen backlight

When you press  from the HOME screen, the light on the screen turns on or off. During programming, the backlight can be turned on by pressing the  and the  together. The light will stay on while you are pressing any of the pump buttons. It will stay on as long as the current screen is active.

To conserve your battery, the backlight will turn off automatically while the pump is vibrating. After the vibration is finished, the light will turn back on. The backlight cannot be turned on in a low or dead battery condition.

## Beep/vibrate

Your pump will beep or vibrate to indicate activity. Refer to the *Setting your alert type* section in the *Utilities* chapter for setup instructions.

## Operating modes

The screen lets you know when a special feature is active or if there is a condition that needs your attention. The active features and pump status will determine the operating mode. The screens for the three modes are shown in the following sections.



## Normal mode

Mode for standard pump operations for normal basal and bolus delivery. No special features are active (such as basal patterns, temp basal, and others). No alarms and no alerts exist.

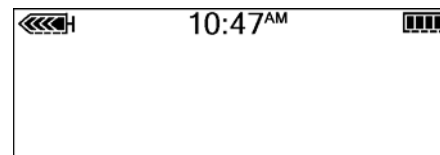

## Special mode

Indicates a special feature is active or an alert condition(s) exists. Special mode does not restrict any of the pump functions. When the pump is in Special mode, an open circle appears at the top of the screen and it beeps or vibrates periodically to remind you of the condition. The conditions and features that put the pump in Special mode are:

- Low Reservoir condition
- Low Battery condition
- Block feature is on
- Dual or Square Wave bolus delivery
- Basal pattern A or B is active
- Sensor alerts
- Temporary basal delivery
- Alert Silence is active

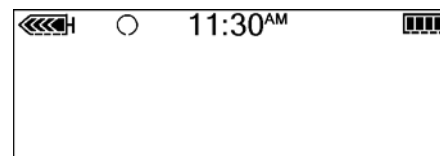

## Attention mode

---

**WARNING: When the pump is in Attention mode, showing a solid circle icon, all insulin deliveries are stopped.**

---

Indicates insulin delivery has stopped. This can mean that the pump is in Suspend mode. It can also mean an alarm is active or an alarm condition exists that needs immediate attention for insulin delivery to resume. A solid circle appears at the top of the screen and the pump will beep periodically until either the pump is taken out of Suspend mode or the condition is cleared. The screen will show text describing the condition that put the pump in Attention mode. For example, if the reservoir is empty, EMPTY RESERVOIR will appear on the screen.

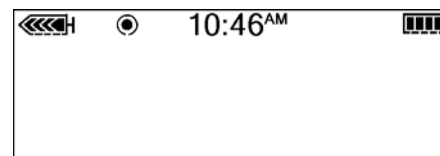

When the pump is in Attention mode, it will beep or vibrate periodically to remind you of the condition. The beep or vibrate frequency varies depending on the condition that put the pump in Attention mode. Refer to the *Alarm conditions* section in the *Troubleshooting, alerts and alarms* chapter for alarm conditions that will trigger the Attention mode. See the *Stopping your pump* section in the *Basic programming* chapter to learn about Suspend mode.

## Menus

The MAIN MENU is the highest level menu. There are submenus, functions, status and programming screens in the lower menu levels. The menus are described in the following paragraphs.

*Tip: If a screen item is flashing (blinking), during programming, press  or  to change the value.*

### MAIN MENU

Highest menu level in the menu system. When you press ACT from the HOME screen, the MAIN MENU will appear.

### BOLUS MENU

Contains the settings and functions for bolus deliveries. The  button allows direct access to MANUAL BOLUS or to the BOLUS WIZARD feature without having to navigate through the menus. Refer to the *Basic programming* chapter for the manual bolus information or to the *Using the Bolus Wizard feature* chapter for bolusing using the Bolus Wizard feature.

### SUSPEND

Stops all current insulin deliveries. Refer to the *Stopping your pump* section in the *Basic programming* chapter for more information.

### SENSOR

Contains the functions to setup the interface between the sensor and the pump and access to the pump's sensor features.

## CAPTURE EVENT

Contains the options you use to enter information about different events into the system. Examples of events include: the amount of insulin used for injections, and the carbohydrates consumed during meals or snacks. The Capture Event option appears in the MAIN MENU after this feature has been turned on in the UTILITIES MENU menu. See the *Capturing Events* section in the *Basic programming* chapter for more details.

## BASAL MENU

Contains the functions to setup and deliver your basal. Refer to the *Basal* section in the *Basic programming* chapter for more information.

## RESERVOIR + SET

Contains the functions required to change your reservoir and fill the infusion set with insulin. Refer to *Changing your infusion set* section in the *Starting on insulin* chapter for more information.

## UTILITIES MENU



Contains features for your safety and convenience. Refer to the *Utilities* chapter for more information.

## STATUS screen

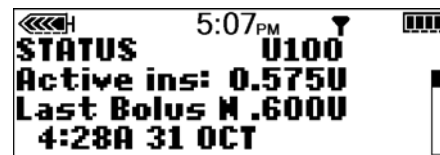
The STATUS screen shows information about what your pump is doing. Only check your pump status (press **ESC**) when you are not programming your pump. If you press **ESC** during programming, you will cancel the settings you are trying to enter.



The information that shows on the STATUS screen depends on the current activities and conditions of your pump.

- To open the STATUS screen, press **ESC** until the STATUS screen appears.
- To view more text on STATUS screen, press  or  to scroll and view all of the information.
- To exit the STATUS screen, press **ESC** until the STATUS screen disappears.

The screen includes information about:

- Last bolus insulin delivery
- Current basal insulin delivery

- The amount of active insulin, if any
- Special features that are turned on
- Last alarm/alert that was cleared within 24 hours
- Most recent BG meter reading received within 24 hours
- Reservoir status
- Battery status
- Time and date

Refer to the *Pump specifications* chapter for a complete list of the information that is available in the STATUS screen.

## If you remove your pump

You may have an occasion when you need or want to remove your pump. If you have to remove and store your pump, it is recommended that you do the following:

- Store your pump with the battery in place
- Keep a record of your current basal rates and use the *Save Settings* feature (see the *Saving the settings* section in the *Utilities* chapter).
- To preserve battery life, reset the basal rates to 0 (zero), turn off the RF options (meter, remote), and set Auto-off to dashes or zeroes.

**Remember, your body still needs insulin while your pump is removed.**

It is important that you consult with your healthcare professional to determine an alternate method of receiving your insulin. You can remove your pump for up to one hour without taking insulin. If you remove your pump for more than one hour, you will have to use another way to take your insulin, such as injections of fast-acting insulin, or reconnecting your pump to take boluses. Take the injection or bolus approximately every four hours. Calculate the amount of insulin to take based on the total of your basal insulin in four hours. Include the amount you need for meal and correction boluses. If you will have your pump off for several days, you will need to return to a multiple injection regimen.



# Basic programming

## Setting the time and date

Setting the correct time and date in your pump is necessary for accurate basal insulin delivery and allows you to keep an accurate record of your insulin delivery and other pump functions. You can select a 12-hour or 24-hour clock. You must reset the time and date if you receive a CHECK SETTINGS alarm or you clear your settings (Clear Settings function).

- 1 Go to the TIME/DATE SETUP screen.

Main > Utilities > Time/Date



- 2 Select 12-Hour Setup or 24-Hour Setup and press ACT.

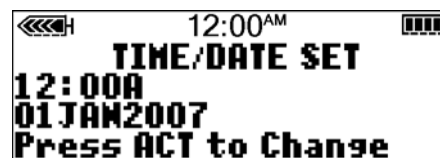



- 3 Press ACT again to change the settings.

- 4 Change each of the settings as follows:

- a. Hour

Change the hour. Press ACT.

For 12-hour setups, press  or  until the correct A (am) or P (pm) appears.

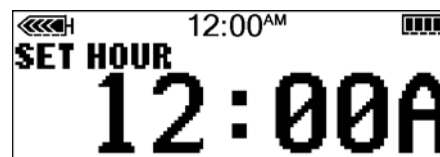

- b. Minutes

Change the minutes. Press ACT.

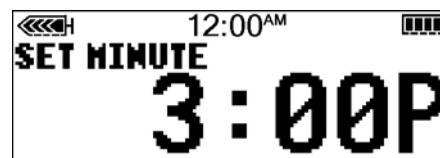

c. Year

Change the year. Press ACT.

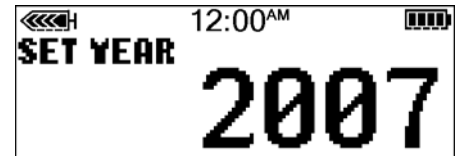

d. Month

Change the month. Press ACT.

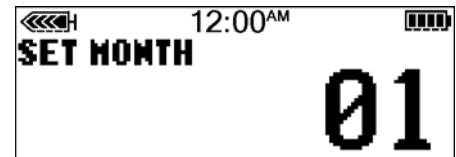

e. Day

Change the day. Press ACT.

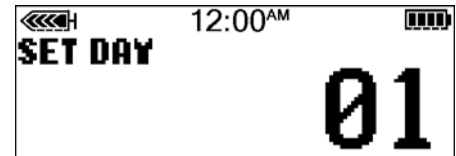

- 5 The TIME SET AT screen will show the settings that you programmed. Press ACT and exit the menus. Your time/date settings are complete.

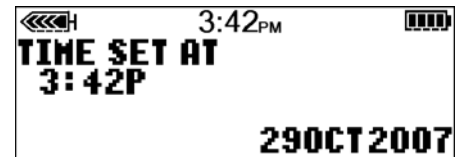

## Selecting the language

The language shown on the pump screens can be changed. Some languages may not be available on all pumps. Before you can select another language, you need to set the time using the English screens. Refer to the previous section.

To change the language for your pump:

- 1 Go to the LANGUAGE MENU screen.  
Main > Utilities > Language
- 2 Select your language, then press ACT.
- 3 The language setting is now changed. Exit the menus.



## Bolus

There are three bolus types: Normal, Square Wave<sup>®</sup>, and Dual Wave<sup>®</sup>. This section gives instructions for a Normal bolus using the **EXPRESS BOLUS** button and navigating through the menus. (For information about Square Wave and Dual Wave boluses, refer to the *Optimizing pump therapy* chapter.)

The Normal bolus delivers an immediate food or correction bolus. It can be delivered at any time except during another Normal bolus. During a Normal bolus, most pump features are disabled until after all the bolus has been delivered. The suspend function and the STATUS screen, however, are always available.

### Setting the Normal bolus

Normal bolus can be used to cover the carbohydrate in a meal or snack and/or to correct a blood glucose that is higher than your blood glucose target.

The following instructions are for a Normal bolus when the Bolus Wizard feature is turned off.

- 1 Go to the BOLUS MENU.  
Main > Bolus



Select **Set Bolus** and press **ACT**. Go to step 2.

You can also use the **⌂B EXPRESS BOLUS** button to get to step 2. Press **⌂B** from your HOME screen.

- 2 a. If the **SET BOLUS** screen appears: (Dual/Square option is off) Go to step 3.
- b. If the **BOLUS TYPE** screen appears: (Dual/Square Wave is on) Select **Normal Bolus** and press **ACT**.  
Go to step 3.

- 3 The **SET BOLUS** screen (or **SET NORMAL BOLUS** screen if the Dual/Square option is on) appears with 0.0 unit bolus amount flashing. Enter your bolus amount and press **ACT**.

If some of the bolus insulin delivered by the pump has not been used and is active in your body, the screen will show this amount as Act. Ins. (Active Insulin). This amount is based on the active insulin setting selected in the Bolus Wizard feature. The Active Insulin amount shows even if the Bolus Wizard feature is turned off. Take this amount into consideration to determine your bolus. See *About active insulin*, on page 72 for more information.

***NOTE:** If you have BG Reminder turned On, the BG REMINDER DURATION screen displays. It allows you to set the duration before you are reminded to check your blood glucose after a bolus. See the BG Reminder section in this chapter for information about this feature.*

- 4 The **BOLUS DELIVERY** screen appears and the Normal bolus starts. The pump will beep/vibrate at the start of the bolus. As the bolus delivers, the amount shown on the screen will increase until the entire bolus has been delivered. When the bolus is finished, the pump will beep/vibrate again and the HOME screen will appear.

The following practice lessons will help you understand this pump feature.

### Normal meal bolus using the exchange system

Normal bolus can be used to cover the carbohydrate in a meal or snack and to correct a blood glucose that is higher than the target that was chosen for you.

Fred has been taught that he needs to take 1 unit of insulin for every carbohydrate exchange that he eats (every milk, every starch or every fruit). For lunch today he will eat:

Turkey sandwich with two slices of bread    **2** starches

1 small apple    **1** fruit

1 cup of non-fat milk    **1** milk

\_\_\_\_\_

**Total carbohydrate exchanges = 4**

Fred's lunch has a total of 4 carbohydrate exchanges so he will take a meal bolus of 4 units for his lunch.

### Bolus practice:

***NOTE:** Make sure that you are not connected to your pump while practicing.*

Going through the menus, program a 2.0 unit Normal bolus now.

Check here if you were able to program it.

Using the **EXPRESS BOLUS** button **⚡B**, program a 2.0 unit Normal bolus now.

Check here if you were able to program it.

### Normal meal bolus practice using exchanges

Choose a meal you might eat and fill in the blanks.

Food: _____	exchange: _____
_____	exchange: _____
_____	exchange: _____
	total exchanges: _____

You will take \_\_\_\_\_ units of insulin for each exchange. Your total bolus is \_\_\_\_\_ for this meal.

### Normal meal bolus using carbohydrate counting

Lydia has been taught that she needs to take 1 unit of insulin for every 10 grams of carbohydrate. This is her insulin to carbohydrate ratio. For dinner she will have:

4 oz. broiled chicken	0 grams
2/3 cup of rice	30 grams
1/2 cup cooked broccoli	5 grams
1 oz. dinner roll	15 grams
1 tsp margarine	0 grams

total grams of carbohydrates = \_\_\_\_\_  
50 grams

Lydia's dinner totals 50 grams of carbohydrate. Her insulin to carbohydrate ratio is 1 unit to 10 grams. She will take a meal bolus of 5 units for her dinner. She determined this by dividing 50 (total grams of carbohydrate) by 10 (insulin to carbohydrate ratio).

## Normal meal bolus practice using carbohydrates

Choose a meal you might eat and fill in the blanks.

Food: _____	grams of carbohydrate: _____
_____	grams of carbohydrate: _____
_____	grams of carbohydrate: _____
	<b>total grams of carbohydrate: _____</b>

Your insulin to carbohydrate ratio: 1 unit of insulin for \_\_\_\_\_ grams carbohydrate.

Divide your total carbohydrates by your insulin to carbohydrate ratio and take \_\_\_\_\_ units of insulin for your meal.

## Meal bolus, correction bolus and insulin sensitivity

Jason is ready to eat his breakfast. He has calculated that he will need 4.0 units for his food.

He tests his blood glucose and finds that it is 200 mg/dL (11.1 mmol/L). Jason knows that his blood glucose level is above his blood glucose target and will need additional insulin before he eats.

**Jason's healthcare professional has determined the following for him:**

BG Target: 110 mg/dL (6.1 mmol/L)

Insulin sensitivity<sup>1</sup>: 36 mg/dL/u (2.0 mmol/L/u)

Jason determines that he will need a correction bolus of 2.5 units insulin to lower his elevated blood glucose. The 2.5 correction bolus will lower his current blood glucose of 200 mg/dL (11.1 mmol/L) to his target of 110 mg/dL (6.1 mmol/L).

- elevated blood glucose:  $200 - 110 = 90$  mg/dL ( $11.1 - 6.1 = 5$  mmol/L)
- correction bolus:  $90 / 36$  mg/dL/u (insulin sensitivity) ( $5.0 / 2.0$  mmol/L/u) = 2.5 units

(He will add this 2.5 correction bolus to the 4.0 units of insulin that he will need for his meal bolus. Jason will take a total bolus of 6.5 units.)

1. *Insulin sensitivity is the amount (in mg/dL or mmol/L) by which blood glucose will be lowered after taking 1 unit of insulin. Consult with your healthcare professional to determine your insulin sensitivity.*

### Practice: Meal bolus

You have determined your meal bolus as: \_\_\_\_\_ units.

Your target blood glucose range is: \_\_\_\_\_ to \_\_\_\_\_ (average is \_\_\_\_\_).

Your current blood glucose level is: \_\_\_\_\_.

Your correction factor is: 1 unit of insulin will drop your blood glucose \_\_\_\_\_.

You will take \_\_\_\_\_ unit(s) of insulin to correct your high blood glucose level.

Your total bolus (meal bolus plus correction bolus) is \_\_\_\_\_.

## Review your bolus deliveries

You can view a list of your bolus deliveries in the BOLUS HISTORY screen. This screen shows a list of the dates, times, units, and types for your last 24 boluses. This feature is helpful for record keeping or to check if you bolused for your last meal.

If a bolus was stopped before delivery was complete, the BOLUS HISTORY screen will show only the amount actually delivered. Refer to the *Bolus details* section in this chapter for instructions about viewing bolus details.

### Do the following steps to view the BOLUS HISTORY screen:

- 1 Go to the BOLUS HISTORY screen and scroll through the bolus deliveries.

**Main > Bolus > Bolus History**

If you used the Bolus Wizard feature to deliver any of these boluses, the BOLUS HISTORY screen shows the carbohydrate/food (CH) and blood glucose values that the Bolus Wizard feature used to calculate the boluses.

(with the Bolus Wizard feature)

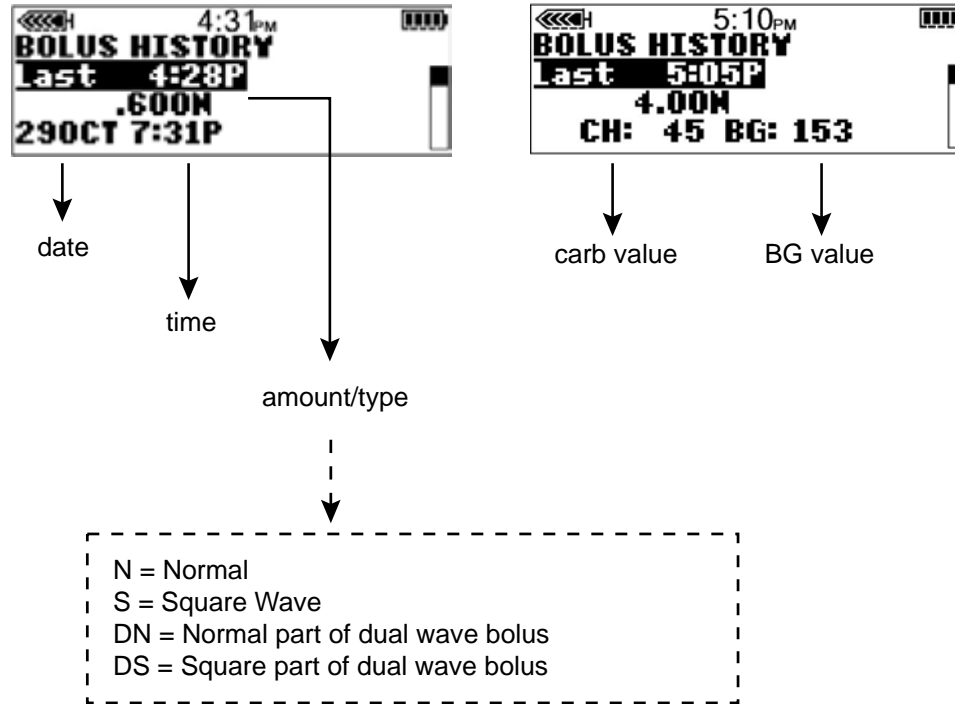

2 Refer to the instructions in the *Bolus details* section to see the details for any of these boluses.

## Bolus details

You can view the details of any of the deliveries in the BOLUS DETAIL screen. The details include:

- bolus types: normal, square, and dual
- programmed bolus amount

- delivered bolus amount
- Bolus Wizard feature information (if used)

To see the details of any bolus, do these steps:

- 1 In the BOLUS HISTORY screen, select the bolus that you want to review and press ACT.
- 2 The details for that bolus will appear on the screen. Scroll through the details.

Without the Bolus Wizard feature

delivery is active

```

<<<<H 12:48PM
BOLUS DETAIL
Type: Normal
User entry: 4.00U
Delivered: 1.40U
  
```

delivery stopped

```

<<<<H 12:48PM
BOLUS DETAIL
Type: Normal
User entry: 4.00U
Stopped at: .650U
  
```

delivery completed

```

<<<<H 12:48PM
BOLUS DETAIL
Type: Normal
Delivered: 4.00U
  
```

- 3 Exit when you are done.

With the Bolus Wizard feature

If the Bolus Wizard feature calculated your bolus, more information will appear in the BOLUS DETAIL screen.

```

<<<<H 5:10PM
BOLUS DETAIL
Type: Normal
Delivered: 4.00U
Bolus wizard:
  
```

Press the down key to see the details

## Maximum bolus limit

The Maximum bolus (Max bolus) is a safety feature that limits the amount of insulin that can be delivered in a single bolus. The factory setting is 10.0 units. You can specify the limit from 0.0 to 25.0 units. It is important to discuss this feature with your healthcare professional to determine your Max bolus amount.

**To set the Maximum bolus limit, do these steps:**

- 1 Go to the MAX BOLUS SETUP screen.  
**Main > Bolus > Bolus Setup > Max Bolus**
- 2 Set your Max bolus limit and press **ACT**. To accept the set Max bolus limit, press **ACT**. To change this limit, press **ESC**, and then set a lower Max bolus limit.
- 3 Your Max bolus is set. Exit the menus.

### Example 1: Max bolus

Shelby takes very small doses of insulin for her meal boluses. As a safety limit, she and her healthcare professional reset her pump with a Maximum bolus of 5.0 units.

### Example 2: Max bolus

David is a growing teenager. He loves to eat big meals and requires very large doses of insulin for his food. He reset his pump with a Maximum bolus of 20.0 units so he can take more insulin when he needs to.

## Scroll rate

The scroll rate feature allows you to program bolus insulin delivery in preset increments. These increments are effective on all bolus screens, except for the SET EASY BOLUS screen. See the *Easy bolus setup* section in the *Optimizing pump therapy* chapter for more information on how to set up the steps for your Easy Bolus. The factory setting for the scroll rate feature is 0.10 units, and the available options are 0.025, 0.05, or 0.10 unit increments.



When you set the scroll rate to 0.025, you can use the following increments to program a bolus:

- 0.025 unit increments for a bolus of 0.975 units or less
- 0.05 unit increments for a bolus between 1 unit and 9.95 units
- 0.10 unit increments for a bolus of 10 units or more

When you set the scroll rate to 0.05, you can use the following increments to program a bolus:

- 0.05 unit increments for a bolus of 9.95 units or less
- 0.10 unit increments for a bolus of 10 units or more

When you set the scroll rate to 0.10, the increments will increase or decrease by 0.10 units during bolus programming regardless of the bolus value.

### To program your scroll rate:

1 Go to the SET SCROLL RATE screen.

**Main > Bolus > Bolus Setup > Scroll Rate**

2 The scroll rate value appears flashing. Change the value and press ACT.

3 The pump returns to the BOLUS SETUP screen. Your scroll rate is now programmed and ready to use. Exit the menus.

#### Example: Scroll rate

You have set your scroll rate to 0.025 units. You need to set your pump to deliver a 2.5 unit bolus. The bolus values on the SET BOLUS screen will change in 0.025 unit increments until you reach 1.0 unit. After this the value will change in 0.05 unit increments until you reach 2.5 units in the SET BOLUS screen.

## BG Reminder

After you deliver a bolus you may want to check your blood glucose. The BG Reminder is an optional feature that makes the pump beep or vibrate to remind you to check your blood glucose after a bolus. However, this reminder is not available after an Easy Bolus. Your pump is set at the factory with the BG Reminder feature turned off.

When setting a bolus, if the BG Reminder is on, your pump will ask you to set up the BG Reminder Duration. This sets how long after bolus delivery you will be reminded to check your BG. This time can be from 30 minutes to 5 hours, or NONE. The BG Reminder is not available after an Easy Bolus.

- 1 Go to the BG REMINDER SETUP screen.

**Main > Bolus > Bolus Setup > BG Reminder**

- 2 Select **On** and press **ACT**. The BG Reminder is now enabled. Exit the menus.

Now, the next time you program a bolus, your pump will ask you for the amount of time after your bolus before you want to be reminded to check your blood glucose.

When the BG Reminder goes off, your pump will beep or vibrate and **CHECK BG** will appear on the screen. Your pump will beep or vibrate periodically until it is cleared (**ESC**, **ACT**).

When you set a BG Reminder after a bolus, the **STATUS** screen will show the amount of time remaining before the reminder goes off.

Here, the **STATUS** screen indicates that the BG Reminder will go off in 18 minutes.

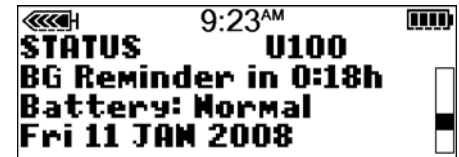

## Capturing Events

The Capture Event feature electronically saves certain types of information. Some examples include:

- Blood glucose (BG) measurements
- The amount of insulin you use
- The amount of carbohydrates you eat or drink
- The exercise you do
- Other (this can be used for anything else as needed)

Make sure that you enter events when they happen since the system records the time of the entry. You cannot change entries after you have put the information into your device. The entered information can be sent to Medtronic CareLink® Personal software. Here it can be used to generate treatment reports that you can share with your healthcare professional. You can view up to 10 of the latest saved events in the **CAPTURE HISTORY** screen.

## Turning on the Capture Event feature

The Capture Events option appears in the MAIN MENU after this feature has been turned on in the UTILITIES MENU.

**To turn on the Capture Event feature, do these steps:**

- 1 Go to the CAPTURE EVENT ON/OFF screen:  
**Main > Utilities > Capture Option**
- 2 Select **On**, then press **ACT**.  
You will now have a Capture Event option in the MAIN MENU.

## Entering BG measurements

You can save non-calibrating BG readings in device history. Non-calibration meter BG measurements are those that are taken at times when you will not use them for calibration, such as after eating or when your blood glucose is rising or falling rapidly. You also have the option of using the entered reading for calibration purposes. Do **not** calibrate if your sensor is not communicating with your device.

Before you can enter BG readings, you must select the BG units for the Capture Event features. You can set the BG units to mg/dL or mmol/L.

**To set the BG units:**

- 1 Go to the BLOOD GLUCOSE UNITS screen.  
**Main > Capture Event > BG Units**
- 2 Select either **mg/dL** or **mmol/L**, then press **ACT**. The CAPTURE EVENT menu shows.
- 3 You can now enter your BG reading.

**To enter the BG measurement:**

- 1 Make a note of the BG measurement.
- 2 Go to the ENTER BG screen.  
**Main > Capture Event > Enter BG**

The ENTER BG screen flashes with dashes or the most recent meter BG measurement you entered.

- 3 Enter your new measurement, then press **ACT**. The BG measurement must be between 20-600 mg/dL (1.1-33.3 mmol/L). A message asks if you want to save the new measurement that is shown on the screen.
  - If the information is correct, select **Save BG**, then press **ACT**. Your BG is saved.
  - If the Bolus Wizard feature is off, the CAPTURE EVENT screen appears.
  - If the Bolus Wizard is on and the saved BG is below your BG Target range, the BG Saved screen appears. This screen indicates that your saved BG is below your BG Target set in the Bolus Wizard feature, and the pump beeps three times. See *Setting the BG Targets, on page 71* for more information.
  - If the Bolus Wizard is on, the saved BG is above your BG Target range, and the calculated correction estimate is more than the preset scroll rate increment, the BG Saved screen appears. This screen indicates that your saved BG is above your BG Target set in the Bolus Wizard feature, and the pump beeps three times. Go to the ENTER BG screen of the Bolus Wizard feature to enter a correction bolus. See *Setting the BG Targets, on page 71* for more information.
  - If you want to use the new BG measurement for calibration, select **Save and Calibrate**. This option is available when your sensor is communicating with the pump, and the BG measurement is between 40 mg/dL (2 mmol/L) and 400 mg/dL (22.2 mmol/L).
  - If the Bolus Wizard is on and the saved BG is below your BG Target range, the BG Saved screen appears. This screen indicates that your saved BG is below your BG Target set in the Bolus Wizard feature, and the pump beeps three times. See *Setting the BG Targets, on page 71* for more information.
  - If the Bolus Wizard is on, the saved BG is above your BG Target range, and the calculated correction estimate is more than the preset scroll rate increment, the BG Saved screen appears. This screen indicates that your saved BG is above your BG Target set in the Bolus Wizard feature, and the pump beeps three times. Go to the ENTER BG screen of the Bolus Wizard feature to enter a correction bolus. See *Setting the BG Targets, on page 71* for more information.
  - If the information is not correct, select **Cancel**, then press **ACT**. The CAPTURE EVENT screen reappears with **Enter BG** selected. Repeat the procedure and enter the correct information.

## Entering insulin injection information

Follow these steps to enter the amount of insulin you use.

- 1 Go to the ENTER INSULIN screen.

**Main > Capture Event > Insulin Marker**

The ENTER INSULIN screen flashes with dashes or the insulin amount that you most recently entered.

- 2 Enter the amount of insulin you used, then press **ACT**. A message appears asking you if you want to save this information. The **Yes** option is selected.
- 3 Make sure that the amount of insulin shown on the screen is correct.
  - If the information is correct, press **ACT**. The information you entered is saved to the system and can now be used in reports.
  - If the information is **not** correct, select **No**, then press **ACT**. The **CAPTURE EVENT** menu shows. Repeat the procedure to enter the correct information.

## Entering carbohydrate information

This section shows you how to enter information about the carbohydrates you eat or drink.

### Before you begin

Before you can enter carbohydrate information, you must select the carbohydrate units (Carb Units) for the Capture Event feature. You can set the carbohydrate units to grams or exchanges.

### To set the carbohydrate units:

- 1 Go to the **CARB UNITS** screen.  
**Main > Capture Event > Carb Units**
- 2 Select either **Grams** or **Exchanges**, then press **ACT**. The **CAPTURE EVENT** menu shows. You are now ready to enter your carbohydrate information.

### To enter carbohydrate information:

- 1 Determine the total units of carbohydrates in the meal or snack that you plan to eat.
- 2 Go to the **ENTER FOOD** screen.  
**Main > Capture Event > Meal Marker**
- 3 The **ENTER FOOD** screen flashes with dashes or with the number of carbohydrate grams or exchanges you entered last time.
- 4 Enter the carbohydrate grams or exchanges, then press **ACT**. A message asks if you want to save the information that is displayed on the screen. The **Yes** option is selected.

- 5 Make sure the number shown on the screen is correct.
  - If the information is correct, press **ACT**. The information you entered is saved to the system and can now be used in reports.
  - If the information is **not** correct, select **No**, then press **ACT**. The CAPTURE EVENT menu shows. Repeat the steps above to enter the correct information.

## Entering exercise information

Follow these steps to enter exercise information. Be consistent and enter the marker either before or after each time you exercise.

- 1 Follow the path below to save your exercise information:  
**Main > Capture Event > Exercise Marker**
- 2 A message asks if you want to save this exercise.
- 3 Make your selection, then press **ACT**.

## Entering Other markers

This section shows you how to enter markers other than Enter BG, Insulin Marker, Meal Marker, or Exercise Marker. Examples of Other markers include: when you take medications, when you feel ill, when you are under stress, and so on. The Other marker appears in CareLink Personal reports, and shows at what time you have entered it in the Capture Event feature.

### To enter Other markers:

- 1 Follow the path below to save your Other marker:  
**Main > Capture Event > Other**  
A message asks if you want to enter this marker.
- 2 Select **Yes**, then press **ACT**. Your pump saves your Other marker and returns to the CAPTURE EVENT screen.

## Viewing Capture Event history

You can view up to 10 captured events saved into the device. The most recent event will be displayed at the top of the CAPTURE HISTORY screen.

### To view the Capture Event history:

- 1 Go to the CAPTURE HISTORY screen:  
**Main > Capture Event > History**
- 2 The CAPTURE HISTORY screen displays the saved events. Each event has the date and time when it was saved, the name, and any detail associated with that event.

## Basal

Basal insulin is required to maintain your target glucose values when you are not eating. Your healthcare professional will calculate this rate for you. Your basal insulin accounts for approximately one half of the body's total daily insulin requirements. Your pump mimics your pancreas by delivering insulin continuously over 24 hours.

You can set your insulin pump to change rates during the day to match your needs. Your needs depend on your lifestyle and insulin requirements. Some people only use one rate throughout the day, while others find they need more. Your basal rates are made up of insulin deliveries that have start and stop times. Once set, these rates make up your 24-hour basal pattern and are repeated daily.

### Start and stop times

When you set your basal rate(s) in the BASAL MENU, your pump prompts you to set the start time for each basal delivery. The start time of one basal rate is the stop time of the previous rate. This gives you continuous basal insulin through a 24-hour period. For basal rate 1, the start time is midnight (00:00 or 12:00 a.m.) and cannot be changed. See the following sample graph of basal rates.

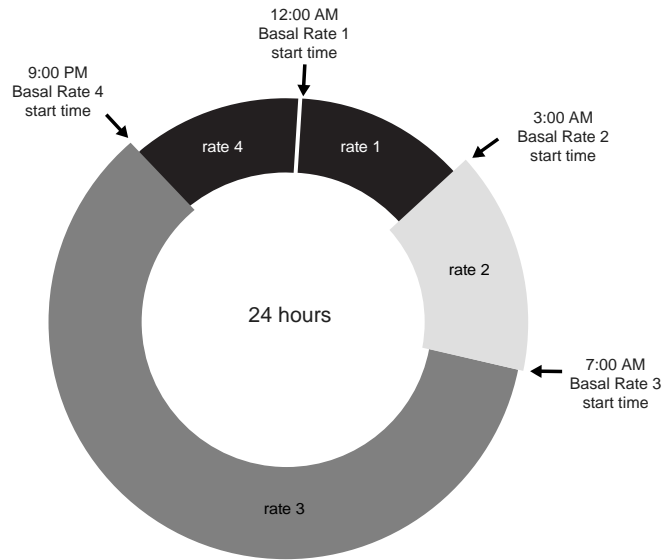

The start and stop times of basal rates for this example are:

- 12:00 a.m. (00:00) to 2:59 a.m. (2:59) for basal rate 1
- 3:00 a.m. (3:00) to 6:59 a.m. (6:59) for basal rate 2
- 7:00 a.m. (7:00) to 8:59 p.m. (20:59) for basal rate 3
- 9:00 p.m. (21:00) to 11:59 p.m. (23:59) for basal rate 4

If you need one basal insulin that starts before midnight and stops after midnight, you need to set up two basal rates. These basal rates have the same rate but different start and stop times. For example, in this graph a basal rate is needed from 9:00 p.m. to 2:59 a.m. (21:00 to 2:59) at one rate. Basal rate 1 always starts at midnight and should be set to end at 2:59 a.m. (2:59). After setting basal rates 2 and 3, rate 4 is set from 9:00 p.m. (21:00) to 11:59 p.m. (23:59) at the same rate as basal rate 1. This gives continuous basal insulin from 9:00 p.m. to 2:59 a.m. (21:00 to 2:59) at one rate.

You cannot set a start time for one basal rate to overlap the next basal rate. The addition of a new basal rate will erase any basal rates that follow.

For best results, setting or changing your basal rate(s) should be discussed with your healthcare professional.



## Your basal settings

You must program your basal settings before you can deliver basal insulin. Keep a written record of your basal settings.

It is recommended that you set your basal rates with the assistance of your healthcare professional.

If you plan to take off your pump for an extended period of time, such as more than a day, set the basal rate to 0.000 U/H. This will ensure that the insulin delivery records in your pump are accurate. Refer to the *If you remove your pump* section in *The basics* chapter for more information.

## Basal programming and delivery

**NOTE:** You cannot make changes to your basal rate settings while a percent temp basal is active.

### To set your basal rates:

- 1 Go to the SET BASAL RATE 1 screen.  
**Main > Basal > Basal Setup > Set/Edit Basal**
- 2 The SET BASAL RATE 1 screen flashes the basal rate in U/H.
- 3 Enter your first basal rate amount and press **ACT**.  
The start time for your first basal rate is midnight and cannot be changed.
- 4 The SET START TIME 2 screen appears. The dashes under the screen name flash. The first basal rate is now set.  
If you do not need a second basal rate for the day, press **ESC**. If you need to set up a second basal rate for the day, follow steps 5 and 6.
- 5 In the SET START TIME 2 screen, enter the start time for the next rate.
- 6 Press **ACT**. The SET BASAL RATE 2 screen appears. Enter the rate.
- 7 Press **ACT**. The SET START TIME 3 screen appears. The second basal rate is now set. If you do not need to set up any more basal rates for the day, press **ESC** and skip to step 9. If you need to set up more basal rates, follow steps 5 and 6 for each basal rate.
- 8 After you program your last basal rate, press **ESC**.
- 9 The BASAL RATE screen appears. Your basal rate(s) will now deliver as programmed. Exit the menus.  
**NOTE:** The pump delivers basal amounts in 0.025 U/H increments for basal rates of less than 1.00 U/H, and in 0.05 U/H increments for basal rates of 1.00 U/H or more.
- 10 When you have finished programming your pump, you can save your settings. Refer to the *User settings* section in the *Utilities* chapter for instructions.

## Current basal delivery

The STATUS screen shows your current basal information.

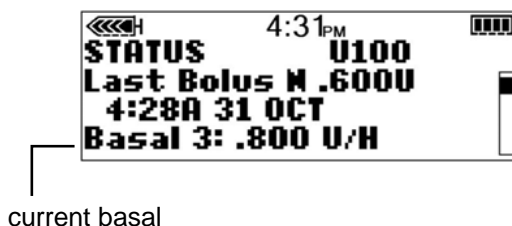

## Daily basal rate(s)

The BASAL REVIEW screen shows your daily basal rates programmed for delivery from midnight to midnight. Compare your daily insulin deliveries to your blood glucose records to help you and your healthcare professional identify your optimal daily basal insulin rate(s).

### To review your basal rates, do these steps:

- 1 Go to the BASAL MENU screen.  
Main > Basal
- 2 Select **Basal Review** and press **ACT**.
- 3 If you do not use patterns, the **STANDARD** screen appears.  
The delivery details for your standard basal will appear.

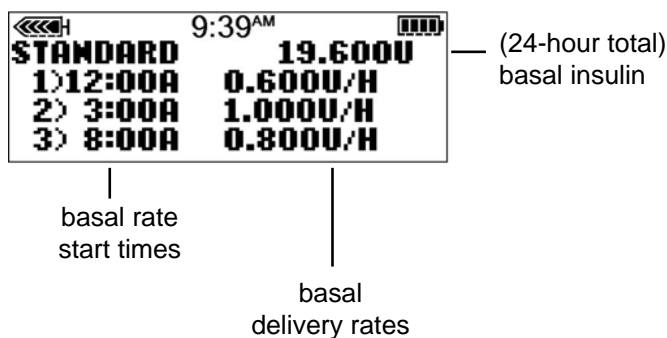

If you use patterns, the BASAL REVIEW screen appears.

The current basal pattern will be highlighted. Select the pattern you want to view. Press **ACT**. The delivery details for that pattern will appear.

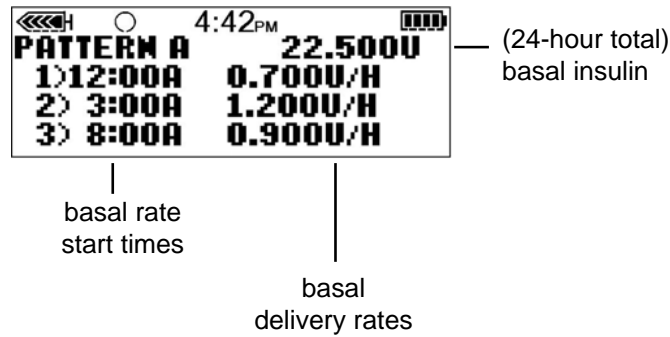

- Exit the menus when you are done.

## Setting the Max basal rate

Maximum basal (Max basal) rate is a safety limit for the amount of basal insulin that is able to be delivered per hour. Your pump is sent from the factory with the Max basal set to 2.00 units per hour. It is important to determine your Max basal rates with your healthcare professional. This safety feature will not allow you to program any basal rates, including patterns and temporary basal rates, that are greater than the Max basal rate.

If you are setting your Max basal rate after your basal rates have been set, you **cannot** set a Max basal that is less than any of the programmed basal rates.

### To set your Max basal rate, do these steps:

- Go to the MAX BASAL RATE screen. The Max basal rate will be flashing.  
Main > Basal > Basal Setup > Max Basal Rate
- Change the rate and press ACT.
- Your Max basal rate is now set. Exit the menus.

#### Example 1: Max basal

Helen has a very low insulin requirement. Her highest basal rate is only 0.400 units per hour. As a safety measure, Helen's healthcare professional set her pump with a Maximum basal rate of 1.00 units per hour.

## Example 2: Max basal

Rusty needs large amounts of insulin to control his blood glucose levels. His new pump was delivered from the factory with a Maximum basal rate of 2.00 units per hour, but he needs 2.80 units per hour in the early morning. Rusty will reprogram his Maximum basal to 3.00 units per hour to accommodate his needs.

## Stopping your pump

**Suspend** stops all insulin delivery, including the current basal and any bolus or Fill Cannula deliveries that are in progress. While suspended, your pump will not deliver insulin until you resume your pump. When you resume your pump, the basal delivery will continue.

The pump will beep or vibrate about every 15 minutes on the hour to remind you that it is not delivering insulin. Example: You suspend your pump at 11:20 AM. The pump will beep/vibrate at 11:30 AM, 11:45 AM, 12:00 PM, and so on until you resume your pump (basal resumes).

When suspended, your pump is in Attention mode with a solid circle showing on the pump. When in **Suspend**, you can only resume your basal or view the STATUS screen. If the Sensor feature is turned on, you can also view the sensor graphs and the SENSOR STATUS screen. No other functions are available.

### To suspend the pump:

- 1 Select **Suspend** from the MAIN MENU, and press **ACT**.  
Main > Suspend
- 2 **SUSPEND** will flash on your screen. Press **ACT** to stop your pump.

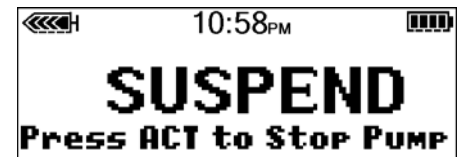

- 3 The screen will show that the pump is suspended and the time that it stopped. After less than one minute, the pump will return to the HOME screen with a solid circle. You can verify on your pump STATUS screen that your pump is suspended.

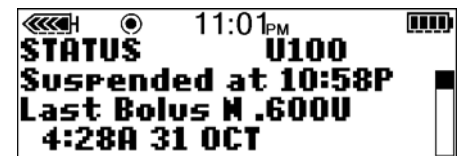

## Resume pump delivery

When the pump is suspended, it defaults to the HOME screen with a solid circle.

To resume your pump and basal delivery, do these steps:

- 1 From any screen, press ACT until the RESUME screen appears. Press ACT again.



- 2 Your pump will beep once, then the HOME screen will appear without the solid circle.

*NOTE: A bolus or fill cannula that was stopped by suspend will not restart when you resume your pump. You must reprogram and activate it to finish delivery.*

### Example: Suspend function

Helen is ready to eat her lunch. She has just programmed her pump to deliver a meal bolus when the phone rings. Helen wants to talk on the phone and not eat her lunch right away. She knows that if she lets the bolus continue and she does not eat her lunch soon, she may be at risk for low blood glucose. Helen suspends delivery of her pump to stop the bolus, but then resumes delivery to restart her basal insulin. When she is off the phone and ready to eat, she checks her STATUS screen to see how much insulin she received from the partially delivered bolus before she suspended her pump. She will reprogram a new bolus for the remainder of her bolus amount.

**Practice:  
Suspend function**

- 1 **Make sure you are NOT connected to your pump while practicing.**  
Program your pump to deliver a Normal bolus of 3.0 units. Once the bolus begins, stop the bolus by suspending your pump.  
**Remember, when you stop the bolus delivery with SUSPEND, all insulin delivery will stop.**
- 2 Now, RESUME delivery, so that your basal insulin will continue.
- 3 Check the STATUS screen.
- 4 How much insulin did the bolus deliver before you Suspended delivery? \_\_\_\_\_.
- 5 If you wanted to take the rest of the bolus later, how much would you take to equal 3.0 units?  
\_\_\_\_\_.

**Practice:  
Resume basal delivery after a suspend**

**Make sure you are NOT connected to your pump while practicing.**

- 1 Give a 3.0 unit bolus now. While it is delivering, suspend the bolus.
- 2 Check here if you were able to suspend the bolus.
- 3 Now restart the pump.
- 4 Check here if you were able to restart the pump.



# Starting on insulin

The Paradigm pump is intended for use with U100 insulin. The following insulins have been tested by Medtronic MiniMed and found to be safe for use in Paradigm REAL-Time insulin pumps (MMT-523, MMT-723, MMT-523K, and MMT-723K):

- Humalog
- Novolog

Before using different insulin with this pump, check the insulin label to make sure the insulin can be used with the pump.

## Prepare your pump for use

Before continuing with the steps in this chapter, we recommend that you watch your pump training CD-ROM and complete your pump start training.

When you are done practicing and ready to use your pump with insulin, you must make sure the time and date are correct on your pump. You must also program your settings as instructed by your healthcare professional.

You will need these items:

- Pump
- Insulin (U100)
- Paradigm reservoir and user guide
- Paradigm compatible infusion set and user guide



## Setting up the reservoir

**Warning:** Do not use the reservoir or infusion set if any liquid gets on the top of the reservoir or inside the tubing connector (as shown in the image). Liquid can temporarily block the vents. This may result in the delivery of too little or too much insulin, which can cause hypoglycemia or hyperglycemia. If any liquid gets on the top of the reservoir or inside the tubing connector, start over with a new reservoir and infusion set.

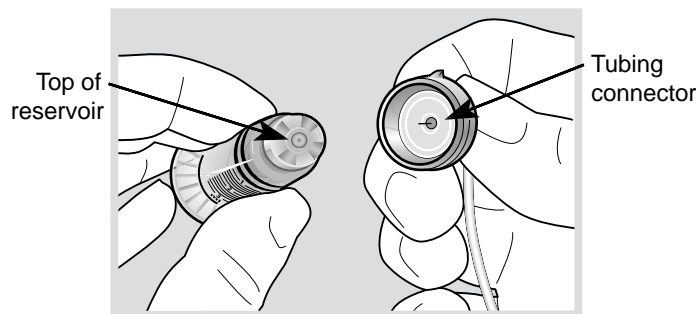

**WARNING:** Using cold insulin can cause air bubbles in the reservoir and tubing. If your insulin is stored in the refrigerator, allow it to reach room temperature before filling your reservoir. When filling the reservoir, take care to remove air bubbles.

## Filling the reservoir

- 1 Remove the reservoir from the package. Make sure the plunger rod is fully extended.
- 2 Swab the vial with alcohol (not shown).
- 3 Making sure you do not push down on the plunger, press the transfer guard onto the vial.

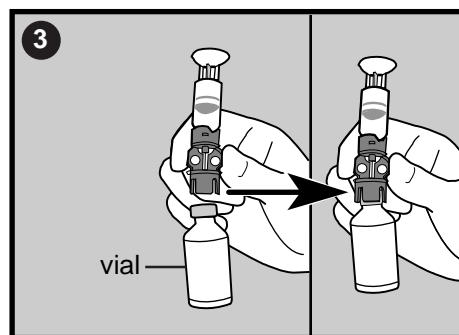
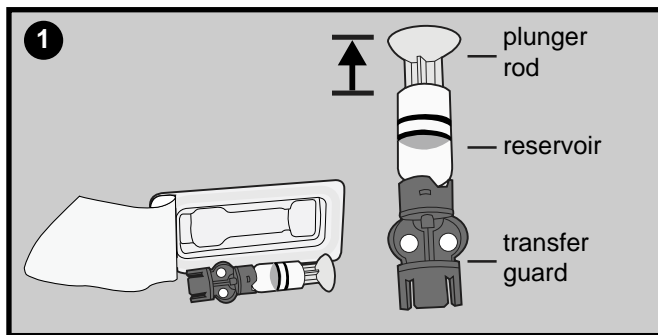

- 4 Push down on the plunger to pressurize the vial. Hold down the plunger rod.

- 5 While still holding the plunger rod, flip the vial over so the vial is on top, slowly pull down on the plunger to fill the reservoir.
- 6 Gently tap the side of the reservoir to make any air bubbles rise to the top of the reservoir.

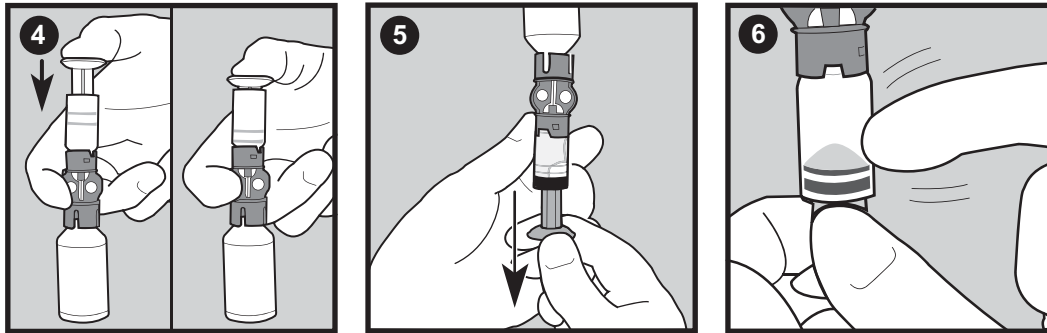

- 7 Slowly push up on the plunger just enough to remove any air bubbles from the reservoir.
- 8 Slowly pull down on the plunger to fill the reservoir to the number of units desired.
- 9 To avoid getting liquid on the top of the reservoir, flip the vial over so that it is upright. Turn the reservoir counter-clockwise, then pull straight up to remove the reservoir from the transfer guard.
- 10 Place the tubing connector onto the reservoir. Turn the connector clockwise, pressing gently against the reservoir until you feel it slide in. Push in and continue turning until the reservoir and the connector lock with a click.

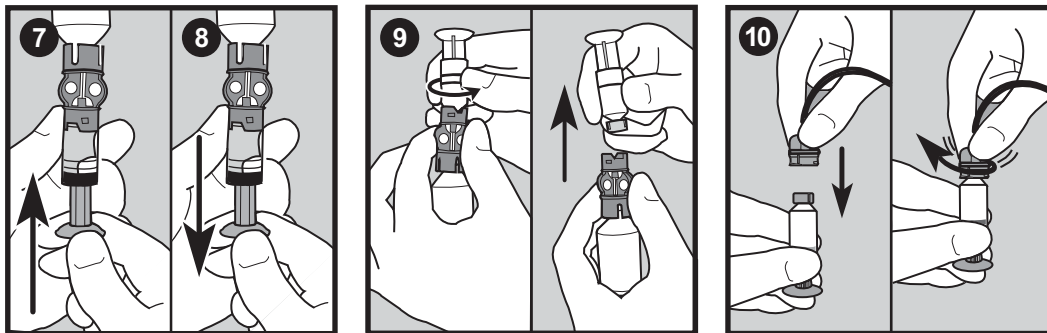

- 11 Tap the side of the reservoir to remove any air bubbles.
- 12 To purge air bubbles that have risen to the top of the reservoir, push up on the plunger until you see insulin in the tubing.
- 13 Without pulling, turn the plunger counter-clockwise to remove it from the reservoir.

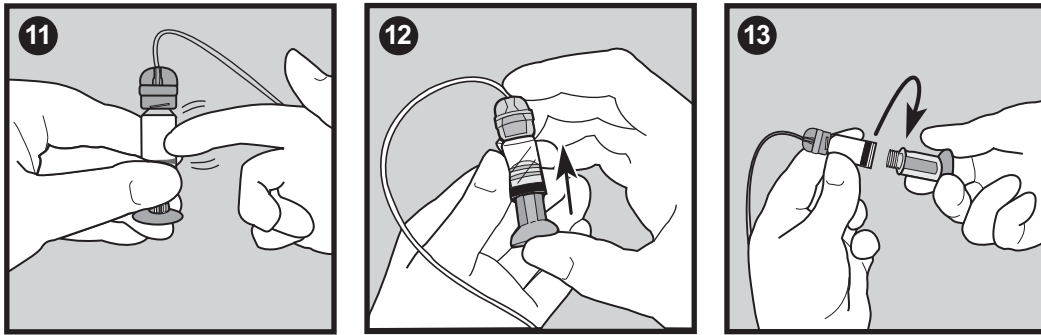

14 Use your reservoir immediately after you fill it. Do not store it filled.

## Changing your infusion set

### Removing the reservoir

Each time you remove and replace a reservoir in your pump, you have to rewind your pump, and fill the infusion set with insulin.

- 1 Remove the entire infusion set from your body.
- 2 If attached, remove the activity guard.
- 3 Turn the tubing connector half-turn counter clockwise, then pull the reservoir and connector out from the pump.

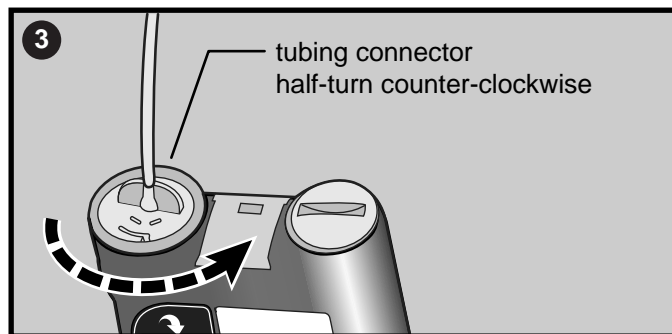

- 4 Safely dispose of the used reservoir and infusion set item in a sharps container.
- 5 You must now rewind your pump as described in the next section.

## Rewinding your pump

Before you continue, make sure the infusion set is NOT connected to your body and the reservoir is NOT in the pump.

---

**WARNING:** Make sure the infusion set is disconnected from your body before you rewind your pump or fill the infusion set tubing. Never insert the reservoir into the pump while the tubing is connected to your body. Doing so could result in an accidental infusion of insulin.

---

- 1 If you removed your reservoir and are replacing it, go to the REWIND screen.  
**Main > Reservoir + Set > Reservoir Setup**
- 2 In the REWIND screen, press **ACT** to start the rewind process. The REWINDING screen will appear while the pump rewinds.
- 3 After the pump rewinds the REWIND COMPLETE screen will appear.  
**If you are practicing:**
  - a. Do **NOT** insert the reservoir in your pump. Make sure the red shipping cap is installed in the reservoir compartment as shipped.
  - b. Press **ACT**, then continue with the instructions in the *Filling the tubing* section in this chapter. If you are **not practicing**, continue to the next section to insert the reservoir in your pump.

## Inserting the reservoir in your pump

If your reservoir is already inserted in your pump, continue to the next section.

You must do these steps in the order described. **If you are practicing, do NOT insert the reservoir in your pump.**

---

**CAUTION:** You must rewind your pump before installing a new reservoir. As part of the pump's function, it calculates the reservoir volume. To ensure correct volume calculations, your pump has been designed to require a rewind before you insert your reservoir.

---

- 1 If you are using the pump for the first time, remove the red shipping cap from the reservoir compartment.

---

**WARNING: Do not insert the reservoir in the pump if you did not rewind. Doing so could result in inaccurate insulin delivery.**

**Never insert the reservoir into the pump while the tubing is connected to your body. Doing so could result in an accidental infusion of insulin.**

---

- 2 Insert the reservoir into the top of the pump case.
- 3 Turn the tubing connector approximately 1/2 -turn clockwise until the connector is seated. The tubing connector should be aligned horizontally with the pump case as shown here.

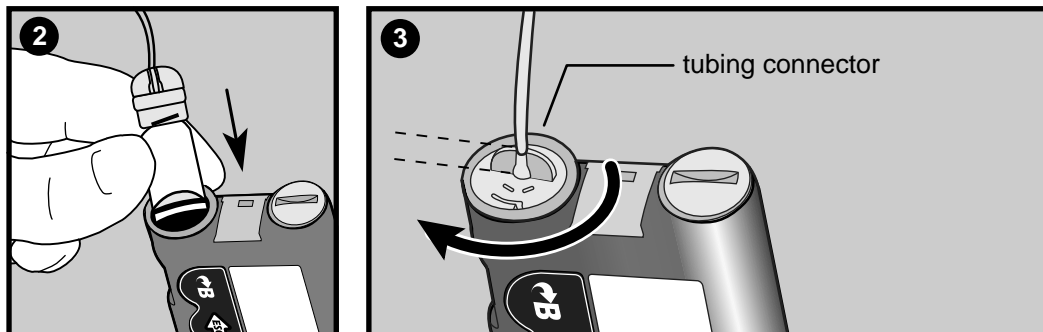

- 4 Attach the activity guard, if desired.
- 5 If the pump has returned to the HOME screen, press **ACT** to show the REWIND COMPLETE screen. Press **ACT** again to go to the FILL TUBING screen.
- 6 You must now fill the infusion set tubing as described in the next section.

## Filling the tubing

You need to fill the infusion set tubing with insulin before you insert the set into the body.

---

**WARNING: Make sure the infusion set is disconnected from your body before you fill the infusion set tubing. Never insert the reservoir into the pump while the tubing is connected to your body. Doing so could result in an accidental infusion of insulin.**

---

- 1 After you rewind your pump, the FILL TUBING screen will appear.
  - a. If the infusion set is **NOT** disconnected from your body, press **ACT** to select **No** on the screen. After you disconnect the infusion set from your body, press **ACT** on the next screen to continue.
  - b. If the infusion set is disconnected from your body, select **Yes** on the FILL TUBING screen. Press **ACT** to continue to the next FILL TUBING screen.
- 2 Press and hold **ACT**. The pump will beep six times indicating that the pump is positioning the reservoir.

- 3 After the reservoir is positioned, you need to fill the infusion set tube with insulin. Press and hold **ACT** until insulin droplets form on the tip of the infusion set needle, then release. Follow the instructions on the screen. You will hear beeps as the pump fills the tubing with insulin. Be sure no bubbles are in the tubing.

---

**WARNING: If the FILL TUBING screen does not display, do NOT continue. Do NOT insert the infusion set into your body. Please contact our 24 Hour HelpLine for assistance.**

**Take care to remove air bubbles when filling the infusion set tubing.**

---

If you use more than 30 units of insulin to fill the infusion set tubing, the MAX FILL REACHED alarm screen will appear. If you get this alarm, do these steps:

- a. Make sure that you are not connected to the pump.
  - b. Read the message on the screen, then press **ESC**, **ACT** to clear.
  - c. To continue filling the infusion set tubing, select **Yes, Continue** and press **ACT**. See the next step to continue. If you have made a mistake, select **No, Rewind** and press **ACT**. The **REWIND** screen will appear. Refer to the pump rewinding and insulin loading instructions in this chapter to continue.
- 4 A message will appear: **DO YOU SEE DROPS AT END OF TUBING?**  
Do **not** press **ESC** because this will trigger a **FINISH LOADING** alarm in 10 minutes. Make sure to complete this Fill Tubing step. Select **Yes** or **No**.
    - a. If you do **NOT** see drops at the tip of the needle, select **No** and press **ACT**. Make sure your infusion set is **NOT** connected to your body. Follow the instructions on the **FILL TUBING** screens to continue filling the infusion set tubing with insulin.
    - b. If you see drops formed at the tip of the needle, select **Yes** and press **ACT**. The **FILL CANNULA** screen will appear.
  - 5 You can now insert the infusion set into your body as described in the next section.

## Inserting the infusion set

---

**WARNING: While the infusion set is connected to your body, do not unscrew and retighten the tubing connector on the reservoir.**

---

After you complete all of the following, you will be ready to insert the infusion set into your body:

- fill your reservoir
- rewind your pump

- insert the reservoir into pump
- and fill the infusion set with insulin

Shown here are the best body areas (shaded) for infusion set insertion. Avoid the 2-inch (5.0 cm) area around the navel.

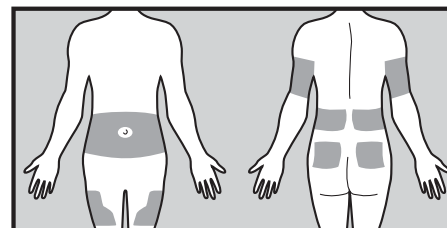

It is important that you change your infusion set every two to three days. Be sure to rotate the infusion set insertion sites so that they do not become overused. The abdominal area is the most common site for set insertions because absorption is very consistent. To keep abdominal sites healthy, some people find it helpful to use a visual scheme to help them rotate their insertion sites in an organized way. Here are two commonly used methods. For maximum effectiveness, use both methods, alternating between them:

use both methods, alternating between them:

- Visualize an imaginary clock drawn on your abdomen surrounding your belly button. Rotate infusion set insertion sites by starting at 12 o'clock and then rotate the site clockwise to 3 o'clock, 6 o'clock, and so on.
- Imagine a letter M or a letter W on either side of your belly button. Start at the end of one letter and proceed through the letter, rotating to each intersection in turn.

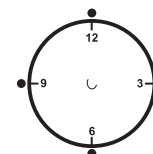

Medtronic Diabetes offers different infusion sets for your pump. Instructions for the Quick-set® begin on the next page as an example. Always refer to the instructions that shipped with your infusion set.

After your infusion set is inserted, see the *Filling the cannula* section in this chapter to fill the infusion set cannula.

## Quick-set infusion set (with Quick-serter®)

There are different infusion sets that you can use with your pump. As an example, the following procedure shows how to insert the Quick-set infusion set. Always refer to the instructions that shipped with your infusion set.

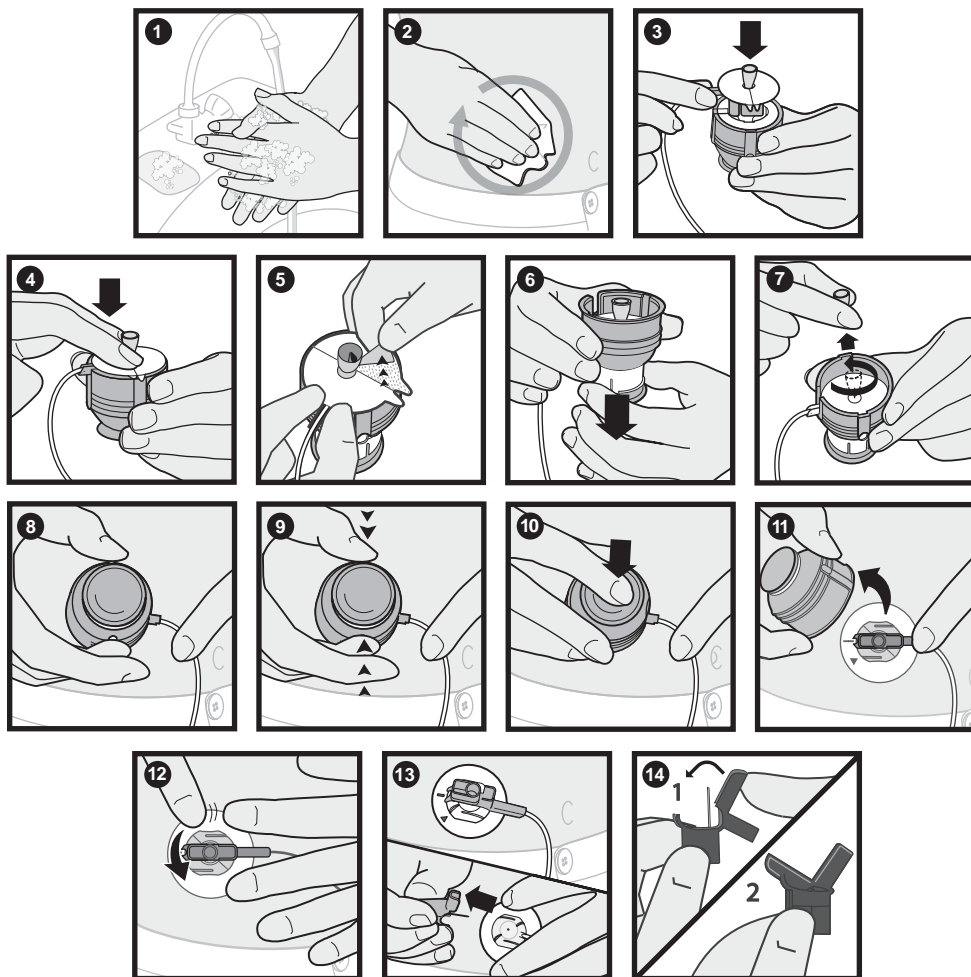



## Filling the cannula

Filling the soft cannula with insulin is required after the infusion set is inserted into your body and the introducer needle is pulled out. The insulin amounts required to fill the cannula depend on the type of infusion set you are using. Refer to your infusion set instructions for this information. If you are using an infusion set with a needle, press **ESC** to skip this step.

If you do not complete the Fill Cannula steps, your pump triggers a FINISH LOADING alarm. If you need to skip the Fill Cannula step, press **ESC** to avoid getting this alarm.

- 1 After you have filled the infusion set tubing, the FILL CANNULA screen appears. It displays a message to connect the infusion set to your body. Press **ACT** to fill the cannula. To skip this step, press **ESC** until you see the MAIN MENU screen. If you do not complete this step, the RESERVOIR + SET MENU screen appears after 15 minutes. After 10 minutes, your pump triggers a FINISH LOADING alarm.
- 2 Enter the amount for your type of infusion set, then press **ACT**. To skip this step, press **ESC** until you see the MAIN MENU screen. If you do not complete this step, the RESERVOIR + SET MENU screen appears after one minute. After 10 minutes, your pump triggers a FINISH LOADING alarm.
- 3 As the cannula starts filling, the FILLING CANNULA screen will count up the units as they are delivered. The pump will beep or vibrate when the cannula is full.

### To see how much insulin was delivered to fill the infusion set:

- 1 Go to the HISTORY screen.  
**Main > Reservoir + Set > History**
- 2 Scroll through the list of insulin deliveries. The letter T at the end of the text line indicates that insulin was delivered to fill the tubing. The letter C at the end of the text line indicates insulin was delivered to fill the cannula. Exit the menus.

## Disconnecting Quick-set

The Quick-set allows you the freedom to temporarily disconnect from your pump without removing the infusion set from your body.

- 1 Hold the side grips of the connector part with your fingers.
- 2 Twist the connector counter-clockwise.
- 3 Remove the connector from the site.

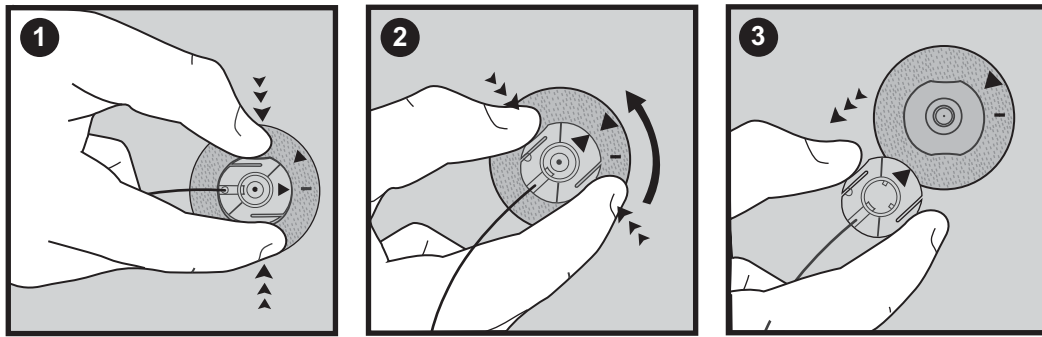

## Reconnecting Quick-set

Place the connector part (flat side facing down) on the infusion site until it is fully seated. Do not squeeze the connector part by the flat side grips.

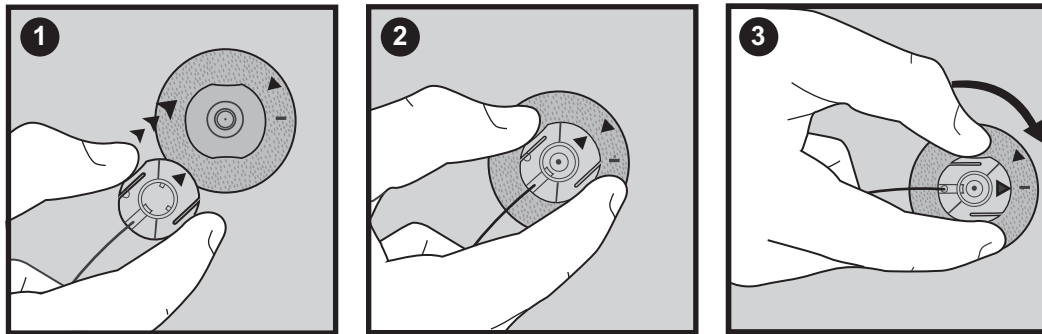

## Record keeping for diabetes management

Now that you are using the pump, we will be asking you to test your blood glucose regularly. It is important to test often and write down your blood glucose readings, the food you eat, any exercise you perform and any other notes to explain your blood glucose results.

You must test at the recommended times and any other time that you feel your blood glucose is high or low. Be sure to include your meal boluses, correction boluses, the amount of carbohydrate you eat, basal rate and any other information that will be helpful in assisting your healthcare professional in adjusting your pump settings.

It is very important to look at your blood glucose readings as feedback regarding your diabetes management, not as statements about you or your self-worth. Try not to have an emotional reaction to the numbers and do not judge them too harshly. You will soon learn how to modify the numbers easily and precisely through insulin pump therapy.

**Test at least four to six times per day. These are the recommended times to test to determine control:**

- Overnight (occasionally, at approximately 2:00 - 3:00 AM)
- Pre-breakfast (fasting)
- Post-breakfast (approximately two hours after eating)
- Pre-lunch
- Post-lunch (approximately two hours after eating)
- Pre-dinner
- Post-dinner (approximately two hours after eating)
- Bedtime
- Before driving

## **Determining your pump settings**

Your healthcare professional will use your daily blood glucose journal records to program your pump. It is very important to keep good records during the first weeks after you start on pump therapy. Not only must you record your blood glucose readings, but it will be important to eat regularly scheduled meals and to keep your activity as consistent as possible.

Until you and your healthcare professional determine the pump settings that will work best for you, it is important to eat meals for which it is easy to count the carbohydrates. After your correct basal rate is determined, you will be able to experiment with varied food choices and amounts.

After you and your healthcare professional are satisfied with your initial pump settings, you may begin to experiment with different food choices, meal times and exercise schedules.

# Using the Bolus Wizard feature

## What is it?

Bolus Wizard is a feature that calculates an estimated bolus to support your food intake or to correct a high blood glucose. To use this feature, you need the following information:

## Carbohydrate counting

You need to know which foods contain carbohydrates and how to count these.

## Your blood glucose reading

You need to know your blood glucose (BG) readings. When using the Bolus Wizard feature, the pump can work with blood glucose meter powered by MWT1 technology to automatically receive your blood glucose reading. MWT1 is the wireless Radio Frequency (RF) technology that is used to transmit information from the meter to the pump. You can program your pump to automatically receive your BG reading from this meter. All meters referenced in this user guide are blood glucose meters supported by MWT1 technology. The *Meter option* section has more information. If you are not using this meter, you will manually enter your blood glucose.



## Your personal Bolus Wizard feature settings

In addition to your blood glucose reading and/or your food entry, the Bolus Wizard feature uses personal settings that you program into the pump. (For instructions see the *How to program the Bolus Wizard feature* section in this chapter.)

- carb units (grams or exchanges)
- carb ratios (in carbohydrate grams/unit of insulin or insulin units/carb exchanges)
- BG units (mg/dL or mmol/L)
- insulin sensitivity

- target blood glucose range
- active insulin time (hours)

Get this information from your healthcare professional, and, for best results, talk to your healthcare professional before making any changes. Keep a record of your settings in the following *Bolus Wizard feature settings* table:

Bolus Wizard feature settings	
Information	Setting
<b>Carb units:</b>	_____ grams or _____ exchanges
<p><b>Carb ratios:</b>            Bolus Wizard feature uses this for your food bolus calculations.</p> <p>If you count carbs:            this ratio is the amount of carbohydrate grams covered by one unit of insulin.</p> <p><b>range: 1-200 grams/unit</b></p> <p>If you count exchanges:            this ratio is the amount of insulin you need to cover one (carb) exchange.</p> <p><b>range: 0.075-15.0 units/exchange</b></p> <p><i><b>NOTE:</b> Your carb ratios may vary throughout the day. Your pump allows you to program up to eight different carb ratios.</i></p>	<p>#1: _____</p> <p>#2: _____</p> <p>#3: _____            (additional settings, if needed)</p> <p>#4: _____</p> <p>#5: _____</p> <p>#6: _____</p> <p>#7: _____</p> <p>#8: _____</p> <p><b>start time (midnight)</b></p>
<b>BG units:</b> (how you measure your blood glucose)	_____ mg/dL or _____ mmol/L

## Bolus Wizard feature settings

Information	Setting	
<p><b>Insulin sensitivity:</b>                      This ratio is used for your correction bolus calculations.                      This ratio is the BG units reduced by 1.0 unit of insulin.                      range: 10-400 mg/dL/u or 0.5-22.2 mmol/L/u</p> <p><i><b>NOTE:</b> Your insulin sensitivity may vary throughout the day. Your pump allows you to program up to eight different insulin sensitivities.</i></p>	<p><b>BG units reduced / 1 unit of insulin</b></p> <p>#1: _____</p> <p>#2: _____</p> <p>#3: _____ (additional settings, if needed)</p> <p>#4: _____</p> <p>#5: _____</p> <p>#6: _____</p> <p>#7: _____</p> <p>#8: _____</p>	<p><b>start time (midnight)</b></p>

Bolus Wizard feature settings		
Information	Setting	
<p><b>BG Target range:</b> If your current blood glucose is above the BG Target range, the Bolus Wizard feature will calculate a correction dose. If your current blood glucose is below the BG Target range, the Bolus Wizard feature will calculate a negative correction and subtract it from your food bolus.</p> <p>range: 60-250 mg/dL or 3.3-13.9 mmol/L</p> <p><i>NOTE: Your pump will allow you to program up to eight different BG Target ranges.</i></p>	<p>#1: _____</p> <p>#2: _____</p> <p>#3: _____ (additional settings, if needed)</p> <p>#4: _____</p> <p>#5: _____</p> <p>#6: _____</p> <p>#7: _____</p> <p>#8: _____</p>	<p>start time (midnight)</p>
<p><b>Active insulin time:</b> The Bolus Wizard feature uses this time to calculate the active insulin in your system (see the <i>About active insulin</i> section in this chapter). Use your healthcare professional's recommendation for the active insulin time that best represents the insulin type you use and your physiological insulin absorption rate.</p> <p>range: 2-8 hours</p>	<p>Number of Hours: _____</p>	

## How the Bolus Wizard feature works

- 1 If you want your current blood glucose to be factored in, enter your BG Reading.
  - automatically from the meter (refer to the *Meter option* section), or
  - manually by selecting the **B** button.
- 2 If you are going to eat, enter your food amount in grams or exchanges.
- 3 The Bolus Wizard feature will calculate a bolus for you. An ESTIMATE DETAILS screen will appear with your estimated total bolus amount.

## Bolus Wizard warnings

When using the Bolus Wizard feature, the pump may display a HIGH BG, LOW BG, and MAX BOLUS EXCEEDED warnings.

### HIGH BG

If your blood glucose in the ENTER BG screen is above 250 mg/dL (13.9 mmol/L), the Bolus Wizard feature displays a HIGH BG warning. Read the instructions, then press **ACT** or **ESC** to clear the message. You can then continue programming to deliver your bolus.

### LOW BG

If your blood glucose in the ENTER BG screen is below 70 mg/dL (3.9 mmol/L), the Bolus Wizard feature displays a LOW BG warning. Read the instructions, then press **ACT** or **ESC** to clear the message. You can then continue programming to deliver your bolus.

### MAX BOLUS EXCEEDED

Bolus Wizard feature will not deliver more than the limit set for your maximum bolus. If the Bolus Wizard feature calculates a bolus amount that is larger than your max bolus limit setting, the message, MAX BOLUS EXCEEDED will appear. If this happens, do these steps:

- 1 In the MAX BOLUS EXCEEDED screen, press **ACT** to continue your bolus programming. The EST : MAX screen appears with the estimated and maximum bolus amounts. Continue to the next step. If you do not want to continue, press **ESC** to cancel and the screen will return to the ENTER BG screen.
- 2 In the EST : MAX screen, press **ACT** again to continue your bolus programming.
- 3 The SET BOLUS screen appears with the maximum bolus amount flashing. Enter the bolus amount. This amount cannot be more than the max bolus amount. Press **ACT**.
- 4 The BOLUS DELIVERY screen appears showing the insulin units being delivered.
- 5 The pump will beep/vibrate after it has completed the insulin delivery.

## How to program the Bolus Wizard feature

You need your personal settings from the Bolus Wizard feature settings table to setup the Bolus Wizard feature. Your Bolus Wizard feature settings are programmed in the EDIT SETTINGS screen.

**Main > Bolus > Bolus Setup > Bolus Wizard Setup > Edit Settings**



Once the settings are programmed, you do not have to program them again unless the values change. After you program one setting, the screen will automatically go to the next required setting. After you program all your settings, review them as described in this section to make sure they are set correctly.

Instructions for programming the Bolus Wizard feature settings are in the next paragraphs. Program your settings in the order described to make sure you program all the settings. If you have not completed setting up all of the required settings, MISSING INFO screen appears. It lists the required settings for this feature. You must program the listed settings before you can use the Bolus Wizard feature.

## Turning on the Bolus Wizard feature

- 1 Go to the EDIT SETTINGS screen.  
**Main > Bolus > Bolus Setup > Bolus Wizard Setup > Edit Settings**
- 2 The EDIT SETTINGS screen appears with **Wizard: Off** selected. Press **ACT**.
- 3 The WIZARD ON/OFF screen appears. Select **On**, then press **ACT**.
- 4 The EDIT SETTINGS screen appears, showing that the wizard is now turned on. You are now ready to select your carb units.

## Selecting the Carb units

The carb unit setting lets the pump know which way to count your carbohydrates (grams or exchanges).

- 1 Make sure the EDIT SETTINGS screen is open.  
**Main > Bolus > Bolus Setup > Bolus Wizard Setup > Edit Settings**
- 2 Select **Carb Units**, then press **ACT**.
- 3 The CARB UNITS screen appears. Select **Grams** or **Exchanges**, then press **ACT**.
- 4 The EDIT SETTINGS screen shows the carb units you selected. You are now ready to set your carb/exchange ratios.

## Setting the Carb/Exch ratios

Your pump allows you to set up to eight Carb/Exch ratios because this ratio may vary throughout the day. Your healthcare professional may only have you program one or two carb ratios when you first start using the Bolus Wizard feature.

### To set the Carb/Exch ratios:

- 1 Make sure the EDIT SETTINGS screen is open.  
**Main > Bolus > Bolus Setup > Bolus Wizard Setup > Edit Settings**
- 2 Select **Carb Ratios**, then press **ACT**.
  - **If you use grams as your carb units:** Carb ratio is the number of carb grams that are covered by one (1.0) unit of insulin.
  - **If you use exchanges as your carb units:** Carb ratio is the number of insulin units that are needed to cover one (1.0) carb exchange.
- 3 The SET CARB RATIO 1 (if you are using grams) or SET EXCH RATIO 1 (if using exchanges) screen appears. The default ratio flashes on the screen.
- 4 Set your first ratio, then press **ACT**. Carb ratio values are normally between 5-50 grams/u or 0.3-3.0 u/exch. If your ratio value is outside the range, a warning message will appear on the screen. This message warns that the entered carb ratio is valid but outside the usual range. Press **ESC** to correct or **ACT** to continue.  
The start time for your first ratio is midnight and cannot be changed.
- 5 The SET START TIME 2 screen appears. The dashes under the screen name flash. The first Carb Ratio or Exchange Ratio is now set.  
If you do not need a second ratio, press **ESC** and skip to the next section. If you need to set up another ratio, follow steps 6 through 9.
- 6 In the SET START TIME 2 screen, enter the time of the day you want this ratio to become active.
- 7 Press **ACT**. The SET CARB RATIO 2 screen (if using grams) or SET EXCH RATIO 2 screen (if using exchanges) appears.
- 8 The default ratio flashes. Select your ratio.
- 9 Press **ACT**. The SET START TIME 3 screen appears. The second carb or exchange ratio is now set.
- 10 If you do not need to set up any more ratios, press **ESC**. If you need to set up more ratios, repeat steps 6 through 9 above for each ratio.  
You are now ready to set up the BG units.

## Setting the BG units

You can select **mmol/L** or **mg/dL** as your Blood Glucose Unit (measurement type). You can also set these units in the Sensor and Capture Event menus.

- 1 Make sure the EDIT SETTINGS screen is open.  
**Main > Bolus > Bolus Setup > Bolus Wizard Setup > Edit Settings**
- 2 Select **BG Units**, then press **ACT**.
- 3 The BLOOD GLUCOSE UNITS screen displays. Select **mmol/L** or **mg/dL**, then press **ACT**.
- 4 The EDIT SETTINGS screen shows the BG units you selected. You are now ready to set your insulin sensitivity.

## Insulin sensitivity

Your insulin sensitivity is the amount your blood glucose (BG) level is reduced by one unit of insulin. This value is used to calculate a suggested insulin dose to correct a high BG. Because this sensitivity may vary throughout the day, your pump lets you set up to eight sensitivity settings. Your healthcare professional may only have you program one or two insulin sensitivities when you first start using the Bolus Wizard feature. Record your settings in the *Bolus Wizard feature settings* table in this chapter.

Insulin sensitivity values are normally between 20-100 mg/dL/u (1.1-5.6 mmol/L/u). If your value is outside this range, a warning message will appear on the screen.

- 1 Make sure the EDIT SETTINGS screen is open.  
**Main > Bolus > Bolus Setup > Bolus Wizard Setup > Edit Settings**
- 2 Select **Sensitivity**, then press **ACT**.
- 3 The INS SENSITIVITY 1 screen appears. The default sensitivity value flashes on the screen.
- 4 Set the value for your first insulin sensitivity setting, then press **ACT**.  
The start time for your first insulin sensitivity is midnight and cannot be changed.
- 5 The SET START TIME 2 screen appears. The dashes under the screen name flash. The first insulin sensitivity is now set.  
If you do not need a second insulin sensitivity, press **ESC** and skip to the next section. If you need to set up another insulin sensitivity, follow steps 6 through 9.
- 6 In the SET START TIME 2 screen enter the time of the day you want this insulin sensitivity to become active.
- 7 Press **ACT**. The INS SENSITIVITY 2 screen appears.
- 8 The default sensitivity value flashes. Select the value for this insulin sensitivity.

- 9 Press **ACT**. The SET START TIME 3 screen appears. The second insulin sensitivity is now set.
- 10 If you do not need to set up any more insulin sensitivities, press **ESC**. If you need to set up more insulin sensitivities, repeat steps 6 through 9 above for each insulin sensitivity.  
You are now ready to set up the BG Target.

## Setting the BG Targets

The BG Target setting allows you to set glucose targets. The Bolus Wizard will use these targets to calculate a correction dose. Because the targets may vary throughout the day, your pump allows you to set up to eight BG Targets each day. If you want to set just one target value, instead of a range, set both the low and high values to the same number.

If your current BG is above the BG Target range, the Bolus Wizard feature may calculate a correction dose. The correction dose will deliver enough insulin to bring your BG down to your current high end of the BG Target range. If your current BG is below the BG Target range, the Bolus Wizard may calculate a negative correction and subtract it from your food bolus. This will bring your BG to the low end of the BG Target range.

### Example:

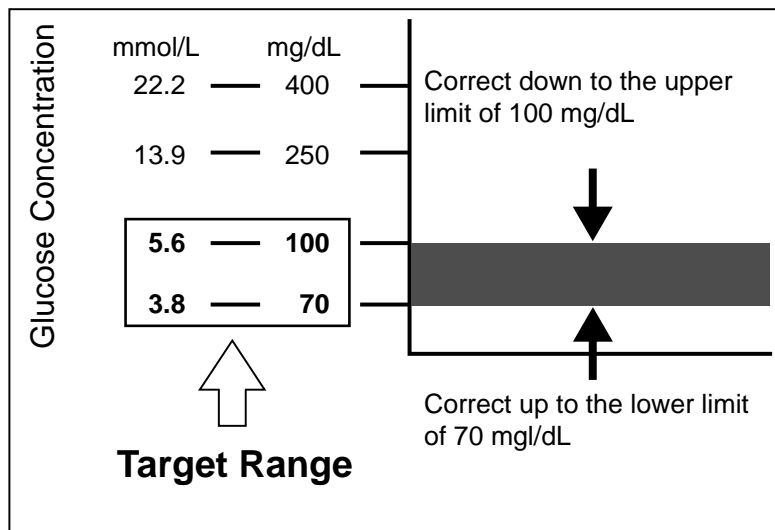

Pumps are sent from the factory with default BG Target range of 100-100 mg/dL (5.6-5.6 mmol/L).

- 1 Make sure the EDIT SETTINGS screen is open.

## Main > Bolus > Bolus Setup > Bolus Wizard Setup > Edit Settings

- 2 Select **BG Target**, then press **ACT**.
- 3 The **TARGET RANGE 1** screen appears. The low end of your BG Target range flashes on the screen.
- 4 Set the BG Target, then press **ACT**.
- 5 The high end of your BG Target range flashes on the screen. Enter the BG Target, then press **ACT**. The start time for your first BG Target is midnight and cannot be changed.
- 6
  - a. If your BG Target is outside of 90-140 mg/dL (5.0-7.8 mmol/L), the pump screen displays a warning that the values are acceptable but outside normal range. Press **ESC** to change your BG Target or press **ACT** to set this range.
  - b. If your BG Target is within 90-140 mg/dL (5.0-7.8 mmol/L), the **SET START TIME 2** screen appears. The dashes under the screen name flash. The first BG Target range is now set. If you do not need a second BG Target range, press **ESC** and skip to the next section. If you need to set up another BG Target range, follow steps 7 through 11.
- 7 In the **SET START TIME 2** screen enter the time of the day you want this BG Target range to become active.
- 8 Press **ACT**. The **TARGET RANGE 2** screen appears.
- 9 The low end of your BG Target range flashes on the screen. Set the BG Target, then press **ACT**.
- 10 The high end of your BG Target range flashes on the screen. Enter the BG Target, then press **ACT**.
- 11 The **SET START TIME 3** screen appears. The second BG Target range is now set.
- 12 If you do not need to set up any more BG Target ranges, press **ESC**. If you need to set up more BG Target ranges, repeat steps 7 through 11 above for each one.  
You are now ready to set up the Active insulin time.

## About active insulin

Active insulin is the bolus insulin that has already been delivered to your body, but has not yet been used. The pump considers your active insulin time setting in determining any active insulin still in your body from prior boluses. This may help prevent hypoglycemia caused by over-correcting for high blood glucose.

The pump shows the active insulin amount in the **ESTIMATE DETAILS** screen during the Bolus Wizard programming steps, the **STATUS** and the **SET BOLUS** screens. However, the active insulin amount is calculated differently in the **ESTIMATE DETAILS** screen and appears with an asterisk (\*Active Insulin). The active insulin amount calculated in the Bolus wizard steps includes the insulin that has already been delivered and insulin that is going to be delivered by the active Square Bolus.

Your Paradigm pump is shipped from the factory with an active insulin time setting of six hours, which most closely matches the published scientific data. If your healthcare professional prescribes a different time for you, the active insulin time setting can be adjusted in the Bolus Wizard menu in one-hour increments from two to eight hours.

For more details about active insulin, see the *Bolus Wizard feature specifications* section in the *Pump specifications* chapter.

---

**CAUTION: If you give yourself insulin by using a syringe, the Bolus Wizard feature will not be able to correctly determine the active insulin in your system. Consult with your healthcare professional on how long you need to wait after a manual injection before you can rely on the active insulin calculation of your Bolus Wizard feature.**

---

## Active insulin time

The active insulin time setting lets the pump know which active insulin time to use in calculating the amount of active insulin to subtract before estimating a bolus. Your healthcare professional should determine the active insulin time that is best for you.

### To set the Active insulin time, do the following steps:

- 1 Make sure the EDIT SETTINGS screen is open.  
**Main > Bolus > Bolus Setup > Bolus Wizard Setup > Edit Settings**
- 2 Select **Active Ins Time**, then press **ACT**.
- 3 The **ACTIVE INS TIME** screen appears. The default time of 6 hours flashes on the screen.
- 4 Set the number of hours for the active insulin time, then press **ACT**.
- 5 The EDIT SETTINGS screen shows the new Active insulin time setting. You have now completed the Bolus Wizard setup. Press **ESC** or wait to see the message: **Bolus Wizard setup is complete**.

## Review your Bolus Wizard feature settings

Check your Bolus Wizard feature settings in the REVIEW SETTINGS screen. If necessary, compare this information with your information in the Bolus Wizard feature settings table.

- 1 Go to the REVIEW SETTINGS screen.  
**Main > Bolus > Bolus Setup > Bolus Wizard Setup > Review Settings**
- 2 Scroll through the text to view your Bolus Wizard settings.
- 3 Exit the menus when you are done.

## Normal bolus using Bolus Wizard feature

After the Bolus Wizard feature is turned on and programmed, this feature can calculate an estimate of insulin you need for your correction bolus and/or your food bolus. You have the option of using the estimate or changing it as necessary. Additionally, your pump can receive your blood glucose reading from the meter, if they are linked.

Use the **B** button to deliver a Normal bolus at any time except during another Normal bolus. A Normal bolus will temporarily interrupt a Square Wave or Dual Wave bolus that is delivering. After the Normal bolus is finished, the Square Wave or Dual Wave bolus delivery will resume.

***NOTE:** If you want to use the pump-to-meter link, make sure the meter option is on. Refer to the Meter option section for instructions.*

- 1 If you want a correction bolus, check your blood glucose with your blood glucose meter and go to step 2. If you want to bolus for food, go to step 2.
- 2 Press **B** on your pump, or go to the BOLUS MENU, select **Use Bolus Wizard**, and press **ACT**.
- 3 The ENTER BG screen will appear.
  - a. If you are **not** using the meter:  
Enter your blood glucose value. Press **ACT** and continue to step 4. If you are not entering a blood glucose and want to bolus for food, select the dashes in the ENTER BG screen. The Bolus Wizard feature will calculate the insulin needed for your food entry without considering your blood glucose level. Press **ACT** and continue to step 4.
  - b. If you are using the meter, you must program your bolus within 12 minutes of the pump receiving the reading from the meter. If more than 12 minutes have passed, the reading will no longer be available from the screen and you must enter your blood glucose manually.

Your pump checks if the entered BG is within your target range. Press **ACT** to accept the blood glucose value. You can also change this blood glucose value, if necessary, then press **ACT**.

- 4 The ENTER FOOD screen appears.
  - a. If this is a food bolus, enter the food value you will eat, then press **ACT**.
  - b. If this is a correction bolus, select 0 (zero) as the value, then press **ACT**.
- 5 The ESTIMATE DETAILS screen appears. Review the information on this screen. If you need to make any changes, press **ESC** to return to the ENTER BG screen (step 3) and make changes as necessary.
- 6 Press **ACT** in the ESTIMATE DETAILS screen. The SET BOLUS screen appears with the estimated bolus amount flashing. Change the amount if desired. Press **ACT** to accept and start delivering your bolus.

***NOTE:** If you have BG Reminder turned On, the BG REMINDER DURATION screen displays. It allows you to set the duration before you are reminded to check your blood glucose after a bolus. See the BG Reminder section in the Basic programming chapter for information about this feature.*

- 7 The BOLUS DELIVERY screen appears. The pump will beep or vibrate at the start and end of the bolus. As the bolus is delivered, the screen shows the bolus type and amount until the total units have been delivered. The screen then returns to the HOME screen.

## Bolus Wizard feature examples

For the scenarios that follow, Michael has his Bolus Wizard feature turned on with the following settings:

Carb ratio: 15 grams per unit of insulin

Insulin Sensitivity: 40 mg/dL (2.2 mmol/L) per unit of insulin

BG Target: 90-120 mg/dL (5.0-6.6 mmol/L)

Active Insulin Time: 6 hours

***NOTE:** If you want to see details of the formulas the Bolus Wizard feature uses to calculate estimate boluses like the ones in the following examples, see the Bolus Wizard feature specifications section in the Pump specifications chapter.*



### Example 1: Blood glucose on target (normal blood glucose) and no active insulin

Michael awakens in the morning before school and his mother has breakfast waiting for him. Before he begins eating, he tests his blood glucose with his meter and his blood glucose result of 120 mg/dL (6.6 mmol/L) is automatically sent to his pump.

He estimates that his meal consists of 60 grams of carbohydrates. When prompted by the Bolus Wizard feature, he enters this amount in the ENTER FOOD screen. Based on his Bolus Wizard feature settings, the pump will suggest that he take 4.0 units of insulin.

#### **Food estimate:**

Carb grams ÷ Carb ratio = Units of insulin

$$60 \text{ g} \div 15 \text{ g/u} = 4 \text{ units}$$

#### **Correction estimate:**

Correction is 0 because the current BG reading is within the BG Target range.

#### **Total bolus estimate:**

Food estimate + Correction estimate = Units of insulin

$$4 \text{ units} + 0 \text{ units} = 4 \text{ units}$$

## Example 2: Blood glucose above target (high blood glucose) and no active insulin

The next day, Michael wakes up before school. Before eating the same breakfast, he tests his blood glucose with his meter and finds it to be 200 mg/dL (11.1 mmol/L), which is above his target of 120 mg/dL (6.6 mmol/L). His blood glucose reading is automatically sent to his pump.

When prompted by the Bolus Wizard feature, he enters his carbohydrate amount of 60 grams in the ENTER FOOD screen. Based on his settings, the pump will suggest that he take 6.0 units of insulin.

### Food estimate:

Carb grams  $\div$  Carb ratio = Units of insulin

$$60 \text{ g} \div 15 \text{ g/u} = 4 \text{ units}$$

### Correction estimate:

(Current BG - High BG Target)  $\div$  Insulin sensitivity = Units of insulin

$$(200 \text{ mg/dL} - 120 \text{ mg/dL}) \div 40 \text{ mg/dL/u} = 2 \text{ units, or}$$

$$(11.1 \text{ mmol/L} - 6.6 \text{ mmol/L}) \div 2.2 \text{ mmol/L/u} = 2 \text{ units}$$

### Total bolus estimate:

Food estimate + Correction estimate = Units of insulin

$$4 \text{ units} + 2 \text{ units} = 6 \text{ units}$$

### Example 3: Blood glucose below target (low blood glucose) and no active insulin

On another morning, Michael sits down before eating the same breakfast. He tests his blood glucose with his meter and finds it at 70 mg/dL (3.9 mmol/L), which is below his Low BG target of 90 mg/dL (5.0 mmol/L). His reading is automatically sent to his pump.

When prompted by the Bolus Wizard feature, he enters his carbohydrate amount of 60 grams in the ENTER FOOD screen. Based on his settings, the pump will suggest that he only take 3.5 unit of insulin.

#### Food estimate:

Carb grams ÷ Carb ratio = Units of insulin

$$60 \text{ g} \div 15 \text{ g/u} = 4 \text{ units}$$

#### Correction estimate:

(Current BG - Low BG Target) ÷ Insulin sensitivity = Units of insulin

$$(70 \text{ mg/dL} - 90 \text{ mg/dL}) \div 40 \text{ mg/dL/u} = -0.5 \text{ units, or}$$

$$(3.9 \text{ mmol/L} - 5.0 \text{ mmol/L}) \div 2.2 \text{ mmol/L/u} = -0.5 \text{ units}$$

#### Total bolus estimate:

Food estimate + Correction estimate = Units of insulin

$$4 \text{ units} + (-0.5) \text{ units} = 3.5 \text{ units}$$

#### Example 4: Blood glucose above target (high blood glucose) with active insulin

Michael is at school and wants to eat a snack in the late morning. He tests his blood glucose with his meter and finds it at 200 mg/dL (11.1 mmol/L), which is above his target of 120 mg/dL (6.6 mmol/L). He estimates that his snack contains 60 grams of carbohydrate, so he enters 60 into the pump when prompted by the Bolus Wizard feature. Based on his settings, and as a result of 1.5 units of active insulin, his pump will suggest that he take 4.5 units.

##### Food estimate:

Carb grams  $\div$  Carb ratio = Units of insulin

$$60 \text{ g} \div 15 \text{ g/u} = 4 \text{ units}$$

##### Correction estimate:

(Current BG - High BG Target)  $\div$  Insulin sensitivity - Active insulin = Units of insulin

$$(200 \text{ mg/dL} - 120 \text{ mg/dL}) \div 40 \text{ mg/dL/u} - 1.5 \text{ units} = 0.5 \text{ units, or}$$

$$(11.1 \text{ mmol/L} - 6.6 \text{ mmol/L}) \div 2.2 \text{ mmol/L/u} - 1.5 \text{ units} = 0.5 \text{ units}$$

##### Total bolus estimate:

Food estimate + Correction estimate = Units of insulin

$$4 \text{ units} + 0.5 \text{ units} = 4.5 \text{ units}$$

### Example 5: Blood glucose below target (low blood glucose) with active insulin

Another day at school, Michael is getting ready to eat lunch. He tests his blood glucose with his meter and finds it at 70 mg/dL (3.9 mmol/L), which is below his Low BG target of 90 mg/dL (5.0 mmol/L). His reading is automatically sent to his pump.

When prompted by the Bolus Wizard feature, he enters his carbohydrate amount of 60 grams in the ENTER FOOD screen. Based on his settings, and despite 1.5 units of active insulin, his pump will suggest that he take 3.5 units of insulin.

#### Food estimate:

Carb grams ÷ Carb ratio = Units of insulin

$$60 \text{ g} \div 15 \text{ g/u} = 4 \text{ units}$$

#### Correction estimate:

(Current BG - Low BG Target) ÷ Insulin sensitivity - Active insulin = Units of insulin

$$(70 \text{ mg/dL} - 90 \text{ mg/dL}) \div 40 \text{ mg/dL/u} - 0^* = -0.5 \text{ units, or}$$

$$(3.9 \text{ mmol/L} - 5.0 \text{ mmol/L}) \div 2.2 \text{ mmol/L/u} - 0^* = -0.5 \text{ units}$$

**NOTE:** \*When the current BG is below the Low BG Target, an active insulin amount is not considered in the Bolus Wizard feature calculations.

#### Total bolus estimate:

Food estimate + Correction estimate = Units of insulin

$$4 \text{ units} + (-0.5) \text{ units} = 3.5 \text{ units}$$

# Optimizing pump therapy

## Square Wave and Dual Wave bolus

**Square Wave bolus** delivers a bolus evenly over a period of time (30 minutes to 8 hours). This bolus can be used for insulin delivery when you have eaten a long meal with extended snacking. It can also be useful if you have delayed food digestion due to gastroparesis or meals high in fat. A Square Wave bolus can be useful if a Normal bolus drops your blood glucose too rapidly. Since the Square Wave portion extends over a period of time, the insulin is more likely to be available to match your individual needs.

***NOTE:** During delivery of a Square Wave bolus, you will not be able to do the following pump functions: change the max bolus amount, change the scroll rate, disable or deliver Dual and Square Wave boluses, rewind or fill the cannula, change the active insulin time, run a self-test, or access the User Settings menu. All other pump functions are still available during the Square Wave bolus.*

**Dual Wave bolus** delivers a combination of an immediate Normal bolus followed by a Square Wave bolus. The Square Wave portion is delivered evenly over a period of time. A Dual Wave bolus is useful for meals with both rapidly and slowly absorbed carbohydrates. For example, a Dual Wave bolus would be appropriate for fruit and crackers followed by pasta. The Dual Wave option meets both immediate and extended insulin needs. A Dual Wave bolus is also useful for correcting elevated blood glucose before a meal.

See the following graphic for a description of the different bolus types:

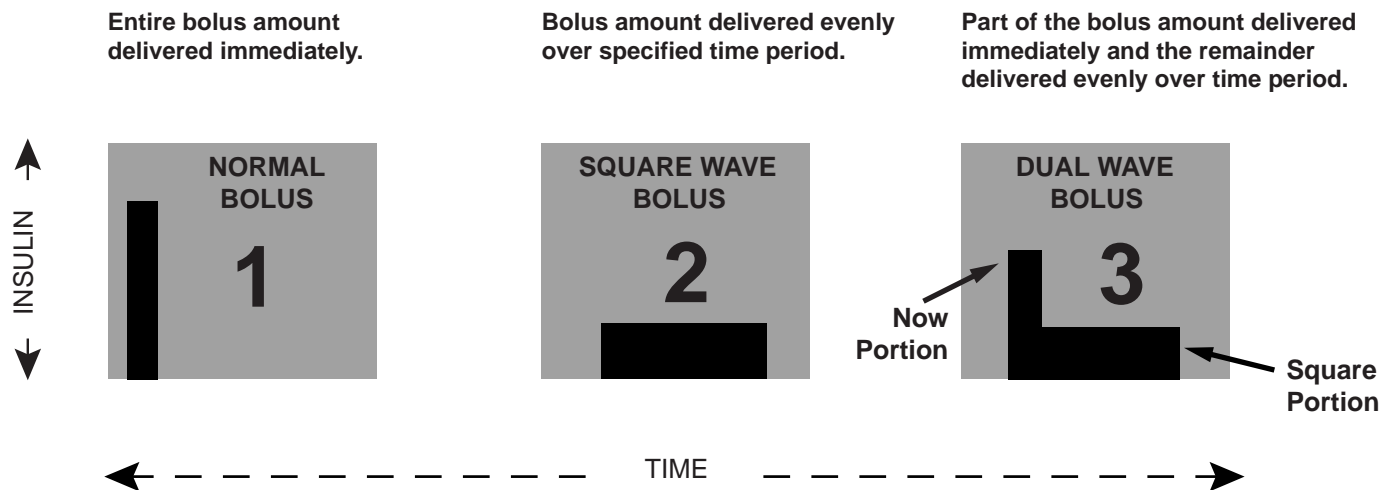

## Turning on the Dual Wave/Square Wave option



It is important that you consult with your healthcare professional before using a Square Wave or Dual Wave bolus. You should be familiar with the basic functions of your pump before exploring these options.

**To set up a Dual Wave or Square Wave bolus, you must first turn on the dual/square bolus option.**

- 1 Go to the DUAL/SQUARE OPTION screen.  
Main > Bolus > Bolus Setup > Dual/Square Bolus
- 2 Select On, then press ACT. The feature is now on. Exit the menus.

## Square Wave or Dual Wave bolus without Bolus Wizard feature

- 1 Make sure the dual/square option is on.
- 2 Calculate your food and/or correction bolus amount.
- 3 Go to the BOLUS TYPE screen.  
Press **⏏B** on your pump, or follow this path:  
Main > Bolus > Set Bolus

- 4 For a Square Wave bolus, do these steps:
  - a. Select **Square Wave Bolus**, then press **ACT**. The SET SQUARE BOLUS screen appears.
  - b. Enter the desired amount for the Square Wave bolus units, then press **ACT**.
  - c. Continue to step 5.
- For a Dual Wave bolus, do these steps:
  - a. Select **Dual Wave Bolus**, then press **ACT**. The SET DUAL BOLUS TOTAL screen appears.
  - b. Enter the desired amount for the total dual bolus units. This amount is the total of Normal and Square Wave bolus units. Press **ACT**.
  - c. The next screen flashes the amounts of Now (Normal) and Square Wave portions of the Dual Wave bolus. The screen also shows the percentage amount of each portion. Press  or  to change the percentage/number of units. Continue to step 5.
- 5 The SQUARE DURATION screen appears. Enter the amount of time you want the Square Wave bolus to last, then press **ACT**.

***NOTE:** If you have BG Reminder turned On, the BG REMINDER DURATION screen displays. It allows you to set the duration before you are reminded to check your blood glucose after a bolus. See the BG Reminder section in the Basic programming chapter for information about this feature.*

- 6 The BOLUS DELIVERY screen appears with an open circle indicating that your pump is in Special mode. The pump beeps/vibrates at the start of the bolus. During bolus delivery, the pump will return to the HOME screen. The pump beeps/vibrates at the end of the bolus and the open circle disappears.



## Square Wave bolus practice

Your target pre-meal blood glucose range is \_\_\_\_\_ to \_\_\_\_\_.

Check your pre-meal blood glucose. Are you within your target? \_\_\_\_\_ If yes, continue. If no, wait to try the following test until your pre-meal blood glucose is within your target range:

TEST: Choose a meal that is high in fat (hot dogs, pizza, cheese enchiladas). Determine your meal bolus amount. Set the Square Wave bolus to deliver the determined amount of insulin over two hours. (This duration time is an example. As always, consult with your healthcare professional for guidance.)

Check your blood glucose and record:

Pre-meal \_\_\_\_\_

1 hour post meal \_\_\_\_\_

2 hours post meal \_\_\_\_\_

3 hours post meal \_\_\_\_\_

4 hours post meal \_\_\_\_\_

Did your blood glucose return to your pre-meal target within 4 hours post meal? \_\_\_\_\_

If yes, then repeat this test with the same meal on another day to verify your results.

If no, discuss this with your healthcare professional for guidance.

## Dual Wave bolus practice

Can you think of any meals where this feature would help you with blood glucose control?

Your target pre-meal blood glucose range is \_\_\_\_\_ to \_\_\_\_\_

Check your pre-meal blood glucose. Are you within your target? \_\_\_\_\_ If yes, continue. If no, try this test when your pre-meal blood glucose is within your target range:

TEST: Choose a meal that has a combination of both rapidly absorbed and slowly absorbed carbohydrates. Determine your meal bolus amount. Set the Dual Wave bolus to deliver the determined amount of insulin. Program your pump to deliver one-half over 2-hours\*, and the other half immediately.

(\* This duration of time and ratio is an example. As always, consult with your healthcare professional for guidance.)

Check blood glucose and record:

Pre-meal\_\_\_\_\_

1 hour post meal\_\_\_\_\_

2 hours post meal\_\_\_\_\_

3 hours post meal\_\_\_\_\_

4 hours post meal\_\_\_\_\_

Did your blood glucose return to your pre-meal target within 4 hours post meal? \_\_\_\_\_\*

If yes, repeat this test with the same meal on another day to verify results.

If no, discuss this with your healthcare professional for guidance.

## Using the Bolus Wizard feature for a Square Wave or Dual Wave bolus

If you are using the Bolus Wizard feature to calculate your Square Wave or Dual Wave bolus amounts, you will be prompted to enter your blood glucose reading and/or the (gram or exchange) units you will eat. The Bolus Wizard feature will use this input to calculate your suggested correction and/or food bolus amount. If you do not want to use the Bolus Wizard feature estimate, you can change it.



The Bolus Wizard feature must be turned on and the settings must be programmed (see the *How to program the Bolus Wizard feature* section in the *Using the Bolus Wizard* chapter). Also, make sure the dual/square option is turned on (see the *Turning on the Dual Wave/Square Wave option* section in this chapter).

If you want to use the pump-to-meter link, make sure the meter option is on. Refer to the *Meter option* section for instructions.

- 1 Go to the ENTER BG screen.

Press  on your pump, or use the following path:

**Main > Bolus > Use Bolus Wizard**

- 2 Enter your blood glucose value, then press **ACT**.
- 3 The ENTER FOOD screen appears. Enter your food, then press **ACT**.
- 4 The ESTIMATE DETAILS screen appears. Scroll down to review the information there. Press **ACT** to continue to step 5.  
If you need to make any changes, press **ESC** to return to the ENTER BG screen. Make changes as necessary.
- 5 The BOLUS EST screen appears with Normal Bolus, Square Wave Bolus, and Dual Wave Bolus options. If your Bolus Wizard feature calculates that your bolus includes a portion to correct your high blood glucose, the Square Wave Bolus option will not be available. This helps you to select a bolus type (Normal or Dual Wave) that has an immediate delivery option to cover your high blood glucose.
- 6 **To set a Square Wave bolus, do these steps:**
  - a. In the BOLUS EST screen, select **Square Wave Bolus**, then press **ACT**.
  - b. The SET SQUARE BOLUS screen flashes the estimated bolus amount. Change the amount if needed. Press **ACT** to accept the bolus amount.**To set a Dual Wave bolus, do these steps:**
  - a. The SET DUAL BOLUS TOTAL screen flashes the estimated bolus amount. This amount is the total of both the Normal and Square Wave bolus units. Change the amount if needed. Press **ACT** to accept the bolus amount.
  - b. The next screen flashes the amounts of Now (Normal) and Square portions of the Dual Wave bolus. The screen also shows the percentage amount of each portion. Press **ACT** to accept the Bolus Wizard's suggested portions. You can also press  or  to change these portions, then press **ACT**.

The Bolus Wizard feature recommends splitting the food portion of your bolus 50/50 between the Square and Now portions. The entire correction amount is always recommended to the Now portion. In this example the NOW portion consists of half of the food insulin plus the correction

amount less the active insulin ( $1.5U + 2.5U - 1.5U$ ). This gives 2.5U or 62% of total insulin of 4.0U. The Square portion consists of the other half of the food insulin (1.5U), which is 38% of total insulin of 4.0U.

- 7 The SQUARE DURATION screen appears. Enter the amount of time you want the Square Wave bolus to last, then press **ACT**.

***NOTE:** If you have BG Reminder turned On, the BG REMINDER DURATION screen displays. It allows you to set the duration before you are reminded to check your blood glucose after a bolus. See the BG Reminder section in the Basic programming chapter for information about this feature.*

- 8 Press **ACT** to accept and deliver the bolus. The BOLUS DELIVERY screen appears with an open circle indicating that your pump is in Special Mode. The pump beeps or vibrates at the start of the bolus. During bolus delivery, the pump returns to the HOME screen. If you want to see the progress of the delivery, press **ESC** to see the STATUS screen. The pump beeps or vibrates at the end of the bolus, and the open circle disappears.

## Easy bolus

The **EASY BOLUS** button  allows a quick way to deliver a Normal bolus. You will preset the settings for this feature in the EASY BOLUS OPTION screen in the BOLUS MENU. Your pump is sent from the factory with the Easy Bolus feature set to off. If you want to use Easy Bolus, turn it on.

After you set up Easy Bolus, with each  press, you can increase the Normal bolus amount by a fixed amount, called a step. Before you can deliver an Easy Bolus, you must set the amount in the EASY BOLUS ENTRY screen. This amount equals the number of units of insulin for each step. The maximum number of steps can equal up to your maximum bolus limit. When using vibrate mode, EASY BOLUS is limited to 20 steps or maximum bolus, whichever comes first.

After you set your step amount, you can program your Easy Bolus. When you are in the HOME screen, each time you press  the Easy Bolus amount increases by one step. You will hear a beep or feel a vibration for each step increase. Each beep is a different tone. This makes it easy for you to count the beeps while you are programming your Easy Bolus.

## Easy bolus setup

- 1 Go to the EASY BOLUS OPTION screen.  
Main > Bolus > Bolus Setup > Easy Bolus  
Select On/Set, then press ACT.

*NOTE: If you are using the remote control, the Easy Bolus must be set to on.*

## Step value setup



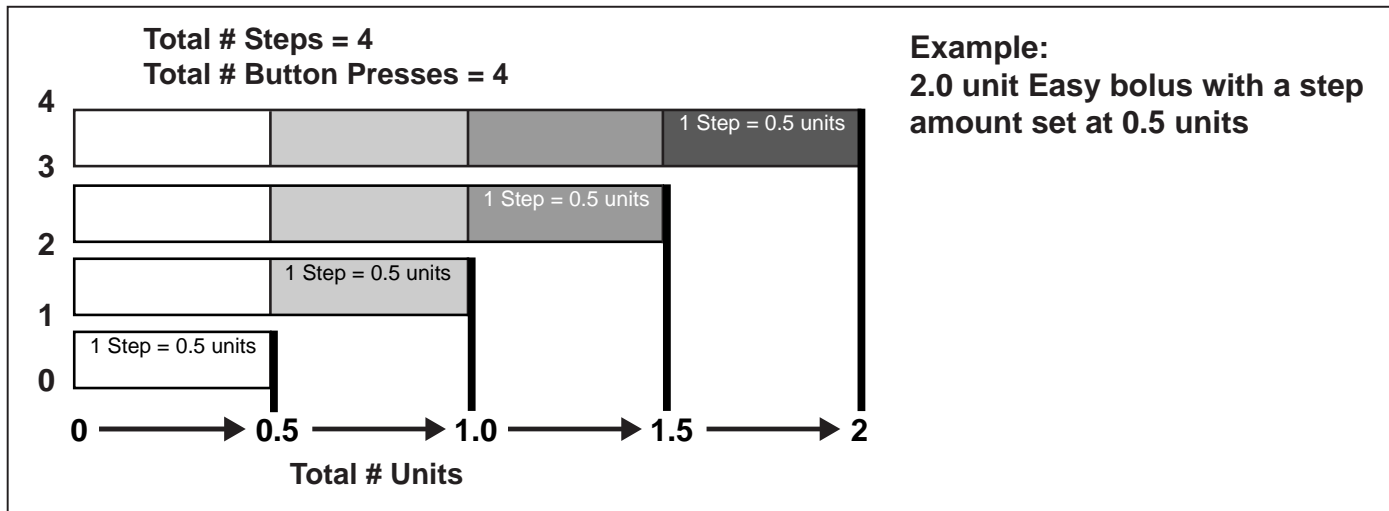

You can set the step value from 0.1 to 2.0 units, or to the set maximum bolus limit of less than 2.0 units (factory setting: 0.1). Set the step to a number that is convenient to use and easy to multiply.



- 1 The EASY BOLUS ENTRY screen flashes the step value. Change the value, then press ACT. The step value is the increment you will use for your Easy bolus.
- 2 The screen will return to the BOLUS MENU. Your step amount is now programmed and Easy Bolus is ready to use. Exit the menus.

## Delivering Easy Bolus

Practice using the Easy Bolus feature while looking at the pump screen as you count the beeps. This feature only works from the HOME screen. After you are familiar with Easy Bolus, you can use the audible tones for bolus delivery without having to look at the screen.

- 1 From the HOME screen, press . The SET EASY BOLUS screen appears with the single step value flashing.
- 2 Press  the number of times needed for your bolus amount. Watch the amount change on the screen with each press. The pump will vibrate or sound a different tone for each  press.
- 3 When your total bolus amount appears on the SET EASY BOLUS screen, press **ACT**. Listen/feel to count the steps without looking at the screen.  
For example: You need to deliver a 2.0 unit bolus, and your step size is set to 0.5. Each time you press , the units increase by the step amount of 0.5 units. To deliver 2.0 units, you need to press the  button four times. (4 X 0.5 = 2.0) The screen will show 2.0 units.



***NOTE:** For your safety, you cannot use the  to select the Easy Bolus values. Pressing  or **ESC** will cancel the Easy bolus.*

- 4 If this amount is correct, press **ACT** to start the Easy Bolus delivery. The BOLUS DELIVERY screen will show the units being delivered. When the total bolus is finished, the pump will beep or vibrate. If this amount is wrong, press **ESC** or  to start over. The pump will return to the HOME screen.

### Example 1: Easy bolus

Alexander is a busy executive with an accounting firm. He wears his Paradigm pump on his belt and does not want to take it off to give himself a bolus. Alexander can easily reach down and feel for the Easy Bolus button  to give a bolus.

He previously programmed his pump to deliver an Easy Bolus in steps of 0.5 unit increments. From the HOME screen, with each press of the , the pump will sound a different tone so he can keep track of the number of button presses.

He wants to give himself 2.0 units for a snack, so he will press  4 times (4 presses x 0.5 units/press = 2.0 units) and then press the **ACT** button. The pump counts back 4 beeps because he pressed  4 times. He simply presses **ACT** to confirm the amount, and his pump delivers the 2.0 units.

When Alexander wants to be more discreet, or does not want his pump to beep in an important meeting, he can set the pump to Vibrate mode and feel for vibrations rather than listening for the tones. (See the *Setting your alert type* section in the *Utilities* chapter for details.)

### Your turn: Easy bolus practice

The factory default setting for the Easy Bolus feature is 0.1 unit steps. You can change the step level as necessary to a value that is more convenient for you to use and easier to multiply.

Give your next bolus by using the Easy Bolus feature on your pump.

Your step level is \_\_\_\_\_.

How many units did you give? \_\_\_\_\_

How many tones did you count? \_\_\_\_\_

It might be a good idea to look at your pump's screen to see the bolus amount as well as counting the steps the first few times you try this until you become familiar and comfortable with the feature.

## Missed Bolus Reminder

Missed Bolus Reminder feature helps you remember to give yourself a meal bolus. It triggers a MISSED BOLUS alert if you do not deliver a bolus during the time periods that you set. Set these time periods for the meals for which you want to receive a reminder. The pump is set at the factory with the Missed Bolus Reminder feature turned Off.

### Add, delete, and review bolus reminders

You have to turn on the Missed Bolus Reminder option to add, delete and review the programmed reminders.

- 1 Go to the MISSED BOLUS REMINDER screen.  
**Main > Bolus > Bolus Setup > Missed Bolus Reminder**
- 2 Select **On/Set**, then press **ACT**.

### Add

You can set up to four Missed Bolus Reminders.

- 1 Select **Add Reminder** on the MISSED BOLUS REMINDER screen, then press **ACT**.
- 2 The Start Time flashes. Times can be entered in 30 minute increments. Set the Start Time, then press **ACT**.
- 3 After this time is set, the End Time flashes. Set the End Time, then press **ACT**.  
If you enter the same Start Time and End Time, you will get one Missed Bolus Reminder in a 24 hour period. If you add a Missed Bolus Reminder with a start time earlier than the current pump time, you will not get this Missed Bolus Reminder until the next day.

### Delete

- 1 Select **Delete Reminder** on the MISSED BOLUS REMINDER screen and press **ACT**.
- 2 In the DELETE REMINDER screen, highlight the bolus reminder that you want to delete and press **ACT**.

### Review

- 1 Select **Review Reminders** on the MISSED BOLUS REMINDER screen and press **ACT**.
- 2 Review your Missed Bolus reminders.



## Basal patterns

The Basal Patterns feature is optional for pump users. You can set your pump to deliver a standard basal and two additional basal patterns to meet your individual daily, weekly, or monthly needs. Keep a paper copy of your programmed patterns with you at all times in case you need to reprogram your pump. To select and use pattern A or pattern B, the patterns option must be turned on and programmed.

***NOTE:** You may want to explore this option after you become familiar with the basic pump functions. It is important that you consult your healthcare professional before using a pattern other than your standard pattern.*

- Standard pattern: Your normal basal that supports your usual day-to-day activity. When the Patterns feature is off, the pump uses your standard basal pattern.
- Pattern A/B: Basal pattern that supports activity levels that are not a part of your day-to-day routine, but are normal in your lifestyle. Such activities could be a sport that you do once a week or a change in your sleep pattern over the weekend, extended periods of higher or lower activity, or menses.

## Turning on the patterns

Your pump is set at the factory with the basal patterns feature turned off. After you turn on patterns, you still have to program and select a pattern (A or B), as described in the next sections, before the patterns feature is active. If you turn off the patterns feature, your pump will automatically select your standard basal pattern.

- 1 Go to the PATTERNS OPTION screen.  
**Main > Basal > Basal Setup > Patterns**
- 2 Select **On**, then press **ACT**. The patterns feature is now on. Exit the menus.

## Programming a pattern

Your pump will keep your pattern settings even when the Patterns option is turned off. However, the patterns feature must be on to program a basal pattern.

### To program your patterns, do these steps:

- 1 Go to the EDIT BASAL screen.  
**Main > Basal > Basal Setup > Set/Edit Basal**
- 2 Select the basal pattern you want to program, then press **ACT**.

- 3 The SET BASAL RATE 1 screen appears. The basal rate flashes, indicating that it can be changed. Set your first rate, then press **ACT**.  
The start time for your first basal rate is midnight and cannot be changed.
- 4 The SET START TIME 2 screen appears. The dashes under the screen name flash. The first basal rate is now set.  
If you want to use the same rate for the whole day, press **ESC** and skip to step 10. If you want to program another basal rate, follow steps 5 through 8.
- 5 In the SET START TIME 2 screen enter the time of the day you want this basal rate to become active.
- 6 Press **ACT**. The SET BASAL RATE 2 screen appears.
- 7 The previously set basal rate or dashes flash on the screen. Select the value for this basal rate.
- 8 Press **ACT**. The SET START TIME 3 screen appears. The second basal rate is now set.
- 9 If you do not need to set up any more basal rates, press **ESC**. If you need to set up more basal rates, repeat steps 5 through 8 above for each rate.
- 10 After you press **ESC**, the BASAL RATE screen appears. The screen will show:
  - the current basal pattern and basal rate,
  - time it started, and
  - the 24-hour basal total.After you make changes to a pattern, the pump will use that pattern as the current basal. Make sure the basal you want is selected in the SELECT PATTERN screen.

## Select a pattern

Before you select a pattern to be active, make sure the Patterns feature is turned on. After your standard pattern and/or pattern A or B are set, do these steps to select a pattern to be the active one:

- 1 Go to the SELECT PATTERN screen.  
**Main > Basal > Select Patterns**
- 2 Select the desired pattern, then press **ACT**.
- 3 The screen will return to the BASAL MENU. Your basal pattern is now active. Exit the menus.

**NOTE:** If pattern A or B is active, the pump is in Special mode. An open circle appears at the top of the screen.

**Example 1:  
Basal patterns**

Ken has had his insulin pump for about a month. He tests his blood glucose 4 - 6 times a day and records his results in his logbook. He is happy with his glucose control during the week but on the weekends, he noticed that he has to eat more food to prevent his blood glucose from running too low.

Ken has realized that during the week while he is at work, he is very inactive and sits at a desk most of the time. On the weekends, though, he is busy with yard work, running errands and playing with his kids. He determines that he needs to have lower basal settings to receive less insulin during active times, such as his weekend.

He can use the Basal Patterns feature to support his weekend change in activity. During the week, he can set his pump to deliver in the standard setting, and on Saturday morning, he can switch over to Pattern A, which he can set with lower basal rates for the weekend. On Monday morning, he can return his pump to the Standard setting for his weekday insulin needs.

**Example 2:  
Basal patterns**

Cynthia has had diabetes for about 12 years and has been on her Paradigm pump for several weeks. Every Monday, Wednesday and Friday, Cynthia goes on a 3 kilometer walk in the morning. To prevent hypoglycemia on these days, she uses the patterns feature. For those days, she simply switches over to Pattern A, which she has programmed with a lower set of basal rates. Before she learned to use the patterns feature, she would have to eat more food throughout the day to keep her blood glucose at a safe level. Cynthia has also noticed that a few days prior to menstruation, her blood glucose levels seem to rise, requiring more insulin. She has programmed Pattern B on her Paradigm pump with higher basal rates for this time. For her usual schedule, she uses the standard basal pattern.

**Your turn:**

Can you think of situations where you might require different basal rate settings on different days?

## Temp basal rates

Temp basal should be used based on the guidance of your healthcare professional. This feature is useful to manage blood glucose levels during **unusual** short-term activities or conditions. These conditions could be an illness or physical activity.

A temporary basal rate allows an immediate short-term change to your basal insulin for a specified period of time (30 minutes to 24 hours). This rate can be up to your Maximum basal rate setting. It offers an easy way to immediately meet short-term insulin needs for temporary activities or situations. When your blood glucose is temporarily high or low, a temp basal rate allows you to set a temporarily higher or lower basal to accommodate your blood glucose. For ongoing periods of increased or decreased activity, the patterns feature may be more suitable.

### How does temp basal work?

During a temp basal delivery, all other basal programming is temporarily overridden. After the temp basal delivery is completed, your pump will return to the programmed basal. A temp basal is delivered only once and does not repeat. If you want another temp basal, you must program the temp basal again. This feature may be useful to temporarily increase or decrease basal insulin during illness, exercise or similar unusual situations.

### Temp basal types

Based on your preference, you can select either Percent of Basal or Insulin Rate.

#### Insulin rate (U/H)

Insulin rate is a fixed basal in units per hour (U/H). This temp basal type is independent of your current basal. When you select **Insulin rate (U/H)** for your temp basal type, your pump will deliver the fixed amount you have set for the duration as set. The amount of your temp basal insulin rate can be set up to your Maximum basal rate setting.

If you make changes to your normal basal rate, your U/H temp basal is not affected and will continue to deliver as programmed.

### **Temp Basal Settings**

Temp basal type: Insulin rate (U/H)

Duration: 4 hours (1:05 p.m.-5:05 p.m.)

Rate: 1.25 U/H

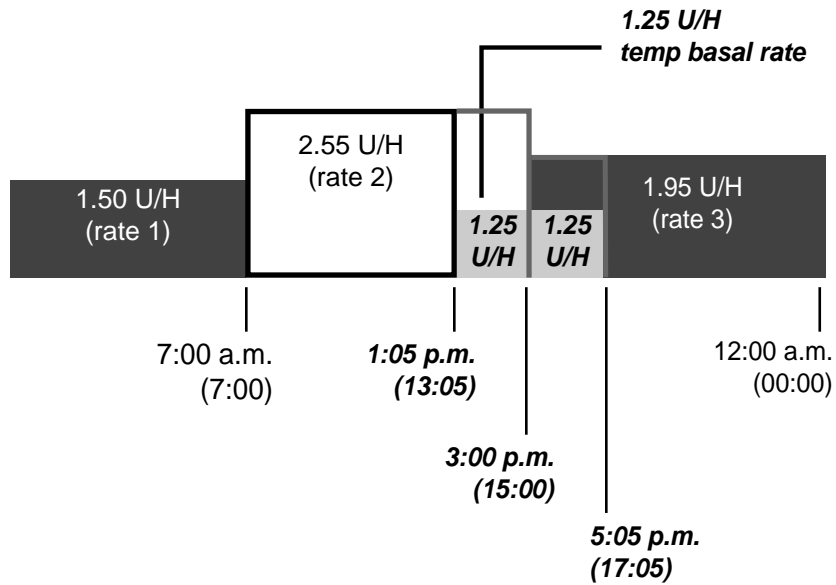

## Percent of basal

Unlike insulin rate, the percent of basal is dependent on your current basal rates. Percent temp basal is a percentage of your current basal (0-200 percent limited to your Maximum basal rate setting). The temp basal amount is rounded down to the next 0.025 or 0.05 U/H increment based on the basal rate.

The maximum percent limit is based on the largest basal rate segment with your programmed temp basal rate time.

**For example:** It is 6:00 AM and your current basal rate is 1.50 U/H. You want to set a temp basal rate of 130 percent for seven hours. The maximum percent temp basal rate you can set is 125 percent. Anything larger would make #2 segment exceed your Maximum basal setting of 2.0 U/H.

Your current basal rates:	Your Maximum basal rate setting: 2.0 U/H
Segment #1: 12:00A	1.50 U/H
Segment #2: 11:00A	1.60 U/H (largest)
Segment #3: 4:00P	1.30 U/H

If your current basal changes (for example, from rate 1 to rate 2), your percent temp basal amount will also change. The pump will deliver the percentage for the duration that you have set.

You cannot make changes to your normal basal rate while a percent temp basal is active. You must either wait until the temp basal is finished or cancel the temp basal in order to reprogram your normal basal rate setting(s).

## Temp Basal Settings

Temp basal type: Percent of basal

Duration: 4 hours (1:05 p.m. - 5:05 p.m.)

Rate: 50%

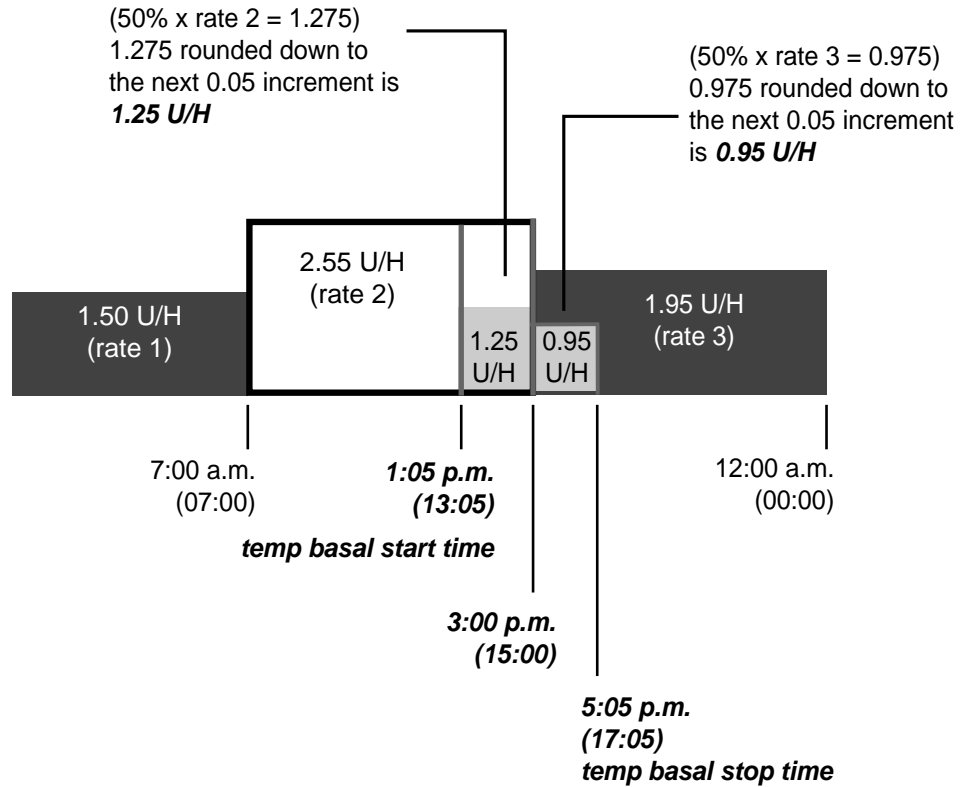

## Selecting temp basal type

Your pump will remember the temp basal type setting. Once the type is set, you do not have to set it again. To select a temp basal type, do these steps:

- 1 Go to the SET TEMP BASAL AS screen.  
**Main > Basal > Basal Setup > Temp Basal Type**
- 2 The SET TEMP BASAL AS screen appears. Select **Insulin Rate (U/H)** or **Percent of Basal**, then press **ACT**.

- 3 The screen will return to the BASAL SETUP screen. The temp basal type is now set. Exit the menus. If you select **Percent of Basal** as your temp basal type, changes to your basal rate are not allowed until after temp basal is completed or cancelled.

## Delivering a temp basal

A temp basal cannot exceed your programmed Max basal rate.

- 1 Go to the BASAL MENU.  
**Main > Basal**
- 2 Select **Set/Edit Temp Basal**, then press **ACT**.
- 3 The SET DURATION screen appears. The duration will flash. Duration is the amount of time it will take for the pump to deliver the temporary basal. Enter the desired minutes or hours (30 minutes to 24 hours), then press **ACT**.
- 4 If you have selected insulin rate as your temp basal type, the SET TEMP BASAL U/H screen appears. If you have selected percent of basal as your temp basal type, the SET TEMP BASAL % screen appears. The temporary basal rate will flash. Enter your temp basal rate, then press **ACT**.
- 5 The BASAL MENU screen appears with an open circle at the top of the screen. Your pump is in Special mode; temp basal is now set and delivering. Exit the menus.



## Verifying temp basal delivery

Temporary basal information is available in the STATUS screen only.

During a temporary (temp) basal, the pump is in Special mode (an open circle appears). This open circle will remind you that a temp basal is active. Additionally, your pump will beep/vibrate three times every hour during delivery. During delivery, go to the STATUS screen to see the current temp basal information.

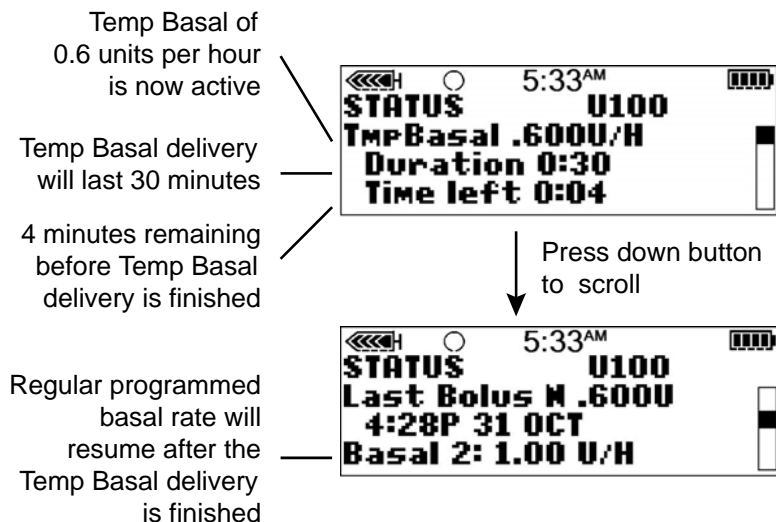

## Canceling a temp basal

Use the Cancel Temp Basal function in the BASAL MENU to cancel a temporary basal. This function immediately stops the temp basal and resumes the regular programmed basal delivery.

### To cancel a temp basal, do these steps:

- 1 Go to the BASAL MENU.

**Main > Basal**

- 2 Select **Cancel Temp Basal**, then press **ACT**.

The screen will return to the BASAL MENU. Your temp basal is cancelled and open circle has disappeared from the top of the screen. The programmed basal is now active again. Exit the menus.

**Example 1:**  
**Temp Basal for a decreased temporary basal rate**

Ramon and his friends got together for an unplanned game of soccer. Before using the pump, he was taking shots to manage his diabetes. Ramon experienced frequent low blood glucose reactions sometimes during, and very often after, he played games with his friends. Now that he is using his Paradigm pump, he can use the Temporary Basal Rate feature to help prevent low blood glucose. He simply programs his pump to temporarily deliver less basal insulin during the time that he is playing, and often for several hours after play, as well.

Ramon was able to determine how to set his Temporary Basal rates by frequent blood glucose testing, both during and after activity, and recording his results. The first time he tried using the pump, his healthcare professional advised him to program his pump to deliver one-half of his usual basal rate for the amount of time that he was playing and for an hour after he was done. He made small adjustments of the temporary basal rate and the duration of time, each time he tried to use the feature. After several different attempts with similar activity for the same amount of time, (such as his soccer game that lasted two hours), he found a temporary basal rate that worked well for him.

**Example 2:**  
**Temp Basal for an increased temporary basal rate**

Gail has had a cold with a cough for a couple of days. Because she is not feeling well, she tests her blood glucose more frequently. She finds that her blood glucose levels are running above target range before meals and she has needed several correction boluses to keep her blood glucose levels within her normal limits. Gail decides to use the Temporary Basal Rate to increase her basal rate during the day today. As advised by her healthcare professional, she will continue to check her blood glucose more frequently until she is feeling well.

**Your turn:**

Think of an activity where you might need to use a Temporary Basal Rate.

At what rate is your current basal rate running? \_\_\_\_\_

What Temporary Basal Rate would you try using at this time? \_\_\_\_\_

How long will you be active? \_\_\_\_\_

What duration will you set for the Temporary Basal Rate? \_\_\_\_\_

Test your blood glucose before and during activity and several times after as well. What are your blood glucose results?

Pre-activity \_\_\_\_\_

During activity \_\_\_\_\_

1 hour after activity \_\_\_\_\_

Several hours after activity \_\_\_\_\_



What Temporary Basal Rate changes will you make for the next time you try this?

# Sensor features

The optional sensor and transmitter can provide continuous glucose measurements to help you control your glucose levels better. The sensor measures the glucose levels in the fluid under your skin. The transmitter receives this measurement from the sensor and sends it wirelessly to the pump. To take advantage of your pump sensor features, call 800-646-4633, +1-818-362-5958 (outside U.S.), or visit our web site at [www.medtronicdiabetes.com](http://www.medtronicdiabetes.com) to purchase your sensor and transmitter.

The sensor glucose and meter blood glucose measurements are not identical. To see the accuracy of the sensor glucose measurements, see the *Sensor accuracy* appendix.

## Entering your sensor settings

Enter your pump sensor settings in the order they appear below, as some of the settings are dependent upon other settings being made first. When you complete each setting, your pump will automatically display the screen for the next setting in the sequence. When a screen item flashes, you may change the value of the flashing item by pressing  or .

## Turning on the sensor

The sensor must be turned on, started and initialized to report glucose measurements.

- 1 Go to the EDIT SETTINGS screen.

**Main > Sensor > Edit Settings**

The EDIT SETTINGS screen appears with **Sensor: Off** selected.

- 2 Press **ACT**. The SENSOR ON/OFF screen appears.
- 3 Select **On**, then press **ACT**. The EDIT SETTINGS screen appears showing the sensor is now turned on. You are now ready to turn on the glucose alerts.

## Turning on the Glucose Alerts

The Glucose alerts must be turned on if you want the system to send you an alert when the sensor glucose measurements reach or exceed your Glucose Limits. For a Low sensor glucose alert, the pump plays four consecutive tones, in falling pitch, if an audible beep has been selected as the alert type. For a High sensor glucose alert, the pump plays four consecutive tones, in rising pitch, if an audible beep has been selected as the alert type.

- 1 Make sure the EDIT SETTINGS screen is open.

**Main > Sensor > Edit Settings**

- 2 Select **Glucose Alerts**, then press **ACT**. The GLUCOSE ALERTS screen appears.
- 3 Select **On**, then press **ACT**. The EDIT SETTINGS screen appears showing the glucose alerts are now turned **On**.

## Setting the Glucose Limits

If you turned the Glucose alerts **On**, then you need to set the high and low Glucose Limits recommended by your healthcare professional. Your recommended glucose limits may vary throughout the day, so your pump allows you to set up to eight pairs.

A Glucose Limit pair includes one High Glucose Limit and one Low Glucose Limit, as shown in the following table:

Glucose Limit pair	Alerts
<b>Low:</b> 80 mg/dL (4.4 mmol/L) for 523/723 90 mg/dL (5.0 mmol/L) for 523K/723K	A <b>Low Glucose Limit</b> alert occurs when the sensor glucose measurement <b>reaches or goes below</b> the Low Glucose Limit in this table.
<b>High:</b> 240 mg/dL (13.3 mmol/L) for 523/723 280 mg/dL (15.5 mmol/L) for 523K/723K	A <b>High Glucose Limit</b> alert occurs when the sensor glucose measurement <b>reaches or goes above</b> the High Glucose Limit in this table.

## Selecting the BG units

You must select the blood glucose units (BG Units) for the system (either mmol/L or mg/dL). All BG measurements will show in the BG unit type you select.

- 1 Make sure the EDIT SETTINGS screen is open.  
**Main > Sensor > Edit Settings**
- 2 Select **BG Units**, then press **ACT**. The **BLOOD GLUCOSE UNITS** screen shows **mg/dL** and **mmol/L**.
- 3 Select your BG units.
- 4 Press **ACT**. The **EDIT SETTINGS** screen shows the BG Units type you selected.  
You are now ready to set up your glucose limits.

## Setting the Glucose Limits start time

If your healthcare professional recommends that you set more than one pair of Glucose Limits, you must enter a start time for each. For example, you may use one pair of Glucose Limits during the day and another pair at night. The example below shows two pairs of Glucose Limits. The first pair begins at midnight, and the second pair begins at 9:00 AM.

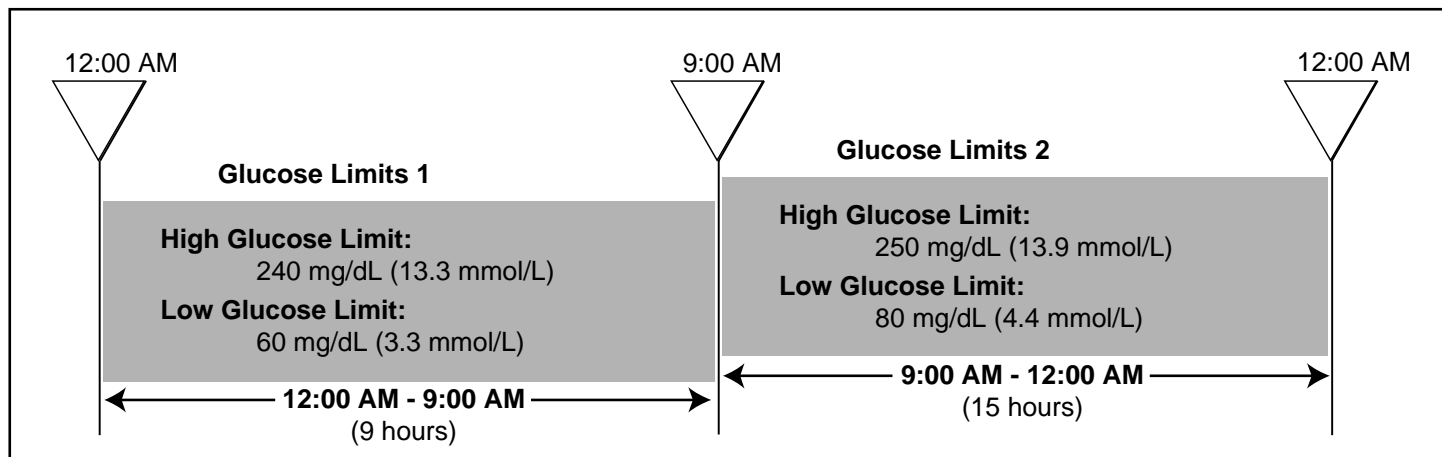

### To set up your Glucose Limits:

- 1 Make sure the EDIT SETTINGS screen is open.  
**Main > Sensor > Edit Settings**

- 2 Select **Glucose Limits**, then press **ACT**. The SET GLUCOSE LIMITS 1 screen appears. The Low Glucose Limit flashes 80 mg/dL (4.4 mmol/L).  
The start time for your first pair of Glucose Limits is midnight and cannot be changed.
- 3 Select your Low Glucose Limit. For the 523 and 723 pumps, the value must be between 40 and 390 mg/dL (2.2 and 21.6 mmol/L). To switch off the Low Glucose Limit, reduce it below 40 mg/dL (2.2 mmol/L) to select **OFF**. For the 523K and 723K pumps, the value must be between 90 and 390 mg/dL (5.0 and 21.6 mmol/L). To switch off the Low Glucose Limit, reduce it below 90 mg/dL (5.0 mmol/L) to select **OFF**.
- 4 Press **ACT** to select your High Glucose Limit. For the 523 and 723 pumps, the screen flashes 240 mg/dL (13.3 mmol/L). The limit you select must be between 50 and 400 mg/dL (2.8 and 22.2 mmol/L). Your High Glucose Limit must also be at least 10 mg/dL (0.6 mmol/L) above your Low Glucose Limit. To switch off the High Glucose Limit, reduce the High Glucose Limit below 50 mg/dL (2.8 mmol/L) to select **OFF**. For the 523K and 723K pumps, the screen flashes 280 mg/dL (15.5 mmol/L). The limit you select must be between 100 and 400 mg/dL (5.6 and 22.2 mmol/L). Your High Glucose Limit must also be at least 10 mg/dL (0.6 mmol/L) above your Low Glucose Limit. To switch off the High Glucose Limit, reduce the High Glucose Limit below 100 mg/dL (5.6 mmol/L) to select **OFF**.
- 5 Press **ACT**. The SET START TIME 2 screen appears. The dashes under the screen name flash. The first pair of Glucose Limits is now set.  
If you do not need a second pair of Glucose Limits, press **ESC** and skip to the next section. If you want to set up a second pair of Glucose Limits, follow steps 6 through 11 below.
- 6 To set a second pair of Glucose Limits, select the time of day you want this pair to become active.
- 7 Press **ACT**. The SET GLUCOSE LIMITS 2 screen appears. The default Low Glucose Limit flashes (**OFF**).
- 8 Select your Low Glucose Limit. For the 523 and 723 pumps, the value must be between 40 and 390 mg/dL (2.2 and 21.6 mmol/L). For the 523K and 723K pumps, the value must be between 90 and 390 mg/dL (5.0 and 21.6 mmol/L).
- 9 Press **ACT**. The default High Glucose Limit flashes (**OFF**).
- 10 Select your High Glucose Limit. For the 523 and 723 pumps, the value must be between 50 and 400 mg/dL (2.8 and 22.2 mmol/L). For the 523K and 723K pumps, the value must be between 100 and 400 mg/dL (5.6 and 22.2 mmol/L).
- 11 Press **ACT**. The SET START TIME 3 screen appears.  
The second pair of Glucose Limits (Glucose Limits 2) is now set. If you do not need any more Glucose Limits pairs, press **ESC**. If you want to set more Glucose Limits, then repeat steps 6 through 11 above for each pair, up to a maximum of eight.  
You are ready to set up your High Repeat.

## Setting the High Repeat

After you receive and clear a High Glucose, Rise Rate of Change, or High Predictive alert, the alert will repeat until the condition that has caused the alert is resolved. The High Repeat feature allows you to set how frequently you want the alert to repeat after you clear it the first time. For example, if your blood glucose levels usually take one to two hours to fall after a correction bolus, you may want to set the High Repeat to one or two hours to avoid unnecessary alerts.

### Example

You set your High Repeat to 15 minutes. You receive an alert at 1:00 PM and immediately clear it. However, the condition that caused the alert still exists, so you will receive a second alert at 1:15 PM, 15 minutes after you cleared the first alert. If you immediately clear the alert again, then the alert will repeat at 1:30 PM and continue to repeat every 15 minutes until you resolve the condition that caused the alert. (This example also applies to the Low Repeat.)

### To set up your High Repeat:

- 1 Make sure the EDIT SETTINGS screen is open.  
**Main > Sensor > Edit Settings**
- 2 Select **Hi Repeat**, then press **ACT**. The SET HI ALERT REPEAT screen flashes the default High Repeat time of 1 hour (1:00).
- 3 Select your High Repeat time. The time must be between 5 minutes (0:05) and 3 hours (3:00).
- 4 Press **ACT**. The EDIT SETTINGS screen shows the High Repeat value set.  
You are now ready to set up your Low Repeat.

## Setting the Low Repeat

After you receive and clear a Low Glucose, Fall Rate of Change, or Low Predictive alert, the alert will repeat until the condition that caused the alert is resolved. The Low Repeat feature allows you to set how frequently you want the above alerts or alarm to repeat after you clear it the first time. The Low Repeat feature works similar to the High Repeat one. See *Setting the High Repeat* section in this chapter for an example.

- 1 Make sure the EDIT SETTINGS screen is open.  
**Main > Sensor > Edit Settings**
- 2 Select **Low Repeat**, then press **ACT**. The SET LO ALERT REPEAT screen flashes the default Lo Alert Repeat time of 20 minutes (0:20).



- 3 Select your Low Repeat time. The time must be between 5 minutes (0:05) and 1 hour (1:00).
- 4 Press **ACT**. The EDIT SETTINGS screen shows the Low Repeat value set. You are now ready to set up the Predictive Alert.

## Setting the Predictive glucose alert

The Predictive alerts calculate when you may reach your Low or High Glucose Limits, then send you an alert before you reach those limits. A Predictive alert tells you that **if your sensor glucose measurements keep falling or rising at the current rate**, you may reach your Glucose Limit in the number of minutes you selected. For a LOW PREDICTED alert, the pump plays three consecutive tones, in falling pitch, if an audible beep has been selected as the alert type. For a HIGH PREDICTED alert, the pump plays three consecutive tones, in rising pitch, if an audible beep has been selected as the alert type.

## Understanding the Time Sensitivity Settings

To use the Predictive alerts, you need to first set your Low or High Glucose Limits, and then your Time Sensitivities. Time Sensitivity means the length of time, in minutes, you want to be notified before you reach your High or Low Glucose Limit. If you set the Low time sensitivity setting at 25 minutes and the High time sensitivity setting at 20 minutes, then the Predictive alerts will be sent:

- **25 minutes before** the sensor glucose reaches your Low Glucose Limit
- **20 minutes before** the sensor glucose reaches your High Glucose Limit

### To set up the Predictive alerts:



- 1 Make sure the EDIT SETTINGS screen is open.  
**Main > Sensor > Edit Settings**
- 2 Select **Predict Alerts**, then press **ACT**. The PREDICTIVE ALERTS LOW/HIGH screen shows that the alerts are turned **Off**.
- 3 Select **On**, then press **ACT**. The SET TIME SENSITIVITY LOW/HIGH screen appears and the LOW time setting flashes the default time: 15 minutes (0:15).
- 4 Select the Time Sensitivity (how many minutes before you reach your Low Glucose Limit). To turn off the Low Predictive Alert, reduce the Time Sensitivity to **OFF**.
  - Range: **5 to 30 minutes (0:05 to 0:30)**
  - Increments: **5 minutes**
- 5 Press **ACT**. The HIGH time setting flashes the default time: 15 minutes (0:15).

- 6 Select the Time Sensitivity (how many minutes before you reach your High Glucose Limit). To turn off the High Predictive Alert, reduce the Time Sensitivity to **OFF**.
  - Range: **5 to 30 minutes (0:05 to 0:30)**
  - Increments: **5 minutes**
- 7 Press **ACT**. The EDIT SETTINGS screen appears.  
You are now ready to set up the rate alerts.

## Setting the Rate of Change Alerts

The Rate of Change alerts tell you when your sensor glucose (SG) changes at, or faster than, the per-minute rate pre-selected by you. There are two alerts:

- **FALL RATE** for SG **decreases** at or faster than your pre-selected rate. The pump plays two consecutive tones, in falling pitch, if an audible beep has been selected as the alert type.
- **RISE RATE** for SG **increases** at or faster than your pre-selected rate. The pump plays two consecutive tones, in rising pitch, if an audible beep has been selected as the alert type.

You can set one or both Rate of Change alerts. The rate of change alert default setting is **OFF**. When you press  or , 4.0 mg/dL (0.220 mmol/L) displays. This value changes up or down with each additional press.

The explanation in the following table shows how the Rate alerts work.

If you set the number	Then
<b>Lower</b> than 4.0 mg/dL/min (0.220 mmol/L/min)	<ul style="list-style-type: none"> <li>• The system is <b>more sensitive</b> to SG changes</li> <li>• Alerts are <b>more frequent</b> than if you use a higher number</li> </ul>
<b>Higher</b> than 4.0 mg/dL/min (0.220 mmol/L/min)	<ul style="list-style-type: none"> <li>• The system is <b>less sensitive</b> to SG changes</li> <li>• Alerts are <b>less frequent</b> than if you use a lower number</li> </ul>

### To set up the Rate of Change alerts:

- 1 Make sure the EDIT SETTINGS screen is open.  
**Main > Sensor > Edit Settings**
- 2 Select **Rate Alerts**, then press **ACT**. The SET FALL RATE LIMIT screen flashes the rate alert default setting: **OFF**.
- 3 Select the Fall Rate Limit.

- Range:           mg/dL/min    from **1.1** to **5.0**  
                      mmol/L/min   from **0.065** to **0.275**
  - Increments:  mg/dL/min    **0.1**  
                      mmol/L/min   **0.005**
- 4 Press **ACT**. The SET RISE RATE LIMIT screen flashes the rate alert default setting: **OFF**.
  - 5 Select the Rise Rate Limit. The range and increments are the same as the Fall Rate Limit (see step 3 above).
  - 6 Press **ACT**. The Rate of Change alerts will now use the settings you specified. You are now ready to set up the Cal Repeat.

## Setting the Cal Repeat

After you receive and clear a METER BG NOW alert, the device will repeat the alert until you enter a new meter blood glucose measurement. The Cal Repeat feature allows you to set how frequently you want the alert to repeat after you clear it.

- 1 Make sure the EDIT SETTINGS screen is open.  
**Main > Sensor > Edit Settings**
- 2 Select **Cal Repeat**, then press **ACT**. The SET CAL REPEAT screen flashes the default Cal Repeat time of 30 minutes (0:30).
- 3 Set your Cal Repeat time between 5 minutes (0:05) and 1 hour (1:00).
- 4 Press **ACT**. The EDIT SETTINGS screen shows the Cal Repeat time you selected. You are now ready to set your Cal Reminder.

## Setting the Cal Reminder

The Cal Reminder feature allows you to set a reminder to calibrate your system. For example, if you set your reminder to four hours, then you will receive a METER BG BY alert (Cal Reminder) four hours before the next meter blood glucose (BG) entry is due (eight hours after your last successful sensor calibration).

### To set up the Cal Reminder:

- 1 Make sure the EDIT SETTINGS screen is open.  
**Main > Sensor > Edit Settings**
- 2 Select **Cal Reminder**, then press **ACT**. The CAL REMINDER screen shows **On**.
- 3 Press **ACT**. The SET CAL REMINDER screen flashes the Cal Reminder default time of 1 hour (1:00).

- 4 Select your Cal Reminder time between 5 minutes (0:05) and 6 hours (6:00).
- 5 Press **ACT**. The EDIT SETTINGS screen shows the Cal Reminder time you selected. You are now ready to enter your transmitter ID number.

## Entering the transmitter ID

The transmitter ID (serial number) starts with 2 and is found on the flat side of your transmitter. You must enter the transmitter ID so that the transmitter and the pump can communicate with each other.

Write the Transmitter ID of the transmitter you are using here: \_\_\_\_\_.

- 1 Make sure the EDIT SETTINGS screen is open.

**Main > Sensor > Edit Settings**

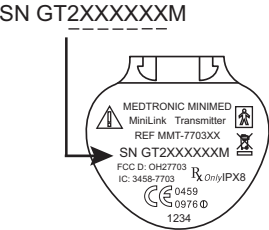
- 2 Select **Transmtr ID**, then press **ACT**. The SET TRANSMITTER ID screen appears. The screen shows seven dashes for the Transmitter ID, the first of which (on the left) is flashing.
- 3 Select the first number of the Transmitter ID (the number on the screen must match the first number of the Transmitter ID). The transmitter ID is located on the transmitter label, as shown.  
The diagram shows a circular transmitter label with the following text: MEDTRONIC MINIMED, MiniLink Transmitter, REF MMT-7703XX, SN GT2XXXXXXM, FCC D. 0457703, IC: 3458-7703, Only IPX8, 0459, 0976, 1234. An arrow points from the label to the first dash of the SN GT2XXXXXXM label above it.
- 4 Press **ACT**. The second dash flashes.
- 5 Select the next number of the Transmitter ID, then press **ACT**.
- 6 Repeat step 5 until all seven digits of the Transmitter ID have been selected.
- 7 A message shows that the Transmitter ID has been changed. After about 30 seconds, the EDIT SETTINGS screen appears. It shows the Transmitter ID you entered.  
You are now ready to set up the Weak Signal.

## Setting up the Weak Signal feature

The Weak Signal feature allows you to determine how quickly you will receive a Weak Signal alert when there is no communication between the transmitter and the pump. For example, if you set the Weak Signal value to 30 minutes, you will receive a Weak Signal alert 30 minutes after loss of communication.

**To set up the Weak Signal feature:**

- 1 Make sure the EDIT SETTINGS screen is open.

### **Main > Sensor > Edit Settings**

- 2 Select **Weak Signal**, then press **ACT**. The SET WEAK SIGNAL screen flashes the default time of 30 minutes (0:30).
- 3 Select your Weak Signal time between 5 minutes (0:05) and 40 minutes (0:40).
- 4 Press **ACT**. The EDIT SETTINGS screen shows the length of time you entered for the Weak Signal option.
- 5 You are now ready to set up the sensor glucose graph timeout.

## **Setting the sensor glucose graph timeout**

The sensor glucose graph timeout is how long the graphs show on the pump screen until the HOME screen automatically appears. The default timeout is two (2) minutes, and you can set it for 2, 4, or 6 minutes.

### **Using a continuous graph display**

You can also select **NONE** to set the sensor graph timeout to display continuously. If you select **NONE**, the sensor graphs will show until another screen or menu is selected, or an alarm/alert occurs. Selecting continuous graph display uses more battery power and decreases battery life. To return to the HOME screen from the sensor glucose graphs, press **ESC** until the HOME screen appears.

### **To set the sensor glucose graph timeout:**

- 1 Make sure the EDIT SETTINGS screen is open.

### **Main > Sensor > Edit Settings**

- 2 Select **Graph Timeout**, then press **ACT**. The SET GRAPH TIMEOUT screen flashes the default time of 2 minutes (0:02).
- 3 Select your Graph Timeout. The time you select must be: 2 minutes; 4 minutes; 6 minutes; or **NONE**.
- 4 Press **ACT**. The EDIT SETTINGS screen shows the Graph Timeout you selected.  
You are now ready to review your sensor glucose monitoring settings.

## **Reviewing your settings**

Make sure that all the settings you have made are correct before you use the system. Use the following procedure to review your settings:

- 1 Open the REVIEW SETTINGS screen.

### **Main > Sensor > Review Settings**

- 2 Press  to scroll through all settings to make sure that they are correct.

- 3 To change any settings, return to the EDIT SETTINGS menu.  
**Main > Sensor > Edit Settings**
- 4 Save your settings after you have set your preferences. This will allow you to restore the settings you have saved if you receive an alarm or error that resets your settings.

## Using the Sensor Demo

The Sensor Demo shows you a demonstration of a sensor graph. To view the Sensor Demo screen, you must first turn on the Sensor Demo feature. After the Sensor Demo feature is turned on, the first line of the STATUS and SENSOR STATUS screens will show **SENSOR DEMO: On**.

### Turning on the Sensor Demo feature



- 1 Make sure the EDIT SETTINGS screen is open.  
**Main > Sensor > Edit Settings**  
The EDIT SETTINGS screen shows **Sensor Demo: Off**.
- 2 Press **ACT**. The SENSOR DEMO ON/OFF screen appears with **Off** selected.
- 3 Select **On**, then press **ACT**. The EDIT SETTINGS screen shows that SENSOR DEMO is now turned **On**.

---

**CAUTION: The Sensor Demo feature affects the sensor demonstration graph only. All other features, screens and options are in the normal mode.**

---

### Viewing the Sensor Demo screens

- 1 From the HOME screen, press **ESC**. The screen briefly shows SENSOR DEMO, then the first Sensor Demo graph appears.
- 2 You can move the cursor (flashing vertical line) through the graph to see examples of how the real-time graphs appear. Press  to move the cursor left, press  to move the cursor right.
- 3 You must turn the Sensor Demo off in order to show your actual, real-time sensor glucose graphs. To turn the Sensor Demo off, follow the above procedure and select **Off**.

## The transmitter

The Medtronic MiniLink Transmitter (MMT-7703) is a device that takes electronic signals generated by the glucose sensor and sends them by radio frequency to the pump. It has a tester (MMT-7706) and a charger (MMT-7705 or MMT-7715). For details on how to use your transmitter, charger and tester, see your transmitter user guide.

## Starting the sensor

To start the sensor working, you must complete the following steps in order:

- Insert a battery into the transmitter's charger.
- Charge the transmitter battery.
- Set up the sensor features.
- Insert the sensor and wait 10-15 minutes.
- Connect the transmitter to the sensor.
- Start the sensor and wait two hours.
- Enter your first meter BG.

## Inserting the sensor

Refer to your Sensor User Guide for information on sensor insertion.

## Removing the sensor

When you are ready to change your sensor, disconnect it from the transmitter as described in your transmitter user guide. Gently pull the sensor from your body to remove it. Place it in a sharps container.

## Preparing the sensor for communication

Connect your transmitter to your sensor as described in the transmitter user guide. When the green light on the transmitter flashes, use your pump to follow the steps below.

- 1 Go to the LINK SENSOR MENU screen.  
**Main > Sensor > Link to Sensor**
- 2 Select **New Sensor**. Press **ACT**.

- 3 Connect the transmitter to your sensor now if you have not already done so. If the screen times out, do **not** disconnect the sensor. Start from step 1 again.
- 4 After your sensor is connected, press **ACT**. The **SENSOR READY 2 HRS** screen appears.
- 5 The sensor will enter a two hour initialization period. Press any button to continue. After 2 hours your pump will alert you to enter a meter BG to calibrate your sensor.

## Calibrating the sensor

Two hours after you use your pump to start the sensor, your pump will alert you to enter a meter BG (METER BG NOW). This meter BG entry will be the **first** calibration for your sensor. You have to wait 10-15 minutes after calibration to see the first sensor glucose reading on the pump screen. Six hours after the first calibration, the pump will alert you to enter the second calibration.

After the second calibration, you must calibrate your sensor every 12 hours. If you fail to enter a meter BG reading after 12 hours, your pump displays the METER BG NOW alert. Your pump will then stop calculating glucose values. However, about 20 minutes after you have entered a meter BG, your pump will continue calculating glucose values.

Follow these guidelines for best calibration results:

- Calibrate three to four times spread out throughout the day.
- Avoid calibrating when your glucose is changing rapidly, such as after eating or exercise.
- Enter your meter BG reading into the pump immediately after testing your BG. Do not wait to enter it later.
- Always use clean dry fingers when you check your blood glucose.
- Only use your fingertips to obtain blood samples for calibration.

After the transmitter successfully transmits signals to the pump, you may choose to put an occlusive dressing over the transmitter and the sensor.



## Entering meter BG for calibration

Sensor calibration is necessary for optimal glucose sensor performance. Only BG entries in the range of 40-400 mg/dL (2.2-22 mmol/L) are accepted for sensor calibration.

Use any of the following methods for your sensor calibrations, including the first calibration after the initialization. You can enter BG values manually or through your linked meter.

### To enter BG values manually:

- 1 You can enter a meter BG value manually in the Bolus Wizard.
  - a. Press the **B** button on your pump, or use the MAIN MENU to go to the ENTER BG screen:  
**Main > Bolus > Use Bolus Wizard**
  - b. Use the up and down arrow buttons on your pump to enter your meter BG. Press **ACT**.
  - c. Select **Yes** to calibrate, or **No** to cancel, when the following screen displays: BG to update Sensor?
- 2 You can enter a meter BG value manually through the Sensor menu.
  - a. Follow this path:  
**Main > Sensor > Calibrate**
  - b. Enter the BG value, and then press **ACT**. Your sensor is now calibrated with the BG value you entered.
    - If the Bolus Wizard feature is off, the **SENSOR MENU** screen appears.
    - If the Bolus Wizard is on and the saved BG is below your BG Target range, the **Cal Saved** screen appears. This screen indicates that your saved BG is below your BG Target set in the Bolus Wizard feature, and the pump beeps three times. See *Setting the BG Targets, on page 71* for more information.
    - If the Bolus Wizard is on, the saved BG is above your BG Target range, and the calculated correction estimate is more than the preset scroll rate increment, the **Cal Saved** screen appears. This screen indicates that your saved BG is above your BG Target set in the Bolus Wizard feature, and the pump beeps three times. Go to the **ENTER BG** screen of the Bolus Wizard feature to enter a correction bolus. See *Using the Bolus Wizard feature* section for more information.
    - If the information is not correct, select **Cancel**, then press **ACT**. The **SENSOR MENU** screen reappears with **Calibrate** selected. Repeat the procedure and enter the correct information.
- 3 You can enter a meter BG value manually through the Capture Event menu. Follow this path:  
**Main > Capture Event > Enter BG**

See *page 38* for more information.

**To enter BG values through your linked meter:**

- 1 Test your BG with a fingerstick.
- 2 The BG value is automatically sent from the meter to your pump. This value displays in the following screen: BG to update Sensor. Select **Yes** if you want to calibrate your sensor. Select **No** if you do not want to use your BG value for calibration.  
Make sure that your pump and the meter are properly programmed for communication. See *Meter option, on page 147* for more information.



# Using your sensor

## Status screens

Your STATUS screens tell you what is going on in your pump. In the SENSOR STATUS screen you can check the status of sensor information including when your next calibration will be needed, your sensor's age, and the state of your transmitter battery.

### To get to your status screens:

- 1 From the HOME screen, press the ESC button twice. This takes you to your pump status screen.
- 2 To see the Sensor Status screen, press ESC one more time. This screen will only be available if the Sensor feature has been turned On.

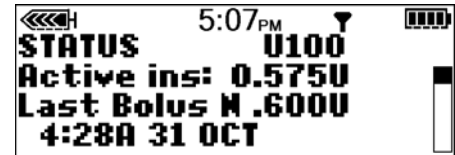

## Reading the sensor glucose graphs

*NOTE: If your graphs say DEMO in the upper left corner of your screen, you must turn off the SENSOR DEMO mode to see your actual graphs (see the Using the Sensor Demo section in the Sensor features chapter).*

Your pump shows an updated, real-time glucose measurement. This measurement is generated by data sent from the sensor to the transmitter, and then to the pump every five minutes. The pump converts these measurements to glucose graphs that include the following information:

- The most recent sensor glucose measurement or the reason that one is not displayed.
- The historical sensor glucose measurements or the reason that one is not displayed for the last 3, 6, 12 or 24 hours.
- Arrows that show the relative rate at which the most recent sensor glucose levels have risen or fallen.

The following conditions can prevent a real-time sensor glucose measurement from being taken:





- A Lost Sensor alert.
- A Sensor Error alert.
- A Change Sensor alert.
- A Cal Error alert.
- Find Lost Sensor (15 minutes).
- Weak signal.
- Reconnect old sensor (two hours).
- A meter BG entry is needed for calibration.

Two other conditions also prevent a real-time SG measurement and generate a WARM UP message on your sensor glucose graphs:

- You started a new sensor, and it has entered a two-hour initialization. The sensor is not ready to take glucose measurements.
- You entered a BG for calibration, and your pump is waiting to receive the first valid SG value.

## Opening and viewing the graphs

The following table describes how to use the graphs.

If you want to:	Do the following:
Open the graphs	From the HOME screen, press <b>ESC</b> . The last graph you viewed (3-, 6-, 12- or 24-hour) shows the details for your most recent sensor glucose (SG) measurement.
View information in a graph	<p>If there is no SG measurement at the time you select, the reason for the missing measurement will be shown on the right side of the graph (for example, LOST SENSOR).</p> <ul style="list-style-type: none"> <li>• When you open the graphs, the cursor (flashing vertical line) is always on the right edge of the graph and the graph shows the most recent SG measurement.</li> <li>• Press  to move the cursor left to see an earlier SG measurement.</li> <li>• Press  to move the cursor right to return to more recent SG measurements.</li> </ul>
View different graphs	<ul style="list-style-type: none"> <li>• With the cursor at the far right edge of a graph, you can press  to open the next graph.</li> <li>• If the cursor is anywhere to the left of the far right edge, press <b>ESC</b> to move it to the right, then press  to open the next graph.</li> </ul>

### The graphs

All graphs show High and Low Glucose Limits lines, a real-time SG measurement line, a data section, and the cursor (flashing vertical line).

When you open any graph, the cursor flashes on the right edge of the graph. There are three marks on the cursor at 100, 200, and 300 mg/dL (or 5, 10, and 15 if mmol/L is selected). The data section shows the most recent SG measurement or the reason why no measurement shows, and the time in the data section matches the time at the top of the screen.

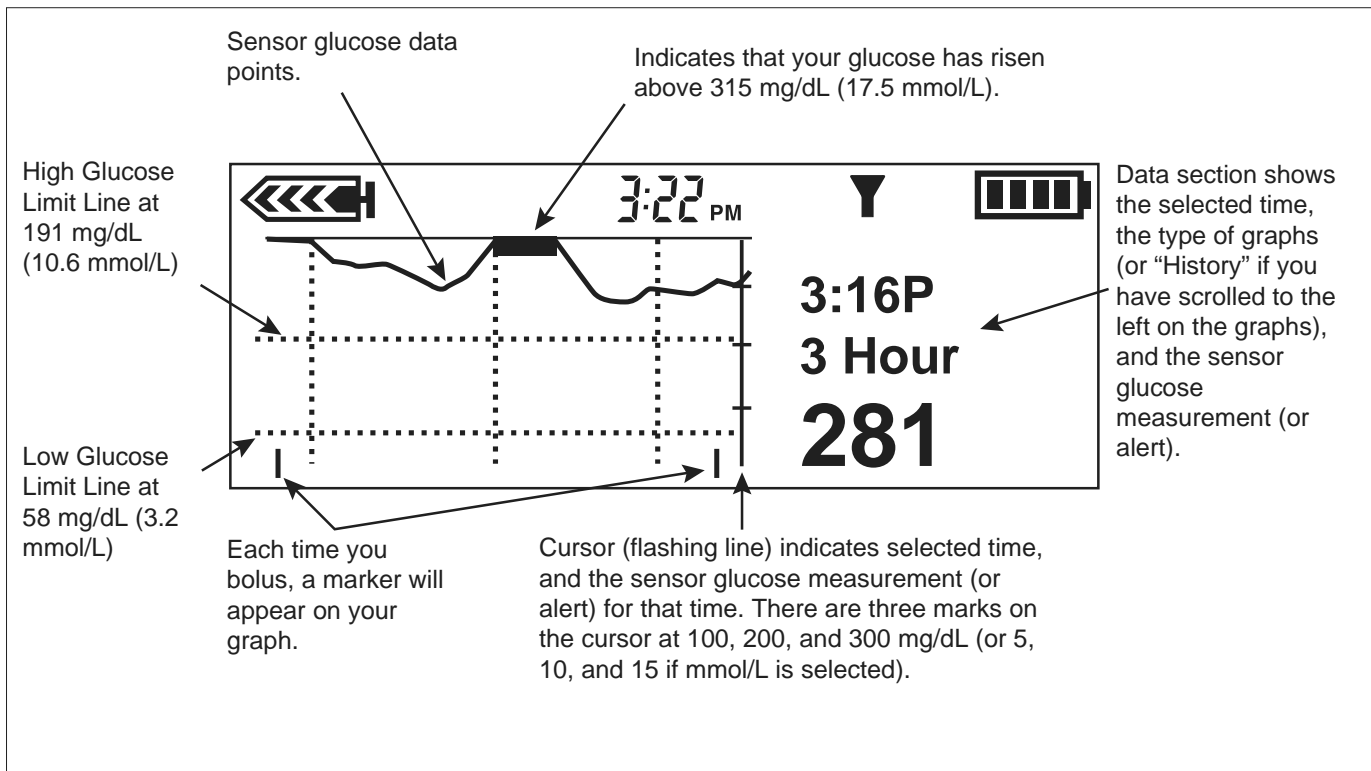

When you move the cursor left to select an earlier SG measurement, the data section of the graph turns black, the word History appears here, and the time in the data section changes to show the time when the SG measurement was taken or the reason why no SG measurement shows for that time.

**NOTE:** There are many reasons your graphs may not show an SG measurement, but your system does not alert for every one. Therefore, your system's alarm/alert history may not match the number of times your graphs do not show an SG measurement.

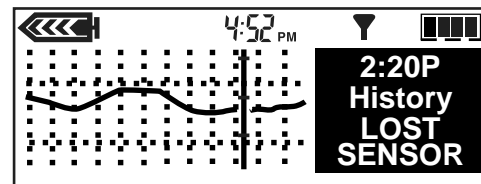

## Examples of real-time sensor glucose graphs

The following pages show examples of the different graph types.

### 3-hour graph

Each part of the graph between the vertical dashed lines represents one hour. In this example, the selected SG measurement was taken at 3:16 PM, and the value at that time was 281 mg/dL (15.6 mmol/L).

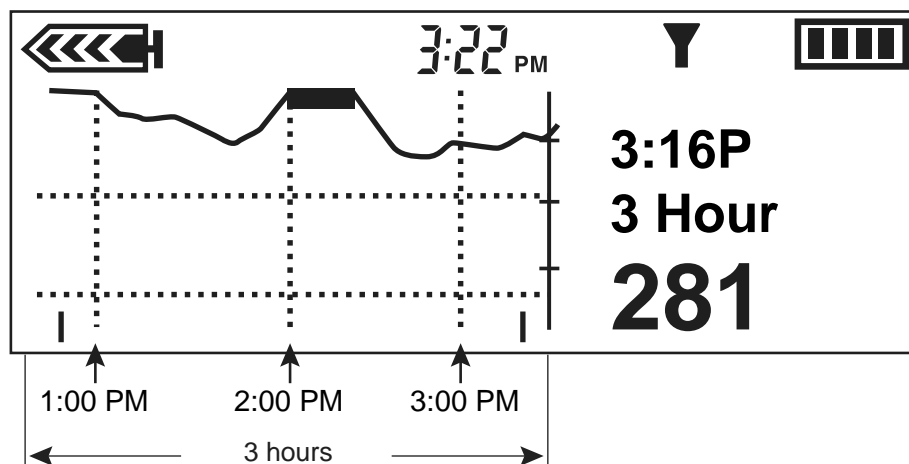

### 6-hour graph

Each part of the graph between the vertical dashed lines represents one hour. In this example, the selected SG measurement was taken at 1:12 AM, and the value at that time was 150 mg/dL (8.3 mmol/L).

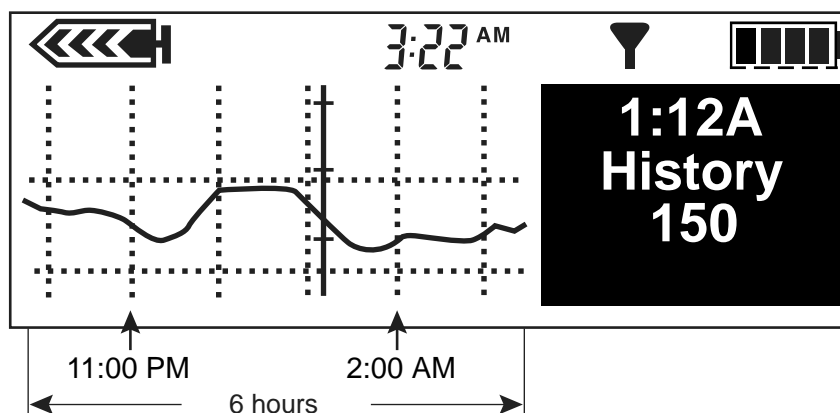



## 12-hour graph

Each part of the graph between the vertical dashed lines represents one hour. In this example, the reason no measurement is displayed is LOST SENSOR and it occurred at 2:20 PM.

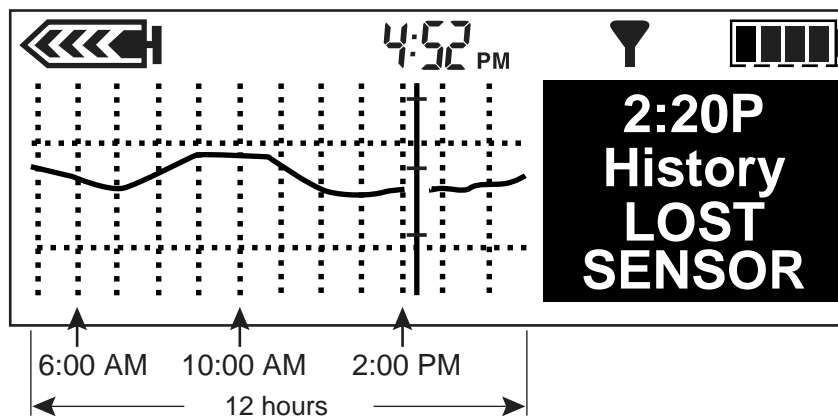

## 24-hour graph

Each part of the graph between the vertical dashed lines represents 12 hours. The shaded area helps you more easily see the sensor glucose measurements for the previous night. In this example, the selected SG measurement was taken at 11:50 AM and the value at that time was 211 mg/dL (11.7 mmol/L).

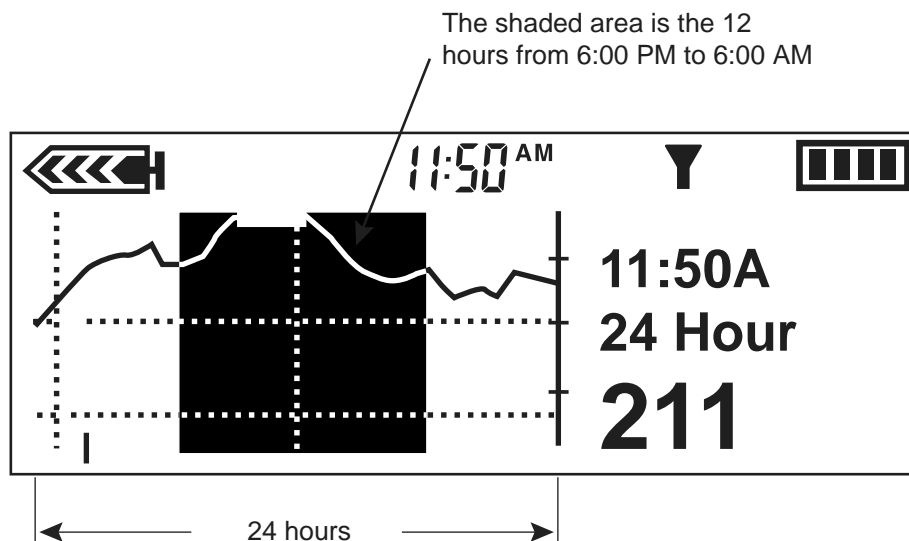

## How to check for rapid changes in sensor glucose

If your sensor glucose (SG) rises or falls faster than a certain rate, rapid change arrows automatically appear in the graphs next to the SG measurement, as shown in the following section.

### The rapid change arrows

These examples show how the rapid change arrows tell you when your SG rises or falls faster than a certain per-minute rate. The arrow direction shows if your SG measurements are rising or falling. The number of arrows (one or two) shows how rapidly your SG is changing.

- One up arrow  $\uparrow$  shows that your SG has been rising at a rate of 1 to 2 mg/dL (0.05 to 0.11 mmol/L) per minute.
- One down arrow  $\downarrow$  shows that your SG has been falling at a rate of 1 to 2 mg/dL (0.05 to 0.11 mmol/L) per minute.
- Two up arrows  $\uparrow\uparrow$  show that your SG has been rising at a rate of 2.0 mg/dL (0.11 mmol/L) or more per minute.
- Two down arrows  $\downarrow\downarrow$  show that your SG has been falling at a rate of 2.0 mg/dL (0.11 mmol/L) or more per minute.

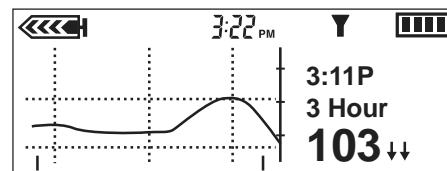
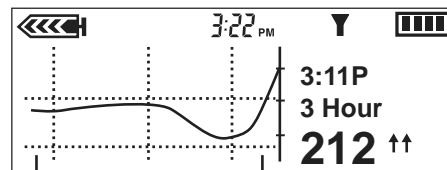
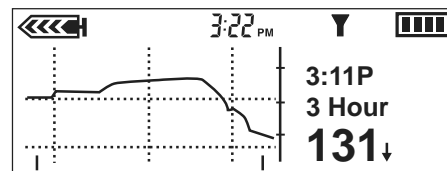
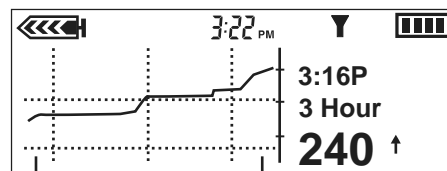

## How to make glucose alerts silent

The Alert Silence feature allows you to silence glucose alerts for a preset amount of time. You may use this feature when you are in a business meeting, watching a movie in a theater, and so on. The system records the time and glucose measurement for each alert during this silent period. You can see this alert information in the SENSOR ALERT HISTORY screen. See the *Sensor alert history* section in this chapter for details.

When one or more glucose alerts occur during the time when the Alert Silence feature is turned on, the pump displays the ALERT SILENCE screen without beeping or vibrating. If this alert is not cleared before the end of the silenced period, the pump beeps or vibrates periodically at the end of the preset time until the alert is cleared. Press **ESC**, then **ACT** to clear the alert.

You can make the glucose alerts silent in the following ways:

- **Off** – This means the Alert Silence feature is **Off** and the alerts are **On**. The pump beeps or vibrates when any sensor glucose alert occurs.
- **Hi Alerts** – The pump does not beep or vibrate if a high or rising sensor related alert occurs during the specified time.
- **Lo Alerts** – The pump does not beep or vibrate if a low or falling sensor related alert occurs during the specified time.
- **Hi and Lo Alerts** – The pump does not beep or vibrate if a high or low, rising or falling sensor related alert occurs during the specified time.
- **All Sensor Alerts** – The pump does not beep or vibrate if any sensor glucose alert occurs during the specified time, including the Hi and Lo glucose alerts, Cal Reminder, and Meter BG Now alerts.

The amount of time that you can make glucose alerts silent is:

- Minimum: 30 minutes
- Maximum: 24 hours

### To make alerts silent:

- 1 Open the SENSOR MENU.  
**Main Menu > Sensor**
- 2 The SENSOR MENU shows you the current status of the Alert Silence feature.

- 3 Depending on your current settings, one of the following **Alert Silence** options will appear in the **SENSOR MENU**.
  - Alert Silence: Off
  - Alert Silence: Hi
  - Alert Silence: Lo
  - Alert Silence: Hi/Lo
  - Alert Silence: All
- 4 To change the current alert silence settings, select **Alert Silence**, then press **ACT**.
- 5 Select the alert silence option you want, then press **ACT**. The **SET DURATION** screen flashes a set of dashes or the length of time that you entered the last time you set an alert to silent.
- 6 Select your alert silence length between 30 minutes (minimum) and 24 hours (maximum), then press **ACT**. The pump is in Special mode for the set silenced period. The **SENSOR MENU** shows the new alert that you selected to be silent.
- 7 Press the **ESC** button until the **MAIN MENU** appears.

## Calibration history

The **CALIBRATE HISTORY** screen lists the successful sensor calibration BG values that were entered into the pump more than 15 minutes ago.

### To view your Calibration History:

- 1 Go to the **CALIBRATE HISTORY** screen.  
**Main > Sensor > Calibration Hist.**
- 2 The **CALIBRATE HISTORY** screen appears. It shows up to 28 calibration values.

## Sensor alert history

The **SENSOR ALERT HISTORY** screen lists all of the sensor alerts that have occurred, displaying up to 36 alerts.

### To view your Sensor Alert History:

- 1 Go to the **SENSOR ALERT HISTORY** screen.  
**Main > Sensor > Sensor Alert History**

- 2 The SENSOR ALERT HISTORY screen appears. The most recent alert is highlighted. Select the alert you want to get more information on, then press **ACT**.
- 3 A new screen will appear with the alert details.

## Using your system in water

Your pump must not be used in water and needs to be removed if planning water activities.

**You should shower, bathe and swim with the transmitter and the sensor by following the guidelines below:**

- 1 Disconnect the infusion set from the pump and remove the pump. The pump is not water-tight.
- 2 After the transmitter and sensor are connected, they form a water-tight seal to a depth of 8 feet (2.4 meters) for up to 30 minutes. You can shower and swim without removing them. Avoid taking hot baths as this may significantly reduce the sensor's life.
- 3 Once out of the water, put the pump back on and reconnect the infusion set.
- 4 Check your infusion set tape and the sensor tape to make sure that they are not damaged.

# Utilities

## Alarm review

You can review alarms and their details in the ALARM HISTORY screen. This screen shows up to 36 past alarms, errors, or LOW RESERVOIR and LOW BATTERY alerts.

- 1 Go to the ALARM HISTORY screen.  
**Main > Utilities > Alarm > Alarm History**
- 2 Scroll through your past alarms.
- 3 In the ALARM HISTORY screen, select the alarm you want to review and press **ACT**. The details for that alarm will appear on the screen.
- 4 Press **ESC** to return to the ALARM HISTORY screen. Select another alarm to review, or exit the menus if you are done.

## Setting your alert type

You can select the type of alert your pump uses (for alarms, special conditions and programming). You can select a vibrate (silent) alert, or an audible beep alert. There are three beep types: long, medium and short tones. The factory setting for this feature is beep-medium.

The vibrate alert type is disabled if you use the block feature, and vibrate must be set again once block is turned off. Vibrate uses more battery power than the beep alert type and may shorten battery life. If your alert type is set to vibrate and you get a LOW BATTERY alert, your pump will use the beep alert type instead to conserve battery power.

- 1 Go to the ALERT TYPE screen.  
**Main > Utilities > Alarm > Alert Type**
- 2 Select your alert type and press **ACT**. That alert type is now active. Exit the menus.

## Auto-off

The factory setting for this feature is **Off**. This is a safety feature that stops insulin delivery after a defined time period (from 1 to 24 hours). If the pump detects that no buttons have been pressed for the selected amount of time in Auto-off, insulin delivery will stop and an alarm will sound. You may choose to program this feature into your pump based on the number of hours that you usually sleep at night. Discuss what uses and settings are best for you with your healthcare professional.

- 1 Go to the AUTO OFF DURATION screen.  
**Main > Utilities > Alarm > Auto Off**
- 2 Set the number of hours you want to set and press **ACT**.  
If you do not want to use the Auto Off feature, make sure the hour is set to zero (0).
- 3 The screen will return to the ALARM MENU. The Auto Off feature is now set. Exit the menus.

## LOW RESV WARNING (Low reservoir warning)

Allows you to program the pump to sound an alert before your reservoir is empty. You can select one of these warning types:

- a specified number of units that remain in the reservoir
- a specified maximum amount of time that remains before the reservoir will be empty

The factory setting for this feature is 20 insulin units.

If you use **Time** as the low reservoir warning type and you deliver large boluses, the actual time remaining could be less than the warning time. The warning time is based on the basal insulin delivery rate. The **Time** low reservoir warning type is intended to let you know if you will have enough insulin while you are sleeping.

- 1 Go to the RESV WARNING TYPE screen.  
**Main > Utilities > Alarm > Low Resv Warning**
- 2 Select **Insulin Units** or **Time** and press **ACT**.

---

**WARNING: When the pump detects a low reservoir condition during a bolus or Fill Cannula delivery, the LOW RESERVOIR alert displays after the delivery is finished. Make sure to check the volume of your reservoir to ensure enough insulin is available.**

---

a. **For Insulin units:**

In the WARNING UNITS screen enter the number of units you want remaining for the first warning, then press ACT.

The pump displays a LOW RESERVOIR alert first when the specified units remain, then again when half that remaining amount is used.

b. **For Time:**

In the WARNING TIME screen enter the amount of remaining time you want the first warning, then press ACT.

The pump displays a LOW RESERVOIR alert first when the specified time remains, then again one hour before empty.

## Review daily insulin totals

The DAILY TOTALS screen provides a day-by-day history of the total amount of insulin that delivered for the last 32 days, including today. This screen includes all bolus and basal amounts delivered midnight-to-midnight for each of the last 32 days. The Today line in the DAILY TOTALS screen shows the amount of insulin you delivered so far that day.

The insulin used to fill the tubing or the cannula is not included in the DAILY TOTALS screen. This amount is counted separately and shown in the HISTORY screen of the RESERVOIR + SET MENU.

**Question:** Why should I review my daily totals?

**Answer:** Comparing your daily insulin deliveries to your blood glucose records helps you and your healthcare professional identify your optimal daily insulin rate(s).

**Question:** What is included in the daily totals?

**Answer:** Daily totals include all basal and bolus insulin deliveries, sensor glucose, meter blood glucose, and AUC information for that day.



## Pump data management

The pump data management feature allows you and your healthcare professional to view and manage your basal and bolus insulin delivery, food intake, BG data, SG data, and AUC data with averages. You can view the details of each day individually or you can average the data over a specified number of days (up to 32 days).

- **Daily totals** – The system automatically tracks certain types of information for you on a day-to-day basis. The daily totals are the totals for a single day.
- **Averages** – The system automatically calculates averages of certain types of information for you. There are two basic types of averages:
  - An average over a number of days (you select the number of days)
  - An average for a single day

The insulin delivery, food intake, sensor glucose information, meter blood glucose information, and AUC data includes daily totals and averages, as described in the following sections.

### Insulin delivery information

This table lists the different types of insulin delivery and food intake information that the system automatically records. This information is calculated by using all of the basal, bolus, and food data for that day.

An asterisk (\*) next to a date means that the data for that day will not be used for the calculations that are displayed in the Daily Average option. Anything, such as a time or date change, that shortens a day at least one hour and twelve minutes (01:12) will cause the asterisk to be displayed.

Item	Description
Carbs	The total number of <b>carbohydrates</b> entered using the Bolus Wizard and Capture Event (Meal marker) features.
Tot Insulin	The <b>total amount</b> of insulin delivered with the pump.
Basal (first line)	The <b>total amount</b> of insulin delivered as <b>basal</b> .
Basal (second line)	The <b>percent</b> of insulin delivered as <b>basal</b> .
Bolus (first line)	The <b>total amount</b> of insulin delivered as <b>bolus</b> .
Bolus (second line)	The <b>percent</b> of insulin delivered as <b>bolus</b> .
Food Only	The <b>total amount</b> of insulin delivered using the Bolus Wizard feature with <b>food amount only</b> .

Item	Description
#Food Only	The number of times the Bolus Wizard feature delivered a food bolus only.
Corr Only	The total amount of insulin delivered using the Bolus Wizard feature with BG correction amount only.
#Corr Only	The number of times the Bolus Wizard feature delivered a BG correction bolus only.
Food+Corr	The total amount of insulin delivered using the Bolus Wizard feature with food and BG correction amount.
#Food+Corr	The number of times the Bolus Wizard feature delivered a food and BG correction bolus.
Manual	The total amount of insulin delivered manually.
#Manual	The number of manual insulin deliveries.

## Sensor glucose information

This table lists the different types of sensor glucose information that the system automatically records. The sensor glucose information is calculated by using all of the sensor glucose measurements that were received by the pump during the day.

Item	Description
SG Average	The average sensor glucose measurement.
Above Hi Limit	The percentage of sensor glucose measurements that were above your High Glucose Limit.
Within Limits	The percentage of sensor glucose measurements that were between your Low Glucose Limit and your High Glucose Limit.
Below Low Limit	The percentage of sensor glucose measurements that were below your Low Glucose Limit.
SG Std. Dev.	The standard deviation of the sensor glucose measurements.
#Hi Alert	The number of High Glucose alerts.
#Lo Alert	The number of Low Glucose alerts.
#Predict Hi	The number of High Predictive Glucose alerts.

Item	Description
#Predict Lo	The number of Low Predictive Glucose alerts.
#Rise Rate	The number of Rise Rate alerts.
#Fall Rate	The number of Fall Rate alerts.
Number SGs	The number of SG measurements received from the transmitter.



## Meter blood glucose information

The table below lists the different types of meter blood glucose information that the system automatically records. The meter blood glucose information is calculated by using all of the automatic and manual meter blood glucose measurements that were received by the pump for the day, or number of days. This includes measurements that were manually entered into the pump during that time.

Item	Description
BG Average	The <b>average</b> meter blood glucose measurement.
Number BGs	The total number of meter blood glucose measurements taken.
Meter L/H	The <b>lowest</b> and <b>highest</b> blood glucose measurements sent by the meter (L is the lowest, and H is the highest). These can be used for calibration or non-calibration purposes.
Manual L/H	The <b>lowest</b> and <b>highest</b> manually entered blood glucose measurements (L is the lowest, and H is the highest). These can be used for calibration or non-calibration purposes.

### To view data for a single day:



- Go to the DAILY TOTALS screen.  
**Main > Utilities > Daily Totals**
- Select the day that you want to view.
  - To view totals for today, select **Today**.
  - To view totals for a previous day, select the date.
- Press **ACT**. The DELIVERY STATS screen shows the basal, bolus, and food intake information for the day you selected in step 2. This day is shown on the title line of the screen.

- 4 Press  to view more information. See the table in the *Insulin delivery information* section in this chapter for descriptions of information shown here.
- 5 To view sensor glucose information for the same day you have selected in step 2, press **ACT** from the DELIVERY STATS screen. The SENSOR STATS screen appears, showing the sensor glucose information for the day you selected. The day you selected is shown on the title line of the screen.
- 6 Press  to view more information. See the table in the *Sensor glucose information* section in this chapter for descriptions of the sensor glucose information.
- 7 To view meter blood glucose measurement information for the same day you have selected in step 2, press **ACT** from the SENSOR STATS screen. The METER STATS screen appears, showing the meter blood glucose information for the day you selected. The day you selected is shown on the title line of the screen.
- 8 Press  to view all of the information in the METER STATS screen. See the table in this section for descriptions of the meter blood glucose information shown here.
- 9 Press **ACT** to toggle between the different STATS screens. Press **ESC** from any STATS screen to go to the DAILY TOTALS screen.  
Continue viewing daily totals by following the steps above, or press **ESC** until the HOME screen appears.

The following procedure shows you how to view insulin delivery, food intake, sensor glucose and meter blood glucose data for a selected number of days.

#### To view data over a number of days:

- 1 Go to the DAILY TOTALS screen.  
**Main > Utilities > Daily Totals**  
The DAILY TOTALS screen shows **Daily Average** selected.
- 2 Press **ACT**. The DAYS TO AVERAGE screen flashes the number of days you selected the last time you used this feature.
- 3 Select the number of days that you want to average. For example, if you want to see the averages for the last seven days, select 7.
- 4 Press **ACT**. A message tells you that the pump is calculating the averages.  
The DELIVERY STATS screen shows the insulin delivery and food intake information for the number of days you selected. The number of days is shown on the title line of the screen.

- 5 Press  to view more information. See the table in the *Insulin delivery information* section in this chapter for descriptions of the information shown here.
- 6 To view sensor glucose information for the same days you selected in step 3, press **ACT**. The **SENSOR STATS** screen appears, showing the sensor glucose information.
- 7 Press  to view more information. See the table in the *Sensor glucose information* section in this chapter for descriptions of the information shown here.
- 8 To view meter blood glucose measurement information for the same days you selected in step 3, press **ACT**. The **METER STATS** screen shows the meter blood glucose information.
- 9 Press  to view more information. See the table in the *Meter blood glucose information* section in this chapter for descriptions of the information shown here.

## AUC calculation

The AUC (Area Under the Curve) feature measures how much and how long your sensor glucose measurements are outside the pre-defined AUC Limits. Check with your healthcare professional to determine the AUC settings that are best for you. The AUC Limits are different than the Glucose Limits. The AUC Limits are used to analyze the sensor glucose measurement data that is stored in your system. The closer the AUC values are to zero, the closer your SG values are to your AUC Limits. If your AUC values are zero, then your SG values are within your AUC Limits.

The default AUC Limits are:

- Low AUC Limit: 70 mg/dL (3.9 mmol/L)
- High AUC Limit: 180 mg/dL (10.0 mmol/L)

### To set the AUC Limits:

- 1 Go to the AUC MENU.  
**Main > Utilities > Daily Totals > Calculate AUC**
- 2 Select **AUC Limit**, then press **ACT**. The **SET AUC LIMITS** screen appears. The default **LOW AUC Limit** flashes 70 mg/dL (3.9 mmol/L).
- 3 Select your Low AUC Limit. The number must be between 40 and 400 mg/dL (2.2 and 22.2 mmol/L).
- 4 Press **ACT**. The default High AUC Limit flashes 180 mg/dL (10.0 mmol/L).
- 5 Select your High AUC Limit. The number must be between 40 and 400 mg/dL (2.2 and 22.2 mmol/L). It can be equal to, but not lower than, the AUC Low Limit.

6 Press **ACT**. The AUC MENU screen shows the AUC Limit you selected.

### To view AUC data for a single day:

1 Go to the AUC MENU.

**Main > Utilities > Daily Totals > Calculate AUC**

2 Select the day that you want to view.

- To view totals for today, select **Today**.
- To view totals for a previous day, select the date.

3 Press **ACT**. AUC High and AUC Low values appear for the selected day.

- **AUC High** is the average of AUC for sensor glucose values above the AUC High Limit for that day.
- **AUC Low** is the average of AUC for sensor glucose values below the AUC Low Limit for that day.

### To view AUC data over a number of days:

1 Go to the AUC MENU.

**Main > Utilities > Daily Totals > Calculate AUC**

2 Select **AUC #Days**, then press **ACT**.

3 The **DAYS TO AVERAGE** flashes the number of days to average. Select the number of days you want. For example, if you want to see the averages for the last seven days, select 7.

4 Press **ACT**. A message tells you that the pump is calculating averages.

5 The Day Average screen shows the data for the number of days you selected. The number of days is shown on the screen. For example, if you have selected seven days, the screen title will be **7Day Average**. AUC High and AUC Low appear below the title.

- **AUC High** is the average value of AUC for sensor glucose values above the AUC High Limit for the number of days selected.
- **AUC Low** is the average value of AUC for sensor glucose values below the AUC Low Limit for the number of days selected.

## Personal reminders

### Alarm clock

The alarm clock is a feature that allows you to set a maximum of eight daily reminders for various events. The factory setting for this feature is off. The alarm clock can be useful to remind you when to check your blood glucose, eat, bolus, etc. When the alarm clock goes off, the ALARM CLOCK screen appears. Press **ESC**, then **ACT** to clear the reminder.

- 1 Go to the ALARM OPTION screen.  
**Main > Utilities > Alarm Clock**
- 2 Select **On/Set**. Press **ACT**.
- 3 Select **Add Alarm**. Press **ACT**.
- 4 Enter the hour (flashing). Press **ACT**.
- 5 Enter the minutes (flashing). Press **ACT**.
- 6 Repeat steps 3 through 5 to program additional alarm times. Exit the menus when you are done.

### PC connect for change settings

PC Connect for Change Settings option allows you to connect your pump to your computer, permitting a change of settings, by way of RF (radio frequency). At this time, PC software to modify pump programmed settings is not available and therefore the Change Settings option is not functional. If you should accidentally navigate to the **Change Settings** option as shown below, press **ESC** to cancel.

**Main > Utilities > Connect Devices > PC Connect**

### Remote control option

The factory setting for this feature is off. You may want to explore the remote option after you have become completely familiar with the basic functions of your pump. It is important that you consult with your healthcare professional before using this feature. Remote controls can be purchased from Medtronic Diabetes.

Refer to the remote control user guide for operating instructions.

**NOTE:** *The use of RF (radio frequency) devices with the pump reduces battery life.*

To use the remote control, these pump settings must be programmed:

- Remote Options = On
- Remote control ID code entered in pump (code is on back of remote)
- Easy Bolus = On

## Turn on remote control option

---

**WARNING:** If there is a **LOW BATTERY** condition, the pump will not receive signals from the remote. To ensure the pump communicates with the remote control, make sure the pump does not have a low battery. (Replacing the low battery with a new battery will restore remote control function.)

---

- 1 Go to the REMOTE OPTION screen.  
**Main > Utilities > Connect Devices > Remotes**
- 2 Select **On**, then press **ACT**.
- 3 The REMOTE ID MENU screen appears. Add, delete or review your remote ID as described in the next section. Exit the menus if you are done.

## Add, delete, review remote control IDs

Each remote control has its own unique ID. Up to three different remote control IDs can be programmed in your pump. You must turn on the remote option to add, delete or review the remote control IDs programmed in your pump.

- 1 **Adding a remote ID**
  - a. Select **Add ID** from the REMOTE ID MENU screen, then press **ACT**.
  - b. Enter each of the six ID numbers found on the back of the remote control. Press **ACT** after each entry. After you set the last number of the ID, the screen will return to the REMOTE ID MENU.
- 2 **Deleting a remote ID**
  - a. Select **Delete ID** from the REMOTE ID MENU screen, then press **ACT**.
  - b. Select the remote ID that you want to delete, then press **ACT**. The selected ID is now deleted.
- 3 **Reviewing remote IDs**
  - a. Select **Review ID** from the REMOTE ID MENU screen, then press **ACT**.
  - b. The programmed IDs will show in the REVIEW REMOTE ID screen.
- 4 Exit the menus when you are done.



## Other Devices option

The factory setting for this feature is **Off**.

Other devices may be available to be linked to your pump. If available, refer to the appropriate device user guide for programming and operating instructions.

*NOTE: The use of RF (radio frequency) devices with the pump reduces battery life.*

## Block feature

Block restricts access to pump programming. The factory setting for this feature is off. Block is an important safety feature if the pump user requires someone else to maintain complete control of pump operation. When block is on, the remote control is used to deliver a bolus and suspend/resume the pump. Direct pump programming is limited to suspend, block, and selftest. You can, however, still view status-type screens such as STATUS, BOLUS HISTORY, BASAL REVIEW, and DAILY TOTALS. Discuss what uses and settings are best for you with your healthcare professional. (You can order the remote control from Medtronic Diabetes.)

### Turning block on

*NOTE: The vibrate alert-type is disabled when block is on.*

- 1 Go to the BLOCK OPTION screen.  
**Main > Utilities > Block**
- 2 Select **On**, then press **ACT**. The HOME screen will appear with an open circle. The Block option is now on and the pump is in Special mode. Exit the menus.



#### Example 1: Block

Nicholas is a very active toddler who wears a Paradigm pump. His parents don't want to worry that he will play with the pump and accidentally change his programmed settings. They simply activated the Block feature, and now, except for the Suspend and Self-Test, no other features are active when using the pump buttons. When Nicholas needs a bolus, his parents and caregivers simply program it with the Remote Control.

**Example 2: Block**

Oscar is an elderly man with diabetes who needs assistance with all of his daily living activities. He needs his caregiver or family member to help him with his pump as well. To be sure that Oscar does not change any pump settings, his family programmed his Paradigm pump with the Block feature turned on. They use the Remote Control to give him his boluses when he needs them.

## Lock keypad feature

Lock keypad prevents accidental pump keypad presses. You can only press the  to view the STATUS screen, and the  button to turn on the backlight. The remote control can be used to give a bolus or put the pump into Suspend.



A locked keypad is automatically unlocked during the following:

- Battery insertion
- Alarms
- Alerts

### Locking the keypad

- 1 Go to the UTILITIES MENU.
- 2 Select **Lock Keypad**, then press **ACT**.
- 3 Press **ACT** again to lock the keypad. The KEYPAD LOCKED screen appears with instructions on how to unlock the keypad.

### Unlocking the keypad

Press the  button and the  button at the same time. Keypad Unlocked screen appears.

## Selftest

Selftest is a safety utility that allows you to check if your pump is operating properly. This self-diagnostic feature can be used for maintenance or to check your pump if it operates unusually. During selftest, your pump will automatically run internal tests, including a check for proper operation of the beep and vibrate modes. The selftest is additional to the routine tests that run independently while the pump operates.

Contact our 24 Hour HelpLine if any of the tests do not occur as described here.

***NOTE:** If the pump detects a condition such as low battery, the selftest will not finish. A message will appear to show the condition that caused the test to stop.*

- 1 Go to the UTILITIES MENU.  
**Main > Utilities > Selftest**
- 2 Select **Selftest**, then press **ACT**.
- 3 Periodically, you will hear beeps as different mechanisms in the pump are being tested. As part of the selftest, the pump will do these tests:
  - a. **Screen Test:**  
The screen will appear all black.
  - b. **Selftest:**  
The pump will count down from 10.
  - c. **Tone Test:**  
You should hear beeps.
  - d. **Vibrate Test:**  
You will feel vibrations.
- 4 After the selftest is finished, **TEST COMPLETE** screen appears. The screen will return to the UTILITIES MENU, then to the HOME screen.

## User settings

The user settings function allows you to save, restore, and clear all pump settings. You can also view a listing of the dates and times of all recent user settings operations you have done. The Save Settings feature lets you keep a set of pump settings that you can restore to your pump if it is cleared or you need to go back to these settings for any reason.

When you clear your pump, the pump settings are restored to the factory defaults, and you must either use Restore Settings, if you have saved a set of pump settings, or reprogram all your settings before you can use your pump again. The pump does not clear the internal pump memory.

---

**WARNING: Do not clear your pump settings while it is connected to your body.**

---

---

**CAUTION:** Do not clear your pump settings unless directed by your healthcare professional or a Medtronic Diabetes representative. If you clear your pump settings, it will be necessary to reprogram all your personal pump settings as directed by your healthcare professional. Additionally, you will have to rewind your pump.

---

## Saving the settings

Do these steps to save your current pump settings:

- 1 Go to the UTILITIES MENU screen and select **User Settings**.  
**Main > Utilities > User Settings**
- 2 Hold down **↶B** and press **ACT**.
- 3 The USER SETTINGS screen is displayed with **Save Settings** highlighted. Press **ACT**.
- 4 If this is the first time you have saved pump settings, go to step 5. If you have previously saved pump settings, a message displays, indicating the date of your last pump settings save. Read the instructions on the screen, then press **ACT** to save your current settings. You can press **ESC** if you want to cancel the save.
- 5 The SETTINGS SAVED message displays to confirm that your current pump settings have been saved. Exit the menus.

## Restoring the settings

Do these steps to restore the most recent pump settings you have saved to your pump:

- 1 Go to the UTILITIES MENU screen and select **User Settings**.  
**Main > Utilities > User Settings**
- 2 Hold down **↶B** and press **ACT**.
- 3 The USER SETTINGS screen is displayed. Select **Restore Settings**, then press **ACT**.
- 4 A message displays, giving you the option of restoring the pump settings that were saved on the given date and erasing the ones currently on your pump. Read the instructions on the screen then press **ACT** to restore the settings. You can press **ESC** if you want to cancel the restore.
- 5 The SETTINGS RESTORED message displays to confirm that your current pump settings have been replaced with the pump settings you had saved on the given date. Exit the menus and check your pump settings to verify the restore.

## Clearing the settings

Take the following steps only if you want to clear your pump to factory default settings.

---

**WARNING: Do not clear your pump settings while it is connected to your body.**

---

**CAUTION: Do not clear your pump settings unless directed by your healthcare professional or a Medtronic Diabetes representative. If you clear your pump settings, it will be necessary to reprogram all your personal pump settings as directed by your healthcare professional. Additionally, you will have to rewind your pump.**

---

- 1 Go to the UTILITIES MENU screen and select **User Settings**.  
**Main > Utilities > User Settings**
- 2 Hold down **⌂** and press **ACT**.
- 3 The USER SETTINGS screen is displayed. Select **Clear Settings**, then press **ACT**.
- 4 A CONFIRM message displays, giving you the option of clearing your pump settings or not. Select **YES** and press **ACT** to clear the settings. You can press **ESC** if you want to cancel.
- 5 You will see a RESET screen, and then the pump will go through various screens while it restarts. After the pump clears all of your settings, the screen will go to the TIME/DATE SETUP screen.
- 6 Reset the time and date as described in *Setting the time and date* section in the *Basic programming* chapter.
- 7 After you set the time and date, you must rewind your pump. Refer to the *Rewinding your pump* section in the *Starting on insulin* chapter for instructions. Remember, all your settings have been cleared and you must either restore or reprogram all your settings.

## History

If you want to view a listing of the dates and times of all recent User Settings operations you have done on your pump, such as saves and restores, take the following steps:

- 1 Go to the UTILITIES MENU screen and select **User Settings**.  
**Main > Utilities > User Settings**
- 2 Hold down **⌂** and press **ACT**.
- 3 The USER SETTINGS screen is displayed. Select **History**, then press **ACT**.

- 4 The SETTINGS HISTORY screen displays, giving you a list of all the dates and times of your most recent User Setting operations. Scroll down to view the entire history. When you are done looking at the history, press ESC to exit the menu.



# Meter option

## About meters

You can set up your pump to automatically receive your blood glucose readings from Bayer's CONTOUR® NEXT LINK Wireless Meter, Bayer's CONTOUR® LINK Wireless Meter, a OneTouch® UltraLink® meter, or a BD Paradigm Link® glucose meter. Your pump is set at the factory with the meter option turned off. See the *Add, delete, review meter IDs* section in this chapter to turn the meter option on, and to enter your meter ID. Programming your meter ID links your pump to the meter. Each meter has its own unique ID. You can link up to three meters to your pump. If you do not link the meter to your pump, you must enter your blood glucose readings manually.



When the pump is idle (at the HOME screen), it will beep or vibrate when it receives a blood glucose reading from the meter. The reading will appear on the pump screen. If your BG reading is not within your set BG Target range, the pump beeps three times. For BG readings that are above the set BG Target range, use the Bolus Wizard feature to enter a correction bolus.

**NOTE:** *The use of RF (radio frequency) devices with the pump reduces pump battery life.*

You have to turn on the meter option to add, delete or review the meter ID(s) programmed in your pump. The meter ID is printed on the back of the meter. See the user guide that came with your meter for detailed information on how to use it.

## Meter rules

**If you want your pump to communicate with the meter, the following conditions must apply:**

- 1 The meter option must be turned on and programmed. Refer to the instructions in this section.
- 2 Your pump must be within 4 feet (1.2 meters) of your meter to receive the blood glucose reading.
- 3 The pump cannot have a LOW BATTERY alert condition.



- 4 When programming a bolus, the blood glucose measurement from the meter will appear as the default blood glucose value on the ENTER BG screen. The pump will not display a reading that is older than 12 minutes on the ENTER BG screen.
- 5 Do not use the RF meter to send your blood glucose readings to the pump while onboard aircraft. Manually enter your blood glucose.

---

**CAUTION: The pump will not receive signals from the meter while it has a LOW BATTERY condition. To ensure the meter communicates with the pump, make sure the pump does not have a low battery. (Replacing the low battery with a new battery will restore meter-pump communication.)**

---

## Add, delete, review meter IDs

The meter programming screens are very similar to those for the remote control. Make sure to select **Meters** in the DEVICE OPTIONS screen when programming your meter.

You have to turn on the meter option to add, delete, or review the meter ID(s) programmed in your pump.

### To turn on the meter option:

- 1 Go to the METER OPTION screen.  
**Main > Utilities > Connect Devices > Meters**
- 2 Select **On**, then press **ACT**. The METER ID MENU appears.
- 3 Add, delete or review your meter ID(s) as desired.  
Adding meter IDs
  - a. Select **Add ID**, then press **ACT**.
  - b. Use the up and down arrow buttons to enter each of the six ID characters. Press **ACT** after each entry.
  - c. After you set the last character of the ID, the screen will return to the METER ID MENU.Deleting meter IDs
  - a. Select **Delete ID**, then press **ACT**.
  - b. Select the meter ID that you want to delete and press **ACT**.
  - c. The selected ID is now deleted.Reviewing meter IDs

If you are not sure that your meter ID is entered in your pump, check the REVIEW METER ID screen.

  - a. Select **Review ID**, then press **ACT**.
  - b. The programmed IDs will show in the REVIEW METER ID screen.
- 4 Exit the menus when you are done.

# Therapy management software

Medtronic provides software to optimize your pump use. Contact our 24 Hour HelpLine for more information.

## CareLink® Personal Software

Your pump provides real-time glucose values so that you can track glucose concentration patterns and possibly identify episodes of low and high blood glucose. It also stores glucose data so that it can be analyzed to track patterns or downloaded to CareLink Personal for analysis of historical glucose values.

CareLink Personal is a Web-based system designed to help you manage your diabetes. It has many key features:

- It copies (uploads) data from your devices: insulin pump and supported blood glucose meters.
- Device data is stored on a centralized database.
- There is an online logbook where you can record self-reported information, such as how many carbohydrates you consumed.
- Uploaded data and other information stored on the system can be viewed through several different types of treatment reports.
- Access to data and personal information on this system is secure.

## Reports

Reports show you data gathered from your device uploads, and from what you directly entered into the system. Examples of the report data you can get include:

- Pump operation, such as alarm settings and maximum allowed bolus amount.
- Insulin delivery rates, types and times.
- Blood glucose reading levels and times.
- Sensor glucose reading levels and times.
- Bolus Wizard or online logbook entry data.

Reports are displayed in PDF format. They can be viewed online, saved, or printed.

You can share your reports with your healthcare professional. These reports can help you and your healthcare professional to discover trends and other information. This can lead to improved therapy management for greater control.

## Logbook

The logbook allows you to enter the following self-reported information:

- Carbohydrates consumed
- Exercise activity
- Urine ketone results
- HbA1c results
- Infusion set changes

The data from your logbook is used in the reports you create. You can see how, for example, your carbohydrate intake compares to blood glucose levels for the same day or time. You can also use it as an online diary of your diabetes management.

# Insulin pump therapy follow-up

We hope that you are now comfortable using the pump and your blood glucose values have improved through insulin pump therapy. Diabetes management requires much more than blood glucose control. You need to take care of your complete physical and mental health. This includes seeking treatment for any condition both directly related to and not related to diabetes. The following recommendations apply to general diabetes as well as insulin pump therapy follow-up. Remember, your healthcare professional is your best resource for successful diabetes management.

## Recommended follow-up

### Everyday

- Check blood glucose four to six times a day and always before bed.
- Test before driving and have a fast-acting carbohydrate with you when you drive.
- If your blood glucose is above 250 mg/dL (13.9 mmol/L) twice in a row, take an injection and change the infusion set.

### Every month

- Review DKA prevention guidelines.
- Check 3:00 AM blood glucose at least once during the month.
- Check two-hour post-meal blood glucose for all meals on a given day.

### Every three months

- Visit your healthcare professional, even if you feel well and your blood glucose values are within target range.
- Review your blood glucose log and insulin pump settings with your healthcare professional.
- Make sure you have an HbA1c test done.

## Laboratory tests

- Test for HbA1c four or more times a year
- Test for cholesterol, HDL, LDL, triglyceride yearly
- Test for microalbuminuria yearly

## Every visit

- Blood pressure check
- Foot exam
- Review goals for blood glucose, meal plan and exercise

## Annually

- Dilated eye exam by a qualified eye care professional
- Annual flu shot
- Regular dental visits
- Nerve function tests
- EKG test over age 35
- Prostate exam for men, breast exam for women
- Diabetes education review
- Replace Glucagon Emergency Kit (new prescription from your healthcare professional)

# Troubleshooting, alerts and alarms

This chapter is designed to help you understand the messages that your pump is giving you when you get an alarm or an alert message. The procedures in the beginning of this chapter are to be used when you get specific alarms or cover a likely condition that might happen. A list of alarms is provided at the end of this chapter.

***NOTE:** It is recommended that you read your warranty statement included with your pump for information on what is covered during your warranty period.*

## My pump has a NO DELIVERY alarm

When a NO DELIVERY alarm occurs, it means that insulin delivery has stopped. Your pump is not broken, but it has detected that something is preventing insulin from being delivered. Do the following steps:

- 1 Check to see if your infusion set has become dislodged or kinked.
- 2 Check your blood glucose and follow your safety guidelines for treating high glucose if necessary.
- 3 Clear the alarm by pressing **ESC** and **ACT**. A screen appears with two choices: **Resume** and **Rewind**.
- 4 Make sure that there is insulin in your reservoir.
  - a. If you identified and fixed a kink in your tubing, select **Resume**.
  - b. If the reservoir is empty, select **Rewind** and change your reservoir and infusion set.
- 5 Monitor your blood glucose closely.
- 6 If you have followed these steps and receive another NO DELIVERY alarm, call our 24 Hour HelpLine.

## What happens if I leave the pump battery out too long?

If you leave the pump battery out too long (more than five minutes) you may receive a BATT OUT LIMIT alarm message when you install the new battery. Do the following steps:

- 1 Set your pump clock to the correct time, date, and year.
- 2 Check to make sure that all your settings, such as basal rate, are set as desired. If need be, reapply your last saved settings to the pump by using the **Restore Settings** option under **User Settings** in the UTILITIES MENU (you can only use this option if you have previously saved your pump settings). See the *Restoring the settings* section in the *Utilities* chapter.
- 3 Check the ALARM HISTORY screen and the STATUS screen for any alarms and/or alerts that may still need attention.

If you leave the battery out for more than three or four days, you may receive an A17 and A47 alarms when you install a new battery. Do the following steps:

- 1 Clear the A17 and A47 alarms.
- 2 Set your pump clock to the correct time, date and year.
- 3 Check to make sure that all your settings, such as basal rate, are set as desired. If need be, reapply your last saved settings to the pump by using the **Restore Settings** option under **User Settings** in the UTILITIES MENU (you can only use this option if you have previously saved your pump settings). See the *Restoring the settings* section in the *Utilities* chapter.
- 4 Check the ALARM HISTORY screen and the STATUS screen for any alarms and/or alerts.

## Why doesn't my pump battery last very long?

A short battery life does not mean that something is wrong with your pump. Battery life in your pump is variable and based on the conditions below:

- The brand of battery you use (we recommend Energizer).
- The storage and/or handling of the battery before use (avoid high or low temperatures).
- The usage of pump in cold temperatures; this may shorten the battery life.
- The usage of your pump, such as how often the buttons are pushed, the number of alerts/alarms and set changes.
- The amount of insulin the pump is delivering.
- The usage of some features. The backlight, vibrate, sensor, remote control and meter options decrease battery life.

## What is a CHECK SETTINGS alarm?

This alarm occurs after an E alarm or after you clear your pump. It is advising you to make sure that all your settings are correct. A CHECK SETTINGS alarm occurs after any of these actions:

- All user settings were cleared (set back to their defaults) because there was an E-error alarm,
- The Clear Settings function was performed, or
- After you rewind when practicing without a reservoir when you first get your pump. In this case, it is just a reminder to make sure all your settings are programmed before you begin using the pump with insulin.

## My screen appears distorted

The screen may appear distorted or have a rainbow-like appearance if you are wearing polarized sunglasses, are in bright sunlight, or in extreme high or low temperatures. If your screen appears distorted:

- Take off your sunglasses.
- Move into the shade.
- Make sure your pump is not in direct heat (next to a heater) or cold (worn on the outside of your clothing on a very cold day).
- **Do not return the pump:** this is a normal property of this type of screen on any device.

## The pump is asking me to rewind

This is normal after any of the following:

- 1 Any E-alarms,
- 2 The Clear Settings function,
- 3 Or, a NO DELIVERY alarm (during the Reservoir + Set sequence).



## My bolus stopped

The Bolus Stopped error can occur if the battery cap is loose or the pump was bumped or dropped during a bolus. It can also happen if the pump receives a static shock. As a safety measure, the pump stops the bolus when this happens.

- 1 If you dropped your pump, visually inspect it to make sure that it is not damaged in any way.
- 2 Review your bolus history and reprogram the remaining bolus, if needed.



## My pump buttons are not acting right during a bolus

If the ,  or  buttons are pressed and held down while a bolus is being delivered, the screen will freeze on that amount. Once the button is released, the units will ramp up to the amount delivered so far. Pressing and holding down the button will not stop the delivery of a bolus.

## My pump will not display my blood glucose reading from my meter

- 1 Make sure you are using the correct meter (a blood glucose meter supported by MWT1 technology). Your pump will communicate with this meter only.
- 2 Make sure your meter's RF (radio frequency) feature is on and working correctly.
- 3 Make sure the meter option in your pump is set to **On** and you have set the meter ID number correctly on the pump.
- 4 Make sure your pump does not have a low battery alert condition.
- 5 Make sure the meter is within 4 feet (1.2 meters) of the pump without anything in between such as another person, a wall, etc.
- 6 Make sure there is no RF (radio frequency) interference from other electronic devices that could prevent communication. These devices can include some cell phones, cordless phones, televisions, computers, radios, other Paradigm pumps, meters and pump remote controls. To restore communication, simply move away from these other types of devices, or turn them off.
- 7 Your pump will not show another reading. Make sure the pump is idle and the HOME screen is blank.
- 8 If your pump still does not receive your blood glucose reading from the meter, use the up/down buttons to manually enter your blood glucose (in the ENTER BG screen).

## I dropped my pump

Take care to protect your pump from being dropped.

- 1 Check that all connections are still tightly in place.  
If you notice that the drive support cap is loose, or sticking out, discontinue use of the pump. **Do not press on the drive support cap. Pushing on the drive support cap may result in unintended insulin delivery, which can cause hypoglycemia.** See *Warnings* in the *Introduction* chapter for more information.
- 2 Check the LCD, keypad and pump case for cracks or damage.
- 3 Check infusion set, including the tubing connector and tubing for cracks or damage.
- 4 Review the status screen, basal rates and other pump settings.

- 5 Perform the Selftest procedure located in the UTILITIES MENU.
- 6 Call our 24 Hour HelpLine for assistance.

## I submerged my pump in water

Your pump is designed to resist accidental contact with water. Do not submerge in water during bathing, showering, swimming, or other water activities.

- 1 Pat the outside of the case until dry.
- 2 Open the reservoir compartment and check the compartment and reservoir for water. If wet, dry it completely within 10 minutes of exposure to water. Exposure to liquids, including water or insulin can corrode the mechanism.
- 3 Dry the reservoir completely—do NOT place a wet reservoir in the pump.
- 4 Do not use hot air to dry your pump. This may damage your pump's internal electronics.
- 5 Check the battery compartment and the battery—if wet, let them dry completely before using the pump.
- 6 Perform a selftest.

## I cannot get to the USER SETTINGS screen

If you press **ACT** when you have **User Settings** highlighted, the following message appears: This feature is not normally accessible. To access, consult your User Guide.

To get to the USER SETTINGS screen:

- 1 Go to the UTILITIES MENU screen.  
**Main > Utilities**
- 2 Select **User Settings**. Hold down **⬅B** and press **ACT**.
- 3 See the *User settings* section in the *Utilities* chapter for information about the menu options.

## Alerts

Your pump has a sophisticated network of safety checks and systems. If it detects an unusual condition that requires your immediate attention, it beeps or vibrates periodically to alert you. The pump goes into Special mode (an open circle displays), and the backlight illuminates.

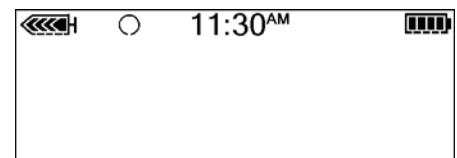

**Question:** Why are alerts important?

**Answer:** Your pump monitors activities and will alert you if a Special mode is active. Some alerts are a normal part of pump therapy, such as an active temporary basal. There are alerts that indicate a condition that is outside normal pump activity. For example, your pump notifies you with an alert when you need to replace the reservoir (LOW RESERVOIR) or replace your pump battery (LOW BATTERY).

It is important that you understand how your pump behaves when you do not clear an alarm or an alert:

- Alarm – If you do not clear an alarm, the pump does not display any subsequent alarms or alerts until the first alarm is cleared. After you clear the first alarm, the pump displays any subsequent alarms, followed by any alerts in order of their importance.
- Alert – If you do not clear an alert, the pump does not display any subsequent alerts until the first alert is cleared. However, the pump displays an alarm even if you do not clear the alert. After you clear the first alert or alarm, the pump displays any subsequent alarms or alerts in order of their importance.

Check your pump and test your blood sugar. Follow the guidelines prescribed by your healthcare professional to manage your diabetes as needed.

**Example:**

John's pump displays a BUTTON ERROR alarm, but he does not clear it. During the time that his pump displays the BUTTON ERROR alarm, his pump receives a LOW RESERVOIR alert. A few minutes later, his pump receives a NO DELIVERY alarm. John's pump does not display the LOW RESERVOIR alert or the NO DELIVERY alarm until he clears the first alarm. After John clears the BUTTON ERROR alarm, his pump displays the NO DELIVERY alarm. After he clears the NO DELIVERY alarm, his pump displays the LOW RESERVOIR alert.

## What to do

When your pump beeps or vibrates notifying you that an alert condition exists:

- 1 Read and follow the instructions on the screen. Press **ESC**, **ACT** to clear the alert message.
- 2 Check the **STATUS** screen to determine what caused the alert.
- 3 If the condition is due to a low battery, replace the battery.
- 4 If the condition is due to a low reservoir, monitor the reservoir volume frequently and change the reservoir when appropriate. Make sure you have a new reservoir, infusion set and vial of insulin with you.

## Pump alert conditions

Listed below are alerts that indicate a condition that is outside normal pump activity.

### LOW RESERVOIR

You can program the pump to sound an alert when either a specified number of units remains or a specified amount of time remains before the reservoir will be empty.

### LOW BATTERY

If you get this alert, **do not go to sleep** without replacing the battery. The backlight, the remote, and meter functions are disabled during a LOW BATTERY condition. If the alert type is set to Vibrate, the pump will change to the audio alert Beep-medium. Clear (**ESC, ACT**) this alert before you replace your battery.

## Sensor alert conditions

Listed below are the alerts that you may encounter while using the sensor feature of your pump, and how to resolve the alert condition.

### WEAK SIGNAL

**Reason:** Occurs when the pump does not receive data from the transmitter for a pre-defined period of time (as set in Weak Signal).

**Action:** Move the pump closer to the transmitter or move the transmitter and the pump to the same side of your body.

### ALERT SILENCE

**Reason:** This alert screen displays when one or more glucose alerts occur during the time that the Alert Silence feature is turned on.

**Action:** Press **ESC**, then **ACT** to clear the alert. Check the SENSOR ALERT HISTORY screen for the recorded glucose alert information. See the *Sensor alert history* section in the *Using your sensor* chapter for details.

## MISSED BOLUS

**Reason:** You have not delivered a bolus during the time period you specified in the Missed Bolus Reminder feature.

**Action:** Set a meal bolus if needed.

## LOST SENSOR

**Reason:** The pump has not received a signal from the transmitter. **Do not disconnect the transmitter from the sensor.**

**Action:**

- 1 Make sure that the sensor is inserted correctly.
- 2 Check the REVIEW SETTINGS screen to make sure that the transmitter ID entered into the pump matches the ID on your transmitter:  
**Main > Sensor > Review Settings**
- 3 Check the transmitter and sensor connection. Touch the inserted sensor at the back of the assembly to prevent movement and push the transmitter firmly:
  - a. If you hear a click, wait 20 seconds and look for a green light on the transmitter flash for 10 seconds to confirm a good connection. If you see the green light, the alert was due to the transmitter and the sensor not being connected.
  - b. If you hear a click, but do not see a green light on the transmitter, check to make sure that the transmitter is charged.
  - c. If you do not hear a click when you check the connection, the alert was due to a transmission problem. Bring the pump closer to the sensor and transmitter.
- 4 Use the **Find Lost Sensor** function to find your sensor (see the *Troubleshooting sensor features* section in this chapter):  
**Main > Sensor > Link to Sensor > Find Lost Sensor**

## LOW TRANSMTR

**Reason:** Occurs when the transmitter battery is close to running out of power. This alert will repeat daily at noon while this condition exists. The transmitter will continue sending sensor signals for several hours and may last for several days until the battery becomes depleted. Be prepared to recharge your transmitter immediately when its battery becomes depleted.

**Action:** Recharge your transmitter as soon as possible. See the *Charging the transmitter* section in the *Sensor features* chapter.

## CHARGE TRANSMTR

**Reason:** The transmitter battery is depleted.

**Action:** Recharge your transmitter immediately. See the *Charging the transmitter* section in the *Sensor features* chapter.

## CHANGE SENSOR

**Reason:** You may receive this alert after you receive two Cal Errors in a row, without the Cal Errors, or when initializing your sensor.

**Action:** If the alert resulted from two Cal Errors in a row, replace the sensor. If the alert happened without two Cal Errors, use the transmitter's tester to make sure your transmitter is working properly. If you received this alert during initialization, you may be able to resolve this alert without replacing your sensor. Call our 24 Hour HelpLine for further assistance.

## SENSOR END

**Reason:** The sensor has reached the end of its life.

**Action:** Replace your sensor. The sensor has a maximum life of 72 hours (3 days). The 72-hour life span of the sensor begins when the pump receives the first METER BG NOW alert.

## CAL ERROR

**Reason:** An error occurred when entering a new meter BG measurement to calibrate the system. Some possible causes are:

- An incorrect blood glucose number was entered from the meter into the pump.
- The entered blood glucose measurement was not current.
- Your blood glucose is rising or falling rapidly.
- The sensor needs more time to stabilize after being inserted.
- The sensor is no longer reading the sensor glucose correctly.

**Action:** Follow the guidelines in the *Calibrating the sensor* section in the *Sensor features* chapter to enter a new meter BG for calibration. If you receive a Cal Error on your second calibration, a CHANGE SENSOR alert will occur. Call our 24 Hour HelpLine if you have questions.

## METER BG NOW

**Reason:** A meter BG measurement is needed immediately to calibrate your sensor so that you can continue receiving sensor glucose readings.

**Action:** Take and enter a meter blood glucose measurement. Follow the guidelines in the *Calibrating the sensor* section in the *Sensor features* chapter.

## METER BG BY

**Reason:** A meter BG measurement must be entered by the time that is shown to calibrate your sensor. The METER BG BY alert is also known as the CAL REMINDER alert.

**Action:** Enter a blood glucose measurement to avoid a METER BG NOW alert.

## LOW XX MG/DL (XX = SG measurement)

**Reason:** The sensor glucose number is equal to or lower than your low glucose limit. If you do not set a Low Glucose Limit and do not set the glucose alerts ON, then you will not get a Low sensor glucose alert. The pump plays four consecutive tones, in falling pitch, if an audible beep has been selected as the alert type.

## HIGH XXX MG/DL (XXX = SG measurement)

**Reason:** The sensor glucose number is higher than or equal to your high glucose limit. If you do not set a High Glucose Limit and do not set the glucose alerts ON, then you will not get a High sensor glucose alert. The pump plays four consecutive tones, in rising pitch, if an audible beep has been selected as the alert type.

## LOW PREDICTED

**Reason:** The sensor glucose measurements may **reach or go below** your Low Glucose Limit in the length of time you selected for the Low Predictive alert. The pump plays three consecutive tones, in falling pitch, if an audible beep has been selected as the alert type.

## HIGH PREDICTED

**Reason:** The sensor glucose measurements may **reach or go above** your High Glucose Limit in the length of time you selected for the High Predictive alert. The pump plays three consecutive tones, in rising pitch, if an audible beep has been selected as the alert type.

## RISE RATE

**Reason:** The sensor glucose measurements are rising at a rate that is equal to or faster than the Set Rise Rate Limit you selected for the alert. The pump plays two consecutive tones, in rising pitch, if an audible beep has been selected as the alert type.

## FALL RATE

**Reason:** The sensor glucose measurements are falling at a rate that is equal to or faster than the Set Fall Rate Limit you selected for the alert. The pump plays two consecutive tones, in falling pitch, if an audible beep has been selected as the alert type.



## SENSOR ERROR

**Reason:** The sensor signals are either too high or too low.

**Action:** You do not need to change the sensor. Clear the alert. If the alert persists, test your transmitter with the tester.

## Alarms

Your pump has a sophisticated network of safety checks and systems. If the safety network detects anything unusual, your pump notifies you of conditions that require your immediate attention. The backlight illuminates the pump screen and the alarm message displays on the screen.

It is important that you understand how your pump behaves when you do not clear an alarm or an alert. See the *Alerts* section in this chapter for an explanation and an example.

Check your pump and test your blood sugar. Follow the guidelines prescribed by your healthcare professional to manage your diabetes as needed.

**NOTE:** *The STATUS screen shows any alarms and alerts that are active.*

**Question:** Why are alarms important?

**Answer:** Your pump monitors activities and notifies you if there is an unusual pump status or your attention is required. When an alarm is active, INSULIN DELIVERY IS STOPPED and immediate operator interaction is required.

If the vibrate mode is on, all alarms and alerts start as vibrations and then change to beeps. For your safety, if there is no response after 10 minutes, the beeps change to a siren. The siren continues every minute until the alarm is cleared.

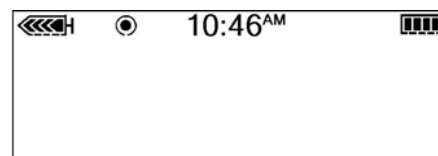

When a solid circle appears, follow the instructions on the screen

## What to do

When an alarm is triggered, the pump goes into Attention mode and an alarm message shows on the screen. The pump then defaults to the HOME screen. Do these steps when you get an alarm:

- 1 **View the alarm:** From the HOME screen, press any button to see the alarm message.
- 2 **Read all of the alarm text.** There are instructions on how to fix the alarm condition. (Press  to read more text, if available.)
- 3 **Clear the alarm.** Press **ESC** then **ACT** after you read the alarm instructions.
- 4 The HOME screen appears.
- 5 **Follow the instructions** that appeared with the alarm to fix the alarm condition.
- 6 **Check your settings.** Check your time, date, basal and other settings to make sure they are correct.

## Alarm conditions

Alarms put the pump in Attention mode.



### A (ALARM)

This alarm shows the letter **A** followed by two numbers. A-alarms cause all insulin delivery to stop. Your pump settings are retained. If this alarm repeats often, call our 24 Hour HelpLine for assistance.



### AUTO OFF

Alerts you that no buttons were pressed during the time limit you set for the AUTO OFF DURATION feature, and so insulin delivery has been stopped.



### BATT OUT LIMIT

Occurs if the battery has been out of the pump for more than five minutes. Verify that the pump time and date are correct. If not correct, go to the UTILITIES MENU and reset the date and time.

## BOLUS STOPPED

If this alarm occurs, it is very important to check bolus history to review how much of the bolus was actually delivered. If necessary, reprogram a bolus with the amount not yet delivered.

## BUTTON ERROR

Occurs if a button has been continually pressed for more than three minutes.

## CHECK SETTINGS

When this alarm is active, you should check and/or reprogram your pump settings, including the time/date.

## E (ERROR)

An E-error alarm will show the letter *E* followed by two numbers. E-alarms cause all insulin delivery to stop, the pump resets, and all your settings are cleared. After receiving this alarm, note the error number then call our 24 Hour HelpLine for assistance.

## EMPTY RESERVOIR

There is no insulin in the reservoir. Change the reservoir immediately.

## FAILED BATT TEST

The pump tests the voltage of each battery installed. This test ensures a battery with low voltage is not used. If the battery does not have enough voltage, this alarm will occur. The pump will not function and the battery must be replaced. (Always make sure that you install a NEW battery into the pump.)

## FINISH LOADING

You have not completed filling the infusion set with insulin. Clear the alarm. This resumes basal delivery. See the *Filling the cannula* section in the *Starting on insulin* chapter to fill the infusion set cannula with insulin. If your infusion set has a needle cannula, press **ESC** to skip this step.



## MAX FILL REACHED

If you use more than 30 units of insulin to fill the infusion set tubing, this message appears. Press **ESC**, **ACT** to clear the message. See the *Filling the tubing* section in the *Starting on insulin* chapter for more information.

## MAX DELIVERY

This alarm alerts you when you have taken more insulin than expected based on Maximum bolus and Maximum basal rates.

## MOTOR ERROR

Insulin delivery has stopped. This alarm occurs if your pump detects a motor error.

## NO DELIVERY

Insulin delivery has stopped. This alarm will occur if your pump detects a blockage or if the reservoir is empty. Refer to the first page of the Troubleshooting chapter for additional information.

## NO RESERVOIR

The reservoir is not inserted correctly or no reservoir has been inserted.

## OFF NO POWER

The battery is dead. Replace battery immediately. Follow the directions on the screen. Check to make sure that the time is correct on the screen. Reset the time if necessary.

## RESET

The Reset alarm triggers when pump settings are cleared because of one of these reasons:

- Pump settings were cleared (Clear Settings function) and settings have not been reprogrammed.
- A download attempt from the PC is incomplete. (The download function is applicable to the optional software feature. Refer to the software user guide for more information.)

## WEAK BATTERY

The pump tests the voltage of each battery installed. If the battery voltage is less than full strength, this alarm may occur. The pump will operate normally, but the battery life will be shorter than expected. Always make sure to install a new battery in the pump.

## Testing the transmitter

The tester acts like a sensor. If you get sensor-related alerts, use the tester to make sure that the transmitter is working.

### Connecting the tester

- 1 Hold the transmitter and the tester as shown. Line up the flat side of the tester with the flat side of the transmitter.

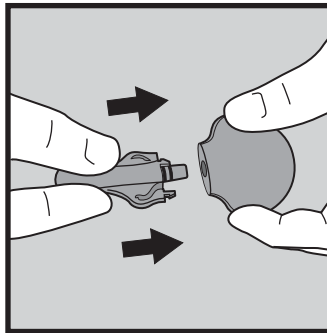

- 2 Push the tester into the transmitter until the flexible side arms of the tester click into the notches on both sides of the transmitter.
- 3 Within 20 seconds, the green light on the transmitter will flash for about 10 seconds when properly connected. The Sensor feature must be turned **On** on your pump. Go to the RECONNECT OLD SENSOR screen to start your sensor.

**Main > Sensor > Link to Sensor > Reconnect Old Sensor**

You should see the sensor icon  on the pump screen, which means that the transmitter and the sensor are communicating.

- 4 Within the next seven to eight minutes, go to the SENSOR STATUS screen to look for the Sensor ISIG value:
  - a. The sensor ISIG value on this screen should be between 24.00-29.00 nA. This range of ISIG values means that the transmitter electronics are working properly. Since the transmitter is sending signals correctly, the sensor must have caused the alert. Remove and discard the sensor. Insert a new sensor in a new site.
  - b. If you see a Sensor ISIG value that is less than 24.00 nA or more than 29.00 nA, contact our 24 Hour HelpLine. It may be time to replace your transmitter.

## Disconnecting the tester

- 1 Hold the transmitter body as shown and pinch the side arms of the tester.

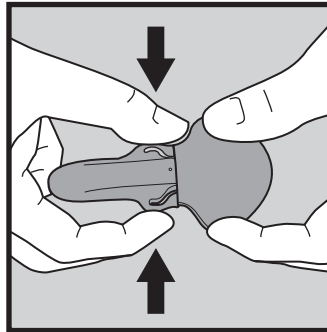

- 2 With the tester arms pinched, gently pull the transmitter away from the tester. To save transmitter battery life, do not leave the tester connected after testing.

## Troubleshooting sensor features

### Reconnect old sensor

You should only use this feature if you have disconnected the sensor from the transmitter and have to reconnect them.

#### To Reconnect old sensor:

- 1 Go to the RECONNECT OLD SENSOR screen.  
**Main > Sensor > Link to Sensor > Reconnect Old Sensor**

- 2 Press **ACT** in the RECONNECT OLD SENSOR screen.
- 3 The SENSOR READY 2 HRS screen appears. Press any button to continue. An alert will sound in two hours when a meter BG is required for calibration.

## Find lost sensor

If you receive a Lost Sensor alert:

- 1 Relocate the pump closer to the sensor, and go to the LINK SENSOR MENU.  
**Main > Sensor > Link to Sensor**
- 2 Select **Find Lost Sensor**, then press **ACT**.
- 3 The SENSOR READY 15 MIN screen appears. Press any button to continue. An alert will sound in 15 minutes when a meter BG is required for calibration.





# Maintenance

It is recommended that you read your warranty statement included in this user guide for information about what is covered during your warranty period.

## Battery

The Paradigm pump uses a single 1.5 V AAA alkaline battery, size E92, type LR03. As a safety measure, Medtronic Diabetes has designed the pump to only accept a NEW battery. If you insert a used battery, the FAILED BATT TEST alarm may be triggered. Refer to the *Install battery* section in *The basics* chapter for instructions.

The use of cold batteries causes erratic pump behavior. To prevent this, do not use batteries that have been in cold storage (such as in the refrigerator or your car in the winter). It takes several hours for these batteries to warm to room temperature.

Certain features on the pump use a lot of battery power. Your battery will need to be replaced more frequently if you use these features:

- Remote control
- Meter
- Backlight
- Vibrate alert type setting

---

**CAUTION:** It is recommended that you use a AAA Energizer battery. Do not use a rechargeable or carbon zinc battery in the pump. Do not remove the battery unless you are changing your battery (installing a NEW battery). Replace it within five minutes. If not replaced within five minutes, the screen may display an alarm message. Follow the instructions in the message and make sure the time and date are set correctly. Check that the battery is inserted correctly. If the battery has been installed backwards, remove the battery and install it properly.

---

## Storage

If you have to remove and store your pump, it is recommended that you store it with the battery in place. Keep a record of your current basal rates. To preserve battery life, reset the basal rates to 0 (zero), turn off the remote and meter options, and set the Auto-off to dashes or zeroes.

## Cleaning your pump

- 1 Use only a damp cloth and mild detergent mixed with water to clean the outside of your pump.
- 2 Rinse the pump with a clean cloth, dampened with clean water.
- 3 Dry with a clean cloth.
- 4 Never use organic solvents, such as lighter fluid, nail polish remover, or paint thinner to clean your pump.
- 5 Keep the reservoir compartment and battery compartment dry and away from moisture.
- 6 Do not use any lubricants with your pump.
- 7 Use a 70 percent alcohol wipe to disinfect your pump.
- 8 Use a dry clean cotton tip to remove any battery residue from the battery cap.
- 9 Use a dry clean cloth to remove any battery residue from the battery compartment opening.

## Cleaning the transmitter

---

**CAUTION: The charger and the tester are NOT water-tight. Do NOT immerse in water.**

**Do NOT discard the transmitter in a medical waste container or otherwise subject it to incineration. Transmitter contains a battery which may explode upon incineration.**

---

- 1 Wash your hands thoroughly.
- 2 Dampen a clean cloth with mild liquid soap and warm water. Wipe the outside of the transmitter.
- 3 Rinse the transmitter under warm tap water but do **not** get water inside the connector. If you get water inside the connector, shake the water out and allow it to air dry.
- 4 Using an antibacterial hand-sanitizer (available at a local drugstore) on a clean, dry cloth, wipe the transmitter's surface. Do **NOT** get any hand-sanitizer inside the connector. Repeated exposure to the hand-sanitizer could damage the connectors and affect the transmitter's performance as a result. If you get hand-sanitizer inside the connector, allow it to air dry.
- 5 Place the transmitter on a clean, dry cloth and air dry for 2-3 minutes.

## Cleaning the Sen-serter

- 1 Wash your hands thoroughly.
- 2 Dampen a clean cloth with mild liquid soap and warm water. Wipe the Sen-serter.
- 3 Rinse with warm tap water.
- 4 Using an antibacterial hand sanitizer (readily available at your local drugstore), wipe down the Sen-serter.
- 5 Place the Sen-serter on a clean dry cloth and allow to air dry.
- 6 Store the Sen-serter in the released position to maintain optimum product performance and life.



# Pump specifications

This section provides detailed information on specifications related to your pump. The safety features of your pump are individually listed and described.

## Alarms and error messages

- Indicators: audible tone (beep) or vibration (silent).
- All alarms and errors show messages on the pump's screen and provide instructions on what to do. Unresolved alarms will escalate to siren mode for added safety.

## Alarm history

Maximum records shown: 36

## Audio frequency

Name	Frequency (+/- 25%)
Alarm	1850 Hz
Escalated alarm	2.5 kHz, followed by 3.2 kHz
Alert	1.8 kHz, followed by 2.1 kHz and 1.8 kHz
High Glucose alert	2.5 kHz, followed by 2.79 kHz, 2.98 kHz and 3.2 kHz
Low Glucose alert	3.2 kHz, followed by 2.98 kHz, 2.79 kHz and 2.5 kHz
Predictive High Glucose alert	2.5 kHz, followed by 2.98 kHz and 3.2 kHz
Predictive Low Glucose alert	3.2 kHz, followed by 2.98 kHz and 2.5 kHz
Rising rate of change alert	2.5 kHz, followed by 3.2 kHz
Falling rate of change alert	3.2 kHz, followed by 2.5 kHz

## Backlight

- LCD (Liquid Crystal Display) type
- Time-out: 30 seconds

## Basal

- Delivery: 0.025-35 units/hour (maximum units: 35/hour)
- Factory maximum setting: 2.0 units/hour
- 3 patterns maximum, each with 48 rates
- Increments:
  - 0.025 units for basal amounts in the range of 0.025 to 0.975 units
  - 0.05 units for basal amounts in the range of 1 to 9.95 units
  - 0.1 units for basal amounts of 10.0 units or larger

## BG Target

Maximum targets: 8

- Range: 60-250 mg/dL (3.3-13.9 mmol/L)
- Warning limits: less than 90 or greater than 140 mg/dL (less than 5.0 or greater than 7.8 mmol/L)

## Bolus delivery

- Insulin delivered/stroke:
  - 0.025 units for bolus amounts in the range of 0.025 to 0.975 units
  - 0.05 units for bolus amounts larger than 0.975 units
- Fluid delivered/stroke: 0.25  $\mu$ L (microliter) for 0.025 unit pump stroke; 0.5  $\mu$ L for 0.05 unit pump stroke

## Maximum bolus

- Range: 0.0-25.0 units

## Bolus history

Maximum records shown: 24

## Bolus units

Increments: Based on selected scroll rate

## Bolus Wizard feature

See the *Bolus Wizard feature specifications* section in this chapter for information.

## Carb ratios

Maximum ratio settings	Range	Warning limits
8	1-200 grams/u	less than 5 or greater than 50 grams/u
	0.075-15.0 u/exch	less than 0.3 or greater than 3.0 u/exch

## Carb units

The food entry when using Bolus Wizard feature:

- grams: 0-300 (increments: 1 gram)
- exchanges: 0.0-20 (increments: 0.5 exch)

## Daily totals

Maximum records shown: 32 days of data, maximum display: 999.975 units/day. Daily delivery accuracy: 0.025 units.

## Default screen

The HOME screen. For most screens, if no buttons are pressed for 30 seconds, the pump returns to this screen.



## Delivery accuracy

- Testing has confirmed that the delivery accuracy for the maximum/minimum bolus/basal amounts are within the +/-5 percent of the programmed value.
- All normal boluses will be delivered within a maximum of six minutes.
- Displacement (piston) accuracy: +/-2 percent.

Delivery Volume Accuracy Curve (-1.20%) Overall Error  
(MMT-523 Model) QTP6303 Qualification Pump (0.01 ml/hr 10/22/07 S/N: PAR162804U); 23°C,  
MMT-326A Reservoir Lot#: WE0107318, MMT-317 Infusion set Lot: 620699

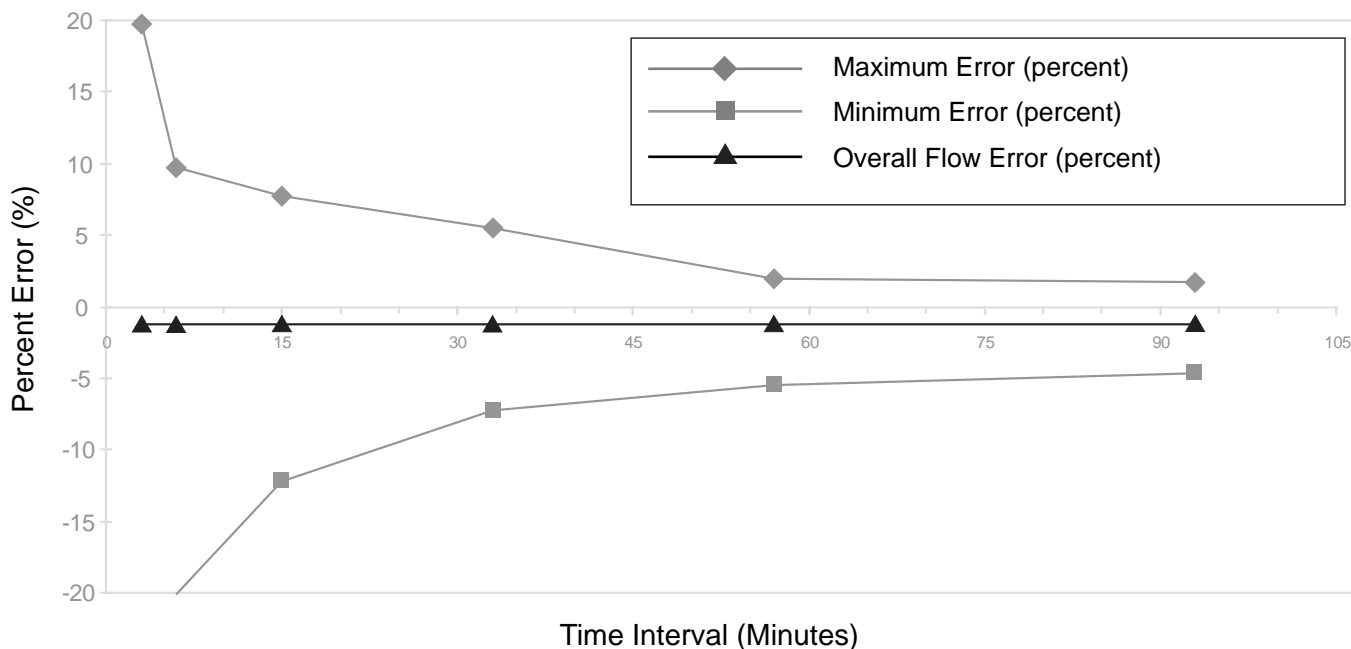

## Pump motor

The pump motor has a unique, patented design with an integrated safety check system. The system delivers in precise increments.

## Dual Wave bolus

Delivers a Normal bolus followed by a Square Wave bolus (limited by maximum bolus).

## Easy bolus

- Features programming using audible tones (or vibrate pulses) in user-defined increments.
  - Beep mode range: 0 to maximum bolus
  - Vibrate mode range: 0 to 20 steps or maximum bolus, whichever comes first
- Factory default: off
- Default step increment: 0.1 unit
- Step size  $\leq$  maximum bolus.
- Adjustable step size: 0.1 to 2.0 units per step.
- Accessible from the remote control or pump buttons.

## Filling the infusion set

- Filling the cannula: up to 10 units (limited by maximum bolus)
- Filling the tubing: warning at 30 units, then at each 10 units thereafter.
- Fill rate: 1 to 5 units/second.
- Insulin used to fill the infusion set is not counted in daily totals but is recorded separately in the Reservoir + Set history.

## Infusion pressure

Maximum infusion pressure and occlusion pressure: 13.7 PSI (94.46 kPa).

## Insulin sensitivity

- Maximum settings: 8
- Factory default: 50 mg/dL/u (2.8 mmol/L/u)
- Range: 10-400 mg/dL/u (0.5-22.2 mmol/L/u)
- Warning limits: less than 20 or greater than 100 mg/dL/u (less than 1.1 or greater than 5.6 mmol/L/u)

## Low resv (reservoir) warning

Values are based on displayed amount, not actual amount.

time:	2-24-hours, and @ 1:00 hour before empty	08:00 hours (default when time is selected)
units:	5-50 units, and @ half of the remaining amount	20 units (factory default)

## Meter value

The BG measurement received from the meter. Appears in the ENTER BG screen during bolus programming. Appears on the screen when the pump is idle at the HOME screen.

- Expiration: 12 minutes
- Range: 20-600 mg/dL (1.1-33.3 mmol/L)
- Maximum meter ID entries: 3

## Normal bolus

Range 0.025 - 25.0 units of insulin (limited by maximum bolus setting).

## Occlusion detection

When occlusion is detected, the NO DELIVERY alarm occurs. The occlusion alarm is triggered by an average of 2.77 units of missed insulin. The Paradigm pump is intended for use with U100 insulin. This table shows occlusion detection for three different situations when using U100 insulin.

Rate	Minimum time before alarm	Typical time before alarm	Maximum time before alarm
bolus delivery (10 units at 2 u/min)	28 seconds	49 seconds	72 seconds
basal delivery (1.0 u/h)	1.95 hours	3.26 hours	4.9 hours
basal delivery (0.025 u/h)	27 hours	112.47 hours	179 hours

## Percent temp basal

Default value: 100% of basal programming

## Power supply

The pump is powered by a standard 1.5 V AAA alkaline battery, size E92, type LR03 (Energizer brand recommended).

## Reservoir + Set history

Maximum records shown: 20 (fill tubing and fill cannula)

## Program safety checks

Maximum infusion with single fault condition: 0.0 units

## Pump size

The dimensions of the pump are approximately:

- 523/523K pumps:
  - 2.0 x 3.3 (2.8 at the battery cap) x 0.82 inches
  - 5.1 x 8.3 (7.1 at the battery cap) x 2.0 cm
- 723/723K pumps:
  - 2.0 x 3.7 (3.5 at the battery cap) x 0.84 inches
  - 5.1 x 9.4 (8.9 at the battery cap) x 2.1 cm

## Pump weight

- 523/523K pumps: approximately 95 grams (with battery installed).
- 723/723K pumps: approximately 102 grams (with battery installed).

## Remote control

Uses radio signals to allow users to program Normal boluses or to suspend/resume their pumps.

## Reservoir

- The user-filled reservoir is made from impact-resistant, insulin-compatible polypropylene.
- 523/523K pump volume: up to 176 units of U100 insulin
- 723/723K pump volume: up to 300 units of U100 insulin

## Square Wave bolus

Delivers bolus insulin over a duration of 30 minutes up to eight hours (limited by the Max bolus setting).

## Temporary (temp) basal rate

Allows you to temporarily change the current basal rate for a duration of 30 minutes up to 24 hours (limited by Maximum basal setting). The temp basal rate can be set to either Percent of basal or Insulin rate.

## Time and date screen

12-hour or 24-hour formats. Pump users set the time/date, including the year, month and day. The date is included in the STATUS screen. Time always appears on the top of the screen.

## Environmental conditions

- Pump operating temperature range: from 37°F (3°C) to 104°F (40°C)
- Air pressure range: from 700 hPa to 1060 hPa (from 10.2 psi to 15.4 psi)
- Operating humidity range of the case: 20% to 95%. This requirement exceeds EN 60601-2-24:1998, Section 10.2.1b (20% to 90%).

## Radio frequency (RF) communication specifications

- Pump to transmitter frequency: 916.5 MHz; proprietary Medtronic protocol; range up to 6 feet (1.8 meters)
- Pump to meter frequency: 916.5 MHz; proprietary Medtronic protocol; range up to 4 feet (1.2 meters)
- Pump to remote frequency: 916.5 MHz; proprietary Medtronic protocol; range up to 24 inches (approximately 60 cm)

## Quality of service

Common consumer electronic devices that transmit in the same frequency band used by the transmitter may prevent the pump from receiving the glucose information sent by the transmitter. Adherence to the following guidelines will result in a consistent and reliable quality of service:

- Cell phone 12 inches away from pump and meter
- Meter and pump within 4 feet of each other
- Pump and transmitter 6 feet of each other

## Data security

The Medtronic MiniMed Paradigm® series insulin pump is designed to only accept radio frequency (RF) communications from recognized and linked devices (you must program your pump to accept information from a specific device).

The Medtronic MiniMed Paradigm® insulin pump and system components (meters and transmitters) ensure data security via proprietary means and ensures data integrity using error checking processes, such as cyclic redundancy checks.

## Status screen

Item	When	What
Active Insulin	(if any)	(Active Ins:) the amount of active insulin, displayed to the next 0.025 U
Alarm Clock*	(appears if scheduled to alarm)	Time set is displayed.
Alert Silence	(if active)	Hi, Lo, Hi/Lo, All with time left
Auto-off	(appears if enabled)	X HR
Basal pattern information	(if active)	Pattern A or B
Battery Status	(always appears)	Normal, Low, Off
BG meter value (most recent BG value received)	(appears if BG meter is enabled)	XXX mg/dL (XX.X mmol/L) time and date received

Item	When	What
BG Reminder* (Only if enabled)	Time remaining before BG Reminder is set to go off H:MM h (if less than 1 hour, 0:XXh where XX is minutes remaining)	
Block	(if active)	ON
Current date	(always appears)	
Current temp basal information	(if active)	rate (units per hour), duration, time remaining
Last alarm/alert	(if cleared within 24 hours)	(Last:) with the date, time and abbreviation for the most recently cleared alarm/alert
Last bolus information	(appears if at least one bolus was started)	type and units delivered delivery time and date  (S = Square, N = Normal, DN = Normal part of dual wave bolus, DS = Square part of dual wave bolus)
Meter: Disabled	(appears if enabled but battery is low or empty)	
Meter: On	(appears if enabled)	
Missed Bolus Reminder	(if this feature is turned on)	Bolus Before and the time that the reminder is due
Pump model number	(always appears)	
Remote: Disabled	(appears if enabled but battery is low or empty)	
Remote: On	(appears if enabled)	
Reservoir started	(always appears)	date, time, units left, time left
Serial number	(always appears)	
Sensor Demo	(if Demo Mode is selected for the sensor graphs)	SENSOR DEMO: On
Software version	(always appears)	
Standard basal delivery data	(always appears)	current basal rate (basal 1, basal 2, etc.)
Status of pump	(such as Rewind, Suspended, Low Reservoir, Set Time, and so on)	

Item	When	What
Time	(always appears)	
*If all of the Reminders and the Alarm Clock are enabled, only the reminder that is nearest to alarming will appear in the STATUS screen.		

## Bolus Wizard feature specifications

There are four different formulas the Bolus Wizard feature uses to estimate a bolus, depending on your current BG. The following formulas apply only when the carb units are in grams.

- If your current BG is greater than your High BG Target, the Bolus Wizard feature subtracts active insulin from the BG correction estimate, then adds this to the food estimate to get the total bolus estimate. However, if the result of subtracting active insulin from BG correction estimate is a negative number (less than zero), the total bolus estimate is based only on the food estimate.

**Food estimate:**  
 $\text{Carb grams} \div \text{Carb ratio} = \text{Units of insulin}$

**Correction estimate:**  
 $(\text{Current BG} - \text{High BG Target}) \div \text{Insulin sensitivity} - \text{Active insulin} = \text{Units of insulin}$

**Total bolus estimate:**  
 $\text{Food estimate} + \text{Correction estimate} = \text{Units of insulin}$
- If your current BG is less than your Low BG Target, the Bolus Wizard feature adds the BG correction estimate to the food estimate to get the total bolus estimate.

**Food estimate:**  
 $\text{Carb grams} \div \text{Carb ratio} = \text{Units of insulin}$

**Correction estimate:**  
 $(\text{Current BG} - \text{Low BG Target}) \div \text{Insulin sensitivity} = \text{Units of insulin}$

**Total bolus estimate:**  
 $\text{Food estimate} + \text{Correction estimate} = \text{Units of insulin}$
- If your current BG is between or equal to your High or Low BG Target, the total bolus estimate is based only on the food estimate.

**Food estimate:**  
 $\text{Carb grams} \div \text{Carb ratio} = \text{Units of insulin}$

**Total bolus estimate = Food estimate**
- If you do not enter a BG, the total bolus estimate is based only on the food estimate.



## NOTES:

- If a Dual Wave bolus is less than the estimate due to the max bolus limit or a user change, the square (sq) portion is reduced first.
- Based on the Active Insulin Time setting you choose, the pump keeps track of how much insulin is still active in your body. This is shown as Active Ins. or Act. Ins. in the STATUS, SET BOLUS, SET NORMAL BOLUS, SET SQUARE BOLUS, SET DUAL BOLUS TOTAL, and SET EASY BOLUS screens. This prevents stacking of insulin, and lowers the chances of hypoglycemia.
- The active insulin amount is also shown in the Bolus Wizard's ESTIMATE DETAILS screen but is calculated differently than in the above screens. The active insulin amount calculated in the ESTIMATE DETAILS screen includes the insulin that has already been delivered and insulin that is going to be delivered by the active Square Bolus. To show this difference in calculation, the active insulin appears with an asterisk (\*Active Insulin) in this screen.

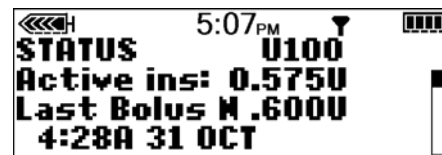

- The Bolus Wizard feature may utilize your current BG measurement, carbohydrate consumption, and active insulin to calculate your estimated bolus.
- Active Insulin Curves

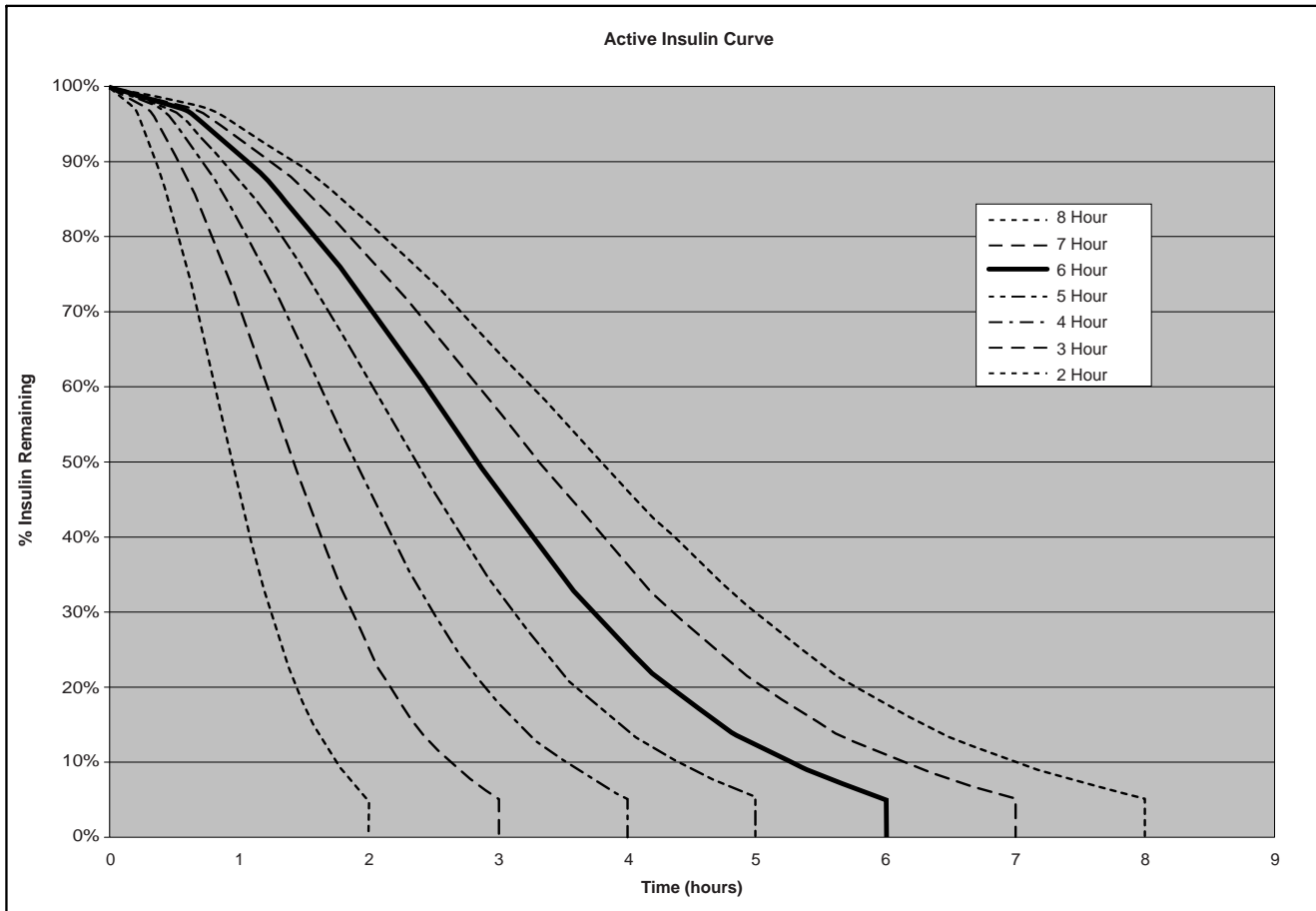

Graph adapted from Mudaliar and colleagues, Diabetes Care, Volume 22, Number 9, Sept. 1999, page 1501.

# Bolus Wizard feature examples

## Settings:

- Carb ratio: 30 grams/unit
  - BG Target: 90-120 mg/dL (5.0-6.7 mmol/L)
  - Insulin Sensitivity: 40 mg/dL/unit (2.2 mmol/L/unit)
  - Active Insulin Time: 6 Hours
- 1 No active insulin from previous bolus delivery. User inputs 60 grams of carbs and does not enter BG.  
**Food estimate:**  
Carb grams ÷ Carb ratio = Units of insulin  
 $60 \text{ g} \div 30 \text{ g/u} = 2 \text{ units}$   
**Total bolus estimate = Food estimate = 2 units**
  - 2 No active insulin from previous bolus delivery. User inputs 60 grams of carbs and a BG of 200 mg/dL (11.1 mmol/L).  
**Food estimate:**  
Carb grams ÷ Carb ratio = Units of insulin  
 $60 \text{ g} \div 30 \text{ g/u} = 2 \text{ units}$   
**Correction estimate:**  
(Current BG - High BG Target) ÷ Insulin sensitivity = Units of insulin  
 $(200 \text{ mg/dL} - 120 \text{ mg/dL}) \div 40 \text{ mg/dL/u} = 2 \text{ units}$ , or  
 $(11.1 \text{ mmol/L} - 6.7 \text{ mmol/L}) \div 2.2 \text{ mmol/L/u} = 2 \text{ units}$   
**Total bolus estimate:**  
Food estimate + Correction estimate = Units of insulin  
 $2 \text{ units} + 2 \text{ units} = 4 \text{ units}$
  - 3 No active insulin from previous bolus delivery. User inputs 60 grams of carbs and a BG of 70 mg/dL (3.9 mmol/L).  
**Food estimate:**  
Carb grams ÷ Carb ratio = Units of insulin  
 $60 \text{ g} \div 30 \text{ g/u} = 2 \text{ units}$   
**Correction estimate:**  
(Current BG - Low BG Target) ÷ Insulin sensitivity = Units of insulin  
 $(70 \text{ mg/dL} - 90 \text{ mg/dL}) \div 40 \text{ mg/dL/u} = -0.5 \text{ units}$ , or  
 $(3.9 \text{ mmol/L} - 5.0 \text{ mmol/L}) \div 2.2 \text{ mmol/L/u} = -0.5 \text{ units}$   
**Total bolus estimate:**  
Food estimate + Correction estimate = Units of insulin  
 $2 \text{ units} + (-0.5) \text{ units} = 1.5 \text{ units}$

- 4 No active insulin from previous bolus delivery. User inputs 60 grams of carbs and a BG of 100 mg/dL (5.6 mmol/L).

**Food estimate:**

Carb grams ÷ Carb ratio = Units of insulin

$$60 \text{ g} \div 30 \text{ g/u} = 2 \text{ units}$$

**Correction estimate:**

Correction is 0 because the current BG reading is within the BG Target range.

**Total bolus estimate:**

Food estimate + Correction estimate = Units of insulin

$$2 \text{ units} + 0 \text{ units} = 2 \text{ units}$$

- 5 Previous bolus activity results in a calculation of 1.5 units unabsorbed (active) insulin. User inputs 60 grams of carbs and a BG of 200 mg/dL (11.1 mmol/L).

**Food estimate:**

Carb grams ÷ Carb ratio = Units of insulin

$$60 \text{ g} \div 30 \text{ g/u} = 2 \text{ units}$$

**Correction estimate:**

(Current BG - High BG Target) ÷ Insulin sensitivity - Active insulin = Units of insulin

$$(200 \text{ mg/dL} - 120 \text{ mg/dL}) \div 40 \text{ mg/dL/u} - 1.5 \text{ units} = 0.5 \text{ units, or}$$

$$(11.1 \text{ mmol/L} - 6.7 \text{ mmol/L}) \div 2.2 \text{ mmol/L/u} - 1.5 \text{ units} = 0.5 \text{ units}$$

**Total bolus estimate:**

Food estimate + Correction estimate = Units of insulin

$$2 \text{ units} + 0.5 \text{ units} = 2.5 \text{ units}$$

- 6 Previous bolus activity results in a calculation of 3.5 units unabsorbed (active) insulin. User inputs 60 grams of carbs and a BG of 200 mg/dL (11.1 mmol/L).

**Food estimate:**

Carb grams ÷ Carb ratio = Units of insulin

$$60 \text{ g} \div 30 \text{ g/u} = 2 \text{ units}$$

**Correction estimate:**

(Current BG - High BG Target) ÷ Insulin sensitivity - Active insulin = Units of insulin

$$(200 \text{ mg/dL} - 120 \text{ mg/dL}) \div 40 \text{ mg/dL/u} - 3.5 \text{ units} = -1.5 \text{ units}^*, \text{ or}$$

$$(11.1 \text{ mmol/L} - 6.7 \text{ mmol/L}) \div 2.2 \text{ mmol/L/u} - 3.5 \text{ units} = -1.5 \text{ units}^*$$

**NOTE:** \*This negative number indicates that active insulin is sufficient to cover the correction that is needed. Thus, correction is 0 units. Active insulin does not reduce the food portion of the estimate.

**Total bolus estimate:**

Food estimate + Correction estimate = Units of insulin

$$2 \text{ units} + 0 \text{ units} = 2 \text{ units}$$

## Insulin delivery default settings

Menu	Item	Default Setting	Limits	Increments
<b>Bolus Menu:</b>	Bolus Wizard feature:	Off		
	Easy bolus:	Off		
	Easy bolus step:	0.1 u	2.0 u	0.1 u
	Scroll Rate:	0.10 u		0.025 u; 0.05 u; 0.10 u
	Dual/Square bolus:	Off		
	Maximum bolus:	10.0 u	0.0-25.0 u (per single bolus)	
	BG Reminder:	Off	0:00 - 5:00	0:30
<b>Basal Menu:</b>	Patterns:	Off		
	Maximum basal rate:	2.00 u/h	0.000-35.0 u/h	0.025 u (for 0.025-0.975 u/h); 0.05 u (for 1.00-9.95 u/h); 0.1 u (for rates of 10 u/h or more)
	Basal rate:	0.000 u/h		0.025 u (for 0.025-0.975 u/h); 0.05 u (for 1.00-9.95 u/h); 0.1 u (for rates of 10 u/h or more)
	Temp basal type:	U/H	Max basal rate setting	0.025 u (for 0.025 - 0.975 u/h); 0.05 u (for 1.00 - 9.95 u/h); 0.1 u (for rates of 10 u/h or more); (or 1%)
<b>Utilities Menu:</b>	Lock Keypad:	Off		
	(Alarm) History:	(no defaults)		
	Alert type:	audio, beep-med		
	Auto-off:	Off		

Menu	Item	Default Setting	Limits	Increments
	Capture Option:	Off		
	Low reservoir warning:	(20) insulin units	<b>if units:</b> 1st @ 5-50 u; 2nd @ half amount remaining <b>(if time:</b> 1st @ 2:00-24:00; 2nd @ 1:00 hour before empty)	20 u  (0:30)
	(Time/Date) Time:	12 a.m. (midnight)		
	(Time/Date) Date:	1/1/07		
	(Time/Date) Time format:	12-hour		
	Block:	Off		
	Alarm clock:	Off		
	Remote option:	Off		
	Meter option:	Off		
	User Settings:	(no defaults)		
	Language:	English		

## Bolus Wizard feature default settings

Item	Default Setting	Limits	Increments	Warning Limits
carb units:	grams	—	—	—
ins to carb (or exch) ratio:	15 grams/u or 1 unit/exch	1-200 g/u or 0.075-15.0 u/exch	0.1 g/u for 0-9.9 g/u; 1 g/u for ratios of 10.0 g/u or more (or 0.001 u/exch for 0.075-0.099 u/exch; 0.01 u/exch for 0.10-9.99 u/exch; 0.1 u/exch for 10.0-15.0 u/exch)	5-50 g/u or 0.3-3.0 u/exch
(insulin) sensitivity:	50 mg/dL/u or 2.8 mmol/L/u	10-400 mg/dL/u or 0.5-22.2 mmol/L/u	1 mg/dL/u or 0.1 mmol/L/u	20-100 mg/dL/u or 1.1-5.6 mmol/L/u
BG Target:	100-100 mg/dL or 5.6-5.6 mmol/L	60-250 mg/dL or 3.3-13.9 mmol/L	1 mg/dL or 0.1 mmol/L	90-140 mg/dL or 5.0-7.8 mmol/L
Active Ins Time:	6 hours	2-8 hours	1 hour	—

## Sensor features default settings

Feature	Options	Default Setting	Limits, Range of Values
Sensor	<ul style="list-style-type: none"> <li>• On</li> <li>• Off</li> </ul>	Off	—
Glucose Alerts	<ul style="list-style-type: none"> <li>• On</li> <li>• Off</li> </ul>	Off	Set the limits using the Glucose Limits feature.

Feature	Options	Default Setting	Limits, Range of Values
<b>Glucose Limits</b>	<ul style="list-style-type: none"> <li>Maximum of 8 Glucose Limits.</li> <li>One pair of Glucose Limits (Glucose Limits 1) is already set up for you, with a default High Glucose Limit and Low Glucose Limit.</li> <li>Glucose Limits 2 through 8 can be set as needed.</li> </ul>		
Glucose Limits 1	523, 723 <ul style="list-style-type: none"> <li>Low: 80 mg/dL (4.4 mmol/L)</li> <li>High: 240 mg/dL (13.3 mmol/L)</li> </ul> 523K, 723K <ul style="list-style-type: none"> <li>Low: 90 mg/dL (5.0 mmol/L)</li> <li>High: 280 mg/dL (15.5 mmol/L)</li> </ul>	523, 723 <ul style="list-style-type: none"> <li>Low: 80 mg/dL (4.4 mmol/L)</li> <li>High: 240 mg/dL (13.3 mmol/L)</li> </ul> 523K, 723K <ul style="list-style-type: none"> <li>Low: 90 mg/dL (5.0 mmol/L)</li> <li>High: 280 mg/dL (15.5 mmol/L)</li> </ul>	Low Glucose Limit range: <sup>a</sup> <ul style="list-style-type: none"> <li>523, 723: 40-390 mg/dL (2.2-21.6 mmol/L)</li> <li>523K, 723K: 90-390 mg/dL (5.0-21.6 mmol/L)</li> </ul> High Glucose Limit range: <sup>b</sup> <ul style="list-style-type: none"> <li>523, 723: 50-400 mg/dL (2.8-22.2 mmol/L)</li> <li>523K, 723K: 100-400 mg/dL (5.6-22.2 mmol/L)</li> </ul>
Glucose Limits 2 through Glucose Limits 8	<ul style="list-style-type: none"> <li>Low: Off</li> <li>High: Off</li> </ul>	Low    Off High   Off	See the Glucose Limits 1 range.
<b>High Repeat</b>	<ul style="list-style-type: none"> <li>On</li> <li>Off</li> </ul> (Set to On when High Glucose, High Predictive, or Rising Rate of Change Alert is on)	On    1 hour	Range: 0:05-3:00 (5 minutes to 3 hours)



Feature	Options	Default Setting	Limits, Range of Values
Low Repeat	<ul style="list-style-type: none"> <li>On</li> <li>Off</li> </ul> (Set to On when Low Glucose, Low Predictive, or Falling Rate of Change Alert is on.)	On 20 minutes	Range: 0:05 - 1:00 (5 minutes to 1 hour)
Predictive Alert	<ul style="list-style-type: none"> <li>On</li> <li>Off</li> </ul>	Off Default time sensitivity: Low 15 minutes High 15 minutes	Range: Off 0:05 - 0:30 (5 to 30 minutes)
Rate of Change Alerts	<ul style="list-style-type: none"> <li>On</li> <li>Off</li> </ul>	Fall Rate Limit Off Rise Rate Limit Off	Fall Rate Limit range: 1.1-5.0 mg/dL/min (0.065-0.275 mmol/L/min) Rise Rate Limit range: 1.1-5.0 mg/dL/min (0.065-0.275 mmol/L/min)
Cal Repeat	(Always on - cannot be turned off)	On 30 minutes	Range: 0:05 - 1:00 (5 minutes to 1 hour)
Cal Reminder	<ul style="list-style-type: none"> <li>On</li> <li>Off</li> </ul>	On 1 hour	Range: 0:05 - 6:00 (5 minutes to 6 hours)
Blood Glucose Units (BG Units)	<ul style="list-style-type: none"> <li>mg/dL</li> <li>mmol/L</li> </ul>	mg/dL	—
Weak Signal	(Always on - cannot be turned off)	30 minutes	Range: 0:05 - 0:40 (5 to 40 minutes)

Feature	Options	Default Setting	Limits, Range of Values
Sensor glucose graph timeout	<ul style="list-style-type: none"> <li>• 2 minutes</li> <li>• 4 minutes</li> <li>• 6 minutes</li> <li>• NONE<sup>c</sup></li> </ul>	2 minutes	—
Alert Silence	<ul style="list-style-type: none"> <li>• Off</li> <li>• Hi Alerts</li> <li>• Lo Alerts</li> <li>• Hi and Lo Alerts</li> <li>• All Sensor Alerts</li> </ul>	Off	If any option other than <b>Off</b> is selected in the ALERT SILENCE screen, the SET DURATION screen displays. The value range is from 00:30 to 24:00.
AUC Limits	Always on	Low Limit 70 mg/dL (3.9 mmol/L)  High Limit 180 mg/dL (10 mmol/L)	Low Limit range: <sup>d</sup> 40-400 mg/dL (2.2-22.2 mmol/L)  High Limit range: <sup>e</sup> 40-400 mg/dL (2.2-22.2 mmol/L)
<p>a. Your Low Glucose Limit must be at least 10 mg/dL (0.6 mmol/L) below your High Glucose Limit. For example, if your High Glucose limit is 200 mg/dL (11.1 mmol/L), then your Low Glucose limit cannot be higher than 190 mg/dL (10.5 mmol/L).</p> <p>b. Your High Glucose Limit must be at least 10 mg/dL (0.6 mmol/L) above your Low Glucose Limit.</p> <p>c. If you select this option the sensor glucose graphs will show continuously on the pump screen.</p> <p>d. The AUC Low Limit can be equal to, but not higher than the AUC High Limit.</p> <p>e. The AUC High Limit can be equal to, but not lower than the AUC Low Limit.</p>			

## Guidance and manufacturer's declaration

Guidance and Manufacturer's Declaration - Electromagnetic Emissions		
<p>The Paradigm 523/723/523K/723K pump system (consisting of the MMT-523/723/523K/723K pump and MMT-7703 transmitter) is intended for use in the electromagnetic environment specified below. The customer or the user of the Paradigm 523/723/523K/723K pump system should make sure that it is used in such an environment.</p>		
Emissions Test	Compliance	Electromagnetic Environment - Guidance
RF emissions CISPR 11	Group 1	The Paradigm 523/723/523K/723K pump system uses RF energy only for system communication functions. Therefore, its RF emissions are very low and are not likely to cause any interference in nearby electronic equipment.
RF emissions CISPR 11 Harmonic emissions IEC 61000-3-2 Voltage fluctuations/flicker emissions IEC 61000-3-3	Class B  Not applicable  Not applicable	<p>The Paradigm 523/723/523K/723K pump system is suitable for use in all establishments other than domestic and those directly connected to the public low-voltage power supply network that supplies buildings used for domestic purposes.</p> <p><b>NOTE:</b> The preceding statement is required by IEC 60601-1-2 for Group 1, Class B devices. However, since the Paradigm 523/723/523K/723K pump system is battery powered, its emissions will not be affected by the establishment power supply and there is no evidence of any issues associated with the use of the system in domestic establishments.</p>

### Guidance and Manufacturer's Declaration - Electromagnetic Immunity

The Paradigm 523/723/523K/723K pump system (consisting of the MMT-523/723/523K/723K pump and MMT-7703 transmitter) is intended for use in the electromagnetic environment specified below. The customer or the user of the Paradigm 523/723/523K/723K pump system should make sure that it is used in such an environment.

Immunity Test	IEC 60601 Test Level	Compliance Level	Electromagnetic Environment - Guidance
Electrostatic discharge (ESD) IEC 61000-4-2	±6 kV contact ±8 kV air	±30 kV air (<5% relative humidity)	The Paradigm 523/723/523K/723K pump system should not be affected by electrostatic discharge that might occur under normal conditions of use.
Electrical fast transient/burst IEC 61000-4-4	±2 kV for power supply lines ±1 kV for input/output lines	Not applicable Not applicable	Not applicable Not applicable
Surge IEC 61000-4-5	±1 kV line(s) to line(s) ±2 kV line(s) to earth	Not applicable Not applicable	Not applicable Not applicable
Voltage dips, short interruptions and voltage variations on power supply lines IEC 61000-4-11	<5% $U_T$ (>95% dip in $U_T$ ) for 0.5 cycle	Not applicable	Not applicable
	40% $U_T$ (60% dip in $U_T$ ) for 5 cycles	Not applicable	Not applicable
	70% $U_T$ (30% dip in $U_T$ ) for 25 cycles	Not applicable	Not applicable
	<5% $U_T$ (>95% dip in $U_T$ ) for 5 seconds	Not applicable	Not applicable

### Guidance and Manufacturer's Declaration - Electromagnetic Immunity

The Paradigm 523/723/523K/723K pump system (consisting of the MMT-523/723/523K/723K pump and MMT-7703 transmitter) is intended for use in the electromagnetic environment specified below. The customer or the user of the Paradigm 523/723/523K/723K pump system should make sure that it is used in such an environment.

Immunity Test	IEC 60601 Test Level	Compliance Level	Electromagnetic Environment - Guidance
Power frequency (50/60 Hz) magnetic field IEC 61000-4-8	3 A/m	3 A/m	Power frequency magnetic fields should be at levels characteristic of a typical location in a typical commercial or hospital environment.

*NOTE:  $U_T$  is the a.c. mains voltage prior to application of the test level.*

### Guidance and Manufacturer's Declaration - Electromagnetic Immunity

The Paradigm 523/723/523K/723K pump is intended for use in the electromagnetic environment specified below. The customer or user of the Paradigm 523/723/523K/723K pump system should make sure that it is used in such an environment.

Immunity Test	IEC 60601 Level	Compliance Level	Electromagnetic Environment Guidance
Conducted RF IEC 61000-4-6	10 Vrms 150 kHz to 80 MHz	Not applicable	Portable and mobile RF communications equipment should be used no closer to any part of the Paradigm 523/723/523K/723K pump, including cables, than the recommended separation distance calculated from the equation applicable to the frequency of the transmitter.  Recommended separation distance Not applicable

### Guidance and Manufacturer's Declaration - Electromagnetic Immunity

The Paradigm 523/723/523K/723K pump is intended for use in the electromagnetic environment specified below. The customer or user of the Paradigm 523/723/523K/723K pump system should make sure that it is used in such an environment.

Immunity Test	IEC 60601 Level	Compliance Level	Electromagnetic Environment Guidance
Radiated RF IEC 61000-4-3	10 V/m 80 MHz to 6.0 GHz	10 V/m	<p> <math>d = 0.35\sqrt{P}</math>      80 MHz to 800 MHz  <math>d = 0.70\sqrt{P}</math>      800 MHz to 6.0 GHz </p> <p>Where <math>P</math> is the maximum output power rating of the transmitter in watts (W) according to the transmitter manufacturer and <math>d</math> is the recommended separation distance in meters (m).</p> <p>Field strengths from fixed RF transmitters, as determined by an electromagnetic site survey<sup>a</sup>, should be less than the compliance level in each frequency range<sup>b</sup>.</p> <p>Interference may occur in the vicinity of equipment marked with the following symbol:</p> 

## Guidance and Manufacturer's Declaration - Electromagnetic Immunity

The Paradigm 523/723/523K/723K pump is intended for use in the electromagnetic environment specified below. The customer or user of the Paradigm 523/723/523K/723K pump system should make sure that it is used in such an environment.

Immunity Test	IEC 60601 Level	Compliance Level	Electromagnetic Environment Guidance
---------------	-----------------	------------------	--------------------------------------

*NOTE: At 80 MHz and 800 MHz, the higher frequency range applies.*

*NOTE: These guidelines may not apply in all situations. Electromagnetic propagation is affected by absorption, and reflection from structures, objects and people.*

<sup>a</sup>Field strengths from fixed transmitters, such as base stations for radio (cellular/cordless) telephones and land mobile radios, amateur radio, AM and FM radio broadcasts and TV broadcast cannot be predicted theoretically with accuracy. To access the electromagnetic environment due to fixed RF transmitters, an electromagnetic site survey should be considered. If the measured field strength in the location in which the Paradigm 523/723/523K/723K pump is used exceeds the applicable RF compliance level above, the Paradigm 523/723/523K/723K pump should be observed to verify normal operation. If abnormal performance is observed, additional measures may be necessary, such as re-orienting or relocating the Paradigm 523/723/523K/723K pump.

<sup>b</sup>Over the frequency range 150 kHz to 80 MHz, field strengths should be less than  $[V_1]$  V/m.

## Recommended separation distances between portable and mobile RF communications equipment and the Paradigm 523/723/523K/723K pump system

This section provides information on the recommended separation distance between portable and mobile RF communications equipment and the Paradigm 523/723/523K/723K pump. The Paradigm 523/723/523K/723K pump is intended for use in an electromagnetic environment in which radiated RF disturbances are controlled. Paradigm 523/723/523K/723K pump users can help prevent electromagnetic interference by maintaining a minimum distance between portable and mobile RF communications equipment (transmitters) and the Paradigm 523/723/523K/723K pump as recommended below, according to the maximum output power of the communications equipment.

Rated maximum output power of transmitter (W)	Separation distance according to the frequency of transmitter (m)	
	80MHz to 800MHz $d = 0.35\sqrt{P}$	800MHz to 6.0GHz $d = 0.70\sqrt{P}$
0.01	0.035	0.07
0.1	0.11	0.11
1	0.35	0.7
10	1.1	2.2
100	3.5	7











For transmitters rated at a maximum output power not listed above, the recommended separation distance  $d$  in meters (m) can be estimated using the equation applicable to the frequency of the transmitter, where  $p$  is the maximum output power rating of the transmitter in watts (W) according to the transmitter manufacturer.

**NOTE:** At 80 MHz and 800 MHz, the separation distance for the higher frequency range applies.

**NOTE:** These guidelines may not apply in all situations. Electromagnetic propagation is affected by absorption and reflection from structures, objects and people.



## Icon table

Follow instructions for use	
Attention: Read all warnings and precautions in instructions for use.	
Manufacturer	
Date of manufacture (year - month)	
Batch code	<b>LOT</b>
Use by (year - month)	
Catalogue number	REF
Device serial number	SN
Storage temperature range	
Magnetic Resonance (MR) unsafe	
Fragile product	
Type BF equipment (Protection from electrical shock)	
Conforms to IEC60601-1 sub-clause 44.6 and IEC60529 standard For more information about IPX7, see the <i>Glossary</i> on <i>page 229</i> .	IPX7
Recycle	
Radio communication	

Radio communication





# Sensor accuracy

**NOTE:** You should review the information in this section with your healthcare professional.

The Medtronic MiniMed Paradigm 523/723/523K/723K pumps use a glucose sensor to continuously monitor your glucose levels. The 523/723/523K/723K pumps use the same algorithm as the Guardian RT®. The Guardian RT was evaluated in two clinical studies and the following information in this section describes the findings. The remainder of this section discusses the results of this pivotal study, and uses the term Guardian RT.

**NOTE:** The Guardian RT is not an abbreviation for the Guardian REAL-Time CGM System. The Guardian RT is a continuous glucose monitoring system that was developed before the Guardian REAL-Time CGM System. The Guardian RT was originally named TGMS II, and later renamed Guardian RT.

The Medtronic Guardian RT uses a glucose sensor to continuously monitor your glucose levels. The Guardian RT sensor is calibrated using your home blood glucose meter. Once calibrated, the Guardian RT records glucose values every five minutes. These values were compared to reference laboratory blood glucose measurements to check the Guardian RT's performance characteristics in two clinical studies.<sup>1, 2</sup>

Although presentations to characterize performance of the Guardian RT are given below, there is no commonly accepted statistical approach for capturing the performance of continuous glucose monitors such as the Guardian RT. Performance may be best characterized by viewing graphs called time-elapsd plots. In these plots, the values from Guardian RT for one subject over time are overlaid with values at the same time from the glucose reference method. Three representative time-elapsd plots are shown at the end of this section of sensors that exhibited excellent performance, average performance and poor performance.

1. Medtronic Diabetes, *A Frequent Sample Accuracy Evaluation of the Medtronic Diabetes Telemetered Glucose Monitoring System II (TGMS II) in Subjects with Type 1 Diabetes Mellitus, August 2004.*
2. Medtronic Diabetes, *An Accuracy Evaluation of the Medtronic Diabetes Guardian RT Glucose Monitoring System in Pediatric Subjects with Type 1 Diabetes Mellitus, February, 2006.*

## Performance results in adults

The performance of the Guardian RT in adults was evaluated in a clinical study. Guardian RT results were compared to plasma glucose values from a reference method, the YSI 2300 STAT Plus™ glucose analyzer (referred to as YSI). Sixteen subjects with Type I diabetes participated in a single-site in-clinic study. Subjects ranged in age from 18 to 65 years old. Each subject wore two Guardian RT systems simultaneously. One Guardian system was calibrated an average of 3.5 times per day, and the other was calibrated approximately five times per day using the Paradigm Link blood glucose meter. YSI measurements were taken every thirty (30) minutes.

Users and their healthcare professionals should consider that performance in this study may be idealized, and that performance may be worse when the Guardian RT is used in a less controlled home setting. For example:

- The mean Hemoglobin A1c among the 16 participants was 8.2 percent. As hemoglobin A1c levels rise, conditions often occur which are most challenging to test systems measuring glucose in interstitial fluid, i.e., higher glucose levels, more rapid changes in glucose concentrations, and often more hypoglycemic episodes.
- Subjects saw, on average, between 4 and 5 fingerstick values per day. This enables subjects to better manage their diabetes when compared to those who perform less fingersticks per day. Agreement between Guardian RT and YSI values is shown to be closer at mid-range glucose levels, as compared to agreement at low or high glucose concentrations.
- Subjects were more limited in their activities than what may exist in home use, and they were provided with all their meals. Sensors were also inserted by clinic staff rather than the subjects themselves. Subjects who are more active, or with poor eating habits, may create more challenging conditions for the Guardian RT.
- Performance of the Guardian RT may vary depending on the glucose meter used and how well the meter is maintained. It is important to carry out quality-control checks on the meter and code the meter according to the manufacturer's instructions to optimize performance of the Guardian RT.

## Accuracy of Guardian RT readings

In this study, YSI measurements (taken every half hour) were paired with the corresponding Guardian RT reading (taken every five minutes). Pairing was done by selecting the Guardian RT value closest in time to the YSI test result. Agreement was analyzed by comparing paired glucose measurements.

Agreement between the matched pair was estimated by evaluating the difference between the Guardian RT reading and the YSI measurement. The difference between them was calculated as a percentage of the YSI (Mean Absolute Percent Difference). The bias was also calculated, and it is defined as the overall difference between the Guardian RT glucose values and the YSI values. The paired glucose measurements are summarized below.

<b>Number of Paired Glucose Measurements</b>	3941
<b>Mean Absolute Percent Difference (<math>\pm</math> SD)</b>	19.7 $\pm$ 18.4%
<b>Bias</b>	-0.8 mmol/L (-15.0 mg/dL)

The accuracy of the Guardian RT was also evaluated by calculating the percentage of Guardian RT readings within 20 percent and within 30 percent of the YSI reading (or within 1.1 mmol/L (20 mg/dL) in the low glucose range). Results are shown below.

<b>Plasma Glucose Range (mg/dl)</b>	<b>Plasma Glucose Range (mmol/l)</b>	<b>Number of Paired Readings</b>	<b>Percent Within 20%</b>	<b>Percent Within 30%</b>
Overall		3941	62%	79%
40-80 <sup>a</sup>	2.2-4.4	356	68%	68%
>80-120	>4.4-6.7	769	60%	77%
>120-240	>6.7-13.3	2362	62%	81%
>240	>13.3	454	61%	82%

a. For the Low glucose range, 2.2-4.4 mmol/L (40-80 mg/dL), the value shown is the percent within 1.1 mmol/L (20 mg/dL).

The Clarke Error Grid was used to assess the clinical relevance of the differences between the Guardian RT readings and the comparative YSI measurements. The Clarke Error Grid divides a correlation plot into 5 zones. See following table.

Results in zones A and B are considered clinically acceptable, while results in zones C, D, and E are potentially dangerous and, therefore, clinically significant errors. The Clarke Error Grid zones are labeled on the correlation plot.

<b>Zone</b>	<b>Description</b>
<b>A</b>	Clinically accurate, would lead to correct treatment decisions
<b>B</b>	Would lead to benign decisions or no treatment
<b>C</b>	Would lead to over-correction of normal glucose levels
<b>D</b>	Would lead to failure to detect and treat high or low glucose levels
<b>E</b>	Would lead to erroneous treatment decisions

The plot below is a correlation plot of Guardian RT readings versus readings from the reference method, the YSI 2300 Glucose Analyzer. It is overlaid with the Clarke Error Grid.

The total number of paired data points is 3941.

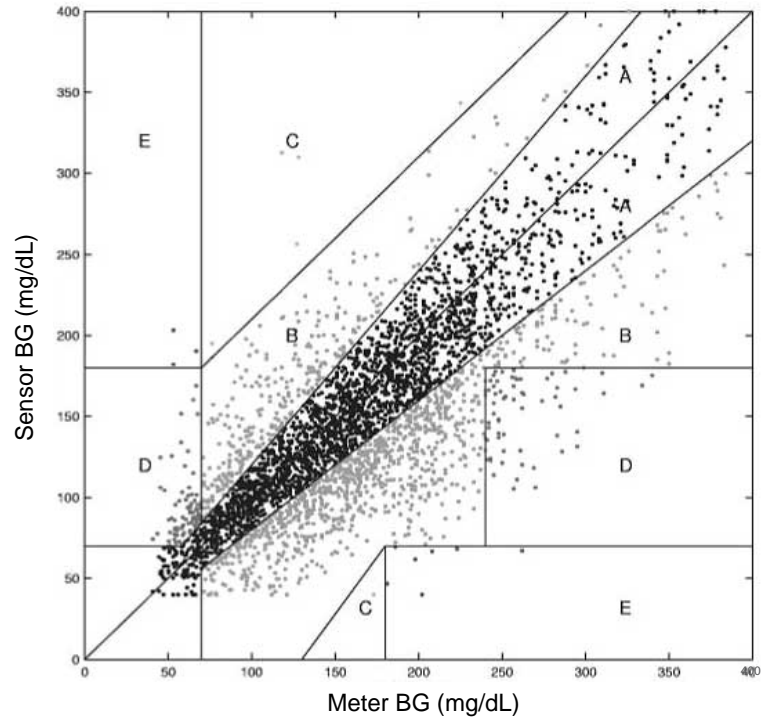



The percent of Guardian RT readings in the previous graph are presented in the following table according to the percentage of points falling within each zone (A-E). Results are further broken down (stratified) according to the range of glucose concentrations.

<b>Glucose Range (mg/dl)</b>	<b>Number and (% of Data Points Evaluated)</b>	<b>A + B</b>	<b>A</b>	<b>B</b>	<b>C</b>	<b>D</b>	<b>E</b>
40-80	356 (9)	271 (76.1)	214 (60.1)	57 (16.0)	2 (0.6)	80 (22.5)	3 (0.8)
81-120	769 (20)	768 (99.9)	463 (60.2)	305 (39.7)	1 (0.1)	N/A <sup>a</sup>	N/A
121-240	2362 (60)	2352 (99.6)	1476 (62.5)	876 (37.1)	4 (0.2)	N/A	6 (0.2)
>240	454 (11)	394 (86.8)	277 (61.0)	117 (25.8)	N/A	59 (13.0)	1 (0.2)
Overall	3941 (100)	3785 (96.0)	2430 (61.7)	1355 (34.4)	7 (0.2)	139 (3.5)	10 (0.2)
<i>a. N/A means that the Clarke Error Grid does not consider the possibility of these zones in that concentration range.</i>							

## Precision of Guardian RT readings

This study was also designed to look at the reproducibility of two sensors worn simultaneously at different locations on the body. Precision was estimated by comparing the glucose readings from the two Guardian RT systems. In this study 11,475 paired sensor Guardian RT values were obtained. On average, they were different by 17.2 percent. **The following figure is an example of how data was paired in this study.** In the graph there are two tracings of Guardian RT values. Each tracing comes from a different Guardian RT unit worn by one subject during a one-day period.

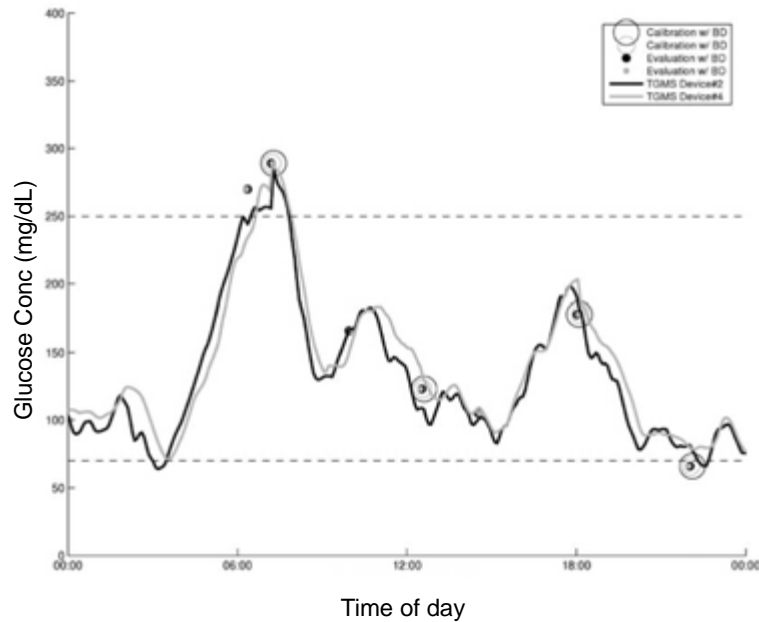

The above chart, Guardian RT device #2 is represented by a solid line, and the Guardian RT device #4 by a light-gray line.

## Low and High alerts in adults

The ability of the Guardian RT to detect high and low glucose levels was measured in the same clinical study. Since it is important to set the alert levels in a conservative fashion, the Low Glucose Alert should be set at a value slightly higher than the value of blood glucose you want to detect, and the High Glucose Alert should be set at a value slightly lower than the value of blood glucose you want to detect.

**NOTE:** Please ask your healthcare professional which low and high alert setting is best for you.

### The Low Glucose alert

The Low Glucose Alert was evaluated for its ability to detect glucose levels at 70 mg/dL (3.9 mmol/L), or below, using the YSI 2300 STAT Plus glucose analyzer. As a reference, with the Low Glucose Alert set at 70 mg/dL (3.8 mmol/L), 49% (100/205) of low glucose events were detected by the Guardian RT. Better detection of low blood glucose can be obtained by setting the Low Glucose Alert level higher. For example, setting the Low Glucose Alert at 90 mg/dL (5.0 mmol/L), instead of 70 mg/dL (3.9 mmol/L), increases the ability to detect low blood glucose levels from 49% to 82% (see the following table).

Sometimes the Guardian RT will alert when the blood glucose levels are not low. When the Guardian RT Low Alert was set at 70 mg/dL (3.9 mmol/L) in this study, 43% of the results were considered false alerts (actual blood glucose values are greater than 85 mg/dL (4.7 mmol/L)). This percentage may be exaggerated because blood glucose may be dropping when the Guardian RT alerts. The table below shows the percent of Low Glucose readings correctly identified by the Guardian RT for specific settings.

Guardian RT Low Alert Setting (mg/dL)	Guardian RT Low Alert Setting (mmol/L)	True Alert Rate <sup>a</sup>	False Alert Rate <sup>b</sup>
70	3.9	49%	60%
80	4.4	68%	64%
90	5.0	82%	75%
100	5.6	90%	79%

a. True Alert Rates are the % of times when the glucose level was at or below the alert setting and the alert sounded.

b. False Alerts Rates are the % of times when the Guardian RT Sensor alarmed but the blood glucose level was greater than the alert setting.

Increasing the Low Alert settings will improve the ability to detect low blood glucose events, but it will also increase the frequency of Guardian RT false alerts for blood glucose levels not below the target value. You should consider this trade-off between the improved ability to detect true low blood glucose versus the increased number of false alerts when setting the low alert threshold.

## The High Glucose alert

The High Glucose Alert was evaluated for its ability to detect glucose levels at 250 mg/dL (13.8 mmol/L), or above, using the YSI analyzer. As a reference, with the High Glucose Alert set at 250 mg/dL (13.8 mmol/L), 53% (195/365) of high glucose events were detected by the Guardian RT. Better detection of high blood glucose can be obtained by setting the High Glucose Alert level lower. For example, setting the High Glucose Alert at 190 mg/dL (10.6 mmol/L), instead of 250 mg/dL (13.8 mmol/L), increases the ability to detect high blood glucose levels from 53% to 85% (see the following table).

Sometimes the Guardian RT will alert when the blood glucose levels are not high. When the Guardian RT High Alert was set at 250 mg/dL (13.8 mmol/L) in this study, 7.2% of the results were considered false alerts (actual blood glucose values are less than 225 mg/dL (12.5 mmol/L)). This percentage may be exaggerated because blood glucose may be rising when the Guardian RT alerts. The table below shows the percent of High Glucose readings correctly identified by the Guardian RT for specific settings.

Guardian RT High Alert Setting (mg/dL)	Guardian RT High Alert Setting (mmol/L)	True Alert Rate <sup>a</sup>	False Alert Rate <sup>b</sup>
190	10.6	85%	64%
200	11.1	81%	58%
225	12.5	67%	40%
250	13.8	53%	25%

a. True Alert Rates are the % of times when the glucose level was at or above the alert setting and the alert sounded.

b. False Alerts Rates are the % of times when the Guardian RT Sensor alarmed but the blood glucose level was lower than the alert setting.

Decreasing the High Alert settings will improve the ability to detect high blood glucose events, but it will also increase the frequency of Guardian RT false alerts for blood glucose levels not above the target value. You should consider this trade-off between the improved ability to detect true high blood glucose versus the increased number of false alerts when setting the high alert threshold.

## Guardian RT sensor performance and calibration stability as a function of time

The Guardian RT sensor may be worn for up to 3 days (72 hours) and must be calibrated at least twice a day. Two sets of data, approximately equal in number, were collected during the clinical trial. One data set was generated when the frequency of calibrations averaged 3.5 per day (Data Set A), and the other averaged 5 times a day (Data Set B). During the study, a total of 38 sensors were evaluated in 16 individuals.

As per the stratified Clarke Error Grid analysis above, agreement between Guardian RT values and YSI values tends to be less at low and high glucose concentrations when compared to other concentration ranges.

Guardian RT performance in the hypoglycemic range, as a function of sensor insertion time, is characterized below. Results from the two different data sets are presented. The two populations were separated according to the number of calibrations per day. This table represents the percentage of Data Points in the 2.2 - 4.4 mmol/L (40-80 mg/dL) range that fell within 1.1 mmol/L (20 mg/dL). Data is presented in 12-hour increments.

<b>Data Set</b>	<b>0-12 hrs</b>	<b>12-24 hrs</b>	<b>24-36 hrs</b>	<b>36-48 hrs</b>	<b>48-60 hrs</b>	<b>60-72 hrs</b>
A	78%	81%	73%	65%	56%	41%
B	67%	70%	93%	60%	75%	38%

An analysis of the mean percentage of Absolute Relative Error (ARE percentage) and standard deviations, across 12-hour increments of wear periods, appears in the table below. Both data sets are pooled together in this data.

<b>Hours From Insertion</b>	<b>Mean ARE (%)</b>	<b>Std. Dev.</b>
0-12 hrs	24.84	20.04
12-24 hrs	19.66	16.17
24-36 hrs	16.43	15.62
36-48 hrs	18.23	19.27
48-60 hrs	16.59	14.25
>60 hrs	22.95	23.51

The median sensor life from Data Sets A and B were 57.5 hours and 72.9 hours, respectively. Twenty-one of the sensors operated for 72 hours, while the others were removed for a variety of reasons, most often because of calibration errors.

The percentage of Guardian RT readings within 20 percent and 30 percent of YSI readings was analyzed according to time after sensor insertion and according to the glucose-concentration range (as determined by the YSI analyzer). See the following table.

Glucose Range (mg/dl)	Percentage of Guardian RT values within 20% of YSI laboratory readings		Percentage of Guardian RT values within 30% of YSI laboratory readings	
	During first 60 hours of sensor wear	After 60 hours of sensor wear	During first 60 hours of sensor wear	After 60 hours of sensor wear
40-80 <sup>a</sup>	62-82%	39%	62-82%	39%
81-120	57-66%	48%	72-84%	66%

*a. Agreement to within  $\pm 1.1$  mmol/L (20 mg/dL) for glucose readings  $\leq 4.4$  mmol/L (80 mg/dL)*

Performance of the Guardian RT was evaluated according to the length of time since calibration. This data is not conclusive because of the limited number of data points during the final 3 hours of the 12-hour calibration cycle, i.e., 10. In contrast, 3-hour time bins, earlier in the 12-hour cycle, contained hundreds of data points. This may suggest that calibrations are often required prior to the 12-hour calibration cycle.

## Effects of calibration frequency

The average bias when Guardian RT was calibrated ~ 3.5 times a day was  $-20.5 \pm 41$  mg/dl (LL: -22.40 mg/dl and UL: -18.63 mg/dl). In those calibrated ~ 5 times a day, the bias was  $-10.2$  mg/dl  $\pm 36$  mg/dl (LL: -11.74 mg/dl and UL: -8.66 mg/dl). When comparing Guardian RT units that were calibrated less often to those calibrated more often, the following alarm performance was observed:

- Specificity increased 2-4 percent in the hypoglycemic range and decreased 0-2 percent in the hyperglycemic range
- Sensitivity increased between 5-9 percent across the hyperglycemic range, and decreased 7-16 percent when the alarm was set to 80 mg/dl or below, and decreased 3-7 percent when set between 85 and 100 mg/dl

Stratified error grid analysis also shows better performance in the hypoglycemic range when fewer calibrations are performed, i.e., 62 percent of data points are in Zone A when fewer calibrations were performed, whereas 58 percent were in Zone A when more calibrations were performed.



## Time-elapsed plots

The plot graph below is a representative example of continuous sensor tracing vs. reference blood glucose reading, where sensor showed excellent performance. The open circles (o) on the graph represent the meter calibration readings. The closed circles (•) represent the reference blood glucose readings, and the solid line (—) represents the sensor glucose value.

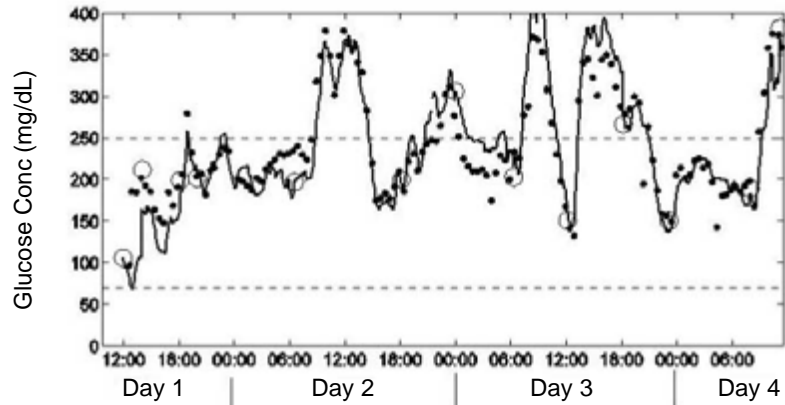

The plot graph below is a representative example of continuous sensor tracing vs. reference blood glucose reading, where sensor showed average (typical) performance. The open circles (o) on the graph represent the meter calibration readings. The closed circles (•) represent the reference blood glucose readings, and the solid line (—) represents the sensor glucose value.

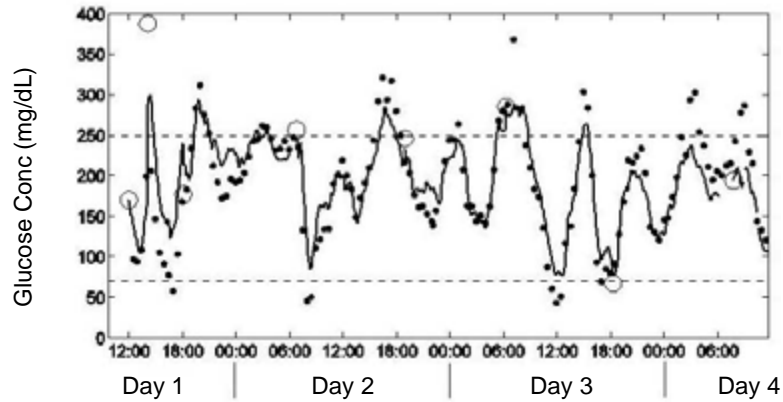

The plot graph below is a representative example of continuous sensor tracing vs. reference blood glucose reading, where sensor showed poor performance. The open circles (o) on the graph represent the meter calibration readings. The closed circles (•) represent the reference blood glucose readings, and the solid line (—) represents the sensor glucose value.

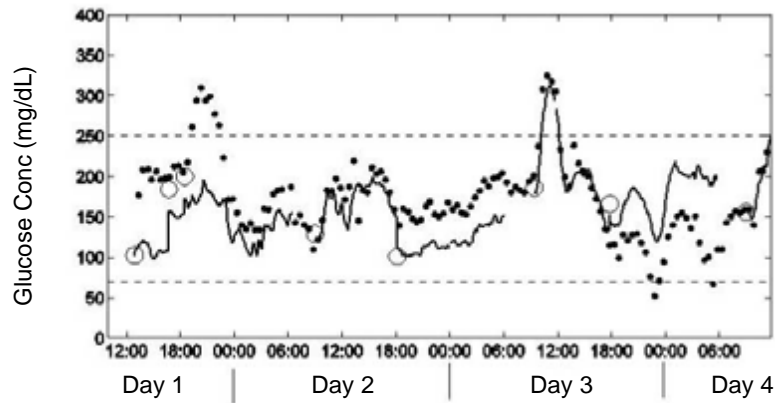

## Performance results in children and adolescents

The performance of the Guardian RT in Children and Adolescents was evaluated in a clinical study. Guardian RT results were compared to capillary blood glucose measured by a OneTouch® Ultra® Meter. Sixty subjects with Type I diabetes participated in a three-site out-patient study. Subjects ranged in age from 7 to 17 years old. Each subject wore a Guardian RT system, which records a sensor glucose value every five minutes. Subjects were instructed to perform at least seven blood glucose meter measurements each day.

### Accuracy of Guardian RT readings

In this study, each blood glucose meter measurement was paired with the corresponding Guardian RT reading (taken every 5 minutes). Pairing was done by selecting the Guardian RT value closest in time to the blood glucose meter result. Agreement was analyzed by comparing paired glucose measurements.

Agreement between the matched pair was estimated by evaluating the difference between the Guardian RT reading and the blood glucose meter measurement. The difference between them was calculated as a percentage of the blood glucose meter measurement (Mean Absolute Percent Difference). The bias was also calculated, and it is defined as the overall difference between the Guardian RT glucose values and the blood glucose meter values. The paired glucose measurements are summarized in the following table

Number of Paired Glucose Measurements	2599
Mean Absolute Percent Difference ( $\pm$ SD)	19.0 $\pm$ 19.7%
Bias	-6.0 mg/dL (-0.3 mmol/L)

The accuracy of the Guardian RT was also evaluated by calculating the percentage of Guardian RT readings within 20% and within 30% of the blood glucose meter reading (or within 20 mg/dL (1.1 mmol/L) in the low glucose range). Results are shown in the following table.

Plasma Glucose Range (mg/dL)	Plasma Glucose Range (mmol/L)	Number of Paired Readings	Percent Within 20%	Percent Within 30%
Overall		2599	68%	82%
40-80 <sup>a</sup>	2.2-4.4	360	51%	----
> 80-120	> 4.4-6.7	482	60%	77%
> 120-240	> 6.7-13.3	1055	74%	90%
> 240	> 13.3	702	75%	89%

*a. For the Low glucose range, 40-80 mg/dL (2.2-4.4 mmol/L), the value shown is the percent within 20 mg/dL (1.1 mmol/L).*

The Clarke Error Grid was used to assess the clinical relevance of the differences between the Guardian RT readings and the comparative blood glucose meter measurements. The Clarke Error Grid divides a correlation plot into 5 zones. See the following table.

Results in zones A and B are considered clinically acceptable, while results in zones C, D, and E are potentially dangerous and, therefore, clinically significant errors. The Clarke Error Grid zones are labeled on the correlation plot.

Zone	Description
A	Clinically accurate, would lead to correct treatment decisions
B	Would lead to benign decisions or no treatment
C	Would lead to over-correction of normal glucose levels
D	Would lead to failure to detect and treat high or low glucose levels
E	Would lead to erroneous treatment decisions

The following figure is a correlation plot of Guardian RT readings versus readings from the reference method, the blood glucose meter. It is overlaid with the Clarke Error Grid. The total number of paired data points is 2599.

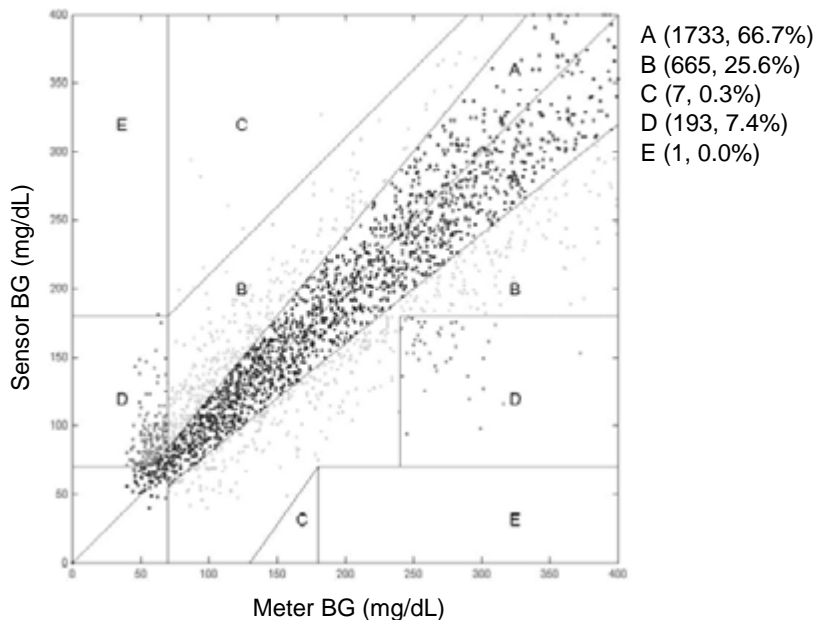

The percent of Guardian RT readings in the above graph are presented in the table below according to the percentage of points falling within each zone (A-E). Results are further broken down (stratified) according to the range of glucose concentrations.

## Stratified Clarke Error Grid Analysis

Range of Comparative Glucose Readings (mg/dL)	Total Count	A + B	A	B	C	D	E
40-80	360 (13.9%)	201 (55.8%)	141 (39.2%)	60 (16.7%)	1 (0.3%)	157 (43.6%)	1 (0.3%)
81-120	482 (18.5%)	478 (99.2%)	287 (59.5%)	191 (39.6%)	4 (0.8%)	0 (0%)	0 (0%)
121-240	1055 (40.6%)	1053 (99.8%)	782 (74.1%)	271 (25.7%)	2 (0.2%)	0 (0%)	0 (0%)
240-400	702 (27.0%)	666 (94.9%)	523 (74.5%)	143 (20.4%)	0 (0%)	36 (5.1%)	0 (0%)
Overall	2599 (100.0%)	2398 (92.3%)	1733 (66.7%)	665 (25.6%)	7 (0.3%)	193 (7.4%)	1 (0.0%)

## Low and High alerts in children and adolescents

The ability of the Guardian RT to detect high and low glucose levels was measured in the same clinical study. Since it is important to set the alert levels in a conservative fashion, the Low Glucose Alert should be set at a value slightly higher than the value of blood glucose you want to detect, and the High Glucose Alert should be set at a value slightly lower than the value of blood glucose you want to detect.

**NOTE:** Please ask your healthcare professional which low and high alert setting is best for you.

### The Low Glucose alert

The Low Glucose Alert was evaluated for its ability to detect glucose levels at 70 mg/dL (3.9 mmol/L), or below, using the blood glucose meter. As a reference, with the Low Glucose Alert set at 70 mg/dL (3.8 mmol/L), 24% (59/244) of low glucose events were detected by the Guardian RT. Better detection of low blood glucose can be obtained by setting the Low Glucose Alert level higher. For example, setting the Low Glucose Alert at 90 mg/dL (5.0 mmol/L), instead of 70 mg/dL (3.9 mmol/L), increases the ability to detect low blood glucose levels from 24% to 70% (see the following table).

Sometimes the Guardian RT will alert when the blood glucose levels are not low. When the Guardian RT Low Alert was set at 70 mg/dL (3.9 mmol/L) in this study, 48% of the results were considered false alerts (actual blood glucose values are greater than 85 mg/dL (4.7 mmol/L)). This percentage may be exaggerated because blood glucose may be dropping when the Guardian RT alerts.

The table below shows the percent of Low Glucose readings correctly identified by the Guardian RT for specific settings.

Guardian RT Low Alert Setting (mg/dL)	Guardian RT Low Alert Setting (mmol/L)	True Alert Rate <sup>a</sup>	False Alert Rate <sup>b</sup>
70	3.9	24%	48%
80	4.4	52%	46%
90	5.0	70%	52%
100	5.6	85%	57%

a. True Alert Rates are the % of times when the glucose level was at or below the alert setting and the alert sounded.

b. False Alerts Rates are the % of times when the Guardian RT Sensor alarmed but the blood glucose level was greater than the alert setting.



Increasing the Low Alert settings will improve the ability to detect low blood glucose events, but it will also increase the frequency of Guardian RT false alerts for blood glucose levels not below the target value. You should consider this trade-off between the improved ability to detect true low blood glucose versus the increased number of false alerts when setting the low alert threshold.

## The High Glucose alert

The High Glucose Alert was evaluated for its ability to detect glucose levels at 250 mg/dL (13.8 mmol/L), or above, using the blood glucose meter. As a reference, with the High Glucose Alert set at 250 mg/dL (13.8 mmol/L), 64% (404/632) of high glucose events were detected by the Guardian RT. Better detection of high blood glucose can be obtained by setting the High Glucose Alert level lower. For example, setting the High Glucose Alert at 190 mg/dL (10.6 mmol/L), instead of 250 mg/dL (13.8 mmol/L), increases the ability to detect high blood glucose levels from 64% to 94% (see the following table).

Sometimes the Guardian RT will alert when the blood glucose levels are not high. When the Guardian RT High Alert was set at 250 mg/dL (13.8 mmol/L) in this study, 13.1% of the results were considered false alerts (actual blood glucose values are less than 225 mg/dL (12.5 mmol/L)). This percentage may be exaggerated because blood glucose may be rising when the Guardian RT alerts. The following table shows the percent of High Glucose readings correctly identified by the Guardian RT for specific settings.

Guardian RT High Alert Setting (mg/dL)	Guardian RT High Alert Setting (mmol/L)	True Alert Rate <sup>a</sup>	False Alert Rate <sup>b</sup>
190	10.6	94%	40%
200	11.1	91%	36%
225	12.5	81%	21%
250	13.8	64%	13%

a. True Alert Rates are the % of times when the glucose level was at or above the alert setting and the alert sounded.

b. False Alerts Rates are the % of times when the Guardian RT Sensor alarmed but the blood glucose level was lower than the alert setting.

Decreasing the High Alert settings will improve the ability to detect high blood glucose events, but it will also increase the frequency of Guardian RT false alerts for blood glucose levels not above the target value. You should consider this trade-off between the improved ability to detect true high blood glucose versus the increased number of false alerts when setting the high alert threshold.

# Glossary

## A

**A1C (HbA1c) test** - A 2-3 month average of blood glucose values expressed in percent. The normal range varies with different labs and is expressed in percent (such as 4 - 6%).

**Accept** - Pressing the **ACT** button to approve the selection or setting.

**Active insulin** - Bolus insulin that has been delivered to your body, but has not yet been used.

**Adverse reaction** - An unexpected, unpleasant or dangerous reaction to a sensor when it is inserted into the body. An adverse reaction may be sudden or may develop over time.

**Alarm** - Audible or vibrating (silent) notice that indicates the pump is in Attention mode and immediate attention is required. Alarms are prefixed in the alarm history with the letter A.

**Alarm clock** - Feature you can set to go off at specified times of the day.

**ALARM HISTORY** - Screen that displays the last 36 alarms/errors that have occurred on your pump.

**Alarm icon** - a solid circle that shows at the top of the screen and the pump beeps or vibrates periodically until the condition is cleared (see Attention mode).

**Alert** - Audible or vibrating (silent) indicator that notifies you the pump needs attention soon or that you should be reminded of something. Insulin delivery continues as programmed.



**Alert icon** - an open circle that appears at the top of the screen and the pump beeps or vibrates periodically to remind you of the condition (see Special mode).

**Attention mode** - Operating mode that stops all current insulin delivery. This mode indicates an alarm or

condition exists that requires immediate attention.

**AUC Limits** - The AUC Limits feature allows you to see how long your sensor glucose measurements are outside your target range. Your target range is the area between your Low AUC Limit and your High AUC Limit. When you set the AUC Limits, you select the Low AUC Limit and High AUC Limit you want for your target range.

## B

**Backlight** - Pump screen light. Turns on whenever the  button is pressed or in combination with the  button if not on the HOME screen. The backlight also appears during alarms and alerts, except for LOW BATTERY alert and OFF NO POWER alarm.

**Basal patterns** - The user can program up to three different basal rate patterns into the

pump for the delivery of basal insulin: Standard, A, and B. For each pattern, there is an option of setting up to 48 basal rates.

**Basal rate** - The pump setting that provides a continuous infusion of insulin to keep the blood glucose stable between meals and during the night. Basal insulin mimics pancreatic insulin delivery—which meets all the body's non-food related insulin needs.

**BASAL REVIEW screen** - shows the basal rates programmed in the pump, with the 24-hour total for each rate.

**BG** - Blood Glucose

**BG Reminder** - Feature that you can set to remind you to check your blood glucose after a bolus.

**BG Target** - Normal blood glucose level

**BG Units** - Blood glucose units used by the pump (mg/dL or mmol/L).

**Block** - Feature that restricts access to all programming except suspend, selftest and the delivery of a bolus with the remote control.

**Blood glucose (BG)** - A form of digested sugar in the bloodstream. Glucose is the major source of energy for living cells, and is carried to each cell through the blood

stream. Cells cannot use glucose without the help of insulin.

**Bolus** - A dose of insulin given to cover an expected rise in blood glucose (such as the rise after a meal) or to lower a high blood glucose down to target range.

**BOLUS HISTORY** - This screen displays the last 24 boluses delivered by your pump.

**Bolus Wizard® feature** - Calculates the bolus amount based on personal information of the pump user.

## C

**Cal Reminder** - The value of the Cal Reminder is the amount of time before the current calibration value expires when the user wants to be reminded to calibrate by having the pump issue a METER BG BY alert. For example, if the Cal Reminder is set to two hours, the METER BG BY alert will occur two hours before the calibration is required.

**Cal Repeat** - Once a METER BG NOW alert occurs, the pump will not repeat the alert until after this selected Cal Repeat time.

**Calibrate** - Check, adjust, or set to a standard (calibrate your pump).

**Cannula** - A short, thin, and flexible tubing at the end of the infusion set that is inserted into the subcutaneous tissue to deliver insulin.

**Carb ratio (Carbohydrate ratio)** - Used when counting carbohydrates in grams. The amount of carbohydrates covered by one unit of insulin. (Also see exch ratio.)

**Carb units** - The food entry when using the Bolus Wizard feature. Entered as (carbohydrate) grams or exchanges.

**Carbohydrate** - One of the three main sources of energy or calories in food. Carbohydrates are mainly sugars found in fruits, milk, and starches that the body breaks down into glucose.

**CH** - Carbohydrate

**Contraindication** - A condition that makes a specific treatment or procedure NOT advisable. A contraindication is literally contra- (against) an indication, against something that is indicated as advisable or necessary.

**Correction bolus** - The amount of insulin needed to return a high blood glucose level back down to target range.

## D

**Daily totals** - Shows the total insulin delivered (basal and bolus) in the last 24-hours. Maximum records: 32 days

**Default** - A setting or value for your pump that is assigned automatically by your system. Some default settings cannot be changed; other default settings remain in effect until you change them.

**Diabetic Ketoacidosis (DKA)** - A serious condition that occurs when the insulin levels are low, blood glucose level are elevated, and the body uses fat for energy. This process produces ketones which upset the body's acid-base balance leading to a potentially life threatening situation.

**DKA** - Diabetic Ketoacidosis

**Dual Wave® bolus** - Combination of a Normal bolus that is delivered immediately, then followed by a Square Wave bolus. The Square Wave portion is delivered evenly over a period of time.

**Duration** - Amount of time it takes to administer a bolus or basal delivery. Also, length of time for an action or condition.

## E

**Easy bolus™** - Method of delivery for a Normal bolus using the Easy Bolus button .

**Electromagnetic compatibility** - The condition that exists when systems and devices that use electromagnetic energy operate properly without causing or suffering accidental electromagnetic interference to or from other electromagnetic devices.

**Electrostatic discharge** - The rapid, spontaneous transfer of electrostatic charge induced by a high electrostatic field. The charge usually flows through a spark, known as static discharge, between two objects at different electrostatic levels as they approach each other (for example, when people touch each other after dragging their feet on a carpet).

**Exch ratio** - (Exchange ratio) Used when counting carbohydrates as exchanges. The amount of insulin required to cover one (1) carbohydrate exchange. (Also see carb ratio.)

**Express bolus** - Method of delivery for any bolus type using the **EXPRESS BOLUS** button .

## F

**Fingerstick** - One method used to test blood glucose by taking a sample of blood for testing from a finger using a lancet or automatic finger puncture device.

**Food bolus** - A dose of insulin given to cover the expected rise in blood glucose that occurs after eating.

## G

**Gastroparesis** - A condition of the digestive system that slows down the emptying of food from the stomach.

**Generate** - create a result (your pump will generate a graph).

**Glucagon Emergency Kit** - An injectable form of glucagon that can be used to treat severe low blood glucose levels (hypoglycemia). A Glucagon Emergency Kit can be obtained in a pharmacy with a prescription.

**Glucose tablet** - A simple sugar in tablet form, that is taken orally to treat low blood glucose (hypoglycemia). Glucose tablets can be purchased from the Medtronic Diabetes online store at [www.medtronicdiabetes.com](http://www.medtronicdiabetes.com) as well as drug stores and pharmacies.

# H

**HbA1c** - Glycosylated hemoglobin

**HDL** - High-density lipoprotein A complex of lipids and proteins in approximately equal amounts that functions as a transporter of cholesterol in the blood.

**High Glucose** - The pump displays an alert if the sensor indicates that your sensor glucose is at or above this value. You have the option to turn this feature on or off.

**High Repeat** - For the High Glucose, High Predictive, and Rising Rate of Change alerts, allows the user to set the delay between the first alert and any subsequent alerts. This will allow the user to avoid getting an alert every five minutes until the condition is corrected.

**Hold** - Press and continue to press a pump button.

**Hypoglycemia** - A condition in which blood glucose values are low below 3.9 mmol/L (70 mg/dL). Symptoms may include behavioral changes, pale complexion, hunger, sweating, sudden weakness, headache, confusion, drowsiness, non-responsiveness to questions, and the most serious: seizure,

convulsion or loss of consciousness.

# I

**Idle** - The pump is at the HOME screen.

**Increment** - A small increase or decrease in a measurement.

**Indication** - A condition that makes a specific medical treatment or procedure advisable or necessary.

**Infusion set** - Flexible tubing with a reservoir connector and an infusion site. This tubing delivers insulin from the pump to the body.

**Infusion site** - The end of the infusion set held to the body with a tape. It consists of a cannula and an introducer needle.

**Initialize** - To set a starting value or prepare your pump, transmitter or sensor for use.

**Insulin** - A hormone that helps the body use glucose (sugar) for energy. The beta cells of the pancreas make the insulin.

**Insulin sensitivity** - The amount by which your blood glucose (BG) level is reduced by one unit of insulin. (Bolus Wizard feature data)

**Insulin to carbohydrate ratio** - The amount of insulin required to cover a given

number of carbohydrates. This ratio helps you estimate what size bolus you should take when eating carbohydrates. Your healthcare professional will determine your insulin to carbohydrate ratio.

**Interstitial fluid** - The fluid between the cells in the human body.

**Introducer needle** - This needle allows the insertion of a cannula or a sensor into the subcutaneous tissue. It is removed and discarded after insertion leaving only the cannula or the sensor in the body.

**IPX7** - Protected against water immersion. Immersion for 30 minutes at a depth of up to 1 meter.

# K

**Ketone** - A chemical created by the human body when there is not enough insulin in the blood.

**kPa (kilopascal)** - A unit of measurement for quantifying force. Used to measure atmospheric pressure. Equivalent to 10,000 dynes per square centimeter.

## L

### **LDL (Low-density lipoprotein) -**

A complex of lipids and proteins, with greater amounts of lipid than protein, that transports cholesterol in the blood.

**Link** - To turn on and setup the meter option that allows the pump to receive BG readings from a meter that communicates with your pump.

**Log** - A record of measurements, alarms or other actions by your pump.

**Low Glucose** - The pump displays an alert if the sensor indicates that your sensor glucose is at or below this value. You have the option to turn this feature on or off.

**Low Repeat** - For the Low Glucose, Low Predictive, and Falling Rate of Change alerts, allows you to set the delay between the first alert and any subsequent alerts. This will allow the user to avoid getting an alert every five minutes until the condition is corrected.

**Low resv warning** - Programmable warning that notifies you with an alert when either a specified number of units remain in the reservoir or a specified amount of time remains

before the reservoir will be empty.

## M

**Manual bolus** - Selectable item available in the BOLUS MENU when the Bolus Wizard feature is active. It is one method of programming a bolus without the Bolus Wizard feature. (see *Set bolus*)

**Marker** - A measurement of a specific event - such as a BG measurements, exercise, or the amount of insulin used.

**Max basal rate** - The maximum amount of basal insulin that the pump will deliver at one time. (set by the user)

**Max bolus** - The maximum amount of bolus insulin that the pump will deliver at one time. (set by the user)

**Meter** - An optional blood glucose meter powered by MWT1 technology. Your pump can be programmed to receive your BG readings from this meter.

**Meter option** - Feature that allows the pump to receive BG readings from a meter powered by MWT1 technology.

**MWT1 technology** - MWT1 is the wireless Radio Frequency (RF) technology that is used to transmit information from the

meter to the pump. You can program your pump to automatically receive your BG reading from this meter.

## N

**Normal bolus** - An immediate delivery of a specified unit amount of insulin.

**Normal mode** - Regular operating mode. No special features are active, no alert or alarm conditions exist. Insulin delivery is normal during this mode.

**Now portion** - The normal portion of a Dual Wave bolus. The now portion delivers immediately and is then followed by the Square portion.

## O

**Occlusive dressing** - A bandage that seals a wound from air or bacteria.

## P

**Pattern A/B** - Basal pattern that supports activities that are not a part of your day-to-day routine, but are normal in your lifestyle. Such activities could be a sport that you do once a week or a change in your sleep pattern over the

weekend, extended periods of higher or lower activity, or menses.

**Predictive alerts** - These alerts can be used so that you receive alarms before the sensor glucose measurements reach your glucose limits. This alert predicts when the sensor glucose measurements will reach your glucose limits by using information about your glucose limits and recent sensor glucose measurements.

**Press** - To push and release a button.

**PSI** - Pound-force per square inch.

**Pump S/N** - Pump S/N is the serial number of the pump currently in use.

## R

**Rate of Change alerts** - These alerts can be used to set up the system so that you receive alerts if the sensor glucose measurements change too rapidly for your needs. You can set the limit for these alerts so that you receive an alert whenever the sensor glucose measurements fall or rise faster than the limit.

**Reservoir** - The syringe that holds insulin.

**Reset** - To set again, or change the information (reset your glucose values).

**Resume** - Restarts basal delivery after the pump is suspended.

**Rewind** - The pump drive moves back to its starting position to prepare the pump for a new reservoir.

**RF** - Radio frequency

## S

**Scroll** - Press the up or down arrow buttons to move through the screen text.

**Select** - Pressing the up or down arrow buttons to highlight a desired screen item.

**Sen-serter** - The Sen-serter is indicated as an aid for insertion of the Medtronic Diabetes glucose sensor.

**Sensitive** - Easily irritated (sensitive skin), or able to measure very slight differences (a sensitive instrument).

**Sensor Age** - Sensor age is the amount of time, in days and hours, since the sensor was first inserted.

**Sensor features** - Optional continuous glucose monitoring capabilities.

**Sensor glucose (SG)** - Glucose levels in the fluid under your skin measured by the sensor.

**Sensor icon** - An icon on your pump that tells you whether

the Sensor feature is On or Off.

**Set** - To enter or establish a value for your pump (set your BG Reminder).

**Set bolus** - Selectable item available in the BOLUS MENU when the Bolus Wizard feature is inactive. One method of programming a bolus without the Bolus Wizard feature. (See *Manual bolus*.)

**S/N#** - Serial number.

**Special mode** - Operating mode that indicates one or more special functions is active or a condition exists that requires attention.

**Square Wave<sup>®</sup> bolus** - Immediate bolus delivered evenly over a specified time period (30 minutes to 8 hours).

**Square Wave portion** - (Sq) The second part of a Dual Wave bolus. The Square Wave portion delivers evenly over a period of time after the NOW portion delivers.

**Stabilize** - To make steady or keep from changing (stabilize your blood glucose).

**Standard pattern** - Your normal basal that supports your usual day-to-day activity. When the Patterns feature is off, the pump uses your standard basal pattern.

**Status** - The condition of a part of your system (battery status, alarm/alert status).

**Status screen** - Displays the current operations of the pump, including active functions, the most recent basal and bolus deliveries, reservoir information, and battery condition.

**Step** - Measurement of insulin that you set and use for Easy Bolus and other bolus deliveries.

**Sterile** - Free from substances or germs that could cause infection.

**Sterile gauze** - A thin medical bandage with loose weave that is free from substances or germs that could cause infection.

**Submerge** - To place under water or cover completely with water.

**Suspend** - Function that stops all current insulin deliveries. The basal delivery is paused until restarted.

## T

**Temp** - Temporary

**Temp basal** - (Tmp basal)  
Temporary one-time basal insulin with a specified amount and duration. Used to support insulin needs for special activities or conditions

that are not part of the normal daily routine.

**Timeout** - If you do not enter information or do something in a specific length of time, your pump automatically stops what it is doing and goes to the HOME screen.

**Transmitter** - The device that sends a signal to your pump with information from your sensor.

**Transmtr Batt** - The status of the transmitter battery. Possible values are **Good**, **Low**, or **Bad**.

**Transmtr ID** - The serial number of the transmitter currently in use.

**Transmtr Ver** - The software version of the transmitter currently in use.

## W

**Weak Signal** - The pump displays an alert if it has not received data from the sensor for an amount of time that you set.





# Index

## Numerics

- 3-hour graph 123
- 6-hour graph 123
- 12-hour graph 124
- 24-hour graph 124

## A

- accessories 3
  - activity guard 4
  - CareLink USB 3
  - holster 3
  - leather case 4
  - meter 3
  - pump clip 3
  - remote control 3
  - sensor 3
  - transmitter 3
- active insulin 72
- Active insulin time setting 73
- adverse reactions 9
- alarm clock 138
- Alarm conditions 165
- alarm frequency 177
- ALARM HISTORY screen 129
- Alarm types
  - A (alarm) 165
  - Auto off 165
  - Batt out limit 165

- Bolus stopped 166
- Button error 166
- Check settings 155, 166
- E (error) 166
- Empty reservoir 166
- Failed batt test 166
- Finish loading 166
- Max delivery 168
- Max fill reached 167
- Motor error 168
- No delivery 153, 168
- No reservoir 168
- Off No power 168
- Reset 168
- Weak battery 169
- Alarms
  - responding to 164
  - review 129
- alert frequency 177
- Alert Silence 126
  - default settings 197
  - options 127
- Alert Silence alert 159
- alert type
  - Setting your 129
- alerts 159
  - Alert Silence 159
  - Cal Error 162
  - Change Sensor 161
  - Charge Transmtr 161
  - Fall Rate 163
  - for alert conditions 159
  - low reservoir alert 159

- High Predicted 163
- High XXX MG/DL 163
- Lost Sensor 160
- Low Predicted 163
- Low Transmtr 161
- Low XX MG/DL 162
- Meter BG By 162
- Meter BG Now 162
- Missed Bolus 160
- Rise Rate 163
- sensor 159
- Sensor End 161
- Sensor Error 164
- Weak Signal 159
- Area Under the Curve 136
- areas
  - inserting infusion set 57
- Attention mode 20
- AUC calculation 136
- AUC Limits 136
  - default settings 197
  - entering 136
- auto-off 130

## B

- backlight 19, 229
- BASAL MENU 22
- basal rate
  - daily 45
  - maximum 46
  - patterns 92

- programming 44
- stop delivery of 47
- temp 95
- bathing 128
- battery, pump 173, 183
  - install 14
  - removing 154
  - short life 154
- beep/vibrate, alert type 19
- BG, entering 38
- BG Reminder 28, 36, 75, 83, 87
- BG Targets 71
- BG units 70
  - default settings 196
- bleeding 7, 9
- Block feature 140
  - turn on 140
- BLOCK OPTION screen 140
- blood glucose
  - checking 115
  - entering incorrect number 162
  - rapid change 162
- blood glucose measurements 38, 110
  - non-calibration meter, examples of 38
- blood glucose units
  - default settings 196
  - setting 104
- bolus
  - basic 27
  - details 33
  - history 32
  - manual 82
  - maximum limit 35
  - stop delivery of 47
- bolus delivery
  - Bolus Wizard 74
  - Easy Bolus 87
- bolus delivery, methods for
  - normal
  - remote control 3

- BOLUS MENU 21
- bolus types
  - Dual Wave 81
  - Normal 27
  - Square Wave 81
- Bolus Wizard
  - about 63
  - entering meter BG 116
  - estimate details 34
  - HIGH BG warning 67
  - how it works 66
  - LOW BG warning 67
  - MAX BOLUS EXCEEDED warning 67
  - maximum delivery 67
  - on/off 68
  - review settings 74
  - settings 63, 64, 65, 66
    - Active insulin time 66
    - BG Target range 66
    - BG units 64
    - Carb ratios 64
    - Carb units 64
    - Insulin sensitivity 65
  - specifications 187
  - your BG reading 63
- bruising 9
- buttons, pump 13, 15

## C

- Cal Error alert 161, 162
- Cal Reminder 162
  - default settings 196
  - setting 110
- CAL REMINDER screen 110
- Cal Repeat
  - default settings 196
  - setting 110
- CALIBRATE HISTORY 127
- calibrating
  - frequency 115

- calibrating sensor 115
  - frequency 115
- calibrating your system
  - Capture Event feature 37
- calibration
  - successful 127
  - values 127
  - when to 115
- Calibration history 127
- CAPTURE EVENT 22
- Capturing Events 37
- Carb ratios
  - exchanges 69
  - grams 69
- carb units 68
- CARB UNITS screen 40
- CareLink Personal Software 37, 149
- CareLink USB 3
- Change Sensor alert 161
- Charge Transmtr alert 161
- charger 3
  - transmitter 114
  - water-tightness 174
- CHECK BG message 37
- checking
  - blood glucose 115
- cleaning
  - Sen-serter® 175
  - transmitter 174
- cleaning the pump 174
- Clear settings 144
- connecting transmitter to tester 169
- consumables 2
- continuous glucose graphs
  - reading 120
- continuous graph display 112
- continuous sensor glucose levels 121
- correction bolus 27, 74, 75
- correction estimate 116, 187

## D

- Daily totals 132
- DAILY TOTALS screen
  - Review 131
- default settings
  - Alert Silence 197
  - AUC Limits 197
  - BG Units 196
  - Cal Reminder 196
  - Cal Repeat 196
  - Glucose Alerts 194
  - Glucose Limits 195
  - Glucose Limits 1 195
  - Glucose Limits 2 through 8 195
  - High Glucose Limit 195
  - High Repeat 195
  - insulin delivery 192
  - Low Glucose Limit 195
  - Low Repeat 196
  - Predictive Alerts 196
  - sensor 194
  - sensor features 194
  - sensor glucose graph timeout 197
  - Weak Signal 196
- DELIVERY STATS screen 134, 135
- discarding
  - transmitter 174
- disconnecting
  - tester from transmitter 170
- downloading pump data 3
- Dual Wave bolus programming
  - with Bolus Wizard 85
  - without Bolus Wizard 82
- dual/square option
  - on-off 82

## E

- Easy bolus 87, 88
  - cancel 89
  - deliver 89
  - step value 88
- electromagnetic emissions 198
- Electromagnetic environment 203
- electromagnetic immunity 199
- emergency kit 2
- emissions 198
- ENTER BG screen 38
- ENTER FOOD screen 40
- entering
  - carbohydrate information 40
  - exercise information 41
  - insulin injection information 39
  - meter BG 115, 116, 117
    - alert 115
    - Bolus Wizard 116
    - frequency 115
  - Other markers 41
- Entering meter BG measurements 38
- ESC 4
  - cancels programming 22
- Examples of real-time sensor glucose graphs 123
- exercising
  - precaution 9
- EXPRESS BOLUS button 16

## F

- Fall Rate alert 163
- Fall Rate of Change
  - setting alert frequency 107
- FILL TUBING screen 56

- filling
  - cannula 60
  - reservoir 52
  - tubing 56
- FIND LOST SENSOR 171
- food bolus 27, 64, 66, 74, 75
- food entry 63, 74
- food estimate 187
- frequency
  - alarm 177
  - alert 177

## G

- Glucose Alerts
  - default settings 194
  - turning on 104
- GLUCOSE ALERTS screen 104
- Glucose Limits
  - default settings 195
- Glucose Limits 1
  - default settings 195
- Glucose Limits 2 through 8
  - default settings 195
- glucose monitoring settings
  - entering 104, 105, 108, 109, 110, 136
  - selecting BG units 105
  - setting AUC limits 136
  - setting Glucose Limits 104
  - setting Glucose Limits, guidelines 105
  - setting Glucose Limits, setting start time 105
  - setting Glucose Limits, switching limits off 105
  - setting Predictive glucose alert 108

- setting Rate of Change alerts 109
- setting the Cal Reminder 110
- turning on Glucose Alerts 104
- graphs 121
  - continuous glucose 120
  - continuous sensor glucose levels 121
  - differentiating between current and earlier events in 121
  - opening 121
- green light transmitter 169

## H

- high BG levels
  - Bolus Wizard and 67
- HIGH BG warning 67
- High Glucose Limit alert 163
  - default settings 195
  - setting 104
- High Predicted alert 163
- High Predictive alert 108
- High Repeat
  - default settings 195
  - setting 107
- High Repeat alert setting 107
- High sensor glucose alert 163
- history
  - alarms 129
  - bolus delivery 32
  - calibration 127
  - delivered insulin 60
  - sensor alert 127
  - user settings 144
- HOME screen 17

- infection 7, 9
- infusion set 2, 51
  - changing your 54
  - inserting 57, 58
    - best sites 58
    - rotating sites 58
- initialization 115, 120
- Insulin sensitivity 70
- irritation
  - occlusive dressing 7, 9
  - skin 7
- ISIG 170

## L

- Language setting 27
- list
  - calibration values 127
  - sensor alert 127
- Lock keypad feature 141
- Lost Sensor alert 160
- low battery
  - affects meter option 148
  - affects remote control 139
  - affects selftest 142
  - affects your alert type 129
- low BG levels
  - Bolus Wizard and 67
- LOW BG warning 67
- Low Glucose
  - setting alert frequency 107
- Low Glucose Limit
  - default settings 195
  - setting 104, 162
- Low Predicted alert 163
- Low Predictive
  - setting alert frequency 107

- Low Repeat
  - default settings 196
  - setting 107
- low reservoir alert 159
- Low resv warning feature 130
- Low sensor glucose alert 162
- low transmitter battery 161
- Low Transmtr alert 161

## M

- MAIN MENU 21
- Max basal rate 46
- MAX BOLUS EXCEEDED warning 67
- Maximum bolus limit 35
- menus 21
- meter 3, 63
  - entering BG 115, 117
- Meter BG By alert 162
- METER BG NOW alert 110
- Meter BG Now alert 162
- meter IDs
  - add, delete, review 148
- meter option
  - rules 147
- METER OPTION screen 148
- METER STATS screen 135, 136
- MiniLink transmitter 3
- Missed Bolus alert 160
- Missed Bolus Reminder 91
- modes
  - Attention 20
  - Normal 20
  - Special 20
- MWT1 3
- MWT1 technology 63, 117

## N

- no delivery 153

Normal bolus  
with Bolus Wizard 74  
without Bolus Wizard 27  
Normal mode 20  
Now 86  
Now portion  
of the Dual Wave bolus 83, 86

## O

occlusive dressing  
irritation 7, 9  
reaction 7, 9  
Other markers 41

## P

pain 9  
Patterns  
basal 92  
on/off 92  
pattern A, B 92  
Program a basal pattern 92  
Select a basal pattern 93  
standard basal pattern 92  
Personal reminders 138  
personal settings 63  
practicing 55  
precaution  
sensor 9  
Predictive Alerts 196  
PREDICTIVE ALERTS LOW/  
HIGH screen 108  
programming sensor 103  
pump  
battery compartment 13  
buttons 13, 15  
if you remove your 23  
screen 13, 17  
using in water 157  
warranty viii

## R

Rate of Change alerts  
sensitivity and alarm  
frequency 109  
reaction to occlusive  
dressing 7, 9  
reading the continuous  
glucose graphs 120  
RECONNECT OLD SENSOR 170  
Reminder, alarm clock 138  
remote control 3  
remote control IDs  
add, delete, review 139  
Remote control option  
turn on 139  
removing  
sensor 114  
removing your pump 23  
reservoir  
filling the 52  
inserting in your pump 55  
low reservoir warning 130  
plunger rod 52  
removing the 54  
transfer guard 52  
tubing connector 13  
RESERVOIR + SET 22  
reservoirs 2  
Restore settings 143  
REVIEW SETTINGS screen 112  
reviewing  
sensor settings 112  
rewinding your pump 55  
during practice 55  
RF communications 203  
RF features  
other devices 140  
remote control 138  
use on aircraft 10  
Rise Rate alert 163

## S

Save settings 143  
screens  
DELIVERY STATS 134, 135  
METER STATS 135, 136  
SENSOR STATS 135, 136  
scroll bar 19  
Scroll rate  
setting 35  
Selftest 141, 157  
Sen-serter®  
cleaning 175  
sensor  
alerts 127, 159  
history 127  
list 127  
calibrating 115, 162  
default settings 194  
disconnected 160  
information 119  
inserting 114  
ISIG 170  
life 161  
precaution 9  
programming 103  
reconnecting 170  
removing 114  
setting up 103  
signals 164  
too high 164  
too low 164  
stabilizing 162  
starting 114  
status screens 119  
Transmitter ID 111  
using in water 128  
SENSOR ALERT HISTORY 128  
sensor alerts  
Alert Silence 159  
Cal Error 162  
Change Sensor 161

Charge Transmtr 161  
 Fall Rate 163  
 High Predicted 163  
 High XXX MG/DL 163  
 Lost Sensor 160  
 Low Predicted 163  
 Low Transmtr 161  
 Low XX MG/DL 162  
 Meter BG By 162  
 Meter BG Now 162  
 Missed Bolus 160  
 Rise Rate 163  
 Sensor End 161  
 Sensor Error 164  
 Weak signal 159  
 Sensor Demo 113  
 SENSOR DEMO ON/OFF  
   screen 113  
 Sensor End alert 161  
 Sensor Error alert 164  
 Sensor function 21  
 sensor glucose graph  
   timeout 112  
     default settings 197  
 sensor glucose graphs  
   continuous display 112  
   WARM UP 120  
 sensor glucose levels  
   graphs 121  
 sensor graph  
   example 113  
 SENSOR ON/OFF screen 103  
 SENSOR STATS screen 135, 136  
 SENSOR STATUS 119  
 SET AUC LIMITS screen 136  
 SET CAL REMINDER screen 110  
 SET CAL REPEAT screen 110  
 SET FALL RATE LIMIT screen 109  
 SET GLUCOSE LIMITS 1  
   screen 106  
 SET GRAPH TIMEOUT screen 112  
 SET HI ALERT REPEAT  
   screen 107  
 SET LO ALERT REPEAT  
   screen 107  
 SET RISE RATE LIMIT screen 110  
 SET TIME SENSITIVITY LOW/  
   HIGH screen 108  
 SET TRANSMITTER ID screen 111  
 SET WEAK SIGNAL screen 112  
 setting  
   Cal Reminder 110  
   Cal Repeat 110  
   High Repeat 107  
   Low Repeat 107  
   sensor glucose graph  
     timeout 112  
 setting up sensor 103  
 settings  
   entering 104, 105, 108,  
   109, 110, 136  
   glucose monitoring  
     settings, setting AUC  
     limits 136  
   glucose monitoring  
     settings, setting  
     Glucose Limits,  
     guidelines 105  
   glucose monitoring  
     settings, setting  
     Glucose Limits,  
     setting start time 105  
   glucose monitoring  
     settings, setting  
     Predictive glucose  
     alert 108  
   glucose monitoring  
     settings, setting Rate  
     of Change alerts 109  
   glucose monitoring  
     settings, setting the  
     Cal Reminder 110  
   glucose monitoring  
     settings, turning on  
     Glucose Alerts 104  
   glucose  
   monitoring 104, 105,  
   108, 109, 110, 136  
   setting AUC limits 136  
   setting Glucose Limits 104  
   setting Glucose Limits,  
   guidelines 105  
   setting Glucose Limits,  
   setting start time 105  
   setting Predictive  
   glucose alert 108  
   setting Rate of Change  
   alerts 109  
   setting the Cal  
   Reminder 110  
   turning on Glucose  
   Alerts 104  
   sensor glucose graph  
   timeout 112  
   settings, reviewing 112  
 showering 128  
 silent alerts 126  
 skin  
   bleeding 7, 9  
   bruising 9  
   infection 7, 9  
   redness 9  
   swelling 7, 9  
 Special mode 20  
 Square portion  
   of the Dual Wave bolus 86  
 Square Wave bolus programming  
   with Bolus Wizard 85  
   without Bolus Wizard 82

- starting sensor
  - steps before 114
- STATUS screen 22
- Step value setup 88
- supplies, ordering 3
- Suspend function 21, 47
- swelling 7, 9
- swimming 128
- system initialization 115

## T

- Temp basal
  - canceling 100
  - delivering 99
  - rates 95
  - selecting type 98
  - verify delivery 100
- temp basal types
  - Insulin rate 95
  - Percent of basal 97
- tenderness 9
- terms and symbols 4
- test plug. See tester 169
- tester 3
  - connecting to transmitter 169
  - disconnecting from transmitter 170
  - transmitter 114
  - water-tightness 174
- therapy follow-up
  - Recommended 151
- time and date, setting 25
- transmitter
  - charger 114
  - cleaning 174
  - depleted battery 161
  - discarding 174
  - disconnected 160
  - green light 169
  - low battery 161

- tester 3, 114
  - using in water 128
  - warning 7
- Transmitter ID
  - setting 111
- troubleshooting 170
- tubing
  - filling 56

## U

- user safety
  - adverse reactions 9
- User settings 142
- User Settings screen 157
- using the Capture Event feature 37
- Utilities 129
- UTILITIES MENU 22

## V

- viewing
  - calibration values 127
  - sensor alert history 127

## W

- WARM UP 120
- warnings
  - sensor 7
  - transmitter 7
- warranty viii
- water, using your system in 128
- water-tightness 128
  - charger 174
  - tester 174
- Weak Signal 159
  - default settings 196
- Weak Signal alert 159

- Weak Signal feature 111
  - description 111



