

RICOH

SLR Digital Camera

PENTAX *K-1*

Operating Manual

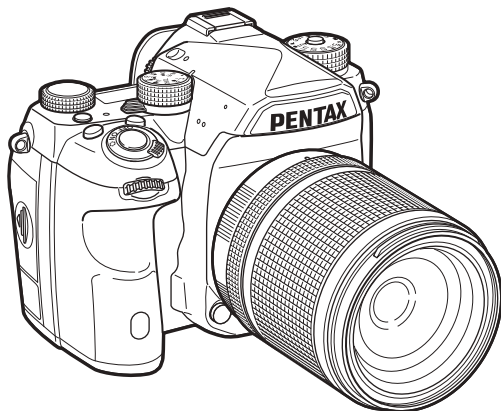

Introduction **1**

Getting Started **2**

Shooting **3**

Playback **4**

Sharing **5**

Settings **6**

Appendix **7**

To ensure the best performance from your camera, please read the Operating Manual before using the camera.

Checking the Contents of the Package



Hot shoe cover Fk
(Installed on camera)



Eyecup Ft
(Installed on camera)



ME viewfinder cap



Sync socket 2P cap
(Installed on camera)



Body mount cap K II
(Installed on camera)



Triangular ring and protective cover
(Installed on camera)



Battery grip terminal cover
(Installed on camera)

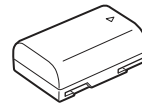

Rechargeable lithium-ion
battery D-L190

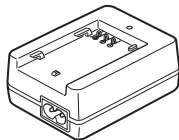

Battery charger
D-BC90



AC plug cord

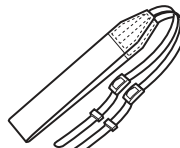

Strap
O-ST162

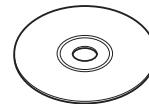

Software (CD-ROM)
S-SW162



Operating Manual (this manual)

Lenses you can use

Lenses that can be used with this camera are D FA, DA, DA L, FA, and FA J lenses and lenses that have an **A** (Auto) position on the aperture ring. To use any other lens or accessory, see p.108.

Introducing the K-1	1
Getting Started	2
Taking Pictures	3
Playback Functions	4
Sharing Images	5
Changing the Settings	6
Appendix	7

How to Use This Manual

1

Introducing the K-1p.7

Gives you an overview of the K-1.
Read this and get to know your K-1!

- Names and Functions of the Working Parts**p.7
- Display Indicators**p.11
- How to Change Function Settings**p.19
- Menu List**p.22

2

Getting Started.....p.32

Explains how to get your K-1 ready for shooting as well as basic operations.

- Attaching the Strap** p.32
- Attaching a Lens** p.32
- Using the Battery and Charger** p.33
- Inserting a Memory Card** p.35
- Initial Settings** p.36
- Basic Shooting Operation** p.39
- Reviewing Images** p.42

3

Taking Pictures.....p.43

Once you've confirmed that the camera works properly, try out the camera and take lots of pictures!

- Configuring the Capture Settings**p.43
- Taking Still Pictures**p.44
- Recording Movies**p.47
- Setting the Exposure**p.49
- Setting the Focus Method**p.51
- Setting the Drive Mode**p.56
- Setting the White Balance**p.63
- Using a Flash**p.65
- Controlling the Image Finishing Tone**p.66
- Correcting Images**p.68
- Using the GPS**p.72

4**Playback Functions.....p.76**

Explains various operations for playing back and editing images.

- Playback Mode Palette Itemsp.76**
- Changing the Playback Methodp.77**
- Editing and Processing Imagesp.81**

5**Sharing Images.....p.87**

Explains how to connect your K-1 to a computer or communication device to operate the camera and use images in the camera.

- Using the Camera with a Computerp.87**
- Using the Camera with a Communication Devicep.88**

6**Changing the Settingsp.98**

Explains how to change other settings.

- Camera Settingsp.98**
- File Management Settingsp.103**

7**Appendix.....p.107**

Provides other resources to get the most from your K-1.

- Restrictions on the Combinations of Special Functionsp.107**
- Functions Available with Various Lensesp.108**
- Functions when Using an External Flashp.111**
- Troubleshootingp.112**
- Main Specificationsp.115**
- Indexp.122**
- For Using Your Camera Safelyp.126**
- Care to be Taken During Handlingp.127**
- WARRANTY POLICYp.131**

There is a possibility that the illustrations and the display screen of the monitor in this manual are different from the actual ones.

Contents

How to Use This Manual2

Introducing the K-17

Names and Functions of the Working Parts7

Operating Controls	8
Adjusting the Angle of the Monitor	10

Display Indicators11

Monitor	11
Viewfinder	17
LCD Panel	18

How to Change Function Settings19

Using the Direct Keys	19
Using the Smart Function	19
Using the Control Panel	20
Using the Menus	21

Menu List22

Rec. Mode Menus	22
Movie Menus	26
Playback Menu	27
Set-up Menus	28
Custom Setting Menus	30

Getting Started32

Attaching the Strap32

Attaching a Lens32

Using the Battery and Charger33

Charging the Battery	33
Inserting/Removing the Battery	34
Using the AC Adapter	35

Inserting a Memory Card35

Initial Settings36

Turning the Camera On	36
Setting the Display Language	36
Setting the Date and Time	37

Setting the LCD Display	38
-------------------------------	----

Formatting a Memory Card	38
--------------------------------	----

Basic Shooting Operation39

Shooting with the Viewfinder	39
------------------------------------	----

Shooting with Live View	40
-------------------------------	----

Reviewing Images42

Taking Pictures43

Configuring the Capture Settings43

Memory Card Settings	43
----------------------------	----

Image Capture Settings	43
------------------------------	----

Movie Capture Settings	43
------------------------------	----

Setting the Angle of View	43
---------------------------------	----

Taking Still Pictures44

Exposure Modes	44
----------------------	----

EV Compensation	46
-----------------------	----

Recording Movies47

Playing Back Movies	48
---------------------------	----

Setting the Exposure49

Sensitivity	49
-------------------	----

AE Metering	50
-------------------	----

Setting the Focus Method51

Setting the AF Mode when Shooting with the Viewfinder	51
---	----

Setting the AF Mode during Live View	53
--	----

AF Fine Adjustment	54
--------------------------	----

Checking the Depth of Field (Preview)	55
---	----

Setting the Drive Mode56

Continuous Shooting	57
---------------------------	----

Self-timer	57
------------------	----

Remote Control	58
----------------------	----

Bracketing	59
------------------	----

Mirror Lock-up Shooting	60
-------------------------------	----

Multi-exposure	60
----------------------	----

Interval Shooting	61
-------------------------	----

Setting the White Balance	63	Sharing Images	87
Adjusting the White Balance Manually	64	Using the Camera with a Computer	87
Adjusting the White Balance with Color	64	Setting the Connection Mode	87
Temperature	64	Copying an Image in the Memory Card	87
Using a Flash	65	Operating the Camera with a Computer	88
Connecting a Flash	65	Using the Camera with a Communication	
Setting the Flash Mode	65	Device	88
Controlling the Image Finishing Tone	66	Enabling the Wi-Fi Function	88
Custom Image	66	Operating the Camera with a Communication	89
Digital Filter	67	Device	89
Correcting Images	68	Changing the Settings	98
Brightness Adjustment	68	Camera Settings	98
Shake Reduction	69	Customizing the Button/E-dial Functions	98
Lens Correction	69	Setting the Lighting on the Camera Body	100
Quality Level and Texture Adjustment	70	Saving Frequently Used Settings	101
Composition Adjustment	71	Displaying the Local Date and Time of the Specified	
Using the GPS	72	City	102
Performing a Calibration	73	Selecting Settings to Save in the Camera	103
Recording the Camera Route (GPS Logging)	74	File Management Settings	103
Shooting Celestial Bodies (ASTROTRACER)	75	Protecting Images from Deletion (Protect)	103
Playback Functions	76	Selecting the Folder/File Settings	104
Playback Mode Palette Items	76	Setting the Copyright Information	106
Changing the Playback Method	77	Appendix	107
Displaying Multiple Images	77	Restrictions on the Combinations of Special	
Displaying Images by Folder	78	Functions	107
Displaying Images by Shooting Date	78	Functions Available with Various Lenses	108
Playing Back Images Continuously (Slideshow)	79	Using the Aperture Ring	109
Displaying Rotated Images	79	Performing Catch-in Focus Shooting	110
Connecting the Camera to an AV Device	80	Setting the Focal Length	110
Editing and Processing Images	81	Functions when Using an External Flash	111
Copying an Image	81	Troubleshooting	112
Changing the Image Size	81	Sensor Cleaning	113
Correcting Color Moiré	82	Error Messages	114
Processing Images with Digital Filters	83	Main Specifications	115
Editing Movies	84	Operating Environment for USB Connection and	
Developing RAW Images	85	Provided Software	121

Index	122
For Using Your Camera Safely	126
Care to be Taken During Handling	127
WARRANTY POLICY	131

Regarding copyrights

Images taken with this camera that are for anything other than personal enjoyment cannot be used without permission according to the rights as specified in the Copyright Act. Please take care, as there are cases where limitations are placed on taking pictures even for personal enjoyment during demonstrations, performances or of items on display. Images taken with the purpose of obtaining copyrights also cannot be used outside the scope of use of the copyright as laid out in the Copyright Act, and care should be taken here also.

To users of this camera

- Do not use or store this camera in the vicinity of equipment that generates strong electromagnetic radiation or magnetic fields. Strong static charges or the magnetic fields produced by equipment such as radio transmitters could interfere with the monitor, damage the stored data, or affect the camera's internal circuitry and cause camera misoperation.
- The liquid crystal panel used for the monitor is manufactured using extremely high precision technology. Although the level of functioning pixels is 99.99% or better, you should be aware that 0.01% or fewer of the pixels may not light up or may light up when they should not. However, this has no effect on the recorded image.
- In this manual, the generic term "computer(s)" refers to either a Windows PC or a Macintosh.
- In this manual, the term "battery(ies)" refers to any type of batteries used for this camera and its accessories.

Regarding User Registration

In order to better serve you, we request that you complete the user registration, which can be found on the CD-ROM supplied with the camera or on our website.

Thank you for your cooperation.

<http://www.ricoh-imaging.com/registration/>

Names and Functions of the Working Parts

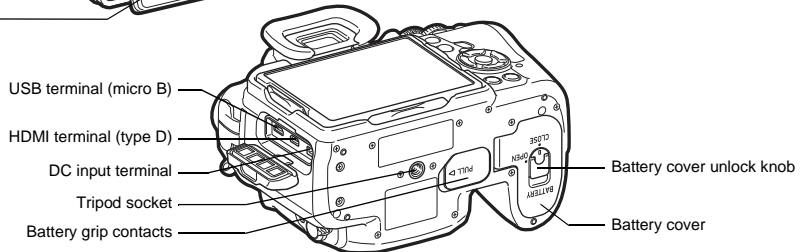
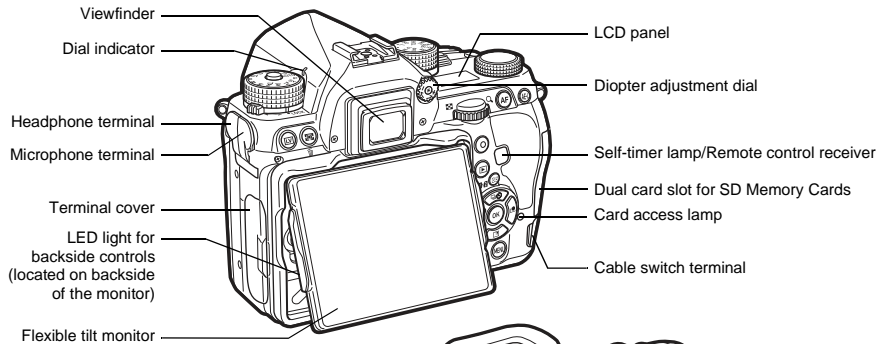
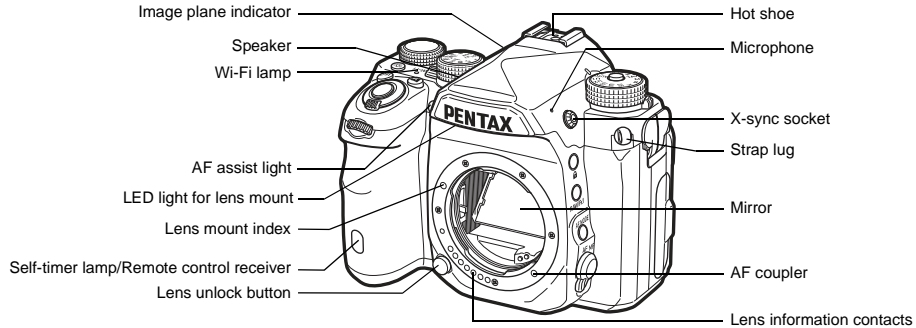

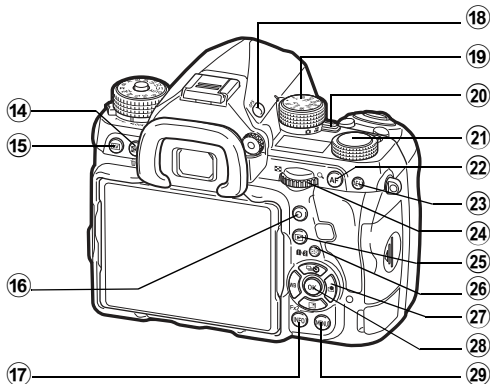
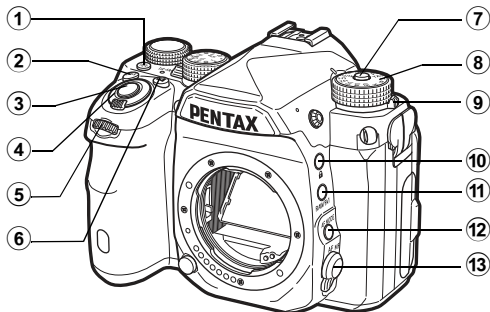

Operating Controls



- ① **Illumination button** (☀️)
Provides lighting for the LCD panel, the backside controls, the lens mount, and the card slot/connector. You can set whether to turn on the light or not for each part. (p.100)
- ② **ISO button** (ISO)
Press to change the ISO sensitivity. (p.49)

- ③ **Shutter release button** (SHUTTER)
Press to capture images. (p.40)
In playback mode, press halfway to switch to capture mode.
- ④ **Main switch**
Turns the power on or off, or activates the preview function. (p.36, p.55)
- ⑤ **Front e-dial** (☀️)
Changes the values for camera settings such as exposure. (p.45)
You can change the menu category when a menu screen is displayed. (p.21)
In playback mode, use this to select a different image.
- ⑥ **EV Compensation button** (±)
Press to change the exposure compensation value. (p.46)
- ⑦ **Mode dial lock button**
Press to allow the mode dial to be turned. (p.39)
- ⑧ **Mode dial**
Changes the capture mode. (p.44)
- ⑨ **Mode dial lock release lever**
Use this lever to release the mode dial lock to operate the mode dial without pressing the mode dial lock button. (p.41)
- ⑩ **Lock button** (L)
Temporarily disables dial and button operations to prevent misoperation. (p.41)
- ⑪ **RAW/Fx1 button** (Fxi)
You can assign a function to this button. (p.98)
- ⑫ **AF Mode button** (MODE)
Press to change the autofocus mode or the focusing area. (p.51)
- ⑬ **Focus mode switch**
Changes the focus mode. (p.51)
- ⑭ **AE Metering/Delete button** (M/⌫)
Press to change the metering method. (p.50)
In playback mode, press to delete images. (p.42)
- ⑮ **Live View button** (LV)
Displays the Live View image. (p.40)

- 16 Green button (O)**
Resets the value being adjusted.
Switches to ISO AUTO when adjusting the sensitivity.
- 17 INFO button (INFO)**
Changes the style of the display on the monitor. (p.11, p.15)
- 18 GPS button (GPS)**
Turns the GPS function on or off. (p.72)
- 19 Function dial**
Selects the function to change its settings with the setting dial. (Smart Function, p.19)
- 20 Capture mode selector switch**
Switches between  (still picture) mode and  (movie) mode. (p.39)
- 21 Setting dial**
Changes the settings for the function selected with the function dial.
- 22 AF button (AF)**
Available for adjusting focus, instead of pressing **SHUTTER** halfway. (p.51)
- 23 AE Lock button (AEL)**
Locks the exposure value before shooting.
In playback mode, the last JPEG image taken can also be saved in RAW format. (p.42)
- 24 Rear e-dial (e)**
Changes the values for camera settings such as exposure. (p.45)
You can change the menu tabs when a menu screen is displayed. (p.21)
You can change camera settings when the control panel is displayed. (p.20)
In playback mode, use this to magnify the image or display multiple images at the same time. (p.42, p.77)
- 25 Playback button (P)**
Switches to playback mode. (p.42) Press the button again to switch to capture mode.
- 26 Change AF Point/Card slot switch button (AF/1/2)**
Enables changing the focusing area. (p.52)
In playback mode, press this button to switch between the memory cards inserted in the two slots, SD1 and SD2. (p.42)
- 27 Four-way controller (▲▼◀▶)**
Displays the Drive Mode, White Balance, or Custom Image setup menu. (p.19)
When a menu or the control panel is displayed, use this to move the cursor or change the item to set.
You can assign a function to ▼ and use it as the Fx2 button (**Fx2**). (p.98)
Press ▼ in single image display of the playback mode to display the playback mode palette. (p.76)
- 28 OK button (OK)**
When a menu or the control panel is displayed, press this button to confirm the selected item.
- 29 MENU button (MENU)**
Displays a menu. Press this button while the menu is displayed to return to the previous screen. (p.21)

About the Four-way Controller

In this manual, each button of the four-way controller is indicated as shown in the illustration on the right.

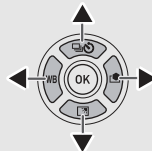

About the Indicator Lamps

You can set the illumination settings for the Wi-Fi lamp, GPS indicator lamp, self-timer lamp, and remote control receiver lamp in [Indicator Lamps] of the  2 menu. (p.100)

Adjusting the Angle of the Monitor

The monitor can be moved in four directions (up, down, left, and right).

- 1 Hold the camera with one hand and hold the both the right and left of the monitor and pull it out with the other hand.

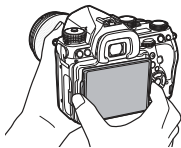

- 2 Adjust the monitor angle.

The monitor angle can be adjusted up to approximately 44° upward or downward, and up to approximately 35° to left or right.

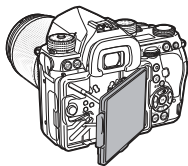
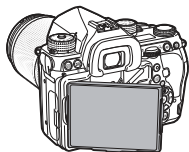

⚠ Caution

- Do not forcefully pull out or apply strong force to the monitor.
- Keep the monitor retracted when carrying the camera.

📌 Memo

- The monitor can be moved in four directions with it placed on the base cradle. When the monitor is pulled up from the base cradle as shown in the illustration on the right, you can take pictures by holding the camera at the waist high position.
- When the monitor is pulled out, you can illuminate the backside controls by pressing . (Default setting: Off) Change the setting in [Backside Controls] of [Illumination Settings] in the 2 menu. (p.100)
- When retracting the monitor, place the monitor on the base cradle and then push both the right and left edges of the monitor to the camera body.

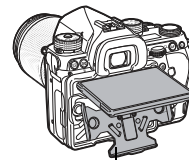

Base cradle

Display Indicators

Monitor

Capture Mode

With this camera, you can take pictures while looking through the viewfinder or while viewing the image on the monitor. When using the viewfinder, you can take pictures while checking the status screen displayed on the monitor and looking through the viewfinder. (p.39) When not using the viewfinder, you can take pictures while viewing the Live View image displayed on the monitor. (p.40)

The camera is in “standby mode” when it is ready to shoot, such as when the status screen or Live View image is displayed. Press **INFO** in standby mode to display the “control panel” and change settings. (p.20) You can change the type of information displayed in standby mode by pressing **INFO** while the control panel is displayed. (p.14)

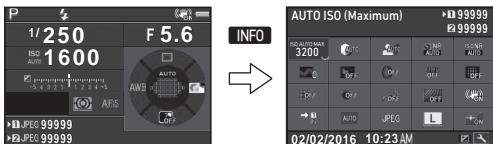

Standby mode
(Status screen)

Control panel

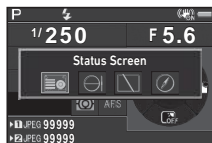

Shooting Info Display
selection screen

Memo

- You can set the display color of the status screen, control panel, and menu cursor in “Initial Settings” (p.36).

Adjusting the Monitor Brightness

If the monitor display is difficult to see when you take pictures outdoors or in other situations, adjust the brightness of the monitor in [Outdoor View Setting] of the **1** menu. When [Outdoor View Setting] is assigned to **Fx1** or **Fx2**, you can adjust the brightness of the monitor by a simple button operation. (p.98) By default, [Outdoor View Setting] is assigned to **Fx2** (▼).

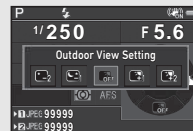

Status Screen

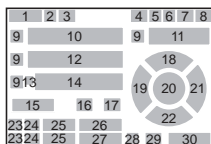
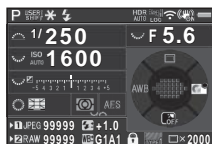

- | | |
|--|---|
| 1 Capture mode (p.44) | 16 AE Metering (p.50) |
| 2 AE Lock | 17 Focus Method (p.51) |
| 3 Flash Mode (p.65) | 18 Drive Mode (p.56) |
| 4 Clarity (p.70)/Skin Tone (p.70)/Digital Filter (p.67)/HDR Capture (p.68)/Pixel Shift Resolution (p.70) | 19 White Balance (p.63) |
| 5 GPS positioning status (p.72) | 20 Focusing area (AF point) (p.52) |
| 6 Wireless LAN status (p.88) | 21 Custom Image (p.66) |
| 7 Shake Reduction (p.69)/Horizon Correction | 22 Operation guide for (p.98) |
| 8 Battery level | 23 Card slot number |
| 9 E-dial guide | 24 File Format (p.43) |
| 10 Shutter speed | 25 Image storage capacity |
| 11 Aperture value | 26 Flash Exposure Compensation (p.65) |
| 12 Sensitivity (p.49) | 27 White Balance fine-tuning (p.63) |
| 13 EV Compensation (p.46)/Bracketing (p.59) | 28 Operation controls disabled (p.41) |
| 14 EV bar scale | 29 AA Filter Simulator (p.71) |
| 15 Operation guide for Smart Function (p.19) | 30 Number of shots during Multi-exposure or Interval Shooting |

Live View

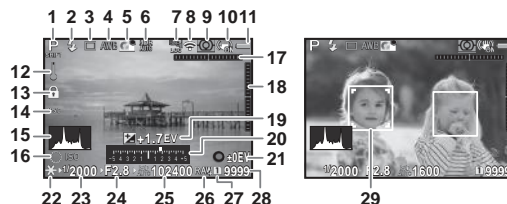

- | | |
|--|--|
| 1 Capture mode (p.44) | 14 Crop (p.43) |
| 2 Flash Mode (p.65) | 15 Histogram |
| 3 Drive Mode (p.56) | 16 Operation guide for Smart Function (p.19) |
| 4 White Balance (p.63) | 17 Electronic Level (horizontal tilt) (p.18) |
| 5 Custom Image (p.66) | 18 Electronic Level (vertical tilt) (p.18) |
| 6 Clarity (p.70)/Skin Tone (p.70)/Digital Filter (p.67)/HDR Capture (p.68)/Pixel Shift Resolution (p.70) | 19 EV Compensation (p.46) |
| 7 GPS positioning status (p.72) | 20 EV bar scale |
| 8 Wireless LAN status (p.88) | 21 Operation guide |
| 9 AE Metering (p.50) | 22 AE Lock |
| 10 Shake Reduction (p.69)/Horizon Correction/ Movie SR | 23 Shutter speed |
| 11 Battery level | 24 Aperture value |
| 12 Temperature warning | 25 Sensitivity (p.49) |
| 13 Operation controls disabled (p.41) | 26 File Format (p.43) |
| | 27 Card slot number in use |
| | 28 Image storage capacity |
| | 29 Face detection frame (when [Contrast AF] is set to [Face Detection]) (p.53) |

Memo



- In [Live View] of the 5 and 2 menus, you can change the display settings of Live View. (p.24, p.26)
- You can display grid lines on the Live View screen using the Smart Function. (p.19)

Shooting Info Display

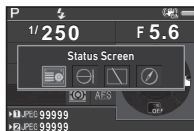
You can change the type of information displayed in standby mode by pressing **INFO** while the control panel is displayed. Use **◀▶** to select the type and press **OK**.



When shooting with the viewfinder

Status Screen	Displays the settings for shooting with the viewfinder. (p.12)
Electronic Level	<p>Displays the camera angle. A bar scale indicating the horizontal camera angle appears at the center of the screen, and a bar scale indicating the vertical camera angle appears on the right side. When the angle exceeds the range that can be displayed in each bar scale, the indicator segments of the scale are displayed in red.</p>  <p>Example: Tilted 1.5° to the left (yellow) Vertically level (green)</p>
Display Off	Nothing is displayed on the monitor.
Electronic Compass	<p>Turns on the GPS function and displays the current latitude, longitude, altitude, lens direction, Coordinated Universal Time (UTC), capture mode, and other information.</p> 

When shooting with Live View

Standard Information Display	The Live View image and the settings for shooting with Live View are displayed. (p.12)
Electronic Level	The electronic level is displayed in Standard Information Display.
No Information Display	Certain icons, such as those for the capture mode and drive mode, are not displayed.

Memo

- The screen selected on the Shooting Info Display selection screen appears when the camera is turned off and on again.

When the Camera is Held Vertically

When the camera is rotated to the vertical position, the status screen is displayed vertically. To not display the status screen vertically, set [Auto Screen Rotation] to **Off** in [Other Display Settings] of the **5** menu. (p.24)



Playback Mode

The captured image and shooting information are displayed in single image display of the playback mode.

Press **INFO** to change the type of information displayed in single image display. Use **◀▶** to select the type and press **OK**.



Single image display
(Standard Information Display)



Playback Info Display
selection screen

Standard Information Display	Captured image, file format, exposure parameters, and operation guide indicators are displayed.
Detailed Information Display	Detailed information on how and when the image was taken is displayed. (p.15)
Histogram Display	Captured image and brightness histogram are displayed. (p.16) Not available during movie playback.
RGB Histogram Display	Captured image and RGB histogram are displayed. (p.16) Not available during movie playback.
No Information Display	Only the captured image is displayed.

Memo

- You can set overexposed areas to blink red in Standard Information Display and Histogram Display. Set in [Highlight Alert] of [Image Display] in the **1** menu.
- The screen selected in the Playback Info Display selection screen is displayed in playback mode when the camera is turned off and on again. If [Playback Info Display] is set to **0** (Off) in [Memory] of the **5** menu, the Standard Information Display always appears first when the camera is turned on. (p.103)

Detailed Information Display

Still pictures

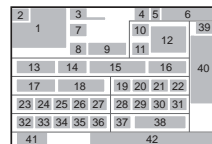

Movies

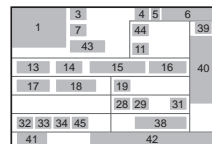

Page 2

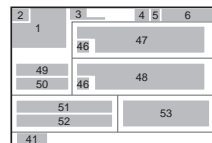

- Captured image
- Rotation information (p.79)
- Capture mode (p.44)
- Protect setting (p.103)
- Card slot number in use
- Folder number-File number (p.104)
- Drive Mode (p.56)
- Flash Mode (p.65)
- Flash Exposure Compensation (p.65)
- Focus Method (p.51)
- AE Metering (p.50)
- Focusing area (AF point) (p.52)
- Shutter speed
- Aperture value
- Sensitivity (p.49)
- EV Compensation (p.46)
- White Balance (p.63)
- White Balance fine-tuning (p.63)
- Digital Filter (p.67)

- 20 HDR Capture (p.68)/ Pixel Shift Resolution (p.70)
- 21 Clarity (p.70)
- 22 Skin Tone (p.70)
- 23 Distortion Correction (p.69)
- 24 Peripheral Illumination Correction (p.69)
- 25 Lateral Chromatic Aberration Adjustment (p.69)
- 26 Diffraction Correction (p.69)
- 27 Color Fringe Correction (p.86)
- 28 Highlight Correction (p.68)
- 29 Shadow Correction (p.68)
- 30 AA Filter Simulator (p.71)
- 31 Shake Reduction (p.69)/ Horizon Correction/ Movie SR
- 32 Crop (p.43)
- 33 File Format (p.43)
- 34 JPEG Recorded Pixels (p.43)/Movie Recorded Pixels (p.43)
- 35 JPEG Quality (p.43)
- 36 Color Space (p.43)
- 37 Color Moiré Correction (p.82)
- 38 Lens focal length
- 39 Custom Image setting (p.66)
- 40 Custom Image parameters
- 41 Operation guide
- 42 Shooting date and time
- 43 Length of time of the recorded movie
- 44 Recording Sound Level (p.47)
- 45 Framerate (p.43)
- 46 Tampered image warning
- 47 Photographer (p.106)
- 48 Copyright Holder (p.106)
- 49 Altitude
- 50 Lens direction
- 51 Latitude
- 52 Longitude
- 53 Universal Coordinated Time

Histogram Display

Use ▲▼ to switch between the brightness histogram and RGB histogram.

Brightness histogram

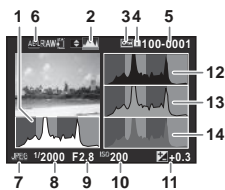
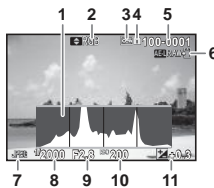

RGB histogram

- 1 Histogram (Brightness)
- 2 RGB histogram/ Brightness histogram
- 3 Protect setting
- 4 Card slot number in use
- 5 Folder number-File number
- 6 Save RAW Data
- 7 File Format
- 8 Shutter speed
- 9 Aperture value
- 10 Sensitivity
- 11 EV Compensation
- 12 Histogram (R)
- 13 Histogram (G)
- 14 Histogram (B)

Viewfinder

When shooting with the viewfinder, information appears in the viewfinder.

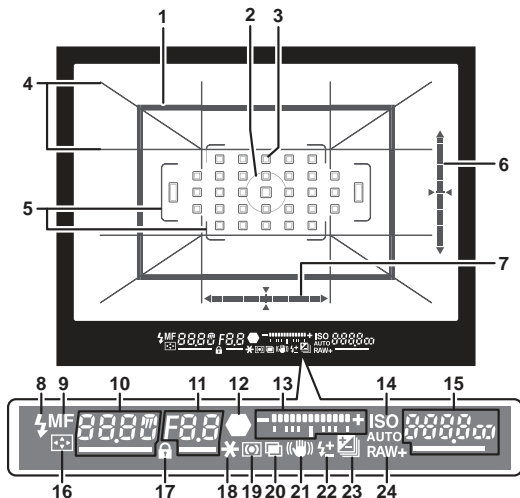

- | | |
|--|---|
| 1 Cropping frame (p.43) | 10 Shutter speed/
Remaining processing
time for Slow Shutter
Speed NR (p.45)/AF
Mode (p.51)/Number of
shots for Bracketing
(p.59) |
| 2 Spot metering frame
(p.50) | 11 Aperture value/Bracket
value (p.59) |
| 3 AF point (p.52) | 12 Focus indicator |
| 4 Grid Display | 13 EV bar scale |
| 5 AF frame (p.40) | 14 ISO/ISO AUTO |
| 6 Electronic Level
(vertical tilt) (p.18) | |
| 7 Electronic Level
(horizontal tilt) (p.18) | |
| 8 Flash indicator | |
| 9 Focus Method (p.51) | |

- | | |
|--|--|
| 15 Sensitivity (p.49)/
Exposure
compensation value/
Image storage capacity/
Focusing area selection
mode (p.52) | 16 Change AF Point (p.52) |
| ⌘-33 Auto (33 AF
Points) | 17 Operation controls
disabled (p.41) |
| ⌘-9 Zone Select | 18 AE Lock |
| ⌘⌘⌘⌘⌘ Select | 19 AE Metering (p.50) |
| ⌘⌘⌘⌘⌘ Expanded Area
AF (S) | 20 Multi-exposure (p.60) |
| ⌘⌘⌘⌘⌘ Expanded Area
AF (M) | 21 Shake Reduction (p.69) |
| ⌘⌘⌘⌘⌘ Expanded Area
AF (L) | 22 Flash Exposure
Compensation (p.65) |
| ⌘⌘⌘⌘⌘ Spot | 23 EV Compensation
(p.46)/Bracketing (p.59) |
| | 24 File Format (p.43) |

Memo

- The information is displayed in the viewfinder when **SHUTTER** is pressed halfway, or during the meter operating time (default setting: 10 sec.).
- The AF point in use for autofocus is emphasized when **SHUTTER** is pressed halfway.
- You can adjust the viewfinder image sharpness using the diopter adjustment dial.
- The display of Grid Display, Electronic Level, AF Frame, Spot Metering Frame, and AF Points can be turned on or off in [Viewfinder Overlay] of the **C5** menu. (p.24)
- The viewfinder is illuminated when focusing the subject or changing the focusing area in a dark place. To change the illumination method, set in [9 Viewfinder Light] of the **C2** menu. (p.30)

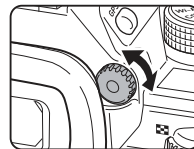

Electronic Level

You can check whether the camera is tilted by displaying the electronic level. The electronic levels for the vertical and horizontal camera angles can be displayed in the viewfinder and on the Live View screen. (p.12)

Select whether to display the electronic level in [Viewfinder Overlay] and [Live View] of the 5 menu. (p.24)

Memo

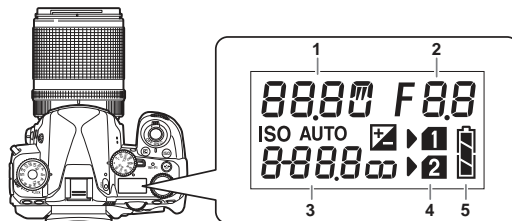

- When [Electronic Level] is assigned to **Fx1** or **Fx2**, you can turn the electronic level display on or off by a simple button operation. (p.98)

LCD Panel



- | | |
|---|--|
| 1 Shutter speed/Number of shots for Bracketing (p.59)/USB connection mode (p.87)/Sensor cleaning in progress (p.113) | 2 Aperture value/Bracket value (p.59) |
| | 3 Sensitivity (p.49)/EV Compensation (p.46) |
| | 4 Card slot number |
| | 5 Battery level |

Memo

- The LCD panel is illuminated when  is pressed. You can set the brightness of the LCD panel when  is pressed in [Illumination Settings] of the 2 menu. (p.100)

How to Change Function Settings

Using the Direct Keys

Press ▲▼◀▶ in standby mode.

▲	Drive Mode	p.56
▼	Fx2 Button	p.98
◀	White Balance	p.63
▶	Custom Image	p.66

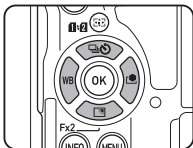

You can assign a function to ▼ and use it as the Fx2 button (Fx2). By default, [Outdoor View Setting] is assigned. (p.11)

Using the Smart Function

You can easily change settings with two dials: the function dial and the setting dial. Use the function dial (①) to select the desired function, and use the setting dial (②) to change its setting value.

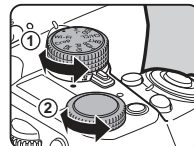

The following functions can be selected.

Function Dial	Function	Page
●	Disables the setting dial operation.	p.40
+/-	Changes the exposure compensation value.	p.46
ISO	Changes the ISO sensitivity.	p.49
CH/CL	Switches between Continuous Shooting and Single Frame Shooting and changes the shooting speed for Continuous Shooting.	p.57
BKT	Changes the bracket value for Bracketing.	p.59
HDR	Changes the type for HDR Capture.	p.68
Grid	Turns the grid display in the viewfinder on or off when shooting with the viewfinder. Changes the type of grid displayed on the Live View screen when shooting with Live View.	p.24
SR	Turns the Shake Reduction and Movie SR functions on or off.	p.69
Crop	Changes the Crop setting.	p.43
Wi-Fi	Turns the Wi-Fi function on or off.	p.89

The operation guide for the Smart Function is displayed on the status screen and Live View screen.

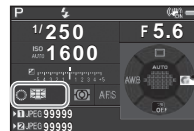

Using the Control Panel

Press **INFO** in standby mode.

Use **▲▼◀▶** to select an item.

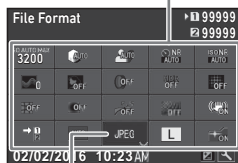

Use **☰** to change settings.

Press **OK** to make detailed settings.

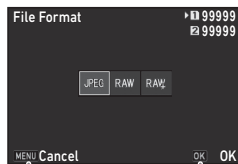

Press **MENU** to cancel the setting operation.

Press **OK** to confirm the selected item and return to the control panel.

Memo

- The functions that can be selected vary depending on the current camera setup.
- If no operations are made within approximately 1 minute while the control panel is displayed, the camera returns to standby mode.

Customizing the Control Panel

The functions displayed on the control panel can be customized.

1 Press **INFO** in standby mode.

The control panel appears.

2 Press **☒**.

The customization screen appears.

3 Use **▲▼◀▶** to select the function to change.

Press **○** to reset to the default settings.

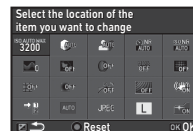

4 Press **OK**.

Selectable functions are displayed in the pop-up menu.

5 Use **▲▼** to select the function to save.

Select **[-]** if you do not want to save any function.



6 Press **OK**.

The screen of Step 3 reappears.

7 Press **☒**.

The control panel reappears.

8 Press **MENU**.

The camera returns to standby mode.

Using the Menus

Most functions are set from the menus.

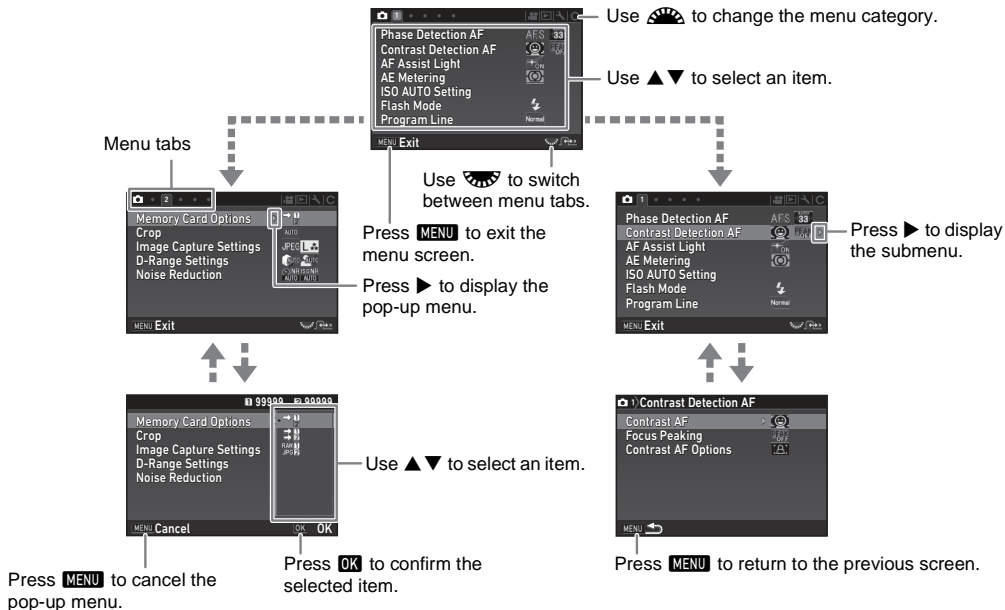

📌 Memo

- For the Custom Setting menu (C1-4), you can show the setting screen of the next item in order of the menus on the monitor by turning ☀ while the submenu of the currently selected item is displayed.
- Press **MENU** to display the first tab of the most appropriate menus for the camera settings at that time. To display the menu tab last selected first, set in [23 Save Menu Location] of the C4 menu.
- The settings changed with the direct keys, Smart Function, control panel, and menus are returned to their default values with [Reset] of the 4 menu. To reset the settings in the Custom Setting menus to the defaults, use [Reset Custom Functions] of the C4 menu. (Some settings do not apply.)

Menu List

1









Introduction

Rec. Mode Menus

Menu	Item	Function	Default Setting	Page	
	Phase Detection AF	AF Mode *1	Selects the autofocus method for shooting with the viewfinder.	A.F.S	p.51
		AF Active Area *1	Selects the area to adjust the focus for shooting with the viewfinder.	Auto (33 AF Points)	p.52
		AF.S Setting	Sets the action priority for when the autofocus mode is set to A.F.S and SHUTTER is fully pressed.	Focus-priority	p.53
		1st Frame Action in A.F.C	Sets the action priority for the first frame when the autofocus mode is set to A.F.C and SHUTTER is fully pressed.	Auto	p.53
		Action in A.F.C Cont.	Sets the action priority during Continuous Shooting when the autofocus mode is set to A.F.C .	Auto	p.53
		Hold AF Status	Maintains the focus for a certain amount of time when the subject happens to move out of the selected focusing area after being focused.	Low	p.53
	Contrast Detection AF	Contrast AF *1	Sets the autofocus mode for shooting with Live View.	Face Detection	p.53
		Focus Peaking *1	Emphasizes the outline of the subject in focus and makes it easier to check the focus.	Off	p.54
		Contrast AF Options	Sets the action priority for when SHUTTER is fully pressed.	Focus-priority	p.54
	AF Assist Light *1	Discharges the assist light when autofocusing in dark locations.	On	p.51	
	AE Metering *1	Selects the part of the sensor to use for measuring brightness and determining the exposure.	Multi-segment	p.50	
	ISO AUTO Setting *1	Sets the range of automatic correction in ISO AUTO and the AUTO ISO Parameters.	ISO 100 to ISO 3200/Standard	p.49	
	Flash Mode *1	Sets the flash mode.	Flash On or Auto Flash Discharge	p.65	
	Program Line *1	Selects the Program Line setting.	Normal	p.46	
	Exposure Mode *2	Exposure Mode	Temporarily changes the exposure mode when the mode dial is set to one of the modes from U1 to U5 .	P	p.102
Program Line		Selects the Program Line setting when the mode dial is set to one of the modes from U1 to U5 .	Normal		

Menu	Item	Function	Default Setting	Page	
☑2	Memory Card Options *1	Sets the recording method for when two memory cards are inserted.	Sequential Use	p.43	
	Crop *1	Sets the angle of view for shooting.	Auto	p.43	
	Image Capture Settings	File Format *1	Sets the file format of images.	JPEG	p.43
		JPEG Recorded Pixels *1	Sets the recording size of JPEG images.	<input type="checkbox"/>	
		JPEG Quality *1	Sets the quality of JPEG images.	★★★	
		RAW File Format	Sets the RAW file format.	PEF	
		Color Space	Sets the color space to use.	sRGB	
	D-Range Settings	Highlight Correction *1	Expands the dynamic range and prevents overexposed areas from occurring.	Auto	p.68
		Shadow Correction *1	Expands the dynamic range and prevents underexposed areas from occurring.	Auto	
	Noise Reduction	Slow Shutter Speed NR *1	Sets the Noise Reduction setting when shooting with a slow shutter speed.	Auto	p.45
High-ISO NR *1		Sets the Noise Reduction setting when shooting with a high ISO sensitivity.	Auto	p.49	
☑3	Clarity *1	Changes the clarity of images using an image processing function.	±0	p.70	
	Skin Tone *1	Enhances the skin tone of images using an image processing function.	Off	p.70	
	Digital Filter *1	Applies a digital filter effect when taking pictures.	No Filter	p.67	
	HDR Capture *1	Sets the type of high dynamic range shooting.	Off/±2EV/On	p.68	
	Pixel Shift Resolution *1	Merges four images shifted pixel by pixel and outputs a high-definition image.	Off	p.70	
	ASTROTRACER *1	Makes settings to track and capture celestial bodies.	Off	p.75	
☑4	AA Filter Simulator *1	Applies a low-pass filter effect using the Shake Reduction mechanism.	Off	p.71	
	Shake Reduction *1	Activates the Shake Reduction function.	On	p.69	
	Horizon Correction *1	Corrects horizontal tilt when in  mode.	Off	–	
	Composition Adjust. *1	Allows you to adjust the composition of your image using the Shake Reduction mechanism.	Off	p.71	











Menu	Item	Function	Default Setting	Page	
☑4	Lens Correction	Distortion Correction *1	Reduces distortions occurring due to lens properties.	Off	p.69
		Peripheral Illumin. Corr. *1	Reduces peripheral light fall-off occurring due to lens properties.	Off	
		Lat-Chromatic-Ab Adj *1	Reduces lateral chromatic aberrations occurring due to lens properties.	On	
		Diffraction Correction *1	Corrects blur caused by diffraction when using a small aperture.	On	
	Input Focal Length *1	Sets the focal length when using a lens of which focal length information cannot be obtained.	35mm	p.110	
☑5	Viewfinder Overlay	Grid Display *1	Displays grid lines in the viewfinder.	On	p.17
		Electronic Level *1	Displays the electronic level in the viewfinder.	On	
		AF Frame	Displays the AF frame in the viewfinder.	On	
		Spot Metering Frame	Displays the spot metering frame in the viewfinder.	On	
		AF Points	Displays the AF points in the viewfinder.	On	
	Live View	Grid Display *1	Sets the type and color of the grid lines displayed during Live View.	Off/Black	p.12
		Electronic Level *1	Displays the electronic level during Live View.	On	
		Histogram Display	Displays the histogram during Live View.	Off	
		Highlight Alert	Sets overexposed areas to blink red during Live View.	Off	
		Flicker Reduction	Cuts down on the Live View screen flicker by setting the power frequency.	50Hz	
	Instant Review	Display Time	Sets the Instant Review display time.	1sec.	p.40
		Zoom Review	Displays the magnified image during Instant Review.	On	
		Save RAW Data	Saves the RAW data during Instant Review.	On	
		Delete	Deletes the displayed image during Instant Review.	On	
		Histogram Display	Displays the histogram during Instant Review.	Off	
Highlight Alert		Sets overexposed areas to blink red during Instant Review.	Off		
Other Display Settings	Guide Display	Displays operation guides when the capture mode is changed.	On	p.40	
	Auto Screen Rotation	Displays the status screen vertically if the camera is held vertically.	On	p.14	
	Display Color	Sets the display color of the status screen, control panel, and menu cursor.	1	p.38	

Menu	Item		Function	Default Setting	Page
 5	Button Customization	Fx1 Button	Sets the function for when Fx1 is pressed.	One Push File Format	p.98
		Fx2 Button	Sets the function for when Fx2 (▼) is pressed.	Outdoor View Setting	
		AF Button	Sets the function for when AF is pressed.	Enable AF1	
		Preview Dial	Sets the camera action for when the main switch is turned to the  position.	Optical Preview	p.55
	E-Dial Programming	P	Sets the  /  /  operation for each exposure mode.	Tv, Av, 	p.99
		Sv		-, ISO, -	
		Tv		Tv , -, -	
		Av		-, Av , -	
		TA_v		Tv, Av, P LINE	
		M		Tv, Av, P LINE	
		B		-, Av , -	
X	-, Av , -				
	Rotation Direction	Reverses the effect obtained when  or  is turned.	Rotate Right		
	Memory	Determines which settings to save when the power is turned off.	On for settings other than Clarity, Skin Tone, Digital Filter, HDR Capture, Pixel Shift Resolution, and Outdoor View Setting	p.103	
	Save USER Mode	You can save frequently used capture settings to U1 to U5 of the mode dial.	-	p.101	

*1 Available as a function in the control panel.



*2 The function appears only when the mode dial is set to one of the modes from **U1** to **U5**.

Menu	Item		Function	Default Setting	Page
1	Contrast Detection AF	Contrast AF *1	Sets the autofocus mode.	Face Detection	p.53
		Focus Peaking *1	Emphasizes the outline of the subject in focus and makes it easier to check the focus.	Off	p.54
	AF Assist Light *1		Discharges the assist light when autofocusing in dark locations.	On	p.51
	AE Metering *1		Selects the part of the sensor to use for measuring brightness and determining the exposure.	Multi-segment	p.50
	Memory Card Options *1		Selects one of the memory cards inserted in the SD1 and the SD2 slots for recording movies.	SD1	p.43
	Crop *1		Sets the angle of view for shooting.	Auto	p.43
	Movie Capture Settings	Recorded Pixels *1	Sets the number of recorded pixels of the movie.		p.43
		Framerate *1	Sets the number of framerate of the movie.	30p	
	Sound Volume Setting	Recording Sound Level *1	Sets the sound level for recording.	Auto	p.47
		Wind Noise Reduction *1	Reduces wind noise.	Off	
Headphone Volume *1		Sets the sound volume when a headphone is connected.	10		
2	D-Range Settings	Highlight Correction *1	Expands the dynamic range and prevents overexposed areas from occurring.	Auto	p.68
		Shadow Correction *1	Expands the dynamic range and prevents underexposed areas from occurring.	Auto	
	Digital Filter *1		Applies a digital filter effect when recording a movie.	No Filter	p.67
	Movie SR *1		Activates the Shake Reduction function.	On	–
Live View	Grid Display *1	Grid Display *1	Sets the type and color of the grid lines displayed during Live View.	Off/Black	p.12
		Electronic Level *1	Displays the electronic level during Live View.	On	
		Histogram Display	Displays the histogram during Live View.	Off	
		Highlight Alert	Sets overexposed areas to blink red during Live View.	Off	
		Flicker Reduction	Cuts down on the Live View screen flicker by setting the power frequency.	50Hz	

Menu	Item		Function	Default Setting	Page
2  Button Customization	AF Button (Movie)		Sets the function for when AF is pressed.	Enable AF1	p.98
	E-Dial Programming		Sets the  /  /  operation for each exposure mode.	-, -, -	p.99
				Tv, -, PLINE	
				-, Av, PLINE	
				Tv, Av, PLINE	
Rotation Direction		Reverses the effect obtained when  or  is turned.	Rotate Right		

*1 Available as a function in the control panel.





Playback Menu





Menu	Item		Function	Default Setting	Page
1  Slideshow	Display Duration		Sets an image display interval.	3sec.	p.79
	Screen Effect		Sets a transition effect when the next image is displayed.	Off	
	Repeat Playback		Starts the slideshow again from the beginning after the last image is displayed.	Off	
	Auto Movie Playback		Plays back movies during the slideshow.	On	
1  Image Display	Protect All Images		Protects all stored images at once.	-	p.103
	Delete All Images		Deletes all stored images at once.	-	-
	Quick Zoom		Sets the initial magnification when magnifying images.	Off	p.42
	Playback Sound Volume		Sets the sound volume during movie playback.	10	p.48
	Auto Image Rotation		Rotates images which were captured with the camera held vertically or of which the rotation information has been changed.	On	p.79
Grid Display		Sets the type and color of grid lines.	Off/Black	p.42	
Highlight Alert		Sets overexposed areas to blink red in Standard Information Display or Histogram Display of the playback mode.	Off	p.15	

Set-up Menus

1

Introduction

Menu	Item	Function	Default Setting	Page	
1	Language/言語	Changes the display language.	English	p.36	
	Date Adjustment	Sets the date and time and the display format.	01/01/2016	p.37	
	World Time	Switches between the date and time display of your hometown city and that of a specified city.	Hometown	p.102	
	Text Size	Magnifies the text size when selecting a menu item.	Std.	p.37	
	Sound Effects	Switches the operation sound on or off and changes the volume for In-focus, AE Lock, Self-timer, Remote Control, Mirror Up, AF Active Area, and the functions saved to Fx1 and Fx2 (One Push File Format, Pixel Shift Resolution, Shake Reduction, Horizon Correction, and Electronic Level).	Volume 3/ All On	–	
	LCD Display Settings	Adjusts the brightness, saturation and the color of the monitor.	0	–	
	Outdoor View Setting	Adjusts the brightness of the monitor for outdoor shooting.	Off	p.11	
2	Illumination Settings	LCD Panel	Sets whether to illuminate the LCD panel when  is pressed.	High	p.100
		Backside Controls	Sets whether to illuminate the backside controls when  is pressed after the monitor is pulled out.	Off	
		Lens Mount	Sets whether to illuminate the lens mount when  is pressed.	Off	
		Card Slot/Connector	Sets whether to illuminate the card slots and connector when  is pressed.	Off	
	Indicator Lamps	Wi-Fi	Sets the brightness of the Wi-Fi lamp.	High	p.100
		GPS	Sets the brightness of the GPS indicator lamp.	High	
		Self-timer	Sets whether to light up the self-timer lamp when shooting with the self-timer.	On	
		Remote Control	Sets whether to light up the self-timer lamp when shooting with remote control.	On	
	Wi-Fi *1		Activates the Wi-Fi function.	Off	p.89
	GPS/ E-Compass	GPS Logging	Sets the camera action during GPS logging.	On	p.74
		GPS Time Sync	Automatically adjusts the date and time settings.	On	
Calibration		Performs a calibration of direction information.	–		

Menu	Item	Function	Default Setting	Page	
2	USB Connection	Sets the USB connection mode when connecting to a computer.	MSC	p.87	
	HDMI Out	Sets the output format when connecting to an AV device with an HDMI input terminal.	Auto	p.80	
	Auto Power Off	Sets the time until the camera turns off automatically if no operations are made for a certain period of time.	1min.	p.36	
3	Create New Folder	Creates a new folder on the memory card.	–	p.104	
	Folder Name	Sets the folder name in which images are stored.	Date	p.104	
	File Name	Sets the file name assigned to an image.	IMG*_IMG	p.105	
	File No.	Sequential Numbering	Continues the sequential numbering for the file name when a new folder is created.	On	p.106
		Reset File Number	Resets the file number setting and returns to 0001 each time a new folder is created.	–	
		Copyright Information	Sets the photographer and copyright information embedded in the Exif data.	Off	p.106
	Format	Formats a memory card.	–	p.38	
4	Pixel Mapping	Maps out and corrects defective pixels on the sensor.	–	p.112	
	Dust Removal	Cleans the sensor by applying high-frequency (ultrasonic) vibrations.	On/On	p.112	
	Sensor Cleaning	Locks the mirror in the up position for cleaning the sensor with a blower.	–	p.113	
	Select Battery	Sets the camera action for when the optional battery grip is attached to the camera.	Auto Select/ Auto-detect	p.34	
	Certification Marks	Displays the certification marks of conformance to wireless technical standards.	–	p.128	
	Firmware Info/Options	Displays the camera's firmware version. You can check the current firmware version before running an update.	–	–	
	Reset	Resets the settings of the direct keys and Smart Function and for the items of the  menus,  menus,  menu,  menus, control panel, and playback mode palette.	–	–	

*1 Available as a function in the control panel.

Custom Setting Menus

1

Introduction

Menu	Item	Function	Default Setting	Page
C1	1 EV Steps	Sets the adjustment steps for the exposure.	1/3 EV Steps	p.45
	2 Sensitivity Steps	Sets the adjustment steps for the ISO sensitivity.	1 EV Step	p.49
	3 Meter Operating Time	Sets the meter operating time.	10sec.	–
	4 Auto EV Compensation	Automatically compensates the exposure when the correct exposure cannot be achieved with the current settings.	Off	–
	5 Link AE and AF Point	Sets whether to link the exposure value and the AF point in the focusing area.	Off	–
	6 Bulb (B) Mode Options	Sets the camera operation when SHUTTER is pressed in B mode.	Type1	–
	7 Flash Sync Speed	Selects the flash sync speed.	1/200	p.111
C2	8 AE-L with AF Locked	Sets whether to lock the exposure value when the focus is locked.	Off	–
	9 Viewfinder Light	Sets whether to light up the viewfinder when focusing the subject or changing the focusing area.	Auto	p.17
	10 AF with Remote Control	Sets whether to use autofocus when shooting with a remote control unit.	Off	p.58
	11 Bracketing Order	Sets the order for Bracketing shooting.	0 - +	p.59
	12 One-Push Bracketing	Shoots all frames with one release when using Bracketing.	Off	p.59
	13 Interval Shooting Options	Sets whether to start counting the time of interval from when exposure starts or when exposure ends for Interval Shooting, Interval Composite, and Interval Movie Record.	Interval	p.62
	14 AF in Interval Shooting	Sets whether to lock the focus position used when the first picture is taken or perform autofocus for each exposure for Interval Shooting, Interval Composite, Interval Movie Record, and Star Stream.	Locks focus at 1st exposure	p.62

Menu	Item	Function	Default Setting	Page
C3	15 WB Adjustable Range	Sets whether to automatically fine-tune the white balance when the light source is specified for the white balance setting.	Fixed	p.63
	16 AWB in Tungsten Light	Sets the tungsten light color tone when the white balance is set to [Auto White Balance].	Strong Correction	p.63
	17 WB When Using Flash	Sets the white balance setting when using a flash.	Auto White Balance	p.63
	18 Color Temperature Steps	Sets the adjustment steps for the Color Temperature option of the white balance.	Kelvin	p.64
	19 Enable/Disable Control	Enables or disables operation of the selected group of buttons and dials.	Type1	p.41
	20 Change AF Point Button	Selects the AF operation when the focusing area selection mode is set to one of some select-type options.	Type1	p.53
	21 Auto SR Off	Automatically turns off the Shake Reduction function when the drive mode is set to [Self-timer] or [Remote Control].	Enable Auto SR Off	p.56
C4	22 Save Rotation Info	Saves rotation information when shooting.	On	p.79
	23 Save Menu Location	Saves the last menu tab displayed on the monitor and displays it again the next time MENU is pressed.	Reset Menu Location	p.21
	24 Catch-in Focus	Enables Catch-in Focus shooting when a manual focus lens is attached. The shutter is released automatically when the subject comes into focus.	Off	p.110
	25 AF Fine Adjustment	Allows you to precisely fine-tune your lenses with the camera's autofocus system.	Off	p.54
	26 Using Aperture Ring	Enables the shutter to release when the lens aperture ring is set to a position other than A (Auto).	Disable	p.109
	Reset Custom Functions	Resets all the settings of the Custom Setting menus to the defaults.	–	–

Attaching the Strap

- 1 Pass the end of the strap through the triangular ring.

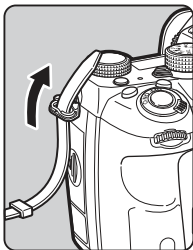

- 2 Secure the end of the strap on the inside of the clasp.

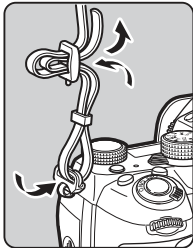

When the Battery Grip is Used

When the optional Battery Grip D-BG6 is used, you can attach one end of the strap to the battery grip.

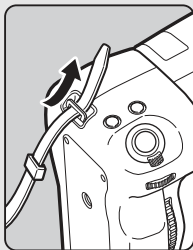

Attaching a Lens

- 1 Make sure that the camera is turned off.

- 2 Remove the body mount cap (1) and lens mount cover (2).

Turn the body mount cap counterclockwise while pressing the lens unlock button (3). After removing the cover, be sure to put the lens down with the lens mount side facing upward.

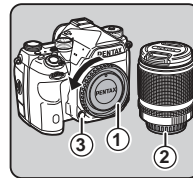

- 3 Align the lens mount indexes (red dots: 4) on the camera and the lens, and secure by turning the lens clockwise until it clicks.

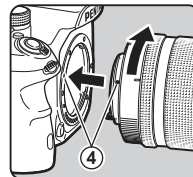

To remove the lens

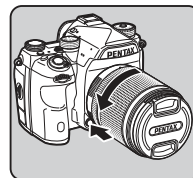

Attach the lens cap, and then turn the lens counterclockwise while pressing the lens unlock button.



⚠ Caution

- When attaching or removing the lens, choose an environment that is relatively free of dirt and dust.
- Keep the body mount cap attached on the camera when a lens is not attached.
- Be sure to attach the lens mount cover and lens cap to the lens after removing it from the camera.
- Do not insert your fingers inside the lens mount of the camera or touch the mirror.
- The camera body and lens mount incorporate lens information contacts. Dirt, dust, or corrosion may damage the electrical system. Please contact your nearest service center for professional cleaning.
- When a retractable lens is attached and is not extended, you cannot take pictures or use some functions. If the lens is retracted during shooting, the camera stops working. Refer to “How to Use a Retractable Lens” (p.41) for details.
- We assume no responsibility nor liability for accidents, damages, and malfunctions resulting from the use of lenses made by other manufacturers.

📄 Memo

- Refer to “Functions Available with Various Lenses” (p.108) for details on the functions of each lens.
- You can illuminate the lens mount by pressing . (Default setting: Off) The lens mount is illuminated even when the camera is turned off. Change the setting in [Lens Mount] of [Illumination Settings] in the  menu. (p.100)

Using the Battery and Charger

Use the battery D-LI90 and battery charger D-BC90 exclusively developed for this camera.

Note: AC plug cord

UL Listed, Type SPT-2 or NISPT-2, 18/2 flexible cord, rated 125 V, 7 A, minimum 6 ft. (1.8 m)

Charging the Battery

1 Connect the AC plug cord to the battery charger.

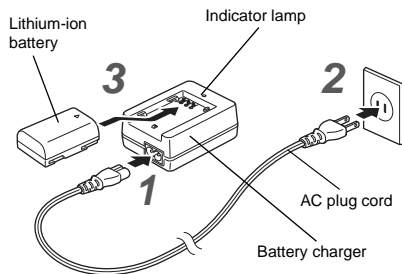

2 Plug the AC plug cord into the power outlet.

3 Face the ▲ mark on the battery up, and insert it into the battery charger.

The indicator lamp is lit while charging and turns off when the battery is fully charged.

⚠ Caution

- Do not use the battery charger D-BC90 to charge batteries other than the battery D-LI90. Charging other batteries may cause damage or heating.
- Replace the battery with a new one in the following cases:
 - If the indicator lamp blinks or does not light after the battery is inserted correctly
 - If the battery starts to run down more quickly even after being charged (the battery may have reached the end of its service life)

Memo

- The maximum charging time is approximately 390 minutes (it depends on temperature and remaining battery power). Charge the battery in a location where the temperature is between 0°C and 40°C (32°F and 104°F).

Inserting/Removing the Battery

Caution

- Insert the battery correctly. If the battery is inserted incorrectly, it may not be removed.
- Wipe the electrodes of the battery with a soft dry cloth before inserting.
- Do not open the battery cover or remove the battery while the power is on.
- Be careful as the camera or battery may become hot after the camera has been used continuously for a long period of time.
- Remove the battery when you do not use the camera for a long time. The battery may leak and damage the camera if left installed during prolonged periods of non-use. If the removed battery is not used for six months or longer, charge the battery for about 30 minutes before storing it. Be sure to recharge the battery every six to twelve months.
- Store the battery in a location where the temperature will remain at or below room temperature. Avoid locations with high temperatures.
- The date and time may be reset if you leave the battery out of the camera for long periods of time. If this happens, set the current date and time again.

1 Open the battery cover.

Lift the battery cover unlock knob, turn it towards OPEN to unlock, and then pull the cover open.

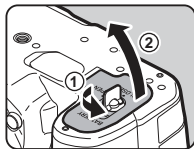

2 Face the ▲ mark on the battery towards the outside of the camera, and insert the battery until it locks into place.

To remove the battery, push the battery lock lever in the direction of ③.

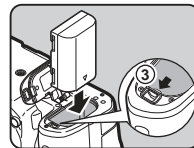

3 Close the battery cover.

Turn the battery cover unlock knob towards CLOSE to lock, and then put it down.

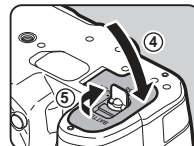

Memo

- The battery level may not be displayed properly if the camera is used at low temperatures or when performing Continuous Shooting for a long time.
- Battery performance temporarily decreases as the temperature decreases. When using the camera in cold climates, have extra batteries at hand and keep them warm in your pocket. Battery performance will return to normal at room temperature.
- Have extra batteries ready when traveling overseas or taking a lot of pictures.
- When the optional Battery Grip D-BG6 is used, the following settings can be made in [Select Battery] of the  4 menu.
 - Priority order of battery use
 - Type of AA batteries to use

Using the AC Adapter

We recommend the use of the optional AC adapter kit K-AC132 when using the monitor for a long time or when connecting the camera to a computer or AV device.

- 1 **Make sure that the camera is turned off, and open the terminal cover.**

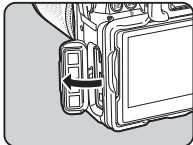

- 2 **Align the ▲ marks on the DC terminal of the AC adapter and DC input terminal of the camera, and connect.**

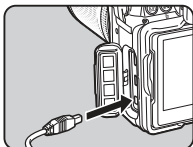

- 3 **Connect the AC adapter to the AC plug cord, and plug the cord into the power outlet.**

⚠ Caution

- Make sure that the camera is turned off before connecting or disconnecting the AC adapter.
- Make sure that the connections are secure between the terminals. The memory card or data may be corrupted if the connection to the power supply is lost while the card is being accessed.
- Be sure to read the manual of the AC adapter kit before using the AC adapter.

Inserting a Memory Card

The following memory cards can be used with this camera.

- SD Memory Card
- SDHC Memory Card
- SDXC Memory Card

In this manual, these cards are referred to as memory cards.

- 1 **Make sure that the camera is turned off.**

- 2 **Slide the memory card cover in the direction of ① and then rotate it to open as shown by ②.**

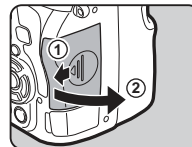

- 3 **Insert a card all the way into each memory card slot with the memory card label facing toward the side with the monitor.**

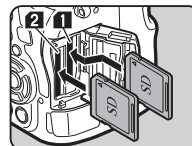

Push the memory card in once and release to remove.

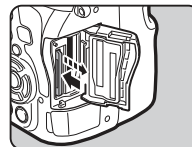

- 4** Rotate the memory card cover as shown by ③, and slide it in the direction of ④.

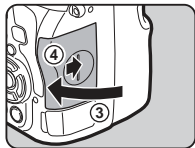

⚠ Caution

- Do not remove the memory card while the card access lamp is lit.
- If the memory card cover is opened while the power is on, the camera turns off. Do not open the cover while the camera is in use.
- Use this camera to format (initialize) a memory card that is unused or has been previously used on other devices. (p.38)
- Use a high-speed memory card when recording movies. If the write speed cannot keep up with the recording speed, writing may stop during recording.

📖 Memo

- For details on how the data is recorded when two memory cards are inserted, refer to “Memory Card Settings” (p.43).
- You can illuminate the card slot chamber by pressing . (Default setting: Off) The card slot chamber is illuminated even when the camera is turned off. Change the setting in [Card Slot/Connector] of [Illumination Settings] in the 2 menu. (p.100)

Initial Settings

Turn the camera on and make the initial settings.

Turning the Camera On

- 1** Turn the main switch to **[ON]**.

The first time the camera is turned on after purchase, the [Language/言語] screen appears.

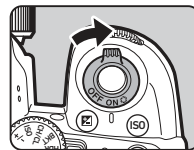

📖 Memo

- The power automatically turns off when you do not perform any operations within a set period of time. (Default setting: 1min.) You can change the setting in [Auto Power Off] of the 2 menu.

Setting the Display Language

- 1** Use to select the desired language and press **OK**.

The [Initial Setting] screen appears in the selected language.

Proceed to Step 6 if (Hometown) does not need to be changed.

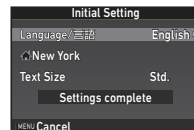

- 2** Press to move the frame to and press . The [Hometown] screen appears.

- 3** Use to select a city.

Use to change the region. Refer to “List of World Time Cities” (p.120) for cities that can be selected as a hometown.

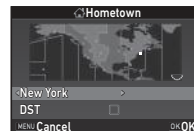

4 Press ▼ to select [DST] (daylight saving time), and use ◀▶ to select ☐ or ☑.

5 Press **OK**.

The camera returns to the [Initial Setting] screen.

6 Press ▼ to select [Text Size] and press ▶.

7 Use ▲▼ to select [Std.] or [Large], and press **OK**.

Selecting [Large] increases the text size of the selected menu items.

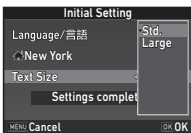

8 Press ▼ to select [Settings complete] and press **OK**.

The [Date Adjustment] screen appears.

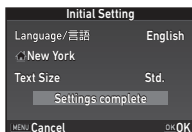

Setting the Date and Time

1 Press ▶, and use ▲▼ to select the date format.

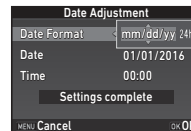

2 Press ▶, and use ▲▼ to select [24h] or [12h].

3 Press **OK**.

The frame returns to [Date Format].

4 Press ▼, and then press ▶.

The frame moves to the month if the date format is set to [mm/dd/yy].

5 Use ▲▼ to set the month.

Set the day, year, and time in the same manner.

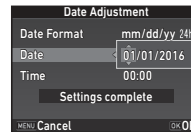

6 Press ▼ to select [Settings complete] and press **OK**.

The [LCD Display] screen appears.

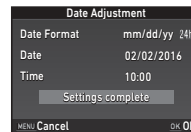

Setting the LCD Display

1 Use ◀▶ to select a color.

Select the display color of the status screen, control panel, and menu cursor from colors 1 to 12.

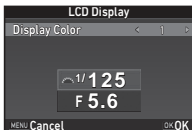

2 Press OK.

The camera switches to capture mode and is ready to take a picture.

Memo

- You can change the language, text size, and date and time settings from the ↵1 menu, and the display color from [Other Display Settings] of the 📷5 menu. (p.24, p.28)
- While the GPS is on, the date and time settings are adjusted using information obtained from satellites. (p.72)

Formatting a Memory Card



1 Press MENU.

The 📷1 menu appears.

2 Use ☀ or 🌑 to display ↵3 menu.

3 Use ▲▼ to select [Format] and press ▶.

The [Format] screen appears.

4 Use ▲▼ to select the memory card slot in which the memory card to format is inserted and press ▶.

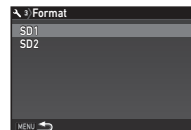

5 Press ▲ to select [Format] and press OK.

Formatting starts. When formatting is completed, the screen of Step 4 reappears.

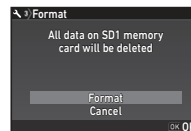

6 Press MENU twice.

Caution

- Do not remove the memory card while formatting, or the card may be damaged.
- Formatting deletes all data, both protected and unprotected.

Memo

- When a memory card is formatted, the volume label "K-1" is assigned to the card. When the camera is connected to a computer, the memory card is recognized as a removable disk with the name "K-1".

Basic Shooting Operation

Take pictures in **AUTO** (Scene Analyze Auto) mode in which the camera analyzes shooting conditions and automatically sets the optimal shooting settings.

Shooting with the Viewfinder

- 1 Remove the front lens cap by pushing the top and bottom portions as indicated in the illustration.

When a retractable lens is attached, extend the lens before turning the camera on.

 How to Use a Retractable Lens (p.41)

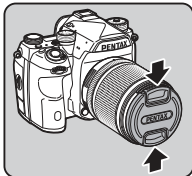

- 2 Turn the camera on.
- 3 Turn the capture mode selector switch to .

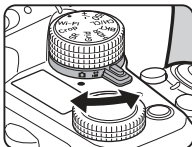

- 4 Set the focus mode switch to **AF**.

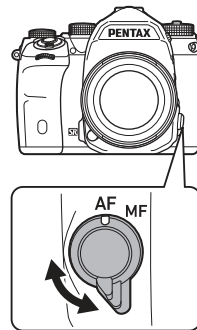

- 5 Set the mode dial to **AUTO** while pressing the mode dial lock button.

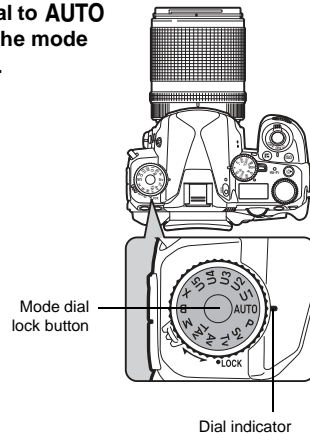

The selected capture mode is displayed on the monitor (Guide Display).

- ↪ Guide Display settings (p.24)

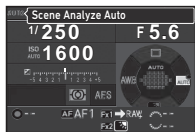

6 Look through the viewfinder to view the subject.

When using a zoom lens, turn the zoom ring to the right or left to change the angle of view.

7 Position the subject inside the AF frame and press **SHUTTER** halfway.

The focus indicator (●) appears and you will hear a beep when the subject comes into focus.

- ↪ Sound Effects settings (p.28)

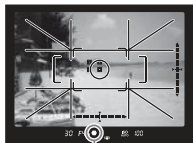

Focus indicator

8 Press **SHUTTER** fully.

The captured image is displayed on the monitor (Instant Review).

Available operations during Instant Review

Deletes the image.

to the right Magnifies the image.

AEL Saves the RAW data (only when a JPEG image was taken and the data remains in the buffer).

Shooting with Live View

1 Press **LV** in Step 6 on “Shooting with the Viewfinder” (p.40).

The Live View image is displayed on the monitor.

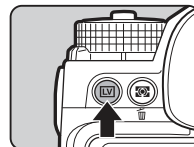

2 Position the subject inside the AF frame on the monitor and press **SHUTTER** halfway.

The AF frame turns green and you will hear a beep when the subject comes into focus.



AF frame

Available operations during Live View

- OK** Magnifies the image.
Use to change the magnification (up to 16x).
Use to change the area to display.
Press to return the display area to the center.
Press **OK** to return to 1x image display.

LV Exits shooting with Live View.

Subsequent steps are the same as shooting with the viewfinder.

Memo

- You can use **AF** to focus on the subject. (p.51)
- You can preview the image on the monitor and check the depth of field before shooting. (p.55)
- You can set the operation and display settings for Instant Review in [Instant Review] of the 5 menu. (p.24) When [Display Time] is set to [Hold], Instant Review is displayed until the next operation.
- When the function dial is set to , you can magnify the image using the setting dial.

⚠ Caution

- Some functions are not available in **AUTO** mode.

Easy Operation of the Mode Dial

Release the mode dial lock using the mode dial lock release lever to easily operate the mode dial without having to press the mode dial lock button.

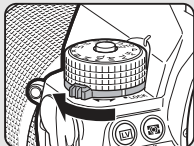

Disabling Operation Controls

Operation of buttons and dials can be temporarily disabled to prevent misoperation during shooting.

Turning while pressing disables the operation of buttons and dials. Turning again enables the operation of them.

is displayed on the status screen and Live View screen and in the viewfinder while the operation of buttons and dials is disabled.

The group of buttons and dials to be disabled can be selected in [19 Enable/Disable Control] of the **C3** menu.

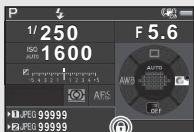
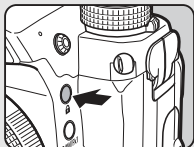

Type	Buttons and Dials Disabled
Type1	, , , ISO , ,
Type2	, , , OK , MENU

How to Use a Retractable Lens

If the camera is turned on when a retractable lens, such as HD PENTAX-DA 18-50mm F4-5.6 DC WR RE, is attached and is not extended, an error message is displayed on the monitor. Turn the zoom ring in the direction of **②** while pressing the button on the ring (**①**) to extend the lens. When retracting the lens, turn the zoom ring in the opposite direction to **②** while pressing the button on the ring and align the white dot to the position **③**.

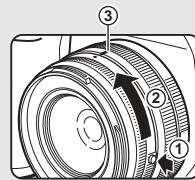

Reviewing Images

Review the captured image on the monitor.

1 Press .

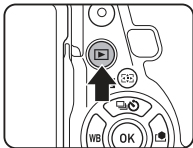











The camera enters playback mode and the most recently captured image is displayed (single image display).



2 Review the captured image.

Available operations

	to the left	Displays the previous image.
	to the right	Displays the next image.
		Deletes the image.
	to the right	Magnifies the image (up to 16x). Use     to change the area to display. Press  to return the display area to the center. Press OK to return to the entire image display.
	to the left	Switches to the thumbnail display (p.77).
		Switches between the SD1 card and the SD2 card.

AE-L

Saves the RAW data (only when a JPEG image was taken and the data remains in the buffer).



INFO

Changes the type of information displayed (p.15).



Displays the playback mode palette (p.76).

Memo

- When  is turned to the right to magnify the image, the magnification is displayed at the bottom right of the screen. **100%** appears when the image is displayed at the actual pixel size (1x image display). You can set the initial magnification when magnifying images in [Quick Zoom] of the  1 menu.
- When **AE-L RAW** is displayed on the monitor, the JPEG image that was just taken can also be saved in RAW format (Save RAW Data).
- You can display grid lines in single image display. Set in [Grid Display] of [Image Display] in the  1 menu. (p.27)

Configuring the Capture Settings

Memory Card Settings



Set the recording method for when two memory cards are inserted in [Memory Card Options] of the 2 menu.

Sequential Use	When the memory card in the SD1 slot becomes full, data is saved to the card in the SD2 slot.
Save to Both	Saves the same data to the memory cards in both the SD1 and the SD2 slots.
Separate RAW/JPEG	Saves the RAW data to the memory card in the SD1 slot, and the JPEG data to the card in the SD2 slot.

When in mode, data is saved to the card in either the SD1 slot or the SD2 slot.

Image Capture Settings



Set the file format for still pictures in [Image Capture Settings] of the 2 menu.

File Format	JPEG, RAW, RAW+
JPEG Recorded Pixels	[L], [M], [S], [XS]
JPEG Quality	★★★, ★★, ★
RAW File Format	PEF, DNG
Color Space	sRGB, AdobeRGB

⚠ Caution

- When [Memory Card Options] is set to [Separate RAW/JPEG], [File Format] is fixed to [RAW+].

📝 Memo

- When [File Format] is set to [RAW+], a JPEG image and a RAW image with the same file number are saved at the same time.
- You can change the setting so that you can take pictures in another file format when or is pressed. (p.99)
- [PEF] of [RAW File Format] is a PENTAX original RAW file format.

Movie Capture Settings



Set the file format for movies in [Movie Capture Settings] of the 1 menu.

Recorded Pixels	Framerate
	60i, 50i, 30p, 25p, 24p
	60p, 50p

Setting the Angle of View



You can change the angle of view in [Crop] of the 2 and 1 menus.

	Automatically changes the angle of view depending on the lens mounted to the camera.
	Sets the angle of view in 35mm full-frame format.
	Provides the angle of view equivalent to that of the APS-C size image sensor.

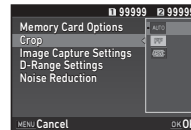

📌 Memo

- The angle of view can also be changed by the Smart Function. (p.19)
- Select when you want a frame corresponding to the APS-C size image sensor irrespective of the lens in use (either DA lenses or 35mm full-frame compatible lenses, such as D FA lenses). Select when you want the camera to select automatically the angle of view between the 35mm full-frame and the APS-C size depending on the lens in use.
- When changing the angle of view, the cropping frame is displayed in the viewfinder. (p.17)

Taking Still Pictures

Select the capture mode that suits the subject and shooting conditions.

The following capture modes are available on this camera.

Capture Mode	Function	Page
AUTO (Scene Analyze Auto mode)	Automatically sets the optimal shooting settings.	p.39
P/Sv/Tv/Av/TAv/M/B/X (Exposure modes)	Allows you to change the shutter speed, aperture value, and sensitivity.	p.44
U1 to U5 (USER modes)	Allows you to save frequently used exposure modes and capture settings together.	p.101

Exposure Modes

✓: Available #: Restricted ✗: Not available

Mode	Change Shutter Speed	Change Aperture Value	Change Sensitivity	EV Compensation
P Program Automatic Exposure	# *1	# *1	✓	✓
Sv Sensitivity Priority Automatic Exposure	✗	✗	✓ *2	✓
Tv Shutter Priority Automatic Exposure	✓	✗	✓	✓

Mode	Change Shutter Speed	Change Aperture Value	Change Sensitivity	EV Compensation
Av Aperture Priority Automatic Exposure	✗	✓	✓	✓
TAv Shutter & Aperture Priority Automatic Exposure	✓	✓	✗ *3	✓
M Manual Exposure	✓	✓	✓ *2	✓
B Bulb Exposure	✗	✓	✓ *2	✗
X Flash X-sync Speed	✗ *4	✓	✓ *2	✓

*1 You can set the value to be changed in [E-Dial Programming] of [Button Customization] in the **C5** menu. (p.99)

*2 [ISO AUTO] is not available.

*3 Fixed to [ISO AUTO].

*4 You can set the flash sync speed in [7 Flash Sync Speed] of the **C1** menu.

1 Set the mode dial to the desired exposure mode.

or appears on the status screen for the value that can be changed.

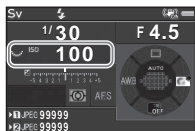

The value that can be changed is underlined in the viewfinder.



The values of the current camera settings are displayed on the LCD panel.

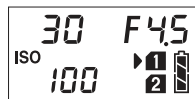

During Live View, appears for the value that can be changed.



2 Turn .

The aperture value is changed in **Av**, **TAv**, **M**, **B**, or **X** mode. The sensitivity is changed in **Sv** mode.

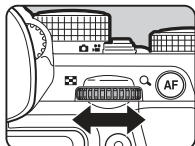

3 Turn .

The shutter speed is changed in **Tv**, **TAv**, or **M** mode.

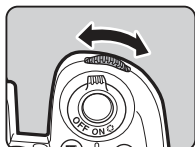

Memo

- The settings for the exposure can be specified in increments of 1/3 EV steps. In [1 EV Steps] of the **C1** menu, you can change the adjustment steps to 1/2 EV steps.
- In **M** or **X** mode, the difference from the correct exposure is displayed on the EV bar scale while the exposure is adjusted.
- For each exposure mode, you can set the camera operation for when or is turned or is pressed. Set in [E-Dial Programming] of [Button Customization] in the 5 menu. (p.99)

Caution

- The correct exposure may not be obtained with the selected shutter speed and aperture value when the sensitivity is fixed at a certain sensitivity.
- In **B** mode, the drive mode cannot be set to [Continuous Shooting], [Bracketing], or [Interval Shooting].

Noise Reduction when Shooting with a Slow Shutter Speed 2

When shooting with a slow shutter speed, you can reduce image noise in [Slow Shutter Speed NR] of [Noise Reduction] in the 2 menu.

AUTO	Applies Noise Reduction according to the shutter speed, sensitivity, and internal temperature of the camera.
ON	Applies Noise Reduction when the shutter speed is slower than 1 second.
OFF	Does not apply Noise Reduction at any shutter speed.

Program Line



In [Program Line] of the menu, you can specify how exposure is controlled.

	AUTO	Determines the appropriate settings.
	Normal	Sets to the basic program automatic exposure (all-around mode).
	Hi-speed Priority	Prioritizes high shutter speeds.
	DOF Priority (Deep)	Closes the aperture for a deep depth of field.
	DOF Priority (Shallow)	Opens the aperture for a shallow depth of field.
	MTF Priority	Sets the sharpest aperture of the attached lens when a D FA, DA, DA L, FA, or FA J lens is used.

The Program Line setting is enabled in the following situations.

- In **P** or **Sv** mode
- When **PLINE** is set for the operation of **TA_v** or **M** in [E-Dial Programming] of [Button Customization] in the menu

EV Compensation

The compensation value can be set between -5 and +5 EV (-2 and +2 EV in mode).

1 Press , and then turn



and the compensation value are displayed on the status screen, LCD panel, Live View screen, and in the viewfinder during adjustment.

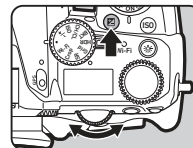

Available operations



Starts/ends adjusting the compensation value.



Resets the adjustment value to the default setting.

Memo

- The compensation value can also be adjusted by the Smart Function. (p.19)

Recording Movies

1 Turn the capture mode selector switch to .

Live View is displayed.

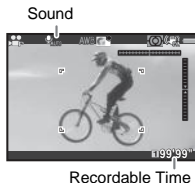

2 Use the mode dial to select an exposure mode.

P, **Tv**, **Av**, **TAv**, or **M** can be selected.

3 Use or to set the exposure.

4 Focus on the subject.

In **AF** mode, press **SHUTTER** halfway.

5 Press **SHUTTER** fully.

Movie recording starts.

In the upper left area of the monitor, "REC" blinks and the size of the recorded movie file is displayed.



6 Press **SHUTTER** fully again.

Movie recording stops.

Caution

- When recording a movie with sound, camera operation sounds are also recorded.
- When recording a movie with an image processing function such as Digital Filter applied, the movie file may be saved with some frames omitted.
- If the internal temperature of the camera becomes high during recording, recording may be terminated.
- When a retractable lens is attached, recording stops if the lens is retracted during recording and an error message is displayed.
- In  mode, the Wi-Fi function is disabled.

Memo

- When the mode dial is set to other than the modes described in Step 2, the camera operates in **P** mode.
- You can change the movie settings in the  1-2 menus. (p.26)
The sound volume for movies can be set in [Sound Volume Setting] of the  1 menu.

Recording Sound Level	AUTO, 0 to 20
Wind Noise Reduction	On, Off
Headphone Volume	0 to 20

Activating the Wind Noise Reduction function cuts off the low-pitch sound. It is recommended to set this function to [Off] when it is not necessary.

- You can record a movie continuously up to 4 GB or 25 minutes. When the memory card is full, recording stops.

Using a Microphone or Headphones

You can reduce the possibility of recording camera operation sounds by connecting a commercially available stereo microphone to the microphone terminal on the camera.

The following specifications are recommended for external microphones.

Plug	Stereo mini plug (ø3.5 mm)
Format	Stereo electret condenser
Power	Plug-in Power Method (operating voltage of 2.0 V or lower)
Impedance	2.2 kΩ

You can record and play back movies while listening to the sound by connecting commercially available headphones to the headphone terminal.

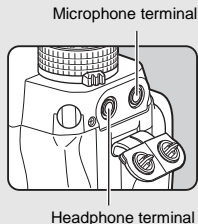

Playing Back Movies

1 Display the movie to play back in single image display of the playback mode.



Available operations

▲	Plays back/pauses a movie.
▶	Forwards a frame (when paused).
Press and hold ▶	Fast-forwards playback.
◀	Reverses a frame (when paused).
Press and hold ◀	Fast-reverses playback.
▼	Stops playback.
	Adjusts the sound volume (21 levels).
AE-L	Saves the displayed frame as a JPEG file (when paused).
INFO	Switches between [Standard Information Display] and [No Information Display].

Memo

- The sound volume at the start of movie playback can be set in [Playback Sound Volume] of the 1 menu. (p.27)
- In [Movie Edit] of the playback mode palette, a movie file can be divided into multiple segments or selected frames can be deleted. (p.84)

Setting the Exposure

Sensitivity

1 Press **ISO**, and then turn



The sensitivity displayed on the status screen, Live View screen, LCD panel and in the viewfinder changes.

Press **OK** to set the sensitivity to [ISO AUTO].

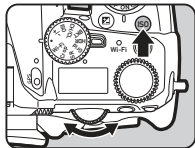

Memo

- The sensitivity can also be changed by the Smart Function. (p.19)
- In **AF** mode, the sensitivity can be set from ISO 100 to ISO 3200.
- The adjustment steps for the sensitivity is 1 EV step. To adjust the sensitivity in accordance with the EV step setting for the exposure, set from [2 Sensitivity Steps] of the **C1** menu.

Setting the Range of ISO AUTO



You can set the range in which the sensitivity is automatically adjusted when the sensitivity is set to [ISO AUTO]. Set in [ISO AUTO Setting] of the **C1** menu.

The manner in which the sensitivity is increased can be specified in [AUTO ISO Parameters].

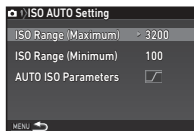

	Increases the sensitivity as little as possible.
	Increases the sensitivity at the intermediate level between slow and fast .
	Actively increases the sensitivity.

Caution

- When [HDR Capture] of the **C3** menu is enabled and [Auto Align] is set to (On), [AUTO ISO Parameters] is fixed to **FAST**.

Noise Reduction when Shooting with a High ISO Sensitivity



You can set the Noise Reduction setting when shooting with a high ISO sensitivity.

1 Select [Noise Reduction] in **C2** menu and press **▶**.



The [Noise Reduction] screen appears.

2 Select [High-ISO NR] and press **▶**.

3 Select the Noise Reduction level and press **OK**.

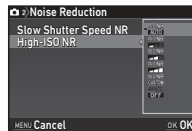

AUTO	Applies Noise Reduction at optimally calculated levels throughout ISO range.
Low/ Medium/ High	Applies Noise Reduction at constant chosen level throughout ISO range.
CUSTOM	Applies Noise Reduction at user-defined levels for each ISO setting.
OFF	Does not apply Noise Reduction at any ISO setting.

Proceed to Step 7 when other than [CUSTOM] is selected.

4 Select [Setting] and press **▶**.

5 Select the Noise Reduction level for each ISO setting.



Available operations



Shows the next/previous page.



Resets the Noise Reduction level to the default setting.

6 Press **MENU**.

The screen of Step 3 reappears.

7 Press **MENU** twice.

AE Metering



Choose the part of the sensor to use for measuring brightness and determining the exposure.

1 Turn while pressing .

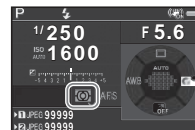
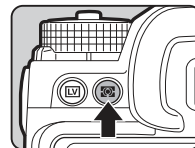

Multi-segment	Meters the brightness in multiple different zones of the sensor. In backlit conditions, this mode automatically adjusts the exposure.
Center-weighted	Meters the brightness with an emphasis on the center of the sensor. The sensitivity increases at the center and no automatic adjustment is performed even in backlit conditions.
Spot	Meters the brightness only within a limited area at the center of the sensor. Useful when the subject is small.

Memo

- The metering method can also be set in [AE Metering] of the 1 and 1 menus.

Setting the Focus Method

Set the focus mode switch to **AF** or **MF**.

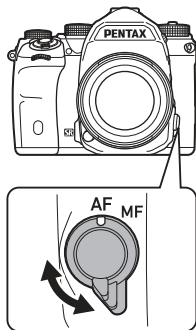

The autofocus method for shooting with the viewfinder differs from that for shooting with Live View.

Shooting with the viewfinder	TTL phase-matching detection AF: Select from A.F.S or A.F.C. Set the focusing area by selecting an AF point. (p.52) Faster autofocus performance than the contrast detection AF is possible.
Shooting with Live View	Contrast detection AF: Face Detection and Tracking are available. (p.53)

Focusing on the Subject Using the **AF** Button

You can use **AF** to focus on the subject. The **AF** button operation can be set in [Button Customization] of the 5 and 2 menus. (p.98)

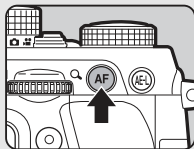

Setting the AF Mode when Shooting with the Viewfinder



1 Turn while pressing .

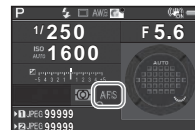
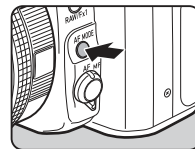

A.F.S Single mode	When SHUTTER is pressed halfway and the subject comes into focus, the focus is locked at that position. The AF assist light turns on as necessary.
A.F.C Continuous mode	The subject is kept in focus by continuous adjustment while SHUTTER is pressed halfway. The shutter can be released even if the subject is not in focus.

Caution

- In **AUTO** mode, the autofocus mode is fixed to **A.F.S**.

1 Turn while pressing .

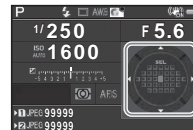
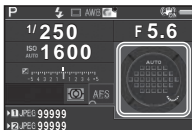

2 Select the desired AF point.

Available operations

	Changes the AF point.
	Returns the AF point to the center.
	Switches the function of the arrow keys () to the AF point change mode or the direct key operation mode.



Caution

- In **AUTO** mode, the focusing area selection mode is fixed to .

Auto (33 AF Points)	Out of the 33 AF points, the camera automatically selects the optimum focusing area.
Zone Select	Out of the selected 9 AF points, the camera automatically selects the optimum focusing area.
Select	Sets the focusing area to the user selected point from 33 points.
Expanded Area AF (S)	Sets the focusing area to the user selected point from 33 points. When the subject happens to move out of the selected focusing area after being focused, 8 peripheral points are used as back-up points. Available only in A.F.C. mode.
Expanded Area AF (M)	Sets the focusing area to the user selected point from 33 points. When the subject happens to move out of the selected focusing area after being focused, 24 peripheral points are used as back-up points. Available only in A.F.C. mode.
Expanded Area AF (L)	Sets the focusing area to the user selected point from 33 points. When the subject happens to move out of the selected focusing area after being focused, 32 peripheral points are used as back-up points. Available only in A.F.C. mode.
Spot	Sets the focusing area to the center of the 33 points.

Proceed to Step 2 when a mode other than or is selected.





Memo

-  is displayed in the viewfinder when the AF point can be changed. The selected AF point can be checked also in the viewfinder. (p.17)
- For the autofocus operation when shooting with the viewfinder, the following settings can be set in [Phase Detection AF] of the  1 menu.

AF Mode	A.F.S., A.F.C
AF Active Area	
AF.S Setting	Focus-priority, Release-priority
1st Frame Action in AF.C	Auto, Focus-priority, Release-priority
Action in AF.C Cont.	Auto, Focus-priority, FPS-priority
Hold AF Status	Off, Low, Medium, High

In [Hold AF Status], you can set whether to immediately reactivate autofocus or to maintain the focus for a certain amount of time before reactivating autofocus when the subject happens to move out of the selected focusing area after being focused. The default setting is to reactivate autofocus a little while after the subject moves out of focus.

- You can select the button operation when changing the focusing area in [20 Change AF Point Button] of the  3 menu.





Type1	Switches the function of the arrow keys () to the AF point change mode or the direct key operation mode when  is pressed.
Type2	Switches the function of the arrow keys () to the direct key operation mode only when  is pressed.

Setting the AF Mode during Live View

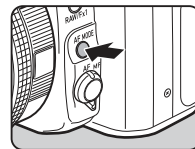
 1/ 1

- 1 Turn  while pressing .



	Face Detection	Detects and tracks faces of people. The main face detection frame for AF and AE is displayed in yellow.
	Tracking	Tracks the subject in focus. The shutter can be released even if the subject is not in focus.
	Multiple AF Points	Sets the focusing area to the desired area. The sensor is divided into 35 areas (7 horizontal by 5 vertical), and you can select a wider or narrower focusing area by using 1, 9, 15, or 25 of those 35 available areas.
	Select	Sets the focusing area by the pixel.
	Spot	Sets the focusing area to a limited area at the center.

Caution

- In **AUTO** mode, the autofocus mode is fixed to .

Selecting the Desired Focusing Area

You can set the position and range of the autofocus area (AF area).

1 Set the autofocus mode to or .

2 Press .

3 Select the AF area.

Use the frame that appears on the monitor to change the position and size of the AF area.



Available operations

Changes the position of the AF area.

Increases/reduces the size of the AF area (when is selected).

Returns the AF area to the center.

4 Press **OK**.

The AF area is set.

Memo

- For the autofocus operation when shooting with Live View, the following settings can be set in [Contrast Detection AF] of the 1 and 1 menus.

Contrast AF	1, 2, 3, 4, 5
Focus Peaking	ON, OFF
Contrast AF Options	Focus-priority, Release-priority

When [Focus Peaking] is set to [ON], the outline of the subject in focus is emphasized, and this makes it easier to check the focus. This function works in both **AF** and **MF** modes.

AF Fine Adjustment

C4

You can precisely fine-tune your lenses with the camera's autofocus system.

1 Select [25 AF Fine Adjustment] in C4 menu and press **▶**.

The [25 AF Fine Adjustment] screen appears.

2 Select [Apply All] or [Apply One] and press **OK**.

Apply All	Applies the same adjustment value to all lenses.
Apply One	Saves an adjustment value for the lens being used. (Up to 20 values)

3 Select [Setting] and adjust the value.

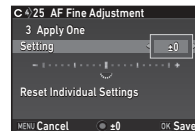

Available operations

to the right Adjusts the focus to a closer position.

to the left Adjusts the focus to a farther position.

Resets the adjustment value to the default setting.

4 Press **OK**.

The adjustment value is saved.

5 Press **MENU** twice.

The camera returns to standby mode.

Checking the Depth of Field (Preview)

Turn the main switch to  to use the preview function.

There are two preview methods.

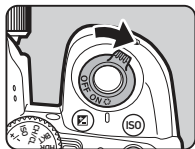

Optical Preview	Activates the Optical Preview function to check the depth of field with the viewfinder.
Digital Preview	Activates the Digital Preview function to check the composition, exposure, and focus on the monitor. You can magnify or save the preview image.

Setting the Preview Method



1 Select **[Button Customization]** in 5 menu and press **▶**.

The [Button Customization] screen appears.

2 Select **[Preview Dial]** and press **▶**.

The [Preview Dial] screen appears.

3 Select **[Optical Preview]** or **[Digital Preview]** and press **OK**.

For Digital Preview, the operations and information displayed during preview can be set.

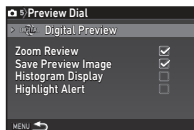

4 Press **MENU** three times.

The camera returns to standby mode.

Memo

- Optical Preview is always used in the following situations regardless of the setting.
 - When the drive mode is set to [Mirror Lock-up Shooting], [Multi-exposure], or [Interval Shooting]
 - When using the ASTROTRACER function
 - In  mode

Caution

- The effects of some functions cannot be checked during Digital Preview or are not applied to the saved preview image.

Setting the Drive Mode

1 Press **▲** in standby mode.

The Drive Mode screen appears.

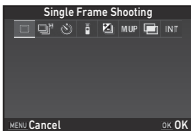

2 Select a drive mode.

Single Frame Shooting (□)	Normal capture mode
Continuous Shooting (□/□/□)	Continuously takes pictures while SHUTTER is kept pressed. (p.57)
Self-timer (○/○/○)	Releases the shutter about 12 seconds or 2 seconds after SHUTTER is pressed. (p.57)
Remote Control (i/SS/□)	Enables shooting with remote control. (p.58)
Bracketing (□/□/□)	Takes consecutive pictures at different exposure levels. (p.59)
Mirror Lock-up Shooting (MUP/MUP)	Takes images with the mirror raised. (p.60)
Multi-exposure (□/□/□/□)	Creates a composite image by taking multiple pictures and merging them into a single image. (p.60)
Interval Shooting (INT/□/□/□)	Automatically takes pictures at set intervals. (p.61)

⚠ Caution

- There are restrictions on some drive modes when used in combination with some other functions. (p.107)

📌 Memo



- The Drive Mode setting is saved even after the power is turned off. If [Drive Mode] is set to **□** (Off) in [Memory] of the **5** menu, the setting returns to [Single Frame Shooting] when the power is turned off. (p.103)
- The [Shake Reduction] of the **4** menu is automatically set to [OFF] when the drive mode is set to [Self-timer], [Remote Control], or [Mirror Lock-up Shooting]. If you do not want to turn off the Shake Reduction function, set in [21 Auto SR Off] of the **3** menu.

If Light Enters through the Viewfinder

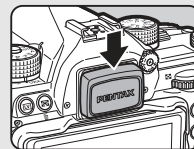



When the drive mode that employs the self-timer or remote control is selected, exposure may be affected by the light entering through the viewfinder. In such a case, use the AE Lock function or attach the optional ME viewfinder cap. Remove the eyecup before attaching the ME viewfinder cap.



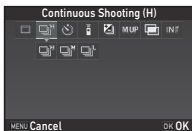

Continuous Shooting

- 1 Select  on the Drive Mode screen and press .





- 2 Use  to select , , or , and press .



	Continuous Shooting (at high speed)
	Continuous Shooting (at medium speed)
	Continuous Shooting (at low speed)

The camera returns to standby mode.

Memo



- , , and  can also be switched by the Smart Function. (p.19)
- When the autofocus mode is set to **A.F.S.**, the focus position is locked in the first frame.

Self-timer

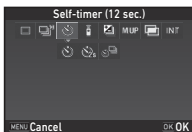
- 1 Select  on the Drive Mode screen and press .



- 2 Use  to select , , or .

	Self-timer (shutter release after about 12 seconds)
	Self-timer (shutter release after about 2 seconds)
	Self-timer + Continuous Shooting

Proceed to Step 6 when  or  is selected.

- 3 Press .

- 4 Set [Shooting Speed] and [Number of Shots].

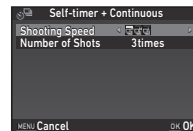

- 5 Press .

The screen of Step 1 reappears.

- 6 Press .

The camera returns to standby mode.

- 7 Press  halfway, and then fully.



The shutter is released after about 12 seconds or 2 seconds.

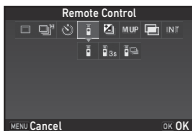

Remote Control

- 1 Select  on the Drive Mode screen and press **▼**.



- 2 Use **◀▶** to select , , or .

	Remote Control
	Remote Control (shutter release after about 3 seconds)
	Remote Control + Continuous Shooting

Proceed to Step 6 when  or  is selected.

- 3 Press **INFO**.

- 4 Set [Shooting Speed].

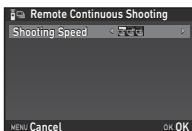

- 5 Press **OK**.

The screen of Step 1 reappears.

- 6 Press **OK**.

The camera returns to standby mode.

- 7 Press **SHUTTER** halfway.

- 8 Point the remote control unit towards the remote control receiver on the front of the camera, and press the shutter release button on the remote control unit.

Memo



- The maximum operating distance of the remote control unit is approximately 4 m from the front of the camera.
- To adjust focus with remote control, set in [10 AF with Remote Control] of the **C2** menu.
- When using the Remote Control Waterproof O-RC1, the autofocus system can be operated with the  button on the remote control unit. The **Fn** button cannot be used.

Bracketing

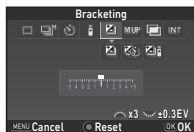
- 1 Select  on the Drive Mode screen and press \blacktriangledown .



- 2 Use \blacktriangleleft \blacktriangleright to select , , or .

	Bracketing
	Bracketing + Self-timer
	Bracketing + Remote Control

Proceed to Step 6 when  is selected.

- 3 Press **INFO**.

- 4 Select the operation mode.

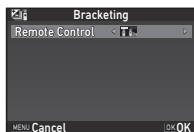





- 5 Press **OK**.

The screen of Step 1 reappears.

- 6 Set the number of shots and bracket value.

Available operations

	Sets the number of shots.
	Changes the bracket value (up to ± 3 EV).
	Adjusts the exposure compensation value.
	Resets the compensation value to the default setting.

- 7 Press **OK**.

The camera returns to standby mode.

- 8 Shoot.

After pictures are taken, the camera returns to standby mode.

Memo

- The bracket value can be set in increments of 1/3 EV steps or 1/2 EV steps according to the [1 EV Steps] setting of the **C1** menu.
- The following settings for Bracketing can be set in the **C2** menu.

11 Bracketing Order	Changes the shooting order of pictures.
12 One-Push Bracketing	Takes all pictures with one release of the shutter.

- The bracket value can also be changed by the Smart Function. (p.19)

Mirror Lock-up Shooting

1 Select **MUP** on the Drive Mode screen and press **▼**.

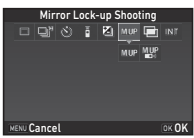

2 Use **◀▶** to select **MUP** or **MUP**.

MUP	Mirror Lock-up Shooting
MUP	Mirror Lock-up Shooting + Remote Control

3 Press **OK**.

The camera returns to standby mode.

4 Press **SHUTTER** halfway, and then fully.

The mirror pops up and the AE Lock function is activated.

5 Press **SHUTTER** fully again.

The mirror returns to its original position after the image is taken.

Memo

- The mirror automatically returns to its original position if 1 minute elapses after the mirror pops up.

Caution

- Mirror Lock-up Shooting cannot be selected when shooting with Live View.

Multi-exposure

1 Select **[M]** on the Drive Mode screen and press **▼**.

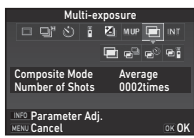

2 Use **◀▶** to select **[M]**, **[M]**, **[M]**, or **[M]**.

[M]	Multi-exposure
[M]	Multi-exposure + Continuous Shooting
[M]	Multi-exposure + Self-timer
[M]	Multi-exposure + Remote Control

Proceed to Step 6 if you do not need to change the shooting conditions.

3 Press **INFO**.

4 Set the shooting conditions.

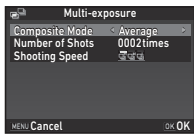

Composite Mode	Select from [Average], [Additive], or [Bright].
Number of Shots	Select from 2 to 2000 times.
Shooting Speed/ Self-timer/ Remote Control	Specify the operation mode for the selected shooting mode.



5 Press **OK**.
The screen of Step 1 reappears.

6 Press **OK**.
The camera returns to standby mode.

7 Shoot.

Instant Review is displayed.

Available operations during Instant Review

- | | |
|---|--|
|  | Discards pictures taken up to that point and takes pictures again from the first picture. |
| MENU | Saves pictures taken up to that point and displays the  menu. |

After the specified number of shots are taken, the camera returns to standby mode.

Memo

- Composite images are created as follows in each Composite Mode.



Average	Creates a composite image with the average exposure.
Additive	Creates a composite image with the cumulatively added exposure.
Bright	Creates a composite image replacing only the portions that are brighter compared with the first image.

Interval Shooting

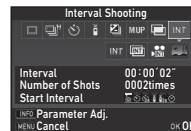
- 1 Select **INT** on the Drive Mode screen and press .



- 2 Use  to select **INT**, , , or .

INT	Interval Shooting Takes pictures at set intervals and saves them.
	Interval Composite Takes pictures at set intervals and merges them into a single image.
	Interval Movie Record Takes still pictures at set intervals and saves them as a single movie file (Motion JPEG, file extension: .AVI).
	Star Stream Takes still pictures at set intervals and merges them into a single movie file (Motion JPEG, file extension: .AVI) using Interval Composite.

Proceed to Step 6 if you do not need to change the shooting conditions.

- 3 Press **INFO**.

- 4 Set the shooting conditions.

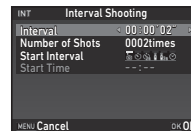

Recorded Pixels	Select from 4K , FUJHD , or HD (only for and).
Interval	Select from 2 seconds to 24 hours.
Standby Interval	Select from the minimum time or 1 second to 24 hours.
Number of Shots	Select from 2 to 2000 times.
Start Interval	Select when and how to take the first picture from [Now], [Self-timer], [Remote Control], or [Set Time].
Start Time	Set the shooting start time when [Start Interval] is set to [Set Time].
Composite Mode	Select from [Average], [Additive], or [Bright] (only for).
Save Process	Select to save images in the middle of processing (only for).
Fade-out	Select the fade-out effect level of light trails (only for).

5 Press **OK**.

The screen of Step 1 reappears.

6 Press **OK**.

The camera returns to standby mode.

7 Press **SHUTTER**.

When [Start Interval] is set to [Now], the first picture is taken. When set to [Set Time], shooting starts at the set time.

To cancel shooting, turn the main switch to [OFF].

After the specified number of shots are taken, the camera returns to standby mode.

Memo

- For **INT** and , a new folder is created and the captured images are saved there.
- The shortest time that can be set for [Interval] is 10 seconds when [Digital Filter], [Clarity], or [Skin Tone] is set, and 20 seconds when [HDR Capture] is set.
- The second and later exposures start at the intervals set in [Interval]. If the exposure time is longer than the time set in [Interval], some of the pictures that are supposed to be taken at the set intervals are not actually taken. For example, if the time set in [Interval] is 2 seconds and the exposure time is 3 seconds, the first exposure has not yet finished at the time the second exposure is supposed to be started (2 seconds after shooting has started), and so the second picture is not taken. As a result, Interval Shooting ends before the specified number of shots are taken. In such cases, you can set [Standby Interval] in [13 Interval Shooting Options] of the **C2** menu so that every picture is taken at the set intervals after each exposure ends. The screen displayed in Step 4 varies depending on the [13 Interval Shooting Options] setting.
- For **INT** and , the focus position used when the first picture is taken is locked. When performing autofocus for each exposure, set [14 AF in Interval Shooting] to [Adjusts focus for each shot] in the **C2** menu.
- For and , set the camera on a fixed support such as tripods during shooting.
- For and , [Shake Reduction] of the **C4** menu is fixed to [OFF].
- For , the camera operates in **M** mode regardless of the mode dial setting.

Setting the White Balance

1 Press in standby mode.

The White Balance setting screen appears. Turn the main switch to to use Digital Preview when shooting with the viewfinder.

2 Select the desired white balance setting.

For (Daylight), (Shade), and (Cloudy), turn to select the type of white balance.

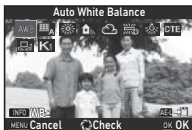

AWB	Auto White Balance
	Multi Auto White Balance
	Daylight
	Shade
	Cloudy
	Fluorescent - Daylight Color
	Fluorescent - Daylight White
	Fluorescent - Cool White
	Fluorescent - Warm White
	Tungsten
CTE	Color Temperature Enhancement
	Manual White Balance 1 to 3
K	Color Temperature 1 to 3

Available operations when shooting with the viewfinder

ABL	Saves the preview image (only when the image can be saved).
------------	---

Proceed to Step 5 if you do not need to fine-tune the white balance.

3 Press **INFO**.

The fine-tuning screen appears.

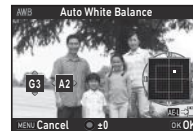

Available operations

	Adjust: Green-Magenta
	Adjust: Blue-Amber
	Resets the adjustment value to the default setting.

4 Press **OK**.

The screen of Step 2 reappears.

5 Press **OK**.

The camera returns to standby mode.

Caution

- In **AUTO** mode, the white balance is fixed to **AWB**.
- The Digital Preview operation in Step 1 is disabled when the drive mode is set to [Mirror Lock-up Shooting], [Multi-exposure], or [Interval Shooting].

Memo

- When is set, even if various light sources are present at the shooting location, the camera automatically adjusts the white balance according to the light source of each area. (is not available in mode.)
- The following settings for the white balance can be set in the **C3** menu.

15 WB Adjustable Range	Fixed, Auto Adjustment
16 AWB in Tungsten Light	Strong Correction, Subtle Correction
17 WB When Using Flash	Auto White Balance, Multi Auto White Balance, Unchanged
18 Color Temperature Steps	Kelvin, Mired

Adjusting the White Balance Manually

You can measure the white balance at a selected location.

1 Select  in Step 2 of “Setting the White Balance” (p.63).

2 Use  to select 1 to 3.
1 to 3 are the locations where you can store three different manual white balance settings.

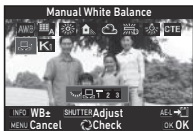

3 Under the light you wish to measure the white balance of, select a white area as the subject, and press **SHUTTER** fully.

The captured image is displayed.

4 Use  to specify the measuring area.



Press  to return the measuring area to the center.



5 Press **OK**.

The White Balance setting screen reappears.
[The operation could not be completed correctly] appears when measuring is unsuccessful. Press **OK** to remeasure the white balance.

Memo

- You can copy the white balance settings of a captured image and save them as  1 to  3 in [Save as Manual WB] of the playback mode palette. (p.76)

Adjusting the White Balance with Color Temperature

Specify the white balance with the color temperature.

1 Select **K** in Step 2 of “Setting the White Balance” (p.63).

2 Use  to select 1 to 3.

3 Press **INFO**.

4 Adjust the color temperature.

Set the color temperature value within the range from 2,500K to 10,000K.

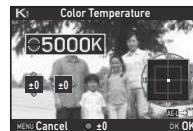

Available operations



Changes the color temperature in increments of 100 Kelvin.



Changes the color temperature in increments of 1,000 Kelvin.





Fine-tunes the color temperature.

5 Press **OK**.

The White Balance setting screen reappears.

Memo

- Select [Mired] in [18 Color Temperature Steps] of the **C3** menu to set the color temperature in mired units. The color temperature can be changed in 20 mired units with , and 100 mired units with . However, figures are converted to and displayed in Kelvin.

Using a Flash

When an external flash (optional) is connected to the camera, you can discharge a flash for shooting.

Connecting a Flash

Remove the hot shoe cover from the camera, and attach an external flash.

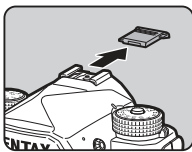

Memo

- Refer to "Functions when Using an External Flash" (p.111) for details on the functions of external flashes.

Setting the Flash Mode



- Select **[Flash Mode]** in **Q1** menu and press **▶**.
The Flash Mode screen appears.

- Select a flash mode.



	Auto Flash Discharge	Automatically measures the ambient light and determines whether to use the flash.
	Auto Flash + Red-eye	Discharges a pre-flash for red-eye reduction before an automatic flash.
	Flash On	Discharges a flash for each picture.

	Flash On + Red-eye	Discharges a pre-flash for red-eye reduction before the main flash for each picture.
	Slow-speed Sync	Sets to a slow shutter speed and discharges a flash for each picture. Use this, for example, when shooting a portrait with the sunset in the background.
	Slow Sync + Red-eye	Discharges a pre-flash for red-eye reduction before the main flash is discharged with Slow-speed Sync.

Available operations

- Compensates the flash exposure.
- Resets the compensation value to the default setting.

- Press **OK**.

- Press **MENU**.
The camera returns to standby mode.

Memo

- The flash modes that can be selected vary depending on the capture mode.

Capture Mode	Selectable Flash Mode
AUTO	, , ,
P, Sv, Av	, , ,
Tv, TvAv, M, B, X	,

- When the flash is used in **Av** mode, the shutter speed automatically changes over a range from 1/200 seconds to a slow shutter speed depending on the lens being used. The shutter speed is locked at 1/200 seconds when a lens other than a D FA, DA, DA L, FA, FA J, or F lens is used.
- When the flash is used in **Tv**, **TvAv**, or **M** mode, any desired shutter speed of 1/200 seconds or slower can be set.
- When [Flash Mode] is assigned to **Fx1** or **Fx2**, you can display the Flash Mode screen in Step 2 by a simple button operation. (p.98)

Controlling the Image Finishing Tone

Custom Image

- 1** Press **▶** in standby mode.
The Custom Image setting screen appears.

- 2** Select an image finishing tone.

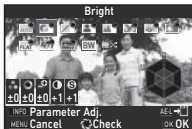

Auto Select	Muted
Bright	Flat
Natural	Bleach Bypass
Portrait	Reversal Film
Landscape	Monochrome
Vibrant	Cross Processing
Radiant	

Available operations when shooting with the viewfinder

Main switch to Uses Digital Preview to preview the background image with the selected setting applied.

AEL Saves the preview image (only when the image can be saved).

Proceed to Step 6 if you do not need to change the parameters.

- 3** Press **INFO**.
The parameter setting screen appears.

- 4** Set the parameters.



Available operations

- Selects a parameter.
- Adjusts the value.
- Switches between [Contrast], [Highlight Adjustment], and [Shadow Adjustment].
- Switches between [Sharpness], [Fine Sharpness], and [Extra Sharpness]. (Not available in mode.)
- Resets the adjustment value to the default setting.

- 5** Press **OK**.
The screen of Step 2 reappears.
The adjustment values for parameters are displayed.

- 6** Press **OK**.
The camera returns to standby mode.

⚠ Caution

- In **AUTO** mode, the image finishing tone is fixed to [Auto Select].
- The Digital Preview operation in Step 2 is disabled when the drive mode is set to [Multi-exposure] or [Interval Shooting].

Saving the Cross Processing Settings of a Captured Image

The outcome of Cross Processing varies each time a picture is taken. If you take a cross processed image that you like, you can save the Cross Processing settings used in the image so that you can repeatedly use the same settings.

1 Press **▼** in single image display of playback mode.

The playback mode palette appears.

2 Select **📷** and press **OK**.

The camera searches for cross processed images starting from the most recent image taken.

[No cross processed image] appears if there are no cross processed images.

3 Use **☰** to select a cross processed image.

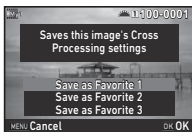

4 Select the "Favorite" number 1, 2, or 3 to save the settings, and press **OK**.

The settings of the selected image are saved as your "Favorite" settings.

📌 Memo

- The saved Cross Processing settings can be loaded by selecting [Cross Processing] in Step 2 of "Custom Image" (p.66), and selecting one of the Favorite settings 1 to 3 for the parameter.

Digital Filter



1 Select [Digital Filter] in **📷3** or **📷2** menu and press **▶**.

The Digital Filter setting screen appears.

2 Select a filter.

Select [No Filter] to not shoot with a digital filter.



Extract Color
Replace Color
Toy Camera
Retro
High Contrast

Shading
Invert Color
Unicolor Bold
Bold Monochrome

Available operations when shooting with the viewfinder

Main switch to **🔄** Uses Digital Preview to preview the background image with the selected effect applied.

AE-L Saves the preview image (only when the image can be saved).

Proceed to Step 6 if you do not need to change the parameters.

3 Press **INFO**.

The parameter setting screen appears.

4 Set the parameters.



Available operations

- ▲▼ Selects a parameter.
- ◀▶ Adjusts the value.

5 Press **OK**.

The screen of Step 2 reappears.

6 Press **OK**.

7 Press **MENU**.

The camera returns to standby mode.

⚠ Caution

- This function cannot be used in combination with some other functions. (p.107)
- The Digital Preview operation in Step 2 is disabled when the drive mode is set to [Multi-exposure] or [Interval Shooting].
- Depending on the filter used, it may take longer to save images.

📝 Memo



- Still images can also be processed with digital filters in playback mode. (p.83)

Correcting Images

Brightness Adjustment

Highlight Correction Shadow Correction



Expands the dynamic range and enables a wider range of tones to be recorded by the CMOS sensor and reduces the occurrence of overexposed/underexposed areas. Set the correction functions from [D-Range Settings] of the 2 or 2 menu.

⚠ Caution

- When the sensitivity is set to less than ISO 200, [Highlight Correction] cannot be set to [ON].

📝 Memo

- [Highlight Correction] in  mode can be set to [AUTO] or [OFF].

HDR Capture



Takes three consecutive images at three different exposure levels to create a single composite image with them.

1 Select [HDR Capture] in 3 menu and press **▶**.
The [HDR Capture] screen appears.

2 Select the capture type and press **OK**.

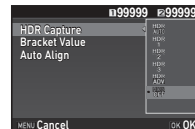

3 Set the range in which to change the exposure in [Bracket Value].

Select from [±1EV], [±2EV], or [±3EV].

4 Set whether to use Auto Align or not.

<input checked="" type="checkbox"/>	Uses Auto Align.
<input type="checkbox"/>	Does not use Auto Align.

5 Press **MENU** twice.

The camera returns to standby mode.

Memo

- The HDR type can also be changed by the Smart Function. (p.19)

Caution

- HDR Capture is not available in **B**, **X**, or **M** mode.
- HDR Capture cannot be used in combination with some other functions. (p.107)
- When the drive mode is set to [Interval Shooting] or [Interval Movie Record], [Auto Align] is fixed to (Off).
- When [Auto Align] is set to (Off), [Shake Reduction] of the **4** menu is fixed to [OFF].
- For HDR Capture, multiple images are combined together to create a single image, so it may take time to save the image.

Shake Reduction



By using the built-in Shake Reduction unit of the camera, blurring of images can be reduced. Set in [Shake Reduction] of the **4** menu.

Memo

- The Shake Reduction function can also be turned on or off by the Smart Function. (p.19)
- When [Shake Reduction] is assigned to **Fx1** or **Fx2**, you can turn the Shake Reduction function on or off by a simple button operation. (p.98)

Lens Correction



The following features can be set in [Lens Correction] of the **4** menu.

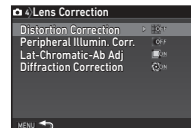

Distortion Correction	Reduces distortions occurring due to lens properties.
Peripheral Illumin. Corr.	Reduces peripheral light fall-off occurring due to lens properties.
Lat-Chromatic-Ab Adj	Reduces lateral chromatic aberrations occurring due to lens properties.
Diffraction Correction	Corrects blur caused by diffraction when using a small aperture.

Memo

- Corrections can only be made when a compatible lens is attached. (p.108) The features are disabled when using an accessory such as rear converters that is attached between the camera and the lens.
- When [File Format] is set to [RAW] or [RAW+] in [Image Capture Settings] of the **2** menu, correction information is saved as a RAW file parameter and you can select whether to apply the correction to the images when developing them. For the RAW Development function, [Color Fringe Correction] can also be set. (p.85)

Caution

- The Lens Correction features are not available when [Crop] of the **2** and **1** menus is set to [FF] while a DA or DA L lens (except DA★200mm F2.8 ED [IF] SDM, DA★300mm F4 ED [IF] SDM, and DA 560mm F5.6 ED AW lenses) is attached.

Quality Level and Texture Adjustment

Clarity



By using an image processing function, the texture and surface details can be adjusted in the range of -4 to +4. Set in [Clarity] of the menu.



Skin Tone



The skin tone of portraits can be enhanced. Select [Type1] or [Type2] in [Skin Tone] of the menu.

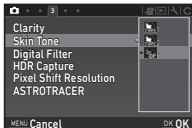

Pixel Shift Resolution



Pixel Shift Resolution is the feature that enables outputting a high-definition image of a stationary object by merging four images shifted pixel by pixel using the Shake Reduction mechanism.

Set in [Pixel Shift Resolution] of the menu.

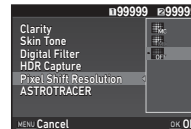

Motion Correction On	Corrects mosaic-pattern noise when a moving object is detected, and creates a composite image.
Motion Correction Off	Creates a composite image by combining the entire range of image.
Off	Does not use Pixel Shift Resolution.

When shooting is performed, captured four images are displayed in turn, and then they are merged into a single image.

⚠ Caution

- This function cannot be used in the following situations.
 - In **B** or **X** mode
 - In mode
- This function cannot be used in combination with some other functions. (p.107)
- While this function is used, [Shake Reduction] of the menu is fixed to [OFF].

📝 Memo

- When [Pixel Shift Resolution] is assigned to **Fx1** or **Fx2**, you can change the [Pixel Shift Resolution] setting by a simple button operation. (p.98)
- If a moving object exists in the frame, mosaic-pattern noise may appear in the image. In such case, select [Motion Correction On].
- When taking pictures with Pixel Shift Resolution, use a tripod and mount the camera on it securely. The use of Self-timer, Remote Control, or Mirror Lock-up Shooting is recommended.

By shaking the Shake Reduction unit, a moiré reduction effect simulating that of a low-pass filter can be achieved.

1 Select **[AA Filter Simulator]** in **CAMERA 4** menu and press **▶**.

2 Select a type and press **OK**.

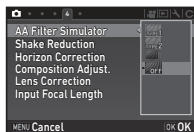

Type1	Takes pictures while balancing the resolution and moiré reduction.
Type2	Prioritizes moiré reduction.
Bracketing	Takes consecutive 3 images in order of [Off], [Type1], and [Type2].

⚠ Caution

- This function cannot be used in some capture modes or in combination with some other functions. (p.107)
- [Bracketing] cannot be selected in the following situations.
 - In **B** mode
 - When the drive mode is set to other than [Single Frame Shooting], [Self-timer] (12 seconds, 2 seconds), or [Remote Control] (now, after 3 seconds)
 - When HDR Capture is set
- When the shutter speed is faster than 1/1000 seconds, the full effect of this function cannot be achieved.

By using the Shake Reduction mechanism, the composition of the image can be adjusted. Use this function when you want to adjust the composition, such as when using a tripod while shooting with Live View.

1 Select **[ON]** in **[Composition Adjust.]** of **CAMERA 4** menu.

2 Press **MENU**.

The camera returns to standby mode.

3 Press **LV**.

Live View is displayed and the message [Adjust the composition of the image] appears.

4 **Adjust the composition.**

The amount of adjustment (the number of steps) is displayed at the top right of the screen.



Available operations

▲▼◀▶ Moves the composition of the image (up to 24 steps).



Adjusts the level of the composition (up to 8 steps. Not available when the amount of adjustment steps is 17 or more).



Resets the adjustment value to the default setting.

5 Press **OK**.

The camera returns to standby mode in Live View.

⚠ Caution

- You cannot use this function when the ASTROTRACER function is used.

📝 Memo

- The adjusted composition is saved even if Live View is ended or the camera is turned off. To reset the saved adjustment value when Live View is ended, set [Composition Adjust.] to (Off) in [Memory] of the 5 menu. (p.103)

Using the GPS

The following functions are available with the camera's built-in GPS unit.

GPS Logging	Saves the GPS positioning data received periodically to the memory card. (p.74)
ASTROTRACER	Tracks and captures celestial bodies. (p.75) By matching the movement of the built-in Shake Reduction unit with the movement of celestial bodies, celestial bodies can be captured as individual points even when shooting with a long exposure setting.
GPS Time Sync	Adjusts the camera's date and time settings using information obtained from GPS satellites.

Press **GPS** to turn the GPS on. The GPS indicator lamp lights up. Press **GPS** again to turn the GPS off.

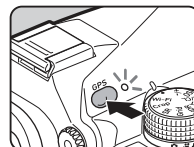

You can check the GPS positioning status on the status screen and Live View screen. The icon color tells the ongoing action.

GPS positioning status

Green	3D positioning
Yellow	2D positioning
Red	No positioning

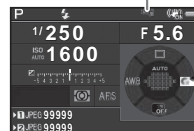

When a picture is taken while the GPS is on, the GPS information is stored internally in the image file. The GPS information is not stored in the movie file. You can check the GPS information in Detailed Information Display in playback mode. (p.15)

⚠ Caution

- While the GPS is on, the battery drains faster than normal.
- If you use the camera near objects which generate a magnetic field such as magnets, or have magnetism such as iron, the electronic compass may not work properly.
- The GPS information stored in the image file cannot be deleted. If you do not want to share the shooting location information with the public when posting the image on SNS, etc., turn the GPS off before shooting.
- You cannot use the optional GPS unit O-GPS1 with this camera.
- For other precautions on the GPS, refer to “About the GPS” (p.129).

📌 Memo

- When the GPS information can be obtained, Coordinated Universal Time (UTC) is recorded as the shooting date and time for images. On the Electronic Compass screen (p.14), the time is displayed after the difference between UTC and the time of the shooting location is corrected.

Performing a Calibration



Perform a calibration to make the GPS unit operate correctly.

1 Select [GPS/E-Compass] in 2 menu and press .

The [GPS/E-Compass] screen appears.

2 Select [Calibration] and press .

The [Calibration] screen appears.

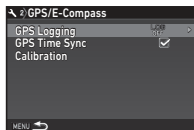

3 Rotate the camera according to the instruction displayed on the monitor.

The result of calibration appears.

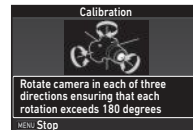

4 Press .

The screen of Step 2 reappears.

If [The operation could not be completed correctly] appears, change the camera direction and perform a calibration again.

⚠ Caution

- When performing a calibration, be careful not to drop the camera. Wrap the strap around your wrist or take other preventive measures.
- If the battery is removed, perform a calibration again after the battery is put back in.
- Changing the lens or the angle of the monitor after performing a calibration may have some effect on the magnetic field environment. In this case, perform a calibration again.

📌 Memo

- When [GPS Time Sync] is set to  on the screen of Step 2, the camera's date and time settings are automatically adjusted.

Recording the Camera Route (GPS Logging)

1 Select [GPS/E-Compass] in menu and press .

The [GPS/E-Compass] screen appears.

2 Select [GPS Logging] and press .

The [GPS Logging] screen appears.

The GPS automatically turns on.

3 Set the logging conditions.

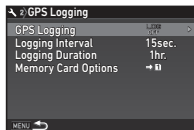

Logging Interval	Select from [5sec.], [10sec.], [15sec.], [30sec.], or [1min.].
Logging Duration	Select from [1hr.] to [24hr.]. (When [Logging Interval] is set to [5sec.], select from [1hr.] to [9hr.]. When [Logging Interval] is set to [10sec.], select from [1hr.] to [18hr.].)
Memory Card Options	Select the SD1 card or the SD2 card.

4 Select [GPS Logging] and press .

The confirmation screen appears.

5 Select [Start] and press .

GPS logging starts.

The screen of Step 3 reappears.

Caution

- GPS log data cannot be recorded when the camera is connected by USB to a computer.

Memo

- During GPS logging, "LOG" is displayed under the GPS positioning status icon on the status screen and Live View screen. When the time set in [Logging Duration] elapses, "LOG END" is displayed and a GPS log file is saved.
- Select [Exit] in Step 5 to stop GPS logging. A GPS log file is saved.
- When the GPS is turned off by pressing , GPS logging stops temporarily. (The countdown for [Logging Duration] continues.) GPS logging starts again when the GPS is turned on.
- If there is GPS log data to be saved as a log file, "LOG END" is displayed in [GPS Logging] on the screen of Step 3. Select [Save] in Step 5 to save the GPS log data as a log file. "LOG END" is displayed also when the power is turned off due to low battery level or when the battery is replaced. In this case, save the GPS log file before restarting GPS logging.
- During GPS logging, you cannot change the settings of [Logging Interval] and [Logging Duration].
- A log file (KML format) is saved in the "GPSLOG" folder on the memory card with a file name of a sequential number from 001 to 999 and month and day (example: 001_0505). However, if there is no GPS log data to be saved, neither a log file nor a folder is created. In addition, if the log file "999_***" has been saved, a new log file cannot be saved.
- You can display the camera route on Google Earth, etc. by transferring a log file to a computer and importing it.

Shooting Celestial Bodies (ASTROTRACER)



Setting the ASTROTRACER

- 1 Press **GPS**.
- 2 Select **[ASTROTRACER]** in **☰3** menu and press **▶**.
The [ASTROTRACER] screen appears.
- 3 Select **[ASTROTRACER]** and press **▶**.
- 4 Select **[ON]** and press **OK**.

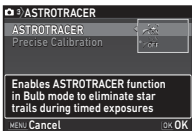

- 5 Select **[Precise Calibration]** and press **▶**.
The [Precise Calibration] screen appears.
Refer to "Performing a Calibration" (p.73) for how to perform a calibration.
- 6 Press **OK**.
The [ASTROTRACER] screen reappears.
- 7 Press **MENU** twice.
The camera returns to standby mode.

⚠ Caution

- As the magnetic field environment varies depending on the shooting location, a precise calibration must be performed at each location when shooting images of celestial bodies with ASTROTRACER.
- Changing the lens or the angle of the monitor after performing a precise calibration may have some effect on the magnetic field environment. In this case, perform a precise calibration again.

Shooting with the ASTROTRACER

- 1 Set the Exposure Mode to **B** and set the Focus Method to **MF**.
- 2 Set the shooting conditions.



Available operations









- | | |
|--|--|
| | Enables/Disables the timed exposure. |
| | Changes the exposure time within the range from 0'10" to 5'00" when the timed exposure is enabled. |
| | Changes the aperture value. |
| | Performs a precise calibration. |
- 3 Adjust the focus and press **SHUTTER** fully.
Shooting starts.
 - 4 Press **SHUTTER** fully again.
Shooting stops.
When the timed exposure is enabled, shooting stops automatically after the set time has elapsed.
- ⚠ **Caution**
- This function cannot be used in combination with some other functions. (p.107)



Playback Mode Palette Items

Playback functions can be set from the playback mode palette as well as the 1 menu (p.27).

Press  in single image display (Standard Information Display or No Information Display) of the playback mode to display the playback mode palette.



Item	Function	Page
 Image Rotation * ¹	Changes the rotation information of images.	p.79
 Digital Filter * ¹	Processes images with digital filters.	p.83
 Color Moiré Correction * ¹ * ²	Reduces color moiré in images.	p.82
 Resize * ¹ * ²	Changes the number of recorded pixels of the image.	p.81
 Cropping * ¹	Crops out only the desired area of an image.	p.82
 Protect	Protects images from being accidentally erased.	p.103
 Slideshow	Plays back images one after another.	p.79
 Save as Manual WB * ¹	Saves the white balance settings of the captured image as Manual White Balance.	p.64
 Save Cross Processing	Saves the settings used for an image captured in Cross Processing mode of Custom Image as your "Favorite" settings.	p.67

Item	Function	Page
 RAW Development * ³	Develops RAW images into JPEG images and saves them as new files.	p.85
 Movie Edit * ⁴	Divides a movie or deletes unwanted segments.	p.84
 Image Copy	Copies images between cards in the SD1 and the SD2 slots.	p.81

*1 Not available when a TIFF image or movie is displayed.

*2 Not available when a RAW image or TIFF image is displayed.

*3 Available only when a RAW image is saved.

*4 Available only when a movie is displayed.

Memo

- The functions of the playback mode palette can be used only for the images saved on the memory card that is currently being played back. To use the functions for the images saved on the other memory card, switch to the other memory card slot by pressing  in single image display, and then display the playback mode palette.

Changing the Playback Method

Displaying Multiple Images

You can display 6, 12, 20, 35, or 80 thumbnail images at the same time.

1 Turn to the left in playback mode.

The multi-image display screen appears.



Available operations



Moves the selection frame.



Shows the next/previous page.



Switches between the SD1 card and the SD2 card.



Shows the display style selection screen.



Deletes the selected images.

2 Press **OK**.

The selected image appears in single image display.

Deleting Selected Images

- 1 Press  in Step 1 of “Displaying Multiple Images” (p.77).
- 2 Select the images to delete.



Available operations



Moves the selection frame.



Confirms/cancels the selection of the image to delete.



Selects the range of images to delete.



Shows the selected image in single image display.
Use  to show a different image.

In the upper left area of the monitor, the number of selected images is displayed.

3 Press .

The delete confirmation screen appears.

4 Select **[Delete]** and press **OK**.

Memo

- You can select up to 500 images at a time.
- Protected images cannot be selected.
- You can delete the images selected individually along with the images selected by specifying the range to delete.
- Use the same steps to select multiple images for the following functions.
 - Image Copy (p.81)
 - RAW Development (p.85)
 - Protect (p.103)



Displaying Images by Folder

- 1 Turn  to the left in Step 1 of “Displaying Multiple Images” (p.77).

The folder display screen appears.



Available operations

  Moves the selection frame.

 Deletes the selected folder.

- 2 Press **OK**.

The images in the selected folder are displayed.

Deleting a Folder

- 1 Select the folder to delete in Step 1 of “Displaying Images by Folder” (p.78), and press .

The delete confirmation screen appears.

- 2 Select **[Delete]** and press **OK**.

The selected folder and all the images in it are deleted. When there are protected images in the folder, select **[Delete all]** or **[Leave all]**.

Displaying Images by Shooting Date

Images are grouped and displayed by shooting date.

- 1 Press **INFO** in Step 1 of “Displaying Multiple Images” (p.77).

The display style selection screen appears.

- 2 Select **[Calendar Filmstrip Display]**.



Shooting date Thumbnail date

Available operations

 Selects a shooting date.

 Selects an image taken on the selected shooting date.

 to the right Shows the selected image in single image display.

 Deletes the selected image.

- 3 Press **OK**.

The selected image appears in single image display.





Playing Back Images Continuously (Slideshow)

1 Select in the playback mode palette.

Slideshow starts.



Available operations

	Pauses/resumes playback.
	Displays the previous image.
	Displays the next image.
	Stops playback.
	Adjusts the sound volume of the movie.

After all images are played back, the camera returns to single image display mode.

Memo



- You can change the [Display Duration], [Screen Effect], [Repeat Playback], and [Auto Movie Playback] settings for slideshow in [Slideshow] of the 1 menu.

Slideshow can also be started from the Slideshow setting screen.

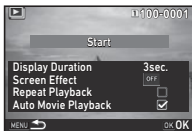
When [Auto Movie Playback] is set to (Off), press  during slideshow to play back a movie.



Displaying Rotated Images

Image rotation information is saved when you take pictures with the camera held vertically. When [Auto Image Rotation] of [Image Display] in the 1 menu is set to  (On), the image is automatically rotated based on the rotation information during playback (default setting).

The rotation information of an image can be changed by following the procedure below.

1 Display the image to edit in single image display.

2 Select in the playback mode palette.

The selected image is rotated in 90° increments and the four thumbnail images are displayed.

3 Use to select the desired rotation direction and press .

The image rotation information is saved, and the camera returns to single image display mode.

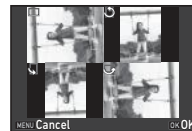

Caution

- When [22 Save Rotation Info] is set to [Off] in the **C4** menu, image rotation information is not saved.
- You cannot change image rotation information in the following cases.
 - Protected images
 - Images without a rotation information tag
 - When [Auto Image Rotation] of [Image Display] in the 1 menu is set to (Off)
- Movie files cannot be rotated.

Connecting the Camera to an AV Device

Connect to an AV device, such as TVs, equipped with an HDMI terminal to display Live View images while shooting or to play back images in playback mode.

Make sure to have a commercially available HDMI cable equipped with an HDMI terminal (type D).

- 1 Turn the AV device and camera off.
- 2 Open the terminal cover of the camera, and connect the cable to the HDMI terminal.

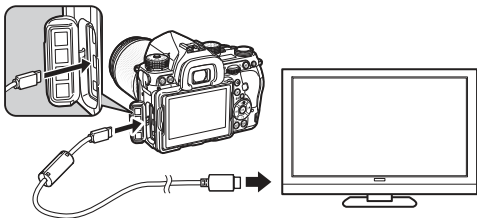

- 3 Connect the other end of the cable to the input terminal on the AV device.
- 4 Turn the AV device and camera on.

The camera turns on in HDMI mode, and the camera information is displayed on the screen of the connected AV device.

Caution

- While the camera is connected to an AV device, nothing is displayed on the camera monitor. Also, you cannot adjust the sound volume on the camera. Adjust the volume on the AV device.

Memo

- Check the operating manual of the AV device and select a suitable input terminal for connecting the camera.
- By default, the maximum resolution supported by both the AV device and camera is automatically selected. If it fails to play back images properly, change the setting in [HDMI Out] of the  2 menu.
- If you intend to use the camera continuously for a long period, the use of the optional AC adapter kit is recommended. (p.35)

Editing and Processing Images

Copying an Image

Copies images between memory cards in the SD1 and the SD2 slots.



- 1 Select an image saved on the memory card which the images are to be copied from, and display it in single image display.
- 2 Select  in the playback mode palette.
- 3 Select [Select image(s)] or [Select a folder] and press **OK**.
- 4 Select image(s) or a folder.
Refer to Step 2 of "Deleting Selected Images" (p.77) for how to select image(s).
- 5 Press **INFO**.
The save confirmation screen appears.
- 6 Select the location to save the image(s) or folder and press **OK**.

Changing the Image Size

- ⚠ **Caution**
 - Only JPEG images captured with this camera can be resized or cropped.
 - Images already resized or cropped to the minimum file size cannot be processed.

Changing the Number of Recorded Pixels (Resize)

Changes the number of recorded pixels of the selected image, and saves it as a new file.

- 1 Display the image to edit in single image display.
- 2 Select  in the playback mode palette.
The screen to select the number of recorded pixels appears.
- 3 Use   to select the number of recorded pixels and press **OK**.
You can select an image size smaller than that of the original image.
The save confirmation screen appears.
- 4 Select [Save to SD1] or [Save to SD2] and press **OK**.







Cropping Out Part of the Image (Cropping)

Crops out only the desired area of the selected image and saves it as a new file.

- 1 Display the image to edit in single image display.
- 2 Select  in the playback mode palette.
The cropping frame to specify the size and position of the area to crop appears on the screen.
- 3 Specify the size and position of the area to crop by using the cropping frame.





Available operations

	Changes the size of the cropping frame.
	Moves the cropping frame.
	Changes the Aspect Ratio or Image Rotation setting.
	Rotates the cropping frame (only when possible).

- 4 Press **OK**.
The save confirmation screen appears.
- 5 Select **[Save to SD1]** or **[Save to SD2]** and press **OK**.

Correcting Color Moiré

Reduces color moiré in images.

- 1 Display the image to edit in single image display.
- 2 Select  in the playback mode palette.
If the image cannot be edited, [This image cannot be processed] appears.
- 3 Use   to select the correction level and press **OK**.
The save confirmation screen appears.
- 4 Select **[Save to SD1]** or **[Save to SD2]** and press **OK**.



⚠ Caution

- The Color Moiré Correction function can be used only for the JPEG images captured with this camera.

Processing Images with Digital Filters

1 Display the image to edit in single image display.

2 Select **INFO** in the playback mode palette.

The screen to select a filter appears.

3 Select a filter.

Use  to select a different image.



Base Parameter Adj	Sketch
Extract Color	Water Color
Replace Color	Pastel
Toy Camera	Posterization
Retro	Miniature
High Contrast	Soft
Shading	Starburst
Invert Color	Fish-eye
Unicolor Bold	Slim
Bold Monochrome	Monochrome
Tone Expansion	

Proceed to Step 7 if you do not need to change the parameters.

4 Press **INFO**.

The parameter setting screen appears.

5 Set the parameters.

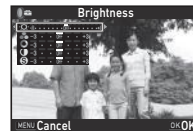

Available operations

 Selects a parameter.

 Adjusts the value.

6 Press **OK**.

The screen of Step 3 reappears.

7 Press **OK**.

The save confirmation screen appears.

8 Select **[Apply additional filter(s)]**, **[Save to SD1]**, or **[Save to SD2]**, and press **OK**.

Select **[Apply additional filter(s)]** when you want to apply additional filters to the same image. The screen of Step 3 reappears.

⚠ Caution

- Only JPEG and RAW images captured with this camera can be edited with the digital filters.
- RAW images captured using HDR Capture or Pixel Shift Resolution cannot be processed with Digital Filter.

📝 Memo

- Up to 20 filters, including the digital filter used during shooting (p.67), can be applied to the same image.

Recreating Filter Effects

Retrieves the filter effects of the selected image and applies the same filter effects to other images.

1 Display a filter-processed image in single image display.

2 Select **[O]** in the playback mode palette.

3 Select [Recreating filter effects] and press **[OK]**.

The filter effects used for the selected image appear.

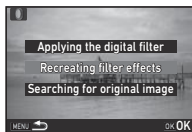

4 To check the parameter details, press **[INFO]**.

Press **[INFO]** again to return to the previous screen.

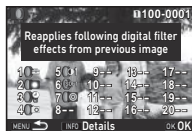

5 Press **[OK]**.

The image selection screen appears.

6 Use **[DIAL]** to select an image for applying the same filter effects, and press **[OK]**.

You can only select an image saved in the same memory card that has not been processed with a filter. The save confirmation screen appears.



7 Select [Save to SD1] or [Save to SD2] and press **[OK]**.

[Memo]

- If [Searching for the original image] is selected in Step 3, the original image prior to digital filter application can be retrieved.

Editing Movies

1 Display the movie to edit in single image display.

2 Select **[S]** in the playback mode palette. The movie editing screen appears.

3 Select the point where you want to divide the movie.

The frame at the dividing point is displayed at the top of the screen.

Up to four points can be selected to divide the original movie into five segments.

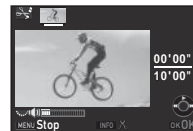

Available operations

[▶]	Plays back/pauses a movie.
[▶▶]	Forwards a frame (when paused).
[▶▶▶]	Fast-forwards playback.
[◀]	Reverses a frame (when paused).
[◀◀]	Fast-reverses playback.
[DIAL]	Adjusts the sound volume.
[INFO]	Confirms/cancels the selected dividing point.

Proceed to Step 7 if you do not want to delete any segment.

4 Press **[DELETE]**. The screen to select the segments to delete is displayed.

5 Use ◀▶ to move the selection frame and press **OK**.

The segments to delete are specified. (Multiple segments can be deleted at once.)

Press **OK** again to cancel the selection.



6 Press **MENU**.

The screen of Step 3 reappears.

7 Press **OK**.

The save confirmation screen appears.

8 Select **[Save to SD1]** or **[Save to SD2]** and press **OK**.

📌 Memo

- Select dividing points in chronological order from the beginning of the movie. When canceling the selected dividing points, cancel each of them in reverse order (from the end of the movie to the beginning). In an order other than specified, you can neither select dividing points nor cancel the selections of the dividing points.

Developing RAW Images

You can develop RAW images into JPEG or TIFF images, and save them as new files.

1 Select **RAW** in the playback mode palette.

The screen for selecting the processing type appears.

2 Select the desired option and press **OK**.

Select single image	Develops an image.
Select multiple images	Develops up to 500 images with the same settings.
Select a folder	Develops up to 500 images in the selected folder with the same settings.

When [Select single image] is selected, proceed to Step 6. The image/folder selection screen appears.

3 Select **image(s) or a folder**.

Refer to Step 2 of “Deleting Selected Images” (p.77) for how to select image(s).

Proceed to Step 5 if a folder is selected.

4 Press **INFO**.

The screen for selecting the parameter setting method appears.

5 Select the parameter setting method and press **OK**.

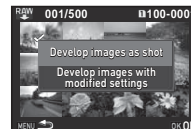

Develop images as shot	Allows you to change only File Format, Aspect Ratio, JPEG Recorded Pixels, JPEG Quality, and Color Space.
Develop images with modified settings	Allows you to change all setting items.

6 Select the setting item to change.



White Balance	Distortion Correction
Custom Image	Peripheral Illumin. Corr.
Sensitivity	Lat-Chromatic-Ab Adj
Clarity	Diffraction Correction
Skin Tone	Color Fringe Correction
Digital Filter	File Format
HDR Capture/	Aspect Ratio
Pixel Shift Resolution	JPEG Recorded Pixels
Shadow Correction	JPEG Quality
High-ISO NR	Color Space

Available operations

	Selects a different image (when in single image display).
	Selects a setting item.
	Changes the value.
	Reviews the image.
	Makes detailed settings.

7 Use to select [JPEG→] or [TIFF→].

Turn to change the file format.

8 Press .

The save confirmation screen appears.

9 Select [Save to SD1] or [Save to SD2] and press .

When [Select single image] is selected, select [Continue] or [Exit], and press .

Caution

- Only RAW images captured with this camera can be developed.
- For RAW images captured when the drive mode is set to [Multi-exposure] or [Interval Composite], the Lens Correction features cannot be applied.

Memo

- When [Select multiple images] or [Select a folder] is selected in Step 2, a folder with a new number is created, and the JPEG or TIFF images are stored in it.
- For [HDR Capture] and [Pixel Shift Resolution], the setting item of which parameters can be changed varies depending on the item used during shooting.
- With the provided software “Digital Camera Utility 5”, you can develop RAW images on a computer.

Using the Camera with a Computer

Connect the camera to a computer using a USB cable. Make sure to have a commercially available USB cable equipped with a micro B terminal.

Setting the Connection Mode



Set the connection mode in [USB Connection] of the 2 menu according to the operation to be performed with a computer.

MSC (default setting)	Allows you to copy the data in the memory card to a computer by making the computer recognize the camera as a removable disk. (p.87)
PTP	Allows you to perform tethered shooting by operating the camera with a computer. (p.88)

You can check the selected connection mode on the LCD panel. (p.18)

Memo

- Refer to “Operating Environment for USB Connection and Provided Software” (p.121) for system requirements to connect the camera to a computer and to use the software.
- If you intend to use the camera continuously for a long period, the use of the optional AC adapter kit is recommended. (p.35)

Copying an Image in the Memory Card

- 1 Set [USB Connection] to [MSC] in the 2 menu.
- 2 Turn the camera off.
- 3 Open the terminal cover of the camera, and connect the USB cable to the USB terminal.

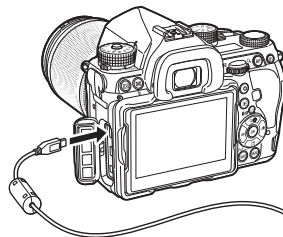

- 4 Connect the USB cable to the USB port of the computer.
- 5 Turn the camera on.
The camera is recognized as a removable disk.
- 6 Save the captured images to the computer.
- 7 Disconnect the camera from the computer.

Caution

- The camera cannot be operated while it is connected to a computer. To operate the camera, terminate the USB connection on the computer first, then turn off the camera and remove the USB cable.
- If the “K-1” dialog appears on the computer screen in Step 5, select [Open folder to view files] and click the OK button.

Operating the Camera with a Computer

You can perform tethered shooting to operate the camera with a computer using the optional “IMAGE Transmitter 2”. Captured images can be directly saved to the computer.

1 Set [USB Connection] to [PTP] in the **2** menu.

2 Turn the camera off.

3 Connect the camera to a computer using a USB cable.

Refer to Steps 3 and 4 of “Copying an Image in the Memory Card” (p.87).

4 Turn the camera on.

5 Start the “IMAGE Transmitter 2” on the computer.

The “IMAGE Transmitter 2” is started and the computer recognizes the camera.

⚠ Caution

- When the capture mode selector switch is set to , tethered shooting cannot be performed.

📄 Memo

- For details on the “IMAGE Transmitter 2”, refer to the “User Guide [Operation]” available at the following site.
http://www.ricoh-imaging.co.jp/english/support/download_manual.html



Using the Camera with a Communication Device

This camera has a built-in Wi-Fi function. By directly connecting to a communication device such as smartphones and tablets via wireless LAN, the camera can be operated from the communication device and images can be shared with others via social networks or e-mail.

Enabling the Wi-Fi Function

The Wi-Fi function is disabled when the camera is turned on. Enable the function using one of the following methods.

- Setting from the menus (p.89)
- Setting with the Smart Function (p.89)

When the Wi-Fi function is enabled, the Wi-Fi lamp lights up and the  (white) icon indicating the wireless LAN status is displayed on the status screen and Live View screen. When  (gray) is displayed, a connection with the communication device is not established correctly.



📄 Memo

- Even after the Wi-Fi function is enabled, it returns to an inactive state when the camera is turned off and on again. Also, when the camera enters  mode, the Wi-Fi function is disabled.
- Auto Power Off is not available while a Wi-Fi connection is established or images are being transferred. If Auto Power Off is activated while a connection is not established or during standby, the Wi-Fi function is disabled. The function is enabled when the camera recovers from Auto Power Off.
- The Wi-Fi function is disabled during the USB connection.

⚠ Caution

- Do not attempt to use the Wi-Fi function in a location where the use of wireless LAN devices is restricted or prohibited, such as on airplanes.
- When using the Wi-Fi function, observe local laws and regulations governing radio communication.
- If a memory card with a built-in wireless LAN function (such as an Eye-Fi card or a Flucard) is used, radio wave interference may occur. When this occurs, disable the Wi-Fi function of the camera.

1 Select [Wi-Fi] in menu and press .

The [Wi-Fi] screen appears.

2 Set [Action Mode] to [ON].

Select [OFF] to disable the Wi-Fi function.



3 Press **MENU** twice.

Memo

- In Step 2, select [Communication Info] to check the SSID, Password, and MAC Address of the wireless LAN. Or, select [Reset Settings] to reset the settings to their default values.

Setting with the Smart Function

1 Set the function dial to [Wi-Fi].

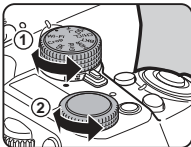

2 Turn the setting dial.

The Wi-Fi function is turned on or off.

Operating the Camera with a Communication Device

The following functions can be used by directly connecting the camera to a communication device via Wi-Fi and using the dedicated application "Image Sync".

Remote Capture	Displays the Live View image of the camera on the communication device, and enables controlling exposure settings and shooting by operating the communication device.
Image View	Displays the images saved on the memory card inserted in the camera on the communication device and imports the images to the communication device.

Image Sync supports iOS and Android, and can be downloaded from the App Store or Google Play. For supported OS and other details, refer to the download site.

Memo

- The Image Sync screenshots used in this manual are the ones under development and may differ from the actual display. The screen layout and elements may be also changed due to causes such as the version upgrade of the application.
- For details on how to operate the communication device, refer to the operating manual of the device.

Connecting the Camera and a Communication Device

Connect the camera and a communication device via Wi-Fi, and start Image Sync installed on the communication device.

When an Android Device is Used

- 1 Set the wireless LAN (Wi-Fi) function to ON on the communication device.
- 2 Start Image Sync on the communication device.
The camera selection screen appears on the communication device.
- 3 Tap [PENTAX K-1].

The [Choose a Network] screen appears on the communication device.



- 4 Tap [PENTAX_XXXXXX] in the [Network List].
The [Enter Password] screen appears.



- 5 Enter the password, and tap [Connect].
A Wi-Fi connection is established between the camera and the communication device.
The list of images appears on the Image Sync screen.

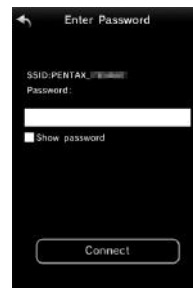

Memo

- Refer to [Communication Info] in [Wi-Fi] of the menu for the default password. (p.89)

When an iOS Device is Used

- 1 Set the wireless LAN (Wi-Fi) function to ON on the communication device.
- 2 Tap [PENTAX_XXXXXX] in the list of detected Wi-Fi networks.
- 3 Enter the password, and tap [Join].
A Wi-Fi connection is established between the camera and the communication device.
- 4 Start Image Sync on the communication device.
Image Sync is started, and the list of images appears.



Screens of Image Sync

Flick left or right on the screen to change screens.

Application image list

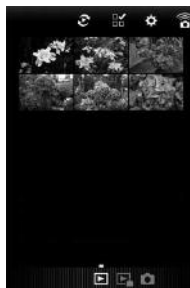

Camera image list



mode



Memo

- You can change operation modes also by tapping the buttons displayed at the bottom of each screen.

Shooting with a Communication Device

The Live View image of the camera and buttons for shooting are displayed on the shooting screen of Image Sync.

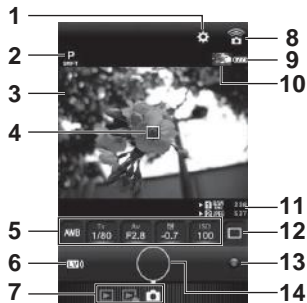

- 1 Settings (p.96)
- 2 Capture mode
- 3 Live View
- 4 AF frame
- 5 White Balance, Shutter Speed, Aperture value, EV Compensation, Sensitivity
- 6 Live View on/off
- 7 Operation modes
- 8 Communication icon
- 9 Battery level
- 10 Thumbnail of the last captured image
(When tapped, the camera image list is displayed.)
- 11 Card slot number, File Format, Image storage capacity
- 12 Drive Mode
- 13 Green button
- 14 Shutter release button

1 Set up the basic settings on the camera.

2 Check the Live View image on the shooting screen of Image Sync.



3 Change the settings using Image Sync as necessary.

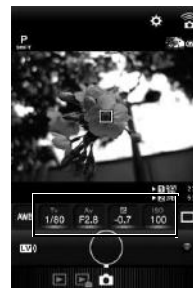

Tap an item and select a value from the list.



4 When the focus mode is set to **AF**, tap the position where you want to perform autofocus in the Live View image.

Autofocus is performed on the tapped position.

5 Tap the shutter release button.

The captured image is displayed as a thumbnail.

⚠ Caution

- Shooting with Image Sync is not available in the following situations.
 - In  mode
 - When the drive mode is set to other than [Single Frame Shooting]
 - When the camera is connected to a device via USB or HDMI terminal
 - When using the ASTROTRACER function
- The captured images are saved to the memory card inserted in the camera. Shooting cannot be performed if there is not enough available space on the memory card.

📝 Memo

- Shooting can also be performed by tapping the Live View image. Set in [Touch AF] on the [Settings] screen. (p.96)
- While shooting with Image Sync, the shutter release always has priority regardless of the [Contrast AF Options] setting of [Contrast Detection AF] in the  1 menu.

Viewing Images

You can view the images saved either in the camera or in the communication device.

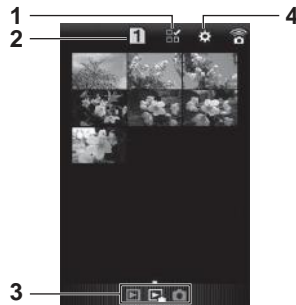

- 1 Multiple image selection button
- 2 Switching between the SD1 card and the SD2 card (available for the camera image list only)
- 3 Operation modes
- 4 Settings (p.96)

Tap the thumbnail image to view it in single image display and check its shooting information.



Touch operations

- | | |
|-------------------------|--------------------------------|
| Flick left/right | Shows the previous/next image. |
| Pinch out/in | Magnifies/reduces the image. |

Selecting the Image Storage Location

When viewing images in application image list display, you can select the image storage location (album) from “Application” or “Gallery” (or “Camera Roll”).

1 Tap .



2 Select the album.

The images in the selected album are displayed.

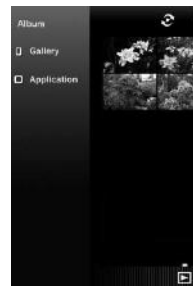

Selecting Multiple Images

1 Tap .



2 Tap the images to select.
Blue check marks appear.

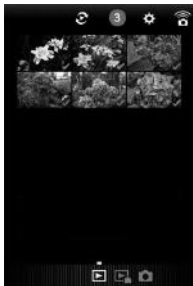

3 Touch and hold one of the selected images.

4 Select the desired action.

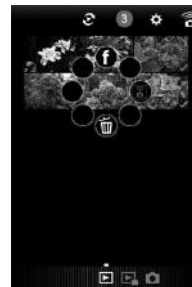

Memo

- When you touch and hold the desired image on the image list display screen or the shooting information display screen, the same screen as Step 4 appears and you can select the action to apply.

5

Sharing

Changing the Settings

1 Tap .



The [Settings] screen appears.

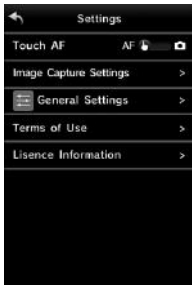

The following settings are available.

Touch AF	Sets whether to perform only autofocus or perform shooting after autofocus when touching the Live View image.
Image Capture Settings	Changes the settings for Memory Card Options, File Format, and JPEG Recorded Pixels.
General Settings	Changes the communication settings and the display language.

2 Tap [General Settings] if you change the communication settings and the display language.

3 Tap the setting item to be changed.

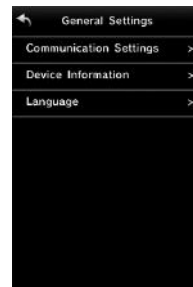

Communication Settings
The password and wireless channel can be changed.

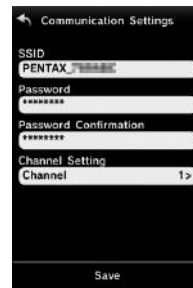

Device Information

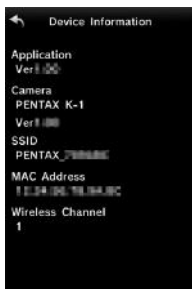

Language



4 Change the settings and tap .

Camera Settings

Customizing the Button/E-dial Functions



Setting the Button Operation

You can set the functions for when **Fx1**, **Fx2** (▼), or **AF** is pressed, or when the main switch is turned to .

In  mode, you can set only the function for when **AF** is pressed.

1 Select **[Button Customization]** in  or  menu and press **▶**.

The **[Button Customization]** screen appears.

2 Select the desired item and press **▶**.

The screen to set the function for the selected item is displayed.



3 Press **▶** and use **▲▼** to select the function to assign to each part.

The following functions can be assigned to each part.

	Setting	Function	Page	
Fx1 Button	One Push File Format	Temporarily changes the file format.	p.99	
	Outdoor View Setting	Adjusts the brightness of the monitor for outdoor shooting.	p.11	
	Flash Mode	Sets the flash mode.	p.65	
	Pixel Shift Resolution	Changes the setting of the Pixel Shift Resolution function.	p.70	
	Fx2 Button	Shake Reduction	Turns the Shake Reduction and Movie SR functions on or off.	p.69
		Horizon Correction	Turns the Horizon Correction function on or off.	–
Electronic Level		Turns the Electronic Level display for the viewfinder and Live View on or off.	p.18	
AF Button	Enable AF1	Autofocus is performed when AF is pressed.	p.51	
	Enable AF2	Autofocus is performed when AF is pressed. Half press of SHUTTER is disabled.		
	Cancel AF	While AF is pressed, half press of SHUTTER is disabled.		
Preview Dial	Optical Preview	Activates the Optical Preview function.	p.55	
	Digital Preview	Activates the Digital Preview function.		

4 Press **OK**.

5 Press **MENU**.

The screen of Step 2 reappears.
Repeat Steps 2 to 5.

6 Press **MENU** twice.

Setting the One Push File Format

Select the file format to change to when **Fx1** or **Fx2** is pressed for each [File Format] setting.

1 Set [Fx1 Button] or [Fx2 Button] to [One Push File Format] in Step 3 of “Setting the Button Operation” (p.98).

2 Select or for [Cancel after 1 shot].

<input checked="" type="checkbox"/>	The recording format returns to the [File Format] setting of [Image Capture Settings] in the 2 menu after a picture is taken.
<input type="checkbox"/>	The setting is retained until any of the following operations is performed: <ul style="list-style-type: none">• When Fx1 or Fx2 is pressed again• When ▶, MENU, or INFO is pressed, or when the mode dial or main switch is turned

3 Select the file format when **Fx1** or **Fx2** is pressed.

The left side is the [File Format] setting and the right side is the changed file format when **Fx1** or **Fx2** is pressed.

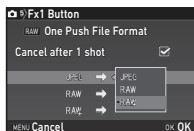

Caution

- The One Push File Format function cannot be used when [Memory Card Options] in the **2** menu is set to [Separate RAW/JPEG]. (p.43)

Setting the E-dial Operation

For each exposure mode, you can set the functions for when and are turned and **○** is pressed.

1 Select [E-Dial Programming] of [Button Customization] in **5** or **2** menu and press **▶**.

The [E-Dial Programming] screen appears.

2 Select an exposure mode and press **▶**.

The screen for the selected exposure mode appears.

3 Press **▶** and use **▲▼** to select the combination of functions for when and are turned and **○** is pressed.

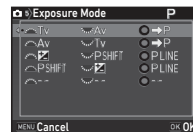

Tv	Change Shutter Speed
Av	Change Aperture Value
ISO	Change Sensitivity
<input checked="" type="checkbox"/>	EV Compensation
▶P	Return to P Mode
PSHIFT	Program Shift
PLINE	Program Line
--	Not available



4 Press **OK**.

5 Press **MENU**.

The [E-Dial Programming] screen reappears.
Repeat Steps 2 to 5.

6 Press **MENU** twice.



Memo

- If you select [Rotation Direction] in Step 2, you can reverse the effect obtained by turning  or .

Setting the Lighting on the Camera Body



Specifying the Illumination Button Settings

You can set whether to turn on the lights for the following camera parts when  is pressed. Set in [Illumination Settings] of the  menu. Selecting [Off] provides no illumination even when  is pressed.

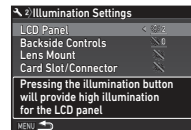

LCD Panel	Off, Low, High
Backside Controls	Off, Low, High
Lens Mount	Off, On
Card Slot/Connector	Off, On

Setting the Illumination of the Indicator Lamps

You can set whether to light up the following indicator lamps on the camera body.

Set in [Indicator Lamps] of the  menu.

For [Self-timer], the self-timer lamp blinks during the countdown for the drive mode [Self-timer (12 sec.)]. For [Remote Control], the remote control receiver lamp blinks during the standby for shooting.

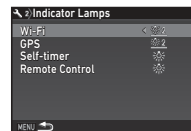

Wi-Fi	Off, Low, High
GPS	Off, Low, High
Self-timer	Off, On
Remote Control	Off, On

Saving Frequently Used Settings



Camera settings can be saved to **U1** to **U5** of the mode dial and used repeatedly.

The following settings can be saved.

Exposure Mode (except for AUTO)	White Balance
Sensitivity	Custom Image
EV Compensation	☑ 1-5 menu settings (with exceptions)
Drive Mode	C 1-4 menu settings

Saving the Settings

1 Set the exposure mode and all the necessary settings to save.

2 Select [Save USER Mode] in 5 menu and press **▶**.

The [Save USER Mode] screen appears.

3 Select [Save Settings] and press **▶**.

The [Save Settings] screen appears.



4 Select a **USER** mode from [USER1] to [USER5], and press **▶**.

5 Select [Save] and press **OK**.

The screen of Step 3 reappears.

⚠ Caution

- [Save USER Mode] cannot be selected when the mode dial is set to **AUTO**.

📝 Memo

- The settings saved as the **USER** mode can be displayed on the monitor when you select [Check Saved Settings] in Step 3.
- To reset the settings to the default values, select [Reset USER Mode] in Step 3.

Editing a Setting Name

You can change the name of the **USER** mode in which you saved settings.

1 Select [Rename USER Mode] in Step 3 of “Saving the Settings” (p.101) and press **▶**.

The [Rename USER Mode] screen appears.

2 Select a **USER** mode from [USER1] to [USER5], and press **▶**.

The text-entry screen appears.

3 Change the text.

Up to 18 single-byte alphanumeric characters and symbols can be entered.

Text selection cursor

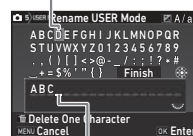

Text input cursor

Available operations

	Moves the text selection cursor.
	Moves the text input cursor.
	Switches between upper and lower case letters.
OK	Enters a character selected with the text selection cursor at the position of the text input cursor.
	Deletes a character at the position of the text input cursor.

- 4** After entering the text, move the text selection cursor to [Finish], and press **OK**.

The [Rename USER Mode] screen reappears.

Using the Saved USER Mode

- 1** Set the mode dial to **U1** to **U5**.

The USER mode name is displayed.

Use **▲▼** to check the saved settings.



- 2** Change the settings as necessary.

The exposure mode can be changed in [Exposure Mode] of the **1** menu.

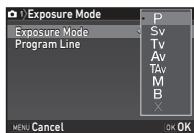

! Memo

- The settings changed in Step 2 are not saved as the USER mode settings. When the camera is turned off, the camera returns to the originally saved settings. To change the original settings, save the USER mode settings again.

Displaying the Local Date and Time of the Specified City

1

The date and time set at the time of initial setting ("Initial Settings" (p.36)) serve as the date and time of your present location and are reflected in the shooting date and time for images.

Setting the destination to a location other than your present location enables you to display the local date and time on the monitor when traveling abroad and also save images time-stamped with the local date and time.

- 1** Select [World Time] in **1** menu.

The [World Time] screen appears.

- 2** Select the time you wish to display in [Time Setting].

1 (Hometown) or **2** (Destination) can be selected.

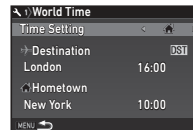

- 3** Select [**2** Destination] and press **▶**.

The [**2** Destination] screen appears.

- 4** Use **◀▶** to select a city.

Use **☀** to change the region.

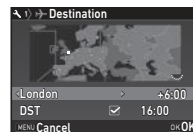



- 5** Select [DST] (daylight saving time), and use **◀▶** to select or .

- 6** Press **OK**.

The screen of Step 2 reappears.



- 7** Press **MENU** twice.

Memo

- Refer to “List of World Time Cities” (p.120) for cities that can be selected as a hometown or destination.
- Select [ Hometown] in Step 3 to change the city and DST settings for the hometown.
-  appears in the control panel when [Time Setting] is set to .

Selecting Settings to Save in the Camera



The setting values for most functions of this camera are saved even if the camera is turned off. For the following function settings, you can select whether to save the settings () or to return the settings to their default values () when the camera is turned off.

Set in [Memory] of the 5 menu.

Sensitivity	Skin Tone
EV Compensation	Digital Filter
Flash Mode	HDR Capture
Flash Exposure Compensation	Pixel Shift Resolution
Drive Mode	Composition Adjustment
White Balance	Playback Info Display
Custom Image	Operation Control Lock
Clarity	Outdoor View Setting

Memo

- When [Reset] of the 4 menu is performed, all Memory settings return to the default values.

File Management Settings

Protecting Images from Deletion (Protect)

You can protect images from being accidentally deleted.

Caution

- Even protected images are deleted if the inserted memory card is formatted.

1 Select in the playback mode palette.

The screen for selecting the processing type appears.

2 Select [Select image(s)] or [Select a folder] and press .

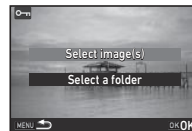

3 Select the image(s) or folder to protect.

Refer to Step 2 of “Deleting Selected Images” (p.77) for how to select image(s).

Proceed to Step 5 if [Select a folder] is selected.

4 Press .

The confirmation screen appears.

5 Select [Protect] and press .

Memo

- To protect all images stored on the memory card, select [Protect All Images] of the 1 menu.

Selecting the Folder/File Settings



Create New Folder

When [Create New Folder] is selected in the 3 menu, a folder is created with a new number when the next image is saved.

Caution

- You cannot successively create multiple folders.

Memo

- A new folder is automatically created in the following cases.
 - When the drive mode is set to [Interval Shooting] (p.61)
 - When [Select multiple images] or [Select a folder] is selected for [RAW Development] of the playback mode palette (p.85)

Folder Name

When images are captured with this camera, a folder is automatically created and the captured images are stored in it. Each folder name consists of a sequential number from 100 to 999 and a string of five characters.

The character string in the folder name can be changed.

1 Select [Folder Name] in 3 menu and press .

The [Folder Name] screen appears.

2 Press and select [Date] or [Optional].



Date	The four digits of the month and day of the shooting date are assigned after the folder number. The month and day appear according to the date format set in [Date Adjustment]. Example) 101_0125: for images taken on January 25th
Optional	A freely defined string of five characters is assigned after the folder number. (Default setting: PENTX) Example) 101PENTX

Proceed to Step 6 if you select [Date] or do not need to change the character string.

3 Press , and then press .

The text-entry screen appears.

4 Change the text.

Enter five single-byte alphanumeric characters.

Text selection cursor



Text input cursor

Available operations

- Moves the text selection cursor.
- Moves the text input cursor.
- Enters a character selected with the text selection cursor at the position of the text input cursor.
- Resets the entered text to "PENTX".

5 After entering the text, move the text selection cursor to [Finish], and press **OK**.

6 Press **MENU** twice.

Memo

- A folder with a new number is created when the folder name is changed.
- A maximum of 500 images can be stored in a single folder. When the number of captured images exceeds 500, a new folder is created with the number following the number of the folder currently being used. When the drive mode is set to [Bracketing], images are stored in the same folder until shooting is completed.

Caution

- The maximum folder number is 999. After the folder number reaches 999, you cannot capture new images if you attempt to change the folder name or create a new folder, or when the file name number reaches 9999.

File Name

One of the following string of characters is used as the file name prefix depending on the [Color Space] setting of [Image Capture Settings] in the **2** menu.

Color Space	File Name
sRGB	IMG****.JPG
AdobeRGB	_IMG****.JPG

The first four characters can be changed to a character string of your choice.

1 Select [File Name] in **3** menu and press **▶**.

The [File Name] screen appears.

2 Select **📷** or **🎥**, and press **▶**.

The text-entry screen appears.



3 Change the text.

Up to four single-byte alphanumeric characters can be entered as an alternative for the first part of the file name, while the asterisks stand for figures that increase automatically shot by shot.

Refer to Steps 4 and 5 of “Folder Name” (p.104) for how to enter text.

4 Press **MENU** twice.

Memo

- When [Color Space] is set to [AdobeRGB], the file name prefix is “_” and first three characters of the entered character string becomes the file name.
- For movies, regardless of the [Color Space] setting, the file name is “IMG****.MOV” or the one with the entered string of characters.

File No.

Each file name consists of a string of four characters and a sequential number from 0001 to 9999. You can set whether to continue the sequential numbering for the file name even if a new folder is created in [Sequential Numbering] of [File No.] in the **3** menu.

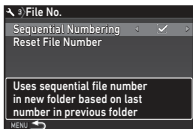

<input checked="" type="checkbox"/>	Continues the sequential numbering for the file name even if a new folder is created.
<input type="checkbox"/>	Returns the file number of the first image saved to a folder to 0001 each time a new folder is created.

Select [Reset File Number] to reset the file number to its default value.

Memo

- When the file number reaches 9999, a new folder is created and the file number is reset.

Setting the Copyright Information



Sets the photographer and copyright information embedded in the Exif data.

1 Select [Copyright Information] in **3 menu and press **▶**.**

The [Copyright Information] screen appears.

2 Use **◀▶ to set [Embed Copyright Data].**



<input type="checkbox"/>	Does not embed copyright information in the Exif data.
<input checked="" type="checkbox"/>	Embeds copyright information in the Exif data.

3 Select [Photographer] or [Copyright Holder], and press **▶.**

The text-entry screen appears.

4 Change the text.

Up to 32 single-byte alphanumeric characters and symbols can be entered.

Refer to Steps 3 and 4 of "Editing a Setting Name" (p.101) for how to enter text.

5 Press **MENU twice.**

Memo

- The Exif information can be checked in Detailed Information Display of the playback mode (p.15) or using the provided software "Digital Camera Utility 5".

Restrictions on the Combinations of Special Functions

#: Restricted ✕: Not available

	Clarity/ Skin Tone/ Digital Filter	HDR Capture	Pixel Shift Resolution	Distortion Correction/ Diffraction Correction	ASTRO- TRACER	AA Filter Simulator	Save RAW Data
Flash		✕	✕				
Drive Mode	Continuous Shooting		✕	✕	✕	# ^{*2}	✕
	Bracketing		✕	✕	✕	# ^{*2}	
	Mirror Lock-up Shooting		✕			# ^{*2}	
	Multi-exposure	✕	✕	✕	✕	✕	# ^{*2}
	Interval Shooting	# ^{*1}	# ^{*1}	✕		✕	# ^{*3}
	Interval Composite	✕	✕	✕	✕	✕	# ^{*2}
	Interval Movie Record	# ^{*1}	# ^{*1}	✕		✕	✕
	Star Stream	✕	✕	✕	✕	✕	# ^{*2}
HDR Capture	✕		✕		✕	✕	
Pixel Shift Resolution	✕	✕			✕	✕	
AA Filter Simulator		✕	✕		✕		

*1 There is a restriction on the minimum value for [Interval].

*2 [Bracketing] is not available.

*3 Only the final frame can be saved.

Functions Available with Various Lenses

All capture modes are available when a D FA, DA, DA L, FA, or FA J lens is used, or when a lens with an **A** position is used with the aperture ring set to the **A** position.

When other lenses than above are used, or a lens with an **A** position is used in a position other than **A**, the following restrictions apply.

✓ : Available # : Restricted ✗ : Not available



Function	Lens [Mount type]					
	D FA DA DA L	FA ^{*6} FA J	F ^{*6}	A	M P	
	[KAF] [KAF2] [KAF3]	[KAF] [KAF2]	[KAF]	[KA]	[K]	
Autofocus (Lens only) (With AF adapter 1.7x) ^{*1}	✓ -	✓ -	✓ -	- #	- #	
Manual focus (With focus indicator) ^{*2} (With matte field)	✓	✓	✓	✓	✓	
Quick-shift focus	# ^{*4}	✗	✗	✗	✗	
Focusing area selection mode [Auto]	✓	✓	✓	✗ ^{*9}	✗ ^{*9}	
AE Metering [Multi-segment]	✓	✓	✓	✓	✗	
P/Sv/Tv/Av/TAv mode	✓	✓	✓	✓	# ^{*10}	
M mode	✓	✓	✓	✓	#	
P-TTL auto flash ^{*3}	✓	✓	✓	✓	✗	
Power zoom	-	# ^{*7}	-	-	-	
Automatic obtaining of the lens focal length information	✓	✓	✓	✗	✗	
Lens Correction	# ^{*5}	# ^{*8}	✗	✗	✗	

^{*1} Lenses with a maximum aperture of F2.8 or faster. Only available at the **A** position.

^{*2} Lenses with a maximum aperture of F5.6 or faster.

- ^{*3} Available when using AF540FGZ, AF540FGZ II, AF360FGZ, AF360FGZ II, AF201FG, AF200FG, or AF160FC.
- ^{*4} Only available with compatible lenses.
- ^{*5} Distortion Correction and Peripheral Illumination Correction are disabled when a DA FISH-EYE 10-17mm lens is used.
- ^{*6} To use an FA SOFT 28mm F2.8 lens, FA SOFT 85mm F2.8 lens, or F SOFT 85mm F2.8 lens, set [26 Using Aperture Ring] to [Enable] in the **C4** menu. Pictures can be taken with the aperture you set, but only within a manually adjustable aperture range.
- ^{*7} The auto zoom and preset zoom are disabled.
- ^{*8} The Lens Correction is available with the following FA lenses:
FA^{*}24mm F2.4 AL [IF], FA 28mm F2.8 AL, FA 31mm F1.8 Limited, FA 35mm F2 AL, FA 43mm F1.9 Limited, FA 50mm F1.4, FA 77mm F1.8 Limited, FA^{*}85mm F1.4 [IF], FA^{*}200mm F2.8 ED [IF], FA^{*}MACRO 200mm F4 ED, FA^{*}300mm F2.8 ED [IF], FA^{*}300mm F4.5 ED [IF], FA^{*}400mm F5.6 ED [IF], FA^{*}600mm F4 ED [IF], FA^{*}28-70mm F2.8 ED [IF], FA^{*}80-200mm F2.8 ED [IF], and FA^{*}250-600mm F5.6 ED [IF].
- ^{*9} Fixed to [Spot].
- ^{*10} **Av** with the aperture set to wide open. (The aperture ring has no effect on the actual aperture value.)

⚠ Caution

- Set the angle of view in [Crop] of the 2 and 1 menus when using a DA or DA L lens. (p.43) When the angle of view is changed to be equivalent to that of the APS-C size image sensor, the cropping frame is displayed in the viewfinder. (p.17) Perform shooting so that the subject is positioned in the frame. The Lens Correction features are not available when [Crop] is set to [FF] while a DA or DA L lens (except DA^{*}200mm F2.8 ED [IF] SDM, DA^{*}300mm F4 ED [IF] SDM, and DA 560mm F5.6 ED AW lenses) is attached.
- When the aperture ring is set to a position other than **A** or a lens without an **A** position or accessories such as an extension tube are used, the camera does not operate unless [26 Using Aperture Ring] is set to [Enable] in the **C4** menu. Refer to "Using the Aperture Ring" (p.109) for details.
- When a retractable lens is attached and is not extended, you cannot take pictures or use some functions. If the lens is retracted during shooting, the camera stops working.

Lens Names and Mount Names

	Mount	Lens Name	Lens Type
MF	S	S	For 35mm full-frame size
	K	K, M	
	KA	A	
AF	KAF	D FA	For both 35mm full-frame size and APS-C size
		DA	For APS-C size Without the aperture ring
		FA	For 35mm full-frame size Power zoom not compatible
		FA J	For 35mm full-frame size Without the aperture ring
		F	For 35mm full-frame size
	KAF2	DA	For APS-C size SDM compatible Without the aperture ring
		FA	For 35mm full-frame size Power zoom compatible
	KAF3	D FA	For both 35mm full-frame size and APS-C size
		DA	For APS-C size Dedicated for SDM Without the aperture ring

- DA lenses with a motor and FA zoom lenses with a power zoom use the KAF2 mount. (Of these lenses, the lenses without an AF coupler use the KAF3 mount.)
- FA single focal length lenses, DA and DA L lenses without a motor, and D FA, FA J, and F lenses use the KAF mount. Refer to respective lens manuals for details.

Using the Aperture Ring

C4

The shutter can be released even if the aperture ring of the D FA, FA, F, or A lens is not set to the **A** position or a lens without an **A** position is attached.

Select [Enable] in [26 Using Aperture Ring] of the **C4** menu.

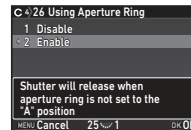

The following restrictions apply depending on the lens being used.

Lens	Restriction
D FA, FA, F, A, M (lens only or with automatic diaphragm accessories such as auto extension tube K)	The aperture remains open. The shutter speed changes in relation to the open aperture but an exposure deviation may occur.
D FA, FA, F, A, M, S (with diaphragm accessories such as extension tube K)	Pictures can be taken with the set aperture value but an exposure deviation may occur.
Manual diaphragm lens such as reflex lens (lens only)	
FA SOFT 28mm/ FA SOFT 85mm/ F SOFT 85mm (lens only)	Pictures can be taken with the set aperture value in the manually adjustable aperture range.

🌀 Memo

- If the aperture ring is set to a position other than **A**, the camera operates in **Av** mode regardless of the mode dial setting except when set to **M**, **B**, or **X** mode.
- [F--] appears for the aperture indicator in the status screen, Live View screen, and viewfinder, and on the LCD panel.

How to Achieve the Correct Exposure with the Aperture Ring Not Set to A

The correct exposure can be achieved by the following procedures when the aperture ring is not set to **A**.

- 1 Set the mode dial to **M**.
- 2 Set the aperture ring to the desired aperture.
- 3 Press **o**.
The correct shutter speed will be set.
- 4 If the correct exposure cannot be achieved, adjust the ISO sensitivity.

Performing Catch-in Focus Shooting **C4**

You can perform Catch-in Focus shooting using a manual focus lens. The shutter is released automatically when the subject comes into focus.

- 1 **Attach a manual focus lens to this camera.**
- 2 **Set [24 Catch-in Focus] to [On] in the C4 menu.**
- 3 **Set the autofocus mode to AF and set [AF Mode] to A.F.S.**
- 4 **Place the camera on a fixed support such as tripods.**
- 5 **Adjust the focus to the position where the subject may pass and press **SHUTTER** fully.**
When the subject comes into focus at the specified position, the shutter is released automatically.

Setting the Focal Length



The Shake Reduction function operates by obtaining the lens information such as focal length. Set the focal length when using a lens that the focal length information cannot be automatically obtained.

- 1 **Set [26 Using Aperture Ring] to [Enable] in the C4 menu.**
- 2 **Turn the camera off.**
- 3 **Attach a lens to the camera and turn the camera on.**
The [Input Focal Length] screen appears.
- 4 **Use **▲▼** to set the focal length.**
Press **◀** to select a value from the list.
When using a zoom lens, select the actual focal length which the zoom is set to.
- 5 **Press **OK**.**
The camera returns to standby mode.

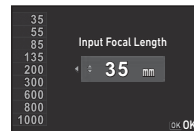

- **Memo**
The focal length setting can be changed in [Input Focal Length] of the **C4** menu.

Functions when Using an External Flash

Use of the following external flashes (optional) enables a variety of flash modes, such as P-TTL auto flash mode.

✓ : Available # : Restricted ✗ : Not available

Camera Function \ Compatible Flash	AF540FGZ AF540FGZ II AF360FGZ AF360FGZ II	AF201FG AF200FG AF160FC
Red-eye reduction flash	✓	✓
Auto Flash Discharge *1	#*2	#*2
Automatic switch to the flash sync speed	✓	✓
Automatic setting of the aperture value in P or Tv mode	#*2	#*2
P-TTL auto flash	#*2	#*2
Slow-speed Sync flash	✓	✓
Flash Exposure Compensation	✓	✓
AF assist light of the external flash	#*3	✗
Trailing Curtain Sync flash *4	✓	#*5
Contrast Control Sync flash	#*6	#*7
Slave flash	#*6	✗
High-speed Sync flash	✓	✗
Wireless flash	#*6	✗

*1 Available only in **AUTO** (Scene Analyze Auto) mode.

*2 Available only when using a D FA, DA, DA L, FA, FA J, F, or A lens.

*3 AF assist light is not available with the AF540FGZ or AF360FGZ.

*4 Shutter speed of 1/100 seconds or slower.

*5 Not available with the AF200FG or AF160FC.

*6 Multiple AF540FGZ, AF540FGZ II, AF360FGZ, or AF360FGZ II units are required.

*7 Available only when combined with the AF540FGZ, AF540FGZ II, AF360FGZ, or AF360FGZ II.

⚠ Caution

- Flashes with the reversed polarity (the center contact on the hot shoe is minus) cannot be used due to the risk of damaging the camera and flash.
- Do not combine with accessories that have a different number of contacts, such as Hot Shoe Grip, as a malfunction may occur.
- Combining with flashes from other manufacturers may cause equipment breakdown.

📌 Memo

- With the AF540FGZ, AF540FGZ II, AF360FGZ, or AF360FGZ II, you can use the high-speed sync flash to discharge a flash and take a picture at a shutter speed faster than 1/200 seconds. Set the exposure mode to **Tv**, **TAv**, or **M**.
- By using two or more external flashes (AF540FGZ, AF540FGZ II, AF360FGZ, or AF360FGZ II), you can use the wireless mode to shoot in P-TTL flash mode without connecting the flash units with a cord. In this case, set the camera channel on the external flashes.
- You can set the flash sync speed in [7 Flash Sync Speed] of the **C1** menu.
- You can connect an external flash to the camera with a sync cord by using the X-sync socket. Remove the Sync socket 2P cap to connect a sync cord to the X-sync socket.

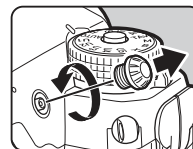

Troubleshooting

Memo

- In rare cases, the camera may not operate correctly due to causes such as static electricity, etc. This can be remedied by taking the battery out and putting it back in again. If the camera operates correctly, it does not require any repairs.

Problem	Cause	Remedy
The camera does not turn on.	The battery is not installed properly.	Check the orientation of the battery.
	The battery power is low.	Charge the battery.
The shutter cannot be released.	There is no available space on the memory card.	Insert a memory card with available space or delete unwanted images.
	Data is being processed.	Wait until processing is finished.
	The lens aperture ring is set to a position other than A .	Set the lens aperture ring to the A position or select [Enable] in [26 Using Aperture Ring] of the C4 menu. (p.109)
Autofocus does not work.	The autofocus mode is set to A.F.S and the subject is not in focus.	Set the focus method to MF and adjust focus manually.
	The subject is difficult to focus on.	AF cannot work well for low-contrast objects (the sky, white walls, etc.), dark colors, intricate designs, rapidly-moving objects, or scenery shot through a window or a net-like pattern. Lock focus on another object located at the same distance as your subject, then aim at the target and take a picture. Alternatively, use MF .
	The subject is too close.	Move away from the subject and take a picture.



Problem	Cause	Remedy
The flash does not discharge.	The flash mode is set to FA or FA .	When the flash mode is set to FA or FA , the flash does not discharge if the subject is bright. Change the flash mode. (p.65)
The camera is not recognized when it is connected to a computer.	The USB connection mode is set to [PTP].	Set [USB Connection] to [MSC] in the M2 menu.
Dust or dirt particles appear in images.	The CMOS sensor is dirty or dusty.	Activate [Dust Removal] from the M4 menu. The Dust Removal function can be activated every time the camera is turned on and off. Refer to "Sensor Cleaning" (p.113) if the problem persists.
Pixel defects such as bright spots and dark spots appear in the image.	There are defective pixels in the CMOS sensor.	Activate [Pixel Mapping] from the M4 menu. It takes about 30 seconds to correct the defective pixels, so be sure to install a fully charged battery.

Sensor Cleaning

Removing Dust with a Blower



Raise the mirror up and open the shutter when cleaning the CMOS sensor with a blower.

- 1 Turn the camera off and remove the lens.**
- 2 Turn the camera on.**
- 3 Select [Sensor Cleaning] in  4 menu and press .**
The [Sensor Cleaning] screen appears.
- 4 Select [Mirror Up] and press .**
The mirror rises up.
- 5 Clean the CMOS sensor with a blower.**
- 6 Turn the camera off.**
The mirror automatically returns to its original position.

Caution

- Never use a spray blower or a blower with a brush. The CMOS sensor may be damaged. Do not wipe the CMOS sensor with a cloth.
- Do not put the tip of the blower inside the lens mount area. If the power is turned off during cleaning, it may cause damage to the shutter, the CMOS sensor, and the mirror. Hold the camera with the lens mount down while cleaning the sensor so dust will fall away from the sensor when the blower is used.
- When the battery level is low, the message [Not enough battery power remaining to clean sensor] is displayed on the monitor. Install a fully charged battery. If the battery capacity becomes low during cleaning, a warning beep will sound. In this case, stop cleaning immediately.

Memo

- Please contact your nearest service center for professional cleaning as the CMOS sensor is a precision part.
- You can use the optional Image Sensor Cleaning Kit O-ICK1 when cleaning the CMOS sensor.

Error Messages

Error Messages	Description
Memory card full	The memory card is full and no more images can be saved. Insert a new memory card or delete unwanted files.
No image	There are no images that can be played back on the memory card.
This image cannot be displayed	You are trying to play back an image in a format not supported by this camera. You may be able to play it back on a computer.
No card in the camera	There is no memory card inserted in the camera.
Memory card error	The memory card has a problem, and image capture and playback are impossible. You may be able to play back or recover the images on a computer.
Card is not formatted	The memory card you have inserted is unformatted or has been previously used on another device and is not compatible with this camera. Use the card after formatting it with this camera.
Card is locked	The write-protect switch on the memory card you have inserted is locked. (p.128)
Cannot use this card	A memory card not compatible with this camera is inserted.
Wi-Fi connection disabled	The capture mode is changed to  mode while the wireless LAN function is enabled.
This image cannot be magnified	You are trying to magnify an image that cannot be magnified.
This image is protected	You are trying to delete an image that is protected. Remove the protection from the image. (p.103)
Not enough battery power remaining to activate Pixel Mapping	These messages appear when you try to perform Pixel Mapping or Sensor Cleaning, or to update the firmware if the battery level is insufficient. Install a fully charged battery.
Not enough battery power remaining to clean sensor	
Not enough battery power remaining to update the firmware	

Error Messages	Description
Unable to update firmware. There is a problem with the firmware update file	The firmware cannot be updated. The update file is damaged. Try downloading the update file again.
Image folder cannot be created	The maximum folder number (999) is being used, and no more images can be saved. Insert a new memory card or format the card.
Unable to store image	The image could not be saved because of a memory card error.
The operation could not be completed correctly	The operation failed. Try the operation again.
No more images can be selected	You are trying to select more than the maximum number of images for the following functions. <ul style="list-style-type: none"> • Select & Delete • Image Copy • RAW Development • Protect
No image can be processed	There are no images that can be processed using the Digital Filter or RAW Development function.
This image cannot be processed	This message appears when you try to perform Resize, Cropping, Digital Filter, Movie Edit, RAW Development, or Save as Manual WB for images captured with other cameras, or when you try to perform Resize or Cropping for minimum file size images.
This function is not available in the current mode	You are trying to set a function that is not available with the currently selected capture mode.
The camera will turn off to prevent damage from overheating	The camera will turn off because its internal temperature is too high. Leave the camera turned off until it has had time to cool down before turning on the camera again.
Shutter release is disabled. Ensure the zooming index on the lens is set to a position that permits shutter release	Pictures cannot be taken when a retractable lens is attached and is not extended. (p.41)

Main Specifications

Model Description

Type	TTL autofocus, auto-exposure SLR digital camera
Lens Mount	PENTAX KAF2 bayonet mount (AF coupler, lens information contacts, K-mount with power contacts)
Compatible Lenses	KAF3, KAF2 (power zoom compatible), KAF, KA mount lenses

Image Capture Unit

Image Sensor	Primary color filter, CMOS, Size: 35.9 x 24.0 (mm)
Effective Pixels	Approx. 36.40 megapixels
Total Pixels	Approx. 36.77 megapixels
Dust Removal	Image sensor cleaning using ultrasonic vibrations "DR II"
Sensitivity (Standard Output)	ISO AUTO, Manual ISO range: 100 to 204800 • EV steps can be set to 1 EV, 1/2 EV, or 1/3 EV
Image Stabilizer	Sensor-shift Shake Reduction (SR; 5-axis image stabilization system)
AA Filter Simulator	Moiré reduction using SR unit: OFF, Type1, Type2, Bracketing (3 images)

File Formats

Recording Formats	RAW (PEF/DNG), JPEG (Exif 2.3 compliant), DCF 2.0 compliant
Recorded Pixels	<p>[35mm Full-Frame]</p> <p>JPEG: L (36M: 7360x4912) M (22M: 5760x3840) S (12M: 4224x2816) XS (2M: 1920x1280)</p> <p>RAW: (36M: 7360x4912)</p> <p>[APS-C Size]</p> <p>JPEG: L (15M: 4800x3200) M (12M: 4224x2816) S (8M: 3456x2304) XS (2M: 1920x1280)</p> <p>RAW: (15M: 4800x3200)</p>
Quality Level	RAW (14bit): PEF, DNG JPEG: ★★★ (Best), ★★ (Better), ★ (Good) • RAW + JPEG simultaneously recordable
Color Space	sRGB, AdobeRGB

Storage Media	SD/SDHC*/SDXC* memory card * UHS-I compatible
Dual Card Slots	Sequential Use, Save to Both, Separate RAW/JPEG, Copying images between slots possible
Storage Folder	Folder Name: Date (100_1018, 101_1019...) or a user-assigned name (default: PENTX)
Storage File	File Name: user-assigned name (default: IMG*****) File No.: Sequential Numbering, Reset

Viewfinder

Type	Pentaprism Finder
Coverage (FOV)	Approx. 100%
Magnification	Approx. 0.70x (50mm F1.4 at infinity)
Eye-Relief Length	Approx. 20.6 mm (from the view window) Approx. 21.7 mm (from the center of lens)
Diopter Adjustment	Approx. -3.5 to +1.2 m ⁻¹
Focusing Screen	Unchangeable Natural-Bright-Matte III focusing screen
Overlay Items	AF Points, Grid Display, Electronic Level, AF Frame, and Spot Metering Frame for Viewfinder Overlay; and frame for Crop

Live View

Type	TTL method using the CMOS image sensor
Focusing System	Contrast detection (Face Detection, Tracking, Multiple AF Points, Select, Spot) Focus Peaking: ON/OFF
Display	Field of view: approx. 100%, Magnified view (up to 16x), Grid Display (4x4 Grid, Golden Section, Scale, Square 1, Square 2, Grid Color: Black, White), Histogram, Highlight Alert, Composition Adjustment

LCD Monitor

Type	A flexible, tiltable wide viewing angle TFT color LCD with air-gapless tempered glass
Size	3.2 inches (aspect ratio 3:2)
Dots	Approx. 1037K dots
Adjustment	Brightness, saturation and colors adjustable
Outdoor View Setting	Adjustable ±2 steps

White Balance

Type	Method using a combination of the CMOS image sensor and the light source detection sensor
Preset Modes	Auto White Balance, Multi Auto White Balance, Daylight, Shade, Cloudy, Fluorescent Light (D: Daylight Color, N: Daylight White, W: Cool White, L: Warm White), Tungsten Light, CTE , Manual White Balance (up to 3 settings), Color Temperature (up to 3 settings), Copying the white balance settings of a captured image
Fine Adjustment	Adjustable ± 7 steps on A-B axis and G-M axis

Autofocus System

Type	TTL phase-matching detection autofocus
Focus Sensor	SAFOX12, 33 points (25 cross type focus points in the center)
Brightness Range	EV -3 to 18 (ISO100, at normal temperature)
AF Modes	Single AF (AFS), Continuous AF (AFC)
Focusing Area Selection Modes	Spot, Select, Expanded Area AF (S, M, L), Zone Select, Auto (33 AF Points)
AF Assist Light	Dedicated LED AF assist light

Exposure Control

Type	TTL open-aperture metering using 86K pixel RGB sensor Metering modes: Multi-segment, Center-weighted, Spot
Metering Range	EV -3 to 20 (ISO100 at 50mm F1.4)
Exposure Modes	Scene Analyze Auto, Program, Sensitivity Priority, Shutter Priority, Aperture Priority, Shutter & Aperture Priority, Manual, Bulb, Flash X-sync Speed, USER1, USER2, USER3, USER4, USER5
EV Compensation	± 5 EV (1/3 EV steps or 1/2 EV steps can be selected)
AE Lock	Button type (timer-control: two times the meter operating time set in Custom Setting); continues as long as SHUTTER is halfway pressed.

Shutter

Type	Electronically controlled vertical-run focal plane shutter • Electronic shutter is used for Pixel Shift Resolution
Shutter Speed	Auto: 1/8000 to 30 seconds, Manual: 1/8000 to 30 seconds (1/3 EV steps or 1/2 EV steps), Bulb

Drive Modes

Mode Selection	[Still picture] Single frame, Continuous (H, M, L), Self-timer (12 sec., 2 sec., continuous), Remote Control (immediately, 3 sec., continuous), Bracketing* ¹ (2, 3, or 5 frames), Mirror Lock-up Shooting* ² , Multi-exposure* ³ , Interval Shooting* ¹ , Interval Composite* ¹ , Interval Movie Record* ¹ , Star Stream* ¹ [Movie] Remote Control * ¹ Available with Self-timer or Remote Control * ² Available with Remote Control * ³ Available with Continuous Shooting, Self-timer, or Remote Control
Continuous Shooting	[35mm Full-Frame] Max. approx. 4.4 fps, JPEG (L): ★★★ at Continuous H); up to approx. 70 frames, RAW: up to approx. 17 frames Max. approx. 3.0 fps, JPEG (L): ★★★ at Continuous M); up to approx. 100 frames, RAW: up to approx. 20 frames Max. approx. 0.7 fps, JPEG (L): ★★★ at Continuous L); up to approx. 100 frames, RAW: up to approx. 100 frames [APS-C Size] Max. approx. 6.5 fps, JPEG (L): ★★★ at Continuous H); up to approx. 100 frames, RAW: up to approx. 50 frames Max. approx. 3.0 fps, JPEG (L): ★★★ at Continuous M); up to approx. 100 frames, RAW: up to approx. 70 frames Max. approx. 1.0 fps, JPEG (L): ★★★ at Continuous L); up to approx. 100 frames, RAW: up to approx. 100 frames • When the sensitivity is set to ISO100
Multi-exposure	Composite Mode: Additive, Average, Bright Number of Shots: 2 to 2000 times
Interval Shooting	[Interval Shooting] Interval: 2 sec. to 24 hr., Standby Interval: minimum time or 1 sec. to 24 hr., Number of Shots: 2 to 2000 times, Start Interval: Now, Self-timer, Remote Control, Set Time [Interval Composite] Interval: 2 sec. to 24 hr., Standby Interval: minimum time or 1 sec. to 24 hr., Number of Shots: 2 to 2000 times, Start Interval: Now, Self-timer, Remote Control, Set Time, Composite Mode: Additive, Average, Bright, Save Process: On, Off

Interval Shooting	[Interval Movie Record] Recorded Pixels: 4K , FullHD , HD , Recording Format: Motion JPEG (AVI), Interval: 2 sec. to 24 hr., Standby Interval: minimum time or 1 sec. to 24 hr., Number of Shots: 8 to 2000 times (When 4K is selected: 8 to 500 times), Start Interval: Now, Self-timer, Remote Control, Set Time [Star Stream]
	Recorded Pixels: 4K , FullHD , HD , Recording Format: Motion JPEG (AVI), Standby Interval: minimum time or 1 sec. to 24 hr., Number of Shots: 8 to 2000 times (When 4K is selected: 8 to 500 times), Start Interval: Now, Self-timer, Remote Control, Set Time, Fade-out: Off, Low, Medium, High

External Flash

Flash Modes	Auto Flash Discharge, Auto Flash + Red-eye Reduction, Flash On, Flash On + Red-eye Reduction, Slow-speed Sync, Slow-speed Sync + Red-eye Reduction, P-TTL, Contrast Control Sync*, High-speed Sync, Wireless Sync* * Available with two or more dedicated external flash units
Sync Speed	1/200 seconds
Flash Exposure Compensation	-2.0 to +1.0 EV

Capture Functions

Custom Image	Auto Select, Bright, Natural, Portrait, Landscape, Vibrant, Radiant, Muted, Flat, Bleach Bypass, Reversal Film, Monochrome, Cross Processing
Cross Processing	Random, Preset 1-3, Favorite 1-3
Digital Filter	Extract Color, Replace Color, Toy Camera, Retro, High Contrast, Shading, Invert Color, Unicolor Bold, Bold Monochrome
Clarity	Adjustable ± 4 steps
Skin Tone	Type1, Type2
HDR Capture	Auto, Type1, Type2, Type3, Advanced HDR Bracket Value adjustable Auto Align: On, Off
Pixel Shift Resolution	Motion Correction On, Motion Correction Off, Off
Lens Correction	Distortion Correction, Peripheral Illumination Correction, Lateral Chromatic Aberration Adjustment, Diffraction Correction
D-Range Settings	Highlight Correction, Shadow Correction

Noise Reduction	Slow Shutter Speed NR, High-ISO NR
GPS	GPS Logging (Logging Interval, Logging Duration, Memory Card Options), GPS Time Sync
Electronic Compass	Available
ASTROTRACER	Available
Horizon Correction	SR On: corrects up to 1 degree SR Off: corrects up to 2 degrees
Composition Adjustment	Adjustment range of ± 1.5 mm up, down, left or right (± 1 mm when rotated); rotating range of ± 1 degree
Electronic Level	Displayed in viewfinder (horizontal direction and vertical direction); displayed on monitor (horizontal direction and vertical direction)

Movie

Recording Format	MPEG-4 AVC/H.264 (MOV)
Recorded Pixels	FullHD (1920x1080, 60i/50i/30p/25p/24p) HD (1280x720, 60p/50p)
Sound	Built-in stereo microphone, external microphone (stereo recording compatible) Recording Sound Level adjustable, Wind Noise Reduction
Recording Time	Up to 4 GB or 25 minutes; automatically stops recording if the internal temperature of the camera becomes high.
Custom Image	Auto Select, Bright, Natural, Portrait, Landscape, Vibrant, Radiant, Muted, Flat, Bleach Bypass, Reversal Film, Monochrome, Cross Processing
Cross Processing	Random, Preset 1-3, Favorite 1-3
Digital Filter	Extract Color, Replace Color, Toy Camera, Retro, High Contrast, Shading, Invert Color, Unicolor Bold, Bold Monochrome

Playback Functions

Playback View	Single image, Multi-image display (6, 12, 20, 35, and 80 thumbnails), Image magnification (Up to 16x, 100% display, and quick zoom), Grid Display (4x4 Grid, Golden Section, Scale, Square 1, Square 2, Grid Color: Black, White), Rotated image display, Histogram (Y histogram, RGB histogram), Highlight Alert, Auto Image Rotation, Detailed Information Display, Copyright Information (Photographer, Copyright Holder), GPS information (Latitude, Longitude, Altitude, Coordinated Universal Time (UTC)), Direction, Folder Display, Calendar Filmstrip Display, Slideshow
---------------	---

Delete	Single image, all images, select & delete, folder, Instant Review image
Digital Filter	Base Parameter Adj, Extract Color, Replace Color, Toy Camera, Retro, High Contrast, Shading, Invert Color, Unicolor Bold, Bold Monochrome, Tone Expansion, Sketch, Water Color, Pastel, Posterization, Miniature, Soft, Starburst, Fish-eye, Slim, Monochrome
RAW Development	Development options: Select single image, Select multiple images, Select a folder Development parameters: White Balance, Custom Image, Sensitivity, Clarity, Skin Tone, Digital Filter, HDR Capture, Pixel Shift Resolution, Shadow Correction, High-ISO NR, Distortion Correction, Peripheral Illumination Correction, Lateral Chromatic Aberration Adjustment, Diffraction Correction, Color Fringe Correction, File Format (JPEG, TIFF), Aspect Ratio, JPEG Recorded Pixels, JPEG Quality, Color Space
Editing Features	Image Rotation, Color Moiré Correction, Resize, Cropping (aspect ratio can be changed and tilt correction is available), Movie Edit (dividing a movie file and deleting unwanted segments), Capturing a JPEG still picture from a movie, Save RAW Data, Image Copy

Customization

USER Mode	Up to 5 settings can be saved.
Custom Functions	26 items
Mode Memory	16 items
Button Customization	Fn1 button: One Push File Format, Outdoor View Setting, Flash Mode, Pixel Shift Resolution, Shake Reduction, Horizon Correction, Electronic Level Fn2 button: Enable AF1, Enable AF2, Cancel AF Preview dial: Optical Preview, Digital Preview E-dials (front/rear): customizable to each exposure mode
AF Customization	AF.S: Focus-priority, Release-priority 1st Frame Action in AF.C: Auto, Focus-priority, Release-priority Action in AF.C Continuous: Auto, Focus-priority, FPS-priority Hold AF Status: Off, Low, Medium, High AF in Interval Shooting: Locks focus at 1st exposure, Adjusts focus for each shot AF with Remote Control: Off, On
Operation Control Lock	Type1: Type2:

Text Size	Standard, Large
World Time	World Time settings for 75 cities (28 time zones)
AF Fine Adjustment	±10 steps, adjustment for all lenses or individual lenses (up to 20 values can be saved)
Illumination Settings	LCD Panel: High, Low, Off Backside Controls: High, Low, Off Lens Mount: On, Off Card Slot/Connector: On, Off
Indicator Lamps	Wi-Fi: High, Low, Off GPS: High, Low, Off Self-timer: On, Off Remote Control: On, Off
Copyright Information	Names of "Photographer" and "Copyright Holder" are embedded to the image file. A revision history can be checked using the provided software.

GPS/Electronic Compass

Satellite Systems	GPS, QZSS SBAS: WAAS, EGNOS, GAGAN, MSAS
Reception Frequency	L1, 1575.42 MHz
Recorded Information	Latitude, Longitude, Altitude, Coordinated Universal Time (UTC), Direction
Geodesics	World Geodetic System (WGS84)
GPS Logging	KML format, Logging Interval: 5sec., 10sec., 15sec., 30sec., or 1min. Logging Duration: 1hr. to 24hr. (Up to 9 hours when Logging Interval is set to "5sec." Up to 18 hours when Logging Interval is set to "10sec.")
Electronic Compass	Azimuth calculation using triaxial geomagnetic sensor and triaxial acceleration sensor, True north standard

Power Supply

Battery Type	Rechargeable Lithium-ion Battery D-Li90
AC Adapter	AC Adapter Kit K-AC132 (optional)
Battery Life	Number of recordable images: approx. 760 images Playback time: approx. 390 minutes • Tested in compliance with CIPA standard using a fully charged lithium-ion battery at a temperature of 23°C. Actual results may vary depending on the shooting conditions/circumstances.

Interfaces

Connection Port	USB 2.0 (micro B), external power supply terminal, cable release terminal, X-sync socket, HDMI output terminal (type D), stereo microphone input terminal, headphone terminal
USB Connection	MSC/PTP

Wireless LAN

Standards	IEEE 802.11b/g/n (standard wireless LAN protocol)
Frequency (Center Frequency)	2412 to 2462 MHz (channels: Ch 1 to Ch 11)
Security	Authentication: WPA2 Encryption: AES

Dimensions and Weight

Dimensions	Approx. 136.5 mm (W) × 110 mm (H) × 85.5 mm (D) (excluding protrusions)
Weight	Approx. 1010 g (Including the dedicated battery and an SD Memory Card) Approx. 925 g (body only)

Operating Environment

Temperature	-10 to 40°C (14 to 104°F)
Humidity	85% or less (no condensation)

Included Accessories

Package Contents	Strap O-ST162, ME Viewfinder Cap, Rechargeable Lithium-ion Battery D-LI90, Battery Charger D-BC90, AC plug cord, Software (CD-ROM) S-SW162 <Mounted to the camera> Eyecup Fr, Hot shoe cover Fk, Sync socket 2P cap, Body mount cap K II, Battery grip terminal cover
Software	Digital Camera Utility 5

Approximate Image Storage Capacity and Playback Time

(When using the fully charged battery)

Battery	Temperature	Normal Shooting	Playback Time
D-LI90	23°C	760	390 minutes

- The image storage capacity (normal recording) is based on measuring conditions in accordance with CIPA standards, while other data is based on our measuring conditions. Some deviation from the above figures may occur in actual use depending on the selected capture mode and shooting conditions.

Approximate Image Storage Capacity by Size

(When using an 8 GB memory card)

Recorded Pixels (35mm Full-Frame)	JPEG Quality			RAW
	★★★	★★	★	
36M	351	676	1164	101
22M	572	1096	1874	–
12M	1054	2013	3364	–
2M	4723	8469	12927	–

Recorded Pixels (APS-C Size)	JPEG Quality			RAW
	★★★	★★	★	
15M	821	1564	2669	215
12M	1054	2013	3364	–
8M	1564	2959	4912	–
2M	4723	8469	12927	–

- The number of storable images may vary depending on the subject, shooting conditions, selected capture mode, and memory card, etc.

List of World Time Cities

The following cities can be set as Hometown and Destination.

Region	City
North America	Honolulu, Anchorage, Vancouver, San Francisco, Los Angeles, Calgary, Denver, Chicago, Miami, Toronto, New York, Halifax
Central and South America	Mexico City, Lima, Santiago, Caracas, Buenos Aires, Sao Paulo, Rio de Janeiro
Europe	Lisbon, Madrid, London, Paris, Amsterdam, Milan, Rome, Copenhagen, Berlin, Prague, Stockholm, Budapest, Warsaw, Athens, Helsinki, Moscow
Africa/ West Asia	Dakar, Algiers, Johannesburg, Istanbul, Cairo, Jerusalem, Nairobi, Jeddah, Tehran, Dubai, Karachi, Kabul, Male, Delhi, Colombo, Kathmandu, Dacca
East Asia	Yangon, Bangkok, Kuala Lumpur, Vientiane, Singapore, Phnom Penh, Ho chi Minh, Jakarta, Hong Kong, Beijing, Shanghai, Manila, Taipei, Seoul, Tokyo, Guam
Oceania	Perth, Adelaide, Sydney, Noumea, Wellington, Auckland, Pago Pago

Operating Environment for USB Connection and Provided Software

With the provided software “Digital Camera Utility 5”, you can develop RAW images, make color adjustments, or check shooting information on a computer. Install the software from the provided CD-ROM (S-SW162).

We recommend the following system requirements to connect the camera to a computer and to use the software.

Windows

OS	Windows 10, Windows 8.1 (32-bit, 64-bit), Windows 8 (32-bit, 64-bit), Windows 7 (32-bit, 64-bit), or Windows Vista (32-bit, 64-bit)
CPU	Intel Core 2 Duo or higher
RAM	4 GB or more
HDD	For installing and starting up the program: Approx. 100 MB or more of available space For saving image files: Approx. 15 MB/file (JPEG), Approx. 50 MB/file (RAW)
Monitor	1280×1024 dots, 24-bit full color or higher

Macintosh

OS	OS X 10.10, 10.9, 10.8, or 10.7
CPU	Intel Core 2 Duo or higher
RAM	4 GB or more
HDD	For installing and starting up the program: Approx. 100 MB or more of available space For saving image files: Approx. 15 MB/file (JPEG), Approx. 50 MB/file (RAW)
Monitor	1280×1024 dots, 24-bit full color or higher

Memo

- Application software that supports both MOV (MPEG-4AVC/H.264) and AVI (Motion JPEG) formats is required to play back movie files transferred to a computer.

Symbols

menus.....	22
menus.....	26
menu.....	27
menus.....	28
menu.....	30
menus.....	47

Numerics

1x image display	42
1st Frame Action in AF.C	53

A

AA Filter Simulator	71
AC adapter	35
Action in AF.C Continuous	53
AdobeRGB	43
AE Metering.....	50
AE-L with AF Locked.....	30
AF area.....	54
AF Assist Light	7, 51
AF Button	98
AF coupler.....	7
AF Fine Adjustment.....	54
AF frame.....	17, 40
AF in Interval Shooting	62
AF Mode.....	51, 53
AF point.....	52
AF with Remote Control ..	58
AF.C	51
A.F.S	51
A.F.S Setting	53
Angle adjustment.....	10
Angle of view	43
Anti-aliasing filter	71

Aperture Priority Automatic Exposure	44
Aperture value	44
Aspect Ratio	82, 86
ASTROTRACER	75
Auto (AF Active Area).....	52
Auto EV Compensation ...	30
Auto Flash Discharge	65
Auto Image Rotation.....	79
AUTO ISO Parameters....	49
AUTO mode.....	39
Auto Power Off	36
Auto Screen Rotation	14
Auto Select (Custom Image)	66
Auto SR Off	56
Auto White Balance (White Balance)	63
Autofocus	51
AV device	80
Av mode	44
AWB in Tungsten Light....	63

B

B mode.....	44
Base Parameter Adjustment (Digital Filter)	83
Battery	33
Battery grip	34
Battery grip contacts.....	7
Bleach Bypass (Custom Image)	66
Bold Monochrome (Digital Filter)	67, 83
Bracketing	59
Bracketing Order	59
Bright (Custom Image)	66

Brightness adjustment.....	68
Brightness histogram.....	16
Bulb (B) Mode Options	30
Bulb Exposure	44
Button	8
Button Customization	98

C

Cable switch terminal	7
Calendar Filmstrip Display	78
Calibration	73
Camera route	74
Capture mode.....	44
Capture mode selector switch	39
Card access lamp.....	7
Catch-in Focus	110
Center-weighted metering	50
Certification Marks.....	129
Change AF Point Button... ..	53
Changing the image size	81
Charging the battery	33
Charging time	34
City names	36, 120
Clarity	70
Cleaning	113
Cloudy (White Balance) ...	63
Color Fringe Correction ...	86
Color Moiré Correction	82
Color Space.....	43
Color Temperature (White Balance)	64
Color Temperature Steps	64

Communication device	89
Communication Info.....	89
Composition Adjustment..	71
Computer.....	87
Continuous mode (AF Mode)	51
Continuous playback	79
Continuous Shooting	57
Contrast (Custom Image)	66
Contrast AF Options.....	54
Contrast Detection AF	54
Contrast detection AF.....	51
Control panel	13, 20
Copyright Holder.....	106
Copyright Information	106
Correcting images	68
Create New Folder	104
Crop	43
Cropping.....	82
Cropping frame.....	17
Cross Processing (Custom Image)	66
CTE	63
Custom Image	66
Custom Setting menus	30
Customization	98

D

Date Adjustment	37
Date Format.....	37
Daylight (White Balance)	63
DC input terminal.....	35
Delete	42
Delete All Images	27

Deleting selected images	77	External flash.....	111
Destination	102	Extract Color (Digital Filter)	67, 83
Detailed Information Display	15	F	
Developing RAW images	85	Face Detection (Contrast AF)	53
Dial	8	File Format	43
Dial indicator.....	39	File Name	105
Diffraction Correction.....	69	File No.	106
Digital Camera Utility 5	86, 121	Filter	67, 83
Digital Filter	67, 83	Firmware Info/Options	29
Digital Preview.....	55	Fish-eye (Digital Filter)	83
Dioptric adjustment dial....	17	Flash.....	65, 111
Direct keys	19	Flash compensation	65
Disabling dial and button operations.....	41	Flash Mode.....	65
Display Color	38	Flash On.....	65
Distortion Correction.....	69	Flash X-sync Speed	44, 111
DNG	43	Flat (Custom Image).....	66
D-Range Settings	68	Flicker Reduction.....	24, 26
Drive Mode	56	Fluorescent - Cool White (White Balance)	63
DST (daylight saving time)	37, 102	Fluorescent - Daylight Color (White Balance)	63
Dust Removal.....	112	Fluorescent - Daylight White (White Balance)	63
Dynamic range	68	Fluorescent - Warm White (White Balance)	63
E		Focus indicator.....	40
E-dial	99	Focus Method.....	51
Editing images	81	Focus mode switch....	39, 51
Electronic Compass	14	Focus Peaking.....	54
Electronic Level.....	14, 18	Folder display	78
Enable/Disable Control....	41	Folder Name.....	104
Error messages	114	Format	38
EV Compensation	46	Four-way controller.....	9, 19
EV Steps	45	Framerate	43
Exif data	106	Fx1/Fx2 button	98
Expanded Area AF (AF Active Area).....	52		
Exposure modes	44, 102		

G		Initializing a memory card	38
GPS.....	72	Input Focal Length.....	110
GPS Indicator Lamp	72	Instant Review	40
GPS Logging	74	Interval Composite.....	61
GPS Time Sync.....	72	Interval Movie Record.....	61
GPS/E-Compass	74	Interval Shooting.....	61
Grid Display	17, 42	Interval Shooting Options	62
Guide Display	40	Invert Color (Digital Filter)	67, 83
H		ISO AUTO Setting	49
HDMI Out	80	ISO sensitivity.....	49
HDR Capture	68	J	
Headphone Volume.....	47	JPEG	43
Headphones	48	JPEG Quality.....	43
High Contrast (Digital Filter)	67, 83	JPEG Recorded Pixels	43
High-ISO NR	49	K	
Highlight Alert	15	Kelvin.....	64
Highlight Correction	68	L	
Histogram Display	16	Landscape (Custom Image)	66
Hold AF Status	53	Language setting.....	36
Hometown	36, 102	Language/言語	36
Horizon Correction	23	Lateral Chromatic Aberration Adjustment.....	69
Hot shoe	65	LCD Display.....	38
I		LCD Display Settings.....	28
Illumination Settings	100	LCD panel.....	18
Image Capture Settings... ..	43	LED light for backside controls	7
Image Copy	81	LED light for card slot/connector.....	36
Image finishing tone	66	LED light for lens mount	7, 33
Image plane indicator	7	Lens.....	32, 108
Image Rotation	79	Lens Correction	69
Image storage capacity	119	Lens focal length	110
Image Sync	89		
IMAGE Transmitter 2.....	88		
Image View (Image Sync)	89		
Indicator Lamps.....	100		
Initial settings.....	36		

Lens information contacts	7	MSC	112	Posterization (Digital Filter)	83	Reversal Film (Custom Image)	66
Lens mount index	7, 32	Multi Auto White Balance (White Balance)	63	Power	36	RGB histogram	16
Lens unlock button	32	Multi-exposure	60	Preview	55	Rotating images	79
Lens with aperture ring ..	109	Multi-image display	77	Preview Dial	55	Rotation Direction	100
Lever	8	Multiple AF Points (Contrast AF)	53	Processing images	81	S	
Link AE and AF Point	30	Multi-segment metering ..	50	Program Automatic Exposure	44	Save as Manual WB	64
Live View	12	Muted (Custom Image)	66	Program Line	46	Save Cross Processing ..	67
Log file	74	N		Protect	103	Save Menu Location	21
M		Natural (Custom Image) ..	66	Protect All Images	103	Save RAW Data	40, 42
M mode	44	Noise Reduction	45, 49	Provided software	121	Save Rotation Info	79
Macintosh	121	O		PTP	112	Save USER Mode	101
Manual Exposure	44	One Push File Format	99	Q		Scene Analyze Auto mode	39
Manual White Balance	64	One-Push Bracketing	59	Quality	43	SD Memory Card	35
ME viewfinder cap	56	Operating environment ..	121	Quality level adjustment ..	70	Select (AF Active Area) ..	52
Memory	103	Optical Preview	55	Quick Zoom	42	Select (Contrast AF)	53
Memory card	35	Outdoor View Setting	11	R		Select Battery	34
Memory Card Options	43	P		Radiant (Custom Image)	66	Self-timer	57
Menu	21	P mode	44	RAW	43	Self-timer lamp	7
Meter Operating Time	30	Pastel (Digital Filter)	83	RAW Development	85	Sensitivity	49
Microphone	7, 48	PEF	43	RAW File Format	43	Sensitivity Priority Automatic Exposure	44
Miniature (Digital Filter) ..	83	Peripheral Illumination Correction	69	Rec. Mode menus	22	Sensitivity Steps	49
Mired	64	Phase Detection AF	53	Recordable time	47	Sensor Cleaning	113
Mirror	7	Photographer	106	Recorded Pixels	43	Sequential Numbering	106
Mirror Lock-up Shooting ..	60	Pixel Mapping	112	Recording Sound Level ..	47	Set-up menus	28
Mode dial	39	Pixel Shift Resolution	70	Red-eye reduction	65	Shade (White Balance)	63
Mode dial lock button	39	Playback Info Display selection screen	15	Remote Capture (Image Sync)	89	Shading (Digital Filter)	67, 83
Mode dial lock release lever	41	Playback menu	27	Remote Control	58	Shadow Correction	68
Moiré reduction	71	Playback mode	42	Remote control receiver	7	Shake Reduction	69
Monitor	11	Playback mode palette	76	Replace Color (Digital Filter)	67, 83	Sharpness (Custom Image)	66
Monochrome (Custom Image)	66	Playback mode volume	48	Reset	29, 31	Shooting	39
Monochrome (Digital Filter)	83	Portrait (Custom Image) ..	66	Resize	81	Shooting celestial bodies	75
Movie Capture Settings	43			Retractable lens	41	Shooting Info Display	14
Movie Edit	84			Retro (Digital Filter) ..	67, 83	Shooting with Live View ..	40
Movie menus	26					Shooting with viewfinder ..	39
Movie mode	47						
Movie SR	26						

Shutter & Aperture Priority	Time Setting	102	World Time	102
Automatic Exposure	Tone Expansion (Digital Filter)	83	X	
Shutter Priority Automatic Exposure	Toy Camera (Digital Filter)	67, 83	X mode	44
Shutter speed	Tracking (Contrast AF)	53	X-sync socket	111
Single Frame Shooting	Tripod socket	7	Z	
Single image display	TTL phase-matching autofocus	51	Zone Select (AF Active Area)	52
..... 15, 42	Tungsten (White Balance)	63	Zoom Review	40, 42
Single mode (AF Mode) ..	Tv mode.....	44		
Sketch (Digital Filter)	U			
Skin Tone	Unicolor Bold (Digital Filter)	67, 83		
Slideshow	USB Connection	87, 121		
Slim (Digital Filter)	USB terminal	87		
Slow Shutter Speed NR ..	User registration	6		
Slow-speed Sync.....	Using Aperture Ring	109		
Smart Function	V			
Soft (Digital Filter)	Vertical position	14		
Sound	Vibrant (Custom Image) ..	66		
Sound Effects	Viewfinder.....	17		
Sound Volume Setting.....	Viewfinder Light.....	17		
Speaker	Viewfinder Overlay	17		
Specifications	Volume label.....	38		
Spot (AF Active Area).....	W			
Spot (Contrast AF)	WARRANTY POLICY....	131		
Spot metering	Water Color (Digital Filter)	83		
sRGB	WB Adjustable Range	63		
Standby mode	WB When Using Flash	63		
Star Stream	White Balance	63		
Starburst (Digital Filter) ...	Wi-Fi	88		
Status Screen	Wi-Fi lamp	7		
Strap	Wind Noise Reduction	47		
Sv mode	Windows	121		
Switch.....	Wireless LAN.....	88		
T				
TAv mode.....				
Tethered shooting				
Text input.....				
Text Size				
Texture adjustment.....				
Thumbnail display				

For Using Your Camera Safely

We have paid close attention to the safety of this camera. When using this camera, we request your special attention regarding items marked with the following symbols.



Warning

This symbol indicates that ignoring this item could cause serious personal injuries.



Caution

This symbol indicates that ignoring this item could cause minor or medium personal injuries, or loss of property.

About the Camera



Warning

- Do not disassemble or modify the camera. High voltage areas are present inside the camera, with the risk of electric shock.
- If the camera interior is exposed due to dropping or otherwise damaging the camera, never touch the exposed portion. There is a risk of electric shock.
- Do not aim the camera at the sun or other strong light sources when taking pictures or leave the camera sitting in direct sunlight with a lens cap off. Doing so may cause the camera to malfunction or cause a fire.
- Do not look at the sun or other strong light sources through a lens. Doing so may lead to a loss of eyesight or cause vision to be impaired.
- If any irregularities occur during use, such as smoke or a strange odor, stop use immediately, remove the battery or the AC adapter, and contact your nearest service center. Continued use can cause a fire or electric shock.



Caution

- Do not place your finger over the flash when discharging the flash. You may burn yourself.
- Do not cover the flash with clothing when discharging the flash. Discoloration may occur.
- Some portions of the camera heat up during use. There is a risk of low temperature burns when holding such portions for long periods.
- Should the monitor be damaged, be careful of glass fragments. Also, be careful not to allow the liquid crystal to get on your skin or in your eyes or mouth.
- Depending on your individual factors or physical condition, the use of the camera may cause itching, rashes or blisters. In case of any abnormality, stop using the camera and get medical attention immediately.

About the Battery Charger and AC Adapter



Warning

- Always use the battery charger and AC adapter exclusively developed for this camera, with the specified power and voltage. Using a battery charger or AC adapter not exclusive to this camera, or using the exclusive battery charger or AC adapter with an unspecified power or voltage can cause a fire, electric shock, or camera breakdown. The specified voltage is 100 - 240V AC.
- Do not disassemble or modify the product. This can cause a fire or electric shock.
- If the generation of smoke or strange odor from the product or other abnormality occurs, immediately discontinue using and consult your nearest service center. Continued use can cause a fire or electric shock.
- If water should happen to get inside the product, consult your nearest service center. Continued use can cause a fire or electric shock.
- If you see a lightning flash or hear thunder during use of the battery charger or AC adapter, unplug the power plug and discontinue using. Continued use can cause damage to the product, fire or electric shock.
- Wipe off the power plug if it should become covered with dust. Accumulated dust may cause a fire.
- To reduce the risk of hazards, use only CSA/UL certified power supply cord set, cord is Type SPT-2 or heavier, minimum NO.18 AWG copper, one end with a molded-on male attachment plug cap (with a specified NEMA configuration), and the other is provided with a molded-on female connector body (with a specified IEC nonindustrial type configuration) or the equivalent.



Caution

- Do not place or drop heavy objects on or forcefully bend the AC plug cord. Doing so may damage the cord. Should the AC plug cord be damaged, consult your nearest service center.
- Do not touch or short-circuit the terminal area of the AC plug cord while the cord is plugged in.
- Do not handle the power plug with wet hands. This can cause an electric shock.
- Do not drop the product, or subject it to violent impact. This can cause the product to breakdown.
- Do not use the battery charger D-BC90 to charge batteries other than the rechargeable lithium-ion battery D-LI90. Attempting to charge other types of batteries may cause an explosion or heating, or may damage the battery charger.

About the Rechargeable Lithium-ion Battery

Warning

- If any leakage from the battery should come in contact with your eyes, do not rub them. Flush your eyes with clean water and get medical attention immediately.

Caution

- Only use the specified battery with this camera. Use of other batteries may cause an explosion or fire.
- Do not disassemble the battery. Disassembling the battery may cause an explosion or leakage.
- Remove the battery from the camera immediately if it becomes hot or begins to smoke. Be careful not to burn yourself during removal.
- Keep wires, hairpins, and other metal objects away from the + and - contacts of the battery.
- Do not short the battery or dispose of the battery in fire. This can cause an explosion or fire.
- If any leakage from the battery should come in contact with skin or clothing, it may cause irritation to the skin. Wash the affected areas thoroughly with water.
- Precautions for D-LI90 Battery Usage:
 - USE SPECIFIED CHARGER ONLY. RISK OF FIRE AND BURNS.
 - DO NOT INCINERATE.
 - DO NOT DISASSEMBLE.
 - DO NOT SHORT CIRCUIT.
 - DO NOT EXPOSE TO HIGH TEMP. (140°F / 60°C)
 - SEE MANUAL.

Keep the Camera and its Accessories out of the Reach of Small Children

Warning

- Do not place the camera and its accessories within the reach of small children.
 1. If the product falls or is operated accidentally, it may cause serious personal injuries.
 2. Wrapping the strap around a neck may cause suffocation.
 3. To avoid the risk of a small accessory such as the battery or memory cards from being swallowed by mistake, keep them out of the reach of small children. Seek medical attention immediately if an accessory is accidentally swallowed.

Care to be Taken During Handling

Before Using Your Camera

- When the camera has not been used for a long time, confirm that it is still working properly, particularly prior to taking important pictures (such as at a wedding or when traveling). Contents of the recording cannot be guaranteed if recording, playback or transferring your data to a computer, etc. is not possible due to a malfunction of your camera or recording media (memory cards), etc.

About the Battery and Charger

- To keep the battery in optimum condition, avoid storing it in a fully charged state or in high temperatures.
- If the battery is left inserted and the camera is not used for a long time, the battery will over-discharge and shorten the battery's life.
- Charging the battery a day before use or on the day of use is recommended.
- The AC plug cord provided with this camera is developed exclusively for the battery charger D-BC90. Do not use it with other devices.

Precautions on Carrying and Using Your Camera

- Do not subject the camera to high temperatures or high humidity. Do not leave the camera in a vehicle, as the temperature can get very high.
- Do not subject the camera to strong vibrations, shocks, or pressure. Use a cushion to protect the camera from vibrations of motorcycles, automobiles, or ships.
- The temperature range for camera use is -10°C to 40°C (14°F to 104°F).
- The monitor may appear black at high temperatures, but will return to normal at normal temperatures.
- The monitor may respond more slowly at low temperatures. This is due to liquid crystal properties, and is not a malfunction.
- Sudden temperature changes will cause condensation on the inside and outside of the camera. Place the camera in your bag or a plastic bag, and remove it after temperatures of the camera and surroundings are equalized.
- Avoid contact with garbage, mud, sand, dust, water, toxic gases, or salt. These could cause the camera to breakdown. Wipe the camera to dry off any rain or water drops.
- Do not press on the monitor with excessive force. This could cause it to break or malfunction.
- Be careful not to overtighten the screw in the tripod socket when using a tripod.

Cleaning Your Camera

- Do not clean the camera with organic solvents such as thinner, alcohol, and benzine.
- Use a lens brush to remove dust accumulated on a lens. Never use a spray blower for cleaning as it may damage the lens.
- Please contact your nearest service center for professional cleaning of the CMOS sensor. (This will involve a fee.)
- Periodic inspections are recommended every one to two years to maintain high performance.

Storing Your Camera

- Do not store the camera with preservatives or chemicals. Storage in high temperatures and high humidity can cause mold to grow on the camera. Remove the camera from its case and store it in a dry and well-ventilated place.
- Avoid using or storing the camera where it may be exposed to static electricity or electrical interference.
- Avoid using or storing the camera in direct sunlight or in locations where it may be exposed to rapid changes in temperature or to condensation.

About SD Memory Cards

- The SD Memory Card is equipped with a write-protect switch. Setting the switch to LOCK prevents new data from being recorded on the card, the stored data from being deleted, and the card from being formatted by the camera or computer.
- The SD Memory Card may be hot when removing the card immediately after using the camera.
- Do not remove the SD Memory Card or turn off the power while the card is being accessed. This may cause the data to be lost or the card to be damaged.
- Do not bend the SD Memory Card or subject it to violent impact. Keep it away from water and store away from high temperatures.
- Do not remove the SD Memory Card while formatting. The card may be damaged and become unusable.
- Data on the SD Memory Card may be deleted in the following circumstances. We do not accept any liability for data that is deleted if
 1. the SD Memory Card is mishandled by the user.
 2. the SD Memory Card is exposed to static electricity or electrical interference.
 3. the SD Memory Card has not been used for a long time.

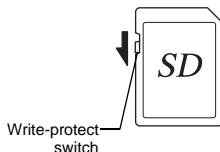

4. the SD Memory Card or the battery is removed while the card is being accessed.
- If the SD Memory Card is not used for a long time, the data on the card may become unreadable. Be sure to regularly make a backup of important data on a computer.
 - Format new SD Memory Cards. Also format SD Memory Cards previously used with other cameras.
 - Please note that deleting data stored on an SD Memory Card, or formatting an SD Memory Card does not completely erase the original data. Deleted data can sometimes be recovered using commercially available software. If you are going to discard, give away or sell your SD Memory Card, you should ensure that the data on the card is completely deleted or the card itself is destroyed if it contains any personal or sensitive information.
 - The data on your SD Memory Card should be managed at your own risk.

About the Wireless LAN Function

- Do not use the camera in a place where electrical products, AV/OA devices, and so on generate magnetic fields and electromagnetic waves.
- If the camera is affected by magnetic fields and electromagnetic waves, it may not be able to communicate.
- If the camera is used near a TV or a radio, poor reception or TV screen glitch may occur.
- If there are multiple wireless LAN access points near the camera and the same channel is used, search operation may not be executed correctly.
- The security of your data stored, sent or received is your own responsibility.

In the frequency band used by the camera, along with industrial, scientific, and medical devices such as microwave ovens, premises radio stations (wireless stations requiring license) and specified low power radio stations (wireless stations not requiring license) for mobile object identification used in factory production lines, etc., and amateur radio stations (wireless stations requiring license) are operated.

1. Before using the camera, confirm that premises radio stations and specified low power radio stations for mobile object identification and amateur radio stations are not operated in the vicinity.
2. In the event that the camera causes harmful radio wave interference to premises radio stations for mobile object identification, immediately change the frequency being used to avoid interference.
3. If you have other troubles such that the camera causes harmful radio wave interference to specified low power radio stations for mobile object identification or to amateur radio stations, contact your nearest service center.

This camera conforms to the technical standards under the Radio Law and Telecommunications Business Law and the certification of conformance to technical standards can be displayed on the monitor.

The certification marks of conformance to wireless technical standards under the Radio Law and Telecommunications Business Law can be displayed from [Certification Marks] of the  menu. Refer to "Using the Menus" (p.21) for how to use the menus.

About the GPS

- Local geographic and atmospheric conditions may prevent or delay the reception of GPS data. This camera may be unable to receive GPS data indoors, underground, or near large structures, trees, or other objects that block or reflect satellite signals.
- The positions of GPS satellites are continuously changing and this may prevent or delay the reception of GPS data at certain hours of the day.
- The presence of mobile phones or other devices that transmit frequencies close to those of GPS satellites, or magnetized high-voltage lines may interfere with the reception of GPS data.
- Note that this camera may take a while to reacquire a signal if it has not been used for an extended period or has been moved a great distance from where the GPS data was last received.
- Turn off the GPS function in any place where, or on any occasion when the use of electronic device is prohibited, such as while visiting a hospital, or taking off and landing of airplane.
- In some countries or regions, using GPS or collecting positioning data may be regulated. When you travel overseas, consult the embassy or your travel agency about using a camera with a GPS function or collecting the positioning log data.
- The GPS function of this camera has been developed for personal-use digital cameras. It cannot be used for surveying or for a navigation system for airplanes, vehicles, or people, etc. We assume no responsibility nor liability for any damages resulting from the use of the function for improper purposes.

Trademarks

- Microsoft, Windows, Windows Vista, and Photosynth are registered trademarks of Microsoft Corporation in the United States of America and other countries.
- Macintosh, OS X, QuickTime, iPhone, and App Store are trademarks of Apple Inc., registered in the U.S. and other countries.
- Intel and Intel Core are trademarks of Intel Corporation in the U.S. and/or other countries.
- SDXC Logo is a trademark of SD-3C, LLC.
- Google, Google Play, Android, and Google Earth are trademarks or registered trademarks of Google Inc.
- Wi-Fi is a registered trademark of Wi-Fi Alliance.
- IOS is a trademark or registered trademark of Cisco in the U.S. and other countries and is used under license.

- Facebook is a registered trademark of Facebook, Inc.
- Twitter is a registered trademark of Twitter, Inc.
- Tumblr is a registered trademark of Tumblr, Inc.
- This product includes DNG technology under license by Adobe Systems Incorporated.
- The DNG logo is either a registered trademark or trademark of Adobe Systems Incorporated in the United States and/or other countries.
- HDMI, the HDMI logo and High-Definition Multimedia Interface are trademarks or registered trademarks of HDMI Licensing, LLC in the United States and/or other countries.

All other trademarks are the property of their respective owners.

- This product uses the RICOH RT font designed by Ricoh Company Ltd.
- This product supports PRINT Image Matching III. PRINT Image Matching enabled digital still cameras, printers and software help photographers to produce images more faithful to their intentions. Some functions are not available on printers that are not PRINT Image Matching III compliant.
Copyright 2001 Seiko Epson Corporation. All Rights Reserved. PRINT Image Matching is a trademark of Seiko Epson Corporation. The PRINT Image Matching logo is a trademark of Seiko Epson Corporation.



AVC Patent Portfolio License

This product is licensed under the AVC Patent Portfolio License for the personal use of a consumer or other uses in which it does not receive remuneration to (i) encode video in compliance with the AVC standard ("AVC video") and/or (ii) decode AVC video that was encoded by a consumer engaged in a personal activity and/or was obtained from a video provider licensed to provide AVC video. No license is granted or shall be implied for any other use.

Additional information may be obtained from MPEG LA, L.L.C.
See <http://www.mpegla.com>.

Announcement on the Use of BSD-Licensed Software

This product includes software licensed under the BSD License. BSD license is a form of license which permits the redistribution of the software provided that it is clearly stated that use is unwarranted, and a copyright notice and a list of licensing conditions are provided. The following contents are displayed based on the abovementioned licensing conditions and are not for the purpose of restricting your use of the product, etc.

Tera Term
Copyright (C) 1994-1998 T. Teranishi
(C) 2004-2015 TeraTerm Project
All rights reserved.

Redistribution and use in source and binary forms, with or without modification, are permitted provided that the following conditions are met:

1. Redistributions of source code must retain the above copyright notice, this list of conditions and the following disclaimer.
2. Redistributions in binary form must reproduce the above copyright notice, this list of conditions and the following disclaimer in the documentation and/or other materials provided with the distribution.
3. The name of the author may not be used to endorse or promote products derived from this software without specific prior written permission.

THIS SOFTWARE IS PROVIDED BY THE AUTHOR "AS IS" AND ANY EXPRESS OR IMPLIED WARRANTIES, INCLUDING, BUT NOT LIMITED TO, THE IMPLIED WARRANTIES OF MERCHANTABILITY AND FITNESS FOR A PARTICULAR PURPOSE ARE DISCLAIMED. IN NO EVENT SHALL THE AUTHOR BE LIABLE FOR ANY DIRECT, INDIRECT, INCIDENTAL, SPECIAL, EXEMPLARY, OR CONSEQUENTIAL DAMAGES (INCLUDING, BUT NOT LIMITED TO, PROCUREMENT OF SUBSTITUTE GOODS OR SERVICES; LOSS OF USE, DATA, OR PROFITS; OR BUSINESS INTERRUPTION) HOWEVER CAUSED AND ON ANY THEORY OF LIABILITY, WHETHER IN CONTRACT, STRICT LIABILITY, OR TORT (INCLUDING NEGLIGENCE OR OTHERWISE) ARISING IN ANY WAY OUT OF THE USE OF THIS SOFTWARE, EVEN IF ADVISED OF THE POSSIBILITY OF SUCH DAMAGE.

WARRANTY POLICY

All our cameras purchased through authorized bona fide photographic distribution channels are guaranteed against defects of material or workmanship for a period of twelve months from the date of your purchase. Service will be rendered, and defective parts will be replaced without cost to you within that period, provided the camera does not show evidence of impact, sand or liquid damage, mishandling, tampering, battery or chemical corrosion, operation contrary to operating instructions, or modification by an unauthorized repair shop. The manufacturer or its authorized representatives shall not be liable for any repair or alterations except those made with its written consent and shall not be liable for damages from delay or loss of use or from other indirect or consequential damages of any kind, whether caused by defective material or workmanship or otherwise; and it is expressly agreed that the liability of the manufacturer or its representatives under all guarantees or warranties, whether expressed or implied, is strictly limited to the replacement of parts as hereinbefore provided. No refunds will be made on repairs by non-authorized service facilities.

Procedure During 12-month Warranty Period

Any camera which proves defective during the 12-month warranty period should be returned to the dealer from whom you purchased the camera or to the manufacturer. If there are no representatives of the manufacturer in your country, send the camera to the manufacturer, with postage prepaid. In this case, it will take a considerable length of time before the camera can be returned to you owing to the complicated customs procedures required. If the camera is covered by warranty, repairs will be made and parts replaced free of charge, and the camera will be returned to you upon completion of servicing. If the camera is not covered by warranty, regular charges of the manufacturer or of its representatives will apply. Shipping charges are to be borne by the owner. If your camera was purchased outside of the country where you wish to have it serviced during the warranty period, regular handling and

servicing fees may be charged by the manufacturer's representatives in that country. Notwithstanding this, your camera returned to the manufacturer will be serviced free of charge according to this procedure and warranty policy. In any case, however, shipping charges and customs clearance fees to be borne by the sender. To prove the date of your purchase when required, please keep the receipt or bills covering the purchase of your camera for at least a year. Before sending your camera for servicing, please make sure that you are sending it to the manufacturer's authorized representatives or their approved repair shops, unless you are sending it directly to the manufacturer. Always obtain a quotation for the service charge, and only after you accept the quoted service charge, instruct the service station to proceed with the servicing.

- **This warranty policy does not affect the customer's statutory rights.**
- **The local warranty policies available from our distributors in some countries can supersede this warranty policy. Therefore, we recommend that you review the warranty card supplied with your product at the time of purchase, or contact our distributor in your country for more information and to receive a copy of the warranty policy.**

For customers in USA
STATEMENT OF FCC COMPLIANCE

This device complies with Part 15 of the FCC Rules. Operation is subject to the following two conditions: (1) This device may not cause harmful interference, and (2) this device must accept any interference received, including interference that may cause undesired operation.

Changes or modifications not approved by the party responsible for compliance could void the user's authority to operate the equipment.

This equipment has been tested and found to comply with the limits for a Class B digital device, pursuant to part 15 of the FCC Rules.

These limits are designed to provide reasonable protection against harmful interference in a residential installation. This equipment generates, uses and can radiate radio frequency energy and, if not installed and used in accordance with the instructions, may cause harmful interference to radio communications. However, there is no guarantee that interference will not occur in a particular installation.

If this equipment does cause harmful interference to radio or television reception, which can be determined by turning the equipment off and on, the user is encouraged to try to correct the interference by one or more of the following measures:

- Reorient or relocate the receiving antenna.
- Increase the separation between the equipment and receiver.
- Connect the equipment into an outlet on a circuit different from that to which the receiver is connected.

* Consult the dealer or an experienced radio/TV technician for help.

FOR CALIFORNIA, U.S.A. ONLY

Perchlorate Material-special handling may apply.

The lithium battery used in this camera contains perchlorate material, which may require special handling.

See www.dtsc.ca.gov/hazardouswaste/perchlorate

Declaration of Conformity
According to 47CFR, Parts 2 and 15 for
Class B Personal Computers and Peripherals

We: RICOH IMAGING AMERICAS CORPORATION

Located at: 633 17th Street, Suite 2600
Denver, Colorado 80202 U.S.A.
Phone: 800-877-0155
FAX: 303-790-1131

Declare under sole responsibility that the product identified herein complies with 47CFR Parts 2 and 15 of the FCC rules as a Class B digital device. Each product marketed is identical to the representative unit tested and found to be compliant with the standards. Records maintained continue to reflect the equipment being produced can be expected to be within the variation accepted, due to quantity production and testing on the statistical basis as required by 47CFR §2.909. Operation is subject to the following two conditions: (1) This device may not cause harmful interference, and (2) This device must accept any interference received, including interference that may cause undesired operation. The above named party is responsible for ensuring that the equipment complies with the standards of 47CFR §15.101 to §15.109.

Product Name: SLR Digital Camera

Model Number: PENTAX K-1

Contact person: Customer Service Manager

Date and Place: January, 2016 Colorado

For customers in Canada **Industry Canada (IC) Compliance Notice**

This Class B digital apparatus complies with Canadian ICES-003 (B).

This device complies with Industry Canada licence-exempt RSS standard(s). Operation is subject to the following two conditions: (1) this device may not cause interference, and (2) this device must accept any interference, including interference that may cause undesired operation of the device.

The available scientific evidence does not show that any health problems are associated with using low power wireless devices. There is no proof, however, that these low power wireless devices are absolutely safe. Low power wireless devices emit low levels of radio frequency energy (RF) in the microwave range while being used. Whereas high levels of RF can produce health effects (by heating tissue), exposure of low-level RF that does not produce heating effects causes no known adverse health effects. Many studies of low-level RF exposures have not found any biological effects. Some studies have suggested that some biological effects might occur, but such findings have not been confirmed by additional research. The K-1 has been tested and found to comply with IC radiation exposure limits set forth for an uncontrolled environment and meets RSS-102 of the IC radio frequency (RF) Exposure rules.

Pour les utilisateurs au Canada **Industrie Canada (IC) Avis de Conformité**

Cet appareil numérique de la classe B est conforme à la norme NMB-003 (B) du Canada.

Le présent appareil est conforme aux CNR d'Industrie Canada applicables aux appareils radio exempts de licence.

L'exploitation est autorisée aux deux conditions suivantes :

- (1) l'appareil ne doit pas produire de brouillage, et
- (2) l'utilisateur de l'appareil doit accepter tout brouillage radioélectrique subi, même si le brouillage est susceptible d'en compromettre le fonctionnement.

Les connaissances scientifiques dont nous disposons n'ont mis en évidence aucun problème de santé associé à l'usage des appareils sans fil à faible puissance. Nous ne sommes cependant pas en mesure de prouver que ces appareils sans fil à faible puissance sont entièrement sans danger. Les appareils sans fil à faible puissance émettent une énergie fréquence radioélectrique (RF) très faible dans le spectre des micro-ondes lorsqu'ils sont utilisés. Alors qu'une dose élevée de RF peut avoir des effets sur la santé (en chauffant les tissus), l'exposition à de faibles RF qui ne produisent pas de chaleur n'a pas de mauvais effets connus sur la santé. De nombreuses études ont été menées sur les expositions aux RF faibles et n'ont découvert aucun effet biologique. Certaines études ont suggéré qu'il pouvait y avoir certains effets biologiques, mais ces résultats n'ont pas été confirmés par des recherches supplémentaires. Le K-1 a été testé et jugé conforme aux limites d'exposition aux rayonnements IC énoncées pour un environnement non contrôlé et respecte les règles d'exposition aux fréquences radioélectriques (RF) CNR-102 de l'IC.

For Customers in Europe

Hereby, RICOH IMAGING COMPANY, LTD., declares that this PENTAX K-1 is in compliance with the essential requirements and other relevant provisions of Directive 1999/5/EC.

For a full version of the Declaration of Conformity (DoC), please refer to <http://www.ricoh-imaging.co.jp/english>

Information for Users on Collection and Disposal of Old Equipment and Used Batteries



1. In the European Union

These symbols on the products, packaging and/or accompanying documents mean that used electrical and electronic equipment and batteries should not be mixed with general household waste.

Used electrical/electronic equipment and batteries must be treated separately and in accordance with legislation that requires proper treatment, recovery and recycling of these products.



By disposing of these products correctly you will help ensure that the waste undergoes the necessary treatment, recovery and recycling and thus prevent potential negative effects on the environment and human health which could otherwise arise due to inappropriate waste handling.

If a chemical symbol is added beneath the symbol shown above, in accordance with the Battery Directive, this indicates that a heavy metal (Hg = Mercury, Cd = Cadmium, Pb = Lead) is present in the battery at a concentration above an applicable threshold specified in the Battery Directive.

For more information about collection and recycling of used products, please contact your local authorities, your waste disposal service or the point of sale where you purchased the products.

2. In other countries outside the EU

These symbols are only valid in the European Union. If you wish to discard used products, please contact your local authorities or dealer and ask for the correct method of disposal.

For Switzerland: Used electrical/electronic equipment can be returned free of charge to the dealer, even when you don't purchase a new product. Further collection facilities are listed on the home page of www.swico.ch or www.sens.ch.



The CE Mark is a Directive conformity mark of the European Union.

Memo

Memo

Memo

RICOH IMAGING COMPANY, LTD.

1-3-6, Nakamagome, Ohta-ku, Tokyo 143-8555, JAPAN
(<http://www.ricoh-imaging.co.jp>)

**RICOH IMAGING EUROPE
S.A.S.**

Parc Tertiaire SILIC 7-9, avenue Robert Schuman - B.P. 70102,
94513 Rungis Cedex, FRANCE
(<http://www.ricoh-imaging.eu>)

**RICOH IMAGING AMERICAS
CORPORATION**

633 17th Street, Suite 2600, Denver, Colorado 80202, U.S.A.
(<http://www.us.ricoh-imaging.com>)

**RICOH IMAGING CANADA
INC.**

5520 Explorer Drive Suite 300, Mississauga, Ontario, L4W 5L1, CANADA
(<http://www.ricoh-imaging.ca>)

**RICOH IMAGING CHINA CO.,
LTD.**

23D, Jun Yao International Plaza, 789 Zhaojiabang Road, Xu Hui District,
Shanghai, 200032, CHINA
(<http://www.ricoh-imaging.com.cn>)

<http://www.ricoh-imaging.co.jp/english>

This contact information may change without notice.
Please check the latest information on our websites.

- Specifications and external dimensions are subject to change without notice.