

## RF PRO-1B INSTALLATION INSTRUCTIONS

This active magnetic loop antenna is designed for reception of signals over the range of 50 kHz to 30 MHz. It includes a very high dynamic range low-noise preamplifier that can be mounted to a pole or any flat surface. The preamplifier is designed for minimum intermodulation distortion in the presence of very high level signals that would normally overload most amplifiers. For proper operation the preamplifier needs to be powered as shown in the diagram shown in Figure 1 with the supplied power inserter and power supply that duplexes DC power on the same cable carrying the preamplifier's output. The antenna should be oriented in the proper direction to maximize reception of the desired signals (see details below). For best performance, the amplifier should be installed near the antenna to avoid amplifying low level local interference that may enter the coaxial cable leading from the loop antenna to the preamplifier's input.

### Cautions:

- **This is a receive-only antenna. Do not connect it to a transmitter as it will be damaged and void your warranty**
- **Do not inadvertently connect the 20 VDC output of the power inserter to your receiver's antenna input as your receiver may be damaged.**
- **See attached cautions and warnings relative to lightning protection and antenna installation near high voltage power lines.**
- **When operating with nearby transmitting antennas, follow the instructions below to avoid over-driving (or damaging) your receiver's input or damaging the loop's low-noise amplifier.**

### Supplied Components *(see Figure 16)*

QTY	Description
1	Loop antenna
1	30 dB preamplifier
1	L-bracket
2	Saddle clamps
2	U-bolts
1	lot Mounting Screws and washers
1	Coaxial- Seal package
1	24 VAC wall mount transformer
1	3 ft F-male to F-male jumper cable
1	1 ft F-male to F-male water-proof jumper cable
1	PL-259 Adapter
1	20 VDC power inserter
1	Twin lead to F-female adapter
1	RCA- plug to RCA- plug cable and Y adapter
1	Grounding Lug
2	Nylon shoulder washers (.375 inch)
2	Nylon flat washers (.25 inch)
1	Instruction Manual

**Figure 1. RF PRO-1B Active Loop Antenna Wiring Diagram**

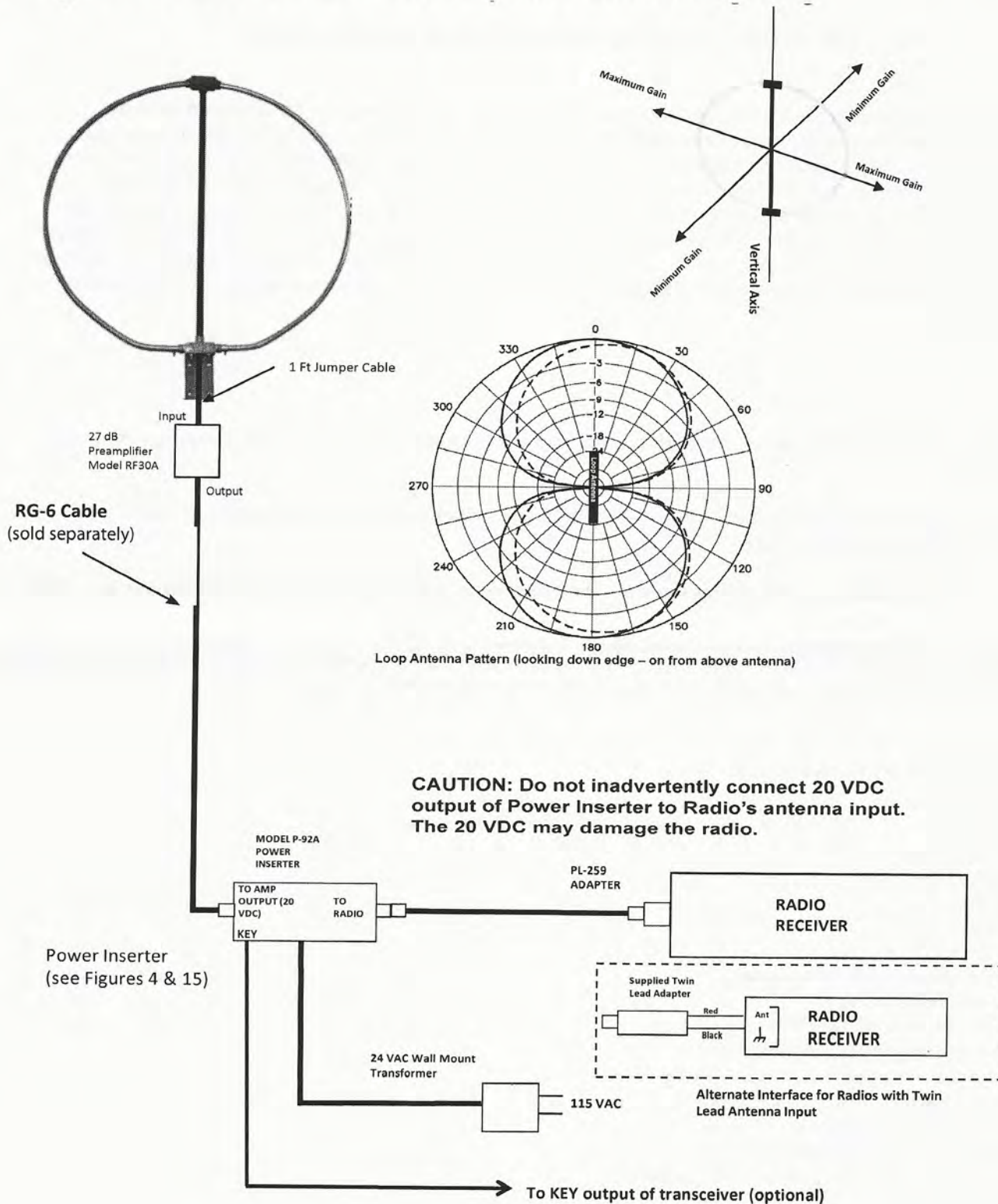

---

## Positioning the Antenna

This antenna has a directional 'Figure Eight' pattern with two deep 25- 30 dB nulls as shown in the diagram in *Figure 1*, so for maximum daytime low-angle ground wave reception of a desired signal it should be oriented so that the imaginary plane in which the loop rests should be vertical to the ground and should, if extended, pass through the general location of the signal's transmitter. There is a label on the antenna's upper junction box that shows the proper pointing directions for maximum signals and the nulls. At night, for reception of high- angle sky waves this antenna is less directional and the nulls are far less prominent.

For best results it should be located as far away as possible from any metal objects that could distort or shield the antenna's reception like gutters, downpipes, metal plumbing and aluminum foil backed thermal insulation. It can be positioned indoors or outdoors at least 5 feet above ground level, but for best results it should be as far as possible from sources of interference such as AC power cables, cat 5 network cables, fluorescent lights, light dimmers, computers and flat panel TV's. If located outdoors it can be camouflaged with shrubbery. Ideally a location outdoors at least 20 feet away from any buildings will yield superior results. It can be mounted to any pole up to 2 inches in diameter or attached to a flat surface or wall via the included L-bracket.

## Use with Near-By Transmitting Antennas

The antenna's low-noise preamplifier will withstand RF input levels of at least 30 dBm without failure. In tests with a 1,500 Watt transmit amplifier and a ¼ wave vertical transmitting antenna we found that the worst- case loop output power into the preamp was 10 dBm when the antenna was located 25 ft from a vertical radiator and adjusted for maximum coupling. This would indicate that at 25 ft separation there is a 20 dB safety margin. The other factor to consider however is that with this kind of input signal (+10 dBm) the preamplifier's 27 dB gain will cause it to saturate and output 1.3 watts into the connected receiver. This high saturated output level is a byproduct of the excellent intermodulation distortion performance of this preamplifier, but while most receivers have some sort of input protection and possibly an internal transmit / receive switch that disconnects or shorts the input when transmitting, we cannot be sure of what the radio's protection limits are and we don't want to be responsible for any damage that may result. Hence included in the loop's power inserter is a relay that can be actuated by the "KEY" output of a typical transceiver. When actuated, the relay disconnects power from the antenna's preamp. A green LED on the power inserter is illuminated when power is applied to the preamp. An RCA-plug to RCA-plug cable is included with the accessories to connect the KEY output of your transceiver to the RCA jack on the side of the power inserter. An RCA Y-adapter is also included to enable connecting the KEY signal from your transceiver to other equipment. (See *Figures 2 and 3*).

The relay's actuation circuit is designed to operate with a typical transceiver's 12 VDC "KEY" signal. The power inserter has internal DIP switches that can be programmed to harmonize relay actuation with the proper state of the transceiver's KEY signal. The default setting is such that when the KEY output is "low" (less than 0.7 VDC) the relay turns on and disconnects the preamp's power and the connection to your receiver is grounded through a resistor. If the KEY signal is "high" or greater than 1.2 VDC the relay is not actuated and power is applied to the amplifier and connection is made to your receiver. If the KEY input to the power inserter is left open or disconnected, then power is always applied to the preamp. If your transceiver has a "KEY" output that goes high on transmit, then you can reverse the polarity of the power inserter relay actuation by removing the power inserter's base plate and programming the DIP switches on the PC board in accordance with the table shown in *Figure 4*.

A simplified schematic of the relay interface circuit is shown in *Figure 5*. Note that the KEY input is pulled up internally via a 10K ohm resistor to the "high" state. If your transceiver's KEY output is not compatible with this interface circuit and does not operate the power inserter relay, please contact our customer service (303 526 1965, [info@pixelsatradio.com](mailto:info@pixelsatradio.com)) for assistance.

**Figure 2. KEY Wiring for RF PRO-1B Loop Antenna**

Typical Receiver



Back of Elecraft K3

To Loop Preamp

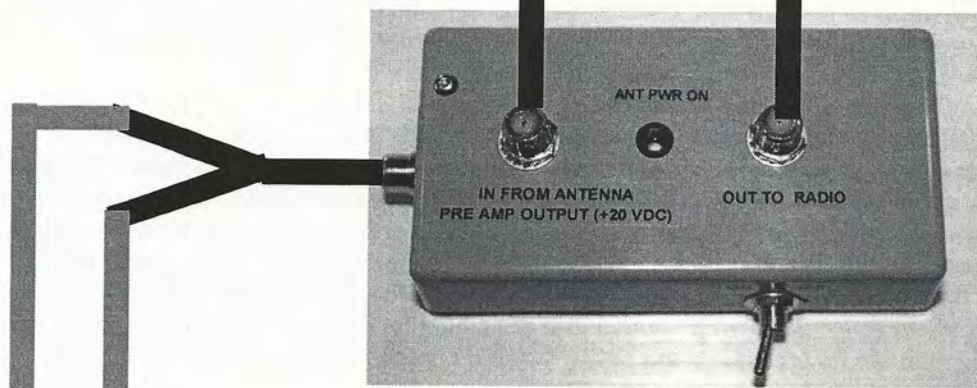

RF PRO-1B Power Inserter

To Key Input on Transmitter Amplifier  
(if you have one)

**Figure 3. KEY Wiring for RF PRO-1B Loop Antenna**

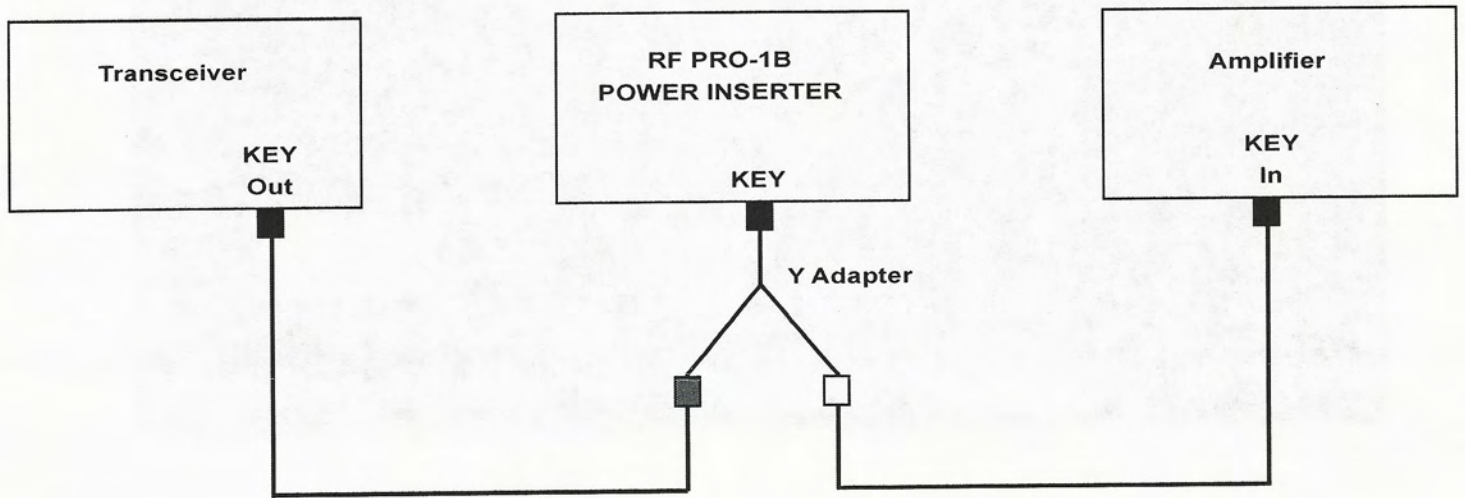
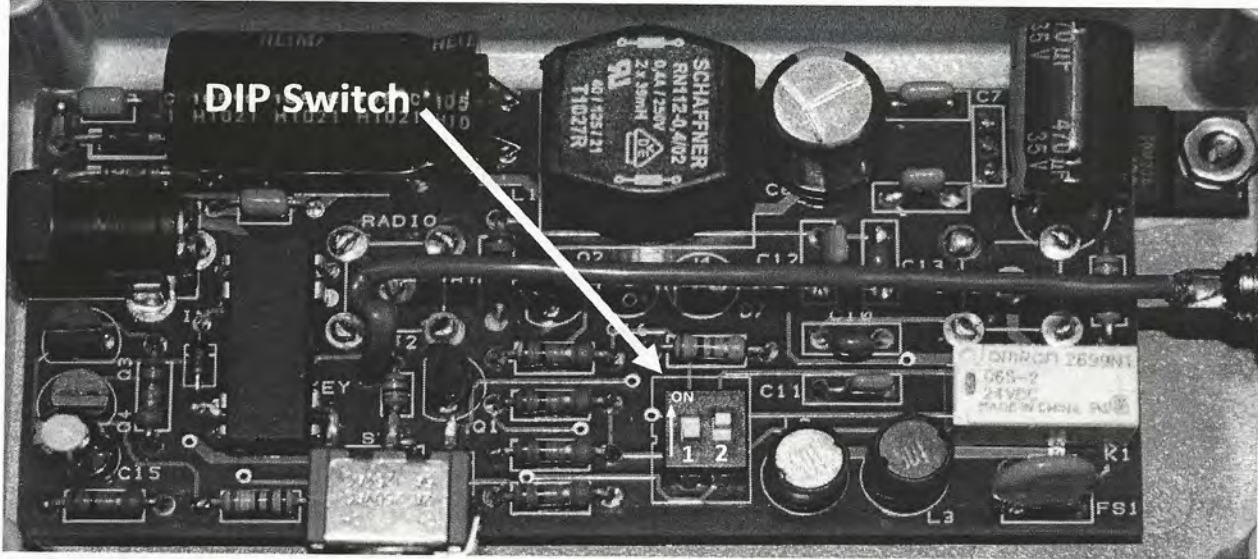

**Figure 4. Power Inserter DIP Switch Settings**

Default Settings →

KEY INPUT	Switch 1	Switch 2	20 VDC ANTENNA POWER
LOW	OFF	ON	OFF
HIGH	OFF	ON	ON
LOW	ON	OFF	ON
HIGH	ON	OFF	OFF

HIGH ≥ 1.2 VDC LOW ≤ 0.7 V DC



**Figure 5. Simplified Relay Interface Schematic**

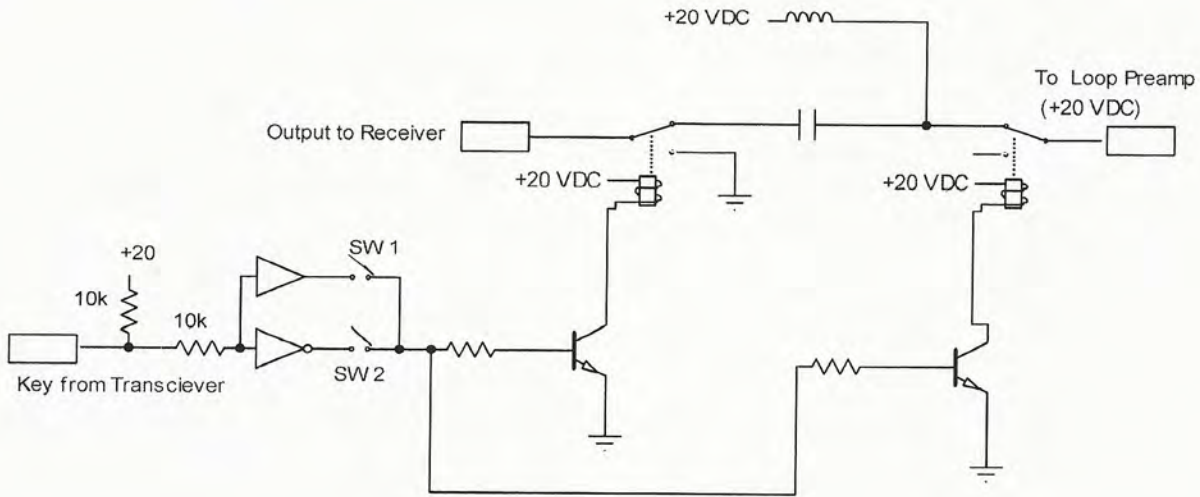

---

## Cable

For best results the cable run from the indoor power inserter to the external amplifier should be quad shielded RG-6 cable with male F connectors on each end.

This cable is available with high-quality compression fit water-proof F-connectors pre-attached that have internal O-rings to keep moisture out.

Pixel part numbers:

**C-50 50 feet**

**C-100 100 feet**

**C-150 150 feet**

**C-200 200 feet**

Standard shield, high quality RG-6 cable can also be used; however the cable's ability to reject external interference is reduced by typically 10 dB.

If the cable run from the power inserter to the antenna's preamplifier is longer than 200 feet, then RG-6 cable that has a solid-core copper center conductor should be used such as Belden 1829AC to minimize DC loss.

## Waterproof F – Connectors & Weather Proofing

The one foot long RG-6 jumper cable included with the accessories (*see Figure 6*) is used to connect the output of the loop to its preamp. This cable uses specially designed F-connectors to eliminate moisture ingress. A package of COAX seal is supplied for additional weatherproofing. Follow the instructions on the side of the package.

## Mounting to a Rotator

*Figure 7* shows the antenna mounted to a rotator. Many users utilize this configuration to take full advantage of the antenna's directional characteristics. Because of the antenna's low weight and wind loading a very low power rotator can be used typical of the type used with TV antennas.

## Mounting the Amplifier

*Figures 8 thru 13* show the details for pole mounting the preamplifier. Nylon shoulder-washers and nylon flat washers are used to electrically isolate the metal case of the preamplifier from the mounting pole. This is required to avoid ground loops. The preamplifier has two small weep holes in its base to drain any condensation that may accumulate internally and should be orientated in the proper vertical direction as indicated by an arrow on its case. (The preamplifier circuit board is conformal coated to protect it from moisture and corrosion). A 1 foot jumper cable is supplied to connect the output of the loop antenna to the input of the preamplifier. The preamplifier's output should be connected to the 20 VDC output of the power inserter via the lead-in RG-6 cable.

---

**Figure 6. One foot RG-6 Jumper Cable with water-proof F-connectors. Connects Loop Antenna Output to Amplifier Input.**



Figure 7. Loop Antenna Mounted on Rotor

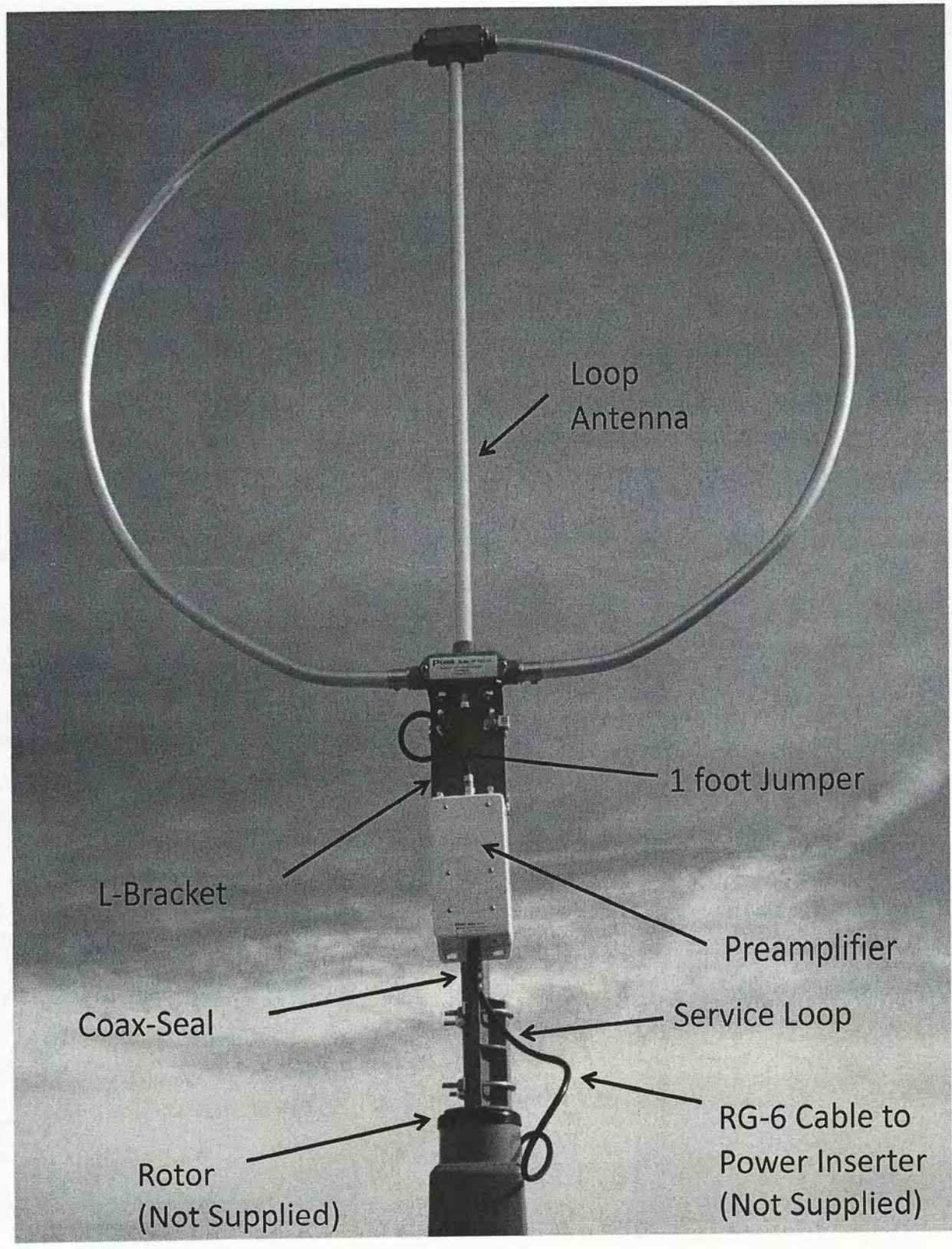

Figure 8. Pole Mounting Details

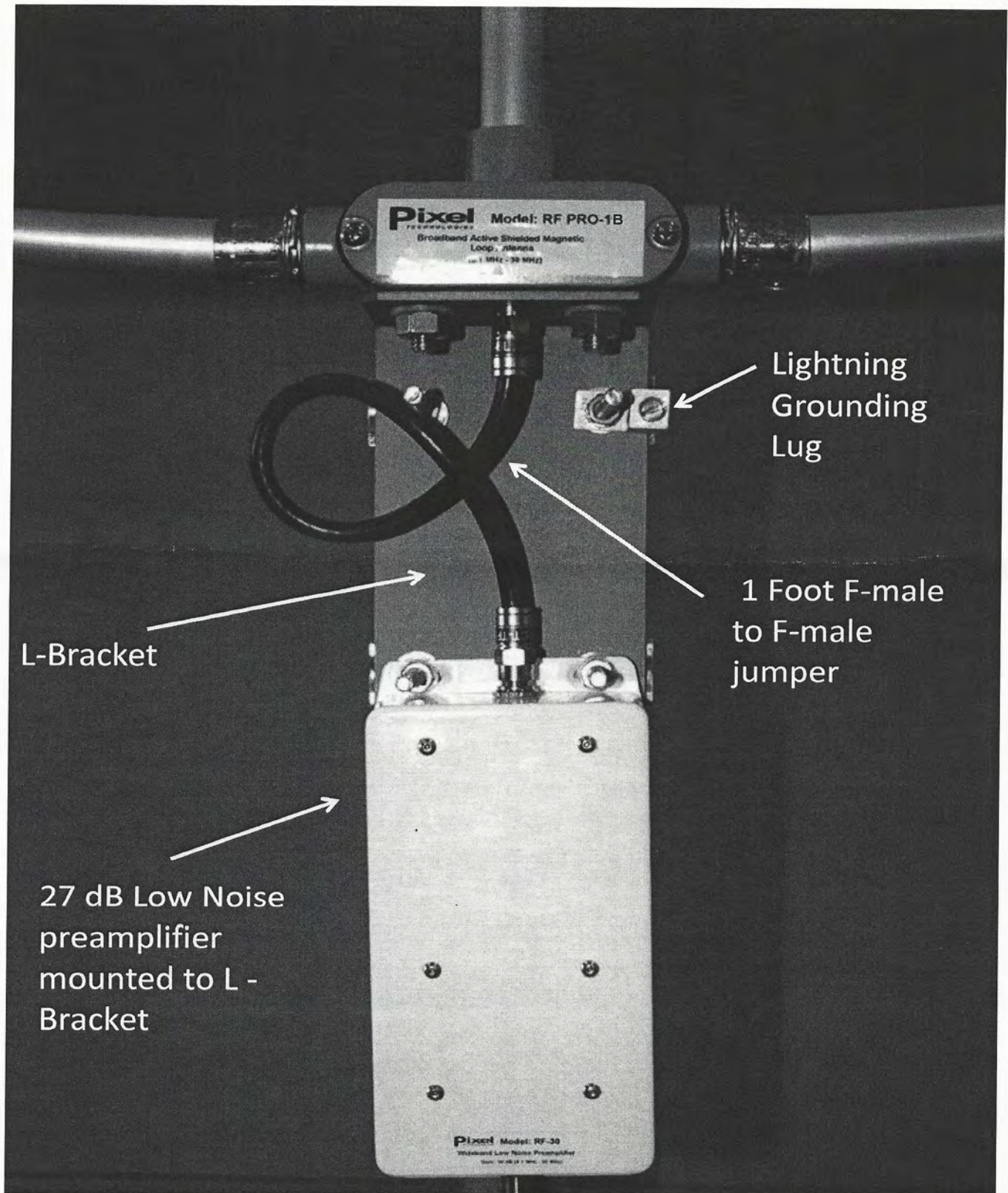

Figure 9. Pole Mounting Details (side view)

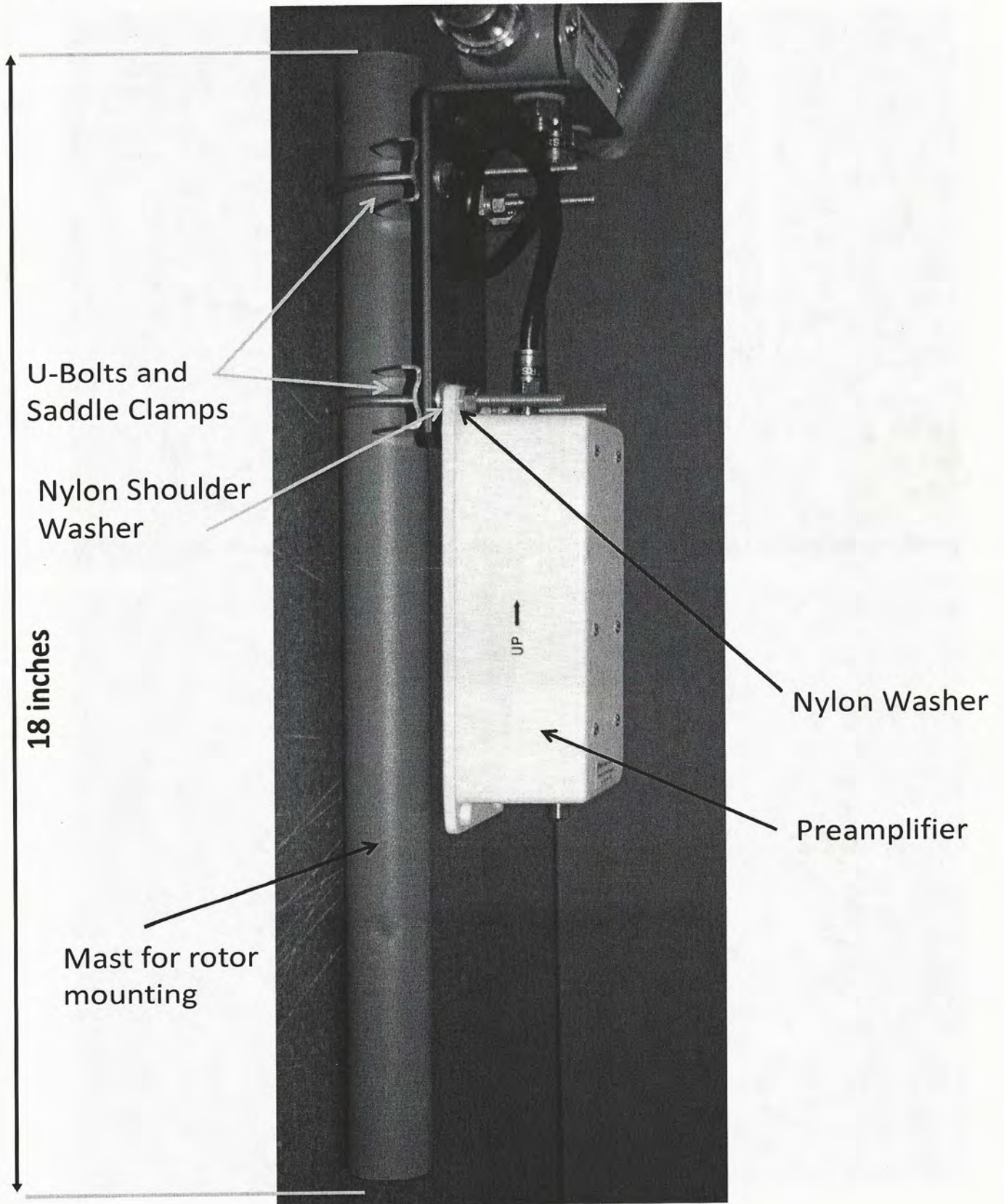
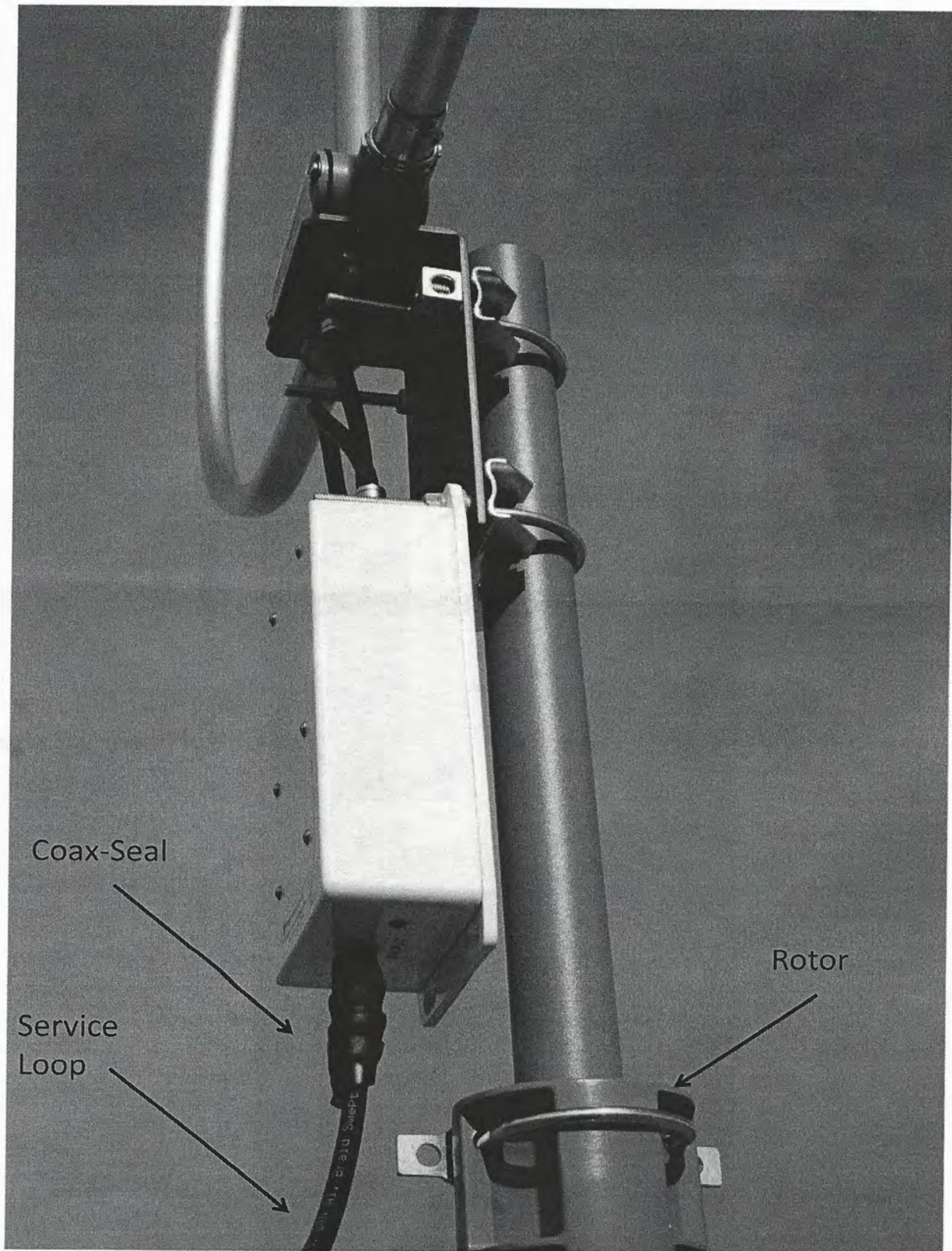

Figure 10. Antenna & Rotor Pole Mounting Details (side view)



---

**Figure 11. Amplifier Mounting Details**

Nylon shoulder washers used to electrically isolate preamplifier from mounting pole

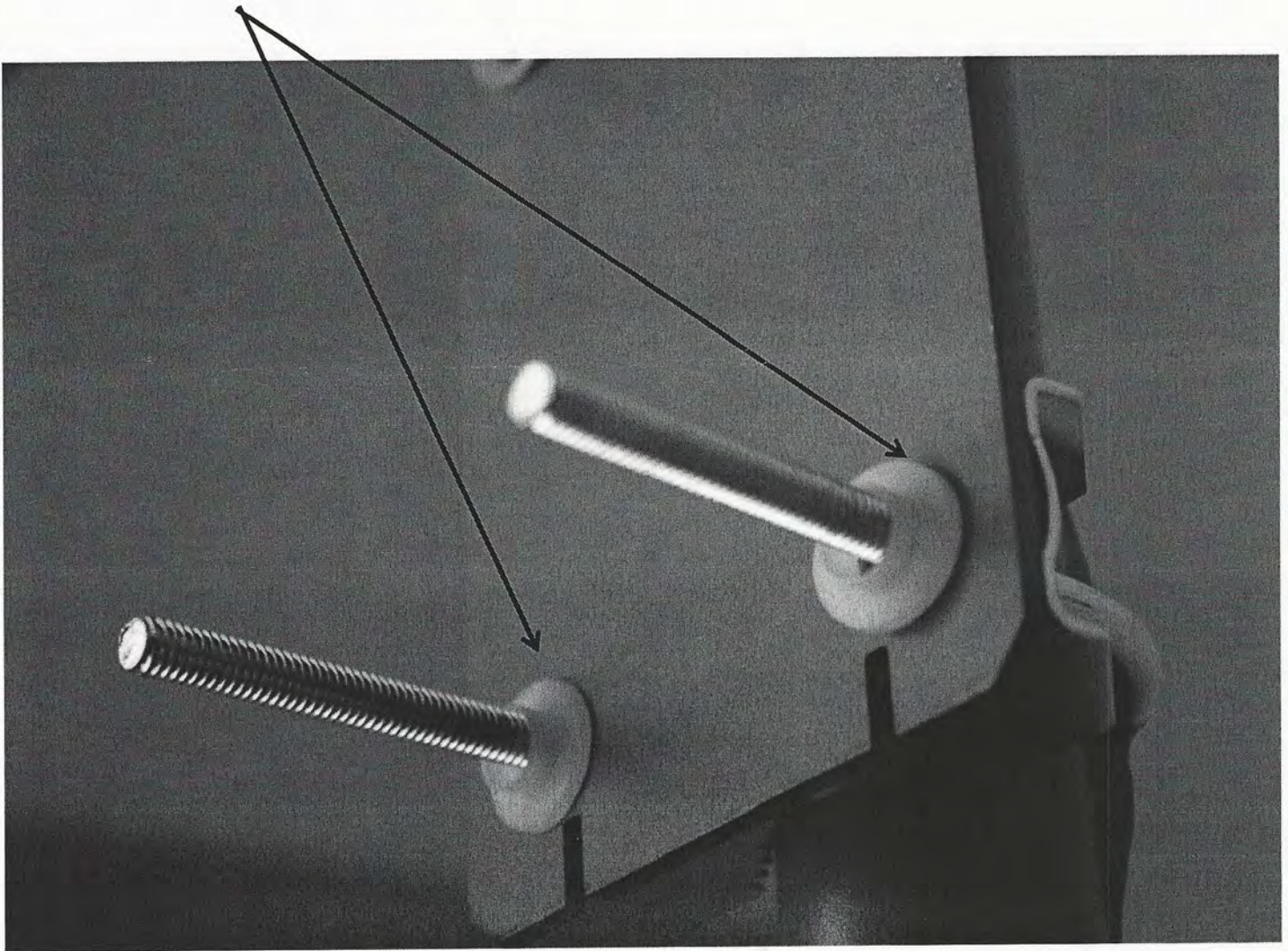

**Figure 12. Preamplifier Mounting Details**

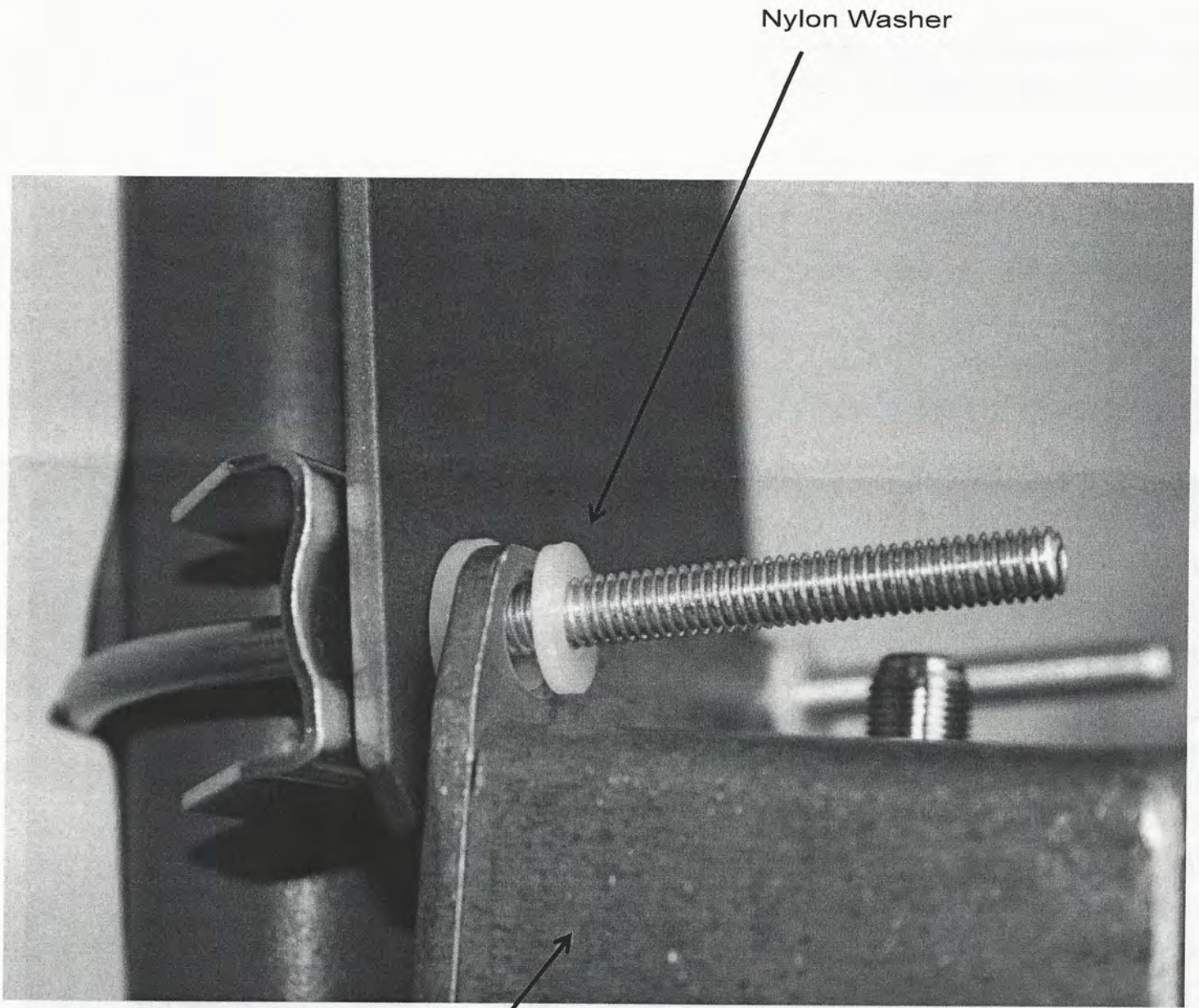

Nylon Washer

Amplifier

---

**Figure 13. Preamplifier Mounting Details**

Lock washer and nut

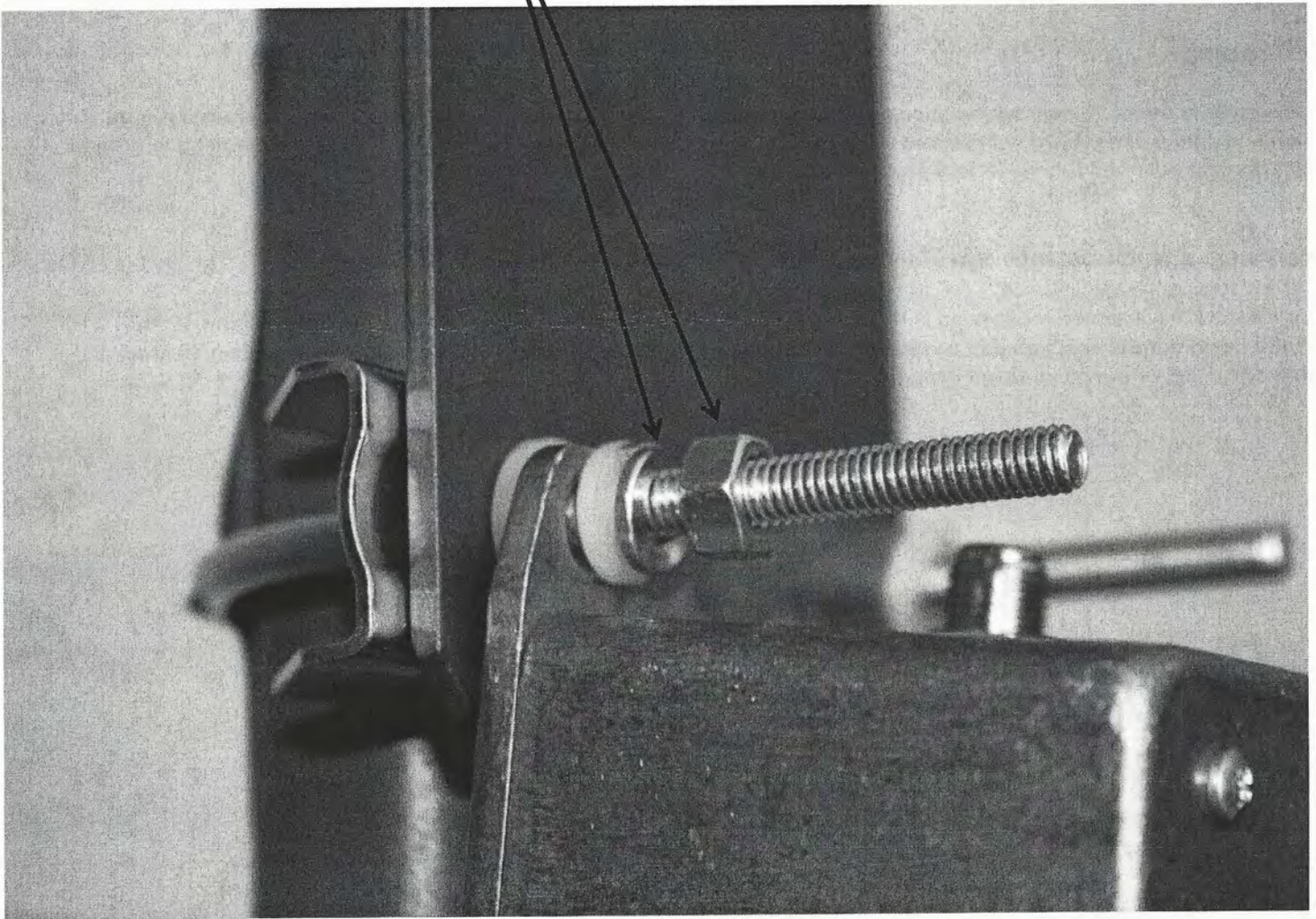

---

## Power Inserter

The power inserter contains a highly filtered linear DC regulator with an internal self resetting fuse that provides protection from short circuits. It is designed for indoor use only. The wall mount transformer provides 24 VAC for the power supply.

## Connection Diagram

Before applying any AC power, connect the antenna to the receiver as shown in *Figure 1*.

Be extremely careful to avoid inadvertently connecting the 20 VDC antenna output of the power inserter to the antenna input on your receiver. Although the power inserter has a self-resetting internal fuse that will trip at a current draw above 400 milliamps, this will put 20 VDC on the input of your receiver momentarily that could damage some receivers.

## Grounding

The loop antenna aluminum tubing should not be grounded. It is electrically isolated from its metal L-bracket mount via nylon shoulder washers. Do not remove these. A grounding lug is provided (*See Figure 14*) that can be used to ground the mounting pole and L-bracket for lightning protection.

## Warranty and Customer Service

This product is warranted for defects in materials and labor for a period of 1 year from the date of shipping. If you require customer service, you can contact us Monday through Friday from 8:00 AM to 4:00 PM (Mountain Time at (303) 526 1965 or e-mail us at [info@PixelSatRadio.com](mailto:info@PixelSatRadio.com)

---

**Figure 11. Grounding Lug Mounting Details**

Grounding Lug for  
Lightning Protection

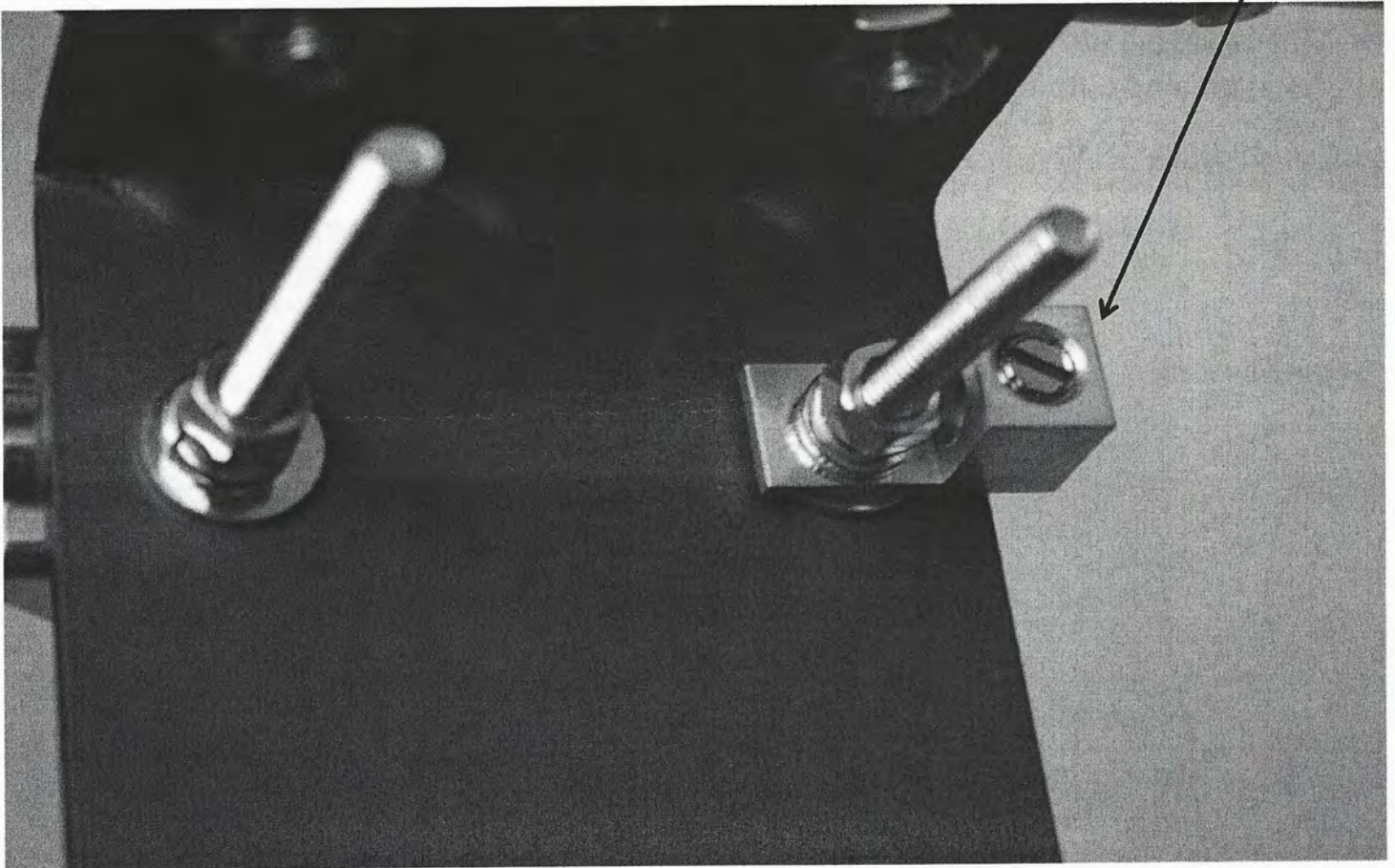

**Figure 15. Power Inserter**

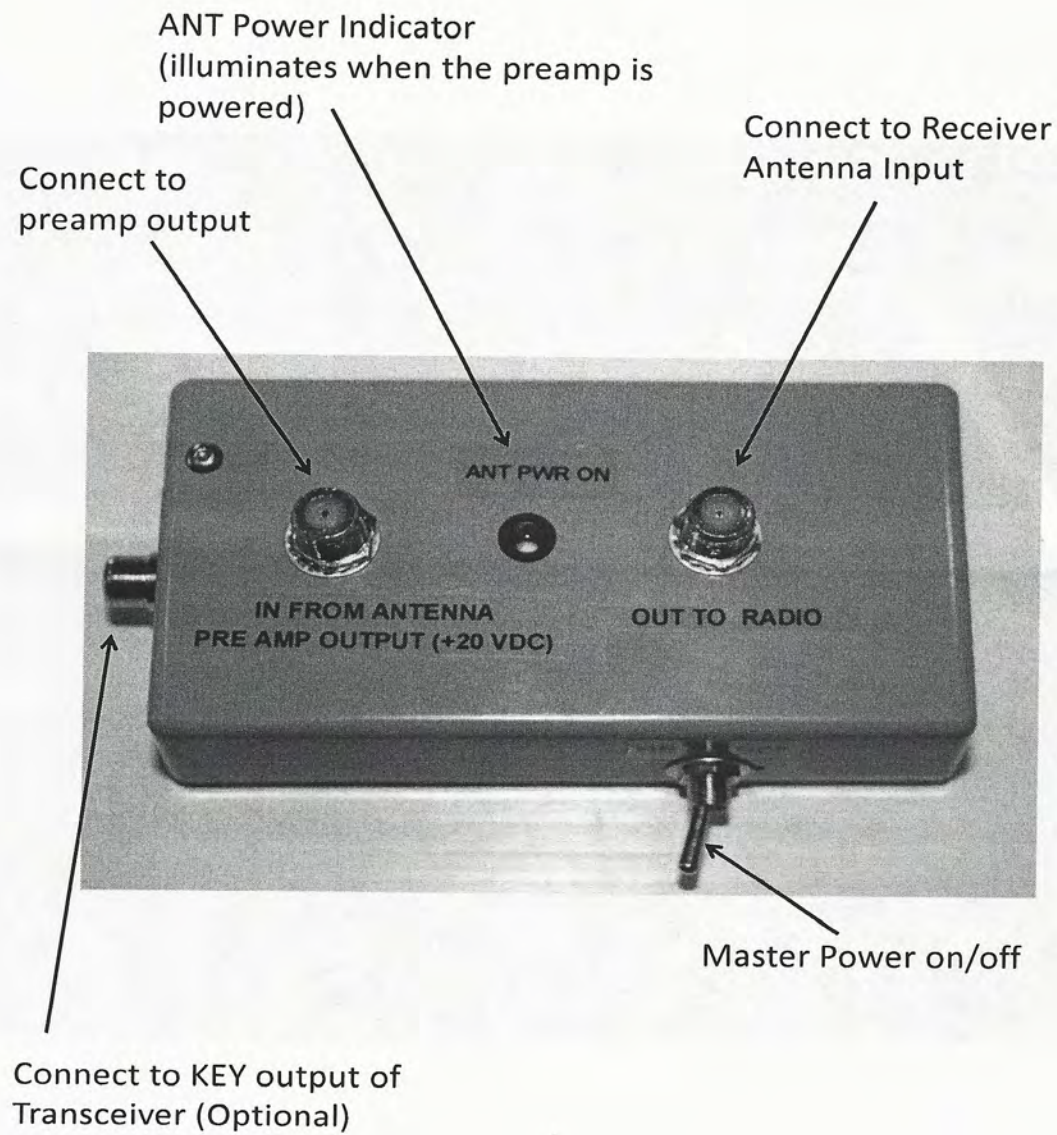

**Figure 16. Supplied Accessories**

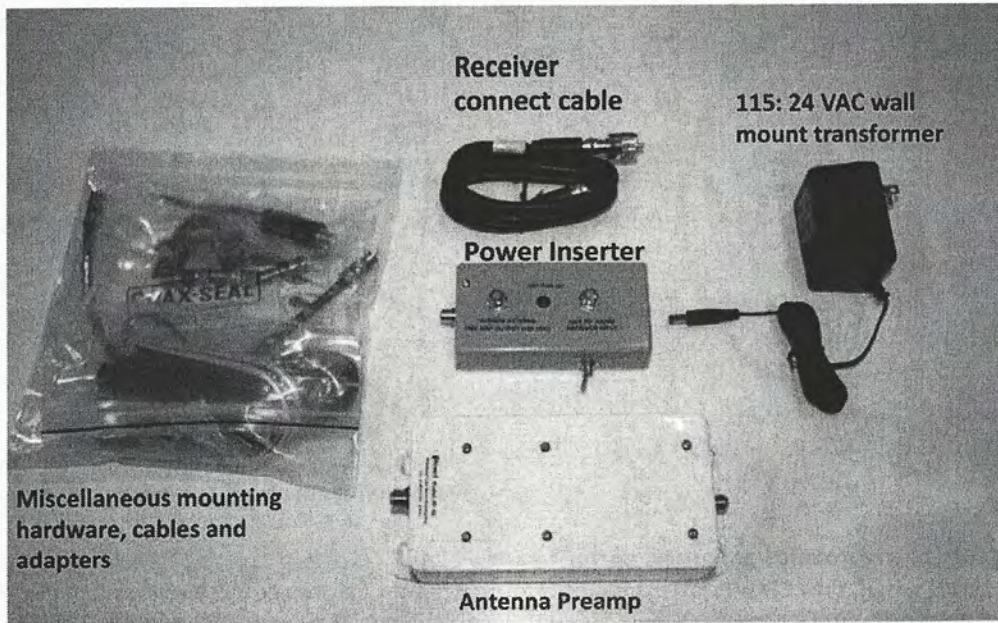

# Magnetic Loop for Improved Reception and Noise Rejection

Model: RF PRO-1B (Receive-Only Antenna)

## Shielded Active Broadband Magnetic Loop Antenna

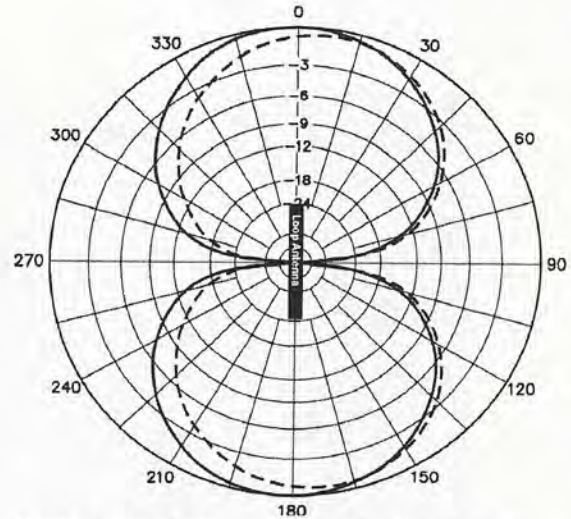

Figure 1. Loop Antenna Pattern (looking down) edge – on from above antenna

- Unique Loop architecture provides enhanced performance
- Very low IMD, 27 dB Low-Noise Clifton Laboratories Norton Preamp insures good performance in both strong and weak signal environments
- Up to 30 dB rejection of locally radiated noise compared to whip antennas
- Figure eight directivity and deep nulls to further reduce interference.
- Useable coverage range: 50 kHz to 30 MHz
- Rejects power line noise
- Rugged construction, easily mounts to a pole or flat vertical surface, 38 inch dia. aluminum loop, supplied with LNA, power inserter and DC power supply
- No manual tuning necessary
- No Home Owners Association problems; low profile, easy to camouflage and works at ground level
- Modular design for easy installation and maintenance
- Internal Transmit / Receive Switch disconnects Antenna / Preamp from receiver when transmitting
- Made in the USA

### NOT YOUR FATHER'S LOOP ANTENNA

Based on the work of Dr Carl Baum for the US Air Force his "Moebius Strip Shielded Magnetic Loop Antenna" architecture outperforms much larger antennas.

Dr Baum was a Senior Scientist at the US Air Force Research Laboratory and is the recipient of several awards from the IEEE (Institute of Electrical and Electronic Engineers) for his work. Originally developed for a classified US Air Force project involving the measurement of EMP (Electro Magnetic Pulse) from nuclear weapons, this design has wide application to antennas for low- noise, interference-free radio reception over a wide frequency range. Pixel has coupled this antenna with a custom made low-noise amplifier developed for Pixel by Clifton Laboratories with very high intermodulation distortion (IMD) specifications (OIP3 = +48 dBm, OIP2 > +100 dBm) that can operate without saturating in high AM and FM broadcast band signal environments.

---

### MAGNETIC LOOP ANTENNA ADVANTAGE

Most active antennas are the whip type and respond mainly to the electrostatic-field portion of an electro-magnetic radio wave. The Magnetic Loop responds primarily to the **magnetic-field** and this ensures high rejection of nearby **electric-fields**. The intensity of the electric field is usually higher than the magnetic-field when an antenna is close to interference sources such as TVs, florescent lamps, power line wiring etc. By rejecting the electric-field there is a reduction in local interference compared to other types of active and passive antennas. Interference reduction is further enhanced by the deep nulls of the antenna's 'Figure-Eight' directivity pattern (see Figure 1) that can be used to null out or reduce interference coming from a specific localized direction.

### INTERMODULATION

Some active antennas generate intermodulation products which can appear as spurious signals interfering with reception. This interference or second and third order intermodulation is caused by non linearity in the amplifier producing signals which are usually the sum and difference of strong AM or FM Broadcast stations and their harmonics. The **RF PRO-1B Loop** has been specifically designed to reduce intermodulation products to a minimum. The third order intercept point is typically **+48 dBm** (OIP3) and the second order intercept point is greater than **+100 dBm** (OIP2 typically 110 dBm). The 1 dB compression point of this amplifier is + 27 dBm making the levels of the intermodulation products generally far below the atmospheric and man-made noise.

### ANTENNA DESIGN

The RF PRO-1B Loop Antenna consists of a rigid light-weight 3/4" diameter anodized aluminum 38 inch diameter loop and a balanced broadband amplifier that is housed in a separate enclosure that can be mounted close to the antenna on its mast or to any nearby flat surface. A 20 volt DC regulated power supply and power inserter unit are provided. The antenna and amplifier have been designed to permit the use of low-cost 75 ohm cable (RG-6 quad-shield recommended, and available separately). For best results the antenna should be positioned approximately 15 feet away from any buildings or other sources of interference.

---

### SUPPLIED COMPONENTS:

QTY	Description
1	Loop antenna
1	27 dB preamplifier
1	L-bracket
2	Saddle clamps
2	U-bolts
1 lot	Mounting Screws and washers
1	CoaxSeal package
1	24 VAC wall mount transformer
1	3 ft F-male to F-male jumper cable
1	1ft F-male to F-male water-proof jumper cable
1	PL-259 Adapter 120 VDC power inserter
1	Twin lead to F-female adapter
1	RCA-plug to RCA-plug cable
1	Grounding Lug
2	Nylon shoulder washers (.375 inch)
2	Nylon washers (.25 inch)
1	RCA Y adapter
1	Instruction Manual

### TECHNICAL INFORMATION

Frequency response: 50 kHz –30 MHz (Nominal Gain: 27 dB ±3 dB)  
DC power: 20 volts at 240 mA  
OIP3: typically +48 dBm  
OIP2: > 100 dBm (typically 110 dBm)  
1dB compression point: +27 dBm  
NF: typically 2 dB (at 10 MHz)  
Antenna Diameter: 38 inches  
Antenna Weight: 3 lbs

The first part of the report deals with the general situation in the country. It is a very interesting and detailed account of the current state of affairs. The author has done a great job of summarizing the key points and providing a clear overview of the situation. The second part of the report is a detailed analysis of the economic situation. It covers a wide range of issues, from inflation to unemployment, and provides a comprehensive overview of the current state of the economy. The author has done a great job of providing a clear and concise summary of the key points, and the report is a very valuable resource for anyone interested in the current state of the country.

The third part of the report is a detailed analysis of the political situation. It covers a wide range of issues, from the current state of the government to the role of the opposition. The author has done a great job of providing a clear and concise summary of the key points, and the report is a very valuable resource for anyone interested in the current state of the country. The fourth part of the report is a detailed analysis of the social situation. It covers a wide range of issues, from the current state of the education system to the role of the media. The author has done a great job of providing a clear and concise summary of the key points, and the report is a very valuable resource for anyone interested in the current state of the country.

The fifth part of the report is a detailed analysis of the environmental situation. It covers a wide range of issues, from the current state of the environment to the role of the government. The author has done a great job of providing a clear and concise summary of the key points, and the report is a very valuable resource for anyone interested in the current state of the country. The sixth part of the report is a detailed analysis of the international situation. It covers a wide range of issues, from the current state of the world to the role of the United States. The author has done a great job of providing a clear and concise summary of the key points, and the report is a very valuable resource for anyone interested in the current state of the world.

Year	Population	GDP	Inflation	Unemployment
1990	100	100	100	100
1991	105	105	105	105
1992	110	110	110	110
1993	115	115	115	115
1994	120	120	120	120
1995	125	125	125	125
1996	130	130	130	130
1997	135	135	135	135
1998	140	140	140	140
1999	145	145	145	145
2000	150	150	150	150
2001	155	155	155	155
2002	160	160	160	160
2003	165	165	165	165
2004	170	170	170	170
2005	175	175	175	175
2006	180	180	180	180
2007	185	185	185	185
2008	190	190	190	190
2009	195	195	195	195
2010	200	200	200	200
2011	205	205	205	205
2012	210	210	210	210
2013	215	215	215	215
2014	220	220	220	220
2015	225	225	225	225
2016	230	230	230	230
2017	235	235	235	235
2018	240	240	240	240
2019	245	245	245	245
2020	250	250	250	250



## Pixel Technologies Warranty & Return Policy

### WARRANTY

Seller warrants for a period of one (1) year from delivery unless a different period is stated on the face of the invoice that all goods and their components are free from defects in workmanship, material, and design.

Seller warrants that all goods are of merchantable quality and are fit and suitable for the purposes advertised. Seller warrants that all raw materials used in the Product are new materials.

For customers in the continental US Seller agrees to repair the goods or to replace any necessary parts at no charge to the Buyer during the warranty period all at Seller's expense. All repairs or replacement parts shall be warranted for the greater of twelve (12) months or the end of the original warranty period.

The warranty applies only to the Products that can be identified by the original, unaltered Pixel Technologies trademark, trade name or logo affixed to them. Pixel Technologies does not warrant any product that is not manufactured by, for, or without permission from Pixel Technologies.

This warranty does not cover any of the following conditions:

- Abuse, unreasonable use, mistreatment, or neglect
- Unusual physical or electrical stress, power fluctuations and lightning damage
- Damage caused by the equipment or system with which the Product is used
- Damage caused by modification or repair not made or authorized by Pixel Technologies

In no case shall Pixel Technologies be liable for any incidental damage to equipment that the Product is connected to or used with.

This warranty shall be null and void if the Buyer fails to follow the written instructions included with the Product.

### Warranty Repair or Replacement

At the sole discretion of Pixel Technologies we will repair or replace any defective Product or part(s) at our expense.

To receive warranty repair or replacement parts contact:

Pixel Technologies  
13200 W 43rd Drive.  
Unit 201  
Golden Co. 80403  
303.526.1965

E-mail  
info@pixelsatradio.com

Please have Model Number, purchase date, and where purchased available when contacting Pixel Technologies.

For Customers in the continental US replacement parts or items will be shipped to customer via FedEx ground service. If customer requests replacement parts overnight or 2 day they will be billed the difference in shipping cost.

Defective parts must be returned to Pixel Technologies within 30 days of receipt of replacement parts using the procedure outlined below or Pixel Technologies will bill the customer the retail cost of the replacement parts sent including all shipping costs.

To return defective / replacement parts to Pixel Technologies;

Included in your replacement part(s) box there will be a Return label to Pixel Technologies. Reuse the original packaging that you received your replacement parts in. Affix return label to box and call FedEx for a pick up or drop off at any FedEx office or FedEx drop-off location. They can be found at;

[www.fedex.com](http://www.fedex.com) and select the orange "Locations" tab to find the closest drop-off location.

**Call 1.800.Go.FedEx, (800) 463-3339 to arrange a pickup or find the closest drop-off location**





**OUTDOOR INSTALLATION WARNING**  
**IMPORTANT SAFETY PRECAUTIONS**

**LIVES MAY BE AT RISK!** Carefully observe these instructions and any special instructions that are included with the equipment you are installing.

**IMPORTANT:** Look over the site before beginning and installation, and anticipate possible hazards, especially the following:

**CONTACTING POWER LINES CAN BE LETHAL.** Make sure no power lines are anywhere where possible contact can be made. Antennas, masts, towers, guy wires or cables may lean or fall and contact these lines. People may be injured or killed if they are touching or holding any part of equipment when it contacts electric lines. Make sure there is NO possibility that equipment or personnel can come into contact directly or indirectly with power lines

**ASSUME THAT ALL OVERHEAD LINES ARE POWER LINES.**

The horizontal distance from a tower, mast or antenna to the nearest power line should be at least twice the total length of the mast/antenna combination. This will ensure that the mast will not contact power if it falls either during installation or later

**TO AVOID FALLING, USE SAFE PROCEDURES WHEN WORKING AT HEIGHTS ABOVE GROUND.**

- Select equipment locations that will allow safe, simple equipment installation.
- Don't work alone. A friend or co-worker can save your life if an accident happens.
- Use approved non-conducting ladders and other safety equipment. Make sure all equipment is in good repair.
- If a tower or mast begins falling, don't attempt to catch it. Stand back and let it fall.
- If anything, such as a wire or mast does come into contact with a power line, **DON'T TOUCH IT OR ATTEMPT TO MOVE IT.** Instead, save your life by calling the power company.
- Don't attempt to erect antennas or towers on a windy day.

**MAKE SURE ALL TOWERS AND MASTS ARE SECURELY GROUNDED, AND ELECTRICAL CABLES CONNECTED TO ANTENNAS HAVE LIGHTNING ARRESTORS.** This will help prevent fire damage or human injury in case of lightning, static build up, or short circuit within equipment connected to the antenna.

- The base of the mast or tower must be connected directly to the building protective ground or to one or more approved grounding rods, using 10 AWG ground wire and corrosion-resistant connectors.
- Refer to the National Electrical Code ANS/NFPA 70, for information with regard to proper grounding of the mast and supporting structure, grounding of the lead-in wire to an antenna discharge unit, size of grounding conductors, location of antenna-discharge unit, connection to grounding electrodes, and requirements for the grounding electrode.
- See opposite for Ground Lug installation instructions.

**IF A PERSON COMES INTO CONTACT WITH ELECTRICAL POWER AND CANNOT MOVE:**

**DO NOT TOUCH THAT PERSON OR YOU MAY BE ELECTROCUTED.**

- Use a non-conductive dry board, stick or rope to push or drag them so they are no longer in contact with electrical power.
- Once they are no longer contacting electrical power, administer CPR if you are certified, and make sure that emergency medical aid has been requested.

Ground Lug Installation for Pixel and QuadraBoost Antennas

AM /FM Antenna Mount



Install Ground Lug Here

Satellite Radio Antenna Mount



Install Ground Lug Here

**IMPORTANT:** Install lock washer under lug to make good electrical connection between mount and lug



Ground lug and Lock Washer

QuadraBoost



Ground Lug

