



# ProPak6™

## Installation & Operation

### User Manual

---

# ProPak6 Installation and Operation User Manual

Publication Number: OM-20000148  
Revision Level: Rev 5  
Revision Date: July 2017

To download the latest firmware and/or software visit: [www.novatel.com/support/firmware-downloads](http://www.novatel.com/support/firmware-downloads)

This manual reflects firmware version 6.606 / OEM060606RN000

## Warranty

NovAtel® Inc. warrants that its GNSS products are free from defects in materials and workmanship, subject to the conditions set forth on our web site: [www.novatel.com/products/warranty/](http://www.novatel.com/products/warranty/).

ProPak6	One (1) Year
GPS Antenna Series	One (1) Year
Cables and Accessories	Ninety (90) Days
Software Warranty	One (1) Year

## Return Instructions

To return products, refer to the instructions found under the Return Policy Tab on the warranty page: [www.novatel.com/products/warranty/](http://www.novatel.com/products/warranty/).

## Proprietary Notice

Information in this document is subject to change without notice and does not represent a commitment on the part of NovAtel Inc. The software described in this document is furnished under a licence agreement or non-disclosure agreement. The software may be used or copied only in accordance with the terms of the agreement. It is against the law to copy the software on any medium except as specifically allowed in the license or non-disclosure agreement.

The information contained within this manual is believed to be true and correct at the time of publication.

STEADYLINE, ALIGN, OEM6, NovAtel and SPAN are registered trademarks of NovAtel Inc.

NovAtel Connect, ProPak6 and GLIDE are trademarks of NovAtel Inc.

All other brand names are trademarks of their respective holders.

Manufactured and protected under U.S. patents.

#5,101,416	#6,184,822 B1
#5,390,207	#6,243,409 B1
#5,414,729	#6,445,354 B1
#5,495,499	#6,608,998 B1
#5,736,961	#6,664,923 B1
#5,809,064	#7,738,536

© Copyright 2016 NovAtel Inc. All rights reserved.

Unpublished rights reserved under International copyright laws.

# Table of Contents

<b>Notices</b>	<b>8</b>
<b>Customer Support</b>	<b>15</b>
<b>1 Introduction</b>	<b>16</b>
1.1 Introduction .....	16
1.2 System Components.....	16
1.3 Models and Features .....	16
1.4 Overview—ProPak6 Hardware .....	17
<b>2 Installation</b>	<b>21</b>
2.1 Additional Equipment Required .....	21
2.2 ProPak6 Hardware.....	22
2.2.1 ProPak6 Cables.....	22
2.2.2 Selecting a GNSS Antenna .....	22
2.2.3 Choosing a Coaxial Cable .....	22
2.3 Communication with the ProPak6.....	23
2.3.1 Power Supply Requirements .....	23
2.3.2 COM1 and COM2 Peripheral Power .....	23
2.4 Standard Configuration Installation.....	24
2.5 Dual Antenna Configuration and Installation.....	26
2.6 Cellular Antenna Installation .....	28
2.6.1 Mounting the GNSS Antenna .....	30
2.7 ProPak6 Alternative Power Source.....	30
2.7.1 Battery Backup .....	31
2.7.2 Connect the Additional Communication Ports on a ProPak6 .....	32
2.7.3 Connect the CAN Bus .....	33
2.7.4 Mounting the ProPak6.....	33
2.8 Installing NovAtel Connect PC Utilities .....	33
2.9 ProPak6 Security .....	34
2.9.1 Administration Password .....	34
2.9.2 FTP Server and ICOM Ports .....	34
2.10 Next Steps .....	34
<b>3 Operation</b>	<b>35</b>
3.1 Communications with the Receiver.....	35
3.1.1 Communicating Using a Remote Terminal.....	35
3.1.2 Communicating Using a Computer.....	35
3.1.3 Status Indicators.....	35
3.1.4 COM Ports LEDs .....	36
3.1.5 Bluetooth LED .....	37
3.1.6 Wi-Fi LED .....	37
3.1.7 INS and ALIGN LEDs.....	37
3.1.8 Satellite Tracking and Positioning LEDs.....	38
3.1.9 Cell Port and LED.....	40
3.1.10 Universal Serial Bus (USB) Port and LEDs .....	40
3.1.11 Ethernet Port .....	41
3.1.12 ICOM Ports.....	42
3.1.13 Serial Ports.....	42
3.1.14 I/O Port .....	43
3.1.15 Expansion Port .....	43
3.1.16 Antenna LNA Port.....	44
3.1.17 External Oscillator Port (model dependent).....	44

3.2 Getting Started .....	44
3.2.1 Applying Power to the Receiver .....	44
3.3 Establishing a Receiver COM Connection .....	45
3.3.1 Communicating with the Receiver Using NovAtel Connect .....	46
3.4 Transmitting and Receiving Corrections .....	47
3.4.1 Defining Antenna and Base Antenna .....	48
3.4.2 Base Station Configuration .....	48
3.4.3 Rover Station Configuration .....	50
3.5 External ALIGN Master or Rover Configuration Only .....	50
3.5.1 PDP and GLIDE™ Configurations .....	51
3.6 STEADYLINE® .....	51
3.6.1 Maintain .....	52
3.6.2 Transition .....	52
3.6.3 Prefer Accuracy .....	53
3.6.4 UAL .....	53
3.6.5 Configuration Notes .....	55
3.6.6 Enabling SBAS Positioning .....	55
3.6.7 Enabling L-Band .....	56
3.7 Logging and Retrieving Data Overview .....	58
3.7.1 Onboard Data Storage .....	59
3.7.2 Reading Data and Post-Processing .....	61
3.7.3 Pass-Through Logging .....	62
3.8 ProPak6 Web User Interface (UI) .....	62
3.8.1 Setup Up Network IP .....	62
3.8.2 Device Menu .....	65
3.8.3 Dashboard .....	66
3.8.4 Terminal .....	71
<b>4 Ethernet Configuration .....</b>	<b>74</b>
4.1 Required Hardware .....	74
4.2 Static IP Address Configuration .....	74
4.2.1 Static IP Address Configuration—Receiver .....	75
4.2.2 Static IP Address Configuration—Windows XP with SP3 .....	76
4.2.3 Static IP Address Configuration—Windows 7 .....	76
4.2.4 Confirming Ethernet Setup .....	77
4.3 Dynamic IP Address Configuration .....	78
4.4 Base/Rover Configuration through Ethernet Connectivity .....	79
<b>5 Radio Configuration and Activation .....</b>	<b>82</b>
5.1 Bluetooth® Configuration .....	82
5.1.1 Enable Bluetooth on the ProPak6 Receiver .....	82
5.2 Wi-Fi Network Configuration .....	84
5.2.1 Configure Wi-Fi as the Network Default .....	84
5.2.2 Wi-Fi AP Configuration .....	85
5.2.3 Wi-Fi Client Configuration .....	87
5.2.4 Wi-Fi Scanning .....	88
5.3 Cellular Activation GSM/GPRS/HSDPA .....	90
5.3.1 Configure Cellular as the Network Default .....	90
5.3.2 Cellular Network Activation and Configuration .....	90
5.3.3 Eject a SIM Card .....	92
5.4 Airplane Mode .....	92
<b>6 NTRIP Configuration .....</b>	<b>93</b>
<b>7 NovAtel Firmware and Software .....</b>	<b>95</b>
7.1 Firmware Updates and Model Upgrades .....	95

7.1.1 Firmware Updates .....	95
7.1.2 Model Upgrades .....	96
7.2 Authorization Code .....	96
7.3 Updating or Upgrading Using the WinLoad Utility.....	97
7.3.1 Transferring Firmware Files.....	97
7.3.2 Using the WinLoad Utility .....	98
7.4 Updating Using SoftLoad Commands.....	99
7.4.1 SoftLoad Commands and Logs.....	99
7.4.2 Working With S-Records .....	100
7.4.3 Sending Firmware Data.....	101
7.4.4 SoftLoad Update Method.....	102
7.4.5 Firmware Update Using FTP or USB Mass Storage Device .....	104
7.4.6 SoftLoad Direct Commands and Logs.....	104
7.4.7 SoftLoad Direct Update Method .....	104
7.4.8 SoftLoad Errors .....	105
7.5 Upgrading Using the AUTH Command.....	105
7.5.1 Upgrade Procedure .....	105
<b>8 Built-In Status Tests</b> .....	<b>106</b>
8.1 Overview .....	106
8.2 Receiver Status Word .....	106
8.3 Error Strobe Signal .....	107
8.4 RXSTATUSEVENT Log.....	107
8.5 RXSTATUS Log.....	107
8.5.1 Overview.....	107
8.5.2 Error Word .....	108
8.5.3 Status Code Arrays .....	108
8.5.4 Receiver Status Code.....	109
8.5.5 Auxiliary Status Codes .....	109
8.5.6 Set and Clear Mask for all Status Code Arrays .....	109
<b>A Technical Specifications</b> .....	<b>110</b>
A.1 OEM638 Receiver Card Performance for ProPak6 .....	110
A.2 ProPak6 Specifications .....	111
A.3 Dimension Drawings .....	113
A.4 OEM615 Receiver Card Performance for ProPak6 ( <b>model dependent</b> ) .....	118
A.5 Cables .....	119
<b>B Replacement Parts</b> .....	<b>125</b>
B.1 ProPak6 .....	125
B.2 Accessories .....	125
B.3 Manufacturer's Part Number .....	126
<b>C Frequently Asked Questions</b> .....	<b>127</b>

# Figures

1	Primary and Secondary Lightning Protection .....	13
2	ProPak6—Back Connectors .....	17
3	ProPak6—Front Communication Ports, Buttons and Connectors .....	18
4	Typical Standard Installation with External Oscillator .....	24
5	Antenna and External Oscillator Ports .....	25
6	Power Port .....	25
7	Ethernet, COM or USB Device Ports .....	25
8	Expansion and I/O Ports .....	26
9	Typical Dual Antenna Installation .....	27
10	GNSS Antenna Ports .....	27
11	Cellular Network Setup .....	28
12	Additional COM ports on the ProPak6 .....	32
13	CAN Bus ports on the ProPak6 .....	33
14	Power Button .....	44
15	Basic Differential Setup .....	47
16	Positioning Change Without STEADYLINE .....	51
17	STEADYLINE Maintain .....	52
18	STEADYLINE Transition .....	52
19	STEADYLINE Prefer Accuracy .....	53
20	STEADYLINE UAL- Warning Limit Example .....	54
21	STEADYLINE UAL - Out of Bounds Example .....	54
22	Product Information (Info) .....	64
23	Status Display Top Panel .....	64
24	Cross-Over Ethernet Cable Configuration—ProPak6 .....	75
25	ProPak6 Ethernet Hardware Setup .....	78
26	Base/Rover Ethernet Setup—ProPak6 .....	80
27	Wi-Fi Configuration Overview .....	84
28	SIM Card Installation .....	91
29	NTRIP System .....	93
30	WinLoad's Open Window .....	98
31	Open File in WinLoad .....	98
32	COM Port Setup .....	98
33	Searching for Card .....	99
34	Authorization Code Window .....	99
35	Upgrade Process Complete .....	99
36	Location of Receiver Status Word .....	107
37	Reading the Bits in the Receiver Status Word .....	107
38	Location of Receiver Error Word .....	108
39	Reading the Bits in the Receiver Error Word .....	108
40	ProPak6 Dimensions .....	113
41	Bluetooth/Wi-Fi Antenna Keep-out Area and Antenna Location .....	114

# Tables

1	ProPak6 Model Features.....	16
2	ProPak6 - Back Connector Definitions .....	17
3	ProPak6 - Front Label Definitions.....	19
4	ProPak6 Cables.....	22
5	Enclosure Power Requirements .....	30
6	Fuse/Holder Recommendations .....	31
7	INS LED States .....	37
8	ALN (ALIGN) LED States .....	38
9	Satellite Tracking LEDs States (GPS and/or GNSS).....	38
10	Satellite Position LEDs States .....	39
11	CELL LED States .....	40
12	Data Communication Port Defaults .....	42
13	Status Drop Menu Examples.....	65
14	COM1 and COM2 Port Pin-Out Descriptions .....	115
15	COM3/IMU Port Pin-Out Description .....	115
16	I/O Port Pin-Out Descriptions .....	116
17	Expansion Port Pin-Out Description .....	116
18	ProPak6 Strobe Electrical Specifications .....	117
19	Wiring Table: .....	120
20	I/O Cable Wiring (01018519).....	122
21	Twisted Pair I/O Cable Wiring Table (01019148).....	122
22	ProPak6 Expansion Cable Pin-Out Descriptions.....	123
23	P2 Connector Pin-Out Descriptions.....	124

# Notices

The following notices apply to the ProPak6 device.



Changes or modifications to this equipment, not expressly approved by NovAtel Inc., could void the user's authority to operate this equipment.

## FCC

This device complies with part 15 of the FCC Rules. Operation is subject to the following two conditions: (1) this device may not cause harmful interference, and (2) this device must accept any interference received, including interference that may cause undesired operation.

ProPak6 has been tested and found to comply with the radiated and conducted emission limits for a Class B digital device. The Class B limits are designed to provide reasonable protection against harmful interference in a residential installation.

The equipment listed generates, uses and can radiate radio frequency energy and, if not installed and used in accordance with the instructions, may cause harmful interference to radio communications. However, there is no guarantee that interference will not occur in a particular installation. If this equipment does cause harmful interference to radio or television reception, which can be determined by turning the equipment off and on, the user is encouraged to try to correct the interference by one or more of the following measures:

- Re-orient or relocate the ProPak6
- Increase the separation between the equipment and the ProPak6
- Connect the equipment to an outlet on a circuit different from that to which the ProPak6 is connected
- Consult the dealer or an experienced radio/TV technician for help



To maintain compliance with the limits of a Class B digital device, you must use properly shielded interface cables (such as Belden #9539 or equivalent) when using the serial data ports, and double-shielded cables (such as Belden #9945 or equivalent) when using the I/O strobe port.

## Innovation, Science and Economic Development (ISED) Canada

ProPak6 Class B digital device complies with Canadian ICES-003.

ProPak6 appareil numérique de la classe B est conforme à la norme NMB-003 du Canada.

This device complies with ISED license-exempt RSS-GEN and RSS-210. Operation is subject to the following two conditions: (1) this device may not cause interference and (2) this device must accept any interference, including interference that may cause undesired operation of the device.



### **Bluetooth®**

The ProPak6 contains *Bluetooth* wireless technology (*Bluetooth 2.1 SPP - Serial Port Profile*).

The *Bluetooth* word mark and logos are registered trademarks owned by Bluetooth SIG, Inc. and any use of such marks by NovAtel Inc., is under license. Other trademarks and trade names are those of their respective owners.

Propak6 contains a Bluetooth radio with the following modular approvals:

- FCC ID: TFB-TIWI1-01
- IC: 5969A-TIWI101

### **Wi-Fi**

The ProPak6 contains Wi-Fi wireless technology (802.11b/g/n). See the caution in *Cell Port and LED* on page 40 and the Wi-Fi antenna keep-out information in *Figure 41, Bluetooth/Wi-Fi Antenna Keep-out Area and Antenna Location* on page 114.

Propak6 contains a Wi-Fi radio with the following modular approvals:

- FCC ID: TFB-TIWI1-01
- IC: 5969A-TIWI101

### **Cellular**

Some Propak6 models contain cellular radio technology.

Propak6 contains a cellular radio with the following modular approvals:

- FCC ID: RI7HE910
- IC: 5131A-HE910



#### **FCC Radiation Exposure Statement**

The radiated output power of this device is below the FCC radio frequency exposure limits. Nevertheless, this device should be used in such a manner that the potential for human contact during normal operation is minimized.

This device has been evaluated for and shown compliant with the FCC RF Exposure limits under mobile exposure conditions. At least 20cm of separation distance between the ProPak6 device (and from its cellular antenna) to the user's body must be maintained at all times.



To comply with FCC and Industry Canada regulations limiting both maximum RF output power and human exposure to RF radiation, the maximum system gain (antenna gain minus system loss) must not exceed 1.4 dBi in the U.S. Cellular band and 3.0 dBi in the PCS band for the GSM/GPRS/HSDPA variant. System loss is the total of external cable and connector losses and ProPak6 internal losses. For reference and system gain calculation purposes, the ProPak6 has internal losses of 0.6 dB for the 800 MHz Cellular band and 1.8 dB for the 1900 MHz PCS band.

---

## European Union (EU)

### **ProPak6 BT/Wi-Fi**

NovAtel Inc. declares that the ProPak6 BT/Wi-Fi transceiver is in compliance with Directive 2014/53/EU (Radio Equipment).

The full text of the EU Declaration of Conformity may be obtained from the NovAtel web site at:  
[www.novatel.com/products/compliance/eu-declaration-of-conformity](http://www.novatel.com/products/compliance/eu-declaration-of-conformity)

#### **Radio Information**

Description of Service: Wi-Fi (802.11b/g/n)  
Operational Frequency: 2400 MHz to 2480 MHz  
Modulation: OFDM  
Rated Power: 18.6 dBm e.i.r.p

Description of Service: Bluetooth  
Operational Frequency: 2400 MHz to 2480 MHz  
Modulation: GFSK  
Rated Power: 13.9 dBm e.i.r.p

### **ProPak6 BT/Wi-Fi/Cellular**

NovAtel Inc. declares that the ProPak6 BT/Wi-Fi/Cellular transceiver is in compliance with Directive 2014/53/EU (Radio Equipment).

The full text of the EU Declaration of Conformity may be obtained from the NovAtel web site at:  
[www.novatel.com/products/compliance/eu-declaration-of-conformity](http://www.novatel.com/products/compliance/eu-declaration-of-conformity)

#### **Radio Information**

Description of Service: UMTS 900 MHz Band VIII  
Transmit Frequency: 880 MHz to 915 MHz  
Receive Frequency: 925 MHz to 960 MHz  
Modulation: QPSK, 16 QAM  
Power Class: Class 3  
Rated Power: 24 dBm, conducted

Description of Service: UMTS 2100 MHz Band I  
Transmit Frequency: 1920 MHz to 1980 MHz  
Receive Frequency: 2110 MHz to 2170 MHz  
Modulation: QPSK, 16 QAM  
Power Class: Class 3  
Rated Power: 24 dBm, conducted

## Instructions for Safe Operation of Equipment



The ProPak6 is capable of operation at ambient temperatures up to 65°C. In such cases the metallic surface temperature of the ProPak6 may exceed 70°C. Therefore, under these conditions the equipment needs to be installed in a RESTRICTED ACCESS LOCATION.

If the ProPak6 is operating in a lower temperature environment where the ambient temperature is less than 60°C, installation in a RESTRICTED ACCESS LOCATION is not required.

### Ethernet Port



The Ethernet ports are safety extra-low voltage (SELV) circuits only and are suitable for connection within a building only. Do not connect them to telephone-network voltage (TNV) circuits.

### WEEE Notice

If you purchased your ProPak6 product in Europe, please return it to your dealer or supplier at the end of its life. The objectives of the European Community's environment policy are, in particular, to preserve, protect and improve the quality of the environment, protect human health and utilise natural resources prudently and rationally. Sustainable development advocates the reduction of wasteful consumption of natural resources and the prevention of pollution. Waste electrical and electronic equipment (WEEE) is a regulated area. Where the generation of waste cannot be avoided, it should be reused or recovered for its material or energy. WEEE products may be recognized by their wheeled bin label (.

See [www.novatel.com/products/compliance/environmental-compliance](http://www.novatel.com/products/compliance/environmental-compliance) for more information.

### RoHS

The ProPak6 is in conformity with Directive 2011/65/EU of the European Parliament and of the council of 8 June 2011 on the restriction of the use of certain hazardous substances in electrical and electronic equipment.

### REACH

The ProPak is compliant with Regulation (EC) No. 1907/2006 of the European Parliament and the Council of 18 December 2006 concerning the Registration, Evaluation, Authorization and Restriction of Chemicals (REACH). The candidate list of Substances of Very High Concern (SVHC) published by the European Chemical Agency (ECHA) is available at:

<https://echa.europa.eu/candidate-list-table>



Cables may contain DEHP (CAS Number 117-81-7) in concentrations above 0.1% w/w.

## Lightning Protection Installation and Grounding Procedure

### What is the hazard?

A lightning strike into the ground causes an increase in the earth's potential which results in a high voltage potential between the center conductor and shield of the coaxial cable. This high voltage develops because the voltage surge induced onto the center conductor lags in time behind the voltage surge induced onto the shield.

### Hazard Impact

A lightning strike causes the ground potential in the area to rise to dangerous levels resulting in harm to personnel or destruction of electronic equipment in an unprotected environment. It also conducts a portion of the strike energy down the inner conductor of the coax cable to the connected equipment.



Only qualified personnel, electricians as mandated by the governing body in the country of installation, may install lightning protection devices.

### Actions to Mitigate Lightning Hazards

1. Do not install antennas or antenna coaxial cables outside the building during a lightning storm.
2. It is not possible to avoid over-voltages caused by lightning, but a lightning protection device may be used to shunt a large portion of the transient energy to the building ground reducing the over-voltage condition as quickly as possible.
3. Primary lightning protection must be provided by the operator/customer according to local building codes as part of the extra-building installation.
4. To ensure compliance with clause 7 "Connection to Cable Distribution Systems" of EN 60950-1, Safety for Information Technology Equipment, a secondary lightning protection device must be used for in-building equipment installations with external antennas. The following device has been approved by NovAtel Inc.:

Polyphaser - Surge Arrestor DGXZ+24NFNF-B

If this device is not chosen as the primary lightning protection device, the device chosen must meet the following requirements:

- UL listed, or equivalent, in country of installation (for example, TUV, VDE and so on) for lightning surge protection
  - The primary device must be capable of limiting an incoming surge of 10 kV
5. The shield of the coaxial cable entering the building should be connected at a grounding plate at the building's entrance. The lightning protection devices should have their chassis grounded to the same ground near to the building's entrance.
  6. The primary and secondary lightning protections should be as close to the building's entrance as possible. Where feasible they should be mounted onto the grounding plate itself. See *Figure 1, Primary and Secondary Lightning Protection* on page 13.

**Figure 1: Primary and Secondary Lightning Protection**

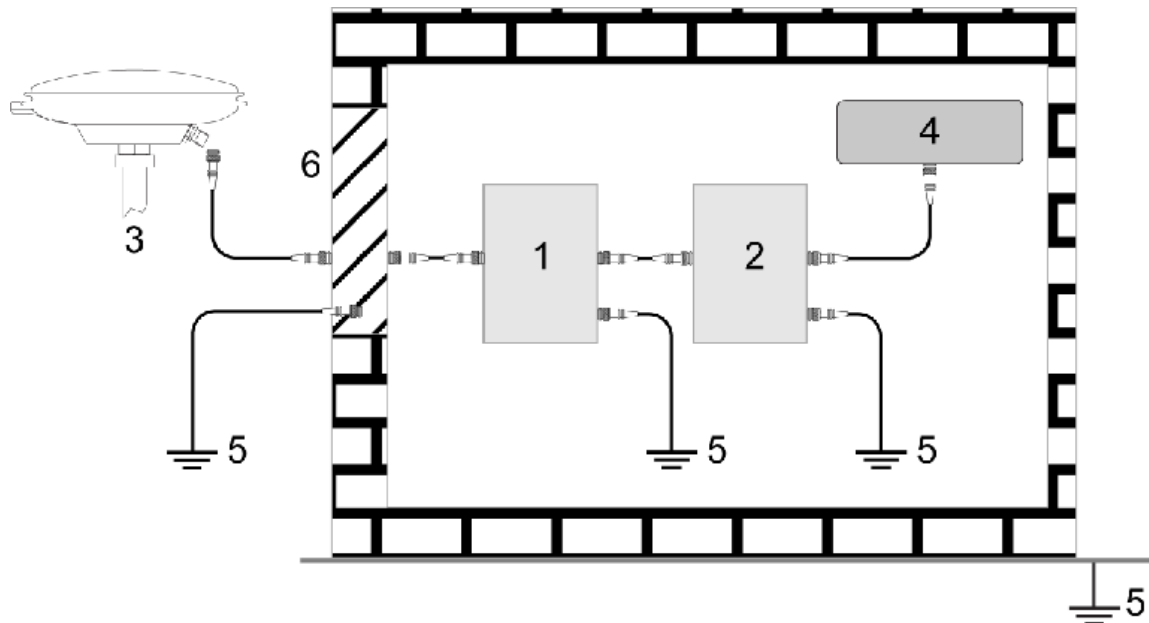

Ref #	Description
1	Primary lightning protection device
2	Secondary lightning protection device
3	External antenna
4	GNSS Receiver
5	To ground
6	Grounding plate or grounding point at the building's entrance



Acceptable choices for Earth Grounds, for central buildings, are:

- Grounded interior metal cold water pipe within five feet (1.5 m) of the point where it enters the building
- Grounded metallic service raceway
- Grounded electrical service equipment enclosure
- Eight-foot grounding rod driven into the ground (only if bonded to the central building ground by #6, or heavier, bonding wire)

These installation instructions are the minimum requirements for receiver and antenna installations. Where applicable, follow the electrical codes for the country of installation. Examples of country codes include:

- USA National Electrical Code (NFPA 70)
- Canada Canadian Electrical Code (CSA C22)
- UK British Standards Institute (BSI 7671)

## Manual Scope

This manual contains information about the installation and operation of the ProPak6 system. It is beyond the scope of this manual to provide details on service or repair. Contact your local NovAtel dealer for any customer-service related inquiries, refer to *Customer Support* on page 15.

A ProPak6 system requires the addition of accessories, an antenna and a power supply.

ProPak6 output is compatible with post-processing software from NovAtel's Waypoint® Products Group. Visit our Web site at [www.novatel.com](http://www.novatel.com) for details.

Global Navigation Satellite System (GNSS) positioning observes range measurements from orbiting GNSS satellites. From these observations, the receiver can compute position and velocity with high accuracy. NovAtel GNSS positioning systems are highly accurate positioning tools. GNSS positioning requires line of sight view to at least four satellites simultaneously and differential GNSS positioning can be accurate to within a few centimeters. For a detailed discussion of GNSS, refer to NovAtel's book [Introduction to GNSS](#) available from our web site.

## Conventions

The following conventions are used in this manual:



Information that supplements or clarifies text.



A caution that actions, operation or configuration may lead to incorrect or improper use of the hardware.



A warning that actions, operation or configuration may result in regulatory noncompliance, safety issues or equipment damage.

# Customer Support

## NovAtel Knowledge Base

If a technical issue is encountered, browse the NovAtel Web site: [www.novatel.com/support/search](http://www.novatel.com/support/search). Use the support pages to search for general information about GNSS and other technologies, information about NovAtel hardware and software and installation and operation issues.

## Before Contacting Customer Support

Before contacting NovAtel Customer Support about a software problem, perform the following steps:

1. Log the following data to a file a computer for 15 minutes:

```
RXSTATUSB ONCHANGED
RAWEPHEMB ONCHANGED
RANGECMPB ONTIME 1
BESTPOSB ONTIME 1
RXCONFIGA ONCE
VERSIONA ONCE
```

2. If using one of the ProPak6 network interfaces, also log the following as necessary:

```
WIFICONFIG ONCE
WIFIAPSTATUS ONCHANGED
WIFICLISTATUS ONCHANGED
BLUETOOTHSTATUS ONCHANGED
CELLULARSTATUS ONCHANGED
LOGFILESTATUS ONCE
```

3. Send the data file to NovAtel Customer Support, using either the NovAtel FTP site at <ftp://ftp.novatel.ca/> or through the [support@novatel.com](mailto:support@novatel.com) e-mail address.
4. You can also issue a `FRESET` command to the receiver to clear any unknown settings.



The `FRESET` command will erase all user settings. You should know your configuration and be able to reconfigure the receiver before you send the `FRESET` command.

If you are having a hardware problem, send a list of the troubleshooting steps taken and results.

## Contact Information

Log a support request with NovAtel Customer Support using one of the following methods:

### Log a Case and Search Knowledge:

Website: [www.novatel.com/support](http://www.novatel.com/support)

### Log a Case, Search Knowledge and View Your Case History: (login access required)

Web Portal: <https://novatelsupport.force.com/community/login>

### E-mail:

[support@novatel.com](mailto:support@novatel.com)

### Telephone:

U.S. and Canada: 1-800-NOVATEL (1-800-668-2835)

International: +1-403-295-4900

## 1.1 Introduction

The ProPak6 is a high performance Global Navigation Satellite System (GNSS) receiver capable of receiving and tracking different combinations of GNSS signal and integrated L-Band on 240 channels. GPS, GLONASS, Galileo, BeiDou, QZSS and SBAS support are standard and the ProPak6 adaptability offers multi-system, frequency and size configurations for any application requirement. ProPak6 models have a NovAtel OEM638 receiver card; some models also include a NovAtel OEM615 receiver card for additional functionality. Excellent acquisition and re-acquisition times allow this receiver to operate in environments where very high dynamics and frequent interruption of signals can be expected. The ProPak6 options include integrated radio and dual input heading options to provide a tightly integrated and rugged solution for any application.

## 1.2 System Components

The ProPak6 system includes the following components:

- OEM638 receiver with built in Wi-Fi, *Bluetooth*, USB 2.0 and 4 GB of onboard memory
- 12 VDC power adapter (CLA) with slow blow fuse
- Null modem cable
- DB9 male extension cable
- I/O DB9 male interface cable
- Mounting bracket and hardware

Refer to *Section 2.2.1, ProPak6 Cables* on page 22, *Section 2.6.1, Mounting the GNSS Antenna* on page 30 and *Appendix A, Technical Specifications* on page 110 for details on cables and mounting the ProPak6.

Refer to *Section 2.1, Additional Equipment Required* on page 21 for a equipment not included with the ProPak6.

## 1.3 Models and Features

The ProPak6 is available in several different firmware models whose configurations may include other additional features.

**Table 1: ProPak6 Model Features**

Model Configuration	Firmware Features				
	External Oscillator	Dual Antenna	Cellular/HSPA	OEM638 Card	OEM615 Card
ProPak6 Dual/Cellular		■	■	■	■
ProPak6 Dual		■		■	■
PP6 Single/Cellular	■		■	■	
PP6 Single	■			■	





Ethernet, Wi-Fi, *Bluetooth*, high speed USB 2.0 and 4 GB onboard memory available on all models. Refer to *Appendix A, Technical Specifications* on page 110, *Section NovAtel Part Numbers* for model details.

## 1.4 Overview—ProPak6 Hardware

The ProPak6 has a series of ports on the back of the unit for connecting specific cables. In the front, the ProPak6 is outfitted with a number of LEDs to indicate receiver status, buttons to initiate functionality and access to onboard storage (model dependent).

**Figure 2: ProPak6—Back Connectors**

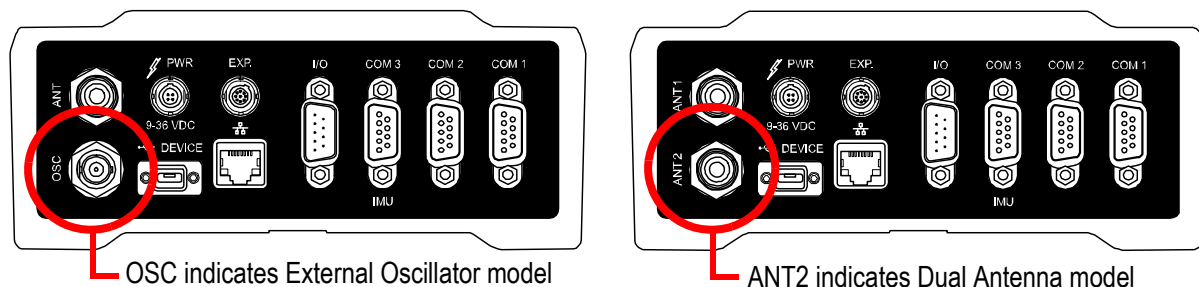
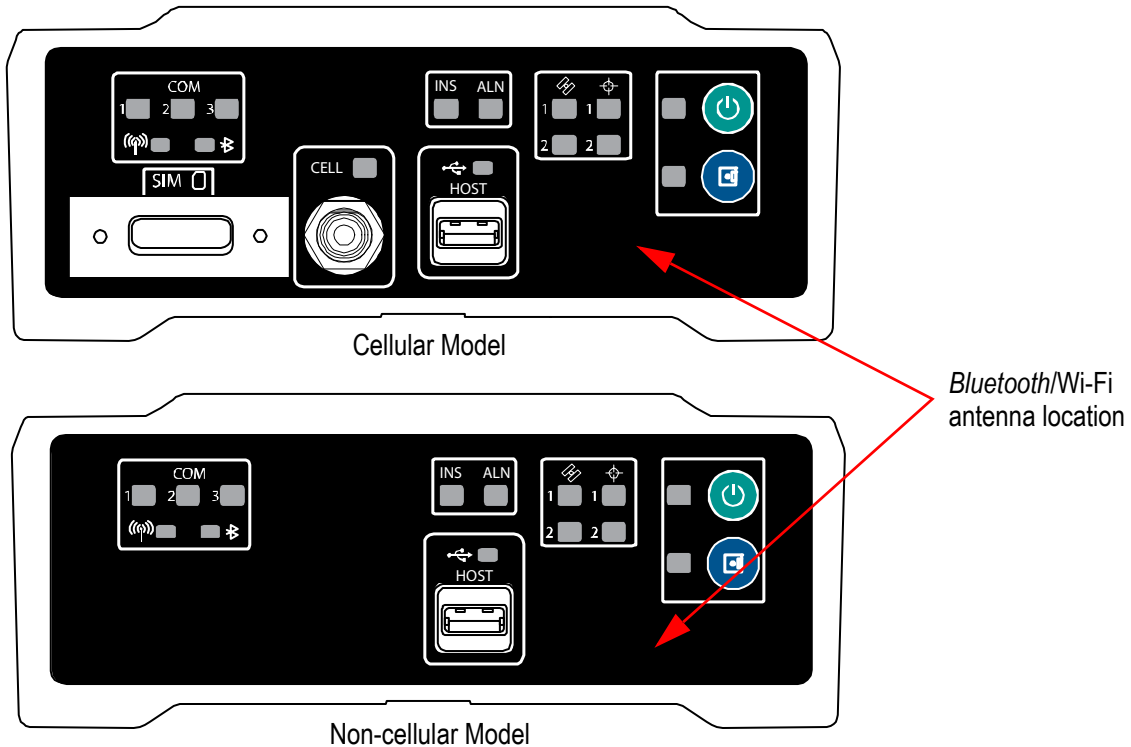

**Table 2: ProPak6 - Back Connector Definitions**

Connector Type	Connector Label	Description
 GNSS Antenna	ANT 1 ANT 2 or ANT1	GNSS GPS1 and GPS2 antennas (TNC) (model dependent) or GNSS GPS1 antenna (TNC) and external oscillator (BNC) (model dependent)
 External Oscillator	OSC	Refer to <i>Figure 5, Antenna and External Oscillator Ports</i> on page 25 for details
 Power	PWR	4-pin LEMO power connector Refer to <i>Figure 6, Power Port</i> on page 25 for details
 Expansion	EXP.	9-pin LEMO expansion port for CAN1, CAN2 and an additional USB host port Refer to <i>Figure 8, Expansion and I/O Ports</i> on page 26 for details
 USB	DEVICE	USB Device (Type micro B) connector Refer to <i>Figure 7, Ethernet, COM or USB Device Ports</i> on page 25 for details
 Ethernet		Ethernet RJ45 connector Refer to <i>Figure 7, Ethernet, COM or USB Device Ports</i> on page 25 for details
 I/O	I/O	Event Input/output (DB9 female connector) I/O port is configurable Refer to <i>Figure 8, Expansion and I/O Ports</i> on page 26 for details
 Serial Communication Port	COM1 COM2 COM3/IMU	COM1, COM2, COM3/IMU DB9 male communications port RS-232 and RS-422 selectable via software Refer to <i>Figure 7, Ethernet, COM or USB Device Ports</i> on page 25 for details

 Also refer to *Appendix A, Technical Specifications* on page 110 for connector details.

**Figure 3: ProPak6—Front Communication Ports, Buttons and Connectors**



 The Bluetooth/Wi-Fi antennas are located on the front of the ProPak6 (not visible). Refer to *Figure 41, Bluetooth/Wi-Fi Antenna Keep-out Area and Antenna Location* on page 114 for exact location and keep-out dimensions for this antenna.

Table 3: ProPak6 - Front Label Definitions









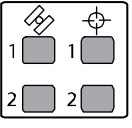

Button/Connector/ LED Type	Label	LED	Description
	N/A	Yes	Power button and status LED Refer to <i>Section 3.2.1, Applying Power to the Receiver</i> on page 44 for details
	N/A	Yes	Logging button with user configurable status LED Refer to <i>Section 3.7, Logging and Retrieving Data Overview</i> on page 58 for details
	Tracking	Yes	Indicates number of satellites being tracked by the corresponding receiver User configurable (refer to the <code>LEDCONFIG</code> command in the <a href="#">OEM6 Firmware Reference Manual</a> - OM-20000129) Refer to <i>Section 3.1.8, Satellite Tracking and Positioning LEDs</i> on page 38 for details
	Position	Yes	Indicates satellite position status for the corresponding receiver User configurable (refer to the <code>LEDCONFIG</code> command in the <a href="#">OEM6 Firmware Reference Manual</a> - OM-20000129) Refer to <i>Section 3.1.8, Satellite Tracking and Positioning LEDs</i> on page 38 for details
	INS ALN	Yes	INS status indication (SPAN configuration only) ALIGN heading status indication (Dual antenna configuration only) Refer to <i>Section 3.1.7, INS and ALIGN LEDs</i> on page 37 for details
	COM 1, 2 and 3	Yes	Transmit/Receive indication (COM 1, 2 and/or 3) Refer to <i>Section 3.1.13.1, Configure COM 1, 2 and 3</i> on page 43 and <i>Section 3.1.4, COM Ports LEDs</i> on page 36 for details
	Wi-Fi	Yes	Wi-Fi radio status LED Refer to <i>Section 3.1.6, Wi-Fi LED</i> on page 37 for details
	Bluetooth	Yes	Bluetooth radio status LED Refer to <i>Section 3.1.5, Bluetooth LED</i> on page 37 for details
	HOST	Yes	USB Host (Type A) connector - ProPak6 built in USB host with status LED Memory stick port for automatic downloading of logged data (refer to <i>Section 3.7, Logging and Retrieving Data Overview</i> on page 58) and updating firmware (refer to <i>Section 7.4, Updating Using SoftLoad Commands</i> on page 99) Refer to <i>Section 3.1.10, Universal Serial Bus (USB) Port and LEDs</i> on page 40 for details
<b>CELLULAR - OPTIONAL (refer to 5.3, Cellular Activation GSM/GPRS/HSDPA on page 90)</b>			
	CELL	Yes	Fully integrated TNC, cellular modem antenna connector (GPRS/HSPA) and status LED Refer to <i>Section 3.1.9, Cell Port and LED</i> on page 40 for details

Table 3: ProPak6 - Front Label Definitions

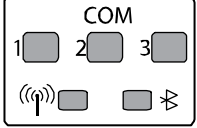
Button/Connector/ LED Type	Label	LED	Description
 Mini-SIM only (25 mm x 15 mm)	SIM	No	Push-push style SIM card holder  Open  Covered Remove SIM card holder cover to insert card; replace cover to avoid damaging card

This chapter contains instructions and tips to install the ProPak6 and create a GNSS receiver system.

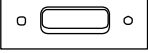
## 2.1 Additional Equipment Required

Refer to *Chapter 1, Introduction* on page 16 for a list of components included with the Propak6. In order for the receiver to perform optimally, the following additional equipment is required:

- At least one GNSS antenna and antenna cable with a TNC male connector at the receiver end. For example, a quality, dual-frequency GNSS antenna such as NovAtel's GPS-702-GG or ANT-A72GA-TW-N for airborne/high speed applications. See the NovAtel website [www.novatel.com/products/gnss-antennas](http://www.novatel.com/products/gnss-antennas)) for information on a variety of quality antennas available to meet your form factor and performance needs.

### *User Supplied Additional Equipment (as required)*

- A quality coaxial cable and interconnect adapter cable as necessary (user-supplied)
- A Windows based computer
- A means of communicating between the ProPak6 and computer or other external devices:
  - Ethernet cable
  - USB micro-B cable
  - RS-232 serial cable
  - RS-422 serial cable
  - A cellular link
- A cell antenna such as PCTEL Inc., MLPV800 (12023303) and magnetic mount such as PCTEL Inc., GMHFML195C (12023300)cellular radio antenna cable
- *Bluetooth* link
- Wi-Fi network



Use a serial COM or USB connection to communicate with the receiver first. This provides the ability to configure the computer and ProPak6 before Wi-Fi, Ethernet, *Bluetooth* or cellular are configured and used.

- Real-time data collection, status monitoring and receiver configuration is possible through the NovAtel Connect™ PC Utilities software is available from our web site: [www.novatel.com/support/info/documents/809](http://www.novatel.com/support/info/documents/809).



When the ProPak6 is installed in a permanent location, such as in a building, it should be protected by a lightning protection device according to local building codes. See *Lightning Protection Installation and Grounding Procedures* on page 12.

## 2.2 ProPak6 Hardware

### 2.2.1 ProPak6 Cables

To prevent damage to both the receiver and the cables, each connector can be inserted in only one way.

Furthermore, the connectors used to mate the cables to the receiver require careful insertion and removal. Observe the following when handling cables.

- To insert a cable, make certain to use the appropriate cable for the port
- Insert the connector until it is on straight and secure
- To remove a cable, grasp it by the connector

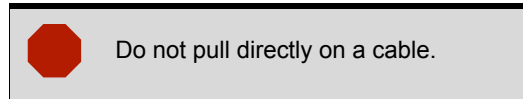

**Table 4: ProPak6 Cables**

NovAtel Part #	Port Labeled	Purpose
01017658	COM1 COM2 COM3/IMU	Null modem cable, 6 foot DB9 female/female Provides connections for: COM1 COM2 COM3/IMU
01017663	PWR	Power cable assembly, 4-Pin LEMO - 6 amp cigarette lighter
01018520	COM1	Extension cable 6 feet DB9 male/female ITE (straight through)
01018519	I/O	6 foot DB9 male/single ended ITE cable (DB9 to wire leads)
01019154	EXP	Expansion cable for access to COM7, 8, 9 and 10 as well as CAN1 and CAN2

For more information about the cables used with ProPak6, refer to *Section A.5, Cables* on page 119.

### 2.2.2 Selecting a GNSS Antenna

An active antenna is required because its Low Noise Amplifier (LNA) boosts the power of the incoming signal to compensate for the line loss between the antenna and the receiver.

NovAtel offers a variety of single and dual-frequency GNSS antenna models. All include band pass filtering and an LNA. The GNSS antenna chosen depends on the particular application. Each model offers exceptional phase-center stability as well as a significant measure of immunity against multipath interference. Each one has an environmentally-sealed radome.

### 2.2.3 Choosing a Coaxial Cable

An appropriate 50 ohm coaxial cable whose line loss does not exceed 10.0 dB. If the limit is exceeded, excessive signal degradation may occur and the receiver may not be able to meet its performance specifications. NovAtel offers a variety of coaxial cables to meet GNSS antenna interconnection requirements, including:

- 5, 15, or 30 m antenna cables with TNC male connectors on both ends (NovAtel part numbers C006, C016 and C032 respectively)

A local NovAtel dealer can offer advise about specific configuration requirements. If an application requires the use of cables longer than 30 m, refer to the application note [APN-003 RF Equipment Selection and Installation](#) on our website or obtain it directly by contacting NovAtel (refer to *Contact Information* on page 15).

High quality coaxial cables should be used.

## 2.3 Communication with the ProPak6

The ProPak6 can communicate with a computer or computer network in a number of ways:

- Communicate via the serial COM ports using either RS-232 or RS-422 (refer to *Section 3.1.13.1, Configure COM 1, 2 and 3 on page 43*)
- Communicate via the USB Device port from a computer containing necessary drivers (refer to *Section 3.1.10, Universal Serial Bus (USB) Port and LEDs on page 40*)
- Remove logged data files using the USB Host port (refer to *Section 3.1.10, Universal Serial Bus (USB) Port and LEDs on page 40*)
- Communicate via the Ethernet port to connect to an existing network (refer to *Section 3.1.11, Ethernet Port on page 41*)
- Communicate using built in *Bluetooth* wireless device communications (refer to *Section 5.1, Bluetooth® Configuration on page 82*)
- Communicate using built in Wi-Fi to create or join a wireless network (refer to *5.2, Wi-Fi Network Configuration on page 84*)
- Communicate using an optional cellular radio (refer to *Section 5.3, Cellular Activation GSM/GPRS/HSDPA on page 90*)

### 2.3.1 Power Supply Requirements

This section contains information on the requirements for the input power to the receiver (refer to *Figure 6, Power Port on page 25* for port location). See *Appendix A, Technical Specifications on page 110* for more power supply specifications.



If the voltage supplied is below the minimum specification, the receiver suspends operation. If the voltage supplied is above the maximum specification, the receiver may be permanently damaged, voiding the warranty. The supply must be capable of providing enough current to operate the ProPak6, including the initial inrush transient. The supply must also be current limited to 6 A with an external fuse.

The ProPak6 is supplied with a 12 V power adapter with a built-in 6 A slow blow fuse for use with a standard 12 VDC power outlet. When valid voltage is present at the power supply input, the ProPak6 power LED briefly flashes red and then turns solid green (operational mode). The power button only needs to be pressed to turn off the ProPak6. Refer to *Section 3.2.1, Applying Power to the Receiver on page 44* for details on powering the ProPak6 and *Section 3.2.1.1, Power Down and Reset the ProPak6 on page 45* for instructions on powering down the ProPak6.



For alternate power supply and battery backup details, refer to *Section 2.7, ProPak6 Alternative Power Source on page 30* and/or *2.7.1, Battery Backup on page 31*.

### 2.3.2 COM1 and COM2 Peripheral Power

The peripheral power from COM1 and COM2 can be controlled using the `COMVOUT` command. The peripheral power is directly supplied from the enclosure input voltage (the 4-pin LEMO) and can be output to pin-4 of both COM1 and COM2 (refer to *Figure 7, Ethernet, COM or USB Device Ports on page 25* for port location).



To avoid damaging the ProPak6 or the connected device, the physical connection must be capable of handling up to 36 V before the `COMVOUT` command is issued.

The available power for both COM ports are shared (maximum 1.5 A total in any combination between the ports). If only one COM port is used, the entire 1.5 A is available to that port. The total peripheral power current is limited to 1.5 A. Transient currents greater than 1.5 A are clamped by the ProPak6.

Refer to A.2, *ProPak6 Specifications* on page 111 for baud rates. Refer to the [OEM6 Firmware Reference Manual](#) (OM-20000129) for COMVOUT command details.

## 2.4 Standard Configuration Installation

Complete the steps below to connect and power a standard ProPak6 configuration.



If using the ProPak6 in a low vibration installation, attach the included mounting brackets to the ProPak6 prior to cabling. Complete mounting instructions are contained in the Quick Start Guide included with the ProPak6. Refer to *Section 2.7.4, Mounting the ProPak6* on page 33 for direct mounting instructions.

**Figure 4: Typical Standard Installation with External Oscillator**

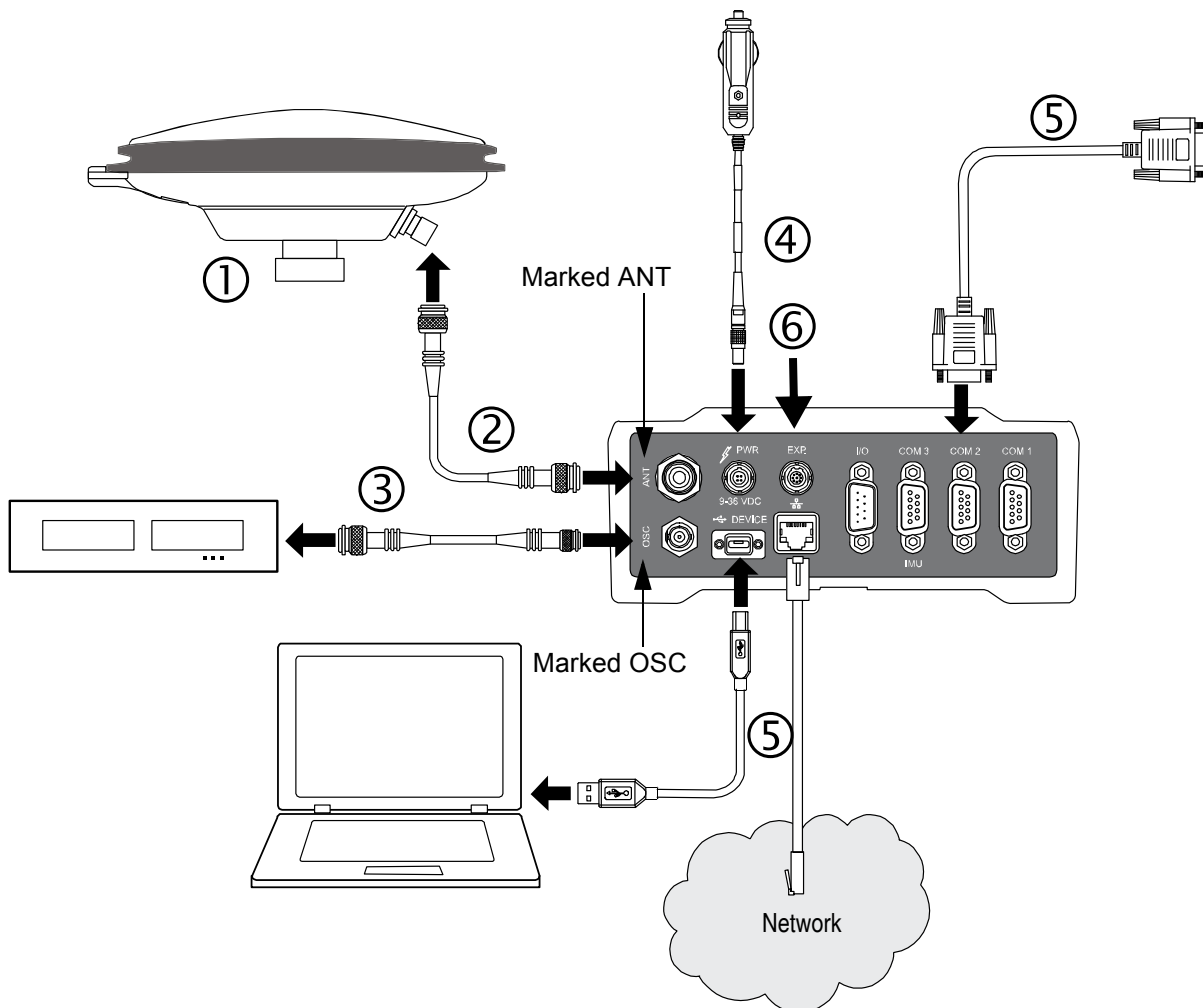

1. Mount a GNSS antenna (user supplied) on a secure, stable structure with an unobstructed view of the sky from horizon to horizon. Refer also to *Section 2.6.1, Mounting the GNSS Antenna* on page 30.



2. Use a coaxial cable (user supplied) to connect an antenna to the TNC ANT port on the back face of the ProPak6 (Figure 5). Refer also to Section 3.1.16, *Antenna LNA Port* on page 44.
3. Use a coaxial cable (user supplied) to connect an external oscillator to the BNC OSC port on the back face of the ProPak6 (Figure 5). Refer also to Section 3.1.17, *External Oscillator Port (model dependent)* on page 44.



The external oscillator is an optional model. If the dual-antenna model is used, refer to Section 2.5, *Dual Antenna Configuration and Installation* on page 26 for installation instructions.

**Figure 5: Antenna and External Oscillator Ports**

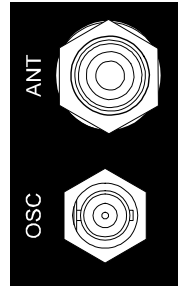

Refer to the Input/Output Connectors section of A.2, *ProPak6 Specifications* on page 111.

4. The power cable connector (included) is keyed to the PWR 9-36 VDC connector (Figure 6) on the back of the ProPak6. Line up the red dot on the cable with the red line on the connector port and insert. Refer also to Section 3.2.1, *Applying Power to the Receiver* on page 44.

**Figure 6: Power Port**



5. Use the appropriate cable to connect a computer to the COM port, Ethernet  $\frac{\square}{\square}$  port or  $\leftrightarrow$  DEVICE port on the back of the ProPak6 (Figure 7).

**Figure 7: Ethernet, COM or USB Device Ports**

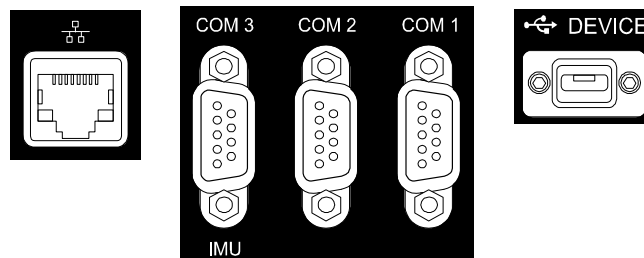

COM ports are configurable to RS-232 or RS-422. Refer to Section 3.1.13.1, *Configure COM 1, 2 and 3* on page 43 for configuration instructions.



The Ethernet port must be configured prior to first use. Refer to *Chapter 4, Ethernet Configuration* on page 74 for configuration instructions.



Refer to the Input/Output Connectors section of *A.2, ProPak6 Specifications* on page 111. Also refer to *Table 14, COM1 and COM2 Port Pin-Out Descriptions* on page 115 and *Table 15, COM3/IMU Port Pin-Out Description* on page 115.

6. Connect the I/O signals (optional) and/or expansion (EXP.) devices (optional) on the back of the ProPak6 using the appropriate cables (*Figure 8*). Refer also to *Section 3.1.14, I/O Port* on page 43 and/or *Section 3.1.15, Expansion Port* on page 43.

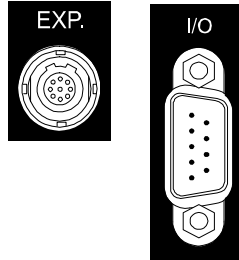
**Figure 8: Expansion and I/O Ports**



Refer to the Input/Output Connectors section of *A.2, ProPak6 Specifications* on page 111. Also refer to *Table 16, I/O Port Pin-Out Descriptions* on page 116 and *Table 17, Expansion Port Pin-Out Description* on page 116.

7. Connect the ProPak6 to a power source. Once power is detected or activity detected on COM1, COM2 or COM3, the ProPak6 automatically enters Operational mode. The LED beside the  button on the front of the ProPak6 briefly turns red and then turns solid green. The ProPak6 is now in Operational mode. The power  button is only pressed to turn off the ProPak6. Refer to *Section 3.2.1, Applying Power to the Receiver* on page 44 for instructions on turning on the ProPak6.

## 2.5 Dual Antenna Configuration and Installation

NovAtel's ALIGN<sup>®</sup> heading technology generates distance and bearing information between a “master” and one or more “rover” receivers. This information can be used by SPAN<sup>®</sup> to update the inertial error estimates and improve attitude accuracy. This is particularly useful in applications with reduced motion.

ProPak6 Dual Antenna provides the hardware necessary to run an ALIGN baseline with a second receiver.

With ProPak6, the ALIGN GNSS baseline can be used to assist the initial alignment of the SPAN solution. In addition, the ALIGN baseline solution aids the heading solution from the receiver if the heading drifts due to slow or constant dynamics.

ALIGN is capable of a 10 Hz heading output rate when integrated with the ProPak6 receiver.

Complete the steps below to connect and power a dual antenna ProPak6 configuration.



The ProPak6 may contain an OEM615 receiver used as a dual antenna. The `DUALANTENNAPOWER` command controls the LNA power to that receiver, independent of the OEM638's LNA. The dual antenna power feature is on, by default, for dual antenna ProPak6 models. Refer to the [OEM6 Firmware Reference Manual](#) (OM-20000129) for command details.

Figure 9: Typical Dual Antenna Installation

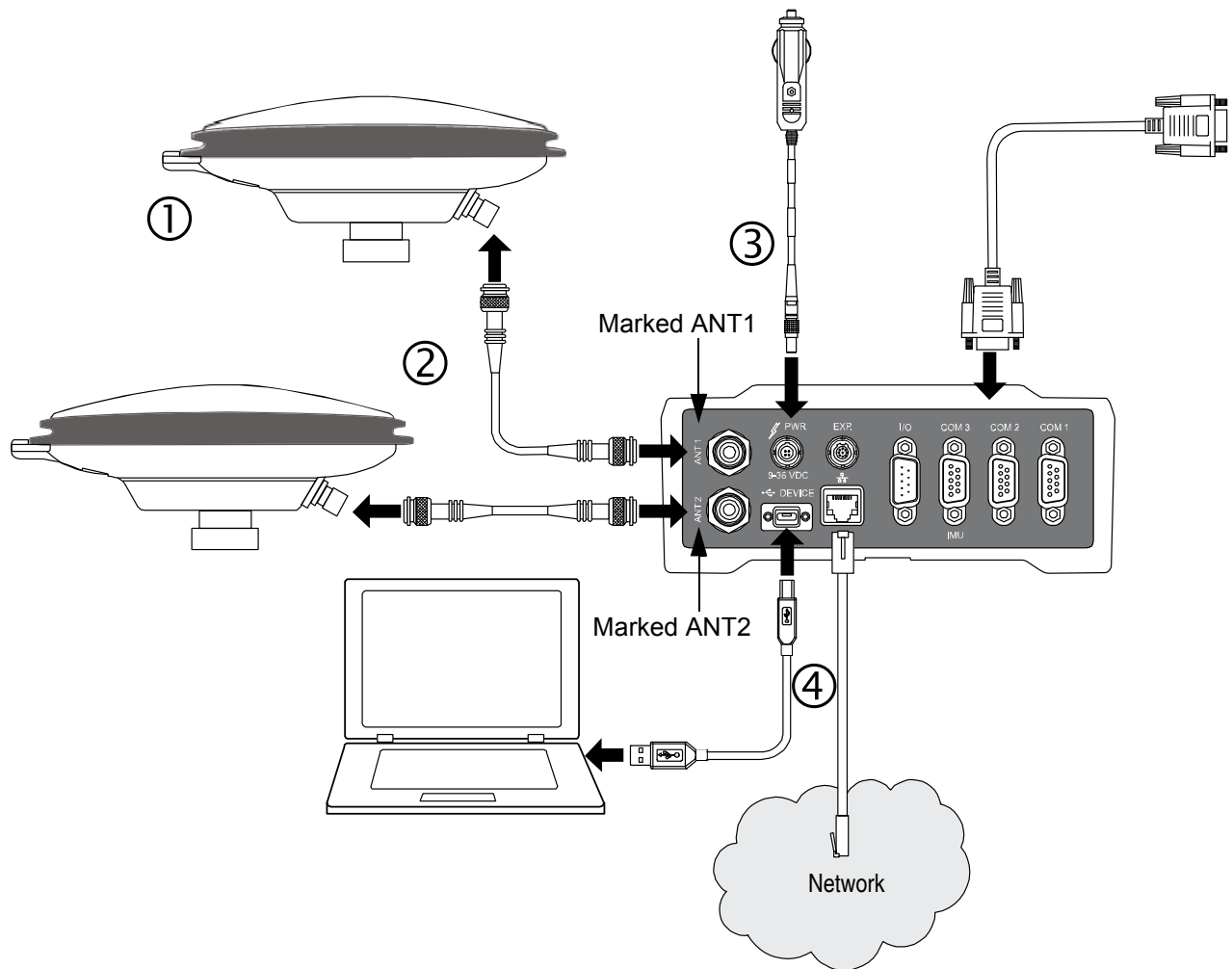

1. Mount GNSS antennas (user supplied) on a secure, stable structure with an unobstructed view of the sky from horizon to horizon. Refer also to *Section 2.6.1, Mounting the GNSS Antenna* on page 30.
2. Use a coaxial cable (user supplied) to connect an antenna to the TNC ANT1 port and connect a second antenna to the other TNC ANT2 port on the back face of the ProPak6 (*Figure 10*).

 Install the ProPak6 and the two antennas in the vehicle such that the relative distance between them is fixed.

Figure 10: GNSS Antenna Ports



3. Insert the power cable connector into the *PWR 9-36 V* connector (Figure 6) on the back of the ProPak6. Refer to Section 3.2.1, *Applying Power to the Receiver* on page 44 for details on applying power and power modes.
4. Use the appropriate cables to make any additional connections for communications as required and as described in the steps for *Standard Configuration Installation* on page 24 beginning at step 5.

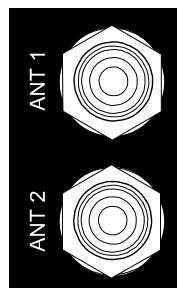

For instructions on setting up heading, refer to 3.5, *External ALIGN Master or Rover Configuration Only* on page 50.



The Ethernet port must be configured prior to first use. Refer to Chapter 4, *Ethernet Configuration* on page 74 for configuration instructions.

## 2.6 Cellular Antenna Installation

The ProPak6 has a cellular antenna port to facilitate the connection of an external cellular antenna. An external antenna must be connected to this port in order to use the integrated cellular radio.



To comply with FCC regulations limiting both maximum RF output power and human exposure to RF radiation, the maximum system gain (antenna gain minus system loss) must not exceed 1.4 dBi in the U.S. Cellular band and 3.0 dBi in the PCS band for the GSM/GPRS/HSDPA variant. System loss is the total of external cable and connector losses and ProPak6 internal losses. For reference and system gain calculation purposes, the ProPak6 has internal losses of 0.6 dB for the 800 MHz Cellular band and 1.8 dB for the 1900 MHz PCS band.

Figure 11: Cellular Network Setup

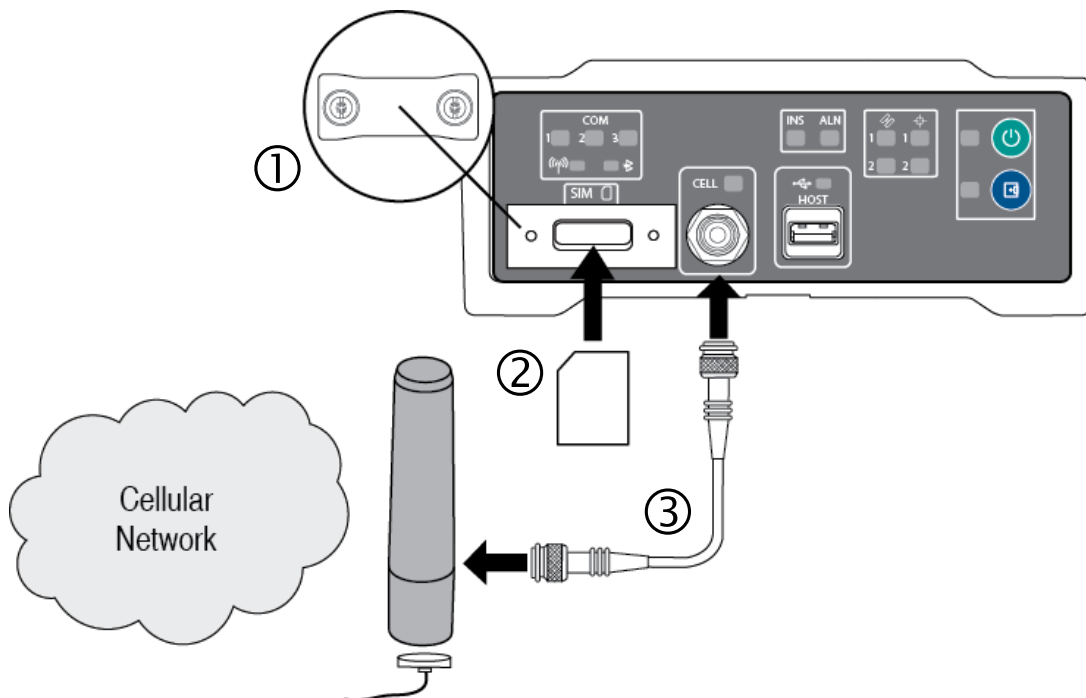

1. Remove the SIM card holder cover.

2. Insert the SIM card and replace the card holder cover.



Once the SIM card is correctly installed, secure the SIM cover to the base using a screwdriver. Screws should be torqued to 4-6 inch-pound. Failure to properly secure SIM cover will violate ProPak6 IP67 ingress rating.

3. Use a coaxial cable to connect an antenna to the CELL port on the front face of the ProPak6. Specific antenna types are available from NovAtel for the GSM/GPRS/HSDPA version of the ProPak6. Secure the RF connector to the ProPak6 ensuring a “hand tight” connection.



Ensure the cellular antenna is installed at least 30 cm away from the ProPak6 or GNSS positioning accuracy may be degraded. Refer to *Figure 41, Bluetooth/Wi-Fi Antenna Keep-out Area and Antenna Location* on page 114 for details.



- Antennas must be installed on a “ground plane”. A vehicle with a metal roof is inherently a ground plane. For vehicles with a non-metallic roof a metal ground plane (available from NovAtel) must be used.
- When installing the antenna on a metallic roof, it is recommended that the antenna be installed no closer than 10 cm, (4 inches) from the edge of the rooftop, to avoid adversely affecting the antenna performance due to distortion of the antenna pattern.
- The NovAtel ground plane accessory for use on non-metallic vehicle cab roofs is designed to provide a sufficient symmetrical ground plane around the antenna to guarantee optimal antenna performance.



- Do not shorten the cable lengths provided with any particular antenna type as this creates a safety hazard.
- Do not use pliers or other tool types to over tighten the RF connector as damage to the connector will occur.
- Ensure the RF connectors (male and female) are clean and dry before mating. Low pressure compressed air can be used to clean the connectors (that is, compressed air available in aerosol can format). Do not use a high pressure compressed air as moisture seals in the connector can be damaged. If the ProPak6 is moved between multiple vehicles each with its own cellular antenna, some means of sealing the unmated RF connectors should be used. Cellular radio frequencies are much higher than older forms of radio communications; the effects of moisture and/or dust will have a greater effect on performance.

Refer to *Section 5.3, Cellular Activation GSM/GPRS/HSDPA* on page 90 for details on activating a cellular network. Refer to *Section 3.1.9, Cell Port and LED* on page 40 for details on cell status information. Also refer to the section *Mobile/Cellular Antenna Port, A.2, ProPak6 Specifications* on page 111.

### 2.6.1 Mounting the GNSS Antenna

The ProPak6 has been designed to operate with any of the NovAtel single-frequency or dual-frequency GNSS antenna models.

When installing the antenna system:

- Choose an antenna location with a clear view of the sky so that each satellite above the horizon can be tracked without obstruction (refer to *Multipath* in NovAtel's book [Introduction to GNSS](#) available from our web site).
- Mount the antenna on a secure, stable structure capable of safe operation in the specific environment.

## 2.7 ProPak6 Alternative Power Source

If a different supply is desired, the table below provides the input range and type of connector required to mate with the enclosure's power connector. The supply should be capable of 14 W.

**Table 5: Enclosure Power Requirements**

Enclosure	Power Cable Connector Required	Power Input Range
ProPak6	4-pin LEMO socket connector <sup>a</sup> labeled PWR	+9 to +36 V DC

a. See *Appendix B, Replacement Parts* on page 125 for connector part numbers.

If the 12 V car adapter is not convenient, it can be cut off from the power cable. The exposed wires can then be tied to a 9-36 VDC power supply capable of at least 14 W through a user supplied 6 Amp fuse.



The supplied 12 V power adapter cannot be used for 24 V or above systems.

For an alternative power source:

1. Cut the 12 V car adapter from the power cable.
2. Install a user supplied 6 A slow blow fuse at the power source to protect the power supply wiring and the warranty.
3. Tie the exposed wires to a 9-36 VDC supply capable of at least 14 W. Be sure to connect the red and orange or green wires to the positive side of the power supply and connect the black and brown or white wires to the negative side of the power supply.



Since the 12 V car adapter on the supplied adapter cable incorporates a 6 A fuse, a user supplied 6 A slow blow fuse in a suitable holder must be used at the alternate power source to protect both the power supply and the warranty.

4. Plug in the adapter and/or turn on the power supply. The power LED briefly turns red when power is detected and then turns green and enters operational mode.



The ProPak6 provides an output voltage on pin 4 of COM1 and COM2 (POUT). This output voltage is at the same level as the power source used to power the ProPak6.

For a 12 V System the following are recommended:

**Table 6: Fuse/Holder Recommendations**

Fuse	Holder
BK/MDA-6-R Fuse (or equivalent)	BK/HFA-R-R Fuse (or equivalent)

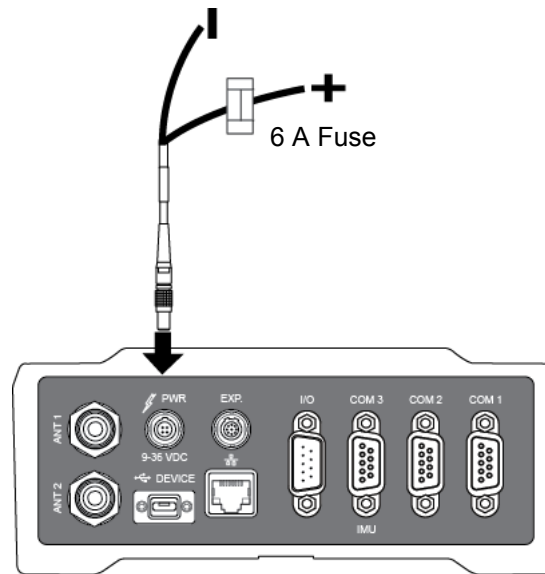

The fuse and holder are made by Cooper/Bussmann; available from Digikey.

### 2.7.1 Battery Backup

If installed in a vehicle so as to avoid loss of lock when tracking L-Band, it is recommended a back-up battery be placed between the receiver and the voltage supply as a power buffer. When a vehicle engine is started, power can dip to below minimum operating voltage or cut-out to ancillary equipment causing the receiver to lose lock and calibration settings.

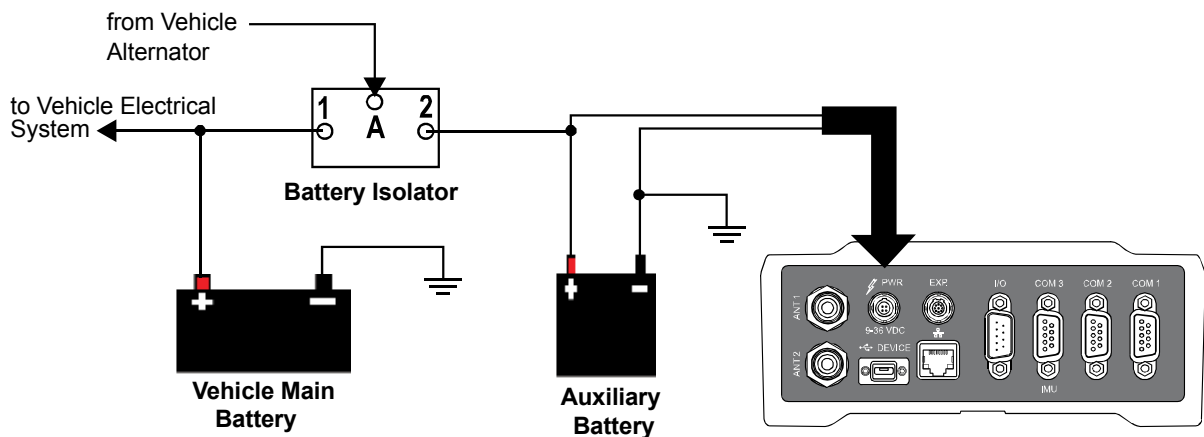

### 2.7.1.1 Seamless Battery Swap

Two batteries can be connected at the same time. Lemo connectors positive wires (2 and 3) should be split. The two positives are combined on the ProPak6 via diodes so no current can flow from one battery to the other. The battery with the highest voltage supplies power to the ProPak6. The negative wires should not be split. Be sure that both supplies share a common ground and are connected to the ground of the ProPak6. If a battery requires charging, it can be removed without experiencing any power interruption (battery A or B).

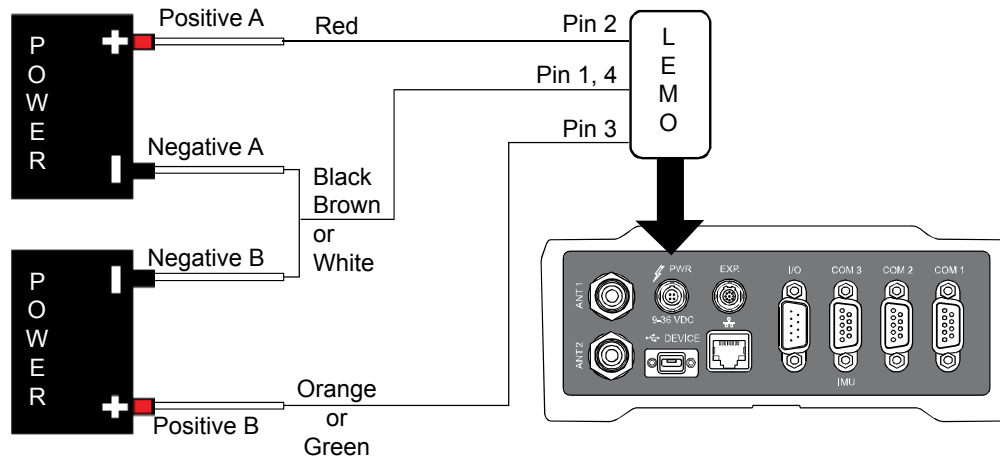

### 2.7.2 Connect the Additional Communication Ports on a ProPak6

In addition to the three COM ports (COM1, COM2 and COM3/IMU) on the back of the ProPak6, there are four additional COM ports available from the EXP port. To access these ports, connect the ProPak6 Expansion Cable (01019154) to the EXP port. For more information about this cable, see *Section A.5.5, ProPak6 Expansion Cable (NovAtel part number 01019154) on page 123.*

**Figure 12: Additional COM ports on the ProPak6**

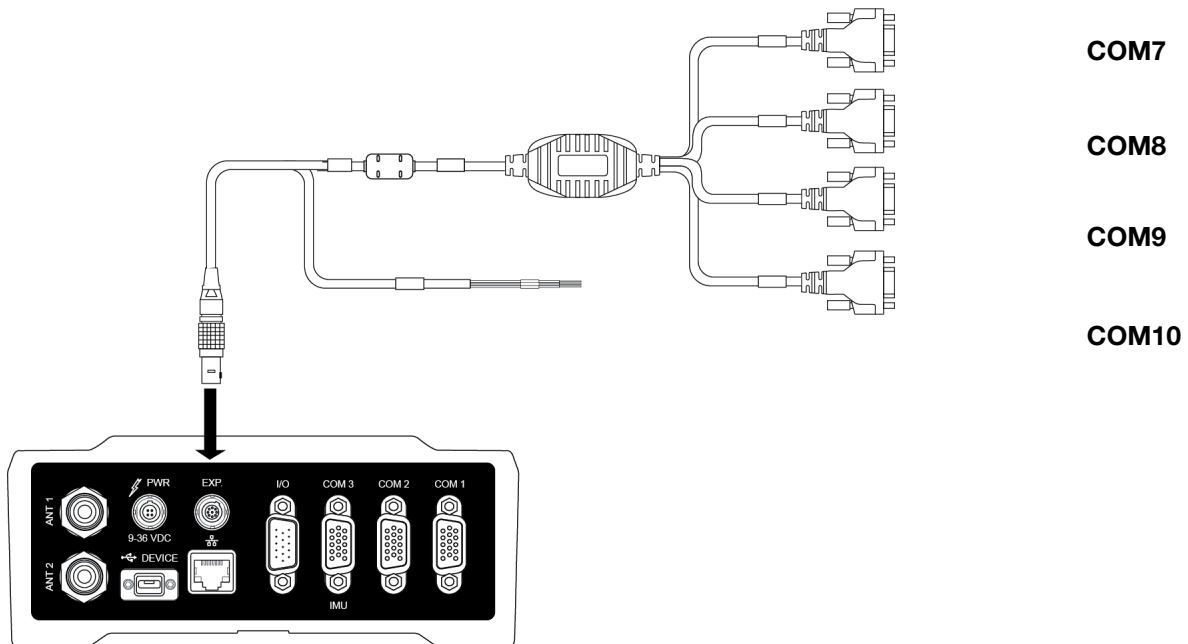

Refer to *A.5.5, ProPak6 Expansion Cable (NovAtel part number 01019154) on page 123* and *Table 22, ProPak6 Expansion Cable Pin-Out Descriptions on page 123* for pin out details.



### 2.7.3 Connect the CAN Bus

OEM6 family receivers incorporate a CAN Bus controller that supports physical layer signals and low level messages specified in the appropriate sections of the J1939 and ISO11783 standards. Manufacturers can also create messages specific to their application without violating these standards. To facilitate manufacturer messages, NovAtel provides an Application Program Interface (API). To obtain information about this API, contact NovAtel Customer Support.

The ProPak6 receiver has two CAN Bus ports, CAN1 and CAN2, which are available on the EXP port. To access these signals, use the ProPak6 Expansion Cable (see *Figure 13, CAN Bus ports on the ProPak6*). For information about the ProPak6 Expansion Cable, see *Section A.5.5, ProPak6 Expansion Cable (NovAtel part number 01019154)* on page 123. For information about the EXP port, refer to *Section 3.1.15, Expansion Port* on page 43 of this manual.

**Figure 13: CAN Bus ports on the ProPak6**

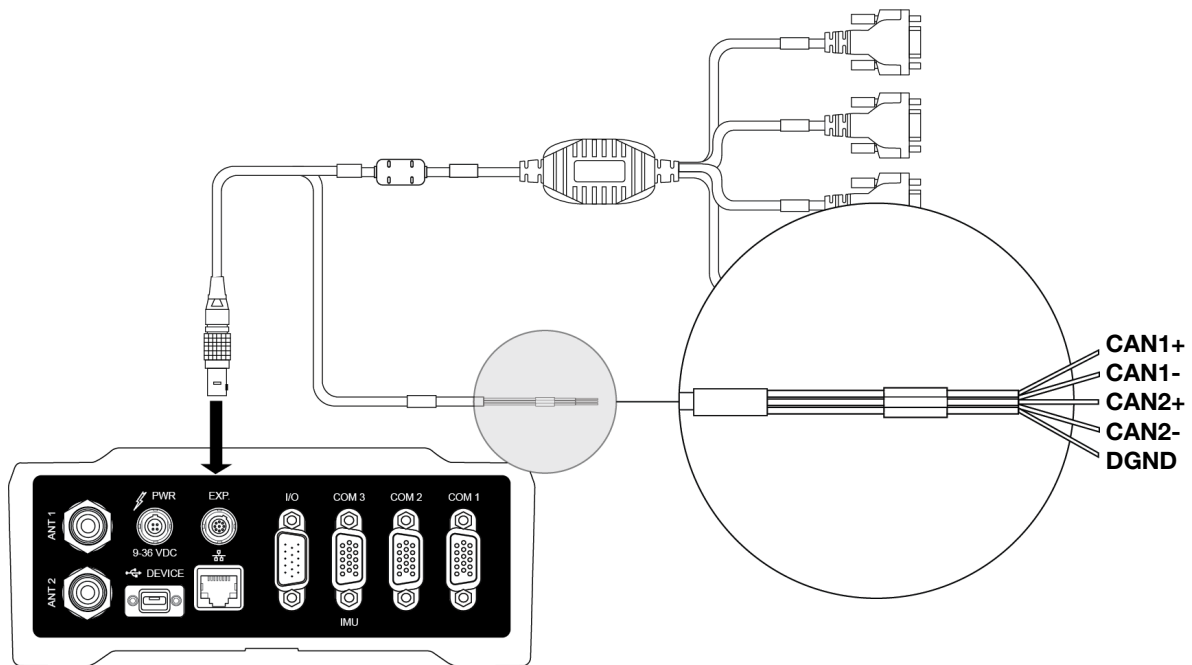

### 2.7.4 Mounting the ProPak6

For general applications, the supplied mounting brackets may be used to install the receiver, refer to the [ProPak6 Quick Start Guide](#) (GM-14915125) provided with the receiver or download the guide from our web site: [www.novatel.com/support](http://www.novatel.com/support).

For high vibration installations, NovAtel recommends mounting the ProPak6 directly using 1/4" 20-UNC threaded screws (4 locations). Vibration dampeners or isolators (user supplied) for additional vibration reduction may be used. Refer to *Figure 40, ProPak6 Dimensions* on page 113 for mounting hole locations.

## 2.8 Installing NovAtel Connect PC Utilities

The NovAtel Connect PC Utilities contain a number of utilities that can be used with the ProPak6 along with complete instructions for installation and use of the NovAtel PC utilities.



Download the latest PC Utilities software including NovAtel Connect™ PC Utilities along with the necessary user documentation from: [www.novatel.com/support/info/documents/809](http://www.novatel.com/support/info/documents/809).

NovAtel Connect is a windows based GUI used to access the receiver's many features without the need for communications protocol or other special software. The Convert utility is a windows based utility used to convert between file formats and strips unwanted records for data file compilation.

 If using Ethernet, the port needs to be configured prior to use. Refer to *Chapter 4, Ethernet Configuration* on page 74 for configuration instructions.

## 2.9 ProPak6 Security

### 2.9.1 Administration Password

 The Administrator password should be changed prior to using the FTP server or ICOM ports.

An Administrator password is available to secure FTP and ICOM ports. The default Administrator password is the Product Serial Number (PSN) of the receiver and the predefined user name is "admin".

Example:



Label is located on the bottom of the ProPak6

An Administrator has read/write access and the ability to change passwords, issue commands, upload files to the FTP server or upload new firmware.

A password can be up to a maximum of 28 characters/digits. The "admin" user name cannot be changed. Use the `SETADMINPASSWORD` command to change the default password.

Refer to the [OEM6 Firmware Reference Manual](#) - OM-20000129 for command details.

### 2.9.2 FTP Server and ICOM Ports

The FTP server is disabled by default. The `IPSERVICE FTP_SERVER` command is issued to enable or disable the FTP server port. Refer to *Section 3.7.1.5, Remote Retrieval of Logged Data* on page 60 for instructions on enabling the FTP port.

For security purposes, the `IPSERVICE SECURE_ICOM` command can also be used to enable password security on the ICOM ports. When security is enabled, the port refuses incoming commands until a valid User Name and Password are entered using the `LOGIN` command. Once logged in to an ICOM port, use the `LOGOUT` command to sign out of the connection and resecure the port. Refer to *Section 3.1.13.1, Configure COM 1, 2 and 3* on page 43 for further details.

Refer to the [OEM6 Firmware Reference Manual](#) - OM-20000129 for details on the `IPSERVICE` command.

## 2.10 Next Steps

Once the physical installation is complete and power is applied, various ports and radios need to be enabled and/or configured. Refer to the upcoming chapters for operation and configuration details.

Before operating the receiver for the first time, please ensure the installation instructions in *Chapter 2, Installation* starting on page 21 were followed.

## 3.1 Communications with the Receiver

Communication with the receiver typically consists of issuing commands through the communication ports from an external serial communications device. This could be either a terminal or a computer connected directly to the receiver serial port using a null-modem cable. If using an RTK radio, connect to the receiver's COM port by means of the radio serial cable. Familiarity with the commands and logs detailed in the [OEM6 Firmware Reference Manual](#) - OM-20000129 will ensure maximum utilization of the ProPak6 capabilities.

### 3.1.1 Communicating Using a Remote Terminal

One method of communicating with the receiver is through a remote terminal. The receiver is wired to allow proper RS-232 interface with the data terminal by default. It is possible to configure RS-422 communication (refer to *Section 3.1.13.1, Configure COM 1, 2 and 3* on page 43 for details). To communicate with the terminal, the receiver only requires the RX, TX and GND lines to be used. Handshaking is an option and is not required. Ensure the terminal's communications setup matches the receiver's RS-232 protocol. *Bluetooth*, Wi-Fi and Ethernet are also available. Refer to *Section 3.1.13, Serial Ports* on page 42 for additional information.

Refer to *Section 3.1.13, Serial Ports* on page 42 for details.

### 3.1.2 Communicating Using a Computer

A computer can be set up to emulate a remote terminal as well as provide the added flexibility of creating multiple command batch files and data logging storage files. Any standard communications software package that emulates a terminal can be used to establish bidirectional communications with the receiver, for example, HyperTerminal or NovAtel's graphic user interface (GUI) program, NovAtel Connect. All data is sent as raw 8-bit binary or ASCII characters.



Refer to *Section 3.3, Establishing a Receiver COM Connection* on page 45 for details.

### 3.1.3 Status Indicators

LED indicators on the front of the ProPak6 provide the status of the receiver. Some LEDs are user configurable and some are fixed.

### 3.1.3.1 User Configurable Status Indicators

Some of the LEDs on the ProPak6 front panel have configurable threshold settings that determine when the LED changes color and states. The user configurable LEDs are:

-  Satellite Tracking 1 and 2 (refer to *Section 3.1.8, Satellite Tracking and Positioning LEDs* on page 38 for LED status states)
-  GNSS Positioning 1 and 2 (refer to *Section 3.1.8, Satellite Tracking and Positioning LEDs* on page 38 for LED status states)
-  Data Logging (refer to *Section 3.7, Logging and Retrieving Data Overview* on page 58 for LED status states)

The `LEDCONFIG` command is used to configure a specific indicator LED. All configuration settings, except the two GNSS positioning LEDs, take two parameters: one value determines when the LED turns red and the other value determines when it turns amber (with the default setting outside the value range being green). Refer to the `LEDCONFIG` command in the [OEM6 Firmware Reference Manual](#) - OM-20000129 for details.

### 3.1.3.2 Fixed Status Indicators

The fixed LEDs are:

- Power (refer to *Section 3.2.1, Applying Power to the Receiver* on page 44 for LED states)
- INS (refer to *Section 3.1.7, INS and ALIGN LEDs* on page 37 for LED states)
- ALN (ALIGN/Heading) (refer to *Section 3.1.7, INS and ALIGN LEDs* on page 37 for LED states)
- COM 1, 2 and 3 (refer to *Section 3.1.4, COM Ports LEDs* on page 36 for LED states)
- Wi-Fi (refer to *Section 3.1.6, Wi-Fi LED* on page 37 for LED states)
- Bluetooth (refer to *Section 3.1.5, Bluetooth LED* on page 37 for LED states)
- USB Host (refer to *Section 3.1.10, Universal Serial Bus (USB) Port and LEDs* on page 40 for LED states)
- Cell (refer to *Section 3.1.9, Cell Port and LED* on page 40 for LED states)

### 3.1.4 COM Ports LEDs

The COM LEDs for COM1, 2 and 3 are on the front of the ProPak6. The LEDs indicates if data is in the process of being transmitted or received.



LED State COM1, COM2, COM3	Description
Off	no activity
Green (blinking)	RS-232 Transmitting data (Tx)
Red (blinking)	RS-232 Receiving data (Rx)
Green (solid)	RS-422 all states

Refer to the `LEDCONFIG` command in the [OEM6 Firmware Reference Manual](#) - OM-20000129 for additional details.

### 3.1.5 Bluetooth LED

The *Bluetooth* LED lights blue when the ProPak6 is enabled and powered. Refer to *Section 5.1, Bluetooth® Configuration* on page 82 for *Bluetooth* details.



LED State	Description
Off	<i>Bluetooth</i> radio is not powered
Blue (solid)	<i>Bluetooth</i> radio is powered

Use the `BLUETOOTHCONFIG` command to power the radio on or off (default off). Refer to the [OEM6 Firmware Reference Manual](#) - OM-20000129 for command details.

### 3.1.6 Wi-Fi LED

The *Wi-Fi* LED lights blue when the ProPak6 is enabled and powered. Refer to *Section 5.2, Wi-Fi Network Configuration* on page 84 for *Wi-Fi* details.



LED State	Description
Off	Wi-Fi radio is not powered
Blue (solid) <sup>a</sup>	Wi-Fi radio is powered

a. By default the radio is on and powered in AP mode.

Use the `WIFICONFIG` command to power the radio on or off (default off). Refer to the [OEM6 Firmware Reference Manual](#) - OM-20000129 for command details.

### 3.1.7 INS and ALIGN LEDs

The *INS* LED indicates the status of the Inertial Navigation System (INS); the *ALN* LED indicates the *ALIGN* heading status.

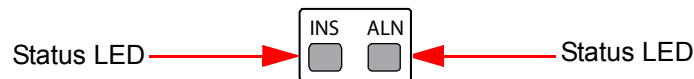



**Table 7: INS LED States**

LED State	Description
Off	INS disabled (GNSS only)
Off	INS enabled-no IMU detected
Red (solid)	INS inactive (IMU detected, no error)
Red (blinking)	IMU error (INS state not applicable)
Red/Amber (alternating)	INS determining orientation (IMU good)
Red/Amber (alternating)	INS waiting initial position
Green/Amber (alternating)	INS solution free
Amber (solid)	INS is aligning
Amber (blinking)	INS high variance
Green (solid)	INS solution good
Green (blinking)	INS alignment complete

**Table 8: ALN (ALIGN) LED States**

LED State	Description
Off	ALIGN is not operational <ul style="list-style-type: none"> <li>- Dual card is disabled or unavailable</li> <li>- Tracking &lt;4 satellites</li> <li>- Heading log not received/updated in 30 seconds</li> </ul>
Amber (solid)	ALIGN has FLOAT solution <ul style="list-style-type: none"> <li>- SOLTYPE_L1_FLOAT</li> <li>- SOLTYPE_NARROW_FLOAT or</li> <li>- SOLTYPE_WIDE_FLOAT</li> </ul>
Green (solid)	ALIGN has fixed solution <ul style="list-style-type: none"> <li>- SOLTYPE_L1_INT</li> <li>- SOLTYPE_NARROW_INT</li> </ul>

### 3.1.8 Satellite Tracking and Positioning LEDs

The Satellite tracking LEDs (  ) indicate the number of satellites being tracked (1 and 2); the Satellite position LEDs (  ) indicate the position of satellites (1 and 2).

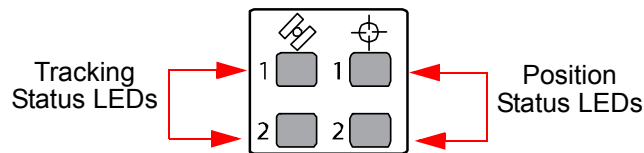
**Table 9: Satellite Tracking LEDs States (GPS and/or GNSS)**

LED State	Description
Off	Tracking 0 satellites
Red (solid)	Tracking 1 to 3 satellites
Amber (solid)	Tracking 4 to 5 satellites
Green (solid)	Tracking more than 5 satellites

Table 10: Satellite Position LEDs States

LED State	Description	Included Position Types
Off	No fix	- SOLTYPE_NONE
Amber (blinking) <sup>a</sup>	Single point	- SOLTYPE_SINGLE - SOLTYPE_INS_PSRSP
Amber (solid)	Converging accuracy	- SOLTYPE_L1_FLOAT - SOLTYPE_IONOFREE_FLOAT - SOLTYPE_NARROW_FLOAT - SOLTYPE_L1L2_FLOAT - SOLTYPE_INS_RTKFLOAT - SOLTYPE_INS_OMNISTAR - Unconverged - SOLTYPE_INS_OMNISTAR_HP - Unconverged - SOLTYPE_INS_OMNISTAR_XP - Unconverged - SOLTYPE_OMNISTAR_HP - Unconverged - SOLTYPE_OMNISTAR_XP - Unconverged - SOLTYPE_PROPAGATED - SOLTYPE_PPP_CONVERGING - SOLTYPE_INS_PPP_CONVERGING
Green (solid)	Converged accuracy	- SOLTYPE_INS_OMNISTAR - Converged - SOLTYPE_INS_OMNISTAR_HP - Converged - SOLTYPE_INS_OMNISTAR_XP - Converged - SOLTYPE_OMNISTAR_HP - Converged - SOLTYPE_OMNISTAR_XP - Converged - SOLTYPE_L1L2_INT - SOLTYPE_L1L2_INT_VERIFIED - SOLTYPE_L1_INT - SOLTYPE_WIDE_INT - SOLTYPE_NARROW_INT - SOLTYPE_RTK_DIRECT_INS - SOLTYPE_INS_RTKFIXED - SOLTYPE_PPP - SOLTYPE_INS_PPP - SOLTYPE_EXT_CONSTRAINED - SOLTYPE_FIXEDPOS
Green (blinking)	PSR/PDP using corrections	- SOLTYPE_PSR_DIFF - SOLTYPE_OMNISTAR - SOLTYPE_INS_SBAS - SOLTYPE_INS_PSRDIFF - SOLTYPE_CDGPS - SOLTYPE_FIXEDHEIGHT - SOLTYPE_FIXEDVEL - SOLTYPE_DOPPLER_VELOCITY - SOLTYPE_WAAS

a. When a OEM615 is used in a dual antenna configuration, the LED for GNSS2 only shows as off or amber.

Both the Satellite Tracking and Satellite Positioning LEDs are user configurable. Refer to the `LEDCONFIG` command in the [OEM6 Firmware Reference Manual](#) (OM-20000129) for details.

### 3.1.9 Cell Port and LED

The ProPak6 has a cellular antenna port to connect an external cellular antenna (TNC). An external antenna must be connected to this port in order to use the integrated cellular modem. Refer to *Section 5.3, Cellular Activation GSM/GPRS/HSDPA* on page 90 for activation and command instructions.

CELL  ← Status LED

**Table 11: CELL LED States**

LED State	Description
Off	Cellular not available
Red (solid)	No cellular signal
Red (blinking)	Error
Amber	Cellular network available-IP connectivity not available
Green (blinking)	Cellular activity (transmitting or receiving)
Green (solid)	Idle PDP context activated but not transmitting/receiving

 Ensure the cellular antenna is installed at least 30 cm away from the ProPak6 antenna or GNSS positioning accuracy may be degraded. Refer to *Figure 41, Bluetooth/Wi-Fi Antenna Keep-out Area and Antenna Location* on page 114 for details.

### 3.1.10 Universal Serial Bus (USB) Port and LEDs

NovAtel USB drivers are available for Microsoft Windows 2000, Windows XP, Windows Vista and Windows 7 to provide three virtual serial ports over a single USB 2.0 connection using the ProPak6's USB Device port. The USB drivers are digitally signed and officially supported on Microsoft Windows XP, Windows Vista and Windows 7. They can also be installed on Microsoft Windows 2000 and Windows Server 2003 but are not WHQL signed in those applications.

 A computer may have several USB ports. The assignment of COM port numbers is tied to a USB port on the computer. This allows receivers to be switched without Microsoft Windows assigning new COM ports. However, if the receiver is connected to a different physical USB port, Windows detects the receiver's presence and assigns three new COM port numbers by default.

The NovAtel USB Configuration Utility, installed with the NovAtel USB drivers, is used to change the COM port numbers assigned to the virtual serial ports. Refer to the NovAtel PC Utilities manual for instructions or check for updates to the drivers and release notes at [www.novatel.com/support](http://www.novatel.com/support).



### 3.1.10.1 USB Host LED

The ProPak6 can be configured to manually (default) or automatically download stored data when a memory stick is inserted into the USB Host port (Type A). Refer to *Section 3.7.1.3, Manual Retrieval of Logged Data* on page 60 for details on configuring the USB Host.

Once USB Host is connected, the LED changes to indicate the state.



LED State	Description
Off	No devices connected or an error has occurred
Red (solid)	Device is idle
Red (blinking)	Device is busy (active)

Refer to *Section 3.7.1.3, Manual Retrieval of Logged Data* on page 60 for details on configuring the USB Host.

### 3.1.10.2 USB Device

The USB Device port (Type micro-B) functions as three virtual serial ports.

A computer may have several USB ports. The assignment of COM port numbers is tied to a USB port on the computer. This allows receivers to be switched without Microsoft Windows assigning new COM ports. However, if the receiver is connected to a different physical USB port, Windows detects the receiver's presence and assigns three new COM port numbers.

### 3.1.11 Ethernet Port

The ProPak6 receiver is equipped with a 10-Base-T/100-Base-TX or 10/100 Mbps Ethernet port that supports IPv4 Internet layer, TCP/IP transport and telnet. Users can conduct remote debugging, accept MRTCA (modified RTCA) data and download firmware. The ProPak6 receiver is also equipped with NTRIP Version 2.0 (Networked Transport of RTCM via Internet Protocol) client and server capability.

The Ethernet port must be configured before using. Refer to *Chapter 4, Ethernet Configuration* on page 74 for configuration details.

The Ethernet ports are Safety Extra-Low Voltage (SELV) circuits only and are suitable for connection within a building only. Do not connect them to Telephone Network Voltage (TNV) circuits.

Issue the `SAVEETHERNETDATA ETHA` command to ensure port settings are retained after a reset and automatically used at boot time. The `SAVEETHERNETDATA ETHA` command is not applicable to the `ICOMCONFIG` and `NTRIPCONFIG` command settings. The `SAVEETHERNETDATA ETHA` command takes precedence over the `SAVECONFIG` command configuration.

The Ethernet port is the default port setting for internet access. If at any time the default is changed to Wi-Fi or Cellular, the `SETPREFERREDNETIF ETHA` command must be issued to return to using Ethernet for internet access. Refer to the [OEM6 Firmware Reference Manual](#) (OM-20000129) for command details.

### 3.1.12 ICOM Ports

ICOM ports are virtual ports. The ProPak6 has three shared ICOM ports for Ethernet, Wi-Fi and Cellular. The transport/application layer of the ICOM ports can be configured using Transmission Control Protocol (TCP) for internet IP or User Datagram Protocol (UDP) a slower and less reliable IP protocol. If using TCP, only one connection at a time is supported.

Although each port can be configured independently, the system only uses one DNS server at a time. Refer to `DNSCONFIG` command for Ethernet DNS and the `WIFICLICONFIG` command for configuring DNS for a static Wi-Fi network. (If using DHCP, DNS is automatically set.)

The following are the default ICOM configurations:

- `ICOMCONFIG ICOM1 TCP :3001`
- `ICOMCONFIG ICOM2 TCP :3002`
- `ICOMCONFIG ICOM3 TCP :3003`

Each ICOM port can act as a server (waiting for an external connection to be made) or as a client (actively establishing a connection to a specific port).

Refer to the [OEM6 Firmware Reference Manual](#) (OM-20000129) for details on the ICOM port commands `DNSCONFIG`, `IPCONFIG`, `ICOMCONFIG`, the `ETHCONFIG` command and the Wi-Fi `WIFICLICONFIG` command.

In this manual, refer to *Section 2.9.2, FTP Server and ICOM Ports on page 34* for details on securing ICOM ports.

### 3.1.13 Serial Ports

The receiver communicates with the computer or terminal via a serial port. For communication to occur, both the receiver and the operator interface must be properly configured. The ProPak6's COM1, COM2 and COM3 default port settings are as follows:

- 9600 bps, no parity, 8 data bits, 1 stop bit, no handshaking, echo off

**Table 12: Data Communication Port Defaults**

Connection Name	COM1	COM2	COM3
Connector location	Rear panel-COM1	Rear panel-COM2	Rear panel-COM3/IMU
Default configuration	RS-232	RS-232	RS-232
Alternate configuration	RS-422	RS-422	RS-422

The data transfer rate determines how fast information is transmitted. Take for example a log whose message byte count is 96. The default port settings allows 10 bits/byte (8 data bits + 1 stop bit + 1 framing bit). It therefore takes 960 bits per message. To get 10 messages per second then requires 9600 bps. Please also remember that even if you set the bps to 9600 the actual data transfer rate is lower and depends on the number of satellites being tracked, data filters in use, and idle time. It is therefore suggested that you leave yourself a margin when choosing a data rate (115200 is recommended for most applications).



Although the receiver can operate at data transfer rates as low as 300 bps, this is not desirable. For example, if several data logs are active (that is, a significant amount of information needs to be transmitted every second) but the bit rate is set too low, data overflows the serial port buffers, causing an error condition in the receiver status that results in lost data.

### 3.1.13.1 Configure COM 1, 2 and 3

COM1, COM2 and COM3/IMU can communicate using the RS-422 protocol in addition to the standard RS-232 protocol. On the ProPak6, the IMUCOM port is equivalent to COM3.

There are 2 ways to select between RS-232 and RS-422 protocol for the various ports (default is RS-232).

1. A Configuration Code obtained from NovAtel Customer Support can be installed in the receiver to select the protocol for COM1 and COM3/IMU independently.
2. The `SERIALPROTOCOL` command can be used to select RS-232 or RS-422 for any of the 3 COM ports. This method overrides the protocol set using the previous method.

The configuration code will configure the ports at boot time so the receiver may be loaded over the configured protocol.

For the `SERIALPROTOCOL` command method, commands are executed after the receiver has completed booting and so the communication lines are configured as RS-232 during boot. For automatic configuration, the `SERIALPROTOCOL` command can be saved using the `SAVECONFIG` command.



The `SERIALCONFIG` command is used to configure certain protocol settings when using either RS-232 or RS-422.

Refer to the [OEM6 Firmware Reference Manual](#) (OM-20000129) for command details.

## 3.1.14 I/O Port

### 3.1.14.1 Strobes

ProPak6 has configurable inputs and outputs, referred to as strobes, that provide status and synchronization signals. Refer to *Table 16, I/O Port Pin-Out Descriptions* on page 116 for details

Also refer to the *Chapter 4, Ethernet Configuration* on page 74 for details and to the `IOCONFIG`, `EVENTINCONTROL` and `EVENTOUTCONTROL` commands in the [OEM6 Family Firmware Reference Manual](#) (OM-20000129) for configuration and command details.

## 3.1.15 Expansion Port

The ProPak6 Expansion port supplies two CAN ports and a USB Host port which is reserved for future use. Refer to *Table 17, Expansion Port Pin-Out Description* on page 116 for details.

- CAN1
- CAN2
- USB Host (reserved for future use)

### 3.1.15.1 CAN Bus

The ProPak6 CAN Bus controller supports physical layer signals and low level messages specified in the appropriate sections of the J1939 and ISO11783 standards. Manufacturers can also create messages specific to their application without violating these standards. To facilitate manufacturer messages, NovAtel provides an Application Program Interface (API). To obtain information about the NovAtel API, contact [www.novatel.com/support](http://www.novatel.com/support).

The ProPak6 has two CAN ports: CAN1 and CAN2. Both CAN ports are brought out to the expansion port. CAN1 and CAN2 both support applications up to 1 Mbps.

CAN interfaces are accessed using NovAtel's API, but shared signals must be disabled to avoid conflicts. Refer to *Appendix A, Technical Specifications* on page 110 for further details.

Proper bus termination is required.



CAN Bus functionality is controlled through NovAtel's optional API software. The API header file includes documentation on using the CAN bus.

### 3.1.16 Antenna LNA Port

NovAtel antennas and coaxial cables meet receiver RF input gain requirements. NovAtel antennas are equipped with built-in LNAs that provide 26 dB of gain to the satellite signal received. The power to the antenna LNA is provided through the receiver's RF port center conductor. To achieve the required input gain to the receiver, NovAtel coaxial cables are designed to introduce no more than 10 dB loss. Antenna supply over current protection limits the LNA power. The ProPak6 provides +5 VDC  $\pm$ 5% at a maximum of 200 mA to the antenna connected to the ANT1 connector. If the ProPak6 is equipped with an ANT2 connector, the second antenna is provided with 5 VDC  $\pm$ 5% at a maximum current of 100 mA.

### 3.1.17 External Oscillator Port (model dependent)

For applications requiring greater precision than what is possible using the on-board Voltage Controlled, Temperature Compensated Crystal Oscillator (VCTCXO), the ProPak6 may be connected to an external, high stability oscillator, at 5 MHz or 10 MHz.

Connect a cable from the external oscillator to the receiver's external oscillator input connector (OSC). The receiver does not have to be powered down during this operation. The input impedance is 50 ohms.

When using the external oscillator, use the `EXTERNALCLOCK` command (refer to the [OEM6 Family Firmware Reference Manual-OM-20000129](#) for details) to set the clock type (e.g: cesium, rubidium or ovenized crystal) and frequency.



An external oscillator is not available for systems with the Heading functionality. On systems with the Heading feature, the port is used for the second GNSS antenna.

## 3.2 Getting Started

### 3.2.1 Applying Power to the Receiver

Connect the power supply to the power port. Once valid power is detected, the ProPak6 power LED briefly flashes red and then turns green as the ProPak6 enters Operational mode. Press the Power button or issue the `SOFTPOWER` command to power down the ProPak6.

Figure 14: Power Button

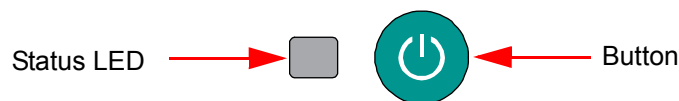

LED State	Description	Mode
Off (not lit)	No power connected	
Red (solid)	Power connected	brief pre-Operational mode
Green (solid)	Power on	Operational



The ProPak6 also automatically enters Operational mode if valid power is connected or if activity is detected on COM1, COM2 or COM3.

### 3.2.1.1 Power Down and Reset the ProPak6

If the ProPak6 button is pressed and held for period of time, the receiver shuts down or resets.

Button Press Time	Result	LEDs
Press and hold minimum 3 s and maximum 10 s	Power to the ProPak6 is turned off	After 3 s, Satellite tracking and GNSS positioning (1 and 2) LEDs = Amber (solid) When the button is released, these LEDs turn off.
Press and hold minimum 10 s and maximum 20 s	A FRESET (factory reset) of the ProPak6 is performed	Satellite tracking and GNSS positioning (1 and 2), IMU and ALN LEDs = Red (solid)
Press over 20 s	Button press aborted-ProPak6 returns to normal operation	Ignored

The ProPak6 can also be powered down by issuing the `SOFTPOWER` command which unmounts the internal flash storage to minimize the risk of losing data. Refer to [OEM6 Firmware Reference Manual](#) (OM-20000129) for details.



Ensure the ProPak6 is properly powered down before removing the power cord.

## 3.3 Establishing a Receiver COM Connection

To establish a new connection to the receiver, complete the following:

1. Launch Connect from the Start menu folder specified during the installation process. The default location is Start | All Programs | NovAtel PC Software | NovAtel Connect.
2. Select New Connection from the Welcome window.

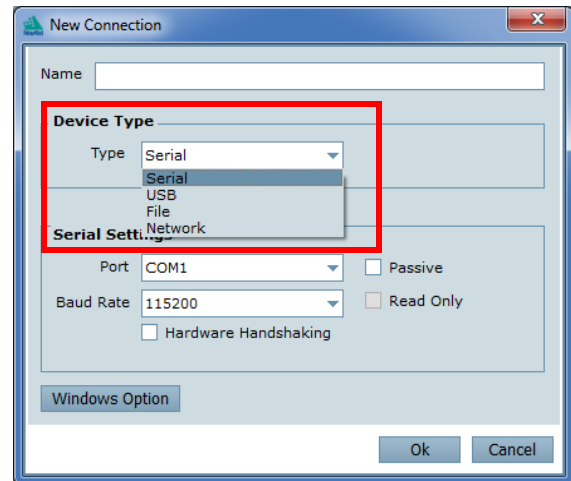
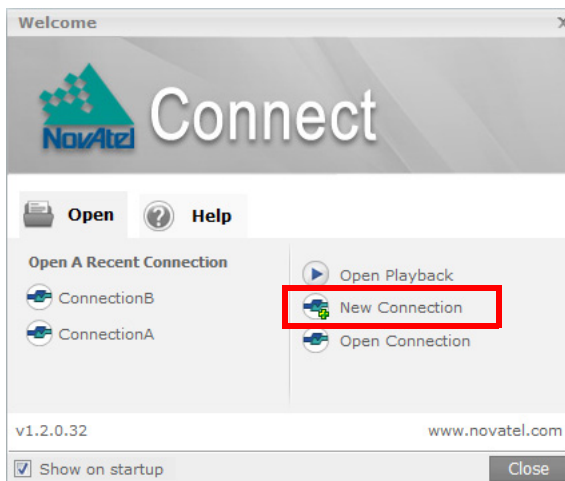

3. Enter a name for the connection.
4. Select Device Type to use to communicate from the drop list:
  - Serial - choose a COM port
  - USB - choose a COM port
  - Network - choose a receiver and define network settings
5. Click the OK button to save the new connection.



Detailed instructions for using NovAtel Connect are available from within the utility Help.

### 3.3.1 Communicating with the Receiver Using NovAtel Connect

Open the NovAtel Connect program and select Device | Open Connection from the main menu. The Open Connection window appears. Open an existing connection or create a New connection.

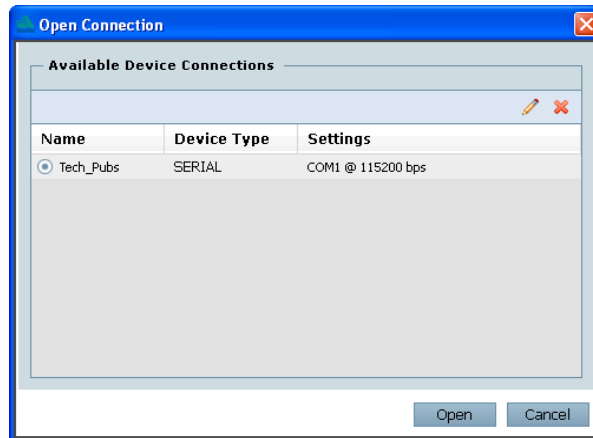

Refer to NovAtel Connect's Help (press F1, click on  icon or select the NovAtel button | Help). Ensure the Console and ASCII Messages windows are displayed (select from the View menu if necessary).

When the receiver is first turned on, no data is transmitted from the COM ports except for the port prompt. The Console window displays a port name:

*[COM1]* if connected to com1 port

*[COM2]* if connected to com2 port

or

*[COM3]* if connected to com3 port

Any of the COM port prompts indicate that the receiver is ready and waiting for command input. The screen may display other port names for other port types (e.g., USB1, USB2, USB3 or AUX).



1. Output from receiver self-tests may take some time. On startup, the ProPak6 receiver is set to log the RXSTATUSEVENTA log ONNEW on all ports. See *Section 8.4 RXSTATUSEVENT Log on page 107* for more details.
2. If NovAtel Connect is unable to locate the ProPak6 receiver, use a different COM port to communicate with the receiver. When communication has been established, issue a `FRESET STANDARD` command. The original communications port should be ready for use.
3. XCOM1, XCOM2 and XCOM3 virtual ports can be generated by the receiver. However, they are unlikely to appear as a port prompt as you cannot connect to these types of ports using NovAtel Connect. Also, the XCOM ports are not available with the `SERIALCONFIG` command but may be used with other commands, such as `INTERFACEMODE` and `LOG`. Refer to the [OEM6 Family Firmware Reference Manual](#) (OM-20000129) for details on the virtual ports.

An example of a response to an input `FIX POSITION` command:

```
[COM2] FIX POSITION 51.11635 -114.0383 1048.2 [carriage return]
```

```
<OK
```

In this example, *[COM2]* is the port prompt.

This example illustrates command input to the base receiver's COM2 port that sets the position of the base station receiver for differential operation.

If the command was accepted, the receiver responds with:

```
<OK
```

If a command is entered incorrectly, the receiver responds with:

<ERROR:Invalid Message ID

(or a more detailed message)



Ensure the computer does not sleep or hibernate during a logging session or data will be lost.

### 3.4 Transmitting and Receiving Corrections

Corrections can be transmitted from a base station to a rover station to improve position accuracy. The base station is the GNSS receiver that acts as the stationary reference. The stationary reference has a known position and transmits correction messages to the rover station. The rover station is the GNSS receiver that does not know its exact position and requires correction messages from a base station to calculate differential GNSS positions.

**Figure 15: Basic Differential Setup**

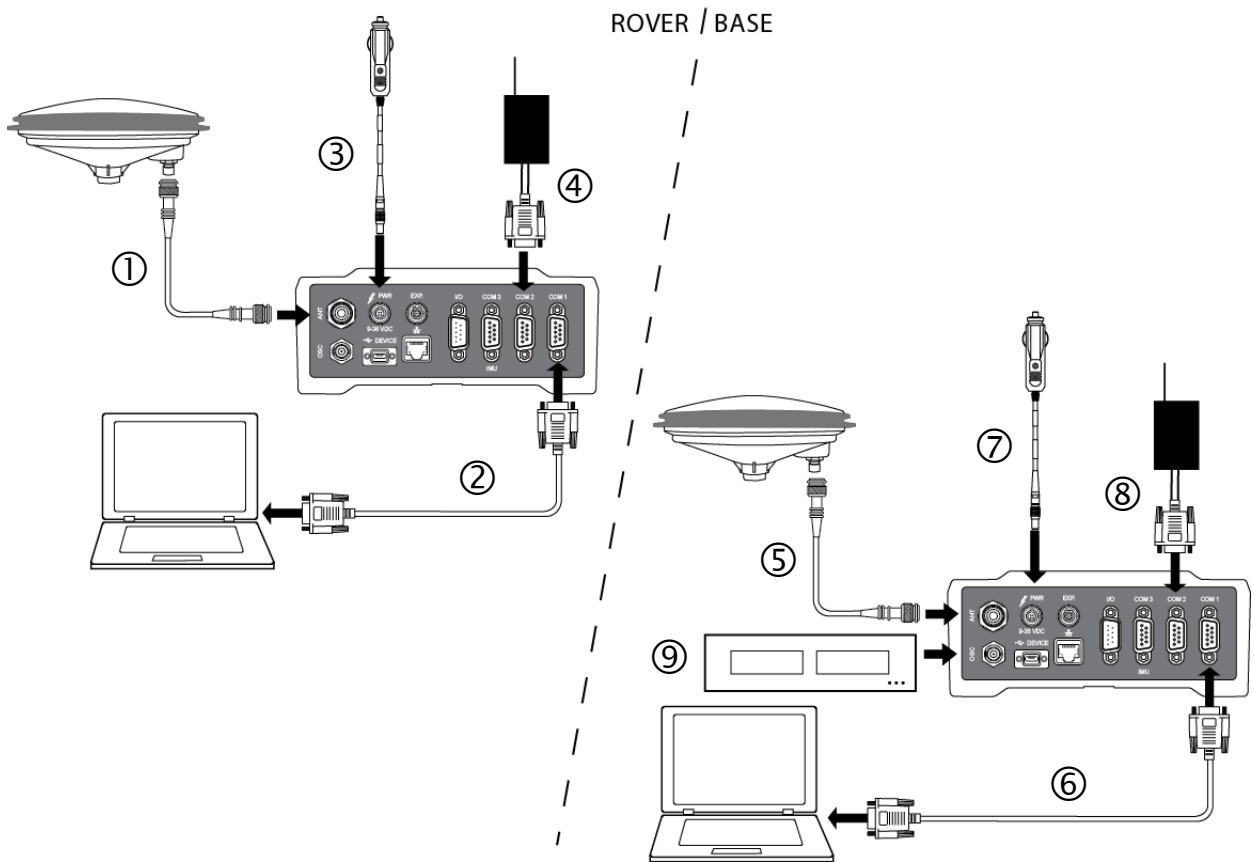

**Use a ProPak6 receiver for the Rover Station**

1. Connection a GNSS antenna
2. Connect a computer to COM1
3. Connect a power supply
4. Connect a user supplied radio device to COM2

**Use a ProPak6 receiver for the Base Station**

1. Connection a GNSS antenna
2. Connect a computer to COM1 for setup and monitoring
3. Connect a power supply
4. Connect a user supplied radio device to COM2
5. Connect an external oscillator (optional) to the OSC port.

For information on positioning errors and the application of corrections for them, refer to the application note [APN-051 Positioning Modes of Operation](#), available at [www.novatel.com/support/search/](http://www.novatel.com/support/search/). To receive corrections with a base/rover setup, a data link between the base station and the rover station is required. The base and rover stations can both be NovAtel receivers, however NovAtel receivers will work with some other brands. Contact Customer Support for further details (refer to *Customer Support on page 15* for details).

The data link should support a rate of at least 19200 bits per second, but a rate of 115200 bits per second, with less than 4.0 s latency, is recommended. Unlike the base/rover concept, SBAS and L-Band corrections can be applied directly to a single receiver.

When your base and rover are set up, configure them as shown in the configuration examples in *Sections 3.5* and *3.5.1*.

### 3.4.1 Defining Antenna and Base Antenna

The type of the antenna and/or the remote base receiving the corrections can be defined using the `THISANTENNATYPE` and `BASEANTENNATYPE` commands respectively.

The Phase Center Variation (PCV) and the Phase Center Offset (PCO) for each can also be specified using the `THISANTENNAPCV` and `THISANTENNAPCO` or the `BASEANTENNAPCV` or `BASEANTENNAPCO` commands.

Refer to the [OEM6 Firmware Reference Manual](#) (OM-20000129) for command details.

### 3.4.2 Base Station Configuration



For ProPak6 Dual model configurations being used as a base station, issue `DUALCARDCONFIG DISABLE` to stop dual card functionality and increase RTK accuracy. Issue `DUALCARDCONFIG ENABLE` to return the ProPak6 to dual card functionality.

At the base station, enter the following commands:

```
interfacemode port rx_type tx_type [responses]
fix position latitude longitude height          (enter your own lat, long and hgt values)
log port message [trigger [period]]          (port = COM2 / refer to Figure 15 above)
saveconfig                                     (optional)
```

For example:

#### RTK Automated Correction Generation

```
fix position lat lon hgt                      (enter your own lat, lon, hgt)
generatertkcorrections rtcm3 com2
```

#### RTCA

```
interfacemode com2 none rtca off
fix position lat lon hgt                      (enter your own lat, lon, hgt)
log com2 rtcaobs2 ontime 1                   (works with both GPS and GPS + GLONASS models)
log com2 rtcaref ontime 10
log com2 rtca1 ontime 5                      (optional, enable code-DGPS coverage)
log com2 rtcaephem ontime 10 1              (optional)
saveconfig                                    (optional)
```

#### RTCM V2.3

```
interfacemode com2 none rtcm off
fix position lat lon hgt                      (enter your own lat, lon, hgt)
log com2 rtcm3 ontime 10
log com2 rtcm22 ontime 10 1
log com2 rtcm1819 ontime 1
log com2 rtcm1 ontime 5                      (optional)
savconfig                                    (optional)
```



**RTCM V2.3 with GLONASS**

```

interfacemode com2 none rtcm off
fix position lat lon hgt (enter your own lat, lon, hgt)
log com2 rtcm1 ontime 5 (optional, GPS PSRDIFF)
log com2 rtcm3 ontime 10
log com2 rtcm22 ontime 10 1
log com2 rtcm31 ontime 5 1 (optional, GLONASS PSRDIFF)
log com2 rtcm32 ontime 10 2
log com2 rtcm1819 ontime 1
saveconfig (optional)

```

**RTCM V3**

```

interfacemode com2 none rtcmv3 off
fix position lat lon hgt (enter your own lat, lon, hgt)
log com2 rtcm1002 ontime 1 (for L1 only models)
log com2 rtcm1004 ontime 1 (for L1/L2 models)
log com2 rtcm1006 ontime 10
log com2 rtcm1019 ontime 120
saveconfig (optional)

```

**RTCM V3 with GLONASS**

```

interfacemode com2 none rtcmv3 off
fix position lat lon hgt (enter your own lat, lon, hgt)
log com2 rtcm1002 ontime 1 (for L1 only models)
log com2 rtcm1004 ontime 1 (for L1/L2 models)
log com2 rtcm1010 ontime 1 (for L1 only models)
log com2 rtcm1012 ontime 1 (for L1/L2 models)
log com2 rtcm1006 ontime 10
log com2 rtcm1033 ontime 10
log com2 rtcm1019 ontime 120
log com2 rtcm1020 ontime 120
saveconfig (optional)

```

**CMRPLUS (CMR+)**

```

interfacemode com2 none cmr off
fix position lat lon hgt (enter your own lat, lon, hgt)
log com2 cmrobs ontime 1
log com2 cmrglobs ontime 1
log com2 cmrplus ontime 1 (important to use ontime 1 with cmrplus)
saveconfig (optional)

```

**CMR**

```

interfacemode com2 none cmr off
fix position lat lon hgt (enter your own lat, lon, hgt)
log com2 cmrobs ontime 1
log com2 cmrglobs ontime 1
log com2 cmrref ontime 10
log com2 cmrdesc ontime 10 1 (optional)
saveconfig (optional)

```

**NOVATELX**

```

interfacemode com2 none novatelx off
fix position lat lon hgt (enter your own lat, lon, hgt)
log com2 novatelxobs ontime 1
saveconfig (optional)

```

### 3.4.3 Rover Station Configuration

At the rover station, enter the following commands:

```
interfacemode port rx_type tx_type [responses]
```

For example, if COM2 was connected to the correction source:

#### RTK Automated Correction Detection

```
interfacemode com2 auto none off
```

#### RTCA

```
interfacemode com2 rtca none off
```

#### RTCAOBS2

```
interfacemode com2 rtca none off
```

#### RTCM V2.3

```
interfacemode com2 rtkcm none off
```

#### RTCM V3

```
interfacemode com2 rtkcmv3 none off
```

#### RTCM V3 with GLONASS

```
interfacemode com2 rtkcmv3 none off
```

#### CMR+

```
interfacemode com2 cmr none off
```

#### CMR

```
interfacemode com2 cmr none off
```

(same as CMR+)

#### NOVATELX

```
interfacemode com2 NOVATELX none off
```

## 3.5 External ALIGN Master or Rover Configuration Only



The ProPak6 product is a dual card enclosure that can provide an ALIGN solution without additional receivers. This section is for applications that require additional rover receivers.

This section provides instructions for setting up an external master station with additional ALIGN capable rover receivers for applications requiring heading output. Refer to [APN-048 ALIGN Overview and Setup](#), at [www.novatel.com/support/search/](http://www.novatel.com/support/search/).

#### Automatic Set Up for Direct-Wire Connection between Master and Rover via COM2

```
alignautomation enable
```

or

```
alignautomation enable com2 230400 10 on
```

## Manual Set Up via COM2

### Master:

```
interfacemode com2 novatel novatelx off
movingbasestation enable
log com2 novatelxobs ontime 1
log com2 novatelxref ontime 1
log headinga onnew
log gphdt onnew
```

### Rover:

```
interfacemode com2 novatelx novatel off
log com2 headingext2b onnew
log headinga onnew
log gphdt onnew
hdtoutthreshold 1.0
```

### 3.5.1 PDP and GLIDE™ Configurations

Pseudorange/Delta-Phase (PDP) and GLIDE position filters can be used for single-frequency single point, WAAS or DGPS positioning. Refer to the `PDPFILTER` and `PDPMODE` commands in the [OEM6 Family Firmware Reference Manual](#) (OM-20000129).

To reset the PDP or GLIDE filter:

```
pdpfilter reset
```

To enable the PDP filter:

```
pdpfilter enable
```

Ensure the `PDPFILTER` command is used before the `PDPMODE` command. Set the PDP type and kinematic type according to the application. For most kinematic applications:

```
pdpmode relative dynamic or pdpmode relative auto
```

The rest of the setup is position type and log dependent according to the application. For example, details of the `RTKSOURCE`, `PSRDIFFSOURCE`, `INTERFACEMODE`, `SERIALCONFIG` and other configuration commands are outlined in the [OEM6 Family Firmware Reference Manual](#) (OM-20000129). Also refer to the NovAtel application note [APN-038 Pseudorange/Delta-Phase \(PDP\) and GLIDE](#) available from [www.novatel.com/support/search/](http://www.novatel.com/support/search/).

## 3.6 STEADYLINE®

The STEADYLINE functionality helps mitigate the discontinuities that often occur when a GNSS receiver changes positioning modes. The effect is especially evident when a receiver transitions from an RTK position mode solution to a lower accuracy “fall back” solution, such as NovAtel CORRECT PPP, DGPS, WAAS+GLIDE or even autonomous GLIDE (see *Figure 16, Positioning Change Without STEADYLINE*). Smooth transitions are particularly important for agricultural steering applications where sudden jumps are problematic.

### Figure 16: Positioning Change Without STEADYLINE

The STEADYLINE feature internally monitors the position offsets between all the positioning modes present in the receiver. When the current positioning mode becomes unavailable, the receiver transitions to the next most accurate positioning mode.

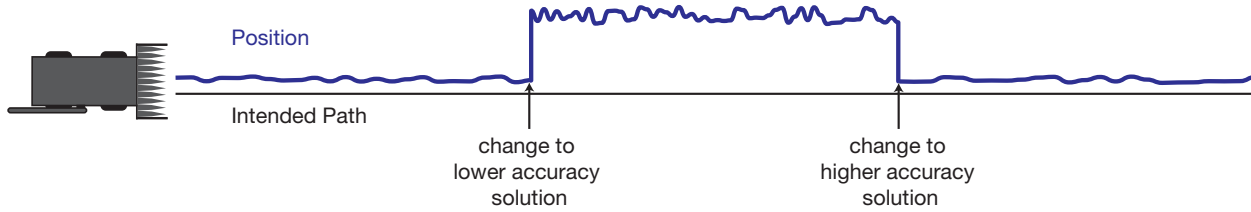

The setting in the `STEADYLINE` command determines how the receiver transitions to the next positioning mode. The following sections describe the `STEADYLINE` modes.



For more information about the `STEADYLINE` command, refer to the [OEM6 Family Firmware Reference Manual](#) (OM-20000129).

### 3.6.1 Maintain

When the receiver transitions to a different positioning mode, it maintains the position offset calculated to limit a potential real position jump. The receiver continues to apply the position offset to all positions calculated in the new positioning mode.

Figure 17: STEADYLINE Maintain

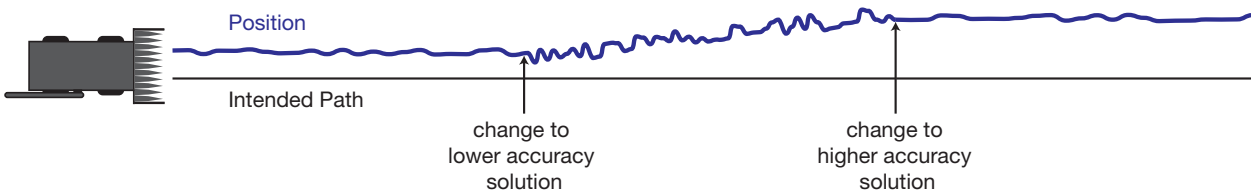

### 3.6.2 Transition

When the receiver transitions to a different positioning mode, the position offset is applied to the calculated position to limit a potential real position jump. The position then slowly transitions to the new reference position type over a specified period of time. This time period is specified by the Transition time parameter in the `STEADYLINE` command.

Figure 18: STEADYLINE Transition

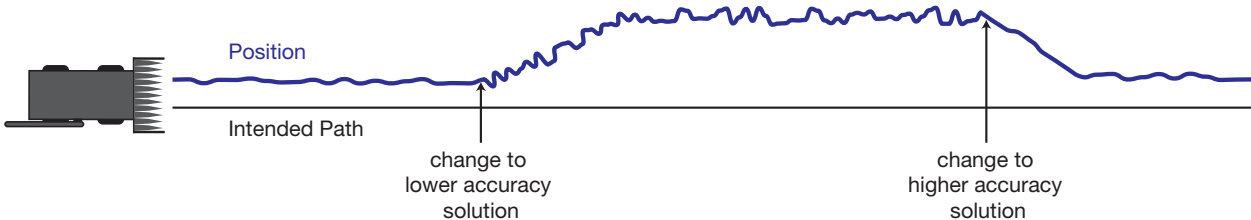

### 3.6.3 Prefer Accuracy

The positioning mode change depends on the accuracy level of the positioning modes.

When the position mode is changing from a more accurate mode to a less accurate mode (e.g., changing from RTK to GLIDE), the receiver uses the Maintain option.

When the position mode is changing from a less accurate mode to a more accurate mode (e.g., GLIDE to RTK), the receiver uses the Transition option.

For example, a receiver is configured to do both RTK and GLIDE. If this receiver has a fixed RTK position and experiences a loss of correction data causing the loss of the RTK solution it will immediately apply the offset between the two position modes and uses the GLIDE position stability to maintain the previous trajectory. Over time the GLIDE (or non-RTK) position will experience some drift. Once the RTK position is achieved again the receiver will start using the RTK positions for position stability and will slowly transition back to the RTK positions at a default rate of 0.005 m/s or the time specified in the STEADYLINE command.

**Figure 19: STEADYLINE Prefer Accuracy**

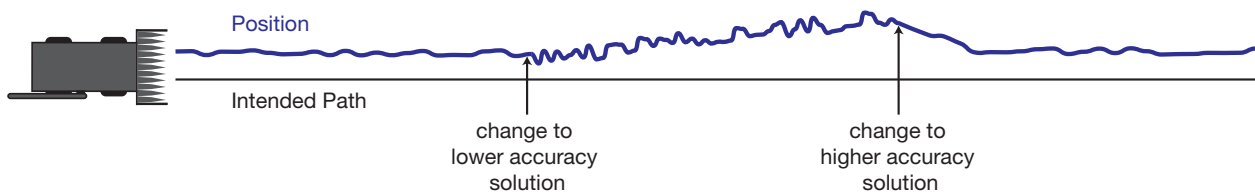

### 3.6.4 UAL



UAL mode will not function unless UALCONTROL is enabled using the UALCONTROL command.

The STEADYLINE mode used depends on the BESTPOS and GPGLA solution types.

When the solution type is OPERATIONAL, the receiver uses the Maintain option.

When the solution type is WARNING, the receiver uses the Prefer option. When the receiver changes from WARNING to OPERATIONAL, it will continue to use the Prefer option until any existing offset is gone.

When the solution type is OUT\_OF\_BOUNDS, the STEADYLINE feature is disabled.

The thresholds used to determine the solution type (OPERATIONAL, WARNING or OUT\_OF\_BOUNDS), can be specified using the UALCONTROL command. Refer to the [OEM6 Family Firmware Reference Manual](#) (OM-20000129) for more information.

Figure 20, STEADYLINE UAL- Warning Limit Example on page 54 and Figure 21, STEADYLINE UAL - Out of Bounds Example on page 54 show an examples of STEADYLINE using the UAL mode.

Figure 20: STEADYLINE UAL- Warning Limit Example

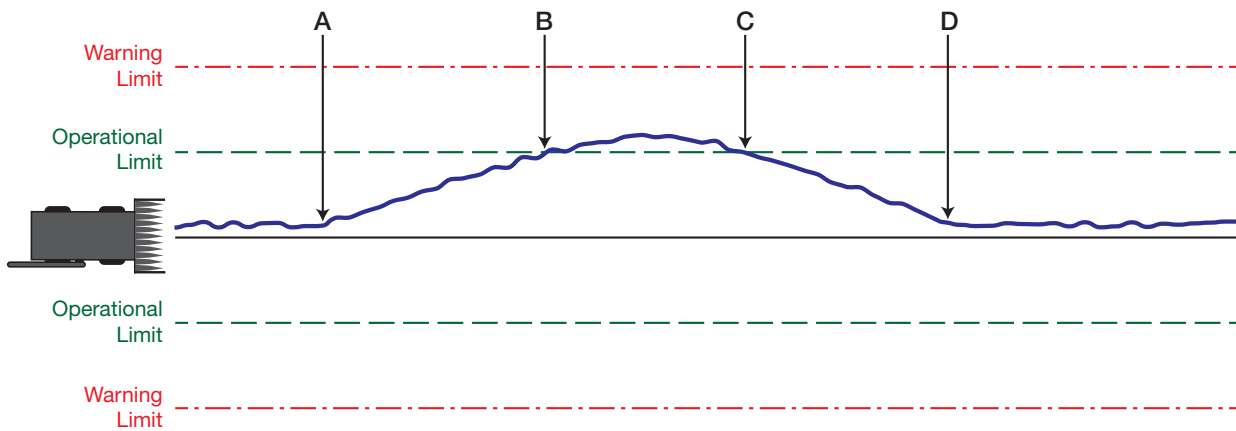

- A** Position type is OPERATIONAL.  
Higher accuracy corrections are lost. The receiver changes to a lower accuracy solution. STEADYLINE operates in Maintain mode while the solution accuracy remains within the Operational limit.
- B** The solution accuracy exceeds the operational limit. The position type changes to WARNING. The STEADYLINE mode changes from Maintain to Prefer.
- C** The solution accuracy moves back within the operational limit. The position type changes to OPERATIONAL. The STEADYLINE mode remains in Prefer mode.
- D** The solution offset is removed. The STEADYLINE mode changes from Prefer to Maintain.

Figure 21: STEADYLINE UAL - Out of Bounds Example

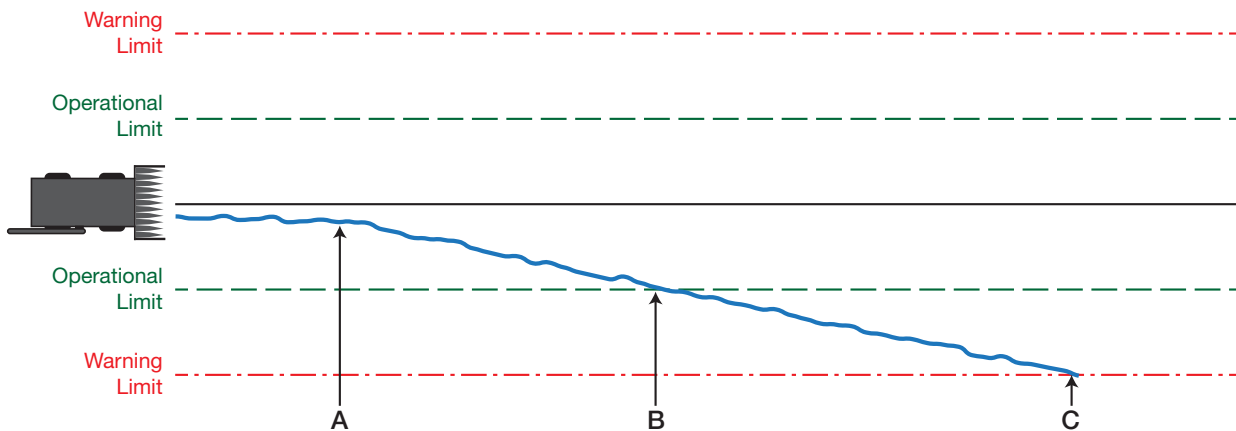

- A** The position type is OPERATIONAL.  
Higher accuracy corrections are lost. The receiver changes to a lower accuracy solution. STEADYLINE operates in Maintain mode while solution accuracy remains within the Operational limit.
- B** The solution accuracy exceeds the operational limit. The position type changes to WARNING. The STEADYLINE mode changes from Maintain to Prefer.
- C** The solution accuracy exceeds the warning limit. The position type changes to OUT\_OF\_BOUNDS. STEADYLINE is disabled.

### 3.6.5 Configuration Notes

For compatibility with other GNSS receivers and to minimize message size, use the standard form of RTCA, RTCM, RTCMV3, CMR+ or CMR corrections shown in the base and rover examples above. This requires using the `INTERFACEMODE` command to dedicate one direction of a serial port to one message type only. When the `INTERFACEMODE` command is used to change the mode from the NOVATEL default, the NovAtel format messages can no longer be used.

To mix NovAtel format messages and RTCA, RTCM, RTCMV3 or CMR messages on the same port, leave the interface mode set to NOVATEL and log out variants of the standard correction messages with a NovAtel header. ASCII or binary variants can be requested by appending an A or B to the standard message name. For example, on the base station:

```
interfacemode com2 novatel novatel
fix position 51.11358042 -114.04358013 1059.4105
log com2 rtcaobs2b ontime 2
```



1. Interface mode must be set to NOVATEL for the receiver to issue logs with an A or B suffix.
2. Using the receiver in NOVATEL mode consumes more CPU bandwidth than using the native differential messages as shown in *Section 3.4.1, Defining Antenna and Base Antenna on Page 48*.
3. To find information on how to send multiple commands and log requests using DOS or Windows, search our knowledge database at [www.novatel.com/support/search/](http://www.novatel.com/support/search/).

At the rover, leave the interface mode default settings (`interfacemode com2 novatel novatel`). The rover recognizes the default and uses the corrections it receives with a NovAtel header.

The `PSRDIFFSOURCE` and `RTKSOURCE` commands set the station ID values that identify the base stations to accept pseudorange or RTK corrections from. They are useful commands when the rover station is receiving corrections from multiple base stations.

At the base station, log the contents of the standard corrections in a form that is easier to read. These larger variants have the correction fields broken out into standard types in the log, rather than compressed into bit fields. This can be useful to modify the format of the corrections for a non-standard application or to look at the corrections for system debugging purposes. These variants have DATA in their names (e.g., `RTCADATA1`, `RTCMDATA1`, `CMRDATAOBS`). Refer to the [OEM6 Family Firmware Reference Manual](#) (OM-20000129) for more information.

### 3.6.6 Enabling SBAS Positioning

The ProPak6 is capable of SBAS positioning. This positioning mode is enabled using the `SBASCONTROL` command:

```
sbascontrol enable auto
```

When the command is entered, the ProPak6 automatically tracks the SBAS that is operating in the region (e.g., WAAS or EGNOS) and applies the corrections from the service. On a simulator, leave the test mode parameter off or specify NONE explicitly. For more on SBAS, refer to the NovAtel application note [APN-051 Positioning Modes of Operation](#) available from our website [www.novatel.com/support/search/](http://www.novatel.com/support/search/).

### 3.6.7 Enabling L-Band

L-Band equipped receivers can achieve sub-metre position accuracy using correction data received from geostationary satellites. To use the L-Band corrections, an L-Band-capable receiver model and antenna are required (refer to our web site [www.novatel.com/products/gnss-antennas](http://www.novatel.com/products/gnss-antennas) for information on NovAtel L-Band-capable antennas).

For more information on L-Band positioning, refer to:

- NovAtel Application Notes: APN-061 NovAtel CORRECT with TerraStar, APN-062 NovAtel CORRECT with Veripos (service dependent) or APN-051 Positioning Modes of Operation available from [www.novatel.com/support/search/items/Application%20Note](http://www.novatel.com/support/search/items/Application%20Note)
- the [OEM6 Family Firmware Reference Manual](#) (OM-20000129) for log/command details and/or
- visit [www.novatel.com/support](http://www.novatel.com/support)
- visit [www.novatel.com/products/novatel-correct](http://www.novatel.com/products/novatel-correct)



OEM615, OEM617, OEM617D and FlexPak6D are not L-Band capable.

#### TerraStar Subscriptions

A subscription is required to use the TerraStar service for land, airborne and near shore applications. Near shore applications are defined as vessels operating within 10 km of shore. To obtain a subscription, contact your local NovAtel sales representative or visit [www.novatel.com/products/terrastar-gnss-corrections](http://www.novatel.com/products/terrastar-gnss-corrections). The receiver's TerraStar Product Activation Code (PAC) or the NovAtel product serial number (PSN) is needed to obtain a subscription. To obtain the receiver-specific PAC, enter the following command:

```
log terrastarinfo
```

This log displays the PAC in the first field following the log header and also displays the status of your subscription.

To activate a subscription, the receiver must be powered and tracking an L-Band TerraStar satellite prior to the planned activation time. Use the `ASSIGNLBANDBEAM` command to configure the receiver to track the TerraStar satellite.

To confirm tracking of an L-Band signal, log the L-Band tracking status information by entering the following command:

```
log lbandtrackstata
```

If receiving TerraStar service, the sixth field following the header (tracking status word) of the `LBANDTRACKSTAT` log will be `00c2`, as shown in the following example:

```
#lbandtrackstata,com1,0,73.5,finesteering,1769,328196.000,00000000,29fd,12602:
1,"98w",1539902500,1200,974c 00c2,0, 316.186,43.842,4.3840,61.920,1088,2,2,
138176,79,0.0001*3e43cb7d
```



The latest services and coverage can be obtained from [www.terrastar.net](http://www.terrastar.net). For additional information on TerraStar activation, contact NovAtel Customer Service at [www.novatel.com/support](http://www.novatel.com/support) or download the APN-061 NovAtel CORRECT with TerraStar from: [www.novatel.com/support/search/items/Application%20Note](http://www.novatel.com/support/search/items/Application%20Note)



## Veripos Subscriptions



Subscriptions to the Veripos Apex and Apex<sup>2</sup> marine services must be obtained directly from Veripos. A unit with a marine subscription can not be switched to a land subscription and vice versa.

A subscription is required to use the [Veripos services](#) for offshore marine applications. Contact Veripos sales at [www.veripos.com/support.html](http://www.veripos.com/support.html) to obtain a Service Access License (SAL) number. To activate the service, contact the Veripos Help Desk at +44 (0) 1224 527 104 or visit [www.veripos.com/support.html](http://www.veripos.com/support.html). Provide the SAL number and the receiver's Veripos Serial Number (VSN). To obtain the receiver-specific VSN, enter the following command:

```
log veriposinfo
```

The log displays the VSN in the first field following the log header and also displays the status of your subscription.

To activate a subscription, the receiver must be powered and tracking an L-Band Veripos satellite prior to the planned activation time. Use the `ASSIGNLBANDBEAM` command to configure the receiver to track the Veripos satellite.



The latest services and coverage can be obtained from [www.veripos.com](http://www.veripos.com). For additional information on Veripos activation, contact NovAtel Customer Service at [www.novatel.com/support](http://www.novatel.com/support) or download the APN-062 NovAtel CORRECT with Veripos from: [www.novatel.com/support/search/items/Application%20Note](http://www.novatel.com/support/search/items/Application%20Note)

## OmniSTAR<sup>®</sup>



OmniSTAR service is not supported for OEM6 products sold after October 24, 2013. If unsure whether the receiver is OmniSTAR capable, contact NovAtel Sales at [www.novatel.com/where-to-buy/sales-offices](http://www.novatel.com/where-to-buy/sales-offices), NovAtel Customer Support at [www.novatel.com/support](http://www.novatel.com/support) or visit [www.novatel.com/products/novatel-correct](http://www.novatel.com/products/novatel-correct).

A subscription is required to use the OmniSTAR service. To obtain a subscription, contact OmniSTAR at 1-888-883-8476 or 713-785-5850. Provide the receiver's OmniSTAR serial number (which is different from the NovAtel serial number). To obtain the OmniSTAR serial number, enter the following command:

```
log lbandinfo
```

The log displays the L-Band serial number in the fifth field following the log header. The log also provides the status of your subscription. Refer to the LBANDINFO log in the [OEM6 Family Firmware Reference Manual](#) (OM-20000129) for more information.

To activate the subscription, the receiver must be powered and tracking an L-Band satellite. When advised by OmniSTAR of the appropriate satellite frequency and data link rate for your location, use the `ASSIGNLBAND` command to configure your receiver.



The latest frequencies can be obtained from: [www.omnistar.com](http://www.omnistar.com).

Example:

```
assignlband omnistar 1557855 1200
```

To confirm tracking of an L-Band signal, log the L-Band status information by entering the following command:

```
log lbandstat
```

If receiving OmniSTAR HP, the fifth field of the LBANDSTAT log should be 00c2, as shown in the following example:

```
lbandstat com1 0 81.0 finesteering 1596 235136.000 00000000 d1c2 5968
<1557854678 48.98 1098.9 0.00 00c2 0000 153860 545 0 0000 0201 154019
68000000 00000000
```

Refer to the NovAtel application note [APN-051 Positioning Modes of Operation](#) for OmniSTAR specifics.

### 3.7 Logging and Retrieving Data Overview

Data can be collected for post-processing and stored directly on the internal flash memory of the ProPak6 (4 GB total). Data logging can be initiated manually from the ProPak6 or remotely from a computer using a variety of communication protocols.

Data can be retrieved from the ProPak6 onboard memory for post-processing manually at the ProPak6 or remotely using a variety of methods.

Manual Logging Initiation	Remote Logging Initiation
- Press the Log button on the ProPak6 (refer to <a href="#">Section 3.7.1.1, Manual Logging Initiation on page 59</a> )	- ICOM port via either Ethernet or Wi-Fi - COM1/COM2/COM3/USB1/USB2/USB3 (refer to <a href="#">Section 3.7.1.2, Remote Logging Initiation on page 60</a> )
Manual Retrieval of Logged Data	Remote Retrieval of Logged Data
- USB Host (memory stick) (refer to <a href="#">Section 3.7.1.3, Manual Retrieval of Logged Data on page 60</a> )	- FTP via either Ethernet or Wi-Fi (refer to <a href="#">Section 3.7.1.5, Remote Retrieval of Logged Data on page 60</a> )



If ICOM port security is enabled (using the `IPSERVICE` command), commands are refused until the `LOGIN` command is issued. Refer to [Section 2.9, ProPak6 Security on page 34](#) and the [OEM6 Family Firmware Reference Manual](#) (OM-20000129) for command details.

The following are the main steps used to perform logging tasks.

- Determine the data to log
- Set the trigger and data rate of each in the `LOG` command
- Specify a port after `LOG` but prior to the specific message to log data to the specified port (if no port specified, data is output to the console or ascii message windows)
- Stop logging in two ways:  
`UNLOG [PORT] [LOGNAME]`  
`UNLOGALL` (stops all logging activity)

Refer to the following sections for detailed instructions on performing logging tasks.

#### Naming Log Files

File names for logs saved to onboard storage can be specified manually or the ProPak6 can be set to automatically name files.

#### Manual Log File Naming

Use NovAtel Connect or HyperTerminal to name logged files. If the file name entered already exists, the command returns an error. Use the `LOGFILESTATUS` log to view errors, determine if a log file is open or closed or if the internal storage device is busy.

### Automatic Log File Naming

If a name is not supplied for a logged file, one is automatically generated based on the PSN of receiver and an automatically incrementing number beginning at one. If a log in the sequence number is deleted, the number is recycled for use in order.

### 3.7.1 Onboard Data Storage

The ProPak6 contains 4 GB of memory for onboard data storage. Data can be logged to internal memory and downloaded for post-processing in a variety of ways.

To begin logging:

- Issue the LOGFILE OPEN command or press the Logging button
- A log file must be open for logs to be recorded
- Only one logging file can be open at a time
- Logs collected unchanged are not output until there is a change to the content
- Use the Status LED or the LOGFILESTATUS log to monitor logging status
- The DIRENT log contains a list of the file contents currently in the onboard memory

#### 3.7.1.1 Manual Logging Initiation

Required log requests must be saved to the NVM prior to logging start.

Example:

```
LOG FILE VERSIONA
LOG FILE RANGE1 ONTIME1
LOG FILE BESTPOSB ONTIME1
SAVECONFIG
```

Logging can be initiated by pressing the Logging button. Logged data is stored in the ProPak6 onboard, internal flash memory.

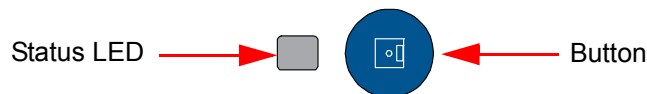

LED State (default)	Description
Green (solid)	Internal memory capacity >40% to within ±0.5%
Amber (solid)	Internal memory capacity between 20 and 40% to within ±0.5%
Red (solid)	Internal memory capacity >20% to within ±0.5% Also, when downloading files via the USB Host when connected on the front of the ProPak6
Green (blink)	Logging as 1 Hz and file is currently open
Green/Amber alternate	System busy (internal setup)
Off	No activity-button not pressed

 The capacity indication level for the Logging LED can be configured using the LEDCONFIG command. Refer to the [OEM6 Family Firmware Reference Manual \(OM-20000129\)](#) for command details.

Pressing the Log button () automatically issues the LOGFILE OPEN or LOGFILE CLOSE commands (the open/close log status toggles between the two states).



A maximum of 256 files can be stored (depending on individual file sizes). For further details about file system limitations, consult the FAT32 standards from MicroSoft.

### 3.7.1.2 Remote Logging Initiation

Once a Wi-Fi or Ethernet connection is established, send the `LOGFILE OPEN` command and specify `FILE` as the output port when issuing `LOG` commands to begin logging data. To stop saving data to the file, issue the `LOGFILE CLOSE` command.



To avoid corrupting files, press the Log button or issue the `LOGFILE CLOSE` command before powering down the receiver or extracting data.

Example to log data to onboard storage:

```
LOGFILE OPEN SAMPLE_DATA.LOG
LOG FILE VERSION
LOG FILE RANGE ONTIME 1
LOG FILE BESTPOSB ONTIME 1
```

### 3.7.1.3 Manual Retrieval of Logged Data

By default, files can be copied from the ProPak6 USB Host port (Type A) to a USB stick using `DOSCMD COPY` command. Example:

```
DOSCMD COPY MYFILE.LOG
```

A check is performed before each file is copied to ensure there is enough space on the USB stick. If there is not enough room, the file is skipped and copying continues with the next file. This is considered an error for all copy options except `SKIP` (refer to [OEM6 Family Firmware Reference Manual](#) for the `SKIP` option description) but will continue copying the rest of the files (if space is available). The USB Host LED blinks red during the copy process.

At the end of the copy, if there is an error the USB Host LED turns off. The USB Host LED is solid red indicating the USB stick is inserted and idle. Refer to *Section 3.1.10.1, USB Host LED* on page 41 for LED details.

### 3.7.1.4 Automatic Retrieval of Logged Data

The `SETFILECOPYMODE` command configures how the receiver copies files from internal memory to a USB stick. The `SETFILECOPYMODE` command must be issued prior to inserting the USB stick to trigger auto-copy. When auto copying files, there must be enough space available on the USB stick to hold the files. Files that won't fit are skipped and therefore are not copied to the USB stick.

Example: `SETFILECOPYMODE AUTO_ALL`



The ProPak6 only supports FAT12/16/32 file systems. Other file systems, in particular NTFS, are not supported. Refer to [OEM6 Family Firmware Reference Manual](#) (OM-20000129) for command details.

### 3.7.1.5 Remote Retrieval of Logged Data

The FTP server on the ProPak6 allow access to the internal flash memory. There is a limitation of one connection at any given time. This not only means that only one user can access the FTP server at a time but the FTP Client software must be set to only use one connection (refer to *Section 5.2.3, Wi-Fi Client Configuration* on page 87 for Client setup details). The FTP server can be accessed via Ethernet or Wi-Fi.

When transferring binary data files, ensure FTP transfer mode is set to binary. If left in ASCII mode, files will not successfully download will become corrupted.

### Setting FTP Transfer Mode to Binary

1. Using standard terminal software, open an FTP connection to the receiver.
2. To change to binary mode, enter: `BIN`
3. To transfer a file, enter: `get <FILENAME . DAT>`

If the FTP connection is lost during the downloading of files, reconnect and begin the file transfer again. The data files are not removed from internal storage until manually deleted. If the Propak6 lost power and commands to configure the Ethernet (*Chapter 4, Ethernet Configuration* on page 74), Wi-Fi (*Section 5.2, Wi-Fi Network Configuration* on page 84), and FTP Server (*Section 2.9.2, FTP Server and ICOM Ports* on page 34) were not saved to NVM using the `SAVECONFIG` command, they must be reconfigured. Otherwise, the receiver is ready for a connection from client software running on a PC or other device. When the transfer is successful, files can be deleted issuing the `DOSCMD DEL` command or by using the 'del' command from within the FTP client.

#### 3.7.1.6 Stop Logging

Press the Log button () to stop logging (open/close toggles based on the last state) or issue the `LOGFILE CLOSE` command.

Logging automatically stops when the ProPak6 internal memory is full (4 GB). To avoid filling internal memory, ensure transferred or no longer needed logs are regularly deleted.

### 3.7.2 Reading Data and Post-Processing

Logs can be directed to any of the ProPak6 communication ports and can be automatically generated when new or changed data becomes available or at regular intervals.

Example:

```
LOG BESTPOSA ONTIME 1
```

Data can be collected through NovAtel Connect using the *Logging Control Window*.

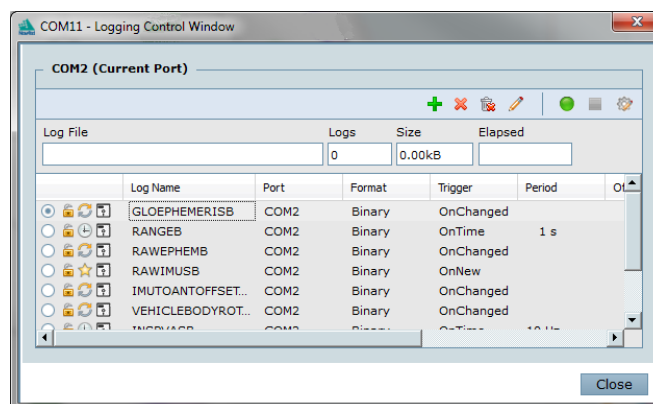

Refer NovAtel Connect within the Help or the .chm file bundled with the software for further logging details.

### 3.7.3 Pass-Through Logging

The pass-through logging feature enables the GNSS receiver to redirect any ASCII or binary data that is input at a specified COM port or USB port, to any specified receiver COM or USB port. This capability, in conjunction with the `SEND` command, allows the receiver to perform bidirectional communications with other devices such as a modem, terminal or another receiver.

There are several pass-through logs: PASSCOM1, PASSCOM2, PASSCOM3, PASSXCOM1, PASSXCOM2, PASSXCOM3, PASSUSB1, PASSUSB2, PASSUSB3, PASSICOMX, PASSNCOM and PASSAUX are available on OEM6 family receivers for logging through serial ports. Refer to the PASSCOM logs in the [OEM6 Family Firmware Reference Manual](#) (OM-20000129) for details.

## 3.8 ProPak6 Web User Interface (UI)

The ProPak6 is able to perform basic monitoring, configuration and updating tasks over a selected Ethernet/Wi-Fi network. The feature/functionality available for the ProPak6 web UI is:

- Advanced Tracking
- DOP Status
- Onboard Storage Status
- Port Configuration
- Position Mode Configuration
- Logging Profile Manager
- Rx Health Status
- Solution Status

If the necessary feature/functionality required is not available in the Web UI, use NovAtel Connect to perform comprehensive monitoring, configuration and updating tasks using various connections. Refer to *Section 2.8, Installing NovAtel Connect PC Utilities* on page 33 for details regarding NovAtel Connect.

The following browsers are supported:

- IE11, Google Chrome (33.0.1750.154 m) and Mozilla Firefox (27.0.1)

### 3.8.1 Setup Up Network IP

After installing and powering up the ProPak6 (follow the steps in *Section 2.4, Standard Configuration Installation* on page 24 or *Section 2.5, Dual Antenna Configuration and Installation* on page 26) perform the following steps to setup the ProPak6 Web UI.

1. Ethernet DHCP is the default network setup for Internet access for the ProPak6. If a Static IP is required, refer to *Section 4.2, Static IP Address Configuration* on page 74. Refer to *Section 5.2, Wi-Fi Network Configuration* on page 84 or *Section 5.3, Cellular Activation GSM/GPRS/HSDPA* on page 90 for additional network configuration details.
2. On a wireless device, locate the list of detected Access Points. By default, the ProPak6 detected is named using the Product Serial Number (PSN). Example: ProPak-6 NMCMxxxxxxxx
3. Select the ProPak6 from the list to connect.
4. Open a supported internet browser, for example, Internet Explorer®.

5. Enter the receiver IP address in the browser address bar and press Enter. The Login page displays:

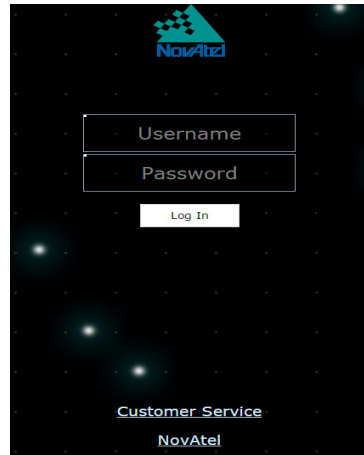

When entering any information into the Web UI, check for auto corrections or turn auto correct off.

6. Click in the Username field and enter the default user name: admin
7. Click in the Password field and enter the default password: the ProPak6 receiver Product Serial Number (PSN) is the default password (located bottom of receiver).
8. Press the Log In button.

The default Product Information home page displays, This page contains information about the connected ProPak6 receiver. Note, it may take a few moments to load all information into the fields.

**Figure 22: Product Information (Info)**

Status Information  
(refer to Figure 23)

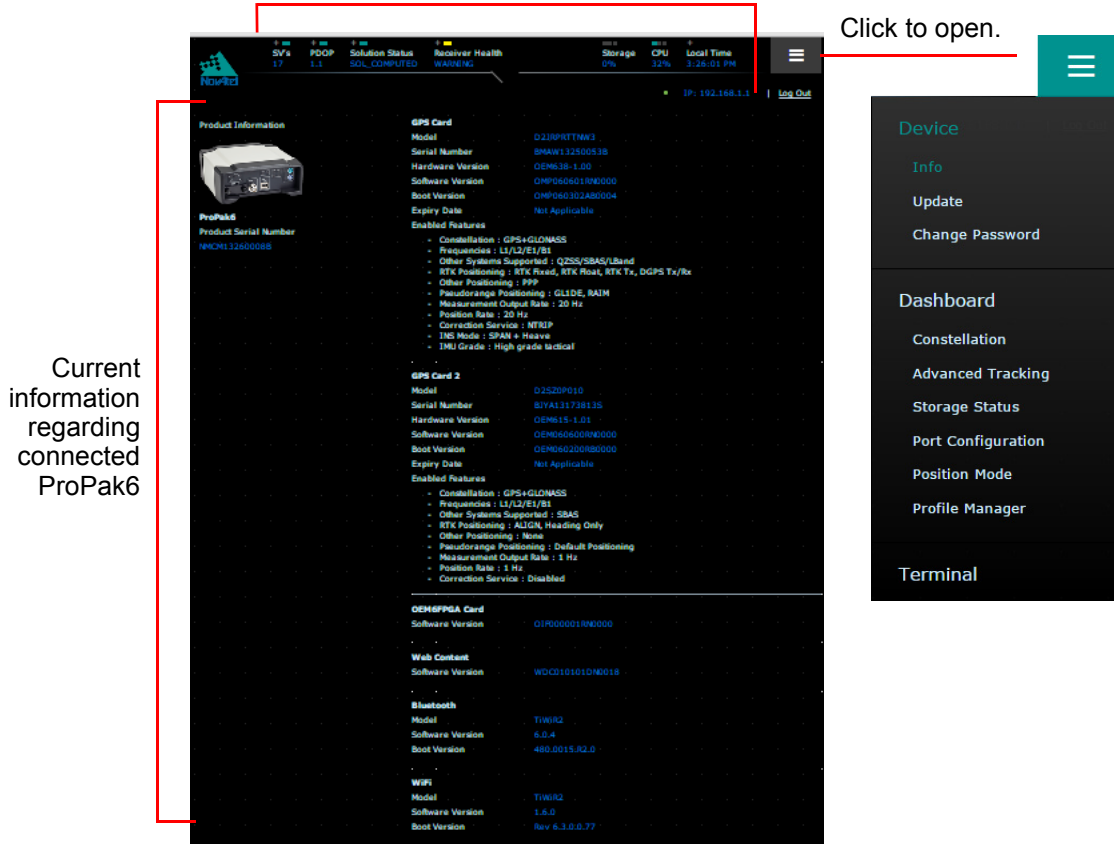

**Figure 23: Status Display Top Panel**

Hover the mouse over the Solution or Receiver Health status to display detailed information on the status message and display troubleshooting suggestions to assist in resolving any error conditions

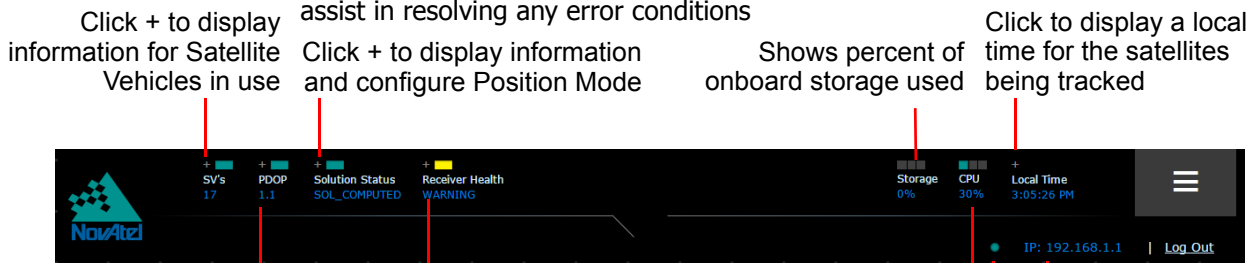

Click + to display information for Dilution of Precision

Click + to display current receiver health information

Shows percent of CPU in use

Shows IP status  
The blinking light indicates receiver connection alive status

Color	Status
Red	Error
Green	Good
Yellow	Warning

Press the  button, in the upper right corner, to display additional information and configuration options.



**Table 13: Status Drop Menu Examples**



### 3.8.2 Device Menu

The Device menu contains the Info Page (default home page), Update and Change Password options.

#### 3.8.2.1 Info

Refer to *Figure 22, Product Information (Info)* on Page 64 for location.

#### 3.8.2.2 Update

Use to update either the firmware on the ProPak6 or the Web UI interface.

Click to move between options

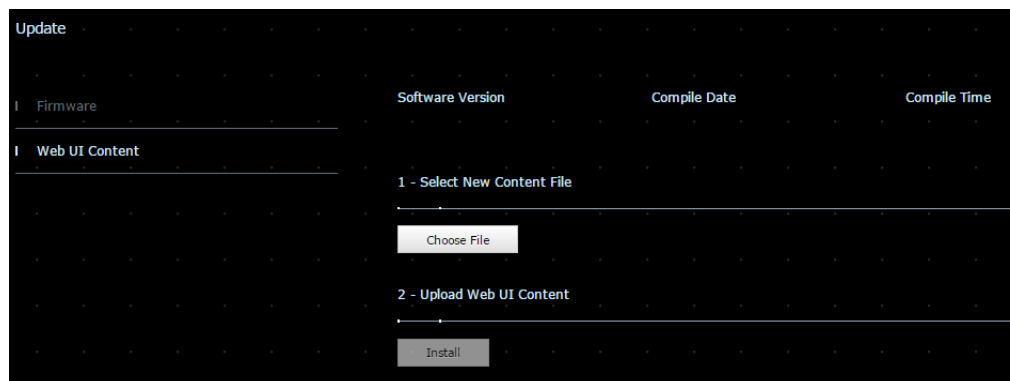
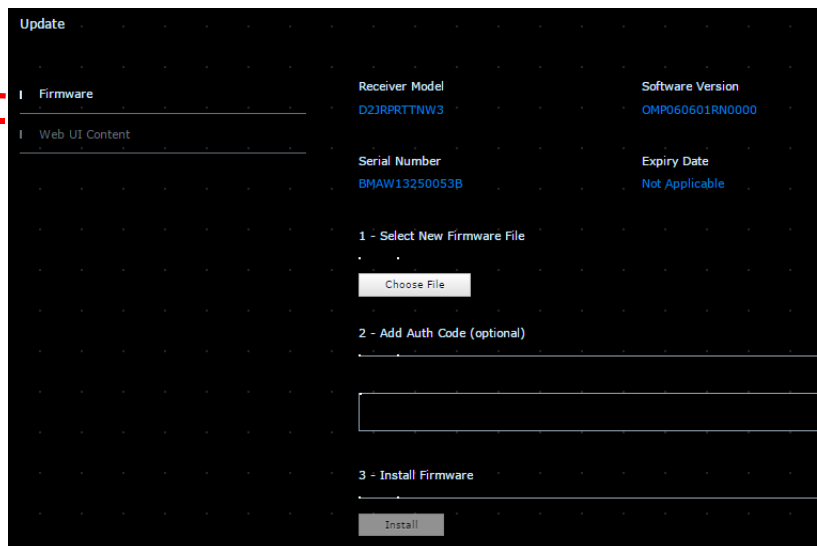

### 3.8.2.3 Change Password

Use this page to change the password.

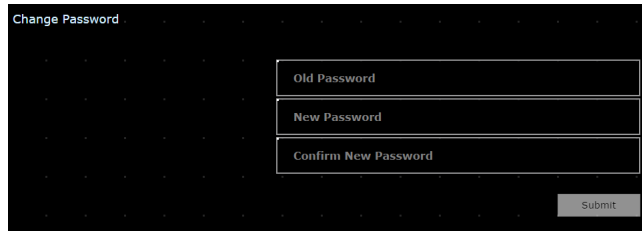

### 3.8.3 Dashboard

The Dashboard contains the Constellation, Advanced Tracking, Storage Status, Port Configuration, Position Mode and Profile Manager.

#### 3.8.3.1 Constellation

Use to monitor the satellites currently being tracked. Each satellite type displays as a different shape. The color indicates the status of the channel; the colored line below the shape indicates the signal strength. Each shape also displays the PRN of that satellite. Click a shape, within the Constellation circle, to display SV information.

Red	No signal match
Blue	No ephemeris
Yellow	No ambiguity
Teal	All other health status
Orange	N/A

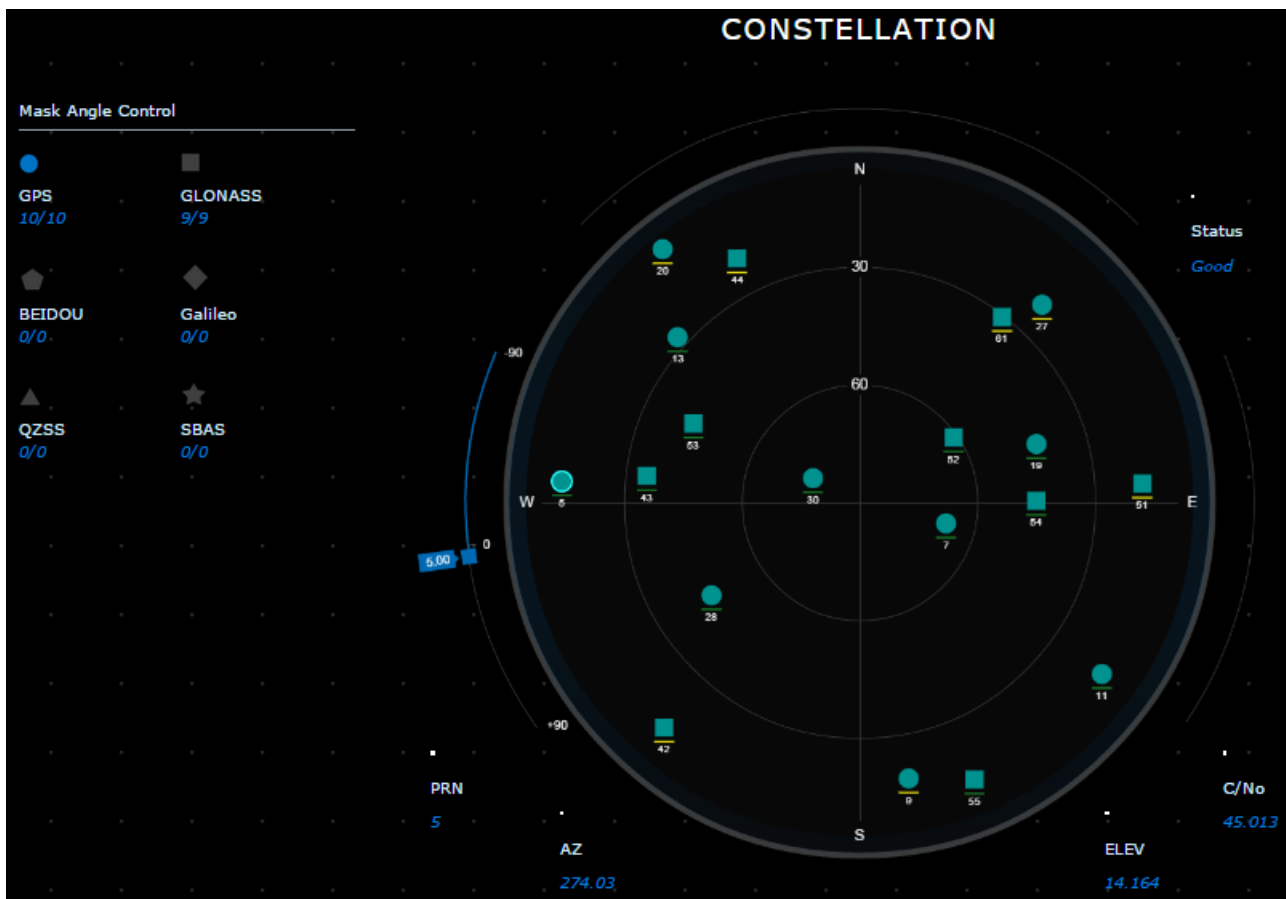

### 3.8.3.2 Advanced Tracking

The page displays receiver channel status information.

Constellations	PRN	Signal	Ch.No	STATE	RejectCode	CNO	PSR	Residual	Doppler	Lc
GPS	28	L1CA	0	Lock	Good	43.0	23640963.57	-0.512	-2856.1	
GLONASS	28	L2P(Y)	0	Lock	L2 observation	38.5	23640965.43	0.000	-2225.6	
QZSS	12	L1CA	1	Lock	Good	47.7	22439212.39	0.917	2984.3	
SBAS	12	L2P(Y)	1	Lock	L2 observation	42.0	22439213.40	0.000	2325.4	
	3	L1CA	2	Lock	Good	43.9	24173932.62	0.372	683.7	
	3	L2P(Y)	2	Lock	L2 observation	41.9	24173938.29	0.000	532.8	
	2	L1CA	3	Lock	Good	44.5	23571295.69	0.220	3375.8	
	2	L2P(Y)	3	Lock	L2 observation	40.8	23571296.48	0.000	2630.5	
	14	L1CA	4	Lock	Good	42.7	25047361.21	-1.183	706.1	
	14	L2P(Y)	4	Lock	L2 observation	35.7	25047364.70	0.000	550.2	
	6	L1CA	5	Lock	Good	49.7	21287237.58	0.550	2186.5	
	6	L2P(Y)	5	Lock	L2 observation	47.2	21287241.74	0.000	1703.7	
	—	L1CA	6	Idle	No Observations	0.0	0.00	0.000	0.0	
	—	L2P	6	Idle	No Observations	0.0	0.00	0.000	0.0	

Green	Good
Red	Bad Health, Misclosure, No Ephemeris, Unknown, Not Used, NA, Bad Integrity, Lossoflock
Yellow	OldEphemeris, Elevationerror, Nodiffcorr, Invalidiode, Lockedout, Lowpower, OBSL2, Noionocolor, OBSL1,OBSE1,OBSL5, OBSE5,OBSB2,OBSB1, NoSignalmatch, Supplementary, Noambiguity

### 3.8.3.3 Storage Status

Displays the amount of memory available, amount used, available space and time left along with a list for files including size and date modified on the ProPak6. Click on one or multiple check boxes and press the delete button to delete selected files. Click on the up/down arrows at the top of each column to customize the sort order.

File Name	Size(KB)	Last Modified
mfgtest.txt	0.021	1/1/1970 0:0
BMAW13250053B_1.LOG	0.215	7/8/2013 21:34
testlogs.txt	1.045	7/8/2013 22:5
BMAW13250053B_2.LOG	0.000	18/9/2013 16:18
BMAW13250053B_3.LOG	0.000	18/9/2013 16:27
BMAW13250053B_4.LOG	0.000	18/9/2013 16:31
BMAW13250053B_5.LOG	0.000	18/9/2013 16:31
BMAW13250053B_6.LOG	0.203	25/9/2013 16:27
BMAW13250053B_7.LOG	0.609	25/9/2013 16:29
BMAW13250053B_8.LOG	1.219	25/9/2013 16:44
Logfile1.txt	2.089	1/1/1970 0:0
Logfile2.txt	2755.537	24/10/2013 4:14
Logfile3.txt	10534.154	24/10/2013 22:45
BMAW13250053B_9.LOG	0.000	9/2/2015 21:7

The ProPak6 contains 4 GB of onboard data storage. Refer to Section 3.7.1, Onboard Data Storage on page 59 for details.

### 3.8.3.4 Port Configuration

Use to configure ports and set the interface mode.

PORT CONFIGURATION								INTERFACE MODE		
PORT	Baud Rate	Parity	Data Bits	Stop Bits	Handshake	Echo	Break	Receive	Transmit	Response
COM1	9600	N	8	1	N	OFF	ON	NOVATEL	NOVATEL	ON
COM2	9600	N	8	1	N	OFF	ON	NOVATEL	NOVATEL	ON
COM3	9600	N	8	1	N	OFF	ON	NOVATEL	NOVATEL	ON

### 3.8.3.5 Position Mode

Displays the current position mode currently used by the receiver. Is also used to configure the receiver for SBAS, PPP and Differential operation.

Use the SBAS page to select the SBAS system to use in the receiver solution, let the receiver determine the best system or do not use SBAS system satellites.

**POSITION MODE**

**Position Data**

Latitude: 51.1166814 (± 1.410 m)      Longitude: -114.0387990 (± 1.273 m)      Solution type: SINGLE      Iono correction: Multi Frequency

Altitude: 1064.951 (± 3.303 m)      Solution Age: 0.000secs      Differential Age: 0.000secs

Position Mode : SINGLE

**Mode Config**

SBAS      System : NONE

PPP      SBAS Cut off Angle : -5

Differential      PRN Selection : AUTO

Once set, use save button to configure the receiver with the selected position mode settings. Set system to NONE to reset to previous position mode.

Use the PPP Tab to configure a position mode for Precise Point Positioning if your receiver is enabled with a TerraStar Subscription. A message at the bottom of the screen indicate the current subscription status. If there is an active subscription, click the 'Enable L-Band' button to automatically select the appropriate L-Band Beam and the system will begin converging a PPP solution. Note that this can take approximately 15-20 minutes to complete. Clicking another beam from the beam table and clicking 'Assign L-Band Beam' will manually assign the beam selected.

If there is no TerraStar subscription available on the receiver, the button text displays 'Track L-Band' beams, and will only allow the user view the available beams and not select one. Contact NovAtel Customer Support (support@novatel.com) to inquire about TerraStar subscription activation. For beam coverage information, visit [www.terrastar.net/coverage.html](http://www.terrastar.net/coverage.html).



Use the Differential page to configure the receiver for Base/Rover operations.

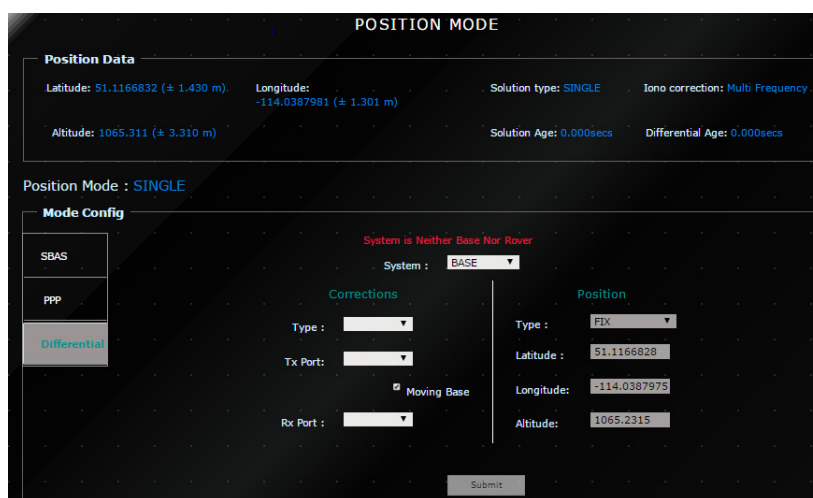

The NovAtel Connect PC Utilities contain a number of additional utilities that can be used to access more advanced features of the ProPak6.

Download the latest PC Utilities that include NovAtel Connect™ along with the necessary user documentation from: [www.novatel.com/support/info/documents/809](http://www.novatel.com/support/info/documents/809).

### 3.8.3.6 Profile Manager

Use the Profile Manager to group sequences of receiver configuration commands under a common profile and to create and store multiple profiles on to a receiver. Use saved profiles to easily configure the receiver for a variety of applications by simply selecting the appropriate profile which after being activated, will be logging automatically whenever the receiver is powered on, until the profile is manually deactivated. Up to 9 profiles can be stored on the ProPak6 and 20 commands per profile.

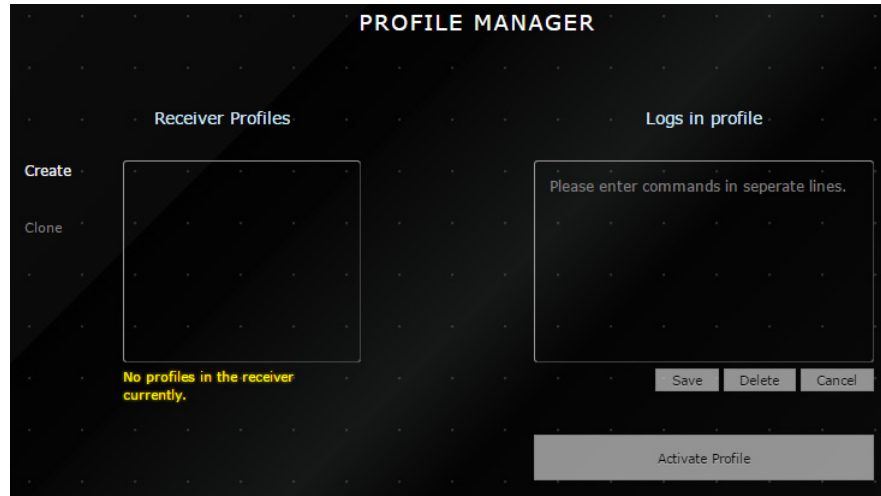

Profile restrictions are each command in a profile cannot exceed 200 characters and a maximum of 1500 characters for all commands in one profile.

Press the Activate Profile to load the selected ProPak6 receiver profile. Activating a profile causes the receiver to reset.

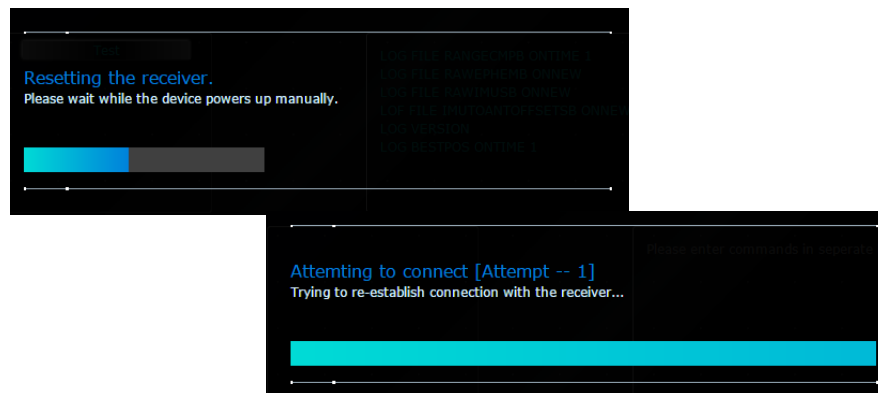

### 3.8.4 Terminal

Commands can be sent to the receiver using the command line at the bottom of the Terminal page.



Only ASCII log responses are allowed. No responses and no recording for binary log requests. If abbreviated ASCII log requests are sent, ASCII responses are shown/recorded.

#### **Load Button**

Create a text file containing a list of commands to be executed in sequence. Name and save the file to the connected computer/device (not the ProPak6). Use the Load button to find and select one of these files.

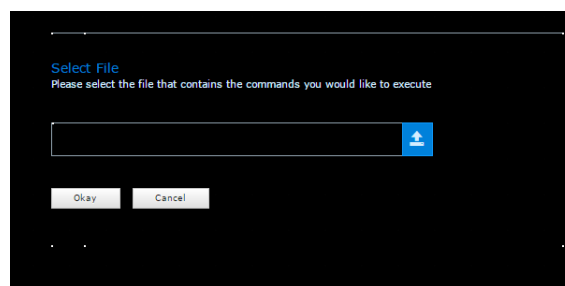

**Save Button**

Press the Save button to name and create a file of any logged data. Logged data files are listed under the Storage menu. Use the Cancel button to return to the Terminal page without saving.

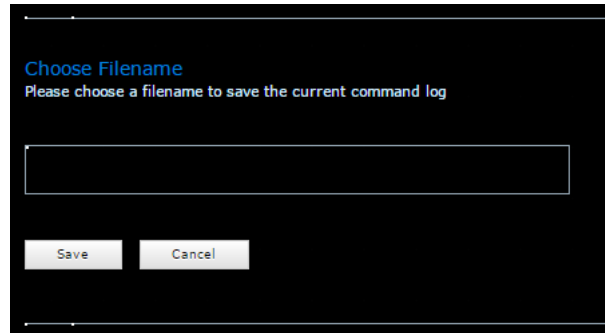



### **Rec Button**

Press the Rec button to record the output results of logged data.

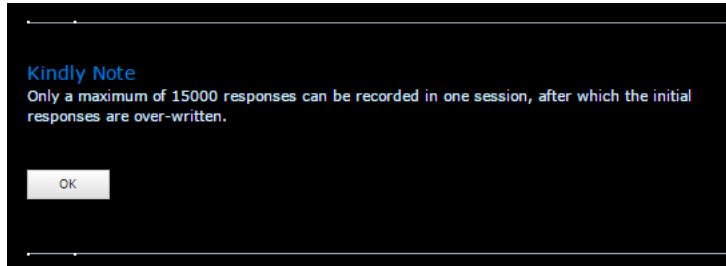

The Rec button flashes during recording. To stop recording, press the Rec button again.



A maximum of 15000 responses can be recorded in one session using the Rec feature. Refer to *Section 3.8.3.6, Profile Manager* on page 70 if intending to log data over a long period of time.

An Ethernet connection can be used to send commands to and obtain logs from an Ethernet capable ProPak6 receiver. An Ethernet connection can also be used to connect two receivers in a base/rover configuration.

This chapter describes how to configure the Ethernet port on an ProPak6 receiver. It provides the step-by-step process for connecting to the ProPak6 receiver through the Ethernet interface, setting up a base/rover configuration through Ethernet connectivity and utilizing the NTRIP interface. The Ethernet port connections for a computer connected to the receiver are also described for both Windows XP (with SP3) and Windows 7 operating systems.



Ethernet (ETHA) is the default network for internet access for the ProPak6. The default network can be changed to Wi-Fi or Cellular or changed back to Ethernet using the `SETPREFERREDNETIF ETHA` command. Refer to the *Section 5.2.1, Configure Wi-Fi as the Network Default* on page 84 or *Section 5.3.1, Configure Cellular as the Network Default* on page 90 for details. Refer to *Section 3.1.11, Ethernet Port* on page 41 for details on the physical parameters of the Ethernet Port.

## 4.1 Required Hardware

The following hardware is required to set up an Ethernet interface to an ProPak6 receiver:

- a user supplied computer with an available Ethernet and serial or USB port or Wi-Fi or *Bluetooth* link
- a ProPak6 receiver
- an RS-232 null modem cable or USB cable
- a cross-over CAT5 Ethernet cable or a user supplied Ethernet network hub or wired router (optional) and CAT 5 Ethernet cable

## 4.2 Static IP Address Configuration



The ProPak6 default is Ethernet DHCP Dynamic IP address.

For a static IP address configuration, unique IP addresses are assigned to both the ProPak6 receiver and the computer. TCP/IP is used for the connection in this simple network. This configuration can also be used in a bench test environment to confirm Ethernet functionality. By default, the ProPak6 is set to Ethernet DHCP Dynamic IP address.

Figure 24: Cross-Over Ethernet Cable Configuration—ProPak6

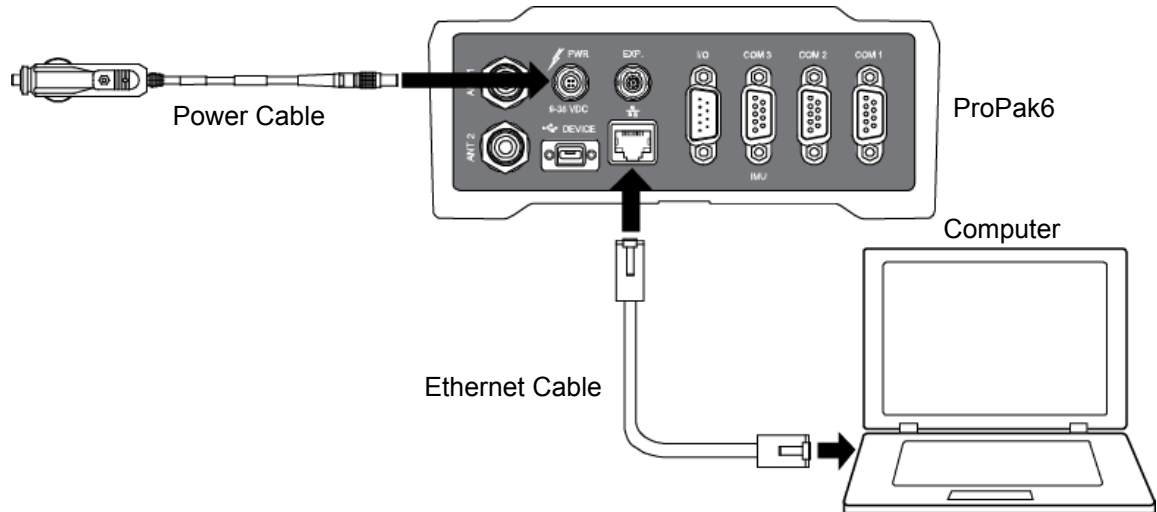

#### 4.2.1 Static IP Address Configuration—Receiver

Follow these steps to set up a static IP address on the ProPak6 receiver:

1. Connect a computer to the ProPak6 receiver using a null modem serial cable or USB cable or use *Bluetooth* or *Wi-Fi*.
2. Establish a connection to the receiver using either NovAtel Connect or another terminal program such as HyperTerminal. This connection is used to send the commands in this procedure to the receiver.



For information about establishing a connection using NovAtel Connect, refer to the Quick Start Guide for the product or NovAtel Connect Help included with NovAtel Connect PC Utilities available from our web site.

3. Enable the Ethernet port on the receiver by entering:
 

```
ethconfig etha auto auto auto auto
```
4. Assign the TCP/IP port number used for the connection by entering:
 

```
icomconfig icom1 tcp :2000
```
5. Assign the receiver IP address, subnet mask and default gateway by entering:
 

```
ipconfig etha static 192.168.74.10 255.255.255.0 192.168.74.1
```



The command above assign the following values to the ProPak6 receiver:

```
ip address = 192.168.74.10
subnet mask = 255.255.255.0
gateway = 192.168.74.1
```

These settings are examples only. The settings appropriate to the network may be different.

6. Save the new Ethernet settings by entering:
 

```
saveconfig
```
7. Log the IPCONFIG command and confirm the TCP/IP configuration by entering:
 

```
log ipconfig once
```



Issue the `SAVEETHERNETDATA ETHA` command to ensure port settings are retained after a reset and automatically used at boot time. The `SAVEETHERNETDATA ETHA` command is not applicable to the `ICOMCONFIG` and `NTRIPCONFIG` settings. The `SAVEETHERNETDATA ETHA` command overrides the `SAVECONFIG` command configuration settings.

8. Configure your computer with a static IP address.  
For a computer using Windows XP Service Pack 3, refer to *Section 4.2.2 Static IP Address Configuration—Windows XP with SP3 on page 76*.  
For a computer using Windows 7, refer to *Section 4.2.3 Static IP Address Configuration—Windows 7 on page 76*.

### 4.2.2 Static IP Address Configuration—Windows XP with SP3

Follow these steps to set up a static IP address on your computer:

1. Click START | Settings | Network Connections.  
The Network Connections window appears.
2. Right click on Local Area Connection and select Properties.  
The Local Area Connection Properties window appears.
3. Click Internet Protocol (TCP/IP) and then click the Properties button.  
The Internet Protocol (TCP/IP) Properties window appears.
4. Select the Use the following IP address radio button.
5. Enter the IP address, Subnet mask and Default gateway for the Ethernet port on the computer.



Ensure the Ethernet settings used for the computer are compatible with the Ethernet settings on the ProPak6 receiver.  
For example, the following settings are compatible with the ProPak6 receiver settings used in *Section 4.2.1 Static IP Address Configuration—Receiver on page 75*:

```
ip address = 192.168.74.11
subnet mask = 255.255.255.0
gateway = 192.168.74.1
```

6. Click the OK button.  
The Local Area Connection Properties window appears.
7. Click the Close button.
8. Proceed to *Section 4.2.4, Confirming Ethernet Setup on page 77*.

### 4.2.3 Static IP Address Configuration—Windows 7

Follow these steps to set up a static IP address on a computer:

1. Click Start | Control Panel.
2. Click View Network Status and Tasks under Network and Internet.
3. Click the Local Area Connection link.  
The Local Area Connection Status window appears.
4. Click the Properties button.  
The Local Area Connection Properties window appears.
5. Select Internet Protocol Version 4 (TCP/IPv4) and then click the Properties button.  
The Internet Protocol Version 4 (TCP/IPv4) Properties window appears.

6. Enter the IP address, Subnet mask and Default gateway for the Ethernet port on the computer.



Ensure the Ethernet settings used for the computer are compatible with the Ethernet settings on the ProPak6 receiver.

For example, the following settings are compatible with the ProPak6 receiver settings used in *Section 4.2.1 Static IP Address Configuration—Receiver on page 75*:

```
ip address = 192.168.74.11
subnet mask = 255.255.255.0
gateway = 192.168.74.1
```

7. Click the OK button.  
The Local Area Connection Properties window appears.
8. Click the Close button.  
The Local Area Connection Status window appears.
9. Click the Close button.
10. Proceed to *Section 4.2.4, Confirming Ethernet Setup on page 77*.

#### 4.2.4 Confirming Ethernet Setup

1. Connect the computer to the ProPak6 receiver using an Ethernet cross-over cable.
2. Connect to the receiver using NovAtel Connect or any third party terminal program that supports TCP/IP connections. Use the static IP address and port number assigned to the ProPak6 receiver in *Section 4.2.1 Static IP Address Configuration—Receiver on page 75*.

The figure below shows the New Connection window in NovAtel Connect with the example Ethernet settings used in *Section 4.2.1*.

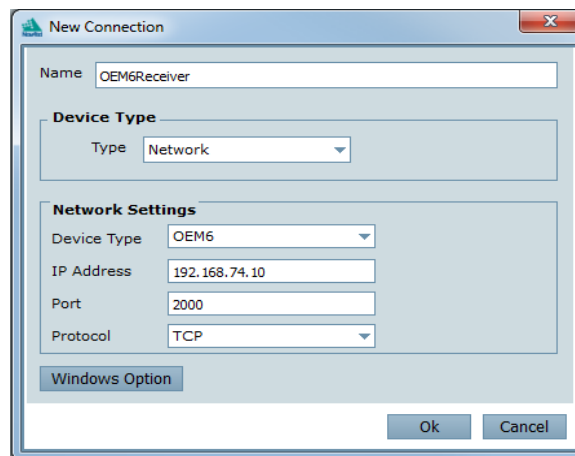
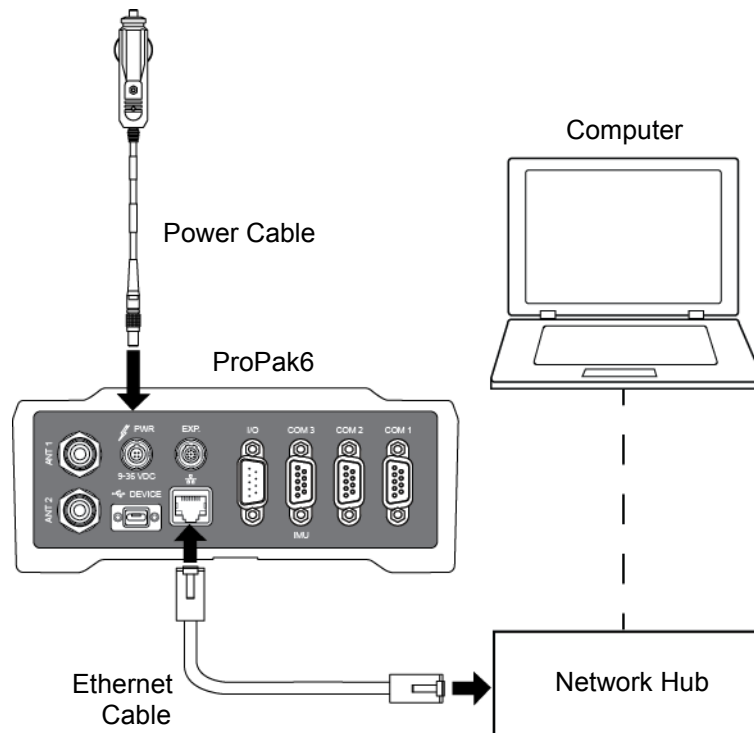

Figure 25: ProPak6 Ethernet Hardware Setup



**i** For information about establishing a connection using NovAtel Connect, refer to the Quick Start Guide for the product or NovAtel Connect Help included with NovAtel Connect PC Utilities.

### 4.3 Dynamic IP Address Configuration

**i** The ProPak6 default is Ethernet DHCP Dynamic IP address.

For this configuration, a direct connection is made from the ProPak6 receiver to a Dynamic Host Communication Protocol (DHCP) network and into a computer. The DHCP server automatically assigns an IP addresses to the OEM6 receiver, based on its predetermined available IP addresses.

To set up a dynamic IP address configuration, follow these steps:

1. For first time configuration, connect a computer to the ProPak6 receiver using a null modem serial cable or USB cable.
2. Establish a connection to the receiver using either NovAtel Connect or another terminal program such as Windows HyperTerminal. This connection is used to send the commands in this procedure to the receiver.

**i** For information about establishing a connection using NovAtel Connect, refer to the Quick Start Guide for the product or NovAtel Connect Help.

3. Enable the Ethernet port by entering:
 

```
ethconfig etha auto auto auto auto
```

4. Obtain the IP address assigned to the ProPak6 receiver by the DHCP server.

```
log ipstatus once
```



Make a note of the IP address returned with this log. This value is used later in this procedure.

5. Confirm that DHCP is enabled. by entering:

```
log ipconfig once
```

6. Assign the TCP/IP port number by entering:

```
icomconfig icom1 tcp :2000
```

7. Confirm the port number assigned to ICOM1 by entering:

```
log icomconfig once
```

8. Save settings the settings by entering:

```
saveconfig
```



Issue the `SAVEETHERNETDATA ETHA` command to ensure port settings are retained after a reset and automatically used at boot time. The `SAVEETHERNETDATA ETHA` command is not applicable to the `ICOMCONFIG` and `NTRIPCONFIG` settings. The `SAVEETHERNETDATA ETHA` command overrides the `SAVECONFIG` command configuration settings.

9. Use the IP address obtained from the IPSTATUS log and the assigned port number. Confirm new settings (refer to the figure below)..



For information about establishing a connection using NovAtel Connect, refer to the Quick Start Guide for the product or NovAtel Connect Help.

## 4.4 Base/Rover Configuration through Ethernet Connectivity

You can use an Ethernet connection to provide communication between a base and rover receiver.

Figure 26: Base/Rover Ethernet Setup—ProPak6

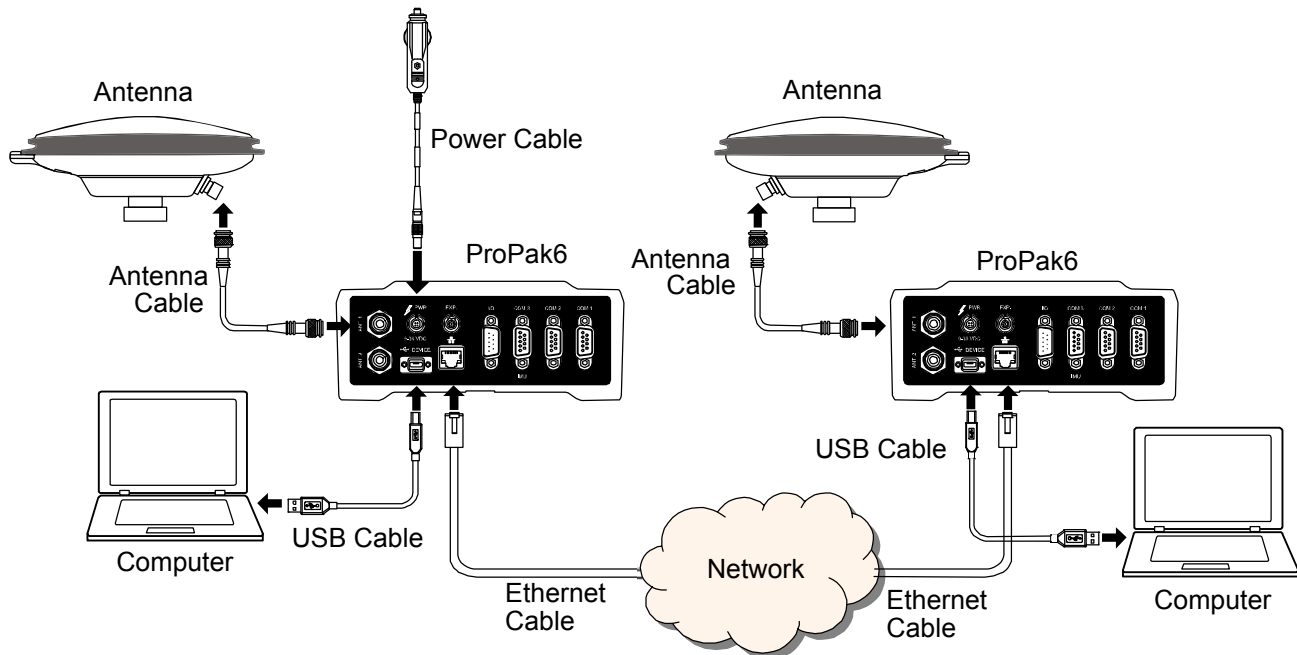

1. Connect your computer to both ProPak6 receivers using null modem serial cables or USB cables.
2. Establish a connection to the receiver using either NovAtel Connect or another terminal program such as Windows HyperTerminal. This connection is used to send the commands in this procedure to the receivers.



For information about establishing a connection using NovAtel Connect, refer to the Quick Start Guide for the product or NovAtel Connect Help.

3. Connect the power cables to both of the ProPak6 receivers and apply power to the receivers.
4. Connect the Ethernet cables to the Ethernet ports on both ProPak6 receivers.
5. Establish an Ethernet connection, either static or dynamic configurations. Refer to *Section 4.2 Static IP Address Configuration on page 74* or *Section 4.3 Dynamic IP Address Configuration on page 78* for more information.
6. Send the following commands to each receiver either through serial or USB ports:

**Base:**

```
fix position <lat> <long> <height>
interfacemode icom1 none rtca off
log icom1 rtcaobs2 ontime 1
log icom1 rtcaref ontime 10
log icom1 rtcal ontime 5
saveconfig
```

**Rover:**

```
icomconfig icom1 tcp <base ip address>:<base port #>
interfacemode icom1 rtca none off
log bestposa ontime 1 (optional)
saveconfig
```

Use the BESTPOS log to confirm that the ProPak6 rover is in RTK mode.





Issue the `SAVEETHERNETDATA ETHA` command to ensure port settings are retained after a reset and automatically used at boot time. The `SAVEETHERNETDATA ETHA` command is not applicable to the `ICOMCONFIG` and `NTRIPCONFIG` settings. The `SAVEETHERNETDATA ETHA` command overrides the `SAVECONFIG` command configuration settings.



The `FRESET` command does not clear Ethernet setting; `FRESET INTERNET` must be issued.

This chapter discusses the methods for configuring the ProPak6 radios and activating network services for *Bluetooth*<sup>®</sup>, Wi-Fi and Cellular radios (model dependent, refer to *Table 1, ProPak6 Model Features* on page 16).



The `FRESET` command can be used to reset any of the *Bluetooth*, Wi-Fi or Cellular ProPak6 radios.

## 5.1 Bluetooth<sup>®</sup> Configuration

*Bluetooth* is a wireless radio communication standard designed for use over short ranges (within 10 m). Before a *Bluetooth* enabled device can communicate with the ProPak6, it must be configured to recognize and communicate with the ProPak6 (paired). Only one incoming *Bluetooth* connection is supported at a time by the ProPak6. A maximum of 16 devices can be paired with the ProPak6.

Refer to *Section 3.1.5, Bluetooth LED* on page 37 for status LED information.

### 5.1.1 Enable Bluetooth on the ProPak6 Receiver

By default, the *Bluetooth* radio is turned off.

1. Connect the ProPak6 to a computer using one of the communication ports and turn power on.
2. To turn on the *Bluetooth* radio, issue  
`BLUETOOTHCONFIG POWER ON` command  
The *Bluetooth* LED on the front of the ProPak6 lights blue .
3. Enter `LOG BLUETOOTHSTATUS ONCHANGED` to display the *Bluetooth* radio status.
4. Issue the `SAVECONFIG` command to save the configuration to Non-Volatile Memory (NVM).

#### 5.1.1.1 Pairing Bluetooth Devices

5. To allow *Bluetooth* devices to locate and pair with other *Bluetooth* devices, found within 10 m of the ProPak6, issue:  
`BLUETOOTHDISCOVERABILITY ON`
6. If prompted, enter the PIN confirmation (ProPak6 default pin number 0000).
7. Accept or `LOG BLUETOOTHSTATUS` to verify pass code.
8. To turn off *Bluetooth* discovery once pairing is complete, issue:  
`BLUETOOTHDISCOVERABILITY OFF`

### 5.1.1.2 Connecting Bluetooth Devices

9. Determine the serial port assigned to *Bluetooth* for the connected computer (COM port X). This information is found in different locations depending on the type of the device and/or operating system. The New Connection window of NovAtel Connect can also be used. Once the COM port is determined, connect to the device over this port.

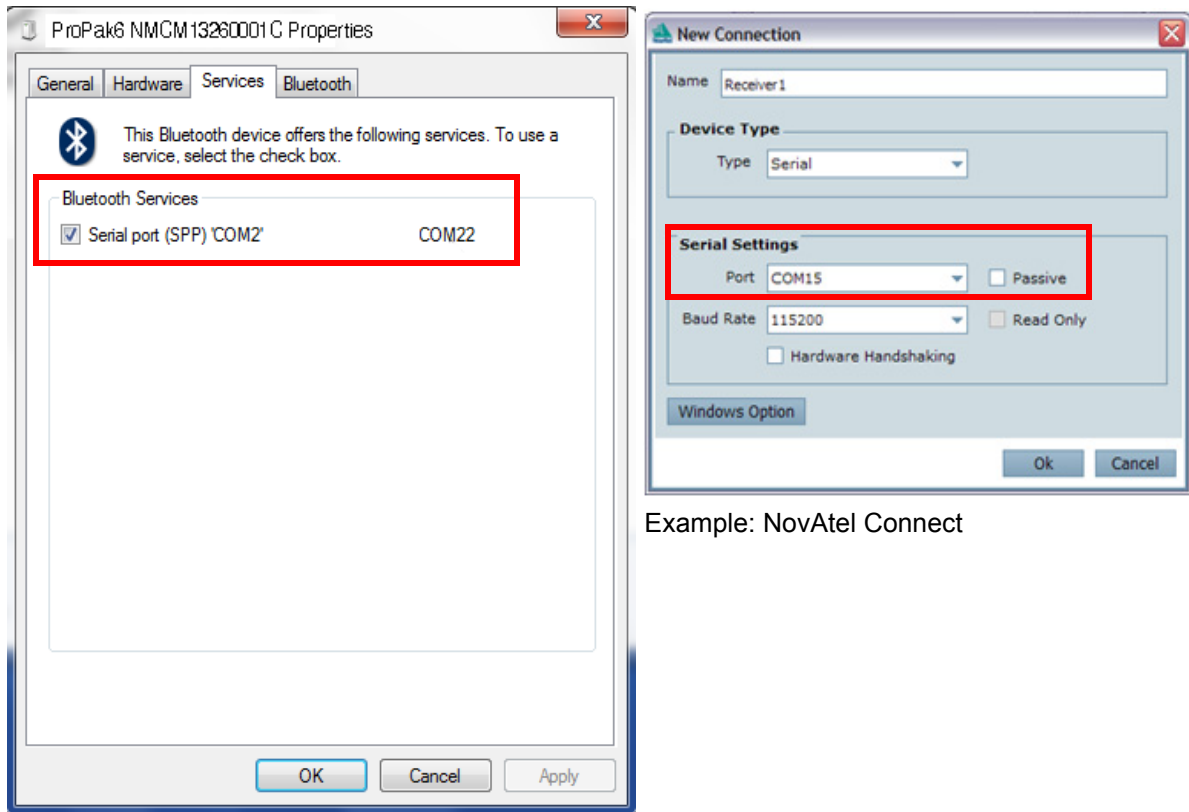

Example: NovAtel Connect

Example: Windows® 7



Instructions for configuring *Bluetooth* devices vary depending on the type of device and/or operating system. Consult the instructions provided with the *Bluetooth* device for detailed setup instructions.

10. To turn off and disconnect devices, issue:

```
BLUETOOTHCONFIG POWER OFF
```



*Bluetooth* discovery may minimally restrict Wi-Fi performance. NovAtel recommends performing any *Bluetooth* discovery prior to joining a Wi-Fi network and always turning off *Bluetooth* discoverability when pairing is complete.

## 5.2 Wi-Fi Network Configuration

Wi-Fi is a Wireless Local Area Network (WLAN) used to exchange data wirelessly over a computer network. When the ProPak6 Wi-Fi radio is enabled, it can be configured to act as a Access Point (AP) or Client. By default, the ProPak6 is configured with Wi-Fi on and as an AP.

When configured as either a Client or AP, users can access the ProPak6 using FTP, ICOM ports, telnet, NTRIP, etc. The mode of operation to use is dependent on how the Local Area Network (LAN) is configured.

To have the ProPak6 accessible on a LAN like other common devices (printer, computer, etc.), configure the ProPak6 as a Client. An existing Wi-Fi access point on the LAN must be available for the ProPak6 to connect to. While in Client mode, the ProPak6 IP address can support both static and dynamic IP address assignment.

If the ProPak6 is not to be accessible to a LAN or is located in a remote location that does not have an AP nearby, configure the ProPak6 as the AP. When configured as the AP, the ProPak6 must use a static IP address, although any devices connecting to the ProPak6 (mobile phone, laptop, etc.) can use either static or dynamic IP address assignment.

**Figure 27: Wi-Fi Configuration Overview**

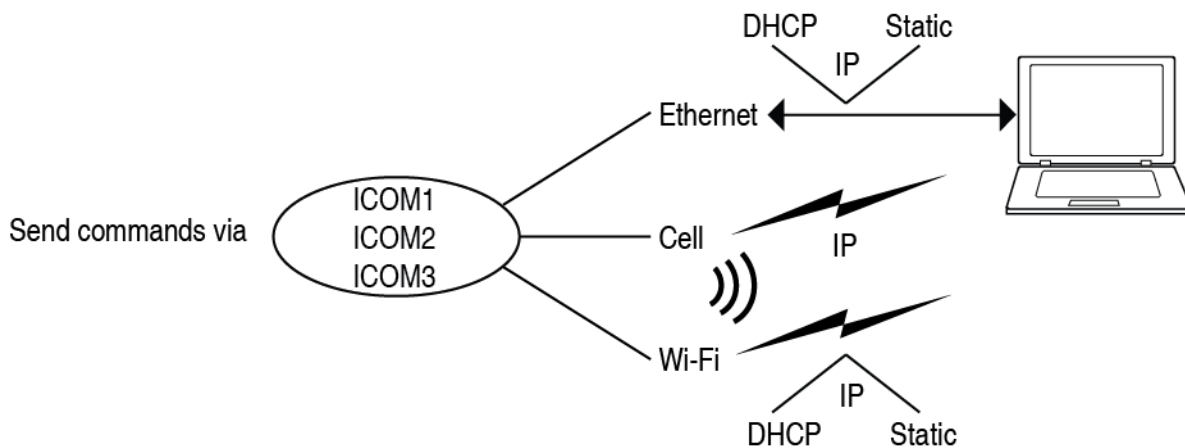

The following commands are used for Wi-Fi Network configuration:

- `WIFICONFIG` - sets the state (enable/disable) and the mode (AP/Client) of the ProPak6
- `WIFIAPCONFIG` - sets AP network parameter values when in AP mode
- `WIFICLICONFIG` -sets Client network parameter values when in Client mode
- `WIFICLICONTROL` - scans for network access points

### 5.2.1 Configure Wi-Fi as the Network Default

Ethernet (ETHA) is the default network for Internet access for the ProPak6. The default network can be changed to Wi-Fi by issuing the `SETPREFERREDNETIF WIFI` command. Refer to the [OEM6 Firmware Reference Manual](#) (OM-20000129) for additional command details.

## 5.2.2 Wi-Fi AP Configuration

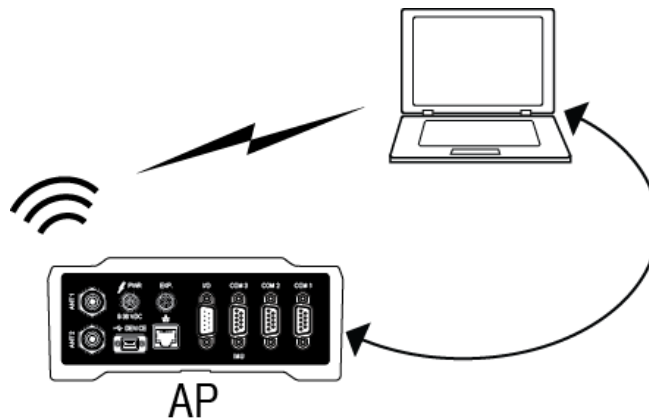

By default, the ProPak6 Wi-Fi radio is configured as an AP and is enabled.



If a ProPak6 is changed from the default AP to a Client configuration and later needs to return to an AP configuration, the `WIFIAPCONFIG MODE AP` command is issued and the Wi-Fi module power cycled (see step 9 below).

1. Connect the ProPak6 to a computer using one of the communication ports and turn power on.
2. The LED on the front of the ProPak6 lights blue (🟦) (it may take up to 10 seconds for the AP to become available). (If the radio is off, issue the `WIFICONFIG STATE ENABLED` command to turn on the Wi-Fi radio.)
3. Enter `LOG WIFIAPSTATUS ONCHANGED` to monitor connection status.
4. Configure the AP by issuing the `WIFIAPCONFIG` command and the required network values.  
Example: `WIFIAPCONFIG X AUTHENTICATION OPEN` (where X is the AP mode number (1-4))

WIFIAP Configuration Parameter	Value	Description
SSID	String (PSN default)	The Service Set Identifier (network name) of the Wi-Fi AP.
IsHidden	TRUE FALSE (default)	When this parameter set to TRUE, the Wi-Fi AP does not broadcast the SSID.
Channel	802.11 Channel (default 6)	The 802.11 Channel to use for this Wi-Fi AP. The valid range of Channels depends on 802.11 regulatory domain. In North America the valid range is: 1-11
Authentication	OPEN WPA_PSK (default) WPA2_PSK WPA/WPA2_PSK	The authentication type used for the Wi-Fi AP. The value for Authentication is dependent on the values for Encryption and Protocol. Refer to the <a href="#">OEM6 Family Firmware Reference Manual</a> (OM-20000129) for details.
Encryption	NONE TKIP AES_CCMP (default) TKIP AES_CCMP	The encryption protocol used for the Wi-Fi AP. The value for Encryption is dependent on the values for Authentication and Protocol. Refer to the <a href="#">OEM6 Family Firmware Reference Manual</a> (OM-20000129) for details.

WIFIAP Configuration Parameter	Value	Description
Passphrase	String (PSN default)	WPA/WPA2 passphrase (8 to 63 ASCII characters) or Hex key (32 bytes - 64 ASCII characters)
IPAddr	ddd.ddd.ddd.ddd (192.168.1.1 default)	The IP address of the Wi-Fi AP. This must be a static IP address.
Netmask	ddd.ddd.ddd.ddd (255.255.255.0 default)	The netmask for Wi-Fi AP IP address.
Gateway	ddd.ddd.ddd.ddd	The IP address of the gateway.
Protocol	b g bg bgn (default)	The 802.11 standard protocol used for the Wi-Fi AP. The value for Protocol is dependent on the values for Authentication and Encryption. Refer to the <a href="#">OEM6 Family Firmware Reference Manual</a> (OM-20000129) for details.
Client_Timeout	1 to 3600 seconds (300 s default)	Time in seconds for the Wi-Fi AP to detect a lost client connection.

5. Configure the ICOM ports to be used (refer to *Section 3.1.12, ICOM Ports* on page 42 for details).
6. If required, configure port security (refer to *Section 2.9.2, FTP Server and ICOM Ports* on page 34 for details).
7. If using, configure NTRIP (refer to *Chapter 6, NTRIP Configuration* on page 93 for details).
8. Issue the `SAVECONFIG` command to save the configuration to Non-Volatile Memory (NVM).
9. If any changes were made to the default WIFIAPCONFIG settings, a power cycle to the Wi-Fi module is required for the changes to take affect. Issue:
 

```
WIFICONFIG STATE OFF
WIFICONFIG STATE ENABLED
```
10. On a Wi-Fi Client, scan for a ProPak6 AP and connect to it.
11. If prompted, enter a password. (The default password is the Product Serial Number (PSN) located on the bottom of the ProPak6.)
12. Configure network properties on the connected Client computer to use a static IP address. Consult the Network Administrator to obtain the necessary network parameters.
  - The first three numbers of the IP should match the receiver
  - To avoid IP conflicts between the static IP address of the Client and the IP of the ProPak6, set the static IP address of the client to 192.168.1.5 or above
  - The subnet should be the same as the ProPak6
  - The gateway is the same as the ProPak6 IP address
13. Open the port to the receiver from a computer or mobile device.
  - The IP address should be the IP address of the ProPak6
  - The port number is the port number assigned to the ICOM port being connected to (default ICOM configurations: `ICOMCONFIG ICOM1 TCP :3001`, `ICOMCONFIG ICOM2 TCP :3002` and `ICOMCONFIG ICOM3 TCP :3003`)



Refer to the [OEM6 Family Firmware Reference Manual](#) (OM-20000129) for log and command details.

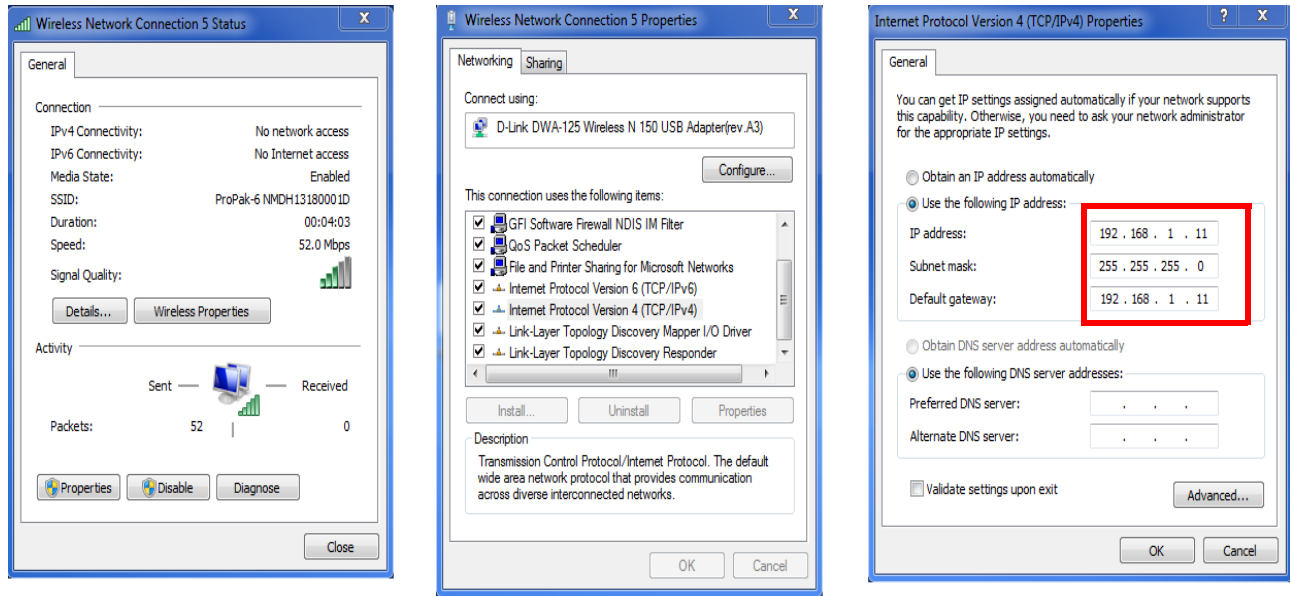

### 5.2.2.1 Multiple AP Configurations

Up to four APs can be configured on the ProPak6. Each AP supports up to 5 Client associations at one time. The default mode is AP1. Default value settings for AP2, AP3 and AP4 are blank.

1. Follow the first three steps in *Section 5.2.2, Wi-Fi AP Configuration on page 85*.
2. Issue the `WIFICONFIG MODE AP X` command, X being 2, 3 or 4 for the additional AP configurations.
3. Continue following the steps in *Section 5.2.2, Wi-Fi AP Configuration on page 85*.
4. Repeat as required for a maximum of 4 APs.



Refer to the `WIFICONFIG` command in the [OEM6 Family Firmware Reference Manual](#) (OM-20000129) for command details.

### 5.2.3 Wi-Fi Client Configuration

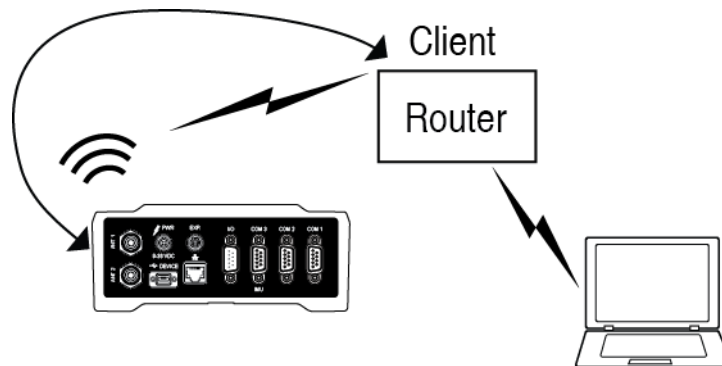

The ProPak6 can store configurations for a maximum of 16 APs on each Client.

1. Before Client configuration, consult the Network Administrator and obtain the necessary configuration values required to connect to the wireless network.

WIFIClient Network Configuration	Value	Description
SSID	String (default blank)	Service Set Identifier of the Wi-Fi AP being connected to This value must be entered in ASCII characters only (no binary).
BSSID	aa::bb::cc::ee::ff	Basic Service Set ID. The client will connect only to this BSSID.
Enabled	TRUE, FALSE	When set to TRUE, the Wi-Fi client network is included as a potential connection when the client interface is enabled and the system is searching for Access Points it knows. When set to FALSE, the Wi-Fi client network is kept for reference but is not automatically used.
Priority	Int	Instructs the client to always attempt connecting to this network, regardless of availability of other networks, signal strength, etc
Authentication	OPEN (default) WPA_PSK WPA2_PSK	The authentication method for the AP being connected to.
Encryption	NONE (default) TKIP AES_CCMP	The encryption method for the AP being connected to.
Passphrase	String, 64	WPA, WPA2 passphrase (8-63 ascii chars), or key (64 hex digits)
DHCP	TRUE (default) FALSE	When set to TRUE, DHCP is used to acquire the network configuration from the AP. When set to FALSE the static configuration values (shown below) are used to connect to the AP. Note that unless this value is specifically set to FALSE, DHCP is enabled regardless of any network parameters that may be set (IP, Netmask, Gateway, DNS)
IPAddr	ddd.ddd.ddd.ddd (for example: 10.0.0.2)	The IP address to be used by the receiver. (If not using DHCP.)
Netmask	ddd.ddd.ddd.ddd (for example: 255.255.255.0)	The netmask to be used by the receiver. (If not using DHCP.)
Gateway	ddd.ddd.ddd.ddd (for example: 10.0.0.1)	The IP address of the default gateway. (If not using DHCP.)
DNS1	ddd.ddd.ddd.ddd (for example: 10.0.0.3)	The IP address of the primary DNS server. (If not using DHCP.)

2. Connect the ProPak6 to a computer using one of the communication ports and turn power on.

### 5.2.4 Wi-Fi Scanning

Wi-Fi scanning is performed before connecting to either an Open/Encrypted, DHCP/Static network.

3. Enter `LOG WIFICLISCANRESULTS ONCHANGED` to display a list of the scan results.
4. Enter `LOG WIFICLISTATUS ONCHANGED` to monitor the connection status.
5. Issue the following commands:
 

<code>WIFICONFIG MODE CLIENT</code>	defines receivers as Client
<code>WIFICONFIG STATE ENABLED</code>	enables Client receiver
<code>WIFICLICONTROL SCAN</code>	initiates scanning for AP
6. Review the `WIFICLISCANRESULTS` log for any detected APs and manually configure the required network settings. Refer to Step 1 above.





Scan results are not used to configure the Client Wi-Fi connection.

#### 5.2.4.1 Connecting to an Open AP Network

7. Consult the Network Administrator for network parameters and values. Issue the following commands depending on the type of network being used
 

```
WIFICLICONFIG 1 SSID XXXX, where XXXX is the open AP to connect to
WIFICLICONFIG 1 AUTHENTICATION OPEN
WIFICLICONFIG 1 ENCRYPTION NONE
WIFICLICONFIG 1 ENABLED TRUE
```

#### 5.2.4.2 Connecting to an Encrypted AP Network

8. Consult the Network Administrator for network parameters and values. Issue the following commands depending on the type of network being used
 

```
WIFICLICONFIG 1 SSID XXXX, where XXXX is the protected AP to connect to
WIFICLICONFIG 1 AUTHENTICATION XXXX, where XXXX is the authentication setting of the AP (WPA_PSK, WPA2)
WIFICLICONFIG 1 ENCRYPTION XXXX, where XXXX is the encryption setting of the AP (TKIP, AES_CCMP)
WIFICLICONFIG 1 PASSPHRASE XXXX, where XXXX is the passphrase (password) of the AP
WIFIWLICONFIG 1 ENABLED TRUE
```
9. Configure the ICOM ports to be used (refer to *Section 3.1.12, ICOM Ports* on page 42 for details).
10. If required, configure port security (refer to *Section 2.9.2, FTP Server and ICOM Ports* on page 34 for details).
11. If using, configure NTRIP (refer to *Chapter 6, NTRIP Configuration* on page 93 for details).
12. Issue the `SAVECONFIG` command to save the configuration to Non-Volatile Memory (NVM).
13. Issue the `WIFICLICONFIG APPLYCONFIG` command to save settings.

Once Wi-Fi is connected, the ProPak6 Client is accessible on the LAN.



To use Wi-Fi as the primary internet access point, issue the `SETPREFERREDNETIF WIFI` command. Refer to the [OEM6 Family Firmware Reference Manual](#)- (OM-20000129), various Wi-Fi commands for details.



If Wi-Fi performance is slow, *Bluetooth* discoverability may be on. NovAtel recommends performing any *Bluetooth* discovery prior to joining a Wi-Fi network.

## 5.3 Cellular Activation GSM/GPRS/HSDPA

By default, the cellular radio is disabled.

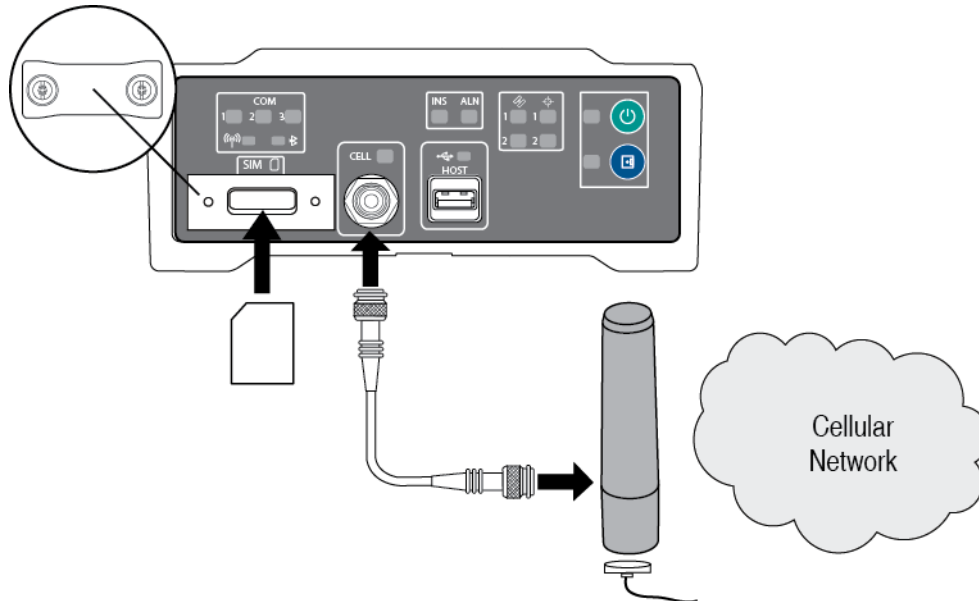

Refer Section 2.6, *Cellular Antenna Installation* on page 28 for instructions on installing a cellular radio antenna. Refer to Section 3.1.9, *Cell Port and LED* on page 40 for status LED information.

### 5.3.1 Configure Cellular as the Network Default

Ethernet (ETHA) is the default network for internet access for the ProPak6. The default network can be changed to Cellular by issuing the `SETPREFERREDNETIF CELL` command. Refer to the [OEM6 Firmware Reference Manual](#) (OM-20000129) for additional command details.

### 5.3.2 Cellular Network Activation and Configuration

The GSM/GPRS/HSDPA modem is not “locked” to any particular carrier. To activate a ProPak6 on a GSM/GPRS/HSDPA network, follow these steps:

1. Obtain an active account and SIM card providing GSM/GPRS/HSDPA data services (recommended data plans for Network RTK are 5GB/Month Rate Plans). The Service Provider may require the following information to setup an active account.
  - a. Product Name: ProPak6 GSM/GPRS/HSDPA
  - b. Modem Serial Number (IMEI): Modem serial number from ProPak6 product label

Example:



The cellular provider may require additional activation steps. Refer to any instructions provided with the SIM card.

Figure 28: SIM Card Installation

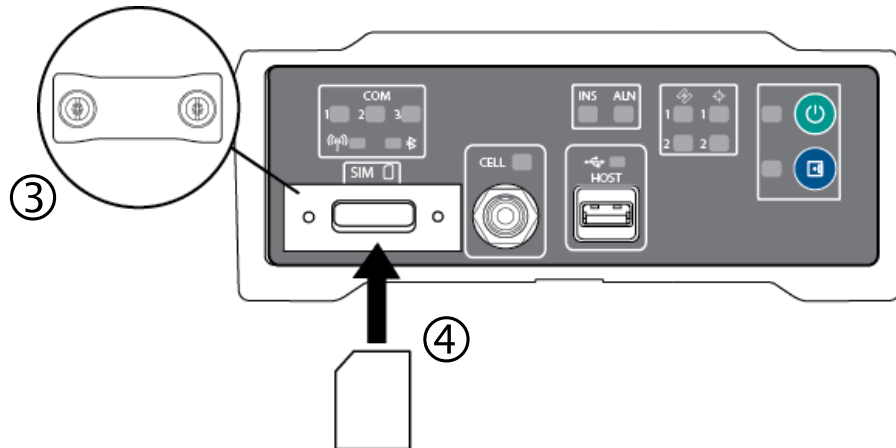

2. Remove the SIM card cover and insert the SIM card.



Only use a mini-SIM card (25 mm x 15 mm). ProPak6 does not support micro-SIM or nano-SIM cards.

3. Once the SIM card is correctly installed, secure the SIM cover to the base using a screwdriver. Screws should be torqued to 4-6 inch-pound.



Failure to properly secure SIM cover will violate ProPak6 IP67 ingress rating.

4. Ensure a cellular antenna is connected to the ProPak6 and turn the ProPak6 power on.
5. `LOG CELLULARSTATUS ONCHANGED` to display the modem and cellular connection status.
6. `LOG CELLULARINFO ONCE` to display modem and network information.
7. The `CELLULARCONFIG` command is issued to configure cellular parameters. Issue the following commands:

<code>CELLULARCONFIG POWER ON</code>	enables the radio
<code>CELLULARCONFIG APN &lt;APN&gt;</code>	sets AP name <sup>1</sup>
<code>CELLULARCONFIG USERNAME &lt;USERNAME&gt;</code>	sets user name <sup>1</sup>
<code>CELLULARCONFIG PASSWORD &lt;PASSWORD&gt;</code>	sets APN password <sup>1</sup>
<code>CELLULARCONFIG DATA ON</code>	enables/disables data connectivity on the configured APN
<code>CELLULARCONFIG DATAROAM ON</code>	enables/disables data connectivity when roaming

8. If internet access is required over this interface, issue the `SETPREFERREDNETIF CELL` command.
9. Issue the `SAVECONFIG` command to save the configuration to Non-Volatile Memory (NVM).



Cellular data consumption and service charges are dependent on the configuration of the ProPak6 receiver and data logging rates.



Refer to the [OEM6 Family Firmware Reference Manual](#) (OM-20000129) for log and command details.

1.Optional—consult the cellular data provider to determine if required.

### 5.3.3 Eject a SIM Card

Issue the `CELLULARCONFIG POWER OFF` command to power down the cellular radio before removing a SIM card.

To remove the SIM card, push it slightly in. It should then partially eject from the SIM card holder. The modem does not work if the SIM is in the partially ejected “ready for removal” position. Replace the SIM Card holder cover and ensure the cover is properly aligned and secured.

Issue the `CELLULARCONFIG POWER ON` command to turn the cellular radio on.

## 5.4 Airplane Mode

Enabling Airplane Mode turns off any Wi-Fi, *Bluetooth* or cellular radios in the ProPak6. Airplane Mode is disabled by default (radios on). If Airplane mode is enabled and then disabled, all radios automatically return to their last state (on or off) however, any connections made before airplane mode was enabled are not restored. Refer to the `AIRPLANEMODE` command and log in the [OEM6 Firmware Reference Manual](#) (OM-20000129) for command details.

To turn all three radios off, issue the following commands:

```
AIRPLANEMODE ENABLE
AIRPLANEMODE DISABLE
LOG AIRPLANEMODE (to view radio status)
```

Network Transport of RTCM via Internet Protocol (NTRIP) is an application protocol used to stream GNSS differential correction data over the Internet.

Configure a ProPak6 receiver as either an NTRIP server or an NTRIP client. For more information about NovAtel's NTRIP, refer to our NTRIP Product Sheet on our website at [www.novatel.com/products/firmware-options/ntrip/](http://www.novatel.com/products/firmware-options/ntrip/).

Figure 29: NTRIP System

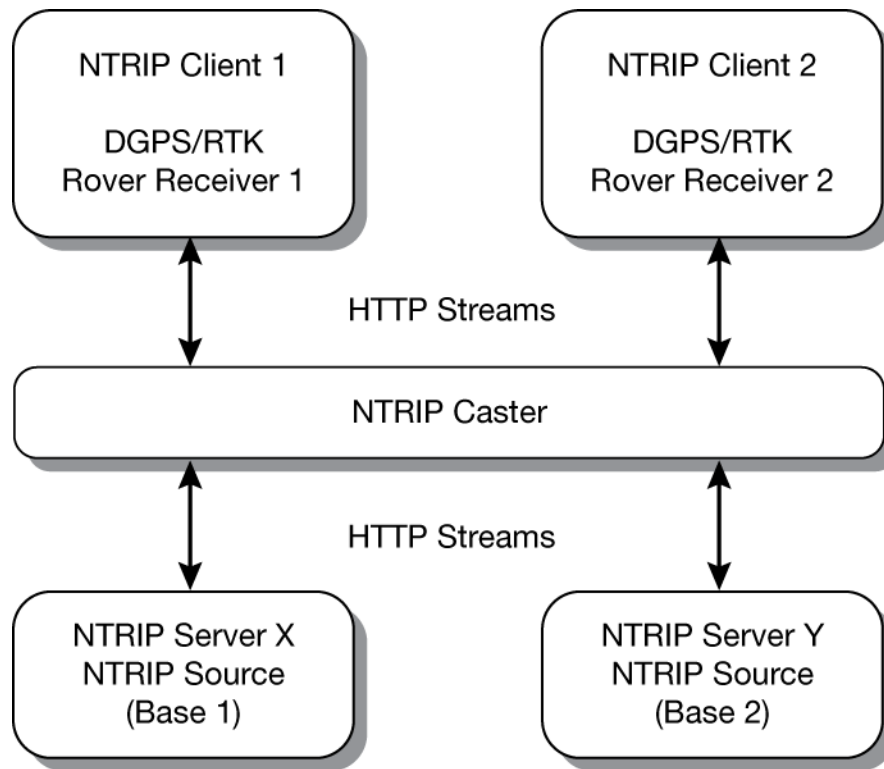

The NTRIP caster is an HTTP internet service that acts as a communication medium between NTRIP servers and NTRIP clients. The NTRIP caster is provided by third party sources. For a full list of NTRIP casters, refer to the following link: [www.rtcn-ntrip.org/home](http://www.rtcn-ntrip.org/home).

The following procedure describes how to configure a NovAtel base and a NovAtel rover through a third party NTRIP caster. This configuration is recommended for optimal RTK performance.

1. Establish a connection to the receiver using Ethernet, Wi-Fi or Cellular. Refer to *Chapter 4, Ethernet Configuration* on page 74 or the sections *Section 5.2, Wi-Fi Network Configuration* on page 84 or *Section 5.3, Cellular Activation GSM/GPRS/HSDPA* on page 90 for details.
2. Use the following commands to enable the base receiver as an NTRIP Server:

```

NTRIPCONFIG NCOM1 SERVER V2 <endpoint> <mountpoint> <username>
<password> etha
INTERFACEMODE NCOM1 NONE RTCA OFF
FIX POSITION <lat> <long> <height>
LOG NCOM1 RTCAOBS2 ONTIME 1
LOG NCOM1 RTCAREF ONTIME 10
LOG NCOM1 RTCA1 ONTIME 1
SETPREFERREDNETIF <WIFI> or <CELL> or <ETHA>
SAVECONFIG
  
```

3. Use the following commands to enable the rover receiver as an NTRIP Client:

```
NTRIPCONFIG NCOM1 CLIENT V1 <endpoint> <mountpoint> <username>
<password > etha
```



If using a specific Network RTK system, certain National Marine Electronics Association (NMEA) strings are required to be sent from the rover back to the RTK network. For example, if connected to the VRS mount point, the rover is required to send its position to the network in a standard NMEA GGA message. This is achieved by issuing the following commands: LOG NCOMx GPGGA ONTIME 5, until data is received by the caster. For more information about Network RTK options and properties, refer to the application note [APN-041 Network RTK](#) for OEMV Receivers found on our website at [www.novatel.com/support/search/](http://www.novatel.com/support/search/).

The following is an NTRIP Client configuration example without the use of a Network RTK system:

```
INTERFACEMODE NCOM1 RTCA NONE OFF
RTKSOURCE AUTO ANY
PSRDIFFSOURCE AUTO ANY
LOG BESTPOS ONTIME 1 (optional)
SETPREFERREDNETIF <WIFI> or <CELL> or <ETHA>
SAVECONFIG
```

Download the most recent versions of the NovAtel firmware and receiver software from the Downloads section of [www.novatel.com/support/search/](http://www.novatel.com/support/search/).

### **OEM6 Firmware and Software**



Refer to 7.3.1, *Transferring Firmware Files* on page 97 for descriptions of the Update and OEM versions.

### **NovAtel Connect PC Utilities Software Bundle**

Bundled PC Utilities software includes:

- NovAtel Connect (a GUI interface)
- Connection Import (imports connection profiles)
- Convert (converts receiver data logs into different formats)
- USB Drivers and Window Signing



The NovAtel Connect PC Utilities bundle can be download from the Downloads section of [www.novatel.com/support/search/](http://www.novatel.com/support/search/).

### **Firmware and Software included**

- Firmware \*.shex file
- WinLoad software utility



WinLoad and SoftLoad instructions follow.

## **7.1 Firmware Updates and Model Upgrades**

A local NovAtel dealer can provide all the information needed to upgrade or update a receiver. Refer to [www.novatel.com/where-to-buy](http://www.novatel.com/where-to-buy) for contact information or contact [sales@novatel.com](mailto:sales@novatel.com) or [support@novatel.com](mailto:support@novatel.com) directly.

### **7.1.1 Firmware Updates**

Firmware updates are firmware releases that include fixes and enhancements to the receiver functionality. Firmware updates are released occasionally on the NovAtel web site as they become available. Firmware upgrades can be performed using the WinLoad utility, SoftLoad commands or with a custom loader application. Contact NovAtel Customer Support ([support@novatel.com](mailto:support@novatel.com)) for details on custom loader requirements.

## 7.1.2 Model Upgrades

Model upgrades enable purchased receiver features.

Contact a local NovAtel dealer to assist in selecting the upgrade options that best suit your GNSS needs at [www.novatel.com/where-to-buy](http://www.novatel.com/where-to-buy). Contact NovAtel Customer Support [www.novatel.com/support](http://www.novatel.com/support) or [NovAtel Sales](#) to request a temporary upgrade authorization code for trial purposes.

Model upgrades can be applied to the receiver with an authorization code and the `AUTH` command without returning the receiver to the dealer.

## 7.2 Authorization Code

An authorization code, commonly known as an auth-code, is required to upgrade an OEM6 family receiver. Auth-codes are obtained by contacting [NovAtel Customer Support](#). Upon contact, NovAtel Customer Support requires:

- the receiver model number
- the receiver serial number
- the receiver firmware version

Enter the `LOG VERSION` command to determine the receiver model, serial number and firmware version.

Example:

```

ENTER → MODEL NUMBER SERIAL NUMBER FIRMWARE VERSION
GPSCARD "D2LR0RTTRA" "BFN11230026" "OEM628-1.00" "OEM060300RN0000"

```

The diagram illustrates the structure of the firmware version string "OEM060300RN0000". It is divided into three main sections: "OEM060300" (Product Family), "RN" (Firmware Number), and "0000" (Release Indicator). The "OEM060300" section is further broken down into "OEM0603" (Product Family) and "0000" (Firmware Number). The "RN" section is also broken down into "R" (Product Family) and "N" (Firmware Number). The "0000" section is broken down into "0000" (Release Indicator).

After determining the appropriate model and firmware version the authorization code (auth-code) is issued. The auth-code is required to unlock the features on the new model type.

To upgrade to a new model with the same firmware version, use the `AUTH` command with the issued auth-code, as outlined in *Upgrading Using the AUTH Command*.

To upgrade to a new model with a new firmware version, the new firmware needs to be loaded into the OEM6 receiver. Refer to 7.3, *Updating or Upgrading Using the WinLoad Utility* on page 97 for use instructions or to 7.4, *Updating Using SoftLoad Commands* on page 99.

There are two types of auth-codes:

- Standard auth-codes, which are tied to a model, serial number and firmware version
- Signature auth-codes, which are tied only to a model and serial number

When upgrading to a new version of firmware, the Standard auth-code for the old version of firmware will not work with the new version of firmware. Therefore, a new auth-code is required for each receiver that is upgraded.

However, Signature auth-codes work with any signed firmware image. Therefore, if a receiver has a Signature auth-code for the old version of firmware, that same auth-code will work for the new version of firmware, provided both images are digitally signed by NovAtel.

Signature auth-codes require firmware version OEM060200RN0000 (6.200) or later and boot code version OEM060100RB0000 (6.100) or later.

Signed firmware images are distributed in \*.shex files, while unsigned firmware images are distributed in \*.hex files.



Temporary auth-codes may be provided by NovAtel for evaluation purposes. Once the trial period has expired, a new auth-code will need to be obtained from NovAtel Customer Support ([support@novatel.com](mailto:support@novatel.com)).

The new download package includes a signed firmware file type that uses an extension designated as “.shex” (example OEM060200RN0000.shex), as well as the latest WinLoad utility and What’s New file containing firmware update change details.



Prior to firmware version OEM060200RN0000, authorization codes depended on the software model, the firmware version and the serial number of the receiver. The authorization code changed if any of the three items changed. This is no longer the case, they are now no longer dependent on firmware version.

## 7.3 Updating or Upgrading Using the WinLoad Utility

WinLoad is the simplest and most common way to update or upgrade an OEM6 receiver.

### 7.3.1 Transferring Firmware Files

To proceed with an update or possibly an upgrade, obtain the latest version of firmware by downloading the (OEM Version) for your product from [www.novatel.com/support/firmware-downloads/](http://www.novatel.com/support/firmware-downloads/).

#### Format of Firmware Files

All of the firmware available on the downloads website are packaged in .zip files with the following names:

- OEMXXRN0000.zip for firmware to be installed on OEM615, OEM617, OEM617D, FlexPak6 or OEM628 receivers
- OMPXXRN0000.zip for firmware to be installed on OEM638 receiver

NovAtel Customer Service may generate and provide the required authorization code. Authorization codes are obtained by contacting [support@novatel.com](mailto:support@novatel.com) or at [www.novatel.com/Support/](http://www.novatel.com/Support/).

For convenience, unzip the update file to a GNSS sub-directory (for example, C:\GNSS\LOADER). If the firmware update file is password protected, NovAtel Customer Support provides the required password.

The zip archive includes the following files:

winload.exe	WinLoad utility program
howto.txt	Instructions on how to use the WinLoad utility
whatsnew.rtf	Information on the changes made in the firmware since the last revision
x..x.shex	Firmware version upgrade file, where x..x defines the product name and release (e.g., OEM060400RN0000.shex)

NovAtel Software License Agreement.rtf License agreement for the firmware.

The files are extracted to unzip/program files/NovAtel Inc/x.xxx Full Update Disk, where x.xxx is the firmware version.



NovAtel has an online video tutorial that explains firmware uploading at: [www.novatel.com/support/videos](http://www.novatel.com/support/videos).

### 7.3.2 Using the WinLoad Utility

If opening WinLoad for the first time, ensure the file and communications settings are correct.

#### Open a File to Download

Select File | Open. Navigate to the file to open (*Figure 30*).

**Figure 30: WinLoad's Open Window**

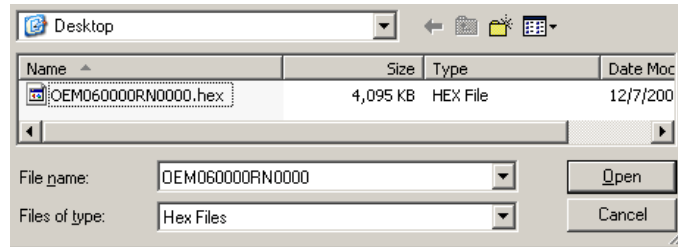

When a file is selected, the filename appears in the main WinLoad display area and in the title bar (*Figure 31*).

**Figure 31: Open File in WinLoad**

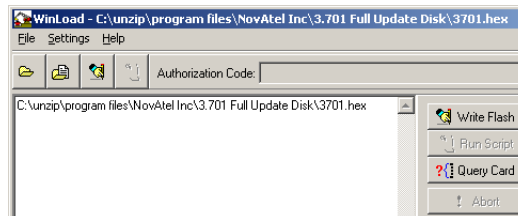

#### Communications Settings

To set the communications port and baud rate, select Settings | COM Settings. Choose the computer port to use from the Com Port drop down list and the baud rate from the Download Baudrate drop down list. Set the baud rate as high as possible (the default of 115200 is preferred if a higher baud rate is not available).

**Figure 32: COM Port Setup**

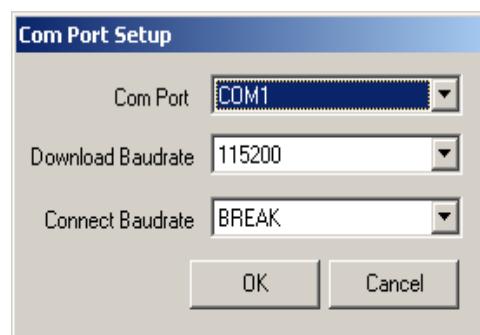

## Downloading Firmware

1. Select the file to download according to *Open a File to Download on Page 98*.
2. Ensure the file path and name are displayed in main display area (see *Figure 31, Open File in WinLoad on Page 98*).
3. Click Write Flash to download the firmware.
4. When Searching for card appears in the main display, power cycle the receiver.

**Figure 33: Searching for Card**



5. If the Authorization Code window appears, enter the auth-code and click **OK**. See *Section 7.2 Authorization Code on page 96* for further information about the Authorization Code.

**Figure 34: Authorization Code Window**

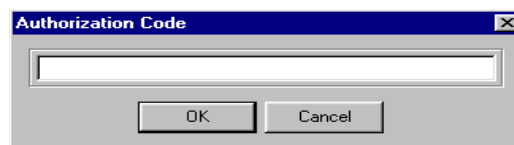

6. The receiver finishes the download and then resets. The process is complete when Done appears in the main display area.

**Figure 35: Upgrade Process Complete**

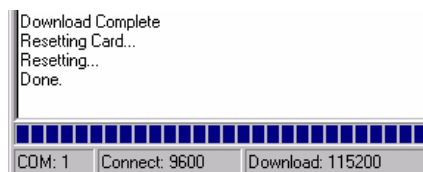

7. Close WinLoad.

## 7.4 Updating Using SoftLoad Commands

Firmware can be updated on a running receiver using a process called SoftLoad. Any available communication ports on the receiver (COM, USB, ICOM, XCOM, etc.) can be used. The SoftLoad process is made up of a set of commands and logs that are used to send new firmware data to a receiver and check the progress of the update. Use SoftLoad if automated loading is desired or if a connection is only possible through USB or Ethernet.

The receiver stops tracking GNSS satellites during the SoftLoad process. Do not attempt to SoftLoad when GNSS satellite tracking on the unit is required. If the unit is connected to the NovAtel Connect utility, only the Console and ASCII Message windows may remain open in the Connect Utility.

### 7.4.1 SoftLoad Commands and Logs

Refer to the [OEM6 Family Firmware Reference Manual](#) (OM-20000129) for further log and command information.

Command	Description
SOFTLOADRESET	Initiate a new SoftLoad process
SOFTLOADSREC	Send an S-Record to the receiver for the SoftLoad process
SOFTLOADDATA	Send firmware image data to the receiver for the SoftLoad process
SOFTLOADCOMMIT	Complete the SoftLoad process
SOFTLOADSETUP	Send configuration information to the receiver for the SoftLoad process. This command is not required when working with a *.hex or *.shex file
Log	Description
SOFTLOADSTATUS	Provides status updates for the ongoing SoftLoad process

Each command and log can be used in abbreviated ASCII, ASCII or binary format, with the exception of SOFTLOADDATA, which should only be used in binary format.

### File Types

Firmware data is stored in \*.hex and \*.shex files as ASCII data in the form of S-Records, based on the Motorola S-Record format. The \*.shex file is the same as the \*.hex file but includes a digital signature for the firmware.

## 7.4.2 Working With S-Records

Each S-Record has a header indicating the type of information contained in the record.

Records beginning with S0, S5 and S7 contain metadata about the firmware image, such as version information and which card types are supported by the firmware image.

### Example S0 Record

```
S0~V~OEM060400RN0000
```

### Example S5 Records

```
S50000
S503D9FE25
S5033158D5A
```

### Example S7 Records

```
S70000
S70500000000FA
```

Records beginning with S3 contain the actual firmware image data. Aside from the header, each pair of characters forms the ASCII representation of a binary byte. The format is as follows:

S3	LL	AAAAAAA	DDDDDDDD...DDDDDDDD	CC
				Check Sum.
			Little Endian Data. These bytes are copied into the "data" field of the SOFTLOADDATA command	
			4 - Byte Address. Set this as the value of "offset" in the SOFTLOADDATA command	
			Length. This is the hexadecimal number of character pairs to follow in the record. This value minus 4 bytes for the address and 1 byte for the check sum is copied into the "data length" field of the SOFTLOADDATA command	
Header				

### 7.4.3 Sending Firmware Data

C++ source code is available to provide example code of processing S-Records and converting them to NovAtel format commands, as well as providing help with the SoftLoad process. Contact [NovAtel Customer Support](#) and ask about the `srec2softload` utility.

The `SOFTLOADSREC` and `SOFTLOADDATA` commands can be used to send firmware data from \*.hex or \*.shex files to the receiver.

S0, S5 and S7 S-Records should be sent directly to the receiver using the `SOFTLOADSREC` command, by enclosing the S-Record in quotation marks and issuing the command to the receiver, as follows:

```
SOFTLOADSREC "<S-RECORD>"
```

S3 records can be sent individually to the receiver using the `SOFTLOADSREC` command. Alternatively, the data from an S3 record can be parsed and packaged together with data from other S3 records into a binary `SOFTLOADDATA` command. Packaging data parsed from multiple S3 records into a binary `SOFTLOADDATA` command can result in improved firmware update times as each S3 record contains only a small number of bytes of firmware data. A single `SOFTLOADDATA` command can package up to 4096 bytes of firmware data from multiple S3 records, whereas a single `SOFTLOADSREC` command contains a maximum of 28 bytes of firmware data from a single S3 record.

Multiple S3 records can be packaged into a single `SOFTLOADDATA` command as long as the data from one S3 record follows immediately after the previous record. That is, the address from the current S3 record must equal the address from the previous S3 record plus the data length of the previous S3 record. If the data is not consecutive then the `SOFTLOADDATA` command can be sent with the amount of data it has packaged up to that point. Subsequent data can be packaged in a new `SOFTLOADDATA` command. Within the `SOFTLOADDATA` command, the "offset" field remains the address of the first S3 record and the "data" and "data length" are updated to include the new data. Refer to the [OEM6 Family Firmware Reference Manual](#) (OM-20000129) for more information regarding the `SOFTLOADDATA` command.

The \*.hex and \*.shex file data may contain many gaps and jumps. For example, in many NovAtel \*.hex and \*.shex files, data for address 0x000\_00000 is stored near the very end of the file.

#### Example Packaging Multiple S3 Records In A SOFTLOADDATA Command

Start a new `SOFTLOADDATA` command

```
S32100407AD48FCA63034B80F5CE0C36507DE3D8DCC0C6C0C00515D74BCACF2F2949E1
```

Address: 0x00407AD4 Num Data Bytes: 0x21 – 0x01 – 0x04 = 0x1C

```
S32100407AF04CCA4985F0F7B081E41D9B7D806C26989AE2D4E4CCBCB47C10FBFD3E43
```

Previous Address + Previous Num Bytes = 0x00407AD4 + 0x1C = 0x00407AF0

Address: 0x00407AF0 Num Data Bytes: 0x1C

Add data to existing `SOFTLOADDATA` command

```
S30D00407B0CDE0400A6374D5BFFC5
```

Previous Address + Previous Num Bytes = 0x00407AF0 + 0x1C = 0x00407B0C

Address: 0x00407B0C Num Data Bytes: 0x0D – 0x01 – 0x04 = 0x08

Add data to existing `SOFTLOADDATA` command

```
S3210000000007F0A7F1F4060000147B4000F49217813C7BB00014493F005C00000009
```

Previous Address + Previous Num Bytes = 0x00407B0C + 0x08 = 0x00407B14

Address: 0x00000000 Num Data Bytes: 0x1C

Requires new `SOFTLOADDATA` command because address does not match previous address + previous number of data bytes

Send existing `SOFTLOADDATA` command, and start a new `SOFTLOADDATA` command

```
S3210000001C80040000E001000030000000082B0100D8060000E4060000C806000063
```

Address: 0x0000001C Num Data Bytes: 0x1C

Previous Address + Previous Num Bytes = 0x00000000 + 0x1C = 0x0000001C

Add data to existing `SOFTLOADDATA` command

The `SOFTLOADDATA` command must be sent as a NovAtel binary format command.

#### 7.4.4 SoftLoad Update Method

This section describes the sequence of commands that are issued to the receiver when updating using a \*.hex or \*.shex file.



The response for each command must be processed before sending the next command so as to determine if the command was accepted or rejected, and to wait for the receiver to complete the operation. Responses to SoftLoad commands are guaranteed to be output from the receiver within a specific time, which varies by command. Refer to the [OEM6 Family Firmware Reference Manual](#) (OM-20000129) for more information on responses, and the timeout values for SoftLoad commands.

1. Open a connection to any port on the receiver (COM, USB, ICOM or XCOM) with the input and output `INTERFACEMODE` set to `NOVATEL`.
2. Request the `SOFTLOADSTATUS` log using the following command:  
`LOG SOFTLOADSTATUSA ONCHANGED`
3. Initialize SoftLoad with a `SOFTLOADRESET` command. This command stops all tracking on the receiver to ensure sufficient memory is available for the loading process. An `RXSTATUSEVENTA` log reports a SoftLoad In Progress status.
4. Open the \*.hex or \*.shex firmware file.
5. Read each line of the \*.hex or \*.shex firmware file.
  - A. Send S0, S5 and S7 S-Records directly to the receiver using the `SOFTLOADSREC` command. The S-Record must be enclosed in quotation marks:  
`SOFTLOADSREC "<S-RECORD>"`  
Data within S0 records can also be sent to the receiver by converting them to `SOFTLOADSETUP` commands. Refer to the [OEM6 Family Firmware Reference Manual](#) (OM-20000129) for details on how to convert from S0 S-Records to `SOFTLOADSETUP` commands.
  - B. S3 S-Records should be parsed and packaged into a `SOFTLOADDATA` command.
6. Send the `SOFTLOADCOMMIT` command after all data from the \*.hex or \*.shex file has been transferred to the receiver. The `SOFTLOADSTATUS` log reports the status of the loading process. Wait for a `SOFTLOADSTATUS` log to indicate the status is `COMPLETE`. The `COMPLETE` status or an error is guaranteed to be output from the receiver within 300 seconds from the time the `SOFTLOADCOMMIT` command was received by the receiver.
7. Send the auth code for the newly downloaded image using the `AUTH` command. This is only required if there is not already a signature auth code on the receiver as signature auth codes are maintained through a SoftLoad update. See [Section 7.2 on page 96](#) for details on Auth Codes.  
`AUTH ADD_DOWNLOAD <AUTH CODE>`
8. Reset the receiver using any of the following methods:
  - A. Enter the `RESET` command
  - B. Enter the `FRESET` command

C. Power-cycle the receiver

Once the receiver resets, the new version of firmware is active.

The SoftLoad process can be safely canceled at any time using the `SOFTLOADRESET` command or by otherwise resetting the receiver. Once the `COMPLETE` status is reported by `SOFTLOADSTATUS`, the new firmware image will be run after the receiver is reset.

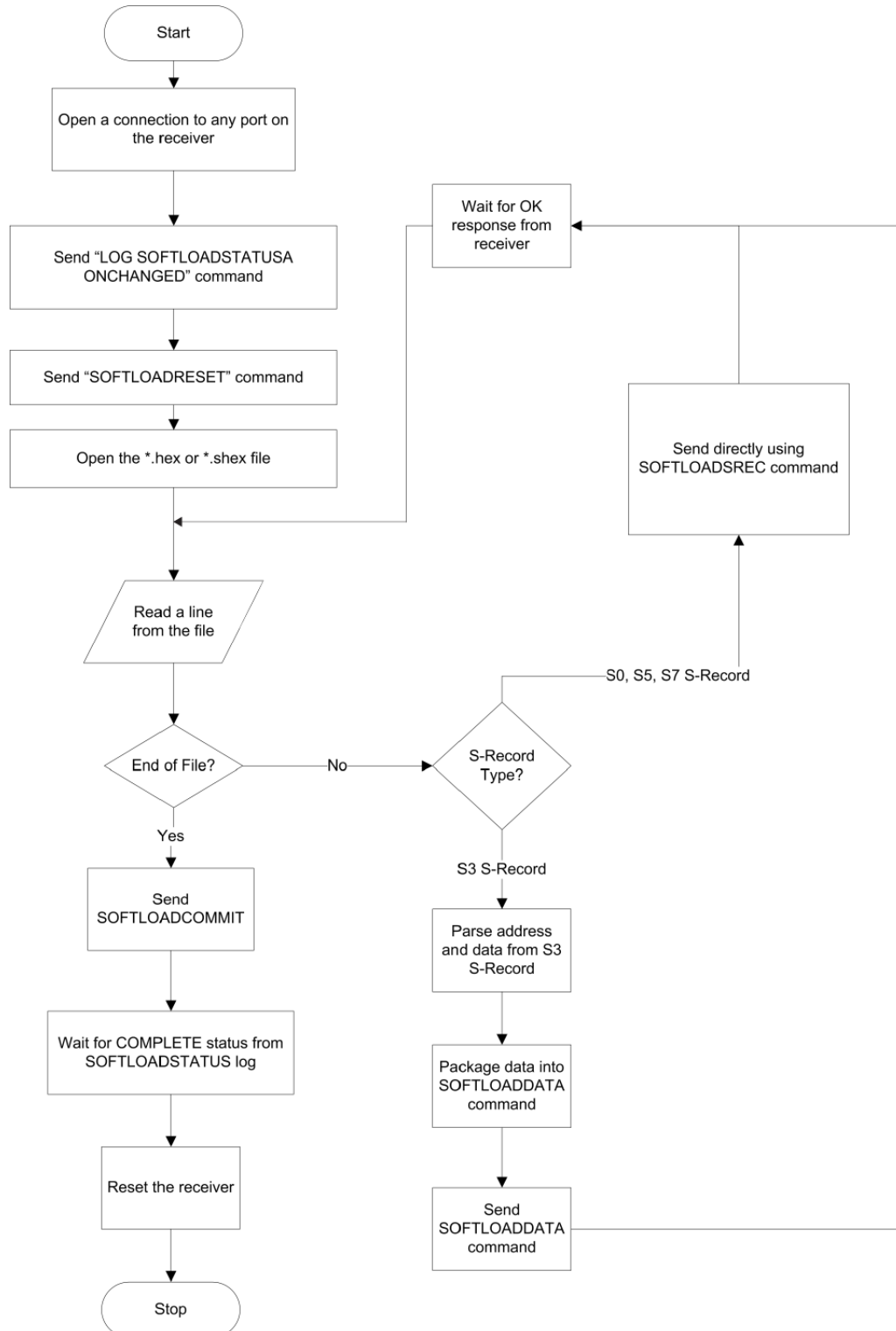

### 7.4.5 Firmware Update Using FTP or USB Mass Storage Device

Select OEM receivers support upload of firmware files via FTP or USB. The `SOFTLOADFILE` command can be used to update the receiver firmware if \*.hex or \*.shex files have been uploaded via FTP or are available on an attached USB mass storage device. This method is called SoftLoad Direct.

The FTP server in the receiver can be accessed using Ethernet or Wi-Fi. Refer to the `IPSERVICE` command in the [OEM6 Family Firmware Reference Manual](#) (OM-20000129) for details. The FTP server allows uploads to the internal flash of the receiver, however the firmware file in internal flash must be copied to the receiver's boot flash device using the `SOFTLOADFILE` command before it becomes the active firmware running on the receiver.

This method of updating firmware is referred to as the SoftLoad Direct method.

### 7.4.6 SoftLoad Direct Commands and Logs

Refer to the [OEM6 Family Firmware Reference Manual](#) (OM-20000129) for further log and command information.

Command	Description
SOFTLOADFILE	Allows updating using a *.hex or *.shex file that has been uploaded to the receiver via FTP or USB on platforms supporting those interfaces
Log	Description
SOFTLOADSTATUS	Provides status updates for the ongoing SoftLoad process

Each command and log can be used in abbreviated ASCII, ASCII or binary format.

### 7.4.7 SoftLoad Direct Update Method

- Open a connection to any port on the receiver (COM, USB, ICOM or XCOM) with the input and output `INTERFACEMODE` set to `NOVATEL`.
- Request the `SOFTLOADSTATUS` log using the following command:  
`LOG SOFTLOADSTATUS ONCHANGED`
- Initiate the firmware update using one of the following commands where <<firmwarefilename.hex>> is the name of the \*.hex or \*.shex file:
  - If using internal flash use this command: `SOFTLOADFILE INTERNAL_FLASH firmwarefilename.hex`
  - If using a USB mass storage device: `SOFTLOADFILE USBSTICK firmwarefilename.hex`
- During the loading process, `SOFTLOADSTATUS` logs report the load status. Wait for the `SOFTLOADSTATUS` to indicate the status is `COMPLETE`.
- Send the auth code for the newly downloaded image using the `AUTH` command. This is only required if there is not already a signature auth code on the receiver as signature auth codes are maintained through a SoftLoad update. See [Section 7.2 on page 96](#) for details on Auth Codes  
`AUTH ADD_DOWNLOAD <AUTH CODE>`
- Reset the receiver using any of the following methods:
  - Enter the `RESET` command
  - Enter the `FRESET` command
  - Power-cycle the receiver
- Once the receiver resets, the new version of firmware is active.



### 7.4.8 SoftLoad Errors

It is possible for errors to occur during the SoftLoad update. All command responses should be checked to verify all issued commands were accepted. The SoftLoad status should also be monitored in the SOFTLOADSTATUS log. Any status enum value greater than the ERROR status indicates an error has occurred during the SoftLoad update. In the event of an error, the SoftLoad update should be restarted by issuing a SOFTLOADRESET command or normal operation can be restored by resetting the receiver.

In rare cases after a SoftLoad error, the boot code may not be able to determine which is the latest firmware to be executed. To protect against this, SoftLoad does not erase the previous valid firmware image from flash on the receiver. In such cases, the boot code will execute the old image and raise the "Safe Mode" error (see RXSTATUS log). If that error is detected, simply restart the SoftLoad process to reload the new firmware image and the error will be resolved.

## 7.5 Upgrading Using the AUTH Command

The AUTH command is used to upgrade to a new OEM6 family model with an authorization code that enables (unlocks) model features. This command only functions with a valid auth-code assigned by [NovAtel Customer Support](#).

The upgrade can be performed directly through the NovAtel Connect command line or from any other communications program.



Refer to the *Format of Firmware Files* section on *Page 97* for details on updating versus upgrading.

### 7.5.1 Upgrade Procedure

1. Power up the OEM6 family receiver and establish communications (refer to the Quick Start Guide included with the product for instructions).
2. Issue the LOG VERSION command to verify the current model, firmware version and serial number (refer to 7.2, *Authorization Code* on page 96 for instructions on obtaining).
3. Issue the AUTH command, followed by the auth-code and model type (refer to *Section 7.2 Authorization Code* on page 96 for details on obtaining any auth-code). The syntax is as follows:

```
auth <your auth-code here>
```

where `auth` is a command that enables model upgrades and `auth-code` is the upgrade authorization code, expressed as follows:

```
XXXXXX,XXXXXX,XXXXXX,XXXXXX,XXXXXX,MODEL,EXPDATE
```

where:

1. Each X character is a case-insensitive ASCII character.
2. The MODEL string is a maximum of 15 characters long and represents the model enabled by the auth-code.
3. The EXPDATE string is the auth-code's expiry date, in YYMMDD format

Example:

```
auth 7WBMBK,887CB6,K5J3FH,5DF5P2,42PW8G,D1SB0GTT0,121211
```

When the AUTH command is executed, the OEM6 family receiver reboots. Issuing the LOG VERSION command confirms the new upgrade model type and firmware version number.

If communicating using NovAtel Connect, the communication path must be closed and reopened using the Device menu.

## 8.1 Overview

The Built-In Status Test monitors system performance and status to ensure the receiver is operating within specifications. The test detects an exceptional condition and informs the user through one or more indicators. The receiver status system is used to configure and monitor the indicators:

1. Receiver status word (included in the header of every message)
2. ERROR strobe signal (see 3.1.14.1, *Strobes on page 43*)
3. RXSTATUSEVENT log
4. RXSTATUS log

In normal operation, the error strobe is driven low. When an unusual and non-fatal event occurs (for example, there is no valid position solution), a bit is set in the receiver status word. Receiver operation continues normally, the error strobe remains off. When the event ends (for example, when there is a valid position solution), the bit in the receiver status word is cleared.

When a fatal event occurs (for example, a receiver hardware failure), a bit is set in the receiver error word, part of the RXSTATUS log, to indicate the cause of the problem. Bit 0 is set in the receiver status word to show that an error occurred, the error strobe is driven high. An RXSTATUSEVENT log is generated on all ports to show the cause of the error. Receiver tracking is disabled but command and log processing continues to allow error diagnosis. Even if the source of the error is corrected, the receiver must be reset to resume normal operation.

Two scenarios describe factory default behavior. These behaviors can be customized to better suit an individual application. RXSTATUSEVENT logs can be disabled completely with the `UNLOG` command. RXSTATUSEVENT logs can be generated when a receiver status bit is set or cleared with the `STATUSCONFIG SET` and `STATUSCONFIG CLEAR` commands. Bits in the receiver status word can also be promoted to act like error bits with the `STATUSCONFIG PRIORITY` command.

## 8.2 Receiver Status Word

The receiver status word indicates the current status of the receiver. This word is found in the header of all logs and in the RXSTATUS log. In addition, the receiver status word is configurable.

The importance of the status bits with priority masks can be determined. For receiver status, setting a bit in the priority mask causes the condition to trigger an error. The error causes the receiver to idle all channels, turn off the antenna and disable the RF hardware, just like it would if a bit in the receiver error word is set. Setting a bit in an Auxiliary Status priority mask causes the condition to set the bit in the receiver status that corresponds to the auxiliary status.

Use the `STATUSCONFIG` command to configure the various status mask fields in the RXSTATUS log. Use the masks to specify whether various status fields generate errors or event messages when set or cleared.

Refer to the RXSTATUS log, RXSTATUSEVENT log and `STATUSCONFIG` command in the [OEM6 Family Firmware Reference Manual](#) for more detailed descriptions of these messages.

### 8.3 Error Strobe Signal

The error strobe signal is one of the I/O strobes. The strobe signal is driven low when the receiver is operating normally. When the receiver is in the error state and tracking is disabled, the error strobe is driven high. This can be caused by a fatal error or by an unusual receiver status indication that the user has promoted to be treated like a fatal error. Once on, the error status remains high until the cause of the error is corrected and the receiver is reset. See also *Section 3.1.14.1 Strobes on page 43*.

### 8.4 RXSTATUSEVENT Log

The RXSTATUSEVENT log is used to output event messages, as indicated in the RXSTATUS log.

On start up, the OEM6 family receiver is set to log the RXSTATUSEVENTA log ONNEW on all ports. Remove this message using the UNLOG command.

Refer to the RXSTATUSEVENT log in the [OEM6 Family Firmware Reference Manual](#) for a more detailed description of this log.

### 8.5 RXSTATUS Log

#### 8.5.1 Overview

The Receiver Status log (RXSTATUS) provides system status and configuration information in a series of hexadecimal words.

The status word is the third field after the header, as shown in the example in *Figure 36*.

**Figure 36: Location of Receiver Status Word**

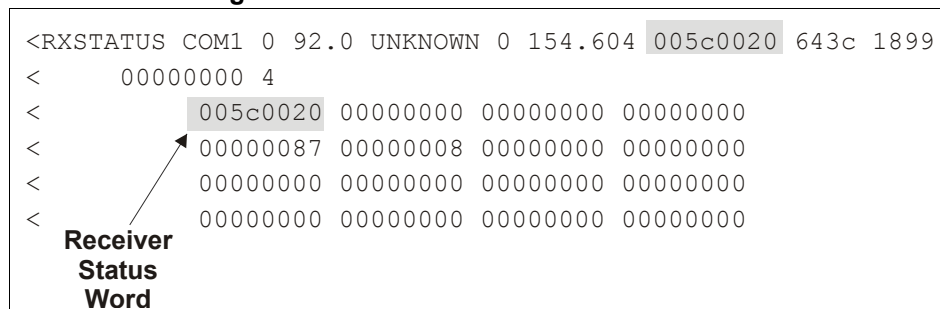

Each bit in the status word indicates the status of a specific receiver condition or function. If the status word is 00000000, the receiver is operating normally. The numbering of the bits is shown in *Figure 37*.

**Figure 37: Reading the Bits in the Receiver Status Word**

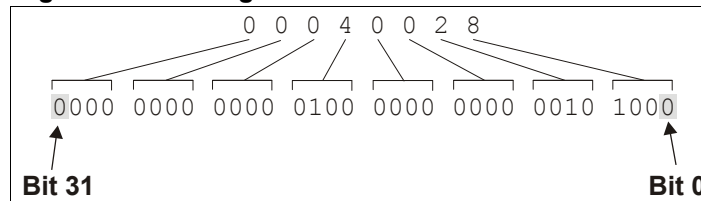

If the receiver status word indicates a problem, see Resolving an Error in the Receiver Status Word table in the troubleshooting section of the [OEM6 Family Installation and Operation User Manual](#) (OM-20000128).

## 8.5.2 Error Word

The error field contains a 32-bit word. Each bit in the word is used to indicate an error condition. Error conditions may result in damage to the hardware or erroneous data, so the receiver is put into an error state. If any bit in the error word is set, the receiver sets the error strobe line, flashes the error code on the status LED, broadcasts the RXSTATUS log on all ports (unless the user has unlogged it), idles all channels, turns the antenna off and disables the RF hardware. To override the error state, reset the receiver.

The receiver can be configured to generate event messages triggered by status conditions. Receiver Error words automatically generate event messages. These event messages are output in RXSTATUS log (see also *Section 8.5.6, Set and Clear Mask for all Status Code Arrays* on page 109).

The error word is the first field after the log header in the RXSTATUS log, as shown in the example in *Figure 38*.

**Figure 38: Location of Receiver Error Word**

```

<RXSTATUS COM1 0 92.0 UNKNOWN 0 154.604 005c0020 643c 1899
< 00000000 4
< 005c0020 00000000 00000000 00000000
< 00000087 00000008 00000000 00000000
< Receiver Error Word 00000000 00000000 00000000 00000000
< 00000000 00000000 00000000 00000000
  
```

*Figure 39* shows an example of a receiver error word.

**Figure 39: Reading the Bits in the Receiver Error Word**

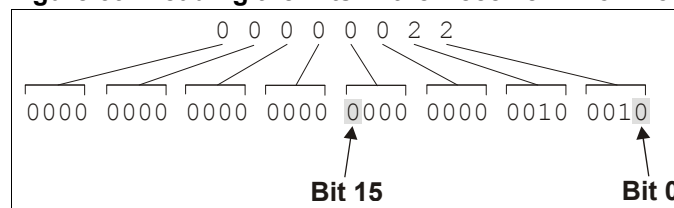

Refer to the RXSTATUS and the RXSTATUS log in the [OEM6 Family Firmware Reference Manual](#) (OM-20000129) for more detailed log descriptions. If the receiver error word indicates an error, refer to Resolving an Error in the Receiver Error Word table in the troubleshooting section of the [OEM6 Family Installation and Operation User Manual](#) (OM-20000128).

## 8.5.3 Status Code Arrays

There are currently 4 status code arrays:

- receiver status word
- auxiliary 1 status
- auxiliary 2 status
- auxiliary 3 status

Each status code array consists of four 32-bit words (the status word, a priority mask, a set mask and a clear mask). The status word is similar to the error word, with each of the 32 bits indicating a condition. The mask words are used to modify the behavior caused by a change in one of the bits in the associated status words. Each bit, in any mask, operates on the bit in the same position in the status word. For example, setting bit 3 in the priority mask changes the priority of bit 3 in the status word.

### 8.5.4 Receiver Status Code

The receiver status word is included in the header of all logs. It has 32 bits that indicate certain receiver conditions. If any of these conditions occur, a bit in the status word is set. Unlike the error word bits, the receiver continues to operate, unless the priority mask for the bit has been set. The priority mask bit changes the receiver status word into an error bit. Anything that results from an error bit becoming active also occurs if a receiver status and its associated priority mask bits are set.

### 8.5.5 Auxiliary Status Codes

The auxiliary status codes are only in the RXSTATUS log. The three arrays that represent the auxiliary status codes indicates the receiver state for information purposes only. The events represented by these bits typically do not cause receiver performance degradation. The priority mask for the auxiliary codes does not put the receiver into an error state. Setting a bit in the auxiliary priority mask results in the corresponding bit in the receiver status code to be set if any masked auxiliary bit is set. Bit 31 of the receiver status word indicates the condition of all masked bits in the auxiliary 1 status word. Likewise, bit 30 of the receiver status word corresponds to the auxiliary 2 status word and bit 29 to the auxiliary 3 status word.

Refer also to the RXSTATUS log in the [OEM6 Family Firmware Reference Manual](#) (OM-20000129) for a more detailed description.

### 8.5.6 Set and Clear Mask for all Status Code Arrays

The other two mask words in the status code arrays operate on the associated status word in the same way. These mask words are used to configure the bits in the status word that result in a RXSTATUSEVENT log broadcast. The set mask is used to turn logging on temporarily while the bit changes from the 0 to 1 state. The clear mask is used to turn logging on temporarily while the bit changes from a 1 to a 0 state. Note the error word does not have any associated mask words. Any bit set in the error word results in a RXSTATUSEVENT log broadcast (unless unlogged).

Refer also to the RXSTATUS log in the [OEM6 Family Firmware Reference Manual](#) (OM-20000129) for a more detailed description.

## A.1 OEM638 Receiver Card Performance for ProPak6

<b>PERFORMANCE (SUBJECT TO GPS SYSTEM CHARACTERISTICS)</b>						
Position Accuracy <sup>a</sup>	<b>Standalone:</b>					
	L1 only	1.5 m RMS				
	L1/L2	1.2 m RMS				
	NovAtel CORRECT	SBAS <sup>b</sup>	60 cm RMS			
		DGPS	40 cm RMS			
		PPP <sup>bc</sup> TerraStar-L TerraStar-C	40 cm RMS 4 cm RMS			
RTK		1 cm + 1 ppm				
Time to First Fix	Hot: 35 s (Almanac and recent ephemeris saved and approximate position and time entered) Cold: <50 s (No almanac or ephemeris and no approximate position or time)					
Reacquisition	0.5 s L1 (typical) 1.0 s L2 (typical) 1.0 s L5 (typical)					
Data Rates	Measurements	100 Hz				
	Position	100 Hz				
Time Accuracy <sup>ad</sup>	20 ns RMS					
Velocity Accuracy <sup>a</sup>	0.03 m/s RMS					
Measurement Precision		<b>GPS</b>		<b>GLO</b>		
		<b>Code</b>	<b>Carrier</b>	<b>Code</b>	<b>Carrier</b>	
	L1 C/A	4 cm	0.5 mm	8 cm	1.0 mm	
	L2 P(Y) <sup>e</sup>	8 cm	1.0 mm	8 cm	1.0 mm	
	L2 C <sup>f</sup>	8 cm	0.5 mm	8 cm	1.0 mm	
	L5	3 cm	0.5 mm	-	-	
Dynamics	Velocity	515 m/s <sup>g</sup>				

- Typical values. All position and velocity RMS values are based on Horizontal position accuracy. Performance specifications are subject to GPS system characteristics, U.S. DOD operational degradation, ionospheric and tropospheric conditions, satellite geometry, baseline length and multipath effects.
- Requires a TerraStar subscription which is available direct from NovAtel [www.novatel.com/products/novatel-correct-ppp](http://www.novatel.com/products/novatel-correct-ppp).
- Performance dependent on local observing conditions.
- Time accuracy does not include biases due to RF or antenna delay.
- L2 P for GLONASS
- L2 C/A for GLONASS
- In accordance with export licensing.

## A.2 ProPak6 Specifications

<b>NOVATEL PART NUMBERS</b>	
ProPak6 BT/Wi-Fi	01019026
ProPak6 BT/Wi-Fi/Cellular	01019027
ProPak6 BT/Wi-Fi/Heading	01019028
ProPak6 BT/Wi-Fi/Heading/Cellular	01018943
ProPak6 High Vibration BT/Wi-Fi	01019073
ProPak6 High Vibration BT/Wi-Fi/Cellular	01019071
ProPak6 High Vibration BT/Wi-Fi/Heading	01019075
ProPak6 High Vibration BT/Wi-Fi/Heading/Cellular	01019069
<b>PHYSICAL</b>	
Size (all models)	190 x 184.9 x 75 mm
Weight (including high vibrate)	1.94 kg <i>Bluetooth/Wi-Fi/Heading/HSPA</i> 1.89 kg <i>Bluetooth/Wi-Fi/HSPA</i> 1.79 kg <i>Bluetooth/Wi-Fi</i> 1.84 kg <i>Bluetooth/Wi-Fi/Heading</i>
<b>ENVIRONMENTAL</b>	
Operating Temperature	-40°C to +75°C -40°C to +65°C (heading) -40°C to +65°C (cellular)
Storage Temperature	-45°C to +95°C
Humidity	Not to exceed 95% non-condensing
Dust	IEC 60529 IP6X
Waterproof	IEC 60529 IPX7
Vibration <sup>a</sup>	Random MIL-STD-810 514.6 Category 24, 20-2000Hz/ 7.7 Grms, 1hr/axis Sinusoidal IEC 68-2-6 10-2000 Hz, 5 g Shock MIL-STD-810G, 516.6, Procedure 1, 40 g 11 ms terminal sawtooth
Acceleration	MIL-STD-810G, Method 513.6, Procedure II (operational) 16 g

a. See also the *Notice* section of this manual starting on *page 8*.

<b>POWER REQUIREMENTS</b>	
Input Voltage	9-36 VDC (external 6 A fuse required, refer to <i>Fuse/Holder Recommendations</i> on page 31 for fuse details)
Power Consumption <sup>a</sup>	Minimum 3.5 W Typical 6.5 W Maximum 15.5 W
Inrush Current	8 A for less than 120 $\mu$ s
<b>INPUT/OUTPUT CONNECTORS</b>	
Antenna Input GPS1 and GPS2 (if equipped)	TNC female jack, 50 $\Omega$ nominal impedance +4.75 to +5.10 VDC, 100 mA max (output from ProPak6 to antenna/LNA) 200 mA - GPS1 100 mA - GPS2 (Refer to <i>Figure 10, GNSS Antenna Ports</i> on page 27)
External Oscillator (if equipped)	BNC (Refer to <i>Figure 10, GNSS Antenna Ports</i> on page 27)
Power	4-pin LEMO connector (LEMO Part Number: HMG.0B.304.CLNP) (Refer to <i>Figure 6, Power Port</i> on page 25)
Expansion port	9-pin LEMO connector (LEMO Part Number: HMA.0B.309.CLNP) (Refer to <i>Figure 8, Expansion and I/O Ports</i> on page 26)
USB 2.0 Device	USB type micro-B connector (Refer to <i>Figure 7, Ethernet, COM or USB Device Ports</i> on page 25)
USB 2.0 Host	USB type A connector (Refer to <i>Section 3.1.10.1, USB Host LED</i> on page 41)
Ethernet	RJ45 connector 10/100 base T Ethernet support (Refer to <i>Figure 7, Ethernet, COM or USB Device Ports</i> on page 25)
I/O	DB9 female connector (Refer to <i>Figure 8, Expansion and I/O Ports</i> on page 26)
COM1 COM2 COM3/IMU	DB9 male connector DB9 male connector DB9 male connector Baud rates: 300, 600, 900, 1200, 2400, 4800, 9600, 19200, 38400, 57600, 115200, 230400, 460800, 921600 (921600 not available on COM 2) (Refer to <i>Figure 7, Ethernet, COM or USB Device Ports</i> on page 25)
SIM Card Slot	Push-push (Refer to <i>Figure 11, Cellular Network Setup</i> on page 28)
<b>MOBILE/CELLULAR ANTENNA PORT</b>	
Frequency Range	850 to 1900 MHz Depending by frequency band(s) provided by the network operator. Use the most suitable antenna for the band(s). NovAtel recommends the accessory ANT GSM/HSPA LP 3 / 4 dBi NMO MTG antenna – P/N 12023303
Bandwidth	70 MHz in GSM850, 80 MHz in GSM900, 170 MHz in DCS and 140 MHz PCS band
Connector Type/Impedance	TNC Female, 50 $\Omega$
VSWR Absolute	Maximum $\leq$ 10:1 Recommended $\leq$ 2:1
Sensitivity	-107 dBm (typical)
Output Power	Class 4 (2 W) @ 850/900 MHz Class 1 (1 W) @ 1800/1900 MHz

a. Power consumption varies based on the receiver and enclosure configuration.



### A.3 Dimension Drawings

Figure 40: ProPak6 Dimensions

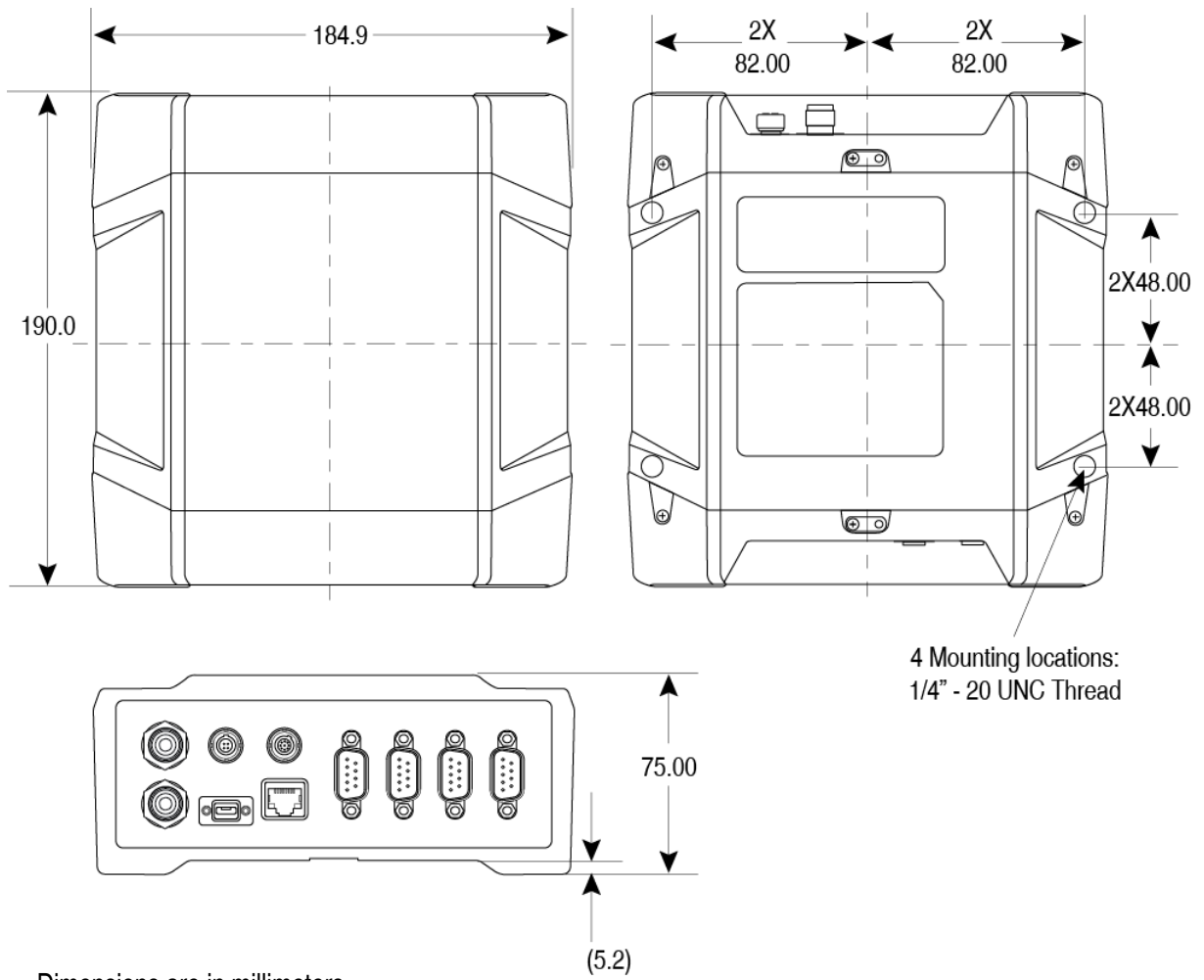
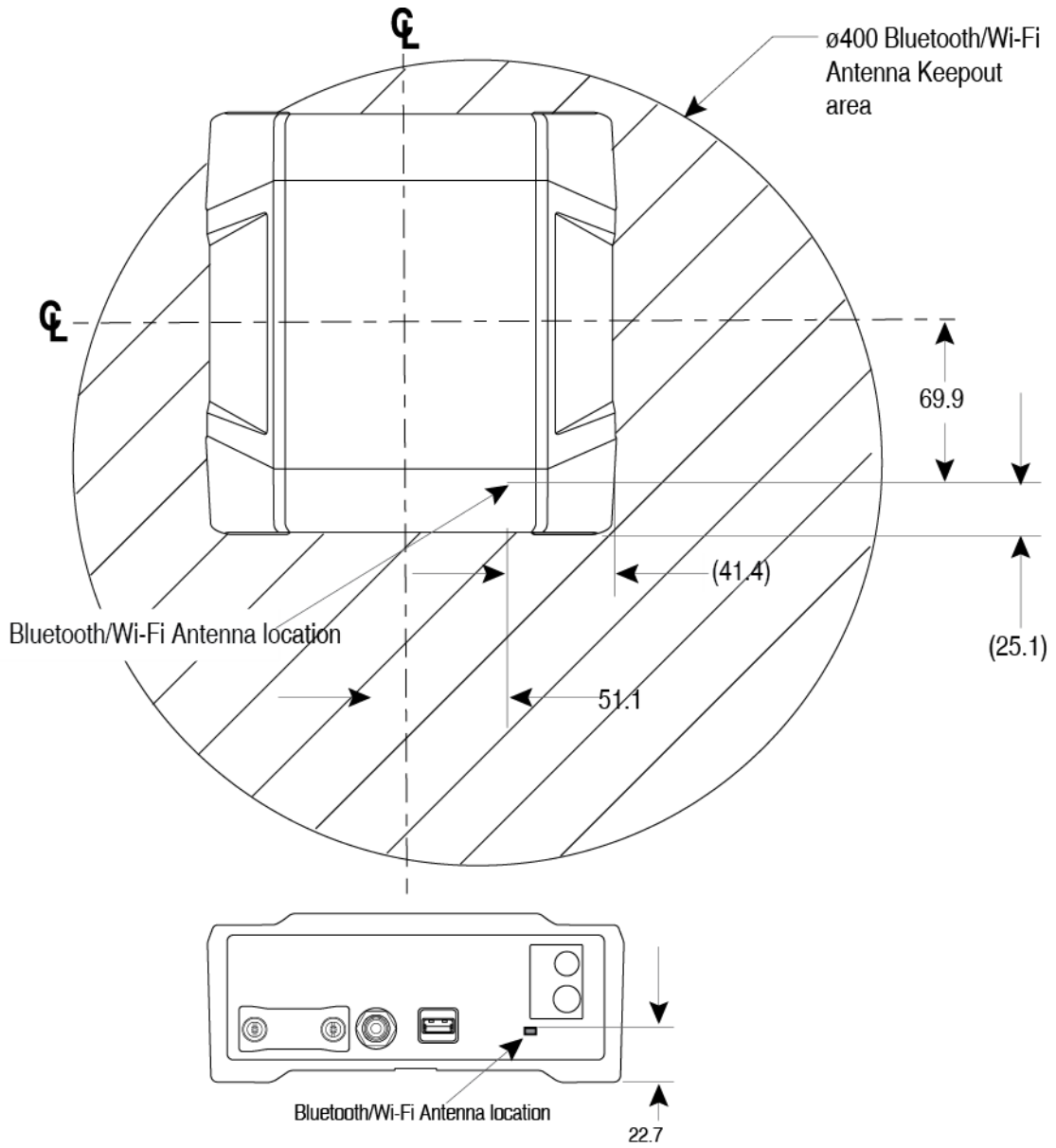

Figure 41: Bluetooth/Wi-Fi Antenna Keep-out Area and Antenna Location



Keep-out 20 cm from *Bluetooth*/*Wi-Fi* antenna.  
Dimensions are in millimeters

### A.3.1 ProPak6 Port Pin-Outs

**Table 14: COM1 and COM2 Port Pin-Out Descriptions**

Connector Pin No.	RS-232 Mode	RS-422 Mode
1	N/C	N/C
2	RXD	RX(+)
3	TXD	TX(+)
4	Vout <sup>a</sup>	Vout <sup>a</sup>
5	GND	GND
6	N/C	N/C
7	RTS	TX(-)
8	CTS	RX(-)
9	N/C	N/C

- a. Can be turned on or off using the `COMVOUT` command. Refer to the [OEM6 Family Firmware Reference Manual](#) (OM-20000129) for more information.

Refer to *Figure 7, Ethernet, COM or USB Device Ports* on page 25.

**Table 15: COM3/IMU Port Pin-Out Description**

Connector Pin No.	RS-232 Mode	RS-422 Mode
1 <sup>a</sup>	IMU_EVENT_OUT(SYNC)1	IMU_EVENT_OUT(SYNC)1
2	RXD	RX(+)
3	TXD	TX(+)
4	N/C	N/C
5	GND	GND
6	N/C	N/C
7	RTS	TX(-)
8	CTS	RX(-)
9	reserved	reserved

- a. The `IMU_EVENT_OUT(SYNC)1` signal can be disabled.

Refer to *Figure 7, Ethernet, COM or USB Device Ports* on page 25.

**Table 16: I/O Port Pin-Out Descriptions**

Connector Pin No.	Default Configuration	Optional Configuration	Description
1	EVENT_OUT 1	VARF	Output Event1 / Variable Frequency (VARF) output
2	PPS	PPS	1 Pulse Per Second (PPS) output
3	EVENT_OUT 2	MSR	Output Event2 / Measured output for Event 2
4	EVENT_IN 1	EVENT1	Input Event1
5	EVENT_OUT 3	PV	Output Event3 / Position valid output
6	EVENT_IN 2	EVENT2	Input Event2
7	EVENT_IN 3	_RESETOUT	Input Event3 / active low reset out
8	EVENT_IN 4	ERROR	Input Event4 / error indicator out
9	GND	GND	

Refer to *Figure 8, Expansion and I/O Ports* on page 26.

**Table 17: Expansion Port Pin-Out Description**

Connector Pin No.	Signal
1	CAN1+
2	CAN1-
3	CAN2+
4	CAN2-
5	DGND
6	VBUS
7	USB (D-)
8	USB (D+)
9	DGND
Shell	DGND

Refer to *Figure 8, Expansion and I/O Ports* on page 26.

**Table 18: ProPak6 Strobe Electrical Specifications**

Strobe	Sym	Min (V)	Max (V)	Current (mA)	Conditions
Event_In1 (Mark 1)	V <sub>IL</sub>		0.8		VCC = 3.3 V; 85°C
Event_In2 (Mark2)	V <sub>IH</sub>	2.0			VCC = 3.3 V; 85°C
Event_In3 (Mark3)					
Event_In4 (Mark4)					
PPS	V <sub>OL</sub>		0.4	8	VCC = 3.3 V; 85°C
	V <sub>OH</sub>	2.4			
PV VARF	V <sub>OL</sub>		0.4	24	VCC = 3.3 V; 85°C
	V <sub>OH</sub>	3.0		24	VCC = 3.3 V; 85°C
RESETIN	V <sub>IL</sub>		0.8		VCC = 3.3 V; 85°C
	V <sub>IH</sub>	2.3			VCC = 3.3 V; 85°C

## A.4 OEM615 Receiver Card Performance for ProPak6 (model dependent)

PERFORMANCE (Subject to GPS System Characteristics)					
Position Accuracy <sup>a</sup>	<b>Standalone:</b>				
	L1 only	1.5 m RMS			
	L1/L2	1.2 m RMS			
	SBAS <sup>b</sup>	0.6 m RMS			
	DGPS	0.4 m RMS			
	RTK	1 cm + 1 ppm RMS			
Time to First Fix	Hot: 35 s (Almanac and recent ephemeris saved and approximate position and time entered) Cold: 50 s (No almanac or ephemeris and no approximate position or time)				
Reacquisition	0.5 s L1 (typical) 1.0 s L2 (typical)				
Data Rates	Measurements	up to 20 Hz			
	Position	up to 20 Hz			
Time Accuracy <sup>ac</sup>	20 ns RMS				
Velocity Accuracy <sup>a</sup>	0.03 m/s RMS				
Measurement Precision		<b>GPS</b>		<b>GLO</b>	
		<b>Code</b>	<b>Carrier</b>	<b>Code</b>	<b>Carrier</b>
	L1 C/A	4 cm	0.5 mm	8 cm	1.0 mm
	L2 P(Y) <sup>d</sup>	8 cm	1.0 mm	8 cm	1.0 mm
	L2 C <sup>e</sup>	8 cm	0.5 mm	8 cm	1.0 mm
Dynamics	Velocity	515 m/s <sup>f</sup>			

a. Typical values. All position and velocity RMS values are based on Horizontal position accuracy. Performance specifications are subject to GPS system characteristics, U.S. DOD operational degradation, ionospheric and tropospheric conditions, satellite geometry, baseline length and multipath effects.

b. GPS-only.

c. Time accuracy does not include biases due to RF or antenna delay.

d. L2 P for GLONASS

e. L2 C/A for GLONASS

f. In accordance with export licensing.

## A.5 Cables

### A.5.1 12 V Power Adapter Cable (NovAtel part number 01017663)

The power adapter cable supplied with the ProPak6, provides a convenient means for supplying +12 V DC while operating in the field.

Input is provided through the standard 12V power outlet. The output from the power adapter utilizes a 4-pin LEMO connector (LEMO part number FGG.0B.304.CLAD52Z) and plugs directly into the *PWR* input located on the back panel of the ProPak6.

This cable is RoHS compliant.

For alternate power sources, see *Section 2.8, Installing NovAtel Connect PC Utilities* on page 33.

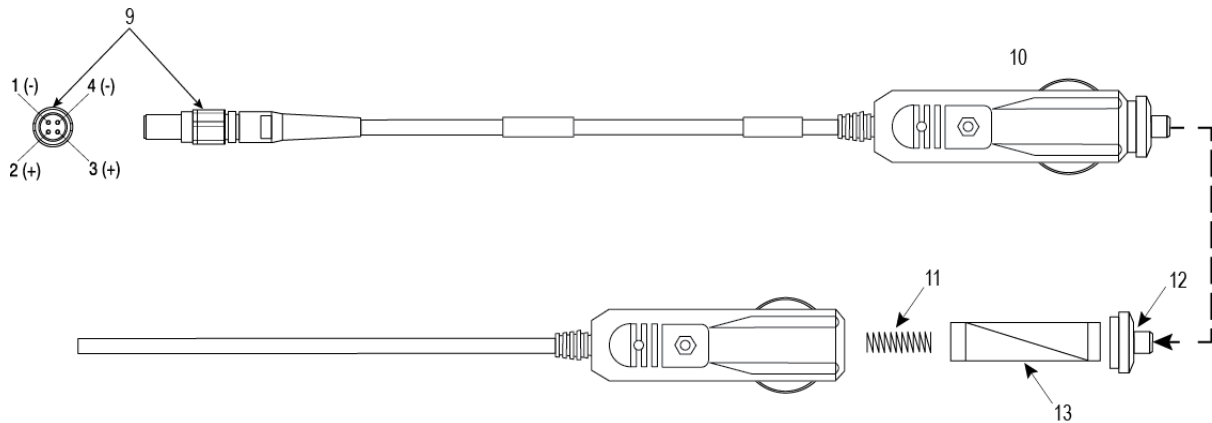

Reference	Description	Reference	Description
1	Black	1	Ground
2	Red	2	12 V
3	Orange or Green	3	12 V
4	Brown or White	4	Ground
9	Connector key marking	12	Universal tip
10	12 V adapter	13	6 Amp slow-blow fuse
11	Spring		

### A.5.2 Null-modem Cable (NovAtel part number 01017658)

This cable supplied with the ProPak6, provides an easy means of communications with a PC/laptop. The cable is equipped with a 9-pin connector at the receiver end which can be plugged into the *COM1*, *COM2*, or *AUX* port. At the PC/laptop end, a 9-pin connector is provided to accommodate a computer serial (RS-232) communication port.

This cable is RoHS compliant.

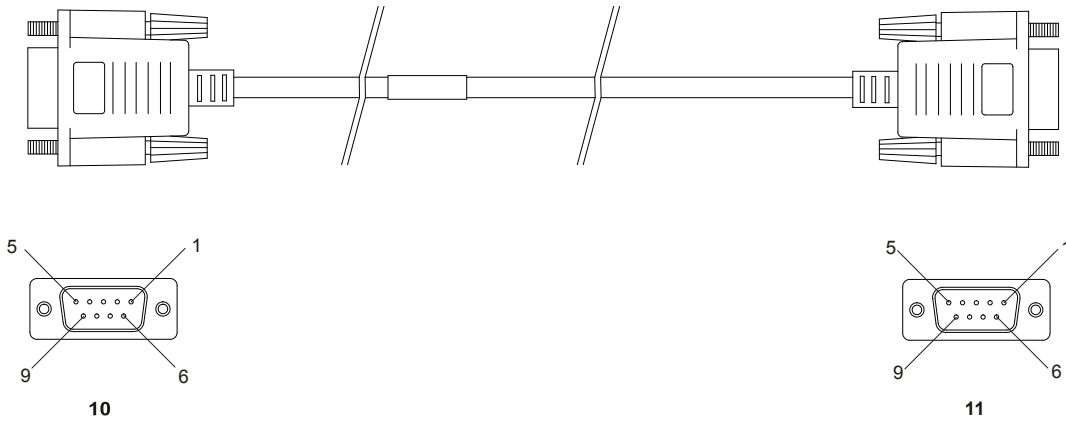

**Table 19: Wiring Table:**

Connector	Pin Number						
To DB9S (10)	2	3	8	7	4	5	1 & 6
To DB9S (11)	3	2	7	8	1 & 6	5	4

Note: Cables may contain DEHP.



---

### A.5.3 Straight Through Serial Cable (NovAtel part number 01018520)

This cable can be used to connect the ProPak6 to a modem or radio transmitter to propagate differential corrections. The cable is equipped with a female DB9 connector at the receiver end. The male DB9 connector at the other end is provided to plug into your user-supplied equipment (please refer to your modem or radio transmitter user guide for more information on its connectors). The cable is approximately 2 m in length.

This cable is RoHS compliant.

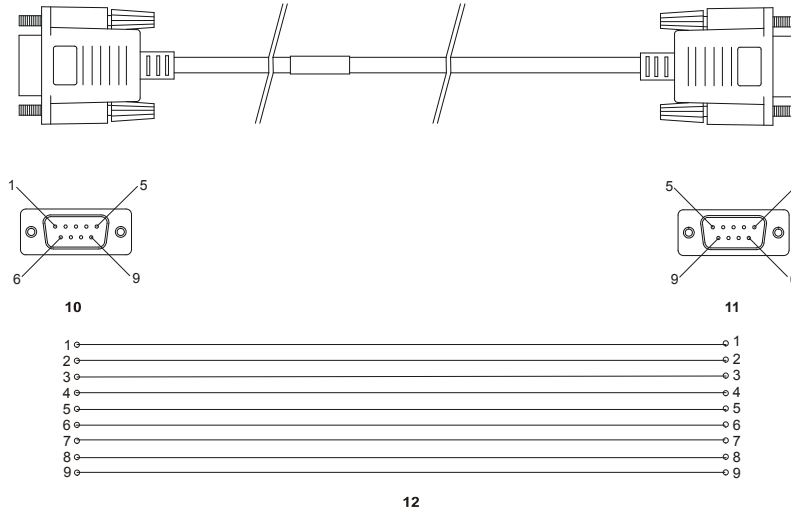

### A.5.4 I/O Cable (NovAtel part number 01018519, 01019148)

These cables can be used to connect the ProPak6 I/O port. The cables are 2 metres in length, with a DB9 male connector at one end and tinned and tagged conductors at the other.

The 01019148 cable is similar in function to the 0108519 cable, however each signal is in a twisted pair with a ground wire to reduce cross talk and improve signal integrity. The 01019148 cable is recommended when using multiple event lines simultaneously in order to prevent false triggers.

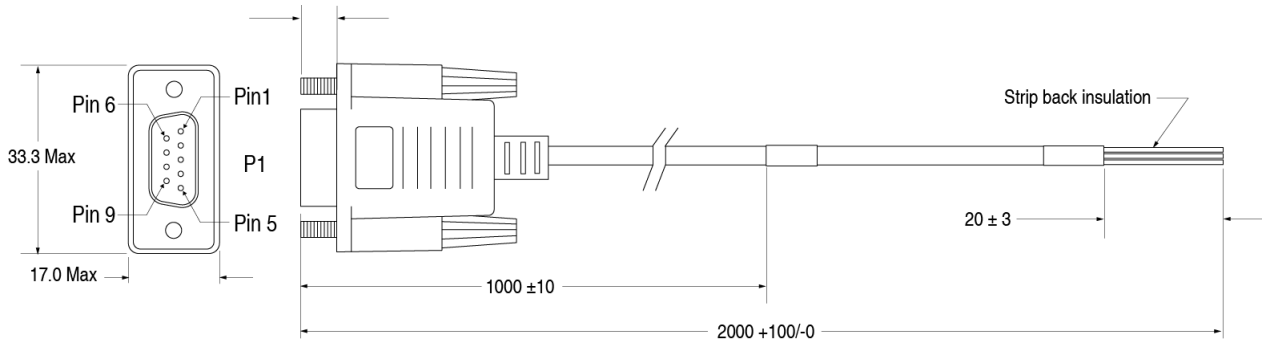

**Table 20: I/O Cable Wiring (01018519)**

DB9 Male to Receiver	Color Code	Pin Function
P1	Black	VARF/EVENT_OUT1
P2	Brown	PPS
P3	Red	MSR/EVENT_OUT2
P4	Orange	EVENT_IN1
P5	Yellow	PV/EVENT_OUT3
P6	Green	EVENT_IN2
P7	Blue	nRESETOUT/EVENT_IN3
P8	Violet	ERROR/EVENT_IN4
P9	White/Grey	Signal Ground
Shell	Shield	Chassis

**Table 21: Twisted Pair I/O Cable Wiring Table (01019148)**

P1	Color Code	Tag Name	P1	Color Code	Tag Name
1	Black	VAR/EVT O1	5	Yellow	PV/EVT O3
9	White (of black pair)	VAR/EVT O1 GND	9	White (of yellow pair)	PV/EVT O3 GND
2	Brown	PPS	6	Green	EVT I2
9	White (of brown pair)	PPS GND	9	White (of green pair)	EVT I2 GND
3	Red	MSR/EVT O2	7	Blue	RST O/EVT I3
9	White (of red pair)	MSR/EVT O2 GND	9	White (of blue pair)	RST O/EVT I3 GND
4	Orange	EVT I1	8	Violet	ERR O/EVT I4
9	White (of orange pair)	EVT I1 GND	9	White (of violet pair)	ERR/EVT I4 GND
			Shell	Shield	

### A.5.5 ProPak6 Expansion Cable (NovAtel part number 01019154)

The optional cable 01019154 provides access to the COM7, COM8, COM9, COM10, CAN1 and CAN2 ports.

 COM4, COM5 and COM6 are used internally on the ProPak6.

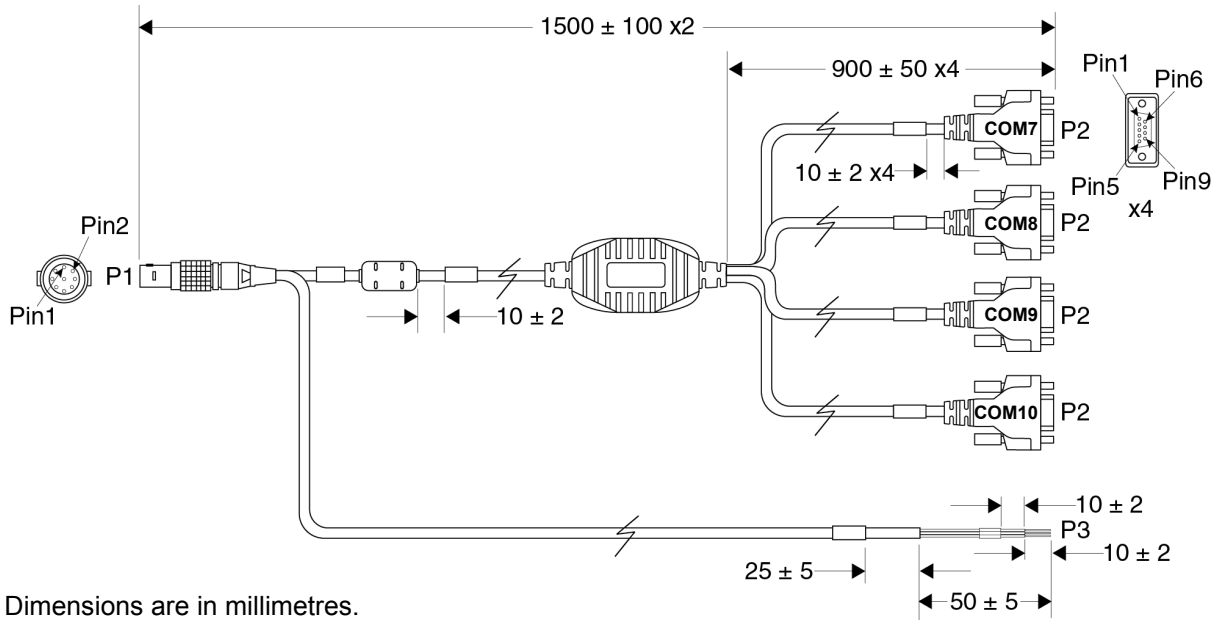

Table 22: ProPak6 Expansion Cable Pin-Out Descriptions

P1 (EXP) Pin #	Function	P2 DB9 Connectors	P3 Wire Bundle Label
1	CAN Bus 1+		CAN1+
2	CAN Bus 1-		CAN1-
3	CAN Bus 2+		CAN2+
4	CAN Bus 2-		CAN2-
5	Digital Ground		DGND
6	VBUS	The ProPak6 Expansion Cable multiplexes four serial COM ports (COM7, COM8, COM9 and COM10) onto a single USB port. See Table 23, P2 Connector Pin-Out Descriptions on page 124 for the pin-out of the four P2 connectors.	
7	USB D-		
8	USB D+		
9	Digital Ground		
Shell	Braid Shield		

---

**Table 23: P2 Connector Pin-Out Descriptions**

<b>Pin</b>	<b>Description</b>
1	No connect
2	Transmit Data (TXD)
3	Receive Data (RXD)
4	No connect
5	Ground (GND)
6	No connect
7	Clear To Send (CTS)
8	Request To Send (RTS)
9	No connect
Shell	Ground (GND)

The following are a list of the replacement parts available for your NovAtel ProPak6 receiver. Should you require assistance, or need to order additional components, please contact your local NovAtel dealer or Customer Service representative.

## B.1 ProPak6

Part Description	NovAtel Part
Extension cable DB9 Male/Female ITE 6 ft	01018520
Null-modem serial data cable DB9 6 ft	01017658
Power cable assembly, 4-pin LEMO 6 AMP CIG LGH	01017663
I/O cable 6 ft DB9 male/single ended	01018519, 01019148

## B.2 Accessories

Part Description	NovAtel Part
GSM/HSPA antenna base, NMO magnetic mount to TNC, 3.65 m cable	12023300
GSM/HSPA antenna, 3/4 dBi, 806-960 MHz/1710-2500 MHz, NMO	12023303
Ethernet PATCH CABLE - 7FT BLACK W/ SR HOOD	60723118
CABLE USB A TO USB MICRO B 2 METER	60723119
30 W AC to DC power adapter (LEMO to wall socket) Operating temperature range: 0 to 40°C (indoor use only)	01018931
Optional NovAtel Antennas:	
Model 702 (L1/L2)	GPS-702
Model 701 (L1-only)	GPS-701
Model 702L (L1/L2/L-Band, B1 BeiDou)	GPS-702L
Model 702GG (L1/L2/GLONASS)	GPS-702-GG
Model 701GG (L1/GLONASS)	GPS-701-GG
Model 703GGG (L1/L2/L5 GPS, L1/L2/L3 GLONASS, B1/B2 BeiDou, E1/E5a-b Galileo)	GPS-703-GGG
Model GPS-704 (GPS L1/L2/L5, Galileo E1/E5a/E5b/E6 and GLONASS L1/L2, TNC connector), B1/B2/B3 BeiDou)	GPS-704-X
Model 702GGL (L1/L2/GLONASS/L-Band, B1 BeiDou)	GPS-702-GGL
Model 701GGL (L1/GLONASS/L-Band, B1 BeiDou)	GPS-701-GGL
Model 35C50P1GLA (L1/GLONASS/L-Band)	ANT-35C50P1GLA-TW-N
Model 26C1GA (L1)	ANT-26C1GA-TBW-N
Model 42G1215A (L1/L2/L-Band)	42G1215A-XT-1-2 and 42G1215A-XT-1-3
Model C2GA (L1/L2)	ANT-C2GA-TW-N

Part Description	NovAtel Part
Model 42G1215A (L1/L2)	42G1215A-XT-1
Optional RF Antenna Cable: 5 meters	GPS-C006
15 meters	GPS-C016
30 meters	GPS-C032

### B.3 Manufacturer's Part Number

The following original manufacturer's part number is provided for information only and is not available from NovAtel as a separate part:

Product	Part Description	Company	Part Number
ProPak6 Power Cable connector	4-pin socket connector	LEMO	FGG.OB.304.CLAD52Z
ProPak6 Expansion Port connector	9-pin socked connector	LEMO	FGA.OB.309.CLAZ

### The ProPak6 Bluetooth and Cellular radios are off by default, why?

They are off by default in order to minimize power consumption as well as EMI (Electromagnetic Interference). Each component has its own setup instructions contained in this manual as well as the Quick Start Guide provided with the product. Instructions include specific commands that allow the configuration of settings associated with each component. These peripherals include Wi-Fi (both client and access point) and *Bluetooth*. By default, the Wi-Fi radio is on.

Refer to *Chapter 5, Radio Configuration and Activation* on page 82 for details.

### How are RTK corrections sent over Ethernet?

In order to utilize Ethernet for correction services, first configure the port settings of the receiver. The ProPak6 Ethernet and Wi-Fi share the same set of ICOM ports. When a connection is established, a specific ICOM port is assigned individually (unlike previous models, which would assign 3 virtual ports when establishing Ethernet connection). Information on Ethernet configuration can be found in the *Chapter 4, Ethernet Configuration* on page 74 or by following the steps laid out in the NovAtel application note [APN-57 – OEM628 Ethernet Configuration](#). Once established, differential corrections can be sent in all standard NovAtel supported message formats (RTCA, RTCM v2.3, RTCM V3.0, CMR). Specific messages, logs, commands and responses are detailed in the [OEM6 Firmware Reference Guide](#) (OM-20000129) under each message format, while sample configurations of each can be found in this manual in *Section 3.4, Transmitting and Receiving Corrections* on page 47.

### Are there any Bluetooth connectivity issues while using Wi-Fi?

The ProPak6 uses a common *Bluetooth* and Wi-Fi antenna. Only when discovering *Bluetooth* devices (pairing) is Wi-Fi performance impacted. Simply ensure *Bluetooth* discoverability is turned off before connecting to a Wi-Fi network (refer to *Section 5.1.1.2, Connecting Bluetooth Devices* on page 83 for details).

The *Bluetooth* connection may also be lost when switching a Propak6 between AP and Client modes.

### When issuing LOG IPCONFIG, the ProPak6 does not have a default IP address, why?

The ProPak6 can be configured as both a Access Point (AP) or a Client. So by default, the unit is not assigned an IP address. However, once an IP address is assigned to the receiver, it is preserved through issuing the `SAVECONFIG` command so the IP address is retained if the ProPak6 is powered down (refer to the *Wi-Fi Network Configuration* on page 84 for details). This is especially important in the preservation of remote Ethernet connectivity.

### Is it possible to save logs directly onto the receiver?

Yes. The ProPak6 is able to log directly onto the OEM638's onboard 4 GB of memory by replacing the usual port number with `FILE`. During internal logging, the ProPak6 automatically names files stored onto the internal memory. It is also possible to manually set file names through the use of the `LOGFILE` command. This command also opens or closes log files. Below are examples of using this feature:

1. Save RANGE logs to an automatically generated file:
 

<code>LOGFILE OPEN</code>	(opens an automatically generated file for logging)
<code>LOG FILE RANGE ONTIME 1</code>	(saves RANGE logs once a second to file)
<code>LOGFILE CLOSE</code>	(issue once sufficient data has been collected to close off file)
2. Log BESTPOS observations to a special file named TESTDATA.DAT:
 

<code>LOGFILE OPEN TESTDATA.DAT</code>	(creates TESTDATA.DAT on internal memory)
--	---

---

```
LOG FILE BESTPOS ONTIME 0.5      (saves BESTPOS logs, twice a second, to named file)
LOGFILE CLOSE
```

Refer to the *Section 3.7, Logging and Retrieving Data Overview* on page 58 for logging details.

## How is SBAS enabled on the ProPak6?

SBAS is enabled or disabled by issuing the `SBASCONTROL` command. This command is also used to set the augmentation system, specific PRN, as well as configure test mode acceptance. The following example enables WAAS:

```
SBASCONTROL ENABLE WAAS
```

Refer to *Section 3.6.6, Enabling SBAS Positioning* on page 55 for additional information and the detailed field breakout of `SBASCONTROL` command available in the [OEM6 Firmware Reference Guide](#) (OM-20000129) from our web site.

## How is L-Band enabled on the ProPak6?

Refer to *Section 3.6.7, Enabling L-Band* on page 56 in this manual for details.

## Does Bluetooth discoverability have to be manually turned off?

Yes. The ProPak6 remains discoverable until this option is turned off or an exclusive connection is established over *Bluetooth* port. Simply pairing a device does not take the receiver out of discoverability mode. A direct communications connection must be established, such as use of a terminal program in order to lock out other devices. Otherwise, *Bluetooth* discoverability can be manually disabled by issuing the command:

```
BLUETOOTHDISCOVERABILTY OFF
```

When the discoverability is disabled, no new device may pair with the ProPak6, however previously paired devices are recognized. The only way to fully disable *Bluetooth* is by issuing the follow command `BLUETOOTHCONFIG POWER OFF` which completely powers down the ProPak6.

## Why is data not being received on the ICOM Ports?

The ProPak6 ICOM ports can be locked and password protection assigned. If enabled, the `LOGIN` command must be issued and a password entered to enable the port to receive data. Refer to *Section 2.9.2, FTP Server and ICOM Ports* on page 34 for detailed instructions.

## Wi-Fi AP settings are not retained, why?

Once the `WIFIAPCONFIG` command is used to modify AP settings, the ProPak6 requires a power cycle to the radio for the changes to take affect. Once satisfied with AP settings, issue the `WIFICONFIG STATE OFF` command and then issue the `WIFICONFIG STATE ENABLED` command.

## My network keeps defaulting to Wi-Fi, why?

Ethernet is the ProPak6 default network primarily used for internet access. It can be changed to either Wi-Fi or Cellular as needed by issuing:

```
SETPREFERREDNETIF <ETHA>, <CELL> or <WIFI>
```

Refer to the `SETPREFERREDNETIF` command in the [OEM6 Firmware Reference Guide](#) (OM-20000129) for command details.

## While performing logging, data gaps are experienced, why?

Data gaps indicate a throughput issue. When performing high data rate Ethernet logging using TCP/IP, disable Windows Delayed Ack Algorithm (DAA) for complete data logging. If DAA is not disabled, data gaps appear due to the Windows Ethernet buffer.



---

If done incorrectly, changing the Windows Registry may impair the operation of the computer. Editing the Windows Registry is for advanced Microsoft Windows users only. NovAtel Inc. is not able to provide any technical support for any actions taken regarding information found in Microsoft's Knowledge Base.

Windows XP (SP3) and Windows Server 2003:

<http://support.microsoft.com/kb/328890>

<http://support.microsoft.com/kb/815230>

Refer to the Chapter *Customer Support* on page 15 for details on contacting NovAtel Customer Support.

**The HWMONITOR log reports Reading Type 6 is under the lower error limit (a voltage reading of 2.7V and status 602). Is this an error?**

This is not an error. The ProPak6 supplies 3.3V directly to the OEM638 within the unit and a back voltage may be present at the point where the "supply voltage" is sampled. As long as Reading Type 3 is showing approximately 3.3V and the status is 300, the power supplies are functioning correctly

