

Quantum Operating System

Upgrade and Update procedure

09/2012 eng
Edition V2.3



Purpose

Subject of this Chapter

This user's guide explains how to upgrade Quantum PLC's Operating System but also the firmware of Ethernet modules

- ✓ Upgrade a PLC from Concept to Unity.
- ✓ Update a PLC from Unity to Unity.
- ✓ Restore Concept IEC / LL984 on a Unity processor
- ✓ Update Quantum NOE modules and embedded Ethernet modules.
- ✓ Upgrade Remote I/O Head and Drop:
 - S908 network based
 - For Ethernet IO network

Note: Examples and screen shots are provided in this documentation using OSLoader version 3.0. However, other versions, ranging from 2.0 to latest versions, may be used. The procedures described hereafter match all versions from 2.0, and the operating modes are the same for all versions. Please refer to chapter "Preparing a Quantum update" for more information.

Summary

| | |
|--|------------|
| 1. Preparing a Quantum update | 4 |
| 2. Upgrading a Quantum PLC from Concept to Unity | 7 |
| 3. Updating a Quantum PLC from Unity to Unity | 23 |
| 4. Restoring a Quantum PLC from Unity to Concept..... | 33 |
| 5. Upgrading a Quantum Hot Standby PLC | 48 |
| Appendix 1: NOE Module Upgrade Procedure | 52 |
| Appendix 2: Quantum CoPro Ethernet Port Upgrade Procedure..... | 60 |
| Appendix 3: FactoryCast NOE 77111 Module Upgrade Procedure | 68 |
| Appendix 4: 140CPU67160/140CPU 67261 HotStandby CPU Copro Upgrade Procedure.. | 76 |
| Appendix 5: 140CRP93x00 S908 RIO Head Upgrade Procedure..... | 85 |
| Appendix 6: 140CRA93x00 S908 RIO Drop Upgrade Procedure | 92 |
| Appendix 7: Installation of Modbus Plus USB converter driver. | 100 |
| Appendix 8: Upgrade of the EIO Head modules (140CRP31200) | 101 |

1. Preparing a Quantum update

Object of this Chapter This chapter describes how to prepare a Quantum PLC in order to update or upgrade PLC's Operating System and / or Ethernet modules.

Prerequisites This update requires a PC with Unity Pro installed and the binary file containing the OS firmware to download.

Software The following softwares are required:

- ✓ Unity Version 2.0 mini must be installed on the PC (note that it is not necessary to launch Unity for an OS upgrade).
- ✓ The eCD "Unity OS firmware" is provided on www.schneider-electric.com and contains all the OS for Quantum, Premium and M340 PLC's.
- ✓ The OS loader (provided with Unity Pro). This tool allows the user to download PLC's Operating System and Ethernet modules firmware.

Connecting the PC to the PLC for an OS update or upgrade

The Quantum CPU OS can only be downloaded by a direct connection between the PC and the CPU by the MODBUS or MODBUS+ ports. Note that MODBUS+ is faster and takes significantly less time to download a binary. The CPU USB port doesn't allow downloading an OS.

Important: Using Modbus or Modbus Plus, only address 1 is allowed for downloading. **Ensure that no other device on the network is using address 1 .**

Several possibilities can be proposed to connect the PC to the PLC depending on the mix processor/protocol:

For Quantum CPU 140CPU 311 10, 140CPU 434 12U and 140CPU 534 14 BU:

- Using the RS232 COM port 1 of the PC by connecting the cable 990 NAA 263 20 (3.7 m) or 990 NAA 263 50 (15 m) to the MODBUS 9 pin sub-D of the Quantum PLC. The protocol used in this case is MODBUS.
- Using the cables 990NAD21110 (2.4m) or 990NAD21130 (6m) connected to the MODBUS+ 9 pin sub-D of the Quantum PLC. The protocol used in this case is MODBUS+.

For Quantum CPU 140 CPU 6x1y0 (65150, 65160, 65160S, 65260, 67160,67261, 67160S):

- Using the adapter 110XCA20300 connected to the RS232 9 pin sub-D connector of the PC (COM port) and to the RJ45 Modbus port of the PLC via a cable 110 XCA28201 (1m) , 110 XCA28202 (3m) or 110XCA28203 (6m). The protocol used in this case is MODBUS.
- Using the cables 990NAD21810 (2.4m) or 990NAD21830 (6m). The protocol used in this case is MODBUS+.
- Using the Modbus Plus Device TSXCUSBMBP

→ Have a look on Appendix 7 for **Modbus Plus** USB converter drivers installation in your PC.

In any case the right communication driver must be first installed on the PC.

Note: The most examples given in this document are using the Modbus protocol.

Connecting the PC to the Ethernet module or PLC coprocessor to update the Ethernet firmware

Although Ethernet allows a remote access via the network and then the upload / download procedure, we strongly recommend installing the processor with the embedded Ethernet module in a system consisting of only the CPU, Power Supply and Rack. Once done,

- ✓ Configure the PLC system with an empty program containing only the IP address configuration. Note that the Ethernet module must be on the same logical Ethernet network than the PC with the OS loader (for that both IP address, Subnet mask and default gateway must be compatible).
- ✓ Ensure the only devices connected to the Ethernet network are the PC running the OS loader and the CPU , NOE or CRP module,
- ✓ The CPU must be in Stop mode and the NOE and CRP modules must have no TCP traffic.

The physical connection between the PC running the OS loader and the CPU or Ethernet communications modules can be performed:

- ✓ by connecting directly a “crossed” Ethernet cable between the PC and the Ethernet Communication module
- ✓ by connecting the PC and the CPU or Ethernet Communication module with two “non crossed” Ethernet cables via a Hub.

In these 2 cases, FTP protocol is used and only the Ethernet Coprocessor firmware of the CPU can be updated by this way.

2. Upgrading a Quantum PLC from Concept to Unity

Object of this Chapter This chapter describes how to upgrade a Quantum PLC from Concept to Unity. The screens shots given below show how to upgrade a 140 CPU 434 12A (Concept) to 140 CPU 434 12U (Unity). The procedure is similar for an upgrade of 140 CPU 534 14A/B (Concept) to 140 CPU 534 14U/BU (Unity).

Important Upgrading a PLC from Concept to Unity requires to perform three main phases:

- ✓ Phase 1 - Upgrade the PLC to Unity with an intermediate OS
- ✓ Phase 2 - Power OFF then ON the PLC
- ✓ Phase 3 - Update the Operating System with the appropriate file

Those phases are mandatory and cannot be by-passed.

Each phase is described in the following procedure.

Connecting the PC to the PLC

Refer to chapter “Prepare a Quantum Update / Connecting the PC to the PLC for an OS update or upgrade.”

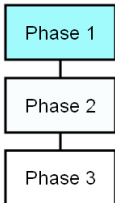

Launching the OS loader

The OS loader (provided with Unity) allows the user to download the Operating System to the PLC. To open it click on **Start/Program/Schneider-Electric/Unity-PRO/OS loader**.

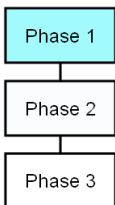

Once done, the following screen appears:

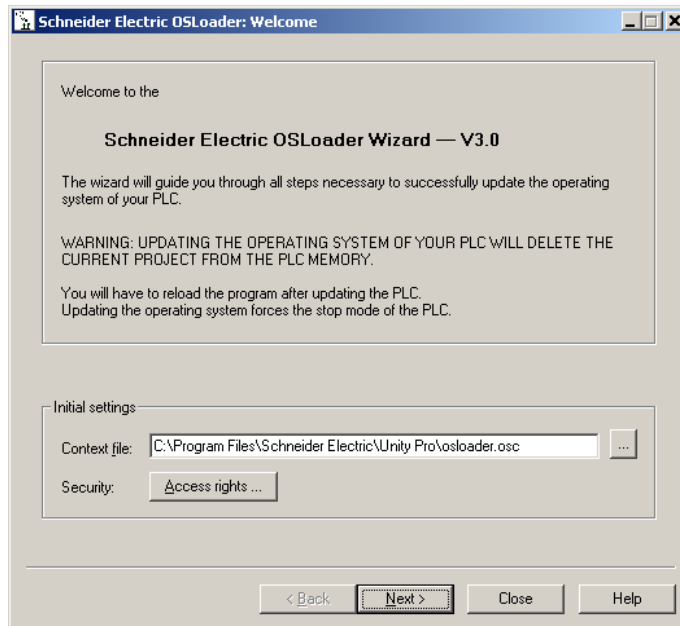

Select the communication protocol



From the main screen of the OS loader, click on the **Next >** button. The following screen appears, the list of communication ways depends of the drivers installed:

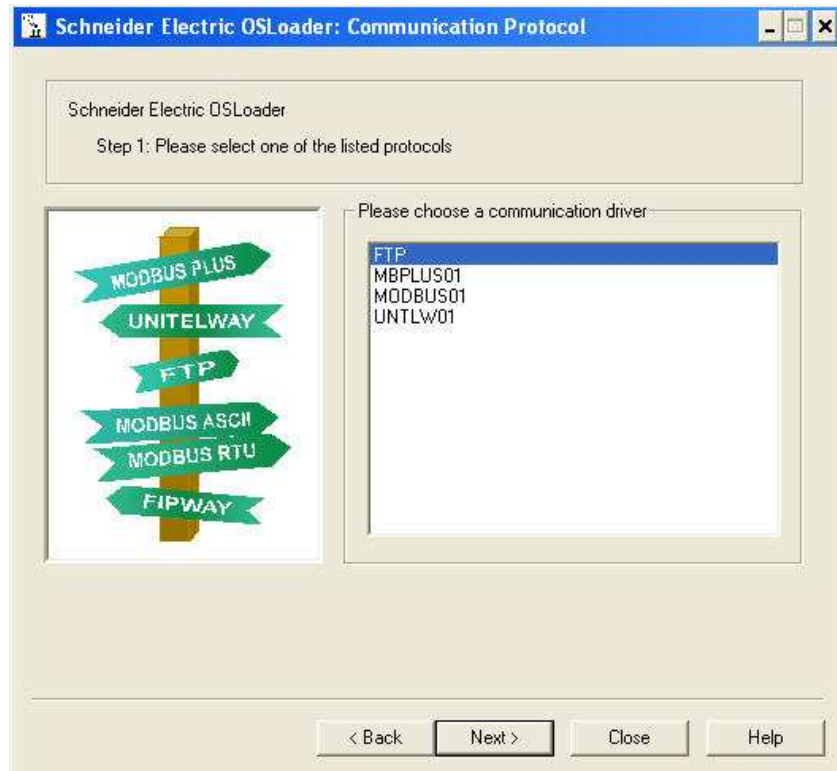

To download the Operating System into the PLC select the right communication protocol (MODBUS01 or MBPLUS01, in accordance with established physical link) and click on the **Next >** button.

Upgrading a Quantum PLC from Concept to Unity

Select the Target Device

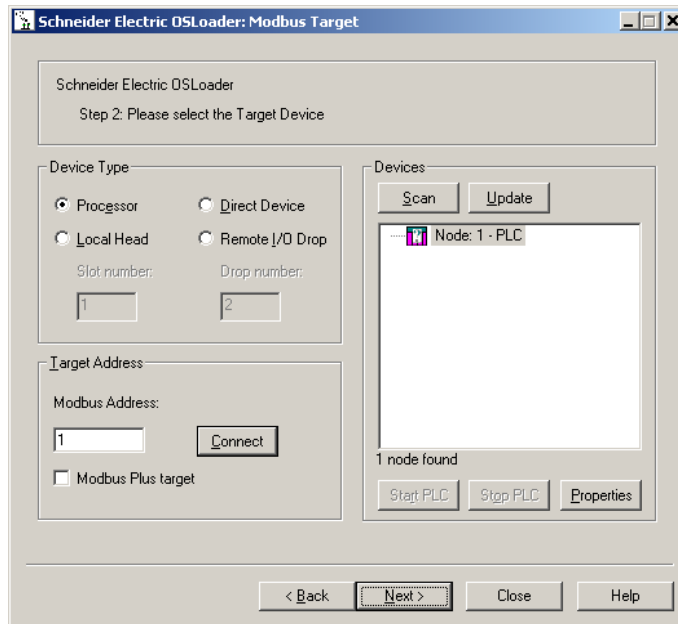



On the Device Type field, select Processor.

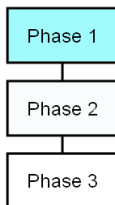

Get the Concept version (Optional)

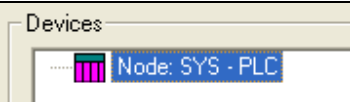

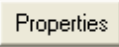
Knowing which Concept version is installed on the processor could be useful if for any reason a restore function from Unity to Concept is needed. For that proceed as follows:

| | |
|----------|---|
| 1 | Select the PLC  |
| 2 | Click on the  button to connect the PC to PLC. |
| 3 | Click on the  button to get info from the PLC. |

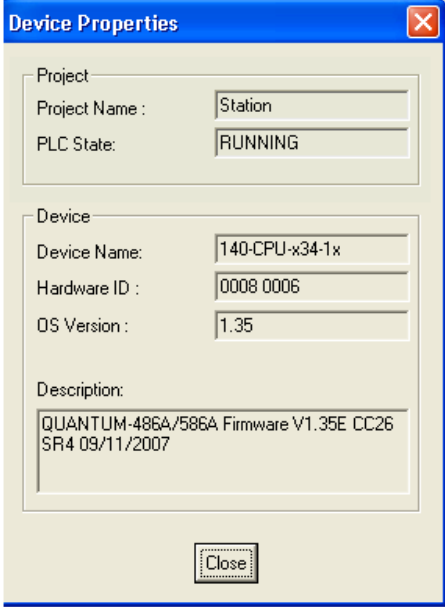
Upgrading a Quantum PLC from Concept to Unity

| | |
|---|---|
| 4 | <p>The following screen gives to the user some information regarding the PLC status:</p> <ul style="list-style-type: none">✓ Not configured, Started, stopped✓ Processor type (in this example: 140CPUx341x)✓ The Hardware identification (for Schneider internal use only)✓ The OS version (in this example the OS version is 1.35)  |
| 5 | <p>Note this version number to avoid compatibility issues between the application program and the OS if Concept has to be restored.</p> |
| 6 | <p>Press the  button to return back to the OS update process.</p> |

Upgrading a Quantum PLC from Concept to Unity

Select the Download Function



From the screen described above in the section “Select the Target Device” press the  button. A new screen is proposed: select “Download OS to device”.

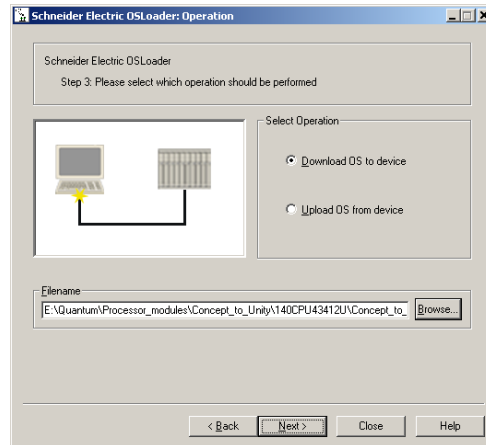

Upgrading a Quantum PLC from Concept to Unity

Select the file to download



Browse...

Click on the **Browse...** button in order to select the file to download into the PLC. In this example we will update the OS from 140CPU43412A to 140CPU43412U. For that select the folder: Quantum\Processor_modules\Concept_to_Unity (in your case, select the folder according to your processor).

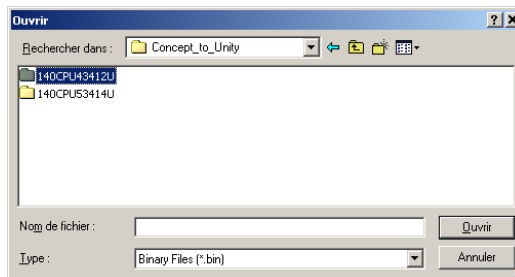

For an upgrade from Concept to Unity two binary files can be selected:

- ✓ Concept_to_Unity_43412U.bin (allows to “format” the processor for Unity)
- ✓ 140CPU43412U_V240.bin is the OS that will finally be download in the processor.

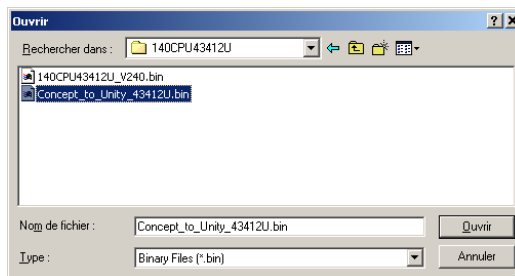

In our example we have to “format” the processor (remember, we still are in the Phase 1) then select and validate “Concept_to_Unity_43412U.bin”.

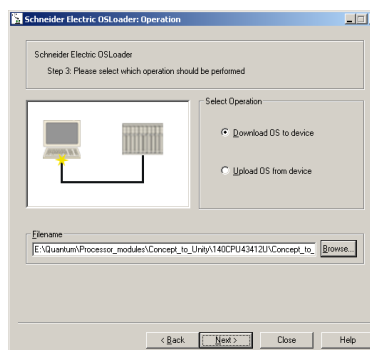

Next >

Once done click on the **Next >** button.

Download the intermediate OS



Once the previous screen is validated a warning is displayed:

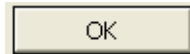
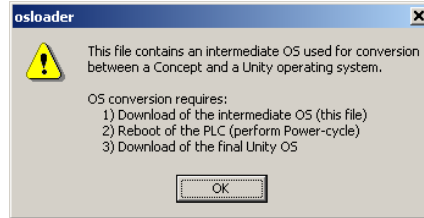

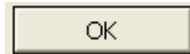
Click the  button. Two screens that give information regarding the file, the processor and the download are now displayed:

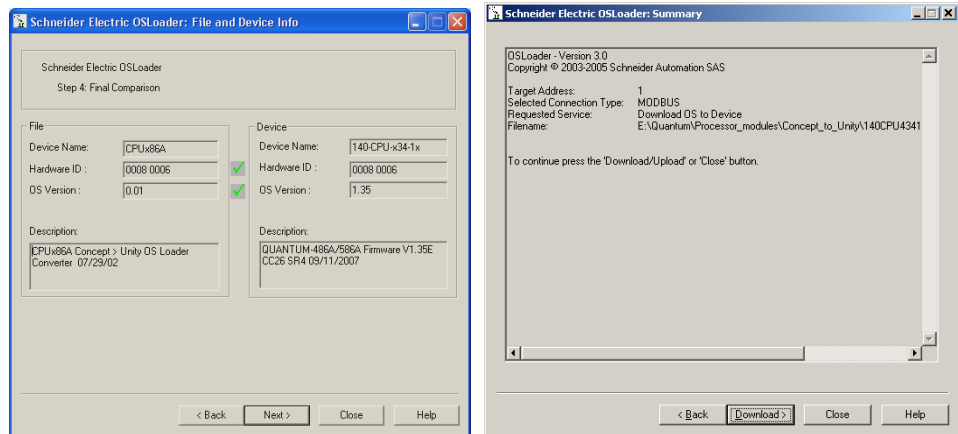

Note: If the system detects a discrepancy on the hardware or on the OS version, the download will not be possible. This is indicated by a red cross and the  button becomes unavailable.



Solve this issue and continue. When the hardware and OS are compatible, clicking on the  button launches the download of the intermediate OS file.

Upgrading a Quantum PLC from Concept to Unity

Upgrading a Quantum PLC from Concept to Unity

Download the intermediate OS file (cnt'd)



During the download the remaining time is displayed:

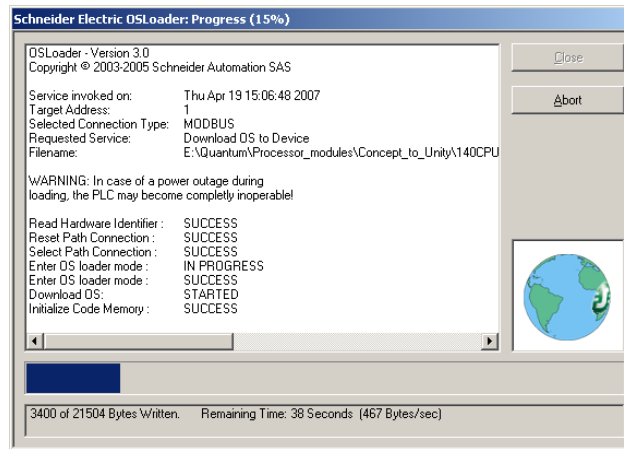

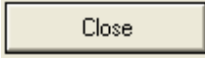
Once the download has successfully completed, the screen below is displayed. Click twice on the  button and go to the Phase 2 (Power OFF then ON or reset the PLC).

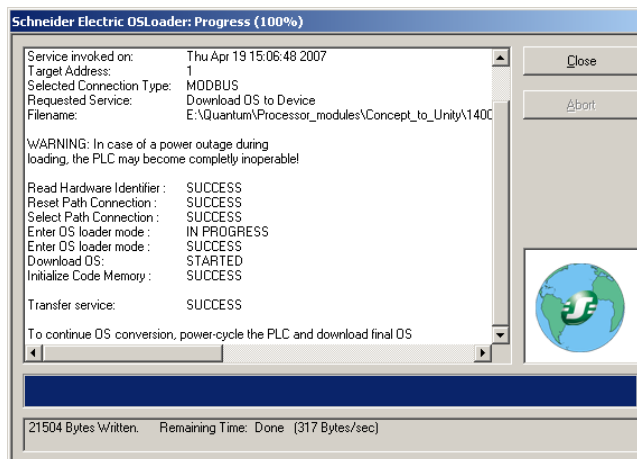

Note: During intermediate download of OS, CPU LEDs do not change state, Ready LED remains steady and RUN LED keeps blinking.

⚠ CAUTION

EQUIPMENT DAMAGE

During the download:

- Do not power OFF the PLC
- Do not power OFF the PC
- Do not disconnect the cable
- Do not shut down OS loader

Any loss of communication during the update procedure can cause severe damage to the CPU or NOE module.

Failure to follow these instructions can result in injury or equipment damage.

Reset the PLC

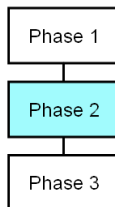

Once the download of the intermediate binary file has completed, the PLC has to be initialized. This task can be performed by one of the two following actions:

- ✓ Reset the PLC by pushing on the Restart button located on the CPU (for more information, refer to the PLC technical documentation).
- ✓ Power OFF then ON the PLC.

Once the PLC has restarted, If steady Run light and no connection with OS loader, Reset the PLC. If State of PLC is steady Ready and blinking Run light, Proceed for phase 3: download the final Unity OS file.

Presentation

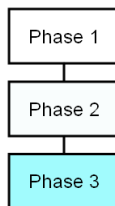

The final binary file “140CPU43412U.bin” (For the selected CPU in our example) has to be downloaded.

For that, follow the same procedure as the one described in the Phase 1.

Download procedure

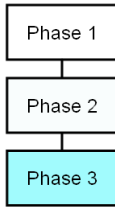

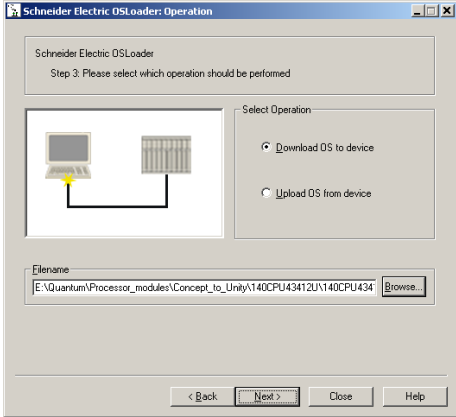
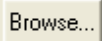
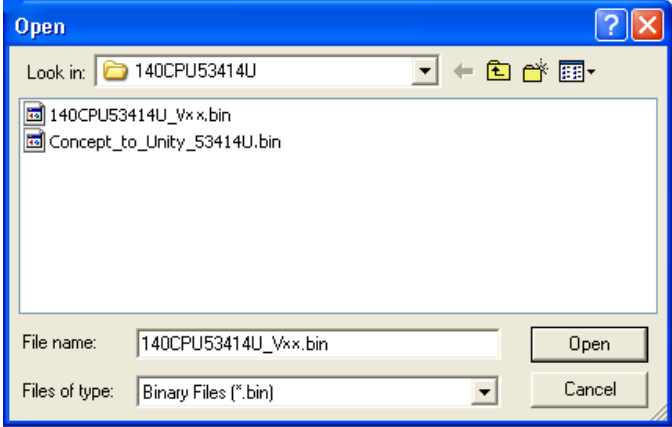
| | |
|--|---|
| <p>As all the necessary actions to download the final Unity OS have been already fully described in the Phase 1, they are shortly reminded here after:</p> | |
| 1 | Open the OS loader (the PC should be still connected to the PLC). |
| 2 | Select the Protocol – Refer to Phase 1. |
| 3 | <p>Select the target device and click on the  button. The next screen appears after few seconds.</p>  |
| 4 | <p>Click on the  button and select (in our example) the file 140CPU43412U_Vxyz.bin located on the CD OS. Then validate this screen.</p>  |

Upgrading a Quantum PLC from Concept to Unity

5

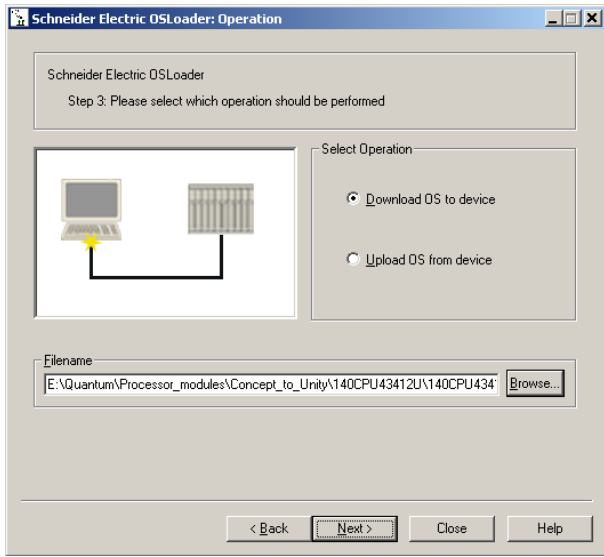

Select the operation to perform (Download OS to device) and press on the **Next >** button.

Download procedure (cnt'd)

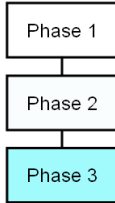

6

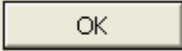
At this stage, and if no functional Operating System is present in the PLC the screen may display “???” in the field “OS Version” and an error message. Click  to validate this message.

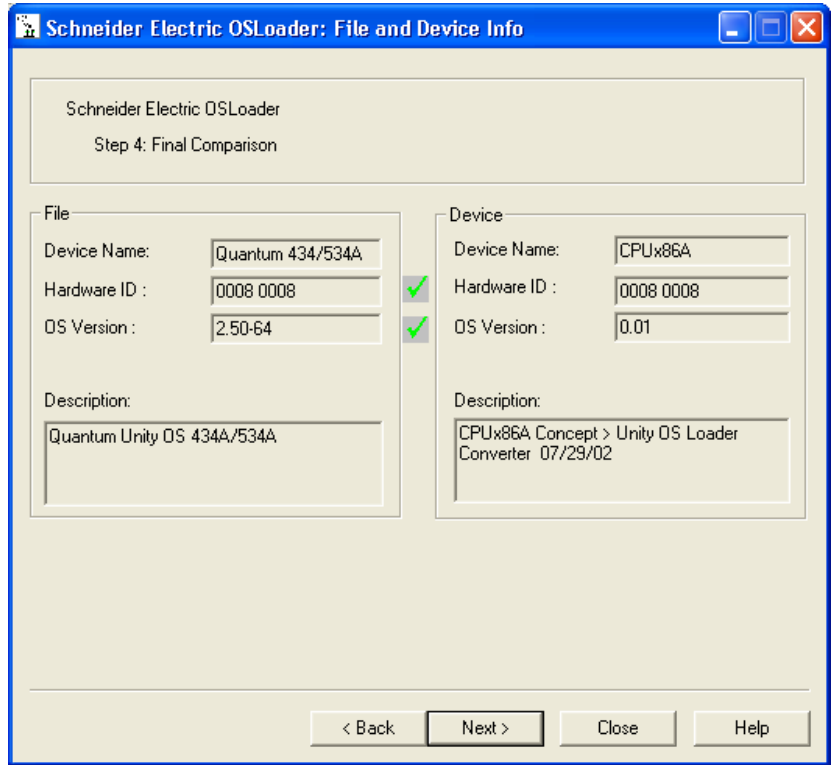

Then click on the  button.

7

Click on  and validate the warning message displayed on the screen to launch the download of the final OS file.

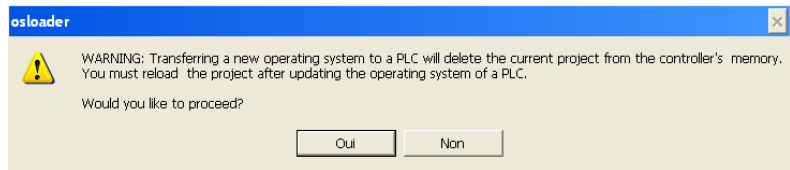

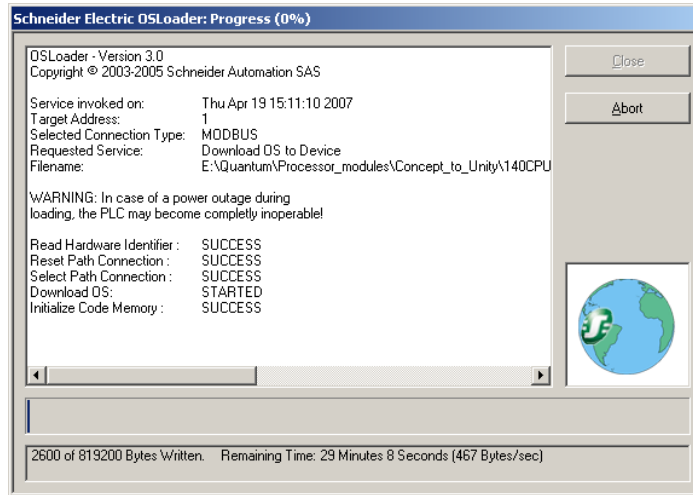

During the download (duration may vary according to the protocol) the remaining time is displayed:

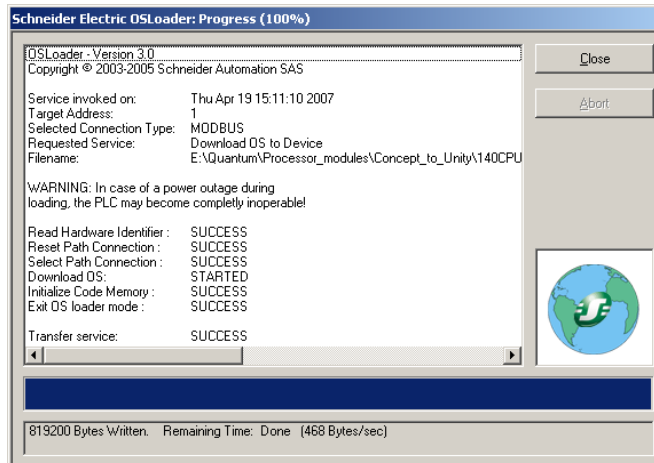

8

Once the download has successfully completed, the screen below is displayed:



Click twice on the  button to exit from the OS loader tool.

9

Reset or power OFF then ON the PLC.

⚠ CAUTION

EQUIPMENT DAMAGE

During the download:

- Do not power OFF the PLC
- Do not power OFF the PC
- Do not disconnect the cable
- Do not shut down OS loader

Any loss of communication during the update procedure can cause severe damage to the CPU or NOE module.

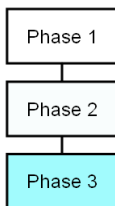

Failure to follow these instructions can result in injury or equipment damage.

Checking version (not mandatory)

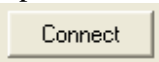

If needed, you can check the new CPU version. For that

- ✓ Open the OS loader tool
- ✓ Select the protocol

- ✓ Click on 
- ✓ Click on 

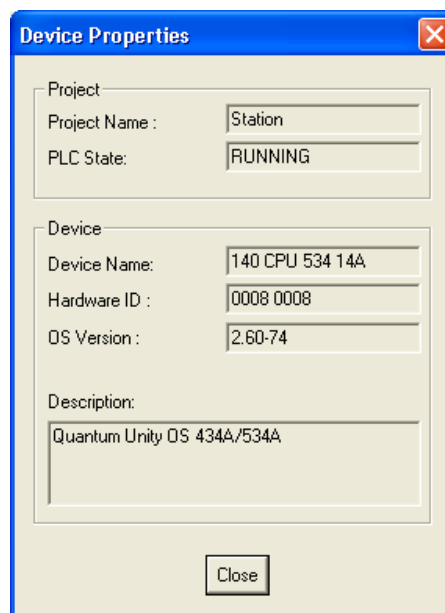

In our example, the CPU has been upgraded to 140CPU43412U and the OS version is 2.60.

3. Updating a Quantum PLC from Unity to Unity

Object of this Chapter This chapter describes how to update a Quantum PLC from Unity version higher than V2.0 to a more recent one. Note that the update from Unity V1.0 to V2 and above is not covered by this document. The screens shots given below show how to update a 140CPU65150 processor.
Note: This procedure can be adopted for all Quantum platforms (High End and Legacy platforms).

Connecting the PC to the PLC Refer to chapter “Prepare a Quantum Update / Connecting the PC to the PLC for an OS update or upgrade.”

Launching the OS loader The OS loader (provided with Unity) allows the user to download the Operating System to the PLC. To open it click on **Start/Program/Schneider-Electric/Unity-PRO/OS loader**.

Once done, the following screen appears:

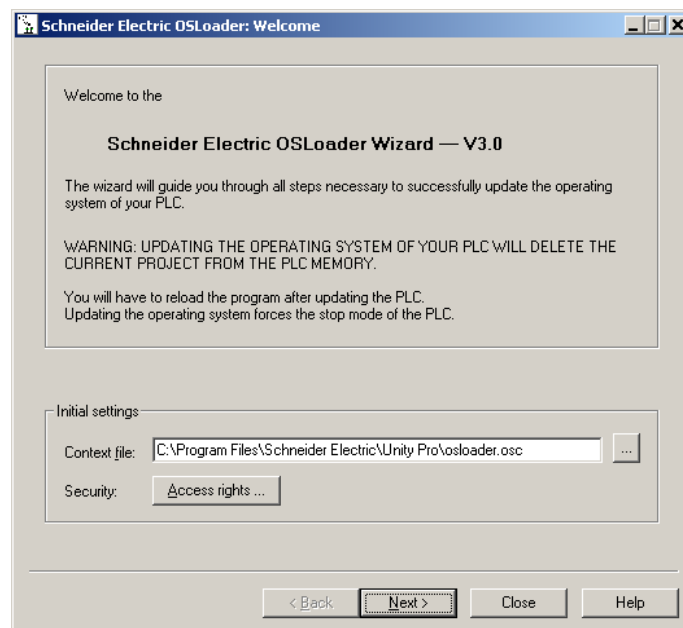

**Select the
Communication
protocol**

From the main screen of the OS loader, click on the  button. The following screen appears:

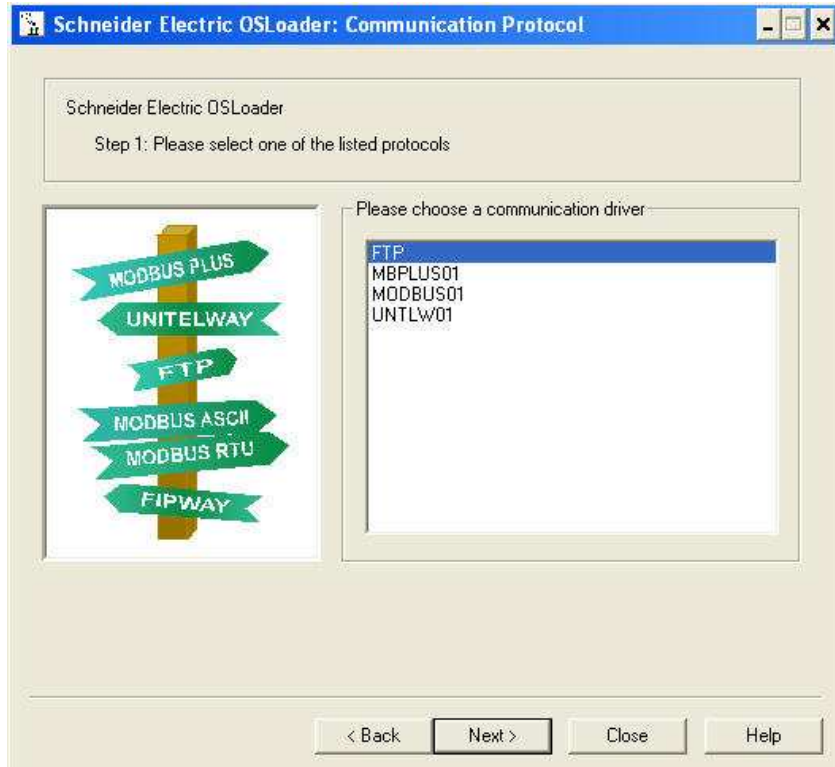

To download the Operating System into the PLC select the right communication protocol (MODBUS01 or MBPLUS01 for Quantum CPU, in accordance with established physical link) and click on the  button.

Updating a Quantum PLC from Unity to Unity

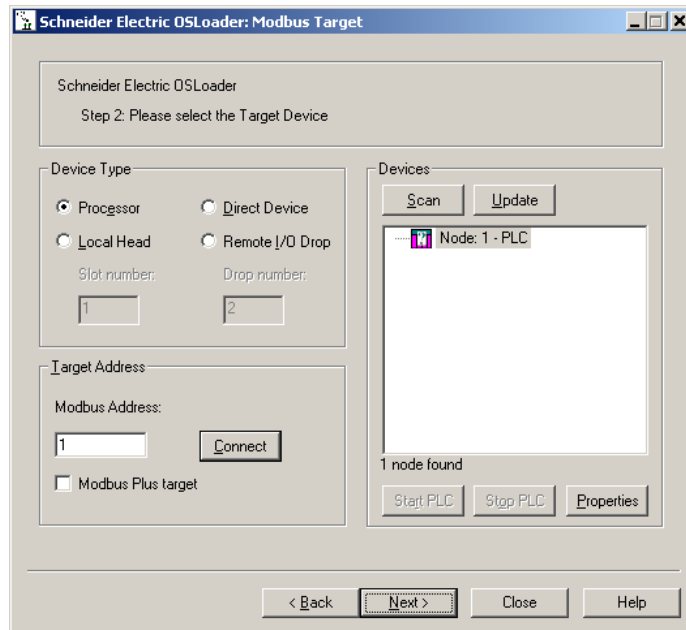

Select the Target Device



On the Device Type field, select Processor.

Get the Unity version (optional)

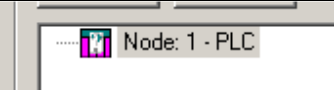
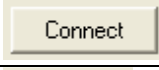
Before the update, knowing which Unity version is already installed on the processor may be useful if for any reason a restore function is needed. For that proceed as follows:

| | |
|----------|---|
| 1 | Select the PLC  |
| 2 | Click on the  button to connect the PC to PLC. |
| 3 | Click on the  button to get info from the PLC. |

| | |
|----------|---|
| <p>4</p> | <p>The following screen gives the user some information regarding the PLC status</p> <ul style="list-style-type: none"> ✓ Started, stopped, Not Configured ✓ Processor type (in this example: <i>140CPU65150</i>) ✓ The Hardware identification (for Schneider internal use only) ✓ The OS version (in this example the OS version is 2.6) <div data-bbox="764 539 1219 1149" style="text-align: center;"> </div> |
| <p>5</p> | <p>Note this version number to avoid compatibility issues between the application program and the OS if the previous version has to be restored.</p> |
| <p>6</p> | <p>Press the  button to return back to the OS update process.</p> |

Select the Download Function

From the screen described above in the section “Select the Target Device” press the  button. A new screen is proposed: select “Download OS to device”.

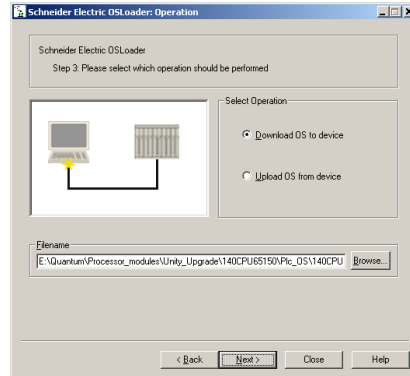

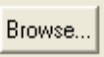
Click on the  button in order to select the file to download into the PLC. In this example we will update the 140CPU65150 OS from version 1.0 to version 2.6. For that select the folders: Quantum\Processor_modules\Unity_upgrade (in your case, select the folder according to your processor type):

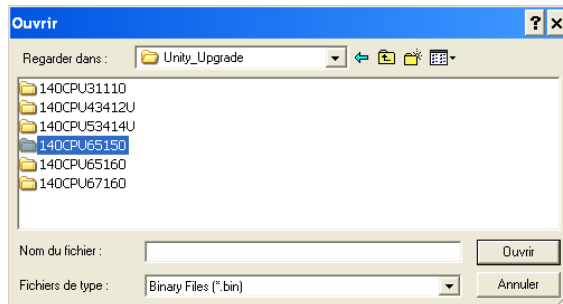

Finally, by browsing the successive sub-directories (PLC_OS) select the binary file “140CPU65150_Vxyz.bin”.

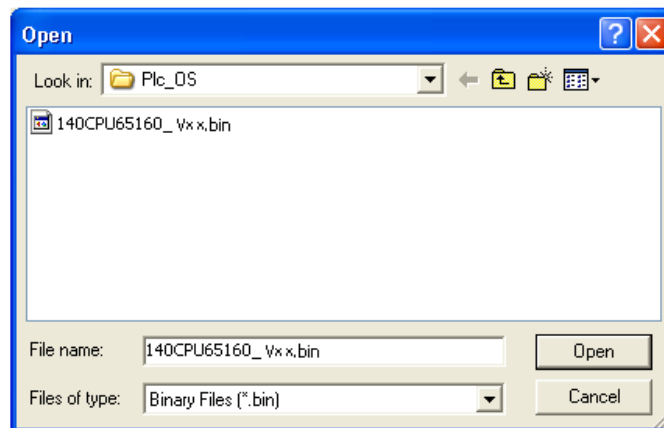

Select the file to download

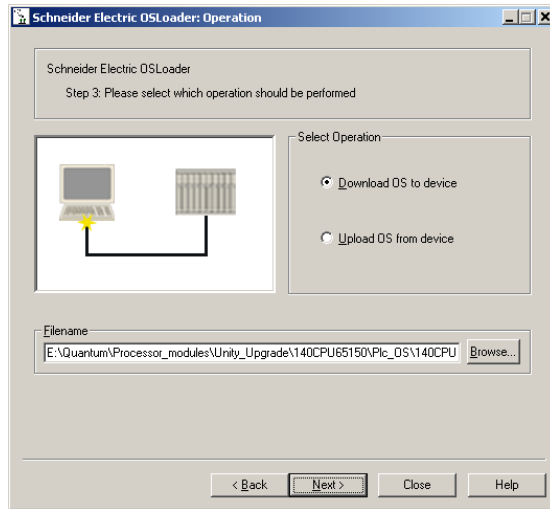

Once done click on the  button.

Updating a Quantum PLC from Unity to Unity

Download the OS file

Once the previous screen is validated, two screens display the current OS version, the processor and the OS file to download:

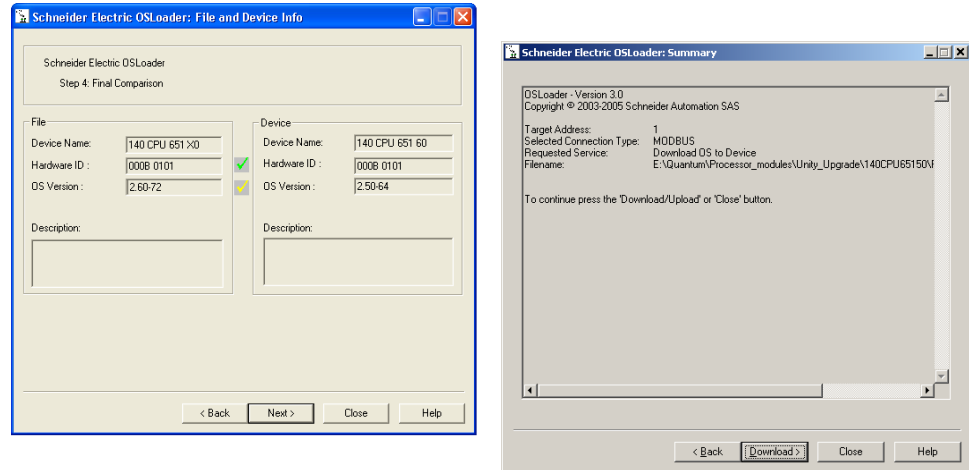

Note: If the system detects a discrepancy on the hardware or on the OS version, the download will not be possible. This is indicated by a red cross and the button becomes unavailable.



Solve this issue and continue. When the hardware and OS are compatible, click on the button and validate the warning message displayed on the screen to launch the download of the OS file.

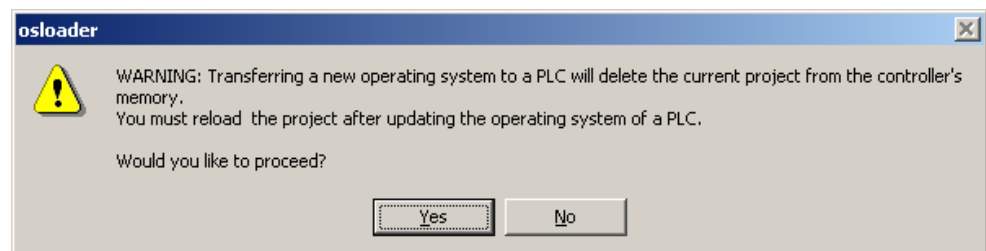

Download the OS file (cnt'd)

During the download (the duration depends on the protocol used, roughly 60 minutes with Modbus) the remaining time is displayed:

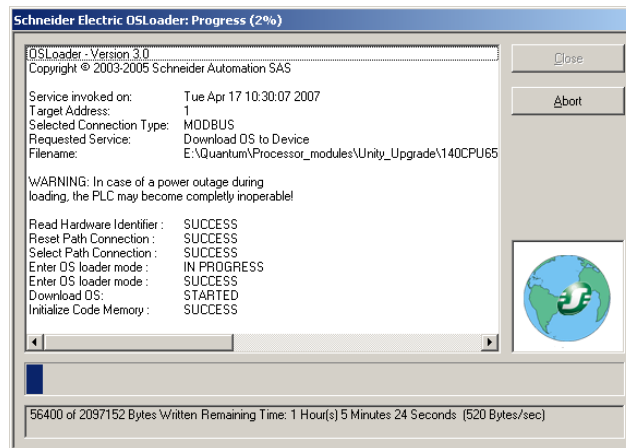

Once the download has successfully completed, the screen below is displayed:

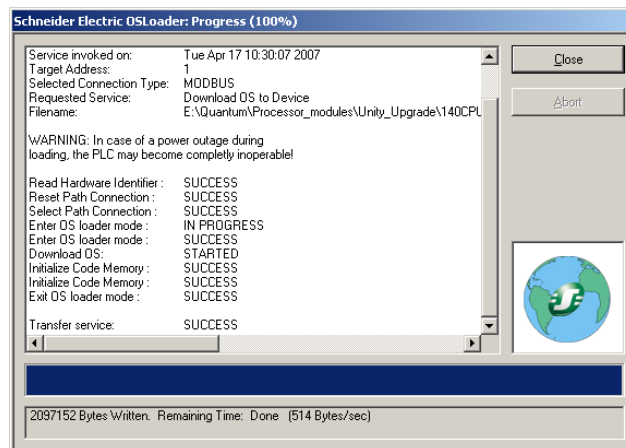

Click twice on the  button.

▲ CAUTION

EQUIPMENT DAMAGE

During the download:

- Do not power OFF the PLC
- Do not power OFF the PC
- Do not disconnect the cable
- Do not shut down OS loader

Any loss of communication during the update procedure can cause severe damage to the CPU or NOE module.

Failure to follow these instructions can result in injury or equipment damage.

Reset the PLC

Once the download of the OS file has completed, the PLC has to be initialized. This task can be performed by one of the two following actions:

- ✓ Reset the PLC by pushing on the Reset button located on the CPU (for more information, refer to the PLC technical documentation).
 - ✓ Power OFF then ON the PLC.
-

Updating a Quantum PLC from Unity to Unity

Checking version (optional)

If needed, you can check the new CPU version. For that

- ✓ Open the OS loader tool
- ✓ Select the protocol

✓ Click on 

✓ Click on 

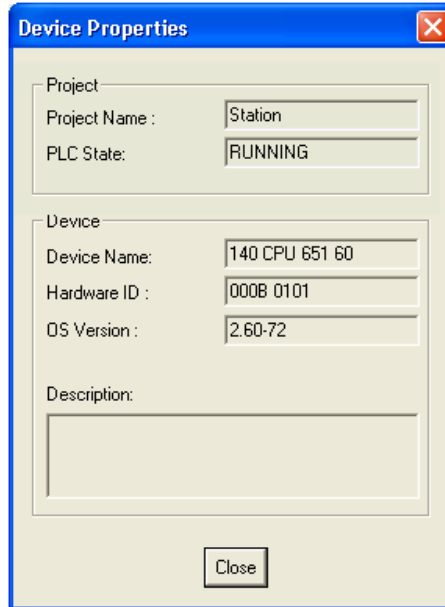

In our example the CPU has been updated to the version 2.60.

4. Restoring a Quantum PLC from Unity to Concept

Object of this Chapter This chapter describes how to restore a Quantum PLC from Unity to Concept. The screen shots given below show how to restore a 140CPU43412U (Unity) to 140CPU43412A (Concept).

Important Restoring a PLC from Unity to Concept requires to perform three main phases:

- ✓ Phase 1 – Restore the PLC to Concept with an intermediate OS.
- ✓ Phase 2 - Power OFF then ON the PLC.
- ✓ Phase 3 – Restore the Operating System with the appropriate file.

Those phases are mandatory and cannot be by-passed.

Each phase is described in the following procedure.

Connecting the PC to the PLC Refer to chapter “Prepare a Quantum Update / Connecting the PC to the PLC for an OS update or upgrade.”

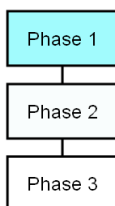

Launching the OS loader



The OS loader (provided with Unity) allows the user to download the Operating System to the PLC. To open it click on **Start/Program/Schneider-Electric/Unity-PRO/OS loader**.

Once done, the following screen appears:

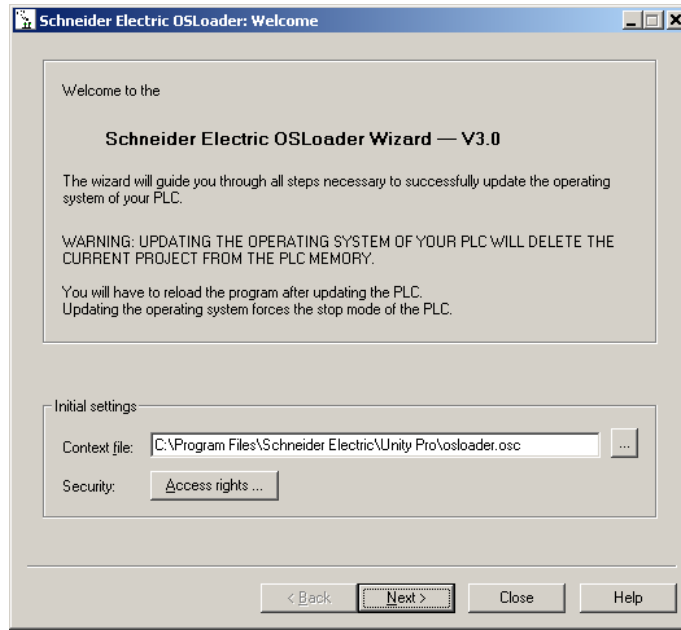



The next steps are fully described later in this document.

Restoring a Quantum PLC from Unity to Concept

Select the Communication protocol

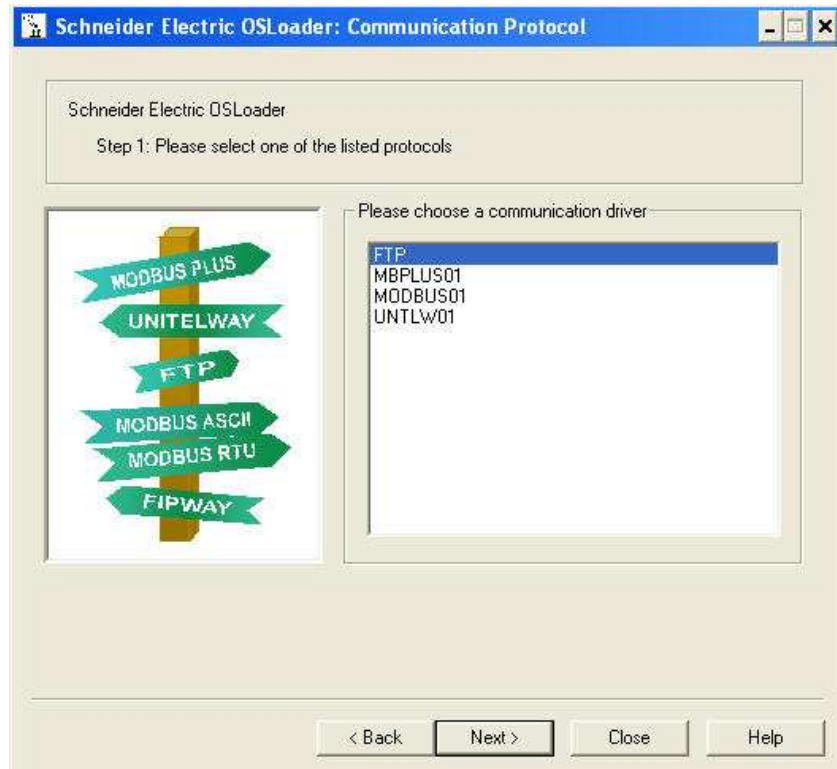
From the main screen of the OS loader, click on the  button. The following screen appears:



To download the Operating System into the PLC select the right communication protocol (in accordance with established physical link) and click on the  button.

Restoring a Quantum PLC from Unity to Concept

Select the Target Device

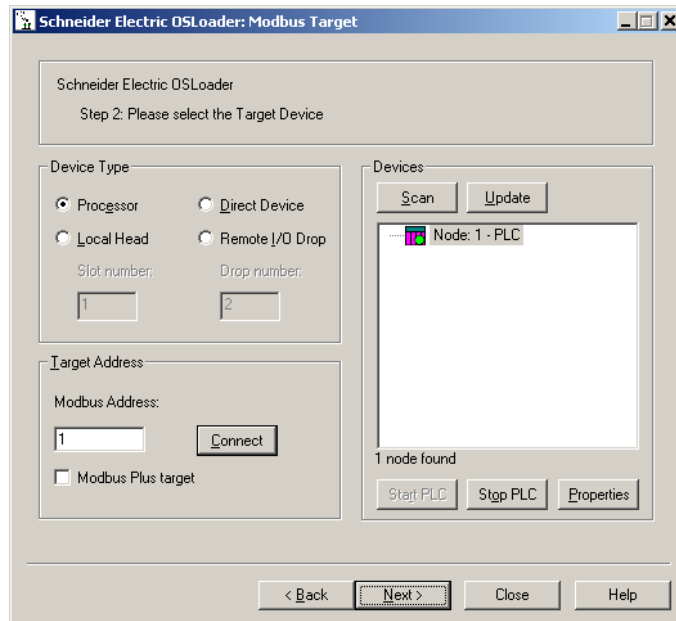

On the Device Type field, select Processor and the other needed parameters (Modbus address....). Then connect to the selected PLC (Node).

Restoring a Quantum PLC from Unity to Concept

Select the Download Function

From the screen described above press the  button. A new screen is proposed: select “Download OS to device”.

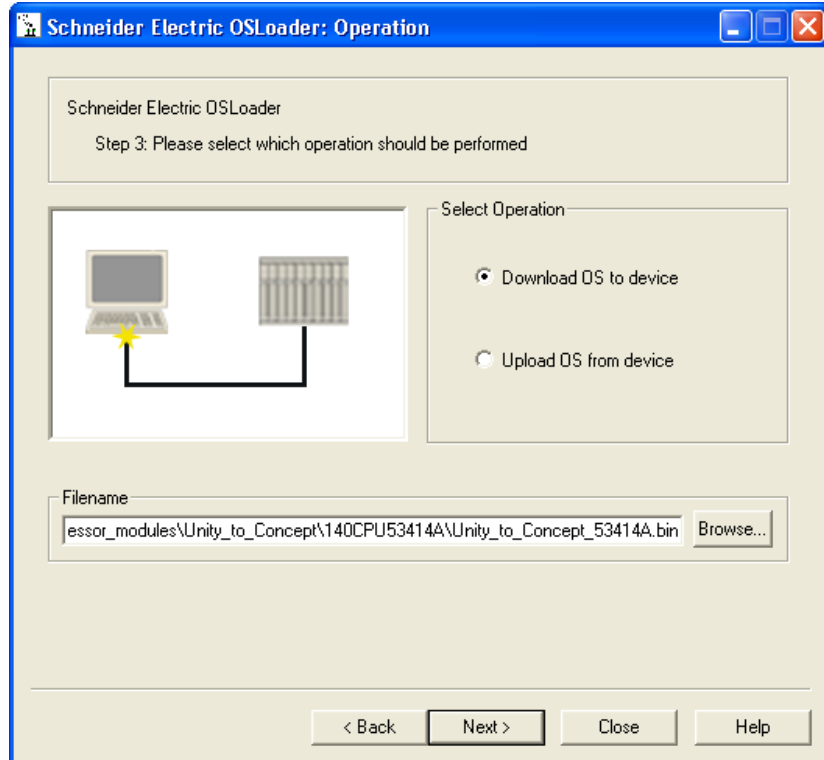

Restoring a Quantum PLC from Unity to Concept

Select the file to be downloaded

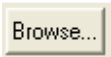

Click on the  button in order to select the file to download into the PLC. In this example we will restore the OS from 140CPU43412U to 140CPU43412A. For that select the following folders: Quantum\Processor_modules\Unity_to_Concept.

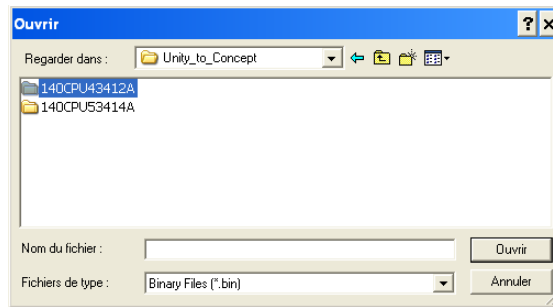

To restore the OS from Unity to Concept, two binary files can be selected:

- ✓ Unity_to_Concept_43412A.bin (allows to “format” the processor to Concept)
- ✓ q5rv135E.bin is the OS that will finally be downloaded in the processor

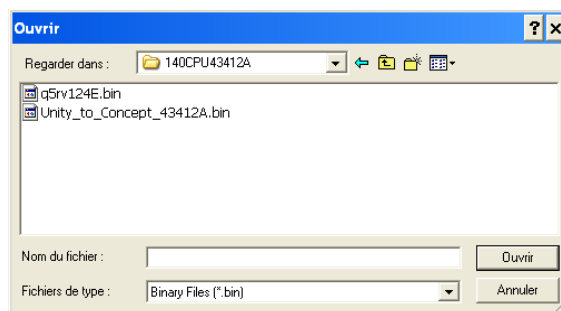

In our example we have to “format” the processor (remember, we still are in the Phase 1) then select and Validate “Unity_to_Concept_43412A.bin”.

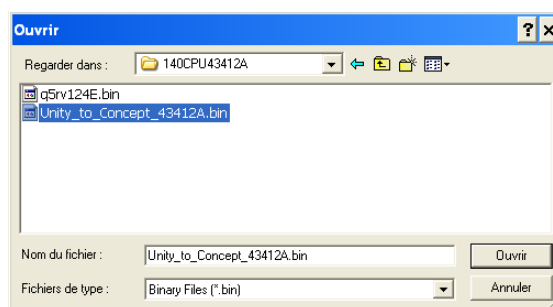

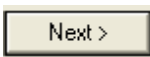
Once done click on the  button.

Restoring a Quantum PLC from Unity to Concept

Download the intermediate OS

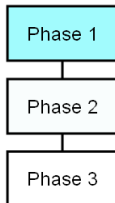

Once the previous screen is validated a warning is displayed:

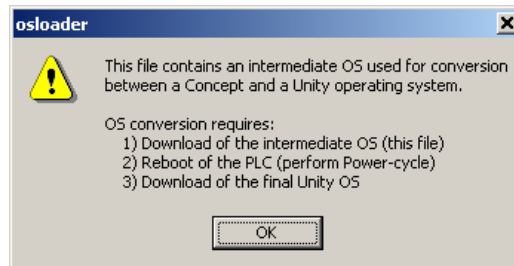

Click the  button. Two screens that give information regarding the file, the processor and the download are now displayed:

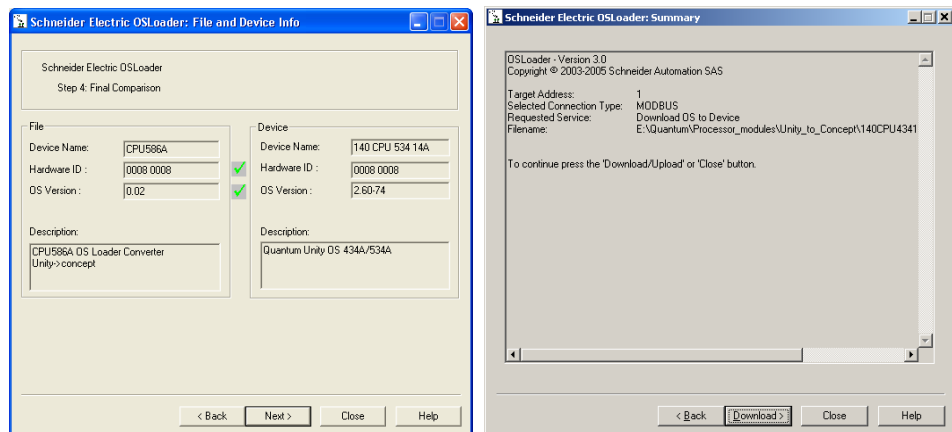

Note: If the system detects a discrepancy on the hardware or on the OS version, the download will not be possible. This is indicated by a red cross and the  button becomes unavailable.

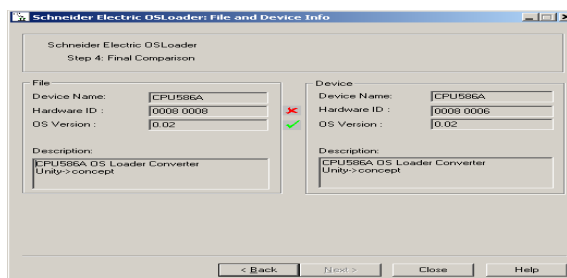

Solve this issue and continue. When the hardware - OS are compatible, click on the  to launch the download of the intermediate OS file.

Restoring a Quantum PLC from Unity to Concept

Restoring a Quantum PLC from Unity to Concept

Download the intermediate OS file (cnt'd)



During the download the remaining time is displayed:

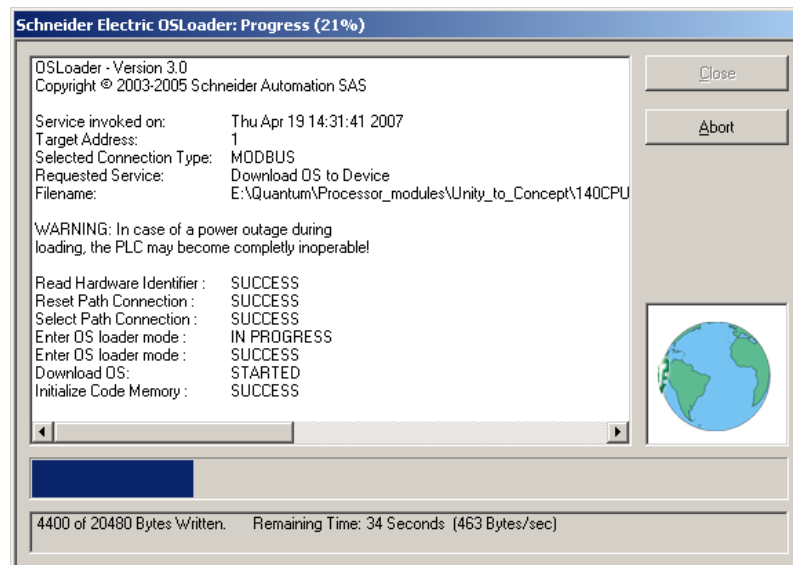

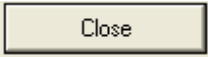
Once the download has successfully completed, the screen below is displayed. Click twice on the  button and go to the Phase 2 (Power OFF then ON or reset the PLC).

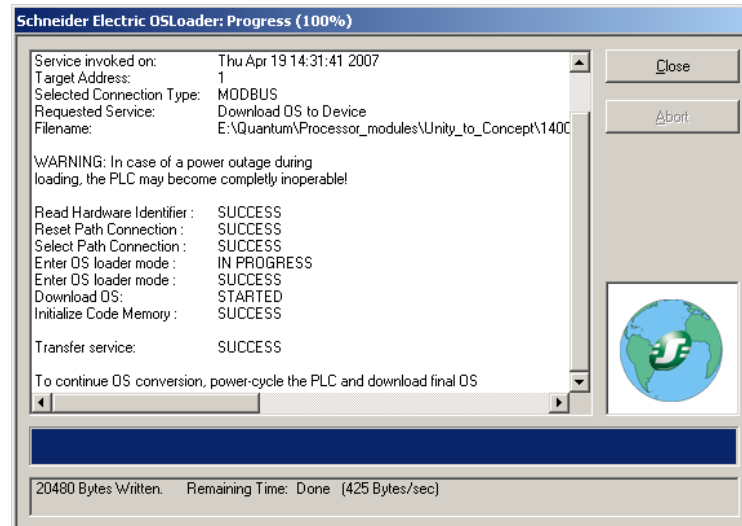

Note: During intermediate download of OS, CPU LEDs do not change state, Ready LED remains steady and RUN LED keeps blinking.

⚠ CAUTION

EQUIPMENT DAMAGE

During the download:

- Do not power OFF the PLC
- Do not power OFF the PC
- Do not disconnect the cable
- Do not shut down OS loader

Any loss of communication during the update procedure can cause severe damage to the CPU or NOE module.

Failure to follow these instructions can result in injury or equipment damage.

Reset the PLC

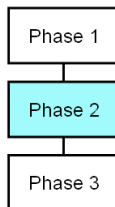

Once the download of the intermediate binary file has completed, the PLC has to be initialized. This task can be performed by one of the two following actions:

- ✓ Reset the PLC by pushing on the Restart button located on the CPU (for more information, refer to the PLC technical documentation).
- ✓ Power OFF then ON the PLC.

Once the PLC has restarted, go to Phase 3: download the final Concept OS.

Presentation

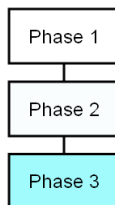

The final binary file “q5rv135E.bin ” (140CPU34312 in our example) has to be downloaded.

For that, follow the same procedure as the one described in the Phase 1.

Restoring a Quantum PLC from Unity to Concept

Download procedure

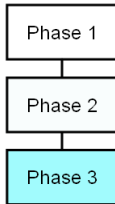

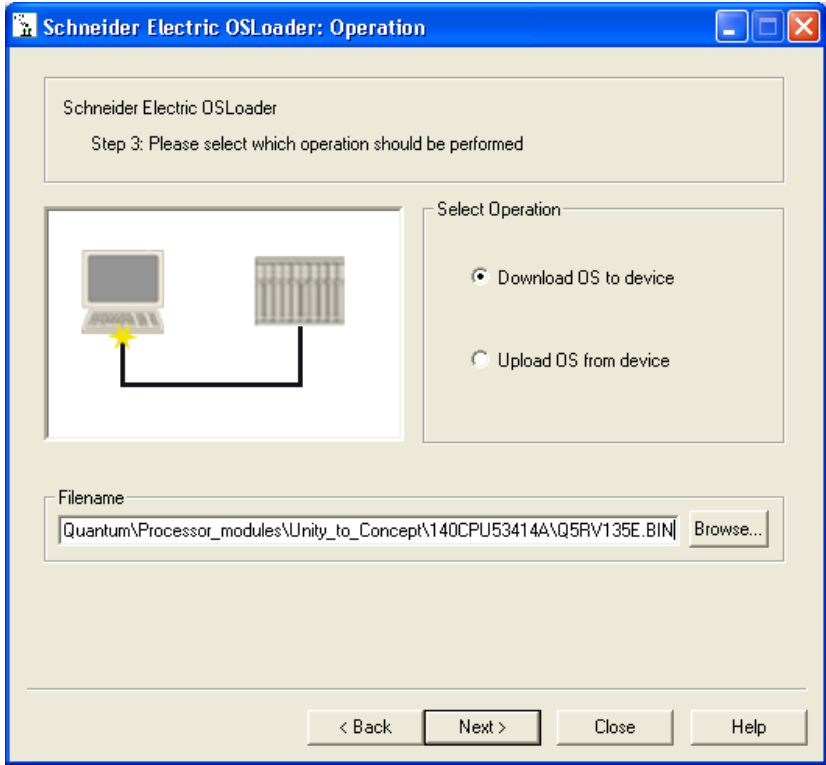
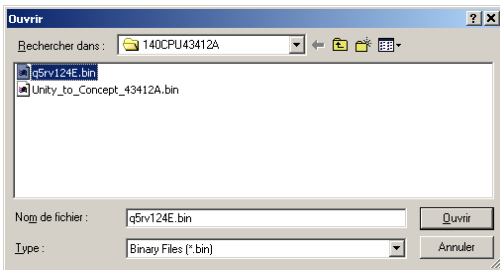
| | |
|---|---|
| As all the necessary actions to download the final Concept OS have been already fully described in the Phase 1, they are shortly reminded here after: | |
| 1 | Open the OS loader (the PC should be still connected to the PLC). |
| 2 | Select the Communication Protocol – Refer to Phase 1. |
| 3 | <p>Select the target device and click on the Next > button. The next screen appears after few seconds.</p>  |
| 4 | <p>Click on the Browse... button and select (in our example) the file q5rv135E.bin located on the CD OS. Then validate this screen.</p>  |

Restoring a Quantum PLC from Unity to Concept

5

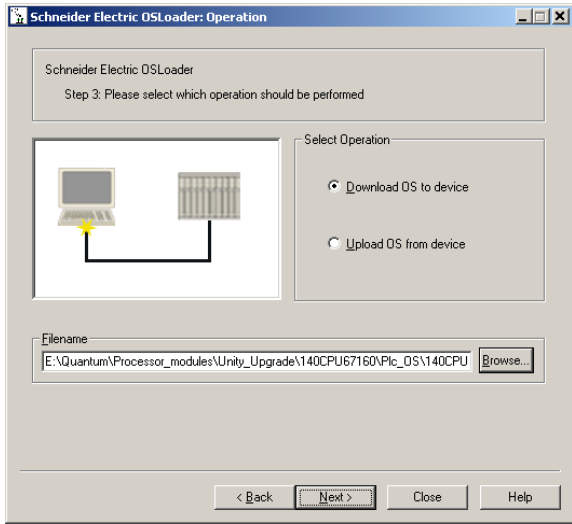

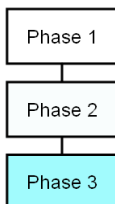

Select the operation to perform (Download OS to device) and press on the  button.

Download procedure (cnt'd)

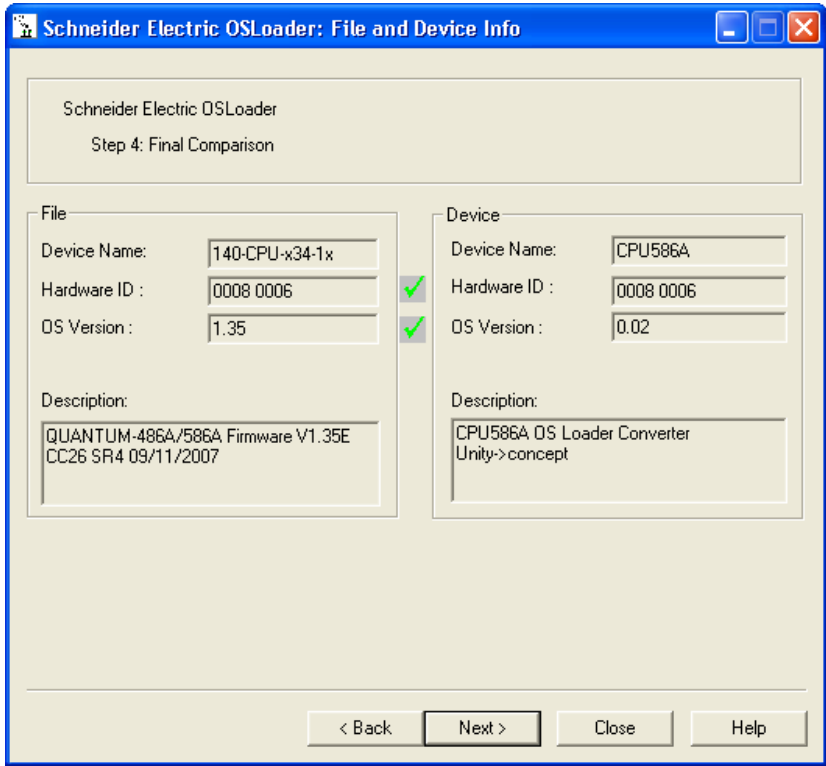

6



Then click on the  button.

Restoring a Quantum PLC from Unity to Concept

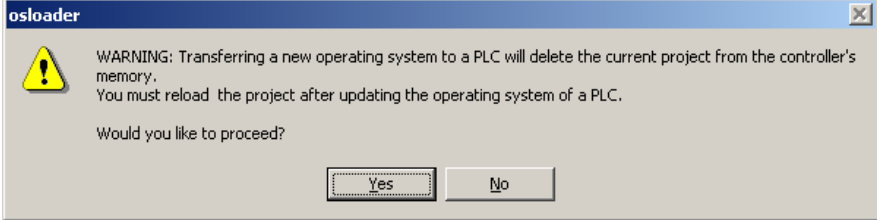
| | |
|----------|--|
| 7 | <p>Click on  and validate the warning message displayed on the screen to download the final OS file.</p>  |
|----------|--|

During the download (duration may vary according to the protocol) the remaining time is displayed:

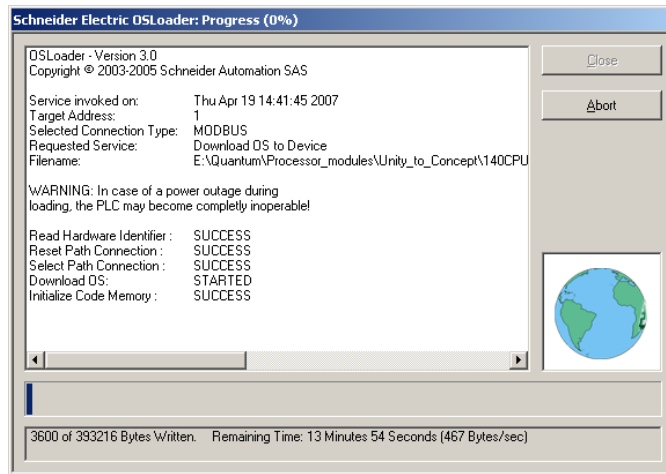

8

Once the download has successfully completed, the screen below is displayed:

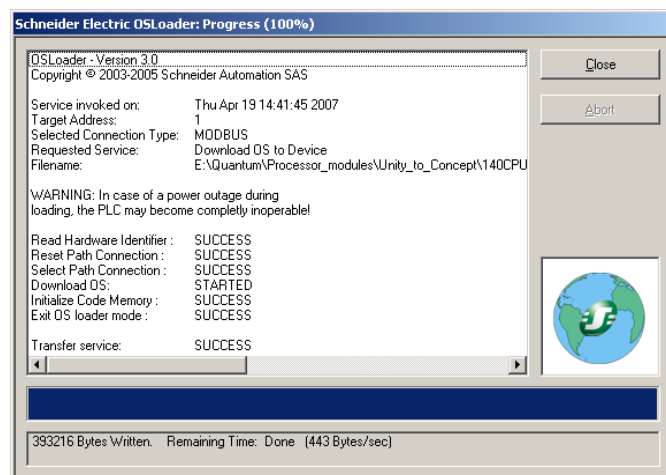

Click twice on the  button to exit the OS loader tool.

9

Reset or power OFF then ON the PLC.

⚠ CAUTION

EQUIPMENT DAMAGE

During the download:

- Do not power OFF the PLC
- Do not power OFF the PC
- Do not disconnect the cable
- Do not shut down OS loader

Any loss of communication during the update procedure can cause severe damage to the CPU or NOE module.

Failure to follow these instructions can result in injury or equipment damage.

Checking version (optional)

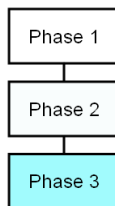

If needed, you can check the new CPU version. For that

- ✓ Open the OS loader tool
- ✓ Select the communication protocol

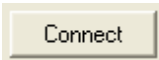
✓ Click on 

✓ Click on 

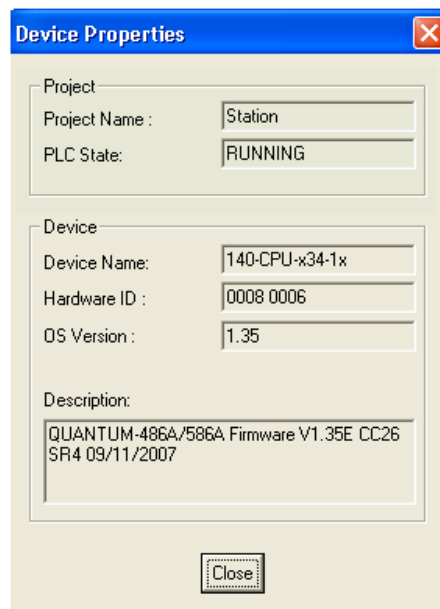

In our example, the CPU has been restored to 140CPU43412A, version 1.60.

5. Upgrading a Quantum Hot Standby PLC

Object of this Chapter This chapter describes how to upgrade a Quantum Hot Stand By PLCs (CPU 67160 , CPU 67261, CPU 67260). This Upgrade can be managed by one of the two communications methods available in the OS loader:

- ✓ Modbus
- ✓ Modbus Plus

Important: the procedure below only gives, step by step, the procedure to follow. The upgrade procedure itself is described in the chapter 3 of this document.

Compatibility issues **Important:** To upgrade a Modicon Quantum Hot Standby with Unity OS loader without shutting down the process, the current application program must be executable by the new OS. Observe this requirement when installing minor revisions targeted for bug fixes or minor enhancements. When a major function enhancement needs to be made, maintaining this compatibility may not be possible. In this case, to perform an OS upgrade requires a system shut down.

Connecting Hot Standby without S908 RIO drop. The error A and error B leds of the RIO Head (CRP) indicate the communication status between RIO Head and RIO Drop. When using CRP module with firmware version lower than 2.00, the led 'fault' is on but this has no impact on communication between the two RIO heads. To have the error leds not returning a detected error, it is mandatory to:

- update the CRP module with a firmware 2.00 or higher (on both Primary and Standby side).
- update the Quantum Hot Standby processor with a firmware 2.70 or higher (on both Primary and Standby side).
- install Unity Pro V4.1 or higher. Select the HotStandby processor V2.70 in the Unity Pro application and take the processor into account through a 'Rebuild All'. Make the full download in both PLCs.
- CPU 67261 is compatible with Unity Pro V5.0 or higher with a firmware 2.80 or higher.

Ethernet RIO At the moment only Head communication module 140CRP31200 is concerned by this procedure.

Important:

- The both CRPs must have the same SoftwareVersion .
 - Begin the update by CPUs then CRP modules.
-

Upgrading a Quantum Hot Standby PLC

Upgrading PLC while the process is running The Executive Upgrade feature allows upgrading the OS of the Standby controller while the Primary controller continues to control the process. However, during the upgrade, the system can no longer be considered as redundant. That is, there is no Standby available to assume control if the Primary should fail before the Standby upgrade is complete.

Upgrading the OS without stopping Under normal operating conditions, both controllers in a redundant system must have the same versions of firmware. In fact, there are checks done by the controllers to detect if there is a mismatch in firmware.

Normally, when a mismatch exists, performing a switchover would not be possible because the Secondary controller would not be allowed to be Standby.

However, to allow an OS Upgrade without stopping the application, it is possible to set the “upgrade without stopping” command in Command Register system word %SW60 (bit %SW60.4 - Details on the Modicon Quantum Hot Standby with Unity command register can be found in Understanding the Unity Command Register, p. 113).

Note:

- ✓ Enabling OS upgrade without stopping the application disable the checking between the Primary and Standby configuration. Disable the “upgrade without stopping” bit as soon as the OS upgrade is finished.
 - ✓ OS upgrade is possible only with compatible firmware.
-

**Upgrade
procedure**

Important: Using Modbus or Modbus Plus, only address 1 is allowed for downloading. Ensure that no other device on the network is using address 1.

1. Connect to the Primary (through Modbus, Modbus Plus or USB).
2. Access the Command Register system bit %SW60.4 and set this bit to 1.
3. Disconnect the PC from the Primary CPU.
4. Depending on the communication media chosen for the upgrade procedure, note the Modbus or Modbus Plus address of the Standby CPU using the keyboard functions (in “PLC Communications / Communications Serial Port” for Modbus or in “PLC Communications / Communications Modbus Plus” for Modbus Plus).
5. Stop the Standby CPU with the keyboard functions.
Note: The standby CPU goes to STOP Offline mode; the Primary operates without a Standby.
6. Disconnect all the communication links (Hot Standby fiber optic cable, Ethernet cables, Modbus Plus cables ...) from the Standby rack and remove the CRP module from the Standby rack.
7. Switch off the power of the Standby rack.
8. When using an application in the PCMCIA card:
 - 8.1. Remove the PCMCIA card from the Standby CPU.
 - 8.2. Remove the PCMCIA batteries to empty the card content.

9. Power on the Standby CPU.
 10. If not set to 1, change the Modbus or Modbus Plus address of the Standby CPU to 1 with the keyboard functions (in “PLC Communications / Communications Serial Port” for Modbus or in “PLC Communications / Communications Modbus Plus” for Modbus Plus).
 11. **Coprocessor Upgrade Step:** please see “*Appendix 4: 140CPU67160/140CPU 67261 HotStandby CPU Copro Upgrade Procedure*”. Don’t forget to power cycle the CPU at the end of the procedure.
 12. **CPU OS Upgrade Step:** please see “*3. Updating a Quantum PLC from Unity to Unity*”
 - 12.1. Connect the PC to the Standby CPU using Modbus or Modbus Plus.
 - 12.2. Open the OSLoader tool.
 - 12.3. Select the Modbus or Modbus Plus communication option.
 - 12.4. Connect to the Standby using address 1.
 - 12.5. Download the OS to the Standby.
 13. Disconnect the PC from the Standby CPU.
 14. Switch off the power of the Standby CPU.
 15. When using an Application in the PCMCIA :
 - 15.1. Insert the PCMCIA batteries.
 - 15.2. Insert the PCMCIA card in the Standby CPU.
 16. Power on the Standby CPU.

Note: the CPU must be in “No Conf” state.
 17. Check the Copro and OS versions in the LCD Screen.
 18. Reconnect all the communication cables (CRP module, Ethernet cables, ...) but not the Hot Standby fiber optic cable.
 19. At last, reconnect the fiber optic cable to both CPUs.
 20. Check the application program is automatically transferred to the Standby CPU ("Transfer ..." on screen for a short time and then "Run Standby CPU"). If not, perform the transfer with the keyboard.

Note: Ensure that the Modbus or Modbus Plus address is the same as the address noted in Step 4.
 21. Put in RUN mode.

Note: Ensure Primary CPU is in Run Primary Mode and Standby CPU is in RUN Standby Mode.
 22. Perform a switchover by stopping the Primary CPU with the keyboard.

Note: Ensure Standby CPU becomes Primary CPU on the LCD screen.
 23. Repeat Steps 4 through 21 on the new Standby.
 24. Connect to the new Primary CPU with the PC and Unity Pro (through Modbus, Modbus Plus or USB).
 25. Access Command Register system bit %SW60.4; set bit to 0.
 26. Disconnect the PC and ensure Primary CPU is in RUN Primary Mode and Standby CPU is in RUN Standby Mode.
-

Appendix 1: NOE Module Upgrade Procedure

Purpose

To outline the steps required to upgrade a NOE module using Unity Pro 2.2 or higher OS loader. Please note that prior version of the OS loader are not compatible with this revision of the firmware. You **MUST** be at the proper OS loader revision of 2.2 or higher.

Applicable Modules

140NOE77101 / 140NOE77111 Kernel 1.0 or higher with any version of Firmware.

Resulting Module after upgrade

140NOE77101 Kernel 2.0 or higher, Firmware V4.9.

Note: The 140NOE77101 reference is given as an example, but the same procedure with the same steps can be used for upgrading a 140NOE77111.

Overview

The upgrade of a NOE module requires multiple steps. Two components must be considered to be upgraded, the Kernel and the Firmware version. Not all steps listed below may be required depending on the version of the NOE module before this upgrade procedure is started.

Pre-conditions

The CPU module must be in STOP mode and the NOE must have NO TCP traffic.

A loss of power during the upgrade may cause the NOE module to be inoperable. Make sure the power supply on the NOE module rack will not be interrupted during the upgrade.

Step 1

Verify the Kernel and Firmware using Concept Exec Loader or Unity OS loader or NOE web page.

For modules that have Kernel V1.0 and Firmware Lower than V3.3, you must upgrade to Kernel V2.0 and Firmware V3.30 using the Concept Exec Loader. For modules that have Kernel V2.0 or higher and Firmware V3.3 or higher, you must upgrade to Firmware V4.4 using the Unity OS loader V2.2 or higher.

Step 2

Select the filename to download based on the Current Module Version in the following table.

| Current Module Version | File to Select | Resulting Module |
|--|--|---|
| 140NOE77101 Kernel V1.0, Firmware – Any | Quantum\Ethernet_modules\Concept_to_Unity\140NOE77101\140NOE77101_V200_KER.bin | 140NOE77101 Kernel V2.0 |
| 140NOE77101 Kernel V2.0, Firmware < V3.3 | Quantum\Ethernet_modules\Concept_to_Unity\140NOE77101\140NOE77101_V330.bin | 140NOE77101 Kernel V2.0, Firmware V3.3 |

If module not listed proceed to Step3.

If module is listed, use the Concept Exec loader download the kernel and executive firmware file. To upgrade module to Firmware V4.6, the Kernel must be upgraded to V2.0 first.

Step 3

Upgrade the Firmware and Web pages to the current V4.4 using the Unity V2.2 OS loader or higher.
Ethernet OS Files to Update: 140NOE771x1 Kernel V2.0 or higher, Firmware at least V3.3.

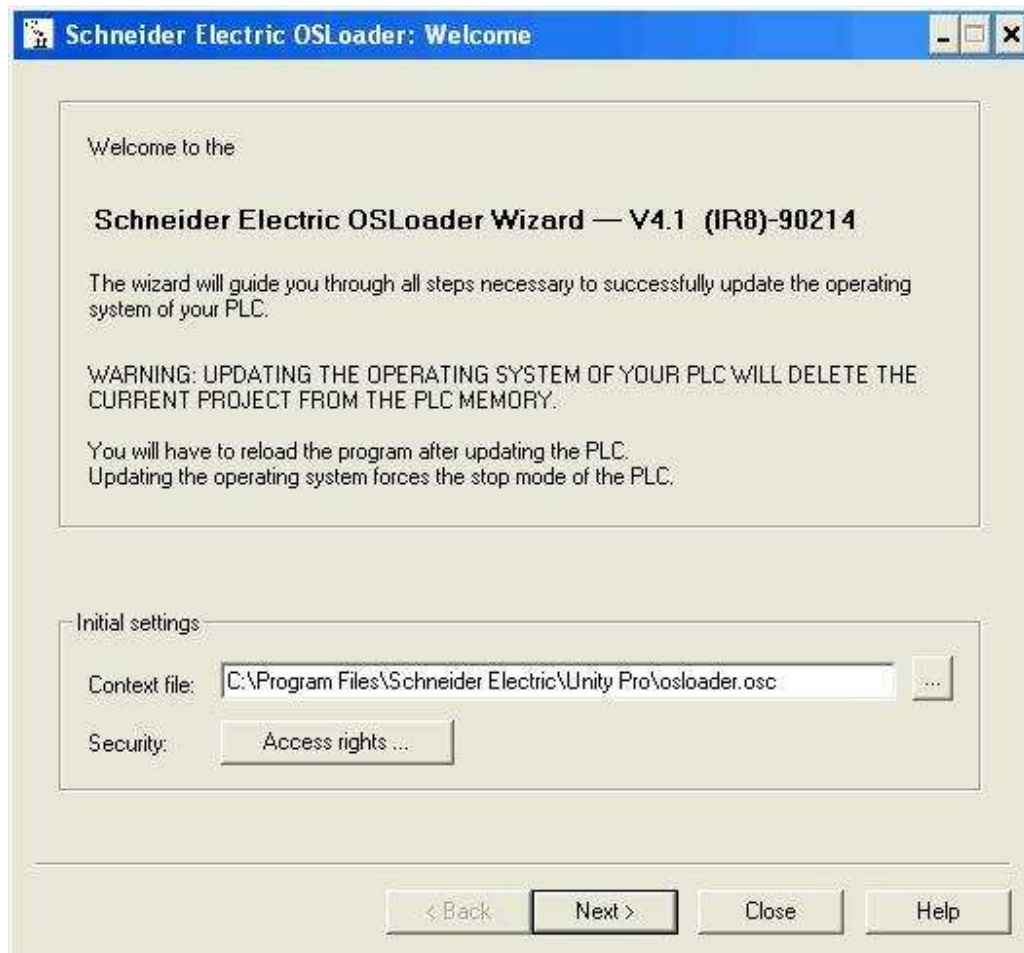

Step4

Select the FTP Driver.
Select 'Next'.

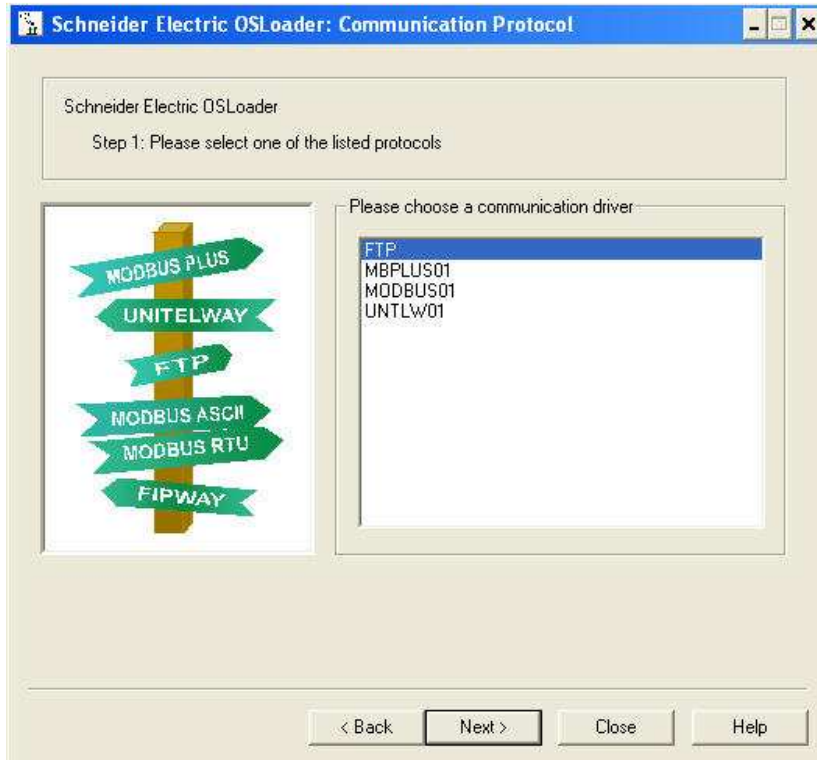

Step5

Select 'Direct Device' and enter the device IP address and select Connect. If requested enter the module's MAC address, the MAC address can be found on the front of the module.

Note: If your module is located remotely, you can get the MAC address by pinging the module's IP address, then using the arp-a command to display the module's physical MAC address.

Select 'Next'.

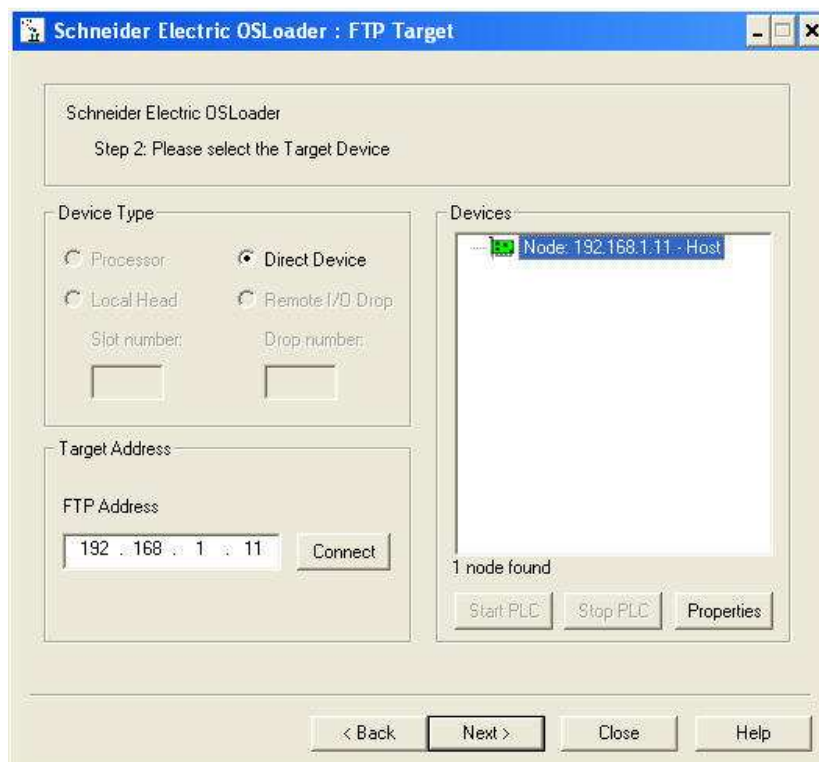

In this example, the IP address used is 192.168.1.11. Adapt this address for the one of your PLC.

Step6

Select Operation 'Download OS to Device'

Select the filename to download based on the Current Module Version in the following table.

| Current Module Version | File to Select | Resulting Module |
|--|---|---|
| 140NOE77101 Kernel V2.0 or higher, Firmware at least V3.3 | Quantum\Ethernet_modules\Unity\140NOE77101\140NOE77101_Vxyz.bin xyz stand for the version of the OS that has to be downloaded for update. It can be for instance 440 | 140NOE77101 Kernel V2.0 or higher, Firmware Vx.yz (4.40 for instance) |

Note: For NOE77101 with kernel V4.5 or higher, the compatible firmware is a V4.0 or higher.

Note: Please read file "Quantum Compatibility Rules" for more version compatibility information.

NOE Module Upgrade Procedure

If module is listed select the correct file and click 'Next'.

The following Screen will appear:

Schneider Electric OSLoader
Step 4: Final Comparison

| File | Device |
|---------------------------|--------------------------|
| Device Name: 140NOE77101 | Device Name: 140NOE77101 |
| Hardware ID : 0000 0422 ✓ | Hardware ID : 0000 0422 |
| OS Version : 4.40 ✓ | OS Version : 4.20 |
| Crash Code: | Crash Code: 0 |
| Description: V4.40 IE36 | Description: V4.20 IE33 |

< Back Next > Close Help

Both the Hardware ID and OS version must be followed by a green tick. Select 'Next' and then 'Download'.

NOE Module Upgrade Procedure

After the download is completed the following screen will appear.

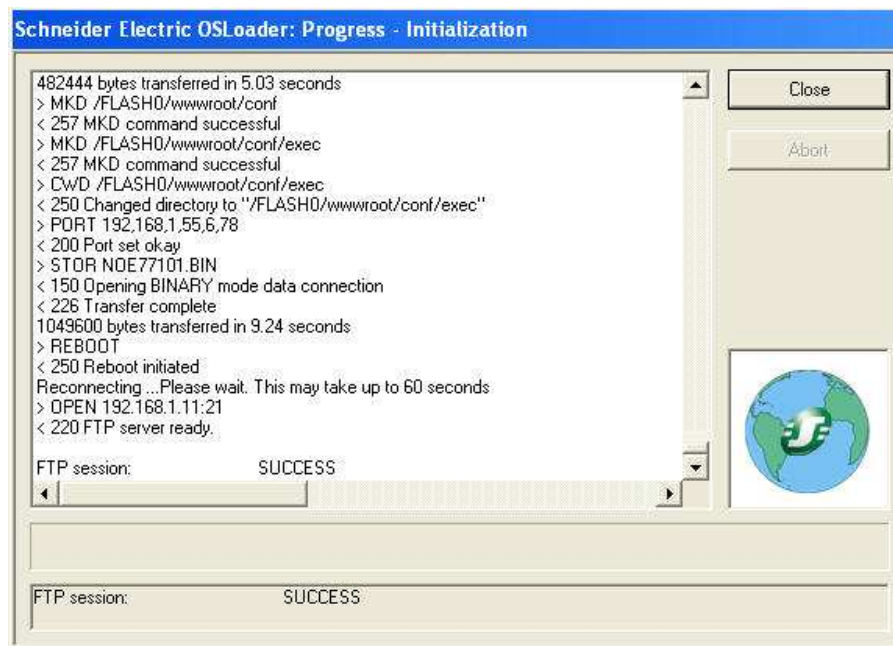

If this screen does not appear recheck each step and contact your local Schneider office for assistance if required.
Select 'Close' and 'Back' in the OS loader.
Exit the OS loader.

Allow the module 60 seconds to complete any actions and power cycle the module to allow the new Firmware to be loaded.

Note: NOE modules should be upgraded to at least Kernel V2.0, Firmware V3.30 while installed in a PLC rack containing a CPU running a Concept Level Executive. Modules running Kernels and Firmwares without this upgrade may not complete their boot sequence in a PLC rack containing a Unity CPU.

Appendix 2: Quantum CoPro Ethernet Port Upgrade Procedure

Applicable Modules

140CPU65150
140CPU65160
140CPU65260

Overview

The upgrade of the CoPro Ethernet Port is complete by installing a single file using the Unity Pro v2.2 or higher OS loader. Please note that prior version of the OS loader are not compatible with this revision of the firmware. **You MUST be at the proper OS loader revision of 2.2 or higher.**

Note: If the CoPro firmware version is less than v2.2, you must upgrade to v2.2 using Unity OS loader v2.2 only.

Note: the CPU Firmware MUST be at OS2.31 or higher before the Ethernet port is upgraded. If the CPU is not at this revision level the Ethernet port of the CoPro will be at its default IP address (as defined by the MAC address).

For Quantum configurations, it is imperative that the update is being carried out in the following order:

- Update of Ethernet coprocessors for 140CPU65150/ 140CPU65160/ 140CPU65260.
- Update of PLC processors.

Special Case: channel not configured.

If the Ethernet channel is not configured in the Unity Pro application, it takes the IP address built from its MAC address:

085.016.xxx.yyy where xxx and yyy are the last two numbers of the MAC address.

Example:

The MAC address is (in hexadecimal): 00 80 F4 01 12 20.

In this case the default IP address is (in decimal): 085.016.018.032.

Step1

Ensure the CoPro Ethernet port to be upgraded is listed in the Applicable Modules section of this document. Refer to the CoPro Ethernet port web pages for version numbers.

Step2

Install the CoPro module in a system consisting of only the PLC CPU, Power Supply, and Rack. Configure the PLC system with an 'empty' program containing only the module's Ethernet link IP address configuration.

Ensure the CoPro Ethernet port has a configured IP address.

Ensure the only devices connected to the Ethernet network are the PC running the OS loader and the CoPro Ethernet port module.

Step3

Ensure the PC is running OS loader V2.2 or higher. To identify this, the first screen of the OS loader should look like the screen bellow. Select 'Next'.

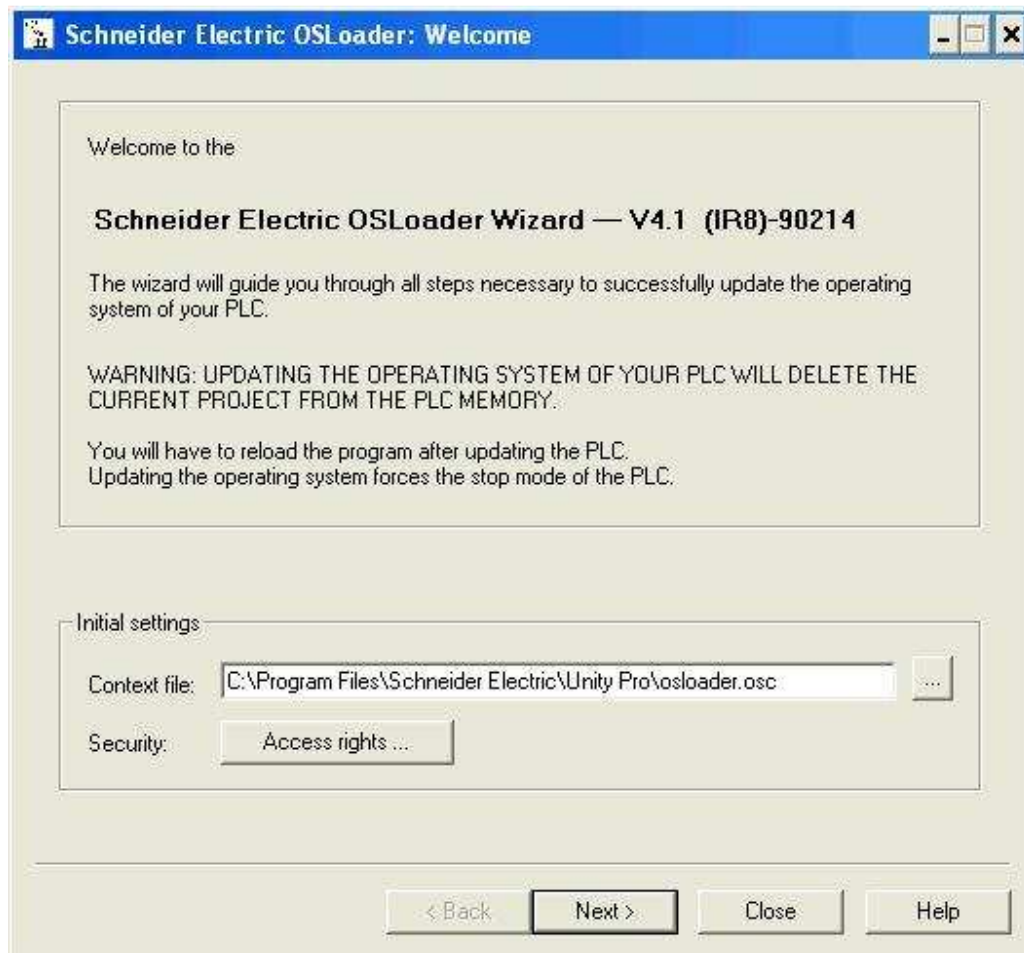

Step4

Select the FTP Driver.
Select 'Next'.

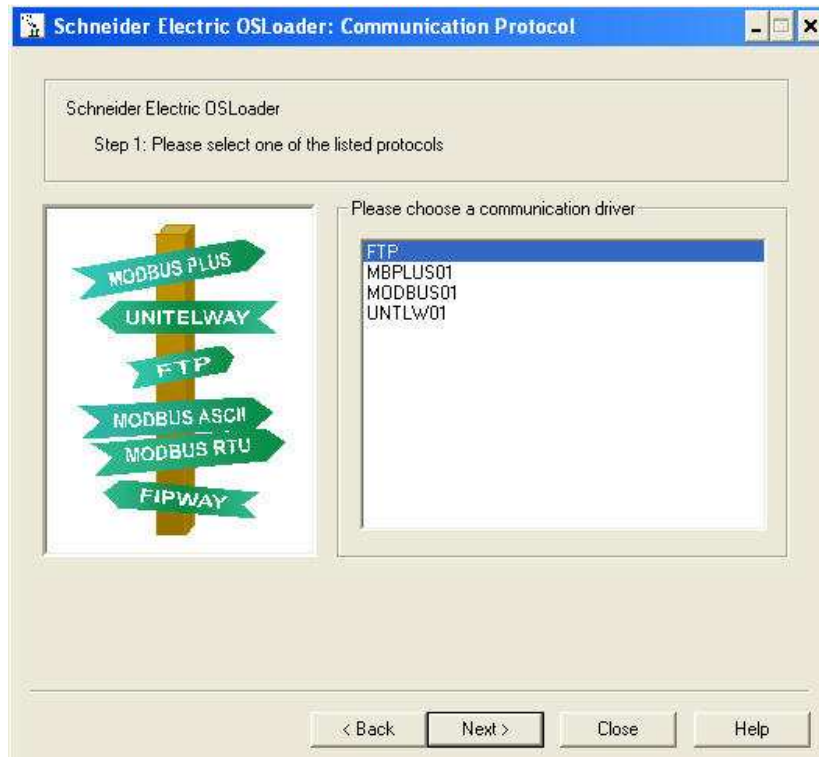

Step5

Select 'Direct Device' and enter the device IP address and select connect. If requested enter the module's MAC address, the MAC address can be found on the front of the module.

Note: If your module is located remotely, you can get the MAC address by pinging the module's IP address, then using the arp -a command to display the module's physical MAC address.

Select 'Next'.

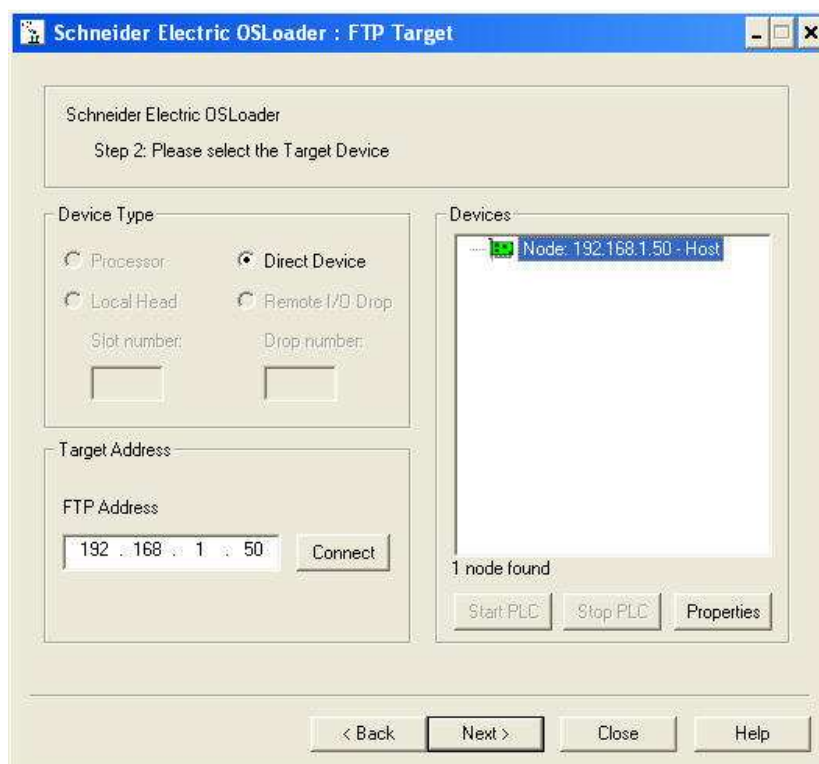

In this example, the IP address used is 192.168.1.50. Adapt this address for the one of your PLC.

Step6

Select Operation 'Download OS to Device'

Select the filename to download based on the Current Module Version in the following table.

| Current Module Version | File to Select | Resulting Module |
|--|--|---------------------------|
| 140CPU65150 140CPU65160 V2.2 or higher | Quantum \ Processor_modules \ Unity_Upgrade\ 140CPU651x0 \Eth_OS\140CPU651x0_Eth Copro_V350.bin | Eth Embedded link V3.5 |
| 140CPU65260 V2.4 or higher | Quantum \ Processor_modules \ Unity_Upgrade\ 140CPU65260 \Eth_OS\140CPU65260_Eth Copro_V350.bin | Eth Embedded link V3.5 |

Note: Please read file "Quantum Compatibility Rules" for more version compatibility information.

Quantum CoPro Ethernet Port Upgrade Procedure

If module is listed select the correct file and click 'Next'.

The following Screen will appear.

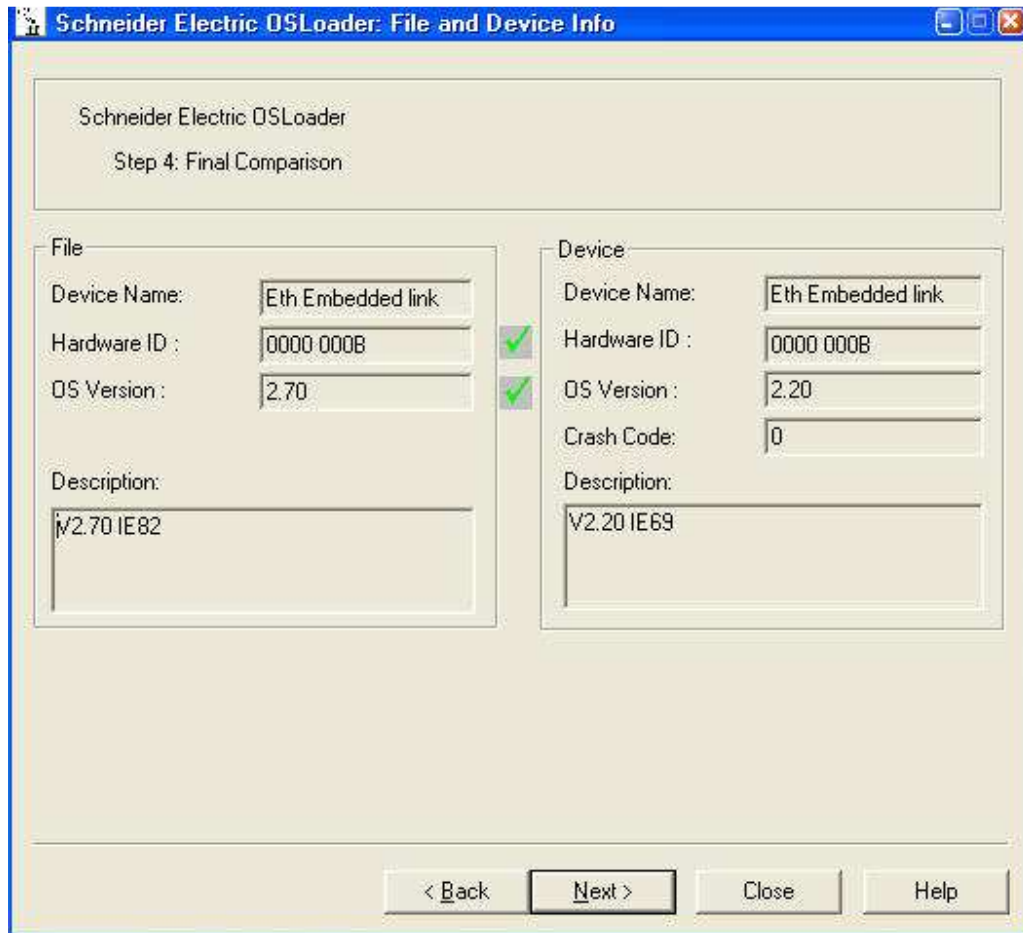

Both Hardware ID and OS Version are followed by a green tick. Select 'Next' and then 'Download'.

Quantum CoPro Ethernet Port Upgrade Procedure

After the download is completed the following screen will appear.

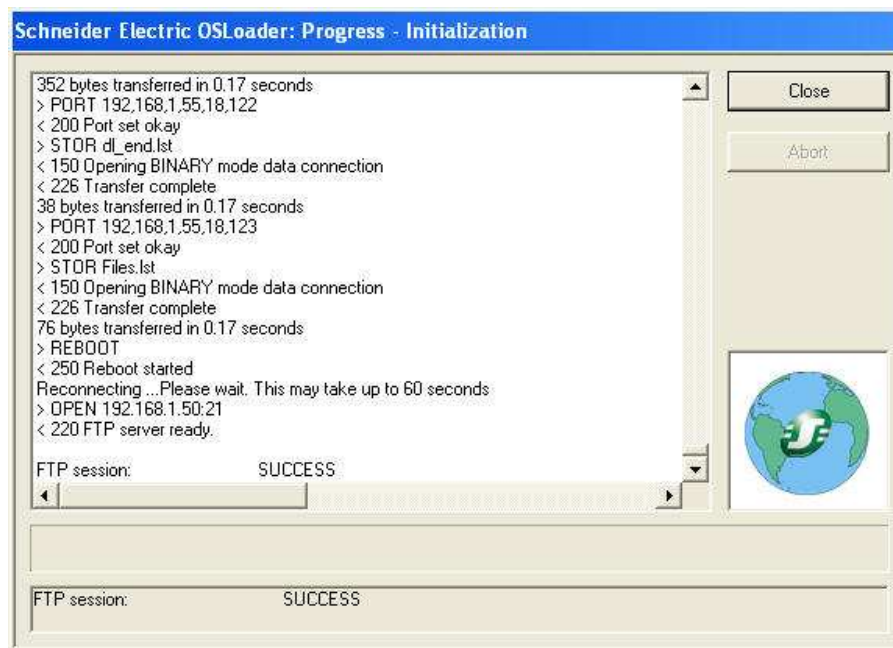

Select 'Close' and exit the OS loader.

Allow the CoPro Ethernet port at least 60 seconds to reboot and implement the new Firmware Files. This process will be complete once the module again shows the "STS" LED on solid for at least 30 seconds continuously.

If the STS LED does not come on continuously after 2 minutes but instead is flashing, proceed by power cycling the module.

Verify the Boot and Firmware versions by viewing the web pages or connecting again with the OS loader.

Appendix 3: FactoryCast NOE 77111 Module Upgrade Procedure

Purpose

To outline the steps required to upgrade a NOE module using Unity Pro 2.2 or higher OS loader. Please note that prior version of the OS loader are not compatible with this revision of the firmware. You MUST be at the proper OS loader revision of 2.2 or higher.

Applicable Modules

140NOE77111 Kernel 1.0 or higher with any version of Firmware.

Resulting Module after upgrade

140NOE77111 Kernel 2.0 or higher, Firmware V5.0.

Overview

The upgrade of a NOE module requires multiple steps. Two components must be considered to be upgraded, the Kernel and the Firmware version. Not all steps listed below may be required depending on the version of the NOE module before this upgrade procedure is started.

Pre-conditions

The CPU module must be in STOP mode and the NOE must have NO TCP traffic. A loss of power during the upgrade may cause the NOE module to be inoperable. Make sure the power supply on the NOE module rack will not be interrupted during the upgrade.

Note: OS Version numbers displayed in screenshots of following steps are only examples.

Step 1

Verify the Kernel and Firmware using Concept Exec Loader or Unity OS loader or NOE web page.

For modules that have Kernel V1.0 and Firmware lower than V3.0, you must upgrade to Kernel V2.0 and Firmware V3.30 using the Concept Exec Loader.

For modules that have Kernel V2.0 or higher and Firmware V3.0 or higher, you must upgrade to Firmware V4.2 using the Unity OS loader v2.2 or higher.

Step 2

Select the filename to download based on the Current Module Version in the following table:

| Current Module Version | File to Select | Resulting Module |
|---|--|---|
| 140NOE77111 Kernel V1.0, Firmware – Any | Quantum\Ethernet_modules\Concept_to_Unity\140NOE77111\140NOE77111_V200_KER.bin | 140NOE77111 Kernel V2.0 |
| 140NOE77111 Kernel V2.0, Firmware < V3.10 | Quantum\Ethernet_modules\Concept_to_Unity\140NOE77111\140NOE77111_V330.bin | 140NOE77111 Kernel V2.0, Firmware V3.30 |

If module not listed proceed to Step3.

If module is listed, use the Concept Exec loader download the kernel and executive firmware file. To upgrade module to Firmware V4.6, the Kernel must be upgraded to V2.0 first.

Step 3

Upgrade the Firmware and Web pages to the current V4.2 using the Unity V2.2 OS loader or higher.

Ethernet OS Files to Update: 140NOE771x1 Kernel V2.0, Firmware at least V3.0.

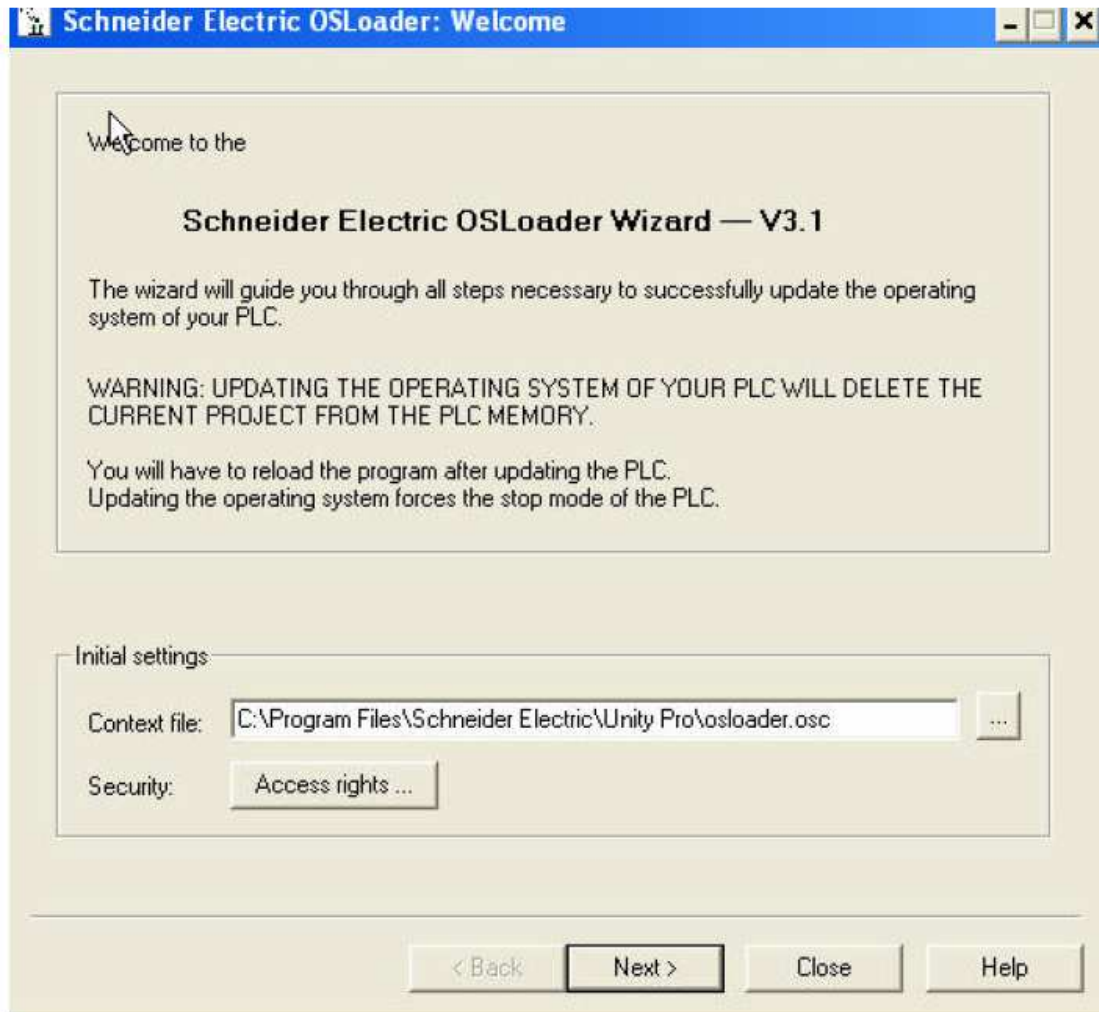

Step4

Select the FTP Driver.
Select 'Next'.

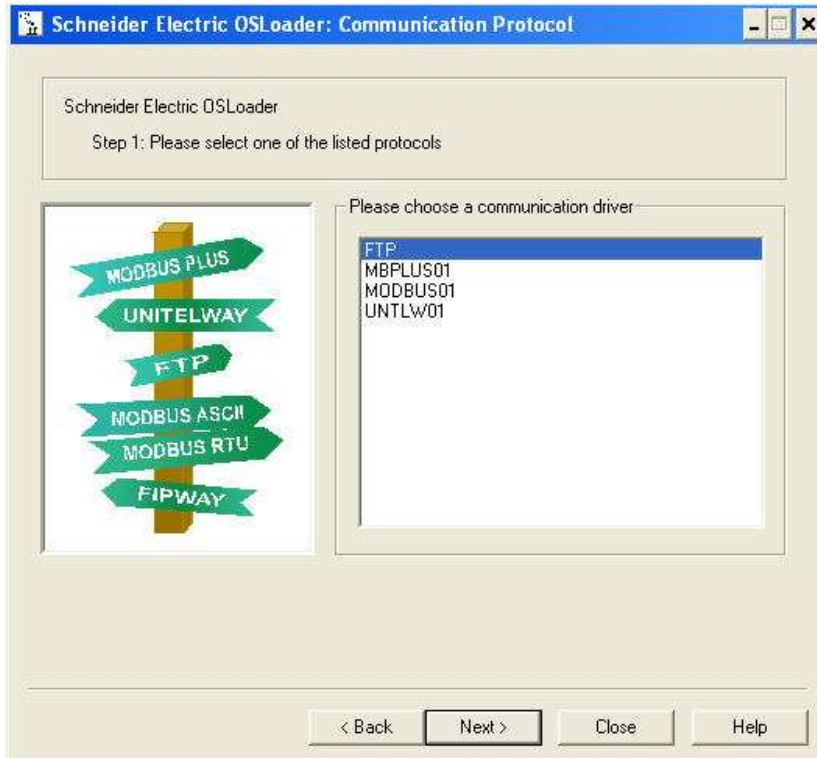

Step5

Select 'Direct Device' and enter the device IP address and select Connect. If requested enter the module's MAC address, the MAC address can be found on the front of the module.

Note: If your module is located remotely, you can get the MAC address by Pinging the module's IP address, then using the arp -a command to display the module's physical MAC address.

Select 'Next'

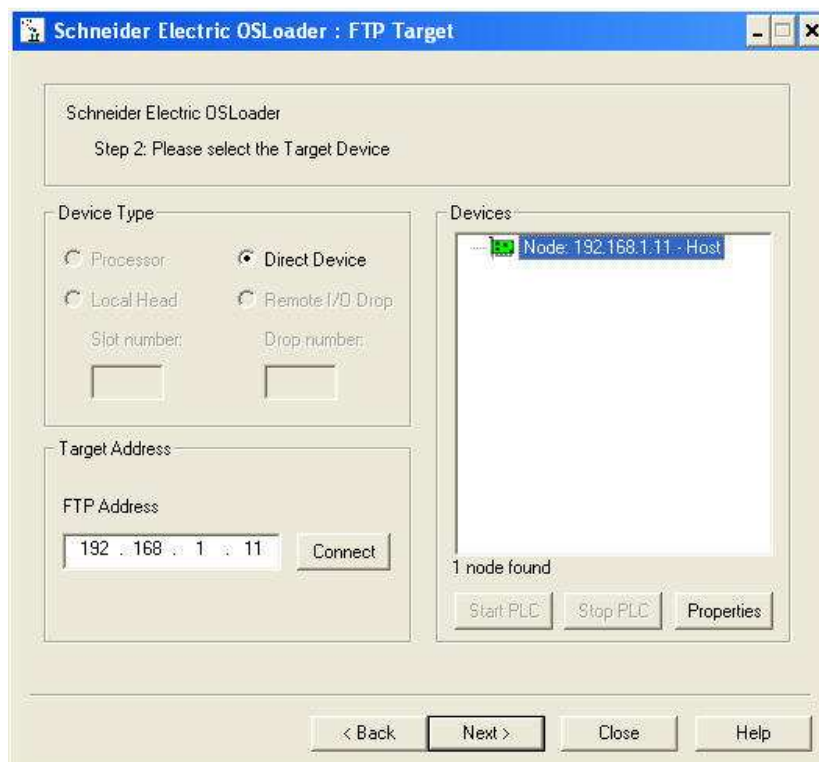

In this example, the IP address used is 192.168.1.11. Adapt this address for the one of your PLC.

Step6

Select Operation 'Download OS to Device'

Select the filename to download based on the Current Module Version in the following table.

| Current Module Version | File to Select | Resulting Module |
|--|--|--|
| 140NOE77111 Kernel V2.0, Firmware at least V3.0 <u>Comment:</u> 140NOE77111Kernel V2.0, Firmware V3.0 or higher can be directly upgraded to Firmware V5.0. If users want to use the early version 3.x, it also can be directly upgraded. | Quantum\Ethernet_modules\Concept_to_Unity\140NOE77111\ 140NOE77111_V500.bin* | 140NOE77111 Kernel V2.0, Firmware V5.0 |

*The name of file should be 140NOE77111_INF_OR_EQ_PV09_V500.bin if you have a 140NOE77111 with a Product Version inferior or equal to 9. Please, read compatibility rules file "Quantum Compatibility_Rules" for more information.

If module is listed select the correct file and click 'Next'.

FactoryCast NOE 77111 Module Upgrade Procedure

The following Screen will appear.

| File | Device |
|---------------------------|---------------------------|
| Device Name: 140NOE77111 | Device Name: 140NOE77111 |
| Hardware ID : 0000 0423 ✓ | Hardware ID : 0000 0423 ✓ |
| OS Version : 4.10 ✓ | OS Version : 4.00 |
| Description: V4.10 IE25 | Description: V4.00 IE21 |

Both the Hardware ID and OS version must be followed by a green tick. Select 'Next' and then 'Download'.

FactoryCast NOE 77111 Module Upgrade Procedure

After the download is completed the following screen will appear.

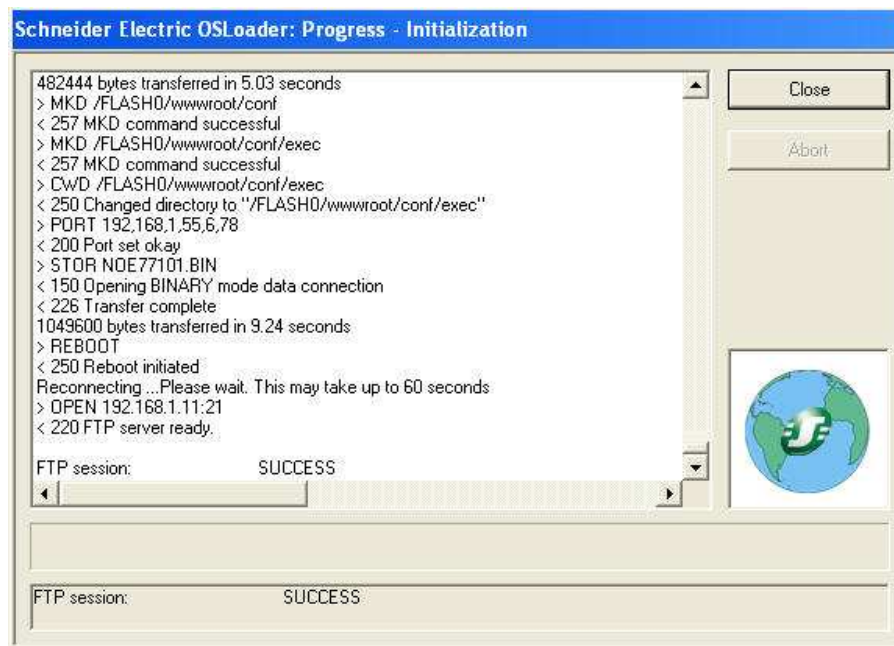

If this screen does not appear recheck each step and contact your local Schneider office for assistance if required.

Select 'Close' and 'Back' in the OS loader.

Exit the OS loader.

Allow the module 60 seconds to complete any actions and power cycle the module to allow the new Firmware to be loaded.

Note: NOE modules should be upgraded to Kernel V2.0, Firmware V3.30 while installed in a PLC rack containing a CPU running a Concept Level Executive. Modules running Kernels and Firmwares without this upgrade may not complete their boot sequence in a PLC rack containing a Unity CPU.

Appendix 4: 140CPU67160/140CPU 67261 HotStandby CPU Copro Upgrade Procedure

Important: Before Upgrading the Copro of a 140CPU67160/ CPU67261 CPU needs to be in STOP mode.

Procedure

The procedure needs 2 preliminary steps before the upgrade operation:
(Each step is detailed in the following pages)

- Preliminary step 1: If necessary, download the Copro firmware from www.schneider-electric.com
- Preliminary step 2: PC IP address modification
- Step 3: Upgrade Copro firmware of the CPU using Unity OS loader
- Step 4: Powercycle the CPU

Connection diagram for CPU 67160 COPRO Upgrade.

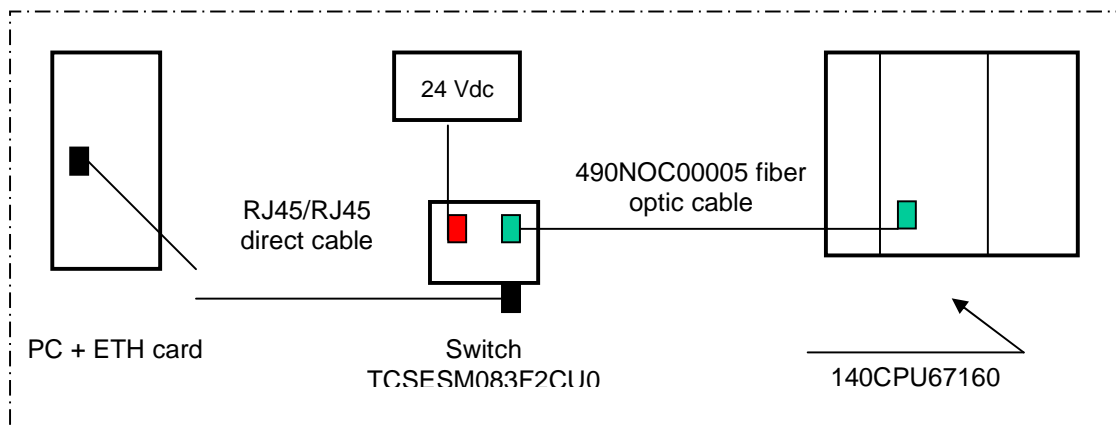

Connection diagram for CPU 67261 COPRO Upgrade

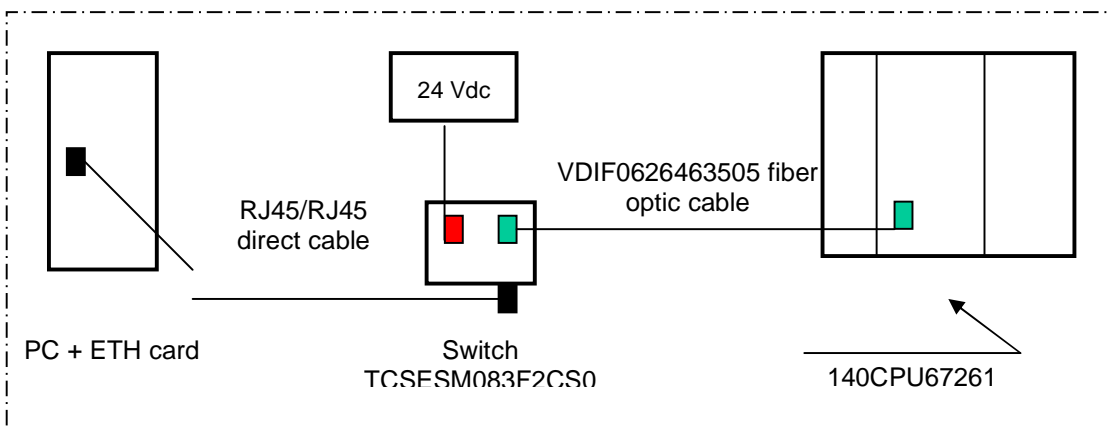

Upgrade operation needs the following equipments:

- PC equipped with an ETH network card with an electric output (RJ45)
- An electric / optic switch Modicon TCSESM083F2CU0 (CPU 67160) / TCSESM043F1CS0 (CPU 67261)
- An RJ45 - RJ45 direct cable
 - For CPU 67160
 - A SC – MTRJ duplex optic cable 490NOC000 05.
 - For CPU 67261
 - A LC - SC duplex optic cable VDIF0626463505.
- A 24Vdc power supply

Note: if the upgrade operation is planned to be done when the process is under HotStandby system control, it is mandatory to do it according to the following sequence detailed in this document, part 'Upgrade using Modbus/ModbusPlus protocol'.

140CPU67160 HotStandby CPU Copro upgrade procedure

Preliminary step 1: Download firmware from www.schneider-electric.com

Connect to www.schneider-electric.com.

Click successively on **Products and Services / Automation and Control/ Product offers/ Automation / PLCs, PC based control, I/O / Modicon Quantum /Firmware-Updates.**

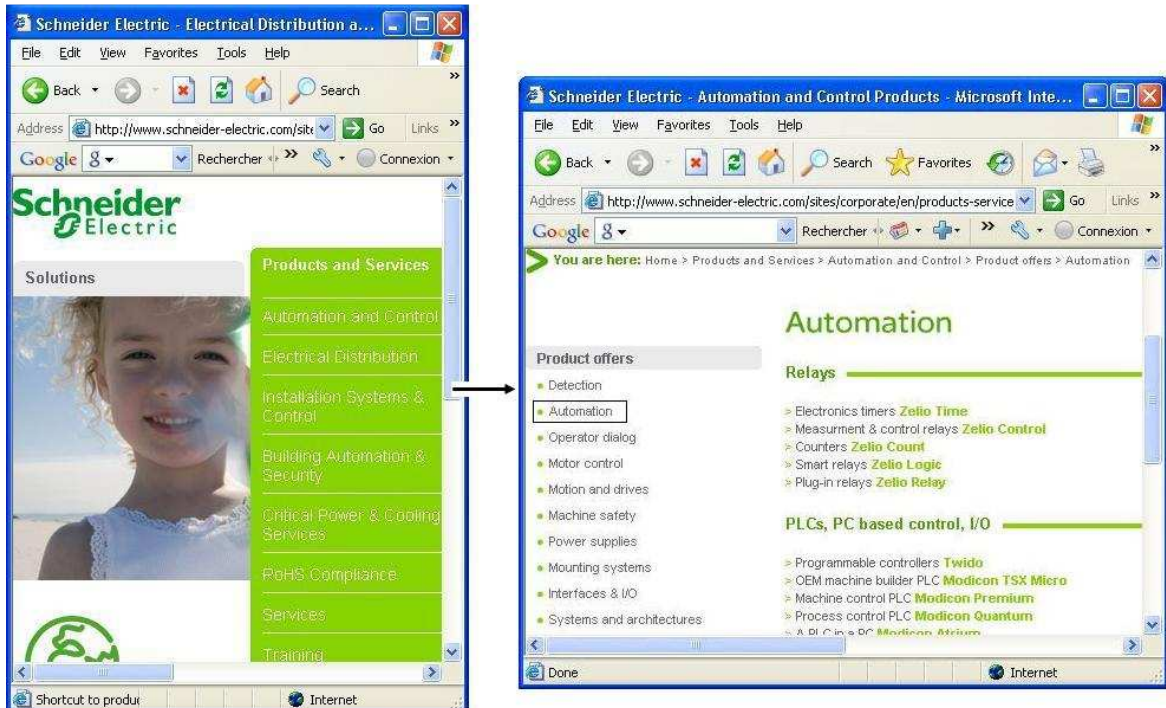

Select "Quantum 140CPU67160 HSBY Copro firmware".

| Title | Type | Version | Lng | Date | Info | Doc |
|---|--------------------|---------|---------|-------------|------|--------|
| Quantum_V2.6_Upgrade_Documentation | Firmware - Updates | - | English | 30 Jul 2008 | i | 2 MB |
| Quantum CD OS V2.60 | Firmware - Updates | V2.60 | English | 12 Jan 2009 | i | 139 MB |
| Quantum 140CPU67160 V2.61 Operating System | Firmware - Updates | V2.61 | English | 31 Oct 2008 | i | 4 MB |
| Quantum 140CPU67160 HSBY V2.60 Copro firmware version | Firmware - Updates | V2.60 | English | 30 Jul 2008 | i | 984 KB |
| Quantum 140CPU65260 V2.61 Operating System | Firmware - Updates | V2.61 | English | 31 Oct 2008 | i | 4 MB |
| Quantum 140CPU65260 Ethernet Copro V2.60 firmware version | Firmware - Updates | V2.60 | English | 31 Jul 2008 | i | 2 MB |

Note: Copro Firmware is common for CPU 67160 and CPU 67261.

140CPU67160 HotStandby CPU Copro upgrade procedure

Download the file into the PC (in this example HSBY Copro Firmware 2.11IE80).

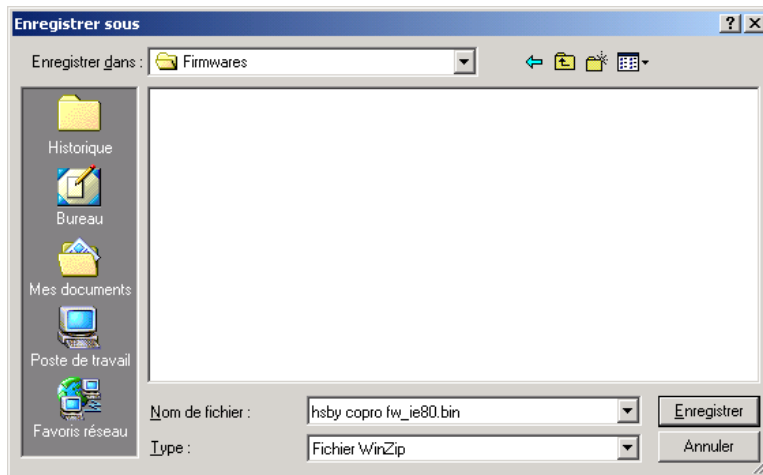

Preliminary step 2: PC IP address modification.

Notice the PLC IP address using the keypad (ex: 85.16.133.13) and the MAC address engraved at the lower part of the front panel (ex: 00.00.54.11.85.0D).

From Windows Control Panel, click twice on Networks icon.

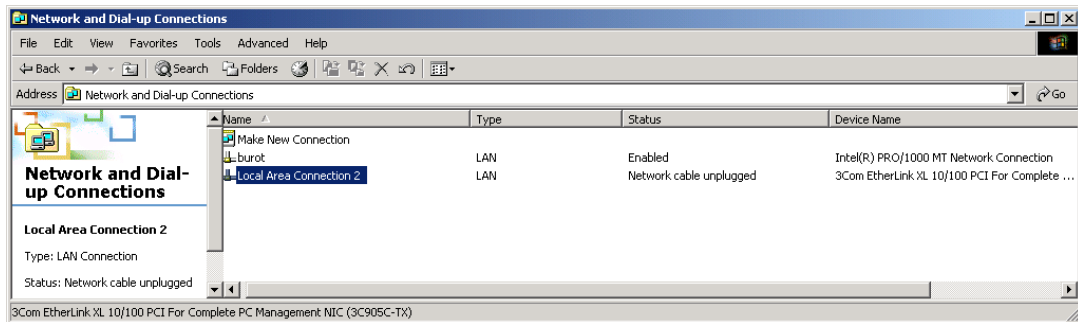

Click twice on the network corresponding to the ETH card , then on Internet Protocol (TCP/IP) from associated window (hereunder).

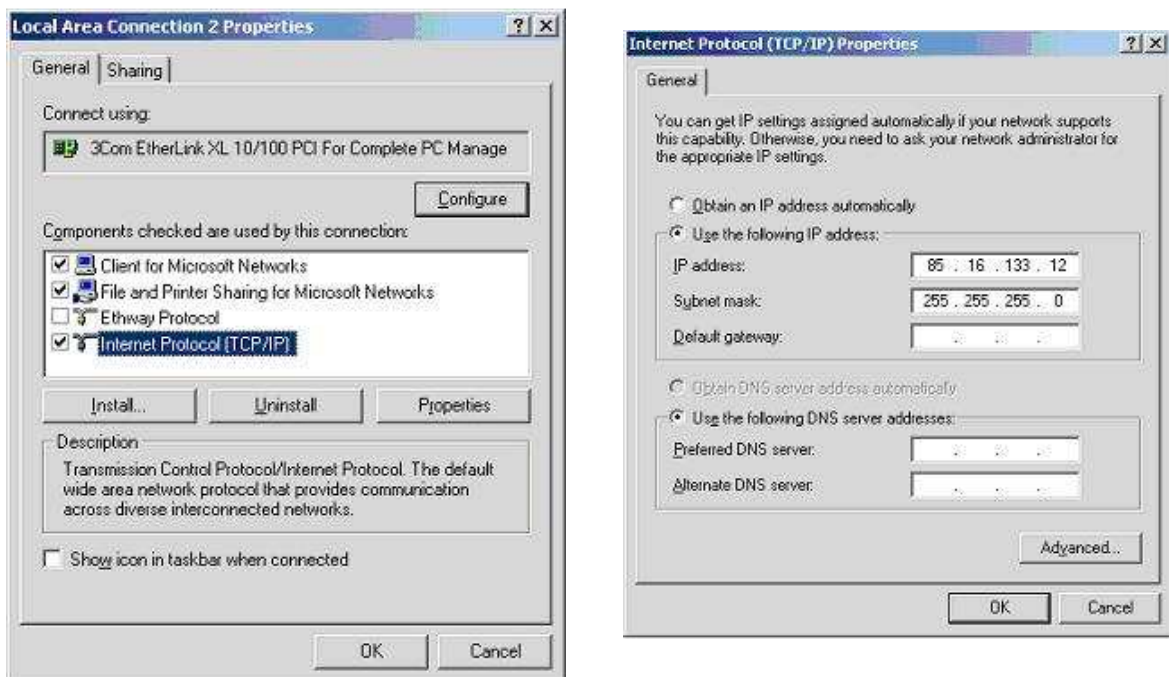

From Internet Protocol window (above on the right part) change IP address field according to PLC one (ex: 85.16.33.12) (don't forget to notice the existing parameters in order to restore them if necessary).

Step 3: Upgrade CPU Copro firmware using Unity OS loader

Activate Unity OS loader.

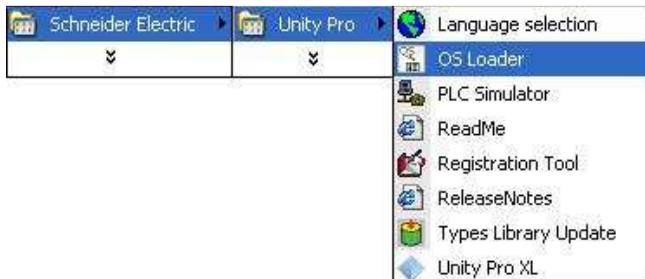

Select FTP protocol then click on Next.

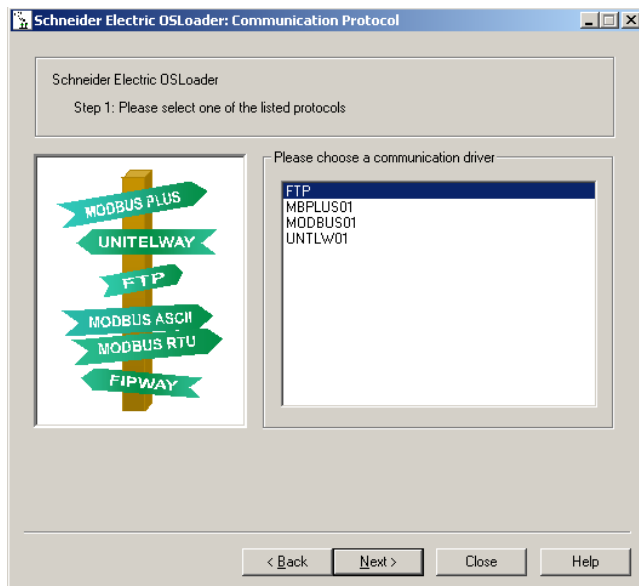

140CPU67160 HotStandby CPU Copro upgrade procedure

Fill the FTP Address field with the PLC IP address (available by the LCD Screen) then:

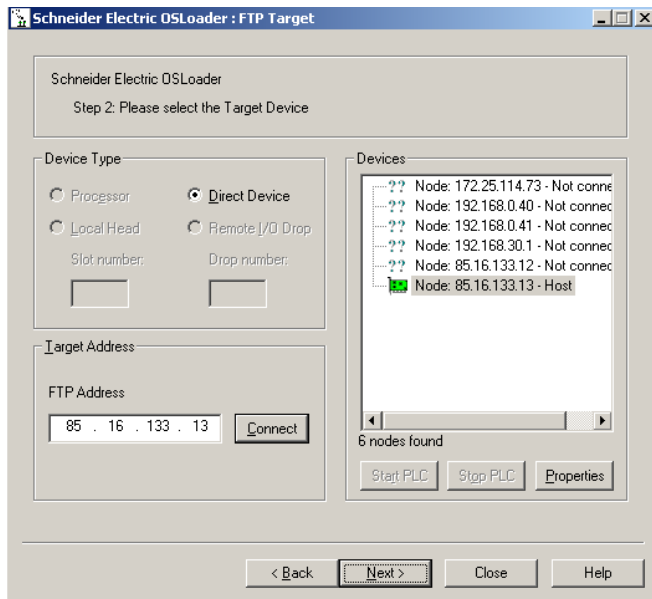

Fill the MAC Address field with the PLC MAC Address then click on OK.

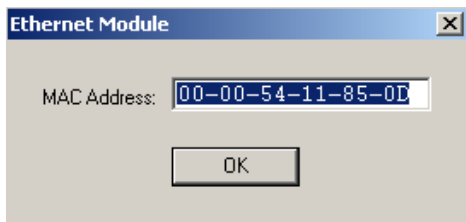

Click on Next.

140CPU67160 HotStandby CPU Copro upgrade procedure

Choose 'Download OS to Device' and Retrieve the firmware file using the Browse facility (in this example "hsby copro fw_ie80.bin").

Valid by clicking on Next.

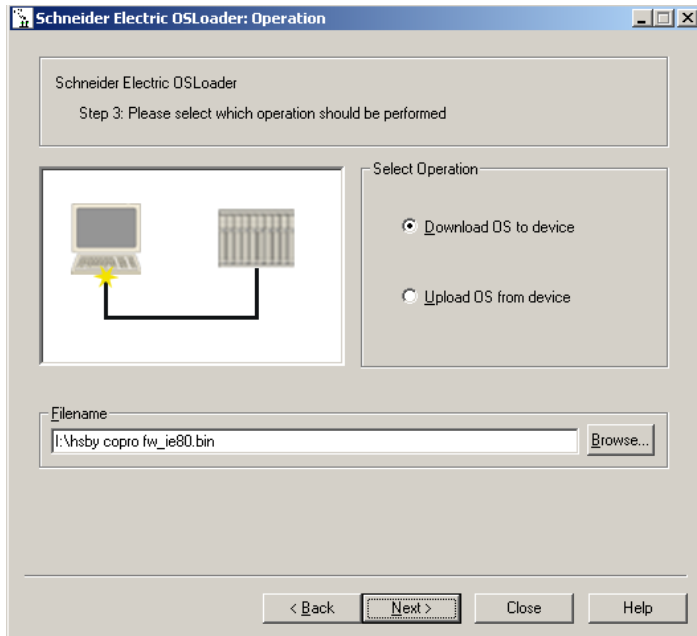

The Device identification screen is displayed. Check that the right Copro Firmware will be downloaded in the device.

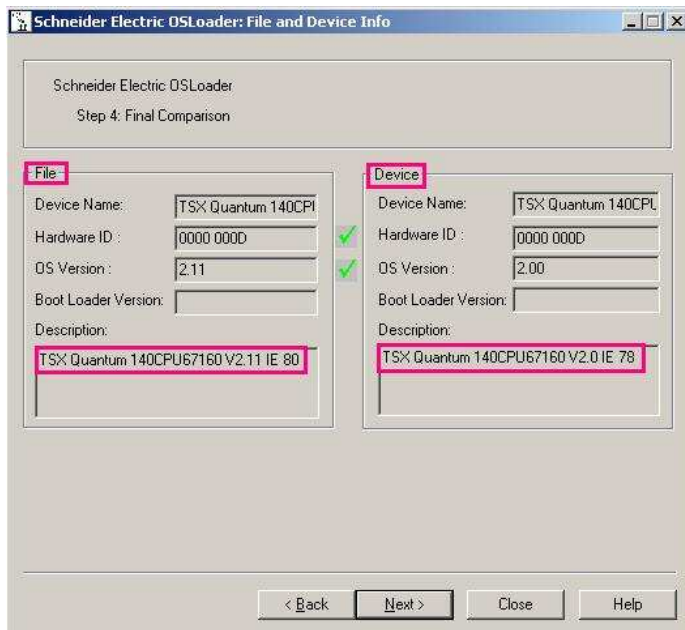

140CPU67160 HotStandby CPU Copro upgrade procedure

Click on Next then on Download and wait end of transfer.

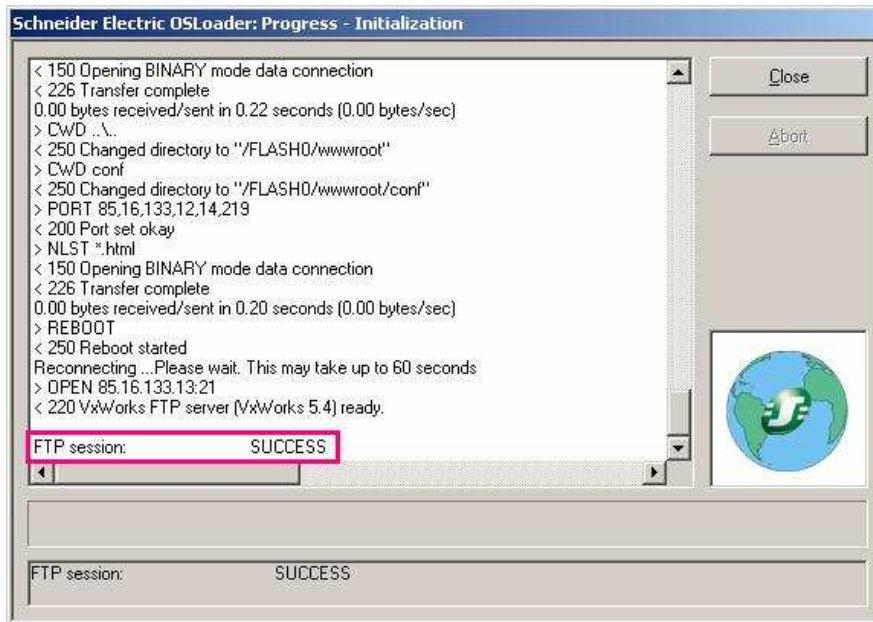

Step 4: Powercycle the CPU

Power off the CPU.

Power it on.

The change of Copro has been done for this CPU.

Now you can go on and upgrade the OS version for this CPU.

Appendix 5: 140CRP93x00 S908 RIO Head Upgrade Procedure

Purpose

To outline the steps required for upgrading a RIO Head to make RIO System CCOTF (Change Config On The Fly) compatible. This Upgrade can be managed by one of the two communications methods available in the OS loader:

Modbus

Modbus Plus

Follow the steps below to download a new CRP Firmware using Osloader.

Note : Here is the configuration used for the procedure.

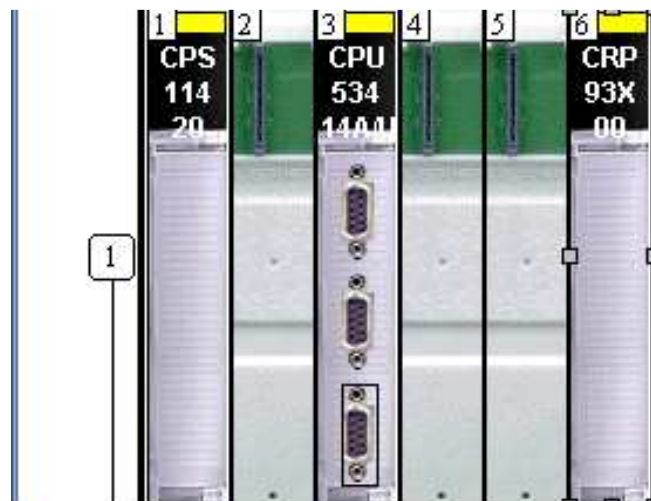

Upgrade using Modbus/ModbusPlus protocol.

| Step | Action |
|------|---|
| 1 | Activate the OSloader program. |
| 2 | Click Next to start the OSloader process. |
| 3 | Click the MBPLUS01 button, and click Next. |

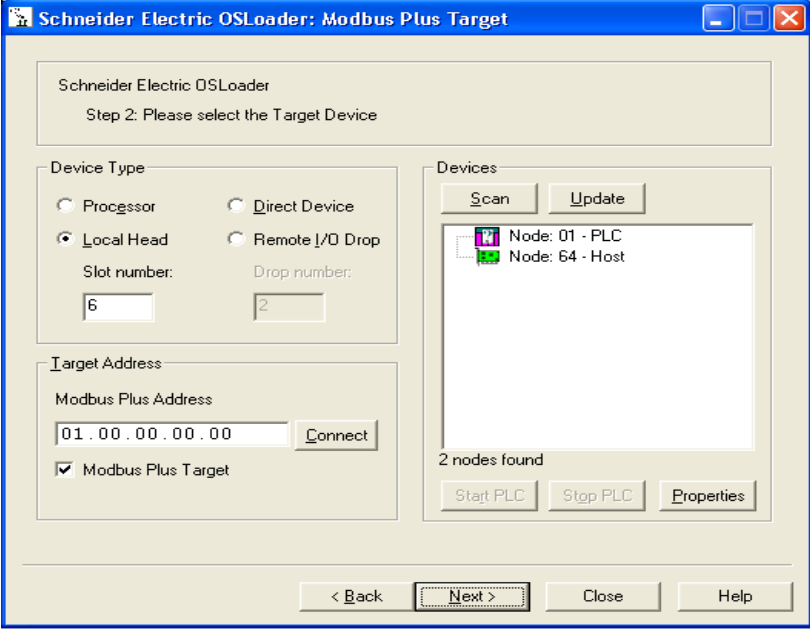
| Step | Action |
|------|---|
| 4 | <p>Click the Local Head (for CRP) and precise Slot number (for this configuration is 6), and click Next.</p>  <p>Scanning a Network To scan a network, select the Scan button. As the network is scanned, a graphic representation of the network is displayed in the Devices scroll box. All currently active devices are represented by icons on the display.</p> |

RIO Head Firmwares (140 CRP 93X00) upgrade procedure

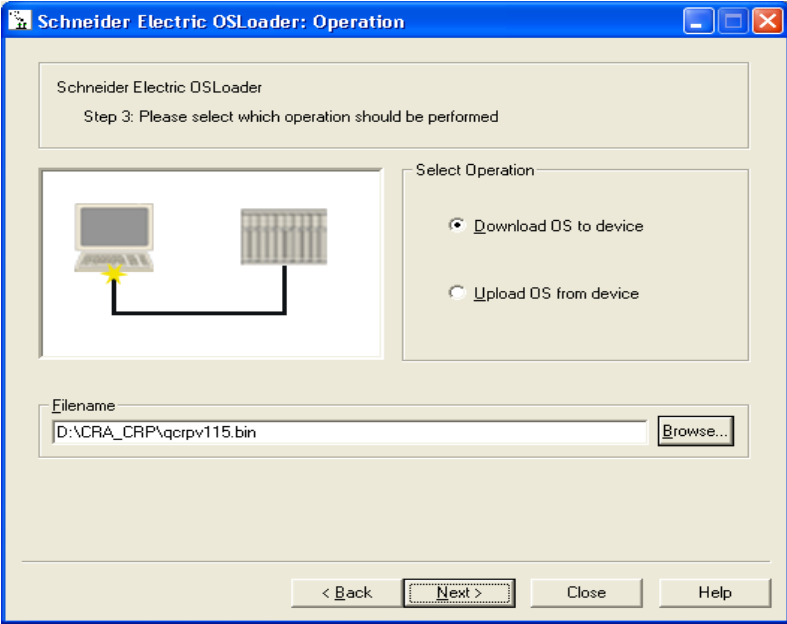
| Step | Action |
|------|---|
| 5 | <p>Click the Download OS to device button.</p>  |
| 6 | Click Browse to select the file name, and click Next . |

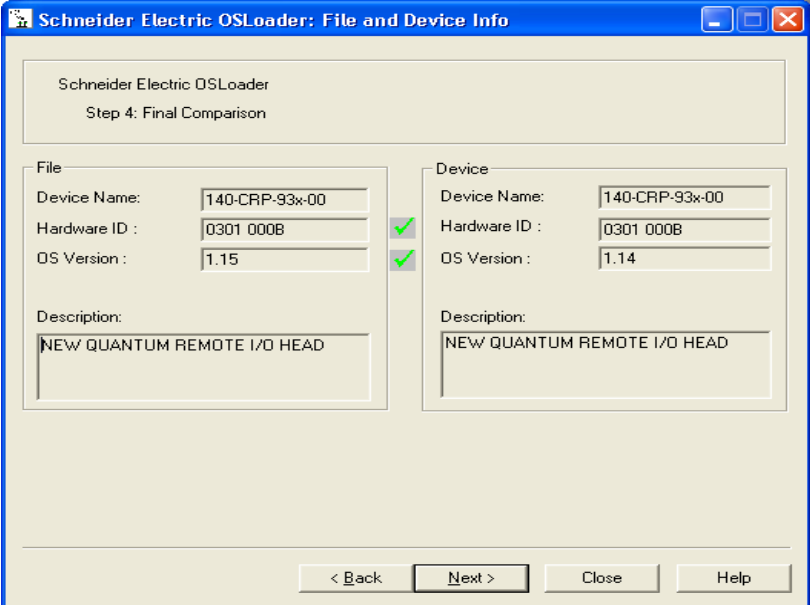
| Step | Action |
|------|--|
| 7 | <p>The OSloader – File and Device info dialog box opens. Click Next.</p>  |

RIO Head Firmwares (140 CRP 93X00) upgrade procedure

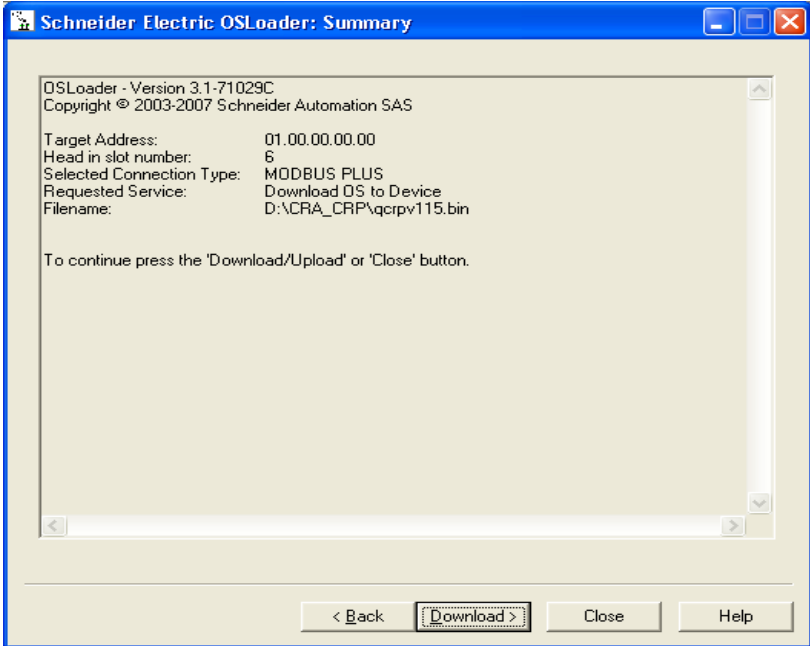
| Step | Action |
|------|---|
| 8 | <p>The OSloader Summary – dialog box opens:</p>  |
| 9 | Click Download to start upgrading FW. |

RIO Head Firmwares (140 CRP 93X00) upgrade procedure

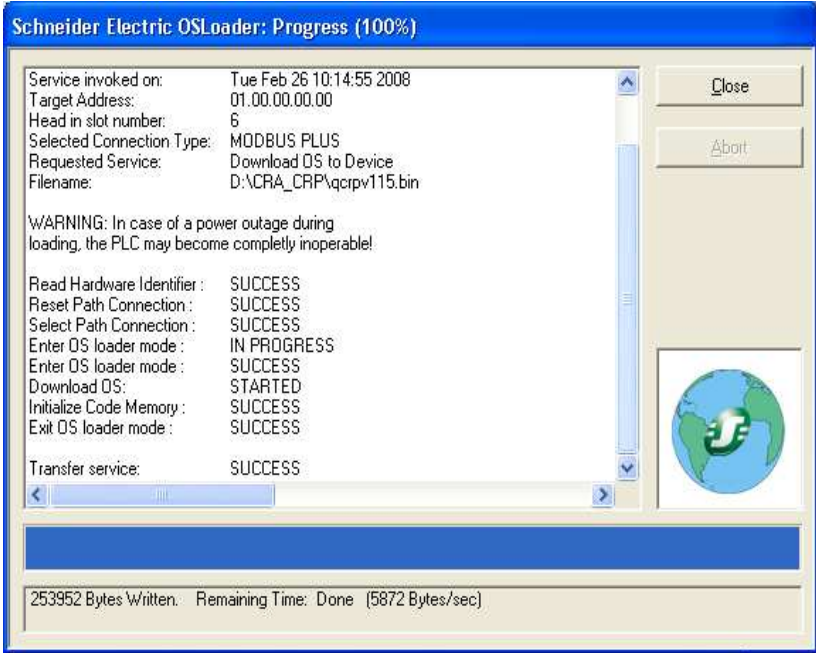
| Step | Action |
|------|--|
| 10 | <p>The OSLoader – Progress dialog box opens:</p>  |
| 11 | When the process is complete, click Close . |

Appendix 6: 140CRA93x00 S908 RIO Drop Upgrade Procedure

Purpose

To outline the steps required for upgrading a RIO Drop to make RIO System CCOTF (Change Config On The Fly) compatible. This Upgrade can be managed by one of the two communications methods available in the OS loader:

- Modbus
- Modbus Plus

Follow the steps below to download a new CRA Firmware using OS loader and CRP 93X00.

Caution : The remote OS update S908 via 140 NRP954 01C may not be possible please follow the following table to see what may causes issues.

| CRA Module Reference | PV | SV | Compatibility | |
|---|------|-----|-------------------|-------------------------------|
| | | | Communication | Remote OS Update via S908 Bus |
| 140 CRA 93x00 | ≤ 08 | 2.0 | Yes | Yes |
| | 09 | 2.0 | No ⁽¹⁾ | No ⁽²⁾ |
| | ≥ 10 | 2.1 | Yes | No ⁽²⁾ |
| PV Product version SV Software version ⁽¹⁾ An upgrade of the SV to 2.1 makes the module communication compatible. NOTE: Upgrading the software version of the CRA module from 2.0 to 2.1 for CRA modules PV 09 is mandatory before using 140 NRP 954 01C in the RIO network. ⁽²⁾ For CRA module with SV ≥2.0, OS update is only possible out of the RIO network. | | | | |

Note: Configuration used for the procedure is as follows.

EIO Head modules firmware (140 CRA 31200) upgrade procedure.

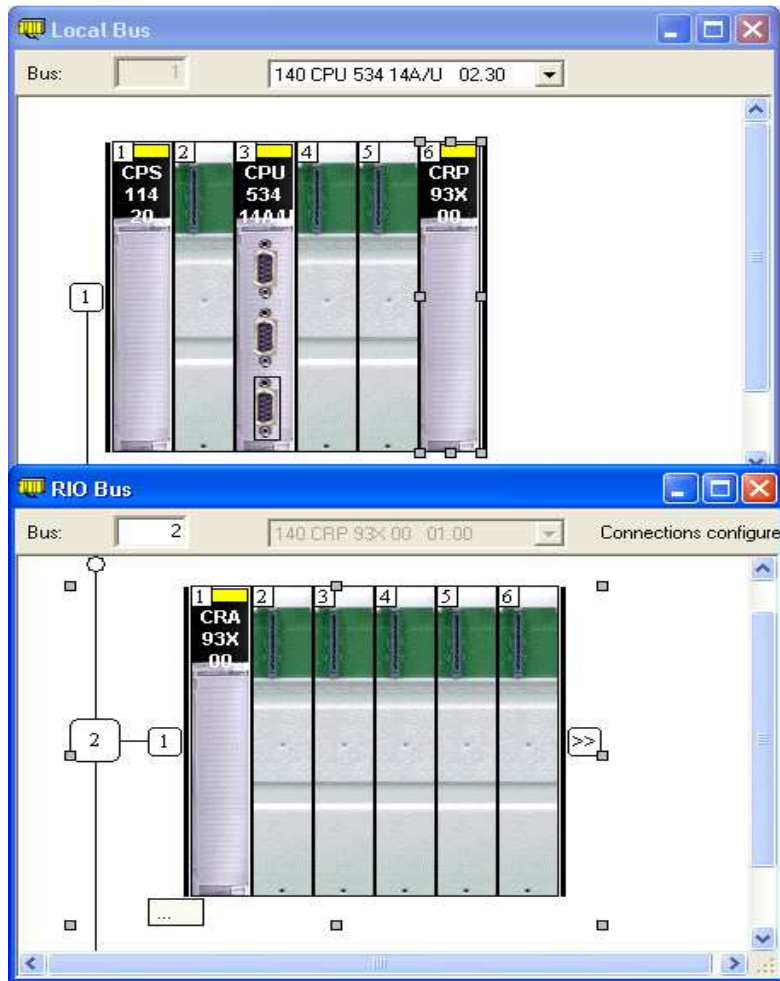

EIO Head modules firmware (140 CRA 31200) upgrade procedure.

Upgrade using Modbus/ModbusPlus protocol

| Step | Action |
|------|---|
| 1 | Activate the OSloader program. |
| 2 | Click Next to start the OSloader process. |
| 3 | Click the MBPLUS01 button, and click Next. |

Schneider Electric OSLoader: Communication Protocol

Schneider Electric OSLoader
Step 1: Please select one of the listed protocols

Please choose a communication driver

- FTP
- MBPLUS01**
- MODBUS01

< Back Next > Close Help

EIO Head modules firmware (140 CRA 31200) upgrade procedure.

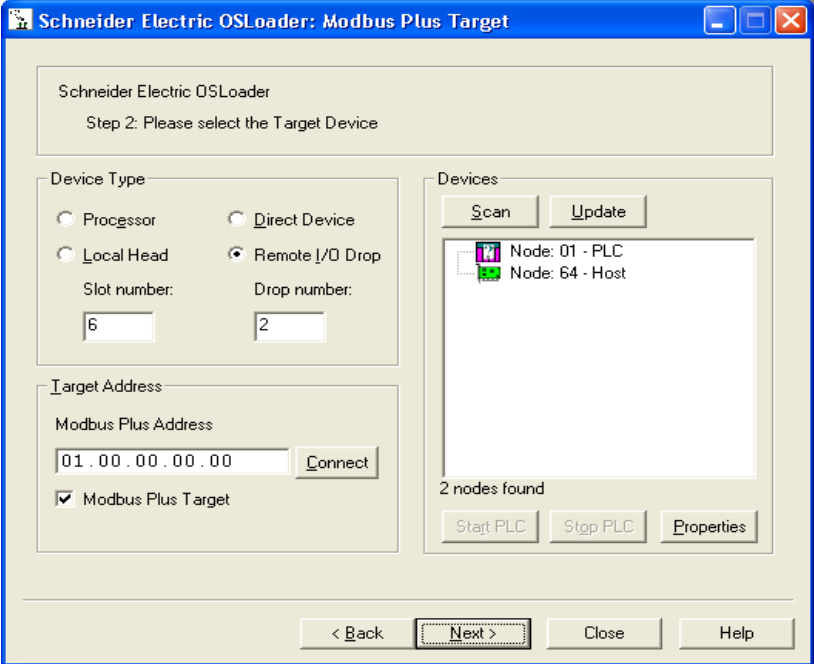
| Step | Action |
|------|---|
| 4 | <p>Click the Remote I/O Drop (for CRA) and precise Slot number (for this configuration is 6) and drop number (for this configuration is 2), and click Next.</p>  <p>Scanning a Network To scan a network, select the Scan button. As the network is scanned, a graphic representation of the network is displayed in the Devices scroll box. All currently active devices are represented by icons on the display.</p> |

EIO Head modules firmware (140 CRA 31200) upgrade procedure.

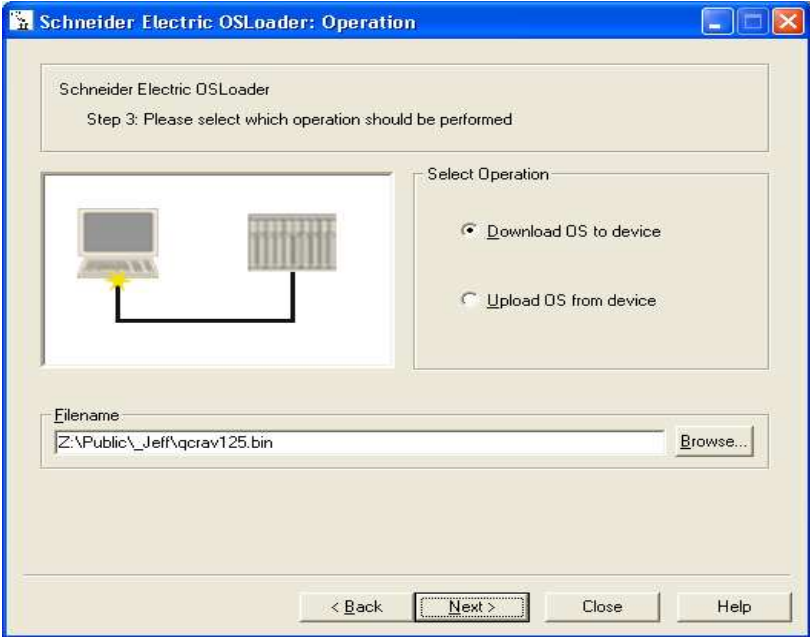
| Step | Action |
|------|---|
| 5 | <p>Click the Download OS to device button.</p>  |
| 6 | Click Browse to select the file name, and click Next . |

EIO Head modules firmware (140 CRA 31200) upgrade procedure.

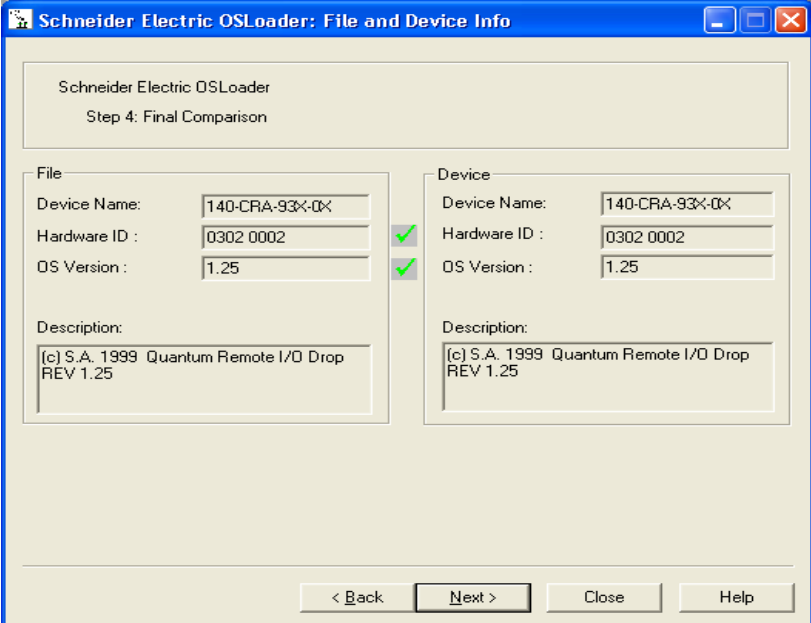
| Step | Action |
|------|--|
| 7 | <p>The OSloader – File and Device info dialog box opens. Click Next.</p>  |

EIO Head modules firmware (140 CRA 31200) upgrade procedure.

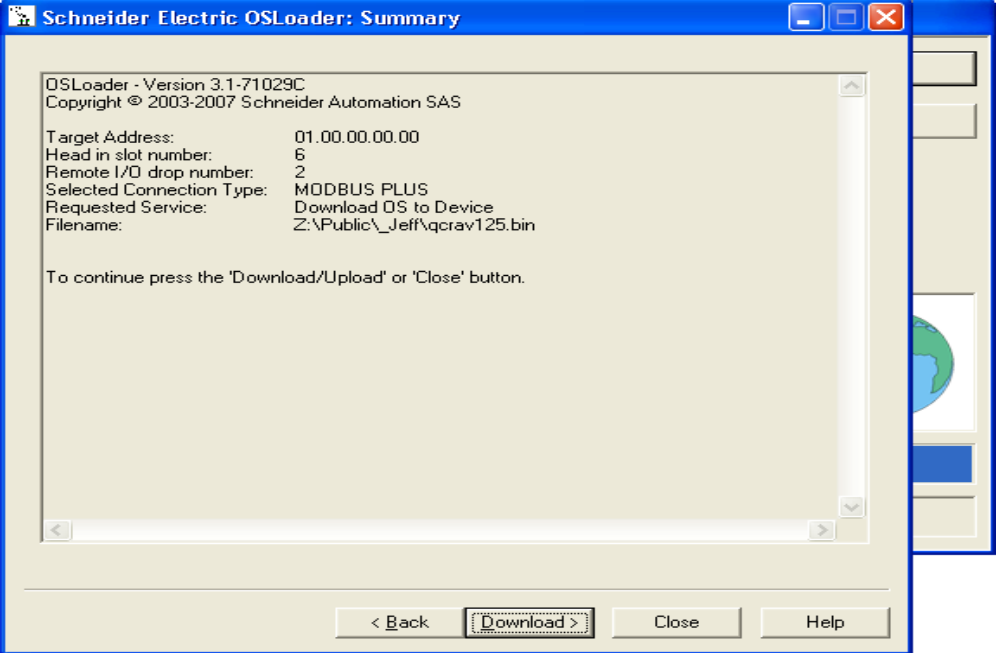
| Step | Action |
|------|---|
| 8 | <p>The OSloader Summary – dialog box opens:</p>  |
| 9 | Click Download to start upgrading FW. |

EIO Head modules firmware (140 CRA 31200) upgrade procedure.

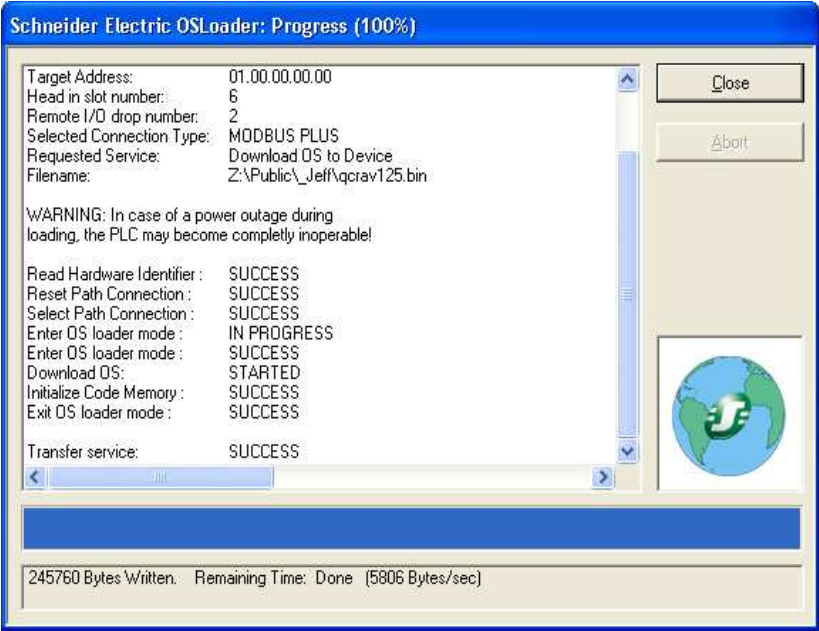
| Step | Action |
|------|--|
| 10 | <p>The OSLoader – Progress dialog box opens:</p>  |
| 11 | When the process is complete, click Close . |

Installation of Modbus Plus Driver for USB converter.

Appendix 7: Installation of Modbus Plus USB converter driver.

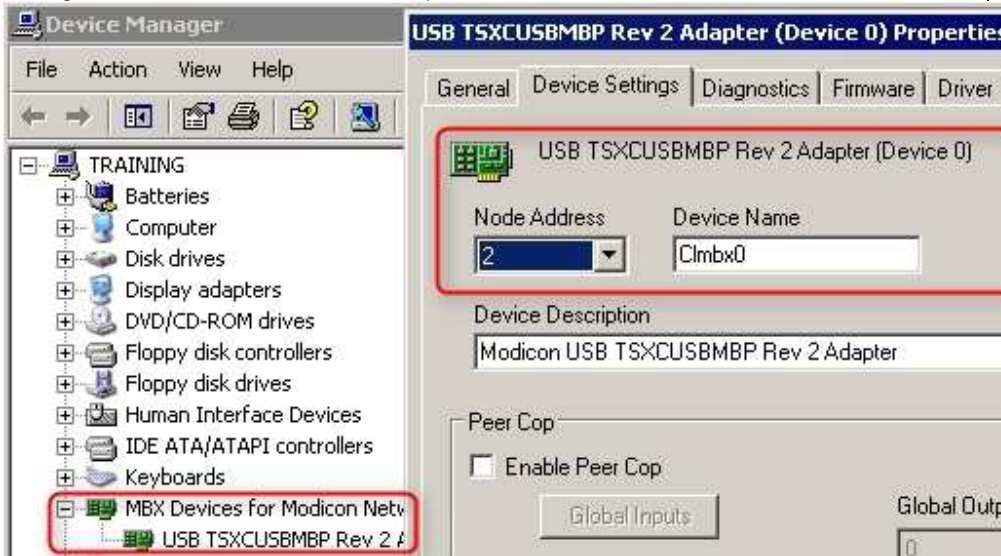
| Step | Action |
|------|---|
| 1 | Download the Modbus Plus drivers (the lastest is in MBX Driver Suite V7.1) from www.schneider-electric.com . |
| 2 | Install on your computer the Modbus Plus drivers following the set up . |
| 3 | Connect the Modbus Plus USB converter to your computer. |
| 4 | Follow the installation process to install the converter in Windows |
| 5 | Reboot your computer. |
| 6 | The default Modbus Plus address of the CPU is 1. As a consequence, we need to change the computer's address. |
| 7 | <ul style="list-style-type: none"> o Make sure the USB converter is connected. o Open Start > All Programs > Schneider Electric – MBX Driver Suite > Configuration > MBX Device Drivers.  <ul style="list-style-type: none"> o Select the USB adapter and click Edit. o When prompted, select Launch Device Manager. o In the Device Manager, select the USB converter under MBX Devices for Modicon Network > USB TSXCUSBMBP. o In the configuration window, select the Device Settings tab. o Change the node address of the computer to 2.  |
| 8 | Now the modbus plus communication is Ok to be used for updating of CPU modules . |

Appendix 8: EIO modules firmware (140CRP31200) upgrade procedure .

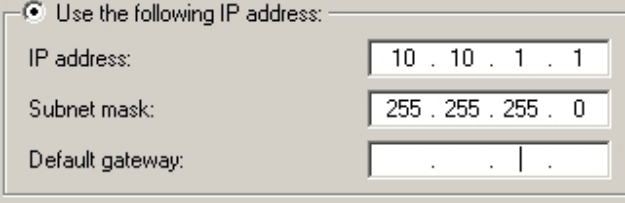
| Step | Action |
|------|--|
| 1 | Download the eCdos from www.schneider-electric.com . |
| 2 | Copy on your computer the binary file to download. |
| 3 | Make sure there is no configuration in the module. Ideally, remove physically the 140CPU6xxxx module. |
| 4 | Power up the module, without any cable connected on it. |
| 5 | Convert the 2 last digit of the MAC address to decimal. They stands for the 2 last numbers of the default IP address, the 2 first being 10.10. →Example: MAC Address = 00-80-F4-09-01-66 <=> IP = 10.10.1.102 |
| 6 | <p>Set the IP address of your computer to be in the same range.</p>  <p>(see <i>online help of Windows</i> for more information)</p> |
| 7 | Connect a RJ45 Ethernet cable between your computer and the module |
| 8 | Launch the OS Loader software. Click Next . |
| 9 | Select the communication driver: FTP . Then click Next . |
| 10 | Enter the IP address of the device. Then click Connect . |

EIO Head modules firmware (140 CRA 31200) upgrade procedure.

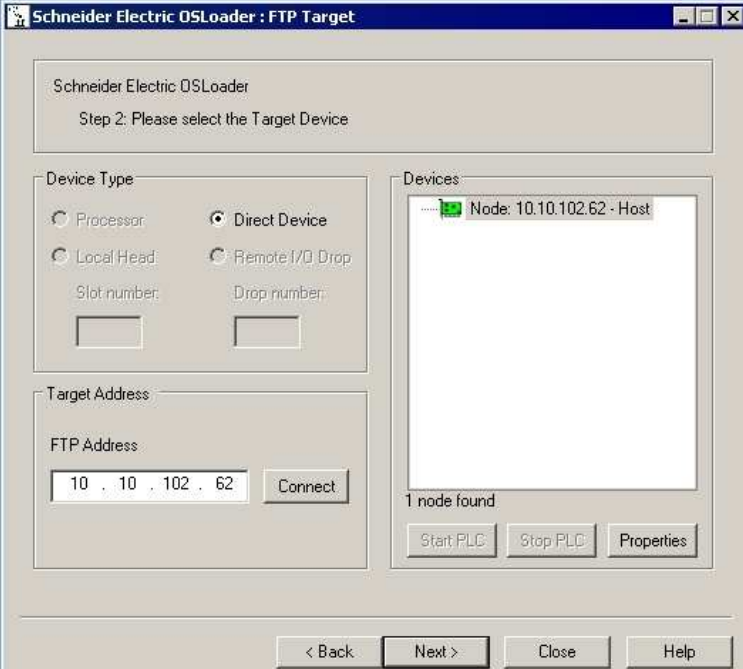
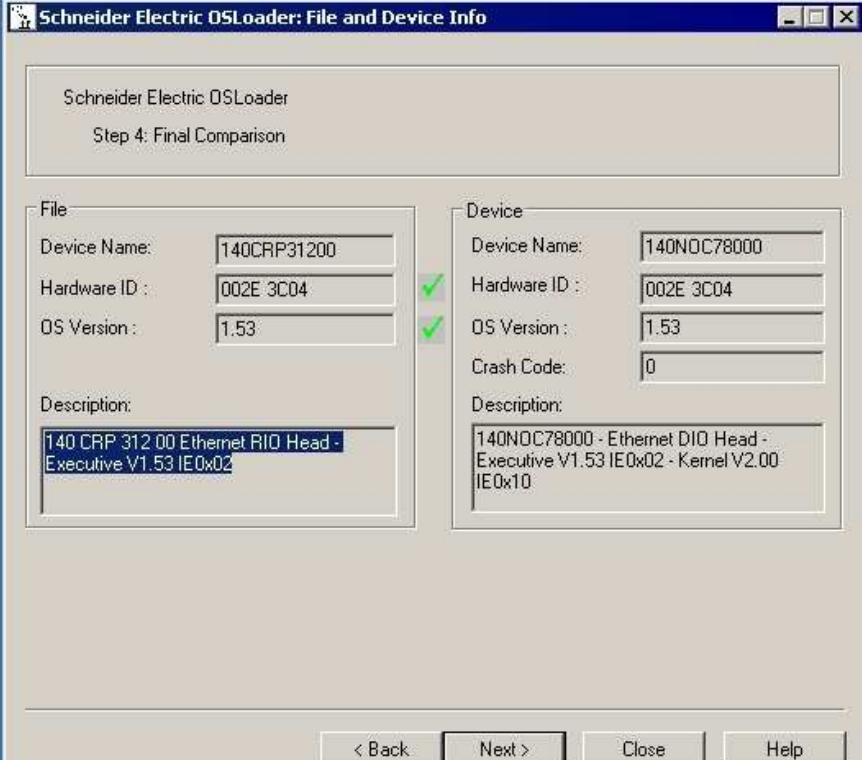
| | |
|----|---|
| 11 | <p>The device should appear in the devices list. Select it and click Next</p>  |
| 12 | <p>Select the ellipsis button in the <i>PC</i> field and browse your computer to find the correct Binary File .bin file. CAUTION: make sure you select the correct file for module.</p> |
| 13 | <p>Check that the final comparison is ok then click Next.</p>  |

EIO Head modules firmware (140 CRA 31200) upgrade procedure.

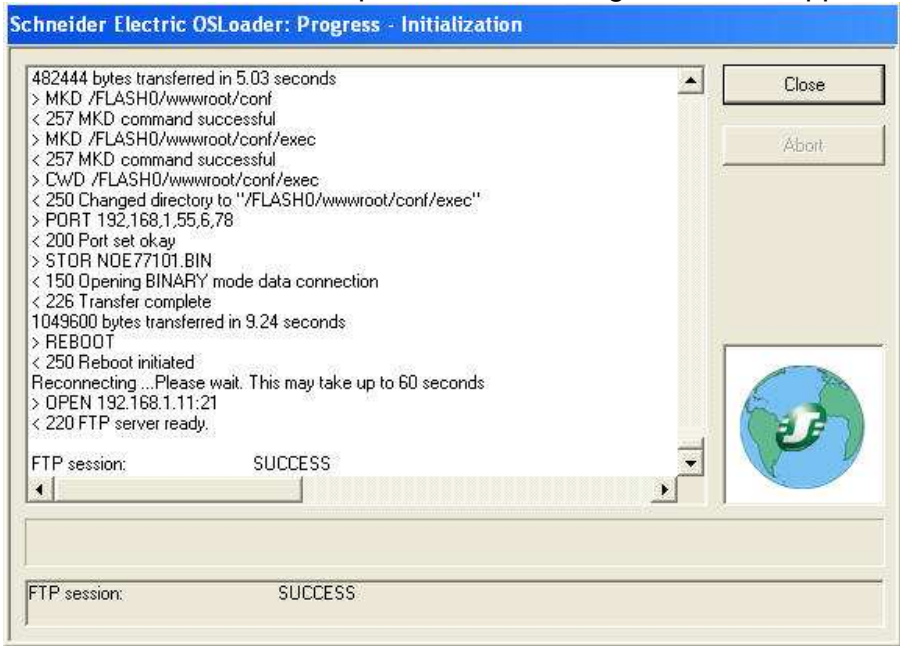
| | |
|----|---|
| 14 | Wait until the transfer is done; do not power cycle or remove the cable. |
| 15 | <p>After the download is completed the following screen will appear.</p>  <p>If this screen does not appear recheck each step and contact your local Schneider office for assistance if required.</p> |
| 16 | Select 'Close' and 'Back' in the OS loader. Exit the OS loader |