

# Rad-8<sup>®</sup>

Signal Extraction Pulse Oximeters

OPERATOR'S MANUAL



MASIMO SET<sup>®</sup>

The Rad-8 Operating Instructions provide the necessary information for proper operation of all Rad-8 pulse oximeter models.

General knowledge of pulse oximetry and an understanding of the features and functions of the Rad-8 pulse oximeter are prerequisites for its proper use.

Do not operate the Rad-8 pulse oximeter without completely reading and understanding the instructions in this manual.

**NOTICE**

Purchase or possession of this device does not carry any express or implied license to use with replacement parts which would, alone or in combination with this device, fall within the scope of one of the relating patents.

**CAUTION:**

FEDERAL LAW (U.S.A.) RESTRICTS THIS DEVICE TO SALE BY OR ON THE ORDER OF A PHYSICIAN.

For further information contact:

Masimo Corporation

40 Parker

Irvine, CA 92618

USA

Tel.: 949-297-7000

Fax.: 949-297-7001

www.masimo.com



EU Authorized Representative for Masimo Corporation:

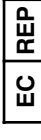

MDSS GmbH

Schiffgraben 41

30175 Hannover, Germany

Tel.: +49-511-62 62 86 30

Fax.: +49-511-62 62 86 33



MEDICAL ELECTRICAL EQUIPMENT WITH RESPECT TO ELECTRIC SHOCK,  
FIRE AND MECHANICAL HAZARDS ONLY IN ACCORDANCE WITH  
UL 60601-1/CAN/CSA C22.2 No. 601.1  
80FK

Covered by one or more of the following U.S. Patents: RE38,492, RE38,476, 6,850,787, 6,826,419, 6,816,741, 6,699,194, 6,684,090, 6,658,276, 6,654,624, 6,650,917, 6,643,530, 6,606,511, 6,501,975, 6,463,311, 6,430,525, 6,360,114, 6,263,222, 6,236,872, 6,229,856, 6,206,830, 6,157,850, 6,067,462, 6,011,986, 6,002,952, 5,919,134, 5,823,950, 5,769,785, 5,758,644, 5,685,299, 5,632,272, 5,490,505, 5,482,036, international equivalents, or one or more of the patents referenced at [www.masimo.com/patents](http://www.masimo.com/patents). Other patents pending.

© 2007 Masimo Corporation. Masimo, Signal IQ, Discrete Saturation Transform, DST, SatShare, SET, , FastSat, Rad-8, Radlink, FastSat, SIQ, LNOP, LNCS and are federally registered trademarks of Masimo Corporation.

RadNet, PI, APOD and LNOPv are trademarks of Masimo Corporation.

### SAFETY INFORMATION, WARNINGS, CAUTIONS AND NOTES

The Rad-8 Compact pulse oximeter is designed to minimize the possibility of hazards from errors in the software program by following sound engineering design processes, risk analysis and software validation.

- Explosion hazard. Do not use the pulse oximeter in the presence of flammable anesthetics or other flammable substance in combination with air, oxygen-enriched environments, or nitrous oxide.
- High intensity extreme lights (such as pulsating strobe lights) directed on the sensor, may not allow the pulse oximeter to obtain vital sign readings.
- The pulse oximeter is NOT intended for use as an apnea monitor.
- A pulse oximeter should be considered an early warning device. As a trend towards patient hypoxemia is indicated, blood samples should be analyzed by laboratory instruments to completely understand the patient's condition.
- The pulse oximeter is to be operated by qualified personnel only. This manual, accessory directions for use, all precautionary information, and specifications should be read and understood before use.
- Electric shock hazard. Do not open the pulse oximeter cover except to replace the battery of the unit. Only a qualified operator may perform maintenance procedures specifically described in this manual. Refer servicing to Masimo for repair of this equipment.
- Only a qualified operator may perform maintenance procedures specifically described in this manual. Refer servicing to Masimo for repair of this equipment.
- As with all medical equipment, carefully route patient cabling to reduce the possibility of patient entanglement or strangulation.
- Do not place the pulse oximeter or accessories in any position that might cause it to fall on the patient. Do not lift the pulse oximeter by the patient cable.
- Interfering Substances: Carboxyhemoglobin and Methemoglobin may erroneously increase readings. The level of increase is approximately equal to the amount of carboxyhemoglobin present. Dyes, or any substance containing dyes, that change usual blood pigmentation may cause erroneous readings.
- Severe anemia may cause erroneous SpO<sub>2</sub> readings.
- Do not use the pulse oximeter or oximetry sensors during magnetic resonance imaging (MRI) scanning. Induced current could potentially cause burns. The pulse oximeter may affect the MRI image, and the MRI unit may affect the accuracy of the oximetry measurements.
- If using pulse oximetry during full body irradiation, keep the sensor out of the irradiation field. If sensor is exposed to the irradiation, the reading might be inaccurate or the unit might read zero for the duration of the active irradiation period.
- Always remove the sensor from the patient and completely disconnect the patient from the pulse oximeter before bathing the patient.
- Do not place the pulse oximeter where the controls can be changed by the patient.
- Do not place the pulse oximeter face against a surface. This will cause the alarm to be muffled.

### SAFETY INFORMATION, WARNINGS, CAUTIONS AND NOTES

- Do not place the pulse oximeter on electrical equipment that may affect the pulse oximeter, preventing it from working properly.
- Do not expose the pulse oximeter to excessive moisture such as direct exposure to rain. Excessive moisture can cause the pulse oximeter to perform inaccurately or fail.
- Do not place containers containing liquids on or near the pulse oximeter. Liquids spilled on the pulse oximeter may cause it to perform inaccurately or fail.
- Failure of Operation - If the pulse oximeter fails any part of the setup procedures remove the pulse oximeter from operation until qualified service personnel have corrected the situation.
- Patient Safety - If a sensor or cable is damaged in any way, discontinue use immediately.
- Disposal of product - Comply with local laws in the disposal of the unit and/or its accessories.
- The pulse oximeter can be used during defibrillation, but the readings may be inaccurate for up to 20 seconds.
- This equipment has been tested and found to comply with the limits for medical devices to the EN 60601-1-2: 2002, Medical Device Directive 93/42/EEC. These limits are designed to provide reasonable protection against harmful interference in a typical medical installation. This equipment generates, uses and can radiate radio frequency energy and, if not installed and used in accordance with the instructions, may cause harmful interference to other devices in the vicinity. However, there is no guarantee that interference will not occur in a particular installation. If this equipment does cause harmful interference to other devices, which can be determined by turning the equipment off and on, the user is encouraged to try to correct the interference by one or more of the following measures:
  - Reorient or relocate the receiving device.
  - Increase the separation between the equipment.
  - Consult the manufacturer for help.
- A functional tester cannot be utilized to assess the accuracy of the pulse oximeter or any sensors.

## table of contents

<b>SECTION 1 - OVERVIEW</b>	
About This Manual	1-1
Warnings, cautions and notes	1-2
Product Description	1-3
Features and Benefits	1-3
Indications for use	1-3
Pulse Oximetry	1-4
General Description	1-4
Principle of Operation	1-4
Functional vs. Fractional Saturation	1-5
Measured vs. Calculated Saturation	1-5
Masimo SET Signal Extraction Technology	1-5
Masimo SET Parallel Engines	1-6
Masimo SET DST	1-6
<b>SECTION 2 - SYSTEM DESCRIPTION</b>	
Introduction	2-1
Rad-8 front panel controls	2-2
Rad-8 rear panel	2-4
Symbols	2-5
<b>SECTION 3 - SETUP</b>	
Introduction	3-1
Unpacking and inspection	3-1
Preparation for monitoring	3-1
Rad-8 power requirements	3-1
Initial battery charging	3-2
Initial installation	3-2
<b>SECTION 4 - OPERATION</b>	
Introduction	4-1
Basic operation	4-1
General Setup and Use	4-1
Factory Default settings	4-3
Successful SpO <sub>2</sub> monitoring	4-4
Numeric Display - SpO <sub>2</sub>	4-4
Masimo Sensors	4-4
Numeric Display - Pulse Rate	4-5
Signal IQ and Pulse bar	4-6
Low Perfusion	4-7
Actions To Be Taken	4-7
Low Battery Audible Alarm	4-8
Normal patient monitoring	4-8
Rad-8 front panel control operation	4-8
Setup menu	4-9
Menu Navigation	4-9
Setup Menu Level 1 – Alarm features and sensitivity	4-9
Setup Menu Level 2 – Button volume, LED brightness and factory default settings	4-10
Setup Menu Level 3 - Clear trend	4-10

## table of contents

Setup Menu Level 4 - Set date and time	4-11
Setup Menu Level 5 - Output	4-11
Output Description	4-12
System interfaces	4-13
Philips VueLink setup	4-13
RadNet Setup	4-13
RadLink Setup	4-13
Special Menu	4-14
Special Menu – Standard, Home and Sleep mode	4-14
Home Mode operation	4-14
Sleep mode Operation	4-14
Trend setup and use	4-15
Introduction	4-15
TrendCom Utility Installation	4-15
TrendCom Utility Operation	4-15
Erasing Trend Memory	4-16
Trend Data Format	4-16
Sample Trend Output	4-16
<b>SECTION 5 - ALARMS AND MESSAGES</b>	
Alarm identification	5-1
Alarm indication	5-1
Alarm limits	5-2
Alarm Silence	5-3
Alarm Silenced Indicator	5-3
Messages	5-4
<b>SECTION 6 - TROUBLESHOOTING</b>	
Troubleshooting	6-1
<b>SECTION 7 - SPECIFICATIONS</b>	
Rad-8 specifications	7-1
Performance	7-1
Accuracy	7-1
Electrical	7-1
Environmental	7-1
Physical characteristics	7-2
Serial interface specifications	7-3
Serial Interface Setup	7-3
Serial Printer Setup	7-4
Nurse call specifications	7-4
Nurse Call	7-4
<b>SECTION 8 - SENSORS &amp; PATIENT CABLES</b>	
Introduction	8-1
Masimo SpO <sub>2</sub> sensors	8-1
Selecting a Masimo SET Sensor	8-1
Sensor Application Instructions	8-2
LNOP® Direct Connect Reusable Sensors	8-2
LNOP® Reusable Sensors	8-2

LNOP® Adhesive Sensors ..... 8-2  
 LNOP® Specialty Sensors ..... 8-3  
 LNOPV™ Adhesive Sensors ..... 8-3  
 LNCS™ Reusable Sensors ..... 8-3  
 LNCS™ Adhesive Sensors ..... 8-3  
 Cleaning And Reuse Of Masimo Sensors ..... 8-4  
 Reattachment of Single Use Adhesive Sensors ..... 8-4  
 Masimo SET patient cables ..... 8-4  
 Cleaning And Reuse Of Masimo SET Patient Cables ..... 8-4

**SECTION 9 - SERVICE AND MAINTENANCE**

Introduction ..... 9-1  
 Cleaning ..... 9-1  
 Battery Service ..... 9-2  
 Performance verification ..... 9-2  
 Service and repair ..... 9-4  
 Repair Policy ..... 9-4  
 Return Procedure ..... 9-4  
 Warranty ..... 9-5  
 Exclusions ..... 9-5  
 End-user license agreement ..... 9-5

**SECTION 10 - ACCESSORIES**

Rad-8 Units and Accessories ..... 10-1

**About This Manual**

This manual explains how to set up and use the Rad-8 pulse oximeter. Important safety information relating to general use of the Rad-8 pulse oximeter appears before this introduction. Other important safety information is located throughout the manual where appropriate.

**Read the entire safety information section before you operate the monitor.**

In addition to the safety section, this manual includes the following sections:

- SECTION 1**     **OVERVIEW** gives a general description of pulse oximetry.
- SECTION 2**     **SYSTEM DESCRIPTION** describes the Rad-8 pulse oximeter system and its functions and features.
- SECTION 3**     **SETUP** describes how to setup the Rad-8 pulse oximeter for use.
- SECTION 4**     **OPERATION** describes the operation of the Rad-8 Pulse Oximetry system.
- SECTION 5**     **ALARMS AND MESSAGES** describes the alarm system messages.
- SECTION 6**     **TROUBLESHOOTING** describes troubleshooting information.
- SECTION 7**     **SPECIFICATIONS** gives the detailed specifications of the Rad-8 pulse oximeter.
- SECTION 8**     **SENSORS AND PATIENT CABLES** outlines how to use and care for the Masimo SET LNOP and LNCS sensors and Masimo SET patient cables.
- SECTION 9**     **SERVICE AND MAINTENANCE** describes how to maintain, service and obtain repair for the Rad-8 pulse oximeter.
- SECTION 10**    **ACCESSORIES** list the available Rad-8 accessories.

## Warnings, cautions and notes

Please read and follow any warnings, cautions and notes presented throughout this manual. An explanation of these labels are as follows:

A **WARNING** is provided when actions may result in a serious outcome (i.e., injury, serious adverse affect, death) to the patient or user. Look for text in a gray shaded box.

Sample of Warning:

**WARNING:** THIS IS A SAMPLE OF A WARNING STATEMENT.

A **CAUTION** is given when any special care is to be exercised by the patient or user to avoid injury to the patient, damage to this device or damage to other property.  
Sample of Caution:

**CAUTION:** THIS IS A SAMPLE OF A CAUTION STATEMENT.

A **NOTE** is provided when extra general information is applicable.  
Sample of Note:

**NOTE:** *This is a sample of a Note.*

## Product Description

The Rad-8 family of pulse oximeters are noninvasive, arterial oxygen saturation and pulse rate monitors. The Rad-8 family features a multicolored LED display that continuously displays numeric values for SpO<sub>2</sub> and pulse rate, as well as LED indicator bars for Perfusion Index (PI) and Signal Identification and Quality Indicator (Signal IQ<sup>®</sup>).

The Rad-8 family consists of two models: the vertical Rad-8 and the horizontal Rad-8.

### FEATURES AND BENEFITS

These features are common to the Rad-8 family:

- Clinically proven Masimo SET<sup>®</sup> technology performance
- Applicable for use on neonate, infant, pediatric and adult patients
- Proven for accurate monitoring in motion and low perfusion environments
- SpO<sub>2</sub>, pulse rate, alarm, and perfusion index displays
- Signal I.Q. for signal identification and quality indication
- Lightweight, convenient compact design
- Audible and visual alarm for no sensor, sensor-off and low battery
- One touch button access to alarms for High/Low saturation and High/Low pulse rate
- Trauma mode
- FastSat<sup>®</sup> mode
- User definable alarm limit settings
- Sleep study mode
- Three sensitivity levels - Max, Normal and APOD<sup>™</sup>
- Stores up to 72 hours of trending memory
- Adjustable alarm volume
- Adjustable averaging 2 to 16 seconds
- Nurse call connection port
- 8 hours Internal battery life with fully charged battery
- Serial output port
- Display capability on Philips/Agilent monitor through Philips VueLink function.
- RadNet<sup>™</sup> and RadLink<sup>®</sup> capability.

### INDICATIONS FOR USE

The Rad-8 family of pulse oximeters and accessories are indicated for the continuous, non-invasive monitoring of functional oxygen saturation of arterial hemoglobin (SpO<sub>2</sub>) and pulse rate (measured by an SpO<sub>2</sub> sensor). The Rad-8 family of pulse oximeters and accessories are indicated for use with adult, pediatric, infant and neonatal patients during both motion and no motion conditions, and for patients who are well or poorly perfused in hospitals, hospital-type facilities, mobile and home environments.

## Pulse Oximetry

### GENERAL DESCRIPTION

Pulse oximetry is a continuous and non-invasive method of measuring the level of arterial oxygen saturation in blood. The measurement is taken by placing a sensor on a patient, usually on the fingertip for adults, and the hand or foot for neonates. The sensor connects to the pulse oximetry instrument directly or with a patient cable. The sensor collects signal data from the patient and sends it to the instrument. The instrument displays the calculated data in two ways:

1. As a percent value for arterial oxygen saturation (SpO<sub>2</sub>) and
2. As a pulse rate (PR).

The following figure shows the general monitoring setup.

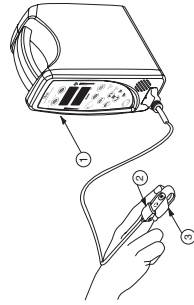

1. Instrument
2. Patient Cable
3. Sensor

### PRINCIPLE OF OPERATION

Pulse oximetry is governed by the following principles:

1. Oxyhemoglobin (oxygenated blood) and deoxyhemoglobin (non-oxygenated blood) differ in their absorption of red and infrared light (spectrophotometry).
2. The amount of arterial blood in tissue changes with your pulse (photoplethysmography). Therefore, the amount of light absorbed by the varying quantities of arterial blood changes as well.

The Rad-8 pulse oximeter uses a two-wavelength pulsatile system to distinguish between oxygenated and deoxygenated blood. Signal data is obtained by passing red (rd) (660 nm wavelength) and infrared (ir) (905 nm wavelength) light through a capillary bed (for example a fingertip, a hand or a foot) and measuring changes in light absorption during the pulsatile cycle. This information may be useful to clinicians. The radiant power of the light is rated at 0.79mW (max.). See figure below. The Rad-8 utilizes a sensor with red and infrared light-emitting diodes (LEDs) that pass light through the site to a photodiode (photodetector). The photodetector receives the light, converts it into an electronic signal and sends it to the Rad-8 for calculation.

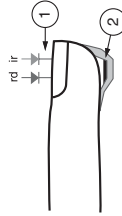

1. Light Emitting Diodes (LEDs)
2. Recessed Photo Detector

Once the Rad-8 receives the signal from the sensor, it utilizes Masimo SET signal extraction technology for calculation of the patient's functional oxygen saturation and pulse rate. The maximum of the skin surface temperature is measured at an ambient temperature of less than 106° F (41° C). This is verified by Masimo sensor skin temperature test procedures.

## FUNCTIONAL VS. FRACTIONAL SATURATION

The Rad-8 is calibrated to measure and display functional saturation which is the amount of oxygenated hemoglobin expressed as a percentage of the hemoglobin that can transport oxygen. The Rad-8 does not measure fractional saturation which is oxygenated hemoglobin expressed as a percentage of all measured hemoglobin. This includes measured dysfunctional hemoglobin such as carboxyhemoglobin or methemoglobin. To convert fractional saturation to functional saturation, the fractional saturation measurements must be converted according to:

$$\text{Functional saturation} = \frac{\text{Fractional saturation}}{100 - (\% \text{ carboxyhemoglobin} + \% \text{ methemoglobin})} \times 100$$

## MEASURED VS. CALCULATED SATURATION

Oxygen saturation measurements obtained from a pulse oximeter are commonly compared to saturations calculated from the partial pressure of oxygen (PO<sub>2</sub>) obtained from an arterial blood gas sample. When comparing the two measurements and interpreting values, caution should be used, as the calculated value obtained from the blood gas sample may differ from the SpO<sub>2</sub> measurement of the pulse oximeter. Different results are usually obtained from the blood gas sample if the calculated saturation is not appropriately corrected for the effects of variables that shift the relationship between PO<sub>2</sub> and saturation, such as: pH, temperature, the partial pressure of carbon dioxide (PCO<sub>2</sub>), 2,3-DPG, and fetal hemoglobin. Also, as blood gas samples are usually taken over a period of 20 seconds (the time it takes to draw blood) a meaningful comparison can only be achieved if the core oxygen saturation of the patient is stable and not changing over the period of time that the blood gas sample is taken.

## MASIMO SET SIGNAL EXTRACTION TECHNOLOGY

Masimo Signal Extraction Technology's signal processing differs from conventional pulse oximeters. Conventional pulse oximeters assume that arterial blood is the only blood moving (pulsating) in the measurement site. During patient motion, however, the non-arterial blood also moves, causing conventional pulse oximeters to read low values, because they cannot distinguish between the arterial and venous blood movement (sometimes referred to as noise). Masimo SET pulse oximetry utilizes parallel engines and adaptive digital filtering. Adaptive filters are powerful because they are able to adapt to the varying physiologic signals and/or noise and separate them by looking at the whole signal and breaking it down to its fundamental components. The Masimo SET signal processing algorithm, Discrete Saturation Transform® (DST)<sup>®</sup>, reliably identifies the noise, isolates it and, using adaptive filters, cancels it. It then reports the true arterial oxygen saturation for display on the monitor.

1

overview

MASIMO SET PARALLEL ENGINES

The flowchart illustrates the MASIMO SET Parallel Engines process. It begins with an input of R/R (Red/Red) which is processed by a 'Digitized, Filtered & Normalized' block. This signal is then fed into five parallel processing paths:

- R/R (Conventional Pulse Oximetry):** Produces MEAS and CONF outputs.
- Adaptive Filter with DST®:** Produces MEAS and CONF outputs.
- SST™:** Produces MEAS and CONF outputs.
- Proprietary Algorithm 4:** Produces MEAS and CONF outputs.
- Proprietary Algorithm 5:** Produces MEAS and CONF outputs.

The outputs from all five paths are fed into a 'Confidence Based Arbitrator' block. The output of the arbitrator goes to a 'Post Processor', which finally outputs the 'Saturation' value.

MASIMO SET DST

The MASIMO SET DST diagram shows the signal processing flow for the Differsential Saturation Technique. It starts with IR (Infrared) and RD (Red) signals, which are processed by a 'Reference Signal Generator'. This generator also receives 'Trial Saturation SpO<sub>2</sub> 95%' as input. The output is a 'Reference Signal' (a square wave) which is fed into an 'Adaptive Filter'. The filter's output is 'Output Power', which is then used to generate a histogram of SpO<sub>2</sub> (r<sub>a</sub>) values. The histogram shows a distribution of SpO<sub>2</sub> values from 30 to 100, with a peak around 95%.

system description

2

Introduction

The Rad-8 family of pulse oximeters are full featured pulse oximeters designed for ease of operation. All pulse oximetry measurement information, as well as device status data, is displayed on the front panel of the device. All user input is handled by control buttons on the front panel and the sensor cable connection is located on the left side of the Rad-8 horizontal and the bottom of the Rad-8 vertical.

- Rad-8 family offers full Masimo SET technology in a small compact device
- Rad-8 family supports the full line of Masimo sensors and patient cables (see Section 8, **Sensors and Patient Cables**)
- Rad-8 family supports standardization of sensors and pulse oximetry technology throughout the hospital

1-6

Rad-8 Signal Extraction Pulse Oximeter Operator's Manual

Rad-8 Signal Extraction Pulse Oximeter Operator's Manual

2-1



## Rad-8 front panel controls

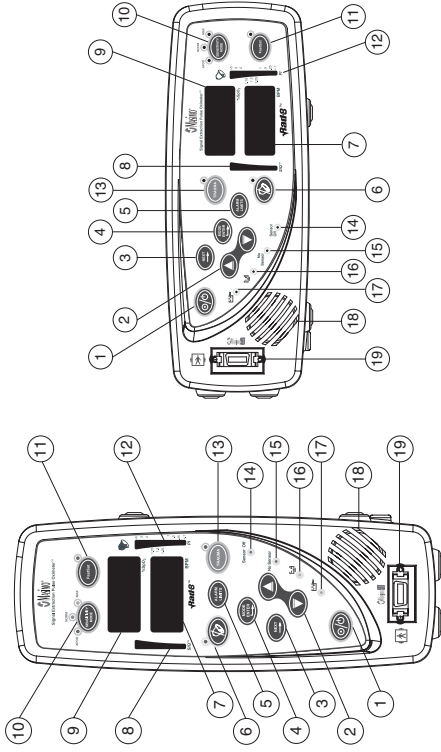

Rad-8 Vertical

Rad-8 Horizontal

CONTROL / INDICATOR	DESCRIPTION
1	Used to turn the unit on and off.
2	During saturation monitoring, use these buttons to adjust the volume of the pulse beep tone. Within the menu/setup system, these buttons are used to select values within each menu option. <b>NOTE: Pressing and holding down these buttons allow for the rapid scrolling of SpO<sub>2</sub> and BPM alarm limits.</b>
3	Used within the menu/setup system to move through setup options. Not active during normal patient monitoring
4	Used to enter the setup menus and to select/activate certain entries within the menu/setup system.
5	Used to enter the alarm menu to adjust Hi/Low SpO <sub>2</sub> and heart rate alarm limits.
6	Push once to temporarily silence the alarm for 120 seconds (default). Push a second time to return the unit to standard alarm monitoring after alarm condition has been corrected. <b>NOTE: The silence time can be set for 120, 90, 60 and 30 seconds. See Section 4 - Setup Menu Level 1.</b>
7	The pulse rate in beats per minute (bpm). When searching for a saturation and pulse, it will flash dashed lines.

CONTROL / INDICATOR	DESCRIPTION
8	The Signal IQ provides an indication of the quality of the acquired signal as well as the timing of the pulse. A green vertical LED bar rises and falls with the pulse, where the height of the bar indicates the quality of the signal.
9	The functional arterial hemoglobin oxygen saturation is displayed in units of SpO <sub>2</sub> . When searching for a saturation and pulse, it will flash dashed lines.
10	Used to set the unit into Maximum Sensitivity, Normal Sensitivity, or APOD Mode.
11	Used to set the unit in the FastSat Mode
12	The Perfusion Index provides an indication of the percentage of pulsatile signal to non pulsatile signal. The bar is highest when the quality of the perfused site is best.
13	Used to set the unit into the most sensitive mode and fastest averaging time.
14	Sensor off indicator will illuminate when the sensor is off the patient and an audible alarm will sound.
15	No sensor indicator will illuminate when no sensor is connected and an audible alarm will sound.
16	The yellow battery low indicator will illuminate with an audible alarm when the battery is low and requires recharging.
17	The AC Power Charging indicator is illuminated when the Rad-8 is connected to AC line power and the battery is charging.
18	Provides audible indication of alarm conditions, pulse tone and feedback for key-presses. Ensure the speaker is not covered or the unit is placed face-down on bedding or other sound absorbing surface.
19	Connects to a Direct Connect Spot Check (DOSC) sensor or Masimo Patient Cable with a sensor. The icon next to the sensor indicates defibrillation proof.

## Rad-8 rear panel

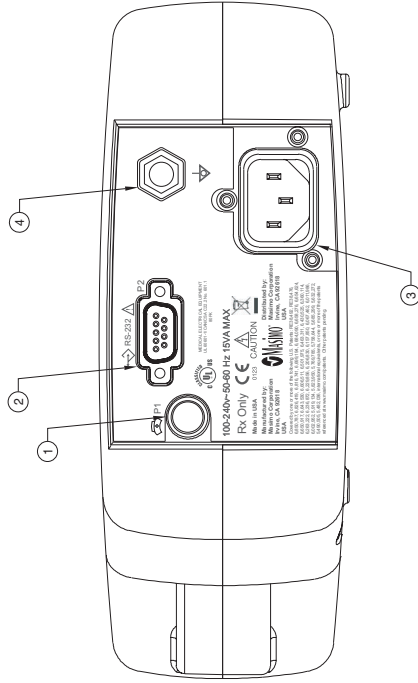

① NURSE CALL CONNECTOR

Use the 1/4" round Connector to interface with a nurse call system. This is a mono output and should be utilized with a mono cable. All external device connections to the Nurse Call Connector must be IEC-60950 compliant.

② SERIAL OUTPUT CONNECTOR

Use the Serial Output Connector to connect a serial device, including a serial printer, RadNet Interface Module, RadLink Interface Module or PC, to the Rad-8. See Section 7, *Serial Interface Specifications*. All external device connections to the Serial Output Connector must be IEC-60950 compliant.

③ POWER ENTRY MODULE













The power entry module contains the input connector for AC power. The AC input provides power to the system from the AC line. Always connect the pulse oximeter to the main power for continuous operation and/or battery recharging.

④ EQUIPOTENTIAL GROUND CONNECTOR

Use the Equipotential Ground Connector for grounding.

## SYMBOLS

The following symbols are found on the back of the Rad-8 pulse oximeter or packaging and are defined below:

	RS-232
	Equipotential Ground Terminal
	Caution, consult accompanying documents
	Nurse Call Interface
	WEEE compliant
	Defibrillation Proof (see front panel)
	Mark of Conformity to European Medical Device Directive 93/42/EEC
R <sub>x</sub> Only	Federal law restricts this device to sale by or on the order of a physician (USA audiences only)
	Year of manufacture
	Underwriter's Laboratories Inc. approved
	Storage humidity range: 5% to 95%
	Storage temperature range: +70 °C to -40 °C Storage altitude range: +1600hPa to +500hPa
	Keep dry
	Fragile/breakable, handle with care

## **Introduction**

Before the Rad-8 pulse oximeter can be used in a clinical setting, it needs to be inspected and properly

## **Unpacking and inspection**

Remove the instrument from the shipping carton and examine it for signs of shipping damage. Check all materials against the packing list. Save all packing materials, invoice and bill of lading. These may be required to process a claim with the carrier.

If anything is missing or damaged, contact the Technical Service Department. The contact address and phone numbers are listed in Section 9, *Service and Repair*.

## **Preparation for monitoring**

The following sections of the manual describe the preparation, set-up and initial installation of the Rad-8 pulse oximeter.

### **RAD-8 POWER REQUIREMENTS**

Always use a hospital grade, AC power cable to connect the Rad-8 pulse oximeter to an AC power source.

**CAUTION: DO NOT CONNECT THE RAD-8 PULSE OXIMETER TO AN AC OUTLET CONTROLLED BY A SWITCH.**

Verify the AC power voltage and frequency before use. Verify that the power source can provide adequate power rating as indicated on the rear panel of the Rad-8.

The Rad-8 pulse oximeter is designed to operate on 100 to 240VAC, 50-60 Hz. The device is rated at 15 VA max.

Connect a hospital grade power cable to the power entry module of the Rad-8 unit (IEC-320 connector type at the unit). Connect the power cable to an AC power source. Ensure that the unit is adequately powered by verifying that the AC power indicator on the Rad-8 is illuminated.

### **CAUTION:**

- **CONNECT THE OXIMETER ONLY TO A HOSPITAL-GRADE RECEPTACLE (FOR HOSPITAL USE).**
- **DO NOT UNDER ANY CIRCUMSTANCES REMOVE THE GROUNDING CONDUCTOR FROM THE POWER PLUG.**
- **DO NOT USE EXTENSION CORDS OR ADAPTERS OF ANY TYPE. THE POWER CORD AND PLUG MUST BE INTACT AND UNDAMAGED.**
- **USE THE POWER CORD AS THE MEANS TO DISCONNECT THE DEVICE FROM THE MAINS POWER SUPPLY.**

- IF THERE IS ANY DOUBT ABOUT THE INTEGRITY OF THE PROTECTIVE EARTH CONDUCTOR ARRANGEMENT, OPERATE THE OXIMETER ON INTERNAL BATTERY POWER UNTIL THE AC POWER SUPPLY PROTECTIVE CONDUCTOR IS FULLY FUNCTIONAL.
- TO ENSURE PATIENT ELECTRICAL ISOLATION, CONNECT ONLY TO OTHER EQUIPMENT WITH ELECTRICALLY ISOLATED CIRCUITS.
- DO NOT CONNECT TO AN ELECTRICAL OUTLET CONTROLLED BY A WALL SWITCH OR DIMMER.

#### INITIAL BATTERY CHARGING

Before use, the Rad-8 battery needs to be fully charged.

To charge the internal battery, plug in the AC power cord. Verify that the battery is charging. The green battery charging LED indicator on the unit will remain illuminated while the battery is charging.

#### INITIAL INSTALLATION

Place the Rad-8 on a stable hard flat surface near the patient. Always place the Rad-8 unit on a dry surface. Maintain a minimum of 1 inch (2.54 cm) free space around the unit. Make sure that Rad-8 loudspeaker is not covered to avoid a muffled alarm sound.

The Rad-8 should not be operated outside the following environmental conditions:

#### OPERATING ENVIRONMENTAL CONDITIONS

TEMPERATURE	+5°C to +40°C, +41°F to +104°F
HUMIDITY	5% to 95%, non-condensing
OPERATING ALTITUDE	500 mbar to 1060 mbar pressure -1000 ft to 18,000 ft (-304 m to 5,486 m)

#### Introduction

To operate the Rad-8 pulse oximeter effectively, the operator must:

- Know how the oximeter derives its readings (see Section 1, *Pulse Oximetry*)
- Be familiar with its controls and operation.
- Understand its status and alarm messages (see Section 5, *Alarm Identification, System Messages* and Section 6, *Troubleshooting*).

#### Basic operation

##### GENERAL SETUP AND USE

1. Inspect the oximeter case for damage.
2. Connect a patient cable or a direct connect sensor to the Patient Cable Connector of the Rad-8 pulse oximeter. Make sure it is a firm connection and the cable is not twisted, sliced or frayed.
3. If utilizing a patient cable, select a sensor that is compatible with the oximeter and the patient before connecting it to the patient cable. See Section 8, **Sensors and Patient Cables**. If using a reusable sensor, make sure it opens and closes smoothly. Remove any substances that may interfere with the transmission of light between the sensor's light source and photodetector.
4. Refer to the Directions for Use of the sensor before attaching the sensor to the patient. If using a single patient adhesive or disposable sensor, check that the emitter (red light) and the photodetector are properly aligned.
5. With a single patient adhesive or disposable sensor, connect the sensor to the patient cable with the logos lining up; make sure it is a firm connection.
6. Press the Power button to turn the oximeter on.
7. Verify all front-panel indicators momentarily illuminate and a tone is heard.
8. Verify the front-panel display is free of alarm and system failure messages (see Section 5, **Alarms and Messages**).
9. Verify the display shows the following:
  - Mode setting: Standard (STD) or Sleep (SLP) or Home (H/H/H)
  - SpO<sub>2</sub> Low Alarm Limit and SpO<sub>2</sub> High Alarm Limit,
  - Pulse Rate Low Alarm Limit and Pulse Rate High Alarm Limit,
  - Averaging Time.
10. On the display, verify the readings for SpO<sub>2</sub> and pulse rate.

**NOTE:** " - - " will flash on the numeric display until the SpO<sub>2</sub> and pulse rate readings have stabilized (approximately 10 seconds).

11. Verify that the patient alarms are functional by setting the high and low SpO<sub>2</sub> and pulse rate alarm limits beyond the patient readings.
    - An alarm tone sounds.
    - The violated alarm limit and reading flash on the display.
    - The Visual Alarm Indicator flashes.
  12. Verify the sensor alarms are functional by removing the sensor from the sensor site.
    - "Sensor off" indicator illuminates.
    - The alarm tone sounds.
    - The Visual Alarm Indicator flashes.
    - Disconnect the sensor from the patient cable or oximeter.
    - Confirm that the "no sensor" indicator illuminates.

**NOTE:** "No sensor" and "sensor off" will only generate an alarm if the Rad-8 was actively monitoring a patient when the sensor was disconnected.
  13. Verify parameter-violation alarm silence operation.
    - Create an alarm condition by lowering the SpO<sub>2</sub> or pulse rate high alarm limits beyond the patient readings.
    - Press the Alarm Silence button.
    - The alarm tone ceases for 120 seconds (default).
  14. To begin patient monitoring:
    - Adjust the alarm limits.
    - Adjust the alarm volume.
    - Adjust the pulse beep volume.
  16. Verify the sensor is applied correctly and that the measured data is appropriate, see Section 4, *Successful SpO<sub>2</sub> Monitoring*.
  17. Monitor the patient.
  18. After monitoring is complete, remove the sensor from the patient and store or dispose of the sensor according to local laws. See the Directions for Use of the sensor.
  19. Press and hold the Power/Standby Button for 2 seconds to turn the oximeter off [3 seconds in the Home Mode].
- NOTE:** Turn the oximeter off between patients so that it can re-calibrate in order to interpret new physiological data.

### FACTORY DEFAULT SETTINGS

The Rad-8 oximeters store two types of default values: those that the device automatically reverts to after a power cycle, and those that can be changed by the user which will be remembered after a power cycle.

The following table outlines the default values that the Rad-8 reverts to after a power cycle if not changed by the user:

OPTION	FACTORY DEFAULT SETTING	CONFIGURABLE SETTING
SpO <sub>2</sub> high alarm limit	Set to Off	2 to 100%
SpO <sub>2</sub> low alarm limit	Set to 90%	1 to 100%
Pulse rate high alarm limit	Set to 140 BPM	30 to 240 BPM
Pulse rate low alarm limit	Set to 50 BPM	25 to 235 BPM
Averaging Time	Set to 8 seconds	2, 4, 8, 10, 12, 14, or 16 seconds
Trauma	Set to Off	Off/On
FastSat	Set to Off	Off/On
Sensitivity	Set to Norm setting	Max/Normal/APOD <b>NOTE: Defaults to APOD and Normal only. MAX sensitivity will default to Normal after a power cycle.</b>
Display brightness	Set to level 2	Levels 1 thru 4
Pulse tone volume	Set to level 2	Off, Levels 1 thru 3
Alarm Silence Time	Set to 120 seconds	30, 60, 90, or 120 seconds
Alarm Volume	Set to level 1	Levels 1 thru 3
Sleep Study Mode*†	Set to Standard	Standard/Sleep/Home
Home Mode†	Set to Standard	
Audible Alarm off	Set to alarms active	On/Off or muted with reminder
Alarm Delay	Set to level 5	0, 5, or 10 seconds
Serial out	Set to ASCII 2	Phillips/ASCII 1/ASCII 2
Interface Alarm	Set to Alarm	Alarm, Off/On
Nurse Call Type	Set to Alarm	Alarm and Signal IQ/ Low Signal IQ/ Alarm
Nurse Call Polarity	Set to Normal	Normal/Invert

\* **CAUTION: ALARMS ARE DISABLED IN THIS MODE.**

† If the unit is connected to a RadNet system, there will be no communication with RadNet in this mode.

### Successful SpO<sub>2</sub> monitoring

The following general points will aid in ensuring oximetry monitoring success.

- Place the sensor on a site that is not too thick, has sufficient perfusion and provides proper alignment of the LED's and photodetector.
- Place the sensor on a site that has unrestricted blood flow.
- Do not select a site near potential electrical interference (electrosurgical unit, for example).
- Read the sensor Directions for Use for proper sensor application.

### NUMERIC DISPLAY - SpO<sub>2</sub>

Stability of the SpO<sub>2</sub> readings may be a good indicator of signal validity. Although stability is a relative term, experience will provide a good feeling for changes that are artifactual or physiological and the speed, timing, and behavior of each. The stability of the readings over time is affected by the averaging mode being used. The longer the averaging time, the more stable the readings tend to become. This is due to a dampened response as the signal is averaged over a longer period of time than during shorter averaging times. However, longer averaging times delay the response of the oximeter and reduce the measured variations of SpO<sub>2</sub> and PR.

### MASIMO SENSORS

Before use, carefully read the LNOP, LNOPv and LNCS sensor Directions for Use.

#### Use only Masimo oximetry sensors for SpO<sub>2</sub> measurements.

Tissue damage can be caused by incorrect application or use of an LNOP, LNOPv or LNCS sensor, for example by wrapping the sensor too tightly. Inspect the sensor site as directed in the sensor Directions for Use to ensure skin integrity and correct positioning and adhesion of the sensor.

### CAUTIONS

- DO NOT USE DAMAGED SENSORS. DO NOT USE A SENSOR WITH EXPOSED OPTICAL OR ELECTRICAL COMPONENTS. DO NOT IMMERSE THE SENSOR IN WATER, SOLVENTS, OR CLEANING SOLUTIONS (THE SENSORS AND CONNECTORS ARE NOT WATERPROOF). DO NOT STERILIZE BY IRRADIATION, STEAM, AUTOCLAVE OR ETHYLENE OXIDE (UNLESS OTHERWISE INDICATED ON THE SENSOR DIRECTIONS FOR USE). SEE THE CLEANING INSTRUCTIONS IN THE DIRECTIONS FOR USE FOR REUSABLE MASIMO SENSORS.
- DO NOT USE DAMAGED PATIENT CABLES. DO NOT IMMERSE THE PATIENT CABLES IN WATER, SOLVENTS, OR CLEANING SOLUTIONS (THE PATIENT CABLE CONNECTORS ARE NOT WATERPROOF). DO NOT STERILIZE BY IRRADIATION, STEAM, AUTOCLAVE OR ETHYLENE OXIDE.
- DO NOT USE ADDITIONAL TAPE TO SECURE SENSOR TO PATIENT.

### NUMERIC DISPLAY - PULSE RATE

The Pulse Rate displayed on the Rad-8 may differ slightly from the heart rate displayed on ECG monitors due to differences in averaging times. There may also be a discrepancy between cardiac electrical activity and peripheral arterial pulsation. Significant differences may indicate a problem with the signal quality due to physiological changes in the patient or one of the instruments or application of the sensor or patient cable. The pulsations from intra-aortic balloon support can be additive to the pulse rate displayed on the pulse oximeter.

### SIGNAL IQ AND PULSE BAR

The Rad-8 display provides a visual indicator of the plethysmogram signal quality and an alert when the displayed SpO<sub>2</sub> values are not based on adequate signal quality. The signal quality indicator displayed on the Rad-8 is called the Signal IQ. The Signal IQ can be used to identify the occurrence of a patient's pulse and the associated signal quality of the measurement.

The Signal IQ is shown as a "bouncing bar" indicator, where the peak of the bar coincides with the peak of an arterial pulsation. Even with a plethysmographic waveform obscured by artifact, the Rad-8 locates the arterial pulsation. The pulse tone (when enabled) coincides with the peak of the Signal IQ bar. As saturation increases or decreases, the pulse tone will ascend or descend accordingly, for each 1% change in saturation.

The height of the Signal IQ bar indicates the quality of the measured signal. A high vertical bar indicates that the SpO<sub>2</sub> measurement is based on a good quality signal. A small vertical bar indicates that the SpO<sub>2</sub> measurement is based on data with low signal quality. When the signal quality is very low the accuracy of the SpO<sub>2</sub> measurement may be compromised. A "Low Signal IQ" is indicated by a bar height of two bars or less and the bars turn red. When this occurs, proceed with caution and do the following:

- Assess the patient.
- Check the sensor and ensure proper sensor application. The sensor must be well secured to the site for the Rad-8 to maintain accurate readings. Also, misalignment of the sensor's emitter and detector can result in smaller signals.
- Determine if an extreme change in the patient's physiology and blood flow at the monitoring site occurred, (e.g. an inflated blood pressure cuff, a squeezing motion, sampling of an arterial blood specimen from the hand containing the pulse oximetry sensor, severe hypotension, peripheral vasoconstriction in response to hypothermia, medications, or a spell of Raynaud's syndrome.)
- With neonates or infants, check that the peripheral blood flow to the sensor site is not interrupted. Interruption, for example, as may occur while lifting or crossing their legs, during a diaper change.

After performing the above, if the "Low Signal IQ" indication occurs frequently or continuously, obtaining an arterial blood specimen for CO-Oximetry analysis may be considered to verify the oxygen saturation value.

### LOW PERFUSION

The Rad-8 indicates perfusion on a 10-bar LED indicator. The lower two segments of the bar will turn red when the amplitude of the arterial pulsations is very low (low perfusion). It has been suggested that at extremely low perfusion levels, pulse oximeters can measure peripheral saturation, which may differ from central arterial saturation<sup>1</sup>. This "localized hypoxemia" may result from the metabolic demands of other tissues extracting oxygen proximal to the monitoring site under conditions of sustained peripheral hypoperfusion. (This may occur even with a pulse rate that correlates with the ECG heart rate.)

**CAUTION:** IF THE LOW PERFUSION INDICATION IS FREQUENTLY DISPLAYED, FIND A BETTER-PERFUSED MONITORING SITE. IN THE INTERIM, ASSESS THE PATIENT AND, IF INDICATED, VERIFY OXYGENATION STATUS THROUGH OTHER MEANS.

<sup>1</sup> Severinghaus JW, Spellman MJ. pulse oximeter Failure Thresholds in Hypotension and Vasoconstriction. *Anesthesiology* 1990; 73:532-537

### ACTIONS TO BE TAKEN

If the SpO<sub>2</sub> readings show significant differences, do the following:

- Make sure the emitter and photodetector are aligned directly opposite each other.
- Select a site where the distance between the emitter and photodetector is minimized.
- Wipe the sensor site with a 70% isopropyl alcohol pad or rubefacient cream (10-30% methyl salicylate and 2-10% menthol) for 20-30 seconds. Strong vasodilator creams, such as nitroglycerin paste, are not recommended.
- If possible, remove electrical noise sources such as electrosurgical units or other electrical/electronic equipment.
- If artificial nails or excessive fingernail polish are present, select another site or remove the polish/artificial nails.
- If possible, ensure that the sensor is placed in a location with low ambient light. Although the Rad-8 pulse oximeter integrated with Masimo SET technology has significant immunity to ambient light, excessive ambient light may cause readings to be incorrect.

**CAUTION:** IF ANY MEASUREMENT SEEMS QUESTIONABLE, FIRST CHECK THE PATIENT'S VITAL SIGNS BY ALTERNATE MEANS AND THEN CHECK THE PULSE OXIMETER FOR PROPER FUNCTIONING.

### LOW BATTERY AUDIBLE ALARM

If a low battery condition occurs during patient monitoring, a low priority alarm will sound, and can be silenced for 120 seconds (default) by pressing the Alarm Silence Button. Refer to Setup Menu Level 1 in this section to change setting.

If a low battery condition occurs while not monitoring a patient, pressing the Alarm Silence Button will suspend the audible alarm until the power is cycled or patient monitoring begins.

A visual low battery indicator will continue to blink while audible alarms are silenced.





If a low battery condition occurs, immediately discontinue patient monitoring and plug the monitor into AC power.

### Normal patient monitoring

During normal operation, the Rad-8 Display shows oxygen saturation (as % SpO<sub>2</sub>) and Pulse Rate (in beats per minute).

The following sections describe the function of the Rad-8 front panel controls during normal patient monitoring.

### RAD-8 FRONT PANEL CONTROL OPERATION

BUTTON	FUNCTION
	Power on/off. Press to turn Rad-8 on. Press-and-hold for 2 seconds to turn Rad-8 off.
	Enters the Rad-8 setup/menu system. See Section 4, Setup menu.
	Allows movement from one menu option to the next.
	Alarm Silence. Pressing this button one time will silence the alarm for 120 seconds (default). A second press will return the unit to standard alarm monitoring.  Pressing this button will acknowledge and permanently silence a 'sensor-off' and 'no-sensor' audible alarm except in the Home and Sleep modes. In Sleep mode, all alarms are disabled. It will also permanently silence a low battery audible alarm if the Rad-8 is not monitoring a patient.  If a low battery alarm occurs during patient monitoring, pressing the Alarm Silence button will silence the audible alarm for 120 seconds (default).
	During normal patient monitoring the Up and Down Arrow keys control the Pulse Tone volume. At the lowest setting, the pulse tone is muted. A low-pitch tone indicates the highest or lowest setting has been reached.  In the setup/menu system, the Up and Down Arrow keys select among the options for each setting and allows navigation through the menu(s).

### Setup menu

This section gives an overview of the Rad-8 menu selections available. To navigate through the menus, use the *Mode/Enter*, *Next*, *Up* and *Down* keys located on the front panel of the oximeter. The following sub-sections describe each menu item in more detail. The oximeter has options that allow user configuration to suit specific needs.





#### MENU NAVIGATION

The Rad-8 set-up and configuration options are accessed through the menu system. The *Mode/Enter* key is used to enter the menu system and to move through the different menu levels. Within each level of the system, the *Next* key is used to move from one option to the next. The *Up* and *Down* arrow keys are used to select values within each option. The parameter is set/selected when either the *Mode/Enter* or *Next* keys are pressed.

**NOTE:** The Rad-8 will automatically 'time out' of the setup menu after 10 seconds with no key presses.

#### SETUP MENU LEVEL 1 – ALARM FEATURES AND SENSITIVITY.

Push the *Mode/Enter* button to enter menu level 1.

BUTTON	SETTING
	Alarm Volume
	Alarm Silence Duration 30, 60, 90 and 120 seconds (Default 120 seconds)
	Alarm on / off Alarm muted with reminder (Default on)
	Alarm Delay *0, 5, 10 seconds (Default 5 seconds)
	Averaging. The signal averaging time of this device can be set to: 2†, 4†, 8, 10, 12, 14 or 16 seconds (Default 8 seconds)

Use *Up* or *Down* Arrow Keys to adjust parameter to desired setting.

**NOTE:** The parameter is set/selected when *Mode Enter* or *Next* are pressed.

\*Alarm delay allows the user to adjust the time in which the audible status indicator will occur. Alarm delay applies only when the saturation limit is exceed by less than 5%.

†FastSat is automatically enabled in 2 and 4 second averaging.



### SETUP MENU LEVEL 2 – BUTTON VOLUME, LED BRIGHTNESS AND FACTORY DEFAULT SETTINGS

Push the Mode/Enter button again to enter menu level 2.

BUTTONS	SETTING
 2X	LED Display Brightness (4 levels) <b>NOTE:</b> Active LED indicators are effected while adjusting this setting
	Button Volume (Off, 3 Levels) <b>NOTE:</b> Use Up or Down Arrow Keys to adjust parameter to desired setting. <b>NOTE:</b> The parameter is set/selected when Mode Enter or Next are pressed.
	Restore Factory Default Settings Yes / No <b>NOTE:</b> Save User Identified Default Settings (First press Up arrow two times and then press Mode/Enter, Password: next button, up arrow, down arrow, next button)

**NOTE:** User default settings can be changed for specific patient environments.

### SETUP MENU LEVEL 3 - CLEAR TREND

Push the Mode/Enter button again to enter menu level 3.







BUTTONS	SETTING
 3X	Clear Trend Yes / No <b>NOTE:</b> Use Up or Down Arrow Keys to adjust parameter to desired setting. <b>NOTE:</b> The parameter is set/selected when Mode Enter or Next are pressed.

The Rad-8 only stores data in the trend memory while the device is turned on, and the trend data remains in memory until the memory fills up or cleared by the user.

**NOTE:** It is recommended that you clear the trend prior to performing a new patient data collection procedure.





### SETUP MENU LEVEL 4 - SET DATE AND TIME

Push the Mode/Enter button again to enter menu level 4.

BUTTONS	SETTING	
 4X	Select Clock	
	 Set Year	Use Up or Down Arrow Keys to adjust parameter to desired setting. <b>NOTE:</b> The parameter is set/selected when Mode Enter or Next are pressed.
	 Set Month	
	 Set Day	
	 Set Hour	
	 Set Minute	

### SETUP MENU LEVEL 5 - OUTPUT

Push the Mode/Enter button again to enter menu level 5.

BUTTONS	SETTING		
 5X	Software Version		
	 Serial out - Phillips, ASCII 1, ASCII 2	Use Up or Down Arrow Keys to adjust parameter to desired setting. <b>NOTE:</b> The parameter is set/selected when Mode Enter or Next are pressed.	
	 Alarm Monitor Interface On / Off		
	 Nurse Call Type		Alarm and Signal IQ
			Low Signal IQ
	 Nurse Call Polarity-Normal / Invert		Alarm

**NOTE:** See tables below for further description of features.

**OUTPUT DESCRIPTION**

<b>MENU ITEMS</b>	<b>DESCRIPTION</b>
<b>SERIAL</b>	<p>The following serial output modes are supported. All serial output is RS-232 based. See the interface specifications in Section 7, Specifications.</p> <p><b>ASCII 1</b> ASCII text data is sent to the serial interface at one-second intervals. The ASCII text includes: date and time stamp, SpO<sub>2</sub> pulse rate, PI, and alarm and exception values. All text is single line followed by a line feed character and a carriage return.</p> <p><b>ASCII 2</b> ASCII text data is sent to the serial interface following a query from the connecting computer. RadNet data output is in this format.</p> <p><b>Philips VUELINK</b> SpO<sub>2</sub>, pulse rate and plethysmographic waveform data are sent in Philips Vuelink format to the serial port.</p>

**MENU ITEMS DESCRIPTION**

<b>NURSE CALL TYPE</b>	<p><b>Alarms</b> The nurse call output will be activated based on alarm events.</p> <p><b>Low Signal IQ</b> The nurse call output will be activated based on Low Signal IQ events.</p> <p><b>Alarm &amp; Low Signal IQ</b> The nurse call output will be activated based on alarm and Low Signal IQ events.</p>
<b>NURSE CALL POLARITY</b>	<p><b>Normal</b> Standard polarity. See section 7, <i>Analog output / nurse call specifications</i>.</p> <p><b>Invert</b> This setting reverses the Normally Open and Normally closed contacts. See section 7, <i>Analog output / nurse call specifications</i>.</p>

**CAUTION:** TO AVOID EXCESSIVE BATTERY DISCHARGING, DO NOT CONNECT ANY EQUIPMENT TO THE SERIAL PORT ON THE BACK PANEL UNLESS THE RAD-8 PULSE OXIMETER IS CONNECTED TO THE AC MAIN POWER SUPPLY.

Pressing  a sixth time returns the Rad-8 to patient monitoring in the Saturation/Pulse Rate Mode. Additionally, the Rad-8 will automatically return to patient monitoring display from any menu level/setting after 10 seconds with no key presses.

**System interfaces****PHILIPS VUELINK SETUP**

- Select the Philips Vuelink selection from the Output menu on the Rad-8. After selecting, choose the preferred settings by stepping through menu options. Refer to Section 5, *Output*.
- Connect one end of the Vuelink cable to the Serial Output connector on the back of the Rad-8.
- Connect the other end of the Vuelink cable to the Vuelink module and insert the module into the Philips/Agilent monitor rack.
- The SpO<sub>2</sub> and pulse rate values will automatically appear on the HP/Agilent monitor.
- In order for the pleth waveform to be displayed on the Philips/Agilent monitor and for the Philips/Agilent monitor to indicate the alarm conditions measured by the pulse oximeter, the user must configure the Philips/Agilent monitor. Please see the Philips/Agilent Operator's manual for complete instructions.
- The Rad-8 pulse oximeter can be set up to audibly indicate all patient alarms while communicating with the Philips/Vuelink module. Use the Interface Alarms setting in the Output menu to enable and disable audible alarms on the Rad-8.

**RADNET SETUP**

- Select the ASCII 2 selection from the Serial options on the Rad-8 pulse oximeter.
- Connect one end of the serial cable to the Serial Output connector on the back of the Rad-8.
- Connect the other end of the serial cable to the RadNet Interface Module connector.
- Turn the RadNet Interface Module on. A proper connection is shown by the RadNet Interface Module's Online LED being solid.
- With a properly configured RadNet Interface Module, the Rad-8 will automatically display the SpO<sub>2</sub> and Pulse Rate parameters on the screen at the RadNet Central Station.
- The Rad-8 pulse oximeter can be set up to audibly indicate all patient alarms while communicating with the RadNet interface module.

**RADLINK SETUP**





- Select the ASCII 1 selection from the Serial options on the Rad-8 pulse oximeter.
- Connect one end of the serial cable to the Serial Output connector on the back of the Rad-8.
- Connect the other end of the serial cable to the RadLink Bedside Radio serial connector.
- Complete setup in accordance with the RadLink Operator's manual.

## Special Menu

This section gives an overview of the Rad-8 special menu selections available. To navigate through the menus, use the *Mode/Enter*, *Next*, *Up* and *Down* keys located on the front panel of the oximeter. The following sub-sections describe each menu item in more detail. The oximeter has options that allow user configuration to suit specific needs.



### SPECIAL MENU – STANDARD, HOME AND SLEEP MODE

Turn instrument on, then push and hold the *Mode/Enter* and *Next* buttons simultaneously for 3 seconds to enter the special menu levels.

BUTTONS		SETTING
 Simultaneous for 3 seconds		Enter Standard Mode - (STZ) Use <i>Up</i> or <i>Down</i> Arrow Keys to adjust parameter to desired setting. <b>NOTE:</b> The parameter is <i>set/selected</i> when <i>Mode Enter</i> or <i>Next</i> are pressed.
 Press	 to toggle to Home Mode - (HMM)	<b>NOTE:</b> Only available Indicators are illuminated while adjusting setting
 Press	 to toggle to Sleep Mode* - (SLP)	

**\*CAUTION: ALARMS ARE DISABLED IN THIS MODE.**

### HOME MODE OPERATION

The Rad-8 can be placed into the Home Mode to protect unqualified users from changing the Rad-8 alarm settings and operation. Only the following menu and front panel functions are available: display brightness (press  +  to adjust brightness), pulse beep volume adjustment and alarm suspend. Alarm volume is at highest setting. All default and user defined default settings are locked to their current values when home mode is selected and return to those values after a power cycle. Upon power up, the HMM mode will be displayed along with a 10 second display of parameters. To turn the unit off the power key must be depressed and held for 3 seconds. The *Mode Enter* and *Next* key held simultaneously for 3 second will put it back into the special menu to select a different mode.





### SLEEP MODE OPERATION

The Rad-8 can be placed into the Sleep Mode to allow the unit to capture normal and abnormal patient data without triggering the alarms. This mode will blank out the unit display with the exception of the Battery Level Indicator and the Alarm Silenced Indicator and disable the alarms even after a power cycle. However, any single key press will bring the display back for 10 seconds. Upon power up, the SLP mode will be displayed along with a 10 second display of parameter settings. The *Mode Enter* and *Next* key held simultaneously for 3 seconds (select next (STD), *Mode Enter*) will put it back into the special menu to exit.

**CAUTION: ALARMS ARE DISABLED IN THIS MODE.**

**NOTE:** If the unit is connected to a RadNet system, there will be no communication with RadNet in Home and Sleep mode.

## SPECIAL MENU – SpO<sub>2</sub> AND BPM ALARM LIMITS

BUTTONS		SETTINGS
		SpO <sub>2</sub> High Alarm Limit
		SpO <sub>2</sub> Low Alarm Limit
		Pulse Rate High Alarm Limit
		Pulse Rate Low Alarm Limit

Use *Up* or *Down* Arrow Keys to adjust parameter to desired setting.  
**NOTE:** The parameter is *set/selected* when the *Mode Enter* or *Next* are pressed.

## Trend setup and use

### INTRODUCTION

The Rad-8 can store up to 72 hours of SpO<sub>2</sub>, pulse rate, and perfusion index trend data captured at 2 second intervals. The trend data can then be transferred to a PC for evaluation.

A serial cable is required to connect the Rad-8 to a PC. Patient monitoring is not possible while trend memory is being transferred to a PC.

Trend data is stored in non-volatile memory, so it is not erased when the unit is shut off.

A trend data download is initiated using the TrendCom utility which downloads the trend data and saves it to an ASCII text (.out) file with an output delimiter option.

### TRENDCOM UTILITY INSTALLATION

Copy the TrendCom utility from the TrendCom CD onto a PC running MS-Windows.

### TRENDCOM UTILITY OPERATION

1. Turn Rad-8 off if not already off.
2. Connect serial cable to Rad-8 and other end to a com port on the PC.
3. Turn the Rad-8 on.
4. Start the TrendCom utility on the PC.
5. Select Rad-8 from the first pull-down menu.
6. Select the appropriate com port number from the second pull-down menu, if necessary.
7. Select the Output Delimiter Option (Tab, Comma or Space).
8. Select the **RETRIEVE TREND** button on the TrendCom utility. Select the desired location and assign a file name for the trend file. Select **SAVE**.
9. The Rad-8 will display "dat out" while trend data is being transferred. A progress bar will advance to indicate the status of the download. Larger trend files will take longer to download. Transfer time is approximately 20 seconds per hour of trend data.

**NOTE:** During download of trend in formation, all normal Rad-8 functions are unavailable and the keypad is locked, except for the power button.

- 10 When trend data transfer is complete, close TrendCom and disconnect the Rad-8 from the serial cable.
- 11 Turn the Rad-8 off to exit the trend download mode.
- NOTE:** Contact USB to serial port adapter manufacturer for assistance or support.

#### ERASING TREND MEMORY

To erase (clear) the trend memory, see section 4, menu navigation, "clear trend" and follow the instructions. The Rad-8 continuously trends data. When performing a new study and gathering data on a new patient, it is highly recommended the "clear function" be utilized in order for the results to be separate. *Turning the Rad-8 off will not erase the trend data.*

#### TREND DATA FORMAT

After a successful download of the trend data, a .out file will be created containing the trend-dump information in ASCII delimited format. The format is defined in the following table.

PARAMETER	SPECIFICATION
Date	MMDDYY
Time	HH:MM:SS
SpO <sub>2</sub>	001 to 100, or "----" meaning parameter not available
Pulse Rate	001 to 240, or "---" meaning parameter not available
Perfusion Index	00.00 to 20.00
Exception Messages	<p>The exceptions are displayed as a 3 digit, ASCII encoded, hexadecimal value. The binary bits of the hexadecimal value are encoded as follows:</p> <p>000 = Normal operation; no exceptions</p> <p>001 = No Sensor</p> <p>002 = Defective Sensor</p> <p>004 = Low Perfusion</p> <p>008 = Pulse Search</p> <p>010 = Interference</p> <p>020 = Sensor Off</p> <p>040 = Ambient Light</p> <p>080 = Unrecognized Sensor</p> <p>100 = reserved</p> <p>200 = reserved</p> <p>400 = Low Signal IQ</p> <p>800 = Masimo SET. This flag means the algorithm is running is full SET mode. It requires a SET sensor and needs to acquire some clean data for this flag to be set</p>

#### SAMPLE TREND OUTPUT

```

07/21/04 09:56:08 SpO2=000 PR=000 PI=00.00 EXC=820:OffPat,SET
07/21/04 09:56:10 SpO2=000 PR=000 PI=00.00 EXC=828:Search,OffPat,SET
07/21/04 09:56:12 SpO2=097 PR=069 PI=04.69 EXC=800:SET
07/21/04 09:56:14 SpO2=096 PR=074 PI=02.28 EXC=C00:LowSigIQ,SET
07/21/04 09:56:16 SpO2=098 PR=078 PI=03.64 EXC=800:SET
07/21/04 09:56:18 SpO2=000 PR=000 PI=00.00 EXC=800:SET
07/21/04 09:56:20 SpO2=000 PR=000 PI=00.00 EXC=820:OffPat,SET
07/21/04 09:56:22 SpO2=096 PR=078 PI=02.68 EXC=800:SET

```

## Alarm identification

The Rad-8 visually and audibly indicates alarm conditions that the system detects.

Audible alarms may be silenced, without affecting the operation of visual alarms.

Two levels of alarm priority are implemented: high and low priority. The following table outlines the alarm priority specifications.

ALARM PRIORITY	PARAMETER	ALARM TYPE
High	Low saturation (SpO <sub>2</sub> range 1-100%)	Audible and visual
	System failures	
	High pulse rate (pulse rate range 30-240 bpm)	
	Low pulse rate (pulse rate range 25-235 bpm)	
Low	Sensor off and no sensor	Audible and visual
	Low battery	
	High saturation (SpO <sub>2</sub> range 2-100%)	

## Alarm indication

An alarm condition is indicated by:

- Audible alarm tone
- Visual Alarm Indicator
- Out-of-limit parameter will flash

"no sensor" and "sensor off" will only generate an alarm condition after a pulse has been found.

## Alarm limits

**CAUTION:** TO ENSURE THAT ALARM LIMITS ARE APPROPRIATE FOR THE PATIENT BEING MONITORED, CHECK THE LIMITS EACH TIME THE PULSE OXIMETER IS USED.

An audible alarm and a flashing alarm status indicator will occur when an alarm limit is exceeded for greater than five seconds (See section 4, *Alarm Features and Sensitivity* to adjust this setting). It is best that the operator be within a minimum of 10 feet from the unit. Directions for alarm suspension are indicated below. When a sensor is not connected to a patient the “no sensor” indicator will illuminate. When a sensor is not connected to its cable, “sensor off” indicator will illuminate. An audible alarm will accompany the visual indicator unless the oximeter has been set to Alarm Suspend Mode.

SETTING	RANGE
SpO <sub>2</sub> High Limit	The SpO <sub>2</sub> high alarm limit can be set anywhere between 2% and 99%, with a 1% step size. In the “----” (off) setting, the SpO <sub>2</sub> High Limit alarm is disabled.
SpO <sub>2</sub> Low Limit	The SpO <sub>2</sub> low alarm limit can be set anywhere between 1% and 99%, with a 1% step size. <b>NOTE:</b> The low alarm limit must always be set below the high alarm setting. Attempting to set the high alarm limit below the low alarm limit, the low alarm limit will automatically adjust the low limit to the next setting below the newly entered high alarm limit setting.
Pulse Rate High Limit (BPM)	The pulse rate high alarm limit can be set anywhere between 30 BPM and 240 BPM, with a 5 BPM step size.
Pulse Rate Low Limit (BPM)	The pulse rate low alarm limit can be set anywhere between 25 BPM and 235 BPM, with a 5 BPM step size. <b>NOTE:</b> The low alarm limit must always be set below the high alarm setting. Attempting to set the high alarm limit below the low alarm limit, the low alarm limit will automatically adjust the low limit to the next setting below the newly entered high alarm limit setting.

**NOTE:** Pressing and holding down the up and down buttons allow for the rapid scrolling of changing SpO<sub>2</sub> and BPM alarm limits.

**NOTE:** If there is a loss of power for any length of time, the Alarm settings will be set back to the User set defaults. If the user has not utilized this option, then they will be set back to the factory defaults.

## ALARM SILENCE

Audible alarms may be suspended, while visual alarms may not. With the exception of Sleep Mode, there are two audible alarm suspension settings, all controlled by the Alarm Suspend Button. Repeated pressing of the Alarm Suspend button will cycle through two alarm suspend options.

**Power-On** – Alarms are active and Alarm Suspended Indicator is off.

**Push Once** – Alarm is suspended for 120 seconds and Alarm Suspended Indicator flashes (See section 4 “Alarm features and sensitivity” to adjust alarm suspension time period).

**Push Twice** - Return to Audible Alarm Active.

## ALARM SILENCED INDICATOR

The Alarm Silenced Indicator provides visual feedback when illuminated, the Rad-8 audible alarms are muted.

While monitoring a patient, acknowledging an alarm condition by pressing the Alarm Silence Button (one time) will silence the alarm tone for 120 seconds (default) and the Alarm Silenced Indicator will flash. Pressing the Alarm Silence Button a second time (while the Alarm Silenced Indicator is still flashing) will activate alarms and alarm silenced indicator is off.

While not monitoring a patient, acknowledging an alarm condition by pressing the Alarm Silence Button (one time) will permanently silence the alarm tone, and the Alarm Silenced Indicator will remain illuminated until the power is cycled or patient monitoring begins. While in the Home Mode and not monitoring a patient, the alarm will be suspended for 120 seconds (default).

Should the alarm condition be created by a low battery condition, plug the unit into AC power immediately.

**MESSAGES**

The Rad-8 will indicate other data or system errors. Message conditions for the Rad-8 follow:

DISPLAY	TYPE	SOLUTION
<b>LEDS FLASH HORIZONTAL BARS</b>	Pulse Search	Wait for found pulse. (This Search should occur whenever a sensor is first applied to a patient).
<b>PULSE BAR TURNS RED</b> (Bottom two LEDs only)	Low Signal IQ	<ol style="list-style-type: none"> <li>1. Rule out occlusion of blood flow.</li> <li>2. Verify placement of sensor.</li> </ol>
<b>PERFUSION BAR TURNS RED</b> (Bottom two LEDs only)	Low Perfusion	<ol style="list-style-type: none"> <li>1. Rule out occlusion of blood flow.</li> <li>2. Attempt to warm patient.</li> <li>3. Move sensor to better perfused site.</li> </ol> <p><b>NOTE:</b> <i>Masimo recommends using an adhesive sensor whenever low perfusion is expected or evident.</i></p>
<b>SpO<sub>2</sub> NUMBER FLASHES</b>	Saturation limit alarm	Assess /address patient condition. Re-set alarm limits if indicated
<b>PULSE RATE NUMBER FLASHES</b>	Pulse Rate limit alarm	Assess /address patient condition. Re-set alarm limits if indicated.
<b>Err ##</b>	System Fault	Return for service There are several error codes, all error codes require return of the unit to an authorized service center for repair. See Section 9, <i>Service and Repair</i> .
<b>bAd</b> <b>SEN</b>	Defective sensor	Replace sensor
<b>SEN</b> (Blinking)	Unrecognized sensor	Connect appropriate cable
<b>Int</b> <b>del</b> (Blinking)	Interference detected	Ensure that the sensor is properly applied, and cover the sensor site with opaque material, if required.

**Troubleshooting**

The following chart describes what to do if the Rad-8 system does not operate properly or fails.

DISPLAY	TYPE	SOLUTION
<b>UNIT DOES NOT POWER ON</b>	Low battery/ not plugged into AC power supply	Check / plug into AC power supply.
<b>CONTINUOUS SPEAKER TONE</b>	Internal Failure	Unit requires service. Press the Alarm Silence button. If alarm continues to sound, power down unit. If the power button does not turn the unit off, press and hold the sensitivity and alarm suspend buttons simultaneously. Return the unit for service.
	Pulse tone set to "mute"	Press Up Arrow (Rad-8) or Alarm Volume Adjust (Rad-8).
<b>NO SPEAKER TONE</b>	Alarm Suspend Enabled	Inspect Alarm Suspend Indicator. See Section 4, <i>Alarm Suspend</i> . Press Alarm Suspend button until Alarm Suspend Indicator is no longer illuminated or flashing.
	Internal Failure	Use auxiliary power down method by pressing and holding sensitivity and Alarm Suspend buttons simultaneously. Return for service.

**Rad-8 specifications**

**PERFORMANCE**

**Measurement Range**

SpO <sub>2</sub> :	1-100%
Pulse Rate:	25-240 beats per minute (bpm)
Perfusion:	0.02% - 20%
Response time:	<1 second delay

**ACCURACY**

Saturation	70% to 100%
<i>No Motion</i> <sup>1</sup>	
Adults, Pediatrics	±2 digits
Neonate	±3 digits

*Motion*<sup>2</sup>

Adults <sup>1</sup> , Pediatrics <sup>1</sup>	±3 digits
Neonate	±3 digits

*Low Perfusion*<sup>3</sup>

Adults, Pediatrics	±2 digits
Neonate	±3 digits

**Pulse Rate Accuracy**

<b>Pulse rate:</b>	25-240 bpm
--------------------	------------

*No Motion*<sup>1</sup>

Adults, Pediatrics, Neonate	±3 digits
-----------------------------	-----------

*Motion*<sup>2</sup>

Adults, Pediatrics, Neonate	±5 digits
-----------------------------	-----------

*Low Perfusion*<sup>3</sup>

Adults, Pediatrics, Neonates	±3 digits
------------------------------	-----------

**Resolution**

Saturation (%SpO <sub>2</sub> )	1%
---------------------------------	----

Pulse Rate (bpm)

	1 bpm
--	-------

**ELECTRICAL**

AC Power requirements:	100-240 VAC, 50-60 Hz
------------------------	-----------------------

Power consumption:	15 VA max.
--------------------	------------

Battery

Type:	Sealed lead acid
-------	------------------

Capacity:	8 hours <sup>4</sup>
-----------	----------------------

Charging time:	8 hours
----------------	---------

**ENVIRONMENTAL**

Operating Temperature:	41°F to 104°F (5°C to 40°C)
------------------------	-----------------------------

Transportation/Storage Temperature:	-40°F to 158°F (-40°C to +70°C) <sup>5</sup>
-------------------------------------	--

Operating/Storage Humidity:	5% to 95%, non-condensing
-----------------------------	---------------------------

Operating Altitude:	500 mbar to 1060 mbar pressure, -1000 ft to 18,000 ft (-304 m to 5,486 m)
---------------------	--

## specifications

### PHYSICAL CHARACTERISTICS

**Dimensions:** 8.2" x 6.0" x 3.0" (20.8 cm x 15.2cm x 7.6 cm)  
**Weight:** 2.1 lbs. = .908 Kg. = 32 oz

#### Rad-8 Modes

Rad-8 Averaging mode: 2, 4, 8,10, 12, 14 or 16 seconds<sup>1</sup>

Rad-8 Sensitivity: Normal, Maximum and APOD

#### Alarms

Sensor condition, system failure and low battery alarms

Audible and visual alarms for high and low saturation and pulse rate

(SpO<sub>2</sub> range 1-99%, --- off, pulse rate range 25-240 bpm)

**High Priority:** 800 Hz tone, 5 pulse burst, pulse spacing: 0.250s, 0.250s, 0.500s, 0.250s, repeat time: 10s

**Low Priority:** 500 Hz tone, 3 pulse, repeat time: 5s

**Alarm Volume:** 80 dB max

#### Display/Indicators

**Data display:** %SpO<sub>2</sub>, pulse rate, alarm status, alarm silenced status, AC power, Signal IQ / pleth bar, perfusion index bar, battery status, no sensor, sensor off

APOD, Norm, Max, FastSat, Trauma

**Type:** LED

**Display update rate** 1 second

#### Compliance

**EMC Compliance:** EN60601-1-2, Class B

**Equipment Classification:** IEC 60601-1/UL 60601-1/IEC 60601-1-1

**Type of Protection** Class 1 (on AC power), Internally powered (on battery power)

**Degree of Protection-Patient Cable:** Type BF-Applied Part

**Rad-8 Mode of Operation:** Continuous

- Masimo SET technology with LNOP Adt/ Neo sensors has been validated for no motion accuracy in human blood studies on healthy adult male and female volunteers with light to dark skin pigmentation in induced hypoxia studies in the range of 70-100% SpO<sub>2</sub> against a laboratory co-oximeter and ECG monitor. This variation equals plus or minus one standard deviation which encompasses 68% of the population. The saturation accuracy of the neonatal sensors were validated on adult male and female volunteers with light to dark skin pigmentation and 1% was added to account for the properties of fetal hemoglobin.
- Masimo SET technology with LNOP Adt sensors has been validated for motion accuracy in human blood studies on healthy adult male and female volunteers with light to dark skin pigmentation in induced hypoxia studies while performing rubbing and tapping motions, at 2 to 4 Hz at an amplitude of 1 to 2 cm and a non-repetitive motion between 1 to 4Hz at an amplitude of 2 to 3 cm in induced hypoxia studies in the range of 70-100% SpO<sub>2</sub> against a laboratory CO-oximeter and ECG monitor. This variation equals plus or minus one standard deviation which encompasses 68% of the population. The saturation accuracy of the neonatal sensors were validated on adult male and female volunteers with light to dark skin pigmentation and 1% was added to account for the properties of fetal hemoglobin.
- Masimo SET technology has been validated for low perfusion accuracy in bench top testing against a Biotek Index 2 simulator and Masimo's simulator with signal strengths of greater than 0.02% and a % transmission of greater than 5% for saturations ranging from 70 to 100%. This variation equals plus or minus one standard deviation which encompasses 68% of the population.
- This represents approximate run time at lowest indicator brightness and pulse tone turned off using a fully charged battery.
- With FastSat the averaging time is dependent on the input signal. For the 2 and 4 second settings the averaging time may range from 2-4 and 4-6 seconds, respectively.

## specifications

### Serial interface specifications

The digital interface for serial communication is based on the standard RS-232 protocol.

The Rad-8 pulse oximeter by default always outputs ASCII12 text data through the serial port, unless the user selects a different output mode in the Output menu. To interface with the Rad-8 and receive serial text data, simply connect a serial interface cable to the serial output connector located on the back of the Rad-8.

**NOTE:** Trend data packets are collected at 2 second intervals. Each data packet contains: the date, time, SpO<sub>2</sub>, pulse rate, perfusion index and alarm and exception values (in ASCII format).

#### SERIAL INTERFACE SETUP

To interface with the Rad-8 serial port, set the following communication parameters on the interfacing serial device:

PARAMETER	SETTING
<b>BAUD RATE</b>	9600 Baud bi-directional
<b>NUMBER OF BITS PER CHARACTER</b>	8
<b>PARITY</b>	None
<b>BITS</b>	1 start, 1 stop
<b>HANDSHAKING</b>	None
<b>CONNECTOR TYPE</b>	Female DB-9

The pin-outs for the RS-232 connector are shown in the following table:

PIN	SIGNAL NAME
<b>1</b>	No Connection
<b>2</b>	Receive data – RS-232 ±9 V (±5 Vmin)
<b>3</b>	Transmit data – RS-232 ±9 V (±5 Vmin)
<b>4</b>	No Connection
<b>5</b>	Signal Ground Reference for COM signals
<b>6</b>	No Connection
<b>7</b>	No Connection
<b>8</b>	No Connection
<b>9</b>	No Connection



### SERIAL PRINTER SETUP

To print the SpO<sub>2</sub> and pulse rate data in ASCII11 format on a serial printer, simply connect the laser printer to the serial port and set output mode to ASCII11. Once serial communication is established, the Rad-8 automatically will start printing the ASCII11 text data.

**WARNING: ALL EXTERNAL DEVICE CONNECTIONS TO THE RS-232 SERIAL PORT MUST BE IEC-60950 COMPLIANT.**

### Nurse call specifications

The nurse call features are accessible via the 1/4" round female connector on the back of the unit.

#### NURSE CALL

The nurse call feature on the Rad-8 pulse oximeter is based on the relay closing or opening depending on alarm, Low Signal IQ events or both. In addition the nurse call polarity can be inverted to accommodate various nurse call stations requirements.

The nurse call relays have the following electrical specification per switch:

PARAMETER	SPECIFICATION
MAX VOLTAGE	36 VDC or 24 VAC peak

**WARNING: THE NURSE CALL FEATURE IS DISABLED WHEN THE AUDIBLE ALARMS ARE SILENCED WHILE THE NURSE CALL SETTING IN THE OUTPUT MENU IS SET TO "ALARMS".**

### Introduction

This section covers the use and cleaning of Masimo SET sensors and Masimo SET patient cables.

### Masimo SpO<sub>2</sub> sensors

Before use of any sensor or cable, carefully read the sensor or cable Directions for Use.

Use only Masimo oximetry sensors and cables for SpO<sub>2</sub> measurements. Other oxygen transducers or sensors may cause improper Rad-8 pulse oximeter performance.

Tissue damage can be caused by incorrect application or use of a Masimo sensor, for example by wrapping the sensor too tightly. Inspect the sensor site as directed in the sensor Directions for Use to ensure skin integrity and correct positioning and adhesion of the sensor.

#### CAUTIONS:

- DO NOT USE DAMAGED SENSORS. DO NOT USE A SENSOR WITH EXPOSED OPTICAL OR ELECTRICAL COMPONENTS. DO NOT IMMERSER THE SENSOR IN WATER, SOLVENTS, OR CLEANING SOLUTIONS (THE SENSORS AND CONNECTORS ARE NOT WATERPROOF). DO NOT STERILIZE BY IRRADIATION, STEAM, OR ETHYLENE OXIDE. SEE THE CLEANING INSTRUCTIONS IN THE DIRECTIONS FOR USE FOR REUSABLE MASIMO SENSORS.
- DO NOT USE DAMAGED PATIENT CABLES. DO NOT IMMERSER THE PATIENT CABLES IN WATER, SOLVENTS, OR CLEANING SOLUTIONS (THE PATIENT CABLE CONNECTORS ARE NOT WATERPROOF). DO NOT STERILIZE BY IRRADIATION, STEAM, OR ETHYLENE OXIDE.
- ALL SENSORS AND CABLES ARE DESIGNED FOR USE WITH SPECIFIC MONITORS. VERIFY THE COMPATIBILITY OF THE MONITOR, CABLE AND SENSOR BEFORE USE, OTHERWISE PATIENT INJURY CAN RESULT.
- DO NOT USE ADDITIONAL TAPE TO WRAP SENSOR.

### SELECTING A MASIMO SET SENSOR

When selecting a sensor, consider, the patient's weight, the adequacy of perfusion, the available sensor sites, and the duration of monitoring. For more information refer to the following table or contact your Sales Representative. Use only Masimo SET sensors and sensor cables. Select an appropriate sensor, apply it as directed, and observe all warnings and cautions presented in the directions for use accompanying the sensor.

High ambient light sources such as surgical lights (especially those with a xenon light source), bilirubin lamps, fluorescent lights, infrared heating lamps, and direct sunlight can interfere with the performance of an SpO<sub>2</sub> sensor. To prevent interference from ambient light, ensure that the sensor is properly applied, and cover the sensor site with opaque material, if required. Failure to take this precaution in high ambient light conditions may result in inaccurate measurements.

**SENSOR APPLICATION INSTRUCTIONS**

Unless indicated otherwise in the directions for use, reposition reusable sensors at least every 4 hours and for adhesive sensors inspect the site at least every 8 hours or sooner, if indicated by circulatory condition or skin integrity, reapply to a different monitoring site.

**LNOP™ DIRECT CONNECT REUSEABLE SENSORS**

SENSOR	Weight Range	Saturation Accuracy		Pulse Rate Accuracy		Low Perfusion Accuracy	
		No Motion	Motion	No Motion	Motion	Saturation	Pulse Rate
LNOP DCSC	> 30 kg	± 2%	± 3%	± 3 bpm	± 5 bpm	± 2%	± 3 bpm
LNOP DC-12	> 30 kg	± 2%	± 3%	± 3 bpm	± 5 bpm	± 2%	± 3 bpm

**LNOP™ REUSABLE SENSORS**

(LNOP sensors must be used in conjunction with PC cables)

SENSOR	Weight Range	Saturation Accuracy		Pulse Rate Accuracy		Low Perfusion Accuracy	
		No Motion	Motion	No Motion	Motion	Saturation	Pulse Rate
LNOP DCI	> 30 kg	± 2%	± 3%	± 3 bpm	± 5 bpm	± 2%	± 3 bpm
LNOP DCIP	10 - 50 kg	± 2%	± 3%	± 3 bpm	± 5 bpm	± 2%	± 3 bpm
LNOP YI	> 1 kg	± 2%	± 3%	± 3 bpm	± 5 bpm	N/A	N/A
LNOP TC-I	> 30 kg	± 3.5%	N/A	± 3 bpm	N/A	± 3.5%	± 3 bpm
LNOP DC-195	> 30 kg	± 2%	± 3%	± 3 bpm	± 5 bpm	± 2%	± 3 bpm
LNOP TF-I	> 30 kg	± 2%	N/A	± 3 bpm	N/A	± 2%	± 3 bpm

**NOTE:** The LNOP TF-I and TC-I sensors were not validated under motion conditions.

**LNOP™ ADHESIVE SENSORS**

(LNOP sensors must be used in conjunction with PC cables)

SENSOR	Weight Range	Saturation Accuracy		Pulse Rate Accuracy		Low Perfusion Accuracy	
		No Motion	Motion	No Motion	Motion	Saturation	Pulse Rate
LNOP Adt	> 30 kg	± 2%	± 3%	± 3 bpm	± 5 bpm	± 2%	± 3 bpm
LNOP Adtx	> 30 kg	± 2%	± 3%	± 3 bpm	± 5 bpm	± 2%	± 3 bpm
LNOP Pdt	10 - 50 kg	± 2%	± 3%	± 3 bpm	± 5 bpm	± 2%	± 3 bpm
LNOP Pdtx	10 - 50 kg	± 2%	± 3%	± 3 bpm	± 5 bpm	± 2%	± 3 bpm
LNOP Neo	< 10 kg	± 3%	± 3%	± 3 bpm	± 5 bpm	± 3%	± 3 bpm
LNOP NeoPt	< 1 kg	± 3%	± 3%	± 3 bpm	± 5 bpm	± 3%	± 3 bpm
LNOP Neo-L	< 3 kg	± 3%	± 3%	± 3 bpm	± 5 bpm	± 3%	± 3 bpm
	> 40 kg	± 2%	± 3%	± 3 bpm	± 5 bpm	± 2%	± 3 bpm
LNOP NeoPHL	< 1 kg	± 3%	± 3%	± 3 bpm	± 5 bpm	± 3%	± 3 bpm
LNOP Inf-L	3 - 20 kg	± 2%	± 3%	± 3 bpm	± 5 bpm	± 2%	± 3 bpm

**LNOP™ SPECIALTY SENSORS**

(LNOP sensors must be used in conjunction with PC cables)

SENSOR	Weight Range	Saturation Accuracy		Pulse Rate Accuracy		Low Perfusion Accuracy	
		No Motion	Motion	No Motion	Motion	Saturation	Pulse Rate
LNOP Blue	2.5 - 30 kg	60 - 80% ± 4%	N/A	± 3 bpm	N/A	± 3%	± 3 bpm
		70 - 100% ± 3.3%	N/A	± 3 bpm	N/A	± 3%	± 3 bpm
		80 - 100% ± 3%	N/A	± 3 bpm	N/A	± 3%	± 3 bpm
LNOP Newborn Neo	< 3 kg	± 3%	± 3%	± 3 bpm	± 5 bpm	± 3%	± 3 bpm
LNOP Newborn Inf	3 - 20 kg	± 2%	± 3%	± 3 bpm	± 5 bpm	± 2%	± 3 bpm

**LNOP™ ADHESIVE SENSORS**

(LNOP sensors must be used in conjunction with PC cables)

SENSOR	Weight Range	Saturation Accuracy		Pulse Rate Accuracy		Low Perfusion Accuracy	
		No Motion	Motion	No Motion	Motion	Saturation	Pulse Rate
LNOPv In	3 - 20 kg	± 2%	± 3%	± 3 bpm	± 5 bpm	± 2%	± 3 bpm
LNOPv Ne	< 3 kg	± 3%	± 3%	± 3 bpm	± 5 bpm	± 3%	± 3 bpm
LNOPv Ad	> 30 kg	± 2%	± 3%	± 3 bpm	± 5 bpm	± 2%	± 3 bpm

**LNCS™ REUSABLE SENSORS**

(LNCS sensors must be used in conjunction with LNC cables)

SENSOR	Weight Range	Saturation Accuracy		Pulse Rate Accuracy		Low Perfusion Accuracy	
		No Motion	Motion	No Motion	Motion	Saturation	Pulse Rate
LNCS DCI	> 30 kg	± 2%	± 3%	± 3 bpm	± 5 bpm	± 2%	± 3 bpm
LNCS DCIP	10 - 50 kg	± 2%	± 3%	± 3 bpm	± 5 bpm	± 2%	± 3 bpm
LNCS TC-I	> 30 kg	± 3.5%	N/A	± 3 bpm	N/A	± 3.5%	± 3 bpm
LNCS TF-I	> 30 kg	± 2%	N/A	± 3 bpm	N/A	± 2%	± 3 bpm
LNCS YI	> 1 kg	± 2%	± 3%	± 3 bpm	± 5 bpm	N/A	N/A

**NOTE:** The LNCS TF-I and TC-I sensors were not validated under motion conditions.

**LNCS™ ADHESIVE SENSORS**

(LNCS sensors must be used in conjunction with LNC cables)

SENSOR	Weight Range	Saturation Accuracy		Pulse Rate Accuracy		Low Perfusion Accuracy	
		No Motion	Motion	No Motion	Motion	Saturation	Pulse Rate
LNCS Adtx	> 30 kg	± 2%	± 3%	± 3 bpm	± 5 bpm	± 2%	± 3 bpm
LNCS Pdtx	10 - 50 kg	± 2%	± 3%	± 3 bpm	± 5 bpm	± 2%	± 3 bpm
LNCS Inf-L	3 - 20 kg	± 2%	± 3%	± 3 bpm	± 5 bpm	± 2%	± 3 bpm
LNCS Neo-L	< 3 kg	± 3%	± 3%	± 3 bpm	± 5 bpm	± 3%	± 3 bpm
	> 40 kg	± 2%	± 3%	± 3 bpm	± 5 bpm	± 2%	± 3 bpm
LNCS NeoPHL	< 1 kg	± 3%	± 3%	± 3 bpm	± 5 bpm	± 3%	± 3 bpm

**CLEANING AND REUSE OF MASIMO SENSORS**

Reusable sensors can be cleaned per the following procedure:

- Remove the sensor from the patient.
- Disconnect the sensor from the monitor.
- Wipe the entire sensor clean with a 70% isopropyl alcohol pad.
- Allow the sensor to air dry before returning it to operation.

**REATTACHMENT OF SINGLE USE ADHESIVE SENSORS**

- Single use sensors may be reapplied to the same patient if the emitter and detector windows are clear and the adhesive still adheres to the skin.
- The adhesive can be partially rejuvenated by wiping with a 70% isopropyl alcohol wipe and allowing the sensor to thoroughly air dry prior to replacement on the patient.

**NOTE:** *If the sensor fails to track the pulse consistently, the sensors may be incorrectly positioned. Reposition the sensor or choose a different monitoring site.*

**WARNING: TO AVOID CROSS CONTAMINATION ONLY USE MASIMO SINGLE USE SENSORS ON THE SAME PATIENT.**

**CAUTIONS:**

- DO NOT REPROCESS ANY SINGLE USE SENSORS.
- DO NOT SOAK OR IMMERSE THE SENSOR IN ANY LIQUID SOLUTION. DO NOT STERILIZE ANY MASIMO SENSOR BY IRRADIATION, STEAM, OR ETHYLENE OXIDE.

**Masimo SET patient cables**

Reusable patient cables of various lengths are available. Only use appropriate Masimo oximetry patient cables for SpO<sub>2</sub> measurements. Other patient cables may cause improper Rad-8 pulse oximeter performance.

**CLEANING AND REUSE OF MASIMO SET PATIENT CABLES**

Patient cables can be cleaned per the following procedure:

- Remove the cable from the sensor.
- Disconnect the cable from the monitor.
- Wipe clean with a 70% isopropyl alcohol pad.
- Allow the cable to dry before returning it to operation.

**CAUTIONS:**

- CAREFULLY ROUTE PATIENT CABLES TO REDUCE THE POSSIBILITY OF PATIENT ENTANGLEMENT OR STRANGULATION.
- DO NOT SOAK OR IMMERSE PATIENT CABLES IN ANY LIQUID SOLUTION. DO NOT STERILIZE PATIENT CABLES BY IRRADIATION, STEAM, OR ETHYLENE OXIDE. SEE THE CLEANING INSTRUCTIONS IN THE DIRECTIONS FOR USE FOR REUSABLE MASIMO PATIENT CABLES.
- DO NOT REPROCESS ANY MASIMO SET PATIENT CABLES.

## Introduction

This chapter covers how to test the operation, properly clean and how to obtain service for the Rad-8 oximeter.

Under normal operation, no internal adjustment or recalibration is required.

**WARNING: BEFORE CLEANING THE OXIMETER, ALWAYS TURN IT OFF AND MAKE SURE THE AC POWER CORD IS DISCONNECTED.**

## Cleaning

To clean the display panel, use a cotton swab moistened with 70% isopropyl alcohol and gently wipe the panel.

To clean the outer surface of the oximeter, the following solutions may be used to wipe the instrument for 30 seconds. *Do not allow liquids to enter the interior of the instrument.*

- Glutaraldehyde Solution
- Ammonium Chloride Wipe
- 10% Chlorine bleach in H<sub>2</sub>O
- 70% Isopropyl alcohol

## CAUTIONS:

- DO NOT AUTOCLAVE, PRESSURE STERILIZE, OR GAS STERILIZE THIS OXIMETER.
- DO NOT SOAK OR IMMERSE THE MONITOR IN ANY LIQUID.
- USE THE CLEANING SOLUTION SPARINGLY. EXCESSIVE SOLUTION CAN FLOW INTO THE MONITOR AND CAUSE DAMAGE TO INTERNAL COMPONENTS.
- DO NOT TOUCH, PRESS, OR RUB THE DISPLAY PANELS WITH ABRASIVE CLEANING COMPOUNDS, INSTRUMENTS, BRUSHES, ROUGH-SURFACE MATERIALS, OR BRING THEM INTO CONTACT WITH ANYTHING THAT COULD SCRATCH THE PANEL.
- DO NOT USE PETROLEUM-BASED OR ACETONE SOLUTIONS, OR OTHER HARSH SOLVENTS, TO CLEAN THE OXIMETER. THESE SUBSTANCES ATTACK THE DEVICE'S MATERIALS AND DEVICE FAILURE CAN RESULT.

Refer to Section 8, *Cleaning and Reuse of Masimo Sensors* for cleaning instructions of the sensor.

## Battery Service

**WARNING: THE BATTERY SHOULD BE INSTALLED AND/OR REMOVED FROM THE RAD-8 BY QUALIFIED PERSONNEL ONLY.**

## Performance verification

To test the performance of the Rad-8 pulse oximeter following repairs or during routine maintenance, follow the procedure outlined in this section. If the Rad-8 fails any of the described tests, discontinue its use and correct the problem before returning the unit back to the user.

Before performing the following tests verify unit is connected to AC power. Also disconnect any patient cables or pulse oximetry probes or serial cables from the instrument.

Power-On Self-Test:

1. Turn the monitor on by depressing the Power Button. For about 5 seconds all available LEDs are illuminated and a brief beep tone sounds.
2. The oximeter begins normal operation.

Key Press Button Test:

1. With the exception of the Power Button, press each button and verify that the oximeter acknowledges each key-press with an audible beep tone or by indicating a change on the display.

Alarm Limit Test:

1. With the monitor turned on, select the depress alarm limits button and enter alarm menu. Change the High Saturation Alarm parameter to a value two points below the currently selected value, and accept the change.
2. Verify that the newly set parameter is shown on the Saturation Alarm Limit Display.
3. Return the High Saturation Alarm parameter to its original setting.
4. Repeat steps 1 to 3 with the Low Saturation Alarm parameter.
5. Repeat steps 1 to 3 with the High Pulse Rate Alarm parameter.
6. Repeat steps 1 to 3 with the Low Pulse Rate Alarm parameter.
7. Reset the alarm limits again to the original settings.

LED Brightness:

1. With the monitor turned on, select menu level 2 (see Section 4, *Setup Menu Level 2 - button volume LED Brightness and Factory Defaults*) and use the Up and Down Arrow keys to cycle through all 4 brightness levels.
2. Exit the Menu system by pressing the Mode/Enter key or waiting for the normal time-out.

Testing the Rad-8 with Masimo SET Tester (Optional):

1. Turn the Oximeter off and then on again.
2. Connect the Masimo SET Tester to the Patient Cable Connector.
3. Verify that within 20 seconds a Signal IQ/pulsebar is displayed.
4. Verify that the SpO<sub>2</sub> measurement is between 79% and 84%.
5. Verify that the pulse rate measurement is between 55 bpm and 65 bpm.
6. Set the SpO<sub>2</sub> low alarm limit to 90 (see Section 4, *Setup Menu Level 1 - Alarm Limits and Alarm Volume*).
7. Verify that an audible alarm occurs and the SpO<sub>2</sub> measurement and the Alarm indicator are both flashing.
8. Press the Alarm Silence button once and verify that the alarm is silenced and the Alarm Silence Indicator is flashing.
9. Wait 120 seconds and verify that the alarm silence times out and the audible alarm is activated again and the Alarm Silence Indicator is off.
10. Press the up arrow button several times and verify that the loudness of the pulse beep tone increases.
11. Press the down arrow button and verify that the loudness of the pulse beep tone decreases until the pulse beep tone is turned off.

## Service and repair

### REPAIR POLICY

Masimo or an authorized Service Department must perform warranty repair and service. Do not use malfunctioning equipment. Have the unit repaired.

Please clean contaminated/dirty equipment before returning, following the cleaning procedure described in Section 9, *Cleaning*. Make sure it is fully dry before packing the equipment.

To return the Rad-8 unit for service, please follow the Return Procedure.

**WARNING: AN OPERATOR MAY ONLY PERFORM MAINTENANCE PROCEDURES SPECIFICALLY DESCRIBED IN THIS MANUAL. REFER SERVICING TO QUALIFIED SERVICE PERSONNEL TRAINED IN THE REPAIR OF THIS EQUIPMENT.**

### RETURN PROCEDURE

Please clean contaminated/dirty equipment before returning and make sure it is fully dry before packing the equipment. Call Masimo at 800-326-4890 and ask for Technical Support. Ask for an RMA number. Package the equipment securely – in the original shipping container if possible – and enclose or include the following information and items:

- A letter describing in detail any difficulties experienced with the pulse oximeter. Please include the RMA number in the letter.
- Warranty information – a copy of the invoice or other applicable documentation must be included.
- Purchase order number to cover repair if the oximeter is not under warranty, or for tracking purposes if it is.
- Ship-to and bill-to information.
- Person (name, telephone/telex/fax number, and country) to contact for any questions about the repairs.
- A certificate stating the oximeter has been decontaminated for bloodborne pathogens.

Return Rad-8 pulse oximeter to the following shipping address:

For USA:	For Europe:	For Asia Pacific:
Masimo Corporation 40 Parker Irvine, California 92618 Tel: 949-297-7000 FAX 949-297-7001	Masimo Europe Limited 304 RN6, Le Bois des Cotes 2 69760 Limonest France Tel: +33 (0) 472 17 93 70 FAX: +33 (0) 478 35 78 08	Masimo Japan Corporation World Times Bldg. 4F 10-7, Ichiban-cho, Chiyoda-ku, Tokyo 102-0082 JAPAN Tel: 03 3237 3057 FAX: 03 3238 1110

## Warranty

Masimo warrants to the initial purchaser that each new pulse oximeter will be free from defects in workmanship or materials for a period of one (1) year from the date of purchase. Masimo's sole obligation under this warranty is to repair or replace any product that Masimo deems to be covered under warranty with a repaired or a replacement pulse oximeter. Batteries are not warranted.

To request a replacement or repair of an instrument under warranty, contact Masimo for a returned goods authorization. If Masimo determines that a product must be replaced or repaired under warranty, it will be replaced or repaired and the cost of shipment covered. All other shipping costs shall be the responsibility of the purchaser.

## Exclusions

This warranty does not extend to any product that has been subject to misuse, neglect or accident; that has been damaged by causes external to the product; that has been used in violation of the operating instructions supplied with the product. The warranty does not extend to any product that has been connected to an unlicensed instrument system, modified accessories or any unit that has been disassembled or reassembled by anyone but an authorized Masimo agent.

THIS WARRANTY, TOGETHER WITH ANY OTHER EXPRESS WRITTEN WARRANTY THAT MAY BE ISSUED BY MASIMO IS THE SOLE AND EXCLUSIVE WARRANTY AS TO MASIMO'S PRODUCTS. THIS WARRANTY IS EXPRESSLY IN LIEU OF ANY ORAL OR IMPLIED WARRANTIES, INCLUDING WITHOUT LIMITATION ANY IMPLIED WARRANTY OF MERCHANTABILITY OR FITNESS FOR A PARTICULAR PURPOSE. MASIMO SHALL NOT BE LIABLE FOR ANY INCIDENTAL, SPECIAL OR CONSEQUENTIAL LOSS, DAMAGE OR EXPENSE DIRECTLY OR INDIRECTLY ARISING FROM THE USE OR LOSS OF USE OF ANY PRODUCTS.

## End-user license agreement

THIS DOCUMENT IS A LEGAL AGREEMENT BETWEEN YOU, THE "PURCHASER," AND Masimo Corporation ("MASIMO"). IF YOU DO NOT AGREE TO THE TERMS OF THIS AGREEMENT, PROMPTLY RETURN THE ENTIRE PACKAGE, INCLUDING ALL ACCESSORIES, IN THEIR ORIGINAL PACKAGE, WITH YOUR SALES RECEIPT TO MASIMO FOR A FULL REFUND.

1. Grant of License: In consideration of payment of the license fee, which is part of the price paid for this product, MASIMO grants to Purchaser a nonexclusive, nontransferable license, without right to sublicense, to use the copy of the incorporated software/firmware and documentation in connection with Purchaser's use of the Masimo Products for their labeled purpose. MASIMO reserves all rights not expressly granted to Purchaser.

2. **Ownership of Software/Firmware:** Title to, ownership of, and all rights and interests in, any MASIMO software and/or firmware and the documentation, and all copies thereof, remain at all times vested in MASIMO Corporation, licensor to MASIMO, and they do not pass to Purchaser.
3. **Assignment:** Purchaser shall not assign or transfer this License, in whole or in part, by operation of law or otherwise, without MASIMO's prior written consent; any attempt without such consent, to assign any rights, duties or obligations arising hereunder shall be void.
4. **Copy Restrictions:** The software/firmware and the accompanying written materials are copyrighted. Unauthorized copying of the software, including software that has been modified, merged, or included with other software, or other written materials is expressly forbidden. You may be held legally responsible for any copyright infringement that is caused or incurred by your failure to abide by the terms of this license. Nothing in this license provides any rights beyond those provided by 17 U.S.C. §117.
5. **Use Restriction:** As the Purchaser, you may physically transfer the products from one location to another provided that the software/firmware is not copied. You may not electronically transfer the software/firmware from the products to any other device. You may not disclose, publish, translate, release or distribute copies of the software/firmware or accompanying written materials to others. You may not modify, adapt, translate, reverse engineer, decompile, disassemble, or create derivative works based on the software/firmware. You may not modify, adapt, translate, or create derivative works based on the written materials without the prior written consent of MASIMO.
6. **Transfer Restrictions:** The software/firmware is licensed to the Purchaser, and may not be transferred to anyone, except other end-users, without the prior written consent of MASIMO. In no event may you transfer, assign, rent, lease, sell, or otherwise dispose of the software/firmware or the products on a temporary basis.
7. **Beneficiary:** Masimo Corporation is a Beneficiary of this Agreement and has the right to enforce its provisions.
8. **U.S. Government Rights:** If you are acquiring software (including the related documentation) on behalf of any part of the United States Government, the following provisions apply: the software is deemed to be "commercial software" and "commercial computer software documentation," respectively pursuant to DFAR Section 227.7202 FAR 12.212, as applicable. Any use, modification, reproduction, release, performance, display or disclosure of the software (including the related documentation) by the U.S. Government or any of its agencies shall be governed solely by the terms of this Agreement and shall be prohibited except to the extent expressly permitted by the terms of this agreement.

## Rad-8 Units and Accessories

PART NUMBER	DESCRIPTION
9019	Rad-8, Horizontal
9020	Rad-8, Vertical
9049	Rad-8, Horizontal, Bulk Pack
9050	Rad-8, Vertical, Bulk Pack
13253	Rad-8 Operators Manual, French
13254	Rad-8 Operators Manual, German
13255	Rad-8 Operators Manual, Italian
13256	Rad-8 Operators Manual, Spanish
13257	Rad-8 Operators Manual, Swedish
13258	Rad-8 Operators Manual, Dutch
13259	Rad-8 Operators Manual, Danish
13260	Rad-8 Operators Manual, Portuguese
30955	Rad-8 Operators Manual, Chinese
30956	Rad-8 Operators Manual, Japanese



[www.masimo.com](http://www.masimo.com)

Instruments and sensors containing Masimo SET technology are identified with the Masimo SET logo. Look for the Masimo SET designation on both the sensors and monitors to ensure accurate pulse oximetry when needed most.



© 2007 Masimo Corporation. Masimo, Signal IQ, Discrete Saturation Transform, DST, Satshare, SET, FastSat, Rad-8, Radlink, FastSat, SIO, LNOP, LNCS and are federally registered trademarks of Masimo Corporation. RadNet, Pi, APOD and LNOPv are trademarks of Masimo Corporation.