

ELECTRIC SUBMERSIBLE SEWAGE PUMPS

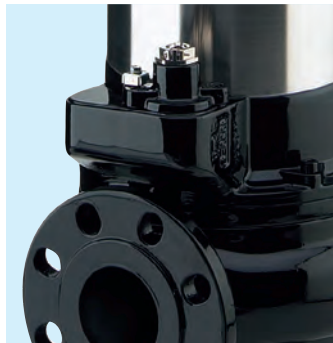

Ranges
AMX, AV(X), AK
Discharge Size
DN 80–DN 150



High Performance in Waste Water Pumping

HOMA submersible waste water and sewage pumps operate worldwide in numerous kinds of domestic, municipal and industrial applications. Decades of experience in the design and manufacturing of submersible pumps plus uncompromising attention to quality in every detail and strict monitoring of production quality ensure the utmost reliability and long service life of all **HOMA** products.



Flexible system-components for problem-free installation

HOMA combines efficiency, safety, high quality and robust design with a flexibility that allows the individual optimization of every project realization:

Pumps for various types of application and installation, a complete program of installation equipment including pipes, valves, pump pits from concrete or composite materials, electric control and monitoring systems. With this range **HOMA** can provide a tailor-made solution for every waste water pumping application.

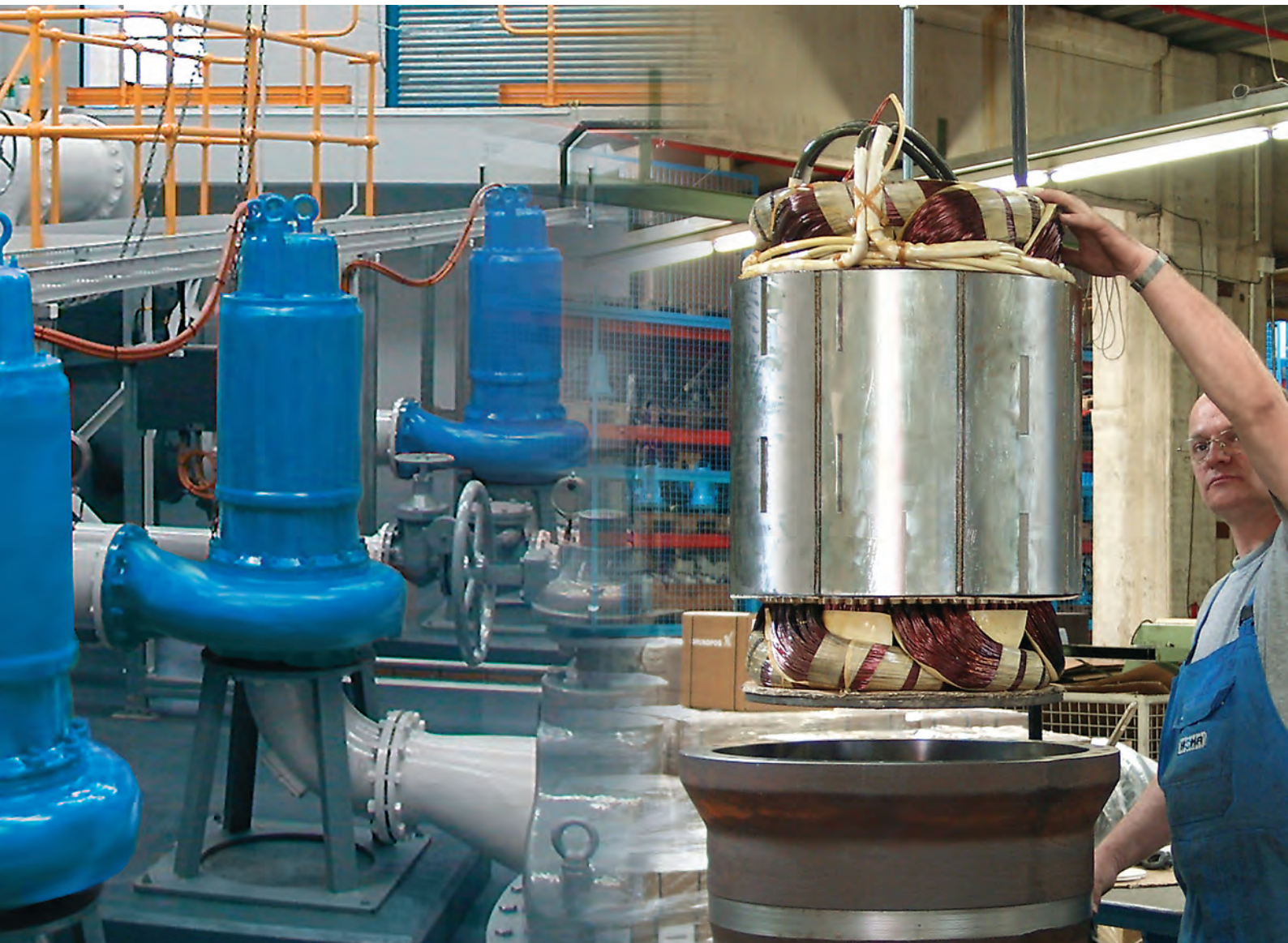

The reliability of fully automatic operation

HOMA waste water pumping stations feature fully automatic control and monitoring. Reliable liquid level control systems of various types (float switch, pneumatic, ultrasound or electronic systems) are available to secure reliable pump operation at minimum energy consumption. All possible fault factors like shaft seal condition, temperatures, moisture or power supply can be automatically monitored and transferred to various alarm systems.

Higher Performance to meet every Challenge

Various challenges – individual solutions: **HOMA** submersible wastewater pumps are designed for pumping sewage, sludge, effluents or surface water, including liquids containing a large proportion of solid or fibrous matter. They are installed in domestic, municipal, industrial and agricultural pumping applications.



The right installation for every pump station

Permanent wet well installation

Submerged autocoupling guide tube system for automatic connection and disconnection of the pump from the pipework from outside the sump. All maintenance or repair work can be done outside the sump. Back in operating position, the weight of the pump ensures leak-proof discharge connection.

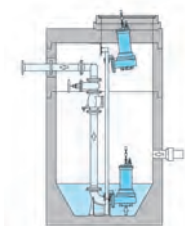

Transportable wet well installation

Submerged pump mounted on a ring base stand for temporary, service or emergency operation. Discharge connection with pipe or hose.

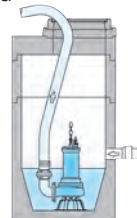

Permanent dry well installation, vertical or horizontal

Flood-proof installation for pump stations with separate collection sump. Fixed flanged connection of suction and discharge pipe.

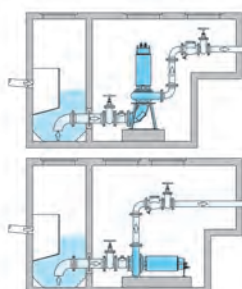

Operating conditions

The motors are designed for continuous operating duty (S1) at maximum 15 starts per hour. In addition to a fully submerged motor housing in wet well installation, a jacket cooled motor-variant is available for S1 operating with a non-fully submerged motor or for dry well installation.

Pumps with enclosed single-channel impellers are designed for intermittent operation, normally in automatic level-controlled wet or dry well sump installations. They are also suitable for limited continuous operation, as in storm water retention tanks. Vortex or enclosed multichannel impeller pumps are also designed for unlimited continuous operation, such as industrial water supply. In this case a low motor speed should be chosen (4- or 6-pole).

Ranges and Models

Motor selection

Motor speed:

For the standard hydraulic ranges, the motors are designed with the following speeds:

- 3450 rpm = 2-pole
- 1750 rpm = 4-pole
- 1160 rpm = 6-pole

Voltages:

All specified data relate to an operating voltage of 380V/3Ph 60Hz or 230V/1Ph 60Hz. Different voltages are available on request.

Type of starting:

The motors are supplied as standard:

- up to 6.5 kW (P2) for DOL starting
- above 6.5 kW (P2) for DOL and star-delta-starting.

On request all motors are available for operating with frequency converter or soft starter device.

Explosion protection:

In addition to the standard version, all motors are available explosion proof according to Cl.I, Div.1, Gr. CD.

Dry well variant:

Besides the version for submerged operation, all pumps are also available for dry well or non-submerged operation. Motor cooling is provided by a cooling jacket, using either the pumped liquid or a closed circuit coolant circulation (model U or L).

Motor monitoring:

All motors are supplied with temperature sensors in the winding, bi-metallic

sensors (standard) or PTC sensors (on request).

● For wet well installation:

Standard motor version /C with oil chamber seal condition monitoring probe and moisture sensor in stator chamber.

Standard motor version /C FM with oil chamber seal condition monitoring probe and – for motors with cable junction chamber – moisture sensor in junction chamber.

● With cooling jacket:

Standard motor version /C with oil chamber seal condition monitoring probe and moisture sensor in stator chamber.

Additional monitoring devices (bearing temperature, stator room moisture) on request.

Hydraulic selection

Discharge and suction flange

- DN 80
- DN 100
- DN 150

Reducing adapters for different auto-coupling system and valve dimensions are available.

Impellers:

A range of different impeller designs are available to provide optimum performance and reliability with various liquids and operating conditions

Impeller spherical clearance:

The pumps are available with impeller spherical clearances from 80 mm to 100 mm according to pump range.



AMX

Enclosed single channel impeller

For liquids containing impurities and sludge with solid particles or long fibres.



AK

Enclosed multi channel impeller

For liquids containing impurities and sludge with solid particles.



AV(X)

Vortex impeller

For liquids containing a high level of impurities or fibrous matter and containing gas.

Pump type code:

Pump	4	4	4	(/1)	-300	Motor /5,5	F	(U)	/C	(FM)
Impeller design	Discharge size (inch):	Spherical clearance (inch):	Speed (rpm):	Voltages:	Impeller diameter (mm):	Motor power (HP):	Motor frame size	Jacket cooled:	Monitoring devices (see motor monitoring)	Explosion proof motor
AMX = Enclosed single channel	3 = DN 80	3 = 80 mm	2-pole = 3450	/1 = 230V/1Ph	e.g. 300 mm	P2		Jacket cooled motor for non-submerged installation		
AV(X) = Vortex	4 = DN100	4 = 100 mm	4-pole = 1750					U= open circuit pumped liquid cooling		
AK = Enclosed two channel	6 = DN150		6-pole = 1160					L= closed circuit liquid cooling		

Design – Proven Quality in Detail

More quality in design and materials – less maintenance and failures

Quality can be measured – **HOMA** submersible waste water pumps are characterized by the robust design, generous dimensioning and high quality materials of all components.

Materials

Motor housing	Cast iron EN-GJL-250 ¹⁾
Pump housing	Cast iron EN-GJL-250 ¹⁾
Impeller	Cast iron EN-GJL-250 ^{1) 2)}
Wear rings	Bronze ¹⁾
Motor shaft	Stainless steel
Mechanical seals	Silicon-carbide / Silicon-carbide
Motor cooling jacket (model U)	Stainless steel
Seals and O-rings	NBR (Perbonane) ³⁾
Cable	H07RN-F (PLUS) ⁴⁾

¹⁾ also available in stainless steel

²⁾ also available in bronze

³⁾ also available from FPM (vitone)

⁴⁾ screened cable on request

1 Discharge

With DIN/ANSI flange DN 80, DN 100 or DN 150 (PN 10).

2 Non-clogging, high efficiency impellers

With large spherical clearance.

Available:

- Enclosed single channel impeller with replaceable wear ring
- Enclosed multi channel impeller with replaceable wear ring
- Vortex impeller.

3 Shaft seals

Two independently working silicon-carbide mechanical seals in tandem-arrangement.

4 Oil chamber

Separate large oil chamber, lubricating and cooling the mechanical seals, forming an extra safety and inspection element. Additional electronic seal condition monitoring probe: standard.

5 Motor

Three-phase electric motors, with 2-, 4- or 6 pole motor speed. Insulation class H (180 °C), degree of protection IP 68.

Explosion protection.

All models available with explosion proof motors.

6 Motor cooling

Motors for submerged operation are cooled by the surrounding liquid.

For dry well or non-submerged operation, motors are available with a cooling jacket, providing a cooling circulation of water from the pump volute (model U). Alternatively, a closed circuit liquid cooling system is available without directly using the pumped liquid for the cooling circuit, providing the heat exchange through a contact surface between heat exchange chamber and pump chamber.

7 Thermal sensor (bi-metal)

Embedded in the motor winding. PTC sensors available on request.

8 Moisture monitoring in stator chamber

Standard, except Model FM.

9 Shaft bearing

Maintenance-free, prelubricated ball bearings.

10 Temperature monitoring of the shaft bearings

Available on request.

11 Cable junction chamber

Separate junction chamber (standard from motor size F, below on request).

12 Electronic moisture sensor in junction chamber

Standard from motor size F, below on request.

13 Pressure sealed, strain relief cable entry.

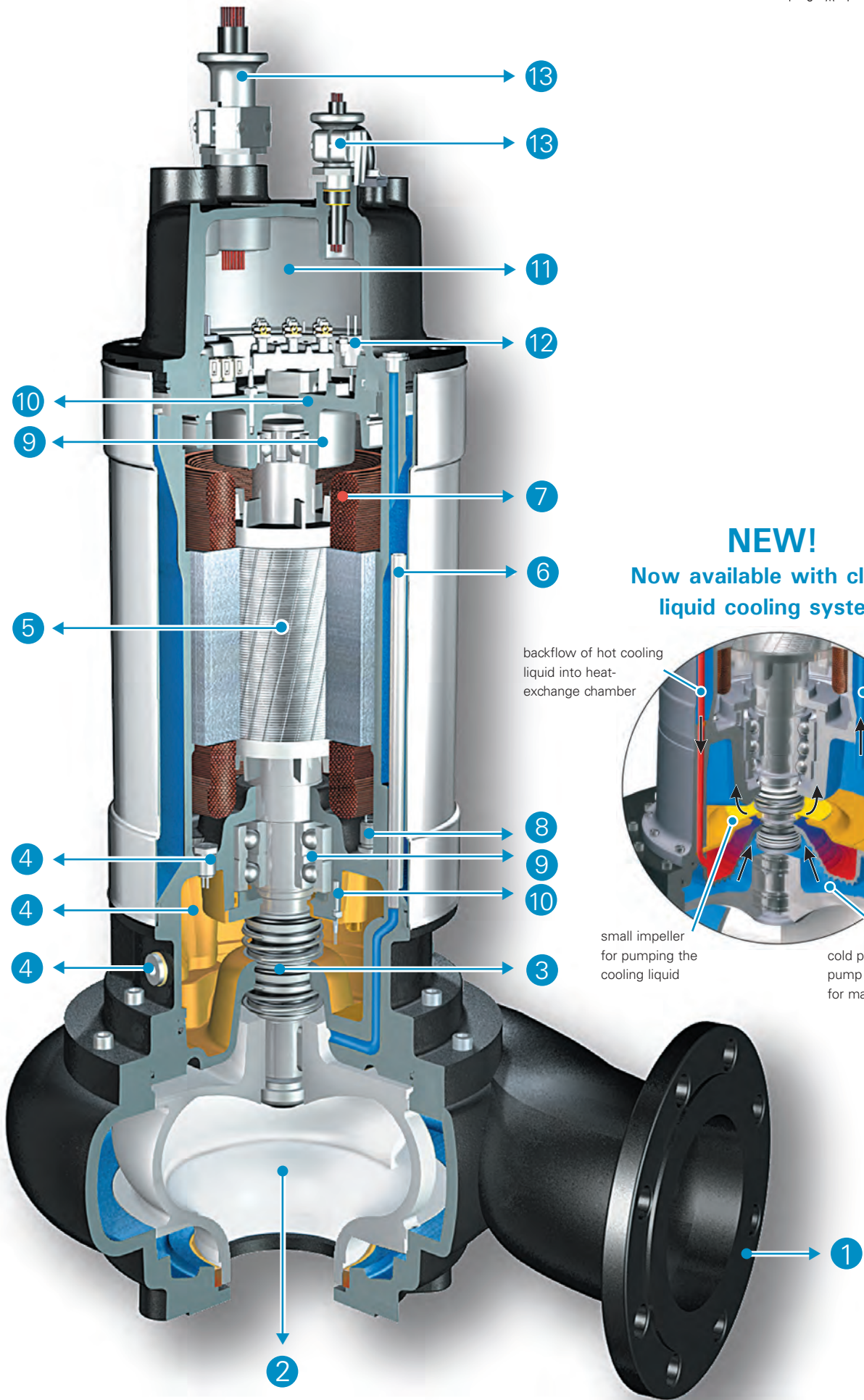

NEW!
Now available with closed
liquid cooling system

backflow of hot cooling
liquid into heat-
exchange chamber

inflow of cold cooling
liquid into motor
jacket chamber

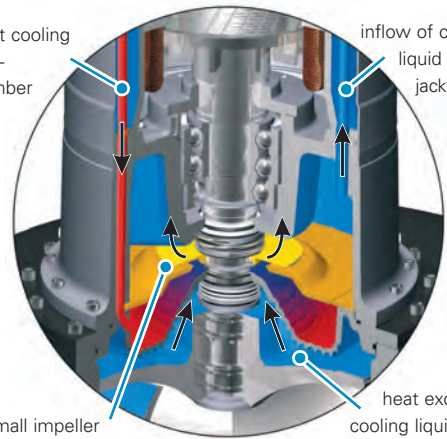

small impeller
for pumping the
cooling liquid

heat exchange of
cooling liquid with
cold pumped liquid trough
pump flange, spiral-shaped
for maximum surface

Pump ranges selection chart

DN80



AV332... -2 pole
Vortex impeller
80 mm Ø Spherical clearance
3450 rpm [See page 11](#)

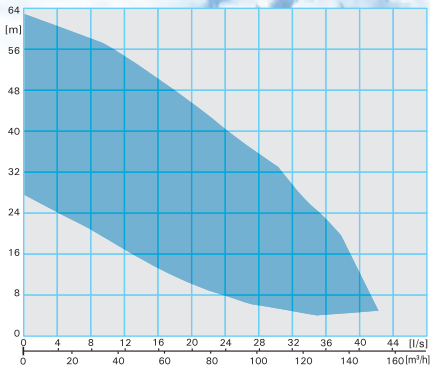

AMX334/1... -4 pole
Enclosed single channel impeller
80 mm Ø Spherical clearance
1750 rpm [See page 12](#)

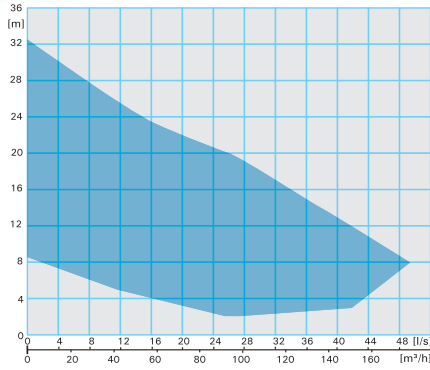

AMX334... -4 pole
Enclosed single channel impeller
80 mm Ø Spherical clearance
1750 rpm [See page 13](#)

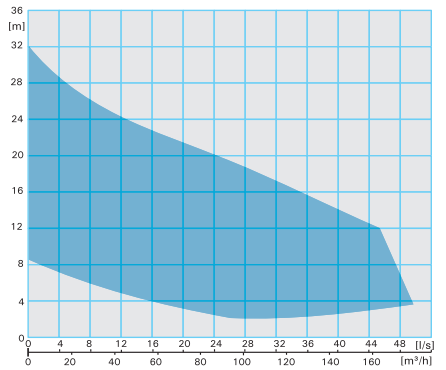

AV(X)334... -4 pole
Vortex impeller
80 mm Ø Spherical clearance
1750 rpm [See page 14](#)

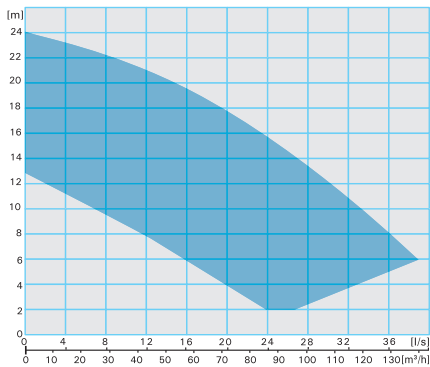

AMX336... -6 pole
Enclosed single channel impeller
80 mm Ø Spherical clearance
1160 rpm [See page 15](#)

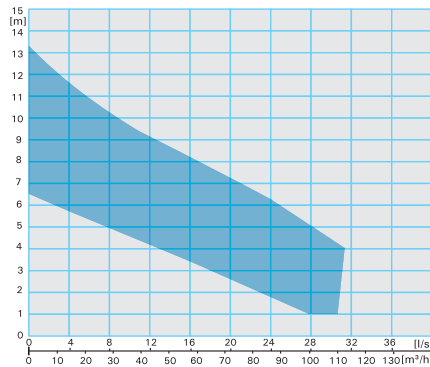

AV(X)336... -6 pole
Vortex impeller
80 mm Ø Spherical clearance
1160 rpm [See page 16](#)

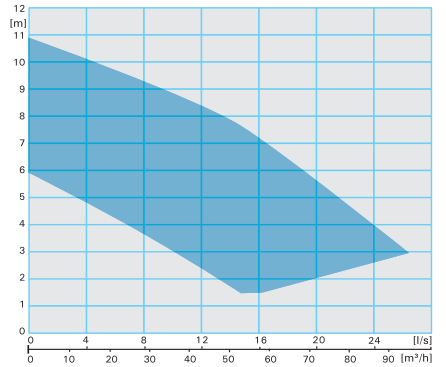

AMX434... -4 pole
Enclosed single channel impeller
80 mm Ø Spherical clearance
1750 rpm [See page 17](#)

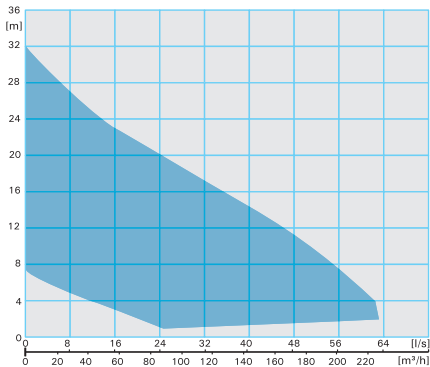

DN100



AV 432... -2 pole
Vortex impeller
80 mm Ø Spherical clearance
3450 rpm [See page 18](#)

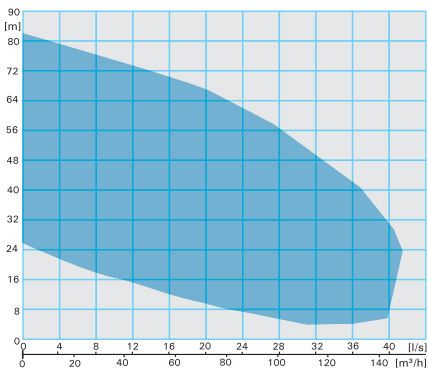

AMX434/1... -4 pole
Enclosed single channel impeller
80 mm Ø Spherical clearance
1750 rpm [See page 19](#)

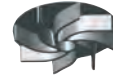
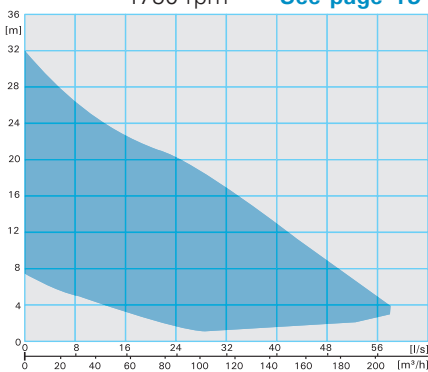

AV(X)434... -4 pole
Vortex impeller
80 mm Ø Spherical clearance
1750rpm [See page 20](#)

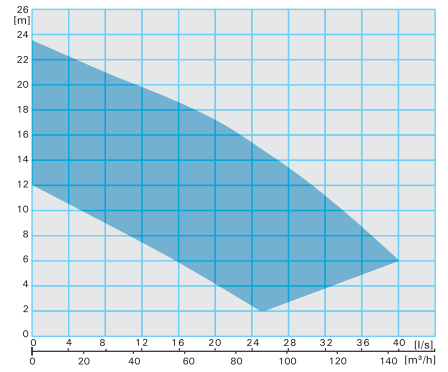

AK434... -4 pole
Enclosed two channel impeller
80 mm Ø Spherical clearance
1750 rpm [See page 21](#)

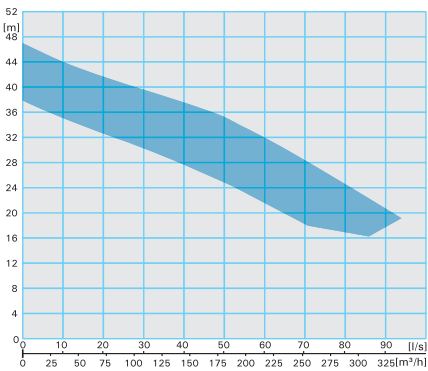

AMX436... -6 pole
Enclosed single channel impeller
80 mm Ø Spherical clearance
1160 rpm [See page 22](#)

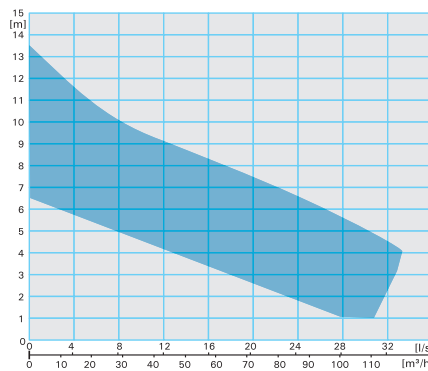

AV(X)436... -6 pole
Vortex impeller
80 mm Ø Spherical clearance
1160 rpm [See page 23](#)

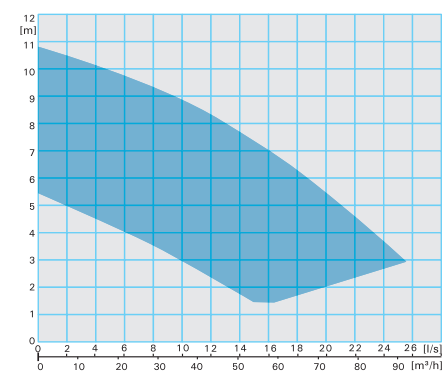

AMX444... -4 pole
Enclosed single channel impeller
100 mm Ø Spherical clearance
1750 rpm [See page 24](#)

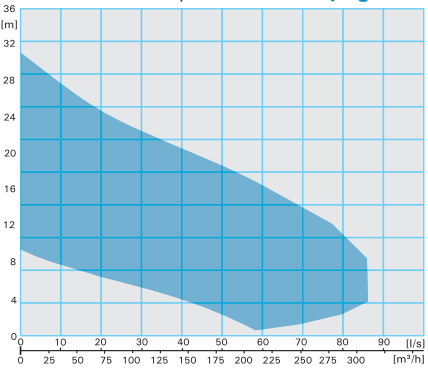

AVX444... -4 pole
Vortex impeller
100 mm Ø Spherical clearance
1750 rpm [See page 25](#)

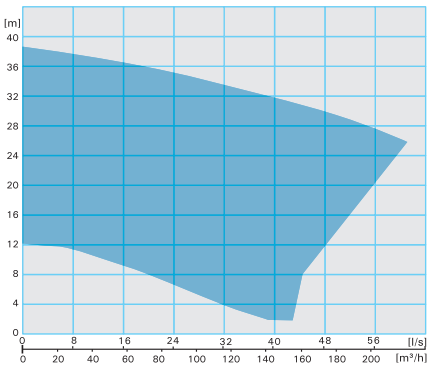

AMX446... -6 pole
Enclosed single channel impeller
100 mm Ø Spherical clearance
1160 rpm [See page 26](#)

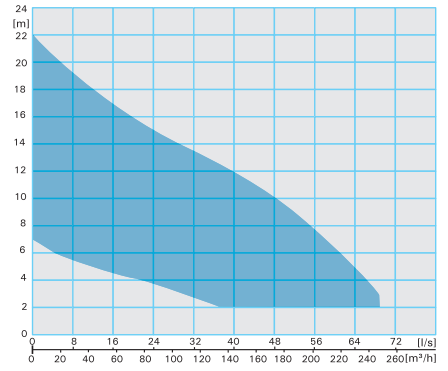

AVX446... -6 pole
Vortex impeller
100 mm Ø Spherical clearance
1160 rpm [See page 27](#)

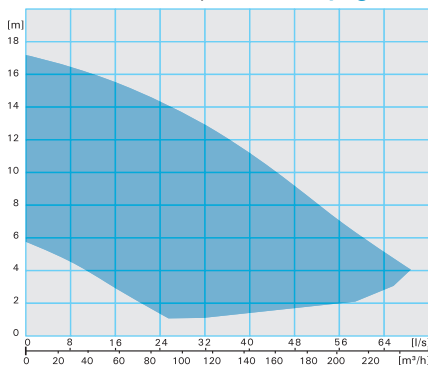

DN150



AK634... -4 pole

Enclosed two channel impeller
80 mm Ø Spherical clearance
1750 rpm [See page 28](#)

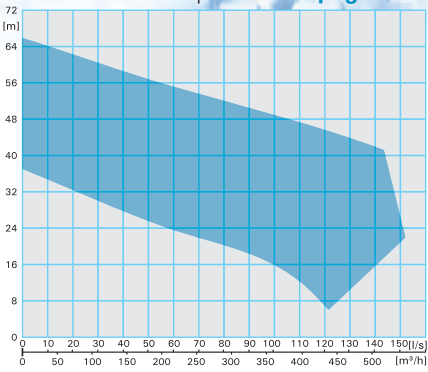

AK636... -6 pole

Enclosed two channel impeller
80 mm Ø Spherical clearance
1160 rpm [See page 29](#)

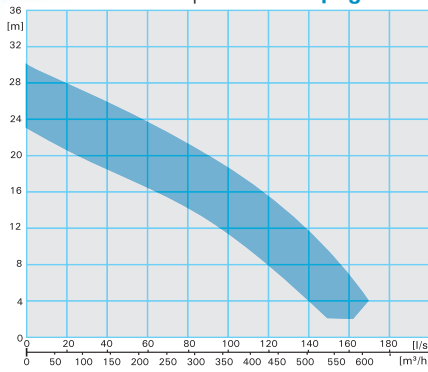

AMX644... -4 pole

Enclosed single channel impeller
100 mm Ø Spherical clearance
1750 rpm [See page 30](#)

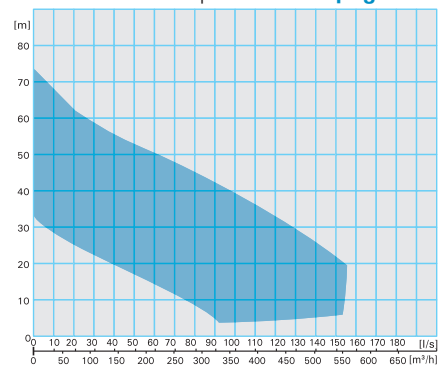

AVX644... -4 pole

Vortex impeller
100 mm Ø Spherical clearance
1750 rpm [See page 31](#)

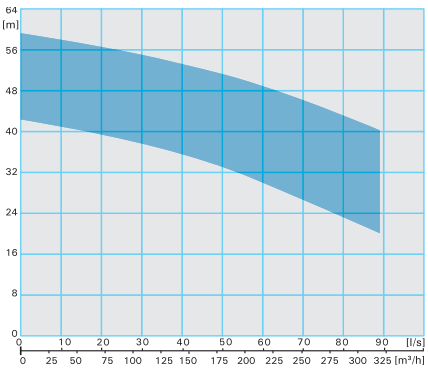

AMX646... -6 pole

Enclosed single channel impeller
100 mm Ø Spherical clearance
1160 rpm [See page 32](#)

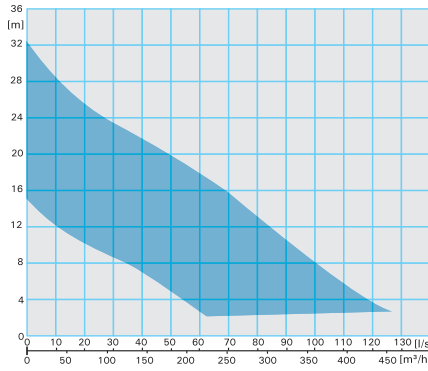

AVX646... -6 pole

Vortex impeller
100 mm Ø Spherical clearance
1160 rpm [See page 33](#)

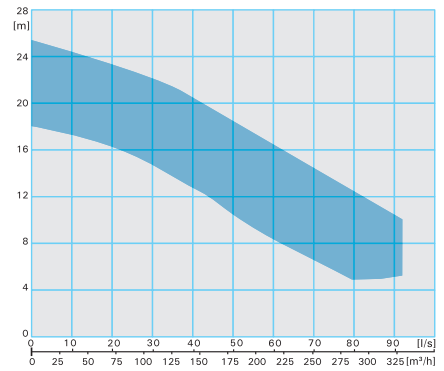



Vortex impeller
80 mm Ø
Spherical clearance
3450 rpm

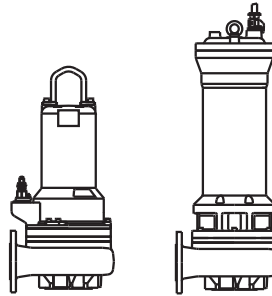

Performance curves

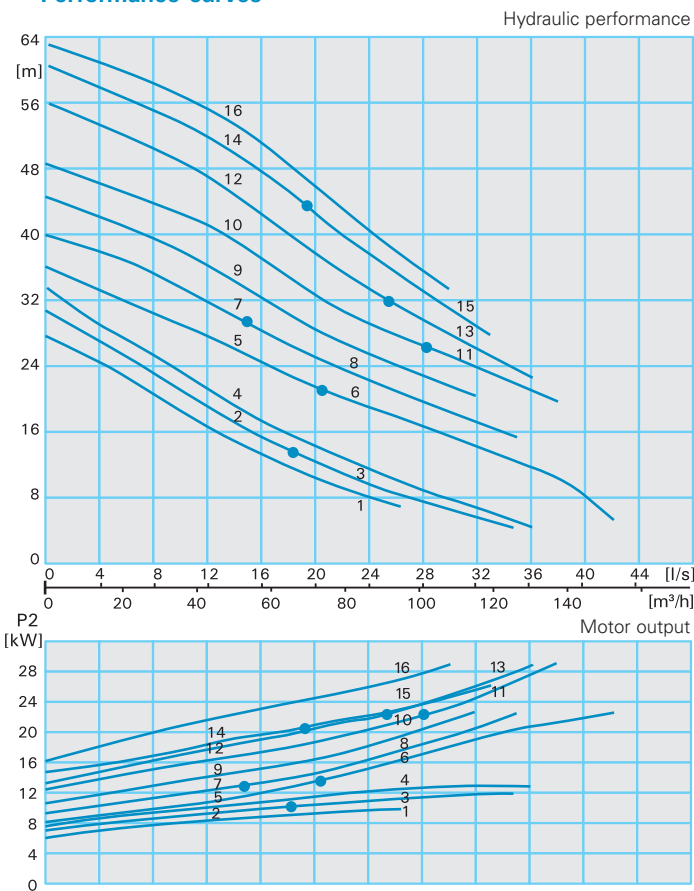

Technical data 380V/3Ph 60Hz

Standard and FM model – Wet well installation						
Curve No.	Pump type	Motor input P ₁ (kW)	Motor output P ₂ (kW)	Rated current I _N (A)	Weight standard (kg)	Weight FM (kg)
1	AV332-174/13T/C (FM)	11.1	9.8	18.8	110	110
2	AV332-178/13T/C (FM)	11.1	9.8	18.8	110	110
3	AV332-178/17.4T/C (FM)	14.6	13.0	24.2	114	114
4	AV332-180/17.4T/C (FM)	14.6	13.0	24.2	114	114
5	AV332-165/17.4T/C (FM)	14.6	13.0	24.2	116	116
6	AV332-165/30P/C (FM)	24.9	22.4	42.3	177	199
7	AV332-175/17.4T/C (FM)	14.6	13.0	24.2	116	116
8	AV332-175/30P/C (FM)	24.9	22.4	42.3	177	199
9	AV332-185/30P/C (FM)	24.9	22.4	42.3	177	199
10	AV332-195/30P/C (FM)	24.9	22.4	42.3	177	199
11	AV332-195/38.2P/C (FM)	31.0	28.5	51.4	197	219
12	AV332-200/30P/C (FM)	24.9	22.4	42.3	178	200
13	AV332-200/38.2P/C (FM)	31.0	28.5	51.4	198	220
14	AV332-210/30P/C (FM)	24.9	22.4	42.3	178	200
15	AV332-210/38.2P/C (FM)	31.0	28.5	51.4	198	220
16	AV332-215/38.2P/C (FM)	31.0	28.5	51.4	198	220

Standard and FM model – Dry well installation						
Curve No.	Pump type	Motor input P ₁ (kW)	Motor output P ₂ (kW)	Rated current I _N (A)	Weight standard (kg)	Weight FM (kg)
1	AV332-174/13TU (FM)	11.1	9.8	18.8	113	113
2	AV332-178/13TU (FM)	11.1	9.8	18.8	113	113
3	AV332-178/17.4TU (FM)	14.6	13.0	24.2	117	117
4	AV332-180/17.4TU (FM)	14.6	13.0	24.2	117	117
5	AV332-165/17.4TU (FM)	14.6	13.0	24.2	119	119
6	AV332-165/30PU (FM)	24.9	22.4	42.3	187	209
7	AV332-175/17.4TU (FM)	14.6	13.0	24.2	119	119
8	AV332-175/30PU (FM)	24.9	22.4	42.3	187	209
9	AV332-185/30PU (FM)	24.9	22.4	42.3	187	209
10	AV332-195/30PU (FM)	24.9	22.4	42.3	187	209
11	AV332-195/38.2PU (FM)	31.0	28.5	51.4	210	232
12	AV332-200/30PU (FM)	24.9	22.4	42.3	188	210
13	AV332-200/38.2PU (FM)	31.0	28.5	51.4	211	233
14	AV332-210/30PU (FM)	24.9	22.4	42.3	188	210
15	AV332-210/38.2PU (FM)	31.0	28.5	51.4	211	233
16	AV332-215/38.2PU (FM)	31.0	28.5	51.4	211	233

DN80 - AMX334/1...-4 pole



Enclosed single channel impeller

80 mm Ø

Spherical clearance

1750 rpm

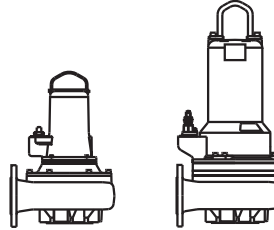

Performance curves

Hydraulic performance

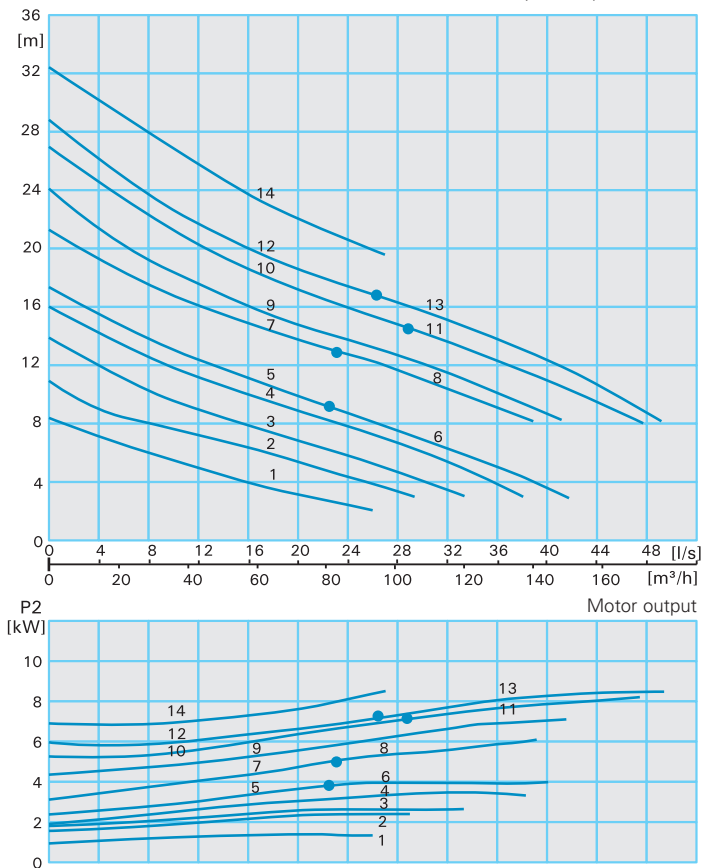

Technical data 230V/1Ph 60Hz

Standard and FM model – Wet well installation						
Curve No.	Pump type	Motor input P ₁ (kW)	Motor output P ₂ (kW)	Rated current I _n (A)	Weight standard (kg)	Weight FM (kg)
1	AMX334/1-142/2C/C	2.0	1.5	8.6	67	-
1	AMX334/1-142/3T/C (FM)	2.8	2.2	11.9	102	102
2	AMX334/1-155/3.6D/C	3.5	2.7	15.5	70	-
2	AMX334/1-155/5.1T/C (FM)	4.6	3.8	21.2	110	110
3	AMX334/1-178/3.6D/C	3.5	2.7	15.5	70	-
3	AMX334/1-178/5.1T/C (FM)	4.6	3.8	21.2	110	110
4	AMX334/1-184/5.1T/C (FM)	4.6	3.8	21.2	110	110
5	AMX334/1-193/5.1T/C (FM)	4.6	3.8	21.2	110	110
6	AMX334/1-193/6.7T/C (FM)	6.0	5.0	27.3	114	114
7	AMX334/1-206/6.7T/C (FM)	6.0	5.0	27.3	114	114
8	AMX334/1-206/9.7T/C (FM)	8.5	7.2	38.7	124	124
9	AMX334/1-218/9.7T/C (FM)	8.5	7.2	38.7	128	128
10	AMX334/1-228/9.7T/C (FM)	8.5	7.2	38.7	128	128
11	AMX334/1-228/11.4T/C (FM)	10.0	8.5	43.0	131	131
12	AMX334/1-235/9.7T/C (FM)	8.5	7.2	38.7	128	128
13	AMX334/1-235/11.4T/C (FM)	10.0	8.5	43.0	131	131
14	AMX334/1-250/11.4T/C (FM)	10.0	8.5	43.0	131	131

Standard and FM model – Dry well installation						
Curve No.	Pump type	Motor input P ₁ (kW)	Motor output P ₂ (kW)	Rated current I _n (A)	Weight standard (kg)	Weight FM (kg)
1	AMX334/1-142/3TU (FM)	2.8	2.2	11.9	107	107
2	AMX334/1-155/5.1TU (FM)	4.6	3.8	21.2	115	115
3	AMX334/1-178/5.1TU (FM)	4.6	3.8	21.2	115	115
4	AMX334/1-184/5.1TU (FM)	4.6	3.8	21.2	115	115
5	AMX334/1-193/5.1TU (FM)	4.6	3.8	21.2	115	115
6	AMX334/1-193/6.7TU (FM)	6.0	5.0	27.3	117	117
7	AMX334/1-206/6.7TU (FM)	6.0	5.0	27.3	117	117
8	AMX334/1-206/9.7TU (FM)	8.5	7.2	38.7	128	128
9	AMX334/1-218/9.7TU (FM)	8.5	7.2	38.7	132	132
10	AMX334/1-228/9.7TU (FM)	8.5	7.2	38.7	132	132
11	AMX334/1-228/11.4TU (FM)	10.0	8.5	43.0	135	135
12	AMX334/1-235/9.7TU (FM)	8.5	7.2	38.7	132	132
13	AMX334/1-235/11.4TU (FM)	10.0	8.5	43.0	135	135
14	AMX334/1-250/11.4TU (FM)	10.0	8.5	43.0	135	135



Enclosed single channel impeller
80 mm Ø
Spherical clearance
1750 rpm

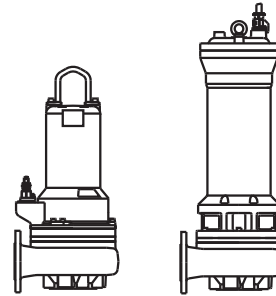

Performance curves

Hydraulic performance

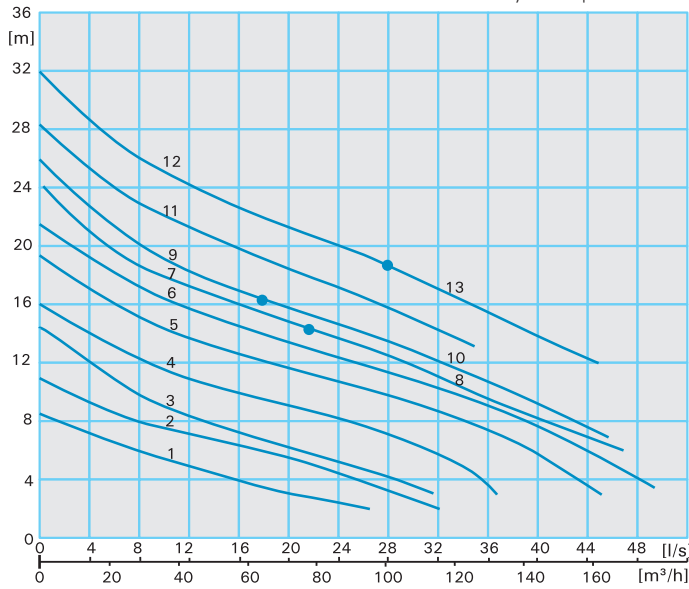

Technical data 380V/3Ph 60Hz

Standard and FM model – Wet well installation						
Curve No.	Pump type	Motor input P ₁ (kW)	Motor output P ₂ (kW)	Rated current I _n (A)	Weight standard (kg)	Weight FM (kg)
1	AMX334-142/1.6C/C (FM)	1.7	1.2	3.8	67	67
1	AMX334-142/2.9T/C (FM)	2.7	2.2	4.8	105	105
2	AMX334-155/2.9T/C (FM)	2.7	2.2	4.8	105	105
2	AMX334-155/4D/C (FM)	3.8	3.0	7.2	70	70
3	AMX334-178/2.9T/C (FM)	2.7	2.2	4.8	105	105
3	AMX334-178/4D/C (FM)	3.8	3.0	7.2	70	70
4	AMX334-184/4D/C (FM)	3.8	3.0	7.2	70	70
4	AMX334-184/4.3T/C (FM)	3.8	3.2	6.7	110	110
5	AMX334-193/5.5T/C (FM)	4.8	4.1	9.0	114	114
6	AMX334-206/7.5T/C (FM)	6.5	5.6	11.4	124	124
7	AMX334-218/7.5T/C (FM)	6.5	5.6	11.4	128	128
8	AMX334-218/10.4T/C (FM)	9.0	7.8	14.9	131	131
9	AMX334-228/7.5T/C (FM)	6.5	5.6	11.4	128	128
10	AMX334-228/10.4T/C (FM)	9.0	7.6	14.9	131	131
11	AMX334-235/10.4T/C (FM)	9.0	7.6	14.9	131	131
12	AMX334-250/10.4T/C (FM)	9.0	7.8	14.9	131	131
13	AMX334-250/13P/C (FM)	11.1	9.7	19.4	157	169

Standard and FM model – Dry well installation						
Curve No.	Pump type	Motor input P ₁ (kW)	Motor output P ₂ (kW)	Rated current I _n (A)	Weight standard (kg)	Weight FM (kg)
1	AMX334-142/2.9TU (FM)	2.7	2.2	4.8	110	110
2	AMX334-155/2.9TU (FM)	2.7	2.2	4.8	110	110
3	AMX334-178/2.9TU (FM)	2.7	2.2	4.8	110	110
4	AMX334-184/4.3TU (FM)	3.8	3.2	6.7	115	115
5	AMX334-193/5.5TU (FM)	4.8	4.1	9.0	117	117
6	AMX334-206/7.5TU (FM)	6.5	5.6	11.4	128	128
7	AMX334-218/7.5TU (FM)	6.5	5.6	11.4	132	132
8	AMX334-218/10.4TU (FM)	9.0	7.8	14.9	135	135
9	AMX334-228/7.5TU (FM)	6.5	5.6	11.4	132	132
10	AMX334-228/10.4TU (FM)	9.0	7.6	14.9	135	135
11	AMX334-235/10.4TU (FM)	9.0	7.6	14.9	135	135
12	AMX334-250/10.4TU (FM)	9.0	7.8	14.9	135	135
13	AMX334-250/13PU (FM)	11.1	9.7	19.4	165	177

DN80 - AV(X)334...-4 pole



Vortex impeller
80 mm Ø
Spherical clearance
1750 rpm

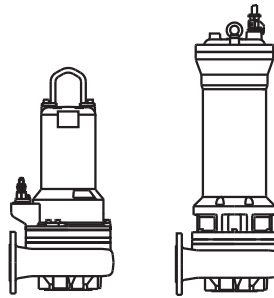

Performance curves

Hydraulic performance

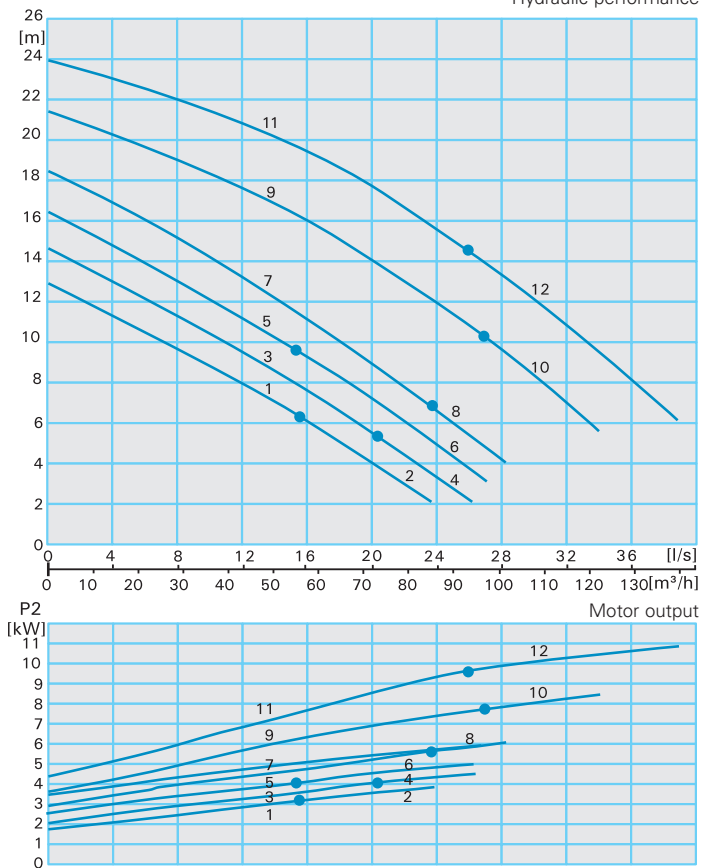

Technical data

380V/3Ph 60Hz

Standard and FM model – Wet well installation

Curve No.	Pump type	Motor input P ₁ (kW)	Motor output P ₂ (kW)	Rated current I _n (A)	Weight standard (kg)	Weight FM (kg)
1	AV334-200/4.3T/C (FM)	3.8	3.2	6.7	102	102
2	AV334-200/5.5T/C (FM)	4.8	4.1	9.0	106	106
3	AV334-215/5.5T/C (FM)	4.8	4.1	9.0	106	106
4	AV334-215/7.5T/C (FM)	6.5	5.6	11.4	112	112
5	AV334-224/5.5T/C (FM)	4.8	4.1	9.0	106	106
6	AV334-224/7.5T/C (FM)	6.5	5.6	11.4	112	112
7	AV334-230/7.5T/C (FM)	6.5	5.6	11.4	112	112
8	AV334-230/10.4T/C (FM)	9.0	7.8	14.9	116	116
9	AVX334-225/10.4T/C (FM)	9.0	7.8	14.9	116	116
10	AVX334-225/13P/C (FM)	11.1	9.7	19.4	139	161
11	AVX334-230/13P/C (FM)	11.1	9.7	19.4	139	161
12	AVX334-230/20P/C (FM)	16.9	14.9	29.7	149	173

Standard and FM model – Dry well installation

Curve No.	Pump type	Motor input P ₁ (kW)	Motor output P ₂ (kW)	Rated current I _n (A)	Weight standard (kg)	Weight FM (kg)
1	AV334-200/4.3TU (FM)	3.8	3.2	6.7	105	105
2	AV334-200/5.5TU (FM)	4.8	4.1	9.0	109	109
3	AV334-215/5.5TU (FM)	4.8	4.1	9.0	109	109
4	AV334-215/7.5TU (FM)	6.5	5.6	11.4	118	118
5	AV334-224/5.5TU (FM)	4.8	4.1	9.0	109	109
6	AV334-224/7.5TU (FM)	6.5	5.6	11.4	118	118
7	AV334-230/7.5TU (FM)	6.5	5.6	11.4	118	118
8	AV334-230/10.4TU (FM)	9.0	7.8	14.9	124	124
9	AVX334-225/10.4TU (FM)	9.0	7.8	14.9	124	124
10	AVX334-225/13PU (FM)	11.1	9.7	19.4	149	169
11	AVX334-230/13PU (FM)	11.1	9.7	19.4	149	169
12	AVX334-230/20PU (FM)	16.9	14.9	29.7	157	182



Enclosed single channel impeller

80 mm Ø

Spherical clearance

1160 rpm

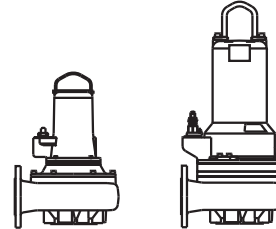

Performance curves

Hydraulic performance

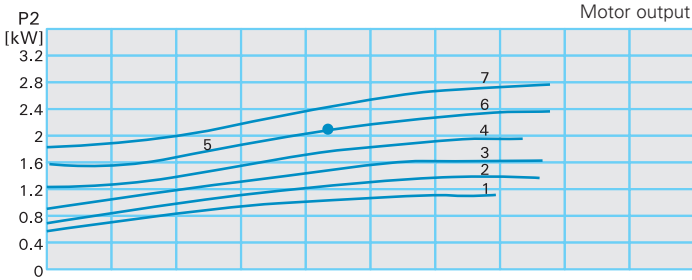
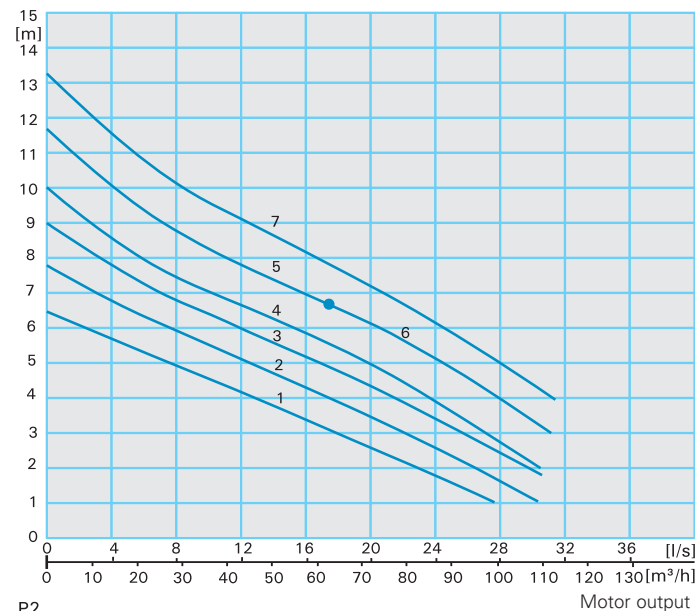

Technical data 380V/3Ph 60Hz

Standard and FM model – Wet well installation						
Curve No.	Pump type	Motor input P ₁ (kW)	Motor output P ₂ (kW)	Rated current I _n (A)	Weight standard (kg)	Weight FM (kg)
1	AMX336-178/2.8T/C (FM)	2.6	2.1	5.0	100	100
1	AMX336-178/3.2D/C (FM)	3.3	2.4	6.4	72	72
2	AMX336-193/2.8T/C (FM)	2.6	2.1	5.0	100	100
2	AMX336-193/3.2D/C (FM)	3.3	2.4	6.4	72	72
3	AMX336-206/2.8T/C (FM)	2.6	2.1	5.0	100	100
3	AMX336-206/3.2D/C (FM)	3.3	2.4	6.4	72	72
4	AMX336-218/2.8T/C (FM)	2.6	2.1	5.0	107	107
5	AMX336-235/2.8T/C (FM)	2.6	2.1	5.0	108	108
6	AMX336-235/3.8T/C (FM)	3.4	2.8	6.7	112	112
7	AMX336-250/3.8T/C (FM)	3.4	2.8	6.7	113	113

Standard and FM model – Dry well installation						
Curve No.	Pump type	Motor input P ₁ (kW)	Motor output P ₂ (kW)	Rated current I _n (A)	Weight standard (kg)	Weight FM (kg)
1	AMX336-178/2.8TU (FM)	2.6	2.1	5.0	103	103
2	AMX336-193/2.8TU (FM)	2.6	2.1	5.0	103	103
3	AMX336-206/2.8TU (FM)	2.6	2.1	5.0	103	103
4	AMX336-218/2.8TU (FM)	2.6	2.1	5.0	110	110
5	AMX336-235/2.8TU (FM)	2.6	2.1	5.0	111	111
6	AMX336-235/3.8TU (FM)	3.4	2.8	6.7	115	115
7	AMX336-250/3.8TU (FM)	3.4	2.8	6.7	116	116

DN80 - AV(X)336...-6 pole



Vortex impeller
80 mm Ø
Spherical clearance
1160 rpm

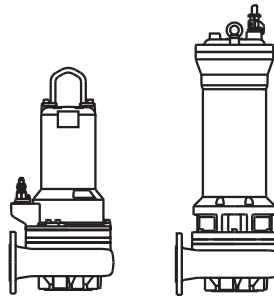

Performance curves

Hydraulic performance

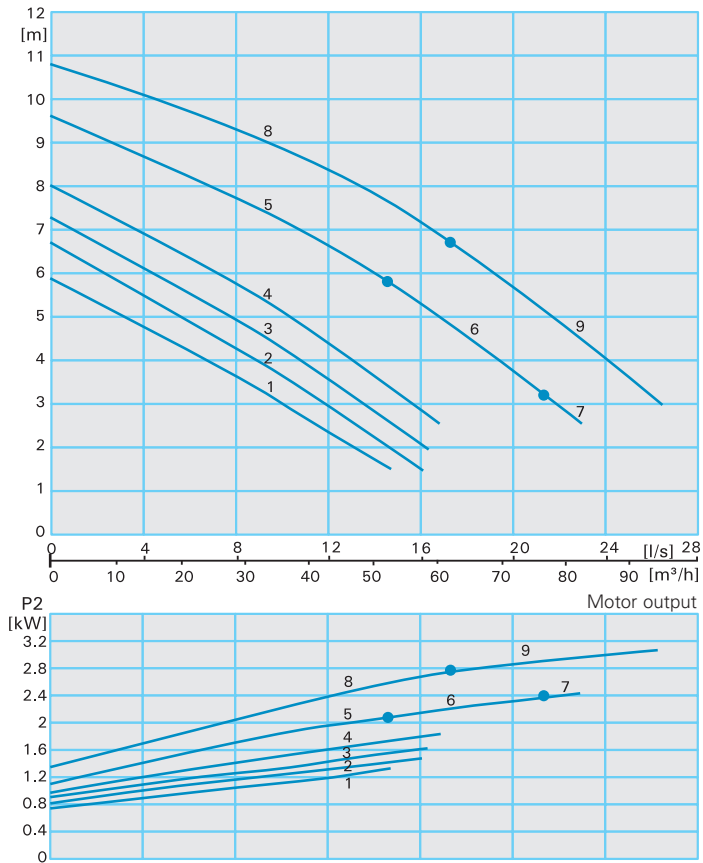

Technical data

380V/3Ph 60Hz

Standard and FM model – Wet well installation						
Curve No.	Pump type	Motor input P ₁ (kW)	Motor output P ₂ (kW)	Rated current I _n (A)	Weight standard (kg)	Weight FM (kg)
1	AV336-200/2.8T/C (FM)	2.6	2.1	5.0	99	99
1	AV336-200/3.2D/C (FM)	3.3	2.4	6.4	69	69
2	AV336-215/2.8T/C (FM)	2.6	2.1	5.0	99	99
2	AV336-215/3.2D/C (FM)	3.3	2.4	6.4	69	69
3	AV336-224/2.8T/C (FM)	2.6	2.1	5.0	99	99
3	AV336-224/3.2D/C (FM)	3.3	2.4	6.4	69	69
4	AV336-230/2.8T/C (FM)	2.6	2.1	5.0	99	99
4	AV336-230/3.2D/C (FM)	3.3	2.4	6.4	69	69
5	AVX336-225/2.8T/C (FM)	2.6	2.1	5.0	99	99
6	AVX336-225/3.2D/C (FM)	3.3	2.4	6.4	69	69
7	AVX336-225/3.8T/C (FM)	3.4	2.8	6.7	102	102
8	AVX336-230/3.8T/C (FM)	3.4	2.8	6.7	102	102
9	AVX336-230/6.2T/C (FM)	5.6	4.6	10.9	107	107

Standard and FM model – Dry well installation						
Curve No.	Pump type	Motor input P ₁ (kW)	Motor output P ₂ (kW)	Rated current I _n (A)	Weight standard (kg)	Weight FM (kg)
1	AV336-200/2.8TU (FM)	2.6	2.1	5.0	102	102
2	AV336-215/2.8TU (FM)	2.6	2.1	5.0	102	102
3	AV336-224/2.8TU (FM)	2.6	2.1	5.0	102	102
4	AV336-230/2.8TU (FM)	2.6	2.1	5.0	102	102
5	AVX336-225/2.8TU (FM)	2.6	2.1	5.0	102	102
7	AVX336-225/3.8TU (FM)	3.4	2.8	6.7	105	105
8	AVX336-230/3.8TU (FM)	3.4	2.8	6.7	105	105
9	AVX336-230/6.2TU (FM)	5.6	4.6	10.9	114	114

DN80 - AMX434...-4 pole



Enclosed single channel impeller

80 mm Ø

Spherical clearance

1750 rpm

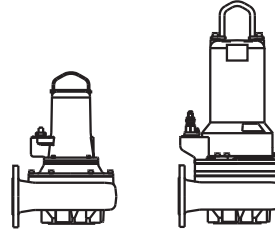

Performance curves

Hydraulic performance

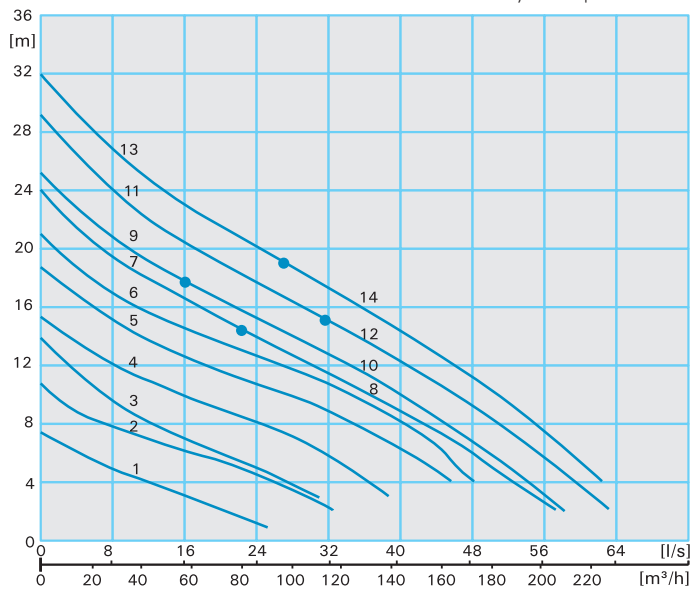

Technical data 380V/3Ph 60Hz

Standard and FM model – Wet well installation						
Curve No.	Pump type	Motor input P ₁ (kW)	Motor output P ₂ (kW)	Rated current I _n (A)	Weight standard (kg)	Weight FM (kg)
1	AMX434-142/1.6C/C (FM)	1.7	1.2	3.8	70	70
1	AMX434-142/2.9T/C (FM)	2.7	2.2	4.8	108	108
2	AMX434-155/2.9T/C (FM)	2.7	2.2	4.8	108	108
2	AMX434-155/4D/C (FM)	3.8	3.0	7.2	73	73
3	AMX434-178/2.9T/C (FM)	2.7	2.2	4.8	108	108
3	AMX434-178/4D/C (FM)	3.8	3.0	7.2	73	73
4	AMX434-184/4D/C (FM)	3.8	3.0	7.2	73	73
4	AMX434-184/4.3T/C (FM)	3.8	3.2	6.7	113	113
5	AMX434-193/5.5T/C (FM)	4.8	4.1	9.0	117	117
6	AMX434-206/7.5T/C (FM)	6.5	5.6	11.4	127	127
7	AMX434-218/7.5T/C (FM)	6.5	5.6	11.4	131	131
8	AMX434-218/10.4T/C (FM)	9.0	7.8	14.9	134	134
9	AMX434-228/7.5T/C (FM)	6.5	5.6	11.4	131	131
10	AMX434-228/10.4T/C (FM)	9.0	7.8	14.9	134	134
11	AMX434-235/10.4T/C (FM)	9.0	7.8	14.9	134	134
12	AMX434-235/13P/C (FM)	11.1	9.7	19.4	160	172
13	AMX434-250/10.4T/C (FM)	9.0	7.8	14.9	134	134
14	AMX434-250/13P/C (FM)	11.0	9.7	19.4	160	172

Standard and FM model – Dry well installation						
Curve No.	Pump type	Motor input P ₁ (kW)	Motor output P ₂ (kW)	Rated current I _n (A)	Weight standard (kg)	Weight FM (kg)
1	AMX434-142/2.9TU (FM)	2.7	2.2	4.8	98	98
2	AMX434-155/2.9TU (FM)	2.7	2.2	4.8	98	98
3	AMX434-178/2.9TU (FM)	2.7	2.2	4.8	98	98
4	AMX434-184/4.3TU (FM)	3.8	3.2	6.7	118	118
5	AMX434-193/5.5TU (FM)	4.8	4.1	9.0	120	120
6	AMX434-206/7.5TU (FM)	6.5	5.6	11.4	131	131
7	AMX434-218/7.5TU (FM)	6.5	5.6	11.4	135	135
8	AMX434-218/10.4TU (FM)	9.0	7.8	14.9	138	138
9	AMX434-228/7.5TU (FM)	6.5	5.6	11.4	135	135
10	AMX434-228/10.4TU (FM)	9.0	7.8	14.9	138	138
11	AMX434-235/10.4TU (FM)	9.0	7.8	14.9	138	138
12	AMX434-235/13PU (FM)	11.1	9.7	19.4	168	180
13	AMX434-250/10.4TU (FM)	9.0	7.8	14.9	138	138
14	AMX434-250/13PU (FM)	11.0	9.7	19.4	168	180

DN100 - AV432...-2 pole



Vortex impeller
80 mm Ø
Spherical clearance
3450 rpm

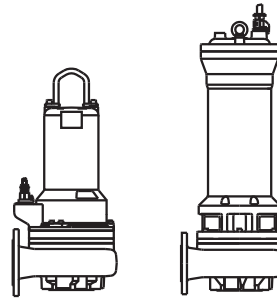

Performance curves

Hydraulic performance

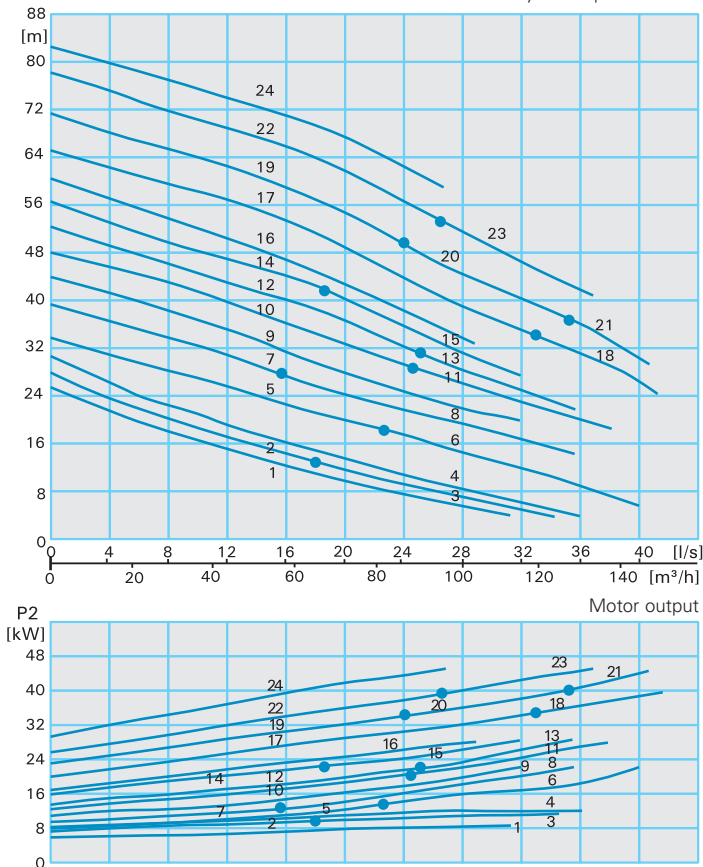

Technical data

380V/3Ph 60Hz

Standard and FM model – Wet well installation

Curve No.	Pump type	Motor input P ₁ (kW)	Motor output P ₂ (kW)	Rated current I _n (A)	Weight standard (kg)	Weight FM (kg)
1	AV432-174/13T/C (FM)	11.1	9.8	18.8	112	112
2	AV432-178/13T/C (FM)	11.1	9.8	18.8	112	112
3	AV432-178/17.4T/C (FM)	14.6	13.0	24.2	116	116
4	AV432-180/17.4T/C (FM)	14.6	13.0	24.2	116	116
5	AV432-165/17.4T/C (FM)	14.6	13.0	24.2	118	118
6	AV432-165/30P/C (FM)	24.9	22.4	42.3	179	201
7	AV432-175/17.4T/C (FM)	14.6	13.0	24.2	118	118
8	AV432-175/30P/C (FM)	24.9	22.4	42.3	179	201
9	AV432-185/30P/C (FM)	24.9	22.4	42.3	179	201
10	AV432-195/30P/C (FM)	24.9	22.4	42.3	179	201
11	AV432-195/38.2P/C (FM)	31.0	28.5	51.8	199	221
12	AV432-200/30P/C (FM)	24.9	22.4	42.3	180	202
13	AV432-200/38.2P/C (FM)	31.0	28.5	51.4	200	222
14	AV432-210/30P/C (FM)	24.9	22.4	42.3	180	202
15	AV432-210/38.2P/C (FM)	31.0	28.5	51.4	200	202
16	AV432-215/38.2P/C (FM)	31.0	28.5	51.4	200	202
17	AV432-220/46F/C	37.1	34.5	61.2	358	-
18	AV432-220/53F/C	42.5	39.5	69.6	374	-
19	AV432-224/46F/C	37.1	34.5	61.2	358	-
20	AV432-224/53F/C	42.5	39.5	69.6	374	-
21	AV432-224/61F/C	48.6	45.2	79.3	381	-
22	AV432-227/53F/C	42.5	39.5	69.6	374	-
23	AV432-227/61F/C	48.6	45.2	79.3	381	-
24	AV432-230/61F/C	48.6	45.2	79.3	381	-

Standard and FM model – Dry well installation

Curve No.	Pump type	Motor input P ₁ (kW)	Motor output P ₂ (kW)	Rated current I _n (A)	Weight standard (kg)	Weight FM (kg)
1	AV432-174/13TU (FM)	11.1	9.8	18.8	115	115
2	AV432-178/13TU (FM)	11.1	9.8	18.8	115	115
3	AV432-178/17.4TU (FM)	14.6	13.0	24.2	119	119
4	AV432-180/17.4TU (FM)	14.6	13.0	24.2	119	119
5	AV432-165/17.4TU (FM)	14.6	13.0	24.2	121	121
6	AV432-165/30PU (FM)	24.9	22.4	42.3	189	211
7	AV432-175/17.4TU (FM)	14.6	13.0	24.2	121	121
8	AV432-175/30PU (FM)	24.9	22.4	42.3	189	211
9	AV432-185/30PU (FM)	24.9	22.4	42.3	189	211
10	AV432-195/30PU (FM)	24.9	22.4	42.3	189	211
11	AV432-195/38.2PU (FM)	31.0	28.5	51.8	212	234
12	AV432-200/30PU (FM)	24.9	22.4	42.3	190	212
13	AV432-200/38.2PU (FM)	31.0	28.5	51.4	213	235
14	AV432-210/30PU (FM)	24.9	22.4	42.3	190	212
15	AV432-210/38.2PU (FM)	31.0	28.5	51.4	213	235
16	AV432-215/38.2PU (FM)	31.0	28.5	51.4	213	235
17	AV432-220/46FU	37.1	34.5	61.2	384	-
18	AV432-220/53FU	42.5	39.5	69.6	400	-
19	AV432-224/46FU	37.1	34.5	61.2	384	-
20	AV432-224/53FU	42.5	39.5	69.6	400	-
21	AV432-224/61FU	48.6	45.2	79.3	407	-
22	AV432-227/53FU	42.5	39.5	69.6	400	-
23	AV432-227/61FU	48.6	45.2	79.3	407	-
24	AV432-230/61FU	48.6	45.2	79.3	407	-

DN100 - AMX434/1...-4 pole



Enclosed single channel impeller

80 mm Ø

Spherical clearance

1750 rpm

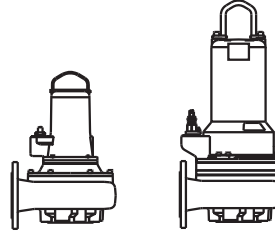

Performance curves

Hydraulic performance

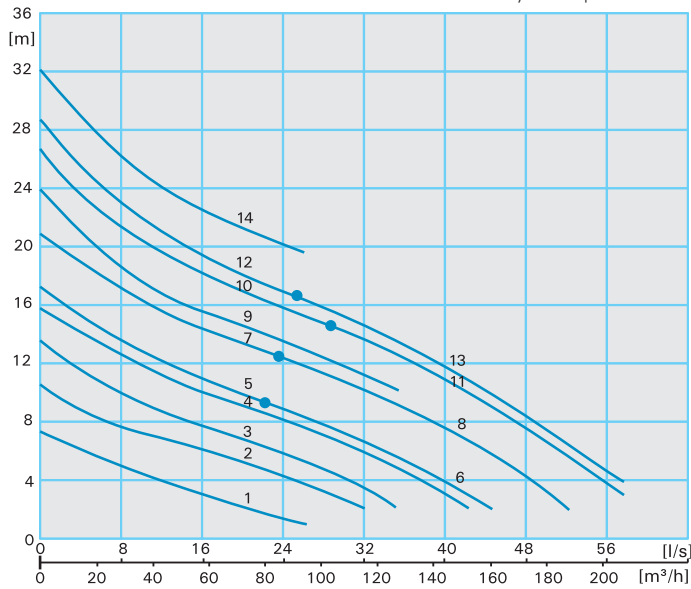

Technical data 230V/1Ph 60Hz

Standard and FM model – Wet well installation						
Curve No.	Pump type	Motor input P ₁ (kW)	Motor output P ₂ (kW)	Rated current I _n (A)	Weight standard (kg)	Weight FM (kg)
1	AMX434/1-142/2C/C	2.0	1.5	8.6	70	-
1	AMX434/1-142/3T/C (FM)	2.8	2.2	11.9	105	105
2	AMX434/1-155/3.6D/C	3.5	2.7	15.5	73	-
2	AMX434/1-155/5.1T/C (FM)	4.6	3.8	21.2	113	113
3	AMX434/1-178/3.6D/C	3.5	2.7	15.5	73	-
3	AMX434/1-178/5.1T/C (FM)	4.6	3.8	21.2	113	113
4	AMX434/1-184/5.1T/C (FM)	4.6	3.8	21.2	113	113
5	AMX434/1-193/5.1T/C (FM)	4.6	3.8	21.2	113	113
6	AMX434/1-193/6.7T/C (FM)	6.0	5.0	27.3	117	117
7	AMX434/1-206/6.7T/C (FM)	6.0	5.0	27.3	117	117
8	AMX434/1-206/9.7T/C (FM)	8.5	7.2	38.7	127	127
9	AMX434/1-218/9.7T/C (FM)	8.5	7.2	38.7	131	131
10	AMX434/1-228/9.7T/C (FM)	8.5	7.2	38.7	131	131
11	AMX434/1-228/11.4T/C(FM)	10.0	8.5	43.0	134	134
12	AMX434/1-235/9.7T/C (FM)	8.5	7.2	38.7	131	131
13	AMX434/1-235/11.4T/C(FM)	10.0	8.5	43.0	134	134
14	AMX434/1-250/11.4T/C(FM)	10.0	8.5	43.0	134	134

Standard and FM model – Dry well installation						
Curve No.	Pump type	Motor input P ₁ (kW)	Motor output P ₂ (kW)	Rated current I _n (A)	Weight standard (kg)	Weight FM (kg)
1	AMX434/1-142/3TU (FM)	2.8	2.2	11.9	110	110
2	AMX434/1-155/5.1TU (FM)	4.6	3.8	21.2	118	118
3	AMX434/1-178/5.1TU (FM)	4.6	3.8	21.2	118	118
4	AMX434/1-184/5.1TU (FM)	4.6	3.8	21.2	118	118
5	AMX434/1-193/5.1TU (FM)	4.6	3.8	21.2	118	118
6	AMX434/1-193/6.7TU (FM)	6.0	5.0	27.3	120	120
7	AMX434/1-206/6.7TU (FM)	6.0	5.0	27.3	120	120
8	AMX434/1-206/9.7TU (FM)	8.5	7.2	38.7	131	131
9	AMX434/1-218/9.7TU (FM)	8.5	7.2	38.7	135	135
10	AMX434/1-228/9.7TU (FM)	8.5	7.2	38.7	135	135
11	AMX434/1-228/11.4TU(FM)	10.0	8.5	43.0	138	138
12	AMX434/1-235/9.7TU (FM)	8.5	7.2	38.7	135	135
13	AMX434/1-235/11.4TU(FM)	10.0	8.5	43.0	138	138
14	AMX434/1-250/11.4TU(FM)	10.0	8.5	43.0	138	138

DN100 - AV(X)434...-4 pole



Vortex impeller
80 mm Ø
Spherical clearance
1750 rpm

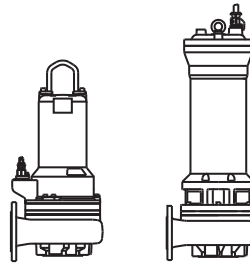

Performance curves

Hydraulic performance

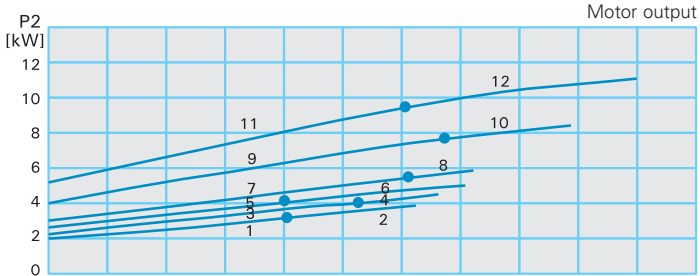
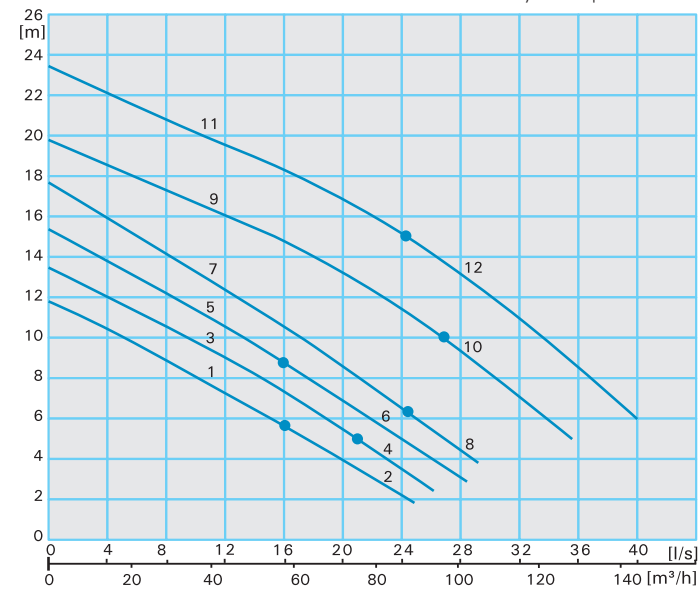

Technical data

380V/3Ph 60Hz

Standard and FM model – Wet well installation						
Curve No.	Pump type	Motor input P ₁ (kW)	Motor output P ₂ (kW)	Rated current I _n (A)	Weight standard (kg)	Weight FM (kg)
1	AV434-200/4.3T/C (FM)	3.8	3.2	6.7	105	105
2	AV434-200/5.5T/C (FM)	4.8	4.1	9.0	109	109
3	AV434-215/5.5T/C (FM)	4.8	4.1	9.0	109	109
4	AV434-215/7.5T/C (FM)	6.5	5.6	11.4	115	115
5	AV434-224/5.5T/C (FM)	4.7	4.1	9.0	109	109
6	AV434-224/7.5T/C (FM)	6.5	5.6	11.4	115	115
7	AV434-230/7.5T/C (FM)	6.5	5.6	11.4	115	115
8	AV434-230/10.4T/C (FM)	9.0	7.8	14.9	119	119
9	AVX434-225/10.4T/C (FM)	9.0	7.8	14.9	119	119
10	AVX434-225/13P/C (FM)	11.0	9.7	19.4	142	164
11	AVX434-230/13P/C (FM)	11.0	9.7	19.4	142	164
12	AVX434-230/20P/C (FM)	16.9	14.9	29.7	152	176

Standard and FM model – Dry well installation						
Curve No.	Pump type	Motor input P ₁ (kW)	Motor output P ₂ (kW)	Rated current I _n (A)	Weight standard (kg)	Weight FM (kg)
1	AV434-200/4.3TU (FM)	3.8	3.2	6.7	108	108
2	AV434-200/5.5TU (FM)	4.8	4.1	9.0	112	112
3	AV434-215/5.5TU (FM)	4.8	4.1	9.0	112	112
4	AV434-215/7.5TU (FM)	6.5	5.6	11.4	121	121
5	AV434-224/5.5TU (FM)	4.7	4.1	9.0	112	112
6	AV434-224/7.5TU (FM)	6.5	5.6	11.4	121	121
7	AV434-230/7.5TU (FM)	6.5	5.6	11.4	121	121
8	AV434-230/10.4TU (FM)	9.0	7.8	14.9	127	127
9	AVX434-225/10.4TU (FM)	9.0	7.8	14.9	127	127
10	AVX434-225/13PU (FM)	11.0	9.7	19.4	152	172
11	AVX434-230/13PU (FM)	11.0	9.7	19.4	152	172
12	AVX434-230/20PU (FM)	16.9	14.9	29.7	160	185

DN100 - AK434...-4 pole



Enclosed two channel impeller

80 mm Ø

Spherical clearance

1750 rpm

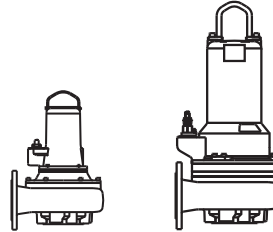

Performance curves

Hydraulic performance

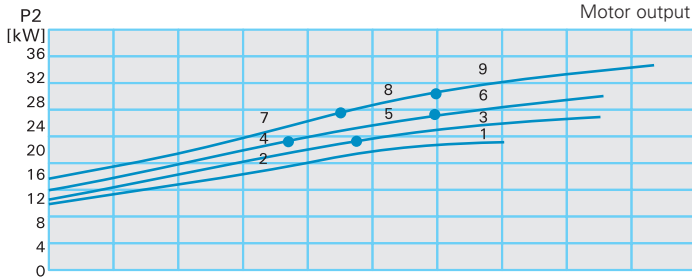
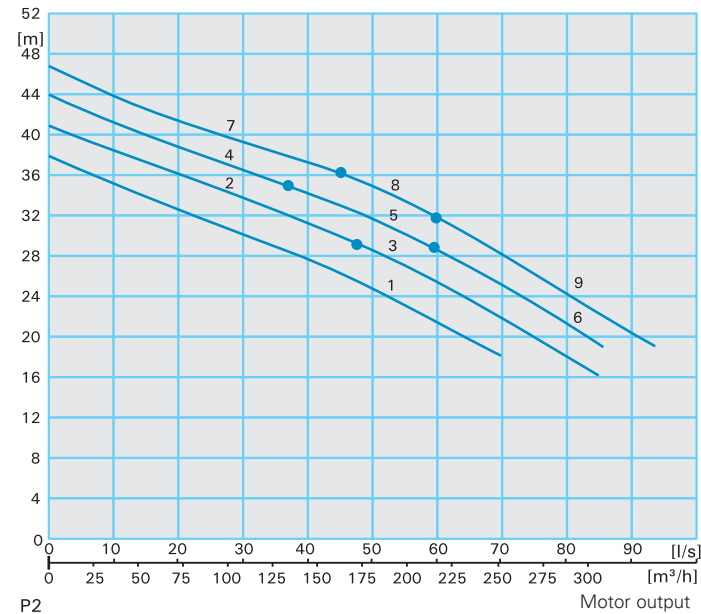

Technical data 380V/3Ph 60Hz

Standard and FM model – Wet well installation						
Curve No.	Pump type	Motor input P ₁ (kW)	Motor output P ₂ (kW)	Rated current I _N (A)	Weight standard (kg)	Weight FM (kg)
1	AK434-260/29P/C (FM)	24.3	21.6	43.0	233	245
2	AK434-270/29P/C (FM)	24.3	21.6	43.0	233	245
3	AK434-270/34.5F/C (FM)	28.6	26.0	51.0	380	380
4	AK434-280/29P/C (FM)	24.3	21.6	43.0	235	247
5	AK434-280/34.5F/C (FM)	28.6	26.0	51.0	381	381
6	AK434-280/39.2F/C (FM)	32.2	29.3	58.0	403	403
7	AK434-290/34.5F/C (FM)	28.6	26.0	51.0	382	382
8	AK434-290/39.2F/C (FM)	32.2	29.3	58.0	404	404
9	AK434-290/45.6F/C (FM)	37.0	34.0	67.0	419	419

Standard and FM model – Dry well installation						
Curve No.	Pump type	Motor input P ₁ (kW)	Motor output P ₂ (kW)	Rated current I _N (A)	Weight standard (kg)	Weight FM (kg)
1	AK434-260/29PU (FM)	24.3	21.6	43.0	246	258
2	AK434-270/29PU (FM)	24.3	21.6	43.0	246	258
3	AK434-270/34.5FU (FM)	28.6	26.0	51.0	401	401
4	AK434-280/29PU (FM)	24.3	21.6	43.0	248	260
5	AK434-280/34.5FU (FM)	28.6	26.0	51.0	402	402
6	AK434-280/39.2FU (FM)	32.2	29.3	58.0	428	428
7	AK434-290/34.5FU (FM)	28.6	26.0	51.0	403	403
8	AK434-290/39.2FU (FM)	32.2	29.3	58.0	429	429
9	AK434-290/45.6FU (FM)	37.0	34.0	67.0	445	445

DN100 - AMX436...-6 pole



Enclosed single channel impeller

80 mm Ø

Spherical clearance

1160 rpm

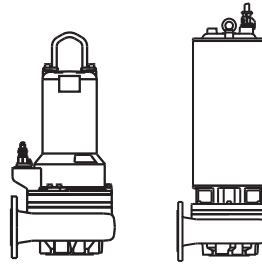

Performance curves

Hydraulic performance

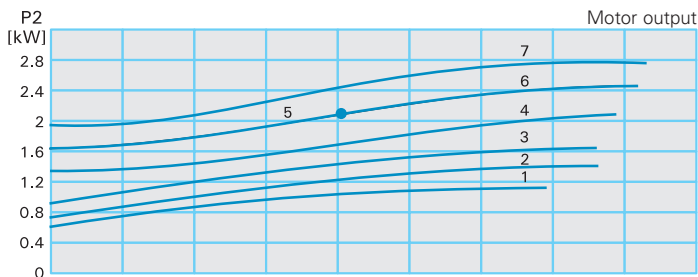
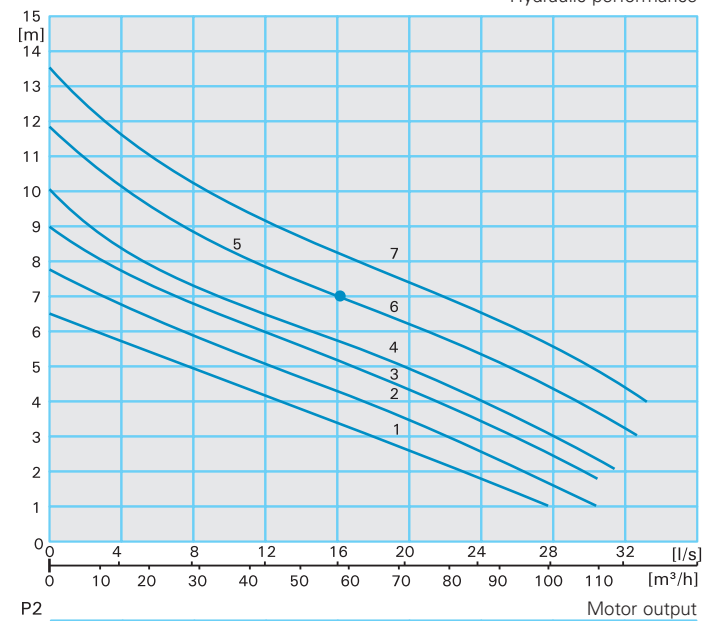

Technical data

380V/3Ph 60Hz

Standard and FM model – Wet well installation

Curve No.	Pump type	Motor input P ₁ (kW)	Motor output P ₂ (kW)	Rated current I _n (A)	Weight standard (kg)	Weight FM (kg)
1	AMX436-178/2.8T/C (FM)	2.6	2.1	5.0	103	103
1	AMX436-178/3.2D/C (FM)	3.3	2.4	6.4	74	74
2	AMX436-193/2.8T/C (FM)	2.6	2.1	5.0	103	103
2	AMX436-193/3.2D/C (FM)	3.3	2.4	6.4	74	74
3	AMX436-206/2.8T/C (FM)	2.6	2.1	5.0	103	103
3	AMX436-206/3.2D/C (FM)	3.3	2.4	6.4	74	74
4	AMX436-218/2.8T/C (FM)	2.6	2.1	5.0	110	110
5	AMX436-235/2.8T/C (FM)	2.6	2.1	5.0	111	111
6	AMX436-235/3.8T/C (FM)	3.4	2.8	6.7	115	115
7	AMX436-250/3.8T/C (FM)	3.4	2.8	6.7	116	116

Standard and FM model – Dry well installation

Curve No.	Pump type	Motor input P ₁ (kW)	Motor output P ₂ (kW)	Rated current I _n (A)	Weight standard (kg)	Weight FM (kg)
1	AMX436-178/2.8TU (FM)	2.6	2.1	5.0	106	106
2	AMX436-193/2.8TU (FM)	2.6	2.1	5.0	106	106
3	AMX436-206/2.8TU (FM)	2.6	2.1	5.0	106	106
4	AMX436-218/2.8TU (FM)	2.6	2.1	5.0	113	113
5	AMX436-235/2.8TU (FM)	2.6	2.1	5.0	114	114
6	AMX436-235/3.8TU (FM)	3.4	2.8	6.7	118	118
7	AMX436-250/3.8TU (FM)	3.4	2.8	6.7	119	119



Vortex impeller
80 mm Ø
Spherical clearance
1160 rpm

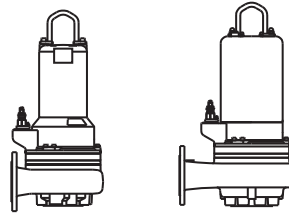

Performance curves

Hydraulic performance

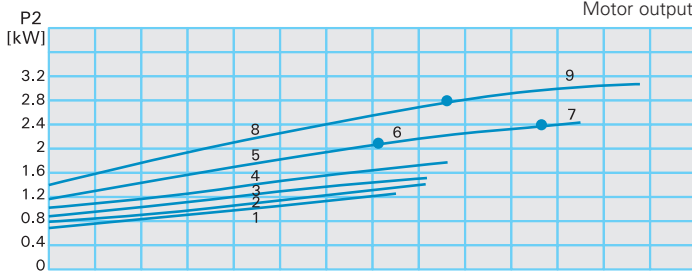
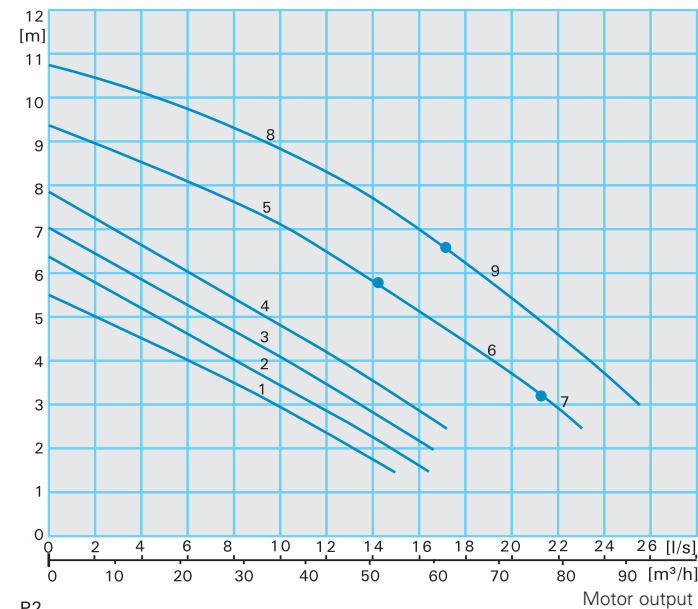

Technical data 380V/3Ph 60Hz

Standard and FM model – Wet well installation						
Curve No.	Pump type	Motor input P ₁ (kW)	Motor output P ₂ (kW)	Rated current I _n (A)	Weight standard (kg)	Weight FM (kg)
1	AV436-200/2.8T/C (FM)	2.6	2.1	5.0	102	102
1	AV436-200/3.2D/C (FM)	3.3	2.4	6.4	72	72
2	AV436-215/2.8T/C (FM)	2.6	2.1	5.0	102	102
2	AV436-215/3.2D/C (FM)	3.3	2.4	6.4	72	72
3	AV436-224/2.8T/C (FM)	2.6	2.1	5.0	102	102
3	AV436-224/3.2D/C (FM)	3.3	2.4	6.4	72	72
4	AV436-230/2.8T/C (FM)	2.6	2.1	5.0	102	102
4	AV436-230/3.2D/C (FM)	3.3	2.4	6.4	72	72
5	AVX436-225/2.8T/C (FM)	2.6	2.1	5.0	102	102
6	AVX436-225/3.2D/C (FM)	3.3	2.4	6.4	72	72
7	AVX436-225/3.8T/C (FM)	3.4	2.8	6.7	105	105
8	AVX436-230/3.8T/C (FM)	3.4	2.8	6.7	105	105
9	AVX436-230/6.2T/C (FM)	5.6	4.6	10.9	110	110

Standard and FM model – Dry well installation						
Curve No.	Pump type	Motor input P ₁ (kW)	Motor output P ₂ (kW)	Rated current I _n (A)	Weight standard (kg)	Weight FM (kg)
1	AV436-200/2.8TU (FM)	2.6	2.1	5.0	105	105
2	AV436-215/2.8TU (FM)	2.6	2.1	5.0	105	105
3	AV436-224/2.8TU (FM)	2.6	2.1	5.0	105	105
4	AV436-230/2.8TU (FM)	2.6	2.1	5.0	105	105
5	AVX436-225/2.8TU (FM)	2.6	2.1	5.0	105	105
7	AVX436-225/3.8TU (FM)	3.4	2.8	6.7	108	108
8	AVX436-230/3.8TU (FM)	3.4	2.8	6.7	108	108
9	AVX436-230/6.2TU (FM)	5.6	4.6	10.9	117	117

DN100 - AMX444...-4 pole



Enclosed single channel impeller

100 mm Ø

Spherical clearance

1750 rpm

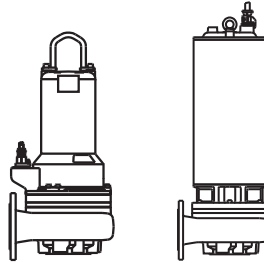

Performance curves

Hydraulic performance

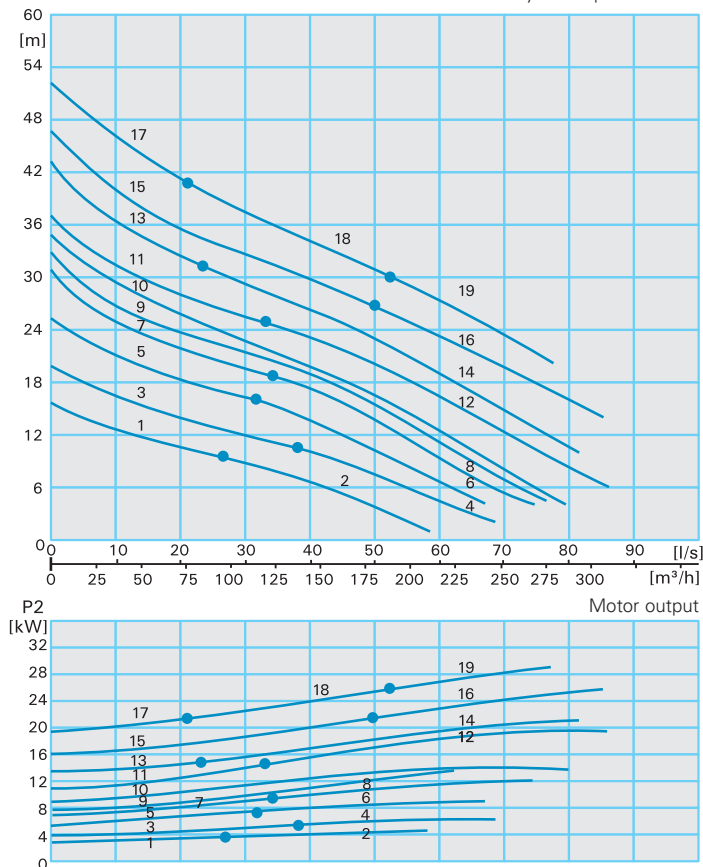

Technical data 380V/3Ph 60Hz

Standard and FM model – Wet well installation						
Curve No.	Pump type	Motor input P ₁ (kW)	Motor output P ₂ (kW)	Rated current I _n (A)	Weight standard (kg)	Weight FM (kg)
1	AMX444-180/5.5T/C (FM)	4.8	4.1	9.0	125	125
2	AMX444-180/7.5T/C (FM)	6.5	5.6	11.4	135	135
3	AMX444-190/7.5T/C (FM)	6.5	5.6	11.4	135	135
4	AMX444-190/10.4T/C (FM)	9.0	7.8	14.9	138	138
5	AMX444-220/10.4T/C (FM)	9.0	7.8	14.9	138	138
6	AMX444-220/13P/C (FM)	11.1	9.7	19.4	164	176
7	AMX444-230/13P/C (FM)	11.1	9.7	19.4	164	176
8	AMX444-230/20P/C (FM)	16.9	14.9	29.7	183	195
9	AMX444-240/20P/C (FM)	16.9	14.9	29.7	183	195
10	AMX444-260/20P/C (FM)	16.9	14.9	29.7	209	221
11	AMX444-270/20P/C (FM)	16.9	14.9	29.7	209	221
12	AMX444-270/29P/C (FM)	24.3	21.6	43.0	231	243
13	AMX444-280/20P/C (FM)	16.9	14.9	29.7	209	221
14	AMX444-280/29P/C (FM)	24.3	21.6	43.0	231	243
15	AMX444-300/29P/C (FM)	24.3	21.6	43.0	231	243
16	AMX444-300/34.5F/C (FM)	28.6	26.0	51.0	377	377
17	AMX444-310/29P/C (FM)	24.3	21.6	43.0	231	243
18	AMX444-310/34.5F/C (FM)	28.6	26.0	51.0	377	377
19	AMX444-310/39.2F/C (FM)	32.2	29.3	58.0	399	399

Standard and FM model – Dry well installation						
Curve No.	Pump type	Motor input P ₁ (kW)	Motor output P ₂ (kW)	Rated current I _n (A)	Weight standard (kg)	Weight FM (kg)
1	AMX444-180/5.5TU (FM)	4.8	4.1	9.0	128	128
2	AMX444-180/7.5TU (FM)	6.5	5.6	11.4	139	139
3	AMX444-190/7.5TU (FM)	6.5	5.6	11.4	139	139
4	AMX444-190/10.4TU (FM)	9.0	7.8	14.9	142	142
5	AMX444-220/10.4TU (FM)	9.0	7.8	14.9	142	142
6	AMX444-220/13PU (FM)	11.1	9.7	19.4	172	184
7	AMX444-230/13PU (FM)	11.1	9.7	19.4	172	184
8	AMX444-230/20PU (FM)	16.9	14.9	29.7	193	205
9	AMX444-240/20PU (FM)	16.9	14.9	29.7	193	205
10	AMX444-260/20PU (FM)	16.9	14.9	29.7	219	231
11	AMX444-270/20PU (FM)	16.9	14.9	29.7	219	231
12	AMX444-270/29PU (FM)	24.3	21.6	43.0	244	256
13	AMX444-280/20PU (FM)	16.9	14.9	29.7	219	231
14	AMX444-280/29PU (FM)	24.3	21.6	43.0	244	256
15	AMX444-300/29PU (FM)	24.3	21.6	43.0	244	256
16	AMX444-300/34.5FU (FM)	28.6	26.0	51.0	398	398
17	AMX444-310/29PU (FM)	24.3	21.6	43.0	244	256
18	AMX444-310/34.5FU (FM)	28.6	26.0	51.0	398	398
19	AMX444-310/39.2FU (FM)	32.2	29.3	58.0	424	424

DN100 - AVX444...-4 pole



Vortex impeller
100 mm Ø
Spherical clearance
1750 rpm

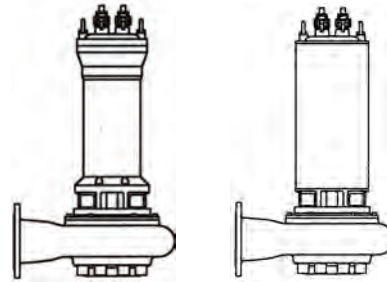

Performance curves

Hydraulic performance

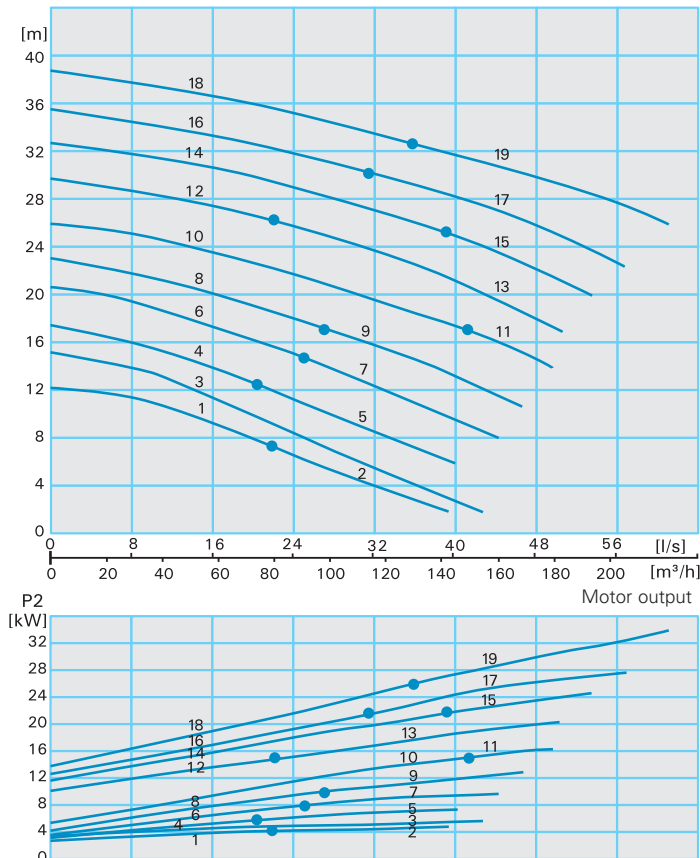

Technical data 380V/3Ph 60Hz

Standard and FM model – Wet well installation

Curve No.	Pump type	Motor input P ₁ (kW)	Motor output P ₂ (kW)	Rated current I _n (A)	Weight standard (kg)	Weight FM (kg)
1	AVX444-180/5.5T/C (FM)	4.8	4.1	9.0	110	110
2	AVX444-180/7.5T/C (FM)	6.5	5.6	11.4	120	120
3	AVX444-198/7.5T/C (FM)	6.5	5.6	11.4	120	120
4	AVX444-200/7.5T/C (FM)	6.5	5.6	11.4	123	123
5	AVX444-200/10.4T/C (FM)	9.0	7.8	14.9	126	126
6	AVX444-210/10.4T/C (FM)	9.0	7.8	14.9	126	126
7	AVX444-210/13P/C (FM)	11.1	9.7	19.4	152	164
8	AVX444-220/13P/C (FM)	11.1	9.7	19.4	152	164
9	AVX444-220/20P/C (FM)	16.9	14.9	29.7	171	183
10	AVX444-230/20P/C (FM)	16.9	14.9	29.7	171	183
11	AVX444-230/29P/C (FM)	24.3	21.6	43.0	193	205
12	AVX444-258/20P/C (FM)	16.9	14.9	29.7	205	217
13	AVX444-258/29P/C (FM)	24.3	21.6	43.0	227	239
14	AVX444-268/29P/C (FM)	24.3	21.6	43.0	227	239
15	AVX444-268/34.5F/C (FM)	28.6	26.0	51.0	372	372
16	AVX444-278/29P/C (FM)	24.3	21.6	43.0	227	239
17	AVX444-278/39.2F/C (FM)	32.2	29.3	58.0	394	394
18	AVX444-288/34.5F/C (FM)	28.6	26.0	51.0	372	372
19	AVX444-288/45.6F/C (FM)	37.0	34.0	67.0	409	409

Standard and FM model – Dry well installation

Curve No.	Pump type	Motor input P ₁ (kW)	Motor output P ₂ (kW)	Rated current I _n (A)	Weight standard (kg)	Weight FM (kg)
1	AVX444-180/5.5TU (FM)	4.8	4.1	9.0	113	113
2	AVX444-180/7.5TU (FM)	6.5	5.6	11.4	124	124
3	AVX444-198/7.5TU (FM)	6.5	5.6	11.4	124	124
4	AVX444-200/7.5TU (FM)	6.5	5.6	11.4	127	127
5	AVX444-200/10.4TU (FM)	9.0	7.8	14.9	130	130
6	AVX444-210/10.4TU (FM)	9.0	7.8	14.9	130	130
7	AVX444-210/13PU (FM)	11.1	9.7	19.4	160	172
8	AVX444-220/13PU (FM)	11.1	9.7	19.4	160	172
9	AVX444-220/20PU (FM)	16.9	14.9	29.7	181	193
10	AVX444-230/20PU (FM)	16.9	14.9	29.7	181	193
11	AVX444-230/29PU (FM)	24.3	21.6	43.0	206	218
12	AVX444-258/20PU (FM)	16.9	14.9	29.7	215	227
13	AVX444-258/29PU (FM)	24.3	21.6	43.0	240	252
14	AVX444-268/29PU (FM)	24.3	21.6	43.0	240	252
15	AVX444-268/34.5FU (FM)	28.6	26.0	51.0	393	393
16	AVX444-278/29PU (FM)	24.3	21.6	43.0	240	252
17	AVX444-278/39.2FU (FM)	32.2	29.3	58.0	420	420
18	AVX444-288/34.5FU (FM)	28.6	26.0	51.0	393	393
19	AVX444-288/45.6FU (FM)	37.0	34.0	67.0	435	435

DN100 - AMX446...-6 pole



Enclosed single channel impeller

100 mm Ø

Spherical clearance

1160 rpm

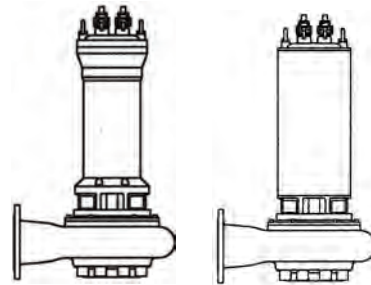

Performance curves

Hydraulic performance

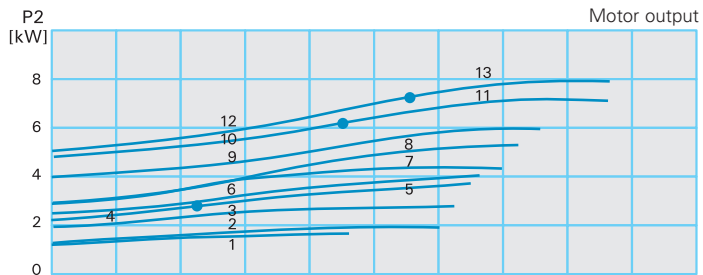
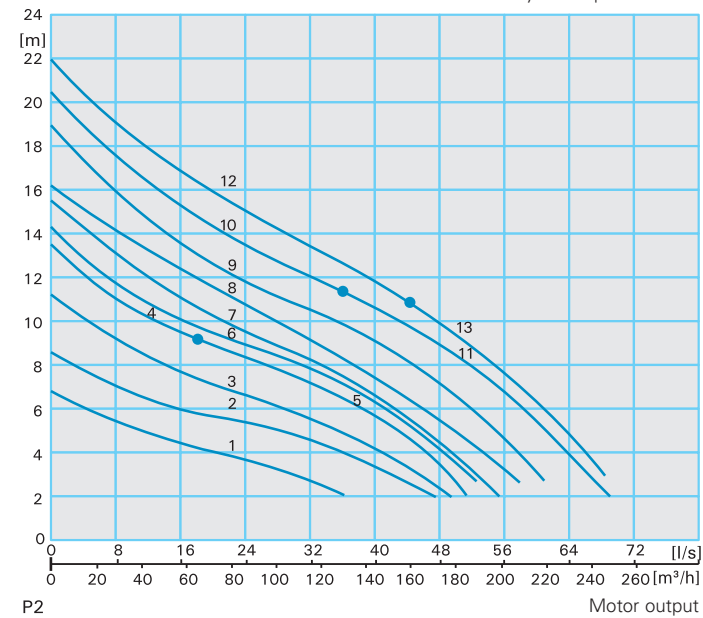

Technical data

380V/3Ph 60Hz

Standard and FM model – Wet well installation						
Curve No.	Pump type	Motor input P ₁ (kW)	Motor output P ₂ (kW)	Rated current I _N (A)	Weight standard (kg)	Weight FM (kg)
1	AMX446-180/2.8T/C (FM)	2.6	2.1	8.2	120	120
2	AMX446-190/2.8T/C (FM)	2.6	2.1	8.2	120	120
3	AMX446-220/3.8T/C (FM)	3.4	2.8	11.0	124	124
4	AMX446-230/3.8T/C (FM)	3.4	2.8	11.0	124	124
5	AMX446-230/6.2T/C (FM)	5.6	4.6	18.0	134	134
6	AMX446-240/6.2T/C (FM)	5.6	4.6	18.0	134	134
7	AMX446-260/6.2T/C (FM)	5.6	4.6	18.0	160	160
8	AMX446-270/8.3T/C (FM)	7.6	6.2	24.0	164	164
9	AMX446-280/8.3T/C (FM)	7.6	6.2	24.0	164	164
10	AMX446-300/8.3T/C (FM)	7.6	6.2	24.0	164	164
11	AMX446-300/9.8P/C (FM)	8.6	7.3	17.0	188	200
12	AMX446-310/9.8P/C (FM)	8.6	7.3	17.0	188	200
13	AMX446-310/15.3P/C (FM)	13.4	11.4	26.0	213	225

Standard and FM model – Dry well installation						
Curve No.	Pump type	Motor input P ₁ (kW)	Motor output P ₂ (kW)	Rated current I _N (A)	Weight standard (kg)	Weight FM (kg)
1	AMX446-180/2.8TU (FM)	2.6	2.1	8.2	123	123
2	AMX446-190/2.8TU (FM)	2.6	2.1	8.2	123	123
3	AMX446-220/3.8TU (FM)	3.4	2.8	11.0	128	128
4	AMX446-230/3.8TU (FM)	3.4	2.8	11.0	128	128
5	AMX446-230/6.2TU (FM)	5.6	4.6	18.0	138	138
6	AMX446-240/6.2TU (FM)	5.6	4.6	18.0	138	138
7	AMX446-260/6.2TU (FM)	5.6	4.6	18.0	164	164
8	AMX446-270/8.3TU (FM)	7.6	6.2	24.0	168	168
9	AMX446-280/8.3TU (FM)	7.6	6.2	24.0	168	168
10	AMX446-300/8.3TU (FM)	7.6	6.2	24.0	168	168
11	AMX446-300/9.8PU (FM)	8.6	7.3	17.0	194	206
12	AMX446-310/9.8PU (FM)	8.6	7.3	17.0	194	206
13	AMX446-310/15.3PU (FM)	13.4	11.4	26.0	223	235



Vortex impeller
100 mm Ø
Spherical clearance
1160 rpm

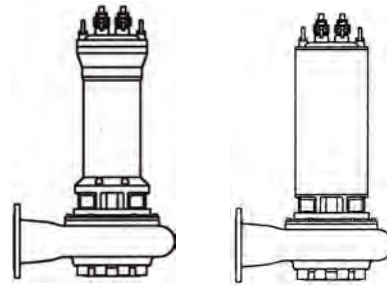

Performance curves

Hydraulic performance

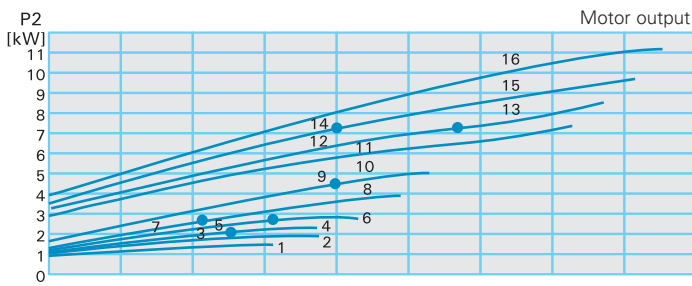
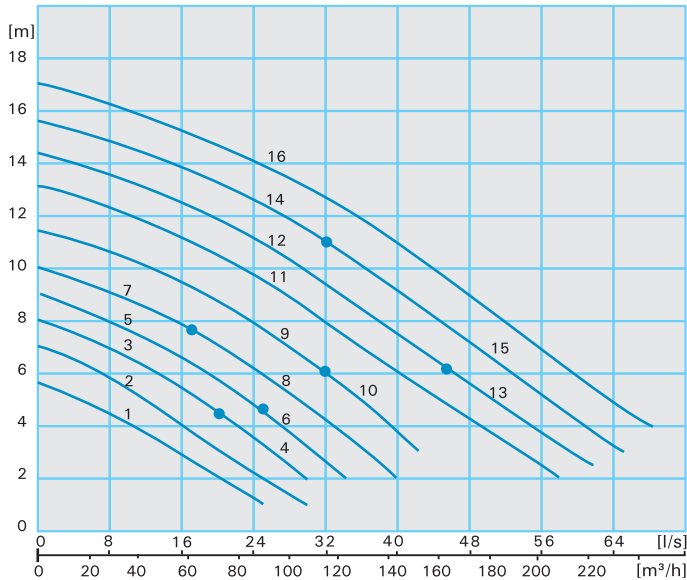

Technical data 380V/3Ph 60Hz

Standard and FM model – Wet well installation						
Curve No.	Pump type	Motor input P ₁ (kW)	Motor output P ₂ (kW)	Rated current I _n (A)	Weight standard (kg)	Weight FM (kg)
1	AVX446-180/2.8T/C (FM)	2.6	2.1	5.0	105	105
2	AVX446-205/2.8T/C (FM)	2.6	2.1	5.0	105	105
3	AVX446-200/2.8T/C (FM)	2.6	2.1	5.0	108	108
4	AVX446-200/3.8T/C (FM)	3.4	2.8	6.7	112	112
5	AVX446-210/3.8T/C (FM)	3.4	2.8	6.7	112	112
6	AVX446-210/6.2T/C (FM)	5.6	4.6	10.9	122	122
7	AVX446-220/3.8T/C (FM)	3.4	2.8	6.7	112	112
8	AVX446-220/6.2T/C (FM)	5.6	4.6	10.9	122	122
9	AVX446-230/6.2T/C (FM)	5.6	4.6	10.9	122	122
10	AVX446-230/8.3T/C (FM)	7.6	6.2	14.5	126	126
11	AVX446-258/9.8P/C (FM)	8.6	7.3	17.0	186	198
12	AVX446-268/9.8P/C (FM)	8.6	7.3	17.0	186	198
13	AVX446-268/15.3P/C (FM)	13.4	11.4	26.0	205	217
14	AVX446-278/9.8P/C (FM)	8.6	7.3	17.0	186	198
15	AVX446-278/15.3P/C (FM)	13.4	11.4	26.0	205	217
16	AVX446-288/15.3P/C (FM)	13.4	11.4	26.0	205	217

Standard and FM model – Dry well installation						
Curve No.	Pump type	Motor input P ₁ (kW)	Motor output P ₂ (kW)	Rated current I _n (A)	Weight standard (kg)	Weight FM (kg)
1	AVX446-180/2.8TU (FM)	2.6	2.1	5.0	108	108
2	AVX446-205/2.8TU (FM)	2.6	2.1	5.0	108	108
3	AVX446-200/2.8TU (FM)	2.6	2.1	5.0	111	111
4	AVX446-200/3.8TU (FM)	3.4	2.8	6.7	116	116
5	AVX446-210/3.8TU (FM)	3.4	2.8	6.7	116	116
6	AVX446-210/6.2TU (FM)	5.6	4.6	10.9	126	126
7	AVX446-220/3.8TU (FM)	3.4	2.8	6.7	116	116
8	AVX446-220/6.2TU (FM)	5.6	4.6	10.9	126	126
9	AVX446-230/6.2TU (FM)	5.6	4.6	10.9	126	126
10	AVX446-230/8.3TU (FM)	7.6	6.2	14.5	130	130
11	AVX446-258/9.8PU (FM)	8.6	7.3	17.0	194	206
12	AVX446-268/9.8PU (FM)	8.6	7.3	17.0	194	206
13	AVX446-268/15.3PU (FM)	13.4	11.4	26.0	215	227
14	AVX446-278/9.8PU (FM)	8.6	7.3	17.0	194	206
15	AVX446-278/15.3PU (FM)	13.4	11.4	26.0	215	227
16	AVX446-288/15.3PU (FM)	13.4	11.4	26.0	215	227

DN150 - AK634...-4 pole



Enclosed two channel impeller

80 mm Ø

Spherical clearance

1750 rpm

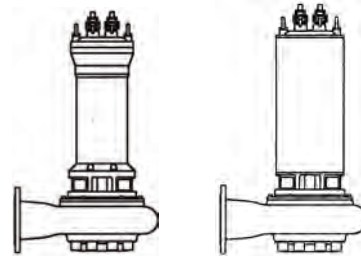

Performance curves

Hydraulic performance

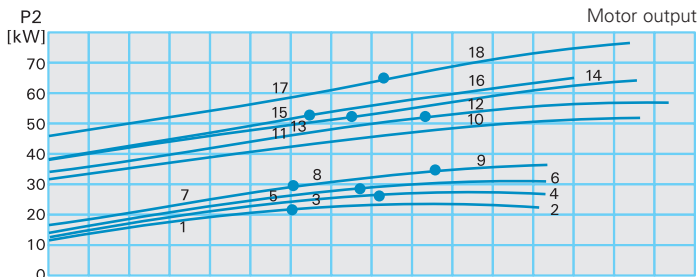
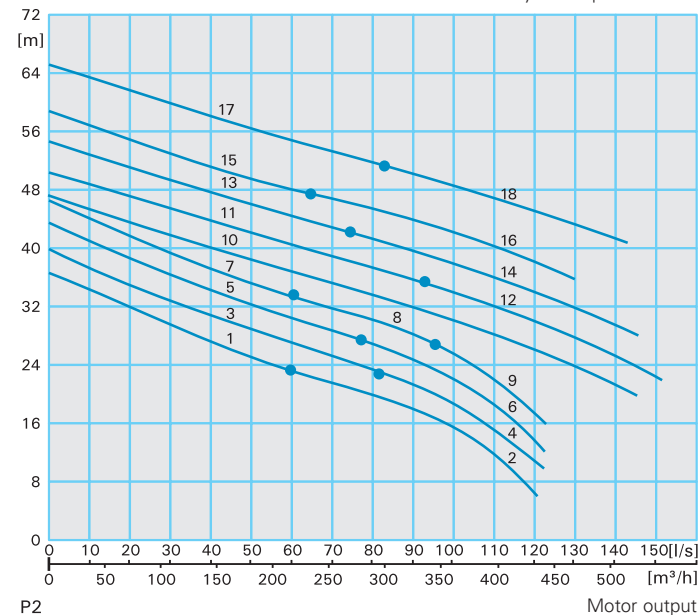

Technical data 380V/3Ph 60Hz

Standard and FM model – Wet well installation						
Curve No.	Pump type	Motor input P ₁ (kW)	Motor output P ₂ (kW)	Rated current I _n (A)	Weight standard (kg)	Weight FM (kg)
1	AK634-260/29P/C (FM)	24.3	21.6	43.0	239	251
2	AK634-260/34.5F/C (FM)	28.6	26.0	51.0	385	385
3	AK634-270/34.5F/C (FM)	28.6	26.0	51.0	385	385
4	AK634-270/39.2F/C (FM)	32.2	29.3	58.0	408	408
5	AK634-280/39.2F/C (FM)	32.2	29.3	58.0	409	409
6	AK634-280/45.6F/C (FM)	37.0	34.0	67.0	424	424
7	AK634-290/39.2F/C (FM)	32.2	29.3	58.0	410	410
8	AK634-290/45.6F/C (FM)	37.0	34.0	67.0	425	425
9	AK634-290/53F/C (FM)	42.9	39.5	76.0	440	440
10	AK634-310/70G/C (FM)	56.1	52.2	98.0	553	553
11	AK634-320/70G/C (FM)	56.1	52.2	98.0	554	554
12	AK634-320/87G/C (FM)	69.8	64.9	121.0	579	579
13	AK634-330/70G/C (FM)	56.1	52.2	98.0	555	555
14	AK634-330/87G/C (FM)	69.8	64.9	121.0	580	580
15	AK634-340/70G/C (FM)	56.1	52.2	98.0	557	557
16	AK634-340/87G/C (FM)	69.8	64.9	121.0	582	582
17	AK634-355/87G/C (FM)	69.8	64.9	121.0	583	583
18	AK634-355/103G/C (FM)	81.7	76.8	144.0	624	624

Standard and FM model – Dry well installation						
Curve No.	Pump type	Motor input P ₁ (kW)	Motor output P ₂ (kW)	Rated current I _n (A)	Weight standard (kg)	Weight FM (kg)
1	AK634-260/29PU (FM)	24.3	21.6	43.0	252	264
2	AK634-260/34.5FU (FM)	28.6	26.0	51.0	406	406
3	AK634-270/34.5FU (FM)	28.6	26.0	51.0	407	407
4	AK634-270/39.2FU (FM)	32.2	29.3	58.0	433	433
5	AK634-280/39.2FU (FM)	32.2	29.3	58.0	434	434
6	AK634-280/45.6FU (FM)	37.0	34.0	67.0	450	450
7	AK634-290/39.2FU (FM)	32.2	29.3	58.0	435	435
8	AK634-290/45.6FU (FM)	37.0	34.0	67.0	451	451
9	AK634-290/53FU (FM)	42.9	39.5	76.0	466	466
10	AK634-310/70GU (FM)	56.1	52.2	98.0	578	578
11	AK634-320/70GU (FM)	56.1	52.2	98.0	579	579
12	AK634-320/87GU (FM)	69.8	64.9	121.0	604	604
13	AK634-330/70GU (FM)	56.1	52.2	98.0	580	580
14	AK634-330/87GU (FM)	69.8	64.9	121.0	605	605
15	AK634-340/70GU (FM)	56.1	52.2	98.0	582	582
16	AK634-340/87GU (FM)	69.8	64.9	121.0	607	607
17	AK634-355/87GU (FM)	69.8	64.9	121.0	608	608
18	AK634-355/103GU (FM)	81.7	76.8	144.0	653	653

DN150 - AK636...-6 pole



Enclosed two channel impeller

80 mm Ø

Spherical clearance

1160 rpm

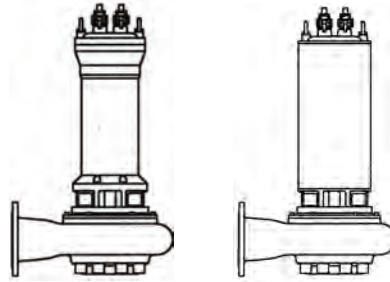

Performance curves

Hydraulic performance

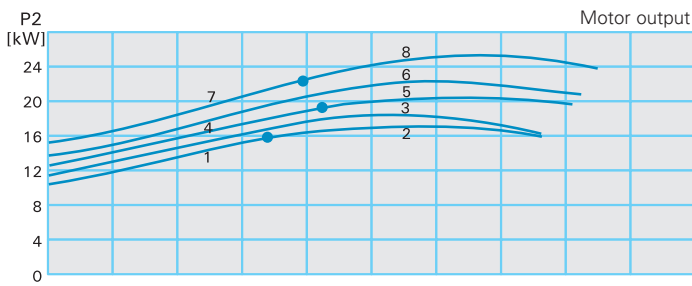
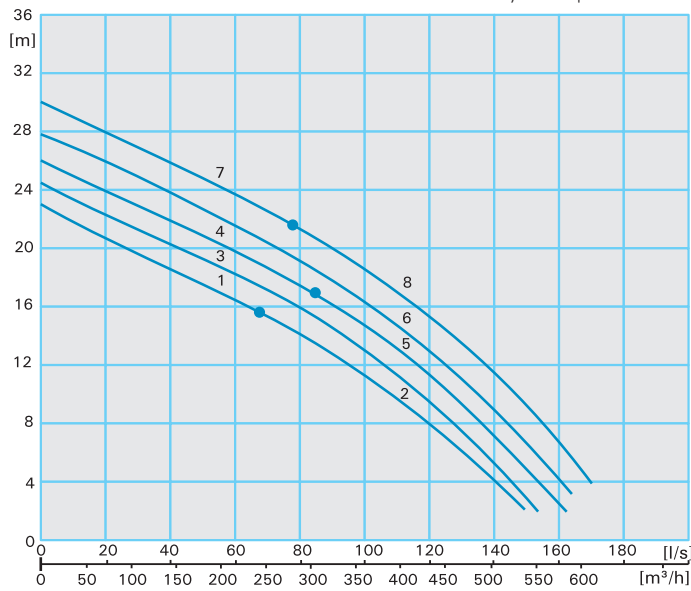

Technical data 380V/3Ph 60Hz

Standard and FM model – Wet well installation						
Curve No.	Pump type	Motor input P ₁ (kW)	Motor output P ₂ (kW)	Rated current I _N (A)	Weight standard (kg)	Weight FM (kg)
1	AK636-320/21.5P/C (FM)	18.6	16.0	36.3	301	313
2	AK636-320/26F/C (FM)	22.0	19.4	42.0	430	430
3	AK636-330/26F/C (FM)	22.0	19.4	42.0	431	431
4	AK636-340/26F/C (FM)	22.0	19.4	42.0	432	432
5	AK636-340/30F/C (FM)	25.5	22.4	48.0	452	452
6	AK636-350/30F/C (FM)	25.5	22.4	48.0	453	453
7	AK636-362/30F/C (FM)	25.5	22.4	48.0	454	454
8	AK636-362/34.5F/C (FM)	29.2	25.7	56.0	466	466

Standard and FM model – Dry well installation						
Curve No.	Pump type	Motor input P ₁ (kW)	Motor output P ₂ (kW)	Rated current I _N (A)	Weight standard (kg)	Weight FM (kg)
1	AK636-320/21.5PU (FM)	18.6	16.0	36.3	314	326
2	AK636-320/26FU (FM)	22.0	19.4	42.0	451	451
3	AK636-330/26FU (FM)	22.0	19.4	42.0	452	452
4	AK636-340/26FU (FM)	22.0	19.4	42.0	453	453
5	AK636-340/30FU (FM)	25.5	22.4	48.0	477	477
6	AK636-350/30FU (FM)	25.5	22.4	48.0	478	478
7	AK636-362/30FU (FM)	25.5	22.4	48.0	479	479
8	AK636-362/34.5FU (FM)	29.2	25.7	56.0	491	491

DN150 - AMX644...-4 pole



Enclosed single channel impeller

100 mm Ø

Spherical clearance

1750 rpm

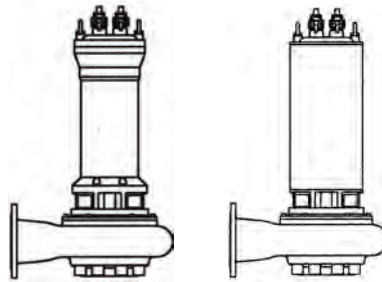

Performance curves

Hydraulic performance

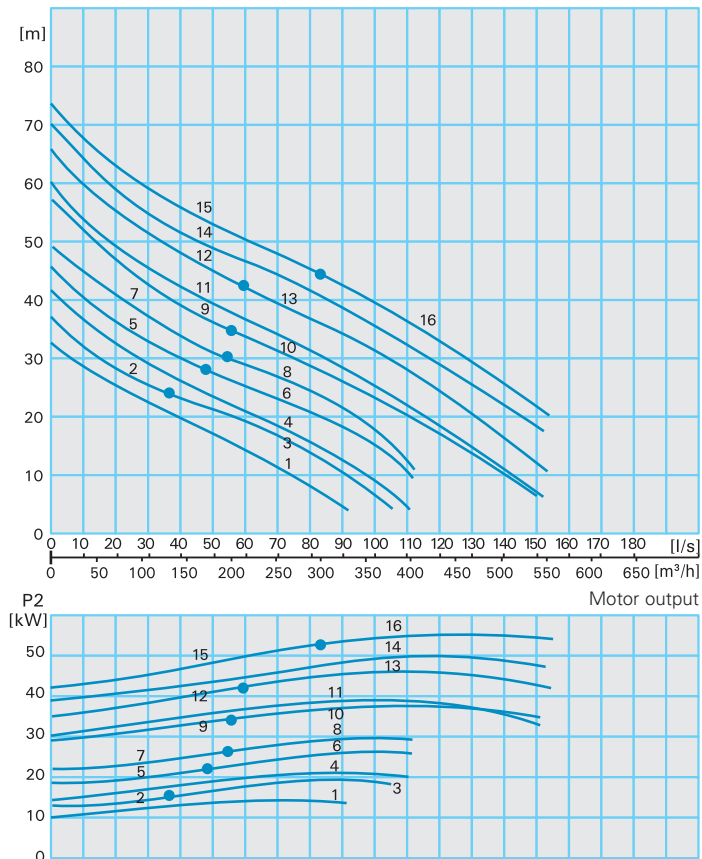

Technical data 380V/3Ph 60Hz

Standard and FM model – Wet well installation						
Curve No.	Pump type	Motor input P ₁ (kW)	Motor output P ₂ (kW)	Rated current I _n (A)	Weight standard (kg)	Weight FM (kg)
1	AMX644-260/20P/C (FM)	16.9	14.9	29.7	215	227
2	AMX644-270/20P/C (FM)	16.9	14.9	29.7	215	227
3	AMX644-270/29P/C (FM)	24.3	21.6	43.0	237	249
4	AMX644-280/29P/C (FM)	24.3	21.6	43.0	237	249
5	AMX644-300/29P/C (FM)	24.3	21.6	43.0	237	249
6	AMX644-300/34.5F/C (FM)	28.6	26.0	51.0	383	383
7	AMX644-310/34.5F/C (FM)	28.6	26.0	51.0	383	383
8	AMX644-310/39.2F/C (FM)	32.2	29.3	58.0	405	405
9	AMX644-330/45.6F/C (FM)	37.0	34.0	67.0	488	488
10	AMX644-330/53F/C (FM)	42.9	39.5	76.0	503	503
11	AMX644-340/53F/C (FM)	42.9	39.5	76.0	504	504
12	AMX644-350/56G/C (FM)	44.9	41.8	80.0	512	512
13	AMX644-350/70G/C (FM)	56.1	52.2	98.0	550	550
14	AMX644-360/70G/C (FM)	56.1	52.2	98.0	551	551
15	AMX644-370/70G/C (FM)	56.1	52.2	98.0	552	552
16	AMX644-370/87G/C (FM)	69.8	64.9	121.0	557	557

Standard and FM model – Dry well installation						
Curve No.	Pump type	Motor input P ₁ (kW)	Motor output P ₂ (kW)	Rated current I _n (A)	Weight standard (kg)	Weight FM (kg)
1	AMX644-260/20PU (FM)	16.9	14.9	29.7	225	237
2	AMX644-270/20PU (FM)	16.9	14.9	29.7	225	237
3	AMX644-270/29PU (FM)	24.3	21.6	43.0	250	262
4	AMX644-280/29PU (FM)	24.3	21.6	43.0	250	262
5	AMX644-300/29PU (FM)	24.3	21.6	43.0	250	262
6	AMX644-300/34.5FU (FM)	28.6	26.0	51.0	404	404
7	AMX644-310/34.5FU (FM)	28.6	26.0	51.0	404	404
8	AMX644-310/39.2FU (FM)	32.2	29.3	58.0	430	430
9	AMX644-330/45.6FU (FM)	37.0	34.0	67.0	514	514
10	AMX644-330/53FU (FM)	42.9	39.5	76.0	529	529
11	AMX644-340/53FU (FM)	42.9	39.5	76.0	530	530
12	AMX644-350/56GU (FM)	44.9	41.8	80.0	534	534
13	AMX644-350/70GU (FM)	56.1	52.2	98.0	575	575
14	AMX644-360/70GU (FM)	56.1	52.2	98.0	576	576
15	AMX644-370/70GU (FM)	56.1	52.2	98.0	577	577
16	AMX644-370/87GU (FM)	69.8	64.9	121.0	602	602

DN150 - AVX644...-4 pole



Vortex impeller
100 mm Ø
Spherical clearance
1750 rpm

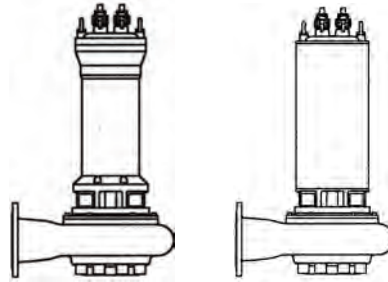

Performance curves

Hydraulic performance

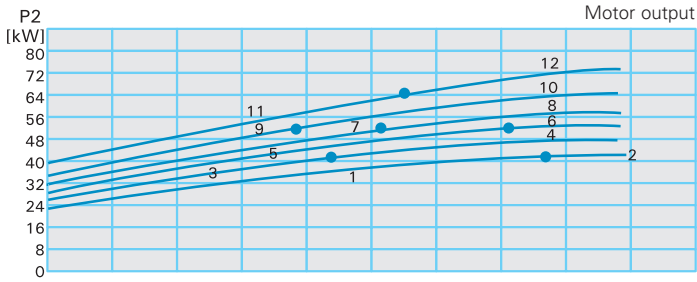
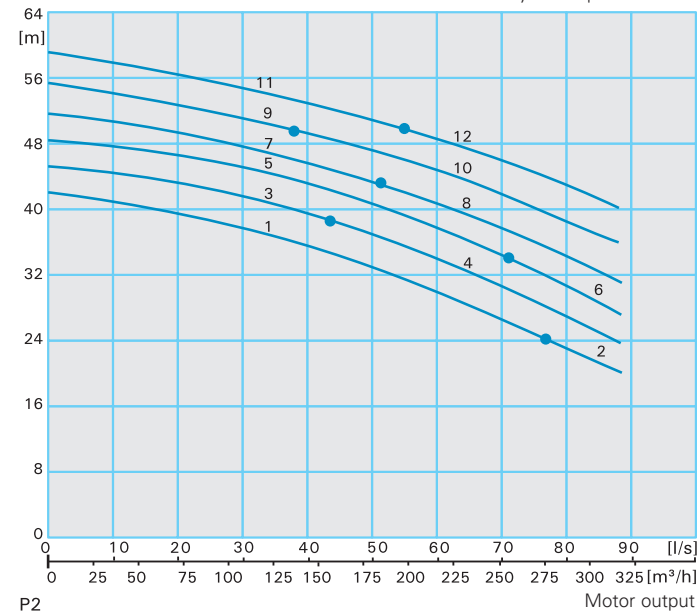

Technical data 380V/3Ph 60Hz

Standard and FM model – Wet well installation						
Curve No.	Pump type	Motor input P ₁ (kW)	Motor output P ₂ (kW)	Rated current I _n (A)	Weight standard (kg)	Weight FM (kg)
1	AVX644-300/56G/C (FM)	44.9	41.8	80.0	495	495
2	AVX644-300/70G/C (FM)	56.1	52.2	98.0	523	523
3	AVX644-315/56G/C (FM)	44.9	41.8	80.0	495	495
4	AVX644-315/70G/C (FM)	56.1	52.2	98.0	523	523
5	AVX644-330/70G/C (FM)	56.1	52.2	98.0	523	523
6	AVX644-330/87G/C (FM)	69.8	64.9	121.0	548	548
7	AVX644-340/70G/C (FM)	56.1	52.2	98.0	523	523
8	AVX644-340/87G/C (FM)	69.8	64.9	121.0	548	548
9	AVX644-350/70G/C (FM)	56.1	52.2	98.0	523	523
10	AVX644-350/87G/C (FM)	69.8	64.9	121.0	548	548
11	AVX644-358/87G/C (FM)	69.8	64.9	121.0	548	548
12	AVX644-358/103G/C (FM)	81.7	76.8	144.0	628	628

Standard and FM model – Dry well installation						
Curve No.	Pump type	Motor input P ₁ (kW)	Motor output P ₂ (kW)	Rated current I _n (A)	Weight standard (kg)	Weight FM (kg)
1	AVX644-300/56GU (FM)	44.9	41.8	80.0	521	521
2	AVX644-300/70GU (FM)	56.1	52.2	98.0	552	552
3	AVX644-315/56GU (FM)	44.9	41.8	80.0	521	521
4	AVX644-315/70GU (FM)	56.1	52.2	98.0	552	552
5	AVX644-330/70GU (FM)	56.1	52.2	98.0	552	552
6	AVX644-330/87GU (FM)	69.8	64.9	121.0	577	577
7	AVX644-340/70GU (FM)	56.1	52.2	98.0	552	552
8	AVX644-340/87GU (FM)	69.8	64.9	121.0	577	577
9	AVX644-350/70GU (FM)	56.1	52.2	98.0	552	552
10	AVX644-350/87GU (FM)	69.8	64.9	121.0	577	577
11	AVX644-358/87GU (FM)	69.8	64.9	121.0	577	577
12	AVX644-358/103GU (FM)	81.7	76.8	144.0	657	657

DN150 - AMX646...-6 pole



Enclosed single channel impeller
100 mm Ø
Spherical clearance
1160 rpm

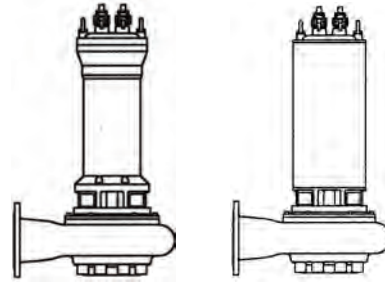

Performance curves

Hydraulic performance

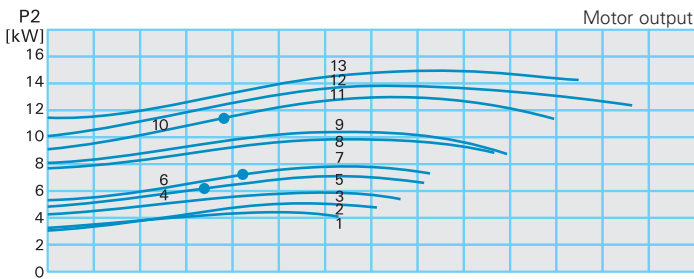
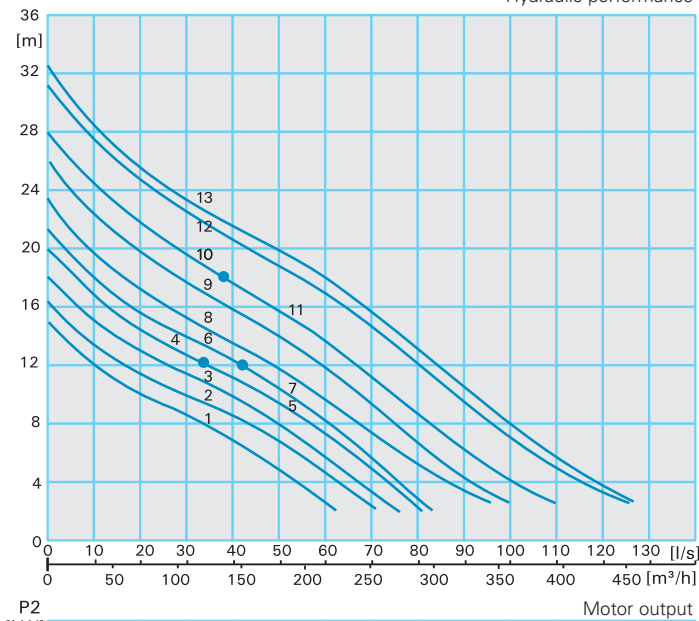

Technical data

380V/3Ph 60Hz

Standard and FM model – Wet well installation						
Curve No.	Pump type	Motor input P ₁ (kW)	Motor output P ₂ (kW)	Rated current I _n (A)	Weight standard (kg)	Weight FM (kg)
1	AMX646-260/6.2T/C (FM)	5.6	4.6	10.9	166	166
2	AMX646-270/8.3T/C (FM)	7.6	6.2	14.5	170	170
3	AMX646-280/8.3T/C (FM)	7.6	6.2	14.5	170	170
4	AMX646-300/8.3T/C (FM)	7.6	6.2	14.5	170	170
5	AMX646-300/9.8P/C (FM)	8.6	7.3	17.0	194	206
6	AMX646-310/9.8P/C (FM)	8.6	7.3	17.0	194	206
7	AMX646-310/15.3P/C (FM)	13.4	11.4	26.0	219	231
8	AMX646-330/15.3P/C (FM)	13.4	11.4	26.0	289	301
9	AMX646-340/15.3P/C (FM)	13.4	11.4	26.0	290	302
10	AMX646-350/15.3P/C (FM)	13.4	11.4	26.0	291	303
11	AMX646-350/21.5P/C (FM)	18.6	16.0	36.3	305	317
12	AMX646-360/21.5P/C (FM)	18.6	16.0	36.3	306	318
13	AMX646-370/21.5P/C (FM)	18.6	16.0	36.3	307	319

Standard and FM model – Dry well installation						
Curve No.	Pump type	Motor input P ₁ (kW)	Motor output P ₂ (kW)	Rated current I _n (A)	Weight standard (kg)	Weight FM (kg)
1	AMX646-260/6.2TU (FM)	5.6	4.6	10.9	170	170
2	AMX646-270/8.3TU (FM)	7.6	6.2	14.5	174	174
3	AMX646-280/8.3TU (FM)	7.6	6.2	14.5	174	174
4	AMX646-300/8.3TU (FM)	7.6	6.2	14.5	174	174
5	AMX646-300/9.8PU (FM)	8.6	7.3	17.0	200	212
6	AMX646-310/9.8PU (FM)	8.6	7.3	17.0	200	212
7	AMX646-310/15.3PU (FM)	13.4	11.4	26.0	229	241
8	AMX646-330/15.3PU (FM)	13.4	11.4	26.0	299	311
9	AMX646-340/15.3PU (FM)	13.4	11.4	26.0	300	312
10	AMX646-350/15.3PU (FM)	13.4	11.4	26.0	301	313
11	AMX646-350/21.5PU (FM)	18.6	16.0	36.3	318	330
12	AMX646-360/21.5PU (FM)	18.6	16.0	36.3	319	331
13	AMX646-370/21.5PU (FM)	18.6	16.0	36.3	320	332



Vortex impeller
100 mm Ø
Spherical clearance
1160 rpm

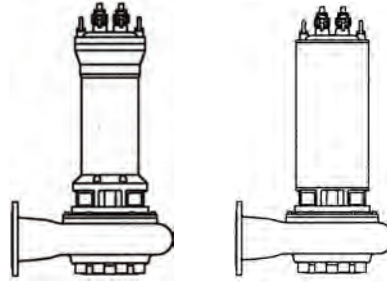

Performance curves

Hydraulic performance

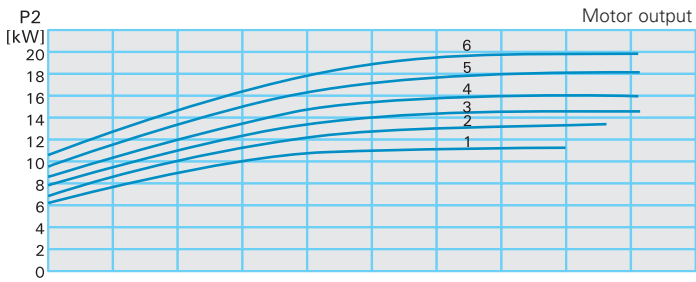
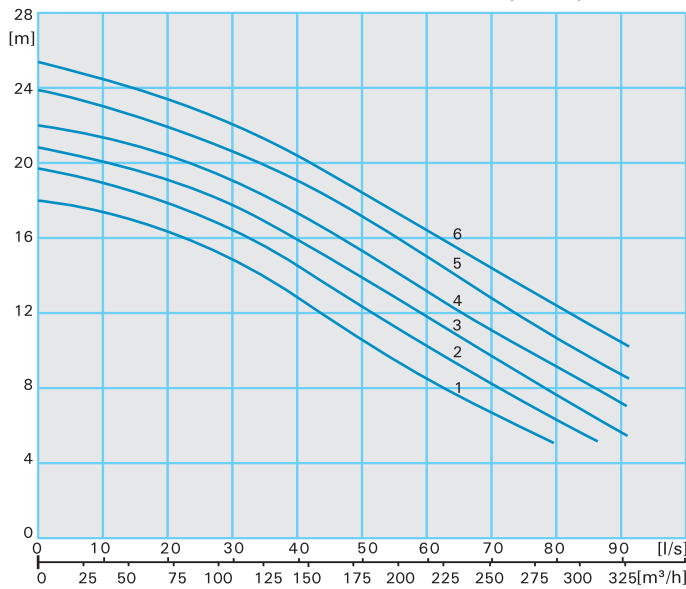

Technical data 380V/3Ph 60Hz

Standard and FM model – Wet well installation						
Curve No.	Pump type	Motor input P ₁ (kW)	Motor output P ₂ (kW)	Rated current I _N (A)	Weight standard (kg)	Weight FM (kg)
1	AVX646-300/15.3P/C (FM)	13.4	11.4	26.0	264	276
2	AVX646-315/21.5P/C (FM)	18.6	16.0	36.3	278	290
3	AVX646-330/21.5P/C (FM)	18.6	16.0	36.3	278	290
4	AVX646-340/21.5P/C (FM)	18.6	16.0	36.3	278	290
5	AVX646-350/26F/C (FM)	22.0	19.4	42.0	405	405
6	AVX646-358/30F/C (FM)	25.5	22.4	48.0	425	425

Standard and FM model – Dry well installation						
Curve No.	Pump type	Motor input P ₁ (kW)	Motor output P ₂ (kW)	Rated current I _N (A)	Weight standard (kg)	Weight FM (kg)
1	AVX646-300/15.3PU (FM)	13.4	11.4	26.0	274	286
2	AVX646-315/21.5PU (FM)	18.6	16.0	36.3	291	303
3	AVX646-330/21.5PU (FM)	18.6	16.0	36.3	291	303
4	AVX646-340/21.5PU (FM)	18.6	16.0	36.3	291	303
5	AVX646-350/26FU (FM)	22.0	19.4	42.0	426	450
6	AVX646-358/30FU (FM)	25.5	22.4	48.0	426	450

Installations and Dimensions

Wet well installation with auto-coupling system

DN80

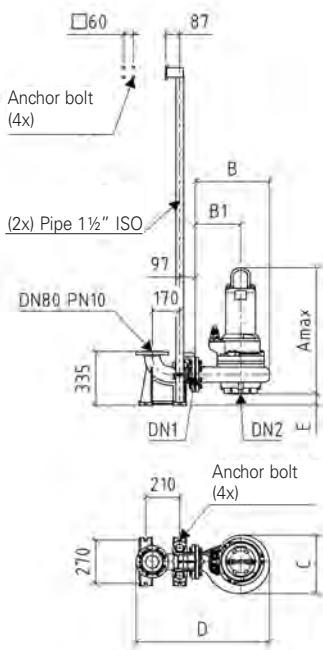

DN100

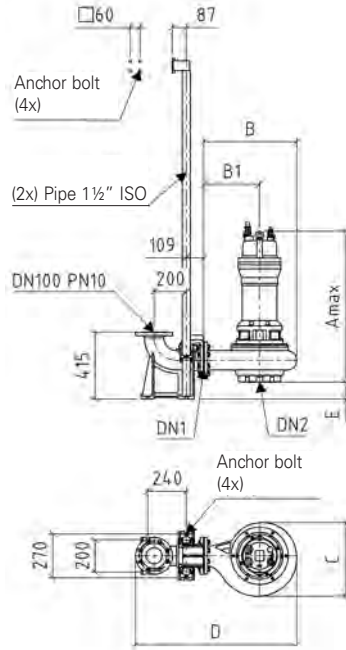

DN150

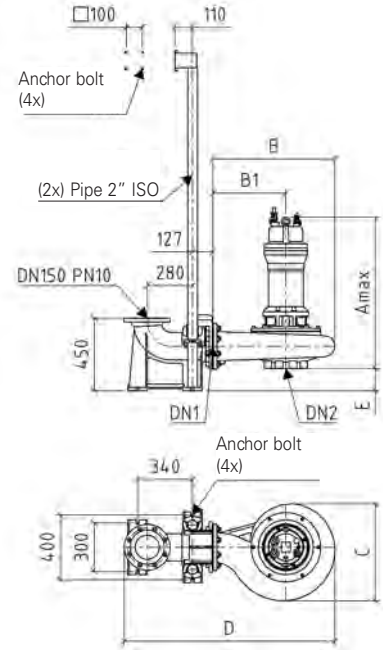

Wet well installation with base stand

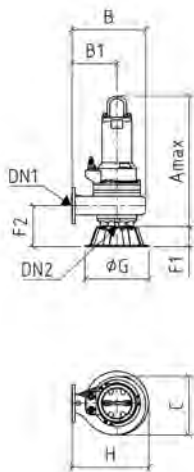

Dry well installation vertical

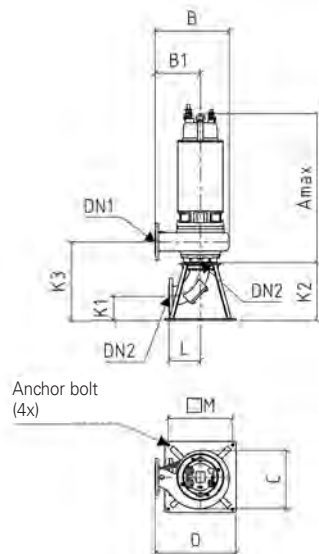

Dry well installation horizontal

Range AV(X)33... + AV(X)43
Separate support flanged to pump housing

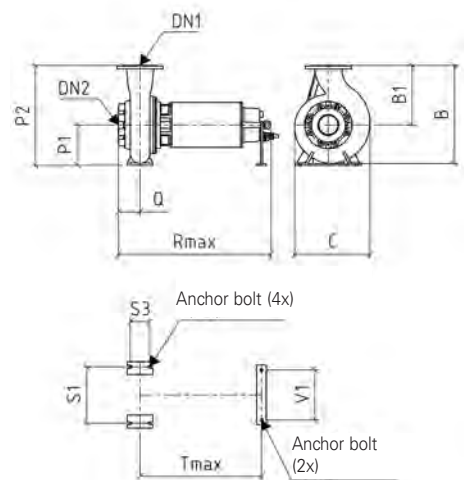

Pump type	DN1	DN2	Amax	B	B1	C	D	E	F1	F2	øG	H	
AMX334/1-(142-178)/C + D		100	554	355	200	307	722	97	125	218	395	398	
AMX334/1-(142-206)/T(U)		100	766	355	200	307	722	97	125	218	395	398	
AMX334/1-(218-250)/T(U)		100	791	459	280	363	826	71	125	244	395	478	
AMX334-(142-184)/C + D		100	554	355	200	307	722	97	125	218	395	398	
AMX334-(142-206)/T(U)		100	766	355	200	307	722	97	125	218	395	398	
AMX334-(218-250)/T(U)		100	791	459	280	363	826	71	125	244	395	478	
AMX334-250/P(U)		100	901	459	280	363	826	71	125	244	395	478	
AMX336-(178-206)/C + D		100	554	355	200	307	722	97	125	218	395	398	
AMX336-(178-206)/T(U)		100	766	355	200	307	722	97	125	218	395	398	
AMX336-(218-250)/T(U)		100	791	459	280	363	826	71	125	244	395	478	
AV332-(174-180)/T(U)	80	100	775	365	220	290	732	112	125	203	395	418	
AV332-(165-175)/T(U)		100	775	365	220	290	732	112	125	203	395	418	
AV332-(165-195)/P(U)		100	1035	365	220	290	732	112	125	203	395	418	
AV332-(200-215)/P(U)		100	1035	408	250	316	775	112	125	203	395	448	
AV334-(200-230)/T(U)		100	774	408	250	316	775	112	125	203	395	448	
AVX334-225/T(U)		100	774	408	250	316	775	112	125	203	395	448	
AVX334-(225-230)/P(U)		100	1035	408	250	316	775	112	125	203	395	448	
AV336-(200-230)/D		100	563	408	250	316	775	112	125	203	395	448	
AV336-(200-230)/T(U)		100	774	408	250	316	775	112	125	203	395	448	
AVX336-(225)/D		100	563	408	250	316	775	112	125	203	395	448	
AVX336-(225-230)/T(U)		100	774	408	250	316	775	112	125	203	395	448	
AMX434/1-(142-178)/C + D			100	554	355	200	307	779	147	125	218	395	398
AMX434/1-(142-206)/T(U)			100	693	355	200	307	779	147	125	218	395	398
AMX434/1-(218-250)/T(U)			100	791	459	280	363	883	121	125	244	395	477
AMX434-(142-184)(178)/C + D			100	554	355	200	307	779	147	125	218	395	398
AMX434-(142-206)/T(U)			100	693	355	200	307	779	147	125	218	395	398
AMX434-(218-250)/T(U)		100	791	459	280	363	883	121	125	244	395	477	
AMX434-(235-250)/P(U)		100	901	459	280	363	883	121	125	244	395	477	
AMX436-(178-206)/C + D		100	554	355	200	307	779	147	125	218	395	398	
AMX436-(178-206)/T(U)		100	693	355	200	307	779	147	125	218	395	398	
AMX436-(218-250)/T(U)		100	791	459	280	363	883	121	125	244	395	477	
AMX444-(180-190)/T(U)		100	818	422	265	323	846	117	125	248	395	463	
AMX444-220/T(U)		100	814	459	280	363	883	110	125	255	395	478	
AMX444-(220-240)/P(U)		100	984	459	280	363	883	110	125	255	395	478	
AMX444-(260-310)/P(U)		150	1091	576	345	457	1000	105	125	260	450	576	
AMX444-(300-310)/F(U)		150	1298	576	345	457	1000	105	174	309	600	645	
AMX446-(260-300)/T(U)		150	831	576	345	457	1000	105	125	260	450	576	
AMX446-(180-190)/T(U)		100	818	422	265	323	846	117	125	248	395	463	
AMX446-(220-240)/T(U)		100	814	459	280	363	883	110	125	255	395	478	
AMX446-(300-310)/P(U)		150	1091	576	345	457	1000	105	125	260	450	576	
AK434-(260-280)/P(U)	100	150	1091	576	345	457	1000	105	125	260	450	576	
AK434-(270-290)/F(U)		150	1298	576	345	457	1000	105	174	309	600	645	
AV432-(174-180)/T(U)		100	775	385	240	290	809	152	125	213	395	438	
AV432-(165-175)/T(U)		100	775	385	240	290	809	152	125	213	395	438	
AV432-(165-195)/P(U)		100	1035	385	240	290	809	152	125	213	395	438	
AV432-(200-215)/P(U)		100	1035	438	280	316	862	152	125	213	395	478	
AV432-(220-230)/F(U)		100	1254	464	280	369	889	152	174	262	600	600	
AV434-(200-230)/T(U)		100	775	438	280	316	862	152	125	213	395	478	
AV436-(200-230)/D		100	563	438	280	316	862	152	125	213	395	478	
AV436-(200-230)/T(U)		100	775	438	280	316	862	152	125	213	395	478	
AVX434-225/T(U)		100	775	438	280	316	862	152	125	213	395	478	
AVX434-(225-230)/P(U)		100	1035	438	280	316	862	152	125	213	395	478	
AVX436-225/D		100	563	438	280	316	862	152	125	213	395	478	
AVX436-(225-230)/T(U)		100	775	438	280	316	862	152	125	213	395	478	
AVX444-(180-198)/T(U)		100	799	410	250	296	834	140	125	225	395	447	
AVX444-(210-230)/P(U)		100	1064	460	280	336	884	140	125	225	395	478	
AVX444-(258-278)/P(U)	150	1098	555	345	410	979	130	125	235	450	570		
AVX444-(268-288)/F(U)	150	1310	555	345	410	979	130	174	284	600	645		
AVX446-(180-205)/T(U)	100	804	410	250	296	834	140	125	225	395	447		
AVX446-(200-230)/T(U)	100	799	460	280	336	799	140	125	225	395	478		
AVX446-(258-288)/P(U)	150	1098	555	345	410	979	130	125	235	450	570		
AMX644-(260-300)/P(U)		150	1086	608	370	468	1158	140	125	260	450	608	
AMX644-(300-310)/F(U)		150	1298	608	370	468	1158	175	174	309	600	670	
AMX644-(330-340)/F(U)		150	1326	690	420	547	1239	137	174	312	600	720	
AMX644-(350-370)/G(U)		150	1382	690	420	547	1239	137	174	312	600	720	
AMX646-(260-300)/T(U)		150	831	608	370	468	1158	140	125	260	450	608	
AMX646-(300-310)/P(U)		150	1086	608	370	468	1158	140	125	260	450	608	
AMX646-(330-370)/P(U)		150	1106	690	420	547	1239	137	125	263	450	690	
AK634-260/P(U)	150	150	1086	608	370	468	1158	140	125	260	450	608	
AK634-(260-290)/F(U)		150	1298	608	370	468	1158	175	174	309	600	670	
AK634-(310-355)/G(U)		150	1494	753	450	599	1302	136	174	313	600	753	
AK636-320/P(U)		150	1088	753	450	599	1302	136	125	264	450	753	
AK636-(320-362)/F(U)		150	1308	753	450	599	1302	136	174	313	600	753	
AVX644-(300-358)/G(U)		200	1409	620	380	464	1170	145	250	380	600	680	
AVX646-(300-340)/P(U)		200	1133	620	380	464	1170	145	250	380	600	680	
AVX646-(350-358)/F(U)		200	1353	620	380	464	1170	145	250	380	600	680	

K1	K2	K3	L	M	O	P1	P2	Q	Rmax	S1	S3	Tmax	V1
148	357	450	195	400	440	200	400	92	701	280	95	552	260
148	357	476	195	400	500	200	480	119	724	280	95	573	260
148	357	450	195	400	440	200	400	92	701	280	95	552	260
148	357	476	195	400	500	200	480	119	724	280	95	573	260
148	357	476	195	400	500	200	480	119	913	280	95	736	310
148	357	450	195	400	440	200	400	92	701	280	95	552	260
148	357	476	195	400	500	200	480	119	913	280	95	573	260
148	357	435	195	400	440	203	423	78	913	360	110	741	260
148	357	435	195	400	440	203	423	78	913	360	110	741	260
148	357	435	195	400	440	203	423	78	1252	360	110	1079	310
148	357	435	195	400	470	203	453	78	1252	360	110	1080	310
148	357	435	195	1400	470	203	453	78	912	360	110	741	260
148	357	435	195	1400	470	203	453	78	912	360	110	741	260
148	357	435	195	400	470	203	453	78	1252	360	110	1080	310
148	357	435	195	1400	470	203	453	78	912	360	110	741	260
148	357	435	195	1400	470	203	453	78	912	360	110	741	260
148	357	450	195	400	440	200	400	93	629	280	95	479	260
148	357	475	195	400	500	200	480	119	724	280	95	548	260
148	357	450	195	400	440	200	400	93	629	280	95	479	260
148	357	475	195	400	500	200	480	119	724	280	95	548	260
148	357	475	195	400	500	200	480	119	913	280	95	736	310
148	357	450	195	400	440	200	400	93	629	280	95	479	260
148	357	475	195	400	500	200	480	119	724	280	95	548	260
148	357	480	195	400	485	200	480	119	724	280	95	548	260
148	357	487	195	400	500	200	480	130	747	280	95	559	260
148	357	487	195	400	500	200	480	130	996	280	95	807	310
205	502	637	283	520	635	250	595	135	1103	350	120	910	310
200	502	637	283	560	670	250	595	135	1310	350	120	1098	360
205	502	637	283	520	635	250	595	135	765	350	120	572	260
148	357	480	195	400	485	200	465	123	751	280	95	570	260
148	357	487	195	400	500	200	480	130	747	280	95	559	260
205	502	637	283	520	635	250	595	135	1103	350	120	910	310
205	502	637	283	520	635	250	595	135	1103	350	120	910	310
200	502	637	283	560	670	250	595	135	1310	350	120	1098	360
148	357	445	195	400	460	203	443	88	913	360	110	741	260
148	357	445	195	400	460	203	443	88	913	360	110	741	260
148	357	445	195	400	460	203	443	88	1252	360	110	1079	310
148	357	445	195	400	500	203	483	88	1252	360	110	1079	310
148	357	445	195	400	500	203	483	88	1471	360	110	1280	360
148	357	445	195	400	500	203	483	88	913	360	110	737	260
148	357	445	195	400	500	203	483	88	913	360	110	737	260
148	357	445	195	400	500	203	483	88	1252	360	110	1079	310
148	357	445	195	400	500	203	483	88	913	360	110	737	260
148	357	457	195	400	470	200	450	100	737	280	95	579	260
148	357	457	195	400	500	200	480	100	1076	280	95	917	310
205	502	612	283	520	635	230	575	110	1110	380	115	941	310
200	502	612	283	560	670	230	575	110	1322	380	115	1135	360
148	357	457	195	400	470	200	450	100	737	280	95	579	260
148	357	457	195	400	500	200	480	100	737	280	95	579	260
205	502	612	283	520	635	230	575	110	1110	380	115	941	310
205	502	637	283	520	660	250	620	135	1103	350	120	910	310
200	502	637	283	560	695	250	620	135	1310	350	120	1098	360
200	502	640	283	560	745	310	730	138	1338	350	90	1123	360
200	502	640	283	560	745	310	730	138	1397	350	90	1162	410
205	502	637	283	520	660	250	620	135	764	350	120	572	260
205	502	637	283	520	660	250	620	135	1103	350	120	910	310
205	502	640	283	520	710	310	730	138	1118	350	90	921	310
205	502	637	283	520	660	250	620	135	1103	350	120	910	310
200	502	637	283	560	695	250	620	135	1310	350	120	1098	360
200	502	641	283	560	775	315	765	139	1509	450	120	1273	410
205	502	641	283	520	753	315	765	139	1100	450	120	902	310
200	502	641	283	560	775	315	765	139	1320	450	120	1104	360
301	692	822	367	560	705	260	640	130	1424	380	115	1197	410
301	692	822	367	560	705	260	640	130	1145	380	115	956	310
301	692	822	367	560	705	260	640	130	1365	380	115	1158	360

Permanent wet well installation with autocoupling system

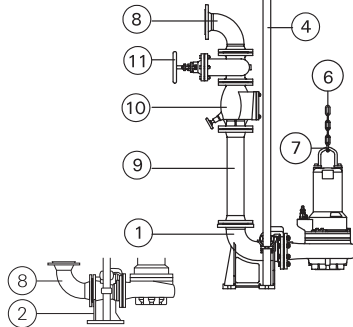

Transportable wet well installation

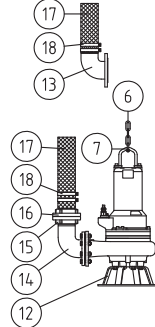

Permanent dry well installation vertical

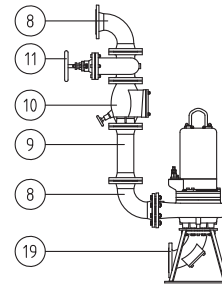

Permanent dry well installation horizontal

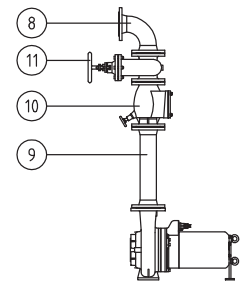

No.	Description	Type	Dimension	Part No.	
1	Auto-coupling system, cast iron, consisting of auto-coupling with flanged elbow, flanged pump coupling and upper slide rail bracket - Cast iron	KK 80/ 80	DN 80	8604025	
		KK 80/ 100	DN 80/DN100	8604030	
		KK 100/ 100	DN100	8604055	
		KK 100/ 80	DN100/DN 80	8604060	
		KK 150/ 150	DN150	8604070	
		KK 150/ 100	DN150/DN100	8603632	
		KK 200/ 150	DN200/DN150	8604105	
		- Cast iron, upper slide-rail bracket stainless steel	KKR 80/ 80	DN 80	8604026
		KKR 80/ 100	DN 80/DN100	8604031	
		KKR 100/ 100	DN100	8604056	
KKR 100/ 80	DN100/ 100	8604061			
KKR 150/ 150	DN150	8604071			
KKR 150/ 100	DN150/ 100	8604073			
KKR 200/ 150	DN200/150	8604106			
- complete stainless steel	KKC 80/ 80	DN 80	8604027		
KKC 100/ 100	DN 100	8604057			
KKC 150/ 150	DN 150	8604072			
2	Auto-coupling system consisting of auto-coupling with horizontal discharge flange, flanged pump coupling and upper slide rail bracket	KS 80/ 100	DN 80/DN100	8604045	
		KS 100/ 100	DN 100	8604065	
		KS 150/ 150	DN 150	8604075	
		KS 200/ 150	DN 200/DN150	8604083	
		Intermittent upper slide rail bracket - Cast iron	1 1/2" for DN 80	7322901	
1 1/2" for DN100	7322931				
2" for DN150	7320121A				
2 1/2" for DN200	7322911				
- Stainless steel	1 1/2" for DN 80	7323854A			
1 1/2" for DN100	7320355A				
2" for DN150	7323974A				
4	Guide rails, pair, per meter - Galvanized steel	1 1/2" for DN 80/100	2190155		
		2" for DN150	2190205		
		2 1/2" for DN200	2190225		
		- Stainless steel	1 1/2" for DN 80/100	2190254	
2" for DN150	2190256				
2 1/2" for DN200	2190258				
6	Lifting chain, Galvanized steel, per meter	5 mm Ø	2800350		
		8 mm Ø	2800380		
		10 mm Ø	2800410		
Stainless steel AISI316 (A4), per meter	8 mm Ø	2800384			
10 mm Ø	2800386				
7	Galvanized steel shackle	f. 5 mm Ø	2801450		
		f. 8 mm Ø	2801380		
		f. 10 mm Ø	2801410		
Shackle, stainless steel AISI316 (A4)	f. 8 mm Ø	2801384			
f. 10 mm Ø	2801386				
8	90° flanged elbow or flanged y-piece for twin pump arrangement, horizontal discharge (optional with vertical discharge) with gasket and fixing bolts	DN 80	2153302		
		DN 100	2153303		
		DN 150	2153353		
		DN 200	2153363		
		DN 80/ 80/ 80	on request		
		DN 80/ 80/100	on request		
DN 100/100/100	on request				
DN 100/100/125	on request				
DN 100/100/150	on request				
DN 150/150/150	on request				
DN 200/200/200	on request				
9	Flanged discharge pipe, 1 m, with gasket and fixing bolts	DN 80	2152081		
		DN 100	2152201		
		DN 125	2152221		
		DN 150	2152251		
		DN 200	2152271		
Discharge pipe, per additional meter	DN 80	2150180			
DN 100	2150100				
DN 125	2150125				
DN 150	2150150				
DN 200	2150200				
Flanged reducer	on request				

No.	Description	Type	Dimension	Part No.
10	Flanged swing check valve, cast iron		DN 80	2212807
			DN100	2212809
			DN125	2212810
			DN150	2212811
			DN200	2212816
11	Flanged gate valve, cast iron		DN 80	2216080
			DN100	2216100
			DN125	2216125
			DN150	2216150
	DN200	2216200		
12	Ring base stand up to 16.9 kW (P2) from 17.0 kW (P2)	NB 100 A	DN100	7321215
		NB 150 A	DN150	7321285
		NB 150	DN150	7321275
13	Flanged spigot elbow with gasket and fixing bolts		DN100/110mm	6001141
14	90° Flanged elbow Double nipple Threaded flange Flanged to thread elbow with gasket and fixing bolts		BSP3"F/M	2111805
			BSP3"M	2128030
			DN80/BSP3"F	2215080
			DN100xBSP4"M	6001121
	DN150xBSP6"M	6001205		
15	STORZ-fixed coupling,		B-BSP3"M	2010603
			B-BSP3"F	2010602
			A-BSP4"F	2010701
			F-BSP6"	2010961
16	STORZ-hose coupling with spigot Aluminium STORZ-reducer		B-75 mm	2013502
			A-110 mm	2013801
			F-150 mm	2013901
	A - B	2015612		
	F - A	2015622		
17	Reinforced hose, per m (inner dia. in mm) Hose with pre-attached couplings		75 mm	2632075
			110 mm	2632110
			150 mm	2632150
	on request			
18	Hose bands		S 85/20	2308520
			S100/20	2310020
			S115/20	2311520
			S118/20	2311820
			S172/20	2317520
19	Flanged pump stand with gasket and fixing bolts Pump stand with suction elbow, cleaning hole, gasket and fixing bolts	TVS 100 A (up to 28kW)	DN100	7321705
		TVS 150 A	DN150	7321725
		TVS 100 A-R (up to 28kW)	DN100	8604220
		TVS 100 A-R	DN100	8604221
		TVS 150 A-R	DN150	8604225
		TVS 150-R	DN150	8604230
		TVS 150/200 A-R	DN150/DN200	8604232
TVS 150/200-R	DN150/DN200	8604235		
Screw kit with gaskets Gavanized steel		DN 80	2214080	
		DN100	2214100	
		DN150	2214150	
Stainless steel		DN 80	2214082	
		DN100	2214102	
		DN150	2214152	

Stainless steel pipes, fittings on request. Electrical or electronic control panels for pumps and pump stations with accessories on request.
Sumps of concrete or synthetic material for complete pump stations please see special leaflet.



HOMA Product Range

- Submersible waste water pumps
- Deep-well submersible pumps
- Submersible sewage pumps
- Submersible grinder pumps with cutter system
- Waste water disposal units
- Sewage disposal units
- Packaged pump stations
- Mixers and flow generators
- Injector systems for tank cleaning
- Garden pumps and domestic booster units
- Control boxes



Worldwide Presence

HOMA pumps are installed in more than 60 countries around the world – in countless projects of various kinds. They comply to all international safety and quality standards and are certified by many institutions and organisations responsible for national waste water treatment standards. To maintain and further develop this high quality level is our main target.



Network of Sales and Service Partners

HOMA provides a worldwide network of agents and distributors supporting our customer with excellent sales and service assistance in planning, specification and selection, including a computer software program available on CD-ROM or from the WorldWide-Web.

HOMA Pumpenfabrik GmbH

P.O. Box 22 63 ➤ 53819 Neunkirchen-Seelscheid; Germany

Phone +49 (0)22 47 /702-0 ➤ Fax +49 (0) 22 47/702-44

e-mail: info@homa-pumpen.de ➤ Internet: www.homapumps.com

