

# Manual

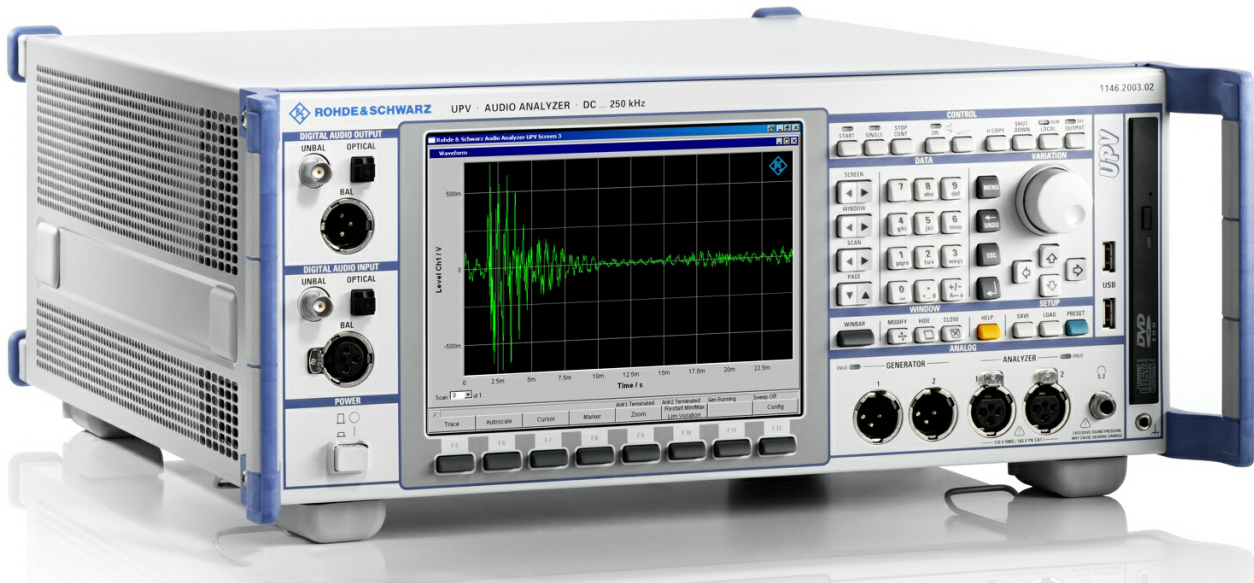

## Audio Analyzer DC to 250 kHz

**R&S® UPV**

1146.2003.02

**R&S® UPV66**

1146.2003.66

Printed in Germany



The firmware of the instrument makes use of several valuable open source software packages. The most important of them are listed below together with their corresponding open source license. The verbatim license texts are provided in on the user documentation CD-ROM (included in delivery).

Package	Link	License
OpenSSL	<a href="http://www.openssl.org">http://www.openssl.org</a>	OpenSSL/SSLeavy
Net-SNMP	<a href="http://www.net-snmp.org">http://www.net-snmp.org</a>	NetSnmp-5.0.8
Xitami	<a href="http://www.xitami.com">http://www.xitami.com</a>	2.5b6
PHP	<a href="http://www.php.net">http://www.php.net</a>	PHP, Version 3
DOJO-AJAX	<a href="http://www.dojotoolkit.org">http://www.dojotoolkit.org</a>	Academic Free License
ResizableLib	<a href="http://www.geocities.com/ppescher">http://www.geocities.com/ppescher</a>	Artistic License
BOOST Library	<a href="http://www.boost.org">http://www.boost.org</a>	Boost Software, v.1
zlib	<a href="http://www.zlib.net">http://www.zlib.net</a>	zlib, v.1.2.3
Xalan Xerces	<a href="http://xalan.apache.org/">http://xalan.apache.org/</a> <a href="http://xerces.apache.org/">http://xerces.apache.org/</a>	Apache, Ver.2
ACE	<a href="http://www.cs.wustl.edu/~schmidt/ACE.html">http://www.cs.wustl.edu/~schmidt/ACE.html</a>	ACE_TAO
TAO (The ACE ORB)	<a href="http://www.cs.wustl.edu/~schmidt/TAO.html">http://www.cs.wustl.edu/~schmidt/TAO.html</a>	ACE_TAO
PC/SC-Lite	<a href="http://www.linuxnet.com/">http://www.linuxnet.com/</a>	PCSCLite
ONC/RPC	<a href="http://www.plt.rwth-aachen.de/index.php?id=258">http://www.plt.rwth-aachen.de/index.php?id=258</a>	SUN

The OpenSSL Project for use in the OpenSSL Toolkit (<http://www.openssl.org/>), includes cryptographic software written by Eric Young ([eay@cryptsoft.com](mailto:eay@cryptsoft.com)) and software written by Tim Hudson ([tjh@cryptsoft.com](mailto:tjh@cryptsoft.com)).

Rohde & Schwarz would like to thank the open source community for their valuable contribution to embedded computing.

R&S® is a registered trademark of Rohde & Schwarz GmbH & Co. KG  
Trade names are trademarks of the owners.

# **Tabbed Divider Overview**

## **Data Sheet**

**EC Certificate of Conformity  
Support Center Address  
List of R&S Representatives**

<b>Chapter 1:</b>	<b>Putting into Operation</b>
<b>Chapter 2:</b>	<b>Getting Started</b>
<b>Chapter 3:</b>	<b>Manual Operation</b>
<b>Chapter 4:</b>	<b>Instrument Functions</b>
<b>Chapter 5:</b>	<b>Remote Control - Basics</b>
<b>Chapter 6:</b>	<b>Remote Control - Description of Commands</b>
<b>Chapter 7:</b>	<b>-</b>
<b>Chapter 8:</b>	<b>Maintenance and Interfaces</b>
<b>Chapter 9:</b>	<b>-</b>
<b>Chapter 10:</b>	<b>Index</b>

# Grouped Safety Messages









## Make sure to read through and observe the following safety instructions!







All plants and locations of the Rohde & Schwarz group of companies make every effort to keep the safety standard of our products up to date and to offer our customers the highest possible degree of safety. Our products and the auxiliary equipment required for them are designed and tested in accordance with the relevant safety standards. Compliance with these standards is continuously monitored by our quality assurance system. The product described here has been designed and tested in accordance with the EC Certificate of Conformity and has left the manufacturer's plant in a condition fully complying with safety standards. To maintain this condition and to ensure safe operation, observe all instructions and warnings provided in this manual. If you have any questions regarding these safety instructions, the Rohde & Schwarz group of companies will be happy to answer them.

Furthermore, it is your responsibility to use the product in an appropriate manner. This product is designed for use solely in industrial and laboratory environments or, if expressly permitted, also in the field and must not be used in any way that may cause personal injury or property damage. You are responsible if the product is used for an intention other than its designated purpose or in disregard of the manufacturer's instructions. The manufacturer shall assume no responsibility for such use of the product.

The product is used for its designated purpose if it is used in accordance with its product documentation and within its performance limits (see data sheet, documentation, the following safety instructions). Using the product requires technical skills and a basic knowledge of English. It is therefore essential that only skilled and specialized staff or thoroughly trained personnel with the required skills be allowed to use the product. If personal safety gear is required for using Rohde & Schwarz products, this will be indicated at the appropriate place in the product documentation. Keep the basic safety instructions and the product documentation in a safe place and pass them on to the subsequent users.

### Symbols and safety labels

							
Observe product documentation	Weight indication for units >18 kg	Danger of electric shock	Warning! Hot surface	PE terminal	Ground	Ground terminal	Attention! Electrostatic sensitive devices

					
Supply voltage ON/OFF	Standby indication	Direct current (DC)	Alternating current (AC)	Direct/alternating current (DC/AC)	Device fully protected by double/reinforced insulation

Observing the safety instructions will help prevent personal injury or damage of any kind caused by dangerous situations. Therefore, carefully read through and adhere to the following safety instructions before putting the product into operation. It is also absolutely essential to observe the additional safety instructions on personal safety that appear in relevant parts of the product documentation. In these safety instructions, the word "product" refers to all merchandise sold and distributed by the Rohde & Schwarz group of companies, including instruments, systems and all accessories.



### Tags and their meaning

DANGER	DANGER indicates a hazardous situation which, if not avoided, will result in death or serious injury.
WARNING	WARNING indicates a hazardous situation which, if not avoided, could result in death or serious injury.
CAUTION	CAUTION indicates a hazardous situation which, if not avoided, may result in minor or moderate injury.
NOTICE	NOTICE indicates a property damage message.

In the product documentation, the word ATTENTION is used synonymously.

These tags are in accordance with the standard definition for civil applications in the European Economic Area. Definitions that deviate from the standard definition may also exist in other economic areas or military applications. It is therefore essential to make sure that the tags described here are always used only in connection with the related product documentation and the related product. The use of tags in connection with unrelated products or documentation can result in misinterpretation and thus contribute to personal injury or material damage.

### Basic safety instructions

1. The product may be operated only under the operating conditions and in the positions specified by the manufacturer. Its ventilation must not be obstructed during operation. Unless otherwise specified, the following requirements apply to Rohde & Schwarz products:  
prescribed operating position is always with the housing floor facing down, IP protection 2X, pollution severity 2, overvoltage category 2, use only in enclosed spaces, max. operation altitude 2000 m above sea level, max. transport altitude 4500 m above sea level.  
A tolerance of  $\pm 10\%$  shall apply to the nominal voltage and of  $\pm 5\%$  to the nominal frequency.
2. Applicable local or national safety regulations and rules for the prevention of accidents must be observed in all work performed. The product may be opened only by authorized, specially trained personnel. Prior to performing any work on the product or opening the product, the product must be disconnected from the supply network. Any adjustments, replacements of parts, maintenance or repair must be carried out only by technical personnel authorized by Rohde & Schwarz. Only original parts may be used for replacing parts relevant to safety (e.g. power switches, power transformers, fuses). A safety test must always be performed after parts relevant to safety have been replaced (visual inspection, PE conductor test, insulation resistance measurement, leakage current measurement, functional test).
3. As with all industrially manufactured goods, the use of substances that induce an allergic reaction (allergens, e.g. nickel) such as aluminum cannot be generally excluded. If you develop an allergic reaction (such as a skin rash, frequent sneezing, red eyes or respiratory difficulties), consult a physician immediately to determine the cause.
4. If products/components are mechanically and/or thermally processed in a manner that goes beyond their intended use, hazardous substances (heavy-metal dust such as lead, beryllium, nickel) may be released. For this reason, the product may only be disassembled, e.g. for disposal purposes, by specially trained personnel. Improper disassembly may be hazardous to your health. National waste disposal regulations must be observed.

## Grouped Safety Messages

5. If handling the product yields hazardous substances or fuels that must be disposed of in a special way, e.g. coolants or engine oils that must be replenished regularly, the safety instructions of the manufacturer of the hazardous substances or fuels and the applicable regional waste disposal regulations must be observed. Also observe the relevant safety instructions in the product documentation.
6. Depending on the function, certain products such as RF radio equipment can produce an elevated level of electromagnetic radiation. Considering that unborn life requires increased protection, pregnant women should be protected by appropriate measures. Persons with pacemakers may also be endangered by electromagnetic radiation. The employer/operator is required to assess workplaces where there is a special risk of exposure to radiation and, if necessary, take measures to avert the danger.
7. Operating the products requires special training and intense concentration. Make certain that persons who use the products are physically, mentally and emotionally fit enough to handle operating the products; otherwise injuries or material damage may occur. It is the responsibility of the employer to select suitable personnel for operating the products.
8. Prior to switching on the product, it must be ensured that the nominal voltage setting on the product matches the nominal voltage of the AC supply network. If a different voltage is to be set, the power fuse of the product may have to be changed accordingly.
9. In the case of products of safety class I with movable power cord and connector, operation is permitted only on sockets with earthing contact and protective earth connection.
10. Intentionally breaking the protective earth connection either in the feed line or in the product itself is not permitted. Doing so can result in the danger of an electric shock from the product. If extension cords or connector strips are implemented, they must be checked on a regular basis to ensure that they are safe to use.
11. If the product has no power switch for disconnection from the AC supply, the plug of the connecting cable is regarded as the disconnecting device. In such cases, it must be ensured that the power plug is easily reachable and accessible at all times (corresponding to the length of connecting cable, approx. 2 m). Functional or electronic switches are not suitable for providing disconnection from the AC supply. If products without power switches are integrated in racks or systems, a disconnecting device must be provided at the system level.
12. Never use the product if the power cable is damaged. Check the power cable on a regular basis to ensure that it is in proper operating condition. By taking appropriate safety measures and carefully laying the power cable, ensure that the cable cannot be damaged and that no one can be hurt by e.g. tripping over the cable or suffering an electric shock.
13. The product may be operated only from TN/TT supply networks fused with max. 16 A (higher fuse only after consulting with the Rohde & Schwarz group of companies).
14. Do not insert the plug into sockets that are dusty or dirty. Insert the plug firmly and all the way into the socket. Otherwise, this can result in sparks, fire and/or injuries.
15. Do not overload any sockets, extension cords or connector strips; doing so can cause fire or electric shocks.
16. For measurements in circuits with voltages  $V_{\text{rms}} > 30 \text{ V}$ , suitable measures (e.g. appropriate measuring equipment, fusing, current limiting, electrical separation, insulation) should be taken to avoid any hazards.
17. Ensure that the connections with information technology equipment comply with IEC 950/EN 60950.
18. Unless expressly permitted, never remove the cover or any part of the housing while the product is in operation. Doing so will expose circuits and components and can lead to injuries, fire or damage to the product.
19. If a product is to be permanently installed, the connection between the PE terminal on site and the product's PE conductor must be made first before any other connection is made. The product may be installed and connected only by a license electrician.

## Grouped Safety Messages

20. For permanently installed equipment without built-in fuses, circuit breakers or similar protective devices, the supply circuit must be fused in such a way that suitable protection is provided for users and products.
21. Do not insert any objects into the openings in the housing that are not designed for this purpose. Never pour any liquids onto or into the housing. This can cause short circuits inside the product and/or electric shocks, fire or injuries.
22. Use suitable overvoltage protection to ensure that no overvoltage (such as that caused by a thunderstorm) can reach the product. Otherwise the operating personnel will be endangered by electric shocks.
23. Rohde & Schwarz products are not protected against penetration of liquids, unless otherwise specified (see also safety instruction 1.). If this is not taken into account, there exists the danger of electric shock for the user or damage to the product, which can also lead to personal injury.
24. Never use the product under conditions in which condensation has formed or can form in or on the product, e.g. if the product was moved from a cold to a warm environment.
25. Do not close any slots or openings on the product, since they are necessary for ventilation and prevent the product from overheating. Do not place the product on soft surfaces such as sofas or rugs or inside a closed housing, unless this is well ventilated.
26. Do not place the product on heat-generating devices such as radiators or fan heaters. The temperature of the environment must not exceed the maximum temperature specified in the data sheet.
27. Batteries and storage batteries must not be exposed to high temperatures or fire. Keep batteries and storage batteries away from children. Do not short-circuit batteries and storage batteries.  
If batteries or storage batteries are improperly replaced, this can cause an explosion (warning: lithium cells). Replace the battery or storage battery only with the matching Rohde & Schwarz type (see spare parts list). Batteries and storage batteries must be recycled and kept separate from residual waste. Batteries and storage batteries that contain lead, mercury or cadmium are hazardous waste. Observe the national regulations regarding waste disposal and recycling.
28. Please be aware that in the event of a fire, toxic substances (gases, liquids etc.) that may be hazardous to your health may escape from the product.
29. The product can be very heavy. Be careful when moving it to avoid back or other physical injuries.
30. Do not place the product on surfaces, vehicles, cabinets or tables that for reasons of weight or stability are unsuitable for this purpose. Always follow the manufacturer's installation instructions when installing the product and fastening it to objects or structures (e.g. walls and shelves).
31. Handles on the products are designed exclusively for personnel to hold or carry the product. It is therefore not permissible to use handles for fastening the product to or on means of transport such as cranes, fork lifts, wagons, etc. The user is responsible for securely fastening the products to or on the means of transport and for observing the safety regulations of the manufacturer of the means of transport. Noncompliance can result in personal injury or material damage.
32. If you use the product in a vehicle, it is the sole responsibility of the driver to drive the vehicle safely. Adequately secure the product in the vehicle to prevent injuries or other damage in the event of an accident. Never use the product in a moving vehicle if doing so could distract the driver of the vehicle. The driver is always responsible for the safety of the vehicle. The manufacturer assumes no responsibility for accidents or collisions.
33. If a laser product (e.g. a CD/DVD drive) is integrated in a Rohde & Schwarz product, do not use any other settings or functions than those described in the product documentation. Otherwise this may be hazardous to your health, since the laser beam can cause irreversible damage to your eyes. Never try to take such products apart, and never look into the laser beam.
34. Prior to cleaning, disconnect the product from the AC supply. Use a soft, non-linting cloth to clean the product. Never use chemical cleaning agents such as alcohol, acetone or diluent for cellulose lacquers.



Certificate No.: 2004-25

This is to certify that:

Equipment type	Stock No.	Designation
UPV	1146.2003.02	Audio Analyzer
UPV66	1146.2003.66	
UPV-B1	1146.5202.02	Low Distortion Generator
UPV-B2	1146.4306.02	Digital Audio I/O
UPV-B20	1402.2000.02	Digital Audio I/O 48 kHz
UPV-B3	1146.4806.02	Second Analog Generator
UPV-B41	1146.5402.02	I2S Interface
UPV-B48	1402.2200.02	8 Channel Analog Inputs
UPV-U2	1402.1704.02	Additional BNC Phone Output

complies with the provisions of the Directive of the Council of the European Union on the approximation of the laws of the Member States

- relating to electrical equipment for use within defined voltage limits (2006/95/EC)
- relating to electromagnetic compatibility (2004/108/EC)

Conformity is proven by compliance with the following standards:

EN61010-1 : 2001-12  
EN55011 : 1998 + A1 : 1999 + A2 : 2002, Class B  
EN61326 : 1997 + A1 : 1998 + A2 : 2001 + A3 : 2003

For the assessment of electromagnetic compatibility, the limits of radio interference for Class B equipment as well as the immunity to interference for operation in industry have been used as a basis.

Affixing the EC conformity mark as from 2004

**ROHDE & SCHWARZ GmbH & Co. KG**  
Mühldorfstr. 15, D-81671 München

Munich, 2008-04-09

Central Quality Management MF-QZ / Radde



Certificate No.: 2008-78

This is to certify that:

Equipment type	Stock No.	Designation
UPV-B42	1146.5802.02	Universal Serial Interface

complies with the provisions of the Directive of the Council of the European Union on the approximation of the laws of the Member States

- relating to electromagnetic compatibility (2004/108/EC)

Conformity is proven by compliance with the following standards:

EN 55011 : 1998 + A1 : 1999 + A2 : 2002, Klasse A  
EN 61326 : 1997 + A1 : 1998 + A2 : 2001 + A3 : 2003

For the assessment of electromagnetic compatibility, the limits of radio interference for Class A equipment as well as the immunity to interference for operation in industry ( ) have been used as a basis.

Affixing the EC conformity mark as from 2008

**ROHDE & SCHWARZ GmbH & Co. KG**  
Mühldorfstr. 15, D-81671 München

Munich, 2008-09-16

Central Quality Management MF-QZ / Radde

## Certified Quality System

**DIN EN ISO 9001 : 2000**  
**DIN EN 9100 : 2003**  
**DIN EN ISO 14001 : 2004**

DQS REG. NO 001954 QM UM

### QUALITÄTSZERTIFIKAT

*Sehr geehrter Kunde,*  
Sie haben sich für den Kauf eines Rohde & Schwarz-Produktes entschieden. Hiermit erhalten Sie ein nach modernsten Fertigungsmethoden hergestelltes Produkt. Es wurde nach den Regeln unseres Managementsystems entwickelt, gefertigt und geprüft. Das Rohde & Schwarz Managementsystem ist zertifiziert nach:

DIN EN ISO 9001:2000  
DIN EN 9100:2003  
DIN EN ISO 14001:2004

### CERTIFICATE OF QUALITY

*Dear Customer,*  
you have decided to buy a Rohde & Schwarz product. You are thus assured of receiving a product that is manufactured using the most modern methods available. This product was developed, manufactured and tested in compliance with our quality management system standards. The Rohde & Schwarz quality management system is certified according to:

DIN EN ISO 9001:2000  
DIN EN 9100:2003  
DIN EN ISO 14001:2004

### CERTIFICAT DE QUALITÉ

*Cher Client,*  
vous avez choisi d'acheter un produit Rohde & Schwarz. Vous disposez donc d'un produit fabriqué d'après les méthodes les plus avancées. Le développement, la fabrication et les tests respectent nos normes de gestion qualité. Le système de gestion qualité de Rohde & Schwarz a été homologué conformément aux normes:

DIN EN ISO 9001:2000  
DIN EN 9100:2003  
DIN EN ISO 14001:2004



# Customer Support

## Technical support – where and when you need it

For quick, expert help with any Rohde & Schwarz equipment, contact one of our Customer Support Centers. A team of highly qualified engineers provides telephone support and will work with you to find a solution to your query on any aspect of the operation, programming or applications of Rohde & Schwarz equipment.

## Up-to-date information and upgrades

To keep your instrument up-to-date and to be informed about new application notes related to your instrument, please send an e-mail to the Customer Support Center stating your instrument and your wish. We will take care that you will get the right information.

### USA & Canada

Monday to Friday (except US public holidays)  
8:00 AM – 8:00 PM Eastern Standard Time (EST)

Tel. from USA 888-test-rsa (888-837-8772) (opt 2)  
From outside USA +1 410 910 7800 (opt 2)  
Fax +1 410 910 7801

E-mail [CustomerSupport@rohde-schwarz.com](mailto:CustomerSupport@rohde-schwarz.com)

### East Asia

Monday to Friday (except Singaporean public holidays)  
8:30 AM – 6:00 PM Singapore Time (SGT)

Tel. +65 6 513 0488  
Fax +65 6 846 1090

E-mail [CustomerSupport@rohde-schwarz.com](mailto:CustomerSupport@rohde-schwarz.com)

### Rest of the World

Monday to Friday (except German public holidays)  
08:00 – 17:00 Central European Time (CET)

Tel. from Europe +49 (0) 180 512 42 42\*  
From outside Europe +49 89 4129 13776  
Fax +49 (0) 89 41 29 637 78

E-mail [CustomerSupport@rohde-schwarz.com](mailto:CustomerSupport@rohde-schwarz.com)

\* 0.14 €/Min within the German fixed-line telephone network, varying prices for the mobile telephone network and in different countries.



# Customer Information Regarding Product Disposal

The German Electrical and Electronic Equipment (ElektroG) Act is an implementation of the following EC directives:

- 2002/96/EC on waste electrical and electronic equipment (WEEE) and
- 2002/95/EC on the restriction of the use of certain hazardous substances in electrical and electronic equipment (RoHS).

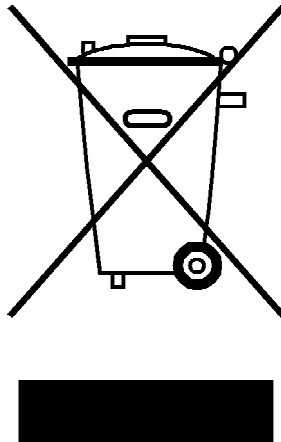

Product labeling in accordance with EN 50419

Once the lifetime of a product has ended, this product must not be disposed of in the standard domestic refuse. Even disposal via the municipal collection points for waste electrical and electronic equipment is not permitted.

Rohde & Schwarz GmbH & Co. KG has developed a disposal concept for the environmental-friendly disposal or recycling of waste material and fully assumes its obligation as a producer to take back and dispose of electrical and electronic waste in accordance with the ElektroG Act.

Please contact your local service representative to dispose of the product.





## Address List

### Headquarters, Plants and Subsidiaries

#### Headquarters

ROHDE & SCHWARZ GmbH & Co. KG  
Mühlendorfstraße 15 · D-81671 München  
P.O.Box 80 14 69 · D-81614 München

Phone +49 (89) 41 29-0  
Fax +49 (89) 41 29-121 64  
[info.rs@rohde-schwarz.com](mailto:info.rs@rohde-schwarz.com)

#### Plants

ROHDE & SCHWARZ Messgerätebau GmbH  
Riedbachstraße 58 · D-87700 Memmingen  
P.O.Box 16 52 · D-87686 Memmingen

Phone +49 (83 31) 1 08-0  
+49 (83 31) 1 08-1124  
[info.rsmb@rohde-schwarz.com](mailto:info.rsmb@rohde-schwarz.com)

ROHDE & SCHWARZ GmbH & Co. KG  
Werk Teisnach  
Kaikenrieder Straße 27 · D-94244 Teisnach  
P.O.Box 11 49 · D-94240 Teisnach

Phone +49 (99 23) 8 50-0  
Fax +49 (99 23) 8 50-174  
[info.rsdt@rohde-schwarz.com](mailto:info.rsdt@rohde-schwarz.com)

ROHDE & SCHWARZ závod  
Vimperk, s.r.o.  
Location Spidrova 49  
CZ-38501 Vimperk

Phone +420 (388) 45 21 09  
Fax +420 (388) 45 21 13

ROHDE & SCHWARZ GmbH & Co. KG  
Dienstleistungszentrum Köln  
Graf-Zeppelin-Straße 18 · D-51147 Köln  
P.O.Box 98 02 60 · D-51130 Köln

Phone +49 (22 03) 49-0  
Fax +49 (22 03) 49 51-229  
[info.rsdc@rohde-schwarz.com](mailto:info.rsdc@rohde-schwarz.com)  
[service.rsdc@rohde-schwarz.com](mailto:service.rsdc@rohde-schwarz.com)

#### Subsidiaries

R&S BICK Mobilfunk GmbH  
Fritz-Hahne-Str. 7 · D-31848 Bad Münder  
P.O.Box 20 02 · D-31844 Bad Münder

Phone +49 (50 42) 9 98-0  
Fax +49 (50 42) 9 98-105  
[info.bick@rohde-schwarz.com](mailto:info.bick@rohde-schwarz.com)

ROHDE & SCHWARZ FTK GmbH  
Wendenschloßstraße 168, Haus 28  
D-12557 Berlin

Phone +49 (30) 658 91-122  
Fax +49 (30) 655 50-221  
[info.ftk@rohde-schwarz.com](mailto:info.ftk@rohde-schwarz.com)

ROHDE & SCHWARZ SIT GmbH  
Am Studio 3  
D-12489 Berlin

Phone +49 (30) 658 84-0  
Fax +49 (30) 658 84-183  
[info.sit@rohde-schwarz.com](mailto:info.sit@rohde-schwarz.com)

R&S Systems GmbH  
Graf-Zeppelin-Straße 18  
D-51147 Köln

Phone +49 (22 03) 49-5 23 25  
Fax +49 (22 03) 49-5 23 36  
[info.rssys@rohde-schwarz.com](mailto:info.rssys@rohde-schwarz.com)

GEDIS GmbH  
Sophienblatt 100  
D-24114 Kiel

Phone +49 (431) 600 51-0  
Fax +49 (431) 600 51-11  
[sales@gedis-online.de](mailto:sales@gedis-online.de)

HAMEG Instruments GmbH  
Industriestraße 6  
D-63533 Mainhausen

Phone +49 (61 82) 800-0  
Fax +49 (61 82) 800-100  
[info@hameg.de](mailto:info@hameg.de)

### Locations Worldwide

Please refer to our homepage: [www.rohde-schwarz.com](http://www.rohde-schwarz.com)

- ◆ Sales Locations
- ◆ Service Locations
- ◆ National Websites

# Contents - Chapter 1 "Putting into Operation"

<b>1 Putting into Operation</b>	1.1
<b>Description of the Front Panel</b>	1.2
1    Screen with softkeys	1.2
2    Navigation keys	1.4
3    Data entry keys	1.4
4    CONTROL panel	1.5
5    VARIATION panel	1.7
6    USB connectors	1.7
7    CD/DVD Combo drive	1.8
8    Ground socket	1.8
9    Headphone connector	1.8
10   SETUP panel	1.8
11   HELP key	1.8
12   WINDOW panel	1.8
13   Analog audio interfaces	1.9
14   WINBAR key	1.9
15   Digital audio interfaces	1.10
16   Power switch	1.10
17   Status LEDs	1.11
<b>Description of the Rear Panel</b>	1.13
1    LAN connection	1.13
2    USB device connector	1.13
3    RS-232-C interface	1.13
4    Printer interface	1.13
5    Connector for external monitor	1.13
6    USB connectors	1.13
7    BNC audio monitoring output	1.14
8    Trigger connectors	1.14
9    Analog auxiliary output	1.14
10   Digital synchronization and expansion interfaces	1.14
11   IEC/IEEE-bus connector	1.15
12   AC supply voltage connector	1.15
13   Slots for expansion plug-ins	1.15
14   I <sup>2</sup> S interface	1.15
15   LAN Reset button	1.16

<b>Putting into Operation</b> .....	1.17
Unpacking the Instrument .....	1.17
Setting up the Instrument or Installing it in a 19" Rack .....	1.17
Safety Instructions.....	1.18
General Safety Instructions .....	1.18
Protection Against Electrostatic Discharge.....	1.18
Setting Up the Instrument.....	1.19
Cleaning the Outside and Storing.....	1.19
EMC Safety Precautions.....	1.19
Connecting the R&S UPV to the AC Supply.....	1.20
Setting the AC Supply Voltage.....	1.20
Switching On .....	1.21
Start Screen and Booting of the R&S UPV .....	1.21
Restarting the R&S UPV .....	1.22
Switching off the instrument.....	1.22
<b>Function Check</b> .....	1.24
<b>Presets</b> .....	1.24
<b>Windows XP</b> .....	1.25
<b>Connecting an External Keyboard</b> .....	1.26
<b>Connecting a Mouse</b> .....	1.26
<b>Connecting an External Monitor</b> .....	1.27
<b>Changing the screen resolution</b> .....	1.28
FMR6.....	1.28
FMR7.....	1.32
<b>Installing Options</b> .....	1.35
<b>Connecting the R&amp;S UPV to a Network (LAN)</b> .....	1.36
Connection to the Network.....	1.36
Configuring the R&S UPV for Network Operation .....	1.37
Preparations.....	1.38
Entering the IP Address.....	1.38
Querying the Computer Name.....	1.40
Accessing Directories in the Network .....	1.41
Configuration via LXI (R&S UPV66) .....	1.42
LXI classes and LXI functionality .....	1.42
LXI LAN Indicator.....	1.43
LXI Default State of Network Settings .....	1.44
LXI Browser Interface .....	1.44
IP Configuration .....	1.46
Advanced LAN Configuration .....	1.47
Ping Client.....	1.48

- Configuration for Manual Remote Operation .....1.49
  - Activating the Remote Desktop Connection program at the R&S UPV.....1.50
  - Starting manual remote operation at the external computer .....1.51
- Firmware update**.....1.53
- Windows XP Recovery and Backup** .....1.54
  - Call the Windows XP Recovery and Backup Partition Menu.....1.54
  - Backup Current System Partition.....1.55
  - Recover Selected Version of System Partition .....1.56
  - Recover Factory Default .....1.57
  - Delete Backups .....1.58

Front Panel R&S UPV

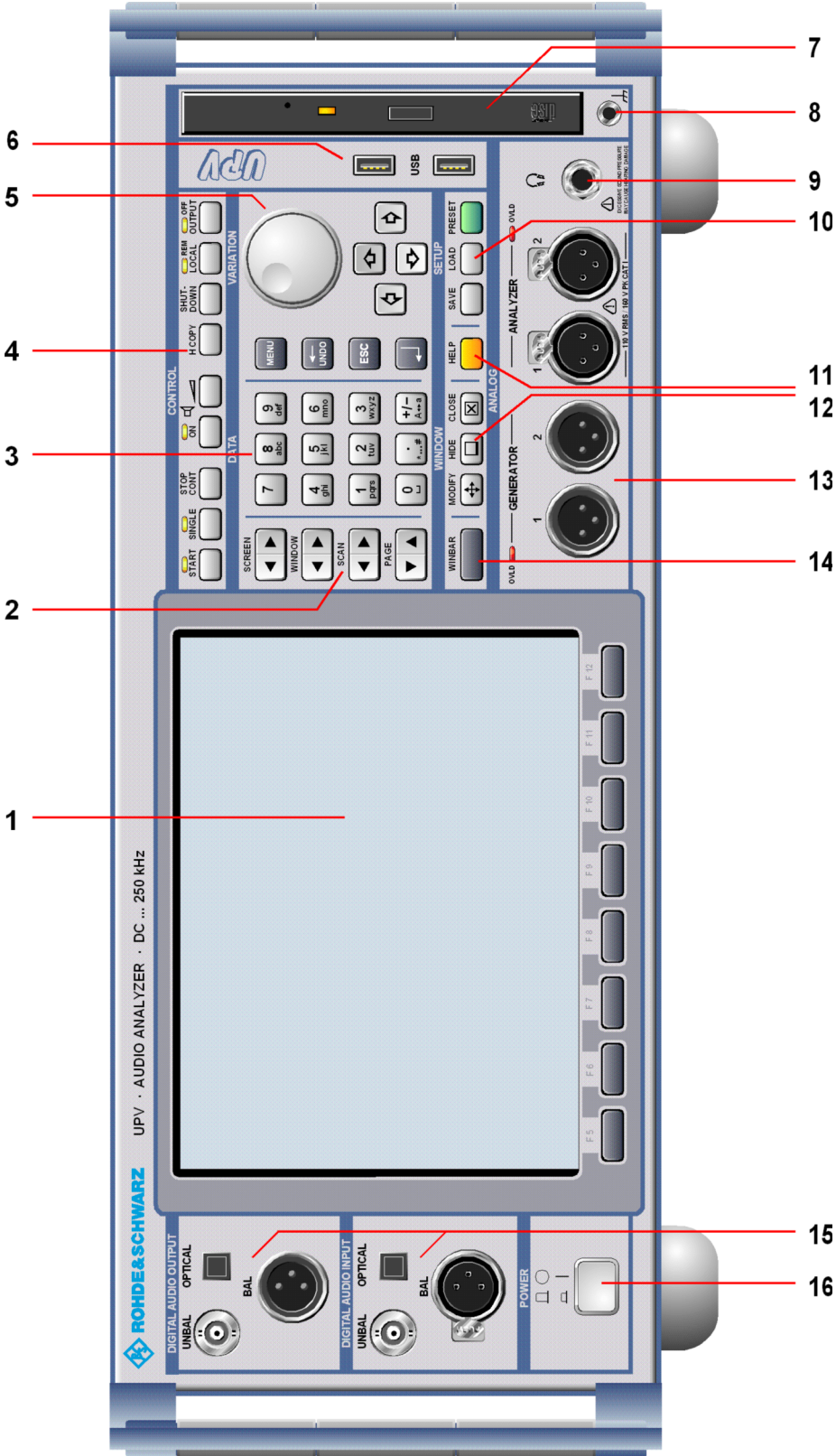

Fig. 1-1 Front Panel R&S UPV

Front Panel R&S UPV66

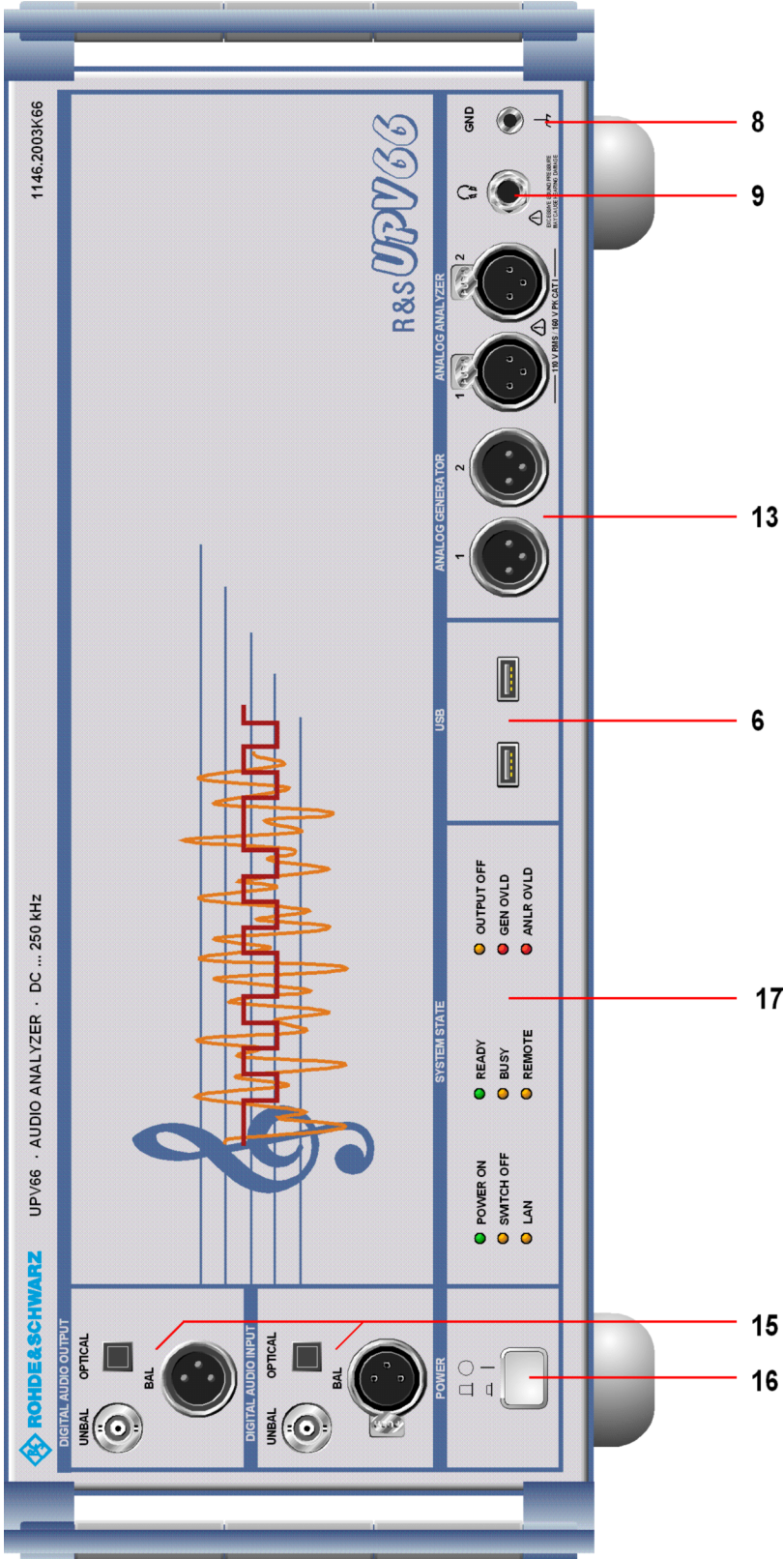

Fig. 1-1a Front Panel R&S UPV66



# 1 Putting into Operation

The R&S UPV audio analyzer is available in two models. The R&S UPV standard model and the R&S UPV66, which is specially designed for use in systems. The R&S UPV66 has no display, no front panel control elements, and no CD/DVD drive. Apart from the omission of front-panel operation, the R&S UPV66 model has largely the same functions as the standard model. This manual therefore describes both instruments in parallel, and any differences are indicated at the appropriate points in the text.

Chapter 1, "*Putting into Operation*", describes the control elements and connectors at the front and rear of the Audio Analyzer R&S UPV and shows how the instrument is put into operation. It also describes the connection of peripherals such as printer, keyboard, mouse and monitor. Specifications for the interfaces can be found in the data sheet.

The introduction in Chapter 2, "*Getting Started*", provides an overview of the functions and operating concept of the audio analyzer. Detailed operating instructions and an overview of the menus are provided in Chapter 3, "*Manual Operation*".

The CD-ROM contains the entire manual complete with the other chapters in printable PDF format: The individual menus and functions of the instrument including the associated remote-control commands are explained in detail in the reference section (Chapter 4). Basic information on remote control of the instrument is provided in Chapters 5 to 7, "*Remote Control - Fundamentals*" and "*Remote Control - Commands*". A detailed description of the instrument interfaces can be found in Chapter 8, "*Maintenance and Interfaces*". Chapter 9, "*Error Messages*" contains an overview of the possible error messages output by the instrument.

---

**Notes:**

*The audio analyzer has the WindowsXP® operating system. No special knowledge of the operating system used is required for operation of the instrument.*

*It is, however, assumed that users possess basic PC knowledge, such as what files and directories etc are or how data is transferred using the Windows® Explorer. This information is therefore not specified in detail here.*

*The R&S UPV audio analyzer can be fully operated via the control elements on the front panel. It is, however, also possible to operate the instrument using an external keyboard and mouse. Operation follows the same basic rules which apply to other Windows programs in use today. It is also assumed that users are familiar with these basic rules. This information is therefore not specified in detail here.*

*The R&S UPV66 model has no front panel keypad, no display, and no CD/DVD drive; however, as is the case with the R&S UPV standard model, it can be operated by means of a keyboard or mouse, provided that an external screen is connected.*

---



# Description of the Front Panel

This section provides an overview of the control elements and connectors on the front of the R&S UPV.

## 1 Screen with softkeys

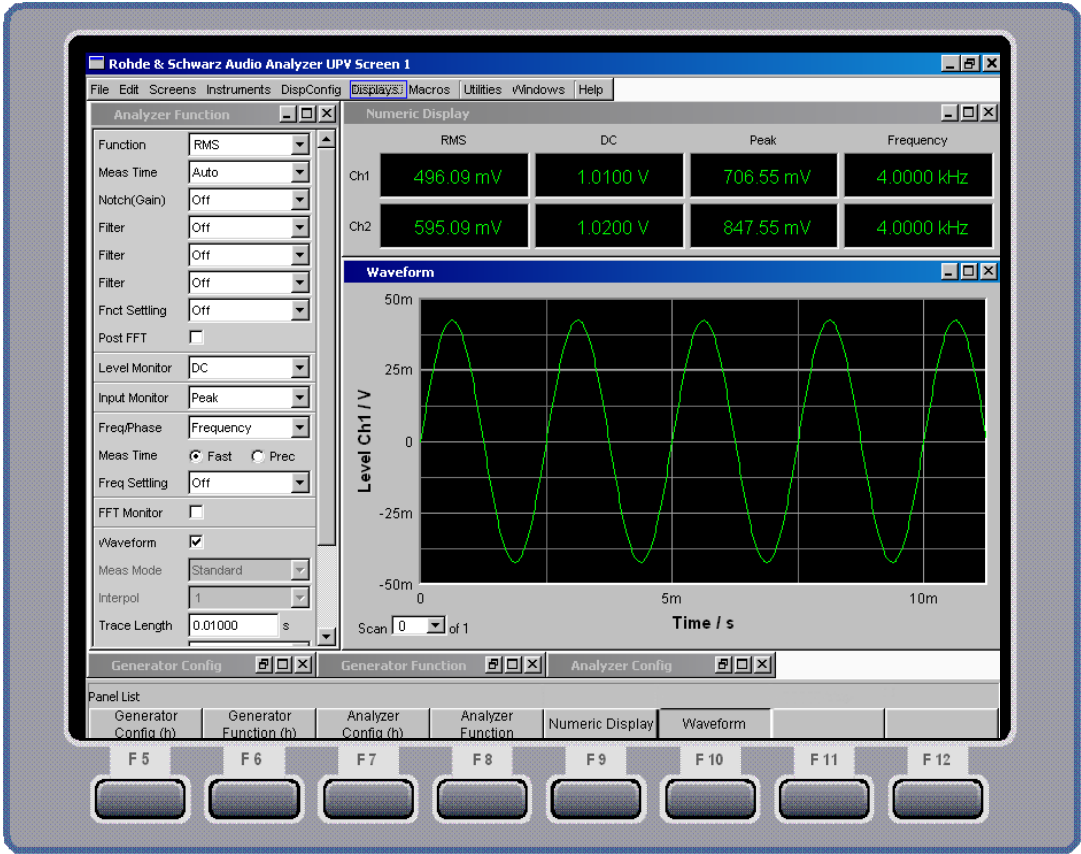

Fig. 1-2 Screen

The large screen shows all of the important settings and states of the audio analyzer in a clearly organized display. 5 displays ("screens") are provided to ensure clearer organization of the many possible panels and display windows.

The **display** is divided into the following sections:

- menu bar
- operating and display area
- **WINBAR** with softkey labels
- softkeys

The **menu bar**

- contains a row of pull-down menus which can be used to, for example, load instrument settings, select panels and screens or call up help functions.
- The menu bar appears when the MENU key is pressed or the mouse pointer is moved to the left of the screen. It otherwise remains hidden in order to save space.

In the **operating and display area**

- the Audio Analyzer R&S UPV is operated using numerous panels which can be selected by the user
- the measurement results are displayed numerically and/or graphically in the format selected by the user

The **softkey bar/WINBAR** at the bottom of the screen has two functions:

- In normal operating mode, the **softkey bar** containing the functions available in the selection windows of the panels is visible; the softkeys permit rapid selection without needing to use the mouse.
- When the WINBAR key is pressed, the **WINBAR** containing the names of all opened panels / graphical windows is displayed in place of the softkey bar. Pressing the associated softkey puts the focus on the corresponding panel / graphical window, i.e. it becomes active. At the same time, the system returns to normal operating mode (see above).
- It is possible to toggle between the softkey bar and WINBAR at any time by pressing the WINBAR key.

The function of the **softkeys**

- corresponds to the label on the softkey bar and WINBAR. The softkeys can also be operated using the function keys on the external keyboard or by clicking the associated button.

## 2 Navigation keys

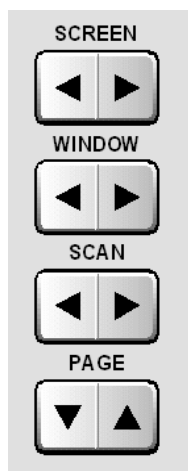

The **navigation keys** are 4 rocker buttons which are used for forward and backward switching.

- |        |   |  |
|--------|---|--|
| SCREEN | – | Switches between the individual display settings (the "screens").  |
| WINDOW | – | Switches the focus to each of the panels open in the visible screen in sequence (the panel with the focus is active).  |
| SCAN   | – | Changes between the individual curve traces ("scans") in graphical displays so that, for example, measurement values can be read off from the curves using the cursor. |
| PAGE   | – | Scrolls back and forward in the tables one page at a time.   |

## 3 Data entry keys

Numeric keys



- |       |   |  |
|-------|---|--|
| 0...9 | – | Entry of numeric values                            |
| .     | – | Entry of decimal point                             |
| +/-   | – | Entry of sign                                      |
| abc   | – | Entry of letters                                   |
| ␣     | – | Entry of a space                                   |
| *...# | – | Entry of special characters                        |
| A ↔ a | – | Switchover between uppercase and lowercase letters |

Function keys



- |       |   |  |
|-------|---|--|
| MENU  | – | Displays the menu bar on the screen                            |
| UNDO  | – | Deletes the character to the left of the cursor                |
|       | – | Undoes the action last performed                               |
| ESC   | – | Closes the open window; the old value or parameter is retained |
| ENTER | – | Completes the data entry; the new value is adopted             |
|       | – | Confirms (OK) and closes open entry windows                    |
|       | – | Pressing the rotary knob has the same effect                   |

**4 CONTROL panel**

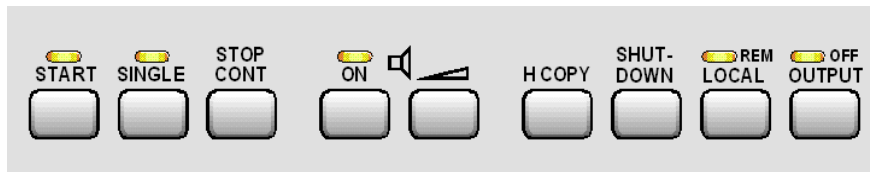

The CONTROL panel contains the following operating functions. These functions are described in detail below:

- Start measurements / sweeps
- Loudspeaker control
- Hardcopy of the screen contents
- Shut down the operating system
- Switch between remote / manual operation
- Switch off outputs

Keys for starting measurements and sweeps

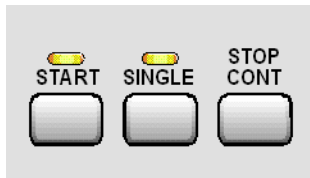

- |           |   |  |
|-----------|---|--|
| START     | - | Starts continuous measurements and sweeps (LED lights up); Resets Min/Max values for bargraph displays, averaging for measurement results, and limit overranging |
| SINGLE    | - | Starts a single measurement or a single sweep (LED lights up during execution)   |
| STOP/CONT | - | Measurement / sweep is stopped or continued (toggle function)  |

Keys for setting the loudspeaker

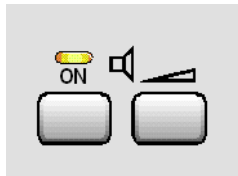

- |        |   |   |
|--------|---|---|
| ON     | - | Switches the loudspeaker or connected headphones on and off (toggle function) |
| Volume | - | Opens a window for adjusting the audio monitoring volume                      |

Keys for printing hardcopies, shutting down the operating system, switching between remote control/local operation, switching off outputs



- H COPY
  - Depending on the settings under Utilities printout of the screen contents on the connected printed is started
  - the screen contents are stored in a file
  
- SHUT-DOWN
  - Stores the current settings on the hard disk and then shuts down the Windows operating system
  
- LOCAL
  - Switches from remote control to manual operation; the LED lights up with remote control
  
- OUTPUT
  - Switches all outputs of the measuring instrument off or on again; the LED lights up when the outputs are switched off

**5 VARIATION panel**

Rotary knob

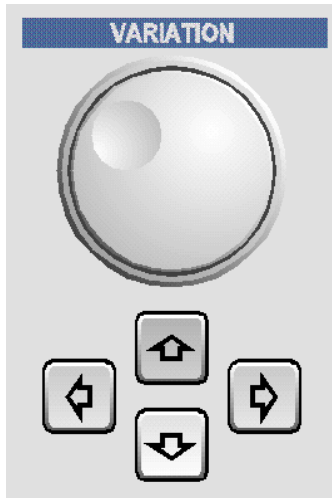

- Moves the focus in the panels, selection windows and tables
- Varies the entry value at the cursor position
- Moves the active cursor inside the graphical windows
- Pressing the rotary knob has the same effect as pressing the Enter key

Cursor keys



- Move the focus in the panels, selection windows and tables
- Vary the entry value at the cursor position

Cursor keys



- Move the active cursor inside the graphical windows
- Move the cursor position in entered values

**6 USB connectors**



USB (Universal Serial Bus) interfaces of type A (host USB) for:

- connecting peripherals such as mouse, keyboard, printer
- connecting a USB stick for transferring files
- There are two additional USB interfaces (type A) at the rear of the instrument.

**7 CD/DVD Combo drive**

The integrated combined CD/DVD drive is used to

- install software updates on the R&S UPV
- install sequence programs and macros
- import data and instrument settings from other R&S UPVs
- store data on a CD

**8 Ground socket**



Connect ground socket with the instrument housing

**9 Headphone connector**



Connection of headphones for audio monitoring of the analysis or generator signal

**10 SETUP panel**

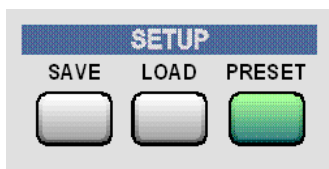

- SAVE - Opens a window for storing instrument settings
- LOAD - Opens a window for loading predefined instrument settings
- PRESET - Loads the factory settings of the instrument

**11 HELP key**



Pressing this key displays a context-sensitive help text

**12 WINDOW panel**

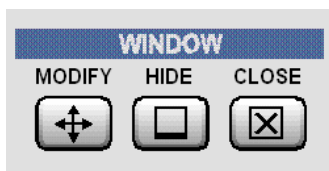

- MODIFY - Opens a selection of functions on the softkey bar; these functions can be used in conjunction with the rotary knob to move or resize the active panel or graphical window
- HIDE - Minimizes ("hides") the active panel or graphical window
- CLOSE - Closes the active panel or graphical window

### 13 Analog audio interfaces

Output and input connectors of the analog generators and analyzers

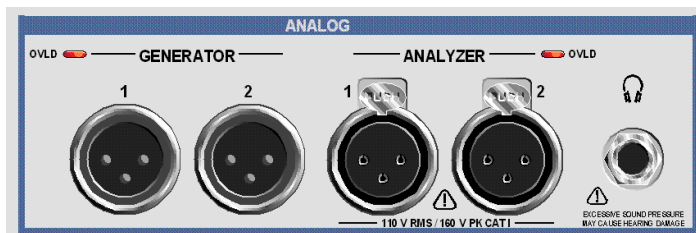

#### ATTENTION



#### Risk of instrument damage

The instrument complies with measuring category I; make sure that the input voltage at the connectors of the analog analyzers does not exceed 110 V (effective, sinusoidal) and 160 V (peak value).

Do not use the instrument in measuring categories II, III and IV.

Explanation:

Measuring circuits as defined in section 6.7.4 of EN61010-1:

Measuring category I is intended for measurements on circuits which are not connected to the high-voltage current system.

### 14 WINBAR key



It is possible to toggle between the softkey bar and WINBAR at any time by pressing the **WINBAR** key:

- In normal operating mode, the softkey bar containing the functions available in the selection windows of the panels is visible; the softkeys permit rapid selection without needing to use the mouse.
- When the **WINBAR** key is pressed, the WINBAR containing the names of all opened panels / graphical windows is displayed in place of the softkey bar. Pressing the associated softkey puts the focus on the corresponding panel / graphical window, i.e. it becomes active. At the same time, the system returns to normal operating mode (see above).



**15 Digital audio interfaces**

Inputs and outputs for connecting digital consumer devices and professional studio equipment.



- UNBAL – BNC connectors
- OPTICAL – Optical interface conforming to EIAJ CP-340, TOSLINK system
- BAL – XLR female and male connector

**Note:**

*These interfaces are only available when the R&S UPV-B2 or -B20 options have been installed.*

**16 Power switch**

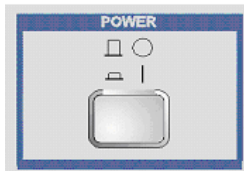

The power switch switches on the instrument and starts the booting process.

**Warning:**

*The instrument must be set up in such a way that operation of the power switch is not obstructed.*

**Note:**

*It is strongly recommended to shut down the operating system before switching off the instrument (using the SHUT-DOWN key or the mouse).*

**17 Status LEDs**

SYSTEM STATE		
● POWER ON	● READY	● OUTPUT OFF
● SWITCH OFF	● BUSY	● GEN OVLD
● LAN	● REMOTE	● ANLR OVLD

With the R&S UPV66 audio analyzer, the instrument's state is indicated via LEDs. The individual LEDs have the following meaning:

- **POWER ON:**  
The instrument is switched on.
- **SWITCH OFF:**  
The operating system has been shut down; you can now switch off the instrument.
- **LAN:**  
The instrument is connected to a local area network.
- **READY:**  
The measuring instrument is ready for operation.
- **BUSY:**  
Illuminated as long as a measurement is running.
- **REMOTE:**  
The instrument is in remote-control operation.
- **OUTPUT OFF:**  
All outputs of the R&S UPV66 audio analyzer are switched off.
- **GEN OVLD:**  
The generator is overloaded.
- **ANLR OVLD:**  
The low impedance input resistors (300 Ohm or 600 Ohm) are overloaded and have been switched off.

Rear Panel

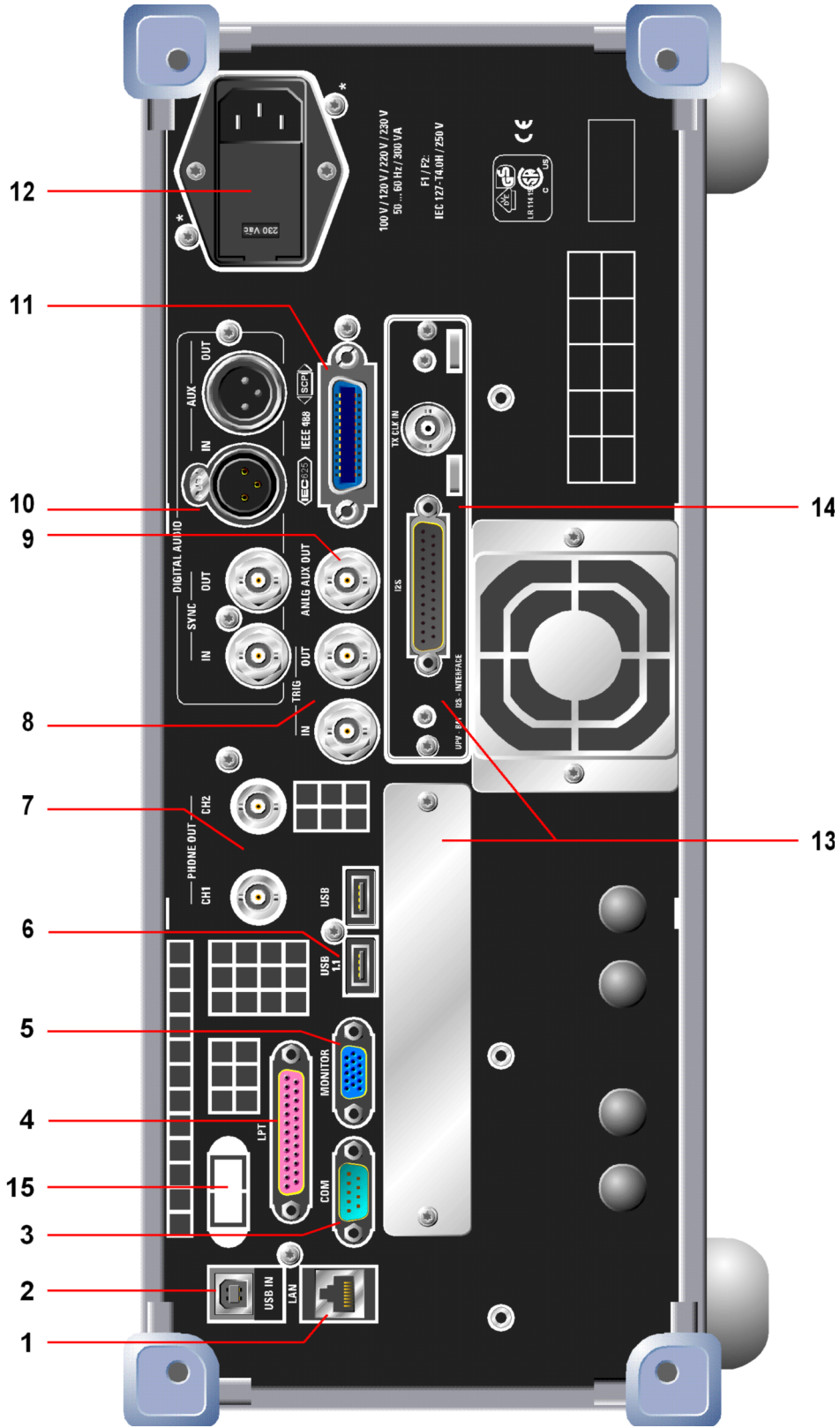

Fig. 1-3 Rear panel

## Description of the Rear Panel

This section provides an overview of the connectors at the rear of the R&S UPV.

### 1 LAN connection



LAN interface

- Integration of the audio analyzer in a network
- Remote operation of the audio analyzer from a remote computer
- Remote control of the audio analyzer (with the R&S UPV-K4 option)

### 2 USB device connector



USB device connector for remote operation of the audio analyzer (with the R&S UPV-K4 option).

### 3 RS-232-C interface

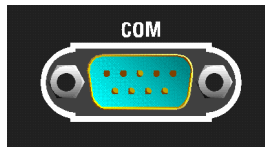

RS-232-C interface, 9-pin D-Sub connector (male)

To connect the R&S UPV via the RS-232-C interface, use a well-shielded cable.

### 4 Printer interface

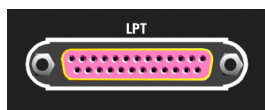

Parallel printer interface, 25-pin D-Sub connector (female)

To connect a printer, use a well-shielded cable.

### 5 Connector for external monitor

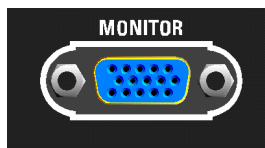

Connector for an external monitor, 15-pin D-Sub connector (female), 3-tier.

Use a very well shielded cable with ferrite cores in order to connect the external monitor to the R&S UPV.

### 6 USB connectors

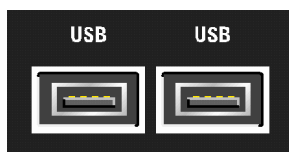

USB (Universal Serial Bus) interfaces of type A (host USB).

- Connection of peripherals such as mouse, keyboard, printer
- Connection of a USB stick for transferring files

There are additional USB interfaces on the front of the instrument.

**7 BNC audio monitoring output**

The signal that is output on these BNC connectors is the same as the signal on the headphone output on the front panel.

**Note:**

Requires the R&S UPV-U2 option (BNC audio monitoring outputs).

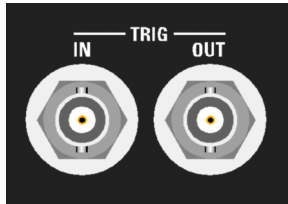
**8 Trigger connectors**

- TRIG IN – Input for triggering measurements
- TRIG OUT – Trigger output and clock output

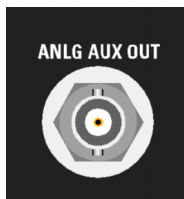
**9 Analog auxiliary output**

Additional analog output for special applications

- DC output, e.g. for supplying power to hearing aids
- Output for the analog generator signal via an integrated amplifier for the direct actuation of small loudspeakers

**10 Digital synchronization and expansion interfaces**

Inputs and outputs for reference and sync signals for the R&S UPV-B2 option (digital audio interfaces)

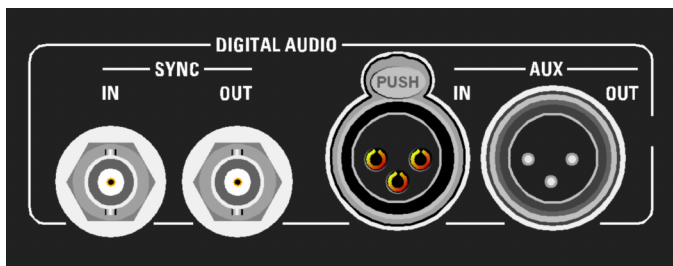

- SYNC IN – Synchronization input for word-clock signals
- SYNC OUT – Output for synchronizing digital peripherals to the word clock or biphas clock of the R&S UPV
- AUX IN – Input for a digital audio reference signal (DARS)
- AUX OUT – Output for a digital audio reference signal (DARS) generated by the R&S UPV

**Note:**

These interfaces are only available in conjunction with the R&S UPV-B2 option.

## 11 IEC/IEEE-bus connector

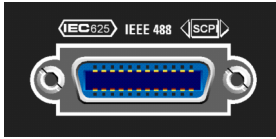

IEC/IEEE-bus connector (IEC 625/IEEE 488) for remote control of the R&S UPV

**Note:**

Requires the R&S UPV-K4 option (remote control).

## 12 AC supply voltage connector

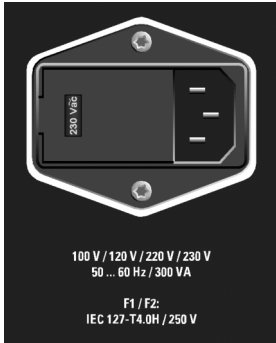

AC supply voltage connector with indication of the set nominal AC supply voltage

**ATTENTION**



**Risk of instrument damage**

The R&S UPV must be set to the nominal voltage of the AC system used. Before switching on the instrument for the first time, check whether the correct AC supply voltage is set.

## 13 Slots for expansion plug-ins

In the rear panel of the R&S UPV, there are two slots into which expansion plug-ins can be inserted (see Chap. 4 and data sheet). For example, an I<sup>2</sup>S interface can be fitted in addition or alternatively to the optional digital audio interfaces on the front of the instrument.

The left plug-in slot at the rear panel of the R&S UPV is designated as Slot 1, and the right one as Slot 2.

## 14 I<sup>2</sup>S interface

The R&S UPV-B41 option, which is an I<sup>2</sup>S interface, is shown here as an example of how an expansion plug-in can be installed in addition to or as an alternative to any optional digital audio interfaces that may be present on the front panel of the instrument.

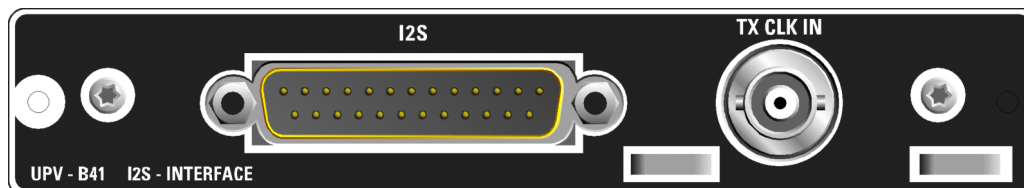

- I<sup>2</sup>S – 25-contact D-Sub connector for connecting the input and output lines of the I<sup>2</sup>S interfaces. The interface assignment is described in Chapter 4. To connect the DUT, use a well-shielded cable.
- TX CLK IN – Additional BNC connector for connecting an external master clock signal. Details are provided in Chapter 4.

**15 LAN Reset button**



The LAN RESET button has two functions:

- Resets the LAN default settings:  
To do this, you have to press the button for 5 seconds until READY LED switches off on the front panel of the R&S UPV66.
- Shuts down the operating system:  
If the operating system of the R&S UPV66 is to be shut down manually without using a mouse, you have to press the LAN RESET button three times within 5 seconds.

---

**Note:**

*This button is present only on the R&S UPV66 model.*

---

## Putting into Operation

The following section describes how to put the instrument into operation and to connect peripherals such as printer and monitor. It contains general safety instructions for instrument operation.

Installation of the options is described separately for each option in the respective sections of *Chapter 4, "Instrument Functions"*; software updates are explained in *Chapter 8, "Maintenance and Interfaces"*.

## Unpacking the Instrument

- Remove the instrument from its packaging and check the equipment for completeness using the delivery note and the accessory lists for the various items.
- First, pull off the polyethylene protection pads from the instrument's rear feet and then carefully remove the pads from the instrument handles at the front.
- Pull off the corrugated cardboard cover that protects the rear of the instrument.
- Carefully unthread the corrugated cardboard cover at the front that protects the instrument handles and remove it.
- Check the instrument for any damage. If there is damage, immediately contact the carrier who delivered the instrument. In this case, make sure not to discard the box and packing material.

It is advisable to keep the original packing material in order to prevent control elements and connectors from being damaged in case the instrument is to be transported or shipped at a later date.

## Setting up the Instrument or Installing it in a 19" Rack

The instrument is designed for indoor use. It can either be set up as a separate unit or mounted in a 19" rack.

A rack adapter (see the data sheet for the order number) is required for installation in a 19" rack . The mounting instructions are supplied with the adapter.

---

**CAUTION****Risk of overheating**

To less airflow for cooling may cause overheating of the instrument.

Prior to putting the instrument into operation always check for space between the ventilation holes and the rack casing to get sufficient air supply in the rack.

---



## Safety Instructions

### General Safety Instructions

**ATTENTION****Instrument damage caused by disregarding the following precautions!**

Any non-compliance with the following precautions may cause damage to the instrument. Prior to putting the instrument into operation, check the following:

- The covers of the housing are in place and screwed on.
- Vents are not obstructed. Make sure that the air can escape freely through the vents at the rear and at the sides. The minimum distance to the wall should therefore be at least 10 cm.
- The signal levels at the inputs do not exceed permissible limits.
- The outputs of the instrument are not overloaded, incorrectly connected or the polarity is incorrect.
- The instrument should only be operated in horizontal position on an even surface.
- The ambient temperature must not exceed the range specified in the data sheet.
- The instrument complies with measuring category I; the input voltage at the connectors of the analog analyzers should not exceed 110 V (effective, sinusoidal) and 160 V (peak value). The instrument should not be used in measuring categories II, III and IV.

*Explanation:*

*Measuring circuits as defined in section 6.7.4 of EN61010-1:*

*Measuring category I is intended for measurements on circuits which are not connected to the high-voltage current system.*

Please also observe the instructions in the following sections and the general safety instructions at the beginning of this manual.

### Protection Against Electrostatic Discharge



To avoid damaging the electronic components of the EUT due to electrostatic discharge produced by contact, the use of appropriate protective measures is recommended.

## Setting Up the Instrument

**WARNING**

**Risk of injury and instrument damage.**

**Safe operation with support feet!**

- Stacked **instruments** may slip off.  
**Secure stacked instruments against slipping** (e.g. by locking the feet to the top of the front-panel frame).  
The feet must be fully folded in or folded out. Only then a stable position of the instrument and reliable operation can be ensured. The uniform pressure on the folded-out feet must not exceed 500 N (weight of instrument and of equipment stacked on top).
- When the instrument with expanded feet, the feet might collapse and fold in.  
**Do not shift the instrument with the feet out.**

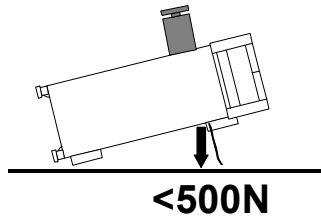

## Cleaning the Outside and Storing

What is necessary is essentially the cleaning of the instrument.

**ATTENTION****Instrument damage caused by cleaning agents!**

Cleaning agents contain substances that may damage the instrument, e.g. solvent-containing cleaning agents may damage the front panel labeling or plastic parts.

Never use cleaning agents such as solvents (thinners, acetone, etc), acids, bases, or other substances.

The outside of the instrument is suitably cleaned using a soft, line-free dust cloth.

## EMC Safety Precautions

To prevent electromagnetic interference, only suitable, shielded signal and control cables should be used.

## Connecting the R&S UPV to the AC Supply

The power supply connector is at the rear of the instrument (see below). The Audio Analyzer R&S UPV can be set up for connection to AC supply systems of **100 V**, **120 V**, **220 V** and **230 V** and can be operated with  $\pm 10\%$  tolerance and an AC supply frequency of 47 Hz to 63 Hz. The instrument is also suitable for operation with power supply systems with the other nominal voltages specified in the table below :

Nominal AC supply voltage	Voltage selector setting	Tolerance of Instrument
110 V	100 V	+4% -18%
	120 V	+20% -6%
115 V	120 V	+15% -10%
127 V	120 V	+4% -18%
240 V	230 V	+10% -14%

## Setting the AC Supply Voltage

### ATTENTION



### Danger of instrument impairment

Before switching on the instrument for the first time, check whether the correct AC supply voltage is set. If the AC supply voltage is not correct, it must be adjusted in the following way:

- Disconnect the power cable.
- Open the flap covering the voltage selector using a small screwdriver (or similar).
- Remove the cylinder labeled with the nominal voltages and reinsert it so that the value visible through the hole in the cover flap when refitted corresponds to the desired nominal voltage. If the desired voltage is not printed on the cylinder, select the nearest suitable value according to the table above.
- Close the flap.

---

### Note:

*The Audio Analyzer R&S UPV is operated with the same fuses for all of the specified nominal AC supply voltages. The precise designation of the fuses is indicated on the rear of the instrument .*

---

## Switching On

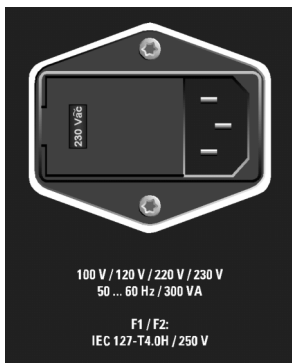

- Connect the audio analyzer to the power supply system using the supplied power cable.

---

**Note:**

*Since the instrument is in compliance with safety class EN61010-1, it should only be connected to a socket with earthing contact.*

---

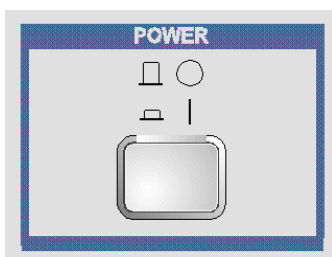

- Press the power switch on the front of the instrument.

The instrument starts the booting process and all modules are supplied with power.

## Start Screen and Booting of the R&S UPV

After the instrument has been switched on, the installed BIOS version and the processor details are displayed on the screen for a few seconds.

After this, the WindowsXP® operating system boots first followed by the instrument firmware. During booting of the instrument firmware, a self-test is performed. The most recent instrument settings saved automatically at power-off are then loaded so that the instrument is in the same state as it was before power-off. After booting is completed, the audio analyzer screen appears and the instrument is ready to be operated.

---

**Note:**

*If the software should crash unexpectedly and the instrument is operated via the front panel, it can only be rebooted by pressing the power switch. If the instrument is operated using an external keyboard, it is recommended to attempt a restart by pressing Ctr+Alt+Del (warm start) first.*

---

## Restarting the R&S UPV

If the R&S UPV firmware was closed without shutting down the operating system (e.g. by clicking the  icon in the title bar), the program can be restarted in two different ways using the mouse:

- Click the "R&S UPV" icon on the desktop
- Click the start button in the task bar, then select the folders "All Programs", "Rohde & Schwarz", "UPV" and click the "R&S UPV" icon.

## Switching off the instrument

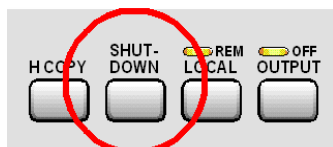

### R&S UPV model:

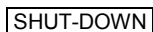
- Press the  button on the front of the instrument.  
The R&S UPV will save the current settings to hard disk and then shut down the operating system.

---

#### Note:

*If the instrument is operating under mouse control, it is also possible to shut down the operating system by using the same method as is commonly used in Windows applications.*

---

### R&S UPV66 model:

- Press the  key at the rear of the instrument three times within 5 seconds.

The R&S UPV66 stores the current settings on the hard disk and then shuts down the operating system.

- With remote control, you can also shut down the operating system by using the SYSTem:SHUTdown command.
- Alternatively, the operating system can also be shut down in the same way as other Windows applications by using the mouse.
- As soon as the operating system is shut down, the SWITCH OFF LED will illuminate. You can disconnect the instrument from the supply system via the power switch.

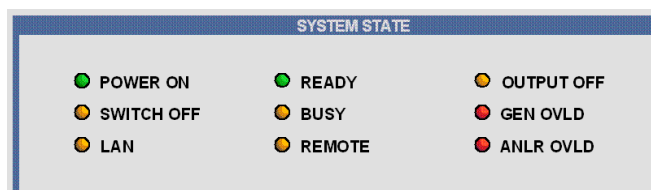

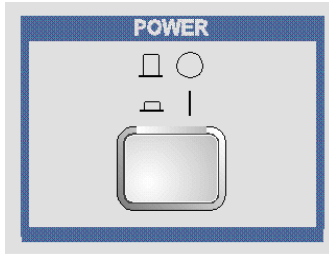

- Press the power switch on the front of the instrument.

The instrument will be disconnected from the AC mains, and power will be removed from all modules.

---

**ATTENTION****Danger of data loss or instrument impairment!**

Switching off the instrument without first shutting down the operating system in an orderly manner can cause loss of data or problems with the boot process the next time the instrument is switched on.

---

# Function Check

The audio analyzer monitors the most important instrument functions automatically when it is switched on.

## Presets

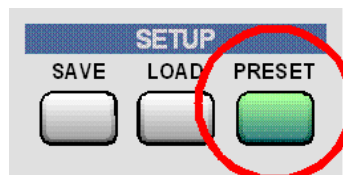

Pressing the **PRESET** key loads a set of defined instrument settings. The most important parameters set here are:

Generator frequency (analog)	1 kHz
Generator level (analog)	0.1 V
Generator signal	Sinusoidal
Generator frequency (digital)	997 Hz
Generator level (digital)	0.1 FS
Generator signal	Sinusoidal
Analyzer interface (analog)	XLR measuring input (analog)
Analyzer interface (digital)	XLR measuring input (digital)
Analyzer function	RMS
Frequency measurement	ON

The preset function sets all parameters and settings, even those of inactive operating modes.

## Windows XP

**ATTENTION****Possible impairment of the instrument functioning**

The instrument is equipped with the WindowsXP® operating system. It is thus possible to install commercial off-the-shelf software on the instrument. The use and installation of commercial off-the-shelf software may impair the instrument function. For this reason, we recommend that you only execute programs tested by Rohde & Schwarz with regard to their compatibility with the instrument software.

The drivers and programs used on the instrument under WindowsXP have been adapted to the instrument. Existing instrument software must only be modified with update software released by Rohde & Schwarz.

The audio analyzer has the WindowsXP® operating system. When supplied, the configuration of this operating system is optimized to the functions of the audio analyzer. Changes in the system setup are only required when peripherals like keyboard and printer are installed or in the event that the network configuration does not comply with the default settings (see sections below).

When the audio analyzer is switched on, the operating system boots and the instrument firmware is then started automatically without a password query (auto login).

**Note:**

*Auto login is performed with the user name and the password "instrument". The standard user has administrator rights so that printer and network installations are possible.*

The operating system can only be accessed if an external keyboard is connected. Pressing the **Windows** key on the external keyboard (next to the CTRL key) opens the WindowsXP® Start menu where the WindowsXP® programs can be called up. Connecting a mouse makes WindowsXP® easier to use.

The system settings under WindowsXP® are made in the menu **Start – Settings - Control Panel** (the required settings can be found in the descriptions of WindowsXP® and the hardware).

The R&S UPV does not have a floppy disk drive. Data is exchanged using a USB stick which is inserted into one of the USB interfaces. The USB stick is automatically assigned a free drive letter and the data can be transferred in Windows Explorer.



## Connecting an External Keyboard

A commercially available, external keyboard with USB interface can be connected to the R&S UPV. A keyboard simplifies the input of list entries, comment texts, file names, etc and is required for operating WindowsXP®.

The keyboard is connected to one of the USB interfaces at the front or rear of the instrument.

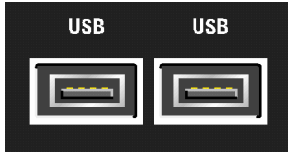

The keyboard is detected automatically when it is connected. The US keyboard assignment is the default setting. The keyboard language and special settings, e.g. the repeat rate and so on, can be changed in the WindowsXP® menu **Start - Control Panel - Keyboard** or **Regional and Language Options**. The menu is opened by pressing the **Windows** key on the external keyboard .

## Connecting a Mouse

A commercially available mouse with USB interface can be connected to the R&S UPV. The mouse makes it easier to move and resize the panels / graphical windows on the screen and provides alternative operating modes. It is recommended for easy operation of WindowsXP®.

The mouse is connected to one of the USB interfaces on the front or rear of the instrument.

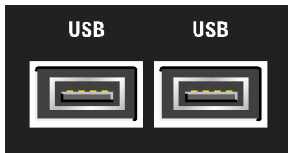

The mouse is detected automatically when it is connected. Special settings, e.g. the speed of the mouse pointer and so on, can be made in the WindowsXP® menu **Start - Control Panel - Mouse**. The menu is opened by pressing the **Windows** key on the external keyboard.

## Connecting an External Monitor

---

**ATTENTION** Danger of damage to the monitor or the instrument

Make sure that the instrument is switched off before connecting the monitor. The monitor and the R&S UPV could otherwise be damaged.

Do not modify the screen driver (Display type) and the display configuration since this will impair instrument operation.

---

An external monitor with an analog interface can be connected to the MONITOR connector at the rear of the R&S UPV.

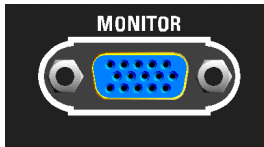

The connector interface is described in Chapter 8 "*Maintenance and Interfaces*".

### Connection

To prevent damage to the monitor and R&S UPV, the instrument must be switched off before an external monitor is connected. After connection, the external monitor is detected when the instrument is started (but not if it is connected while the instrument is in operation). The screen display with all elements, e.g. panels, measurement displays, WINBAR and so on, then appears both on the external screen and on the instrument. No further settings are required.

## Changing the screen resolution

The R&S UPV audio analyzer comes with a built-in PC. Before March 2007, the instruments were supplied with a PC carrying the Rohde & Schwarz designation FMR6; instruments supplied as of March 2007 include a PC of the FMR7 type.

The procedure for setting the screen resolution when using an external monitor is different for the two PC models. The procedure for each is described below.

### FMR6

#### Set external screen resolution to higher than 800 x 600 pixels.

Switch off the R&S UPV. Connect external screen, keyboard, and mouse to the R&S UPV.

Switch on the R&S UPV. After starting the R&S UPV, terminate or minimize the R&S UPV program by clicking the  buttons on the right-hand edge of the title bar.

Using the right mouse button, click the desktop to open the following context menu.

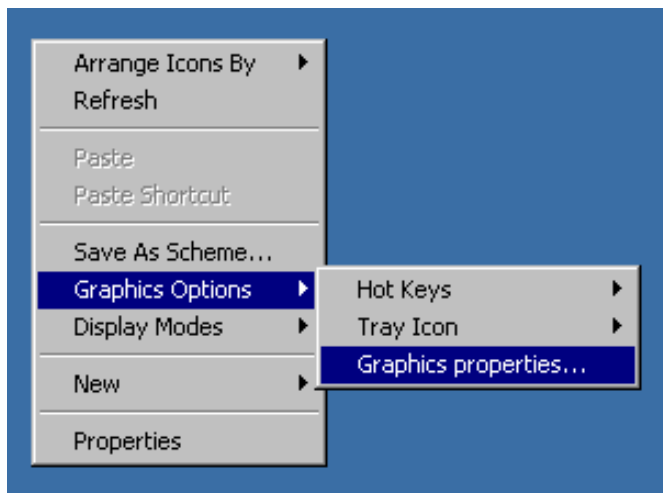

Select **Graphics properties...**



Click **Monitor** and place the focus on the **True Color** field, as shown in the screenshot below.

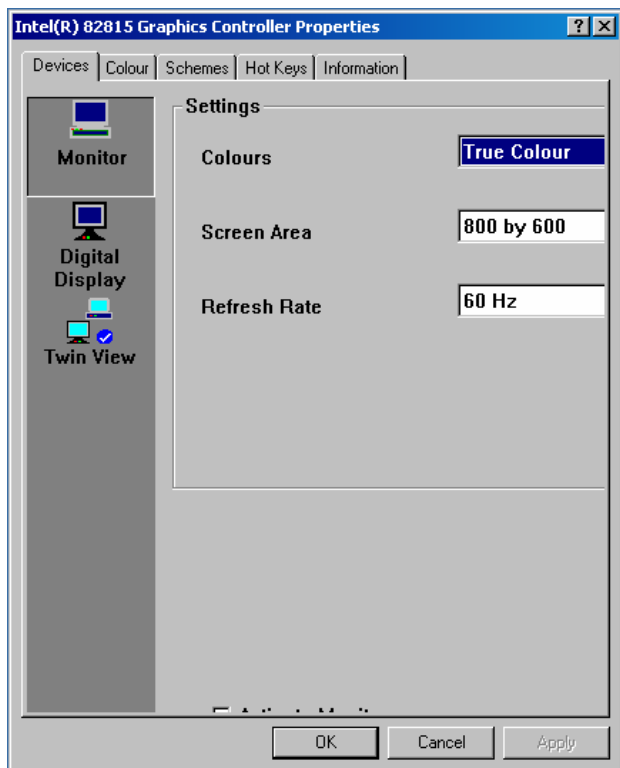

Press the **TAB** key three times to select the invisible button; then press the **space** key. Now press the **Apply** key. The internal LC screen (digital display) will be switched off.

Click **OK** to confirm the change. Now click **OK** again to close the window.

You can now set the external screen to a resolution higher than 800 x 600 pixels.

Using the right mouse button, click the desktop to open the following context menu again.

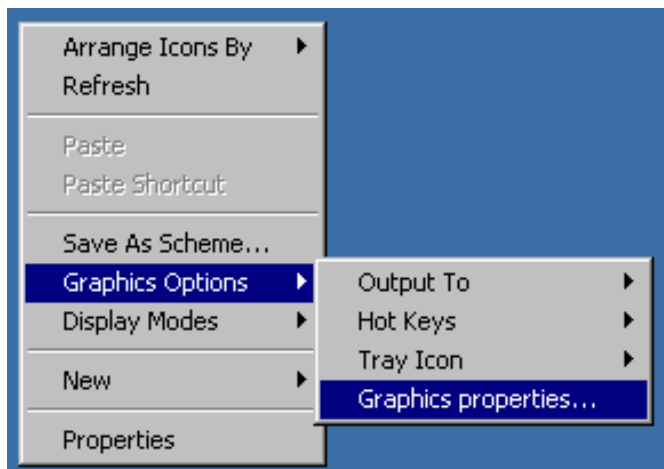

Select **Graphics properties...**

From the Screen Area field, select the resolution you want, e.g. **1024 by 768**.

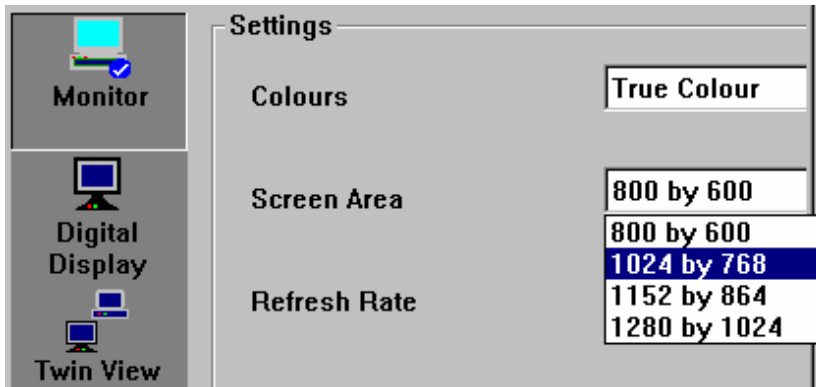

Click **Apply**.

Click **OK** to confirm the change. Now click **OK** again to close the window.

**Reset external screen resolution to 800 x 600 pixels.**

External keyboard and mouse are connected to the R&S UPV. Terminate or minimize the UPV program by clicking the  buttons on the right-hand edge of the title bar.

Using the right mouse button, click the desktop to open the following context menu.

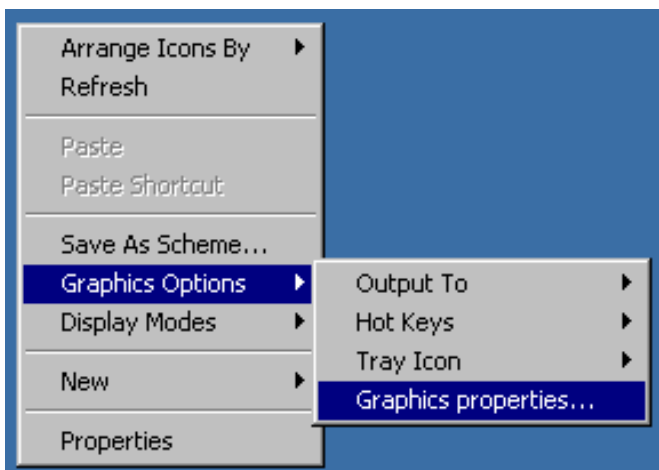

Select **Graphics Properties...**



Click **Twin View** and place the focus on the **Monitor** field, as shown in the screenshot below.

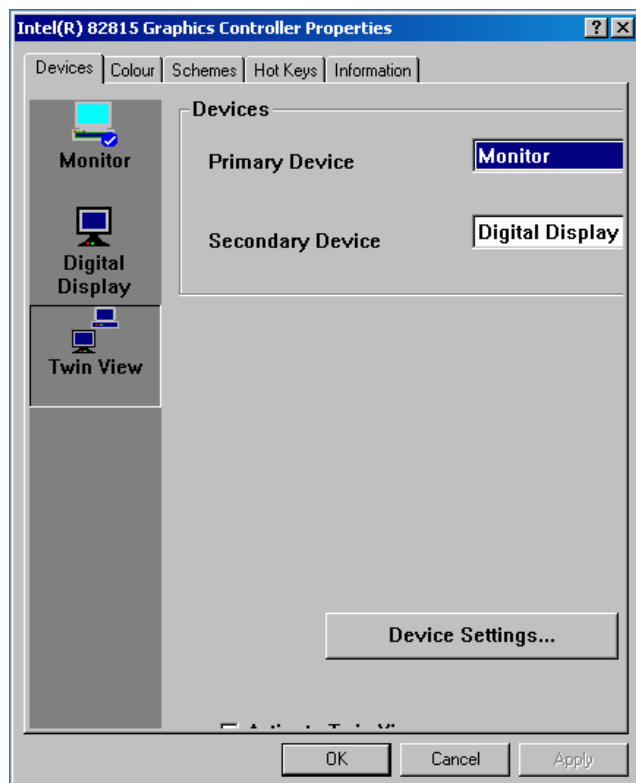

Press the **TAB** key three times to select the invisible button. Now press the **space** key and then the **Apply** button.

The resolution will be reset to 800 x 600 pixels. This is the same as for the internal LC screen, which will be switched on again.

Click **OK** to confirm the change. Now click **OK** again to close the window.

## FMR7

### Set external screen to a resolution higher than 800 x 600 pixels.

Switch off the R&S UPV. Connect external screen and mouse to the R&S UPV. Switch on the R&S UPV. After starting the R&S UPV, terminate or minimize the UPV program by clicking the  buttons on the right-hand edge of the title bar.

Using the right mouse button, click the desktop to open the following context menu.

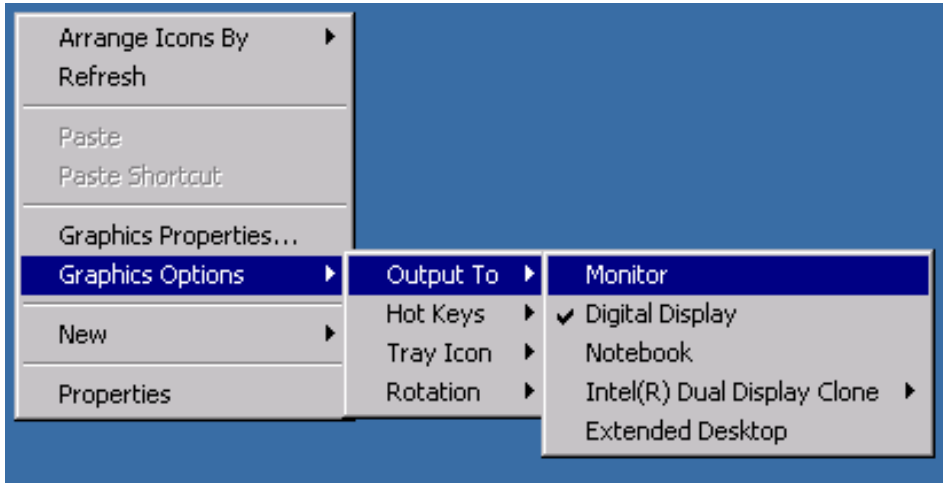

Select **Monitor**

Switch off the internal LC screen and switch on the external screen if it was previously switched off.

Now you can set the external screen to a resolution higher than 800 x 600 pixels.

Using the right mouse button, click the desktop to open the following context menu again.

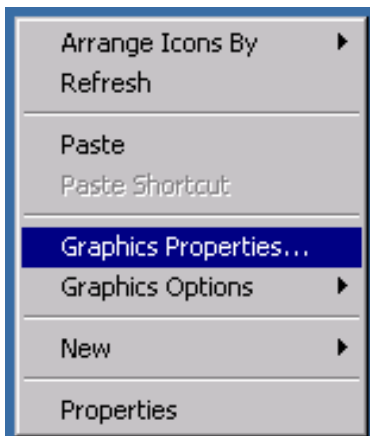

Select **Graphics Properties...**

Select **Display Settings**, and then select the resolution you want, e.g. **1024 x 768** pixels.

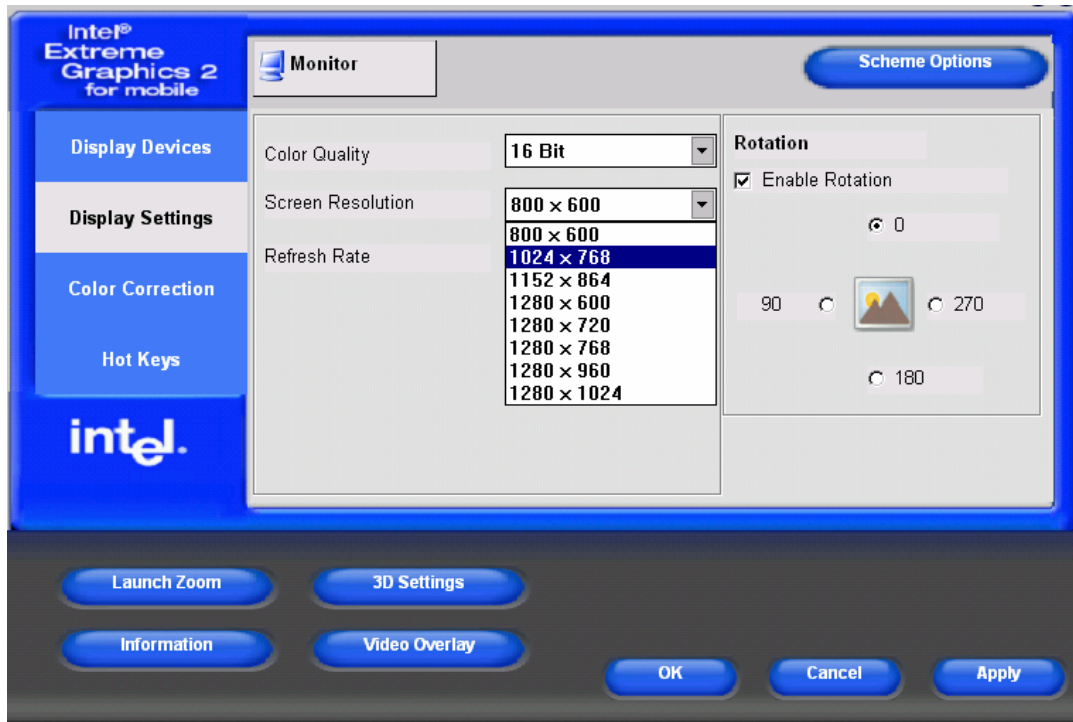

Click **Apply**

Click **OK** to confirm the change, and then click **OK** again to close the window.

**Reset external screen to a resolution of 800 x 600 pixels**

A mouse is connected to the R&S UPV. Terminate or minimize the UPV program by clicking the  buttons on the right-hand edge of the title bar.

Using the right mouse button, click the desktop to open the following context menu.

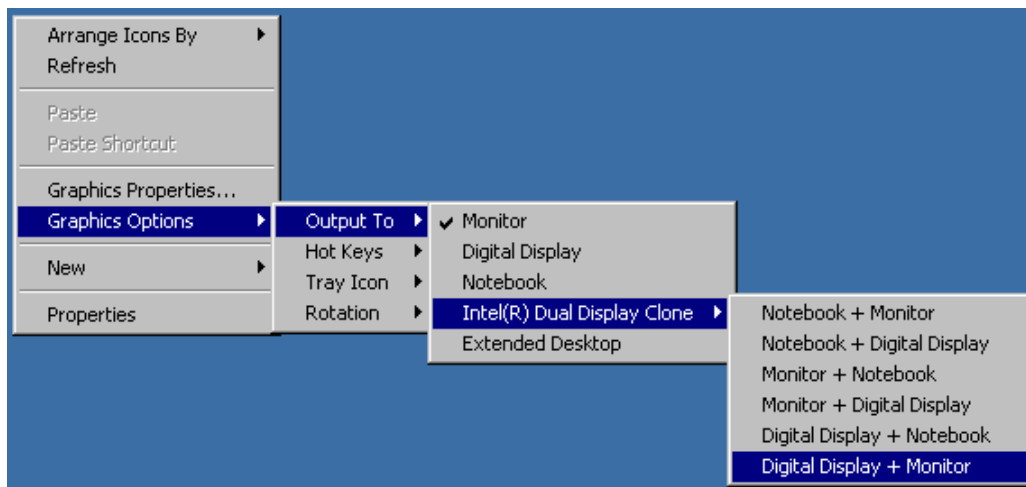



**Select Digital Display and Monitor**

Reset resolution to 800 x 600 pixels, which is the same resolution as for the internal LC screen, which is switched on again.

**Switch off external screen**

Using the right mouse button, click the desktop to open the following context menu.

Select **Digital Display**. The external screen will be switched off.

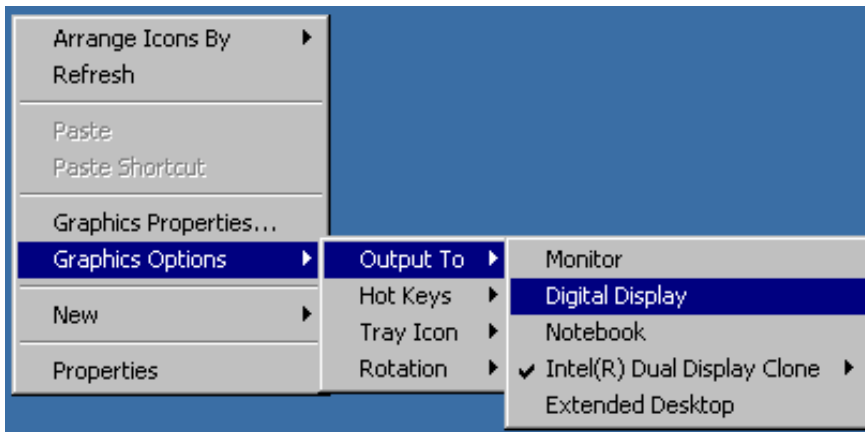

**Important** *The graphics driver of the FMR7 PC module in the R&S UPV saves the screen configuration that was last selected and detects whether an external monitor is connected.*

*If the R&S UPV was previously operated only with an external monitor and was switched off in that state, the internal screen will remain deactivated the next time the R&S UPV is switched on if no external monitor is connected. Since no external monitor is detected in this case when the instrument is switched on, the monitor output will remain deactivated even if a monitor is connected at a later time.*

*To reactivate the screen display, you need an external keyboard:*

*By using the key combination CTRL + ALT + F1 on an external keyboard, you can switch to the external monitor.*

*By using the key combination CTRL + ALT + F4 on an external keyboard, you can switch on the screen. From march 2008 R&S UPV is shipped with a new LCD, which can be switched on using the key combination CTRL + ALT + F3.*

## **Installing Options**

The R&S UPV can be equipped with numerous options. These options can be divided into three basic categories:

Software options	Can be installed by the user himself; a unique activation code supplied with the option is required.
Hardware plug-ins	Inserted into the appropriate slots in the rear of the Audio Analyzer R&S UPV (usually by a Rohde & Schwarz Service Center).
Hardware options	Installed in the Audio Analyzer R&S UPV; these options can only be retrofitted by a Rohde & Schwarz Service Center.

## Connecting the R&S UPV to a Network (LAN)

The R&S UPV has a network connector and can be connected to a LAN (Local Area Network).

Network administrators with the appropriate rights can transfer files across the network and use network resources such as the network directories or printers. The instrument can also be remote-controlled and manually operated in the network.

With manual remote operation, the R&S UPV can be operated from an external computer at any remote location. For example, from your desk you can operate one or more R&S UPVs that are part of a test setup located in another section of the building.

The R&S UPV comes equipped with an activated WindowsXP® firewall. File transfer via LAN or manual remote operation using the remote desktop requires only a partial exception in the firewall. It is advisable to coordinate the configuration of the firewall with the network administrator.

Remote control of the instrument via the LAN interface is described in Chapter 5, *"Remote Control - Fundamentals"*.

### Connection to the Network

#### ATTENTION



#### Risk of network errors!

Connecting errors may affect the entire network.

We recommend that connection of the instrument to the network be co-ordinated with the network administrator.

**Do not connect or disconnect** the network cable until the instrument is **switched off** (standby). Only then the network connection can be reliably detected and impairments to instrument operation can be avoided.

The instrument is connected to the network using a commercially available RJ45 cable connected to the LAN interface at the rear of the instrument.



The connector is described in Chapter 8 *"Maintenance and Interfaces"*.

## Configuring the R&S UPV for Network Operation

The network interface operates with 100 MHz-Ethernet IEEE 802.3u. The TCP/IP network protocol and the associated network services are preconfigured.

In order to exchange data in a local network (LAN), each connected computer or instrument must have a unique IP address or a unique computer name. In addition, network access of the different users is organized by the assignment of access rights.

The access rights determine which of the available network resources, e.g. file storage systems, are available for the R&S UPV.

### Networks with DHCP

The R&S UPV is preconfigured for networks using DHCP (Dynamic Host Configuration Protocol). In these networks, the R&S UPV is automatically assigned a free IP address. In this case, a unique computer name is used for identification in the network.

Each R&S UPV is given a unique computer name at the factory. This name can be queried and changed in the WindowsXP® menu **Start - My Computer** (see *"Querying the Computer Name"* below).

### Networks with fixed IP addresses

In networks using fixed IP addresses, usually the network operator organizes the addresses. The IP address has to be entered in the Windows menu **Start - Control Panel** (see *"Entering the IP Address"*).

### Point-to-point connections

To set up a simple network (a LAN connection between an R&S UPV and a computer without integration in a large network), an IP address must be assigned to the R&S UPV and the computer. The IP addresses 192.168.xxx.yyy are available, whereby both xxx and yyy can have the values 1 to 254; the value for the subnet mask is 255.255.255.0.

In this case, a commercially available cross-over RJ45 cable must be used for the connection.

### User ID

The user **"instrument"** is set for the R&S UPV. The user is used for the auto login when the instrument is started and for manual remote operation. The password is also **"instrument"**. By assigning the respective rights, the network administrator decides which directories and resources in the network can be accessed by the R&S UPV.

## Preparations

The instrument is configured for network operation in the menus of the WindowsXP® operating system. The operating system can only be accessed if an external keyboard is connected; connection of a mouse is recommended for easy operation. The instrument should be switched off before the keyboard and mouse are connected. This will ensure that the keyboard and mouse are correctly detected by the operating system.

## Entering the IP Address

The default setting is "Obtain an IP address automatically" (Dynamic Host Configuration Protocol (DHCP)).

### 1. Start – Settings – Control Panel

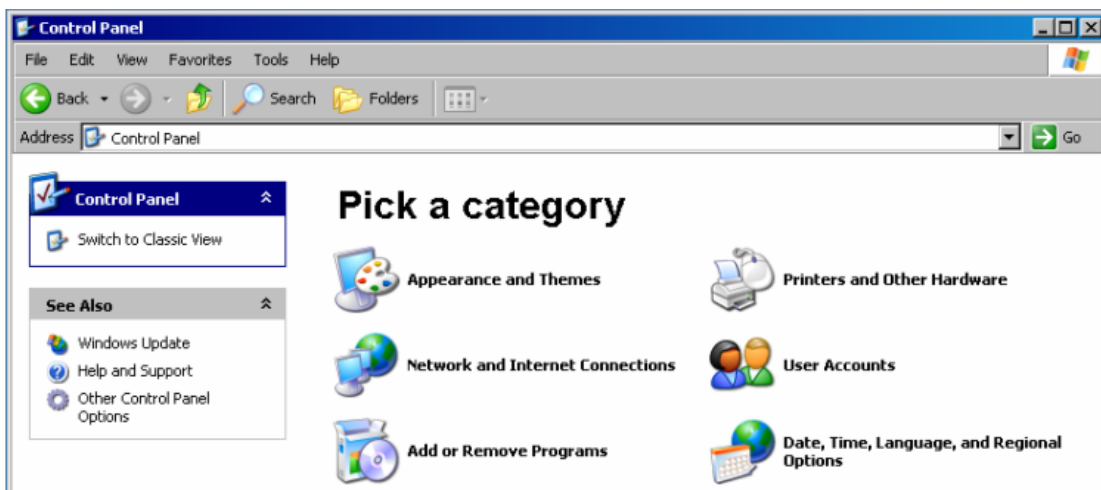

### 2. Click **Network and Internet Connections** and then click **Network Connections** bottom right in this menu.

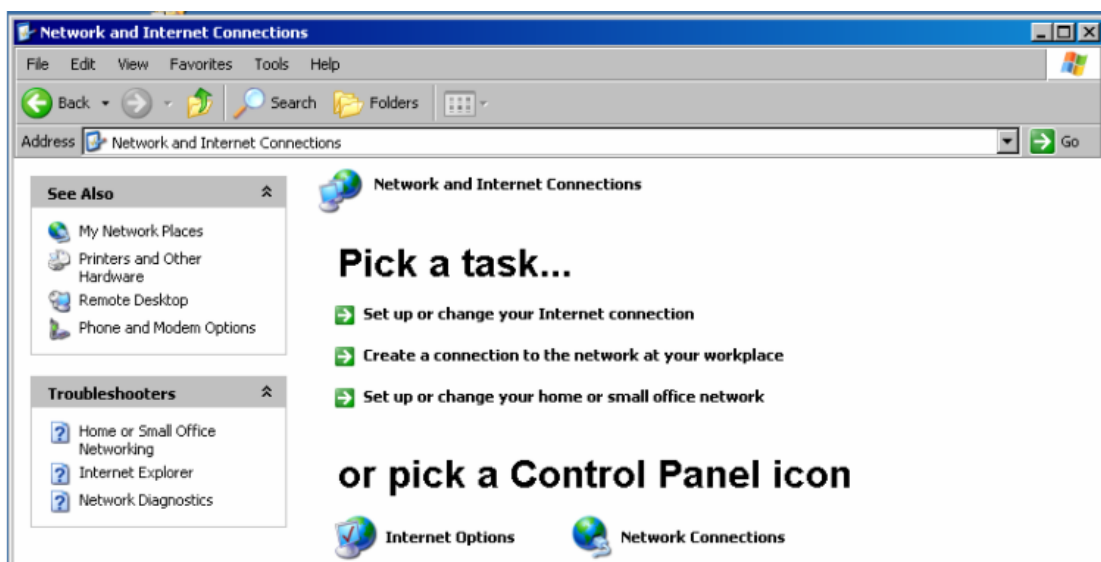

3. In the **Network Connections** menu, right-click **Local Area Connection** and then click the **Properties** button.

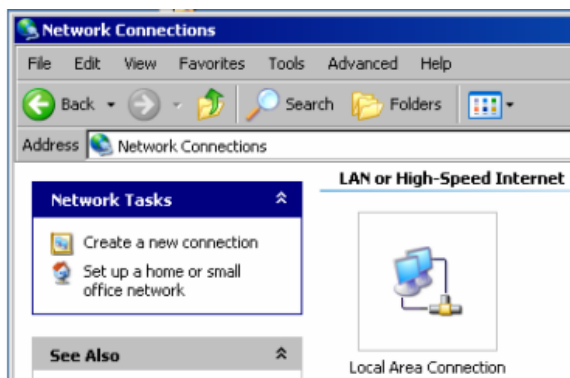

4. On the **General** tab, select **Internet Protocol (TCP/IP)** in the field **This connection uses the following items:** and then click the **Properties** button.

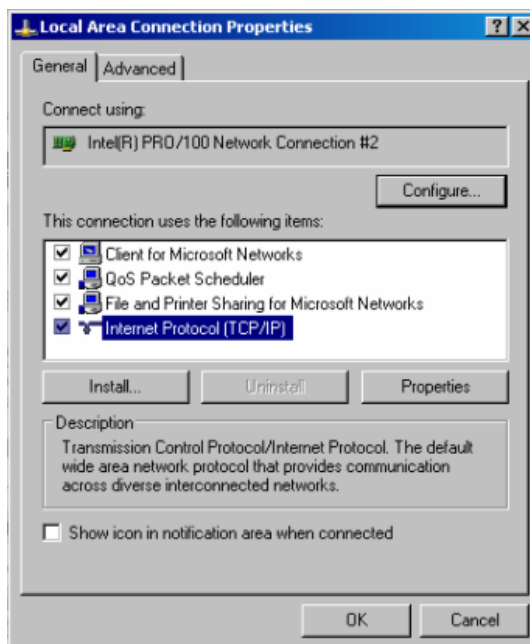

5. In the **Internet Protocol (TCP/IP) Properties** menu, enter the IP address in the **Use the following IP address:** field (all data can be accessed by the network administrator). Terminate the entry in all menus with OK.

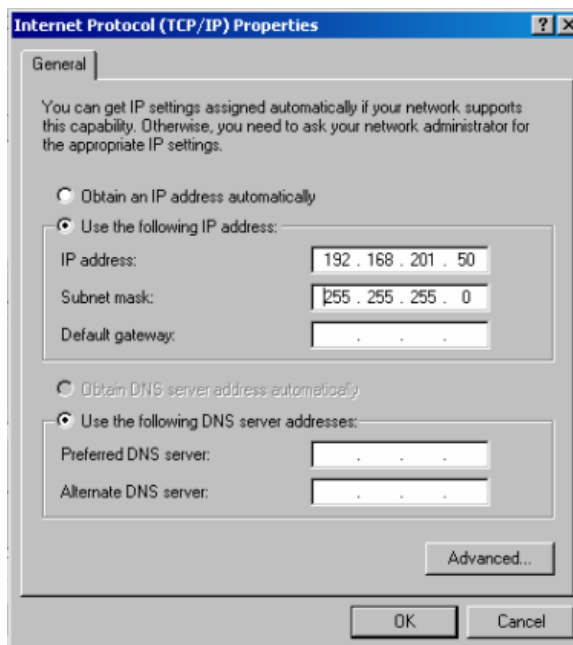

## Querying the Computer Name

1. Click **Start – Settings – Control Panel: Performance and Maintenance**.
2. Click **System** and select the **Computer Name** tab in the menu.

The computer name is displayed under **Full Computer Name**:. The name can be changed in the **Change** submenu.

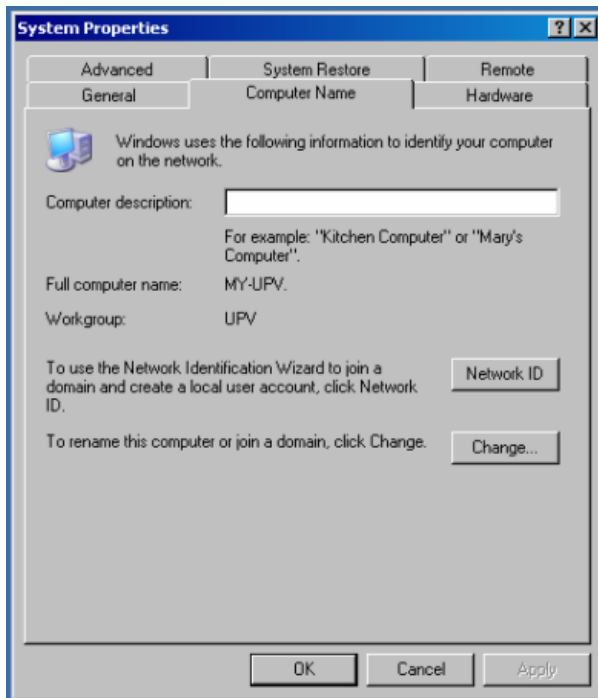

## Accessing Directories in the Network

Access to network drives depends on access rights and whether the drives in question have been enabled. The complete integration of the R&S UPV in a large network with the necessary assignment of rights is highly complex and normally performed by a network administrator.

Accessing the hard disk of a computer connected to the network from the R&S UPV is, however, relatively easy. The directory which the R&S UPV is to access simply has to be enabled on the remote computer. This directory is then accessed from the R&S UPV using a WindowsXP® search function.

This procedure is also of importance for a point-to-point connection, for instance in order to start a firmware update for which the files have been stored on the hard disk of the remote computer.

---

**Note:**

*Both the computer and the audio analyzer must have a computer name and an IP address (see the section "Configuring the R&S UPV for Network Operation")*

---

### Enabling the desired directory on the remote computer

---

**Note:**

*The menu name may deviate from the name specified in the operating sequence, depending on the language and on the operating system used on the computer.*

---

1. On the computer, select the directory to be enabled in Windows Explorer and right-click to call up the **Properties** menu.
2. In the **Sharing** panel, activate the **Share this folder** tick box.
3. Write down the name of the computer (see the section "Querying the Computer Name").

### Accessing the enabled directory from the R&S UPV

1. Press the **Windows** key to call up the Start menu.
2. In the **Search** menu, select **Computers or People** and then **A Computer on the Network**.
3. Enter the name of the computer under **Which Computer you are looking for?** and start the search by pressing Enter.  
The name of the computer is given as the search result.
4. Click the computer name. The enabled directory is displayed and the files stored there can be used in the R&S UPV.

---

**Note:**

*If a user name and password are requested when you click the computer, the login name and password used on the computer must be entered.*

---



## Configuration via LXI (R&S UPV66)

LAN eXtensions for Instrumentation (LXI) is an instrumentation platform for measuring instruments and test systems that is based on standard Ethernet technology. LXI is intended to be the LAN-based successor to GPIB, combining the advantages of Ethernet with the simplicity and familiarity of GPIB. This standard provides a new way for configuring virtual front panel instruments by using a network and a Web interface. The main tool for this configuration method is a browser, such as Microsoft Internet Explorer, but it is also possible to use other browsers such as Firefox or Netscape.

### LXI classes and LXI functionality

LXI-compliant instruments are divided into three classes, A, B and C, with the functionality of the classes hierarchically based one upon the other:

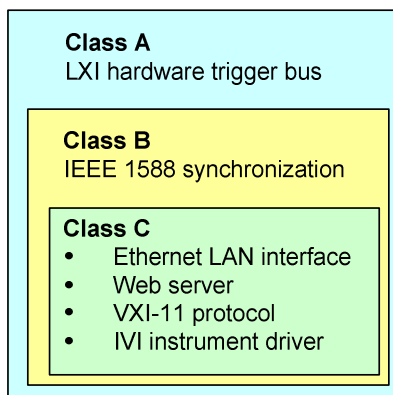

- Class C instruments are characterized by a common LAN implementation, including an ICMP ping responder for diagnostics. The instruments can be configured via a web browser; a LAN Configuration Initialize (LCI) mechanism resets the LAN configuration. The LXI class C instruments shall also support automatic detection in a LAN via the VXI-11 discovery protocol and programming by means of IVI drivers.
- Class B adds IEEE 1588 Precision Time Protocol (PTP) and peer-to-peer communication to the base class. IEEE 1588 allows all instruments on the same network to automatically synchronize to the most accurate clock available and then provide time stamps or time-based synchronization signals to all instruments with exceptional accuracy.
- Class A instruments are additionally equipped with the eight-channel hardware trigger bus (LVDS interface) defined in the LXI standard.

Instruments of classes A and B can generate and receive software triggers via LAN messages and communicate with each other without involving the controller.

The R&S UPV66 complies with LXI class C. In addition to the general class C features described above, it provides the following LXI-related functionality:

- Integrated display of the current instrument settings
- Possibility of remote controlling the instrument within the WEB browser.

---

**Note:**

LXI is only available as a standard feature with the R&S UPV66, but it can also be retrofitted to the R&S UPV if necessary.

The LXI functionality for R&S UPV requires a Windows XP operating system with service pack 2, which may not yet be installed on older instruments. In this case please contact your Rohde & Schwarz service representative. The version of the operating system can be checked in the General menu of the Instrument Properties dialog.

---

## LXI LAN Indicator

The LAN Indicator at the front panel of the R&S UPV66 always gives an information about the accessibility of the instrument via LAN. The indicator lights in green color and has three states.

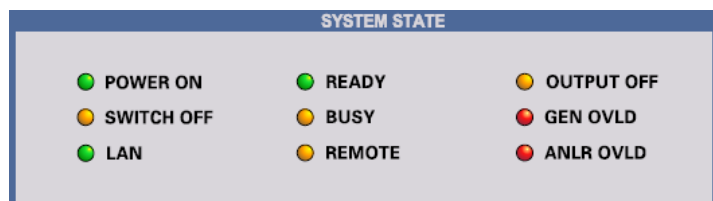

### LAN Indicator is OFF

The instrument has no valid IP address. This may happen on one of following reasons: 1) the device is configured with DHCP but no DHCP router present, 2) the device is configured manually and has a IP address conflict, 3) the device lost a DHCP configured IP address and switched to Auto IP.

This state is called "error state" and normally can be resolved by the LCI mechanism (LAN reset). This mechanism also is required by the standard and can be invoked with the "LAN RESET" button on the rear side of the instrument. Please refer to the section "*Description of the Rear Panel*" in the same chapter for further details.

### LAN Indicator is ON

The instrument has a valid IP address and is reachable via TCP/IP.

### LAN Indicator flashes

The instrument is in the "Device Indicator" state initiated by the WEB interface. This state is required by the standard and is used for finding instruments in racks. Please refer to the section "LXI Browser Interface" for further details.

## LXI Default State of Network Settings

After an LCI (LAN reset) the instrument automatically reboots and starts up with following LAN settings:

Parameter	Value
Hostname	RSUPV66-<serial number>
Description	Audio Analyzer
TCP/IP Mode	DHCP + Auto IP Address
Dynamic DNS	Enabled
ICMP Ping	Enabled
Negotiation	Auto Detect
VXI-11 Discovery	Enabled
Password for LAN Configuration	LxiWebIfc

---

### Tip:

For information about the LXI standard refer to the LXI website at <http://www.lxistandard.org>. See also "News from Rohde & Schwarz, article 2006/II - 190".

---

## LXI Browser Interface

The only information necessary for performing configuration via the LXI/Web interface is the name of the instrument (which means its Windows name) in networks that operate with DHCP enabled, or its IP address in networks that operate with manual network configuration. In rare cases where neither one of these names is known, it is also possible to derive the IP address from the MAC address, which is printed on the rear panel of the instrument.

The instrument's LXI browser interface works correctly with all W3C compliant browsers. Typing the instrument's host name or IP address in the address field of the browser on your PC, e.g.

<http://rsupv66-100002> or <http://10.113.10.203>

opens the Instrument Home Page (welcome page). The instrument name is always RSUPV66-xxxxxx for the R&S UPV66, where "xxxxxx" stands for the six-digit serial number of the instrument.



The instrument home page shows all important information in a compact form. This includes the MAC address and the IP address, which is often assigned dynamically, as well as the full resource string for VISA remote control (see *Chapter 5, Remote Control via LAN Interface*).

The LAN indicator on the instrument will blink if Device Indicator is set to ACTIVE. Pressing the **INACTIVE (press to toggle)** button alternately enables and disables the Device Indicator function. It can be used to quickly identify an instrument that is mounted together with several other instruments of the same type, such as in a 19" rack.

Device Indicator

Pressing **ACTIVE (press to toggle)** disables the blinking function.

Device Indicator



A navigation panel is displayed on the left-hand side of the window, with a link to the important **LAN Configuration** page. This page of the LXI Web configuration website enables extensive configuration of all important LAN parameters, which is necessary because the configuration steps mentioned in the next sections cannot be performed as described with a virtual front panel instrument.

**Note:**

*Changing the LAN configuration is password-protected. The password reads `LxiWebIfc` (notice upper and lower case characters). This password cannot be changed in the current firmware version.*

## IP Configuration

The screenshot shows the LXI IP Configuration web interface. The browser address bar displays the URL: `http://upv66/Lxi/Html/ip_configuration.php?mID=3`. The page header includes the Rohde & Schwarz logo and a 75th anniversary banner. The left sidebar contains navigation links: Home, Lan Configuration (with sub-links for IP Configuration, Advanced Config, and Ping Client), Status, Instrument State, Remote Operation, Help, Datasheet, Manual, Glossary, and the website URL `www.rohde-schwarz.com`. The main content area is titled 'LAN Parameters' and contains the following configuration fields:

- Hostname: `train1.rsint.net`
- Domain: `rsint.net`
- Description: `Rohde & Schwarz / Audio Analyzer / ...`
- TCP/IP Mode: `DHCP + Auto IP Address` (dropdown menu)
- IP Address: `10.113.10.65`
- Subnet Mask: `255.255.0.0`
- Default Gateway: `10.113.0.1`
- DNS Server(s): `10.0.2.166` and `10.0.23.159`
- Dynamic DNS:  Enabled

At the bottom of the form, there is a 'Submit' button and a password field with the text '(Password required)'. Below the form, a 'Status' section displays 'No error'. The footer of the page includes the copyright notice '© 2008 ROHDE&SCHWARZ. All rights reserved.' and the browser status bar shows 'Local intranet' and '100%' zoom.

### TCP/IP Mode

Determines whether DHCP is enabled or disabled. The IP Address, Subnet Mask, Default Gateway and DNS Server configuration fields are only enabled if DHCP is disabled. Consult the network administrator if it is necessary to modify these settings or any other settings.

### Note:

Switching from DHCP enabled mode to manual configuration mode may trigger an instrument restart when the new setting is confirmed (depends on the configuration). If incorrect network configuration settings have been entered, LAN RESET on the rear panel of the instrument must be used to restore access to the Web interface.

### IP Address

Allows the IP address of the instrument to be modified if DHCP is disabled.

### Subnet Mask, Default Gateway

It is sometimes necessary to change these settings from the displayed default values when DHCP is disabled. Consult the network administrator for the proper values if it is necessary to modify these settings.

### DNS Server

This is the IP address of the domain name server of the network segment. Consult the network administrator if it is necessary to modify this setting when operating with DHCP disabled.

### Dynamic DNS

Allows different DNS servers to be addressed in succession. Consult the network administrator if it is necessary to modify this setting when operating with DHCP disabled.

## Advanced LAN Configuration

Advanced LAN Configuration provides LAN settings that are not declared mandatory by the LXI standard.

These advanced parameters should only be modified by experienced users.

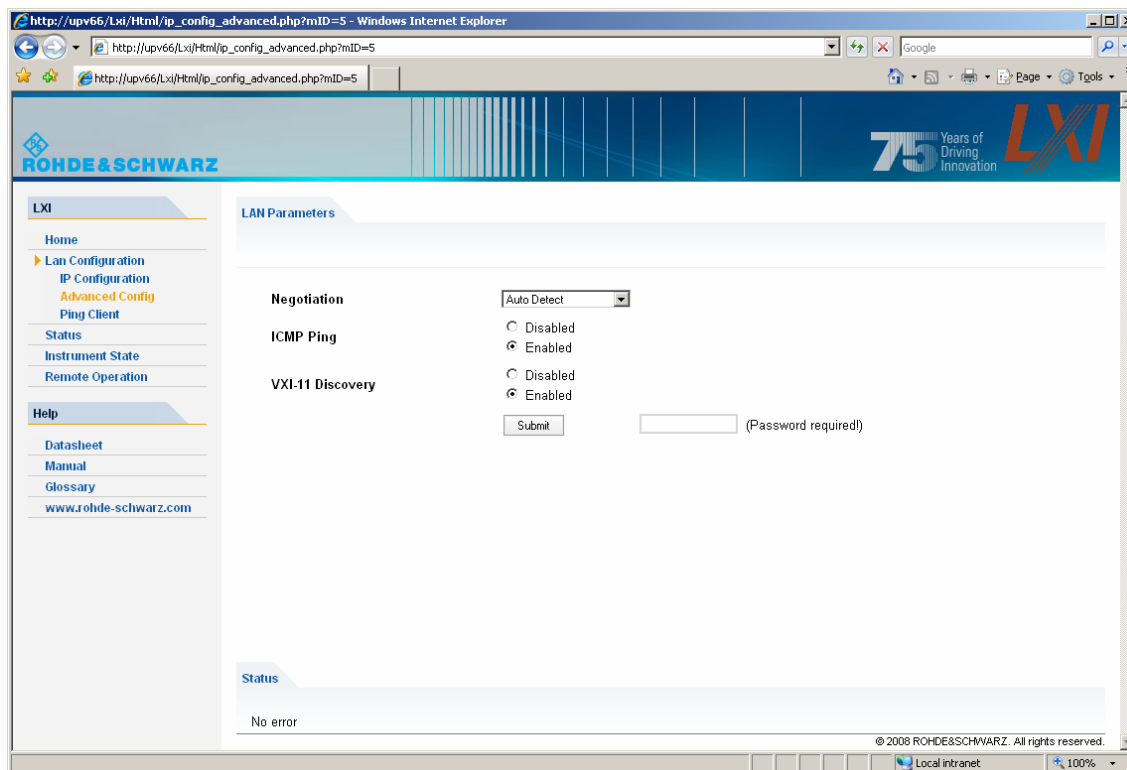

### Negotiation

The Negotiation configuration field provides different Ethernet speed and duplex mode settings. In general, the Auto Detect mode is sufficient.

### ICMP Ping

ICMP Ping must be enabled to use the ping utility.

### VXI-11 Discovery

Enables or prevents discovering the instrument via the “VXI-11 Discovery” protocol, which is a protocol jointly developed by National Instruments and VISA for searching for devices on aLAN.

VXI-11 is the protocol that is used for discovery of the instrument in the LAN. According to the standard, LXI devices must use VXI-11 to provide a discovery mechanism; other additional discovery mechanisms are permitted.

## Ping Client

Ping is a utility that verifies the connection between the LXI-compliant instrument and another device. The ping command uses the ICMP echo request and echo reply packets to determine whether the LAN connection is functional. Ping is useful for diagnosing IP network or router failures.

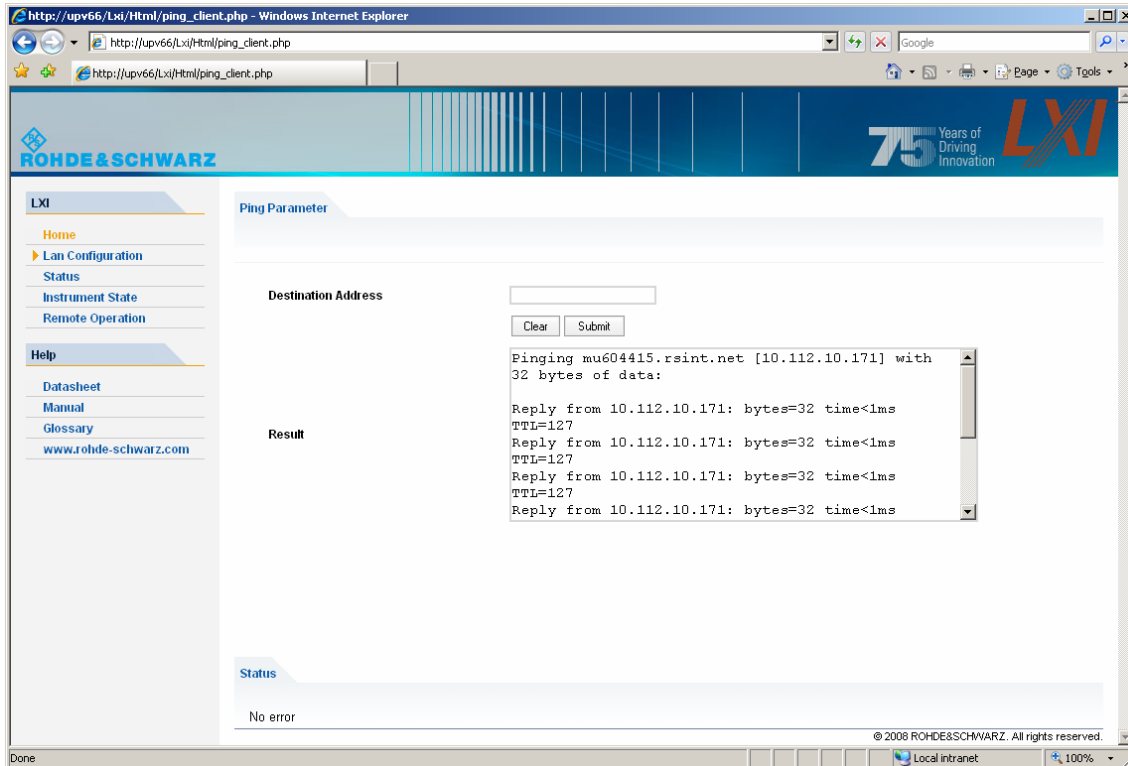

The ping utility is not password-protected.

To initiate a ping between the LXI-compliant instrument and a second connected device,

1. Enable ICMP Ping on the Advanced LAN Configuration page (enabled after an LCI).
2. Enter the IP address of the second device without the ping command and without any further parameters into the Destination Address field (e.g. 10.113.10.203).
3. Click Submit.

## Configuration for Manual Remote Operation

The R&S UPV can be operated manually from an external computer via a network connection. The Windows program **Remote Desktop Connection** is used for operation. Manual remote operation is described in Chapter 3 in the section "*Manual Remote Operation*".

Manual remote operation of the audio analyzer is only possible if

- the Windows 95 operating system or higher and the **Remote Desktop Connection** program are installed on the external computer and a LAN interface is configured for the network
- the audio analyzer and the computer are connected via the LAN (see "*Configuring the R&S UPV for Network Operation*")
- the **Remote Desktop Connection** program is activated on the audio analyzer (see "*Activating the Remote Desktop Connection program at the R&S UPV*")
- the R&S UPV data has been entered in the **Remote Desktop Connection** program on the external computer (IP address or computer name of the R&S UPV in the network (see "*Querying the Computer Name*"))
- the user has logged on at the R&S UPV from the external computer by entering the correct user name (instrument) and the correct password (instrument) (see "*Starting manual remote operation at the external computer*")



## Activating the Remote Desktop Connection program at the R&S UPV

**ATTENTION****Risk of unauthorized access!**

After activation of the remote desktop, any user on the network who knows the computer name and login data of the audio analyzer can access this R&S UPV.

1. Click **Start – Settings – Control Panel: Performance and Maintenance**.
2. Click **System** and select the **Remote** tab in the menu.
3. Activate the **Allow users to connect remotely to this computer** tick box.

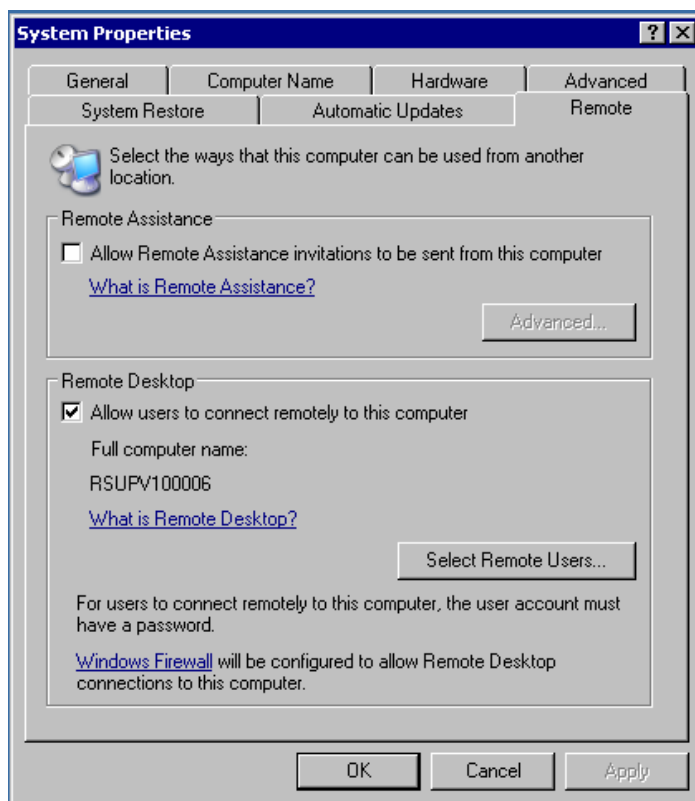

## Starting manual remote operation at the external computer

The **Remote Desktop Connection** program is already installed in the WindowsXP® operating system. For all other Windows operating systems from Windows95™ and higher, the program can be downloaded free-of-charge from the Internet (<http://www.microsoft.com>). It can be loaded onto any external computer by following the instructions also provided on the Internet.

1. If necessary, install the **Remote Desktop Connection** program on the external computer.
2. Start the program in the Windows menu **Start - All Programs - Accessories - Communications**.

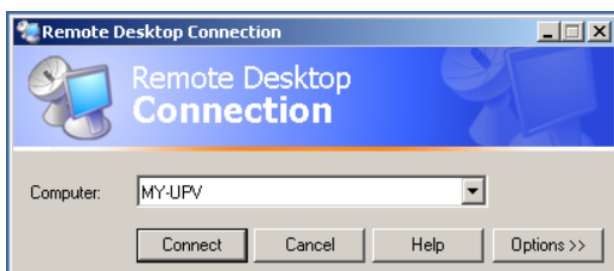

Before the program can be used for the first time, the instrument and user ID of the R&S UPV must be entered on the external computer. The instrument ID (i.e. the computer name of the R&S UPV) identifies the R&S UPV in the network. Every R&S UPV is supplied together with a computer name which can be used for manual remote operation. Querying the computer name is described in the section *"Querying the Computer Name"*.

The user ID is necessary as it authorizes access to the R&S UPV. It is preset on the R&S UPV and is **instrument** for both the user name and the password. No entry is needed in the **Domain** field.

3. Enter the instrument and user ID on the **General** tab of the extended **Remote Desktop Connection** menu (called up by pressing the **Options>>** button).

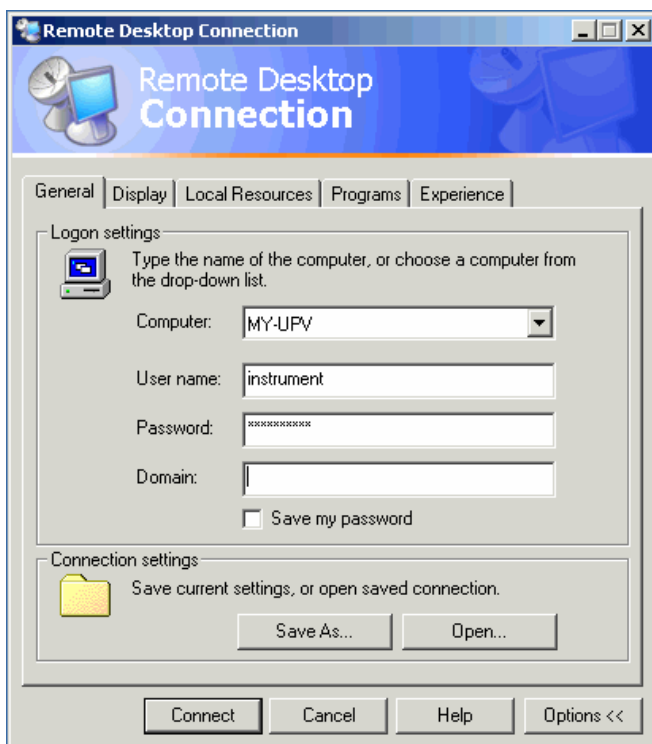

- The login data can be stored with the **Save As** button. If it is stored as the file **default.rdp**, the connection to the R&S UPV is offered by default when the program is started. If it is stored under a different name, the setting for the connection to the R&S UPV is offered in the selection list which is displayed by pressing the  button in the **Computer:** field.
- Set the display resolution of the R&S UPV screen to 800 x 600 on the **Display** tab.



- Set up the connection by pressing the **Connect** button.

When the connection has been set up, the audio analyzer screen appears on the external computer. Operation is possible with the mouse and/or the keyboard. Keys on the front panel which do not have a direct equivalent on the keyboard can be replaced by key combinations (see the table in Chapter 3 in the section "Operation Using an External PC Keyboard").

If several R&S UPVs are to be manually operated from one computer by means of manual remote control, a separate **Remote Desktop Control** window must be opened for each R&S UPV. This is possible by repeatedly starting the program on the external computer.

## Firmware update

The R&S UPV firmware is supplied in a file named "setupxxxRelease.exe". The sequence of digits for "xxx" consists of the main version number followed by the subversion number, revision number and build number.

The initial installation and firmware updates are carried out by starting this EXE file. By doing this you start an Installer program which automatically checks which type of installation is necessary:

<b>Main installation</b>	The Installer displays what it has found out about the environment into which the firmware will be installed and how much disk space is needed. It then takes you through the "Setup Wizard". You normally just click the "Next" button to go from step to step.
<b>Major update</b>	The Installer detects that the installed firmware is too old for a minor update to be carried out. It therefore displays a message asking you to uninstall the old software completely.
<b>Minor update</b>	The Installer simply displays a short prompt asking whether you wish to update the firmware. The rest is performed automatically.

The two most common problems that can occur when installing the software (or during a major update) are these:

- a) At the very start, before the progress bar appears, the progress window displays the message "Installshield is preparing installscript". Occasionally you then see an error message and installation is canceled.

This problem can usually be solved by restarting Windows and carrying out the firmware installation again.

- b) When the Installer has installed the firmware and the progress bar is full, the progress window displays the message "Removing Backup Files", "Registering Components" or "Publishing Product Information". Here, too, it occasionally happens that an error message is followed by a second message, and the firmware is then not installed.

This problem can sometimes be solved by restarting Windows and carrying out the setup again. If the error occurs again, this may be for two reasons:

- 1) Installation of the front panel driver went wrong. In this case, you must install it using the Windows Wizard; the necessary INF file is called c:\UPV\fpnl\_wdm.inf. You should now reinstall the firmware.
- 2) The installation of additional Windows settings went wrong. In this case, execute the files "C:\UPV\ScanFirmwareVersions.exe" and "C:\UPV\SetReg.exe" one after the other. You should now reinstall the firmware.

If neither of these steps is successful, the instrument needs to go in for service (or the Windows image program must be reloaded).

# Windows XP Recovery and Backup

The R&S UPV provides an invisible backup and recovery partition. A backup of the factory system partition (C:\) is stored per default and can be recovered in case of a system crash.

In addition, backups of up to 5 firmware versions can be stored on this partition. It is e.g. possible to backup the current system partition prior to a firmware update or to provide different system configurations for different environments.

When recovered, the system partition (C:\) is deleted, formatted and then newly written. The data partition (D:\) is not affected.

## Call the Windows XP Recovery and Backup Partition Menu

1. Switch the instrument off and on again
2. In the boot menu select line **Backup/Recovery** with the up/down cursors.
3. Open **Windows XP Recovery and Backup Partition** menu by pressing the rotary knob.  
The menu shows the available selections for the recovery and backup partition:

---

**Note:**

*If several backups are already stored on the disk, the remaining space might not be sufficient for an additional backup. In this case a warning is indicated in the Windows XP Recovery and Backup Partition menu and the user is requested to remove an old backup before making a new one.*

---

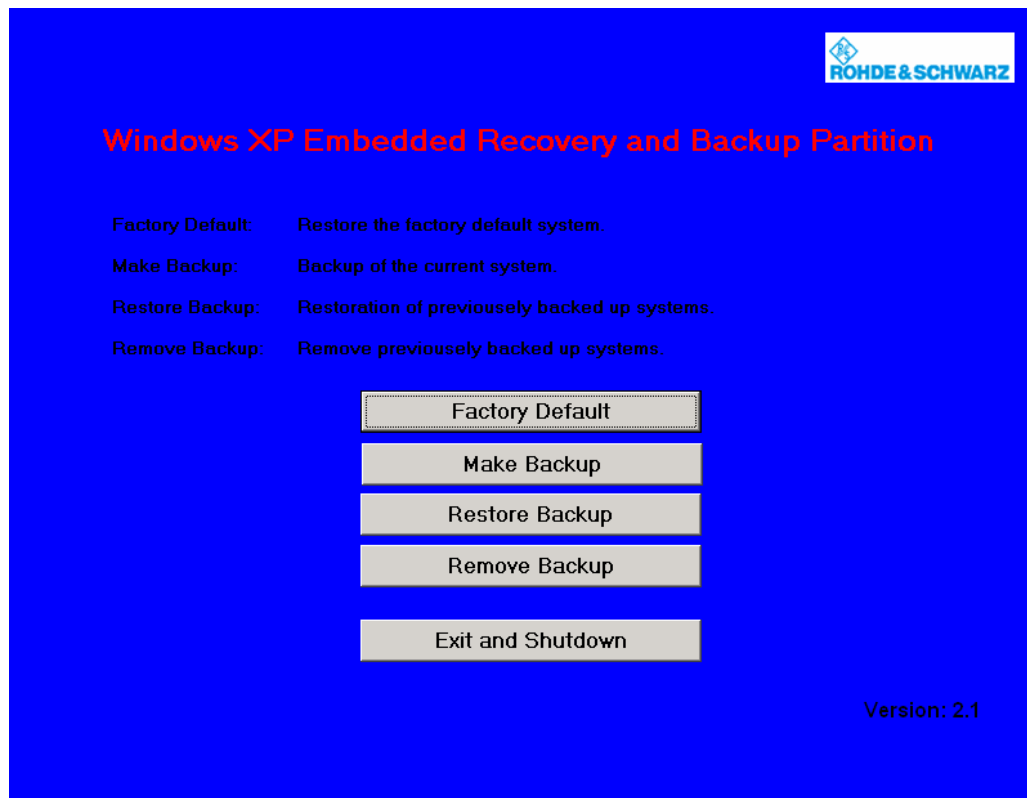

## Backup Current System Partition

1. Select the **Make Backup** button in the Windows XP Recovery and Backup Partition menu with the rotary knob.
2. Open the **Make Backup** menu with the **ENTER** key.  
The menu shows the current versions of the firmware and the software platform.

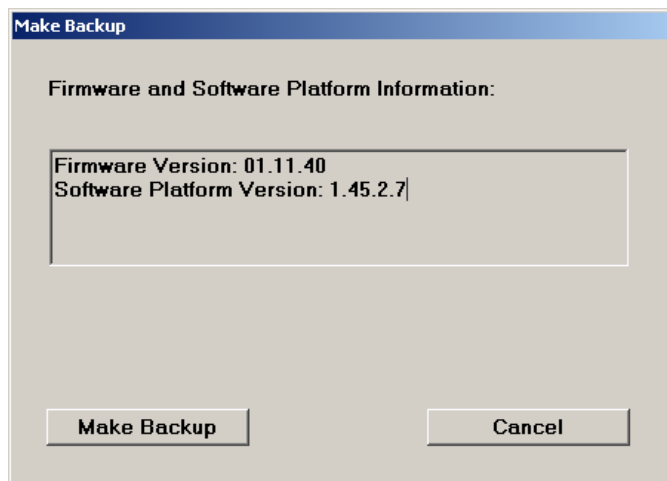

3. Select the **Make Backup** button with the rotary knob.
4. Start the backup with the **ENTER** key.  
After the backup, the **Windows XP Recovery and Backup Partition** menu appears again.
5. Select the **Exit and Shutdown** button with the rotary knob.
6. Exit and shut down with the **ENTER** key.

## Recover Selected Version of System Partition

1. Select the **Restore Backup** button in the **Windows XP Recovery and Backup Partition** menu with the rotary knob to recover a selected version of the system partition.
2. Open the **Restore Backup** menu with the **[ENTER]** key.  
The menu shows the versions of the firmware and the software platform of the backup displayed in the **Select Backup** window.

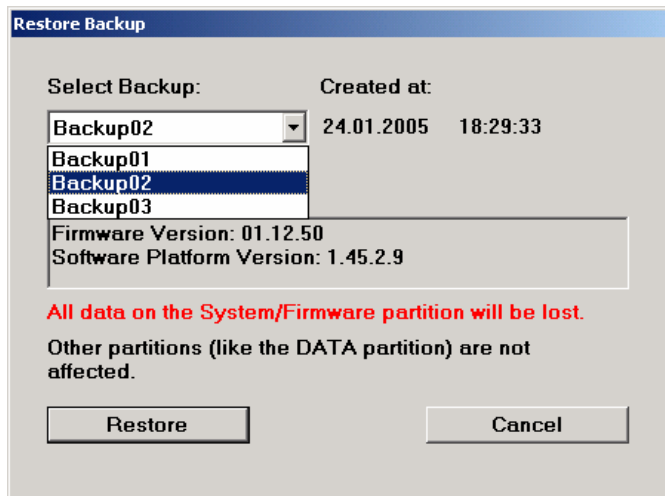

3. Select the **Select Backup** window with the rotary knob.
4. Select the backup to be restored with the up/down cursor keys and the **[ENTER]** key.
5. Select the **Restore** button with the rotary knob.
6. Start the recovery with the **[ENTER]** key.  
The script that is performed during recovery is displayed.  
After the recovery, the instrument is shut down and switched off.

## Recover Factory Default

1. Select the **Factory Default** button in the **Windows XP Recovery and Backup Partition** menu with the rotary knob to recover the factory version of the system partition.
2. Open the **Factory Default** menu with the **[ENTER]** key.  
The menu shows the versions of the firmware and the software platform on delivery.



3. Select the **Recover now** button with the rotary knob.
4. Start the recovery with the **[ENTER]** key.  
The script that is performed during recovery is displayed.  
After the recovery, the instrument is shut down and switched off.



## Delete Backups

Up to five backups in addition to the factory default can be stored on the recovery partition. To provide space for new backups, it might be necessary to remove older backups. The factory default cannot be deleted.

1. Select **Remove Backup** button in the **Windows XP Recovery and Backup Partition** menu with the rotary knob to delete a selected backup.
2. Open the **Remove Backup** menu with the **[ENTER]** key.  
The menu shows the versions of the firmware and the software platform of the backup displayed in the **Select Backup** window.

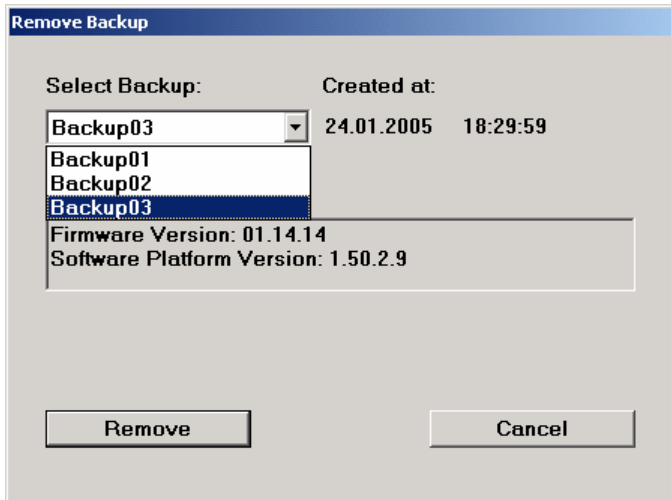

3. Select the **Select Backup** window with the rotary knob.
4. Select the backup to be deleted with the up/down cursor keys and the **[ENTER]** key.
5. Select the **Remove** button with the rotary knob.
6. Start the deletion with the **[ENTER]** key.  
After the deletion, the instrument returns to the **Remove Backup** menu as long as backups are still available. If the last backup is deleted, the **Windows XP Recovery and Backup Partition** menu opens again.
7. Select the **Cancel** button with the rotary knob.
8. Close the **Remove Backup** menu with the **[ENTER]** key.  
The **Windows XP Recovery and Backup Partition** menu opens.
9. Select the **Exit and Shutdown** button with the rotary knob.
10. Exit the menu and shut down the instrument with the **[ENTER]** key.

## Contents - Chapter 2 "Getting Started"

<b>2 Getting Started</b> .....	2.1
<b>Introduction - Getting Started</b> .....	2.1
<b>Important Information for Measurements</b> .....	2.2
Maximum Output Voltage of the R&S UPV Generator .....	2.2
Rapid Deactivation of the Outputs .....	2.2
Avoiding Hum Loops .....	2.3
Help System .....	2.3
<b>Brief Introduction to the R&amp;S UPV Operating Concept</b> .....	2.4
Windows User Interface and Control Elements .....	2.4
Display.....	2.4
Panels and Display Windows.....	2.6
Structure of the Panels and Display Windows .....	2.7
Basic Rules of Operation .....	2.9
Function Selection and Value Entry.....	2.9
Help function .....	2.15
Measurement Functions and Displaying Measurement Results.....	2.16
Numeric display field.....	2.17
Combi display .....	2.17
Configuring the numeric display field and combi display.....	2.18
Graphical windows.....	2.19
<b>Introduction to Instrument Operation Using Examples</b> .....	2.20
Measuring the Frequency Response of an Amplifier, Equalizer, etc.....	2.20
Step 1: Loading the factory settings .....	2.20
Step 2: Setting the required generator signal .....	2.20
Step 3: Selecting the required measurement .....	2.23
Step 4: Displaying the measurement results – Numeric measurement display .....	2.25
Step 5: Starting the sweep.....	2.25
Step 6: Displaying the measurement results – Graphical windows.....	2.26
Step 7: Using a relative unit in the graphical window .....	2.28
Step 8: Saving the instrument setup.....	2.30
Measuring the Harmonic Distortion (THD+N) of a DUT.....	2.31
Step 1: Loading the factory settings .....	2.31
Step 2: Setting the required generator signal .....	2.31
Step 3: Selecting the required measurement .....	2.32
Step 4: Displaying the measurement results – Numeric measurement display .....	2.33
Step 5: Displaying the spectrum in the graphical window .....	2.33
Step 6: Evaluating the graphical display with markers and cursors .....	2.36
Step 7: Saving the instrument setup.....	2.37
<b>Loading Predefined Instrument Setups</b> .....	2.38



## 2 Getting Started

### Introduction - Getting Started

This chapter describes the manual operation of the R&S UPV audio analyzer. The information in this chapter also largely applies to the R&S UPV66 (which was primarily designed for use in systems) provided that an external monitor, keyboard, and mouse are connected to the instrument.

The Audio Analyzer R&S UPV is able to perform virtually all measurements occurring in the audio world, from frequency response measurements through distortion factor and spectral displays to the analysis of digital data streams. Several measurement functions can be carried out and displayed at the same time, whereby in the audio frequency range the measurements are performed as real two-channel functions.

The R&S UPV performs all measurements using digital signal processing. Here, analog signals to be measured are first subjected to complex preprocessing on analog measurement modules before they are digitalized and fed to the digital measurement routines.

This concept offers numerous advantages, for example:

- The measurement methods at the analog and digital interfaces are identical.
- The measurement functions are available at both the analog and the digital interfaces.
- Operation at the analog and digital interfaces is the same.

The many available options mean that the Audio Analyzer R&S UPV can be adapted to perform a wide variety of different tasks. The basic version of the instrument has analog audio interfaces. A number of other measurement functions are also available, but only after the appropriate options have been installed (see the data sheet for details).

This chapter, "Getting Started", only describes the functions available in the basic version of the Audio Analyzer R&S UPV.

# Important Information for Measurements

## Maximum Output Voltage of the R&S UPV Generator



The generator of the Audio Analyzer R&S UPV can generate analog output voltages with an RMS of up to 20 V. These levels can damage or even destroy sensitive input circuits.

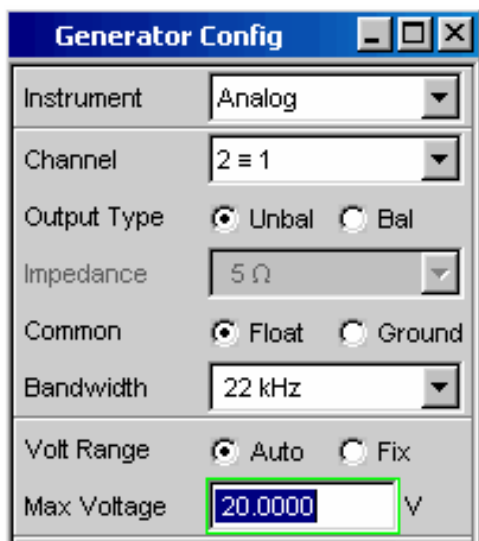

In the **Generator Config** panel, it is possible to limit the analog output voltage. For measurements on sensitive circuits, it is advisable to set an appropriately low value in the **Max Voltage** field; this value then applies to all analog output signals, irrespective of the signal shape. The maximum voltage is not exceeded even in the case of changes made using the rotary knob.

The section *"Function Selection and Value Entry"* from page 2.9 onwards and Chapter 3 *"Manual Operation"* explain how to set these values and change values using the rotary knob.



The pulse level of the digital audio signals can be up to 8 V. Although the risk of destruction is generally much smaller than for analog circuits, care must still be taken when making settings for digital circuit energization.

## Rapid Deactivation of the Outputs



In the event of faults, all outputs of the R&S UPV can be deactivated by pressing the **Output OFF** key. The key affects all audio outputs, i.e. for both analog and digital audio signals.

The deactivated lines can only be reactivated by pressing the **OUTPUT OFF** key again.

The status of the key is indicated by an LED. Illumination of the LED means **OUTPUT OFF**.

More detailed information on this key can be found in Chapter 3 in the section *"Rapid Deactivation of the Outputs"*.

## Avoiding Hum Loops

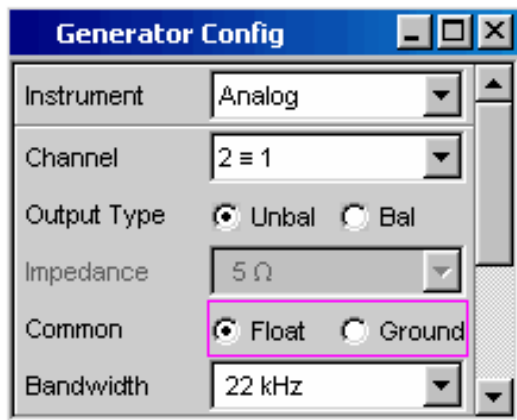

It is generally known in audio engineering that analog circuits must always be set up in such a way that hum signal pick-up is avoided. For this reason, it is important that a ground connection (grounding contact) be provided at only one point in the entire circuit.

Both the generator and the analyzer are configured as floating devices in order to prevent an additional, inadvertent ground connection via the Audio Analyzer R&S UPV. The two **Common** fields of the **Generator Config** and **Analyzer Config** panels are factory-set to **Float**.

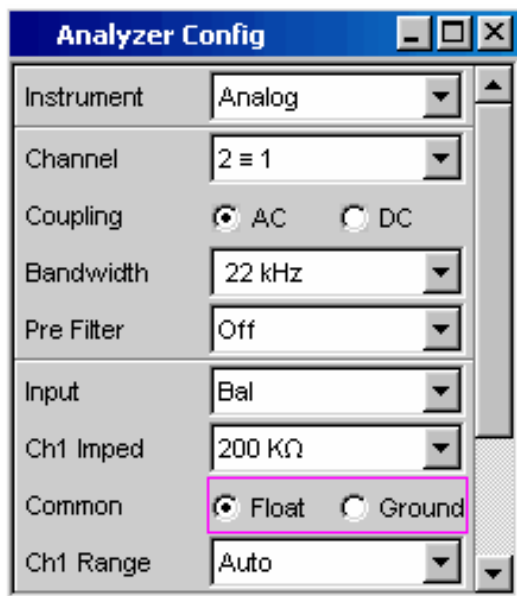

There are, however, some applications where the audio circuit to be tested is set up without any ground connection at all. It may be necessary to create a defined ground connection especially if hum pick-up is suspected. This can be done at the Audio Analyzer R&S UPV by switching the **Common** field to **Ground** for either the generator or the analyzer (depending on the application).

More detailed information on how to make these settings can be found in this chapter in the section *"Function Selection and Value Entry"* from page 2.9 onwards and in Chapter 3 *"Manual Operation"*.

## Help System



The Audio Analyzer R&S UPV has a context-sensitive help system. If you have a question while operating the instrument, pressing the **[HELP]** key opens a help page containing information on the currently highlighted parameter field. From here it is possible to move to other help pages using the contents list, the index, scroll arrows and page-internal links.

More detailed information on this key can be found in Chapter 3 in the section *"Help System"*.

# Brief Introduction to the R&S UPV Operating Concept

## Windows User Interface and Control Elements

To provide the user with a familiar environment, operation is largely based on the Windows® user interfaces. All panels, entry windows, etc are made up of known elements.

Operation follows the same basic rules which apply to other Windows® programs in use today. It is assumed that the user is familiar with these basic rules. This information is therefore not given in detail in this manual.

The R&S UPV can be operated via the front panel. Additional peripherals such as a mouse and keyboard can be connected but are not essential requirements.

After being switched on, the instrument is in the same state as it was before it was switched off. This applies to all setting parameters of the R&S UPV, including those not currently displayed on the screen.

The instrument is operated using function keys with permanently assigned functions, softkeys with functions which vary according to the application, the rotary knob with integrated entry function, and the display screen via which the panels are operated.

Operation using an external keyboard and mouse is also possible; this is explained in Chapter 3 "Manual Operation".

Selection frames or the highlighting of an entry field (dark background) indicate the current entry focus. Entries can be made in the element with entry focus.

## Display

The display is the central element for operating the R&S UPV. Both the instrument settings in the various panels, and the measurement results are displayed here.

To make the various functions of the Audio Analyzer R&S UPV easier to operate, they are organized in a series of panels. The measurement results can be displayed as digital numeric values, data lists, in analog bargraphs or in result graphics. The user can freely choose the number of panels and the number of graphical windows to be shown in the display. The size of the windows can be changed within wide limits, whereby the font size, scaling and so on are adapted automatically (depending on the selected window). Panels and display windows can be activated by pressing the **WINBAR** key.

5 display windows (or "screens") are provided so that the wealth of information can be better organized.

The direction keys  are used to toggle between the individual screens.

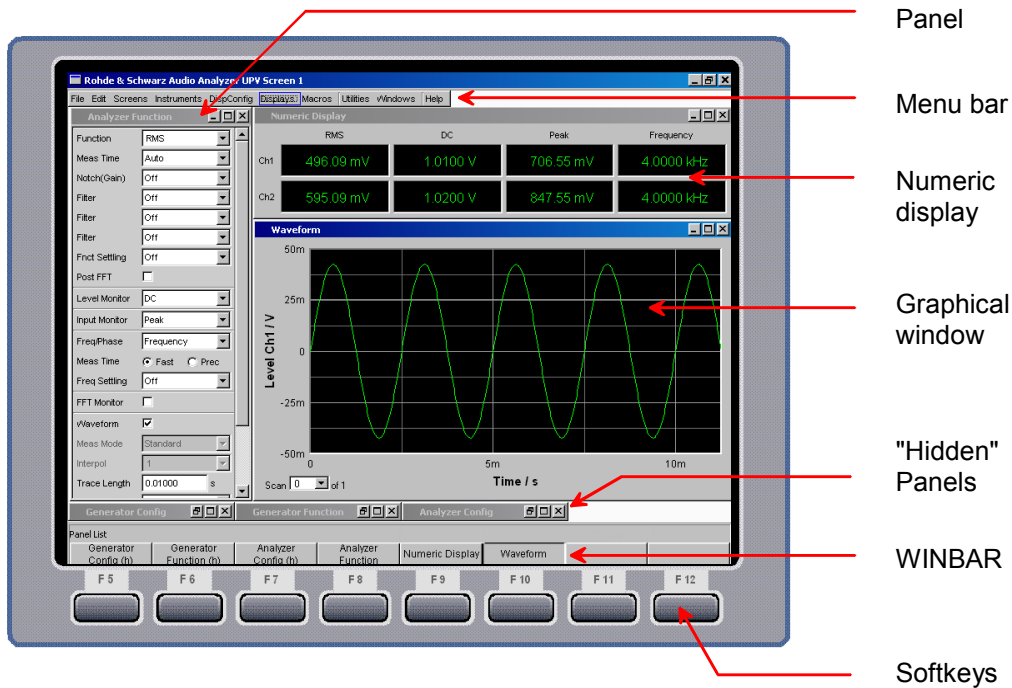
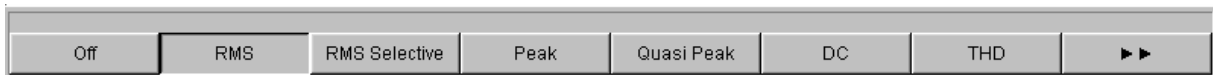

Fig. 2-1 R&S UPV display with main elements

One of the two bars (either the softkey bar or the WINBAR) is always displayed at the bottom of the screen.

In normal operating mode, the softkey bar is visible; it contains eight buttons which are assigned the functions available in the selection windows of the panels. The softkeys underneath the buttons are labeled with their assigned function; pressing the respective softkey permits rapid selection.

If there are more than 8 elements to choose from, the hidden elements in the selection list can be displayed by pressing the last softkey containing the ►► symbol or the first softkey containing the ◀◀ symbol.



When the **WINBAR** key is pressed, the WINBAR appears in place of the softkey bar; this is indicated by "Panel List" in the left-hand corner:



The labeled buttons show the names of all panels and graphical windows open in the current screen. Pressing the associated softkey puts the focus on the corresponding panel / graphical window, i.e. it becomes active. At the same time, the system returns to normal operating mode (i.e. the softkey bar).

Hidden panels (see "Panels and Display Windows") are also listed in the WINBAR. If a hidden panel is selected, it is redisplayed on the screen with its previously set size and position; it simultaneously receives the focus.



## Panels and Display Windows

The Audio Analyzer R&S UPV distinguishes between the following panels and display windows:

- **Panels** used to make function settings
- **Configuration panels** used for configuring how the measurement values are to be displayed
- **Numeric display fields** for displaying the measurement values of the various measurement functions
- **Combi displays** in which numeric measurement values can be supplemented by bargraphs and limit monitoring
- **Graphical windows** in which measurement values are displayed in the form of diagrams
- **Data lists** in which the measurement values are listed in tabular form

Panels are opened on the currently displayed screen by activating the menu bar using the **MENU** key, highlighting the **Instruments** or **DispConfig** button with the rotary knob or cursor keys, opening the pulldown menu with the Enter key or rotary-knob click, and then highlighting the desired panel and selecting it with a rotary-knob click.

Display windows are selected in the same way, except that they are listed under the **Displays** button.

Each panel and display window is a separate window which can be either closed, opened or hidden. Panels / display windows are open if they are displayed on the currently visible screen. If the window is minimized and moved to the bottom of the screen, it is referred to as being "hidden". In both cases, the panel / window is assigned an entry in the WINBAR at the bottom of the display. Only one window on the screen can be activated at any one time using the softkeys on the WINBAR (active windows are identified by their blue title bar).

As soon as a panel / display window is active, it can be moved around on the screen. This is done in the following way:

- Press the **MODIFY** key; the following softkeys then appear on the WINBAR:

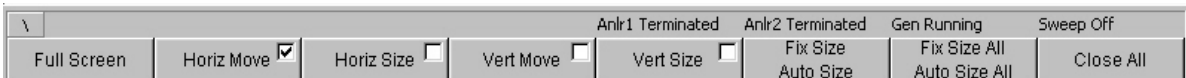

After selecting the desired direction of movement using the appropriate softkey, the panel can be moved / resized using the rotary knob.

The same panel / display window can be displayed in several screens at the same time. The display characteristics can be different for each of the screens; the content is, however, always the same.

## Structure of the Panels and Display Windows

The table below shows the panels of the Audio Analyzer R&S UPV as well as the main settings that can be made in these panels (a detailed list of all panels together with the most important setting parameters can be found at the end of Chapter 3 "Manual Operation"):

Panels which can be selected via the **Instruments** menu bar button:

<b>Generator Config</b>	<ul style="list-style-type: none"> <li>• Selection of instrument (analog or digital interfaces)</li> <li>• Configuration of channels and bandwidths</li> <li>• Reference values</li> </ul>
<b>Generator Function</b>	<ul style="list-style-type: none"> <li>• Selection of test signals</li> <li>• Sweep function</li> <li>• Frequency and level settings</li> <li>• Filter and equalizer</li> </ul>
<b>Analyzer Config</b>	<ul style="list-style-type: none"> <li>• Selection of instrument (analog or digital interfaces)</li> <li>• Configuration of channels and measurement bandwidth</li> <li>• Start and trigger conditions</li> </ul>
<b>Analyzer Function</b>	<ul style="list-style-type: none"> <li>• Selection of measurement functions</li> <li>• Measurement speed and accuracy</li> <li>• Activation of filter and equalizer</li> <li>• Activation of Post-FFT</li> <li>• Selection and settings for level monitor</li> <li>• Selection and settings for input monitor</li> <li>• Selection and settings for frequency, phase, group delay measurement</li> <li>• Selection and settings for FFT monitor</li> <li>• Selection and settings for waveform monitor</li> </ul>
<b>Filter</b>	<ul style="list-style-type: none"> <li>• Definition of filter properties</li> </ul>
<b>Auxiliaries</b>	<ul style="list-style-type: none"> <li>• Settings for integrated loudspeaker and connected headphones</li> <li>• Settings for the R&amp;S UPV-U2 option (BNC audio monitoring outputs)</li> <li>• Settings for auxiliary analog output</li> <li>• Settings for trigger input and trigger output</li> </ul>
<b>Switcher Panel</b>	<ul style="list-style-type: none"> <li>• Operation of one or more Audio Switchers R&amp;S UPZ</li> </ul>
<b>Protocol Generator</b>	<ul style="list-style-type: none"> <li>• Settings for the Digital Audio Protocol R&amp;S UPV-K21</li> </ul>

Panels which can be selected via the **DispConfig** menu bar button:

<p><b>Function Config</b>  <b>Level Monitor Config</b>  <b>Input Config</b>  <b>Freq Phase Config</b></p>	<p>These four panels contain settings for displaying measurement values</p> <ul style="list-style-type: none"> <li>• in the numeric display fields</li> <li>• in the associated combi displays</li> <li>• and settings for limits, minimum values and maximum values</li> </ul>
<p><b>Sweep Graph Config</b>  <b>FFT Graph Config</b>  <b>Waveform Config</b>  <b>Bargraph Config</b></p>	<p>Up to four of each of these panels are available; they contain settings for displaying measurement values in the graphical windows, e.g.</p> <ul style="list-style-type: none"> <li>• one or two-channel display</li> <li>• units, scaling, gridlines, etc</li> <li>• evaluation of minimum values and maximum values</li> <li>• entry of limit curves</li> <li>• settings for cursors and markers</li> </ul>

The measurement results of the Audio Analyzer R&S UPV are shown in the following display windows (a detailed list of all panels together with the most important setting parameters can be found at the end of Chapter 3 "Manual Operation"):

<p><b>Numeric Display</b></p>	<ul style="list-style-type: none"> <li>• Display of measurement results for measurement function selected in <b>Analyzer Function</b> panel</li> <li>• Display of measurement results for level monitor and/or input monitor selected in <b>Analyzer Function</b> panel</li> <li>• Frequency measurement results, or frequency measurement result and phase / group delay measurement result</li> </ul>
<p><b>Funct Ch1...2</b>  <b>Lev Mon Ch1...2</b>  <b>Input Ch1...2</b>  <b>Freq Ch1</b>  <b>Freq / Phase</b></p>	<p>These combi displays are extensions to the numeric measurement displays; they show the respective numeric value plus the following additional features:</p> <ul style="list-style-type: none"> <li>• Analog bargraphs</li> <li>• Limits</li> <li>• Minimum and maximum values</li> </ul>
<p><b>Sweep Graph 1...4</b>  <b>FFT Graph 1...2</b>  <b>Waveform</b>  <b>Bargraph 1...2</b></p>	<ul style="list-style-type: none"> <li>• Up to four of each of these display windows can be opened (depending on the window type) in order to display the scans of the different measurements</li> <li>• Graphical display shows one or two channels</li> <li>• The measurement results are displayed in the way defined in the associated configuration panel</li> </ul>
<p><b>Dig Analyzer Protocol</b></p>	<ul style="list-style-type: none"> <li>• The analyzed data of the digital audio protocol (R&amp;S UPV-K21 option) is displayed here</li> </ul>

## Basic Rules of Operation

The following basic rules are intended to simplify operation of the Audio Analyzer R&S UPV:

- **Operating sequence in the panels: top to bottom**  
Changes to parameters of individual menu items may affect the selection or value range of menu items which are usually located further down (they affect the selection or value range in fields located higher up in only a few exceptional cases).
- **Sequence: generator – analyzer – measurement value display**  
Many setting parameters can be used in other panels. For example, the sweep frequency settings can automatically be adopted as the scaling for the graph.

Observing this sequence saves the user having to enter parameters twice.

## Function Selection and Value Entry



All functions and parameters are set in the panels.

The rotary wheel is used for navigating inside the panels. Turning the rotary knob clockwise moves the cursor down or to the right. Here the cursor first moves to the right inside a field, then down through the current group, then jumps over to the right-hand column, down again to the end of the group from where the cursor then moves to the left-hand column of the following group, and so on.

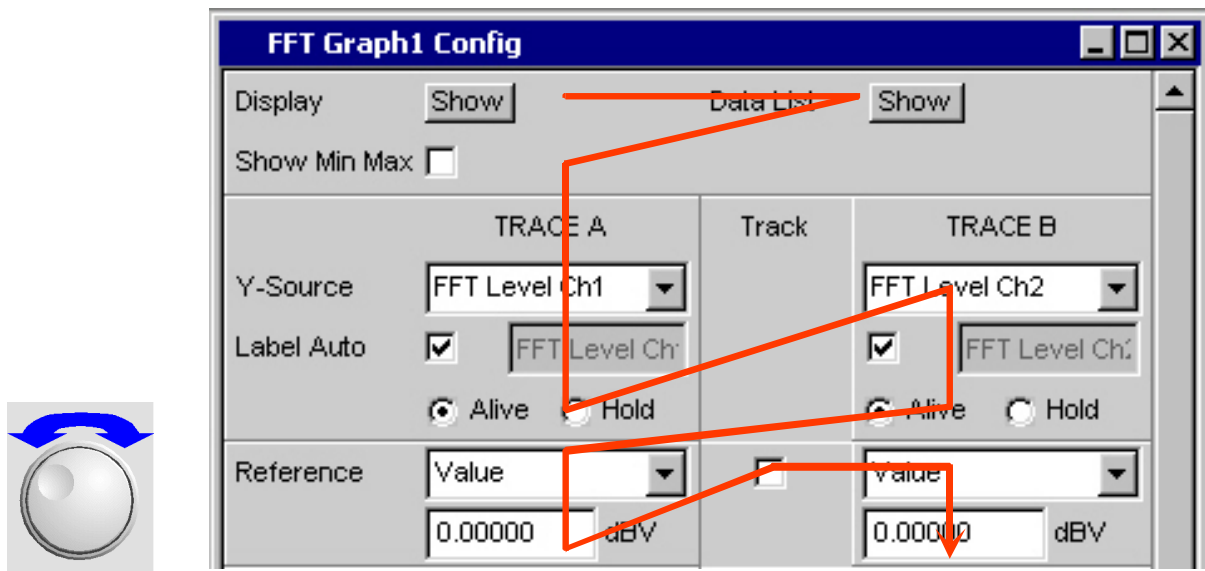
Alternatively, the cursor keys  and  can also be used for navigation.



Panels can only be operated if they have the focus (indicated by the blue title bar).

The simplest way of changing from one panel to another in the case of operation via the front panel is using the direction keys . The  key switches from panel to panel in the sequence in which the panels were opened. Changing to a different open (or to a hidden) panel is also possible using the WINBAR (see the section "Display" on page 2.4).

Before settings can be made in a panel, the relevant parameter field must be highlighted, i.e. it must have the focus. This is indicated by a selection frame around the entry field.

The settings are made in the following ways:



**Highlighting control elements**

A control element is activated by shifting the focus to this element using the rotary knob. The entry focus is indicated by a blue, green or magenta border.



**Activating/deactivating functions**

A tick box is used to activate or deactivate functions. If the tick box is activated (checkmark), the assigned setting is selected / enabled.



**Toggling functions**

Radio buttons are used for functions which can be toggled between two settings. A black dot in the appropriate button indicates the selected status.

Only one of the two options can be active at any one time.

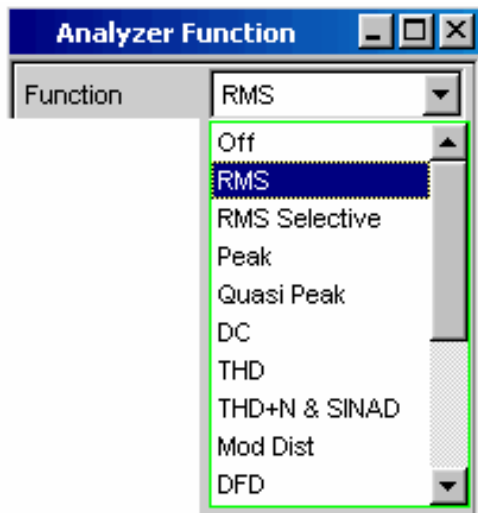

### Selecting a parameter

Actuating the  button opens a selection field. As soon as this parameter field has the focus, a list for selecting the available parameters can be opened with a rotary-knob click. The fold-down parameter list is displayed below the selection field.

Parameters are selected by highlighting the desired item and confirming with the **[ENTER]** key or rotary-knob click.

Items in the parameter list are highlighted using the rotary

knob, the cursor keys   or the keys .

The parameter list can be quit without adopting the highlighted parameter by pressing the **[ESC]** key.

If the list is longer than the displayed window, a scroll bar is available.

Alternatively, parameters can also be selected using the softkeys.

---

#### **Note:**

*The contents of the parameter lists are not fixed but vary depending on other settings selected.*

---

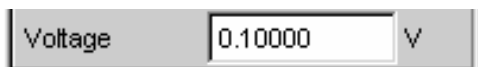

### Numeric value entries

Numeric values can be entered or edited in these fields.

The following applies: Entries outside the possible value range are not accepted; an audible warning is issued and the entry is changed to its permissible minimum or maximum value. The possible value range is displayed above the softkey bar.

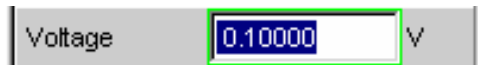

**Value entries in Edit mode**

When the focus is moved to a numeric entry field, the system enters Edit mode, which is indicated by a green selection frame.

To enter the new value, simply begin entering digits using the numeric keypad on the front panel; the old value is deleted automatically when the first key is pressed. The digit to the left of the cursor can be deleted at any time during entry using the **UNDO** key.

If certain digits only are to be changed, position the digit cursor accordingly using the or cursor key and enter the new digits.

The numeric entry field is closed with:

**ENTER** The newly entered value is adopted.

**ESC** The old value is retained.

**Softkeys** The selected unit is set and adopted together with the newly entered value.

The entered value is set in the hardware as soon as the numeric entry field is closed.



**Value entries in Direct mode**

When the focus is moved to a numeric entry field, the system enters Edit mode, which is indicated by a green selection frame.

Changing to Direct mode is performed by pressing the **ENTER** key or with rotary-knob click; the color of the selection frame then changes to magenta.

The digit cursor then moves to the first digit to the right of the decimal point or, if there is no decimal point, to the digit at the extreme right.

A digit can now be entered using the keypad on the front panel; the digit at the cursor position is replaced. The cursor does not change its position.

The digit cursor can be placed at a different position at any time using the and cursor keys. Digits are then entered at the new position.

In Direct mode, every setting change is immediately passed on to the hardware and executed.

Direct mode can be quit using the **ENTER** function or the **ESC** key.



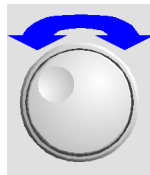

v



### Rotary-knob entries in Direct mode

When the focus is moved to a numeric entry field, the system enters Edit mode, which is indicated by a green selection frame.

Changing to Direct mode is performed by pressing the **ENTER** key or with rotary-knob click; the color of the selection frame then changes to magenta.



The digit cursor then moves to the first digit to the right of the decimal point or, if there is no decimal point, to the digit at the extreme right.

The highlighted digit can then be changed directly using the rotary knob, whereby the numeric value is "carried over", i.e. transferred to the next digit.

The digit cursor can be placed at a different position at any time using the  and  cursor keys so that other digits can be changed using the rotary knob.

This method is ideal for adjustment work as every change has an immediate effect in the hardware.

Value entry can be completed with a rotary-knob click, the **ENTER** key or the **ESC** key.

As an alternative to the rotary knob, the numeric values can also be changed using the  and  cursor keys.

### Entering / changing the unit of a value

The unit of a numeric value is displayed next to the entry field. When the value is entered, all units available for the respective function are offered on the softkey bar (on more than one level where necessary). The entry can be completed by selecting the unit using a softkey.

This is done differently depending on the selected mode:

- In Edit mode, the newly entered numeric value is adopted and set together with the selected unit.
- In Direct mode, the physical value (number with the previously selected unit) is converted to the newly selected unit and adopted as the new numeric value.



**Information on using reference values**

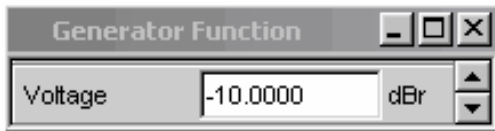

The Audio Analyzer R&S UPV allows reference values to be used when entering various values. These reference values are used as a basis for settings for other parameters.

The example below explains these interdependencies:

A reference voltage (Ref Voltage) can be set in the **Generator Config** panel. The actual output voltage is set in the **Generator Function** panel where the unit is dBr, i.e. it is possible to enter the output voltage in dB relative to this reference value.



**Alphanumeric entries**

When the focus is moved to a text entry field, the system enters Edit mode, which is indicated by a green selection frame.



If the complete text (e.g. for graph labels) is to be newly entered, simply begin entering characters using the keypad on the front panel; the old text is deleted automatically when the first key is pressed. The keypad on the front panel of the R&S UPV is automatically switched to the mode for entering alphanumeric characters. Text is entered in the same way as on mobile phones: The characters assigned to a key are called up in sequence by repeatedly pressing the key. A different key can be pressed immediately to enter the next character; a brief pause must, however, be made when entering characters assigned to the same key. The space character is assigned to the key, special characters are entered using the decimal-point key and the key is used to toggle between upper and lower-case characters.

The character to the left of the cursor can be deleted at any time during entry using the **UNDO** key.

If certain characters only are to be changed, position the cursor accordingly using the or cursor key and enter the new characters (if the position of the cursor is changed before the first character is entered, the old text will not be deleted).

The text entry field is closed with:

- ENTER      The newly entered text is adopted.
- ESC        The old text is retained.



### Display fields

Sometimes it is very useful for operators to receive additional information about their settings.

Display fields inside the panels are used in such cases. These fields are shown in grey and cannot be accessed. They always contain valid values and therefore always show settings active in the background; the fields are updated as soon as a setting in the associated parameter field is changed.

### Adopting parameters

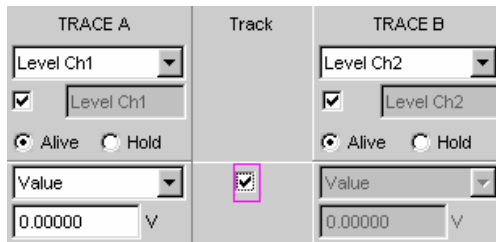

In many cases, settings are to apply e.g. to both measurement channels or to both traces. Here the R&S UPV provides multi-column panels which allow settings to be transferred from the left-hand to the right-hand column without the parameter having to be entered a second time.

If the track box has a checkmark, all of the settings within the function group are applicable to both columns. All fields with transferred settings in the right-hand column are shown as display fields. They appear grey and cannot be accessed while the track function is active. If a setting is changed in the associated parameter field in the left-hand column, this change is also shown in the display field in the right-hand column.

## Help function

Information on the possible entries is given at the bottom of the screen above the softkey bar. The units offered in the softkey bar and the limits specified in the "Valid Range" field always refer to the highlighted parameter field. The valid value range is given in the unit currently selected.

Entries outside the specified value range are not accepted; an audible warning is issued and the entry is changed to its permissible minimum or maximum value.

### Note:

*The specified ranges for value entries always take the current status of the instrument into consideration. They are therefore not constant and depend on the presets already configured for other parameters.*

Below is an example for entry of the generator output voltage; additional units can be displayed by actuating the ►► button:



## Measurement Functions and Displaying Measurement Results

The Audio Analyzer R&S UPV offers various types of measurement windows for displaying the results of the numerous measurement functions. The measurement results can be displayed as digital numeric values, in analog bargraphs, in result graphics or in data lists. The user can open any number of measurement windows on the screen.

- **What** (which measurement function) is measured and **how** (which measurement method) measurement is performed, is preset in the **Analyzer Function** panel.
- The **panels for configuring the measurement value display** are used to determine how the measurement results are presented (i.e. which unit, how many digits, etc). A series of panels for the different measurement windows are provided for this purpose.
- The results are finally displayed in the various **measurement windows**.

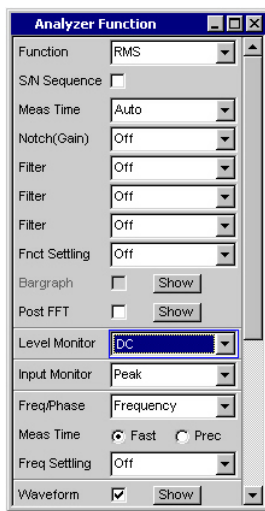

**What is measured and how measurement is performed**

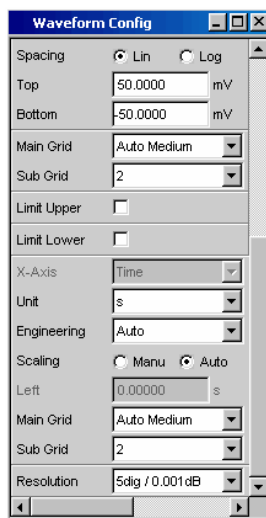

**Display type for measurement results**

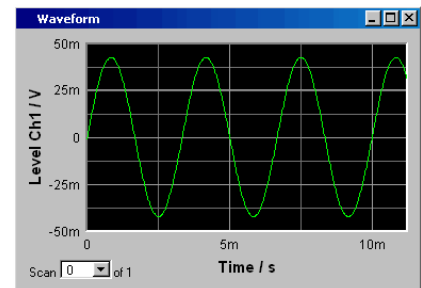

**Display of measurement results**

## Numeric display field

The numeric display field provides a clear overview of the numeric values from various analyzer functions and displays a maximum of 8 numeric value results from the **Analyzer Function** panel. The individual columns are permanently assigned, from left to right:

- Column 1:** Measurement results from the function which is set in the **Function** field of the **Analyzer Function** panel.
- Column 2:** Measurement results for the set **Level Monitor** function.
- Column 3:** Measurement results for the **Input Peak** function.
- Column 4:** Display of either the frequency measurement result or, if **Freq & Phase** or **Freq & GrpDel** is set, display of the frequency measurement result in the first row and display of the phase or group delay measurement in the second row.

	RMS	Lev DC	Input Peak	Frequency
Ch1	132.49 mV	19.054 mV	204.46 mV	1.0000 kHz
Ch2	132.43 mV	19.015 mV	204.35 mV	1.0000 kHz

## Combi display

The combi display is used if the numeric value of a measurement result is to be supplemented by analog bargraphs, limit monitoring or the storage of maximum and minimum values.

The free selection and free scalability mean that especially important or critical results can be monitored and tracked even when viewing the R&S UPV screen from a relatively long distance.

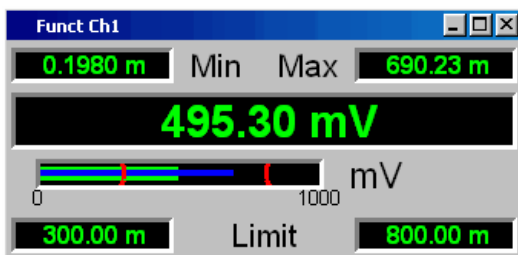

Measured minimum and maximum values

Measurement display

Bargraph

Limit settings

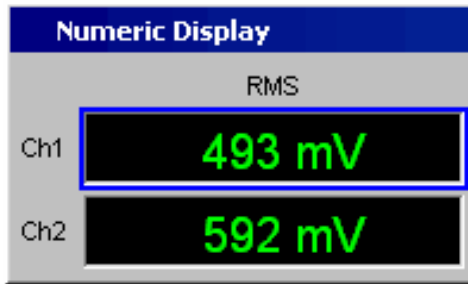

**Opening combi displays**

The easiest way to open combi displays is to highlight the respective measurement display in the numeric display field (blue selection frame) and to select the display with the **ENTER** key or rotary-knob click.

**Configuring the numeric display field and combi display**

The settings for the individual columns of the numeric display field or for the combi displays are made in the following four configuration panels which can be opened by actuating the **DispConfig** button in the menu bar:

- Funct Config
- Lev Mon Config
- Input Config
- Freq / Phase Config

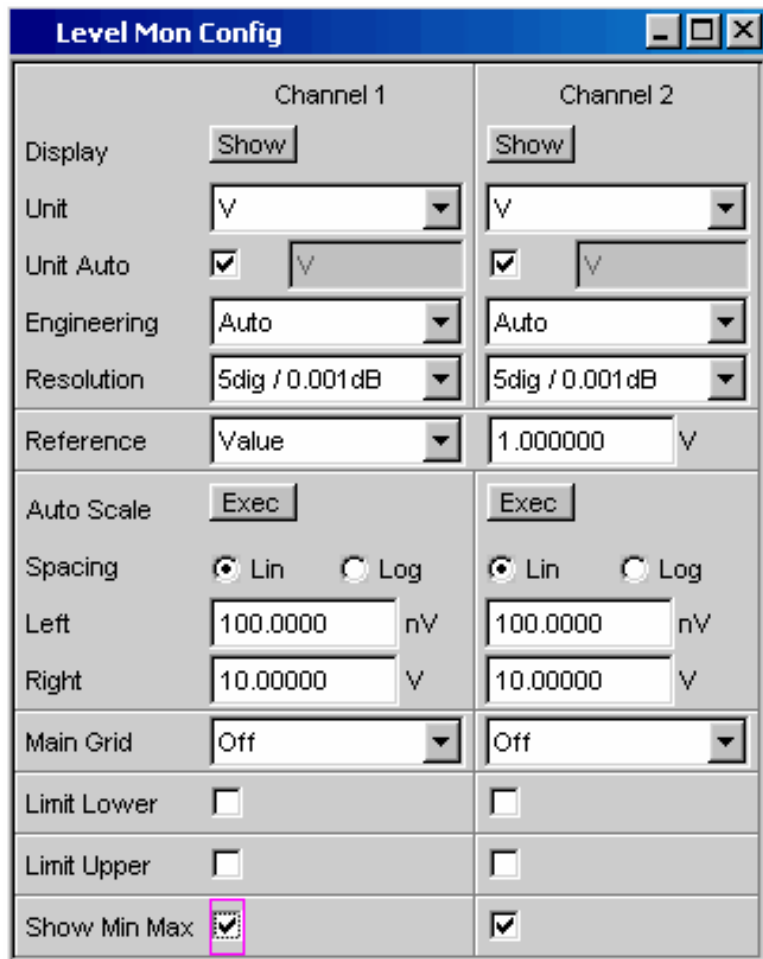

## Graphical windows

The most informative way of displaying measurement results is to use a two-dimensional graph. The Audio Analyzer R&S UPV makes a distinction between the following graphical windows:

- Sweep Graph
- FFT Graph
- Waveform
- Bargraph

These windows can be set using the associated configuration panels.

All graphical displays can be evaluated using horizontal and vertical cursors; markers are used to identify important measurement points. A broad range of softkey control functions can be used to scale graphs, to display sections of graphs, and to perform many other tasks.

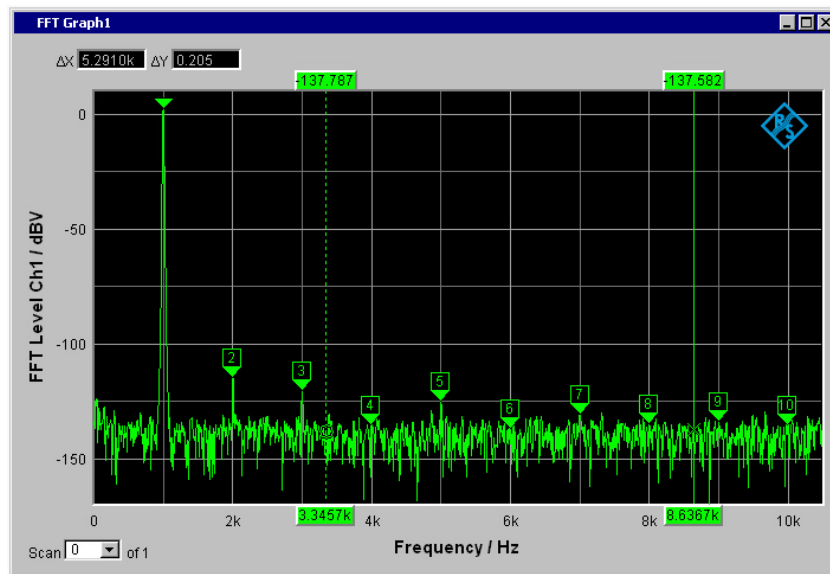

# Introduction to Instrument Operation Using Examples

## Measuring the Frequency Response of an Amplifier, Equalizer, etc

This example is based on the factory settings of the Audio Analyzer R&S UPV. It explains the changes made in the individual panels to set up the measurement and describes how to graphically display the measurement results. Finally, the example shows how to save the defined measurement setup on the R&S UPV so that it can be used again for other applications.

### Step 1: Loading the factory settings



The easiest way to load the factory settings of the instrument is to press the **PRESET** key on the front of the R&S UPV.

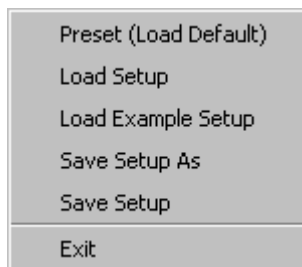

Alternatively, the factory settings can be loaded by opening the menu bar with the **MENU** key, highlighting the **File** button with the rotary knob and actuating it with a rotary-knob click, and then highlighting and actuating **Preset (Load Default)** in the displayed list in the same way.

### Step 2: Setting the required generator signal

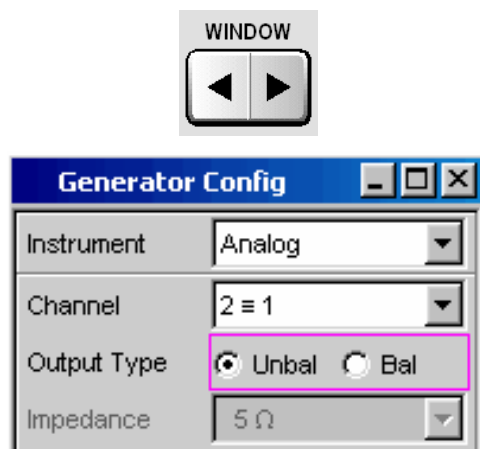

The basic settings for configuring the generator are made in the **Generator Config** panel.

The panel must have the focus before it can be operated. This is already the case with the default setup, otherwise press the **WINDOW** key until the color of the title bar in the desired panel changes to blue.

The frequency response is usually measured on both channels; this is already configured in the **Channel** field.

- ← Depending on the DUT, **Output Type** can be switched to balanced circuitry; various output impedances can then be selected in the field below. If necessary, the required parameter field can be highlighted with the rotary knob; this is then indicated by a selection frame (see the screenshot to the left). A rotary-knob click toggles between the two radio buttons.

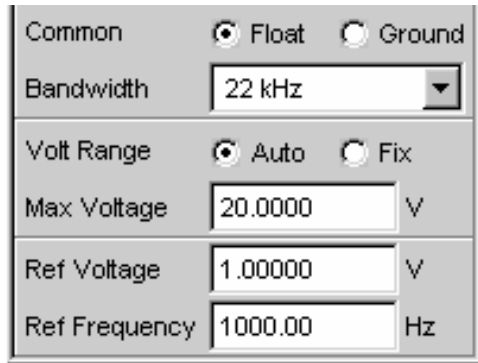

← Floating output circuitry for the generator (see the section "Avoiding Hum Loops" on page 2.3) and a maximum signal frequency of 22 kHz are normally the right settings to be used.

← The other settings are also suitable for the majority of applications and do not have to be adjusted unless necessary.

This completes the settings in the **Generator Config** panel.

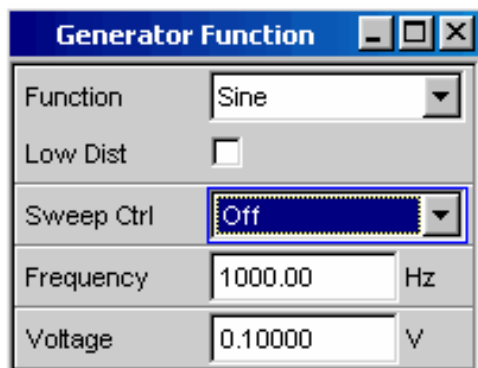

← The **Generator Function** panel must now be activated; once again, press the **WINDOW** key until the color of the panel's title bar changes to blue.

← Sinusoidal signals (Sine) are required; this setting is already selected.

← To be able to measure the frequency response, the sinusoidal signal must be swept in the frequency. A fixed frequency of 1 kHz is preset in the default instrument setup.

To activate the sweep, highlight the **Sweep Ctrl** field by actuating the rotary knob until this field has the blue selection frame (see the screenshot to the left).

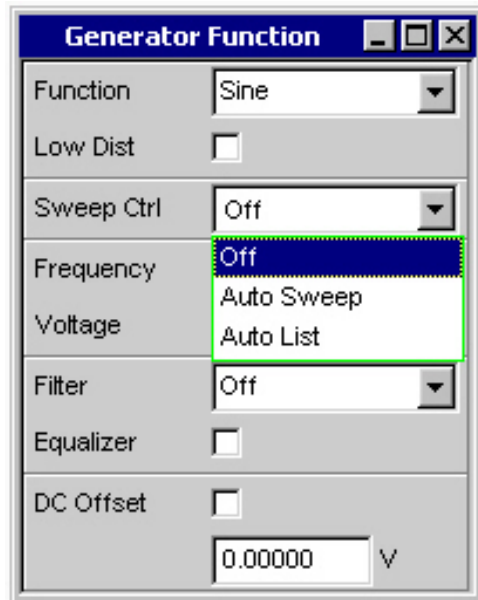

← The fold-down parameter list is opened with a rotary-knob click or by pressing the ENTER key.

← Use the rotary knob to highlight **Auto Sweep** and activate this setting with another rotary-knob click or with the ENTER key.

The parameter list closes and a number of additional fields appear in which further sweep parameters can be set.



Generator Function

Function: Sine

Low Dist:

Sweep Ctrl: Auto Sweep

Next Step: Anlr Sync



The **Next Step** field must remain set to **Anlr Sync**; this setting causes the next sweep step to be triggered as soon as a valid measurement result is available in the analyzer part. This synchronization optimizes the sweep speed.

X Axis: Frequency

Z Axis: Off

Frequency Spacing: Log Points



The sweep variable must now be specified in the next field. Frequency is already preset here (as required in this example).



No other sweep variable is required; the **Z Axis** field therefore remains set to **Off**.



The next selection field is used to select the algorithm for advancing through the sweep points.

This can be done using a linear or logarithmic step size; the number of individual sweep points (**Points**) or the step size from point to point (**Steps**) can be set.

This selection field is factory-set to **Log Points**; this is the usual setting for frequency response measurements.

Start: 20.0000 Hz

Stop: 20.0000 kHz



The values for the start and stop frequency of the sweep must be entered in the next two fields.

Highlighting the desired field gives it the green selection frame. The required frequency value can now be entered directly using the numeric keypad on the front panel (20 Hz in this example). Pressing the ENTER key adopts the value and adjusts the hardware accordingly.

Valid Range is 100mHz to 21.75kHz

Hz kHz



The possible value range is given above the softkey bar. Entries outside the specified value range are not accepted; an audible warning is issued and the entry is changed to its permissible minimum or maximum value.

As soon as the value entry field is highlighted, all available units are displayed on the softkey bar; additional hidden units can be shown by actuating the ►► button. Value entry can be completed by actuating the softkey labeled with the desired unit; this is a particularly useful feature if a value is to be changed to a different unit.

Start	20.0000	Hz
Stop	20.0000	kHz
Points	50	



The value for the stop frequency is entered in the same way (here 20 kHz).



The number of desired sweep points must be entered in the **Points** field; 30 points are preset here. Up to 1024 points can be selected. 50 points are entered in this example; this generally provides an adequate number of measurement cycle values without making the overall measurement cycle too long.

Voltage	0.10000	V
Filter	Off	▼
Equalizer	<input type="checkbox"/>	
DC Offset	<input type="checkbox"/>	
	0.00000	V



The desired output voltage for the measurement is entered in the **Voltage** field; once again, the field must be highlighted before the value can be entered. The value range is again displayed above the softkeys and the available units are shown in the softkeys.

The remaining fields are not relevant for this example. Configuration of the generator is therefore complete.

### Step 3: Selecting the required measurement

Analyzer Config	
Instrument	Analog ▼
Channel	2 = 1 ▼



The basic settings for configuring the analyzer are made in the **Analyzer Config** panel.

Once again, the panel must have the focus before it can be operated ( **WINDOW** key).

The frequency response is usually measured on both channels; this is already configured in the **Channel** field. The setting **2 = 1** means that both channels have the same settings; the following parameter fields appear once only in the panel but affect both channels.

Coupling	<input checked="" type="radio"/> AC <input type="radio"/> DC
Bandwidth	22 kHz
Pre Filter	Off
Input	Bal
Ch1 Imped	200 kΩ
Common	<input checked="" type="radio"/> Float <input type="radio"/> Ground
Ch1 Range	Auto
Ref Imped	600.000 Ω
Start Cond	Auto
Delay	0.00000 s

- ← If necessary, it is possible to toggle between AC and DC coupling using the two radio buttons.
  - ← The fields for the measurement bandwidth are already preset with the appropriate setting; no prefilter is required here.
  - ← In this example, the signal to be measured is supplied via the balanced input sockets (**Bal** setting). The analyzer can also be connected to the generator internally.
  - ← Floating input circuitry for the analyzer (see the section "Avoiding Hum Loops" on page 2.3) and the autorange function are normally the right settings to be used.
- The default settings in the following fields are also correct.
- This completes the settings in the **Analyzer Config** panel.

The following are set in the **Analyzer Function** panel:

- **what** is measured (which measurement function) and
- **how** measurement is performed (which measurement method)

Analyzer Function	
Function	RMS
S/N Sequence	<input type="checkbox"/>
Meas Time	Gen Track
Notch(Gain)	Off
Filter	Off
Filter	Off
Filter	Off
Funct Settling	Off
Bargraph	<input type="checkbox"/> Show
Post FFT	<input type="checkbox"/> Show
Level Monitor	Off
Input Monitor	Peak
Freq/Phase	Frequency
Meas Time	<input checked="" type="radio"/> Fast <input type="radio"/> Prec
Freq Settling	Off
Waveform	<input type="checkbox"/> Show

- ← The RMS of the voltage must be measured for the frequency response measurement described here; the required setting (**RMS**) is already preselected.
  - ← The measurement time for each individual measurement point is selected in the **Meas Time** field. The default instrument setting here is **Auto** which means that the measurement time is automatically adapted to the input frequency, i.e. the measurement cycle speeds up as the frequency increases. This setting can (with just a few exceptions) be used for the majority of applications.
- If the integrated generator is used for measuring the frequency response (as in this example), the setting **Gen Track** should be used. The measurement time is then automatically adapted to the frequency generated in the generator. The frequency information from the generator is passed on directly to the analyzer. The analyzer then adjusts its measurement time to precisely one period (or to an integer multiple of one period). The advantage of this method is maximum measurement speed with maximum accuracy.
- All other parameter fields are not relevant for this example; the settings in the **Analyzer Function** panel are therefore complete.

**Step 4: Displaying the measurement results – Numeric measurement display**

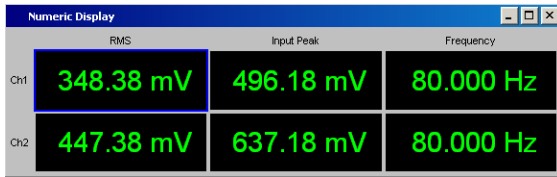

In the default instrument setup, the numeric measurement display is also already open.

If the DUT is correctly connected to the Audio Analyzer R&S UPV, measurement values will already be displayed.

The **panels for configuring the measurement value display** are used to determine how the measurement results are presented (i.e. which unit, how many digits, etc). A series of panels for the different measurement windows are provided for this purpose.

The **Function Config** panel is shown here as an example; the first column of the numeric measurement display is configured in this panel, i.e. the display fields which show the measured level values for the frequency response measurement described here.

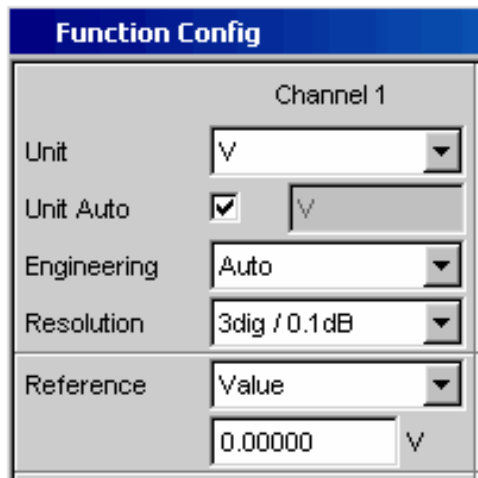

The panel has two columns; to simplify matters, only Channel 1 is shown here.

← The unit for the numeric measurement displays is set in the **Unit** field.

← The **Engineering** parameter is used to determine whether the display automatically toggles between  $\mu$ V, mV and V, for example, or whether other unit formats are desired.

← If the measurement results are to be displayed as relative values, they are referred to the reference value set in the **Reference** field.

Other parameter fields in this panel are used to set limits and to display extreme values. These functions are described in detail in Chapter 3 "Manual Operation" and Chapter 4 "Instrument Functions".

**Step 5: Starting the sweep**

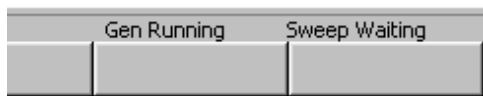

Although the analyzer is already supplying measurement results, the status message "**Sweep Waiting**" above the softkeys indicates that the sweep has not yet been started, although it has been configured in the **Generator Function** panel.

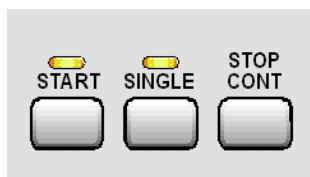

The sweep is started by pressing the **START** key in the top right-hand part of the R&S UPV front panel. The status message "**Sweep Run Cont**" informs the user that when this key is pressed the sweep will start and be repeated continuously.

The sweep can be stopped at any time by pressing the **STOP CONT** key (the status message "Sweep Stopped" is displayed); the sweep continues if the key is pressed again.

If the **SINGLE** key is pressed, the sweep is started once only; "Sweep Terminated" appears in the status field when the sweep cycle has been terminated.

### Step 6: Displaying the measurement results – Graphical windows

The results of a frequency response measurement are usually displayed graphically with the measured output voltage values of the DUT being plotted on the frequency axis.

The following settings are required for this:

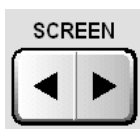

Use a different screen for the graphical display so that Screen 1 is not filled with too many panels. To do this, change to Screen 5 by pressing the **SCREEN** key; this screen is empty in the default R&S UPV setup.

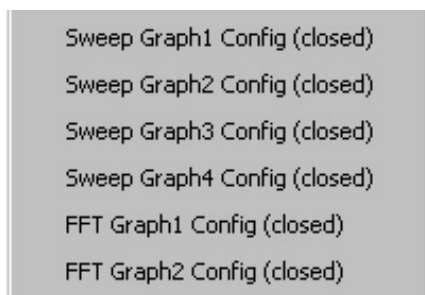

Open the menu bar with the **MENU** key and open the **Sweep Graph 1 Config** panel by selecting it in the selection list displayed by actuating the **DispConfig** button.

As explained above, the way in which the measurement results are presented is determined in the **configuration panels**. Each graphical window has its own configuration panel.

The **Sweep Graph 1 Config** panel required here has two columns; to simplify matters, only Trace A is shown in the example.



←

The associated graphical window can be opened by actuating the **Show** button in the **Display** field. The window appears in the same screen so that the effect of the following settings can be observed directly.

←

In each graphical window, one or two traces (Trace A and Trace B) can be plotted on one X-axis. Each trace can consist of a large number of scans. In this example, only one single scan is to be displayed; the **Scan** field can therefore remain set to **Single**.



←  
←

The scans can display the results of the different measurements available in the R&S UPV.

For the frequency response measurement, the measurement results for the measurement function selected in the **Function** field in the **Analyzer Function** panel (here the RMS measurement) must be displayed on a graph. For Trace A, the **Source** field is therefore set to the function result of measuring channel 1 (this is already preset in the default setup).

The **Alive** setting means that the results are displayed continuously; the **Hold** setting "freezes" the traces.

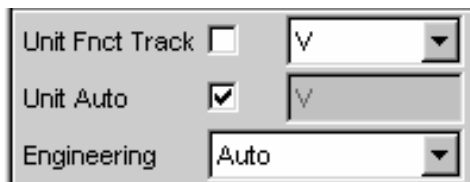

←  
←

The units to be used for the measurement values on the Y-axis are set in the next section.

If the unit used in the numeric display window is also to be used in the graphical window, the **Unit Fct Track** tick box must be activated. If this is not the case, a unit can be selected from the parameter list next to the tick box.

The **Engineering** parameter is used to determine whether the display automatically toggles between  $\mu\text{V}$ ,  $\text{mV}$  and  $\text{V}$ , for example, or whether other unit formats are desired.

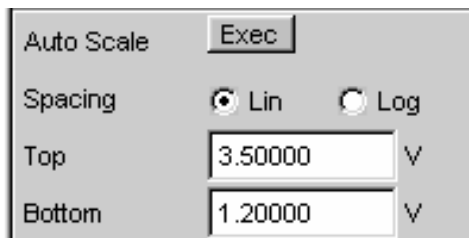
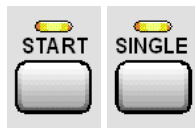

←  
←  
←

All the other default instrument settings are correct and allow a result to be displayed immediately in the form of a graph. If the sweep is started with the **START** or **SINGLE** key, the scan appears in the graphical window.

The scaling will probably need to be adjusted. Actuating the **Exec** button in the line **Autoscale** rescales the graph on the basis of the measured minimum and maximum values so that the entire trace fits in the graphical window.

The end values for the Y-axis can, however, also be entered in the two fields **Top** and **Bottom**.

The default R&S UPV settings for the X-axis are also mostly correct for this example:

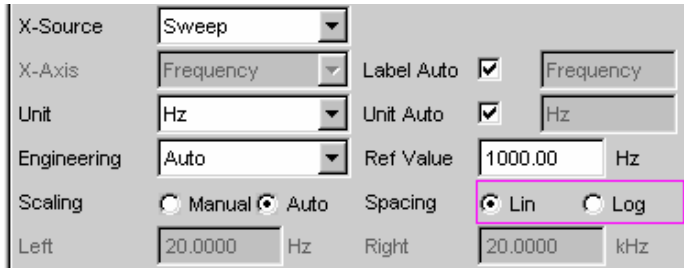

By selecting a frequency sweep in the **Generator Function** panel, the X-axis is automatically defined as the frequency axis with the unit Hz.

If **Auto** is set in the **Scaling** field, the start and stop frequency of the sweep defined in the **Generator Function** panel is automatically used as the upper and lower end value for the X-axis.

The **Lin** setting in the **Spacing** field is unsuitable for this example. Since a sweep with logarithmic step size has been selected for this measurement, the X-axis should also be subdivided logarithmically. This setting can be changed quickly with a rotary-knob click.

### Step 7: Using a relative unit in the graphical window

The settings so far made allow the frequency response of the DUT to be displayed graphically but not in a way that conforms to standards.

In the case of frequency response measurement, the relevant standards stipulate that the deviations of the output voltage must be plotted over frequency, whereby the output voltage of the DUT at the reference frequency 1 kHz (for analog measurements) is used as the reference level.

The following settings in the **Sweep Graph 1 Config** panels are used to adapt the graph for this measurement example:



A default reference value of 1 V is set in the **Reference** field.

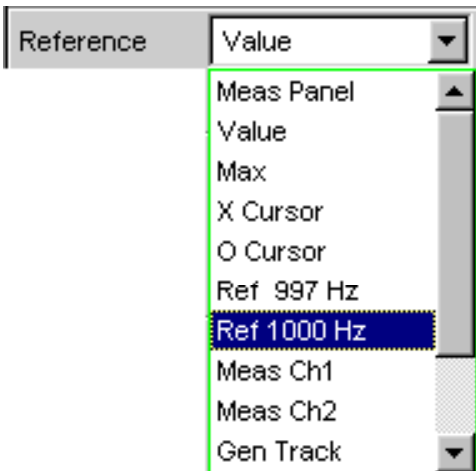

This value must be replaced by the output voltage value of the DUT measured with the reference frequency of 1 kHz.

The R&S UPV offers a very simple way of doing this:

Open the parameter list in the **Reference** field and select the **Ref 1000 Hz** setting. With this setting, the value measured at this frequency is determined (if necessary by means of interpolation between the measurement values at the two adjacent frequencies) and used as the reference value.



← All that remains is to select the unit **dBr** in the **Unit Fnc Track** field. All measurement values are then displayed in dB relative to the reference value selected above. This satisfies the standards defining frequency response measurement.

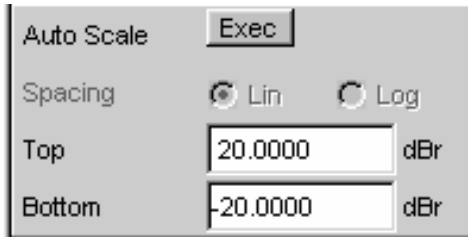

← The Y-axis must now be scaled according to requirement, e.g. from +20 dBr to -20 dBr.

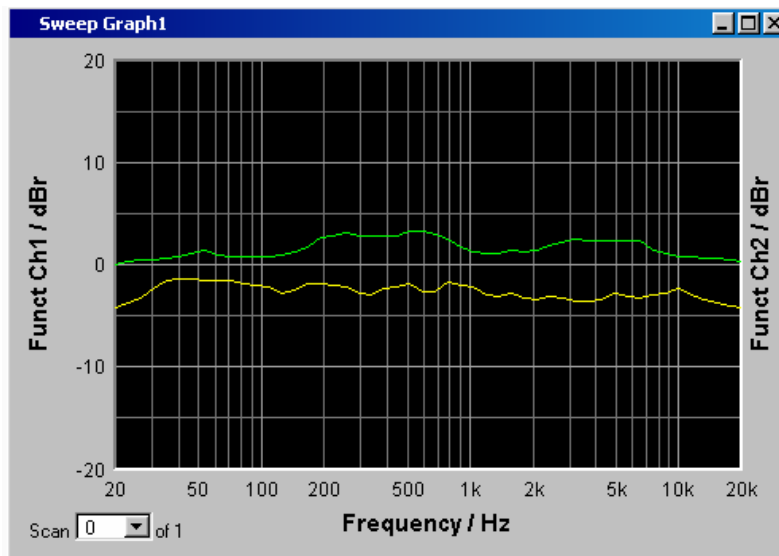

If the measurement result of the second channel has been selected for Trace B, the graphical display for the measured frequency response may look like the example shown opposite.



**Step 8: Saving the instrument setup**

Pressing the **SAVE** key opens the window for saving files.



The desired file name can now be entered using the keypad on the front panel.

The keypad on the front panel of the R&S UPV is automatically switched to the mode for entering alphanumeric characters. Text is entered in the same way as on mobile phones: The characters assigned to a key are called up in sequence by repeatedly pressing the key. A different key can be pressed immediately to enter the next character; a brief pause must, however, be made when entering characters assigned to the same key.

The file extension is assigned automatically once the file name has been entered (here .SET); it is advisable to use this automatic assignment function as it prevents entry errors.



If this instrument setup is to be used again at a later date, simply press the **LOAD** key to reload the setup in the file window.

## Measuring the Harmonic Distortion (THD+N) of a DUT

This example is also based on the factory settings of the Audio Analyzer R&S UPV. However, only the settings in the individual panels which differ from the settings in the previous example are explained.

### Step 1: Loading the factory settings



The easiest way to load the factory settings of the instrument is to press the **PRESET** key on the front of the R&S UPV.

Alternatively, the default setup can also be loaded via the menu bar.

### Step 2: Setting the required generator signal

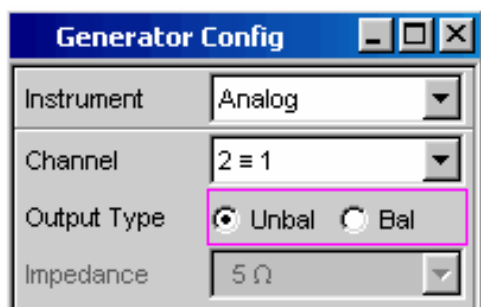

In the **Generator Config** panel, the basic settings for configuring the generator in this example are the same as those set for the frequency response measurement described in the previous section.

Depending on the DUT, **Output Type** may have to be switched to balanced circuitry.

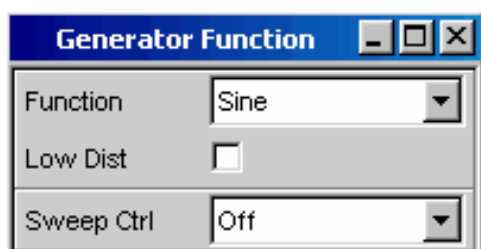

The **Generator Function** panel must now be activated; once again, press the **WINDOW** key until the color of the panel's title bar changes to blue.

Sinusoidal signals (Sine) are required; this setting is already selected.

The harmonic distortion is often only specified for the reference frequency 1 kHz (for analog applications). Fixed frequencies are therefore used for measurement; as a result, **Sweep Ctrl** must remain set to **Off**.

Frequency	1000.00	Hz
Voltage	0.10000	V
Filter	Off	
Equalizer	<input type="checkbox"/>	
DC Offset	<input type="checkbox"/>	
	0.00000	V

←

The frequency 1 kHz is already preset in the default instrument setup.

←

Only the output level required for the measurement may have to be adjusted (in the **Voltage** field).

The remaining fields are not relevant for this example. Configuration of the generator is therefore complete.

### Step 3: Selecting the required measurement

Analyzer Config	
Instrument	Analog
Channel	2 = 1

The basic settings for configuring the analyzer are again made in the **Analyzer Config** panel.

These settings are made in the same way as shown in the previous example.

Analyzer Function	
Function	RMS
	Off
	RMS
	RMS Selective
	Peak
	Quasi Peak
	S/N
	DC
	FFT
	THD
	THD+N & SINAD

←

The **Analyzer Function** panel must now be activated; once again, press the **WINDOW** key until the color of the panel's title bar changes to blue.

The measurement function and measurement method are set in this panel.

The measurement function is selected first; the fold-down parameter list is opened with a rotary-knob click or by pressing the ENTER key.

Use the rotary knob to highlight **THD+D & SINAD** and activate this setting with another rotary-knob click or with the ENTER key. The parameter list is then closed again.

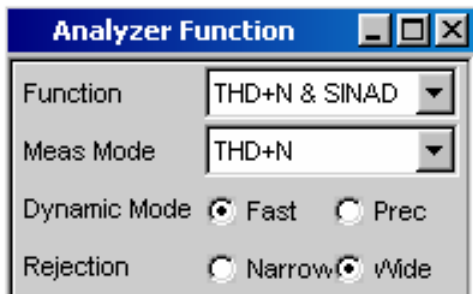

In the next field **Meas Mode**, various modes for distortion factor measurement can be selected; the presetting **THD+N** is correct for this example.

← **Dynamic Mode** determines the maximum dynamic response for this measurement: fast measurement with restricted dynamic response or maximum dynamic response with a slightly longer measurement time are the two possible options.



← With the THD+N measurement, the fundamental of the signal to be measured is suppressed using a notch filter. The R&S UPV can automatically determine the fundamental from the spectrum and adjust the notch filter to it (**Fundamental Auto**).

**Filter** and **Equalizer** are only required in exceptional cases.

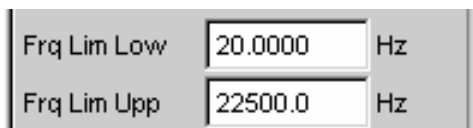

← The calculation for harmonics and noise components can if necessary be restricted to within band limits which can be entered in the two fields **Freq Lim Low** and **Freq Lim Upp**.

All other parameter fields are not relevant for this example; the settings in the **Analyzer Function** panel are therefore complete.

#### Step 4: Displaying the measurement results – Numeric measurement display

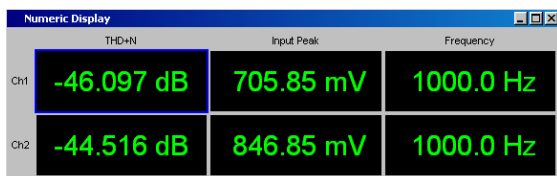

In the default instrument setup, the numeric measurement display is already open.

If the DUT is correctly connected to the Audio Analyzer R&S UPV, the measurement values for the harmonic distortion can be read off in the first column.

In the default setup, THD+N values are given in dB; if a display in % is desired, this unit can be changed in the **Function Config** panel.

#### Step 5: Displaying the spectrum in the graphical window

Display of the numeric value alone is sufficient for the majority of harmonic distortion measurements. Here, however, the spectral composition of the output signal at the DUT is also to be analyzed. With the Audio Analyzer R&S UPV, it is possible to follow up all distortion measurements with an FFT analysis.

The necessary settings for this are explained in the following section:

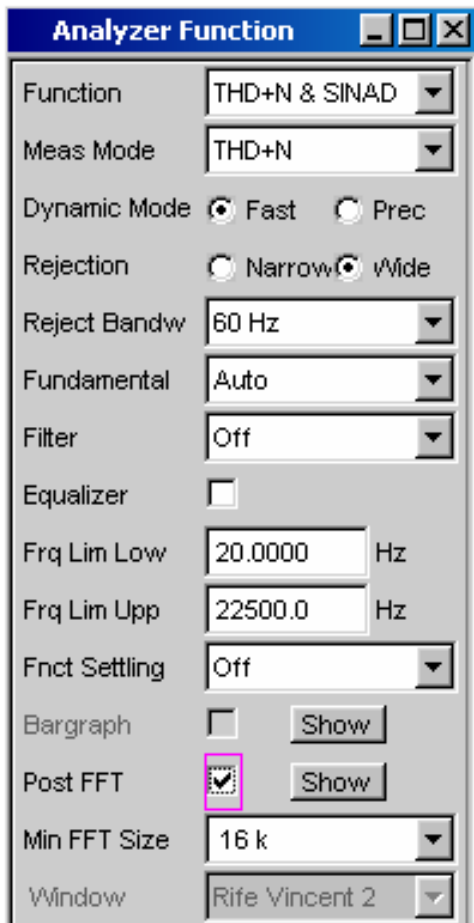

In the **Analyzer Function** panel already used for configuring the THD+N measurement, an FFT analysis to be performed following the measurement can be set after the actual measurement function has been selected.

← To do this, highlight the **Post FFT** tick box with the rotary knob and activate it with a rotary-knob click. The size of the FFT can be adjusted if necessary.



To display the results of the FFT analysis graphically, first change to Screen 5 by pressing the **SCREEN** key; this screen is empty in the default R&S UPV setup.

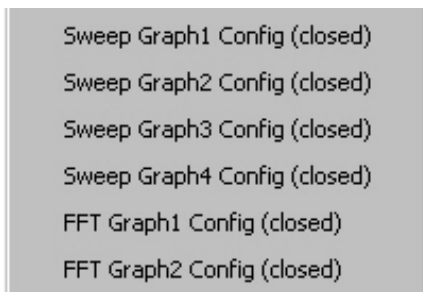

Open the menu bar with the **MENU** key and open the **FFT Graph 1 Config** panel by selecting it in the selection list displayed by actuating the **DispConfig** button.

As explained in the previous example, the way in which the measurement results are presented is determined in the **configuration panels**. Each graphical window has its own configuration panel.

The **FFT Graph 1 Config** panel required here has two columns; to simplify matters, only Trace A is shown in the example.

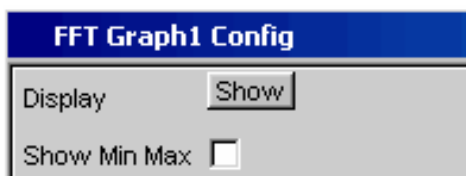

← The associated graphical window can be opened by actuating the **Show** button in the **Display** field. The window appears in the same screen so that the effect of the following settings can be observed directly.

In each FFT window, one or two traces (Trace A and Trace B) can be plotted on the frequency axis.

In this example, the level measurement results of the FFT analysis are to be displayed on a graph. For Trace A, the **Source** field is therefore set to **FFT Level Ch1** (this is already preset in the default setup).

The **Alive** setting means that the results are displayed continuously; the **Hold** setting "freezes" the traces.



←

←

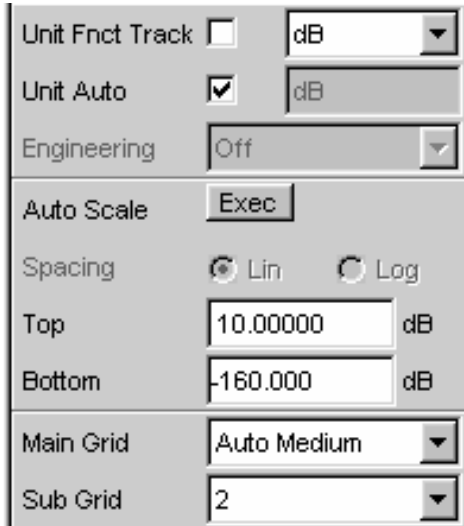

The settings for unit, Y-axis scaling and grid are already preset in the default setup; a result should therefore be visible. If necessary, these settings must be adjusted.

The settings for the X-axis are also mostly correct for this example; they were explained in the previous example.



**Note:**

*In the Analyzer Function panel, you can also use the Show button to open the graphical window for Post FFT. However, this displays the window in the same screen, without opening the associated configuration panel.*

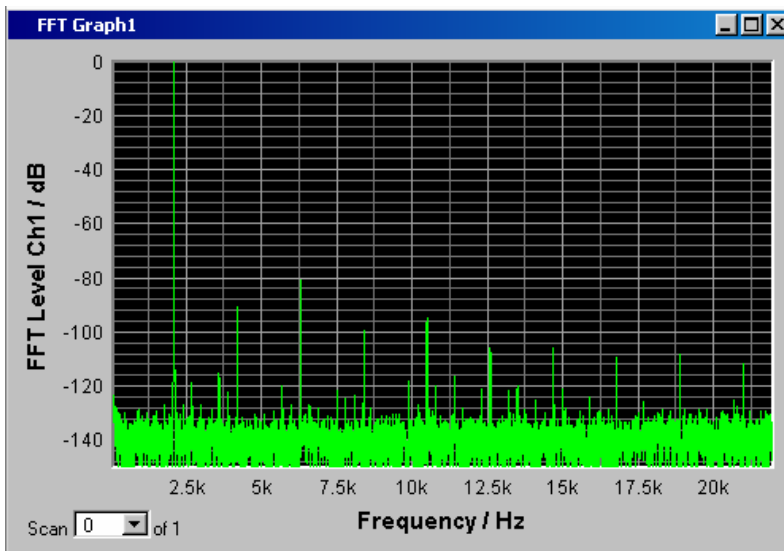

The spectral display of the output signal with its harmonics may now look like the example shown opposite.

## Step 6: Evaluating the graphical display with markers and cursors

All graphical displays can be evaluated using horizontal and vertical cursors; the X and Y-values shown in the display fields associated with the cursors are always current values.

Markers are used to identify important measurement points.

The cursors and markers can only be operated using the softkey bar; the required softkeys are displayed at the bottom of the screen as soon as the graphical window has the focus.

The softkeys are arranged in several levels; the lower levels are accessed by actuating the respective button. Actuating the **Back** button redisplay the higher level.



### Setting markers:

Actuating the **Marker** button displays the marker softkeys:



The trace in which markers are to be set (**Trace A** in this example) must first be selected using the softkey. The next softkey level appears simultaneously:

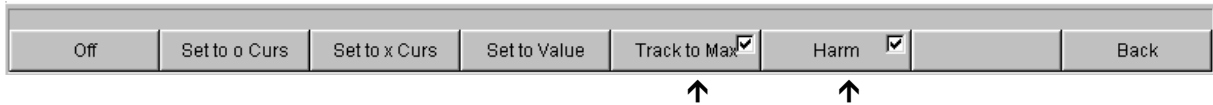

The **Track to Max** button is used to set a marker at the maximum value of the curve, i.e. the fundamental in this example THD+N measurement.

The **Harmonics** button is used to mark the harmonics of the fundamental indicated by the marker.

Actuating the **Back** softkey twice redisplay the first softkey level.



### Using cursors:

Actuating the **Cursor** button displays the cursor softkeys:

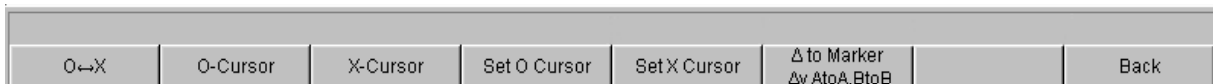

The Audio Analyzer R&S UPV uses two cursors which are identified by the O and × symbols. These symbols are used to mark the measured points in the graph (see the example graph below).

Only one cursor is active and can be moved in the graph at any one time. The active cursor is displayed with a solid line; the inactive cursor is displayed with a broken line.

The  $O \leftrightarrow \times$  button or a rotary-knob click is used to toggle between the  $O$  and  $\times$ -cursor. If, for example, the cursor was activated with the  $O$ -Cursor button, the following softkeys appear:

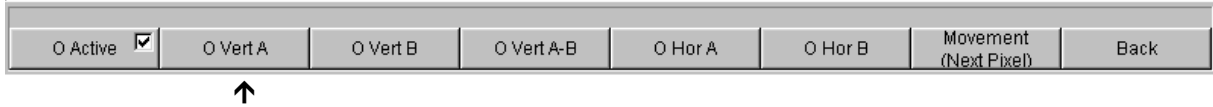

Actuating the  $O$  Vert A button activates a vertical cursor on Trace A; this cursor can then be moved using the rotary knob.

The step size with which the cursor is moved can be set using further softkeys.

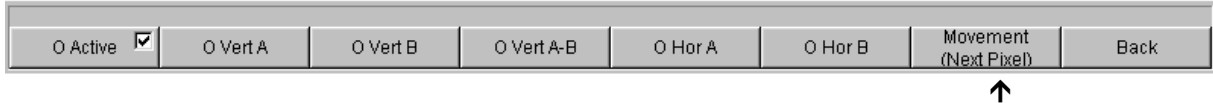

The Movement button opens the next softkey level where various step sizes for moving the cursor are offered. The currently selected step size is indicated in brackets in the second label line of the Movement button.

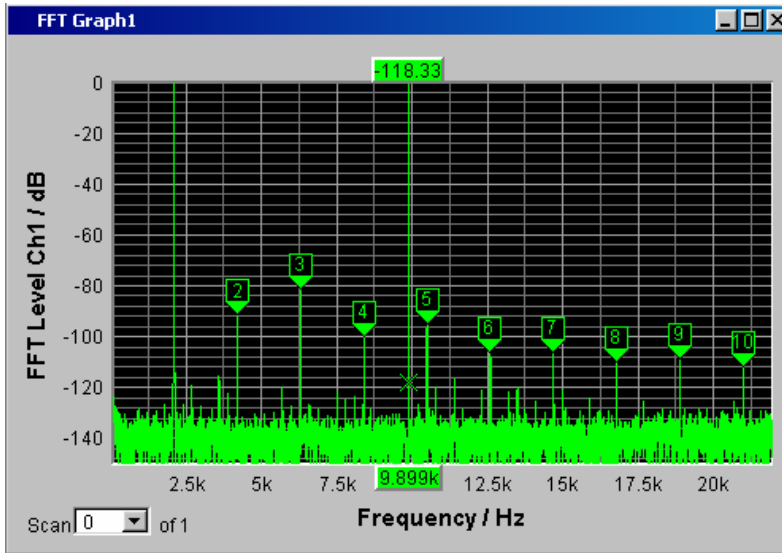

With activated markers and a cursor, the graphical display of the output signal with its harmonics may look like the example shown opposite.

### Step 7: Saving the instrument setup



This example can also be saved as an instrument setup. Pressing the  $\boxed{\text{SAVE}}$  key opens the file window. The file is then saved in the way described in the previous example.



## Loading Predefined Instrument Setups

To make initial measurements easier for new users, example setups for the basic measurements required in audio engineering are supplied with every Audio Analyzer R&S UPV. These setups allow the instrument to be used almost immediately.

The setup files are available for the different domains (analog or digital) of the generator and analyzer. They are stored in the AA to DD subdirectories of the D:\UPV\Applications directory; the generator domain is listed first followed by the analyzer domain. The file name indicates the respective application.

Many of these example measurements (essentially those at the analog interfaces) can be performed using the basic version of the Audio Analyzer R&S UPV. The R&S UPV-B2 option or the R&S UPV-B20 option (digital audio interfaces) is required for all measurements at the digital interfaces.

The predefined instrument setups can be loaded in the following way:

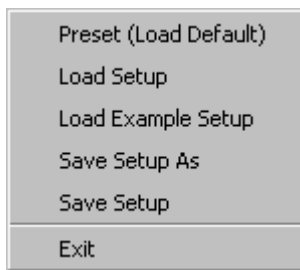

The quickest way to load setups is to open the menu bar with the **MENU** key, highlight the **File** button with the rotary knob and actuate it with a rotary-knob click. The item **Load Example Setup** in the fold-down list that then appears must then be highlighted and actuated in the same way.

The file window is opened already displaying the directory in which the example measurements can be selected.



Alternatively, the file window used to select the example measurements can also be opened using the **LOAD** key on the front of the R&S UPV; in this case, however, the appropriate directories must be selected manually.

All of the setups listed here use the same basic settings.

### Basic settings for analog inputs/outputs:

- Both channels of the generator and analyzer are active; the balanced XLR connections with minimum generator impedance and maximum analyzer impedance are used.
- All inputs/outputs are floating; the autorange function is activated.
- Frequency sweeps are usually performed logarithmically from 20 Hz to 20 kHz; the appropriate graphical windows are open on the screen; the X-axis is scaled automatically in the associated configuration panels; the Y-axis is permanently set to standard values.
- Voltages are mostly given in volts; the generator output voltage is set to 0.1 V; distortion and intermodulation values are given in dB.

**Basic settings for digital inputs/outputs:**

- Both channels are active; the generator generates 24 bit words; the analyzer analyzes 24 audio bits. The sampling frequency is set to 48 kHz; the Professional format to AES 3 is used. The digital pulse amplitude of the generator is 1 V at the BNC outputs; this corresponds to 4 V at the XLR sockets.
- Levels are mostly given in dBFS; audio signals are usually generated at a level of –20 dBFS.

Users can, of course, adapt the used basic settings to their own specific measurement tasks at any time. To do this, the respective setup must be loaded and the appropriate changes are then made in the panels. The setup can then be saved again.

The application setups are also updated when new R&S UPV firmware is installed. Modified setups should therefore be saved under a different file name.

Users are also free to create new directories for their customized setups.



## Contents - Chapter 3 "Manual Operation"

<b>3 Manual Operation</b> .....	3.1
<b>Introduction - Manual Operation</b> .....	3.1
<b>Functional Organization of the Audio Analyzer R&amp;S UPV</b> .....	3.2
Instrument Concept.....	3.2
Generators.....	3.2
Analyzers.....	3.4
<b>General Information on Operation</b> .....	3.9
Windows User Interface.....	3.9
Using the Rotary Knob.....	3.9
Operation Using the Mouse.....	3.10
Operation Using an External PC Keyboard.....	3.11
<b>Display</b> .....	3.12
Display and Screens.....	3.12
WINBAR and Softkeys.....	3.14
Moving and Resizing Panels and Graphical Windows.....	3.16
Status Displays and Messages.....	3.19
<b>Panels</b> .....	3.21
Panel and Window Types.....	3.21
Opening, Operating, Hiding and Closing Panels.....	3.21
Panel Structure.....	3.23
Navigating in the Panels.....	3.27
<b>Settings on the Audio Analyzer R&amp;S UPV</b> .....	3.28
<b>Settings in the Panels</b> .....	3.29
Focus.....	3.29
Changing the Instrument.....	3.30
Changing Functions.....	3.30
Hiding Parameter Fields.....	3.31
Highlighting Control Elements.....	3.32
Activating/Deactivating Functions – Tick boxes.....	3.32
Toggling Functions – Radio Buttons.....	3.33
Selecting a Parameter – Selection Fields.....	3.34
Numeric Entries – Numeric Entry Fields.....	3.35
Alphanumeric Entries – Text Entry Fields.....	3.42
Display Fields.....	3.43
Adopting Parameters – Track Box.....	3.44
Help Functions.....	3.44
Completing Settings.....	3.45
Entries During Measurement / Data Output.....	3.46

<b>Measurement Displays</b> .....	3.47
Measurement Functions and Displaying Measurement Results.....	3.47
Numeric Display Field .....	3.48
Combi Display .....	3.50
Graphical Windows .....	3.56
Evaluating Graphical Displays with Cursors and Markers .....	3.69
Data Lists .....	3.82
<b>Settings in the Menu Bar</b> .....	3.86
<b>Settings in the Toolbar</b> .....	3.91
<b>Settings in the Operating System</b> .....	3.94
<b>Auxiliaries Panel</b> .....	3.94
Audio Monitor Function .....	3.94
Auxiliary Analog Output.....	3.96
Trigger Input, Trigger Output .....	3.97
<b>Rapid Deactivation of the Outputs</b> .....	3.98
<b>Help System</b> .....	3.99
Operating Help .....	3.99
Help Text Language.....	3.100
<b>File Management</b> .....	3.102
Selecting the File Select Window.....	3.103
Integrated File Select Window .....	3.104
File Manager .....	3.105
Loading and Saving Instrument Settings .....	3.106
List of File Extensions Used.....	3.107
<b>Manual Remote Operation</b> .....	3.109
<b>Units</b> .....	3.110
Units in Measurement Result Displays .....	3.111
Units for Value Entries .....	3.115
<b>Overview of Keys</b> .....	3.118
<b>Overview of Panels and Measurement Displays (Graphical Windows)</b> .....	3.122
<b>Overview of Status Messages</b> .....	3.126

# 3 Manual Operation

## Introduction - Manual Operation

The R&S UPV audio analyzer is available in two models. The R&S UPV standard model and the R&S UPV66, which is specially designed for use in systems. The R&S UPV66 has no display, no front panel control elements, and no CD/DVD drive. Apart from the omission of front-panel operation, the R&S UPV66 model has largely the same functions as the standard model. This manual therefore describes both instruments in parallel, and any differences are indicated at the appropriate points in the text.

The Audio Analyzer R&S UPV uses the WindowsXP® operating system. The instrument is therefore operated in largely the same way as other Windows® applications. All panels and display windows have the standard Windows® format and are operated in the same way. The rotary knob, keys and softkeys, or alternatively an external keyboard and/or mouse, allow direct and convenient access to entries and settings. The clearly organized display shows the current state of the audio analyzer.

The R&S UPV model can be fully operated using the control elements on the front panel; additional peripherals such as a mouse and keyboard are not essential requirements. They can, however, be connected so that the user is free to decide how he would like to operate the R&S UPV. Mixed operation is also possible.

If the R&S UPV66 model is to be operated manually, you need to connect an external screen, a mouse, and a PC keyboard. The section "*Overview of Keys*" at the end of this chapter provides the keys and key combinations on a PC keyboard that correspond to the front-panel keys available with the R&S UPV model. For further information on operation by means of mouse and keyboard, refer to the sections "*Operation Using the Mouse*" and "*Operation Using an External PC Keyboard*" in this chapter. The use of the toolbar simplifies the operation of both models when using the mouse. See the section "*Settings in the Toolbar*" in this chapter.

Numerous online help functions assist the user in making settings.

After being switched on, the instrument is in the same state as it was before it was switched off. This applies to all setting parameters of the R&S UPV, including those not currently displayed on the screen.

The following chapter describes manual operation of the Audio Analyzer R&S UPV. This includes a description of the screen displays, how to operate the panels and how to set parameters. Each of the setting descriptions is accompanied by a table explaining how the different functions are performed via the front panel and using an external PC keyboard or mouse.

An overview of the keys, panels and display windows can be found at the end of this chapter.

The functions of the Audio Analyzer R&S UPV are described in detail in Chapter 4. Chapter 2 contains a description of the general operating concept and a brief introduction in which initial measurements are configured step by step. Remote control of the instrument is described in Chapters 5, 6 and 7.

# Functional Organization of the Audio Analyzer R&S UPV

## Instrument Concept

The Audio Analyzer R&S UPV combines the following components in a single housing:

- generators with analog and (with the R&S UPV-B2 and -B20 options) digital audio interfaces for generating the various test signals
- analyzers with analog and (with the R&S UPV-B2 and -B20 options) digital audio interfaces for comprehensive measuring possibilities and
- a computer (PC) with the WindowsXP® operating system for controlling and operating the entire instrument and with connections for PC peripherals and LAN

## Generators

### Universal generator

The **universal generator** consists of signal processors and generates the various test signals from sinusoidal tones through intermodulation test signals (two-tone signals) to noise signals and multi-tones. Following appropriate conversion, these signal are made available at the analog outputs.

Using the R&S UPV-B2 and -B20 options, they can also be output as digital data streams in various formats at the AES/EBU and SPDIF interfaces and at optical interfaces.

The R&S UPV-B4x options, which can be installed in the expansion slots at the rear of the instrument, provide further interfaces for outputting the test signals.

By using the R&S UPV-B2 and -K21 options, you can also generate additional digital data such as channel status data as well as validity and parity bits.

By using the R&S UPV-B20 and -K22 options, the universal generator can also be used to generate **impairment signals** for applying jitter or common-mode interference to the DUT connected to the AES/EBU and SPDIF interfaces.

All test signals can be output on one or two channels. With the R&S UPV-B2 (and R&S UPV-B20) option, two different signals are also available at the digital outputs.

The hardware option R&S UPV-B3 provides the R&S UPV with a **second analog output amplifier**. This allows different signals to be output on the two analog output channels.

### Low-distortion generator

The **low-distortion generator** (R&S UPV-B1 option) is required for all applications where extremely pure analog signals are necessary or an extended frequency range up to 185 kHz is needed. Its intrinsic distortion is considerably less than the already excellent values for the universal generator.

Function blocks and their assignment to the panels

The diagram below shows the function blocks of the generators in the Audio Analyzer R&S UPV:

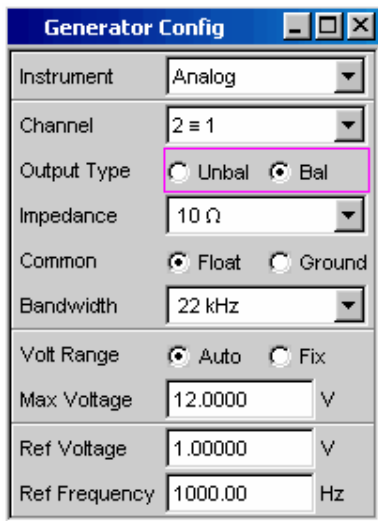
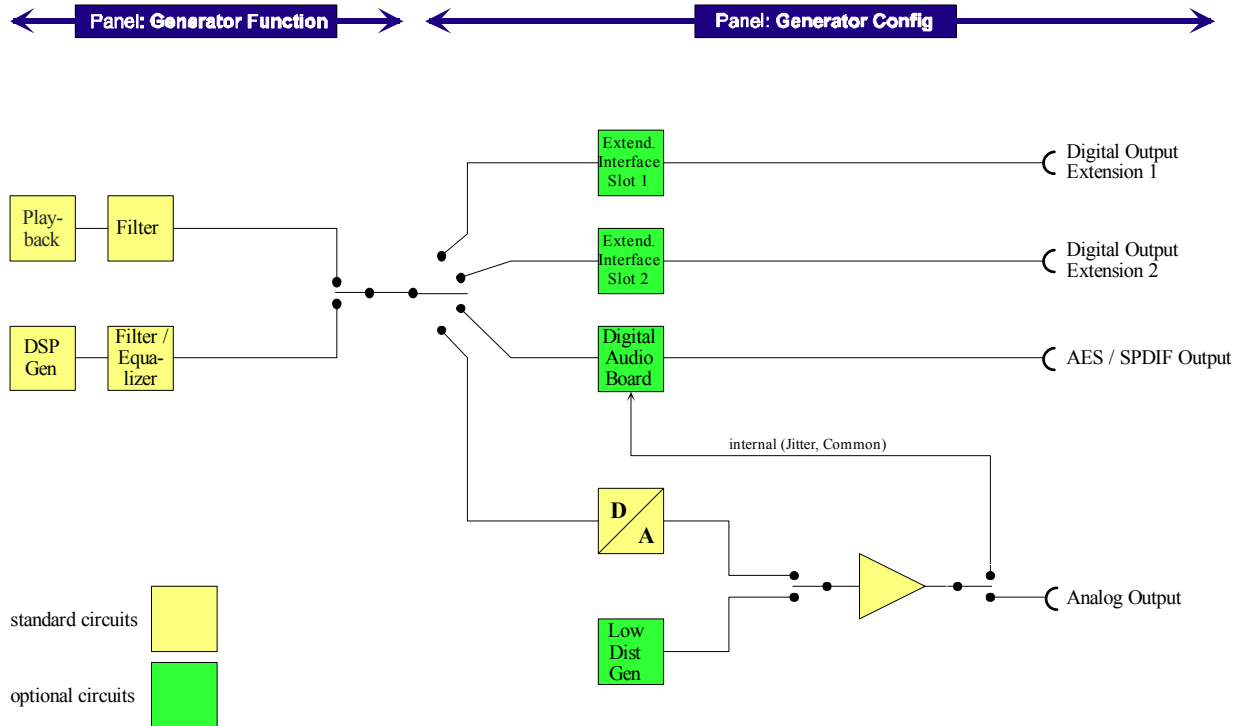

The generators of the R&S UPV are operated in two steps:

In the first step, the following settings are made in the **Generator Config** panel:

- the audio interfaces at which the test signals are to be output
- the channels which are to be active
- maximum level and reference values
- etc

Output as impairment test signals is also set here.



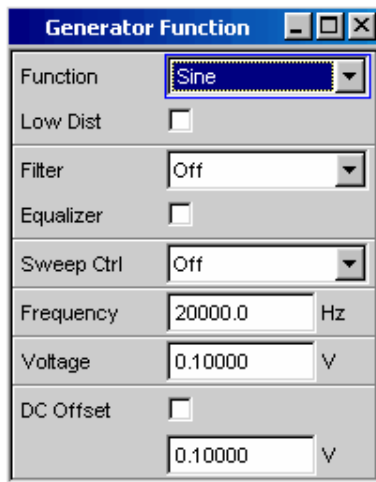

In the second step, the following settings are made in the **Generator Function** panel:

- type of test signal
- output level
- frequencies
- etc

## Analyzers

### Basic concept of the analyzers

The R&S UPV performs all measurements using digital signal processing. Here, analog signals to be measured are first subjected to complex 2-channel **analog preprocessing** on analog measurement modules before they are digitalized and fed to the digital measurement routines.

This concept has the following advantages:

- All audio measurement functions are available at both the analog and the digital interfaces.
- The measurement methods at the analog and digital interfaces are identical.
- Operation at the analog and digital interfaces is always the same.
- The analog preprocessing makes it possible to achieve a higher dynamic response than that provided by the internally used 24-bit converter.
- The R&S UPV can also perform the complex measurement functions simultaneously on both channels; this alone halves the time required for stereo measurements.
- Several measurement functions, e.g. level measurement, FFT analysis, waveform analysis, etc, are calculated simultaneously on separate signal processors and can therefore be displayed at the same time without a delay.
- The digital measurement routines can continuously adapt their speed to the current input frequency and thus achieve high measurement speeds.
- Since the filters are also digital, an almost infinite number of filters is available and can also be used for measurements at analog interfaces.

With the R&S UPV-B2 (and R&S UPV-B20) option, digital audio data streams can also be measured at the AES/EBU and SPDIF interfaces.

The R&S UPV-B4x options, which can be installed in the expansion slots at the rear of the instrument, provide further interfaces for analyzing signals in other formats.

## Function blocks and measurement levels

The analyzer part of the R&S UPV offers a large range of measurement options which are organized in various measurement levels. The measurement results of these levels can also be displayed simultaneously.

The unfiltered input signal is analyzed in the **input level**. The peak level at the input connectors is analyzed here.

The pre-filter, which can be looped into the signal path before all other analyses, is located in front of the **monitor level**. Here you can analyze the RMS value or the DC voltage component of the signal to be tested.

Following any additional filtering using up to 3 filters, detailed analysis is initiated in the **function level**. All the usual analysis tools for measuring linear and non-linear distortion, interferences etc can be found here. The analysis in the time domain (waveform) as well as the FFT analysis with extreme dynamic response and frequency resolution take place here. Moreover, it is possible to record input signals to the hard disk in order to analyze them at some point later.

The measurement values for **frequency** and **phase** or **group delay** can be displayed in a different measurement window parallel to the structure described above.

The **audio monitoring output** (integrated loudspeaker or headphones connection) can be activated on each of the three levels and thus permits audio monitoring of analog or digital input signals both directly at the input and in the different analysis levels. The generator signal can also be switched to the loudspeaker / headphones.

With the R&S UPV-U2 option, the signals of the audio monitoring output can also be output at the BNC connectors on the rear panel of the instrument.

By using the R&S UPV-B2 and -K21, you can also analyze additional digital data such as channel status data as well as validity and parity bits.

With the R&S UPV-B2 and -K22 options, it is also possible to analyze the **digital interface parameters** of DUTs (e.g. jitter, pulse amplitude, sampling frequency, etc) at the AES/EBU and SPDIF interfaces.

The results of these different measurement functions can be displayed in various ways in the **measurement windows**. The type of display, the units used, scaling, etc can be set differently for each measurement function in the associated panels.

The diagram below shows the function blocks and the analysis levels of the R&S UPV analyzer part:

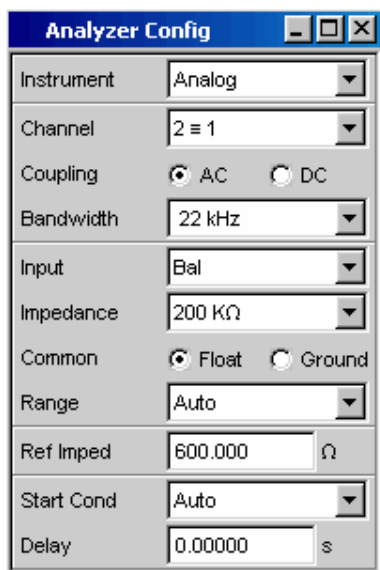
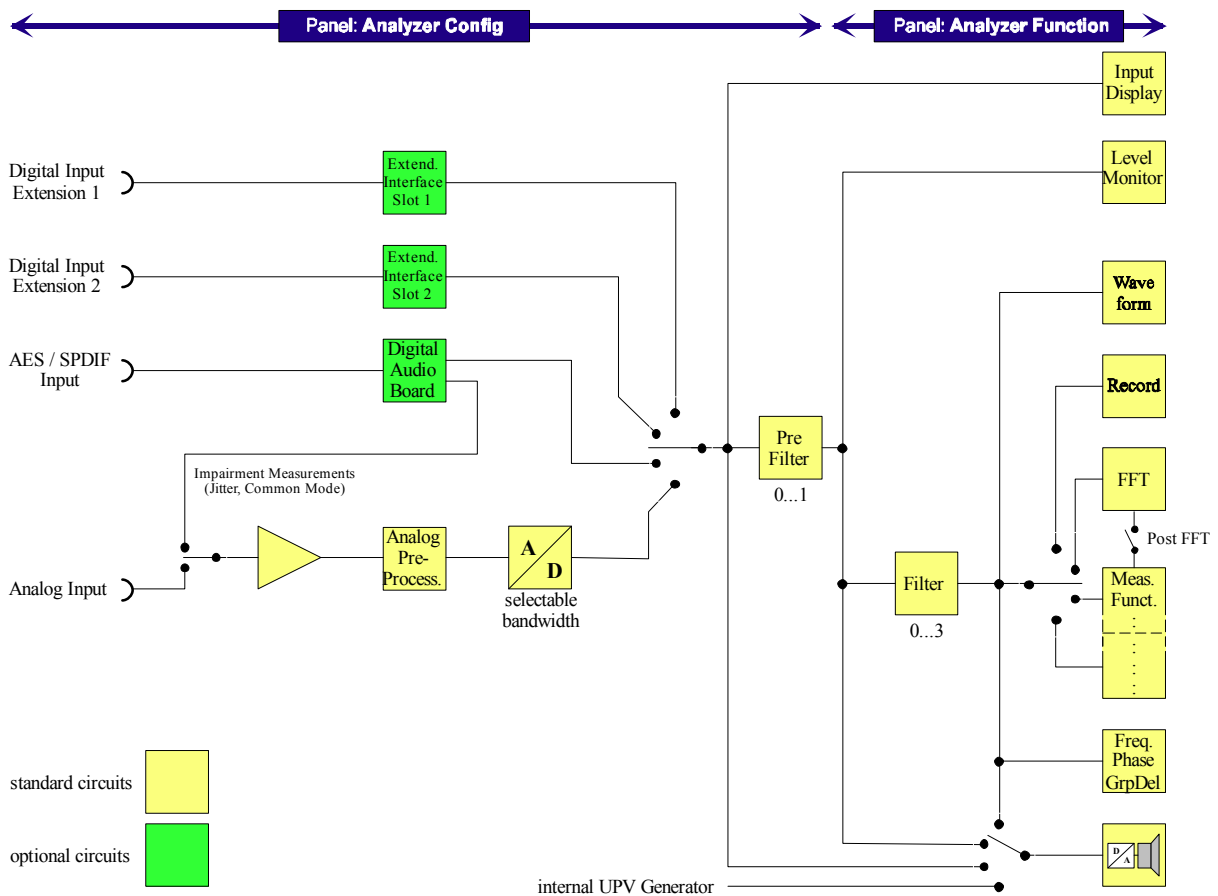

The analyzer part of the R&S UPV is also operated in two steps:

Operation begins in the **Analyzer Config** panel with the selection of:

- analog or digital input connectors
- number of channels
- AC or DC coupling
- measurement bandwidth
- and a number of other parameters

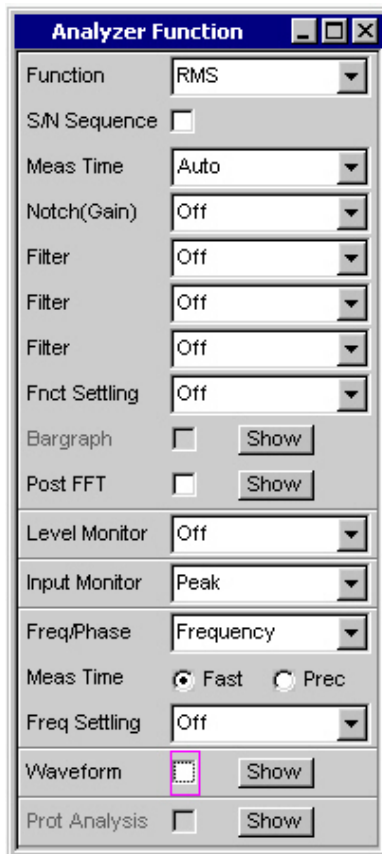

Following this step, the measurements at the various analysis levels of the R&S UPV are set in the **Analyzer Function** panel. The measurements are set in the order of their importance:

- measurements in the function level, e.g. distortion measurements (possibly with Post-FFT enabled)
- settings in the monitor level, e.g. DC measurement
- display of the peak value in the input level
- display of frequency, phase / group delay

In addition, the Waveform and, if necessary, Protocol Analysis functions can be switched on and off in this panel.

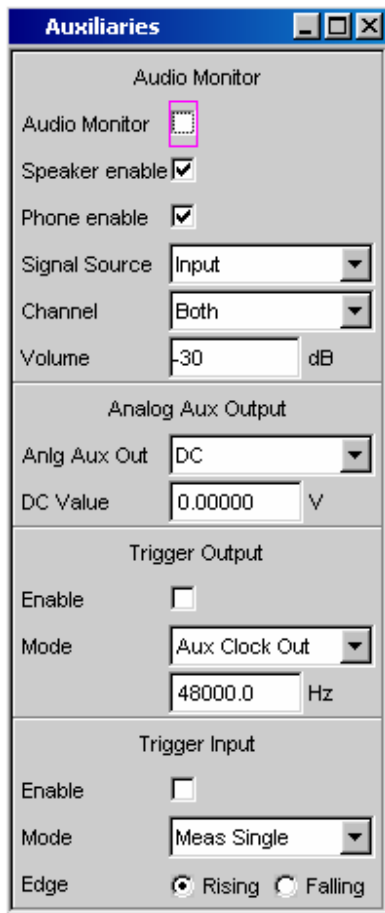

If audio monitoring using the integrated loudspeaker or with headphones is required, this is set in the **Auxiliaries** panel.

The following settings can be made in other panels:

- the way in which the measurement results are to be displayed (numerically or graphically)
- scaling
- limit monitoring
- minimum and/or maximum values
- and many other parameters

# General Information on Operation

## Windows User Interface

To provide the user with a familiar environment, operation is largely based on the Windows® user interfaces. All panels, entry windows, etc are made up of known elements, for example:

Selection fields with parameter lists

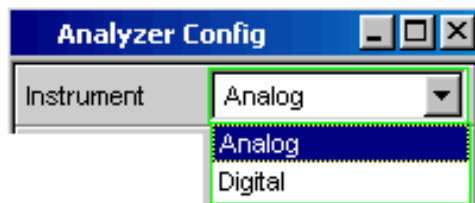

Tick boxes



Radio buttons



Entry fields



A blue, green or magenta selection frame or the highlighting of an entry field (dark background) indicates the current entry focus. Entries can be made in the element with entry focus.

Operation follows the same basic rules which apply to other Windows® programs in use today. It is assumed that the user is familiar with these basic rules. This information is therefore not given in detail in this manual.

## Using the Rotary Knob

Operation is possible using the front-panel keys, an external keyboard and/or a mouse. However, most of the settings can be made with the rotary knob:

- Turning the rotary knob shifts the entry focus to the desired element.
- Pressing the rotary knob (rotary-knob click) opens the parameter list in the selection fields; a parameter can be selected from the list by again turning and then clicking with the rotary knob.
- Tick boxes are activated/deactivated by clicking with the rotary knob.
- The individual radio buttons are selected by turning the rotary knob; they are toggled by clicking with the rotary knob.
- In the entry fields, the numeric values can be changed directly (with immediate effect on the setting) or first edited and then adopted by clicking again with the rotary knob.

## Operation Using the Mouse

Similar to other Windows® programs, the Audio Analyzer R&S UPV can also be operated using a mouse. To permit this, a commercially available mouse (not supplied with the instrument) is connected to one of the 4 USB interfaces at the front or rear of the instrument (see Chapter 1, "Connecting a Mouse", page 1.26).

The mouse makes it easier to move and resize the panels and graphical windows on the screen and provides alternative operating modes. It allows easy operation of Windows®.

The Audio Analyzer R&S UPV also features a special tool bar for mouse operation. You can define whether the tool bar should always be visible at the top edge of the screen or whether it should appear at the right-hand edge of the screen as soon as you move the mouse pointer there. This tool bar contains a number of icons for calling up frequently used functions.

The functions of the mouse correspond to the following front-panel functions:

Mouse	Front panel	Function
Left-click	<input type="checkbox"/> ENTER key, rotary-knob click	<ul style="list-style-type: none"> <li>– Activates selection fields</li> <li>– Selects parameters</li> <li>– Activates/deactivates tick boxes</li> <li>– Toggles radio buttons</li> <li>– Quits the Edit mode</li> </ul>
Move mouse pointer to left-hand edge of screen	<input type="checkbox"/> MENU key	Shows the menu bar
Turning mouse wheel	Turning rotary knob	<ul style="list-style-type: none"> <li>– Navigation in panels, parameter lists, etc</li> <li>– Changes numeric values</li> </ul>
Pressing mouse wheel	Rotary-knob click	<ul style="list-style-type: none"> <li>– Selects parameters</li> <li>– Quits the Edit mode</li> </ul>

## Operation Using an External PC Keyboard

A commercially available, external PC keyboard (not supplied with the instrument) can be connected to one of the 4 USB interfaces at the front or rear of the instrument (see Chapter 1, "Connecting an External Keyboard", page 1.26).

It simplifies the input of list entries, comment texts, file names, etc. A keyboard is required for operating Windows®.

The keys on the front panel of the Audio Analyzer R&S UPV correspond to the following keys and key combinations on the external PC keyboard:

Front panel	PC keyboard
Softkeys F5 ... F12	F5 ... F12
START	CTRL + F5
SINGLE	CTRL + F6
STOP CONT	CTRL + F7
Loudspeaker ON	CTRL + F8
Volume	CTRL + F9
H COPY	CTRL + P
SHUT-DOWN	CTRL + F10
LOCAL	CTRL + F11
OUTPUT OFF	CTRL + F12
SCREEN ◀	CTRL + PAGE UP
SCREEN ▶	CTRL + PAGE DOWN
WINDOW ◀	CTRL + SHIFT + TAB
WINDOW ▶	CTRL + TAB
SCAN ◀	ALT + PAGE UP
SCAN ▶	ALT + PAGE DOWN
PAGE ▼	PAGE DOWN
PAGE ▲	PAGE UP

Front panel	PC keyboard
0 ... 9; A ... Z	0 ... 9; A ... Z
_	SPACE
• ; * ... #	• ; * ... #
+ / -	+ / -
A ↔ a	SHIFT + A ... Z
MENU	CTRL + M
UNDO	BACKSPACE
ESC	ESC
Enter, rotary-knob click	ENTER
Cursor keys	Cursor keys
WINBAR	ALT + W
MODIFY	ALT + M
HIDE	ALT + H
CLOSE	ALT + C
HELP	F1
SAVE	ALT + S
LOAD	ALT + L
PRESET	ALT + P



# Display

## Display and Screens

The display is the central element for operating the R&S UPV. Both the instrument settings in the various panels, and the measurement results are displayed here.

To make the various functions of the Audio Analyzer R&S UPV easier to operate, they were organized in a series of panels.

The measurement results can be displayed as digital numeric values, in data lists, in analog bargraphs or in result graphics. The user can freely choose the number of panels and the number of graphical windows to be shown in the display. The size of the panels can be changed within wide limits, whereby the font size, scaling and so on are adapted automatically according to the type of display window.

5 display windows (or "screens") are provided so that the wealth of information can be better organized. The user can toggle between the individual screens in the following way:

<b>From front panel</b>	Use the direction keys 
<b>With PC keyboard</b>	Use the key combinations CTRL + PAGE UP and CTRL + PAGE DOWN
<b>With mouse</b>	First open the menu bar at the top of the display, then click the <b>Screen</b> button and finally select the desired screen.  Alternatively, you can also select the desired screen directly by clicking it on the tool bar.

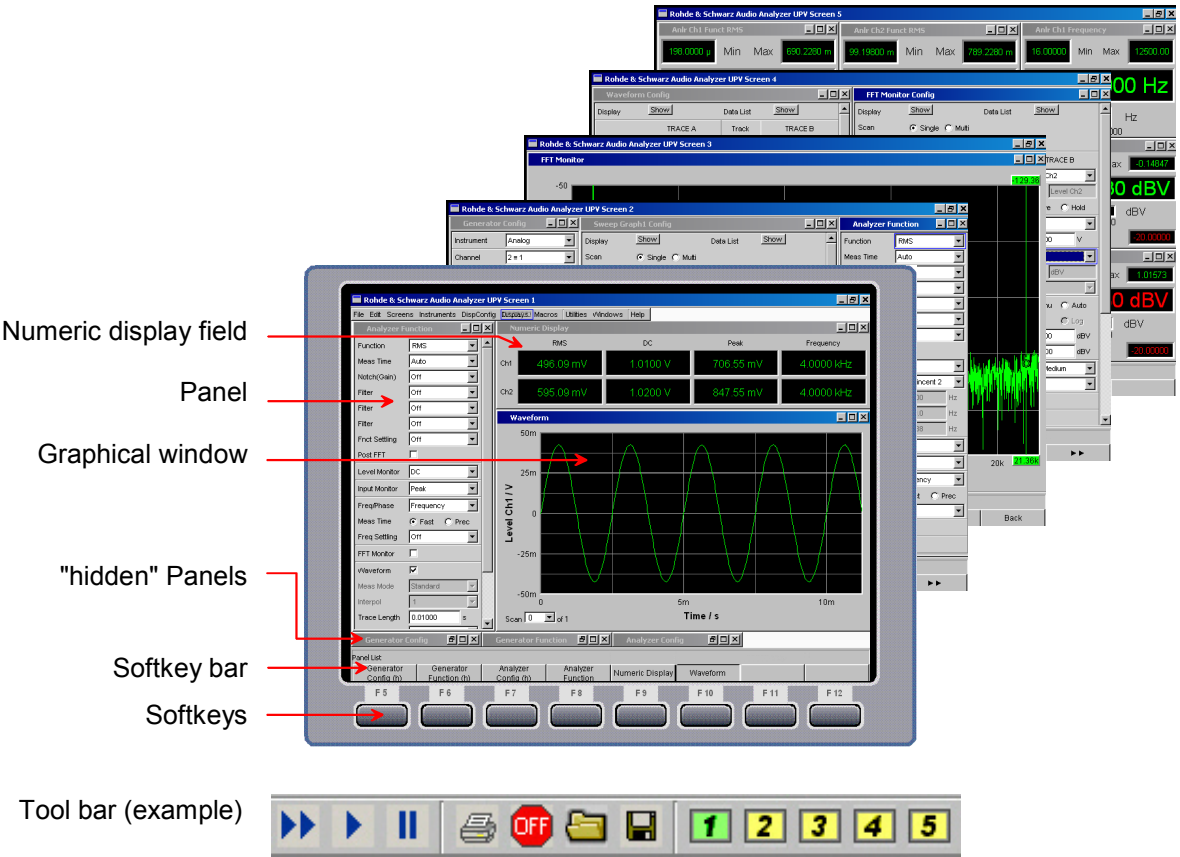
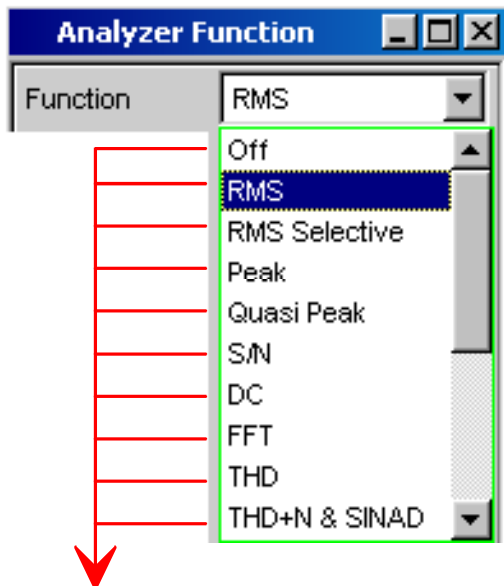

Fig.: 3-1 R&S UPV display with its 5 screens and example of a tool bar

## WINBAR and Softkeys

One of the two bars (either the softkey bar or the WINBAR) is always displayed at the bottom of the screen.



The **softkey bar** which has a varying range of functions is visible in normal operating mode.

In most cases, the functions available in the selection windows of the panels are displayed in the eight buttons; these functions are displayed even if the parameter lists have not (yet) been opened. The labelling of these buttons indicates the functions of the softkeys underneath them.

The function that has just been selected is indicated by a "pressed" button, as shown in the example below for the "RMS" function.

If there are more than 8 elements to choose from, the hidden elements in the selection list can be displayed by pressing the last softkey containing the ►► symbol or the first softkey containing the ◀◀ symbol.

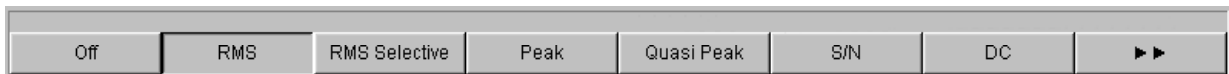

Pressing the respective softkey permits rapid selection.

Softkeys with an additional tick box are also used for a number of applications. In the example below, the left-hand softkey F5 can be used to activate and deactivate the X cursor in a curve diagram. The other softkeys are used to make other settings affecting this cursor. The advantage of this combination is that the user can activate/deactivate a function (here the cursor) using one button and at the same time use the other softkeys for additional settings.

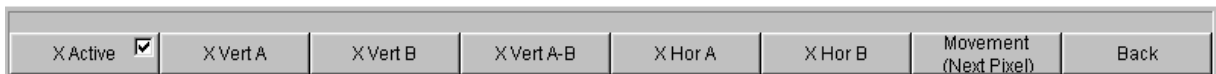

Another variant is the combination of several softkeys with tick box and softkeys without tick box. The example below shows the softkeys for the MODIFY function, described in detail in the section "Moving and Resizing Panels and Graphical Windows" on page 3.16. When a softkey with tick box is selected, the softkey bar remains open so that further settings (e.g. moving a panel) can be carried out. Actuating the other softkeys immediately triggers an action (here, for example, fixing the size of the panel), whereupon the softkey bar is hidden.



If an external PC keyboard is used, the softkeys can be operated using the F5 to F12 keys; if a mouse is used, the buttons in the softkey bar can be clicked directly.

When the **WINBAR** key is pressed, the **WINBAR** appears in place of the softkey bar; this is indicated by "Panel List" in the left-hand corner:



The labeled buttons show the names of all panels and graphical windows open in the current screen. Pressing the associated softkey puts the focus on the corresponding panel / graphical window, i.e. it becomes active. At the same time, the system returns to normal operating mode (i.e. the softkey bar). Hidden panels (see "Opening, Operating, Hiding and Closing Panels", page 3.21) are also listed in the WINBAR. If a hidden panel is selected, it is redisplayed on the screen with its previously set size and position; it simultaneously receives the focus.

The panels and graphical windows displayed in the WINBAR can also be selected by pressing the F5 to F12 keys on the PC keyboard or by clicking with the mouse.

The panel with the focus can be recognized by the highlighted title bar (as shown here in the example on the right-hand side):



It is possible to toggle between the softkey bar and WINBAR at any time by pressing the **WINBAR** key.

Function	Front panel	PC keyboard	Mouse
Select softkey function	Press softkey.	Press keys F5 to F12.	Click button of associated softkey.

## Moving and Resizing Panels and Graphical Windows

As soon as a panel or display window has the focus, it becomes active and can be moved around the screen or resized. This can be done in the following ways:

- The mouse can be used to move or resize the selected panel directly in the same way as other Windows® applications.
- In the case of operation without mouse, the **MODIFY** key (key combination ALT + M on an external PC keyboard) must be pressed, whereupon the following labels appear on the softkey bar:



The associated panel can now be resized or moved; this is indicated by the label in the title bar:



Pressing the **MODIFY** key again restores the original operating mode.

Apart from resizing and moving, the **MODIFY** mode also offers a number of other functions described in the following list:

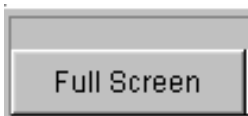

This button is particularly useful for graphical windows. When the **Full Screen** button is actuated, the selected panel is enlarged so that it covers the entire screen.

If this command is used for panels, they are enlarged to their full length and width. Panels the length of which exceeds the screen height are reduced to full screen height.

Actuating this softkey quits the **MODIFY** mode and the selected panel becomes active again.

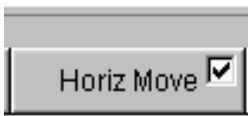

When the **Horiz Move** button is selected, the rotary knob can be used to move the panel/window horizontally without changing the size.

When all modifications to the panel have been made, pressing the **MODIFY** key restores the original operating mode.

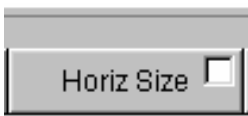

When the **Horiz Size** button is selected, the rotary knob can be used to resize the panel/window (the right-hand edge of the selected panel is moved).

When all modifications to the panel have been made, pressing the **MODIFY** key restores the original operating mode.

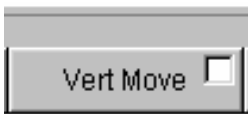

When the **Vert Move** button is selected, the rotary knob can be used to move the panel/window vertically without changing the size.

When all modifications to the panel have been made, pressing the **MODIFY** button restores the original operating mode.

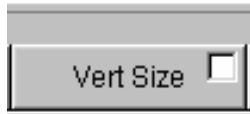

When the **Vert Size** button is selected, the rotary knob can be used to resize the panel/window (the bottom edge of the selected panel is moved).

When all modifications to the panel have been made, pressing the **MODIFY** key restores the original operating mode.

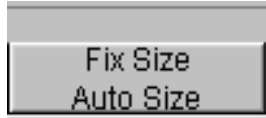

Actuating the **Fix Size Auto Size** button switches to "Auto Size" mode and adjusts the size of the selected panel/window to display all setting times or to use the full height of the screen. This state is indicated by an asterisk in the title bar.

The default setting is "Fix Size". With this setting, the panel is not enlarged if, for example, additional fields appear in the panel when certain functions are selected; only the scroll bar indicates the presence of additional fields.

Actuating the button again toggles between the two modes.

Actuating this softkey quits the MODIFY mode and the selected panel becomes active again.

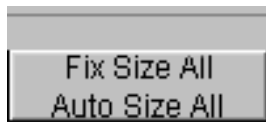

Actuating the **Fix Size All Auto Size All** button switches all panels/windows to "Auto Size" mode and adjusts the size of the panels/windows to display all setting times or to use the full height of the screen. This state is indicated by an asterisk in the title bars.



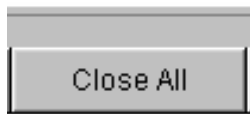

Actuating the button again toggles between the two modes.

Actuating this softkey quits the MODIFY mode and the selected panel becomes active again.



When the **Close All** button is selected, all of the panels and measurement windows displayed on the screen are closed. The function corresponds to the **CLOSE** key, except that it affects all panels and measurement windows displayed on the screen.

Actuating this softkey quits the MODIFY mode and the selected panel becomes active again.

Function	Front panel	PC keyboard	Mouse
<b>Enlarge graphical window to full screen size</b>	Press <b>MODIFY</b> key and actuate F5 softkey.	Press key combination ALT + M and then F5 key.	Click  button in title bar of respective graphical window.
<b>Move panel/graphical window</b>	Press <b>MODIFY</b> key, select direction of movement using softkey and move panel using rotary knob.	Press key combination ALT + M, select direction of movement using keys F6 or F8 and move panel using keys TAB and SHIFT + TAB.	Click title bar of panel and drag to resize.
<b>Resize panel/graphical window horizontally and vertically</b>	Press <b>MODIFY</b> key, select resizing direction using softkey and resize panel using rotary knob.	Press key combination ALT + M, select resizing direction using keys F7 or F9 and resize panel using keys TAB and SHIFT + TAB.	Drag top/bottom or side edge of panel.
<b>Resize panel/graphical window proportionally (horizontally and vertically)</b>	Press <b>MODIFY</b> key, change to second level using  button, actuate F6 softkey and resize panel using rotary knob.	Press key combination ALT + M, press F12 key and then F6 key, and resize panel using keys TAB and SHIFT + TAB.	Drag one corner of panel.
<b>Adjust panel/graphical window to the required size</b>	Press <b>MODIFY</b> key and actuate  or  button.	Press key combination ALT + M, then press F10 or F11 key.	---
<b>Close all panels/panel on screen</b>	Press <b>MODIFY</b> key, change to second level using  button and actuate F10 softkey.	Press key combination ALT + M, F12 key and then F10 key.	---

## Status Displays and Messages

In some cases, the user is presented with additional information on the screen. This information includes status messages, messages concerning the value ranges, information on settings, warnings and error messages.

### Status displays

The status of the R&S UPV is continuously displayed for the generator, analyzer, sweep system and other instrument states at the bottom of the screen above the four right-hand softkeys.

Status displays always appear at the same position; they are assigned to the fields above the softkeys as shown below.

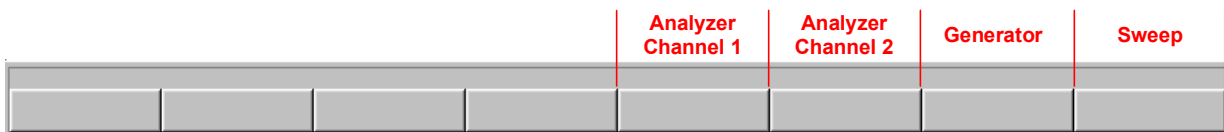

A list of all possible status messages can be found at the end of this chapter (section "Overview of Status Messages", page 3.126).

### Valid value range

Information on the possible entries is given at the bottom of the screen above the softkey bar. The ranges for value entries specified here always take the current status of the instrument into consideration and therefore depend on the presets already configured. Below is an example for entry of the generator output voltage:



### Information

Information concerning the panel settings and so on is also given at the bottom of the screen above the softkey bar (only the space above the four left-hand softkeys is used).

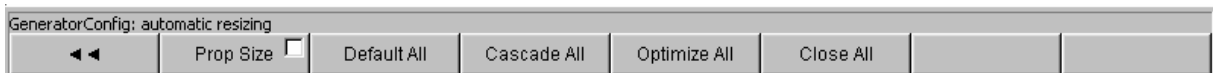



**Warnings**

If the user attempts to make measurement settings which conflict with the usual test specifications, warnings appear on the screen; and remain there until they are acknowledged with ENTER.

Warnings are issued if no measurement results are produced during measuring mode. This is normally the result of unsuitable input signals or settings. For example, input signals may be too low to produce a stable measurement result. In this case, a warning is displayed in the middle of the screen instead of the measurement result. The warning indicates why no measurement result can be displayed and may also list several reasons for this.

**Error messages**

If faults in the instrument occur during operation, an error message appears in the middle of the screen. This message remains on screen until it is acknowledged with ENTER.

# Panels

## Panel and Window Types

In the case of the Audio Analyzer R&S UPV, associated settings and functions are always combined in "panels". Each of these panels has a name (headline in the title bar) by which it is called up.

Only one panel can have the focus, i.e. only one panel can be active at any one time. The panel with the focus can be identified by its blue title bar.

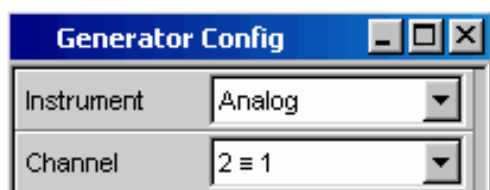

The Audio Analyzer R&S UPV distinguishes between the following panels and display windows:

- **Panels** used to make function settings
- **Configuration panels** used for configuring how the measurement values are to be displayed
- **Numeric display fields** for displaying the measurement values of the various measurement functions
- **Combi displays** in which the numeric display of measurement values can be supplemented by bargraphs, min/max values and limit monitoring
- **Graphical windows** in which measurement values are displayed in the form of diagrams
- **Data lists** in which the measurement values are listed in tabular form; this also includes the "Dig Analyzer Protocol" display window, in which the values of the protocol data of a digital audio data stream are displayed (R&S UPV-K21 option).

A detailed list of all panels together with the most important setting parameters can be found at the end of this chapter (see *"Overview of Panels and Measurement Displays (Graphical Windows)"*, page 3.122).

## Opening, Operating, Hiding and Closing Panels

Each panel and display window is a separate panel which can be either closed, opened or hidden. All panels/display windows visible on the currently displayed screen are referred to as being "open". If the panel is minimized and moved to the bottom of the screen, it is referred to as being "hidden". In both cases, the panel/window is assigned an entry in the WINBAR at the bottom of the display.

The same panel or display window can be displayed (i.e. opened) in several screens. The display characteristics (position, size) can be different for each of the screens; the content is, however, always the same.

### Open panel

Panels/display windows are open if they are visible on the currently displayed screen.

A panel is opened on the currently displayed screen by activating the menu bar using the **MENÜ** key, highlighting the **Instruments** or **Disp Config** button with the rotary knob or cursor keys, opening the pulldown menu with the **ENTER** key or rotary-knob click, and highlighting and selecting a panel.

Graphical windows are selected in the same way, except that they are listed under the **Displays** button.

### Activate panel

Only one panel can be active on the screen at any one time.

Every open or hidden panel can be activated using the softkeys on the WINBAR or using the **Windows** key (active panels are identified by their blue title bar).

### Hide panel



Open panels/display windows can be minimized and placed at the bottom of the screen. They are referred to as being "hidden".

A panel must be activated before it can be hidden. It is then hidden by pressing the **HIDE** key.

### Close panel

A panel must be activated before it can be closed. It is then closed by pressing the **CLOSE** key and no longer appears on the WINBAR.

The table below shows the alternative operating modes for mouse and external keyboard:

Function	Front panel	PC keyboard	Mouse
<b>Open panel</b>	Press <b>MENÜ</b> key and highlight <b>Instruments</b> , <b>Disp Config</b> or <b>Displays</b> button using rotary knob or cursor keys, open pulldown menu using <b>ENTER</b> key or rotary-knob click, and highlight and select a panel.	Press key combination CTRL + M, then highlight <b>Instruments</b> , <b>Disp Config</b> or <b>Displays</b> button using TAB or SHIFT + TAB keys, open pulldown menu using Enter key, highlight a panel using cursor keys and select using Enter key.	Open menu bar by moving to left edge of screen, actuate <b>Instruments</b> , <b>Disp Config</b> or <b>Displays</b> button and click desired panel.
<b>Activate panel</b>	Press <b>WINBAR</b> key and actuate softkey of desired panel.	Press key combination ALT + F5, then actuate softkey of desired panel using appropriate key F5 to F12.	Click anywhere in desired panel.
<b>Hide panel</b>	Pressing <b>HIDE</b> key hides currently active panel.	Pressing key combination ALT + H hides currently active panel.	Click  button in title bar of respective panel.
<b>Close panel</b>	Pressing <b>CLOSE</b> key closes currently active panel.	Pressing key combination ALT + C hides currently active panel.	Click  button in title bar of respective graphical window.

## Panel Structure

This section describes the panel structure. The section *"Opening, Operating, Hiding and Closing Panels"*, page 3.21 describes how to operate panels on the screen; the section *"Selecting a Parameter – Selection Fields"*, page 3.34 describes how to set the parameters. The panels are in Windows® format. They differ in detail depending on their function but they consist of the same main elements.

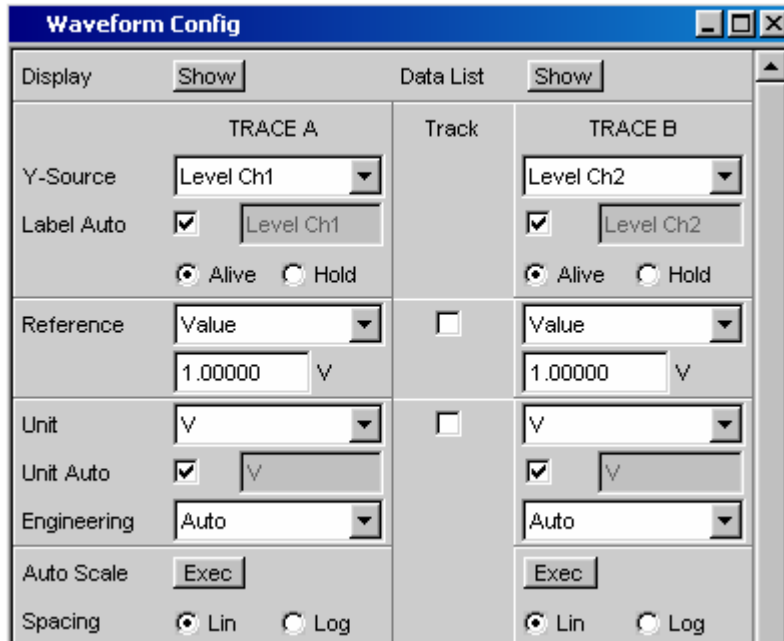



Panels consist of up to three columns, depending on the function block on which the panel is based. For example, two-channel functions are operated in panels with two columns. When defining graphical windows, settings from Trace 1 can be adopted for Trace 2 in a third column between the two original columns so that Trace 2 does not have to be configured separately.

Each panel contains a selection of different parameter fields which are combined in groups. Various types of parameter fields, which are operated in different ways, are used. The parameter fields have labels indicating their function.

Panels consist of the following elements:



#### Title bar

The top field contains the name of the panel ("Analyzer Function" in the example) and the title-bar buttons for hiding  and closing  the menu. The buttons can be operated with the mouse. For operation using the front panel, the **HIDE** and **CLOSE** keys can be used.

The  button maximizes graphical windows so that they cover the entire screen (see "WINBAR and Softkeys", page 3.14).

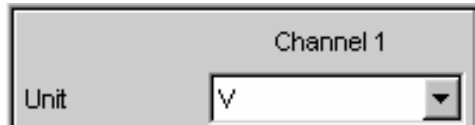

#### Headlines in panels

With multi-column panels, each column has a headline.

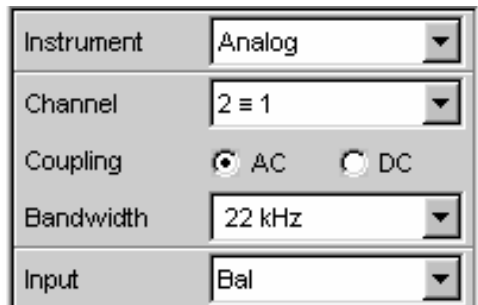

#### Function groups

In panels, parameter fields which belong together with respect to their function are frequently combined in function groups. Grey lines indicate these groups.



#### Numeric entry field

A numeric value (e.g. the frequency) can be entered in this field.



#### Units

The unit of a numeric value is displayed next to the entry field. When the value is entered, all possible units are offered on the softkey bar (on more than one level where necessary). The entry can be completed by selecting the unit using a softkey. The unit can be changed after the entry has been made. In this case, the physical value remains unchanged; however, the value displayed in the entry field is adapted automatically to the changed unit.



#### Text entry field

An alphanumeric value (e.g. a label text) can be entered in this field.

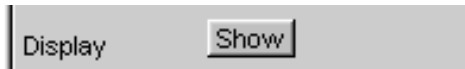

**Button**

Buttons are used to trigger actions; here, for example, to show the display of a measurement graph.



**Tick box**

If a tick box is activated, the assigned setting can be disabled or enabled.

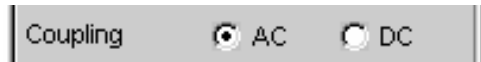

**Radio button**

With radio buttons, it is possible to toggle between two settings by simply clicking the desired setting.

Only one of the two options can be active at any one time.

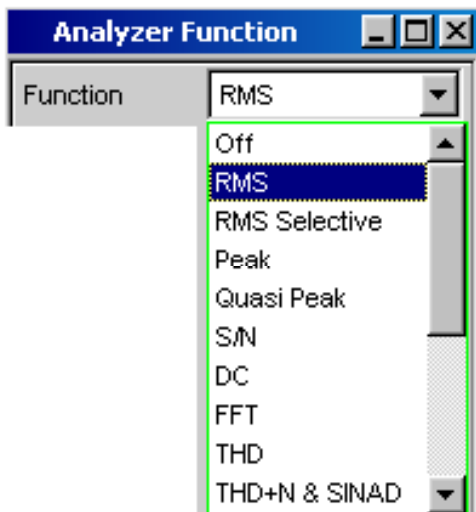

**Selection field**

The  button indicates that a parameter list is available. The fold-down parameter list is displayed below the selection field. Depending on the number of items, the full list or only part of it is shown.

Only one item at a time can be selected from the parameter list.



**Display fields**

Some settings can only be made in a specific configuration. If the setting is not permitted with the specific configuration selected, the respective item is disabled and displayed in grey and the field cannot be accessed. In this case, the field acts as a display field, i.e. the value displayed there corresponds to the value actually set.

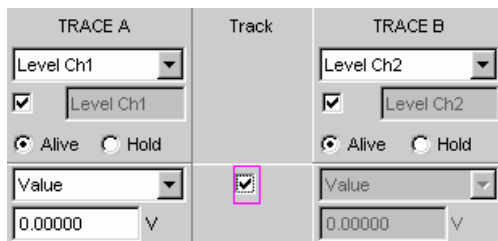

**Track box**

With multi-column panels, settings can be transferred from the left-hand to the right-hand column without the parameter having to be entered a second time. If the track box has a checkmark, all of the settings within the function group are applicable to both columns. All fields with transferred settings are shown as display fields and cannot be accessed while the track function is active.

Zooming	<input type="checkbox"/>
Start	<input type="text" value="0.00000"/> Hz



Zooming	<input checked="" type="checkbox"/>
Zoom Fact	<input type="text" value="2"/>
Center	<input type="text" value="10000.0"/> Hz
Span	<input type="text" value="21.94 kHz"/>
Start	<input type="text" value="0.97656"/> Hz



**Hidden parameter fields**

The R&S UPV always attempts to keep the panels as short as possible. For this reason, unneeded fields are hidden. The example to the left demonstrates this more clearly: The fields for Zoom Factor, Center and Span only appear if the Zooming function is activated.

## Navigating in the Panels

If a panel has more fields than can be displayed on the screen or if the size of the panel has been fixed such that its full length cannot be displayed (see *"Moving and Resizing Panels and Graphical Windows"*, page 3.16), the scroll bar appears along the right-hand side of the panel. The length of the scroll bar symbolizes the overall length of the panel; the dark part of the scroll bar indicates which section of the panel is currently visible.

There are various ways of navigating inside panels, i.e. moving the entry focus:

- With operation via the front panel, the easiest navigation method is using the rotary knob. Turning the rotary knob clockwise moves the focus down or to the right. Here the focus first moves to the right inside a field, then down through the current group, then jumps over to the right-hand column, down again to the end of the group from where the focus then moves to the left-hand column of the following group, and so on.
- Alternatively, the cursor keys  and  can also be used for navigation; the movement sequence is the same as that described for operation using the rotary knob.
- In the case of an external PC keyboard, the cursor keys  $\uparrow$  and  $\downarrow$  can be used to move around a panel. Once again, the movement sequence is the same as that described for navigation using the rotary knob. The TAB and SHIFT + TAB keys on the external keyboard can also be used as an alternative to the cursor keys.
- The mouse can also be used to move inside the panels in the same way as other Windows® applications, i.e. by directly clicking the desired parameter fields or by moving the scroll bar.

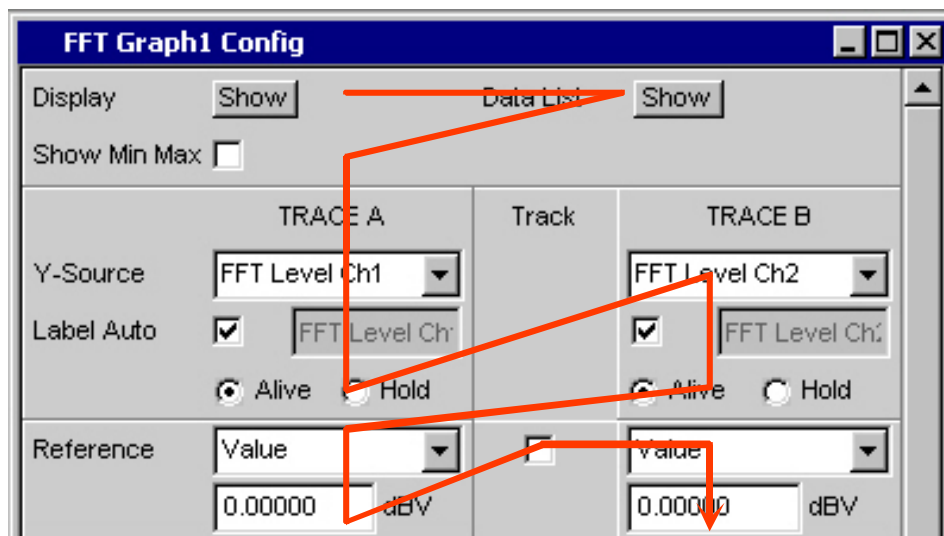



## Settings on the Audio Analyzer R&S UPV

The R&S UPV offers several and sometimes alternative options for setting parameters. Operation is possible via the front panel, using a mouse and/or a connected PC keyboard (see the sections *"Using the Rotary Knob"*, *"Operation Using the Mouse"* and *"Operation Using an External PC Keyboard"* from page 3.9 onwards). The tables below list the operating options with the available entry media.

Some keys on the front panel of the R&S UPV trigger a setting immediately; for example, the **OUTPUT OFF** key deactivates or reactivates outputs. An overview showing the function of all keys can be found at the end of this chapter (section *"Overview of Keys"*, page 3.118).

Most of the parameters are set in the panels. The panels are operated on the screen in the way described in the section *"Opening, Operating, Hiding and Closing Panels"* (see page 3.21). How to enter and select setting parameters in the panels is described in the following sections; a detailed description of all setting parameters can be found in Chapter 4, *"Instrument Functions"*.

Entries for file management tasks, such as saving and loading instrument settings, saving files, and so on, are made in special panels. Refer to the section *"File Management"* (see page 3.102) for more detailed information.

A number of settings are made via the menu bar. These include all global configuration settings for the R&S UPV, e.g. setting of the IEC/IEEE-bus address, the function of the H Copy key, etc. More detailed information can be found in the section *"Settings in the Menu Bar"* on page 3.86 and in Chapter 4, *"Instrument Functions"*.

The R&S UPV uses the WindowsXP® operating system. Settings at system level are only rarely required, e.g. installation of a new printer driver. Connecting a keyboard and mouse makes Windows® easier to use.

## Settings in the Panels



Associated settings and functions are combined in panels of the Audio Analyzer R&S UPV. Each function block has its own panel.

The panels can be set independently of each other; however, there are also a number of interdependencies. For example, the digital measurement function of the protocol analysis only appears in the **Analyzer Function** panel if a digital analyzer has been selected in the **Analyzer Config** panel. If an analog analyzer is selected, the protocol analysis is automatically deactivated in the **Analyzer Function** panel and a message is displayed on the screen.

### Focus

Panels can only be operated if they have the focus (indicated by the blue title bar).

The simplest way of changing from one panel to another in the case of operation via the front panel is

using the direction keys . The  key switches from panel to panel in the sequence in which the panels were opened. Hidden panels are not highlighted. Changing to a different open (or to a hidden) panel is also possible using the WINBAR; this has already been explained in the section "WINBAR and Softkeys" on page 3.14.

Before settings can be made in a panel, the relevant parameter field must be highlighted, i.e. it must have the focus. This is indicated by a selection frame which is blue, green or magenta depending on the entry mode.

The colors of the selection frame have the following meaning:



A blue selection frame indicates a highlighted field.



A green selection frame highlights fields in which parameters can be selected or in which an entry can be made without the selection / entry having an immediate effect on the hardware of the R&S UPV.

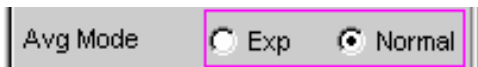

A magenta selection frame indicates that selecting a button, activating a tick box or changing a numeric value will be immediately passed on to the hardware and executed.

When the instrument is switched on, the most recently saved instrument settings are loaded automatically so that the instrument is in the same state as it was before power-off. The focus is placed on the first position of the active panel.

Panels are opened using the menu bar (see the section "Open panel", page 3.22). How to move the focus is described in the section "Navigating in the Panels" (see page 3.27).

## Changing the Instrument

The Audio Analyzer R&S UPV can, depending on the installed options, be used at analog and digital interfaces. Optional plug-ins can be installed to allow additional interfaces to be operated. Each of these interfaces determines the basic characteristics of the R&S UPV, whereby these characteristics are separate for generator and analyzer. These interface characteristics define quasi-independent instruments within the R&S UPV. The settings for these instruments are made in the selection field in the first field of the **Generator Config** and **Analyzer Config** panel.



Each of these instruments has its own data set. If a different instrument is selected, this data set is saved. As a result, the previous settings are available when the original instrument is selected again.

The data set has a different content for each instrument. The data sets differ with regard to the following points:

- **Selection of parameter fields / parameters**  
Example: In the case of analog instruments, all settings for configuring the analog interfaces are available (e.g. impedances); all settings for the other instruments, e.g. the digital sampling rate and so on, do not appear in the panel but remain in the background.
- **Valid value range of parameters**  
For example, the frequency ranges can be different in the different instruments.
- **Units used**  
Levels are given in different units in analog and digital applications.
- **Selection of functions**  
A number of measurement functions are only available for digital audio applications; they are therefore not offered in analog instruments. Examples: Digital protocol analysis, jitter, etc.

The examples given above show that the choice of instrument not only affects the Generator Config and Analyzer Config panel, but also has an effect on the other panels.

## Changing Functions

The principles that apply to changing an instrument also apply to changing functions (e.g. from an RMS measurement to a THD measurement or from generating a sinusoidal to a multi-tone signal):

Each measurement function and generator function has its own data set. If a different function is selected, this data set is saved. As a result, the previous settings are available again when a different function is selected.

The data set has a different content for each function. The data sets differ with regard to the following points:

- **Selection of parameter fields / parameters:**  
Example: With the RMS measurement, various measurement times are offered; this is not the case for the FFT analysis.
- **Valid value range of parameters**  
For example, the frequencies which can be set for intermodulation test signals are different to those which can be set for sinusoidal signals.
- **Units used**  
For example, THD measurements and level measurements are given in different units.

The following generally applies: All the settings for the other functions, e.g. filter settings and so on, remain in the background with the function settings and are displayed in the panel and set in the instrument again the next time this function is called up.

## Hiding Parameter Fields

The R&S UPV always attempts to keep the panels as short as possible. For this reason, unneeded fields are hidden.

The example below explains this more clearly: As soon as **Auto Sweep** is selected in the **Sweep Ctrl** menu item in the **Generator Function** panel, all of the fields required for configuring the sweep are displayed in the panel (together with the parameters set for the sweep last performed). If the sweep is deactivated, all of the sweep parameter fields are hidden. The user is presented with a shorter panel and is not burdened with parameter fields which are currently not needed.

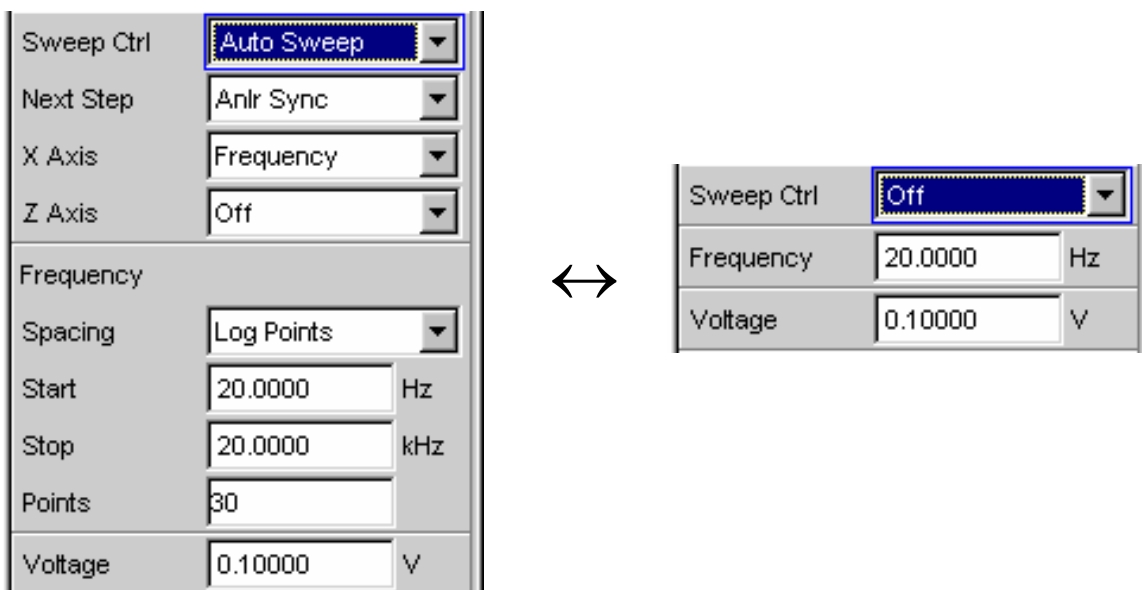

### Note:

The sequence of the individual parameter fields in the panel is such that changes to parameters usually only cause changes in the fields below. When making settings in panels, it is therefore recommended to begin at the top of the panel and work down.

## Highlighting Control Elements

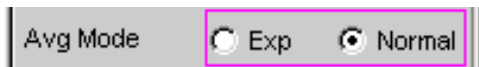

A control element is always selected in the same way, regardless of whether it is a tick box, radio button, entry field and so on.

A control element is activated by shifting the focus to this element. The entry focus is indicated by a blue, green or magenta border.

The entry focus can be moved using the rotary knob, cursor keys or mouse. Refer to the section "Navigating in the Panels", page 3.27.

## Activating/Deactivating Functions – Tick boxes

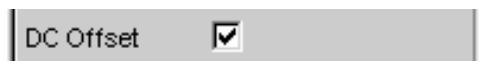

A tick box is always used for functions which can be activated and deactivated only. If the tick box is activated (checkmark), the assigned setting can be disabled or enabled.

Before a function can be activated and deactivated, the associated element must be highlighted (see the section "Highlighting Control Elements", page 3.32). The highlighted element is then activated or deactivated (toggle function) using the ENTER functions of the various entry media (  key, rotary-knob click and so on).

If the mouse is used, functions are activated/deactivated as soon as the tick box is clicked.

Function	Front panel	PC keyboard	Mouse
Activate/deactivate	Highlight desired element using rotary knob or cursor keys, activate/deactivate function with rotary-knob click or <input type="text" value="ENTER"/> key.	Highlight desired element using cursor keys, activate/deactivate function with Enter key.	Click tick box.

## Toggling Functions – Radio Buttons



Radio buttons are used for functions which can be toggled between two settings. A black dot in the appropriate button indicates the selected status.

Only one of the two options can be active at any one time.

Before a function can be toggled, the associated element must be highlighted (see the section *"Highlighting Control Elements"*, page 3.32). The ENTER functions of the various entry media can then be used to switch between the two settings (toggle function).

If the mouse is used, settings are executed as soon as the corresponding radio button is clicked.

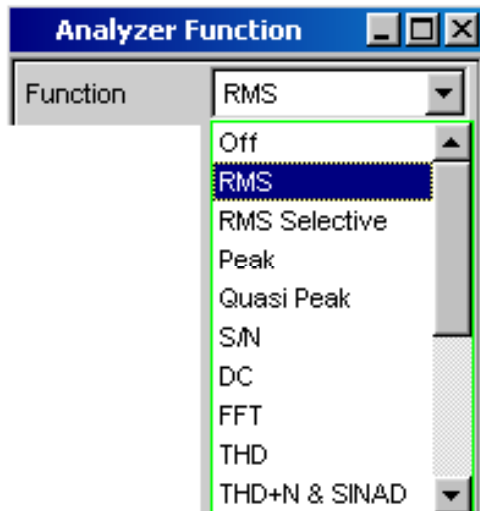

Function	Front panel	PC keyboard	Mouse
<b>Toggle</b>	Highlight desired element using rotary knob or cursor keys, toggle function with rotary-knob click or <b>ENTER</b> key.	Highlight desired element using cursor keys, toggle function with Enter key.	Click desired radio button.

## Selecting a Parameter – Selection Fields



Actuating the  button opens a selection field. As soon as a parameter field has the focus, a list for selecting the available parameters can be opened with a rotary-knob click, the **ENTER** key or by clicking with the mouse. The fold-down parameter list is displayed below the selection field.

Selection is made by highlighting the desired item and confirming with **ENTER**; only one item at a time can be selected.

Items in the parameter list are highlighted using the rotary knob, the cursor keys   or the keys .

If a mouse is used, the items are selected and activated by clicking with the mouse.

The parameter list can be quit without adopting the highlighted parameter by pressing the **ESC** key.

If the list is longer than the displayed window, a scroll bar is available.

---



### Note 1:

*The contents of the parameter lists are not fixed but vary depending on other settings selected.*

### Note 2:

*Alternatively, parameters can also be selected using the softkeys (see the section "WINBAR and Softkeys", page 3.14).*

---

Function	Front panel	PC keyboard	Mouse
Open parameter list	Rotary-knob click or press <b>ENTER</b> key.	Press Enter key.	Click  button.
Scroll	Move displayed section of list using rotary knob or up/down cursor keys.	Move displayed section of list using up/down cursor keys.	Click  or  button in scroll bar until desired item is displayed.
Select parameter	Highlight selection using rotary knob or up/down cursor keys and confirm with rotary-knob click or <b>ENTER</b> key.	Highlight selection using up/down cursor keys and press Enter key.	Click parameter.
Quit parameter list without adopting a setting	Press <b>ESC</b> key.	Press ESC key.	Click anywhere outside parameter list.

## Numeric Entries – Numeric Entry Fields

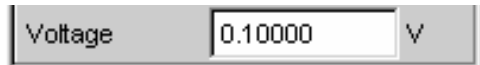

Numeric values (e.g. the output voltage) can be entered or edited in these fields.

This can be done in various ways. However, the following applies irrespective of the chosen method:

---

**Note:**

*Entries outside the possible value range are not accepted; an audible warning is issued and the entry is changed to its permissible minimum or maximum value. The possible value range is displayed above the softkey bar.*

---





## Value entries in Edit mode – green selection frame



When the focus is moved to a numeric entry field, the system enters Edit mode, which is indicated by a green selection frame. In addition, the current numeric value is highlighted with a blue background.

If a completely new value is to be entered, simply begin entering digits using the numeric keypad on the front panel or external PC keyboard; the old value is deleted automatically when the first key is pressed. The digit to the left of the cursor can be deleted at any time during entry using the **[UNDO]** key.

If certain digits only are to be changed, position the digit cursor accordingly using the  or  cursor key and enter the new digits (if the position of the digit cursor is changed before the first digit is entered, the old value will not be deleted). The default setting is insert mode. It is only possible to change between insert and overwrite mode if an external PC keyboard is used.

The numeric entry field is closed with:

**ENTER** The newly entered value is adopted.

**ESC** The old value is retained.

**Softkeys** The selected unit is set and adopted together with the newly entered value.

The entry is set in the hardware as soon as the numeric entry field is closed.

---

### **Note:**

*Only the number keys and cursor keys are accepted; the rotary knob, letters and special characters have no effect when numeric values are being entered.*

---

When an external PC keyboard is connected, digit entry can also be completed by entering the unit. Here it is sufficient for example to enter *m* to the set voltage value to *mV*, or *k* to set a frequency value to *kHz*.

## Value entries in Direct mode – magenta selection frame

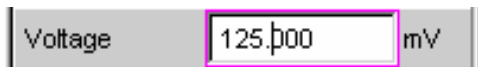



When the focus is moved to a numeric entry field, the system enters Edit mode, which is indicated by a green selection frame.

Changing to the Direct mode is performed by pressing the **ENTER** key or with rotary-knob click, the selection frame is changed to magenta.

The digit cursor then moves to the first digit to the right of the decimal point or, if there is no decimal point, to the digit at the extreme right.

A digit can now be entered using the keypad on the front panel or the external PC keyboard; the digit at the cursor position is replaced. The cursor does not change its position.

The digit cursor can be placed at a different position at any time using the  and  cursor keys. Digits are then entered at the new position.

Entries in Direct mode are always made in overwrite mode (this also applies when an external PC keyboard is used).

In Direct mode, every setting change is immediately passed on to the hardware and executed.

The Direct mode can be quit using the ENTER function, the **ESC** key or by clicking in a different field with the mouse.



---

### **Note:**

*Only rotary-knob entries, number keys and cursor keys are accepted; letters and special characters have no effect.*

---

## Rotary-knob entries in Direct mode – magenta selection frame



When the focus is moved to a numeric entry field, the system enters Edit mode, which is indicated by a green selection frame.



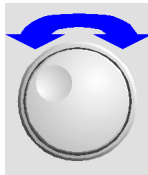

Changing to the Direct mode is performed by pressing the **ENTER** key or with rotary-knob click, the selection frame is changed to magenta.

The digit cursor then moves to the first digit to the right of the decimal point or, if there is no decimal point, to the digit at the extreme right.





The highlighted digit can then be changed directly using the rotary knob, whereby the numeric value is "carried over", i.e. transferred to the next digit.

The digit cursor can be placed at a different position at any time using the  and  cursor keys so that other digits can be changed using the rotary knob.

This method is ideal for calibration work as every change has an immediate effect in the hardware.

Value entry can be completed with a rotary-knob click or, alternatively, using the ENTER function, the **ESC** key or by clicking in a different field with the mouse.



As an alternative to the rotary knob, the numeric values can also be changed using the  and  cursor keys.

---

### Note:

*Changes made to values using the rotary wheel are not accepted if the entries are outside the possible value range; an audible warning is issued and the entry is changed to its permissible minimum or maximum value. The possible value range is displayed above the softkey bar.*

---

## Entering / changing the unit of a value

v

The unit of a numeric value is displayed next to the entry field. When the value is entered, all units available for the respective function are offered on the softkey bar (on more than one level where necessary). The entry can be completed by selecting the unit using a softkey.

This is done differently depending on the selected mode:

- In Edit mode, the newly entered numeric value is adopted and set together with the selected unit.
- In Direct mode, the physical value (number with the previously selected unit) is converted to the newly selected unit and adopted as the new numeric value.

It is possible to change the unit in any highlighted numeric field using the softkeys at a later stage after value entry has been completed and also if the value itself is not to be changed. In this case, the physical value remains unchanged (as in the Direct mode); however, the value displayed in the entry field is adapted automatically to the changed unit. This function allows numeric values to be "converted" to other units very easily.

## Information on using reference values when entering values

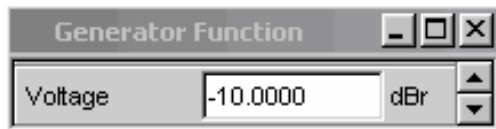
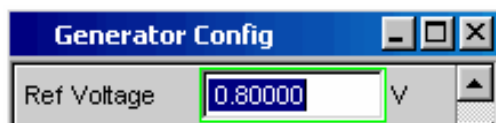

The Audio Analyzer R&S UPV allows reference values to be used when entering various values. These reference values are used as a basis for settings for other parameters.

The example below explains these interdependencies:





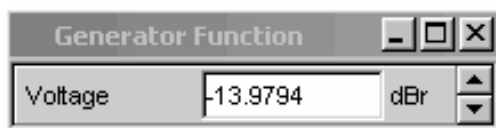
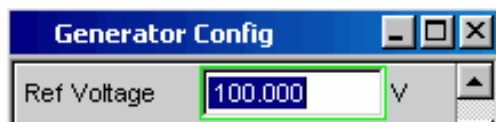











A reference voltage (Ref Voltage) can be set in the **Generator Config** panel. The actual output voltage is set in the **Generator Function** panel where the unit is dBr, i.e. it is possible to enter the output voltage in dB relative to this reference value.

This method is particularly useful if, e.g. with an A/D converter, the clipping level has been determined and other measurements (frequency response, THD+N, etc) have to be performed using test signals which are a certain dB value (defined in the test specifications) below this full-scale level.



However, it is important to note that the maximum values of the R&S UPV cannot be exceeded; this applies to both system-specific maximum values and maximum values which originate from other elements (here for example the Max. Voltage setting).



If by increasing the reference value the maximum output voltage is exceeded, the value for Voltage in the **Generator Function** panel is automatically reduced. In the example shown opposite, the maximum output voltage of 20 V forms the limit; setting the reference value to 100 V results in a reduction of the Voltage value in the bottom window.

Function	Front panel	PC keyboard	Mouse
Enter new value (Edit mode)	Highlight numeric entry field and enter new value directly using numeric keypad.	Highlight numeric entry field and enter new value directly using number keys.	---
Change individual digits (Edit mode)	Highlight numeric entry field, position digit cursor with  or  cursor key and enter new digit directly using numeric keypad.	Highlight numeric entry field, position digit cursor with  or  cursor key and enter new digit directly using number keys.	---
Complete value entry	Complete entry with  key.	Complete entry with ENTER key.	---
Complete value entry with unit selection	Press softkey with desired unit.	Use F5 to F12 keys to select desired unit or Complete entry by pressing the keys <i>m</i> , <i>k</i> , etc. to set the value to mV, kHz, etc.	Click softkey button with desired unit.
Quit value entry without adopting value	Press  key.	Press ESC key.	Click in a different entry field.
Change value (Direct mode)	Highlight numeric entry field, switch to Direct mode with  key, position digit cursor with  or  cursor key and enter new digit directly using numeric keypad. All changes are set directly in hardware.	Highlight numeric entry field, switch to Direct mode with ENTER key, position digit cursor with  or  cursor key and enter new digit directly using number keys. All changes are set directly in hardware.	---
Vary value (Direct mode)	Highlight numeric entry field, switch to Direct mode with rotary-knob click; position digit cursor with  or  cursor key. Vary numeric value using rotary knob. All changes are set directly in hardware.	Highlight numeric entry field, switch to Direct mode with ENTER key; position digit cursor with  or  cursor key. Vary numeric value using  or  cursor key. All changes are set directly in hardware.	---
Change unit	Highlight numeric entry field, select unit using appropriate softkey. Physical value is converted to new numeric value with newly selected unit.	Highlight numeric entry field, select unit using F5 to F12 keys. Physical value is converted to new numeric value with newly selected unit.	Highlight numeric entry field, click appropriate softkey button to select unit. Physical value is converted to new numeric value with newly selected unit.

## Alphanumeric Entries – Text Entry Fields





When the focus is moved to a text entry field, the system enters Edit mode, which is indicated by a green selection frame.

If the complete text (e.g. for graph labels) is to be newly entered, simply begin entering characters using the keypad on the front panel; the old text is deleted automatically when the first key is pressed. The keypad on the front panel of the R&S UPV is automatically switched to the mode for entering alphanumeric characters. Text is entered in the same way as on mobile phones: The characters assigned to a key are called up in sequence by repeatedly pressing the key (see also the section "Overview of Keys", page 3.118). A different key can be pressed immediately to enter the next character; a brief pause must, however, be made when entering characters assigned to the same key. The space character is assigned to the  key, special characters are entered using the decimal-point key and the  key is used to toggle between upper and lower-case characters.

The character to the left of the cursor can be deleted at any time during entry using the **UNDO** key.

If an external PC keyboard is used, characters can be entered in the usual way.

If certain characters only are to be changed, position the cursor accordingly using the  or  cursor key and enter the new characters (if the position of the cursor is changed before the first character is entered, the old text will not be deleted). The default setting is insert mode. It is only possible to change between insert and overwrite mode if an external PC keyboard is used.





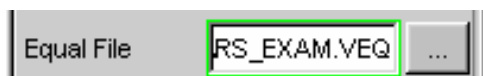

The text entry field is closed with:

ENTER      The newly entered text is adopted.

ESC         The old text is retained.



A text entry field also appears whenever files saved on the R&S UPV are to be called up (e.g. to load saved scans in a diagram) or special functions are to be adopted from files, and so on. Here, the file name can be typed or the  button can be actuated to call up the file directory where the desired file can then be selected (details are given in the section "File Management" on page 3.102).

Function	Front panel	PC keyboard	Mouse
Enter new text	Highlight text entry field and enter new text directly using front panel keypad.	Highlight text entry field and enter new text directly using keyboard.	---
Change individual characters	Highlight text entry field, position cursor with  or  cursor key and enter new character directly using front panel keypad.	Highlight text entry field, position cursor with  or  cursor keys and enter new character directly using keyboard.	---
Complete character entry	Complete entry with  key.	Complete entry with ENTER key.	---
Quit text entry without adopting entered characters	Press  key.	Press ESC key.	Click in a different entry field.

## Display Fields



Sometimes it is very useful for operators to receive additional information about their settings. For example, the selected FFT parameter directly affects the frequency resolution in the displayed spectrum. Display fields inside the panels are used in such cases. These fields are shown in grey and cannot be accessed. They always contain valid values and therefore always show settings active in the background; the fields are updated as soon as a setting in the associated parameter field is changed.

Depending on the settings selected beforehand, it may in some cases no longer be possible to operate certain elements – the entry field then becomes a display field and is shown in grey as described above.



Example: In the case of the analog generator, various impedances can be set for balanced output. If the generator is switched to unbalanced output, the entry field for impedance becomes a display field and shows the impedance that is valid in this case.

Display fields are also used when adopting parameters using track boxes.



## Adopting Parameters – Track Box

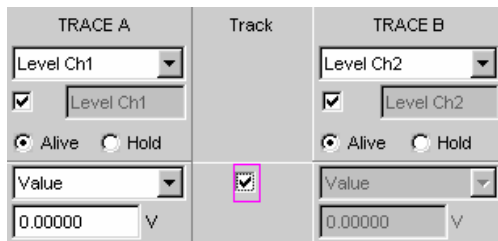

In many cases, settings are to apply e.g. to both measurement channels or to both traces. Here the R&S UPV provides multi-column panels which allow settings to be transferred from the left-hand to the right-hand column without the parameter having to be entered a second time.

The track boxes, which are displayed in a separate column, are used for this purpose. Track boxes always apply to an entire function group (information on function groups can be found in the section "*Panel Structure*" on page 3.23). If the track box has a checkmark, all of the settings within the function group are applicable to both columns. All fields with transferred settings in the right-hand column are shown as display fields. They appear grey and cannot be accessed while the track function is active. If a setting is changed in the associated setting field in the left-hand column, this change is also shown in the display field in the right-hand column.

## Help Functions

Information on the possible entries is given at the bottom of the screen above the softkey bar. The units offered in the softkey bar and the limits specified in the "Valid Range" field always refer to the highlighted parameter field. The valid value range is given in the unit currently selected.

Entries outside the specified value range are not accepted; an audible warning is issued and the entry is changed to its permissible minimum or maximum value.

### Note:

*The specified ranges for value entries always take the current status of the instrument into consideration. They are therefore not constant and depend on the presets already configured for other parameters.*

Below is an example for entry of the generator output voltage; additional units can be displayed by actuating the ►► button:



## Completing Settings

When numeric values are entered, the R&S UPV makes a distinction between Edit mode (indicated by a green selection frame) and Direct mode (indicated by a magenta selection frame). See also the section "Numeric Entries – Numeric Entry Fields" from page 3.35 onwards.













- Numeric entries in Edit mode are not adopted and set in the hardware until the ENTER function is actuated (  key or rotary-knob click) or a unit is selected using the softkey bar.
- In Direct mode, numeric values entered or changed using the rotary knob are immediately passed on to the hardware and executed.

With tick boxes, functions are activated and deactivated by the hardware as soon as the status of the tick box is toggled with the ENTER function. In the case of operation using the mouse, functions are activated/deactivated as soon as the tick box is clicked.

With radio buttons, settings are executed by the hardware as soon as the radio button is toggled with the ENTER function. In the case of operation using the mouse, functions are toggled as soon as the corresponding radio button is clicked.

A parameter from a selection field is also executed by actuating the ENTER function. In this case, a simple mouse-click will select and activate the desired parameter.

Most settings are made without any noticeable adjustment or calculation times. If a brief calculation time is necessary (e.g. to calculate a multi-tone signal adapted to the FFT analysis), the calculation is performed in the background while the current measurements are continued.

Function	Front panel	PC keyboard	Mouse
Complete numeric value entry (Edit mode)	Complete entry with  key or  press softkey with desired unit.	Complete entry with ENTER key or  use F5 to F12 keys to select desired unit or Complete entry by pressing the keys <i>m</i> , <i>k</i> , etc. to set the value to mV, kHz, etc.	Click softkey button with desired unit.
Adopt changed numeric values in hardware immediately (Direct mode)	Highlight numeric entry field, switch to Direct mode with  key, position digit cursor with  or  cursor key and enter new digit directly using numeric keypad.	Highlight numeric entry field, switch to Direct mode with ENTER key, position digit cursor with  or  cursor key and enter new digit directly using number keys.	---
Change numeric values with immediate adoption by hardware (Direct mode)	Highlight numeric entry field, switch to Direct mode with rotary-knob click; position digit cursor with  or  cursor key. Vary numeric value using rotary knob.	Highlight numeric entry field, switch to Direct mode with ENTER key; position digit cursor with  or  cursor key. Vary numeric value using  or  cursor key.	---
Activate/deactivate function	Highlight desired element using rotary knob or cursor keys, activate/deactivate function with rotary-knob click or  key.	Highlight desired element using cursor keys, activate/deactivate function with Enter key.	Click tick box.

Function	Front panel	PC keyboard	Mouse
Toggle function	Highlight desired element using rotary knob or cursor keys, toggle function with rotary-knob click or <b>ENTER</b> key.	Highlight desired element using cursor keys, toggle function with Enter key.	Click desired radio button.
Select parameter from list	Highlight selection using rotary knob or up/down cursor keys and confirm with rotary-knob click or <b>ENTER</b> key.	Highlight selection using up/down cursor keys and press Enter key.	Click parameter.

## Entries During Measurement / Data Output

Entries can be made at any time.

### Single measurements, spectral displays:

If the entry affects parameters of the current measurement, the current measurement or output is terminated as soon as the entry is confirmed (the newly selected parameters are set and the measurement or output is restarted).

### Sweep activated:

Since changes to parameters during a sweep can influence the measurement and thus have a negative effect on the reliability of the results displayed in the screen graphic, the current sweep is stopped and then after restarted such changes are made.

### Entries which do not affect the measurement process:

Entries which do not affect the current measurement process (e.g. changing a unit) are adopted immediately without the current measurement being interrupted.

## Measurement Displays

The Audio Analyzer R&S UPV offers various types of measurement windows for displaying the results of the numerous measurement functions. The measurement results can be displayed as digital numeric values, in analog bargraphs, in result graphics or in data lists. The user can open any number of measurement windows on the screen. The size of the panels can be changed within wide limits, whereby the font size, scaling and so on are adapted automatically (see also the section "Moving and Resizing Panels and Graphical Windows" on page 3.16).

### Measurement Functions and Displaying Measurement Results

- **What** (which measurement function) is measured and **how** (which measurement method) measurement is performed, is preset in the **Analyzer Function** panel.
- The **panels for configuring the measurement value display** are used to determine how the measurement results are presented (i.e. which unit, how many digits, etc). A series of panels for the different measurement windows are provided for this purpose.
- The results are finally displayed in the various **measurement windows**.

The basic settings in these configuration panels and measurement windows are described in the following sections. A detailed description of the individual parameter fields can be found in Chapter 4 "Graphical Display".

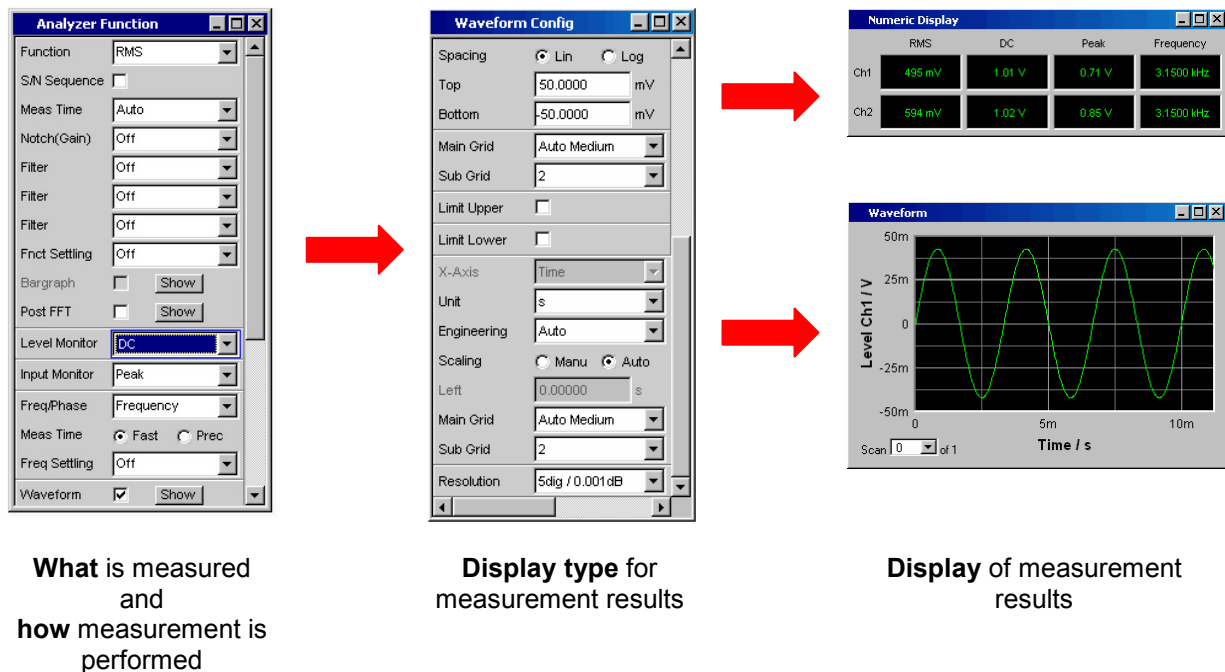
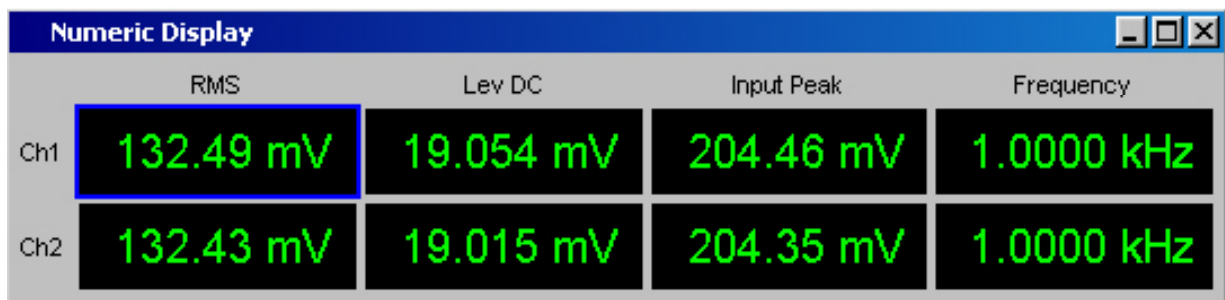

Fig.: 3-2 Measurements and display of results with Audio Analyzer R&S UPV

## Numeric Display Field

The numeric display field provides a clear overview of the numeric values from various analyzer functions and displays a maximum of 8 numeric value results from the **Analyzer Function** panel. The individual columns are permanently assigned, from left to right:

- Column 1:** Measurement results from the function which is set in the **Function** field of the **Analyzer Function** panel.
- Column 2:** Measurement results for the set **Level Monitor** function.
- Column 3:** Measurement results for the **Input Peak** function.
- Column 4:** Display of either the frequency measurement result or, if **Freq & Phase** or **Freq & GrpDel** is set, display of the frequency measurement result in the first row and display of the phase or group delay measurement in the second row.



Each column is labeled with the name of the displayed measurement function, whereby additional, more specific function-related information may also be shown. Example: With difference frequency distortion measurement, the type of measurement and the associated measurement standard, e.g. **DFD d2 (IEC 268)**, is also displayed.

The results from the two measurement channels are shown in both rows (exception: frequency/phase or frequency/group delay measurement).

If not all of the columns are required because one or more of the associated measurement functions is deactivated, the column in question is hidden.

The numeric display field is opened via the menu bar; it is called up using the **Displays** button.

Function	Front panel	PC keyboard	Mouse
Open numeric display field	Press <b>MENU</b> key and highlight <b>Displays</b> button using rotary knob or cursor keys, open pulldown menu with <b>ENTER</b> key or rotary-knob click, and highlight and select numeric display field.	Press key combination CTRL + M, then highlight <b>Displays</b> button using TAB or SHIFT + TAB keys, open pulldown menu using Enter key, highlight numeric display field using cursor keys and select using Enter key.	Open menu bar by moving to left edge of screen, actuate <b>Displays</b> button and click numeric display field.

## Measurement result display in numeric display field

The display of measurement results in the numeric display field is configured in the following panels:

- Funct Config
- Lev Mon Config
- Input Config
- Freq / Phase Config

The following examples of measurement value displays demonstrate the various display options. A number of basic settings made in these configuration panels are described in the following section. A detailed description of the display options can be found in Chapter 4 "Graphical Display".



If the measurement value is within the preset limits or no limits were specified, the measurement value is displayed in green on a black background.

A measurement value in a linear unit is displayed with 3 to 7 digits; a measurement value in logarithmic units can be displayed with a resolution of 0.1 dB to 0.00001 dB.



If the measurement value overranges or underranges preset limits, the measurement value is displayed in red on a black background.

As soon as the measurement value is within the limits again, it is displayed in green.



If one of the two measurement channels is deactivated, OFF appears in the associated measurement display.



If no measurement result is available (e.g. there is no frequency result during a DC measurement), --- is displayed.

## Combi Display

It is often the case that the numeric value of a measurement result does not contain adequate information. Additional features such as analog bargraphs, limit monitoring or the storage of maximum and minimum values are frequently required.

The combi display is used for this purpose. Additional information can be displayed for every measurement shown in the numeric display field.

The free selection and free scalability mean that especially important or critical results can be monitored and tracked even when viewing the R&S UPV screen from a relatively long distance.

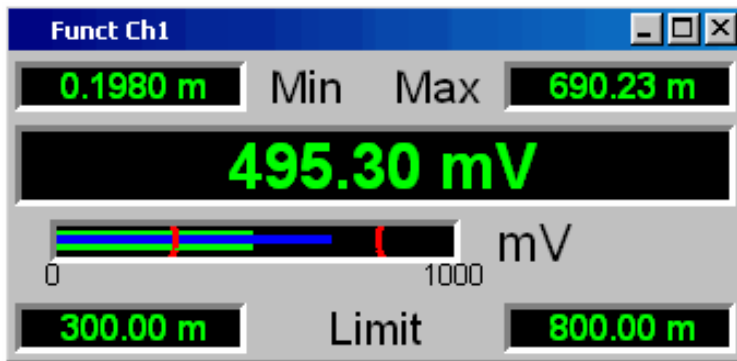

Measured minimum and maximum values

Measurement display

Bargraph

Limit settings

### Opening combi displays

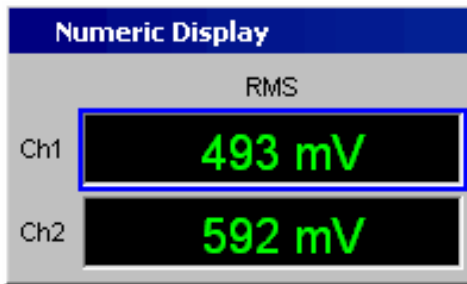

The easiest way to open combi displays is to highlight the respective measurement display in the numeric display field (blue selection frame) and to trigger an ENTER function ( **ENTER** key or rotary-knob click).

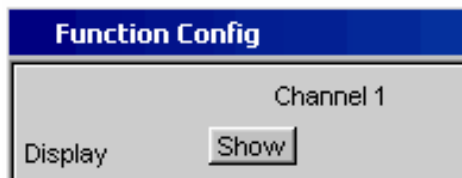

Alternatively, the combi displays can also be opened using the associated configuration panel (see the following section). The associated combi display is activated using the **Show** button in the Display line.

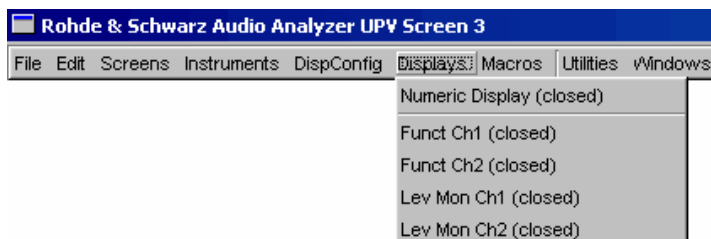

Another way is to open the combi display via the menu bar; they are called up using the **Display** button.

Function	Front panel	PC keyboard	Mouse
<b>Activate combi display via numeric display field</b>	Highlight desired measurement display in numeric display field and open combi display with <b>ENTER</b> key or rotary-knob click.	Highlight desired measurement display in numeric display field and open combi display with Enter key.	Double-click desired measurement display in numeric display field.
<b>Activate combi display via Config panel</b>	Highlight <b>DISPLAY</b> button in associated Config panel and open combi display with <b>ENTER</b> key or rotary-knob click.	Highlight <b>DISPLAY</b> button in associated Config panel and open combi display with Enter key.	Click <b>DISPLAY</b> button in associated Config panel.

### Settings for measurement result display in combined fields

Since a combi display is available for each measurement display of the numeric display field, up to eight of these displays can be opened. The settings for the combi displays (and for the numeric display field itself) are made in four configuration panels, whereby the two measurement channels are displayed in one panel. This results in the following four panels for configuring the measurement results in the combi displays:

- Funct Config
- Lev Mon Config
- Input Config
- Freq / Phase Config

The associated panels for configuring the combi displays are opened via the menu bar; they are called up using the **Disp Config** button.

Function	Front panel	PC keyboard	Mouse
Open panel for configuring combined field or numeric display field	Press <b>MENU</b> key and highlight <b>Disp Config</b> button using rotary knob or cursor keys, open pulldown menu with <b>ENTER</b> key or rotary-knob click, and highlight and select desired panel.	Press key combination CTRL + M, then highlight <b>Disp Config</b> button using TAB or SHIFT + TAB keys, open pulldown menu using Enter key, highlight desired panel using cursor keys and select using Enter key.	Open menu bar by moving to left edge of screen, actuate <b>Disp Config</b> button and click desired panel.



Some of the basic settings in these panels are described here using the **Lev Mon Config** panel as an example. Since the combi display is an extension of the numeric display field, the settings also influence the numeric display field.

A detailed description of the display options can be found in Chapter 4 "Instrument Functions" in the section "Graphical Display".

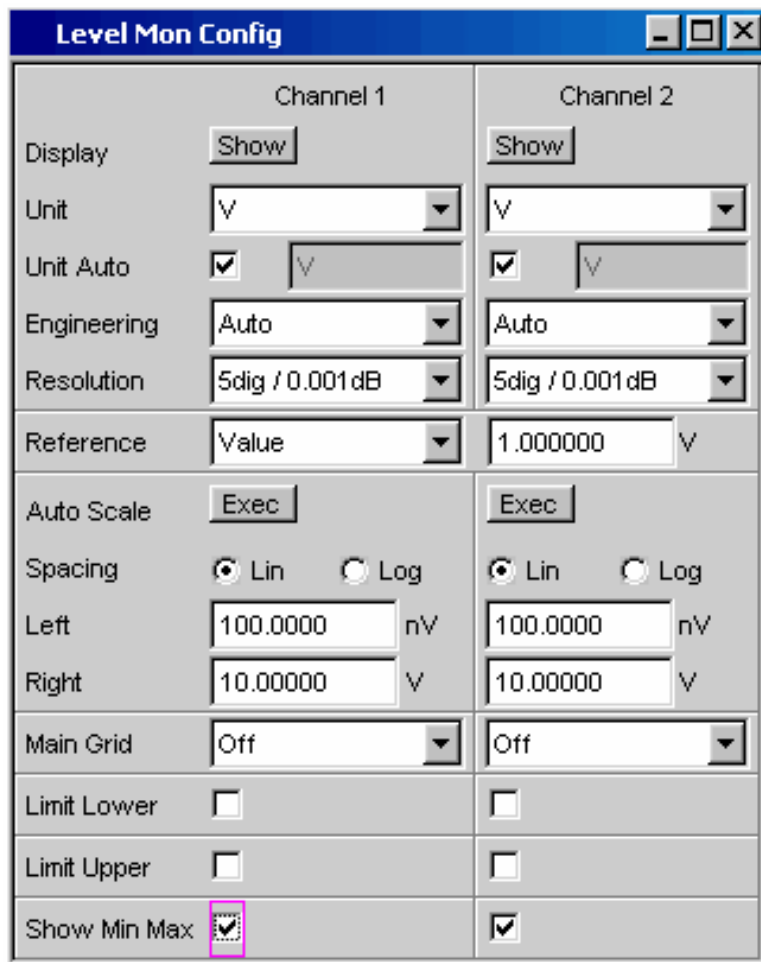

**Note:**

Some of the settings described below are only visible if the combi display is of adequate size on the screen. For example, scaling and gridlines are hidden automatically and stepwise if the display is reduced in size.

### Unit of measurement result

This parameter field is used to set the unit for the measurement result display. The units available in the parameter list depend in the type of measurement.

An overview of all units used with the Audio Analyzer R&S UPV and their conversion formulae can be found at the end of this chapter (section "Units" from page 3.110 onwards).

Details concerning the numeric value display can be specified here for all linear units.

For example, it is possible to select whether voltage is to be given in V, mV,  $\mu$ V, and so on. If "Auto" is set, these unit prefixes are automatically adapted to the measurement value.

### Reference values

The reference value for relative measurement values can be set here.

This can be a fixed preset value; however, values measured at a different location or values based on the generator settings and so on can also be adopted automatically as reference values.

### Bargraph scaling

If the Autoscale button is actuated, the extreme values that have so far occurred are used for scaling the left-hand and right-hand scale end value. The scaling can, however, also be set manually.

The axis can be displayed with linear or logarithmic subdivisions.

If manual scaling was selected, the start and end value of the bargraph must be entered in the two fields.



If the selected scaling does not encompass all measurement values, a red arrow indicates the end of the scale at which the measurement value is beyond the range of the bargraph.

**Gridlines**

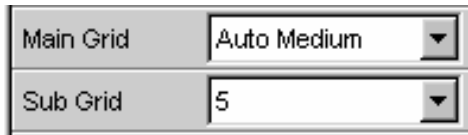

The settings **Main Grid** and **Sub Grid** are used to subdivide the bargraph.

Main gridlines which are labeled with the associated numeric values can be added with different intervals.

Subgridlines are used for further subdivisions; these lines are not labeled.



**Limits**

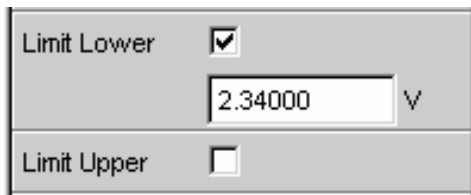

A lower and/or upper limit can be defined for each measurement result.

If the limit is activated, each measurement value is compared with the limit.

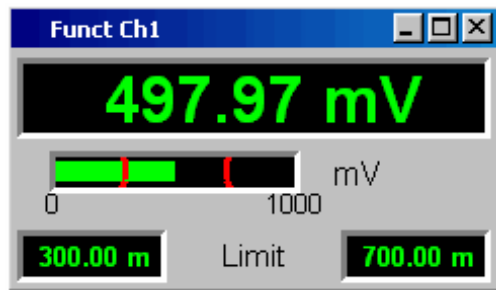

The set limits are shown in the bottom part of the combi display and appear as a red limit marking on the bargraph.

As soon as one of the limits is exceeded, the measurement display and measurement bar changes from green to red. If the measurement value is within the limits, the measurement display and measurement bar are displayed in green.

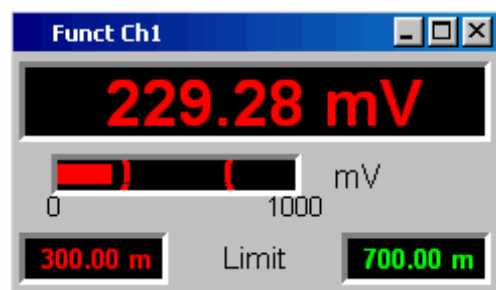

In order to monitor limit violations over a long period of time without having to watch the measurement displays continuously, the lower and/or upper limit is displayed permanently in red as soon as it is exceeded. Pressing the **START** key again or entering a new limit resets the limit to green.

The measurement display in the numeric display field always behaves in the same way as the measurement display in the combined field; current limit violations can therefore also be monitored in the numeric display field.



**Extreme values**

If this tick box is activated, the lowest and highest measurement value is displayed.

Display of the Min/Max values can be set separately for each measurement display and for the two measurement channels.

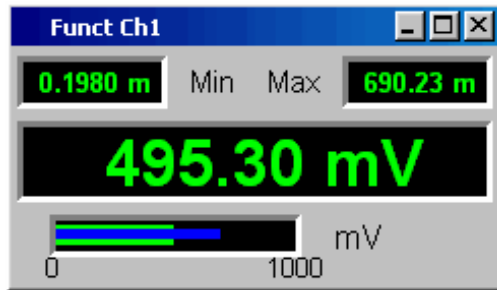

The minimum and maximum values which have been measured are shown in the top part of the combi display; an additional blue bar which records the span between the extreme values is also displayed.

The Min/Max values can thus also be recorded over a long period of time without the measurement displays having to be monitored continuously.

Pressing the **START** key again resets the Min/Max values.

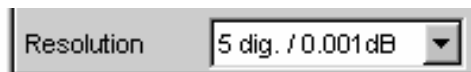

**Number of displayed digits**

The **Resolution** field is used to set the number of digits used when displaying the measurement values, Min/Max values and limits.

Values in linear units can be displayed with 3 to 7 digits; values in logarithmic units can be displayed with a resolution of 0.1 dB to 0.00001 dB.



## Graphical Windows

The most informative method of displaying measurement results is usually a two-dimensional graph. Measurement values as a function of frequency, measurements over a time axis and so on are just a few examples of the many possible applications. The Audio Analyzer R&S UPV makes a distinction between the graphical windows (shown in the following sections) which can be set and modified using the associated configuration panels.

All graphical displays can be evaluated using horizontal and vertical cursors; markers are used to identify important measurement points. A broad range of softkey control functions can be used to scale graphs, to display sections of graphs, and to perform many other tasks.

### Sweep graph

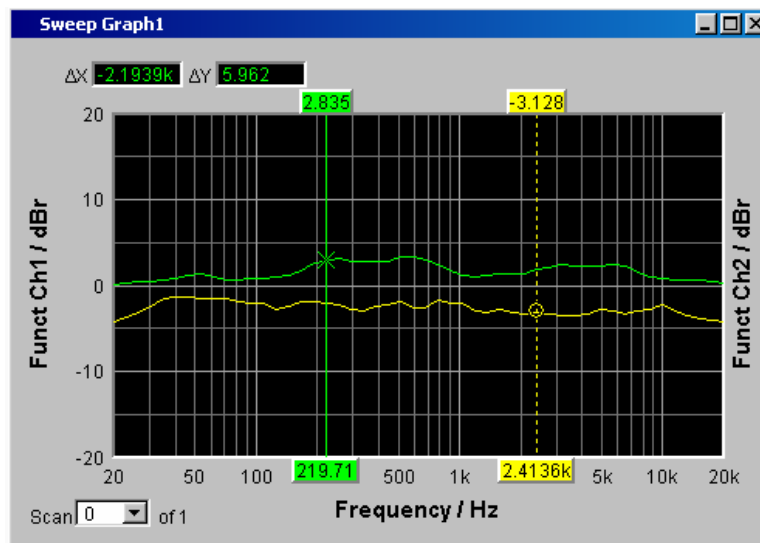

Here, the measurement values of a measurement sequence (sweep) can be displayed as a line diagram in a co-ordinate system. One or two traces (TRACE A and TRACE B) can be recorded along an X-axis. Each trace can consist of a large number of scans. The traces can be saved and saved traces, reference curves and/or limit curves can be imported into the graph.

Up to four sweep graphs can be displayed at the same time and can all be configured differently. As a result, it is possible to display different measurement functions or display the same measurement function in a different way.

## FFT graph

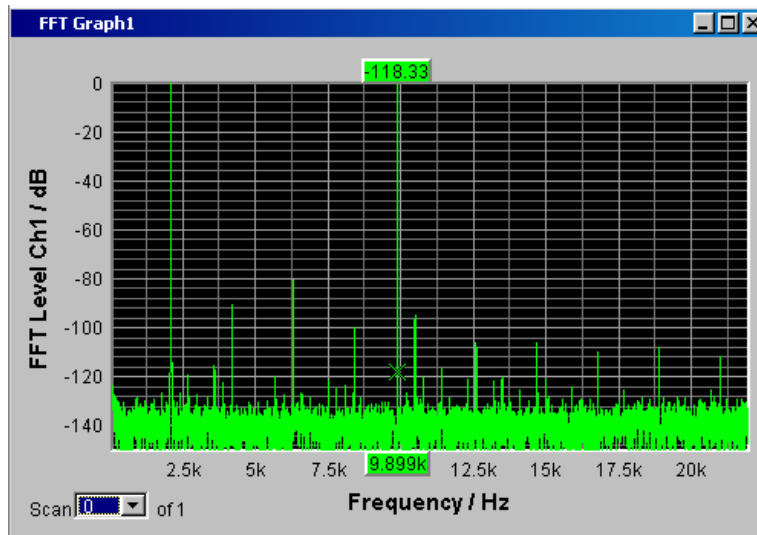

The frequency spectrum of the **FFT** measurement function and of the **Post FFT** which follows a different measurement function is displayed in these panels. One or two traces (TRACE A and TRACE B) can be recorded along a frequency axis. Each trace can consist of a large number of scans. The traces can be saved and saved traces, reference curves and/or limit curves can be imported into the graph.

Up to two FFT graphs can be displayed at the same time and can both be configured differently.

## Waveform

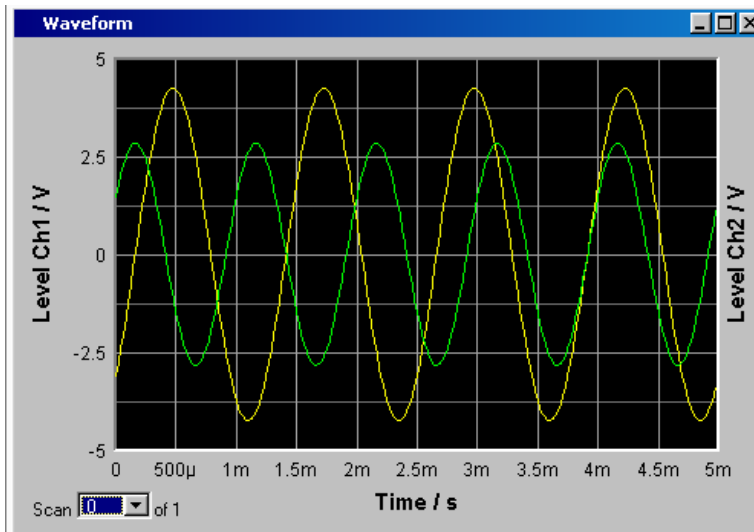

The waveform display is a type of oscillogram in which the signal characteristic of the analyzed audio signal over time is displayed. One or two traces (TRACE A and TRACE B) can be recorded along a time axis. The traces can be saved and saved traces, reference curves and/or limit curves can be imported into the graph.

This graph can be displayed once only; it is linked to the **Waveform Monitor** function in the **Analyzer Function** panel.

## Bargraph

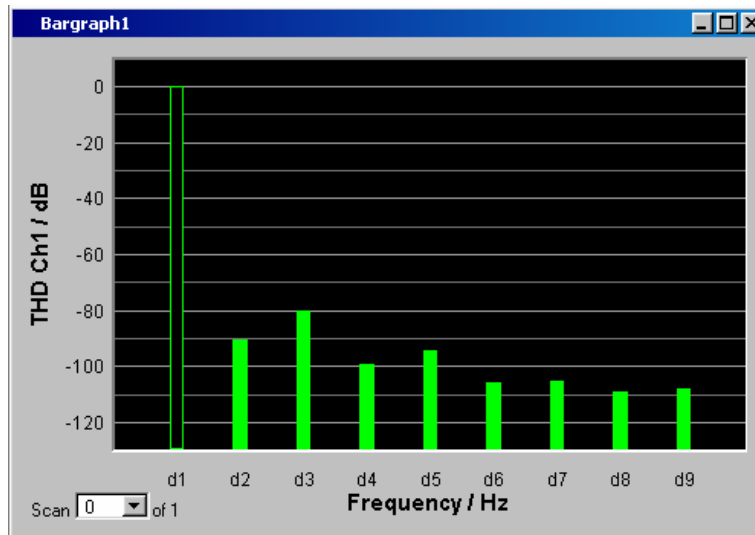

If one of the functions THD, Mod Dist, DFD or DIM is selected in the **Analyzer Function** panel, the function measurement result can be displayed broken down into its frequency components on a bargraph. The individual distortion products are recorded along a frequency axis. The structure of the distortion products (2nd, 3rd, 4th, ... harmonic, DFD of 2nd or 3rd order, etc) can be recognized at a glance. The bargraph can display one or two channels; once again, the results can be saved and saved results can be imported into the graph.

Two bargraphs are available so that, for example, THD values at two different measurement points can be displayed or the measurement values of both input channels can be shown on two separate graphs.

## PESQ graph

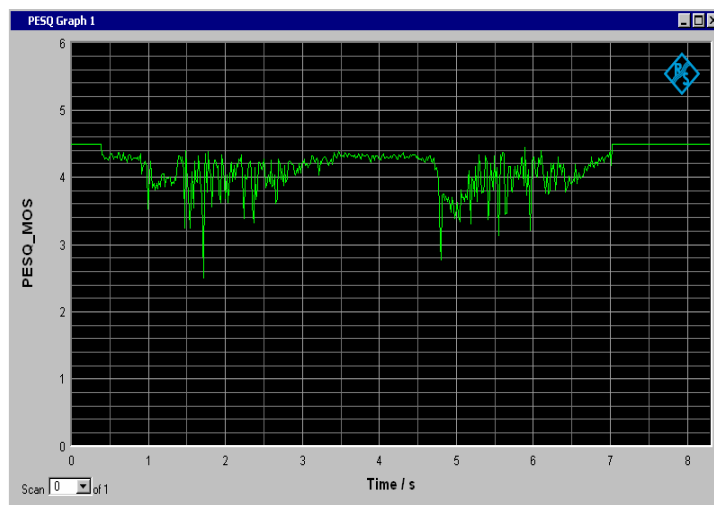

In these graphics windows, you can display the MOS value of the PESQ measurement as well as the time delay between the reference and measurement signal over a time axis. It is possible to display up to two PESQ graphs simultaneously, where they can be configured differently.

### Opening graphical windows

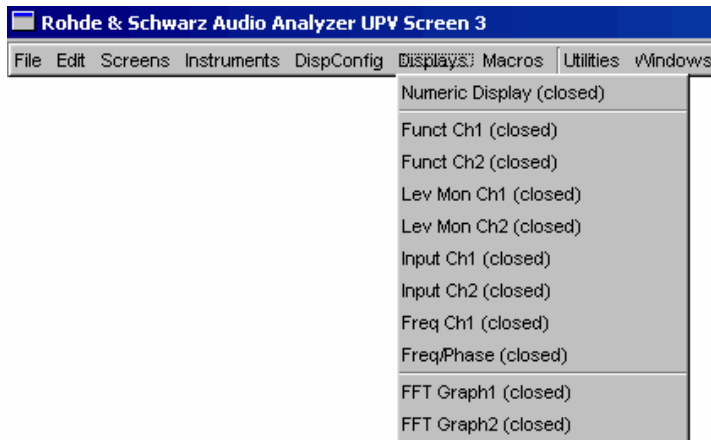

The graphical windows can be opened via the menu bar; they are called up using the **Displays** button.



Alternatively, the graphical windows can also be opened using the associated configuration panels (see the following section). The associated graphical window is activated using the **Show** button.

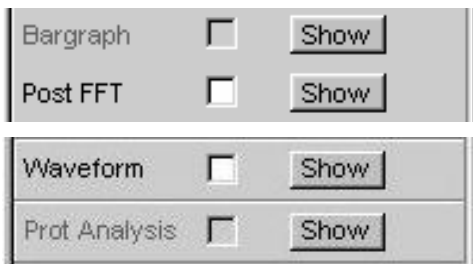

In the Analyzer Function panel, it is also possible to use the **Show** button to open some graphical or data windows. They will then be displayed in the same screen, without opening the associated configuration panels.

Function	Front panel	PC keyboard	Mouse
<b>Open graphical window via menu bar</b>	Press <b>MENU</b> key and highlight <b>Displays</b> button using rotary knob or cursor keys, open pulldown menu with <b>ENTER</b> key or rotary-knob click, and highlight and select desired graphical window.	Press key combination CTRL + M, then highlight <b>Displays</b> button using TAB or SHIFT + TAB keys, open pulldown menu using Enter key, highlight desired graphical window using cursor keys and select using Enter key.	Open menu bar by moving to left edge of screen, actuate <b>Displays</b> button and click desired graphical window.
<b>Open graphical window via Config panel</b>	Highlight <b>Show</b> button in associated Config panel and open graphical window with <b>ENTER</b> key or rotary-knob click.	Highlight <b>Show</b> button in associated Config panel and open graphical window with Enter key.	Click <b>Show</b> button in associated Config panel.
<b>Open graphical window via Analyzer Function panel</b>	Highlight <b>SHOW</b> button in Analyzer Function panel and open graphical window with <b>ENTER</b> key or rotary-knob click.	Highlight <b>SHOW</b> button in Analyzer Function panel and open graphical window with <b>ENTER</b> key.	Click <b>SHOW</b> button in Analyzer Function panel.



### Settings for measurement result display in the graphical windows

The settings for configuring the graphical displays are made in the following panels:

- Sweep Graph1 ... 4 Config
- FFT Graph 1 ... 2 Config
- Waveform Config
- Bargraph1 ... 2 Config

The associated panels for configuring the graphical windows are opened either using the **Disp Config** button in the menu bar or using the **Settings** softkey in the graphical window.

Function	Front panel	PC keyboard	Mouse
Open panel for configuring a graphical window	Press <b>MENU</b> key and highlight <b>Disp Config</b> button using rotary knob or cursor keys, open pulldown menu with <b>ENTER</b> key or rotary-knob click, and highlight and select desired panel.	Press key combination CTRL + M, then highlight <b>Disp Config</b> button using TAB or SHIFT + TAB keys, open pulldown menu using Enter key, highlight desired panel using cursor keys and select using Enter key.	Open menu bar by moving to left edge of screen, actuate <b>Disp Config</b> button and click desired panel.
Open panel for configuring a graphical window via softkeys in graphical window	Press <b>Settings</b> softkey of respective graphical window.	Press F12 key for <b>Settings</b> softkey in respective graphical window.	Click <b>Settings</b> softkey in respective graphical window.

Some of the basic settings in these panels are described here using the *FFT Graph1 Config* panel as an example.

A detailed description of the display options can be found in Chapter 4 "Graphical Display".

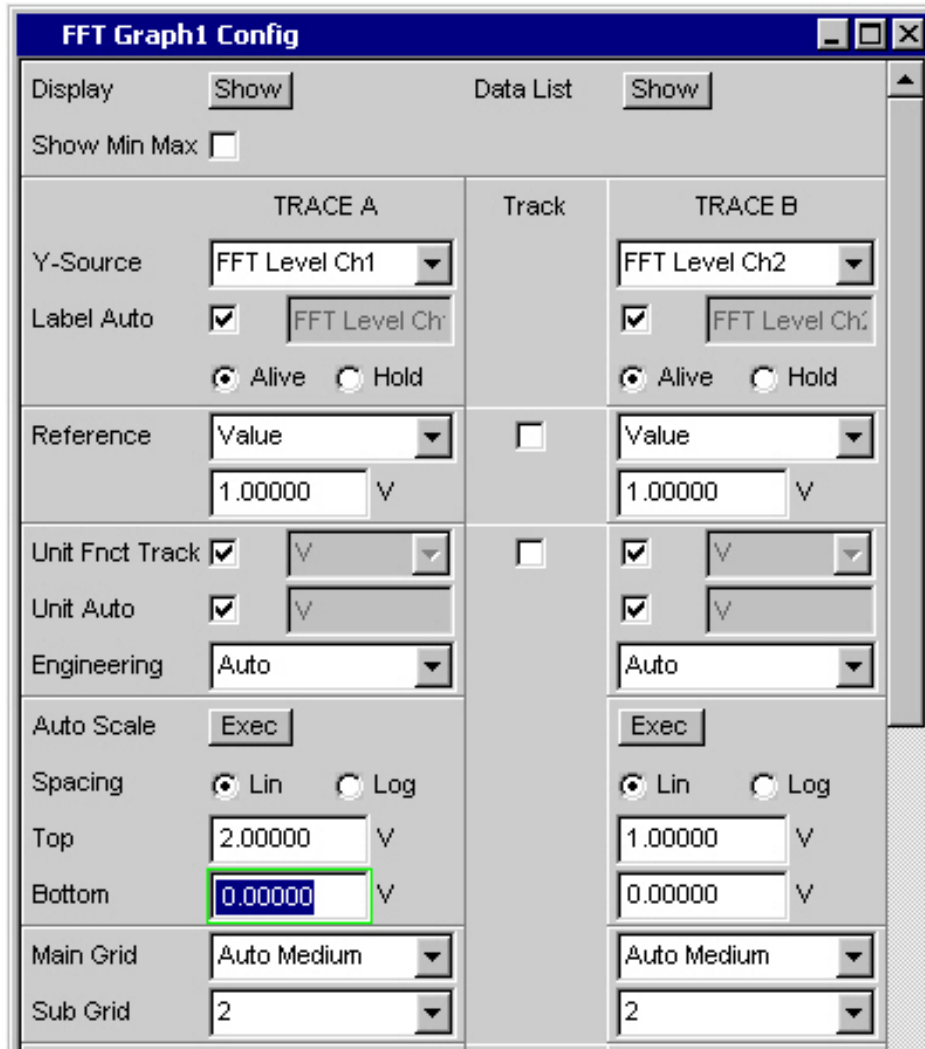

**Note:**  
 Some of the settings described below are only visible if the graphical window is of adequate size on the screen. For example, scaling and gridlines are hidden automatically and stepwise if the display is reduced in size.

Settings for the Y-axis

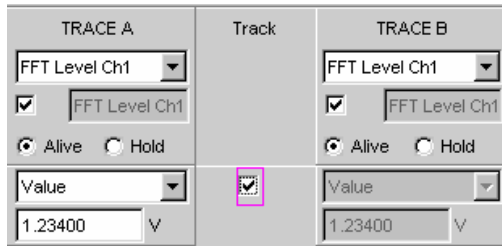

All the panels used for configuring graphical windows have three columns.

In all graphical windows, two traces (TRACE A and TRACE B) can be recorded along an X-axis. Each trace can consist of several scans.

In many cases, settings are to apply to both traces. The track boxes provide multi-column panels which allow settings to be transferred from the left-hand to the right-hand column without the parameters having to be entered a second time.

If the track box has a checkmark, all of the settings within the function group are applicable to both columns. All fields with transferred settings are shown in the right-hand column as grey display fields. These fields cannot be accessed while the track function is active. If a setting is changed in the associated parameter field in the left-hand column, this change is also shown in the display field in the right-hand column.

Values to be displayed



The data which is to be graphically displayed can be determined for each trace. Usually this data comes from the selected measurement functions; however, saved data (reference data) can also be displayed.

With **Label Auto**, the Y-axis of the graph can be labeled with the data name selected under **Source** (see example below), or users can define their own label.

The **Hold** radio button is used to "freeze" the graphical display.

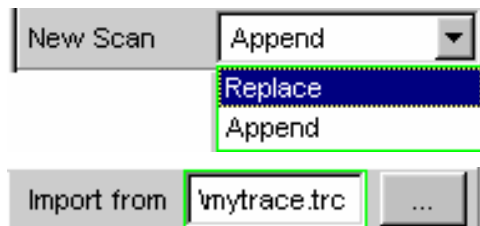

Additional scans can be added to a graph ("Append"), or existing scans in a graph can be replaced by new ones ("Replace").

Furthermore, it is also possible to load previously measured and saved scans and append them to the current measurement or replace individual scans with saved ones.

Reference Value  
1.23400 V

**Reference values**

The reference value for relative measurement values can be set here.

This can be a fixed preset value; however, values measured at a different location or entire scans from files, from the other measurement channel and so on can also be used automatically as reference values / reference curves.

Unit Anlr Track  V

**Units of measurement values**

This parameter field is used to set the unit for the trace. The units available in the parameter list depend in the type of measurement.

Alternatively, if the tick box is selected, the unit used in the analyzer will be used.

An overview of all units used with the Audio Analyzer R&S UPV and their conversion formulae can be found at the end of this chapter (section "Units" from page 3.110 onwards).

Engineering Auto

Details concerning the numeric value display can be specified here for all linear units.

For example, it is possible to select whether voltage is to be given in V, mV,  $\mu$ V, and so on. If "Auto" is set, these unit prefixes are automatically adapted to the measurement value.

Unit Auto  V

The used unit will appear on the Y-axis of the graph (see example below). Sometimes it is better to use a label defined by the user; this label can be entered in the parameter field.

Auto Scale Exec  
Spacing  Lin  Log  
Top 10.00000 dBV  
Bottom -170.000 dBV

**Y-axis scaling**

If the button for automatic scaling is selected, the Audio Analyzer R&S UPV uses the minimum and maximum values of the available measurement cycle to automatically determine a suitable value range for the graph to be displayed. This scaling is determined once and retained until the autoscale function is triggered again.

If manual scaling is required, the upper and lower end value of the Y-axis must be entered in the two fields.

If a linear unit has been selected for the Y-axis, this axis can be displayed with linear or logarithmic subdivisions.

**Gridlines**

Main Grid	Auto Medium
Sub Grid	5

The settings **Main Grid** and **Sub Grid** are used to subdivide the graph with horizontal gridlines.

Main gridlines which are labeled on the Y-axis with the associated numeric values can be added with different intervals.

Subgridlines are used for further subdivisions; these lines are not labeled.

**Limits**

Lim upper	<input checked="" type="checkbox"/>
Source	Value
	-65.0000 dBV
Lim lower	<input type="checkbox"/>

Lower and/or upper limits can be defined for each trace; these limits can be different or the same for the two traces.

The limits can be fixed preset values; however, values measured at a different location or entire scans from files, from the other measurement channel and so on can also be used automatically as limits / limit curves.

If the limits are activated, each measurement value is compared with the limits.

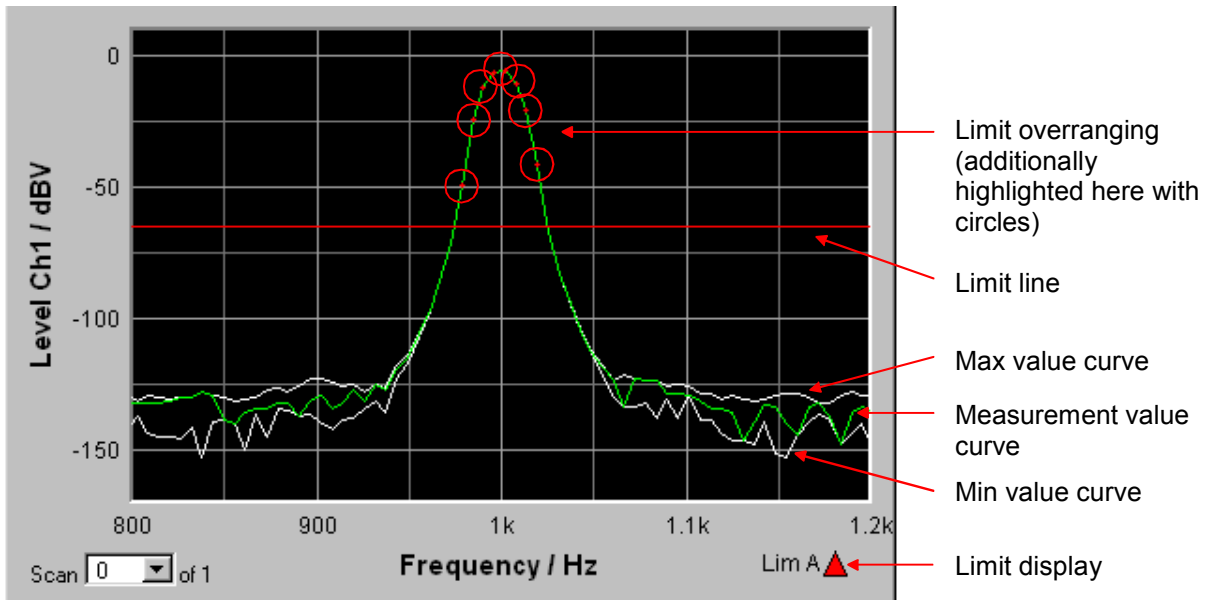

Limit curves appear as a red line on the graph.

Each measurement value which violates a limit is highlighted by a red dot on the curve.

In addition, a red arrow pointing up/down in the bottom right-hand corner of the graph provides a permanent indication of limit overranging/underranging.

Limit monitoring is reset each time the  START key is pressed.

Limit monitoring can also be reset using a softkey; see the section "Restart Min/Max, Lim Viol function" on page 3.81.

### Extreme values

Show Min Max

If this tick box is activated, the lowest and highest measurement value is displayed.

Two additional grey lines which represent the measured extreme values (see the example above) then appear in the graph.

Extreme value recording is reset each time the  START key is pressed.

Extreme value recording can also be reset using a softkey; see the section "Restart Min/Max, Lim Viol function" on page 3.81.

### Settings for the X-axis



A screenshot of a software interface showing a dropdown menu for 'X-Axis'. The selected option is 'Frequency'.

The quantity displayed on the X-axis is normally determined by the type of measurement; it can be seen in the display field shown opposite.

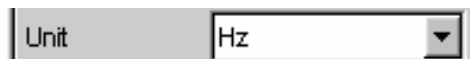

A screenshot of a software interface showing a dropdown menu for 'Unit'. The selected option is 'Hz'.

#### Units for the X-axis

The units available in the parameter list depend in the type of measurement.

An overview of all units used with the Audio Analyzer R&S UPV and their conversion formulae can be found at the end of this chapter (section "Units" from page 3.110 onwards).



A screenshot of a software interface showing a checkbox labeled 'Unit Auto' which is checked, and a text field containing 'Hz'.

Usually it is the used unit that is displayed on the X-axis of the graph.

Sometimes it is better to use a label defined by the user; this label can be entered in the parameter field.



A screenshot of a software interface showing a dropdown menu for 'Engineering'. The selected option is 'Auto'.

Details concerning the numeric value display can be specified here for all linear units.

For example, it is possible to select whether frequency is to be given in Hz, mHz, kHz, and so on. If "Auto" is set, these unit prefixes are automatically adapted to the measurement value.



A screenshot of a software interface showing a checkbox labeled 'Label Auto' which is checked, and a text field containing 'Frequency'.

With **Label Auto**, the X-axis of the graph can be labeled with the data name selected under **X-Axis**, or users can define their own label in the entry field.



A screenshot of a software interface showing a text field for 'Ref Value' containing '1000.00' and a unit field containing 'Hz'.

#### Reference values

A reference value can be set here for labels of X-values with relative units.

Scaling	<input checked="" type="radio"/> Manu	<input type="radio"/> Auto
Spacing	<input checked="" type="radio"/> Lin	<input type="radio"/> Log
Left	<input type="text" value="800.000"/>	Hz
Right	<input type="text" value="1.20000"/>	kHz

**X-axis scaling**

If automatic scaling is selected, the Audio Analyzer R&S UPV uses the minimum and maximum values defined for the measurement, e.g. by the start/stop values of a sweep, by the measurement bandwidth of an FFT analysis, and so on.

If manual scaling has been selected, the upper and lower end value of the X-axis must be entered in the two fields.

If a linear unit has been selected for the X-axis, this axis can be displayed with linear or logarithmic subdivisions.

Main Grid	<input type="text" value="Auto Medium"/>
Sub Grid	<input type="text" value="2"/>

**Gridlines**

The settings **Main Grid** and **Sub Grid** are used to subdivide the graph with vertical gridlines.

Main gridlines which are labeled on the X-axis with the associated numeric values can be added with different intervals.

Subgridlines are used for further subdivisions; these lines are not labeled.



X- and Y-value display



The **Resolution** field is used set how many digits the values on the X and Y-axis and at the cursor are to have.

Values in linear units can be displayed with 3 to 7 digits; values in logarithmic units can be displayed with a resolution of 0.1 dB to 0.00001 dB.

Loading and saving traces / scans



The current trace together with all scans can be saved in these parameter fields by calling up the file directory using the **...** button (for details see the section "File Management" on page 3.102).

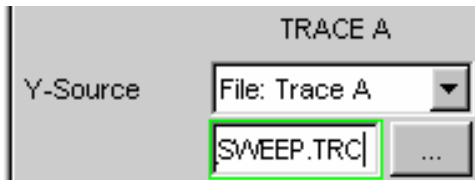

Here, saved traces together with all of their scans can be loaded and displayed in the current graph by calling up the file directory using the **...** button (details are given in the section "File Management" on page 3.102).

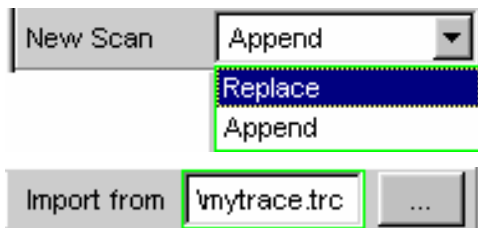

On a graph, it is possible to replace individual scans with saved scans; it is also possible to add (append) additional saved scans. Once again, this is done by calling up the file directory using the **...** button (details are given in the section "File Management" on page 3.102).

## Evaluating Graphical Displays with Cursors and Markers

All graphical displays can be evaluated using horizontal and vertical cursors; the X and Y-values shown in the display fields associated with the cursors are always current values.

Markers are used to identify important measurement points.

The cursors and markers can only be operated using the softkey bar; the softkeys can be operated from the front panel, using the keys F5 to F12 on the external PC keyboard or by clicking with the mouse.

As an alternative and in a slightly different way to operation via the panels, the softkeys can also be used to scale the graphs or to zoom sections of the displays.

The basic settings in these functions are described here using examples.

A detailed description of the display options can be found in Chapter 4 "Graphical Display".

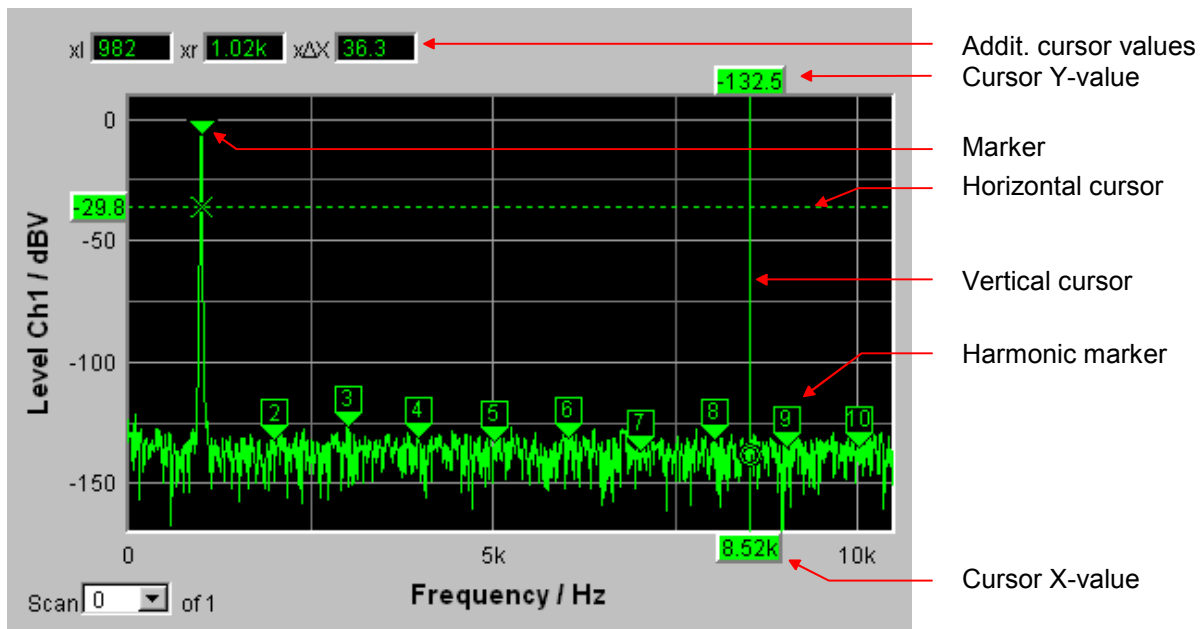

As soon as the graphical window has the focus, the softkey bar for operating the graphical elements is shown at the bottom of the screen.



The softkeys are arranged in several levels; the lower levels are accessed by actuating the respective button. Actuating the Back button redisplay the higher level.

The level currently displayed is indicated in the info line above the softkey.

The desired function is executed by actuating the buttons displayed in the lowest level.

### Showing and hiding traces – Trace function



Actuating the **Trace** button opens another softkey level.



The two buttons **Show A** and **Show B** are used to show and hide the associated trace. These buttons only affect the curve display; the measurement values are retained in the background even when the curve is hidden, and can be used as reference values, for example.

### Scaling graph – Autoscale function



Actuating the **Autoscale** button opens another softkey level.



The softkeys available here are used to rescale the selected axes (if required, it is also possible to rescale the axes for certain traces only). The action triggered with these buttons corresponds to that of the **Autoscale** button for the X and Y-axis in the associated configuration panels.

The **All** button scales both the X and Y-axis simultaneously.

### Operating the cursors



Actuating the **Cursor** button displays the cursor softkeys:

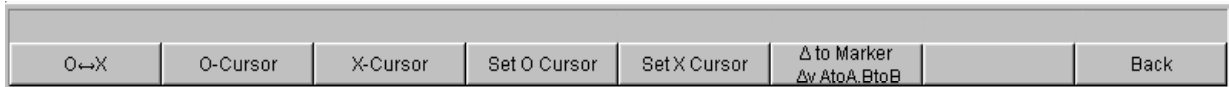

The Audio Analyzer R&S UPV uses two cursors which are identified by the O and × symbols. These symbols indicate the measured point in the graph (see the example graph above).

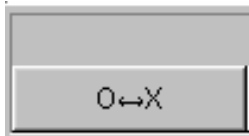

Only one cursor is active and can be moved in the graph at any one time. The active cursor is displayed with a solid line; the inactive cursor is displayed with a broken line.

The **O↔X** button is used to activate the O and X-cursor alternately.

Alternatively, the Enter key or a rotary-knob click can also be used to toggle between the two cursors.



The two buttons **O-Cursor** and **X-Cursor** activate the associated cursor and display the next softkey level.

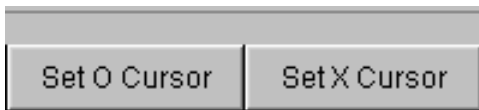

The two buttons **Set O Cursor** and **Set X Cursor** open the next softkey level where the associated cursor can be set to certain values, e.g. maximum, minimum, etc.

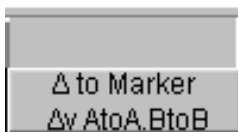

This button is used to display a further level. A large selection of differential values can be displayed using the softkeys on this level.

If, for example, the cursor was activated with the **O-Cursor** button, the following softkeys appear:



Here a softkey with an additional tick box is used. The softkey indicates that the O-cursor is active and that further settings for this cursor are available under the adjacent softkeys. Activating/deactivating the tick box shows/hides the cursor in the graph.



The two buttons **O Vert A** and **O Vert B** activate vertical cursors and place them on TRACE A and TRACE B. Both the cursor and its label fields are displayed in the color of the associated trace.

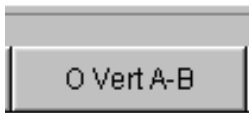

Actuating the **O Vert A-B** button displays a grey cursor which represents the difference between the values for TRACE A and TRACE B.



The two buttons **O Hor A** and **O Hor B** activate horizontal cursors and place them on TRACE A and TRACE B. Both the cursor and its label fields are displayed in the color of the associated trace.

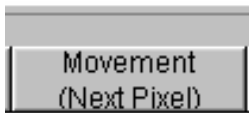

The **Movement** button opens the next softkey level where it is possible to set how the cursor is moved with the rotary knob (see the next section). The second line of the label shows the currently set step size in brackets.

### Moving cursor

Only one cursor is active and can be moved in the graph at any one time. The active cursor is displayed with a solid line; the inactive cursor is displayed with a broken line.

The O<->X button is used to activate the O and X-cursor alternately. Alternatively, the Enter key or a rotary-knob click can also be used to toggle between the two cursors.

In the case of operation using the mouse, the desired cursor or one of its display fields can be activated and moved by simply clicking with the mouse.

A cursor can be moved in a number of different ways:

- The active cursor is linked to the rotary knob and can be moved directly using the rotary knob.
- On the external PC keyboard, the keys **TAB** / **CTRL** + **TAB** move the cursor to the right / left.
- In the case of operation using the mouse, the cursor can be clicked and moved by holding down the mouse key.

The step size with which a cursor is moved can be set using softkeys. To do so, the softkey of the desired O or X-cursor must first be selected:



The **Movement** button opens the next softkey level where various step sizes for moving the cursor are offered irrespective of the graph currently being used. This is described in greater detail below. The currently selected step size is indicated in brackets in the second label line of the **Movement** button.

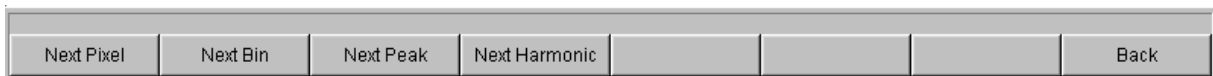

Sweep graph:

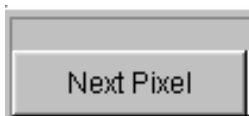

If the **Next Pixel** button is selected, the cursor is moved in the graph by one pixel with each increment (rotary knob, mouse or **TAB** key).

If in the graphical display there is not a measurement value at every pixel (because only a few measurement points were recorded relative to the size of the displayed graph), the cursor value is interpolated linearly at the pixels between the measurement values.

If in the graph the number of recorded measurement points is greater than the number of pixels available for display, the largest measurement value in each case is displayed at the corresponding pixel with X and Y-value.

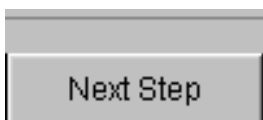

If the **Next Step** button is selected, the cursor is moved to the next measurement value with each increment (rotary knob, mouse or **TAB** key).

The cursor is therefore moved in smaller or larger steps depending on the number of measurement points.

If the graph is displayed relatively small or the number of recorded measurement values displayed is greater than the number of pixels available in the graphical field, the cursor sometimes does not appear to move (it remains on the same pixel). However, the associated display fields always show the currently selected measurement point with X and Y-value.

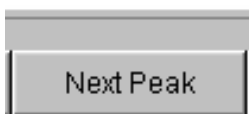

If the **Next Peak** button is selected, the cursor is moved to the next measured peak with each increment (rotary knob, mouse or **TAB** key).

## FFT graph:

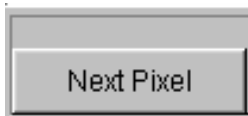

If the **Next Pixel** button is selected, the cursor is moved in the graph by one pixel with each increment (rotary knob, mouse or **[TAB]** key).

With FFT analyses, the number of recorded measurement points (bins) is usually much greater than the number of pixels available for display in the graph; the cursor then indicates the bin with the largest measurement value at the pixel in question and displays this bin with its X and Y-values.

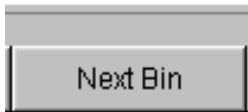

If the **Next Bin** button is selected, the cursor is moved to the next measured bin with each increment (rotary knob, mouse or **[TAB]** key).

Since with FFT analyses the number of recorded measurement points (bins) is usually much greater than the number of pixels available for display, the cursor sometimes does not appear to move (it remains on the same pixel). However, the associated display fields always show the currently selected measurement point with X and Y-value.

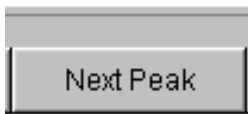

If the **Next Peak** button is selected, the cursor is moved to the next measured peak with each increment (rotary knob, mouse or **[TAB]** key).

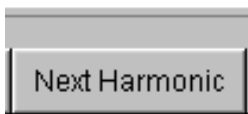

If the **Next Harmonic** button is selected, the cursor is moved to the next marked harmonic with each increment (rotary knob, mouse or **[TAB]** key).

This button is also available if the harmonic marker is not active (see the next section "*Operating the markers*"). In this case, the button activates the harmonic marker.

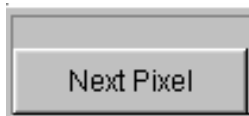

**Waveform:**

If the **Next Pixel** button is selected, the cursor is moved in the graph by one pixel with each increment (rotary knob, mouse or **TAB** key).

If in the graphical display there is not a measurement value at every pixel (because only a few measurement points were recorded relative to the size of the displayed graph), the cursor value is interpolated linearly at the pixels between the measurement values.

If in the graph the number of recorded measurement points is greater than the number of pixels available for display, the largest measurement value in each case is displayed at the corresponding pixel with X and Y-value.

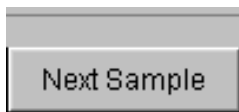

If the **Next Sample** button is selected, the cursor is moved to the next measurement value with each increment (rotary knob, mouse or **TAB** key).

If the graph is displayed relatively small or the number of recorded measurement values (samples) displayed is greater than the number of pixels available in the graphical field, the cursor sometimes does not appear to move (it remains on the same pixel). However, the associated display fields always show the currently selected measurement point with X and Y-value.

**Bargraph:**

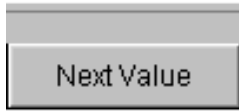

Only the **Next Value** setting is available here; the cursor moves to the next measured distortion point (harmonic or intermodulation product) with each increment (rotary knob, mouse or **TAB** key).

This button does not open a further softkey level; actuating the **Movement** softkey displays the step size without further settings being made.

All of the step-size settings for cursor movement described here only affect the currently selected cursor and are only applicable in the selected graphical window. This means that when a different cursor is activated or a different graphical window is selected, the cursor is moved using the settings applicable there.

The selected step size applies equally to vertical and horizontal cursors.

Function	Front panel	PC keyboard	Mouse
Move cursor	Activate desired cursor via softkeys and move using rotary knob.	Activate desired cursor via softkeys and move using keys TAB and CTRL + TAB.	Click desired cursor or associated display field and move cursor with mouse key held down.
Select active cursor via softkey	Actuate <b>O&lt;-&gt;X</b> softkey; this softkey toggles between O and X-cursor.	Press F5 function key for <b>O&lt;-&gt;X</b> softkey; this softkey toggles between O and X-cursor.	Click desired cursor or one of its display fields.
Select active cursor via Enter function	If desired graph has focus, <b>ENTER</b> key or rotary-knob click toggles between both cursors.	If desired graph has focus, Enter key toggles between both cursors.	Click desired cursor or one of its display fields.

## Cursor in traces with several scans

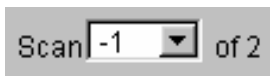

If a trace consists of several scans, the cursors only move along one scan and indicate the X and Y-values of this scan. The scan number displayed in the bottom left-hand corner of the graph in the respective display field indicates which scan is being analyzed.

In order to analyze individual scans with cursors, the cursor is switched to the desired scan in the following way:

- Front panel: with the  keys
- External PC keyboard: with the keys `ALT` + `PAGE UP` and `ALT` + `PAGE DOWN`
- Mouse: by clicking the "Scan" field shown above

### Operating the markers



Actuating the **Marker** button displays the marker softkeys:



The user must then first select the trace on which a marker is to be set. The next softkey level appears simultaneously:

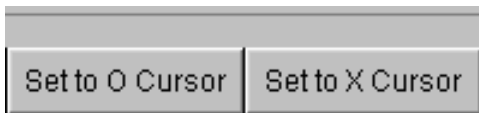

The two buttons **Set to O-Cursor** and **Set to X-Cursor** set the marker to the value of the currently selected cursor.

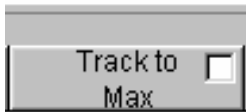

The **Track to Max** button is used to set a marker at the maximum value of the curve. If the maximum value changes, the marker is set at the new maximum value.

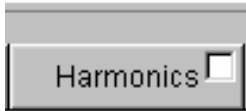

The **Harmonics** button marks harmonics of the frequency indicated by the marker. If no marker has been set, actuating the **Harmonics** button sets the marker to the maximum value of the trace and calculates and marks the harmonics from this frequency.

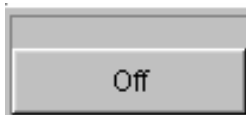

The **Off** button deactivates the marker and indication of the harmonics.

### Zooming the graph



Actuating the **Zoom** button displays the zoom functions.

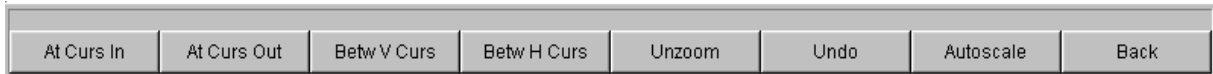

The **Act Curs In** button zooms in on the section of graph on either side of the active X-cursor.

The **Act Curs Out** button zooms out from the section of graph on either side of the active X-cursor.

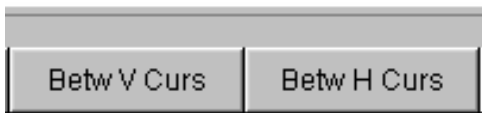

The **Betw V Curs** or **Betw H Curs** button zooms in on the area between the two X or Y-cursors. The zoomed display is fitted to the size of the set graph.

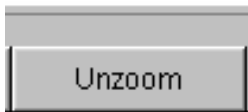

The **Unzoom** button restores the original axis, i.e. undoes all of the zoom operations performed.

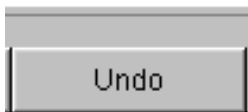

The **Undo** button undoes the zoom operation last performed.

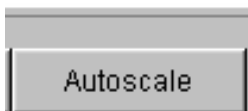

The **Autoscale** button displays the next softkey level. The softkeys available here are used to rescale the selected axes (if required, it is also possible to rescale the axes for certain traces only). The action triggered with this button corresponds to that of the **Autoscale** button in the associated configuration panels, as described in the section "Scaling graph – Autoscale function" on page 3.70.

## Restart Min/Max, Lim Viol function



Actuating the **Restart Min/Max, Lim Violation** button displays another softkey level.

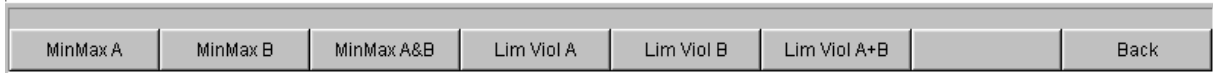

If the **Show Min Max** function was selected in the associated configuration panel, actuating the appropriate button in the softkey bar reactivates indication of the lowest and highest measurement value.

If the **Lim upper** or **Lim lower** function was selected in the associated configuration panel, actuating the appropriate button in the softkey bar reactivates limit monitoring.

## Config function



The **Config** softkey allows the user to open or close the configuration panel while operating the associated graphical window.

## Data Lists

The measurement values can also be displayed in lists instead of or in combination with the graphical windows.

Measurement values which have violated the preset limits are display in red.

In addition, a red arrow pointing up/down in the bottom right-hand corner of the graph provides a permanent indication of limit overranging/underranging.

Pressing the **[START]** key and actuating the **Start Min/Max, Lim** button (see "Restart Min/Max, Lim Viol function" on page 3.81) resets the limit monitoring function.

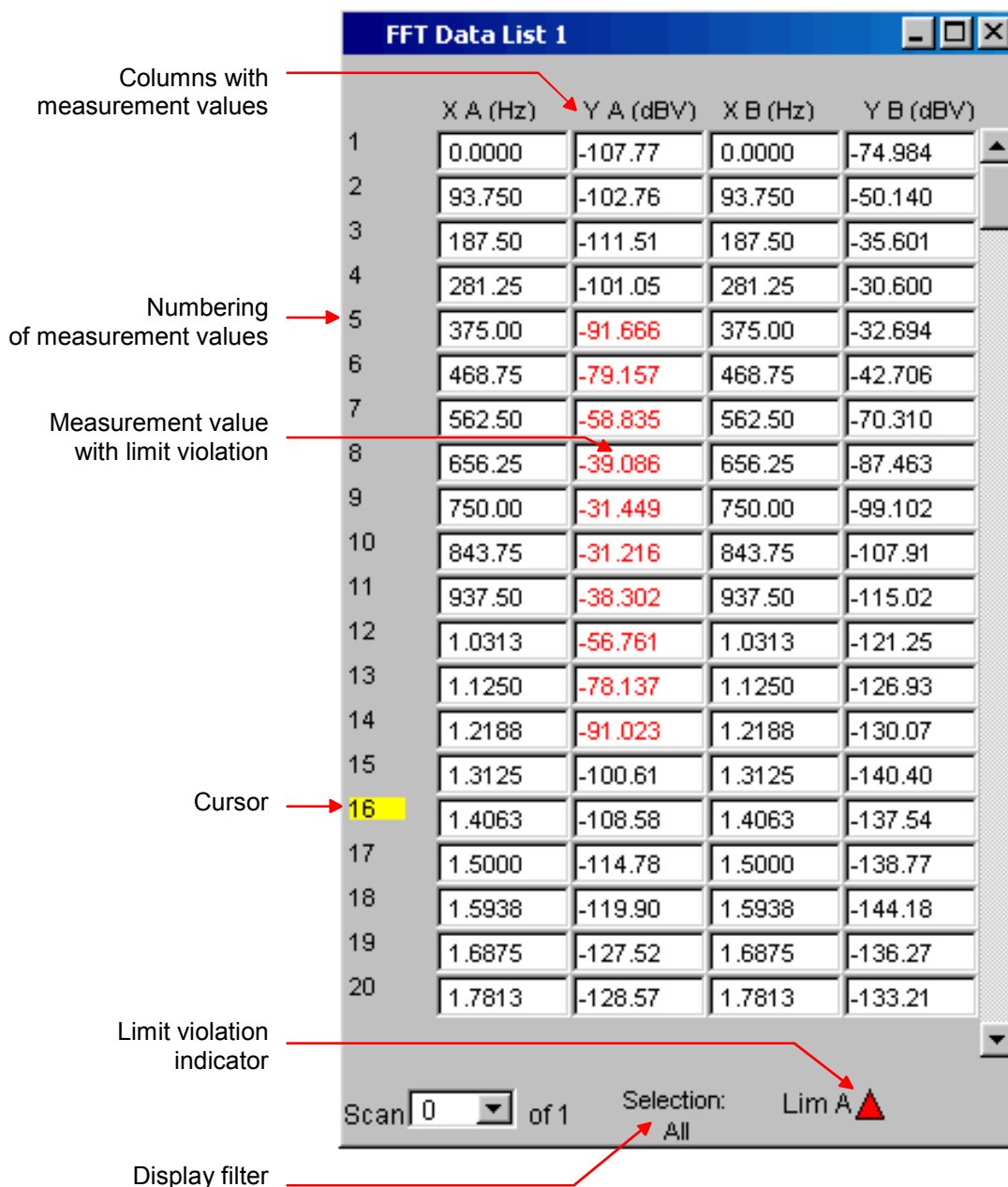

### Opening data list



Data lists can be opened using the associated configuration panel (see "Data Lists"). The associated graphical window is activated using the **Data List** button.

Function	Front panel	PC keyboard	Mouse
Open data list	Highlight <b>Data List</b> button in associated Config panel and open graphical window with <b>ENTER</b> key or rotary-knob click.	Highlight <b>Data List</b> button in associated Config panel and open graphical window with Enter key.	Click <b>Data List</b> button in associated Config panel.

### Data list settings

The settings for configuring the data lists are made in the same panels used to configure the graphical windows:

- Sweep Graph1 ... 4 Config
- FFT Monitor Config
- FFT Graph 1 ... 2 Config
- Waveform Config
- Bargraph1 ... 2 Config

The panels for configuring the data lists are opened via the menu bar; they are called up using the **Disp Config** button.

Function	Front panel	PC keyboard	Mouse
Open panel for configuring a data list	Press <b>MENU</b> key and highlight <b>Disp Config</b> button using rotary knob or cursor keys, open pulldown menu with <b>ENTER</b> key or rotary-knob click, and highlight and select desired panel.	Press key combination CTRL + M, then highlight <b>Disp Config</b> button using TAB or SHIFT + TAB keys, open pulldown menu using Enter key, highlight desired panel using cursor keys and select using Enter key.	Open menu bar by moving to left edge of screen, actuate <b>Disp Config</b> button and click desired panel.

A detailed description of the setting options in these panels can be found in Chapter 4 "Graphical Display".







A number of basic settings for the data lists are described here using examples.

The measurement values displayed in the lists are always linked to the values in the result graphics. This means that all settings in the configuration panels, e.g. unit, engineering, set limits and so on, are also applied to the measurement values in the lists.

The position of the cursor is also shown in the lists; the highlighted measurement number indicates the location of the cursor. Similarly, the step size of cursor movement set via the softkey bar (see the previous section) also affects the movement of the cursor in the data list.

There are three ways of navigating in the lists:

- As soon as a value has been highlighted in the list (blue selection frame), it is possible to use the rotary knob to move from value to value within the column. The cursor keys can also be used to move around in the lists.

The keys  and  are used to navigate through columns and the keys  and  to navigate through rows.

- If an external PC keyboard is used, the keys `TAB` / `CTRL` + `TAB` can also be used to move down/up within the column. Once again, the cursor keys `↑` and `↓` are used to navigate through the columns and the cursor keys `←` and `→` to navigate through the rows.
- If a mouse is used, you can either click the desired value or navigate using the scroll bar.

As soon as the data list has the focus, softkeys appear at the bottom of the screen.

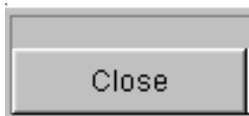
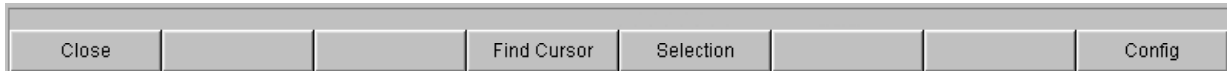

The `Close` button closes the data list.

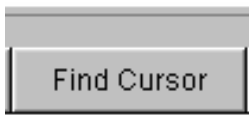

If the `Find Cursor` button is actuated, the displayed section of the data list changes so that the value highlighted with the cursor is in the middle of the list. If both cursors are activated, this button is used to toggle between the two cursor values.

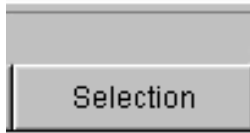

Using the Selection button, it is possible to filter the list of displayed measurement values, i.e. to list only selected rows.

If this button is actuated, a further softkey level appears containing softkeys for selecting the displayed values:

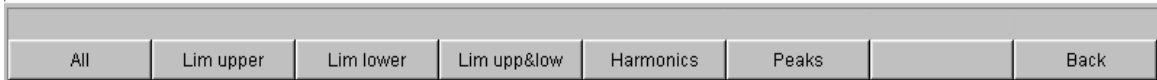

Depending on the selected softkey,

- all
- only the values which exceed the upper, lower or both limits
- only harmonics or
- only peaks

are listed in the data list.

### Cursor in lists with several individual scans

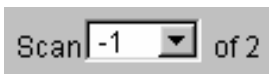

If a trace consists of several scans, only the values of one scan can be displayed in the list at any one time. The scan number displayed in the bottom left-hand corner of the data list in the respective display field indicates which scan is entered in the list.

In order to list individual scans, the desired scan is selected in the following way:

- Front panel: with the  keys
- External PC keyboard: with the keys **ALT** + **PAGE UP** and **ALT** + **PAGE DOWN**
- Mouse: by clicking the "Scan" field shown above

# Settings in the Menu Bar

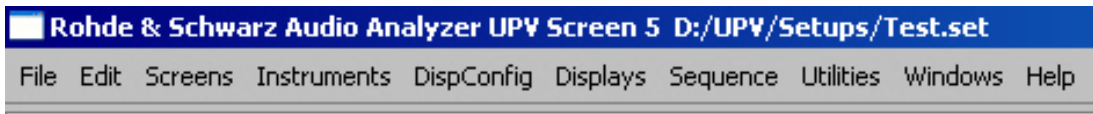

The menu bar of the Audio Analyzer R&S UPV is used in a similar way to other Windows® applications. The following settings are made in the menu bar:

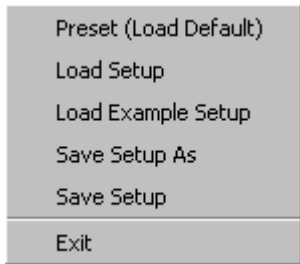

## File button

- To load default settings (same function as the **[PRESET]** key on the front panel, see the section *"Loading and Saving Instrument Settings"*, page 3.106).
- To load instrument settings (same function as the **[LOAD]** key on the front panel, see the section *"Loading and Saving Instrument Settings"*, page 3.106).
- To load instrument settings already prepared by Rohde & Schwarz for a broad range of typical measurements and available on the instrument as example applications; these setups are divided into various application areas (AA, AD, DD, DA) depending on whether the generator or analyzer is operated with analog or digital interfaces.
- To save instrument settings under a new name or to overwrite a setup that already exists (same function as the **[SAVE]** key on the front panel, see the section *"Loading and Saving Instrument Settings"*, page 3.106).
- To exit the R&S UPV measurement program.

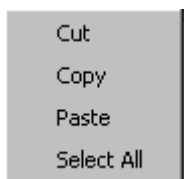

## Edit button

- To cut characters, character strings, data, etc and transfer them to the clipboard.
- To copy characters, character strings, data, etc to the clipboard.
- To paste characters, character strings, data, etc from the clipboard.
- To select characters, character strings, data, etc and transfer them to the clipboard.



## Screens button

- To select one of the five display options (screens), see the section *"Display and Screens"*, page 3.12.

**Instruments button**

Generator Config (closed)  
 Generator Function (closed)  
 Analyzer Config (closed)  
 Analyzer Function (closed)  
 Filter (closed)  
 Auxiliaries (closed)  
 Switcher Panel (closed)  
 Protocol Generator (closed)

- To select the panels for configuring the generators, analyzers, filters and supplementary functions.
- The desired panel must first be highlighted and is then displayed in the currently selected screen (see the section *"Opening, Operating, Hiding and Closing Panels"*, page 3.21).
- In the list, open panels are displayed without a suffix, closed panels are identified by the suffix "closed", and open minimized panels by the suffix "hidden".

**Disp Config button**

Function Config (closed)  
 Level Mon Config (closed)  
 Input Config (closed)  
 Freq / Phase Config (closed)  
 Sweep Graph1 Config (closed)  
 Sweep Graph2 Config (closed)  
 Sweep Graph3 Config (closed)  
 Sweep Graph4 Config (closed)  
 FFT Graph1 Config (closed)  
 FFT Graph2 Config (closed)  
 Waveform Config (closed)  
 PESQ Graph1 Config (closed)  
 PESQ Graph2 Config (closed)  
 Bargraph1 Config (closed)  
 Bargraph2 Config (closed)

- To select the panel used to configure the measurement display windows.
- The desired panel must first be highlighted and is then displayed in the currently selected screen (see the section *"Opening, Operating, Hiding and Closing Panels"*, page 3.21).
- In the list, open panels are displayed without a suffix, closed panels are identified by the suffix "closed", and open minimized panels by the suffix "hidden".

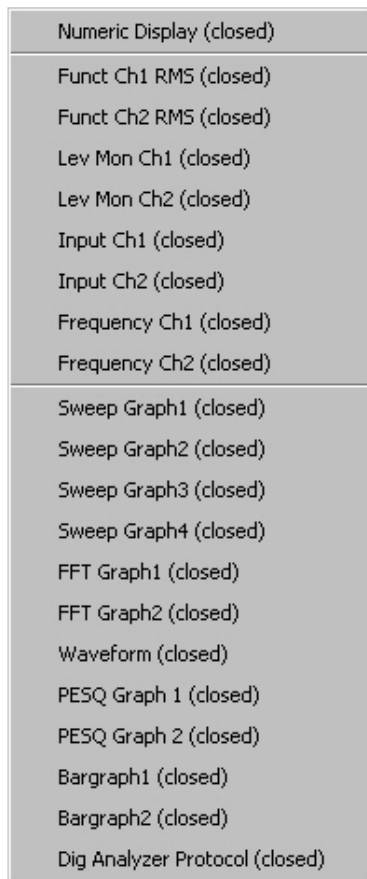

### Displays button

- To select the measurement display windows.
- The desired measurement window must first be highlighted and is then displayed in the currently selected screen (see the section "Opening, Operating, Hiding and Closing Panels", page 3.21).
- In the list, open windows are displayed without a suffix, closed windows are identified by the suffix "closed", and open minimized windows by the suffix "hidden".

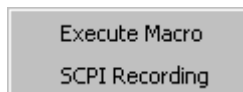

### Sequence button

- To select sequences (macros) used to automate previously programmed measurement procedures to start.
- To record remote-control commands used to simplify the creation of measurement programs (see Chapter 5, "Remote Control – Basics").

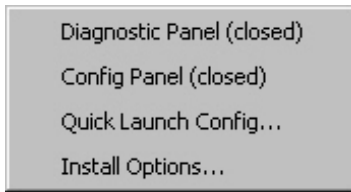

### Utilities button

A series of settings for configuring the Audio Analyzer R&S UPV are grouped under this button:

- To install software options.
- To set the remote-control interface (see Chapter 5).
- To perform service functions.
- To set the Quick Launch Config function.
- To define whether the menu bar and the tool bar should always be visible on the screen or only when the mouse pointer is moved to the left-hand edge (for menu bar) or right-hand edge (for tool bar) of the screen (see below).
- To define the form of the file selector (see section "*File Management*").

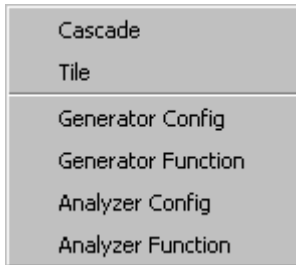

### Windows button

- To cascade all open panels / measurement windows.
- To tile all open panels / windows.
- To display and select all panels / measurement windows which are open and displayed in the current screen.



### Help button

- To call up the help system of the Audio Analyzer R&S UPV (see the section "*Help System*", page 3.99). To call up information about the firmware version installed on the instrument.

**Utilities button, "Always visible" setting**

Always visible	
Menu Bar	<input type="checkbox"/>
Tool Bar	<input type="checkbox"/>

The Audio Analyzer R&S UPV allows you to have the menu bar and/or the tool bar displayed at the top edge or at the right-hand edge of the screen all the time. This feature is primarily for operation with the mouse.

**Menu bar:**

Menu Bar	<input type="checkbox"/>
----------	--------------------------

If the Menu Bar box is not activated, the menu bar appears at the top edge of the screen as soon as you move the mouse pointer to the left-hand edge of the screen. It disappears again after a function has been selected.

Menu Bar	<input checked="" type="checkbox"/>
----------	-------------------------------------

If the Menu Bar box is activated, the menu bar always remains visible at the top edge of the screen.

**Tool bar:**

Tool Bar	<input type="checkbox"/>
----------	--------------------------

If the Tool Bar box is not activated, the tool bar appears at the right-hand edge of the screen as soon as you move the mouse pointer to this edge. The bar disappears again after a function has been selected.

Tool Bar	<input checked="" type="checkbox"/>
----------	-------------------------------------

If the Tool Bar box is activated, the tool bar always remains visible at the top edge of the screen.



## Settings in the Toolbar



As with other Windows® applications, the toolbar on the R&S UPV audio analyzer uses symbols that perform functions when clicked with the mouse. These are mainly functions that are also available as keys on the front panel of the R&S UPV model. The symbols simplify operation with the mouse and can thus also be used with the R&S UPV66 model.

The following functions are offered:



- Corresponds to the **START** key on the front panel of the R&S UPV model.
- Starts continuous measurements or sweeps.
- Resets MIN/MAX values for bargraph displays, averaging for measurement results, and limit overranging.



- Corresponds to the **SINGLE** key on the front panel of the R&S UPV model.
- Starts a single measurement or a single sweep.



- Corresponds to the **STOP CONT** key on the front panel of the R&S UPV model.
- Measurement/sweep is stopped or continued (toggle function).



- Corresponds to the **HCOPY** key on the front panel of the R&S UPV model.
- Depending on the settings under Utilities, printout of the screen contents on the connected printer is started or the screen contents are stored in a file.



- Corresponds to the **OUTPUT OFF** key on the front panel of the R&S UPV model.
- Switches all outputs of the measuring instrument off or on again (toggle function).



- Corresponds to the **LOAD** key on the front panel of the R&S UPV model.
- Opens a panel for storing predefined instrument settings.





- Corresponds to the **SAVE** key on the front panel of the R&S UPV.
- Opens a panel for storing instrument settings.

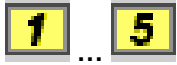

- Selects the appropriate display window (screen), where the colors used have the following meaning:



- The currently selected visible display window is indicated in green.



- All screens in which windows are activated are indicated in yellow.



- Blank display windows are indicated in grey.



- Symbols for conveniently loading predefined instrument settings or for starting macros by means of the mouse. The required settings are described in the following section.



### Utilities button, "Quick Launch Config..." setting

Diagnostic Panel (closed)  
 Config Panel (closed)  
 Quick Launch Config...  
 Install Options...

In the toolbar, you can define up to eight icons that either load setups or execute macros when clicked with the mouse.

You can determine these functions in the **Quick Launch Config...** window.

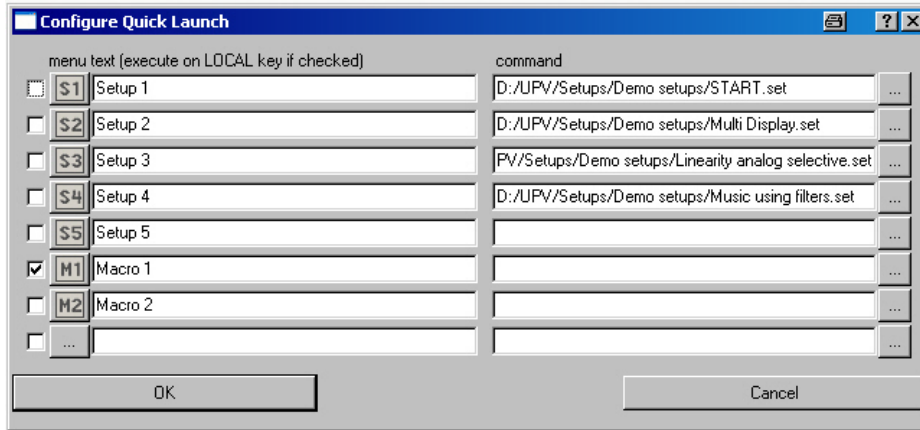

- If this check box is enabled, the corresponding setup or macro can be performed by means of the LOCAL key on the front panel.



- In this column, you can define icons however you want. You can do this by using the symbols (S1 to S8 or M1 to M8), which are standard on the instrument and can be found in the C:\UPV\Configres directory. However, you can also use any other icon. The only requirements are that the icon has a size of 20 x 20 pixels and that it is available as a BMP file on the hard disk of the R&S UPV. Clicking the ... button with the mouse opens the File Selector, where you can select the icon file you want.



- In these text lines, you can enter comments to describe the individual setup/macro.

- In the command column, you can select the setup/macro that is to be activated with the symbol. The easiest way to do this is to click the ... button with the mouse, whereupon the File Selector is opened, making it possible to select the required file.

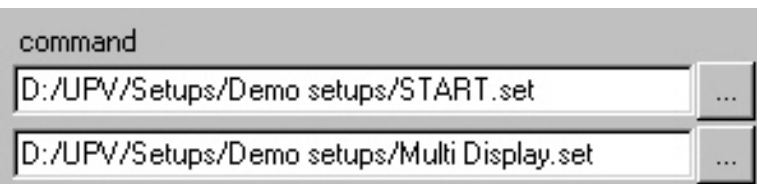

## Settings in the Operating System

The R&S UPV uses the WindowsXP® operating system. Settings at system level are only rarely required, e.g. installation of a new printer driver.

Connecting a keyboard and mouse makes Windows® easier to use.

## Auxiliaries Panel

A number of supplementary functions can be selected in the **Auxiliaries** panel. It is divided into the following sections:

- **Audio Monitor**,  
for configuring the audio-monitoring functions
- **Anlg Aux Out**,  
the auxiliary analog output at the rear of the R&S UPV can be configured here
- **Trigger In / Out**,  
for configuring the trigger inputs and outputs at the rear of the instrument

## Audio Monitor Function



The audio monitoring output (integrated loudspeaker or headphone connection) permits audio monitoring of analog or digital input signals both directly at the input of the Audio Analyzer R&S UPV and at the various analysis levels after any filters that may be active. Audio monitoring of the generator signal is also possible.

If the R&S UPV-U2 option is installed, the signal of the headphone output is also available at two BNC connectors on the instrument's rear panel.

The required settings are made in the Auxiliaries panel; the settings described here are intended as examples.

A detailed description of the options can be found in Chapter 4 "Instrument Functions".

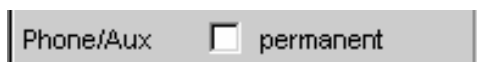
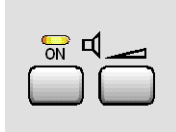
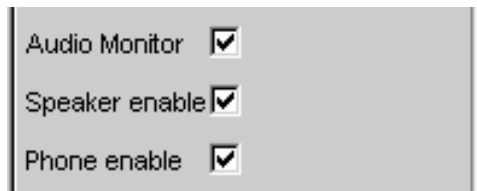

These tick boxes are used to operate the audio monitoring function.

- **Audio Monitor** switches the loudspeaker or the headphones on/off. This function corresponds to the loudspeaker ON key on the front panel of the instrument.
- **Speaker enable** and **Phone enable** are used to preselect which of the two components the on/off function described above applies to.
- If installed, the R&S UPV-U2 option is connected in parallel to the headphone output; these BNC connectors are therefore switched on and off just like the jack.
- If the **Phone/Aux** box is activated, the headphone output and, if installed, the BNC connectors (R&S UPV-U2 option) remain permanently activated. The ON key only affects the loudspeaker. This "permanent" setting is very useful, for example, if you connect an oscilloscope on which the signal is to be continuously monitored and the loudspeaker is to remain selectable at the same time.

The **Signal Source** field is used to select which signal is to be monitored. This can be the measurement signal switched to the analysis path either in the input level, monitor level or function level, i.e. with or without filtering.

Alternatively, the generator signal can also be monitored.

The individual levels of the analyzer are explained in greater detail in the section "*Function blocks and measurement levels*" on page 3.5.



Either the signal of a single channel (Mono) or the stereo signal can be applied at the audio monitoring output.

If Both is set, both channels are separately available at the two headphone outputs; the loudspeaker outputs the signal from both channels.

If the R&S UPV-U2 option is installed, the same applies to the two BNC connectors, which are then available.

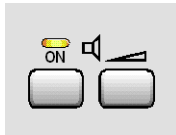
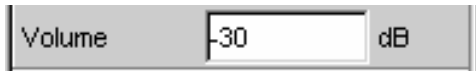
The volume at the loudspeaker or connected headphones can be set in two ways:



- By entering or changing the numeric value in the associated field of the panel (permitted range: 0 dB to -120 dB).
- Pressing the volume key on the front of the instrument opens a window containing a volume control which can be operated directly using the rotary knob, the cursor keys  and  or using the mouse. The ENTER function or pressing the volume key again confirms the setting and closes the window.

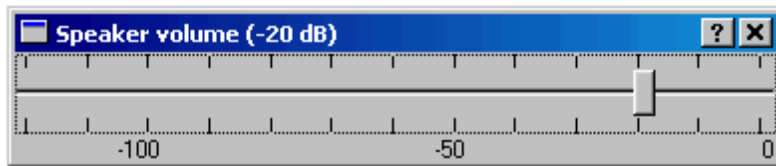

**Warning:**

*The output voltage of the built-in headphones amplifier is influenced by the incoming signal, by instrument settings such as the selected measurement range and test function, as well as by the set volume. If the volume is set to maximum, the headphones amplifier may generate high output voltages with an RMS value of up to 8 V. Depending on the headphones' sensitivity, this may produce very high sound pressure levels that may cause hearing damage. To monitor varying input signals, therefore, it is advisable to reduce the volume and take off the headphones until the signal has settled.*

## Auxiliary Analog Output

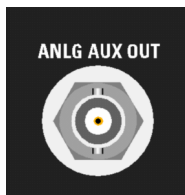
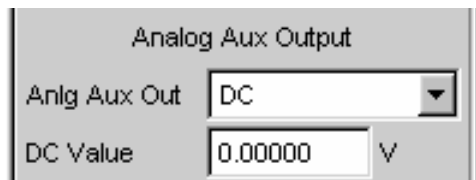

An auxiliary analog output for the following special applications is provided at the rear of the R&S UPV:

- Output of a DC signal, e.g. for supplying power to hearing aids
- Auxiliary output for the analog generator signal via an integrated amplifier for the direct actuation of small loudspeakers
- Output for single-channel audio monitoring

Details are given in Chapter 4 "Instrument Functions".

## Trigger Input, Trigger Output

Trigger Output	
Enable	<input type="checkbox"/>
Mode	Aux Clock Out
	48000.0 Hz

  

Trigger Input	
Enable	<input type="checkbox"/>
Mode	Meas Single
Edge	<input checked="" type="radio"/> Rising <input type="radio"/> Falling

A trigger input and trigger output for the following applications are provided at the rear of the R&S UPV:

- Input for triggering measurements
- Output for a measurement-event-dependent signal that can be used to trigger external instruments / circuits
- Alternatively, clock signals can also be output at the TRIG OUT socket

Details are given in Chapter 4 "Instrument Functions".

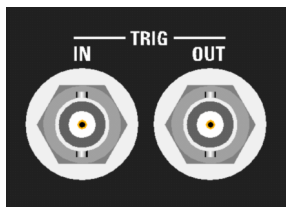

## Rapid Deactivation of the Outputs



In the event of faults, the outputs of the R&S UPV can be deactivated by pressing the `Output OFF` key. This means the following:

- The levels of all digital outputs are set to 0 V
- The levels of all analog outputs are set to 0 V; the outputs remain terminated (i.e. the impedance is retained)

The deactivated lines can only be reactivated by pressing the OUTPUT OFF key again.

### Specialty Anlg Aux Output:

If DC is selected as signal source in the Anlg Aux Out line in the Auxiliaries panel, the DC voltage indicated in the line below will be retained even if you press the `Output OFF` key.

This ensures the supply voltage or the operation point is retained when a device under test (DUT) is connected.

The status of the key is indicated by an LED. Illumination of the LED means OUTPUT OFF.

In order to protect the analyzer input, the generator output is also deactivated automatically if the analyzer inputs are overloaded (input voltage at 300  $\Omega$  or 600  $\Omega$  is higher than 25 V), and the OUTPUT OFF LED lights up as if the OUTPUT OFF key has been pressed. After the analyzer inputs have been overloaded in this way, measurements can be resumed provided that the overvoltage has been rectified or the input impedance has been switched to 200 k $\Omega$ .

Remote-control command:

OUTPut ON | OFF

# Help System

The R&S UPV has a context-sensitive help system. The help system provides a help page for every parameter and can be called up at any time while the instrument is being operated.

The help system has a navigation bar, i.e. starting from the context-sensitive page it is possible to move to other help pages using the contents list, the index, scroll arrows and page-internal links.

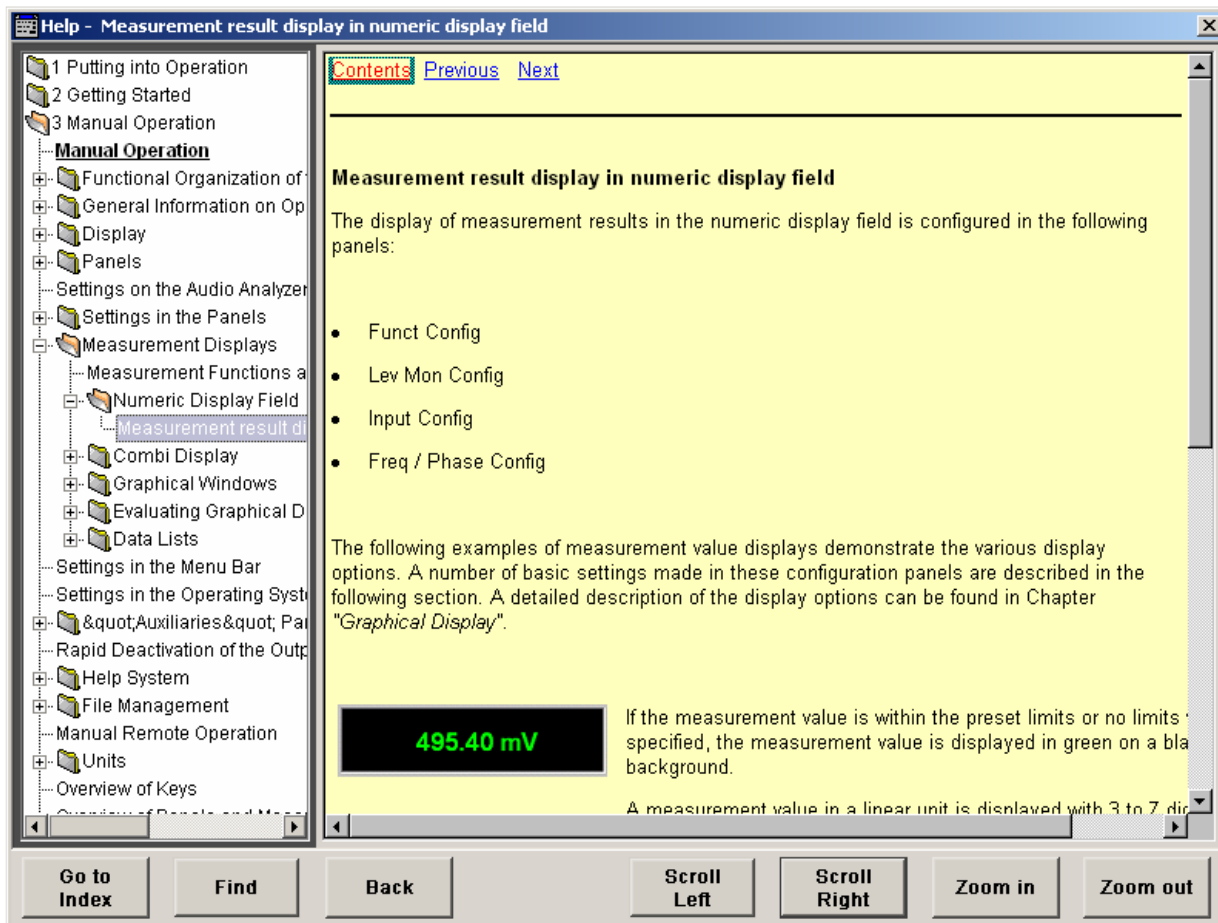

In addition to the context-sensitive help, online help for all functions of the R&S UPV is compiled on the supplied CD-ROM. This help can be called up on any computer using the Internet Explorer (version 4.0 and higher).

## Operating Help

The Help window is divided into three areas. On the left-hand side is a column that displays either the entire help contents list or the index. To the right of that is a large area showing the current help page and, if necessary, a vertical scrollbar. This area can also be moved up or down with the rotary knob. The bottom of the window contains several buttons for operating the help system.

### Note:

*If the left-hand area containing the contents list or the index is activated, you can use the letter keys to go directly to the desired first letters in the area.*



You can use the rotary knob to move the blue highlighting. Clicking the rotary knob activates the highlighted segment, and its color changes to gray. Pressing the **ESC** key deactivates the segment, and you can use the rotary knob again to move the highlighting.

The bottom of the window contains several buttons for operating the help system. These buttons can be operated using the mouse or the buttons:

**Go to Index** This button changes the display on the left-hand side to the index. You also use this button to return to the contents list; the button is then called "Go to Content".

**Find**

**Back** If you navigate in the online help by activating links, actuating this button returns you to the previous page.

**Scroll Left** Sometimes the help pages are too wide to fit completely in the display. In this case, a horizontal scrollbar is displayed. You can then use these buttons to scroll horizontally without losing the input focus.

**Scroll Right**

**Zoom In** This button makes the help display larger.

**Zoom Out** This button makes the help display smaller.

The advantage of using these buttons is that the appropriate help area is always activated, allowing you to work smoothly.

## Help Text Language

Both the context-sensitive help and the online help are available in English and German. The language of the help texts can be set under the **Utilities** button on the menu bar.

**Help Language** Selects the language in which the online help is to be displayed.

**English** The online help is displayed in English.

**Deutsch** The online help is displayed in German.

## Overview of operating the context-sensitive help system

Function	Front panel	PC keyboard	Mouse
<b>Open help</b> Help page for selected parameter is displayed.	Press <b>HELP</b> key.	Press F1 key.	---
<b>Close help</b>	Press <b>HELP</b> key again.	Press F1 key again.	---
<b>Activate link</b> Help opens linked page.	Highlight link using rotary knob or arrow keys and activate with rotary-knob click or <b>ENTER</b> key.	Highlight link using cursor keys and activate with Enter key.	Click link.
<b>Scroll through help</b>	Highlight <b>Previous</b> or <b>Next</b> in help window using cursor keys and activate with rotary-knob click or <b>ENTER</b> key.	Highlight <b>Previous</b> or <b>Next</b> in help window using cursor keys and activate with Enter key.	Click <b>Previous</b> or <b>Next</b> .
<b>Change size of text</b>	Use the <b>Zoom In</b> and <b>Zoom Out</b> softkeys to set the desired size.	Use the <b>F11</b> ( <b>Zoom In</b> ) and <b>F12</b> ( <b>Zoom Out</b> ) keys to set the desired size.	Use the <b>Zoom In</b> and <b>Zoom Out</b> buttons to set the desired size.
<b>Switch to index</b>	Go to Index softkey switches to index or back to contents list.	<b>F5</b> ( <b>Go to Index</b> ) key switches to index or back to contents list.	Go to Index button switches to index or back to contents list.
<b>Scroll horizontally</b>	Use the <b>Scroll Left</b> and <b>Scroll Right</b> softkeys.	Use the <b>F9</b> ( <b>Scroll Left</b> ) and <b>F10</b> ( <b>Scroll Right</b> ) keys.	Use the <b>Scroll Left</b> and <b>Scroll Right</b> buttons.
<b>Select item from contents list</b> Help page for selected item is displayed.	Press <b>Focus</b> button below contents list. Highlight desired item using rotary knob or cursor keys and then press rotary knob or <b>ENTER</b> key.	Highlight <b>Focus</b> button below contents list using cursor keys and activate with Enter key. Highlight desired item using cursor keys and then press Enter key.	Click item.
<b>Select index item</b> Help page for selected item is displayed.	Press <b>Focus</b> button below index. Type desired term in entry field and then press rotary knob or <b>ENTER</b> key or highlight item using rotary knob or cursor keys and then press rotary knob or <b>ENTER</b> key.	Highlight <b>Focus</b> button below index using cursor keys and activate with Enter key. Type desired term in entry field and press Enter key or highlight item using cursor keys and press Enter key.	Click item.
<b>Select help text language</b>	Press <b>MENU</b> key and highlight <b>Utilities</b> button using rotary knob or cursor keys, open pull-down menu with <b>ENTER</b> key or rotary-knob click, highlight and select <b>Config Panel</b> button, and highlight and select desired language in <b>Help Language</b> item in next level.	Press key combination CTRL + M, then highlight <b>Utilities</b> button using keys TAB or SHIFT + TAB, open pull-down menu with Enter key, highlight <b>Config Panel</b> button using cursor keys, select with Enter key and highlight desired language in <b>Help Language</b> item in next level using cursor keys and select with Enter key.	Click top of screen to open menu bar, actuate <b>Utilities</b> button, click <b>Config Panel</b> button and click desired language in <b>Help Language</b> item in next level.

## File Management

The R&S UPV uses files to store all instrument data, i.e. system and user data. User data includes stored instrument settings, data for equalizer files, lists for sweeps, and so on.

The files are stored on the instrument's hard disk. The D:\ drive is available for storing user-defined data and can have any number of directory structures. A number of default directories are preconfigured; they can, however, be changed at any time.

The C:\ drive is a protected system drive. The files on this drive contain data which should not be modified. This drive should therefore not be accessed, otherwise reconstruction of the system partition will not be possible without loss of data. To prevent system files from being deleted or overwritten inadvertently, the C:\ drive is not displayed in the File menu. It can be accessed by disabling a protection level (see Protection Level in the Setup menu).

Files can be transferred either using a USB stick or via a connected network. The USB stick is inserted into one of the USB interfaces and is assigned the drive letter F:\. If the instrument is connected to a network, all network drives for which the user has access authorization are also available (see Chapter 1, section *Accessing Directories in the Network*, page 1.41). The files are distinguished by their extension; each file type has a certain content. Normally, the extension is of no importance to the user since the files are accessed in the associated panels where only the relevant file type is available. For example, the files with equalizer settings can only be loaded in the **Generator Function** and **Analyzer Function** panels if the appropriate function settings have been made.

To load loaded settings or to store results, the **File Manager** must be called up using the  button in the respective panel; a **File Select** window then appears.

## Selecting the File Select Window

You can select between two fundamentally different types of the File Select window. You can set the style you wish to have by using the **Utilities** button in the menu bar.

- **Windows Style:**  
The File Select window known from Windows is used to select files. This makes for very convenient operation when using the mouse, but operation via the front panel is very restricted.
- **UPV Style:**  
The R&S UPV uses its integrated File Select window to select files. This window is fully operable via the front panel and allows you, for example, to enter file names via the number keys as on a mobile phone.

### File Selector

Selects the style in which the File Select window is to be displayed.



**ON** The R&S UPV displays the File Select window known from Windows ("Windows Style").

**OFF** The R&S UPV displays the integrated File Select window ("UPV Style").

## Integrated File Select Window

The **File Select** window has several sections.

The files last used are listed in the top section **Recent Data Sets**; a maximum of ten files are displayed.

The available drives and directories are shown underneath on the left-hand side, and the files in the selected directory are shown on the right-hand side. The currently selected path is displayed above the window. Only the relevant files (without file extensions) are shown. If several files are opened, the path selected last is displayed.

Any file name can be used when saving and creating files; the file extension is, however, assigned automatically and cannot be entered. The file is saved on the selected path.

This panel is operated in the same way as other panels, whereby each section of the File Select window is treated as a separate panel: The rotary knob or cursors are used to highlight the desired section and the entry focus is moved to this section by pressing the rotary knob or the Enter key. The rotary knob and up/down cursors then only navigate within this section. The left/right cursor can be used to toggle between the directory tree and the file list. After a brief delay, the subdirectories of the selected directory are displayed to permit fast navigation in the directory tree. Pressing the ESC key moves the entry focus up again by one level. The button used to save or load the file can be highlighted and actuated. After the desired operation has been completed, e.g. selection of the file, the menu is closed automatically.

- **Loading file:**  
Highlight the file and load by pressing the rotary knob or actuating the **Select** button/softkey.
- **Saving file:**  
Enter the file name in the **File Name:** field. Highlight the directory in which the file is to be saved and then actuate the **Save** button/softkey.
- **Creating file:**  
Enter the file name in the **File Name:** field. Highlight the directory in which the file is to be saved and then actuate the **Create** button/softkey. The created file is empty; it has to be filled with the desired values using the associated editor.

## File Manager

The **File Manager** is used to perform general file management tasks, such as copying, moving, renaming and deleting files and creating new directories. It can also be used to save externally created files in the R&S UPV by copying them from a USB stick, from a CD ROM or from a network to the internal hard disk.

The **File Manager** can be called up in all panels in which files can be loaded. It is called up using the **File Manager...** button in the **File Select** window.



Additionally, it is also possible to call up the File Manager via the menu bar.

The file types which are to be displayed can be selected in the **File Type** section at the top of the **File Manager**. All files (All Files (\*.\*)) or specific file types (e.g. Waveforms (\*.wav)) can be selected. A list of file types is given in the panel at the end of this section.

The available drives and directories are shown underneath on the left-hand side, and the files in the selected directory are shown on the right-hand side. The currently selected path is displayed above the window. If several files are opened, the path selected last is displayed. Unlike the **File Select** window, the **File Manager** displays the complete file name including the extension.

The buttons/softkeys trigger the assigned action, e.g. copying, moving or deleting the highlighted file. In addition, it is possible to create a new directory in the level below the highlighted directory.

The File Manager is operated in the same way as other panels, whereby each section of the File Manager is treated as a separate panel: The rotary knob or cursors are used to highlight the desired section and the entry focus is moved to this section by pressing the rotary knob or the Enter key. The rotary knob and up/down cursors then only navigate within this section. The left/right cursor can be used to toggle between the directory tree and the file list. After a brief delay, the subdirectories of the selected directory are displayed to permit fast navigation in the directory tree. Pressing the ESC key moves the entry focus up again by one level. The buttons/softkeys can be selected and actuated.

- **Moving file:**  
Highlight the file and then actuate the **Cut** button/softkey. Highlight the directory to which the file is to be moved and then actuate the **Paste** button/softkey. If a file with the same name already exists in the target directory, a confirmation query appears which the user must acknowledge before the file is overwritten.
- **Copying file:**  
Highlight the file and then actuate the **Copy** button/softkey. Highlight the directory to which the file is to be copied and then actuate the **Paste** button/softkey. If a file with the same name already exists in the target directory, a confirmation query appears which the user must acknowledge before the file is overwritten.
- **Renaming file:**  
Highlight the file and then actuate the **Rename** button/softkey. A window opens in which the new file name can be entered. Enter the name and press the Enter key. If a file with the same name already exists, a confirmation query appears which the user must acknowledge before the file is overwritten.
- **Deleting file:**  
Highlight the file and then actuate the **Delete** button/softkey. A confirmation query then appears which the user must acknowledge before the file is deleted.
- **Creating a new directory:**  
Highlight the drive or directory level under which the new directory is to be created, and then actuate the **Create New Directory** button/softkey. A window opens in which the new directory name can be entered. Enter the name and press the Enter key.

## Loading and Saving Instrument Settings

Instrument settings are loaded and saved in the same way as described for loading and saving files in the previous section. The File Select window is opened using the **File** button in the menu bar.

Instrument settings can also be loaded/saved directly using the **LOAD** / **SAVE** keys on the front of the instrument. Pressing these keys opens the File Select window.

Every Audio Analyzer R&S UPV has a range of instrument settings which have been prepared by Rohde & Schwarz for a broad selection of typical measurements and which are available on the instrument as example setups. These setups are divided into various application areas (AA, AD, DD, DA) depending on whether the generator or analyzer is operated with analog or digital interfaces. This allows users to make settings for their own specific measurement tasks very simply by modifying these example setups.

All of these example settings can be found in the **Applications** directory.

The default factory presettings are also available on every R&S UPV. These can be called up directly using the **File** button on the menu bar or by pressing the **PRESET** key on the front of the instrument.

## List of File Extensions Used

List of the user-file extensions which are assigned automatically in the R&S UPV:

File type	File extension	Meaning
<b>Instrument settings</b>		
	.SET	Setup file for saving and loading the instrument parameters set by the user ("complete" setup)
	.SAC	Setup file for saving and loading the instrument parameters set by the user ("current" setup)
<b>Equalizer settings</b>		
	.FTF	Amplitude/frequency table for noise generation in the frequency range
	.VEQ	Equalizer file; loaded in the "Equal File" parameter field of the <i>Generator Function</i> and <i>Analyzer Function</i> panels
<b>Sweep settings</b>		
	.SWL	Sweep list for the following: <ul style="list-style-type: none"> <li>- Dwell times for automatic generator sweeps, loaded in the "Dwell File" field of the <i>Generator Function</i> panel</li> <li>- Frequency of the generator or of the selective RMS measurement; loaded in the <i>Generator Function</i> panel ("Freq File", "Mean Freq File", "Upper Freq File" fields) or in the <i>Analyzer Function</i> panel ("File Name" field)</li> <li>- Burst interval; loaded in the "Interval File" field of the <i>Generator Function</i> panel</li> <li>- Burst duration; loaded under the "On Time File" menu item of the <i>Generator Function</i> panel</li> <li>- Generator voltage; loaded in the "Volt File" or "Tot Volt File" field (depending on the function) of the <i>Generator Function</i> panel</li> </ul>
<b>Files for data or limit lists</b>		
	.LIM	Limit curve, loaded in the configuration panels for measurement windows under "Limit Upper" and "Limit Lower"
	.TRC	Trace lists for measurement values, loaded in the configuration panels for measurement windows
<b>Graphic files</b>		
	.BMP	Pixel graphic
<b>Other instrument files</b>		
	.ARB	Time table for generating arbitrary signals
	.WAV	Standard format for audio signals to allow processing with PC sound cards



File type	File extension	Meaning
<b>Filter files</b>		
	.COE	Coefficient file for file-defined filters, loaded in the <i>Filter</i> panel in the "File Name" field
	.NPZ .XPZ .ZPZ	Pole/zero file for file-defined filters, loaded in the <i>Filter</i> panel in the "File Name" field

## Manual Remote Operation

The R&S UPV permits manual remote operation using an external computer. As a result, the audio analyzer can be operated conveniently from the user's desk even if, for example, the audio analyzer is installed in a rack in a different room.

Unlike **remote control** where remote-control commands are used, **manual remote operation** requires separate Windows® software which is installed on the external computer. When launched, the Windows® software **Remote Desktop Connection** simulates the R&S UPV user interface. This allows the instrument to be manually operated at the external computer in the same way as at the instrument itself.

Manual remote operation is only possible if the audio analyzer and computer are connected via LAN and the Windows® software is installed on the computer.

How to set up a connection and install the remote operation software on the external computer is described in Chapter 1 in the section *Configuration for Manual Remote Operation* on page 1.49

Manual remote operation is started on the external computer by calling up the **Remote Desktop Connection** program and clicking the **Connect** button. The R&S UPV must be selected as the remote operation device, i.e. its computer name must be displayed in the **Computer:** field. If the computer has been configured for remote operation of more than one instrument, the desired instrument can be selected from the list which is displayed by clicking the  button. The user ID and password (**instrument** in both cases) can be stored when the software is first installed. The entries are made in the extended menu "Options>>" (see Chapter 1, section *Configuration for Manual Remote Operation*, page 1.49).

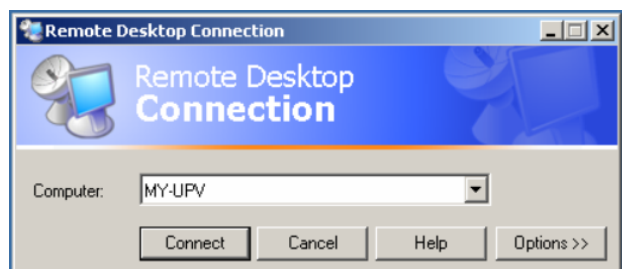

After login, the instrument firmware of the R&S UPV boots on the external computer. After booting is completed, the audio analyzer screen appears and the R&S UPV is ready for manual remote operation from the external computer. The starting configuration is that which was active before the connection was set up. The individual functions are operated using the mouse and panel. Front panel keys which are not directly available on the panel may be replaced by key combinations (see the section "Overview of Keys" starting on page 3.118). The instrument firmware on the R&S UPV is terminated when the connection is set up. Operation at the R&S UPV itself is not possible during manual remote operation. Access by an external computer and the identity of the remote user is indicated on the login display of Windows®.

To enable direct operation at the R&S UPV again, the external user must first log out and then log in as the local user.

The external user can log out at the external computer in the **Start** menu of the R&S UPV window by clicking **Disconnect** in the bottom right-hand corner of the menu.

It is also possible to log off directly at the R&S UPV in the remote operation window.

The local user must press the key combination Ctrl + Alt + Del before logging in at the remote operation screen on the R&S UPV. The default name of the local user on the R&S UPV is "**instrument**"; the password is also "**instrument**".

After login, the instrument software starts with the settings used for manual remote operation.

## Units

There are two types of unit in the R&S UPV:

- **Units for measurement result display:**  
In the configuration panels for the measurement displays, a display unit must be selected for each measurement function. This unit is then used for the measurement result displayed in the measurement display windows. The unit is selected in the *Unit* fields of the respective panel.
- **Units for value entries (e.g. reference values, frequencies, levels, etc):**  
When data is entered, the available units are displayed on the softkeys. This allows value entries to be adopted by selecting the unit without a further entry window having to be opened.

## Units in Measurement Result Displays

To simplify matters:

In the following conversion formulae the entry values are designated by the unit only.  
Example: "dBu" means "value in dBu".

### Units for analog level measurement results:

Basic unit: V

Table 3-1 Units for analog level measurement results

Value in	IEC/IEEE-bus notation	Conversion formula
V	V	
dBV	DBV	$20 \times \lg(V)$
dBu	DBU	$20 \times \lg(V/0.7745967)$
dBm	DBM	$10 \times \lg(V^2 \times 1000/R_{REF})$
W	W	$V^2/R_{REF}$
$\Delta\%V$	DPCTV	$(V/U_{REF}-1) \times 100$
$\Delta V$	DV	$V-U_{REF}$
V/Vr	VVR	$V/U_{REF}$
$\%V/Vr$	PCTVVR	$100 \times V/U_{REF}$
$\Delta\%W$	DPCTW	$((V^2/R_{REF})/P_{REF} - 1) \times 100$
$\Delta W$	DW	$(V^2/R_{REF}) - P_{REF}$
P/Pr	PPR	$(V^2/R_{REF})/P_{REF}$
$\%P/Pr$	PCTPPR	$(V^2/R_{REF})/P_{REF} \times 100$
dBr	DBR	$20 \times \lg(V/U_{REF})$

$R_{REF}$  = Reference impedance (Ref Imped) from *Analyzer Config* panel

$U_{REF}$  = Reference level (Reference) from *Config* panel for measurement function

$P_{REF}$  =  $(U_{REF})^2/R_{REF}$

**Units for digital level measurement results:****Basic unit:** FS (Full Scale)

Table 3-2 Units for digital level measurement results

Value in	IEC/IEEE-bus notation	Conversion formula
FS	FS	
%FS	PCTFS	$FS \times 100$
dBFS	DBFS	$20 \times \lg (FS)$
Hex *)	HEX	$FS \times (2^{\text{Audiobits}-1}-1)$ for $FS > 0$ $FS \times (2^{\text{Audiobits}-1}-1) + (2^{\text{Audiobits}-1})$ for $FS < 0$
$\Delta\%$	DPCT	$(FS/U_{REF}-1) \times 100$
dBr	DBR	$20 \times \lg (FS/U_{REF})$
LSBs	LSBS	$FS \times 2^{\text{Audiobits}-1}$
bits	BITS	$1 + \lg (FS \times 2^{\text{Audiobits}-1})$

$U_{REF}$  = Reference level (Reference) from *Config* panel for measurement function

\*) Level measurement result in hex notation

All digital analyzer measurement functions usually deliver values ranging from 0 to 1 FS.

FS values >1 may occur in the following cases:

- In the case of the peak measurement function with Meas Mode Peak to Peak.
- In the case of a filter with gain (e.g. CCIR wtd) is used.

FS values <0 may occur in the following cases:

- In the case of the peak measurement function with Meas Mode Neg Peak.
- In the case of the DC measurement function.

**Units for distortion measurement results:****Basic unit:** %

Table 3-3 Units for distortion measurement results

Value in	IEC/IEEE-bus notation	Conversion formula
%	PCT	
dB	DB	$20 \times \lg (\% / 100)$

In the case of SINAD:  $-20 \times \lg (\% / 100)$

**Unit for S/N measurement results:**

Table 3-4 Units for S/N measurement results

Value in	IEC/IEEE-bus notation	Formula
dB	DB	$20 \times \lg(S/N)$

S: Measurement level with activated generator

N: Measurement level with deactivated generator

**Units for frequency measurement results:**

Basic unit: Hz

Table 3-5 Units for frequency measurement results

Value in	IEC/IEEE-bus notation	Conversion formula
Hz	HZ	
$\Delta$ Hz	DHZ	$\text{Hz} - F_{\text{REF}}$
$\Delta\%$ Hz	DPCTHZ	$100 \times (\text{Hz} - F_{\text{REF}}) / F_{\text{REF}}$
Toct *	TOCT	$\lg(\text{Hz} / F_{\text{REF}}) \times 9.96578$
Oct	OCT	$\lg(\text{Hz} / F_{\text{REF}}) \times 3.32193$
Dec	DEC	$\lg(\text{Hz} / F_{\text{REF}})$
f/fr	FFR	$\text{Hz} / F_{\text{REF}}$

\*) Toct = Third octave

 $F_{\text{REF}}$  = Reference frequency (Ref Freq) from *Freq Phase Config* panel for frequency measurement**Units for phase measurement results:**

Basic unit: ° (degrees)

Table 3-6 Units for phase measurement results

Value in	IEC/IEEE-bus notation	Conversion formula
°	DEG	
RAD	RAD	$^{\circ} \times \pi / 180$
$\Delta^{\circ}$	DDEG	$^{\circ} - P_{\text{REF}}$
$\Delta$ RAD	DRAD	$(^{\circ} - P_{\text{REF}}) \times \pi / 180$

 $P_{\text{REF}}$  = Reference phase (Ref Phase) from *Freq Phase Config* panel for phase measurement

**Units for group delay measurement results:****Basic unit:** s

Table 3-7 Units for group delay measurement results

Value in	IEC/IEEE-bus notation	Conversion formula
s	S	
$\Delta s$	DS	$s - T_{REF}$

$T_{REF}$  = Reference time (Ref Grp Del) from *Freq Phase Config* panel for group delay measurement

**Units for digital jitter measurement results:****Basic unit:** UI (unit interval)

Table 3-8 Units for digital jitter measurement results

Value in	IEC/IEEE-bus notation	Conversion formula
UI	UI	
%UI	PCTUI	$100 \times UI$
dBUI	DBUI	$20 \times \log (UI)$
ppm	PPMUI	$10^6 \times UI$
ns	NS	$10^9 \times UI / (128 \times \text{sampling frequency})$
dBr	DBR	$20 \times \log (UI/U_{REF})$
Ulr	UIR	$UI/U_{REF}$

$U_{REF}$  = Reference level (Reference) from *Config* panel for measurement function

**Unit for digital phase measurement results (Phase to Ref):****Basic unit:** UI (unit interval)

Table 3-9 Units for digital phase measurement results

Value in	IEC/IEEE-bus notation	Conversion formula
UI	UI	
%FRM	PCTFRM	$100 \times UI / 128$
°FRM	DEGFRM	$360 \times UI / 128$
ns	NS	$10^9 \times UI / (128 \times \text{sampling frequency})$

The magnitude of jitter and phase is normally indicated in UI (unit interval). One UI corresponds to the clock period with which the digital signal is clocked (biphase clock). With digital audio signals, one UI corresponds to 128th of the sampling period. At 48 kHz, one UI is 162.76 ns.

## Units for Value Entries

To simplify matters:

In the following conversion formulae the entry values are designated by the unit only.

Example: "dBu" means "value in dBu".

Table 3-10 Absolute analog level units (without reference)

Conversion formulae	IEC/IEEE-bus notation
V, mV, $\mu$ V	V, MV, UV
V <sub>pp</sub> , mV <sub>pp</sub> , $\mu$ V <sub>pp</sub> (peak-to-peak voltage of signal)	VPP, MVPP, UVPP
$\text{dBu} = 20 \times \lg(V/0.7746)$	DBU
$V = 0.7746 \times 10^{(\text{dBu}/20)}$	
$\text{dBV} = 20 \times \lg(V)$	DBV
$V = 10^{(\text{dBV}/20)}$	
$\text{dBm} = 10 \times \lg(V^2 \times 1000/R_{\text{REF}})$ *)	DBM
$V = \sqrt{10^{(\text{dBm}/10)} \times R_{\text{REF}} / 1000}$	
$W = V^2/R_{\text{REF}}$	W, MW, UW
$V = \sqrt{(W \times R_{\text{REF}})}$	

R<sub>REF</sub> = Reference impedance (Ref Imped) from the *Analyzer Config* panel

\*) In the case of the generator, the reference impedance R<sub>REF</sub> is always 600 Ohm. The IEC/IEEE-bus notation is DBMG. To calculate the open-circuit voltage V<sub>o</sub>, the source impedance R<sub>s</sub> (Impedance) from the *Generator Config* panel is also taken into account, which means that  $V = V_o \times R_{\text{REF}} / (R_s + R_{\text{REF}})$  is to be used in the above formula.

Table 3-11 Relative analog level units (with reference)

Conversion formulae	IEC/IEEE-bus notation
$\Delta V = V - U_{\text{REF}}$	DV, DMV, DUV
$V = \Delta V + U_{\text{REF}}$	
$\Delta\%V = (V/U_{\text{REF}} - 1) \times 100$	DPCTV
$V = U_{\text{REF}} \times (1 + \Delta\%V/100)$	
$V/V_r = V/U_{\text{REF}}$	VVR
$V = V/V_r \times U_{\text{REF}}$	
$\text{dBr} = 20 \times \lg(V/U_{\text{REF}})$	DBR
$V = 10^{(\text{dBr}/20)} \times U_{\text{REF}}$	
$V/\text{on} = V/\text{Burst amp}[V]$	VON
$V = V/\text{on} \times \text{Burst amp}[V]$	
$\%\text{on} = 100 \times V/\text{Burst amp}[V]$	PCTON
$V = \%\text{on} \times \text{Burst amp}[V]/100$	
$\text{dBon} = 20 \times \lg(V/\text{Burst amp}[V])$	DBON
$V = 10^{(\text{dBon}/20)} \times \text{Burst amp}[V]$	

U<sub>REF</sub> = Reference level (Ref Voltage) in V from the *Generator Config* panel

Table 3-12 Absolute digital level units (without reference)

Conversion formulae	IEC/IEEE-bus notation
FS	FS
$\text{bits} = 1 + \lg(FS \times 2^{\text{Audio bits}-1})$	BITS
$FS = 2^{\text{Bits}-1} / 2^{\text{Audio bits}-1}$	
$\%FS = 100 \times FS$	PCTFS
$FS = \%FS/100$	
$\text{dBFS} = 20 \times \lg(FS)$	DBFS
$FS = 10^{(\text{dBFS}/20)}$	
$\text{LSBS} = FS \times 2^{\text{Audio bits}-1}$	LSBS
$FS = \text{LSBS} / 2^{\text{Audio bits}-1}$	



Table 3-13 Relative digital level units (with reference)

Conversion formulae		IEC/IEEE-bus notation
$dBr = 20 \times \lg (FS/U_{REF})$	$FS = 10^{(dBr/20)} \times U_{REF}$	DBR
$\Delta\% = 100 \times (FS/U_{REF} - 1)$	$FS = (\Delta\% / 100 + 1) \times U_{REF}$	DPCT
$\%on = 100 \times FS/Burst\ amp[FS]$	$FS = \%on \times Burst\ amp[FS]/100$	PCTON
$dBon = 20 \times \lg (FS/Burst\ amp[FS])$	$FS = 10^{(dBon/20)} \times Burst\ amp[FS]$	DBON

$U_{REF}$  = Reference level (Ref Voltage) in FS from the *Generator Config* panel

Table 3-14 Absolute time units

Conversion formulae		IEC/IEEE-bus notation
s		S, MS, US
min = 60 s	s = min / 60	MIN
cyc = s * signal frequency	s = cyc / signal frequency	CYC, KCYC, MCYC

Table 3-15 Absolute frequency units

Conversion formulae		IEC/IEEE-bus notation
Hz, kHz		HZ, KHZ

Table 3-16 Relative frequency units (with reference)

Conversion formulae		IEC/IEEE-bus notation
$\Delta Hz = Hz - F_{REF}$	$Hz = \Delta Hz + F_{REF}$	DHZ, DKHZ
$f/fr = Hz/F_{REF}$	$Hz = f/fr \times F_{REF}$	FFR
$\Delta\%Hz = 100 \times (Hz - F_{REF})/F_{REF}$	$Hz = (\Delta\%Hz/100 + 1) \times F_{REF}$	DPCTHZ
$Toct = \lg (Hz/F_{REF}) \times 9.96578$	$Hz = 2^{Toct/3} \times F_{REF}$	TOCT
$Oct = \lg (Hz/F_{REF}) \times 3.32193$	$Hz = 2^{Oct} \times F_{REF}$	OCT
$Dec = \lg (Hz/F_{REF})$	$Hz = 10^{Dec} \times F_{REF}$	DEC
(Toct = Third octave)		

$F_{REF}$  = Reference frequency (Ref Frequency) from the *Generator Config* panel

Table 3-17 Absolute phase units

Conversion formulae	IEC/IEEE-bus notation
°	DEG
rad = ° · $(\pi/180)$ ° = rad × (180/π)	RAD

Table 3-18 Deviations (tolerance) relative to previous measurement values in settling function

Conversion formulae	IEC/IEEE-bus notation
% = $(10^{dB/20} - 1) \times 100$ dB = $20 \times \lg (\% / 100 + 1)$	DB, PCT

Table 3-19 Step size of a logarithmic level sweep

Conversion formulae	IEC/IEEE-bus notation
MLT = $10^{dB/20}$ dB = $20 \times \lg (MLT)$	[MLT], DB

Table 3-20 Absolute resistance unit

Conversion formulae	IEC/IEEE-bus notation
Ω	OHM, KOHM

Table 3-21 Unit for jitter

Conversion formulae	IEC/IEEE-bus notation
UI	UI
%UI = $100 \times UI$ UI = %UI / 100	PCTUI
dBUI = $20 \times \log (UI)$ UI = $10^{dBUI/20}$	DBUI
ppm = $10^6 \times UI$ UI = $10^{-6} \times ppm$	PPMUI
ns = $10^9 \times UI / (128 \times \text{sampling frequency})$ UI = $128 \times \text{sampling frequency} \times 10^{-9} \times ns$	NS











Table 3-22 Unit for Phase to Ref















Conversion formulae	IEC/IEEE-bus notation
UI	UI
%FRM = $100 \times UI / 128$ UI = $128 \times \%FRM / 100$	PCTFRM
°FRM = $360 \times UI / 128$ UI = $128 \times ^\circFRM / 360$	DEGFRM
ns = $10^9 \times UI / (128 \times \text{sampling frequency})$ UI = $128 \times \text{sampling frequency} \times 10^{-9} \times ns$	NS











## Overview of Keys







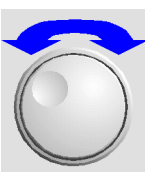

The following table gives an overview of the key functions on the front panel. The table also gives the PC keyboard key combinations which can be used to trigger the functions of the keys on the front of the instrument. Details regarding mouse operation are also included in this column.

The table is sorted according to the function blocks on the front panel.

Key on front panel	Key on PC keyboard <i>Mouse operation</i>	Function
<b>Softkeys</b>		
	F5 ... F12	Triggers the function assigned to the softkey.
<b>CONTROL panel</b>		
	CTRL + F5	<ul style="list-style-type: none"> <li>– Starts continuous measurements and sweeps</li> <li>– Resets the Min/Max values for bargraph displays, averaging for measurement results, and limit overranging</li> </ul>
	CTRL + F6	Starts a single measurement or a single sweep
	CTRL + F7	Measurement / sweep is stopped or continued (toggle function)
	CTRL + F8	Switches the loudspeaker or connected headphones on and off (toggle function)
	CTRL + F9	Opens / closes the window for adjusting the audio monitoring volume
	CTRL + P	Depending on the settings under Utilities, printout of the screen contents on the connected printer is started or the screen contents are stored in a file
	CTRL + F10	Stores the current settings on the hard disk and then shuts down the Windows® operating system
	CTRL + F11	Switches the instrument from remote operation to manual operation
	CTRL + F12	Switches the outputs of the measuring instrument off or on again (toggle function)

Key on front panel	Key on PC keyboard <i>Mouse operation</i>	Function
<b>Navigation keys</b>		
	CTRL + PAGE UP	Switches to the previous display setting (screen)
	CTRL + PAGE DOWN	Switches to the next display setting (screen)
	CTRL + SHIFT + TAB	Switches the focus to the previous panel open in the visible screen (the panel with the focus is active)
	CTRL + TAB	Switches the focus to the next panel open in the visible screen (the panel with the focus is active)
	ALT + PAGE UP	Changes to the previous scan in graphical displays so that, for example, measurement values can be read off using the cursor
	ALT * PAGE DOWN	Changes to the next scan in graphical displays so that, for example, measurement values can be read off using the cursor
	PAGE DOWN	Scrolls to the next page in tables
	PAGE UP	Scrolls to the previous page in tables
<b>Data entry keys</b>		
	1 p, q, r, s	Entry of numeric value: 1 Entry of letters: p, q, r, s
	2 t, u, v	Entry of numeric value: 2 Entry of letters: t, u, v
	3 w, x, y, z	Entry of numeric value: 3 Entry of letters: w, x, y, z
	4 g, h, i	Entry of numeric value: 4 Entry of letters: g, h, i
	5 j, k, l	Entry of numeric value: 5 Entry of letters: j, k, l
	6 m, n, o	Entry of numeric value: 6 Entry of letters: m, n, o
	7	Entry of numeric value: 7

Key on front panel	Key on PC keyboard <i>Mouse operation</i>	Function
	8 a, b, c	Entry of numeric value: 8 Entry of letters: a, b, c
	9 d, e, f	Entry of numeric value: 9 Entry of letters: d, e, f
	0 SPACE	Entry of numeric value: 0 Entry of a space
	. * ... #	Entry of a dot / decimal point; entry of special characters
	- (SHIFT +) A ... Z	Entry of sign; switchover between uppercase and lowercase letters
<b>VARIATION panel</b>		
	CTRL + M	Displays the menu bar on the screen
	BACKSPACE	Deletes the character to the left of the cursor; undoes the action last performed
	ESC	Closes the open panel; the old value or parameter is retained
	ENTER  Click with left-hand mouse key Press mouse wheel	Completes the data entry (the new value is adopted); confirms and closes open entry windows
	TAB (to right) SHIFT + TAB (to left) <i>Turn mouse wheel</i>	<ul style="list-style-type: none"> <li>- Moves the focus in the panels, selection windows and tables</li> <li>- Varies the entry value at the cursor position</li> <li>- Moves the active cursor in the graphical windows</li> <li>- Switches the measuring steps forwards and backwards for manual sweeps</li> </ul>
	ENTER	Pressing the rotary knob has the same effect as pressing the ENTER key
	UP/DOWN cursor keys	<ul style="list-style-type: none"> <li>- Move the focus in the panels, selection windows and tables</li> <li>- Vary the entry value at the cursor position</li> </ul>

Key on front panel	Key on PC keyboard <i>Mouse operation</i>	Function
	LEFT/RIGHT cursor keys	<ul style="list-style-type: none"> <li>- Move the active cursor inside the graphical windows</li> <li>- Move the cursor position in entered values</li> <li>- Switch the measuring steps forwards and backwards for manual sweeps</li> </ul>
<b>WINDOW and SETUP panels</b>		
<p>WINBAR</p> 	ALT + W	Toggles between the softkey bar and the WINBAR
<p>MODIFY</p> 	ALT + M	Opens a selection of functions on the softkey bar; these functions can be used in conjunction with the rotary knob to move or resize the active panel or graphical window
<p>HIDE</p> 	ALT + H	Minimizes ("hides") the active panel or graphical window
<p>CLOSE</p> 	ALT + C	Closes the active panel or graphical window
<p>HELP</p> 	F1	Opens and closes the context-sensitive help function
<p>SAVE</p> 	ALT + S	Opens a panel for storing instrument settings
<p>LOAD</p> 	ALT + L	Opens a panel for loading predefined instrument settings
<p>PRESET</p> 	ALT + P	Loads the factory settings of the instrument

# Overview of Panels and Measurement Displays (Graphical Windows)

Panels which can be selected via the **Instruments** menu bar button:

<b>Generator Config</b>	<ul style="list-style-type: none"> <li>• Selection of instrument (analog or digital interfaces)</li> <li>• Configuration of channels</li> <li>• Bandwidth and sampling rate</li> <li>• Reference values</li> <li>• Synchronization settings and wordwidth (for digital interfaces)</li> </ul>
<b>Generator Function</b>	<ul style="list-style-type: none"> <li>• Selection of test signals</li> <li>• Sweep function</li> <li>• Frequency and level settings</li> <li>• Filter and equalizer</li> </ul>
<b>Analyzer Config</b>	<ul style="list-style-type: none"> <li>• Selection of instrument (analog or digital interfaces)</li> <li>• Configuration of channels</li> <li>• Measurement bandwidth and sampling rate</li> <li>• Reference impedance</li> <li>• Start and trigger conditions</li> </ul>
<b>Analyzer Function</b>	<ul style="list-style-type: none"> <li>• Selection of measurement functions</li> <li>• Measurement speed and accuracy</li> <li>• Activation of filter and equalizer</li> <li>• Activation of Post-FFT</li> <li>• Selection and settings for level monitor</li> <li>• Selection and settings for input monitor</li> <li>• Selection and settings for frequency, phase, group delay measurement</li> <li>• Selection and settings for waveform monitor</li> </ul>
<b>Filter</b>	<ul style="list-style-type: none"> <li>• Definition of filter properties</li> </ul>
<b>Auxiliaries</b>	<p><b>Audio monitoring function</b></p> <ul style="list-style-type: none"> <li>• Settings for integrated loudspeaker and connected headphones</li> <li>• Signal source and channels</li> <li>• Volume</li> <li>• ON/OFF and volume control also possible using keys in CONTROL panel</li> </ul> <p><b>Auxiliary Analog Output</b></p> <ul style="list-style-type: none"> <li>• Function selection and settings</li> </ul> <p><b>Trigger Input, Trigger Output</b></p> <ul style="list-style-type: none"> <li>• Function selection and settings</li> </ul>
<b>Switcher Panel</b>	<ul style="list-style-type: none"> <li>• Function settings and operation of one or more connected Audio Switchers R&amp;S UPZ</li> </ul>
<b>Protocol Generator</b>	<ul style="list-style-type: none"> <li>• Settings for the generator functions for generating the digital audio protocol of the R&amp;S UPV-K21 option</li> </ul>

## R&S UPV Overview of Panels and Measurement Displays (Graphical Windows)

Panels which can be selected via the **Disp Config** menu bar button:

<b>Function Config</b>	<ul style="list-style-type: none"> <li>• Settings for measurement values of active measurement function in numeric display field</li> <li>• Settings for associated combi displays</li> <li>• Settings for limits, minimum values and maximum values</li> </ul>
<b>Level Monitor Config</b>	<ul style="list-style-type: none"> <li>• Settings for numeric measurement values of level monitor in numeric display field</li> <li>• Settings for associated combi displays</li> <li>• Settings for limits, minimum values and maximum values</li> </ul>
<b>Input Config</b>	<ul style="list-style-type: none"> <li>• Settings for measurement values of input monitor in numeric display field</li> <li>• Settings for associated combi displays</li> <li>• Settings for limits, minimum values and maximum values</li> </ul>
<b>Freq / Phase Config</b>	<ul style="list-style-type: none"> <li>• Settings for measurement values of frequency, phase and group delay measurement in numeric display field</li> <li>• Settings for associated combi displays</li> <li>• Settings for limits, minimum values and maximum values</li> </ul>
<b>Sweep Graph 1...4 Config</b>	<ul style="list-style-type: none"> <li>• Four of these panels are available so that up to 4 sweep graphical windows can be displayed simultaneously</li> <li>• Setting of all details for one-channel or two-channel graphical display of sweep functions, e.g. units, scaling, gridlines, etc</li> <li>• Evaluation of minimum values and maximum values</li> <li>• Entry of limit curves</li> <li>• Settings for cursors and markers</li> </ul>
<b>FFT Graph 1...2 Config</b>	<ul style="list-style-type: none"> <li>• Two of these panels are available so that up to 2 FFT graphical windows can be displayed simultaneously</li> <li>• Setting of all details for one-channel or two-channel display of FFT graph, e.g. units, scaling, gridlines, etc</li> <li>• Evaluation of minimum values and maximum values</li> <li>• Entry of limit curves</li> <li>• Settings for cursors and markers</li> </ul>
<b>Waveform Config</b>	<ul style="list-style-type: none"> <li>• Setting of all details for graphical display of waveform analyzer, e.g. number of curves, units, scaling, gridlines, etc</li> <li>• Entry of limit curves</li> <li>• Settings for cursors and markers</li> </ul>
<b>PESQ Graph 1...2 Config</b>	<ul style="list-style-type: none"> <li>• Two of these panels are available, allowing you to display up to two PESQ windows simultaneously</li> <li>• Setting of all details for the display of the PESQ MOS value and the DELAY, e.g. units, scaling, gridlines, etc</li> <li>• Evaluation of minimum values and maximum values</li> <li>• Entry of limits</li> <li>• Settings for cursors and markers</li> </ul>



<p><b>Bargraph1...2 Config</b></p>	<ul style="list-style-type: none"> <li>• Two of these panels are available so that up to 2 bargraph windows can be displayed simultaneously</li> <li>• Setting of all details for one-channel or two-channel display of bargraphs, e.g. units, scaling, gridlines, etc</li> <li>• Evaluation of minimum values and maximum values</li> <li>• Entry of limits</li> <li>• Settings for cursors and markers</li> </ul>
------------------------------------	---

**Measurement windows which can be selected via the **Displays** menu bar button:**

<p><b>Numeric Display</b></p>	<ul style="list-style-type: none"> <li>• Display of one-channel or two-channel measurement results of measurement function selected in Analyzer Function panel</li> <li>• Display of one-channel or two-channel measurement results of level monitor selected in Analyzer Function panel</li> <li>• Display of one-channel or two-channel measurement results of input monitor selected in Analyzer Function panel</li> <li>• Display of one-channel or two-channel frequency measurement results, or display of frequency measurement result and phase or group delay measurement result</li> <li>• The measurement results are displayed in the way defined in the configuration panel</li> </ul>
<p><b>Funct Ch1...2</b></p>	<ul style="list-style-type: none"> <li>• These combi displays are extensions to the numeric measurement displays of the measurement function selected in the Analyzer Function panel; they show the respective numeric value plus the following additional features:             <ul style="list-style-type: none"> <li>• Analog bargraphs</li> <li>• Monitoring and display of limits</li> <li>• Storage of minimum and maximum values</li> </ul> </li> <li>• The measurement results are displayed in the way defined in the configuration panel</li> </ul>
<p><b>Lev Mon Ch1...2</b></p>	<ul style="list-style-type: none"> <li>• These combi displays are extensions to the numeric measurement display of the level monitor selected in the Analyzer Function panel; they show the respective numeric value plus the following additional features:             <ul style="list-style-type: none"> <li>• Analog bargraphs</li> <li>• Monitoring and display of limits</li> <li>• Storage of minimum and maximum values</li> </ul> </li> <li>• The measurement results are displayed in the way defined in the configuration panel</li> </ul>
<p><b>Input Ch1...2</b></p>	<ul style="list-style-type: none"> <li>• These combi displays are extensions to the numeric measurement display of the input monitor selected in the Analyzer Function panel; they show the respective numeric value plus the following additional features:             <ul style="list-style-type: none"> <li>• Analog bargraphs</li> <li>• Monitoring and display of limits</li> <li>• Storage of minimum and maximum values</li> </ul> </li> <li>• The measurement results are displayed in the way defined in the configuration panel</li> </ul>

## **R&S UPV Overview of Panels and Measurement Displays (Graphical Windows)**

<b>Freq Ch1 Phase Ch2/Ch1</b>	<ul style="list-style-type: none"> <li>• These combi displays are extensions to the numeric measurement display for one-channel or two-channel frequency measurement results or for the frequency measurement result and the phase or group delay measurement result; they show the respective numeric value plus the following additional features:</li> <li>• Analog bargraphs</li> <li>• Monitoring and display of limits</li> <li>• Storage of minimum and maximum values</li> <li>• The measurement results are displayed in the way defined in the configuration panel</li> </ul>
<b>Sweep Graph 1...4</b>	<ul style="list-style-type: none"> <li>• Up to four of these display windows can be open simultaneously to display scans from sweep measurements</li> <li>• One-channel or two-channel graphical display</li> <li>• The measurement results are displayed in the way defined in the Sweep Graph 1...4 Config panel</li> </ul>
<b>FFT Graph 1...2</b>	<ul style="list-style-type: none"> <li>• Up to two of these display windows can be open simultaneously to display the FFT analyses of the selected measurement function or of the Post-FFT</li> <li>• One-channel or two-channel graphical display</li> <li>• The measurement results are displayed in the way defined in the FFT Graph 1...2 Config panel</li> </ul>
<b>Waveform</b>	<ul style="list-style-type: none"> <li>• This display window shows the characteristic of the measurement signal over time</li> <li>• One-channel or two-channel graphical display</li> <li>• The measurement results are displayed in the way defined in the Waveform Config panel</li> </ul>
<b>PESQ Graph 1...2</b>	<ul style="list-style-type: none"> <li>• Up to two of these windows can be opened simultaneously to display PESQ measurement values</li> <li>• The measurement results are displayed in the manner defined in the individual PESQ Graph 1...2 Config panel</li> </ul>
<b>Bargraph 1...2</b>	<ul style="list-style-type: none"> <li>• Up to two of these display windows can be opened to display bargraphs of the selected measurement function</li> <li>• One-channel or two-channel graphical display</li> <li>• The measurement results are displayed in the way defined in the Bargraph 1...2 Config panel</li> </ul>
<b>Dig Analyzer Protocol</b>	<ul style="list-style-type: none"> <li>• Display window for the data regarding the digital audio protocol of the R&amp;S UPV-K21 option</li> </ul>

## Overview of Status Messages

The status of the R&S UPV is continuously displayed for the generator, analyzer, sweep system and other instrument states at the bottom of the screen in four fields above the four right-hand softkeys.

Status displays always appear at the same position; they are assigned to the fields above the softkeys as shown below.

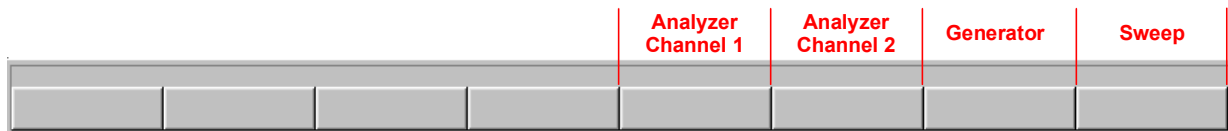

The following overview shows the possible status messages and their meaning:

### Analyzer status:

#### Status information which applies to the two channels Anlr1 and Anlr2

Off	Measurement channel is deactivated
Overload	Analyzer has been deactivated owing to overload
Over	Measuring range has been overranged; this can occur if: <ul style="list-style-type: none"> <li>• <b>Range Fix</b> setting is being used</li> <li>• a signal with a level at range limit is applied with a crest factor &gt; 2</li> <li>• common-mode voltage is applied in BAL input configuration</li> </ul>
Under	Measuring range has been underranged; this can occur if <b>Range Fix</b> or <b>Lower</b> setting is being used
Single	Single measurement is being performed
Cont	Continuous measurement is being performed
Terminated	Single measurement has been terminated
Stopped	Measurement has been stopped
Wait for Trigger	Analyzer is waiting for set trigger condition

Wait for DC Adj	Analyzer is waiting for internal DC offset adjustment; this is, however, not possible at present because: <ul style="list-style-type: none"><li>• cyclic DC offset adjustment has been deactivated or</li><li>• cyclic DC offset adjustment is disabled owing to a currently active sweep</li></ul>
-----------------	---

DC Adjusting	Cyclic internal DC offset adjustment of A/D converter is being performed
--------------	--

**Generator status:**

Gen Off	Generator is deactivated
Gen Running	Generator signals are being output
Output Off	All output lines are deactivated
Gen Overload	Generator has been deactivated owing to overload

**Sweep status:**

Sweep Off	No sweep is being performed
Sweep Waiting	Sweep has been defined but not yet started
Sweep Terminated	Single sweep has been terminated
Sweep Stopped	Sweep has been stopped but can be continued
Sweep Run Cont	Continuous sweep is being performed
Sweep Run Single	Single sweep is being performed
Sweep Run Manual	Manual sweep is being performed



## Contents - Chapter 4 "Instrument Functions"

<b>4 Instrument Functions</b> .....	4.1
<b>Selecting the Generator</b> .....	4.1
Generator Configuration Panel .....	4.1
<b>Configuring Analog Generator</b> .....	4.2
Analog Generator Config Panel .....	4.2
Generator Outputs .....	4.8
Output Power .....	4.16
<b>Configuring the Digital Generator</b> .....	4.16
Digital Generator Configuration Panel .....	4.16
Digital Impairments Configuration Panel.....	4.27
<b>Configuring the I<sup>2</sup>S Generator</b> .....	4.29
I <sup>2</sup> S Generator Configuration Panel.....	4.29
Timing Diagrams .....	4.38
Interface Assignment .....	4.40
<b>Configuring the USI Dual Channel Generator</b> .....	4.42
USI Dual Channel Generator Configuration Panel .....	4.42
Meaning of the TX_DATA 1 to TX_DATA 4 setting line strings.....	4.56
Timing Diagrams .....	4.60
Interface assignment.....	4.61
<b>Generator Signals</b> .....	4.63
Sine .....	4.63
Stereo Sine.....	4.66
Multisine .....	4.70
Sine Burst.....	4.73
Sine <sup>2</sup> Burst.....	4.76
Mod Dist .....	4.77
DFD .....	4.80
DIM.....	4.82
Random.....	4.84
Arbitrary.....	4.91
Play .....	4.93
Play+Anlr.....	4.98
Polarity .....	4.106
Modulation.....	4.106
DC (Direct-Current Voltage).....	4.108
Square.....	4.108
<b>Amplitude Variation</b> .....	4.110
<b>Equalization</b> .....	4.111
<b>Generator Filters</b> .....	4.112

<b>Digital Audio Protocol Generator</b> .....	4.113
Advanced Settings .....	4.113
Setting Bytes as Numerical Values .....	4.114
Setting Bytes in Remote-Control Mode .....	4.116
Displaying and Setting Parameters in Plain Text .....	4.117
<b>Sweeps</b> .....	4.119
Activating / Deactivating the Sweep System .....	4.120
One-Dimensional Sweep .....	4.122
Two-Dimensional Sweep .....	4.124
Automatic Sweep .....	4.126
Linear and Logarithmic Sweep .....	4.129
List Sweep .....	4.134
Sweep Speed .....	4.135
<b>Selecting the Analyzer</b> .....	4.140
Analyzer Configuration Panel .....	4.140
<b>Configuring the Analog Analyzer</b> .....	4.142
Analog Analyzer Configuration Panel .....	4.142
<b>Configuring the Analog Multichannel Analyzer</b> .....	4.154
Multichannel Analyzer Configuration Panel .....	4.154
<b>Configuring the Digital Analyzer</b> .....	4.166
Digital Analyzer Configuration Panel .....	4.166
<b>Configuring the I<sup>2</sup>S Analyzer</b> .....	4.174
I <sup>2</sup> S Analyzer Configuration Panel .....	4.174
Timing Diagrams .....	4.179
Interface Assignment .....	4.180
<b>Configuring the USI Dual Channel Analyzer</b> .....	4.183
USI Dual Channel Analyzer Configuration Panel .....	4.183
Timing Diagrams .....	4.198
Interface allocation .....	4.199
<b>Configuring the USI 8 Channel Analyzer</b> .....	4.201
USI 8 Channel Analyzer Configuration Panel .....	4.201
Timing Diagrams .....	4.215
Interface assignment .....	4.215
<b>Starting Measurements</b> .....	4.216
Overview of the Measurement System .....	4.216
Activating and Deactivating Measurement Types .....	4.216
States of the Measurement System .....	4.217
<b>Start Conditions</b> .....	4.221
Setting Start Condition .....	4.222
Time-Controlled Measurement Value Recording .....	4.230
External Sweeps and Level-Controlled Measurement Value Triggering .....	4.231

<b>Sweep Options</b> .....	4.235
Overview of the Sweep Options.....	4.235
Activating and Deactivating Sweeps.....	4.236
States of the Sweep System.....	4.236
Several Sweep Traces in One Diagram.....	4.240
<b>Level Measurements</b> .....	4.241
Filter Settings .....	4.241
RMS Measurement, Broadband .....	4.246
RMS Measurement, Selective.....	4.249
Rub & Buzz Measurement .....	4.263
Peak Measurement .....	4.268
Quasi Peak Measurement.....	4.270
DC Voltage Measurement.....	4.271
<b>Signal-to-Noise Measurements</b> .....	4.272
S/N Measurement Function .....	4.273
S/N Sequence in Level Measurements.....	4.279
<b>Distortion Measurements</b> .....	4.280
General Settings .....	4.282
THD .....	4.285
THD+N / SINAD .....	4.291
MOD DIST.....	4.299
DFD .....	4.301
DIM (dynamic intermodulation distortion analysis) .....	4.304
<b>Polarity Measurement</b> .....	4.307
<b>Frequency Band Analysis</b> .....	4.308
Nth Octave Analysis.....	4.308
<b>FFT Analysis</b> .....	4.316
FFT Size.....	4.316
Window Function.....	4.318
Post FFT.....	4.320
FFT Measurement Function.....	4.321
<b>Speech Quality Measurements (PESQ)</b> .....	4.333
PESQ Value and MOS Value .....	4.334
Electrical PESQ Measurements.....	4.335
Acoustic PESQ Measurements.....	4.335
PESQ Graphs .....	4.337
PESQ Measurement Function .....	4.338
<b>Audio quality measurements (PEAQ)</b> .....	4.345
DI value and ODG value .....	4.346
PEAQ measurements .....	4.347
PEAQ graphics.....	4.347
PEAQ measurement function .....	4.348



<b>Analysis in the Time Domain</b> .....	4.353
Waveform Monitor .....	4.353
Delay Measurement .....	4.364
<b>Offline Analysis</b> .....	4.368
Applications .....	4.369
Recording Format .....	4.369
Monitoring the Recording .....	4.370
Recording Modes of the Record Function .....	4.371
Operating the Record Function .....	4.371
Creating WAV Files for External Sweeps .....	4.378
<b>Infrasound Measurements</b> .....	4.379
Infrasound Signals .....	4.379
Infrasound Analysis .....	4.379
<b>Protocol Analysis</b> .....	4.383
Activating and Configuring the Protocol Analysis .....	4.383
Channel-Status Information Display .....	4.386
Error Flag Display .....	4.387
<b>Frequency, Phase and Group Delay Measurement</b> .....	4.389
<b>Input Monitor</b> .....	4.397
<b>Level Monitor</b> .....	4.399
<b>Settling Methods</b> .....	4.401
Applications .....	4.401
Settling Algorithms .....	4.402
Settling for Measurement Functions .....	4.403
Settling for Frequency Measurements .....	4.406
Settling for Phase Measurements .....	4.409
Settling for Start Conditions (Event-Triggered Measurements) .....	4.412
<b>Examples of Settling</b> .....	4.415
<b>Filters</b> .....	4.416
Analyzer Prefilter .....	4.416
Analyzer Function Filters .....	4.417
Generator Filters .....	4.417
Filter Table .....	4.419
<b>User-Definable Filters</b> .....	4.420
Filter 0i .....	4.420
Low-Pass Filter and High-Pass Filter .....	4.421
Band-Pass Filters and Band-Stop Filters .....	4.422
Notch Filter, Third-Octave Filter and Octave Filter .....	4.423
File-Defined Filter .....	4.424
Parameters Common to All Filters .....	4.426
Filter Settling Time .....	4.427
<b>Weighting Filters</b> .....	4.428
<b>Highpass and Lowpass Filters</b> .....	4.435

<b>Audio Monitoring</b> .....	4.436
Auxiliaries Panel.....	4.436
<b>Switcher Panel</b> .....	4.446
Connecting the Switcher to the R&S UPV .....	4.446
Default Setting.....	4.447
Operation.....	4.447
<b>Traces, Spectrum Displays and Bargraphs</b> .....	4.450
Graphical Display, Explanation of the Elements.....	4.450
Calling Up.....	4.457
Parameter Fields of the Panel.....	4.458
Softkey Menu .....	4.539
Single Sweep .....	4.544
Trace Group .....	4.544
Interpolation on the Common X Axis .....	4.547
<b>Result List</b> .....	4.547
Graphical Display, Explanation of the Elements.....	4.547
Calling Up.....	4.549
Parameter Fields of the Panel.....	4.549
Softkey Menu .....	4.552
<b>Numeric Display</b> .....	4.552
Graphical Display, Explanation of the Elements.....	4.553
Calling Up.....	4.555
Parameter Fields of the Panel.....	4.555
Softkey Menu .....	4.555
<b>Combi Display</b> .....	4.555
Graphical Display, Explanation of the Elements.....	4.556
Calling Up.....	4.558
Parameter Fields of the Panel.....	4.560
Softkey Menu .....	4.574
<b>Limit Monitoring</b> .....	4.576
Traces and Bargraphs.....	4.576
Measurement Results .....	4.578
<b>Measurement value sequences</b> .....	4.580
<b>Saving</b> .....	4.580
Trace files.....	4.580
Equalization files .....	4.581
Sweep list.....	4.581
Limit files .....	4.582
<b>Loading</b> .....	4.583
Trace files.....	4.583
Equalization Files .....	4.589
Sweep Lists.....	4.589
Limit Files .....	4.589

---

<b>Format</b> .....	4.590
Trace Files.....	4.590
Equalization Files .....	4.594
Sweep Lists .....	4.595
Limit Files .....	4.597
<b>Editing</b> .....	4.598
<b>Exporting</b> .....	4.604
<b>Loading and Saving</b> .....	4.607
Integrated File selection box .....	4.607
File manager .....	4.607
Windows file selection box .....	4.608
<b>Loading and Saving Setups</b> .....	4.608
<b>Printing and Saving the Display Screen</b> .....	4.609
Configuring Print and Save Operations .....	4.609
Starting Print and Save Operations .....	4.612

# 4 Instrument Functions

## Selecting the Generator

### Generator Configuration Panel

The Config panel allows settings for analog and digital generators.

To adapt the R&S UPV generator to the measurement task at hand, first define the settings in the Generator Config panel. These settings will determine which capabilities are available in the Generator Function panel.

#### Instrument

Used to select the generator.

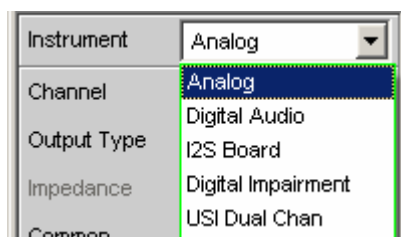

#### Analog

In the Generator Function panel, the user can choose between the universal generator for virtually any signal shape (up to max. 80 kHz) and a low-distortion sinewave generator (R&S UPV-B1 option "Low-Distortion Generator" up to max. 185 kHz). The sinewave generator can be activated for the generator function "Sine".

The digital audio generator continues to run.

```
Remote-control command:
INSTRUMENT[1][:SELECT] ANLG
```

#### Digital Audio

Select digital audio generator.  
If no impairments were applied (jitter or a common-mode signal), the analog generator continues to run (see section "Configuring the Digital Generator" on page 4.16).

```
Remote-control command:
INSTRUMENT[1][:SELECT] DIG
```

#### I<sup>2</sup>S Board

The I<sup>2</sup>S generator can generate audio data in I<sup>2</sup>S format.

The analog generator is deactivated.

```
Remote-control command:
INSTRUMENT[1][:SELECT] I2SBoard
```

**Digital Impairment**

(with R&S UPV-B2 only)

The impairments (jitter or a common mode signal) are configured for the digital-audio generator in this panel (see section "Digital Impairments Configuration Panel" on page 4.27), which can then be switched on or off on the digital generator operating panel (see section "Digital Generator Configuration Panel" on page 4.16).

The analog generator is switched off as soon as this panel is opened as it is used internally for the production of the impairments.

```
Remote control command:
INSTRument[1][:SElect] IMPairment
```

**USI Dual Channel**

Audio data can be produced in serial format with the USI dual channel generator. The analog generator is switched off.

```
Remote control command:
INSTRument[1][:SElect] U2Channel
```

# Configuring Analog Generator

## Analog Generator Config Panel

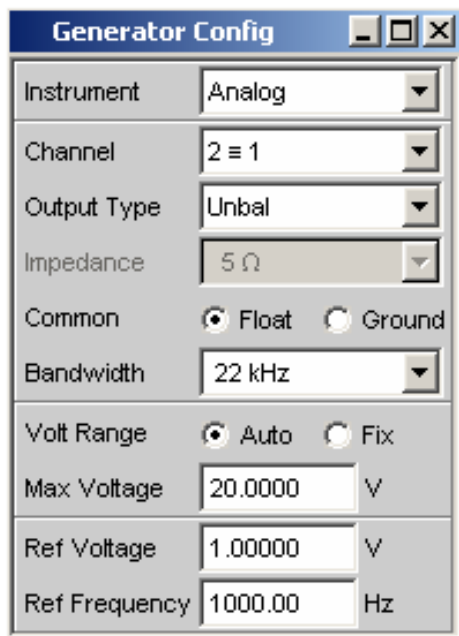
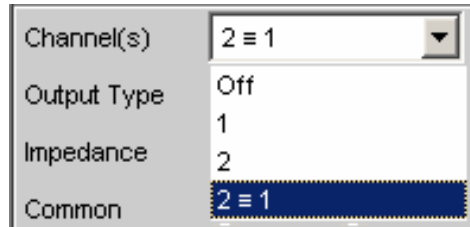

Figure 4-1 Analog generator configuration panel

The Config panel is used to set up the analog and digital generator. The configuration options for the analog generator are described below.

### Channel

Used to select the signal-carrying XLR plugs in the bottom right-hand part of the R&S UPV front panel.



- |              |   |
|--------------|---|
| <b>OFF</b>   | Both XLR plugs are deactivated.<br><br>Remote-control command:<br>OUTput:CHANnel OFF                                      |
| <b>1</b>     | XLR plug 1 supplies the generator signal; XLR plug 2 is deactivated.<br><br>Remote-control command:<br>OUTput:CHANnel CH1 |
| <b>2</b>     | XLR plug 2 supplies the generator signal; XLR plug 1 is deactivated.<br><br>Remote-control command:<br>OUTput:CHANnel CH2 |
| <b>2 ≡ 1</b> | Both XLR plugs supply an output signal.   |

---

**Note:**

*If the generator function "Stereo Sine" is selected (in the Generator Function panel; the R&S UPV-B3 option is required for this), the level and frequency can be different for each channel of the output signal.*

---

Remote-control command:  
OUTput:CHANnel CH2Is1

**Output Type**

The generator output can be configured to be unbalanced (Unbal) or balanced (Bal). The setting always applies to both outputs.

The generator can also supply a common-mode signal.

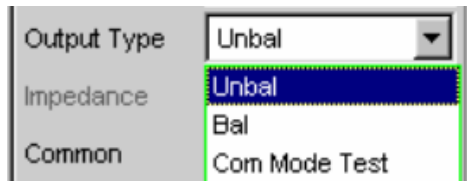
**Unbal**

The RMS of the generator signal can be max. 10 V. The output impedance is 5 Ohm.

If commercially available BNC cables are to be used, it is recommended to use an XLR/BNC adapter R&S UPL-Z1.

```
Remote-control command:
OUTPut:TYPE UNBalanced
```

**Bal**

The RMS of the generator signal can be max. 20 V. The user can choose between three different output impedance values.

```
Remote-control command:
OUTPut:TYPE BALanced
```

**Com Mode Test**

Identical output signals are present at pins 2 and 3 of the XLR connectors. The signal lines are referenced to the generator ground. The output impedance is made up of two identical resistances in the two signal lines.

This generator output configuration is suitable for measuring the common-mode rejection of balanced DUTs.

To correctly address the object to be measured it is necessary to set the generator earth (Common) to "Ground" because otherwise the input signal has no ground reference and is not detected by the object to be measured.

If "Common" is set to "Float", the following warning appears:

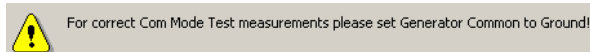

This function is only available for firmware 1.4.0.206 and higher. If the selection is not available with this firmware, the R&S UPV is equipped with an older Analog Audio Board (AAB) which doesn't support this function.

```
Remote-control command:
OUTPut:TYPE CTEST
```

**Impedance**

This field can only be operated if "Bal" has been selected as the Output Type in the field above. If "Unbal" has been selected, only a field showing a fixed impedance (5 Ohm in this case) is displayed.

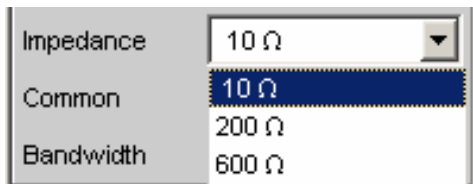
**10 Ohm**

The output impedance is 10 Ohm.

Remote-control command:  
OUTPut:IMPedance R10

**200 Ohm**

The output impedance is 200 Ohm. If the R&S UPV-U1 option is installed, the output impedance is 150 Ohm. After the R&S UPV-U1 option has been installed, the R&S UPV must be informed of this via the diagnostics panel so that "150 Ohm" is then displayed in the selection box. The installation instructions supplied with the option explain which entries are required for this.

Remote-control command:  
OUTPut:IMPedance R200

**600 Ohm**

The output impedance is 600 Ohm.

Remote-control command:  
OUTPut:IMPedance R600

**Common**

The generator ground can be floating or connected to the instrument ground.  
XLR Pin 1 always remains unconnected, regardless of the selected configuration.

**Float**

The generator ground is not electrically connected to the instrument ground. With the default configuration "Unbal", a capacitance of approx. 25 nF is connected between the two ground connections. With "Bal", the capacitance is approx. 2 nF and is primarily determined by the layout and coupling capacitance inside the toroidal transformer which delivers the supply voltages for the generator.

Remote-control command:  
OUTPut:LOW FLOat



**Ground** The generator ground is electrically connected to the instrument ground with approx. 50 Ohm.

Remote-control command:  
 OUTPut:LOW GROund

**Bandwidth**

When you choose the universal generator you can set three different fixed frequency ranges and one signal-dependent sampling frequency.

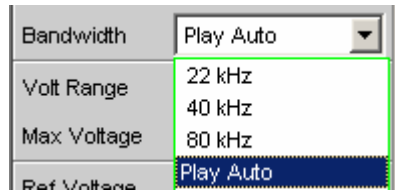

**22 kHz** The maximum output frequency is 22 kHz. The generator D/A converter is then clocked at 48 kHz.

Remote-control command:  
 OUTPut:BANDwidth:MODE B22

**40 kHz** The maximum output frequency is 40 kHz. The generator D/A converter is then clocked at 96 kHz.

Remote-control command:  
 OUTPut:BANDwidth:MODE B40

**80 kHz** The maximum output frequency is 80 kHz. The generator D/A converter is then clocked at 192 kHz.

Remote-control command:  
 OUTPut:BANDwidth:MODE B80

**Play Auto** For the Play generator function only. The bandwidth is automatically determined as a function of the sample rate entered in the WAV file. This sample rate is likewise used for clocking the generator DAC.

Remote-control command:  
 OUTPut:BANDwidth:MODE AUTO alias AUTO

**Volt Range**

Two different modes are available for generator level control.



- Auto** The internal signal paths are optimally driven; the output voltage is adjusted using the analog hardware.
- Advantage:**  
Optimum noise and distortion values.
- Remote-control command:  
SOURce:VOLTage:RANGe AUTO
- Fix** The analog hardware is permanently set to the specified maximum voltage. The actual output voltage is obtained by controlling the level of the D/A converter; the analog hardware settings remain unchanged.
- Advantage:**  
Faster level changes and better settling. Voltage dips when switching over the attenuator are avoided as no relays are connected.

**Note:**

*This setting is ignored if the "Low-Distortion Generator" option (R&S UPV-B1) is used. In this case, level control is always performed according to the **Auto** algorithm.*

If the Volt Range = Fix setting is chosen for the signal to noise measurement, the generator level does indeed oscillate more rapidly, but in certain cases the lowest possible noise level may not be obtained. This restricts the dynamic response of the signal to noise measurement.

Remote-control commands:  
SOURce:VOLTage:RANGe FIX  
SOURce:VOLTage:MAXimum <nu>

**Max Voltage**

Maximum value for the output voltage; prevents excessively high voltage values from being entered inadvertently in the Generator Function panel.

The voltage set in the Generator Function panel cannot be higher than the voltage specified here.

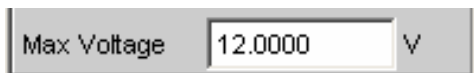

The RMS for sinewave signals is entered, i.e. the maximum peak value is higher by a factor of  $\sqrt{2}$ .

Remote-control command:  
SOURce:VOLTage:MAXimum <nu>

**Ref Voltage**

Reference value for the relative voltage units.  
 If the reference level is changed, all voltage settings linked to the reference value also change. The relative voltage of the generator signal remains unchanged.

By varying the reference voltage, a level sweep defined with relative start and stop levels, for example, can be shifted by a constant "gain factor".

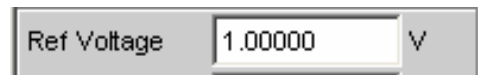

Remote-control command:  
 SOURce:VOLTage:REFerence <nu>

**Ref Frequency**

Reference value for the relative frequency units.  
 If the reference frequency is changed, all frequency settings linked to the reference value also change. The relative frequency of the generator signal remains unchanged.

By varying the reference frequency, the fundamental of a distortion spectrum set using a multi-sinewave, for example, can thus be shifted without the harmonics having to be calculated and set again by the user.



Remote-control command:  
 SOURce:FREQuency:REFerence <nu>

**Generator Outputs**

Each output of the analog R&S UPV generator can be configured differently (see the panel description under "Channel", "Output Type", "Impedance" and "Common"). The circuit diagrams for the generator output are shown below.

**Unbalanced Output (Output Type "Unbal")**

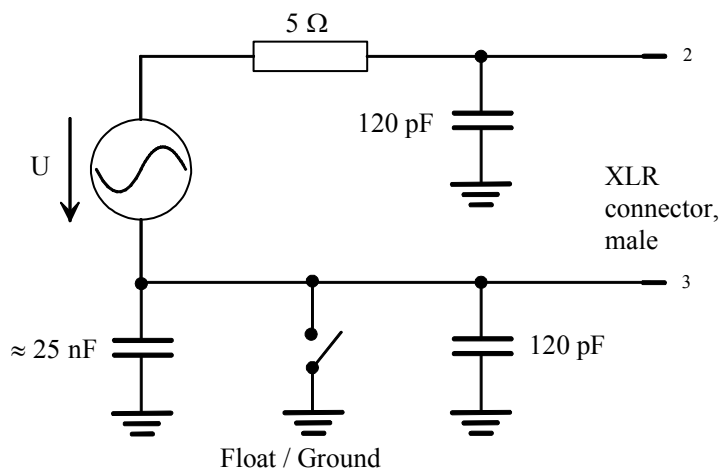

Figure 4-2 Unbalanced Output

The following output circuit configurations are available depending on the selected channel setting (capacitors are not shown; the ground symbol denotes the floating generator ground connection):

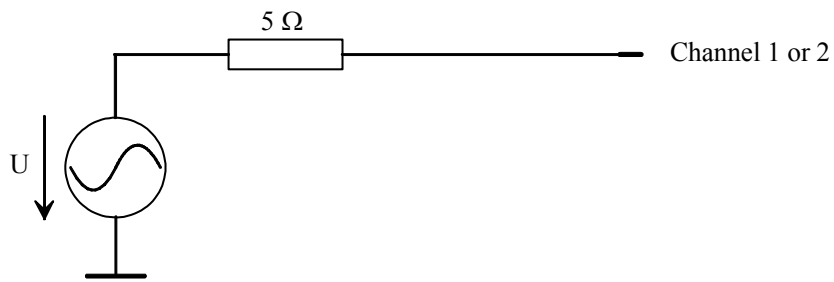

Figure 4-3 Channel = 1 or 2

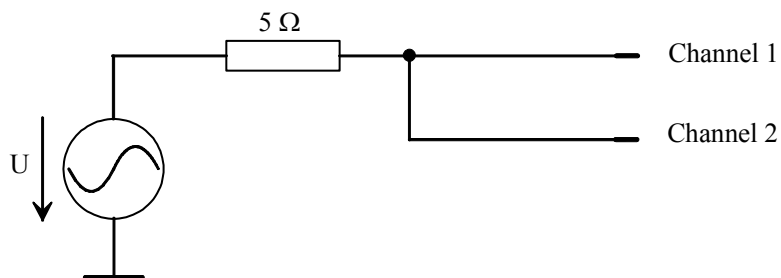

Figure 4-4 Channel = 2 ≡ 1

The selected output impedance is retained even if the output is deactivated; XLR Pin 3 is connected to the generator ground.

**Balanced Output (Output Type "Bal")**

The balanced output signal is applied between Pin 2 and Pin 3 of the XLR plug. Pin 1 is not connected. The source impedance consists of two identical resistors in both signal lines. In the diagrams, the ground symbol with the single line represents the floating generator ground connection and the earth symbol represents the R&S UPV housing ground connection.

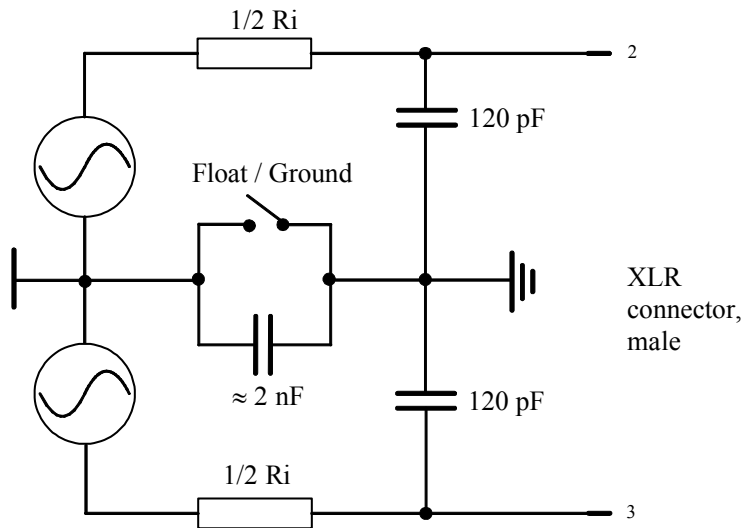

Figure 4-5 Balanced Output

The following output circuit configurations are available depending on the channel and impedance (capacitors are not shown):

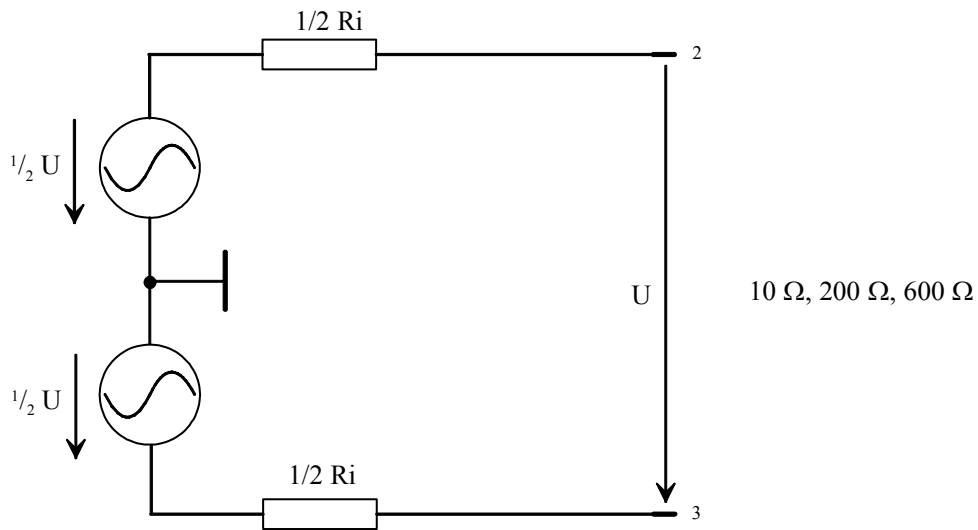

Figure 4-6 Channel = 1 or 2

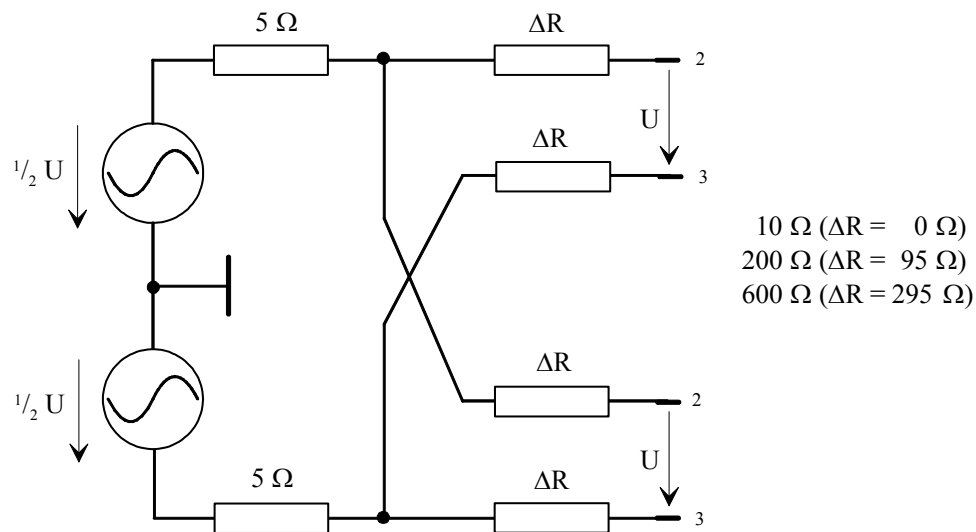

Figure 4-7 Channel = 2 = 1

The selected output impedance is retained even if the output is deactivated. The deactivated generator output is not connected to generator ground.

The diagrams above apply to all generator functions, except "Stereo Sine" and "DIM". The R&S UPV-B3 option (Second Generator) is required if a stereo or DIM signal is to be generated. In this case, the XLR plugs Ch1 and Ch2 are supplied slightly differently.

If the R&S UPV-B3 option (Second Generator) is installed and the generator function "Stereo Sine" is set, the XLR plugs of the outputs are connected as shown below:

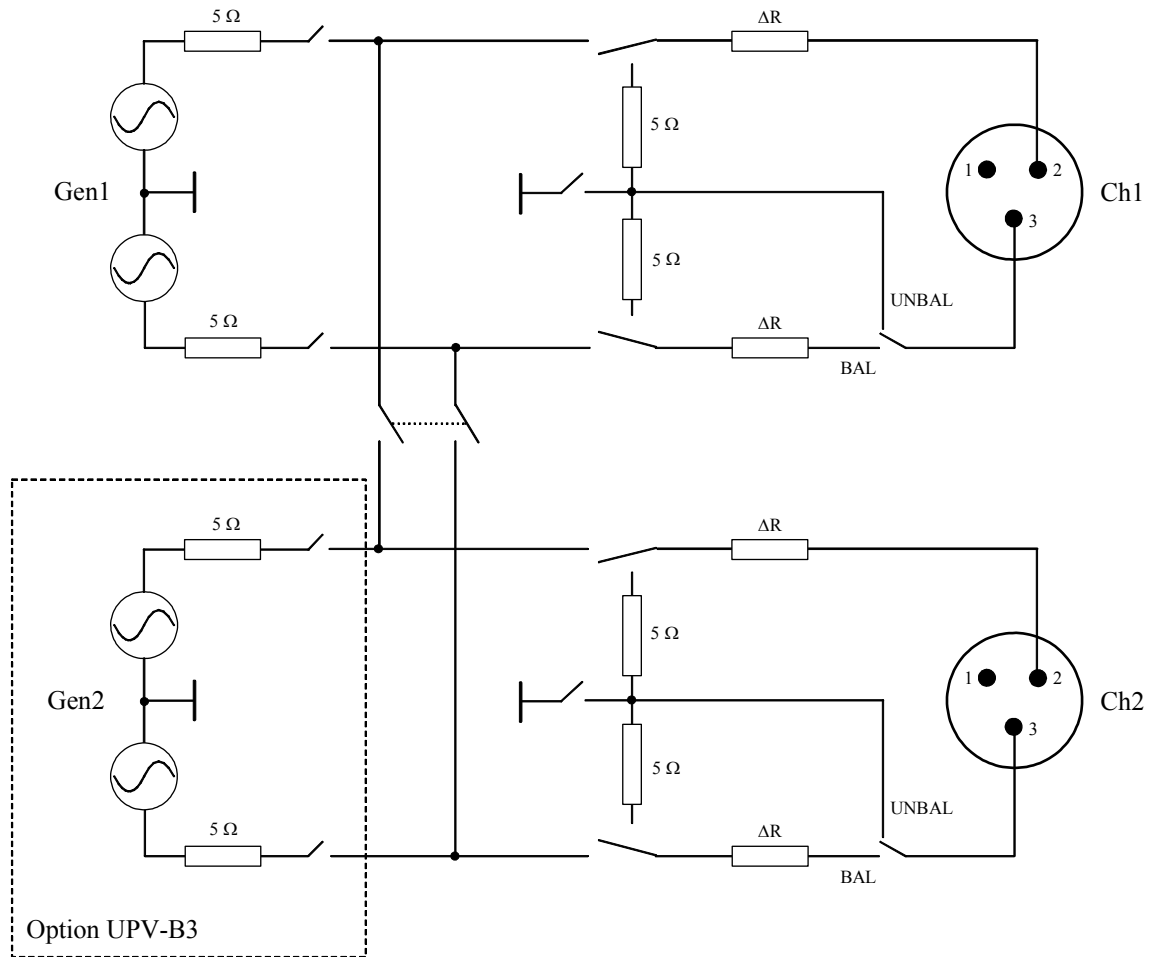

Figure 4-8 Connection of outputs with "Stereo Sine"

As can be seen in the circuit diagram, the two generator outputs are supplied by two independent sources.

If the R&S UPV-B3 option (Second Generator) is installed and the generator function "DIM" is set, the XLR plugs of the outputs are connected as shown below:

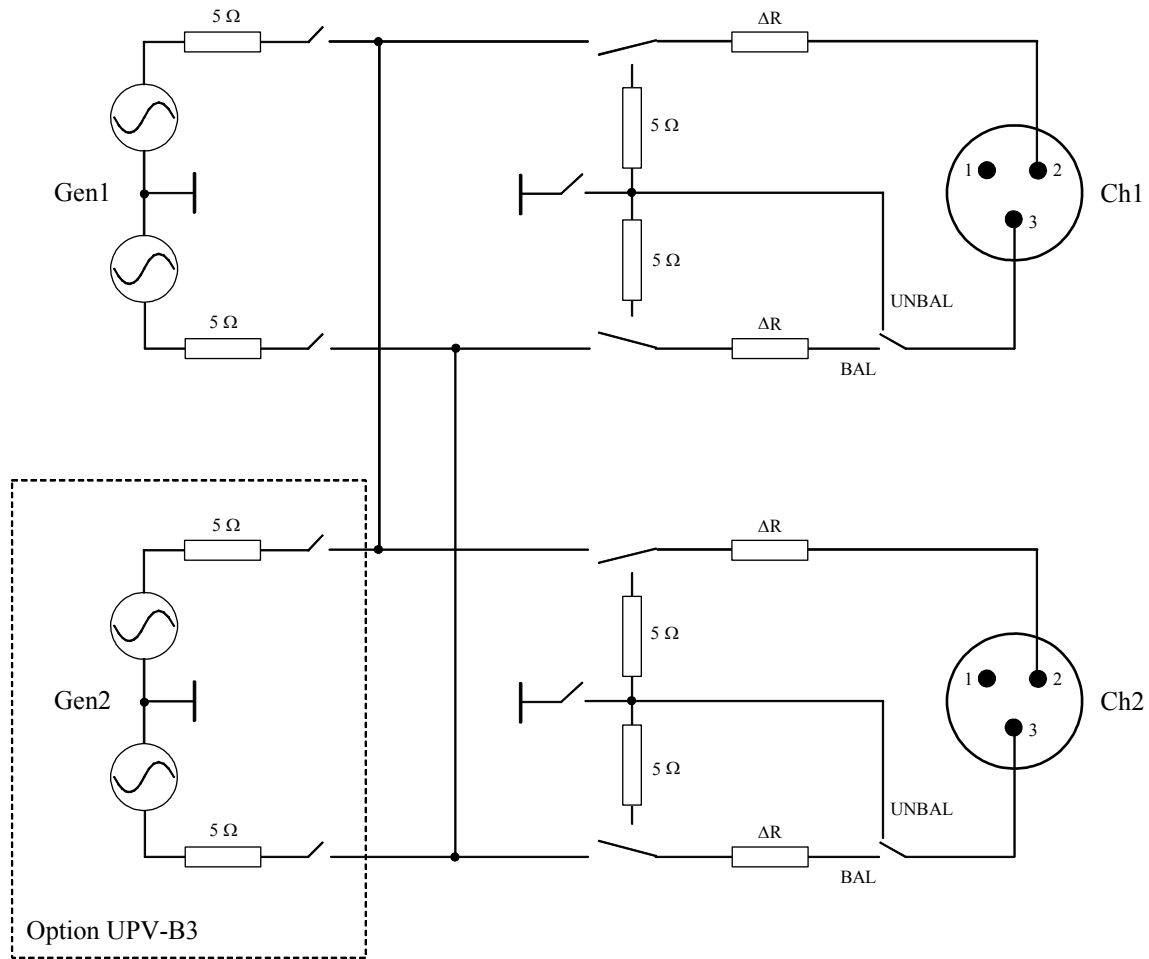

Figure 4-9 Connection of outputs with "DIM"

The two generator outputs are supplied by the R&S UPV-B3 option (Second Generator).



**Balanced Output with Common-Mode Signal (Output Type "Com Mode Test")**

The generator output signal is present with equal phase at pins 2 and 3 of the XLR connectors. The signal lines are referenced to the generator ground. The output impedance is made up of two identical resistances in the two signal lines. The signal source is connected via a  $5\ \Omega$  resistance to the node where the signal line branches into two.

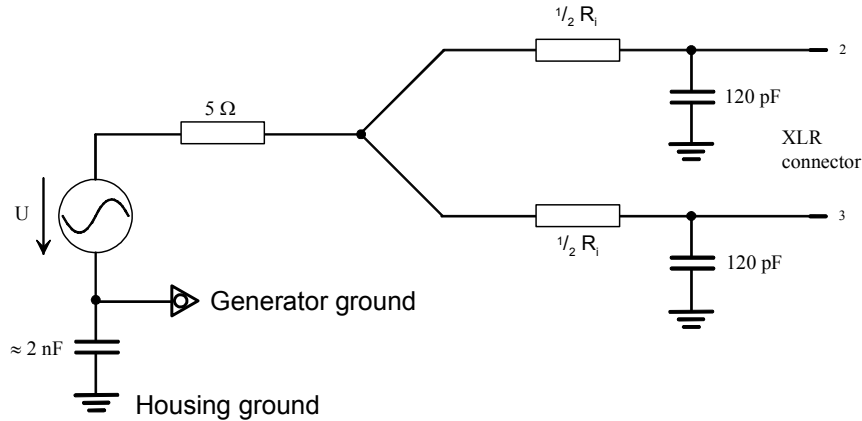
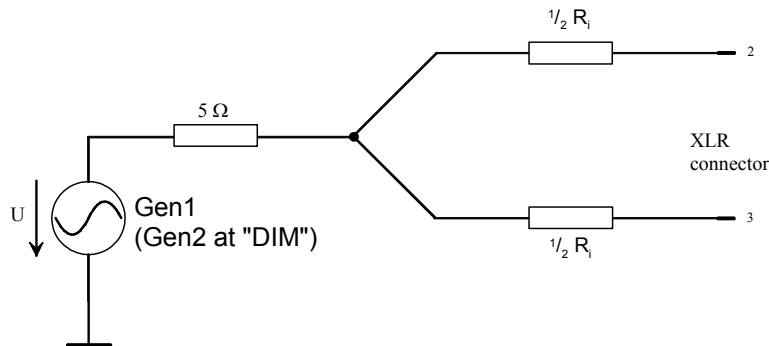

Figure 4-10 Balanced Output with common mode signal

Depending on the selected channel/channels, the impedance and the waveform, various output configurations are possible as shown below (capacitors not shown).

The common source impedance is  $5\ \Omega$  for all configurations. The resistances designated  $\frac{1}{2} R_i$  represent half the value of the set output impedance.

**Channel 1 oder 2**



Channel 2  $\equiv$  1

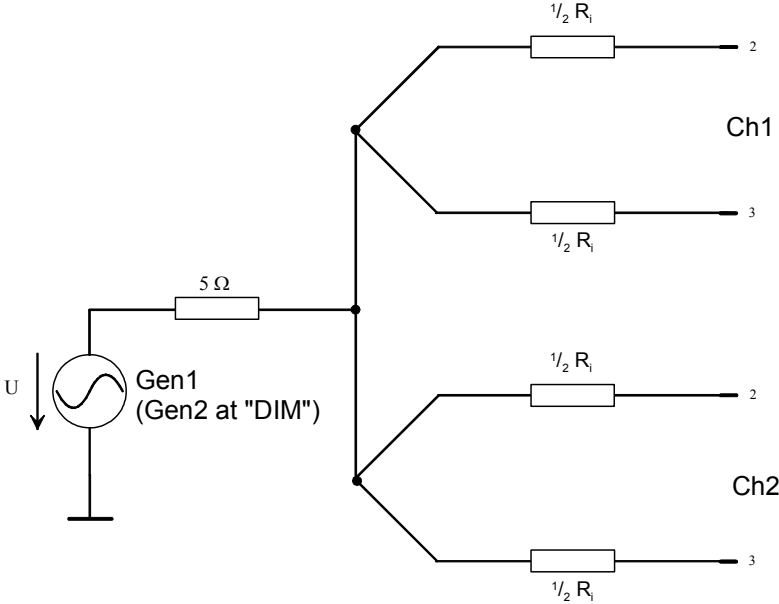

If "Stereo Sine" is set in the Generator Function panel, the two generator outputs are fed by two separate sources:

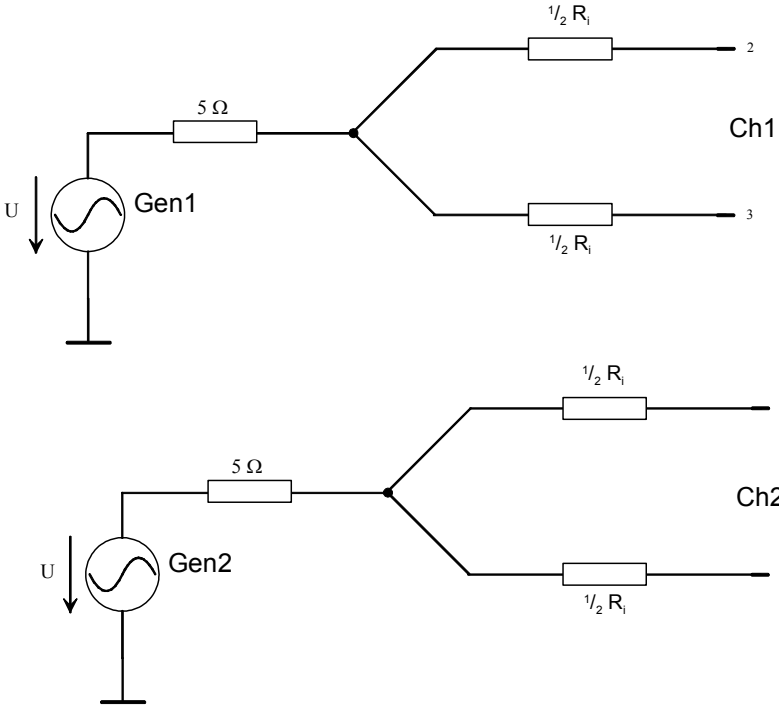

## Output Power

The output amplifier, attenuator and all internal resistors are short-circuit-proof. The peak current value is limited to approx. 200 mA. With a maximum RMS of 20 V (balanced) / 10 V (unbalanced), the maximum power loss in the load resistor (in the case of a short-circuit in the internal resistor) is 2.8 W / 1.4 W.

## Configuring the Digital Generator

### Digital Generator Configuration Panel

The configuration settings for the digital audio generator are described below.

With digital audio interfaces, there are basically two signal types which occur: the analog interface signal and the encoded audio signal itself. The digital interface signal has analog parameters on which, for example, noise or other interference signals can be superimposed – this interference is also noticeable as shifting of the signal edges. When this effect (known as "jitter") exceeds a certain magnitude, it becomes impossible to decode or regenerate the audio signal correctly.

The R&S UPV can generate the various digital signal impairments: Shifting of the signal edges (jitter) and superimposition of a common-mode voltage on the digital lines (common mode). The internal analog generator is used for generating such interference signals.

Generating impairments require options R&S UPV-B2 and R&S UPV-K22.

**Add Impairment** (with R&S UPV-B2 only) Used to set whether impairments (jitter or a common-mode signal) are to be added to the output signal of the digital audio generators: (see also section *"Digital Impairments Configuration Panel"* on page 4.27).

**ON**

Add Impairment

The impairment signal (jitter or common-mode) is activated.

The analog generator is deactivated, since it is used for generating the impairment signal.

```
Remote      control      commans :
SOURCE:IMPairment ON
```

**OFF**

Add Impairment

The impairment signal is deactivated.

```
Remote      control      command :
SOURCE:IMPairment OFF
```

**Channel**

Used to select the digital audio channels left and right.

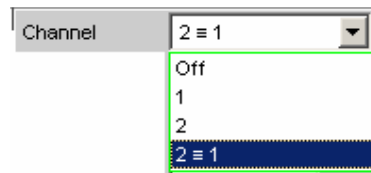
**OFF**

Both channels are deactivated.  
The frequency and level setting of the channels have no effect.  
An "empty frame" which does not contain any audio data is generated.

Remote-control command:  
OUTput:CHANnel OFF

**1**

Only the left-hand channel supplies the generator signal; the right-hand channel is deactivated.

Remote-control command:  
OUTput:CHANnel CH1

**2**

Only the right-hand channel supplies the generator signal; the left-hand channel is deactivated.

Remote-control command:  
OUTput:CHANnel CH2

**2 = 1**

Both the left and right-hand channel supply the same output signal.  
If the generator function "Stereo Sine" is selected, both channels may differ with regard to frequency, phase and amplitude.

Remote-control command:  
OUTput:CHANnel CH2Is1

**Sync To**

(with R&S UPV-B2 only)

Used to select the source to which the digital audio generator is synchronized.

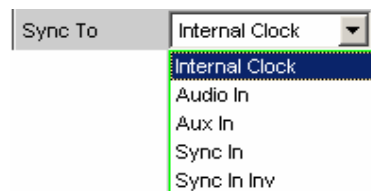
**Internal CLK**

The generator is synchronized to the internal clock generator.  
The clock frequency is determined by the sample frequency setting.

Remote-control command:  
SOURce:SYNC:TO INTClock

- Audio In**                      Synchronization to the digital audio input signal.

Remote-control command:  
SOURce:SYNC:TO AINPut
- Aux In**                        Synchronization to the digital audio signal at the AUX input XLR socket at the rear of the instrument.

Remote-control command:  
SOURce:SYNC:TO AUXinput
- Sync In**                       Synchronization to the word-clock signal at the SYNC input BNC socket at the rear of the instrument. The generator sync PLL is used.

Remote-control command:  
SOURce:SYNC:TO SINPut
- Sync In inv**                  Synchronization to the inverted word-clock signal at the SYNC input BNC socket at the rear of the instrument.

Remote-control command:  
SOURce:SYNC:TO SINVinput

**Sync Output**  
(with R&S UPV-B2 only)

Used to select the source for the digital audio sync output at the rear of the instrument. "Sync Out Type" can be set to either Word Clock or Biphase Clock (the frequency of the biphase clock is 128 times that of the word clock).

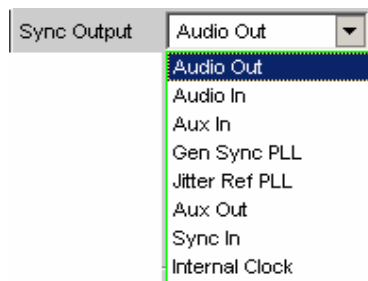

- Audio Out**                    Clock signal of the digital audio generator. Always the same as the clock rate of the digital audio output on the front panel.

If "Jitter" is set, jitter is applied to this output.

Remote-control command:  
OUTPut:SYNC:OUTPut ADOutput
- Audio In**                      Clock signal of the selected digital audio input on the front panel.

Remote-control command:  
OUTPut:SYNC:OUTPut ADINput

<b>Aux In</b>	<p>Clock signal of the digital audio auxiliary input at the rear of the instrument.</p> <p>Remote-control command:  <code>OUTPut:SYNC:OUTPut AXINput</code></p>
<b>Gen Sync PLL</b>	<p>Clock signal at the output of the generator sync PLL. Allows the frequency of a word clock applied at the sync input to be increased by a factor of 128. If "Jitter" is set, the set jitter is not applied to this output.          See setting of the generator sampling rate.</p> <p>Remote-control command:  <code>OUTPut:SYNC:OUTPut GSYPl1</code></p>
<b>Jitt Ref PLL</b>	<p>Clock signal at the output of the jitter reference PLL. Allows a low-jitter clock to be recovered from the digital audio input signal.          See setting of the digital audio analyzer sampling rate.</p> <p>Remote-control command:  <code>OUTPut:SYNC:OUTPut JRFP11</code></p>
<b>Aux Out</b>	<p>Clock signal of the digital audio auxiliary generator. This generator is used e.g. for the frame phase setting and the relock function.</p> <p>Remote-control command:  <code>OUTPut:SYNC:OUTPut AXOutput</code></p>
<b>Sync In</b>	<p>Loop-through option of the digital audio sync input, e.g. for cascading several instruments which synchronize to the word clock.</p> <p>Remote-control command:  <code>OUTPut:SYNC:OUTPut SYINput</code></p>
<b>Internal Clk</b>	<p>Output signal of the internal clock source. If the digital audio generator is not synchronized to the internal clock, the internal clock is available as an independent clock source and is set using the selection parameter "Int Clk Freq".</p> <p>Remote-control command:  <code>OUTPut:SYNC:OUTPut INTClck</code></p>

**Int Clk Freq**  
(with R&S UPV-B2 only)

Used to set the (word-clock) frequency of the internal clock generator if the internal clock generator is used as an independent clock source at the digital audio sync output.



Remote-control command:  
OUTPut:INTClockfreq <nu>

**Sync Out Type**  
(with R&S UPV-B2 only)

"Sync Out Type" can be set to either Word Clock or Biphase Clock (the frequency of the biphase clock is 128 times that of the word clock).

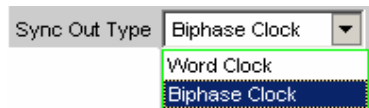

**Word CLK** The signal of the digital audio sync output corresponds to the sampling frequency of the selected source.

Remote-control command:  
OUTPut:SYNC:TYPE WCLock

**Biphase CLK** The signal of the digital audio sync output corresponds to the biphase clock, i.e. 128 times the sampling frequency of the selected source. The biphase clock is often used for direct clocking of the digital audio modules.

Remote-control command:  
OUTPut:SYNC:TYPE BCLock

**Aux Output**  
(with R&S UPV-B2 only)

Used to select the source for the digital audio auxiliary output at the rear of the instrument.

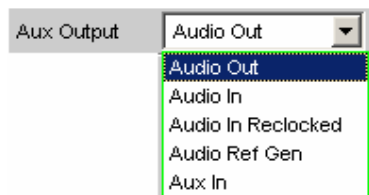

<b>Audio Out</b>	<p>The digital audio generator signal at the auxiliary output is identical to the signal at the front output. The signal output level is constant and does not depend on the selected BAL / UNBAL output level. The long cable simulator and common-mode superimposition have no effect on this output. If a jitter is set, it will also affect this output.</p> <p>Remote-control command: OUTPut:AUXiliary AOUTput</p>
<b>Audio In</b>	<p>Loop-through option of the digital audio signal from the selected input to the digital audio auxiliary output. The signal output level is constant and does not depend on the selected input or the pulse amplitude at the digital input.</p> <p>Remote-control command: OUTPut:AUXiliary AINPut</p>
<b>Audio In Reclocked</b>	<p>The jitter-reduced input signal is output. The audio data content is extracted from the input signal and output again via the digital audio auxiliary generator. This generator is controlled using the low-jitter clock from the jitter reference PLL.</p> <p>Remote-control command: OUTPut:AUXiliary AINReclock</p>
<b>Audio Ref Gen</b>	<p>Here, the digital audio auxiliary generator is used as the reference generator for the frame phase setting of the digital audio generator. If this setting is selected, it is then possible to set a frame phase and select the reference generator data. This setting cannot be selected if the digital generator is synchronized to the sync input.</p> <p>Remote-control command: OUTPut:AUXiliary RGENerator</p>
<b>Aux In</b>	<p>Loop-through option of the digital audio auxiliary input, e.g. for cascading several instruments.</p> <p>Remote-control command: OUTPut:AUXiliary AUXin</p>



**Ref Gen Data**  
(with R&S UPV-B2 only)

If "Audio Ref Gen" is selected as the "Aux Output" source, it is then possible to configure the audio data for this reference generator.

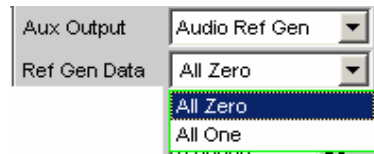

**All Zero** All audio data bits are set to zero. An "empty frame" is output (this is normally the case).

Remote-control command:  
SOURce:REFerence AZERO

**All One** To allow digital audio receivers to be tested, the audio data bits can all be set to one.

Remote-control command:  
SOURce:REFerence AONE

**Phase To Ref**  
(with R&S UPV-B2 only)

If "Audio Ref Gen" is selected as the "Aux Output" source, it is then possible to vary the frame phase offset of the digital audio signal between the front output and the digital audio AUX output at the rear of the instrument. The phase is shifted internally using the generator sync PLL.

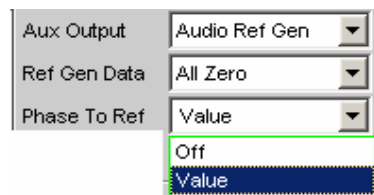

**Off** "Phase To Ref" variation is deactivated. Here, the generator sync PLL is bypassed, which generally results in an improvement of the clock for the digital audio generator.

Remote-control command:  
SOURce:PTORef OFF

**Value** A frame phase shift is activated and an appropriate setting value can be entered.

Remote-control command:  
SOURce:PTORef VALue

**Frame Phase**  
(with R&S UPV-B2 only)

Used to enter the value for the desired frame phase shift.  
The value can be entered in various units.  
The maximum variation range for the shift always corresponds to a phase shift of +/- 180° relative to the frame phase of the reference generator.  
The generator sync PLL is used for generating the phase shift.

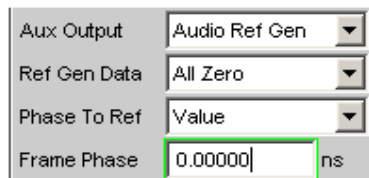

Remote-control command:  
SOURce:FRAMEphase <nu>

**Sample Frequency**

Used to set the clock rate of the digital audio signal for the generator.  
The sample frequency setting is used as a reference whenever audio data signals are generated.  
With "Common Only" and "Jitter Only" generation (with R&S UPV-B2 only), this setting therefore determines the clock rate of the generated empty frame.  
The selected clock rate determines the maximum signal frequency which can be input. For sinus signals this is 49.9% of the sampling rate.

**R&S UPV-B2:**

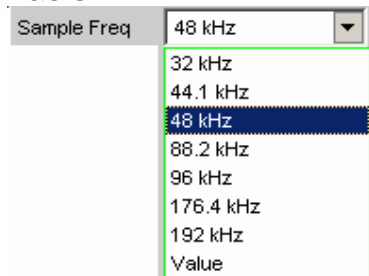

**R&S UPV-B20:**

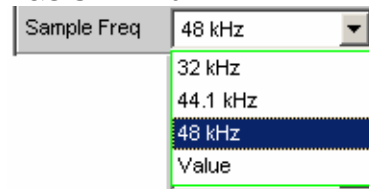

If the entered sample frequency is not the same as the actual clock rate (e.g. with external synchronization), the frequency of all audio data signals is shifted accordingly.

This setting is also used to select the correct range for the generator sync PLL.

Value range for numeric entries:  
30 kHz to 200 kHz (30 to 55 kHz with R&S UPV-B20)  
Standard sampling frequencies can be set directly in the selection field.

Only R&S UPV-B2:

Synchronization ranges for the generator sync PLL:

30 kHz to 64 kHz (base rate range)

65 kHz to 128 kHz (high rate range)

129 kHz to 200 kHz (extended rate range)

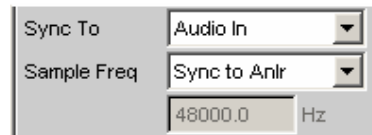

If "Audio In" is selected as the synchronization in the "Sync To" line, the generator can be set to the same sample frequency as the digital analyzer by selecting "Sync to Anlr" from the "Sample Freq" line.

<b>32 kHz</b>	Standard sampling rate 32 kHz  Remote-control command: OUTPut:SAMPlE:MODE F32
<b>44.1 kHz</b>	Standard sampling rate 44.1 kHz  Remote-control command: OUTPut:SAMPlE:MODE F44
<b>48 kHz</b>	Standard sampling rate 48 kHz  Remote-control command: OUTPut:SAMPlE:MODE F48
<b>88.2 kHz</b>	Standard sampling rate 88.2 kHz  Remote-control command: OUTPut:SAMPlE:MODE F88
<b>96 kHz</b>	Standard sampling rate 96 kHz  Remote-control command: OUTPut:SAMPlE:MODE F96
<b>176.4 kHz</b>	Standard sampling rate 176.4 kHz  Remote-control command: OUTPut:SAMPlE:MODE F176
<b>192 kHz</b>	Standard sampling rate 192 kHz  Remote-control command: OUTPut:SAMPlE:MODE F192
<b>Sync To Anlr</b>	The sampling rate of the digital audio analyzer is used for synchronization. Remote-control command: OUTPut:SAMPlE:MODE SYNChron

**Value:** Variable sampling rate entry

```
Remote-control command:
OUTPut:SAMPlE:MODE VALue
OUTPut:SAMPlE:FREQuency <nu>
```

**Audio Bits** Wordwidth used by the digital audio generator for the Source Mode "Audio Data".  
If the wordwidth is reduced, the values of the audio samples are rounded off to the specified wordwidth. Unused data bits are encoded as zeroes in the digital audio signal.

Value range: 8 to 24

A screenshot of a control panel for 'Audio Bits'. It features a label 'Audio Bits' on the left and a numerical input field on the right containing the value '20'. The input field is highlighted with a green border.

```
Remote-control command:
OUTPut:AUDIobits <n>
```

**Bal Ampl** Used to set the pulse amplitude of the digital audio signal at the BAL (XLR) output. The set voltage corresponds to the peak-to-peak value of the pulse amplitude when the output is terminated with the nominal impedance (110 Ohm)  
The standard voltage is 4 V  
Setting range: 0 V to 8.5 V  
This voltage is linked to the setting for the UNBAL amplitude and is always 4 times higher than this amplitude.

A screenshot of two control panels. The top panel is for 'Bal Ampl' and shows a value of '4.00000' with a 'V' unit indicator. The bottom panel is for 'Unbal Ampl' and shows a value of '1.00000' with a 'V' unit indicator. Both input fields are highlighted with green borders.

```
Remote-control command:
OUTPut:SIGNal:BALanced:LEVel <nu>
```

**Unbal Ampl** Used to set the pulse amplitude of the digital audio signal at the UNBAL (BNC) output. The set voltage corresponds to the peak-to-peak value of the pulse amplitude when the output is terminated with the nominal impedance (75 Ohm)  
The standard voltage is 1 V  
Setting range: 0 V to 2.125 V  
This voltage is linked to the setting for the BAL amplitude and is always a quarter of this amplitude.

A screenshot of two control panels. The top panel is for 'Bal Ampl' and shows a value of '4.00000' with a 'V' unit indicator. The bottom panel is for 'Unbal Ampl' and shows a value of '1.00000' with a 'V' unit indicator. Both input fields are highlighted with green borders.

```
Remote-control command:
OUTPut:SIGNal:LEVel <nu>
```

**Unbal Output**

The unbalanced output can be switched so that the digital audio signal of the selected BAL or UNBAL input is output. If the BAL input is selected, the balanced signal is converted into an unbalanced signal. The signal at the BAL input can then be monitored conveniently e.g. on a connected oscilloscope.



**Audio Out**

The digital audio generator signal is output.

Remote-control command:  
 OUTPut:UNBalanced:OUTPut AOUTput

**Audio In**

The digital audio signal from the selected BAL or UNBAL input is output. It is not possible to output the signal of the optical input in this case. The pulse amplitude setting and the cable simulator do not have any effect on this output.

Remote-control command:  
 OUTPut:UNBalanced:OUTPut AINPut

**Cable Sim**

Cable simulation used to check the effect of attenuated input signals along long cables when tests are performed on digital audio receivers. A cable length of approx. 100 m is simulated.



**Off**

Cable simulation is deactivated.

Remote-control command:  
 OUTPut:CSIMulator OFF

**Long**

Cable simulation for the BAL and UNBAL outputs is activated.

Remote-control command:  
 OUTPut:CSIMulator SIMLong

**Ref Voltage**

Reference value for the relative amplitude units.

If the reference value is changed, all amplitude settings linked to the reference value also change.

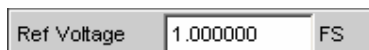

Remote-control command:  
 SOURce:VOLTage:REFerence <nu>

**Ref Frequency**

Reference value for the relative frequency units.

If the reference frequency is changed, all frequency settings linked to the reference value also change.

Ref Frequency	1000.000	Hz
---------------	----------	----

Remote-control command:  
 SOURce:FREQuency:REFeRence <nu>

## Digital Impairments Configuration Panel

The digital impairment configuration panel requires option R&S UPV-B2.

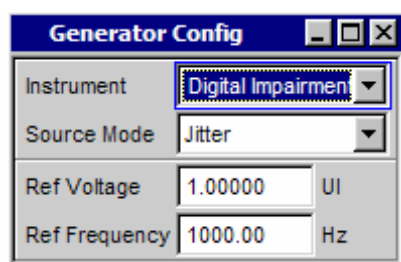

This panel is used to select the digital impairment signal - jitter or common-mode - which can be added to the output signal of the digital audio generator. The parameters of the signals are set in the generator function panel.

The impairments are activated or deactivated in the Digital Audio Generator Config panel.

**Source Mode**

Used to set whether jitter or a common-mode signal is generated.

**Jitter**

A digital audio signal with jitter for tests on digital audio receivers can be generated.

The value of the jitter and delay impairment is normally specified in UI (Unit Interval). One UI is defined as the smallest pulse width of the digital audio signal (eye width) and does not depend on the selected sampling rate. One UI corresponds to the clock period with which the digital signal is clocked ("biphase clock"). With digital audio signals, one UI corresponds to the 128th part of the sampling period; at 48 kHz, one UI is 163 approx. ns.

Remote control command:  
 SOURce:SRCMode JITTer

**Common**

A digital audio signal with superimposition of a common-mode signal at the BAL output can be generated.

Balanced cables are also used for the digital audio signal links. Here, coupled impairments (e.g. from ground loops) occur as common-mode voltage at the interfaces.

Remote control command:  
 SOURce:SRCMode COMMon

**Ref Voltage**

Reference value for the relative amplitude units.  
The unit for the reference value corresponds to the selected source mode (e.g. UI in the source mode "Jitter").  
If the reference value is changed, all amplitude settings linked to the reference value also change.

Ref Voltage	1.00000	UI
-------------	---------	----

Remote-control command:  
SOURce:VOLTage:REFerence <nu>

**Ref Frequency**

Reference value for the relative frequency units.  
If the reference frequency is changed, all frequency settings linked to the reference value also change.

Ref Frequency	1000.000	Hz
---------------	----------	----

Remote-control command:  
SOURce:FREQuency:REFerence <nu>

# Configuring the I<sup>2</sup>S Generator

## I<sup>2</sup>S Generator Configuration Panel

The Config panel is used to set the analog and digital generator. The configuration options for the I<sup>2</sup>S generator are described below.

**Channel** Used to select the digital audio channels left (Ch1) and right (Ch2).

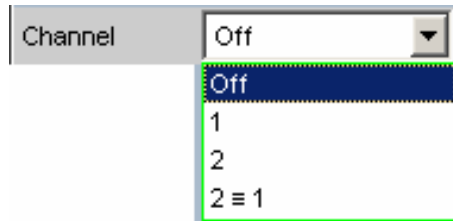

- |              |  |
|--------------|--|
| <b>OFF</b>   | <p>Both channels are deactivated.<br/>The frequency and level setting of the channels have no effect.<br/>An "empty frame" that does not contain any audio data (all bits = zero) is generated.</p> <p>Remote-control command:<br/>OUTPut:CHANnel OFF</p>  |
| <b>1</b>     | <p>Only the left channel supplies the generator signal; the right channel is deactivated (all bits = zero).</p> <p>Remote-control command:<br/>OUTPut:CHANnel CH1</p>  |
| <b>2</b>     | <p>Only the right channel supplies the generator signal; the left channel is deactivated (all bits = zero).</p> <p>Remote-control command:<br/>OUTPut:CHANnel CH2</p>  |
| <b>2 ≡ 1</b> | <p>Both the left and right channels supply the same output signal.<br/>If the generator function "Stereo Sine" is selected, the two may differ with regard to frequency, phase and amplitude.</p> <p>Remote-control command:<br/>OUTPut:CHANnel CH2Is1</p> |



**Sync To** Used to select the source to which the I<sup>2</sup>S generator is synchronized.

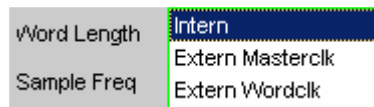

**Intern** The generator uses the internal clock.

Remote-control command:  
 SOURce:DIGital:SYNc:TO Intern

**Extern Masterclk** Synchronization to the applied master clock signal at the rear TX CLK IN connector.

Remote-control command:  
 SOURce:DIGital:SYNc:TO EXTMasterclock

**Extern Wordclk** Synchronization to the applied word clock signal at the rear TX CLK IN connector.

Remote-control command:  
 SOURce:DIGital:SYNc:TO EXTWordclock

**Word Length** Word length of a data frame for each channel.

Value range: 16, 24, 32.

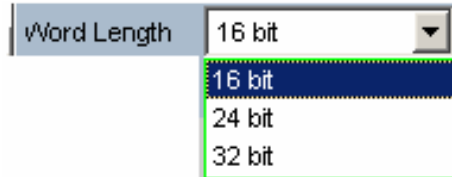

**16 bit** Word length 16 bits

Remote-control command:  
 OUTPut:WLENgth W16

**24 bit** Word length 24 bits

Remote-control command:  
 OUTPut:WLENgth W24

**32 bit** Word length 32 bits

Remote-control command:  
 OUTPut:WLENgth W32

**Sample Frequency**

Used to set the sampling frequency.

The sampling frequency corresponds to the frequency of the FSYNC signal. All frequency information of generated audio data are with reference to this setting. If the I<sup>2</sup>S generator is operated with external wordclock synchronization and the frequency of the external clock signal does not correspond to the set sampling frequency, the I<sup>2</sup>S generator generates audio data with an incorrect frequency. Even with external masterclock synchronization, the external clock signal must correspond to the set sampling frequency multiplied by the selected MClk ratio. Otherwise, the I<sup>2</sup>S generator also generates audio data with an incorrect frequency.

The selected clock rate determines the maximum signal frequency which can be input. For sinus signals this is 49.9% of the sampling rate.

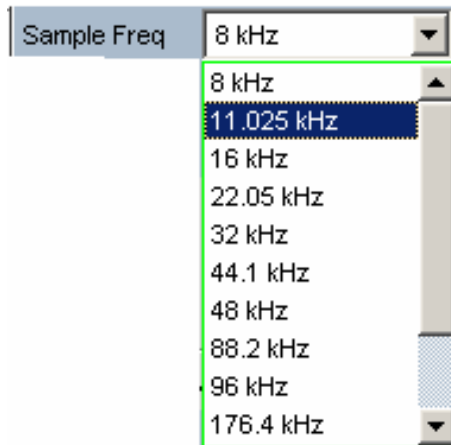

Value range for numeric entry:  
6.75 kHz to 410 kHz

Standard sampling frequencies can be set directly in the selection field.

<b>8 kHz</b>	Standard sampling rate 8 kHz  Remote-control command: OUTPut:SAMPlE:MODE F08
<b>11.025 kHz</b>	Standard sampling rate 11.025 kHz  Remote-control command: OUTPut:SAMPlE:MODE F11
<b>16 kHz</b>	Standard sampling rate 16 kHz  Remote-control command: OUTPut:SAMPlE:MODE F16
<b>22.05 kHz</b>	Standard sampling rate 22.05 kHz  Remote-control command: OUTPut:SAMPlE:MODE F22

<b>32 kHz</b>	Standard sampling rate 32 kHz  Remote-control command: OUTPut:SAMPlE:MODE F32
<b>44.1 kHz</b>	Standard sampling rate 44.1 kHz  Remote-control command: OUTPut:SAMPlE:MODE F44
<b>48 kHz</b>	Standard sampling rate 48 kHz  Remote-control command: OUTPut:SAMPlE:MODE F48
<b>88.2 kHz</b>	Standard sampling rate 88.2 kHz  Remote-control command: OUTPut:SAMPlE:MODE F88
<b>96 kHz</b>	Standard sampling rate 96 kHz  Remote-control command: OUTPut:SAMPlE:MODE F96
<b>176.4 kHz</b>	Standard sampling rate 176.4 kHz  Remote-control command: OUTPut:SAMPlE:MODE F176
<b>192 kHz</b>	Standard sampling rate 192 kHz  Remote-control command: OUTPut:SAMPlE:MODE F192
<b>384 kHz</b>	Standard sampling rate 384 kHz  Remote-control command: OUTPut:SAMPlE:MODE F384
<b>Value:</b>	Variable sampling rate entry  Remote-control commands: OUTPut:SAMPlE:MODE VALue OUTPut:SAMPlE:FREQuency <nu>

**Bclk Freq**

Bitclock frequency display. This is calculated from the product of Word Length / Sample Freq.

Value range: 216 kHz ... 26.24 MHz

Bclk Freq 1536.00 kHz

Remote control command:  
OUTPut:BCLk:FREQuency?

**MClk Ratio**

Ratio between MCLK and FSYNC.

Value range: 64, 96, 128, 192, 256, 512

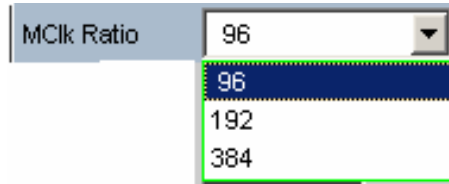

The value range is limited by word length and sampling frequency.

**Word Length 16 bit, Sync To Intern:**

Sampling frequency	Selectable MClk ratio
6.75 kHz to 108 kHz	64, 128, 256, 512
>108 kHz to 216 kHz	64, 128, 256
>216 kHz to 410 kHz	64, 128

**Word Length 24 bit, Sync To Intern:**

Sampling frequency	Selectable MClk ratio
6.75 kHz to 108 kHz	96, 192, 384
>108 kHz to 216 kHz	96, 192

**Word Length 32 bit, Sync To Intern:**

Sampling frequency	Selectable MClk ratio
6.75 kHz to 108 kHz	128, 256, 512
>108 kHz to 216 kHz	128, 256
>216 kHz to 410 kHz	128

**Word Length 16 bit, Sync To Extern Masterclk:**

Sampling frequency	Selectable MClk ratio
6.75 kHz to 108 kHz	128, 256, 512
>108 kHz to 216 kHz	128, 256
>216 kHz to 410 kHz	128

**Word Length 24 bit, Sync To Extern Masterclk:**

Sampling frequency	Selectable MClk ratio
6.75 kHz to 108 kHz	192, 384
>108 kHz to 216 kHz	192

**Word Length 32 bit, Sync To Extern Masterclk:**

Sampling frequency	Selectable MClk ratio
6.75 kHz to 108 kHz	128, 256, 512
>108 kHz to 216 kHz	128, 256
>216 kHz to 410 kHz	128

**Word Length 16 bit, Sync To Extern Wordclk:**

Sampling frequency	Selectable MClk ratio
6.75 kHz to 108 kHz	64, 128, 256, 512
>108 kHz to 216 kHz	64, 128, 256
>216 kHz to 410 kHz	64, 128

**Word Length 24 bit, Sync To Extern Wordclk:**

Sampling frequency	Selectable MClk ratio
6.75 kHz to 108 kHz	96, 192, 384
>108 kHz to 216 kHz	96, 192

**Word Length 32 bit, Sync To Extern Wordclk:**

Sampling frequency	Selectable MClk ratio
6.75 kHz to 108 kHz	128, 256, 512
>108 kHz to 216 kHz	128, 256
>216 kHz to 410 kHz	128

<b>64</b>	64 times the sampling rate (with word length 16 bits)  Remote-control command: OUTPut:MCLKratio M64
<b>96</b>	96 times the sampling rate (with word length 24 bits)  Remote-control command: OUTPut:MCLKratio M96
<b>128</b>	128 times the sampling rate (with word length 16 and 32 bits)  Remote-control command: OUTPut:MCLKratio M128
<b>192</b>	192 times the sampling rate (with word length 24 bit)  Remote-control command: OUTPut:MCLKratio M192

- 256**                    256 times the sampling rate (with word length 16 and 32 bit)

Remote-control command:  
OUTPut:MCLKratio M256
- 384**                    384 times the sampling rate (with word length 24 bits)

Remote-control command:  
OUTPut:MCLKratio M384
- 512**                    512 times the sampling rate (with word length 16 and 32 bits)

Remote-control command:  
OUTPut:MCLKratio M512

**Audio Bits**

Resolution of audio data within a frame.

If the resolution is reduced, the values of the audio samples are rounded off to the specified word length. Unused data bits are encoded as zeroes in the digital audio signal.

Value range: 8 ... "Word Length"

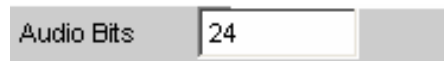

Remote-control command:  
OUTPut:AUDIobits <n>

**Format**

Selection of the I<sup>2</sup>S generator function.

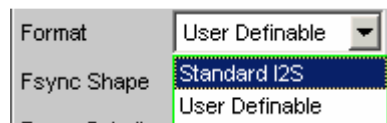

**Standard I2S**    The I<sup>2</sup>S generator transmits in the standard I<sup>2</sup>S format. The following parameters are assigned a fixed default:

Fsync Shape      Square Pulse  
Fsync Polarity   Left(1) = Low  
Word Offset      -1

Remote-control command:  
OUTPut:FORMat SI2S

**User-definable** Der I<sup>2</sup>S generator transmits in I<sup>2</sup>S-like format. The following format-influencing parameters are additionally available:

Fsync Shape  
 Fsync Polarity  
 Word Offset

Remote-control command:  
 OUTPut:FORMat USER

**Fsync Shape**

Selection of the FSYNC signal form.

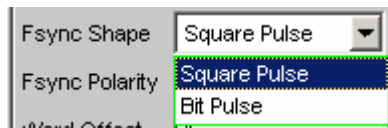

**Square Pulse** The FSYNC signal is transmitted as a symmetrical rectangle.

Remote-control command:  
 OUTPut: FSHape SQU

**Bit Pulse** The FSYNC signal is transmitted as a bit pulse.

Remote-control command:  
 OUTPut: FSHape BITP

**Fsync Polarity**

FSYNC signal polarity.

If Fsync Shape is set to Square Pulse, the following selection is available:

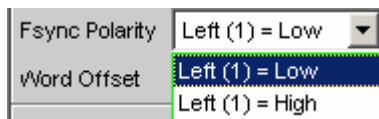

**Left (1) = Low** While the left channel (channel 1) is being sent, a low level is applied at the FSYNC signal at a word offset of 0.

Remote-control command:  
 OUTPut:FPulse LFTL

**Left (1) = High** While the left channel (channel 1) is being sent, a high level is applied at the FSYNC signal at a word offset of 0.

Remote-control command:  
 OUTPut:FPulse LFTH

If Fsync Shape is set to to Bit Pulse, the following selection is available:

Fsync Polarity	Negative
Word Offset	Negative
	Positive

**Positive** At a Word Offset of 0, a positive pulse marks the beginning of the left data word.

Remote-control command:  
OUTPut:FPulse POS

**Negative** At a Word Offset of 0, a negative pulse marks the beginning of the left data word.

Remote-control command:  
OUTPut:FPulse NEG

### Word Offset

By using Word Offset, you can set the number of SCK clock cycles by which the Fsync signal transmission is delayed relative to the audio data.

Value range: -"Word Length"... 0 ... +"Word Length"-1

Word Offset	1
-------------	---

Remote-control command:  
OUTPut:WOffset <n>

### Ref Voltage

Reference value for the relative amplitude units.

If this reference value is changed, all amplitude settings linked to the reference value also change.

Ref Voltage	1.000000	FS
-------------	----------	----

Remote-control command:  
SOURce:VOLTage:REFerence <nu>

### Ref Frequency

Reference value for the relative frequency units.

If this reference frequency is changed, all frequency settings linked to the reference value also change.

Ref Frequency	1000.000	Hz
---------------	----------	----

Remote-control command:  
SOURce:FREQuency:REFerence <nu>



## Timing Diagrams

The timing diagrams below show a number of configuration examples that illustrate the effect of the parameters.

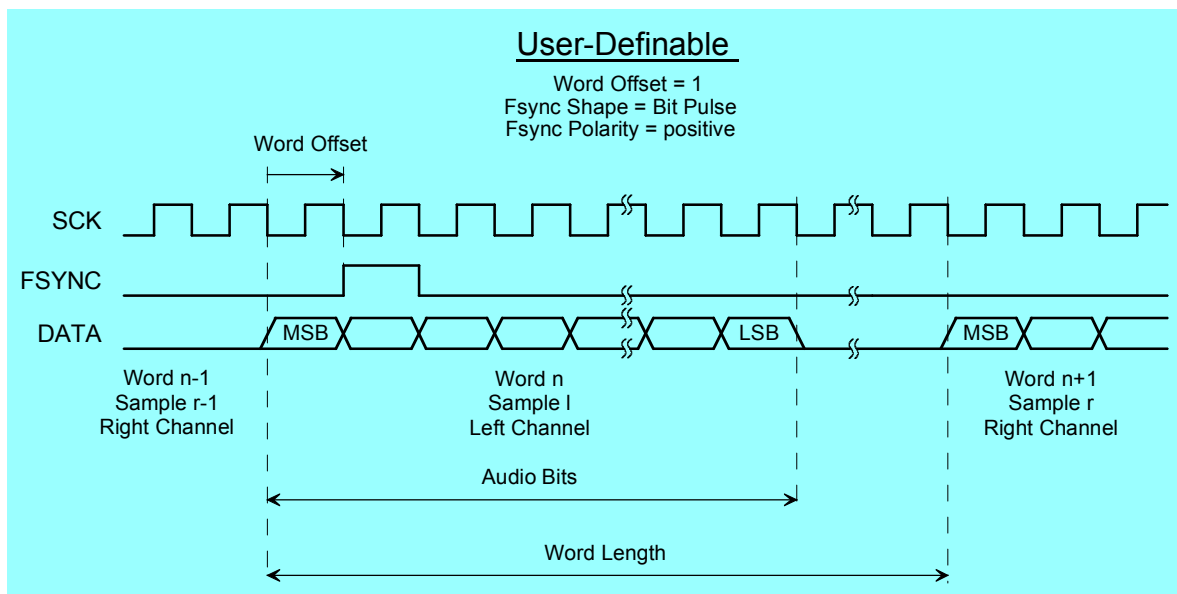
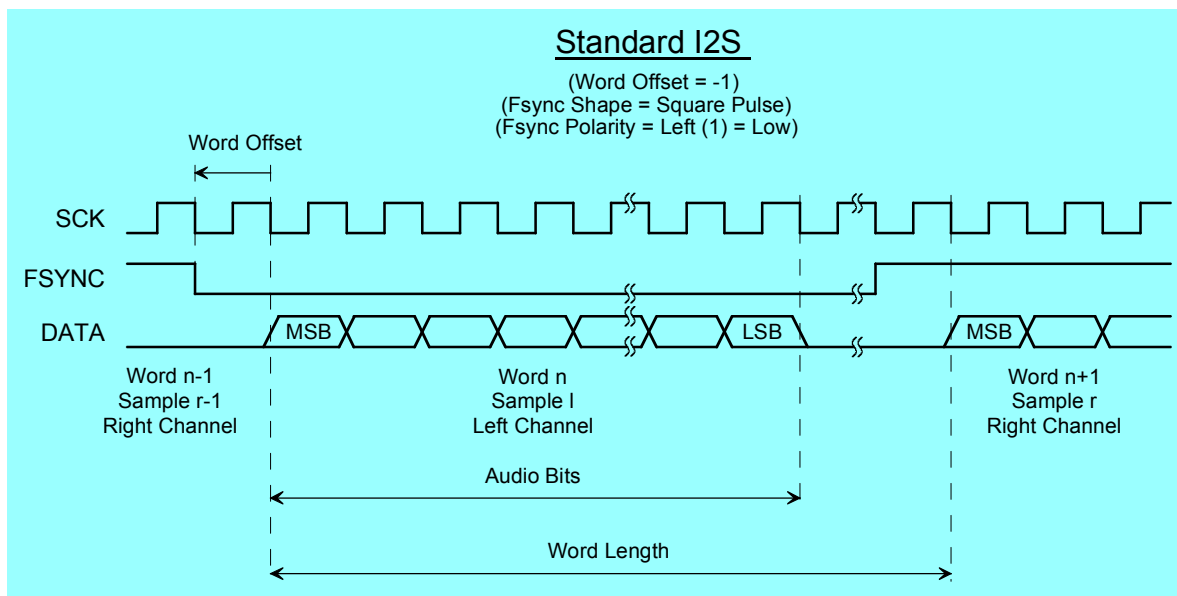

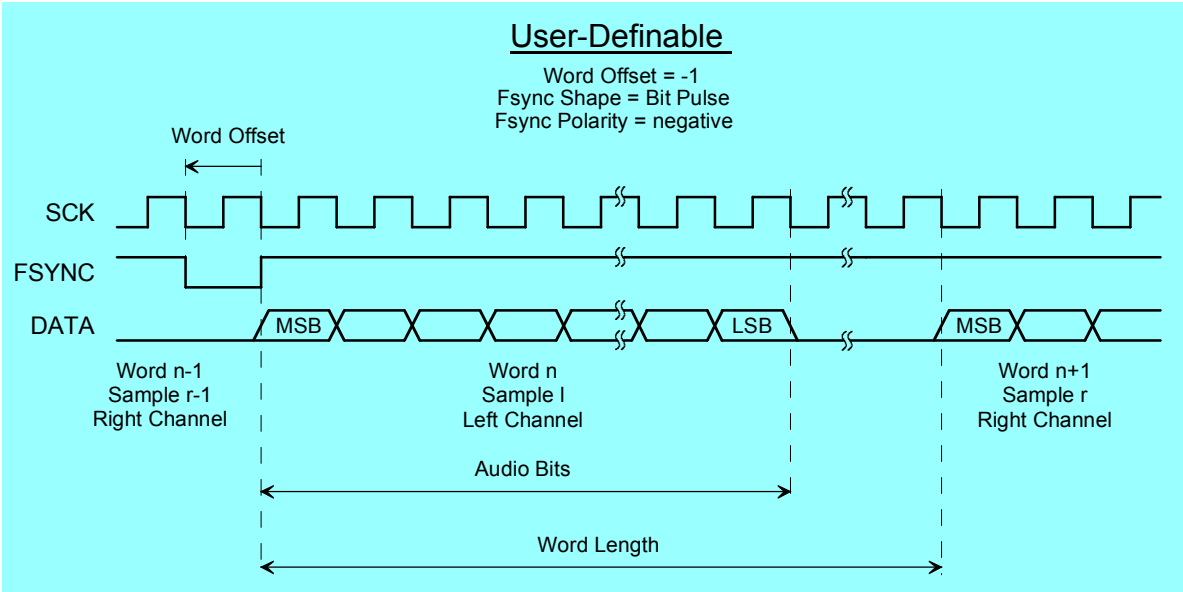

## Interface Assignment

I<sup>2</sup>S connector (25-contact D-Sub connector)

It is recommended to use a shielded cable when connecting the R&S UPV via the RS 232-C-interface.

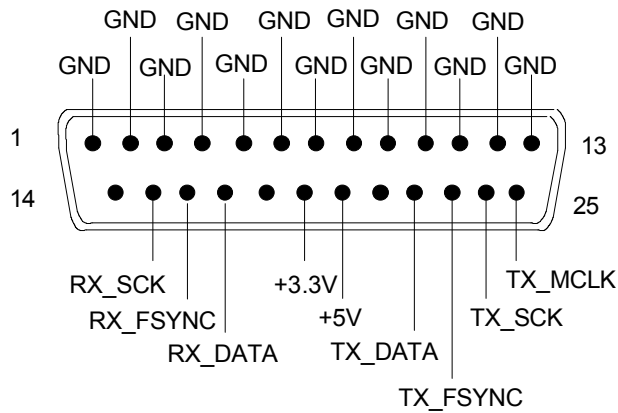

Pin	Signal	Input (I) Output (O)	Data direction
1	GND		Ground connection
2	GND		Ground connection
3	GND		Ground connection
4	GND		Ground connection
5	GND		Ground connection
6	GND		Ground connection
7	GND		Ground connection
8	GND		Ground connection
9	GND		Ground connection
10	GND		Ground connection
11	GND		Ground connection
12	GND		Ground connection
13	GND		Ground connection
14	not connected		
15	RX_SCK	I	Serial clock analyzer
16	RX_FSYNC	I	Frame sync analyzer
17	RX_DATA	I	Serial data analyzer
18	not connected		
19	+3.3 V (500 mA)	O	Power supply
20	+5 V (500 mA)	O	Power supply
21	not connected		
22	TX_DATA	O	Serial data generator
23	TX_FSYNC	O	Frame sync generator
24	TX_SCK	O	Serial clock generator
25	TX_MCLK	O	Master clock output generator

**TX CLK IN (BNC connector)**

Pin	Signal	Input (I) Output (O)	Data direction
1	GND		Ground connection
2	TX_CLK	I	Master clock input generator

# Configuring the USI Dual Channel Generator

## USI Dual Channel Generator Configuration Panel

The configuration panel is used for the analog and digital generator settings. The configuration options for the USI dual channel generator are described below.

**Clock** Used to select the continuous clock or gated clock operating modes.

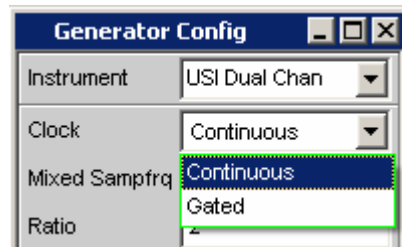

**Continuous** The continuous clock operating mode requires a continuous clock for the generator. The clock source may be internal or external. Several types of synchronisation are available if the timing device is external.

```
Remote control command:
OUTPut:CLOCK CONTInous
```

**Gated** The gated clock operating mode must be selected if the externally supplied bit clock (BClk) and the externally supplied word clock (Fsync) are discontinuous or have such a large jitter that the internal PLL can no longer follow this clock. The synchronisation type is limited to the "external word clock and bit clock" (Ext Fsync&BClk) mode. Audio monitoring of the audio signal generated is not possible.

```
Remote control command:
OUTPut:CLOCK GATed
```

**Mixed Sampfrq** Used to produce data streams of varying sampling rates in both generator channels. When activated, the generator filter is not available.



```
Remote control command:
OUTPut:MSAMplefrequency ON|OFF
```

**Ratio** Down-sampling factor for 2nd generator channel with regard to the sampling rate.  
Value range: 2 ... 6

 A screenshot of a control panel showing a label 'Ratio' followed by a text input field containing the number '2'. The input field has a green border.

Remote control command:  
OUTPut:RATio <n>

**Samples/Frame** Defines the number of samples of a generator channel per frame. The parameter simultaneously determines the minimum settable sampling rate according to the relationship:  $fs_{min} = 843.75 \text{ Hz} * \text{samples/frame}$ .

Value range: 1 ... 32

 A screenshot of a control panel showing a label 'Samples/Frame' followed by a text input field containing the number '1'. The input field has a green border.

Remote control command:  
OUTPut:SPFRame <n>

**No of Slots** Defines the number slots per frame.  
Value range: 1 ... 256

$\text{No\_of\_Slots} * \text{Slot\_Length} \leq 2048$   
 $\text{Slot\_Length} * \text{No\_of\_Slots} * \text{Sample\_Freq} \leq 55.926 \text{ MHz}$

 A screenshot of a control panel showing a label 'No of Slots' followed by a text input field containing the number '2'. The input field has a green border.

Remote control command:  
OUTPut:NOSlots <n>

**TX\_DATA1** Defines which signal is output on the individual slots of the TX\_DATA1 data line.

 A screenshot of a control panel showing a label 'TX\_DATA1' followed by a text input field containing the string 'Gen1:1.Gen2:2'. The input field has a grey border.

Remote control command:  
OUTPut:TXData <string>

**TX\_DATA2** Defines which signal is output on the individual slots of the TX\_DATA2 data line.

 A screenshot of a control panel showing a label 'TX\_DATA2' followed by a text input field containing the string 'Gen1:1.Gen2:2'. The input field has a grey border.

Remote control command:  
OUTPut:TXData2 <string>

**TX\_DATA3** Defines which signal is output on the individual slots of the TX\_DATA3 data line.



Remote control command:  
 OUTPut:TXData3 <string>

**TX\_DATA4** Defines which signal is output on the individual slots of the TX\_DATA4 data line.



Remote control command:  
 OUTPut:TXData4 <string>

**Sync To** Used to select the source to which the USI generator is synchronised.

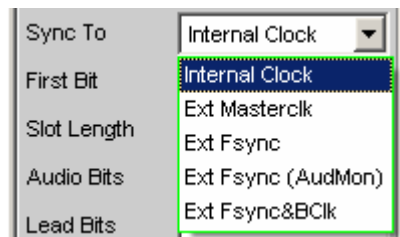

**Internal Clock** The generator uses the device's internal clock.

Remote control command:  
 SOURce:SYNC:TO IClock

**Ext Masterclk** Synchronises to the externally supplied master clock signal (TX\_MCLK\_IN).

Remote control command:  
 SOURce:SYNC:TO EMASterclock

**Ext Fsync** Synchronises to the external FrameSync signal (TX\_FSYNC\_IN). The generator signal cannot be audio-monitored. A master clock signal is additionally generated and output.

Remote control command:  
 SOURce:SYNC:TO EFSync

**Ext Fsync (AudMon)** Synchronises to the external FrameSync (TX\_FSYNC\_IN) signal. The generator signal can be audio-monitored. No master clock signal is output.

Remote control command:  
 SOURce:SYNC:TO EFAMon

**Ext Fsync&Bclk** Synchronises to the external FrameSync (TX\_FSYNC\_IN) and bit clock (TX\_BCLK\_IN) signals.

Remote control command:  
 SOURCE:SYNC:TO EFBClk

Overview of the various synchronisation modes:

	Internal clock	External master clock	External frame sync	External frame sync with audio monitor	External frame sync, bit clock	External frame sync, bit clock (gated)
Master clock output	o	tri	o	tri	o	tri
Master clock input	--	x	--	--	--	--
Bit clock output	o	o	o	o	tri	tri
Bit clock input	--	--	--	--	x	x
Frame sync output	o	o	o	o	tri	tri
Frame sync input	--	--	x	x	x	x
Slot clock output	o	o	o	o	o	o

- x Input signal must be present
- o Output signal is available
- tri Output in tristate mode (high impedance)
- input not used

**First Bit** Defines the sequence in which the data bits are transmitted



**MSB** The most significant bit is transmitted first.

Remote control command:  
 OUTPUT:FBIT MSB

**LSB** The least significant bit is transmitted first.

Remote control command:  
 OUTPUT:FBIT LSB

**Slot Length** Slot length of a slot including gaps ( 0 bits)  
 Value range: 8 to 256

No\_of\_Slots \* Slot\_Length <= 2048  
 Slot\_Length \* No\_of\_Slots \* Sample\_Freq <= 55.926 MHz

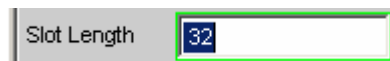

Remote control command:  
 OUTPUT:SLTLength <n>



**Audio Bits**

Slot length of the audio data within a slot (sub-frame).  
Unused data bits are coded as zeros in the digital audio signal.  
Value range: 8 to slot length (max 32)

A screenshot of a configuration window showing a label 'Audio Bits' followed by a text input field containing the number '32'. The input field is highlighted with a green border.

Remote control command:  
OUTPut:AUDiobits <n>

**Lead Bits**

Defines the offset of the audio bits within a slot relative to the start of the slot.

If LSB is selected as first bit the lead bits setting is automatically corrected if the audio bits setting is changed so that the MSB is transmitted in the same position. This has the advantage that the resolution of the signal transmitted is changed but not the amplitude if the audio bits are changed.

**Example:**

Channel Length: 32

Audio bits: 24 → 23 (setting changed by user)

Lead bits: 8 → 9 (automatic correction)

Value range: 0 to slot length - audio bits

A screenshot of a configuration window showing a label 'Lead Bits' followed by a text input field containing the number '0'. The input field is highlighted with a green border.

Remote control command:  
OUTPut:LBITS <n>

**Sample Freq**

Used to set the sample frequency.

All frequency specifications of the audio data transmitted refer to this setting. If the USI generator is operated with external synchronisation and the frequency of the external clock signal does not correspond to the set frequency of the Fsync signal, the generator generates signals with the wrong frequency.

The selected clock rate determines the maximum signal frequency which can be input. For sinus signals this is 49.9% of the sampling rate. For data formats with one sample per frame, the sample frequency corresponds to the FSync signal frequency. In the case of several audio data samples from one source within a frame, the frequency of the FSync signal results from the sample frequency divided by the samples/frame factor.

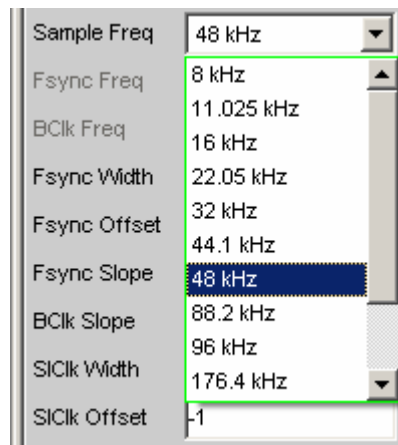

Value range for numeric input:

0.84375 kHz to 400 kHz

$\text{No\_of\_Slots} * \text{Slot\_Length} \leq 2048$

$\text{Slot\_Length} * \text{No\_of\_Slots} * \text{Sample\_Freq} \leq 55.926 \text{ MHz}$

Standard sampling frequencies can be set directly in the selection list.

**Auto**

Automatic setting of the sampling rate. The sampling rate is measured, set and displayed in the following line. The set value is automatically updated if the existing sampling rates changes. This setting is only available with external synchronisation.

**Note:**

*The digital generator must be re-initialized with every new sampling frequency. If an external clock with a large jitter is fed in a fixed frequency should be selected instead of the Auto setting.*

Remote control command:  
 OUTPut:SAMPlE:MODE AUTO

<b>8 kHz</b>	8 kHz standard sampling frequency  Remote control command: OUTPut:SAMPlE:MODE F08
<b>11,025 kHz</b>	11.025 kHz standard sampling frequency  Remote control command: OUTPut:SAMPlE:MODE F11
<b>16 kHz</b>	16 kHz standard sampling frequency  Remote control command: OUTPut:SAMPlE:MODE F16
<b>22,05 kHz</b>	22.05 kHz standard sampling frequency  Remote control command: OUTPut:SAMPlE:MODE F22
<b>32 kHz</b>	32 kHz standard sampling frequency  Remote control command: OUTPut:SAMPlE:MODE F32
<b>44,1 kHz</b>	44.1 kHz standard sampling frequency  Remote control command: OUTPut:SAMPlE:MODE F44
<b>48 kHz</b>	48 kHz standard sampling frequency  Remote control command: OUTPut:SAMPlE:MODE F48
<b>88,2 kHz</b>	88.2 kHz standard sampling frequency  Remote control command: OUTPut:SAMPlE:MODE F88
<b>96 kHz</b>	96 kHz standard sampling frequency  Remote control command: OUTPut:SAMPlE:MODE F96
<b>176,4 kHz</b>	176.4 kHz standard sampling frequency  Remote control command: OUTPut:SAMPlE:MODE F176
<b>192 kHz</b>	192 kHz standard sampling frequency  Remote control command: OUTPut:SAMPlE:MODE F192
<b>384 kHz</b>	384 kHz standard sampling frequency  Remote control command: OUTPut:SAMPlE:MODE F384

**Value** Numeric input of the sampling frequency



Remote control command:  
 OUTPut:SAMPlE:MODE VALue  
 OUTPut:SAMPlE:FREQuency <nu>

### Fsync Freq

Is only displayed for multi-sampling formats. The Frame Sync frequency corresponds to the sampling frequency divided by the samples/frame factor.

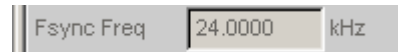

Remote control command:  
 OUTPut:FSYnc:FREQuency?

### Bclk Freq

Displays the bit clock frequency. Is calculated from the product of channel length \* no of slots \* sample freq / samples/frame.

Value range: 6.75 kHz ... 55.296 MHz

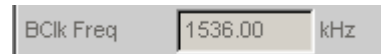

Remote control command:  
 OUTPut:BCLk:FREQuency?

### Fsync Width

Width of the FSYNC pulse

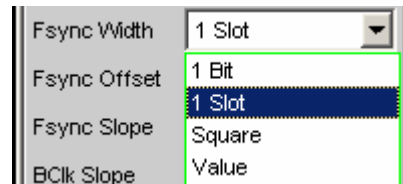

**1 bit** The FSYNC pulse is one data bit in length (BCLK period)

Remote control command:  
 OUTPut:FWIDth ONEBit

**1 slot** The FSYNC pulse is the length of an audio channel (= slot length)

Remote control command:  
 OUTPut:FWIDth ONESlot

**Square** The FSYNC pulse has the shape of a symmetrical rectangle. If the number of the slot's bit clock (BClk) cycles is odd the high phase is one cycle longer than the low phase (if Fsync slope = rising)

Remote control command:  
 OUTPut:FWIDth SQUare

**Value** The length of the FSYNC pulse corresponds to the numeric value in data bits (BClk periods).

Value range: 1 to (slot length\*no of slots)-1

Remote control command:  
 OUTPut:FWIDth VALue  
 OUTPut:FWIDth:VALue <n>

**Fsync Offset**

Determines the offset of the Fsync pulse relative to the reference point (start of the first slot)  
 Value range: -slot length\*(no of slots)...+slot length\*(no of slots)-1

A screenshot of a control panel with a label 'Fsync Offset' and a text input field containing the number '1'. The input field is highlighted with a green border.

Remote control command:  
 OUTPut:FOFFset <n>

**Fsync Slope**

Polarity of the Fsync pulse

A screenshot of a control panel with a label 'Fsync Slope' and two radio button options: 'Rising' (which is selected) and 'Falling'.

**Rising** The Fsync pulse begins with a positive edge.

Remote control command:  
 OUTPut:FSLope RISing

**Falling** The Fsync pulse begins with a negative edge.

Remote control command:  
 OUTPut:FSLope FALLing

**BClk Slope**

Bit clock polarity (BClk)

A screenshot of a control panel with a label 'BClk Slope' and two radio button options: 'Rising' (which is selected) and 'Falling'.

**Rising** The TX\_FSYNC\_OUT, TX\_SLCLK\_OUT, TX\_DATA1, TX\_DATA2, TX\_DATA3 and TX\_DATA4 signals are sampled with a rising bit clock edge (relative to TX\_BCLK\_IN in slave mode or TX\_BCLK\_OUT in master operation and with internal synchronisation). In case of external synchronisation the TX\_FSYNC\_IN signal is always sampled with the reverse bit clock edge (TX\_BCLK\_IN). In this case with the **falling** edge of the external bit clock signal.

```
Remote control command:
OUTPut:BSlope RISING
```

**Falling** The TX\_FSYNC\_OUT, TX\_SLCLK\_OUT, TX\_DATA1, TX\_DATA2, TX\_DATA3 and TX\_DATA4 signals are sampled with a falling bit clock edge (relative to TX\_BCLK\_IN in slave mode or TX\_BCLK\_OUT in master operation and with internal synchronisation). In case of external synchronisation, the TX\_FSYNC\_IN signal is always with the reverse bit clock edge (TX\_BCLK\_IN). In this case with the **rising** edge of the external bit clock signal.

```
Remote control command:
OUTPut:BSlope FALLING
```

## SIClk Width

Slot clock pulse (SIClk) width

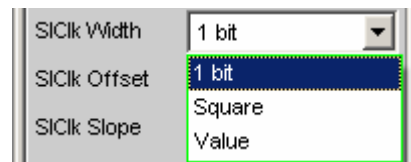

**1 bit** The SIClk pulse is one data bit in length (BCLK period).

```
Remote control command:
OUTPut:SLCWidth ONEBit
```

**Square** The SIClk pulse has the shape of a symmetrical rectangle. If the number of the slot's bit clock (BCLK) cycles is odd the high phase is one cycle longer than the low phase (with SIClk slope = rising).

```
Remote control command:
OUTPut:SLCWidth SQUARE
```

**Value** The length of the SIClk pulse corresponds to the numeric value in data bits (BCLK periods).

Value range: 1 to slot length -1

```
Remote control command:
OUTPut:SLCWidth VALUE
OUTPut:SLCWidth:VALUE <n>
```

**SIClk Offset**

Determines the slot clock (SIClk) offset relative to the start of the slot.  
Value range: -slot length ... + slot length-1

A screenshot of a control element for 'SIClk Offset'. It consists of a label 'SIClk Offset' followed by a text input field containing the value '-1'. The input field has a green border and a blue selection bar on the left.

Remote control command:  
OUTPut:SLCOffset <n>

**SIClk Slope**

Slot clock (SIClk) pulse polarity.

A screenshot of a control element for 'SIClk Slope'. It consists of a label 'SIClk Slope' followed by two radio button options: 'Rising' (which is selected) and 'Falling'.

**Rising**            The SIClk pulse begins with a positive edge.

Remote control command:  
OUTPut:SLCSlope RISING

**Falling**            The SIClk pulse begins with a negative edge.

Remote control command:  
OUTPut:SLCSlope FALLING

**MClk Ratio**

Relationship between the master clock (MCLK) and the FrameSync (FSYNC).

Value range: 16 to 768

$MClk\_Ratio * Sample\_Freq \leq 110,592 \text{ MHz}$

A screenshot of a control element for 'MClk Ratio'. It consists of a label 'MClk Ratio' followed by a text input field containing the value '16'. The input field has a green border and a blue selection bar on the left.

Remote control command:  
OUTPut:MRATio <n>

**BClk Jitt Freq**

The generator output signals (TX\_BCLK\_OUT, TX\_FSYNC\_OUT, TX\_SLCLK\_OUT, TX\_DATA1 to 4) can be jittered sinusoidally. The jitter oscillator frequency is set with this parameter.

Value range: 100 mHz to 110 MHz max (depending on the amplitude set).

A screenshot of a control element for 'BClk Jitt Freq'. It consists of a label 'BClk Jitt Freq' followed by a text input field containing the value '1000.00' and the unit 'Hz'.

Remote control command:  
OUTPut:BCLock:JITFrequency <nu>

**BCLK Jitt Ampl**

The generator output signals (TX\_BCLK\_OUT, TX\_FSYNC\_OUT, TX\_SLCLK\_OUT, TX\_DATA1 to 4) can be jittered sinusoidally. This parameter determines the jitter oscillator's peak amplitude. Value range: 0 to 2.5 UI max (depending on the frequency set). One UI corresponds to the bit clock (BCLK) cycle period.

A screenshot of a control panel for 'BCLK Jitt Ampl'. It features a text label 'BCLK Jitt Ampl', a numeric input field containing '0.00000', and a unit selector dropdown menu set to 'UI'.

Remote control command:  
 OUTPut:BClock:JITAmplitude <nu>

**MCLK Jitt Freq**

The TX\_MCLK\_OUT generator signal can be jittered sinusoidally. The jitter oscillator frequency is set with this parameter. Value range: 100 mHz to 110 MHz max (depending on the amplitude set).

A screenshot of a control panel for 'MCLK Jitt Freq'. It features a text label 'MCLK Jitt Freq', a numeric input field containing '1000.00', and a unit selector dropdown menu set to 'Hz'.

Remote control command:  
 OUTPut:MClock:JITFrequency <nu>

**MCLK Jitt Ampl**

The TX\_MCLK\_OUT generator signal can be jittered sinusoidally. This parameter determines the jitter oscillator peak amplitude. Value range: 0 to 2.5 UI max (depending on the set frequency). One UI corresponds to the master clock (MCLK) cycle period.

A screenshot of a control panel for 'MCLK Jitt Ampl'. It features a text label 'MCLK Jitt Ampl', a numeric input field containing '0.00000', and a unit selector dropdown menu set to 'UI'.

Remote control command:  
 OUTPut:MClock:JITAmplitude <nu>

**Logic Voltage**

Used to set the generator logic voltage. Changing the voltage level causes the probe to be reloaded. The probe can be attached and disconnected and put back into operation during operation with this mechanism.

A screenshot of a dropdown menu for 'Logic Voltage'. The menu is open, showing a list of voltage options: 0.9 Volt, 1.2 Volt, 1.5 Volt, 1.8 Volt, 2.5 Volt, and 3.3 Volt. The '3.3 Volt' option is currently selected and highlighted in blue.

**0.9 Volt**

0.9 volts CMOS logic voltage

Remote control command:  
 OUTPut:LOGVoltage MV0900



- 1.2 Volt**      1.2 volts CMOS logic voltage  
  
Remote control command:  
OUTPut:LOGVoltage MV1200
- 1.8 Volt**      1.8 volts CMOS logic voltage  
  
Remote control command:  
OUTPut:LOGVoltage MV1800
- 2.5 Volt**      2.5 volts CMOS logic voltage  
  
Remote control command:  
OUTPut:LOGVoltage MV2500
- 3.3 Volt**      3.3 volts LVTTTL logic cvoltage  
  
Remote control command:  
OUTPut:LOGVoltage MV3300

**Coding**

Generator data coding regulation. A Law and  $\mu$  Law quantification characteristics are available for telephony applications.

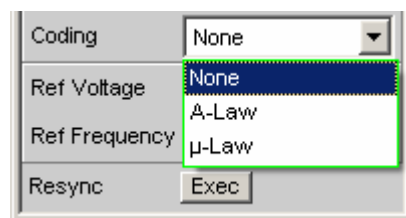

- None**      Generator data is analyzed linearly PCM coded.  
  
Remote control command:  
OUTPut:CODing NONE
- A-Law**      Generator data is quantified in accordance with A Law.  
  
Remote control command:  
OUTPut:CODing ALAW
- $\mu$ -Law**      Generator data is quantified in accordance with  $\mu$  Law.  
  
Remote control command:  
OUTPut:CODing ULAW

**Ref Voltage**

Reference value for the relative amplitude units. If this reference value is changed, all reference value-related amplitude settings are also changed.

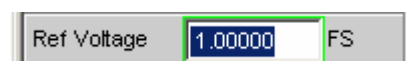

Remote control command:  
SOURce:VOLTage:REFerence <nu>

**Ref Frequency**

Reference value for the relative frequency units.  
If the reference frequency is changed, all reference value-related frequency settings are also changed.



Remote control command:  
SOURce:FREQuency:REFerence <nu>

**Resync**

Using this function triggers renewed synchronisation of the generator. If this is synchronised externally, this function must be called once after applying the external clock signal

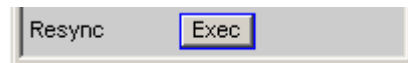

Remote control command:  
OUTPut:RESYnc ONCE

## Meaning of the TX\_DATA 1 to TX\_DATA 4 setting line strings

### Setting strings for standard formats with one sample per frame:

If the generator is configured with the following setting lines, each slot within a frame contains the same sample of the selected signal source. The exemplary format visualised below corresponds to current converter formats.

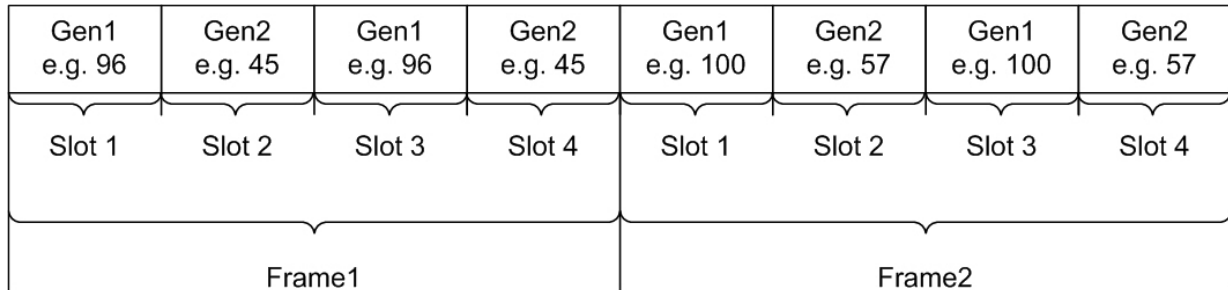

In the TX\_DATA1 to 4 setting lines the “Generator1”, “Generator2”, “Null” and “Tristate” signal sources can be separately assigned to the maximum 256 slots of any single data line.

### Syntax:

<Source>:<Target>.<Target>.<Source>:<Target>.<Target>.<Target>.<Target> etc.

### Signal sources:

**Gen1** = keyword for generator 1

**Zero** = zeros are output

**Gen2** = keyword for generator 2

**Tri** = output is switched to high impedance

### The following targets are available:

**n** = slot n (mit n=1...256)

**all** = all slots

**x-y** = slot x to slot y

**even/odd** = all even/odd slots

The individual target slots are separated from one another by dots (.). They can be both separately addressed (e.g. 1. 2. 3.), specified as a slot range (e.g. 4-15) or addressed via the pre-defined “all”, “even” or “odd” group designations. All undefined target slots are set to signal source zero by default.

Spaces are ignored by the software, even if they occur within keywords. The assignment commands can be written in any combination of capital and small letters. The setting string for any given data line is analyzed from left to right so that commands situated further to the right overwrite previous settings.

The combination of the “Tri:ext” keywords can occur at any position in the string and transfers the tristate control to the externally supplied TX\_OE signal; this has a higher priority than the OE control which can be set internally with the “Tri:<target>” command line.

The following applies for external OE control activated by “Tri:ext”:

TX\_OE = “1”

The generator behaves as defined in the string

TX\_OE = “0”

The generator switches the data line to tristate for the duration of the low level, regardless of the content of the command string.

The external TX\_OE does not function combinatively but must be applied one cycle before the start of the slot or the desired action time. The signal is transferred with the same BCk edge with which the date is output. The following diagram shows how the external Output Enable signal works.

Parameters:  
 Sync to: Internal Clock  
 No of Slots: 2  
 Slot Length: 10  
 Audiobits: 8  
 TX\_DATA: Gen1:1.2.tri:2  
 Bitclk Slope: Falling

Fsync Offset: 0  
 Fsync Wdith. Square or 10  
 Fsync Slope: Falling  
 SIClk Wdith: 1bit or 1  
 SIClk Offset: 0  
 SIClk Slope: Rising  
 Lead Bits 0  
 Bit Order: MSB first

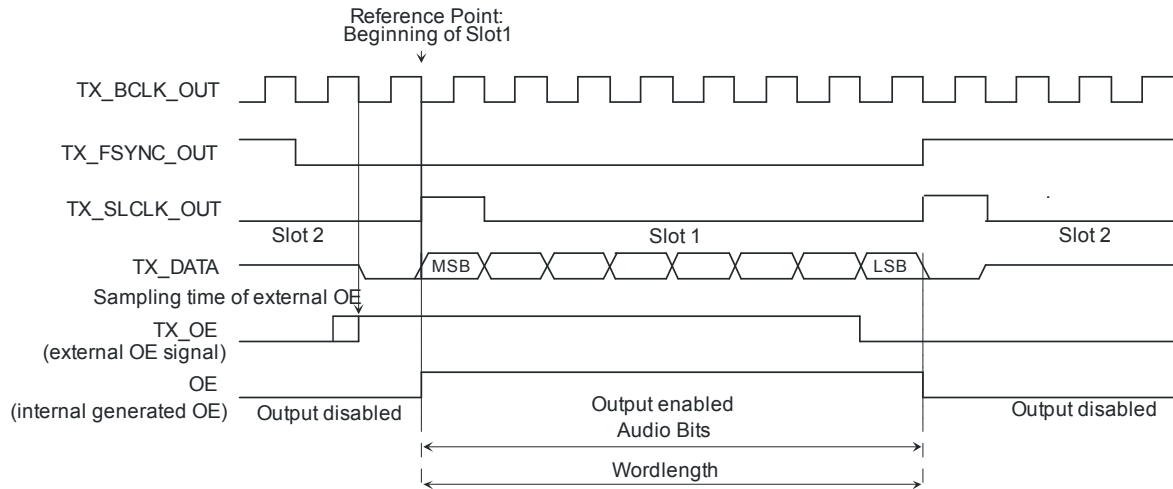

**Examples for common setting strings:**

**gen1:even.1.3.5.Tri:ext**

All even slot numbers and also slots 1, 3 and 5 contain the audio signal generated in generator 1. The external tristate control is also switched on.

**tri:all.gen1:1.3.6.gen2:3.4-6**

Slot 1 transmits the audio signal generated in generator 1 whilst slots 3, 4, 5 and 6 contain the second generator's signal. All other slots are switched to tristate.

**Setting strings for multi-sample formats with several samples per frame:**

If the generator is configured with the following setting strings any sample from the selected signal source can be assigned to any slot within a frame; these can even be placed in any arbitrary order. This freedom of selection is intended for specific proprietary formats and permits all imaginable combinations. The following shows a format with two samples per frame which can be placed in any slot.

Gen1 S1 e.g. 96	Gen2 S2 e.g. 51	Gen1 S2 e.g. 98	Gen2 S1 e.g. 45	Gen1 S1 e.g. 100	Gen2 S2 e.g. 63	Gen1 S2 e.g. 102	Gen2 S1 e.g. 57
Slot 1	Slot 2	Slot 3	Slot 4	Slot 1	Slot 2	Slot 3	Slot 4
Frame1				Frame2			

The individual samples from the “Generator1”, “Generator2”, “Null” und “Tristate” signal sources can be arbitrarily assigned to the maximum 256 slots of each data line in the TX\_DATA1 - 4 setting lines. The transmission sequence of the individual samples is not important. Care must just be taken that the product of the number of signal sources (e.g. Gen1 and Gen2 = 2 signal sources) and the number of samples per frame remains smaller or equal to the the number of slots. With three samples per frame and the use of both generator slots there must be at least six slots.

**Syntax:**

<source>-<sample number>:<target>.<target>.<source>-<sample number>:<target>.<target>.<target>.  
etc.

**Signal source:**

**Gen1** = keyword for generator 1  
**Zero** = zeros are output

**Gen2** = keyword for generator 2  
**Tri** = output is switched to high impedance

**The following targets are available:**

**n** = slot n (with n=1 to 256)  
**all** = all slots

**x-y** = slot x to slot y  
**even/odd** = all even /odd slots

The individual target slots are separated by points (.). They can be addressed separately (e.g. **1. 2. 3.**), specified as a range (e.g. **4-15**) or addressed with the pre-defined “**all**”, “**even**” or “**odd**” group designations. Every undefined target slot is assigned signal source zero by default.

Spaces are ignored by the software, even if they occur within keywords. The assignment commands can be written in any combination of capital and small letters.

The setting string for any given data line is analyzed from left to right so that commands situated further to the right overwrite previous settings.

The combination of the “Tri:ext” keywords can occur at any position in the string and transfers the tristate control to the externally supplied TX\_OE signal which has a higher priority than the OE control which can be set internally with the “Tri:<target>” command line.

The following applies for external OE control activated by “**Tri:ext**”:

**TX\_OE = “1”**

The generator behaves as defined in the string

**TX\_OE = “0”**

The generator switches the data line to tristate for the duration of the low level, regardless of the content of the command string.

The external TX\_OE does not function combinatively but must be applied one cycle before the start of the slot or the desired action time. The signal is transferred with the same BClk edge with which the data is output. The following diagram shows how the external Output Enable signal works.

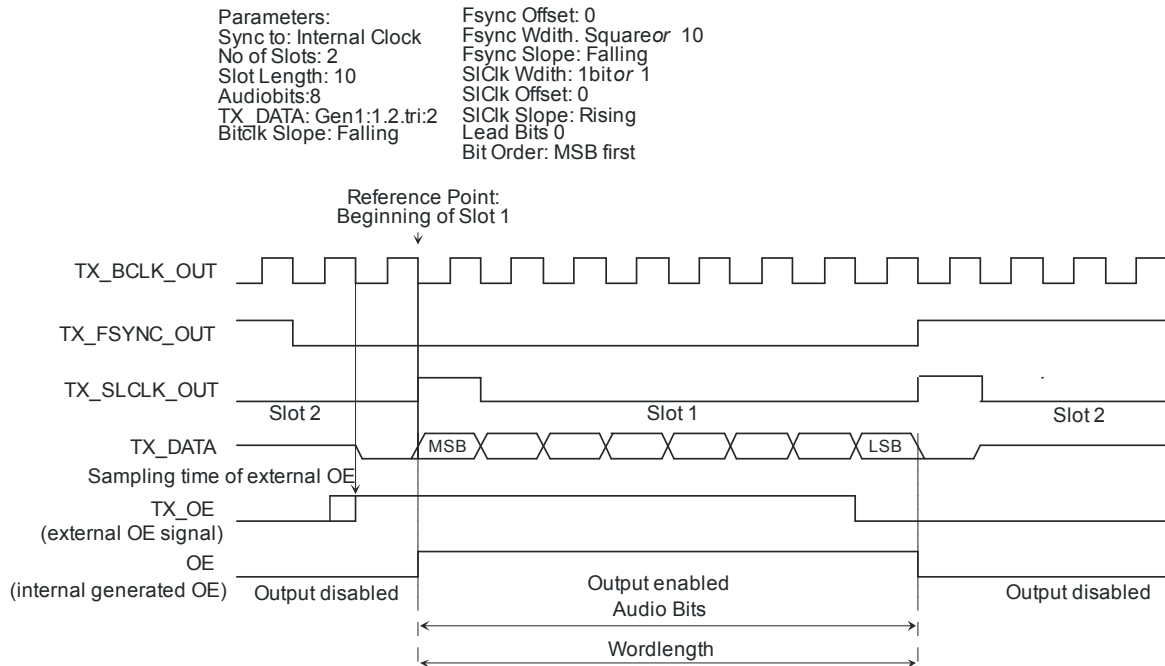

**Examples of settings strings:**

**Tri:all.gen1-1:1.gen1-2:3.gen2-1:4.gen2-2:2**

The samples from generator 1 are transmitted consecutively in slots 1 and 3, whilst the samples from generator 2 are located in reverse order in slots 2 and 4.

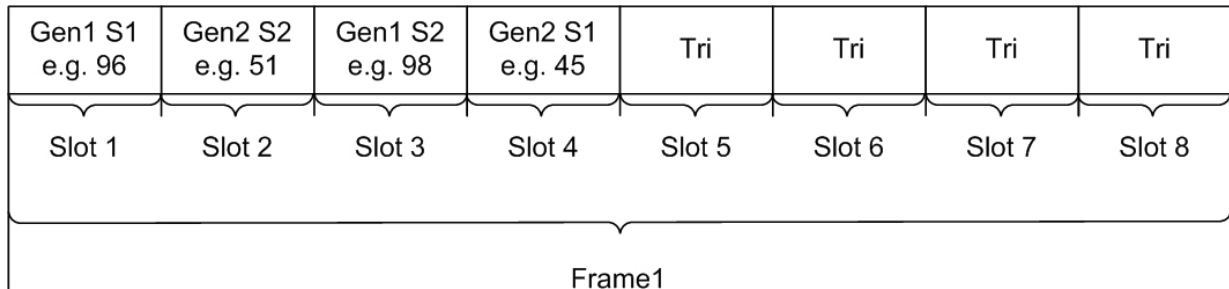

## Timing Diagrams

Parameters: Sync to: Internal Clock No of Slots: 2 Slot Length: 10 Audiobits:8 TX\_DATA: Gen1:1.2.tri:2 BClk Slope: Falling Fsync Offset: -1 Fsync Wdith. Squareor: 10 Fsync Slope: Falling SClk Wdith: 1bitor 1 SClk Offset: 1 SClk Slope: Rising Lead Bits 1 Bit Order: MSB first

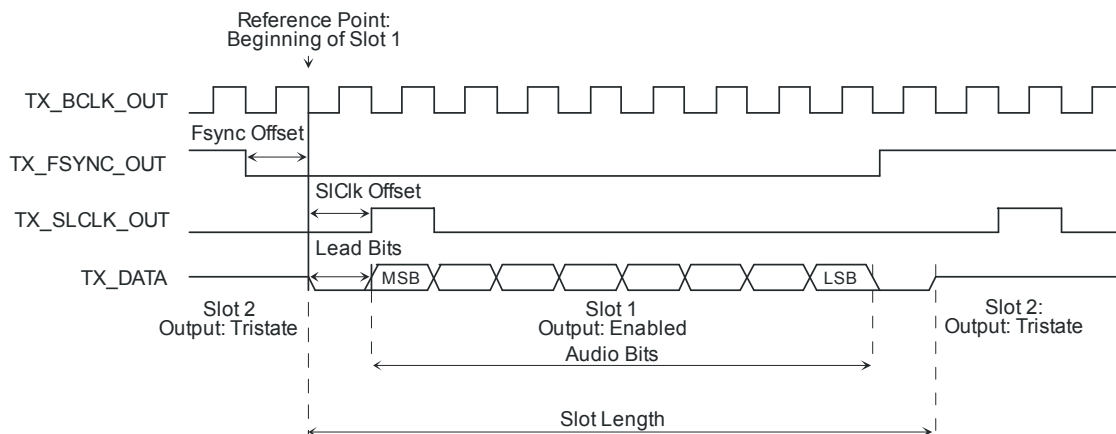

Parameters: Sync to: Internal Clock No of Slots: 2 Slot Length: 10 Audiobits:8 TX\_DATA: Gen1:1.2 BClk Slope: Falling Fsync Offset: 2 Fsync Wdith. 1 bitor 1 Fsync Slope: Falling SClk Wdith: 8 SClk Offset: 1 SClk Slope: Rising Lead Bits 1 Bit Order: LSB first

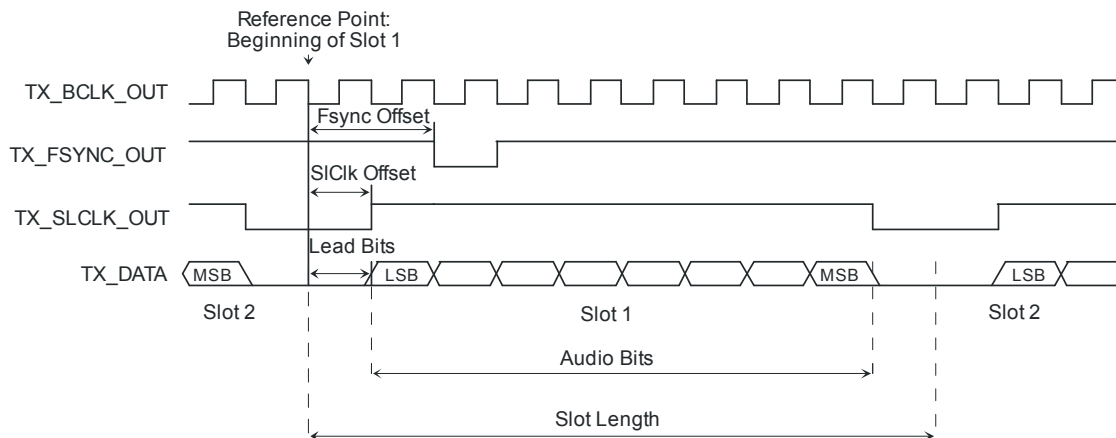

Parameters:  
 No of Slots: 2  
 Slot Length: 32  
 Audiobits: 32  
 TX\_DATA: Gen1:1.Gen2:2  
 Fsync Offset: -1  
 Fsync Width: Square or 32  
 Fsync Slope: Falling  
 SIClk Width: Square or 16  
 SIClk Offset: 1  
 SIClk Slope: Rising  
 Lead Bits: 0  
 Bit Order: MSB first

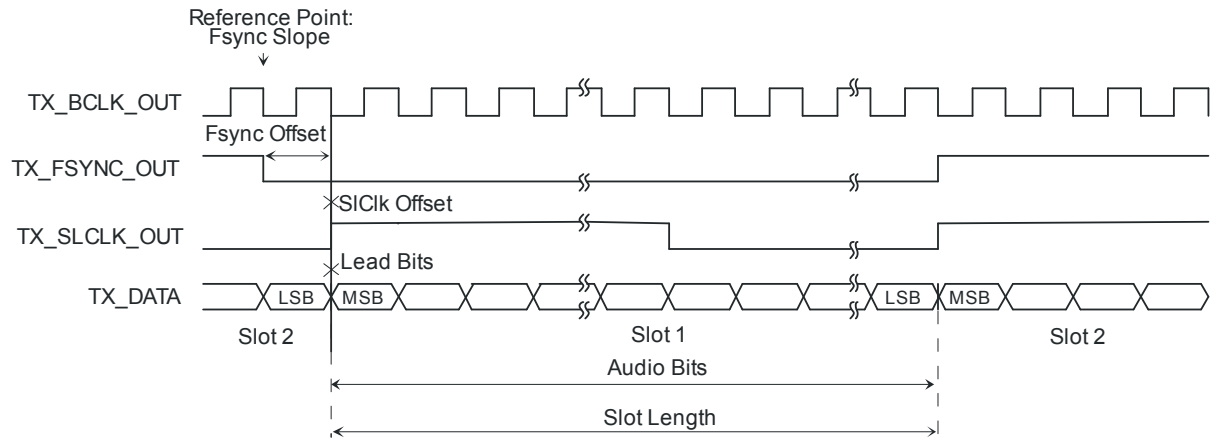

## Interface assignment

Pin	Signal	(I)input (O)output	Signal description	Pin	Signal	(I)input (O)output	Signal description
1	TX_MCLK_OUT	A	Master clock output generator	14	GND		Ground connection
2	GND		Ground connection	15	TX_DATA1	A	Serial Data 1 generator
3	TX_MCLK_IN	E	Master clock input generator	16	GND		Ground connection
4	GND		Ground connection	17	TX_DATA2	A	Serial Data 2 generator
5	TX_BCLK_OUT	A	Serial clock output generator	18	GND		Ground connection
6	GND		Ground connection	19	TX_DATA3	A	Serial Data 3 generator
7	TX_BCLK_IN	E	Serial clock generator	20	GND		Ground connection
8	GND		Ground connection	21	TX_DATA4	A	Serial Data 4 generator
9	TX_FSYNC_OUT	A	Frame Sync output generator	22	GND		Ground connection
10	GND		Ground connection	23	TX_OE	E	Output enable generator
11	TX_FSYNC_IN	E	Frame Sync input generator	24	TX_RESERVED1		Reserved for future expansion
12	GND		Ground connection	25	TX_RESERVED2		Reserved for future expansion
13	TX_SLCLK_OUT	A	Channel clock output generator	26	TX_RESERVED3		Reserved for future expansion



**CLK IN (BNC connector)**

Connection	Signal	Input (I) output (O)	Signal description
	CLK_IN	E	Reserved for future expansion

**CLK OUT (BNC connector)**

Connection	Signal	Input (I) output (O)	Signal description
	CLK_OUT	A	Reserved for future expansion

**Probe Generator/Analyzer Layout:**

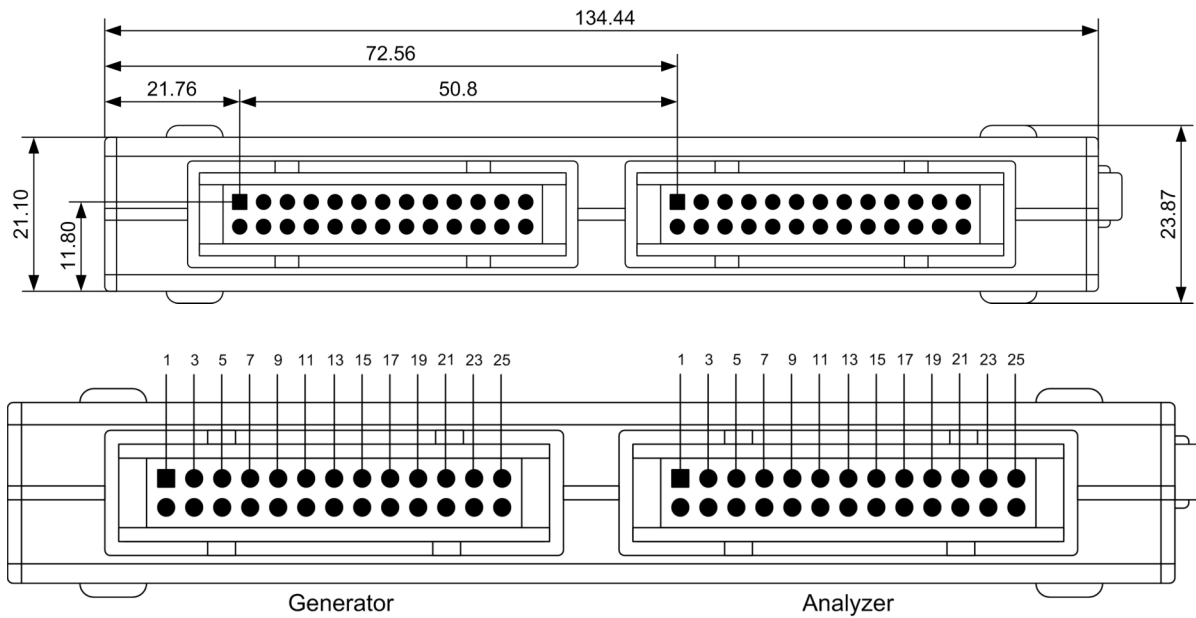

**Recommended PCB Male Plug:**

TYCO AMP LATCH 2-827745-6

## Generator Signals

The section "Generator Signals" describes the setting parameters for all signals which can be generated at the analog or digital outputs. The signals are selected using the "Function" selection field in the "Generator Function" panel. The selected function determines which parameter fields are available in the panel.

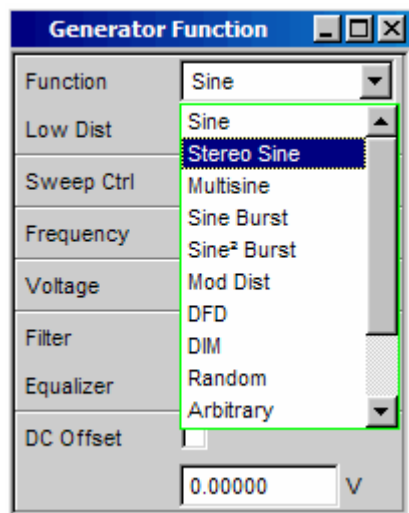

The panels for the analog and digital generator are almost identical; the settings are therefore described together. Any differences are indicated.

### Sine

The generator generates a sinewave signal. Frequency and level are the same for both channels.

Remote-control command:  
`SOURce:FUNCTION[:SHAPE] SINusoid`

### Low Dist

In the analog generator, the very low-noise and low-distortion generator (R&S UPV-B1 option) can be used to generate a sinewave signal instead of the universal generator. The maximum frequency is 185 kHz, irrespective of the bandwidth set in the "Generator Config" panel.

This parameter field does not appear in the digital generator.

ON

Low Dist

The low-distortion generator is activated.  
A DC Offset is not possible; the parameter field is displayed in grey and cannot be accessed.

DC Offset

No filters can be used; the parameter field is hidden.

**Note:**

*When the low distortion generator is active, "Gen Track" measurement modes and times should be avoided in the analyzer, because the frequency setting is not quartz accurate and thus inaccurate measurement results can be expected.*

Remote-control command:  
SOURce:LOWDistortion ON

OFF

Low Dist

The low distortion generator is deactivated. The frequency setting is quartz accurate and limited to 80 kHz as a function of bandwidth.

Remote-control command:  
SOURce:LOWDistortion OFF

**Dither**

In the digital generator, a noise component with adjustable amplitude can be superimposed on the signal. The tick box is used to activate/deactivate this function. The distribution function for amplitude can be selected in the "PDF" parameter field.

The parameter fields for Dither and PDF do not appear in the analog generator.

Remote-control commands:  
SOURce:SINusoid:DITHer:STATe ON | OFF  
SOURce:SINusoid:DITHer <nu>  
SOURce:RANDom:PDF GAUSSian | TRIangle | RECTangle

**Sweep Ctrl**

Used to activate the sweep system. The frequency or level of the signal can be varied within a selectable range from the start to the stop value. If frequency or level is selected as the X-axis, the measurement values can be displayed as a curve in the Sweep Graph graphical window.

Sweep points: Linear or logarithmic between start and stop or read from a file.

Stepping: Automatic in a defined time grid or synchronized to the measurement time of the analyzer. Manual using the rotary knob. All the setting parameters of the sweep system are described in the section "Sweeps" on page 4.119.

**Frequency**

Used to set the frequency of the sinewave. The value range depends on the analog bandwidth set in the Generator Config panel or the digital clock rate. Digital generator sinus signals can be produced up to 49.9% of the sampling rate.

**Note:**

*If "Gen Track" is selected as the measurement time in the analyzer, the measurement time and generator frequency are synchronized to each other so that the signal periods recorded in the measurement time contain a whole number of samples. If necessary the generator frequency is modified slightly to allow this to happen.*

Remote-control command:  
SOURce:FREQuency[1] <nu>

**Voltage**

Used to set the level of the sinewave. The maximum value depends on the set DC offset. In the analog generator, the maximum total voltage also depends on the settings for Output Type and Max Voltage in the Generator Config panel.

Remote-control command:  
SOURce:VOLTage[1] <nu>

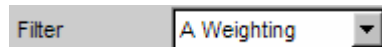
**Filter**

The generator signal is filtered in the time domain. One of the user-definable filters in the filter panel or a weighting filter can be selected. It is not possible to use a filter if the low-distortion oscillator is activated.

See also the section "Generator Filters" on page 4.112.

Remote-control command:  
SOURce:FILTer <parameter>

List of <parameter> see section "Filter Table" on page 4.419.

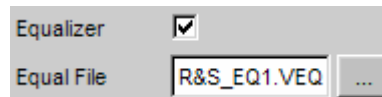
**Equalizer**

The generator signal is precorrected in the frequency domain using the file selected in the "Equal File" parameter field. The tick box is used to activate/deactivate this function.

The  button opens a browser which can be used to select the precorrector file, see also the section "Equalization" on page 4.111.

Remote-control commands:

```
SOURce:VOLTage:EQUalize:STATe ON | OFF
MMEMory:LOAD:OEQualize 'filename'
```

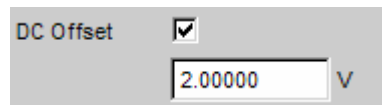
**DC Offset**

A DC offset is superimposed on the generator signal. This offset reduces the maximum possible AC voltage. The tick box is used to activate/deactivate this function. The value set for the offset voltage is always displayed.

If the low-distortion generator is activated, no DC offset is possible; the parameter field is displayed in grey and cannot be accessed.

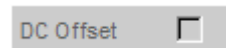

Remote-control commands:

```
SOURce:VOLTage:OFFSet:STATe ON | OFF
SOURce:VOLTage:OFFSet <nu>
```

**Stereo Sine**

The generator generates a sinewave signal on both channels. The frequency, level and phase can be set freely and separately for Channel 1 and 2. In the analog generator, the R&S UPV-B3 option is required for this function.

Remote-control command:

```
SOURce:FUNCTion[:SHAPE] STEReo
```

**Dither**

Dither

0.00010 FS

PDF Triangle

Freq Mode Gauss  
Triangle  
Rectangle

Volt Mode

In the digital generator, a noise component with adjustable amplitude can be superimposed on the signal. The tick box is used to activate/deactivate this function. The distribution function for amplitude can be selected in the "PDF" parameter field. The Dither setting is the same for both channels.

The parameter fields for Dither and PDF do not appear in the analog generator.

Remote-control commands:

```
SOURce:SINusoid:DITHer:STATe ON | OFF
```

```
SOURce:SINusoid:DITHer <nu>
```

```
SOURce:RANDom:PDF GAUSSsian | TRIangle | RECTangle
```

**Freq Mode**

Determines the frequency and phase setting for Channel 1 and 2. The value range for frequency depends on the analog bandwidth set in the Generator Config panel or the digital clock rate.

**F&Ph**

Channel 1 and 2 have the same frequency but the phase between the two channels can be selected. With the frequency sweep, the phase between the two channels remains constant.

Remote-control command:

```
SOURce:FREQuency:SElect FQPH
```

**Ch1&2**

The frequency can be entered separately for Channel 1 and 2. There is no fixed phase relationship between the channels. With the frequency sweep, the frequency of Channel 1 is swept but Channel 2 remains unchanged.

**Note:**

*If "Gen Track" is selected as the measurement time in the analyzer, measurement channel 1 tracks the frequency of generator channel 1 and measurement channel 2 tracks the frequency of generator channel 2.*

Remote-control command:

```
SOURce:FREQuency:SElect FQFQ
```

**Volt Mode**

Determines the level setting for Channel 1 and 2. The maximum value depends on the set DC offset. In the analog generator, the maximum total voltage also depends on the settings for "Output Type" and "Max Voltage" in the Generator Config panel.

**Ch2/1** The levels of Channel 1 and 2 have a fixed ratio relative to each other.  
With the level sweep, this ratio remains constant.

Remote-control command:  
SOURce:VOLTage:SElect VLRT

**Ch1&2** The level can be set separately for Channel 1 and 2.  
With the level sweep, the level of Channel 1 is swept but Channel 2 remains unchanged.

Remote-control command:  
SOURce:VOLTage:SElect VLVL

### Sweep Ctrl

Used to activate the sweep system. The frequency, phase or level of the signal can be varied within a selectable range from the start to the stop value. The *Freq Mode* and *Volt Mode* settings determine how frequencies and levels are changed during the sweep.

If frequency, phase or level is selected as the X-axis, the measurement values can be displayed as a curve in the Sweep Graph graphical window.

Sweep points: Linear or logarithmic between start and stop or read from a file.

Stepping: Automatic in a defined time grid or synchronized to the measurement time of the analyzer. Manual using the rotary knob. All the setting parameters of the sweep system are described in the section "Sweeps" on page 4.119.

### Frequency

The frequency is identical for both channels (Freq Mode F&Ph).

---

**Note:**

*If "Gen Track" is selected as the measurement time in the analyzer, the measurement time and generator frequency are synchronized to each other so that the signal periods recorded in the measurement time contain a whole number of samples. If necessary the generator frequency is modified slightly to allow this to happen.*

---

Remote-control command:  
SOURce:FREQuency[1] <nu>

### Freq Ch1

Frequency of Channel 1 (Freq Mode Ch1&2).

---

**Note:**

*If "Gen Track" is selected as the measurement time in the analyzer, measurement channel 1 tracks the frequency of generator channel 1. If necessary the generator frequency is modified slightly so that the signal periods recorded in the measurement time contain a whole number of samples.*

---

Remote-control command:  
SOURce:FREQuency[1] <nu>

<b>Volt Ch1</b>	<p>Level of Channel 1.</p> <p>Remote-control command: SOURce:VOLTage[1] &lt;nu&gt;</p>
<b>Phase Ch2/1</b>	<p>Phase of Channel 2 relative to Channel 1 (Freq Mode F&amp;Ph).</p> <p>Remote-control command: SOURce:PHASe &lt;nu&gt;</p>
<b>Freq Ch2</b>	<p>Frequency of Channel 2 (Freq Mode Ch1&amp;2).</p> <hr/> <p><b>Note:</b> <i>If "Gen Track" is selected as the measurement time in the analyzer, measurement channel 2 tracks the frequency of generator channel 2. If necessary the generator frequency is modified slightly so that the signal periods recorded in the measurement time contain a whole number of samples.</i></p> <hr/> <p>Remote-control command: SOURce:FREQuency:CH2Stereo &lt;nu&gt;</p>
<b>Volt Ch2</b>	<p>Level of Channel 2 (Volt Mode Ch1&amp;2).</p> <p>Remote-control command: SOURce:VOLTage:CH2Stereo &lt;nu&gt;</p>
<b>Volt Ch2/1</b>	<p>Ratio of the level of both channels relative to Channel 1 (Volt Mode Ch2/1).</p> <p>Remote-control command: SOURce:VOLTage:RATio &lt;n&gt;</p>
<b>Filter</b>	<div data-bbox="550 1202 933 1251" style="border: 1px solid gray; padding: 2px;"> <span style="background-color: #d3d3d3; padding: 2px;">Filter</span> <span style="border: 1px solid gray; padding: 2px; display: inline-block;">A Weighting ▼</span> </div> <p>The generator signal is filtered in the time domain. One of the user-definable filters in the filter panel or a weighting filter can be selected, see also the section "Generator Filters" on page 4.112.</p> <p>Remote-control command: SOURce:FILTer &lt;parameter&gt;</p> <p>List of &lt;parameter&gt; see section "Filter Table" on page 4.419.</p>

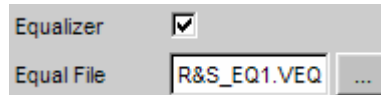

**Equalizer**

The generator signal is precorrected in the frequency domain using the file selected in the "Equal File" parameter field. The tick box is used to activate/deactivate this function. The precorrection is the same for both channels.

The  button opens a browser which can be used to select the precorrector file, see also the section "Equalization" on page 4.111.

Remote-control commands:  
 SOURce:VOLTage:EQualize:STATe ON | OFF  
 MMEMory:LOAD:OEQualize 'filename'

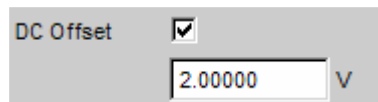
**DC Offset**

A DC offset is superimposed on the generator signal. This offset reduces the maximum possible AC voltage. The tick box is used to activate/deactivate this function. The value set for the offset voltage is always displayed. The DC voltage is the same for both channels.

Remote-control commands:  
 SOURce:VOLTage:OFFSet:STATe ON | OFF  
 SOURce:VOLTage:OFFSet <nu>

**Multisine**

The generator generates a multi-tone signal with up to 32 sinewave tones. The frequency, level and phase can be freely selected for each tone. However, it is also possible to optimize the phase so that the ratio of peak value to rms value is minimal, as is often required in the case of noise-like signals. Owing to the absence of associated windowing, linking the frequency spacing of the multi-sinewave to the resolution of the FFT allows extremely fast frequency response measurement.

Remote-control command:  
 SOURce:FUNCTion[:SHAPE] MULTisine

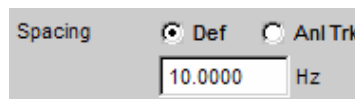
**Spacing**

Used to set the frequency spacing. The frequency of each sinewave line is an integer multiple of this frequency spacing.

**Def** The frequency spacing can be freely defined.  
 Minimum value: Sampling rate/262144

Remote-control command:  
 SOURce:RANDom:SPACing:MODE USERdefined  
 SOURce:RANDom:SPACing:FREQuency <nu>

<b>Anl Trk</b>	<p>The frequency spacing is adopted from the FFT set in the analyzer. This value depends on the sampling rate and the size of the FFT. This setting is only possible if an FFT or Post FFT is selected in the analyzer.</p> <p>The parameter field for entering values is then hidden.</p>
	<pre>Remote-control command: SOURCE:RANDOM:SPACING:MODE ATRack</pre>
<b>Voltage Mode</b>	<p>Used to select the entry mode for the voltages of the individual sinewave tones.</p>
<b>Equal</b>	<p>All sinewave lines have the same amplitude. It is entered in the "Volt No1" parameter field.</p>
	<pre>Remote-control command: SOURCE:FUNCTION:MODE EQUAlvoltage</pre>
<b>Define</b>	<p>A separate amplitude can be defined for each sinewave line.</p>
	<pre>Remote-control command: SOURCE:FUNCTION:MODE DEFInedvoltage</pre>
<b>Crest Factor</b>	<p>The peak value to rms value ratio (crest factor) of the signal can be influenced by the phase of the individual sinewave lines.</p>
<b>Optimized</b>	<p>The ratio of peak value to RMS of the signal is minimized.</p>
	<pre>Remote-control command: SOURCE:VOLTage:CREStfactor:MODE MINimized</pre>
<b>Define Phase</b>	<p>The start phase of each sinewave line can be defined.</p>
	<pre>Remote-control command: SOURCE:VOLTage:CREStfactor:MODE DPHase</pre>
<b>No of Sine</b>	<p>Used to set the number of sinewave tones of the multi-sinewave signal.</p>
	<pre>Remote-control command: SOURCE:MULTIsine:COUNT &lt;n&gt;</pre>
<b>Freq No i</b>	<p>Used to set the frequency of sinewave number i of the multi-sinewave signal.</p>
	<pre>Remote-control command: SOURCE:FREQuency&lt;i&gt; &lt;nu&gt;</pre>

**Phase No i** Used to set the start phase of sinewave number *i* of the multi-sinewave signal. This parameter field only appears if Define Phase is selected for Crest Factor.

Remote-control command:  
SOURce:PHASe<i> <nu>

**Volt No i** Used to set the voltage of sinewave number *i* of the multi-sinewave signal. The maximum value depends on the set DC offset. In the analog generator, the maximum total voltage also depends on the settings for *Output Type* and *Max Voltage* in the Generator Config panel.

Remote-control command:  
SOURce:VOLTage<i> <nu>

**Total Gain** Used to set a gain factor which can be used to vary the total level of the multi-sinewave signal. The maximum value depends on the set DC offset. In the analog generator, the maximum total voltage also depends on the settings for *Output Type* and *Max Voltage* in the Generator Config panel.

Remote-control command:  
SOURce:VOLTage:TOTal:GAIN <n> DB

**Total Peak** Indicates the peak value of the multi-sinewave signal.

Remote-control command:  
SOURce:VOLTage:TOTal?

**Total RMS** Indicates the RMS of the multi-sinewave signal (only in the analog generator).

Remote-control command:  
SOURce:VOLTage:RMS?

**Amplitude variation** The amplitude of the signal can be varied as sinewave or pulse shaped (burst) with a frequency selected by the user (see section "*Amplitude Variation*" on page 4.110).

**Filter**

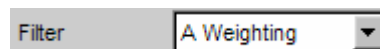

The generator signal is filtered in the time domain. One of the user-definable filters in the filter panel or a weighting filter can be selected, see also the section "*Generator Filters*" on page 4.112.

Remote-control command:  
SOURce:FILTer <parameter>

List of <parameter> see section "*Filter Table*" on page 4.419.

**Equalizer**



The generator signal is precorrected in the frequency domain using the file selected in the "Equal File" parameter field. The tick box is used to activate/deactivate this function.

The  button opens a browser which can be used to select the precorrector file, see also the section "Equalization" on page 4.111.

```
Remote-control command:
SOURCE:VOLTage:EQUalize:STATE ON | OFF
MMEMory:LOAD:OEQualize 'filename'
```

**DC Offset**

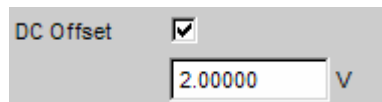

A DC offset is superimposed on the generator signal. This offset reduces the maximum possible AC voltage. The tick box is used to activate/deactivate this function. The value set for the offset voltage is always displayed.

```
Remote-control command:
SOURCE:VOLTage:OFFSet:STATE ON | OFF
SOURCE:VOLTage:OFFSet <nu>
```

**Sine Burst**

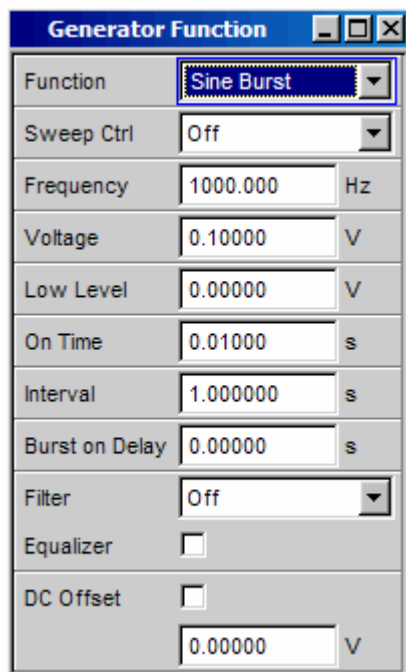

The generator generates a sinewave signal, the amplitude of which changes periodically between high level (Voltage) during the burst duration (On Time) and low level (Low Level) during the burst pause. The "Interval" parameter field is used to set the repetition rate of the burst. The following always applies: Burst pause = Burst period (Interval) – Burst duration (On Time). Low Level can be set as a fixed value or as a ratio relative to the burst level.

When generator settings have been changed or a measurement has been started, the burst starts with the positive sinusoidal half-wave of the burst duration (On Time). The "Burst On Delay" parameter is used to set a defined delay time.

```
Remote-control command:
SOURCE:FUNCTION[:SHAPE] BURSt
```

<b>Sweep Ctrl</b>	<p>Used to activate the sweep system. The frequency, level, ON-time and interval of the burst signal can be varied within a selectable range from the start to the stop value. If one of these parameters is selected as the X-axis, the measurement values can be displayed as a curve in the Sweep Graph graphical window.</p> <p>Sweep points: Linear or logarithmic between start and stop or read from a file.</p> <p>Stepping: Automatic in a defined time grid or synchronized to the measurement time of the analyzer. Manual using the rotary knob. All the setting parameters of the sweep system are described in the section "Sweeps" on page 4.119.</p>
<b>Frequency</b>	<p>Used to set the frequency of the sinewave. The value range depends on the analog bandwidth set in the Generator Config panel or the digital clock rate.</p> <p>Remote-control command: SOURce:FREQuency[1] &lt;nu&gt;</p>
<b>Voltage</b>	<p>Used to set the level of the sinewave during the burst duration. The maximum value depends on the set DC offset. In the analog generator, the maximum total voltage also depends on the settings for "Output Type" and "Max Voltage" in the Generator Config panel.</p> <p>Remote-control command: SOURce:VOLTage[1] &lt;nu&gt;</p>
<b>Low Level</b>	<p>Used to set the level of the sinewave during the burst pause. Low Level cannot be higher than the Voltage; if Voltage is reduced (also during a sweep), Low Level may also be reduced. Low Level can also be set as a fixed ratio relative to Voltage; the units %on, dBon and (in the analog generator only) V/on are available for this purpose.</p> <p>Remote-control command: SOURce:VOLTage:LOWLevel &lt;nu&gt;</p>
<b>On Time</b>	<p>Used to set the burst duration. Entered as a fixed time or as a number of periods (cycles) of the sinewave frequency. On Time is always less than Interval; if increased, Interval may also be increased.</p> <p>Minimum value: 1 sample Maximum value: 60 s – 1 sample</p> <p>Remote-control command: SOURce:ONTime &lt;nu&gt;</p>
<b>Interval</b>	<p>Used to set the repetition rate of the burst signal. Entered as a fixed time or as a number of periods (cycles) of the sinewave frequency. Interval is always greater than or equal to On Time.</p> <p>Minimum value: On Time Maximum value: 60 min</p> <p>Remote-control command: SOURce:INTerval &lt;nu&gt;</p>

**Burst on Delay**

Used to set the delay time which must expire (after generator settings have been changed or a measurement has been started) before the generator can start the burst with the high level (Voltage). During this time, the signal is output with the low level (Low Level).  
Value range: 0 to 60 s

Remote-control command:  
SOURce:ONTime:DElay <nu>

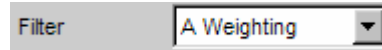
**Filter**

The generator signal is filtered in the time domain. One of the user-definable filters in the filter panel or a weighting filter can be selected, see also the section "*Generator Filters*" on page 4.112.

Remote-control command:  
SOURce:FILTer <parameter>

List of <parameter> see section "*Filter Table*" on page 4.419.

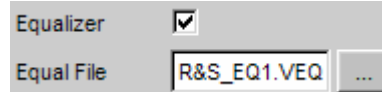
**Equalizer**

The generator signal is precorrected in the frequency domain using the file selected in the "Equal File" parameter field. The tick box is used to activate/deactivate this function.

The  button opens a browser which can be used to select the precorrector file, see also the section "*Equalization*" on page 4.111.

Remote-control command:  
SOURce:VOLTage:EQualize:STATe ON | OFF  
MMEMory:LOAD:OEQualize'file name'

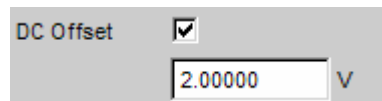
**DC Offset**

A DC offset is superimposed on the generator signal. This offset reduces the maximum possible AC voltage. The tick box is used to activate/deactivate this function. The value set for the offset voltage is always displayed.

Remote-control command:  
SOURce:VOLTage:OFFSet:STATe ON | OFF  
SOURce:VOLTage:OFFSet <nu>

## Sine<sup>2</sup> Burst

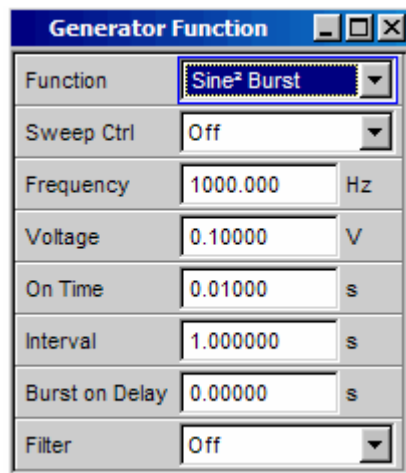

The generator generates a sine<sup>2</sup> signal, the amplitude of which is periodically activated (during the burst duration, i.e. On Time) and deactivated. The pulse can be inverted by entering a negative voltage.

The "Interval" parameter field is used to set the repetition rate of the burst. The following always applies: Burst pause = Burst period (Interval) – Burst duration (On Time).

The burst starts after generator settings have been changed or a measurement has been started. The "Burst On Delay" parameter is used to set a defined delay time.

Remote-control command:

```
SOURce:FUNCTION[:SHAPE] S2Pulse
```

### Sweep Ctrl

Used to activate the sweep system. The frequency, level, ON-time and interval of the burst signal can be varied within a selectable range from the start to the stop value. If one of these parameters is selected as the X-axis, the measurement values can be displayed as a curve in the Sweep Graph graphical window.

Sweep points: Linear or logarithmic between start and stop or read from a file.

Stepping: Automatic in a defined time grid or synchronized to the measurement time of the analyzer. Manual using the rotary knob. All the setting parameters of the sweep system are described in the section "Sweeps" on page 4.119.

### Frequency

Used to set the frequency of the sinewave. The value range depends on the analog bandwidth set in the Generator Config panel or the digital clock rate.

Remote-control command:

```
SOURce:FREQuency[1] <nu>
```

### Voltage

Used to set the level of the sinewave during the burst duration. The pulse is inverted by entering a negative voltage; conversion into logarithmic units is then not possible. In the analog generator, the maximum total voltage depends on the settings for *Output Type* and *Max Voltage* in the Generator Config panel.

Remote-control command:

```
SOURce:VOLTage[1] <nu>
```

**On Time** Used to set the burst duration. Entered as a fixed time or as a number of periods (cycles) of the sinewave frequency. On Time is always less than Interval; if increased, Interval may also be increased.  
 Minimum value: 1 sample  
 Maximum value: 60 s – 1 sample

Remote-control command:  
 SOURce:ONTime <nu>

**Interval** Used to set the repetition rate of the burst signal. Entered as a fixed time or as a number of periods (cycles) of the sinewave frequency. Interval is always greater than or equal to On Time.  
 Minimum value: On Time  
 Maximum value: 60 min

Remote-control command:  
 SOURce:INTerval <nu>

**Burst on Delay** Used to set the delay time which must expire (after generator settings have been changed or a measurement has been started) before the generator can start the burst. During this time, the signal voltage is 0 V (or 0 FS in the digital range).  
 Value range: 0 to 60 s

Remote-control command:  
 SOURce:ONTime:DELay <nu>

## Filter

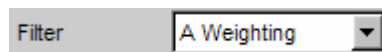

The generator signal is filtered in the time domain. One of the user-definable filters in the filter panel or a weighting filter can be selected, see also the section "*Generator Filters*" on page 4.112.

Remote-control command:  
 SOURce:FILTer <parameter>

List of <parameter> see section "*Filter Table*" on page 4.419.

## Mod Dist

The generator generates a test signal for the intermodulation measurement in accordance with SMPTE and for the modulation factor analysis in accordance with IEC 268-3.

The signal consists of two sinewaves: a low-frequency noise signal and a high-frequency useful signal. The level of the noise signal is 1 to 10 times higher than that of the useful signal.

According to IEC 268-3, the frequency of the noise signal must be between 0.5 and 1.5 octaves above the lower limit frequency of the DUT (60 Hz according to SMPTE).

According to IEC 268-3, the frequency of the useful signal must be between 0.5 and 1.5 octaves below the upper limit frequency of the DUT (7 kHz according to SMPTE).

The frequency ratio of useful signal to noise signal should be greater than 8.

According to SMPTE, the level ratio of noise signal to useful signal must be 4:1; according to IEC 268-3, a ratio of 10:1 is also possible.



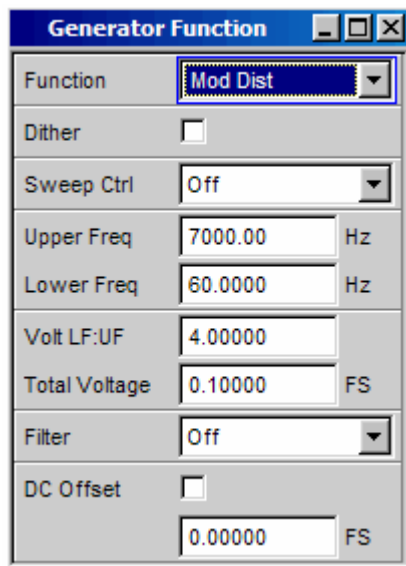

Panel of digital generator with Mod Dist function selected

Remote-control command:  
 SOURce:FUNCTion[:SHAPE] MDIST

**Dither**

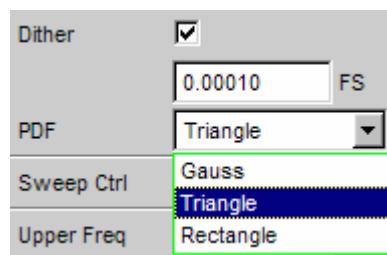

In the digital generator, a noise component with adjustable amplitude can be superimposed on the signal. The tick box is used to activate/deactivate this function. The distribution function for amplitude can be selected in the "PDF" parameter field.

The parameter fields for Dither and PDF do not appear in the analog generator.

Remote-control command:  
 SOURce:SINusoid:DITHer:STATe ON | OFF  
 SOURce:SINusoid:DITHer <nu>  
 SOURce:RANDom:PDF GAUSSsian | TRIangle | RECTangle

**Sweep Ctrl**

Used to activate the sweep system. The frequency of the useful signal (Upper Freq) or the total level (Total Voltage) of the signal can be varied within a selectable range from the start to the stop value. If frequency or level is selected as the X-axis, the measurement values can be displayed as a curve in the Sweep Graph graphical window. Sweep points: Linear or logarithmic between start and stop or read from a file. Stepping: Automatic in a defined time grid or synchronized to the measurement time of the analyzer. Manual using the rotary knob. All the setting parameters of the sweep system are described in the section "Sweeps" on page 4.119.

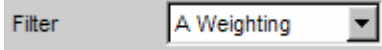
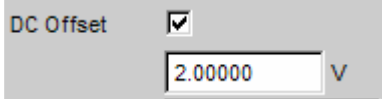
- Upper Freq** Used to set the frequency of the high-frequency useful signal.
- Remote-control command:  
 SOURce:FREQuency[1] <nu>
- Lower Freq** Used to set the frequency of the low-frequency noise signal.
- Remote-control command:  
 SOURce:FREQuency2 <nu>
- Volt LF:UF** Used to set the level ratio of noise signal to useful signal as a dimension-less number.
- Remote-control command:  
 SOURce:VOLTage:RATio <n>
- Total Voltage** Used to set the level of the overall signal. The maximum RMS depends on the level ratio. The maximum value depends on the set DC offset. In the analog generator, the maximum total voltage also depends on the settings for *Output Type* and *Max Voltage* in the Generator Config panel.
- Remote-control command:  
 SOURce:VOLTage:TOTal <nu>
- Filter**
- 
- The generator signal is filtered in the time domain. One of the user-definable filters in the filter panel or a weighting filter can be selected, see also the section "*Generator Filters*" on page 4.112.
- Remote-control command:  
 SOURce:FILTer <parameter>
- List of <parameter> see section "*Filter Table*" on page 4.419.
- DC Offset**
- 
- A DC offset is superimposed on the generator signal. This offset reduces the maximum possible AC voltage. The tick box is used to activate/deactivate this function. The value set for the offset voltage is always displayed.
- Remote-control command:  
 SOURce:VOLTage:OFFSet:STATe ON | OFF  
 SOURce:VOLTage:OFFSet <nu>

## DFD

The generator generates a test signal for the intermodulation measurement using the differential-tone method in accordance with IEC 118 or 268.

The signal consists of two very close sinewaves of the same amplitude.

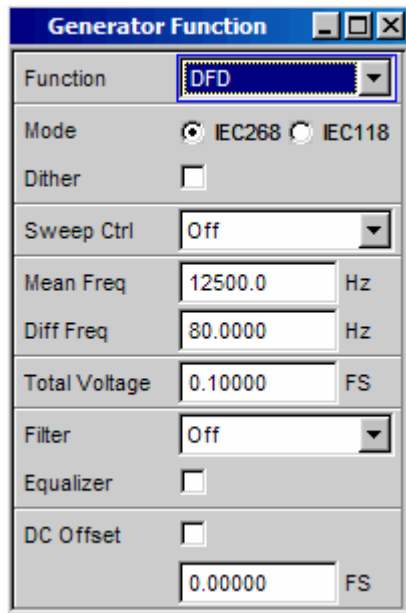

Panel of digital generator with DFD function selected

Remote-control command:  
 SOURce:FUNction[:SHAPE] DFD

**Mode** Used to select the entry mode for the frequencies of both signals.

**IEC 268** Entry of center frequency (Mean Freq) and difference frequency (Diff Freq). If a frequency sweep (for the X or Z-axis) is selected, the center frequency is swept.

Remote-control command:  
 SOURce:FUNction:MODE IEC268

**IEC 118** Entry of upper frequency (Upper Freq) and difference frequency (Diff Freq). If a frequency sweep (for the X or Z-axis) is selected, the upper frequency is swept.

Remote-control command:  
 SOURce:FUNction:MODE IEC118

**Dither**

The screenshot shows a control panel for the Dither function. At the top, there is a checkbox labeled 'Dither' which is checked. Below it is a text input field containing '0.00010' and a unit label 'FS'. Underneath is a dropdown menu labeled 'PDF' with 'Triangle' selected. The dropdown menu is open, showing three options: 'Gauss', 'Triangle' (which is highlighted with a blue background), and 'Rectangle'. The 'Sweep Ctrl' and 'Mean Freq' labels are visible on the left side of the panel.

In the digital generator, a noise component with adjustable amplitude can be superimposed on the signal. The tick box is used to activate/deactivate this function. The distribution function for amplitude can be selected in the "PDF" parameter field.

The parameter fields for Dither and PDF do not appear in the analog generator.

```
Remote-control command:
SOURCE:SINusoid:DITHer:STATe ON | OFF
SOURCE:SINusoid:DITHer <nu>
SOURCE:RANDom:PDF GAUSSsian | TRIangle | RECTangle
```

**Sweep Ctrl**

Used to activate the sweep system. The center frequency (in the IEC 118 mode) and the upper frequency (in the IEC 268 mode) or the total level (Total Voltage) of the signal can be varied within a selectable range from the start to the stop value. If frequency or level is selected as the X-axis, the measurement values can be displayed as a curve in the Sweep Graph graphical window.

Sweep points: Linear or logarithmic between start and stop or read from a file.

Stepping: Automatic in a defined time grid or synchronized to the measurement time of the analyzer. Manual using the rotary knob. All the setting parameters of the sweep system are described in the section "Sweeps" on page 4.119.

**Mean Freq**

Used to set the center frequency (in the IEC 268 mode).

```
Remote-control command:
SOURCE:FREQuency:MEAN <nu>
```

**Upper Freq**

Used to set the upper frequency (in the IEC 118 mode).

```
Remote-control command:
SOURCE:FREQuency[1] <nu>
```

**Diff Freq**

Used to set the frequency difference of the two sinewaves.

```
Remote-control command:
SOURCE:FREQuency:DIFFerence <nu>
```

**Total Voltage**

Used to set the level of the overall signal. The maximum value depends on the set DC offset. In the analog generator, the maximum total voltage also depends on the settings for *Output Type* and *Max Voltage* in the Generator Config panel.

```
Remote-control command:
SOURCE:VOLTage:TOTAL <nu>
```

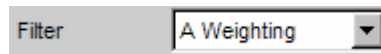
**Filter**

The generator signal is filtered in the time domain. One of the user-definable filters in the filter panel or a weighting filter can be selected, see also the section "Generator Filters" on page 4.112.

Remote-control command:  
 SOURce:FILTer <parameter>

List of <parameter> see section "Filter Table" on page 4.419.

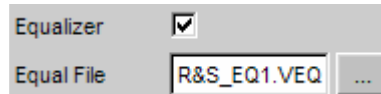
**Equalizer**

The generator signal is precorrected in the frequency domain using the file selected in the "Equal File" parameter field. The tick box is used to activate/deactivate this function.

The  button opens a browser which can be used to select the precorrector file, see also the section "Equalization" on page 4.111.

Remote-control command:  
 SOURce:VOLTage:EQUalize:STATe ON | OFF  
 MMEMory:LOAD:OEQualize 'filename'

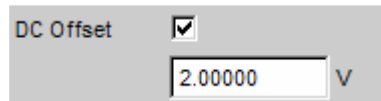
**DC Offset**

A DC offset is superimposed on the generator signal. This offset reduces the maximum possible AC voltage. The tick box is used to activate/deactivate this function. The value set for the offset voltage is always displayed.

Remote-control command:  
 SOURce:VOLTage:OFFSet:STATe ON | OFF  
 SOURce:VOLTage:OFFSet <nu>

**DIM**

The generator generates a test signal for measuring the Dynamic InterModulation distortions in accordance with IEC 268-3. The R&S UPV-B3 option is required to generate this signal in the analog range.

A high-frequency sinewave is superimposed on a low-frequency squarewave signal. The squarewave signal is limited with respect to bandwidth using a first-order filter. The amplitude of the squarewave signal is 4 times higher than that of the sinewave signal.

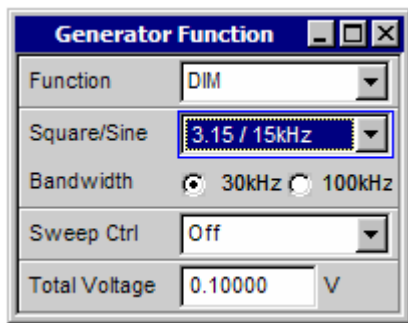

Panel of generator with DIM function selected

Remote-control command:  
 SOURce:FUNctIon[:SHAPE] DIM

**Square/Sine**

Used to select the ratio between the frequencies of the squarewave signal and sinewave signal.

**2.96/14** Squarewave signal: 2.96 kHz; sinewave signal: 14.0 kHz

Remote-control command:  
 SOURce:DIM DIMA

**3.15/15** Squarewave signal: 3.15 kHz; sinewave signal: 15.0 kHz

Remote-control command:  
 SOURce:DIM DIMB

**2.96/8** Squarewave signal: 2.96 kHz, sinewave signal: 8.0 kHz

Remote-control command:  
 SOURce:DIM DIMS

**Bandwidth**

Used to select the bandwidth (3 dB) of the first-order filter in order to limit the bandwidth of the squarewave signal.

**30kHz** Bandwidth limited to 30 kHz.

Remote-control command:  
 SOURce:BANDwidth F30

**100kHz** Bandwidth limited to 100 kHz.

Remote-control command:  
 SOURce:BANDwidth F100

**Sweep Ctrl** Used to activate the sweep system. The total level (Total Voltage) of the signal can be varied within a selectable range from the start to the stop value. If the level is selected as the X-axis, the measurement values can be displayed as a curve in the Sweep Graph graphical window.  
Sweep points: Linear or logarithmic between start and stop or read from a file.  
Stepping: Automatic in a defined time grid or synchronized to the measurement time of the analyzer. Manual using the rotary knob. All the setting parameters of the sweep system are described in the section "Sweeps" on page 4.119.

**Total Voltage** Used to set the level of the overall signal. The maximum value depends on the settings for *Output Type* and *Max Voltage* in the Generator Config panel.

Remote-control command:  
SOURce:VOLTage:TOTal <nu>

## Random

The generator generates a noise signal, the characteristics of which can be defined in either the time or frequency domain:

### *Time domain*

Selectable distribution function for amplitude

### *Frequency domain*

Several thousand equidistant sinewave lines in a selectable frequency domain

### **Special application:**

If the frequency spacing of the sinewave lines generated here is identical to the analysis grid of the FFT, analysis can be performed without leakage in the FFT. It is therefore possible to obtain a selectivity of one line with the squarewave window. This type of generator/analyzer configuration allows frequency responses of DUTs to be determined in one go with high precision and selectivity.

Remote-control command:  
SOURce:FUNCTion[:SHAPE] RANDom

**Domain**

Function	Random
Domain	<input type="radio"/> Freq <input checked="" type="radio"/> Time

Used to select whether the characteristics of the noise signal are defined in the frequency or time domain.

**Freq**

To generate the output signal, sinewave lines with adjustable amplitude are generated and superimposed on each other with a defined frequency spacing. Depending on the selectivity of the analyzer, the output signal is displayed not as a sequence of individual lines but as a noise signal with a continuous level versus frequency. The frequency-defined noise can be used to generate several thousand single tones of any given amplitude (multi-tone).

Remote-control command:  
 SOURce:RANDOM:DOMain FREQuency

**Time**

In this mode, noise signals are generated with interleaved random functions which have been optimized for uniformly distributed noise. Periodicity only occurs after at least 1 day.

Remote-control command:  
 SOURce:RANDOM:DOMain TIME

**Time domain**

Panel used to define the noise signal in the time domain.

Generator Function	
Function	Random
Domain	<input type="radio"/> Freq <input checked="" type="radio"/> Time
Shape	White
PDF	Gauss
Volt Peak	0.10000 V
Volt RMS	0.02550 V
Ampl Var	Off
Filter	Off
DC Offset	<input type="checkbox"/> 0.00000 V



**Shape** Defines the amplitude distribution of the signal spectrum within a selectable frequency range.

**White** Uncorrelated white noise without periodicity is produced.

Remote control command:  
`SOURce:RANDom:SHApe WHITE`

**Pink** WAV files are available in the User folder for producing broadband periodicity-free pink noise for the fixed frequencies between 11.025 kHz and 192 kHz (and thus for all settable generator bandwidths). They can be played with the Play generator function and are labeled Pink\_Noise\_XXXXX.WAV, XXXXX being the sampling rate in Hz.

Remote control command:  
`SOURce:RANDom:SHApe PINK`

**PDF**

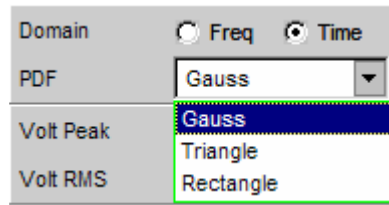

The distribution function for amplitude can be selected in the "PDF" parameter field.

Remote-control command:  
`SOURce:RANDom:PDF GAUSSian | TRIangle | RECTangle`

The other settings for time-domain noise (level, filter and DC offset) are described following the settings for frequency-domain noise at the end of this chapter, starting with *Volt Peak*.

## Frequency domain

Panel used to define the noise signal in the frequency domain.

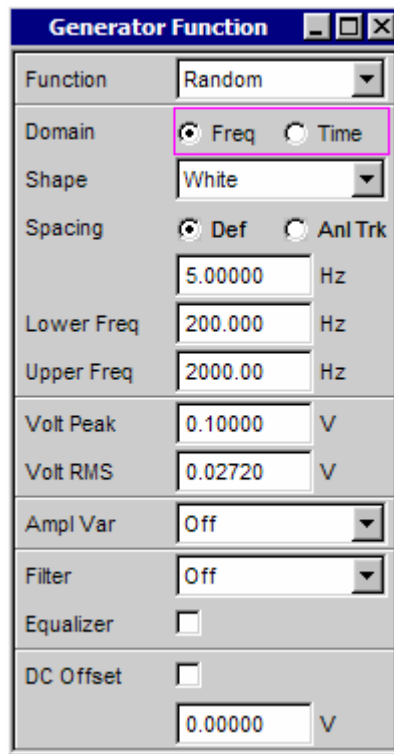
**Please note:**

The noise signals generated in the frequency range demonstrate an audible periodicity which, however, does not represent a disadvantage with measurement in any way. A reduction of the periodicity can be achieved with refined frequency resolution and a correspondingly longer cycle duration. ARB files labelled pseudoRandomxxxk.arb are available for this in the User folder, xxx being the FFT size expressed in k which requires the same channel spacing when the sampling frequency of the generator and the analyzer are identical.

**Shape**

Used to define the amplitude distribution of the signal spectrum within a selectable frequency domain.

**White**

All sinewave lines between the lower and upper frequency limit have the same amplitude.

Remote-control command:  
SOURce:RANDom:SHAPE WHITE

**Pink**

Pink noise. The amplitude of the sinewave lines between the lower and upper frequency limit is proportional to the function  $\sqrt{1/f}$ , i.e. it decreases by 3 dB per octave. Measurements performed using a third-octave analyzer return a uniform frequency spectrum.

Remote-control command:  
SOURce:RANDom:SHAPE PINK

**Third Octave** Pink noise with a bandwidth of one third octave. The center frequency is adjustable.

```
Remote-control command:
SOURCE:RANDOM:SHAPE TOCTave
```

**File** The amplitude distribution is read from the file which is displayed in the next parameter field "Shape File".

```
Remote-control command:
SOURCE:RANDOM:SHAPE FILE
```

### Shape File

File containing the amplitude distribution.

The  button opens a browser which can be used to select the file.

```
Remote-control command:
MMEMory:LOAD:LIST ARBItrary,'filename'
```

### File format:

ASCII file containing max. 8192 amplitude values which have to be entered as a sequence of numbers (value range FLOAT). The file must contain one line with the keyword "FREQUENCY\_FILE" before the number sequence. Comment lines must begin with '#' and can be used anywhere in the file. No distinction is made between upper-case and lower-case characters. The recommended and preset file extension is '.FTF'. However, due to the keyword "FREQUENCY\_FILE" which must always be entered, it is also possible to use any other file extension.

The amplitudes of the individual frequency lines must be entered as dimensionless numeric values starting with 0 Hz. The numbers only indicate the amplitude ratio of the lines with respect to each other and not the output amplitude. The output amplitude is set following phase optimization according to the value defined in the "Volt Peak" parameter field. Since the ratio of peak value to RMS is calculated internally, it is also possible to enter the RMS.

The frequency spacing is taken from the "Spacing" setting defined in the panel. Alternatively it can also be defined in the file. To do this, specify the keyword "frequency\_spacing" (not case-sensitive), followed by the value in Hz. If this value is lower than the minimum value (sampling rate/16384), the minimum value is set.

Example: rs\_exam.ftf in the directory D:\UPV\User

In addition to this file format, an equalization file (example: rs\_exam.veq in directory D:\UPV\User) can be loaded as the shape file. The amplitudes of individual frequency lines are set with respect to the equalization frequency response. The noise signal band is limited to the frequency range defined in the equalization file.

### Spacing

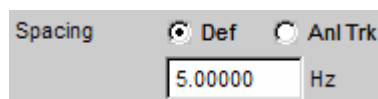

Used to set the frequency spacing. The frequency of each sinewave line is an integer multiple of this frequency spacing.

<b>Def</b>	<p>The frequency spacing can be freely defined. Minimum value: Sampling rate/16384 If frequency spacing has been defined in the file, the line where a value would be entered for this setting is grayed out and the value is displayed instead.</p> <p>Remote-control command: SOURce:RANDom:SPACing:MODE USERdefined SOURce:RANDom:SPACing:FREQuency &lt;nu&gt;</p>
<b>Anl Trk</b>	<p>The frequency spacing is adopted from the FFT set in the analyzer. This value depends on the sampling rate and the size of the FFT. This setting is only possible if an FFT or Post FFT is selected in the analyzer. The line where a value would be entered for this setting is grayed out and the value is displayed.</p> <hr/> <p><b>Please note:</b> <i>The finest channel spacing corresponds to an FFT size of 16 k. To measure with longer FFTs – and thus a smaller channel spacing – ARB files labeled pseudoRandomxxxxk.arb are available in the User folder, xxx being the FFT size in k to which the generator channel spacing is dimensioned. The generator and the analyzer must be operated with the same sampling rate and the same analog bandwidth.</i></p> <hr/> <p>Remote-control command: SOURce:RANDom:SPACing:MODE ATRack</p>
<b>Lower Freq</b>	<p>Used to define the lower frequency limit of the noise signal if Shape is set to White or Pink.</p> <p>Remote-control command: SOURce:RANDom:FREQuency:LOWer &lt;nu&gt;</p>
<b>Upper Freq</b>	<p>Used to define the upper frequency limit of the noise signal if Shape is set to White or Pink.</p> <p>Remote-control command: SOURce:RANDom:FREQuency:UPPer &lt;nu&gt;</p>
<b>Mean Freq</b>	<p>Used to set the center frequency in the case of third-octave noise.</p> <p>Remote-control command: SOURce:FREQuency:MEAN &lt;nu&gt;</p>
<b>Volt Peak</b>	<p>Used to enter the peak value of the noise signal. The maximum value depends on the set DC offset. In the analog generator, the maximum total voltage also depends on the settings for <i>Output Type</i> and <i>Max Voltage</i> in the Generator Config panel. The peak value to rms value ratio of the signal (crest factor) is minimized. If the noise is defined in the time domain, the selected distribution function for amplitude determines the crest factor.</p> <p>Remote-control command: SOURce:VOLTage:TOTal &lt;nu&gt;</p>

**Volt RMS**

Used to enter the RMS of the noise signal (only in the analog generator). The peak value to rms value ratio of the signal (crest factor) is minimized. If the noise is defined in the time domain, the selected distribution function for amplitude determines the crest factor.

Remote-control command:  
SOURce:VOLTage:RMS <nu>

**Amplitude variation**

The amplitude of the signal can be varied as sinewave or pulse shaped (burst) with a frequency selected by the user (see section "Amplitude Variation" on page 4.110).

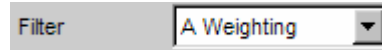
**Filter**

The generator signal is filtered in the time domain. One of the user-definable filters in the filter panel or a weighting filter can be selected, see also the section "Generator Filters" on page 4.112.

Remote-control command:  
SOURce:FILTer <parameter>

List of <parameter> see section "Filter Table" on page 4.419.

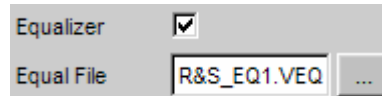
**Equalizer**

The generator signal is precorrected in the frequency domain using the file selected in the "Equal File" parameter field. The tick box is used to activate/deactivate this function.

These parameter fields are hidden if time-domain noise (Domain Time) is selected.

The  button opens a browser which can be used to select the precorrector file, see also the section "Equalization" on page 4.111.

Remote-control command:  
SOURce:VOLTage:EQualize:STATe ON | OFF  
MMEMory:LOAD:OEQualize 'filename'

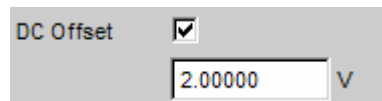
**DC Offset**

A DC offset is superimposed on the generator signal. This offset reduces the maximum possible AC voltage. The tick box is used to activate/deactivate this function. The value set for the offset voltage is always displayed.

Remote-control command:  
SOURce:VOLTage:OFFSet:STATe ON | OFF  
SOURce:VOLTage:OFFSet <nu>

## Arbitrary

The generator generates a freely definable curve shape which is read out from a file as a sequence of samples. The maximum length is 262144 (256 k) samples. When output, the curve is repeated continuously in an unbroken sequence. If a measurement is restarted (Start button), the curve starts again from the beginning of the file. The individual samples are output at the sampling rate selected in the generator.

Remote-control command:  
 SOURce:FUNCTion[:SHAPE] ARBbitrary

**File** File from which the curve shape is read.

The  button opens a browser which can be used to select the file.

Remote-control command:  
 MMEMory:LOAD:ARBbitrary 'filename'

### File format:

ASCII file with max. 524288 (512 k) samples. The individual samples are entered as a sequence of numbers (value range -1.0 bis +1.0). The file must contain one line with the keyword "TIMETAB\_FILE" before the number sequence. Comment lines must begin with '#' and can be used anywhere in the file. No distinction is made between upper-case and lower-case characters. The recommended and preset file extension is '.ARB'. However, due to the keyword "TIMETAB\_FILE" which must always be entered, it is also possible to use any other file extension.

The numerically highest value (Maximum) is output with the peak voltage set in the "Volt Peak" entry field; the other samples are level-controlled according to their ratio to the maximum. Since the ratio of peak value to RMS is calculated internally from the samples, it is also possible to enter the RMS.

Example: rs\_exam.arb in the directory D:\UPV\User

**Volt Peak** Used to enter the peak value of the arbitrary signal. The maximum value depends on the set DC offset. In the analog generator, the maximum total voltage also depends on the settings for *Output Type* and *Max Voltage* in the Generator Config panel. The peak value and RMS are interlinked by means of the crest factor.

Remote-control command:  
 SOURce:VOLTage:TOTal <nu>

**Volt RMS** Used to enter the RMS of the arbitrary signal (only in the analog generator). The peak value and RMS are interlinked by means of the crest factor.

Remote-control command:  
 SOURce:VOLTage:RMS <nu>

**Amplitude variation** The amplitude of the signal can be varied as sinewave or pulse shaped (burst) with a frequency selected by the user (see section "*Amplitude Variation*" on page 4.110).

## Filter

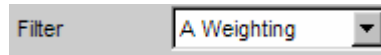

The generator signal is filtered in the time domain. One of the user-definable filters in the filter panel or a weighting filter can be selected, see also the section "*Generator Filters*" on page 4.112.

Remote-control command:  
SOURce:FILTer <parameter>

List of <parameter> see section "*Filter Table*" on page 4.419.

## DC Offset

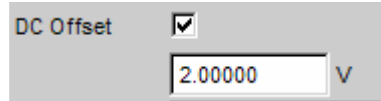

A DC offset is superimposed on the generator signal. This offset reduces the maximum possible AC voltage. The tick box is used to activate/deactivate this function. The value set for the offset voltage is always displayed.

Remote-control command:  
SOURce:VOLTage:OFFSet:STATe ON | OFF  
SOURce:VOLTage:OFFSet <nu>

## Play

This function enables any WAV file to be replayed. These files may have been created with the aid of the "Record" measurement function (reference), though this is not obligatory. Coded audio signals are *not* decoded, but instead are played back to the DUT unchanged. This generator function covers the following cases:

- Offline analysis of data streams that have been recorded using the "Record" analyzer function or some other suitable recording instrument.
- Playing back specific speech and music signals for special measurements in mobile radio or for gearing aids,
- Playing back specific test sequences such as for external sweeps.
- Data source for coded audio signals that are intended to be decoded by a connected DUT.

For **offline analysis** the generator is not connected to the DUT, but directly (i.e. internally) to the R&S UPV analyzer, which then performs all the desired measurements sequentially or simultaneously. All available interfaces (preferably digital) can be used for this. Thus for example a formerly analog measurement signal can be examined loss-free in offline analysis via one of the optional R&S UPV digital interfaces.

Playback starts as soon as the WAV file has been successfully loaded. Playback starts again every time a generator setting is changed or the START key is clicked.

Generator Function	
Function	Play
File	C:\UPV\config\us...
Scale Pk to FS	<input checked="" type="checkbox"/>
Channel	Mono Left
Play Mode	Time Single
Time	12.0000 s
ID	0
Type	1163280727
Channels	2
Sample Rate	48000
Byte Rate	384000
BitsPerSample	32
Channel Mask	3
Block Align	8
Format Tag	65534
Volt Peak	0.10000 V
Ampl Var	Off
Filter	Off
DC Offset	<input type="checkbox"/>
	0.00000 V

Panel of the analog generator for the Play function.

This panel also displays information about the WAV header. The meanings attached to this information are dependent on the format (standard or extended) and may be inferred from the WAV specification.



Remote-control command:  
 SOURce:FUNction[:SHAPE] PLAY

### Shape File

For entering the drive, path and file name of the WAV file from which the waveform will be read.



The  button opens a browser which can be used to select the WAV file.

Since the file is read online during playback, only data media having a high transfer rate are suitable. These include data partition of the hard drive or a network drive with at least 100 MBits/s. USB sticks and drives should be used only for files of less than 0.5 Msamples.

When the file name has been entered, the WAV file header information is displayed in the panel and playback starts. At this time a check is made on whether the set sampling rate (or bandwidth in the analog analyzer) matches the sampling rate stored in the WAV file. If appropriate a warning is given, but the sampling rate set in the Generator Config panel is still used.

---

#### Note:

*The sampling rate in the analog analyzer is derived from the set bandwidth (reference). The special setting "Play Auto" has the effect that the sampling rate stored in the WAV file is used, so that even WAV files with "crooked" sampling rates (e.g. 44.1 kHz) can be played back in the analog generator.*

---

Remote-control command:  
 MMEMory:LOAD:ARBitrary 'filename'

### Scale Pk to FS

Enables optional scaling up of samples in order to obtain full control.



The samples from the WAV file are output without change. This mode enables the WAV file to be loaded faster, since it does not need to be fully scanned. WAV files that are already fully controlled should be used in this mode.

Remote-control command:  
 SOURce:PLAY:SCALEpktofs OFF



The WAV file is searched for the highest sample and is scaled during playback in such a way that the highest occurring sample reaches exactly to full scale and is therefore output with the specified peak voltage.

In the case of poorly controlled WAV files, this mode improves the dynamic response of the analog generator.

---

**Note:**

*Since the entire WAV file must be searched during loading in order to determine the scaling factor, the loading process takes somewhat longer in this mode, especially with large files.*

---

Remote-control command:  
 SOURce:PLAY:SCALEpktofs ON

## Channel

For stereo WAV files only. Enables a single WAV channel to be output as a mono signal on both generator channels.

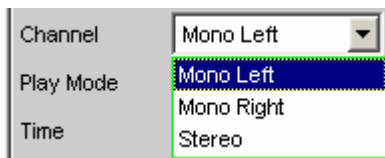

In the case of mono WAV files this choice is not available. Such files are always output to both generator channels.

---

**Note:**

*As with all generator signals, the question of whether the generator channels actually output a signal depends on the appropriately named menu item in the Generator Config panel.*

---

**Mono Left** The left WAV channel is output to all active generator channels.

Remote-control command:  
 SOURce:PLAY:CHANnel MLEFT

**Mono Right** The right WAV channel is output to all active generator channels.

Remote-control command:  
 SOURce:PLAY:CHANnel MRIGHT

**Stereo** The left WAV channel is output to generator channel 1 and the right WAV channel is output to generator channel 2. Stereo mode can only be switched on in the analog generator if option R&S UPV-B3 has been installed. This menu item will therefore be available only if the R&S UPV-B3 option has been installed.

Remote-control command:  
 SOURce:PLAY:CHANnel STEReo

**Play Mode**

Defines the playback mode of the loaded WAV file.

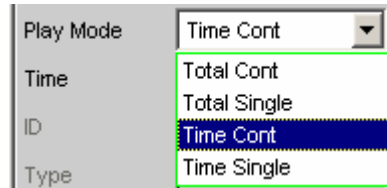

**Total Cont** The complete WAV file is played back continuously. On reaching the end of the file, playback returns without interruption to the start of the file.

---

**Note:**  
*There is normally a discontinuity in the signal during the return. In the case of pure sinewave signals this is visible as noise in the spectrum close to the carrier.*

---

Remote-control command:  
 SOURce:PLAY:MODE TOCont

**Total Single** The complete WAV file is played back once, after which the generator is muted.

Remote-control command:  
 SOURce:PLAY:MODE TOSingle

**Time Cont** The start of the WAV file is played back continuously. After expiration of the playback time, which can be selected from the next menu line, playback returns without interruption to the start of the file.

Remote-control command:  
 SOURce:PLAY:MODE TICont

**Time Single** The start of the WAV file is played back once. After expiration of the playback time, which can be selected from the next menu line, playback is interrupted and the generator is muted.

Remote-control command:  
 SOURce:PLAY:MODE TISingle

**Time** For displaying or entering the playback time.



The maximum playback time is derived from the number of samples in the WAV file and the *set* sampling rate, and can last up to 24 hours.

Depending on the selected play mode, the playback time can be

- displayed ("Play Mode Total ...") if the intention is to play back the WAV file in full;
- entered ("Play Mode Time ...") in order to reset or prematurely interrupt playback.

---

**Note:**

*In the event of a subsequent increase in the sampling rate the playback time is reduced as necessary.*

---

Remote-control command:

SOURCE:PLAY:TIME <nu>

**Volt Peak**

Sets the level of the whole signal. The maximum value depends on the DC offset that has been set. In the analog generator, the maximum total voltage also depends on the settings for *Output Type* and *Max Voltage* in the Generator Config panel.

This voltage value is output when the samples in the loaded WAV file are at full scale, that is, fully controlled.

---

**Note:**

*The "Scale Pk to FS" option must be enabled in order to ensure that this level is achieved even with WAV files that do not utilize the full amplitude range.*

---

Remote-control command:

SOURCE:VOLTage:TOTAL <nu>

**Amplitude variation**

The amplitude of the signal can be varied as sinewave or pulse shaped (burst) with a frequency selected by the user (see section "Amplitude Variation" on page 4.110).

**Filter**

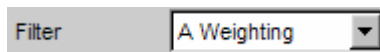

The generator signal is filtered in the time domain. One of the user-definable filters in the filter panel or a weighting filter can be selected; see also section "Generator Filters" on page 4.112.

Remote-control command:

SOURCE:FILTer

## DC Offset

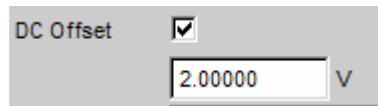

A DC offset is superimposed on the generator signal. This reduces the maximum possible AC voltage. The tick box switches this function on or off. The set value of the offset voltage is always displayed.

Remote-control command:  
SOURce:VOLTage:OFFSet:STATe ON | OFF  
SOURce:VOLTage:OFFSet <nu>

## Play+Anlr

Using this function, you can play back any WAV file, and optionally superimpose on it a signal looped back from the analyzer. This function is needed to perform the stability margin measurement included in the GSM acoustic test cases 30.6.2. It is available only if the R&S UPV-K6 option is installed.

A file containing narrowband noise in line with ITU-T Recommendation O.131 should be used as a WAV file. A suitable file with the name O\_131.WAV is supplied as standard and loaded as a default file.

---

**Note:**

*Playing back coded audio signals is possible but not meaningful for practical purposes.*

---

The analyzer signal can be a mono signal taken from one measurement channel or a stereo signal taken from both channels. It can be amplified or attenuated by a selectable factor.

To generate this special signal, a few *conditions must be met*:

- The active analog generator must be operated with a fixed analog gain. To this effect, "Volt Range" must be set to FIX and be assigned, as a minimum value, the value of the voltage maximally to be set.
- The active *digital* generator is to be synchronized to the analyzer. To this effect, "Sync To" must be set to "Audio In".
- The analyzer used *must not* be a multichannel instrument.

The "Play+Anlr" signal will not be available until the above conditions are met. The following *recommendations* should be observed in addition:

- The analog analyzer channels should be operated with fixed level ranges in order to ensure a constant loop gain.
- An identical sampling rate should be used for the generator and the analyzer. The WAV file supplied as standard was recorded with a sampling rate of 48 kHz; the digital sampling rate should, therefore, also be 48 kHz, and a bandwidth of 22 kHz should be used in the analog domain.

---

**Note:**

*When "Play+Anlr" has been switched on in the analog generator, the bandwidth of the analog analyzer can no longer be selected manually but is automatically set to the generator bandwidth. This is to prevent operator errors.*

---

Playback is started immediately after the WAV file has been successfully loaded. Playback will be restarted each time a generator setting is modified or the START key is operated.

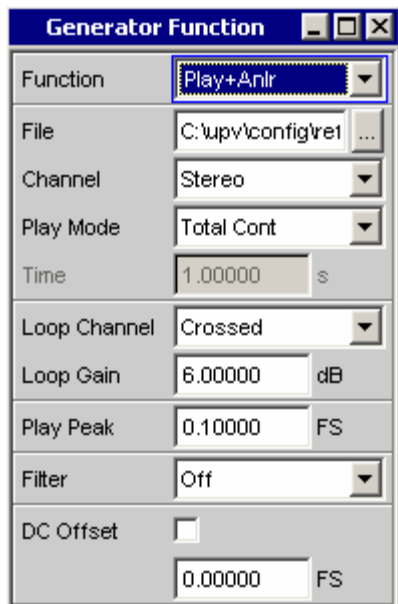

Digital generator panel for Play+Anlr function.

Remote-control command:  
 SOURce:FUNCTION[:SHAPE] PLYAnlr

**File**

Used to select the drive, directory and name of the WAV file from which the waveform is to be read.

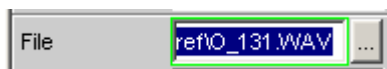

The button  opens a browser for selecting the WAV file.

The file "O\_131.WAV" is loaded as a default file. This file is supplied as standard and stored in the "C:\upv\config\ref" directory. It contains narrowband noise (white noise band-limited to 350 Hz to 550 Hz) in line with ITU-T Recommendation O.131; the signal is driven to full scale; and the playback duration is exactly 1 s at 48 kHz sampling rate.

After the file name has been entered, playback is started. It is checked whether the selected sampling rate (or bandwidth in the analog generator) equals the sampling rate stored in the WAV file. If this is not the case, a warning will be output. In any case, the sampling rate selected in the Generator Config panel will be used.

---

**Note:**  
 For the analog generator, the sampling rate results from the set bandwidth (see section "Bandwidth" on page 4.6). The "Play Auto" special setting is not available for the "Play+Anlr" function.

---

Remote-control command:  
 MMEMory:LOAD:ARBitrary 'filename'

**Channel**

Available for stereo WAV files only. This function enables a single WAV channel to be played back as a mono signal on both generator channels.

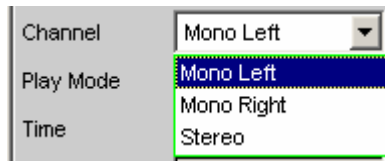

This selection is not available for mono WAV files. Their signal is always output on both generator channels.

**Note:**

*As with all generator signals, it depends on the setting of the menu item of identical name in the Generator Config panel whether or not a signal is actually output on the generator channels.*

**Mono Left**

The left WAV channel is output on all active generator channels.

Remote-control command:  
 SOURce:PLAY:CHANnel MLEFt

**Mono Right**

The right WAV channel is output on all active generator channels.

Remote-control command:  
 SOURce:PLAY:CHANnel MRIGHt

**Stereo**

The left WAV channel is output on generator channel 1, the right WAV channel on generator channel 2.

In the *analog* generator, the stereo mode can be switched on only if the R&S UPV-B3 option is installed. The stereo menu item will, therefore, be available in the analog generator only if the R&S UPV-B3 is installed.

Remote-control command:  
 SOURce:PLAY:CHANnel STEReo

**Play Mode**

Used to select the play mode of the WAV file that has been loaded.

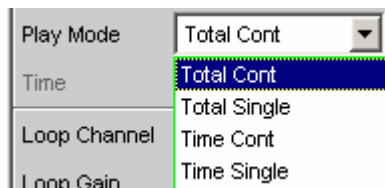

**Total Cont** Playback of the entire WAV file is continuously repeated. On reaching the end of the file, playback is restarted at the beginning without any interruption.

---

**Note:**

*On returning from the end to the beginning of the file, a discontinuity normally occurs in the signal, which, in the case of a pure sinewave signal, is visible in the spectrum as a noise surge close to the carrier.*

---

Remote-control command:  
SOURCE:PLAY:MODE TOCont

**Total Single** The entire WAV file is played a single time; then the generator is muted.

When the O\_131.WAV default file is used, this setting delivers noise for the duration of a second, which is followed by silence.

Remote-control command:  
SOURCE:PLAY:MODE TOSingle

**Time Cont** Playback of the beginning of the WAV file is continuously repeated; i.e. playback is resumed without interruption at the beginning of the file when the playback time – which is selected in the next menu line – has elapsed.

Remote-control command:  
SOURCE:PLAY:MODE TICont

**Time Single** The beginning of the WAV file is played a single time. When the playback time – which is selected in the next menu line – has elapsed, playback is stopped and the generator is muted.

Remote-control command:  
SOURCE:PLAY:MODE TISingle



**Time** Used to display or enter the playback time.



The maximum playback time is determined by the number of samples contained in the WAV file and the *selected* sampling rate. It may be as long as 24 hours.

Depending on the selected "Play Mode", there are the following options for the playback time:

- It can be displayed if the entire WAV file is to be played ("Play Mode Total ...")
- or
- A value not exceeding the playback time of the loaded WAV file can be entered in order to stop or restart playback before the end of the file is reached ("Play Mode Time ...").

When the O\_131.WAV default file is used and the sampling rate and bandwidth are correct, "1 s" is displayed here.

---

**Note:**

*If the sampling rate is increased subsequently, the playback time may be decreased if necessary.*

---

Remote-control command:  
 SOURce:PLAY:TIME <nu>

**Loop Channel**

Used to select the analyzer channel whose signal is to be looped back to the generator and to be superimposed on the noise signal.

The analyzer signal can be looped back in mono or stereo mode.

- In the mono mode, *one* of the two analyzer channels is looped back to both generator channels.
- In the stereo mode, both analyzer channels are looped back separately and superimposed on the generator channels. This can be done by superimposing each analyzer channel on the generator channel of the same number or by crossing the channels.

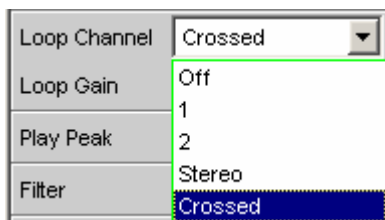

---

<b>Off</b>	<p>Loopback is switched off. Only the WAV signal is played.</p> <p>The loop gain can be set by means of the following menu item, but it is not active with loopback off.</p> <p>Remote-control command: SOURce:LOOP:CHANnel OFF</p>
<b>1</b>	<p>The analyzer channel 1 is superimposed on both generator channels.</p> <p>Remote-control command: SOURce:LOOP:CHANnel CH1</p>
<b>2</b>	<p>The analyzer channel 2 is superimposed on both generator channels.</p> <p>Remote-control command: SOURce:LOOP:CHANnel CH2</p>
<b>Stereo</b>	<p>The analyzer channel 1 is superimposed on the generator channel 1. The analyzer channel 2 is superimposed on the generator channel 2.</p> <p>Remote-control command: SOURce:LOOP:CHANnel STEReo</p>
<b>Crossed</b>	<p>The analyzer channel 1 is superimposed on the generator channel 2. The analyzer channel 2 is superimposed on the generator channel 1.</p> <p>Remote-control command: SOURce:LOOP:CHANnel CROSSed</p>

**Loop Gain**

Used to set the gain for loopback of the analyzer signal.

A screenshot of a control panel for 'Loop Gain'. It features a text label 'Loop Gain' on the left, a central input field containing the value '0.00000', and the unit 'dB' on the right. The input field is highlighted with a green border.

The analyzer input signal of the selected channel is tapped *ahead of the filters* and superimposed on the generator signal without undergoing further division. The gain should be set such that the level of the input signal, after amplification, does not exceed the headroom allowed for the WAV playback signal.

**Note:**

*The two signals are combined by adding the sample of the level-controlled WAV signal and the corresponding sample of the amplified loopback signal. The resulting signal is available as the generator output sample. If the sum sample exceeds a value of 1.0 FS, it is limited to FS.*

A value lower than 1 (or lower than 0 dB) causes an attenuation of the analyzer signal.

Entering the value of 0 (or -240 dB) will switch off the loopback signal.

Remote-control command:  
SOURce:LOOP:GAIN <nu>

**Play Peak**

Used to set the peak output level of the noise signal. This entry does *not* affect the loopback signal.

A screenshot of a control panel for 'Play Peak'. It features a text label 'Play Peak' on the left, a central input field containing the value '0.10000', and the unit 'FS' on the right. The input field is highlighted with a green border.

The maximum total voltage in the analog generator depends on the settings in the Generator Config panel.

This voltage value is attained by those samples in the loaded WAV file that are driven to maximum level (+/- FS).

When entering the peak output level, it must be taken into account that the analyzer signal will be added to the entered value. An appropriate headroom must therefore be allowed for the analyzer signal. Entering a peak level of 1.0 FS is, therefore, meaningful only if the loopback is switched off or if the WAV file in question already comes with a headroom, i.e. if the file is not scaled to FS.

**Note:**

*Unlike the Play function, the Play+Anlr function does not provide for automatic scaling up to FS of the WAV signal. The O.131 signal supplied as standard is already scaled to FS.*

Remote-control command:  
SOURce:VOLTage:TOTal <nu>

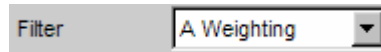
**Filter**

The WAV playback signal is filtered in the time domain. This filtering has no effect on the loopback signal.

You can use either a user-defined filter (to be defined in the filter panel) or a weighting filter, see also section "Generator Filters" on page 4.112.

Remote-control command:

SOURce:FILTer <parameter>

List of <parameter> see section "Filter Table" on page 4.419.

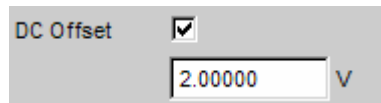
**DC Offset**

A DC voltage offset is superimposed on the generator signal. The offset reduces the maximum possible DC voltage. The tick box is used to switch this function on or off. The offset voltage entered is displayed in either case.

Remote-control command:

SOURce:VOLTage:OFFSet:STATe ON | OFF

SOURce:VOLTage:OFFSet <nu>

## Polarity

The generator generates a test signal for polarity measurement. This measurement is used to check the polarity of the input signal transmitted by the DUT.

```
Remote-control command:
SOURCE:FUNCTION[:SHAPE] POLarity
```

The test signal consists of two sinewaves, one of which is a fundamental and the other a harmonic, having the same amplitude in each case. The phase of the harmonic is selected so that the positive peak value is greater than the negative.

**Frequency** Used to set the frequency of the fundamental.

```
Remote-control command:
SOURCE:FREQUENCY[1] <nu>
```

**Total RMS** Used to set the level of the signal. In the analog generator, the maximum total voltage depends on the settings for *Output Type* and *Max Voltage* in the Generator Config panel.

```
Remote-control command:
SOURCE:VOLTage[1] <nu>
```

**Total Peak** Used to display the peak value of the signal.

```
Remote-control command:
SOURCE:VOLTage:TOTAL?
```

## Modulation

The generator generates a sinewave signal which can be modulated with respect to frequency or amplitude according to a sinusoidal function.

```
Remote-control command:
SOURCE:FUNCTION[:SHAPE] MODulation
```

**Mode** Used to select the modulation type: amplitude or frequency modulation.

**FM** Frequency modulation

```
Remote-control command:
SOURCE:FUNCTION:MODE FM
```

**AM** Amplitude modulation

```
Remote-control command:
SOURCE:FUNCTION:MODE AM
```

<b>Mod Freq</b>	<p>Used to set the modulation frequency.</p> <p>Remote-control command: SOURce:FREQuency[1] &lt;nu&gt;</p>
<b>Carrier Freq</b>	<p>Used to set the carrier frequency.</p> <p>Remote-control command: SOURce:FREQuency2 &lt;nu&gt;</p>
<b>Deviation</b>	<p>With FM, this parameter field is used to set the modulation deviation in % relative to the carrier frequency.</p> <p>Remote-control command: SOURce:VOLTage[1] &lt;n&gt; [PCT]</p>
<b>Mod Depth</b>	<p>With AM, this parameter field is used to set the modulation depth in % relative to the carrier amplitude.</p> <p>Remote-control command: SOURce:VOLTage[1] &lt;n&gt; [PCT]</p>
<b>Carrier Volt</b>	<p>Used to set the level of the unmodulated sinewave signal. With AM, only up to half of the maximum value; this ensures that 100 % AM can always be set. The maximum value depends on the set DC offset. In the analog generator, the maximum total voltage also depends on the settings for <i>Output Type</i> and <i>Max Voltage</i> in the Generator Config panel.</p> <p>Remote-control command: SOURce:VOLTage2 &lt;nu&gt;</p>
<b>Filter</b>	<div data-bbox="550 1144 933 1195" style="border: 1px solid #ccc; padding: 2px; margin-bottom: 10px;"> <span style="background-color: #f0f0f0; padding: 2px;">Filter</span> <span style="border: 1px solid #ccc; padding: 2px; display: inline-block;">A Weighting ▼</span> </div> <p>The generator signal is filtered in the time domain. One of the user-definable filters in the filter panel or a weighting filter can be selected, see also the section "<i>Generator Filters</i>" on page 4.112.</p> <p>Remote-control command: SOURce:FILTer &lt;parameter&gt;</p> <p>List of &lt;parameter&gt; see section "<i>Filter Table</i>" on page 4.419.</p>
<b>DC Offset</b>	<div data-bbox="550 1500 933 1600" style="border: 1px solid #ccc; padding: 2px; margin-bottom: 10px;"> <span style="background-color: #f0f0f0; padding: 2px;">DC Offset</span> <input checked="" type="checkbox"/> <div style="border: 1px solid #ccc; padding: 2px; display: inline-block; margin-left: 10px;">2.00000 V</div> </div> <p>A DC offset is superimposed on the generator signal. This offset reduces the maximum possible AC voltage. The tick box is used to activate/deactivate this function. The value set for the offset voltage is always displayed.</p> <p>Remote-control command: SOURce:VOLTage:OFFSet:STATe ON   OFF SOURce:VOLTage:OFFSet &lt;nu&gt;</p>

## DC (Direct-Current Voltage)

The generator generates a DC voltage signal. Unlike the DC offset, it is possible to sweep this DC voltage.

Remote-control command:  
 SOURce:FUNction[:SHAPE] DC

### Sweep Ctrl

Used to activate the sweep system. The DC voltage can be varied within a selectable range from the start to the stop value. If the level is selected as the X-axis, the measurement values can be displayed as a curve in the Sweep Graph graphical window.

Sweep points: Linear or logarithmic between start and stop or read from a file.

Stepping: Automatic in a defined time grid or synchronized to the measurement time of the analyzer. Manual using the rotary knob. All the setting parameters of the sweep system are described in the section "Sweeps" on page 4.119.

### Voltage

DC voltage level. In the analog generator, the maximum value depends on the settings for *Output Type* and *Max Voltage* in the Generator Config panel.

Remote-control command:  
 SOURce:VOLTage:TOTal <nu>

## Square

The generator produces a square wave signal. The frequency and the level are the same for both channels.

Remote control command:  
 SOURce:FUNction[:SHAPE] SQUARE

### Domain

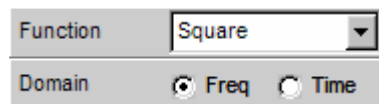

Here it is possible to define whether the square wave signal should be defined in the frequency or the time domain.

### Freq

The square wave signal is formed from a series of sinus oscillations whose amplitudes and phases are calculated correspondingly to the Fourier expansion of a rectangle. The maximum frequency of the fundamental wave is selected so that the spectrum reaches at least to the fifth fundamental wave. The frequency resolution is good. In the time domain, however, the signal demonstrates system theory-related overshoots.

Remote control command:  
 SOURce:RANDom:DOMain FREquency

<b>Time</b>	<p>In the <b>analogue domain</b> this is only possible with the UPV-B3 option (second generator channel which also contains the square wave generator). The frequency resolution is good. The edge sharpness corresponds to a first-order low pass with a critical frequency of 100 kHz. A DC offset is not possible.</p> <p>In the <b>digital domain</b>, the signal consists of a series of sampling values which alternate between the maximum positive and negative value. Only sub-harmonics of the sampling frequency with an even number of sampling values can be produced so that the rectangle remains symmetrical. The frequency resolution increasingly deteriorates at higher frequencies. The time behavior is ideal.</p> <p>Remote control command: SOURce:RANDom:DOMain TIME</p>
<b>Sweep Ctrl</b>	<p>Activation of the sweep system. The frequency or the level of the signal can be varied between the start and stop values within a selectable range. With the frequency or the level as the X axis the measurement values can be shown as a curve in the sweep graph dialog.</p> <p>Sweep points: linear or logarithmic between start and stop or read out of a file.</p> <p>Switching over: automatically synchronized within a defined time frame or to the measurement time of the analyzer. All sweep system setting parameters are described in detail in the section <i>Sweeps</i>.</p>
<b>Frequency</b>	<p>Sets the square wave signal frequency. The value range depends on the analogue bandwidth or the digital clock frequency set in the generator configuration panel.</p> <p>Remote control command: SOURce:FREQuency[1] &lt;nu&gt;</p>
<b>Voltage</b>	<p>Sets the level effective value of the square wave signal. The maximum value depends on the set DC offset. In the analogue generator the maximum total voltage additionally depends on the output type and maximum voltage settings in the generator configuration panel.</p> <p>Remote control command: SOURce:VOLTage[1] &lt;nu&gt;</p>



## DC Offset

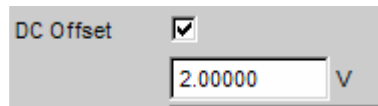

A direct voltage offset is superimposed on the generator signal. This reduces the maximum possible alternating voltage. The checkbox switches this function on or off. The set offset voltage value is constantly displayed.

A DC offset in the time domain is not possible in the analogue generator when the square wave signal is generated; the setting line is not visible.

Remote control commands:  
 SOURce:VOLTage:OFFSet:STATe ON | OFF  
 SOURce:VOLTage:OFFSet <nu>

## Amplitude Variation

With generator signals multisine, arbitrary, random and play, the amplitude can be varied either with respect to sinewave between the maximum value set on the panel and a selectable minimum value or with respect to pulse shape.

**Amplitude variation** The amplitude of the signal can be varied either with respect to sinewave or pulse shape (burst) with selectable frequency.

**OFF** Amplitude variation is deactivated.

Remote control command:  
 SOURce:AM:MODE OFF

**Sine** The amplitude of the generator signal is modulated with respect to sinewave.

Remote control command:  
 SOURce:AM:MODE SINusoid

**Modulation frequency** Used to set the modulation frequency. The value range depends on the analog bandwidth set in the Generator Config panel or the digital clock rate.

Remote control command:  
 SOURce:FREQuency:AM <nu>

**Variation** Used to set the value in % by which the amplitude of the signal is reduced. Value range 0 to -100 %.  
 Example: If an amplitude of 1 V and a variation of -80 % is selected, the generator level varies between 1 V and 200 mV.

Remote control command:  
 SOURce:VOLTage:AM <n> [PCT]

**Amplitude variation** The amplitude of the signal can be varied with respect to sinewave or pulse shape (burst) with selectable frequency.

**Burst** The generator signal is cyclically activated and deactivated. This setting is not possible in the Play generator function.

Remote control command:  
SOURce:AM:MODE BURSt

**On Time** Used to set the time during which the signal is activated. On Time is always less than Interval; if increased, Interval may also be increased.

Remote control command:  
SOURce:ONTime <nu>

**Interval** Used to set the repetition rate of the burst signal. Interval is always greater than or equal to On Time.

Remote control command:  
SOURce:INTerval <nu>

**Burst on Delay** Used to set the delay time which must expire (after generator settings have been changed or a measurement has been started) before the generator can start the signal. During this time, the generator signal is deactivated.

Remote control command:  
SOURce:ONTime:DELay <nu>

## Equalization

The generator can be given a predefined frequency response using a table containing frequency points and the associated gain factors. The set amplitude of the generator is changed automatically according to frequency on the basis of this table.

The table must be saved in a particular format in a file (see example RS\_EXAM.VEQ in the folder d:/upv/user) which can be loaded in the "Equalization" parameter field in the Generator Function panel.

The file can also be created from a measured curve or a curve imported from a file by storing the trace as Equalization List in the Display Config panel. A number of different settings are available.



**Norm Freq** The gain factors are normalized to the level at this frequency.

**Invert** The measured frequency response is inverted. There is then a flat frequency response when this file is loaded in the generator.

**Modify**      Enables several equalization curves to be chained. If equalization is turned on in the generator, the file already loaded and the new file stored here are "connected in series" and loaded in the generator.

## **Generator Filters**

The generator signal is filtered in the time domain. One of the user-definable filters in the filter panel or a weighting filter can be selected. All level settings apply to the unfiltered signal (see section "*Filters*" on page 4.416).

# Digital Audio Protocol Generator

The option R&S UPV-K21 can be used to generate and analyze the channel status data in the data stream of the digital audio interface (Option R&S UPV-B2) according to IEC standard 60958-3 for the Consumer mode and IEC standard 60958-4 or AES3 for the Professional mode. The various settings of the protocol generator are described below.

## Advanced Settings

Open the control panel for the digital audio protocol generator by means of **Menu – Instruments – Protocol Generator**

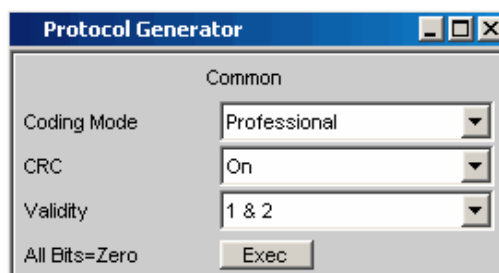
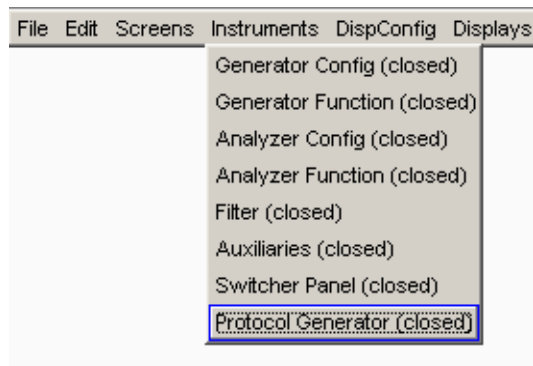

### Coding Mode

Set the entry mask for channel status data to Consumer or Professional.

#### Automatic

The mask is set in accordance with bit 0 in byte 0, and can be different for each of the two channels.  
 Bit 0 = 0 => Consumer  
 Bit 0 = 1 => Professional

Remote-control command:  
 SOURCE:PROTOCOL:MODE AUTOMATIC

#### Consumer

Entry mask for the Consumer mode, for both channels in common.

Remote-control command:  
 SOURCE:PROTOCOL:MODE CONSUMER

#### Professional

Entry mask for the Professional mode, for both channels in common.

Remote-control command:  
 SOURCE:PROTOCOL:MODE PROFESSIONAL

**CRC** Cyclic redundancy check character: A checksum is generated from the content of bytes 0 to 22 of the channel status data and transferred to byte 23 (Professional mode only).

**ON** The checksum is generated and transferred to Byte 23.

Remote-control command:  
SOURCE:PROTOCOL:CRC ON

**OFF** No checksum is generated.

Remote-control command:  
SOURCE:PROTOCOL:CRC OFF

**Validity** Defines the state of the validity bit.

**1 & 2** The validity bit is set in both channels.

Remote-control command:  
SOURCE:PROTOCOL:VALIDITY CH1And2

**None** The validity bit is not set in either channel.

Remote-control command:  
SOURCE:PROTOCOL:VALIDITY NONE

**All Bits = Zero**

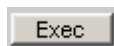

This sets all bits to zero. Exception: Bit 0 in byte 0, which defines the coding mode as Consumer or Professional, is not changed.

Remote-control command:  
SOURCE:PROTOCOL:AZERO ONCE

## Setting Bytes as Numerical Values

Numerical Byte Entry	
Channel	<input type="text" value="2"/>
Byte Number	<input type="text" value="1"/>
Value	<input type="text" value="11"/>
Hex Entry	<input type="text" value="b"/> <input type="button" value="hex"/>

A channel byte can be set to any value in this entry block. It is even possible to set bit combinations that are not yet defined in the standard.

**Channel** Selects the channel, 1 or 2.

Remote-control command:  
SOURCE:PROTOCOL:NUMERICAL:CH <n>

**Byte Number**

Selects the byte, 0 to 3.

Remote-control command:  
 SOURce:PROTOcol:NUMerical:BYTE <n>

**Value**

The decimal value for the byte selected in channel 1 or 2 is displayed here and can also be entered.

Remote-control command for a query:  
 SOURce:PROTOcol:NUMerical:VALue?

Remote-control command for an entry:  
 SOURce:PROTOcol:NUMerical:VALue <n>

**Hex Entry**

The byte value can be displayed or entered in hexadecimal, binary or decimal.

Remote-control command: ---

If the entry brings about a bit combination that is not yet defined in the standard, the parameter has no meaning that can be displayed. In this event **\*\*\*\*\*** is displayed.

Example: The entry ...

Numerical Byte Entry	
Channel	1
Byte Number	0
Value	9

... gives the following display, since the meaning of the bit combination "010" for pre-emphasis is not defined in the standard.

Channel 1	
Format	1 Professional
Audio Mode	0 Linear PCM
Pre-emphasis	*****
Source Freq Lock	0 Not indicated
Sample Frequency	00 Not indicated

## Setting Bytes in Remote-Control Mode

When entering or querying values in remote control mode, an easier method than the three individual commands described in the previous section for channel, byte and value

```
SOURce:PROTOcol:NUMerical:CH <x>
SOURce:PROTOcol:NUMerical:BYTE <y>
SOURce:PROTOcol:NUMerical:VALue <n>
```

is to use the following, combined remote-control command:

```
SOURce:PROTOcol:CH<x>:BYTE<y> <n>    for an entry
SOURce:PROTOcol:CH<x>:BYTE<y> ?      for a query
```

**Note:**

*If this remote-control command is used to set a byte in Channel 2, the parameter display is switched to a two-channel (split) version.*

After switching back to local mode, the settings entered via this remote-control panel are displayed in plain text in the corresponding parameter fields of the Protocol Generator panel.

Parameter:	<x>	1 or 2
	<y>	0 to 3
	<n>	0 to 255 (decimal)

Example: "SOUR:PROT:CH1:BYTE0 7"  
 makes the Protocol Generator panel look like this:

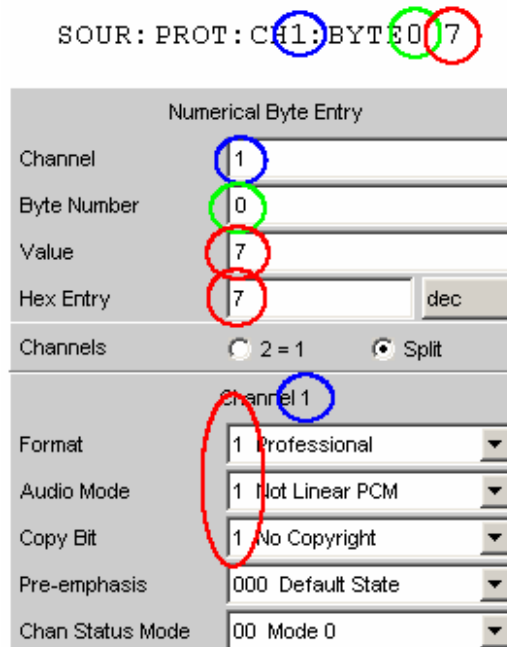

## Displaying and Setting Parameters in Plain Text

Channels	
	<input checked="" type="radio"/> 2 = 1 <input type="radio"/> Split
Channel 1 & 2	
Format	0 Consumer
Audio Mode	0 Linear PCM
Copy Bit	0 Copyright
Pre-emphasis	001 Pre-emph 50/15
Chan Status Mode	00 Mode 0
Category Code	0000001 CD IEC 60908
L-bit	0 Pre-rec SW

Parameters can be entered here as defined in the standard. This is possible only for manual operation, and is not available in remote-control mode.

The bit combination and meaning are displayed.

The effect of an entry via Numerical Byte Entry is also displayed here.

### Channels

Parameters can be set separately or for both channels in common.

#### 2 = 1

The same parameters for both channels. On switching over from Split, Channel 2 takes the settings of Channel 1.

```
Remote-control command:
SOURCE:PROTOCOL:CHANNELS CH2Is1
```

#### Split

Different parameters can be entered for each of the two channels. On switching over to 2 = 1, Channel 2 takes the settings of Channel 1.

```
Remote-control command:
SOURCE:PROTOCOL:CHANNELS SPLit
```



Setting parameters

A selection is offered for each parameter as defined in the standard. This example is for the Sample Frequency in Consumer mode.

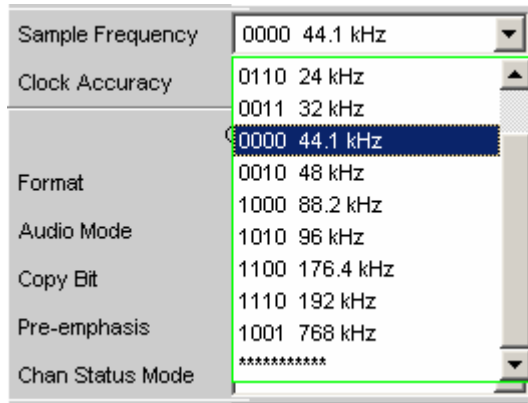

The line \*\*\*\*\* indicates an undefined bit combination (which is possible when Numeric Byte Entry is used).

An attempt to set this line is met with the following message:

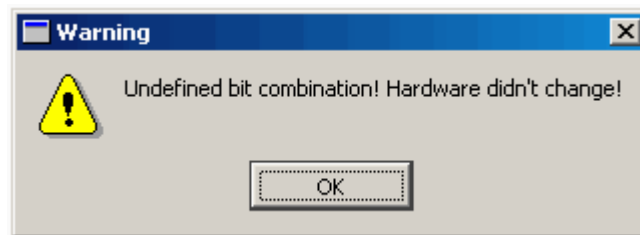

The hardware remains unchanged and the prior status is displayed.

## Sweeps

With many generator functions, it is advisable to output the signal parameters (level, frequency and, with burst signals, ON-time and interval length) not only statically but also to vary them over time. Varying one or more of the signal parameters is referred to as a (generator) sweep. The measurement values obtained can be, but do not have to be, recorded as series of measurement values.

For this purpose, the R&S UPV has a very flexible sweep system where up to two generator parameters or one analyzer parameter can be varied in many different ways. When the generator sweep is activated, any analyzer sweep that may be active (variation of the center frequency for the RMS Selective filter) is deactivated.

The sweep results (series of measurement values) can be displayed graphically (2-D graph in a sweep window) or numerically (sweep list, see section "*List Sweep*" on page 4.134). With the graphical display, the 1<sup>st</sup> sweep parameter is usually plotted on the X-axis, the recorded measurement value on the Y-axis and the optional 2<sup>nd</sup> sweep parameter on the Z-axis (not visible in the 2-D graph).

A *Z sweep* is therefore equivalent to a sweep with two parameters (2-dimensional sweep). It is also possible to plot the *measured* frequency (*X-Source: Frequency*) or the *measured* level (*X-Source: LevMon...*) along the X axis.

Up to 8 measurement values can be recorded for each sweep point (in 4 sweep windows each with 2 traces).

To plot a specific measurement parameter, the following setting has to be made in (at least) one of the four sweep display panels:

- *X-Source* has to be set to *Sweep* or the desired X parameter to be measured.
- (At least) one trace has to be set to the desired Y parameter to be measured.

It is also possible to set more than one trace to one measurement value.

The generator sweeps can be configured in many different ways and can be distinguished according to the following characteristics:

- *number of varied signal parameters* in **1 or 2-dimensional sweeps** ("Z-sweeps")
- *type of stepping* in **manual and automatic sweeps**
- *stepping condition* in **synchronous and time-triggered sweeps**
- *sweep-axis spacing* in **linear, logarithmic and list-controlled sweeps**
- *sweep direction* in **upward and downward sweeps**
- *physical basic unit* of the sweep parameter in **frequency, level, time and phase sweeps**
- *behavior when the stop value is reached* in **single and continuous sweeps**

Which sweep parameters are available for the individual generator functions depends on the characteristics of the respective signal. The following generally applies:

- A frequency sweep is not possible for multi-tone signals or noise signals.
- A phase sweep, i.e. the variation in phase shift between Channel 1 and 2, is only possible for stereo-sinewaves and should only be performed if both frequencies are the same.
- Time sweeps, i.e. the variation in ON-time and interval length, are only possible with burst signals.

- Z-sweeps are only possible if at least 2 signal parameters of the set generator function have sweep capability.

Table 4-1 List of sweep-capable function parameters depending on selected function

Function	VOLTAGE	FREQUENCY	Phase	ON-TIME	INTERVAL
Sine	yes	yes	---	---	---
Stereo Sine	yes	yes	yes	---	---
Multisine	no	no	---	---	---
Sine Burst	yes	yes	---	yes	yes
Sine <sup>2</sup> burst	yes	yes	---	yes	yes
Mod Dist	yes (total voltage)	yes (user frequency)	---	---	---
DFD	yes (total voltage)	IEC268 mode: center frequency IEC118 mode: upper frequency	---	---	---
DIM	yes (total voltage)	---	---	---	---
Random	no	---	---	---	---
Arbitrary	no	---	---	---	---
Polarity	no	---	---	---	---
Modulation	no	no	---	---	---
DC	yes	---	---	---	---

## Activating / Deactivating the Sweep System

The sweep system is activated and deactivated using "Sweep Ctrl". How the sweep is to be stepped and how the sweep axis is to be defined are also determined at the same time. For generator sweeps, this parameter field is available in the generator functions; the analyzer sweep is only available for the measurement function "RMS Selective" and is described in greater detail in the associated section "*RMS Measurement, Selective*" on page 4.249.

The sweep system can be activated and configured separately in each generator function. If the function (or instrument) is changed, the sweep system is reconfigured, activated or deactivated implicitly.

The *generator* sweep is also deactivated when the *analyzer* sweep is activated and when "Time Chart" is selected as the start condition, see section "*Start Conditions*" on page 4.221.

A sweep cycle is started by pressing the START key (for continuous sweeps) or SINGLE key (for single sweeps).

Each new sweep point that the sweep system sets automatically triggers a new measurement. When using one of the burst functions of the R&S UPV universal generator, the generator signal is reset at the same time, that is, the generator starts at the burst phase or "Burst on Delay". If the measurement values generated during measurement are to be recorded and displayed (graphically or numerically), the desired measurement values (e.g. "Funct Ch1") must be selected as "Traces" in the sweep display panels. Furthermore, it must also be ensured that during measurement value recording the X-axis is set to "Auto" in the used sweep display panels.

On completion of the sweep measurements, the used traces and the associated X-axes should be switched to "Hold" to prevent the sweep results from being deleted if instrument settings are changed inadvertently.

When the sweep system is active, the START, SINGLE and STOP/CONT keys have the following effect:

- START starts a continuous sweep.
- SINGLE starts a single sweep or causes an already started continuous sweep to be continued as a single sweep.
- STOP/CONT stops an active sweep or restarts a stopped sweep.

### Sweep Ctrl

Used to activate and configure or deactivate the generator sweep system.

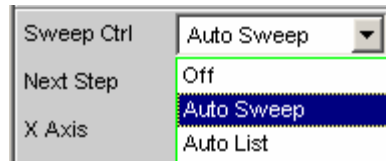

#### Off

The generator sweep system is *deactivated*; no additional parameter fields are displayed. If the analyzer sweep system is also deactivated, the START, SINGLE and STOP/CONT keys affect the measurement system:

- START starts a continuous measurement
- SINGLE starts a single measurement or causes an already started continuous measurement to be continued as a single measurement
- STOP/CONT stops an active measurement or starts a stopped or completed measurement as a continuous measurement

Remote-control command:  
`SOURce:SWEEp:CONTrol OFF`

#### Auto Sweep

The generator sweep system is *activated*; the sweep stepping is performed automatically; the sweep axis is calculated from the start value, stop value and step size or point number.

The stepping condition (fixed time grid or synchronized to the analyzer) is determined in the "Next Step" parameter field.

Remote-control command:  
`SOURce:SWEEp:CONTrol ASWEEP`

#### Auto List

The generator sweep system is *activated*; the sweep stepping is performed automatically; the sweep axis is determined from the predefined list of sweep points (usually loaded as a file).

The stepping condition (fixed time grid or synchronized to the analyzer) is determined in the "Next Step" parameter field.

Remote-control command:  
`SOURce:SWEEp:CONTrol ALIST`

**Manual Sweep** The generator sweep system is activated; the sweep stepping is performed manually; the sweep axis is calculated from the start value, stop value and step size or point number.

Remote-control command:  
SOURce:SWEep:CONTrol MSWEEP

**Manual List** The generator sweep system is *activated*; the sweep stepping is performed manually; the sweep axis is determined from the predefined list of sweep points (usually loaded as a file).

Remote-control command:  
SOURce:SWEep:CONTrol MLIST

## One-Dimensional Sweep

With one-dimensional sweeps, only 1 parameter is varied; the Z-axis is deactivated.



Each sweep cycle can consist of max. 1024 individual points, which means that the X-axis is divided into max. 1023 steps.

As soon as all of the points on the X-axis have been processed, the analyzer returns to the 1<sup>st</sup> X-value and performs the next sweep cycle using the same settings.

---

### Note:

*The last 20 sweep cycles (scans) are available as the data set. If more than 20 scans have been performed, only the last 20 can be saved as the trace data set. Similarly, only the last 20 scans are retained if the graph is rescaled.*

---

A one-dimensional continuous sweep which was started by pressing the START key is repeated infinitely often.

**X Axis**

Used to select the sweep parameter (with *one*-dimensional sweeps) or the *first* sweep parameter (with *two*-dimensional sweeps). Only visible for activated generator sweep system.

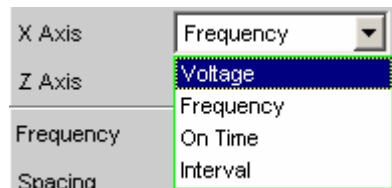

The reason why the sweep axis is referred to as the X-axis is because this sweep parameter is usually plotted on the X-axis in the 2-D graph.

**Note:**

*It is also possible to plot a measurement value on the X-axis (e.g. the measured RMS in the case of external measurement value triggering). In such cases, the sweep axis (sweep X-axis) and the graphical X-axis are not necessarily identical.*

**Voltage**

Used to activate a level sweep. Which signal parameter is actually swept (e.g. the level of a single sinewave line or the total level of a multi-tone signal) depends on the respective generator function.

Remote-control command:  
SOURce:SWEEp:XAXis VOLTage

**Frequency**

Used to activate a frequency sweep. Not possible for noise signals and multi-tone signals. Which signal parameter is actually swept (e.g. the frequency of a single sinewave line or the center frequency of a two-tone signal) depends on the respective generator function.

Remote-control command:  
SOURce:SWEEp:XAXis FREQuency

**Phase**

Used to activate a phase sweep. Only possible for stereo signal.

Remote-control command:  
SOURce:SWEEp:XAXis PHASe

**On Time**

Used to activate a burst-duration sweep. Only with burst signals.  
The ON-time of the burst signal is swept, i.e. the time during which the high level of the burst is output.

Remote-control command:  
SOURce:SWEEp:XAXis ONTime

**Interval** Used to activate a burst-interval sweep. Only with burst signals.  
The interval length of the burst signal is swept.

Remote-control command:  
SOURce:SWEep:XAXis INTervall

## Two-Dimensional Sweep

With two-dimensional sweeps, 2 (different) parameters are varied; the 1st parameter is selected as the X-axis and the 2nd parameter as the Z-axis.



Both axes (sweep dimensions) can each consist of max. 1024 individual points, which means that each axis is divided into max. 1023 steps.

As soon as all of the points on the X-axis have been processed, the analyzer returns to the 1<sup>st</sup> X-value and simultaneously sets the next Z-value. When the sweep cycle for the last Z-point has been completed, the X and Z-values are reset to their original start values.

---

### Note:

*The last 20 sweep cycles (scans) are available as the data set. If the Z-axis contains more than 20 points, only the last 20 scans can be saved as the trace data set. Similarly, only the last 20 scans are retained if the graph is rescaled.*

---

A two-dimensional continuous sweep which was started by pressing the START key is stopped after the sweep cycle for the last Z-point.

### Z Axis

Used to select the second sweep parameter for the two-dimensional sweep. Used both to activate and to deactivate the two-dimensional sweep. Only visible for activated generator sweep system.

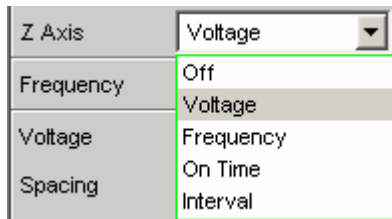

---

### Note:

*With some generator functions (e.g. DC, DIM), it is possible to sweep one parameter only. The "Z Axis" parameter field (and therefore a two-dimensional sweep) is not available in this case.*

*When "Z Sweep" is enabled, the Sweep Graph Config panel is switched to "Multi Scan" if the X source of the current window is set to "Sweep.". At the same time, the number of points on the Z axis (20 maximum) is copied to the Sweep Graph Config panel as "History" if it is larger than the value specified there.*

---

<b>Off</b>	<p>Used to deactivate the two-dimensional sweep (switch-over to a one-dimensional sweep).</p> <p>Remote-control command:  SOURce:SWEep:ZAXis OFF</p>
<b>Voltage</b>	<p>Used to activate the two-dimensional sweep and select the level variation as the second sweep parameter. Which signal parameter is actually swept (the level of a single sinewave line or the total level of a multi-tone signal) depends on the respective generator function.</p> <p>Remote-control command:  SOURce:SWEep:ZAXis VOLTage</p>
<b>Frequency</b>	<p>Used to activate the two-dimensional sweep and select the frequency variation as the second sweep parameter. Not possible for noise signals and multi-tone signals. Which signal parameter is actually swept (the frequency of a single sinewave line or the center frequency of a two-tone signal) depends on the respective generator function.</p> <p>Remote-control command:  SOURce:SWEep:ZAXis FREQuency</p>
<b>Phase</b>	<p>Used to activate a two-dimensional sweep and select phase variation as the second sweep parameter. Only possible for stereo signal.</p> <p>Remote-control command:  SOURce:SWEep:ZAXis PHASe</p>
<b>On Time</b>	<p>Used to activate the two-dimensional sweep and select the burst-duration variation as the second sweep parameter. Only with burst signals. The ON-time of the burst signal is swept, i.e. the time during which the high level of the burst is output.</p> <p>Remote-control command:  SOURce:SWEep:ZAXis ONTime</p>
<b>Interval</b>	<p>Used to activate the two-dimensional sweep and select the burst-interval variation as the second sweep parameter. Only with burst signals. The interval length of the burst signal is swept.</p> <p>Remote-control command:  SOURce:SWEep:ZAXis INTervall</p>



**Note:**

The smallest "Interval" value must be greater than the largest occurring "On Time" value. With logarithmic and linear sweeps, this is ensured by limiting and, where necessary, correcting the start and stop values. With the list sweep, the user should make sure that this condition is observed in the used lists since automatic correction (if required) only begins with the currently active sweep, which can lead to unexpected results.

Theoretically, it is possible (and not forbidden on the user interface) to specify the same parameter (e.g. voltage) for both axes. In this case, the Z-parameter has no effect but nevertheless still determines the number of sweep cycles.

## Automatic Sweep

With automatic sweeps, the sweep stepping is performed automatically when a measurement has been completed (synchronous sweep) or when a definable dwell time has expired (time-triggered sweep, dwell sweep). Once started, the sweep continues to run indefinitely if no further user entries are made (in the case of one-dimensional continuous sweeps) or until the last sweep point has been reached.

Synchronous sweep ensures that sweep stepping is performed when the analyzer has carried out all the required measurements. At the same time it ensures the highest possible sweep speed, since the next sweep point is set as *soon* as measurements have finished.

Time-triggered sweep is only worthwhile in exceptional cases:

- When the analyzer is not in use.
- When the analyzer is actually being used, but the intention is for sweep stepping to be performed independently of measurement time. However, the chosen dwell time must be long enough for all measurements to have been completed before the dwell time expires.
- For the purpose of creating WAV files for external sweeps with the aid of the "Record" measurement function (Reference).

**Note:**

If it is also intended to generate valid measurement values in the course of a time-triggered sweep, it is recommended that the settings in the analyzer should be selected so as to exclude incalculable lengthening of measurement times (e.g. turn off settling, turn off autorange in the analog analyzer, select a fixed measurement time).

The automatic sweeps are selected in the "Sweep Ctrl" parameter field, whereby the sweep axis

- is calculated from user entries ("Auto Sweep") or
- is loaded with a predefined list (e.g. from a file) ("Auto List")

**Next Step**

Used to select the sweep stepping. Only visible for automatic sweeps.

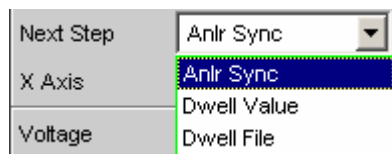

**Anlr Sync**

The sweep stepping is synchronized to the analyzer, i.e. a new sweep point is set automatically when all measurements activated in the analyzer have been completed. This setting should be selected whenever the internal analyzer is used for sweeping. It ensures that a measurement value is determined for every sweep point with minimum sweep time.

**Note:**

*If one or more measurement values cannot be determined for a particular sweep point (e.g. the selected level range of the analyzer is too low or the signal supplies a level which is too high), the measurement values concerned are marked as invalid ("NAN") and the next sweep point is set.*

Remote-control command:  
 SOURce:SWEep:NEXTstep ASYNc

**Dwell Value**

The sweep stepping is time-controlled in *constant* intervals, i.e. a new sweep point is set automatically if the preset time has expired, irrespective of whether the measurements activated in the analyzer have been completed. A new measurement is started at the same time.

The user can enter the dwell time in the next parameter field.

Dwell	0.10000	s
-------	---------	---

This setting ensures that sweep stepping is carried out in a fixed time grid. It should only be chosen if the internal analyzer is not in use, measurement values are not needed or the dwell time is longer than the longest measurement time.

**Note:**

*The measurement time needed at individual sweep points differs very widely, particularly in the case of frequency sweeps. If it is intended to generate measurement values, the "slowest" sweep point must be taken as a basis when defining the necessary dwell time (for frequency sweeps this is normally the lowest frequency). A higher sweep speed can be achieved by using "dwell files". If the selected dwell time is too short thus preventing one or more measurement values from being determined, the measurement values concerned are marked as invalid ("NAN").*

Remote-control command:  
 SOURce:SWEep:NEXTstep DWELl  
 SOURce:SWEep:DWELl <nu>

**Dwell File**

The sweep stepping is time-controlled in *individually set* intervals, i.e. a new sweep point is set automatically if the associated time has expired, irrespective of whether the measurements activated in the analyzer have been completed. A new measurement is started at the same time. The file containing the list of dwell times can be specified by the user in the parameter field below.

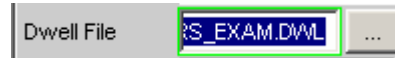

This setting makes it possible to specify not only a separate dwell time for each sweep point, but also an individual measurement time. It should only be chosen if the internal analyzer is not in use, measurement values are not needed or the dwell time of a sweep point is longer than the associated measurement time.

The dwell list is processed in the direction of the sweep, i.e. starting with the last entry in the case of a *downward sweep*. The specified dwell time will thus be maintained for each sweep point even if the sweep direction is changed.

---

**Note:**

*If measurement values are also required in this mode, the individual measurement time should be determined and entered for each sweep point in order to achieve a high sweep speed. This applies particularly to frequency sweeps using automatic measurement time.*

*If the dwell-time list is shorter than the sweep list or the length of the sweep axis, the last dwell time in the list is applicable for all remaining sweep points.*

---

Remote-control command:  
SOURCE:SWEep:NEXTstep LIST

## Linear and Logarithmic Sweep

Both linear and logarithmic sweeps are calculated automatically from user entries. For this purpose, the user must specify:

- the spacing type (logarithmic or linear)
- either the number of points ("Points") or the step size ("Step")

Spacing	Log Points	
Start	20000.0	Hz
Stop	20.0000	Hz
Points	30	

Spacing	Lin Steps	
Start	100.000	Hz
Stop	20000.0	Hz
Step	50.0000	Hz

- the start and stop value ("Start" and "Stop"), which implies the sweep direction

---

**Note:**

Since the start and stop values indicate the part of the X axis that is of interest, they are used to scale the X axis in the sweep graphs if the X axis scaling is "Auto".

---

A maximum of 1024 points are available for each sweep axis which means that each axis can be divided into max. 1023 (linear or logarithmic) equidistant steps.

**Spacing**

Used to select the sweep range spacing, i.e. the way in which the sweep points are distributed on the sweep axes. Only visible for activated generator sweep system. It is set separately for each sweep parameter.

Spacing	Log Points
Start	Lin Points
Stop	Lin Steps
Points	Log Points
	Log Steps

It can be selected separately for each sweep parameter (i.e. X and Z-axis).

**Lin Points** The sweep range is divided linearly by specifying a number of points (linear sweep). This number is entered in the "Points" parameter field.

Should be selected if equidistant, linear spacing of *all* points is required.

Remote-control command:  
(must be entered separately for each sweep parameter used)

```
SOURce:SWEEp:FREQuency:SPACing
LINPoints
SOURce:SWEEp:PHASe:SPACing LINPoints
SOURce:SWEEp:VOLTage:SPACing LINPoints
SOURce:SWEEp:ONTime:SPACing LINPoints
SOURce:SWEEp:INTerval:SPACing
LINPoints
```

**Lin Steps** The sweep range is divided into intervals of a specified linear step size starting at "Start" (linear sweep). This step size is entered in the "Step" parameter field.

Remote-control command:  
(must be entered separately for each sweep parameter used)

```
SOURce:SWEEp:FREQuency:SPACing
LINSteps
SOURce:SWEEp:PHASe:SPACing LINSteps
SOURce:SWEEp:VOLTage:SPACing LINSteps
SOURce:SWEEp:ONTime:SPACing LINSteps
SOURce:SWEEp:INTerval:SPACing LINSteps
```

**Log Points** The sweep range is divided logarithmically by specifying a number of points (logarithmic sweep). This number is entered in the "Points" parameter field. Not possible for phase sweep.

Should be selected if equidistant, logarithmic spacing of *all* points is required.

Remote-control command:  
(must be entered separately for each sweep parameter used)

```
SOURce:SWEEp:FREQuency:SPACing
LOGPoints
SOURce:SWEEp:VOLTage:SPACing LOGPoints
SOURce:SWEEp:ONTime:SPACing LOGPoints
SOURce:SWEEp:INTerval:SPACing
LOGPoints
```

**Log Steps** The sweep range is divided into intervals of a specified logarithmic step size starting at "Start" (logarithmic sweep). Each sweep point is calculated by multiplying the previous point by a constant factor. This factor is entered in the "Step" parameter field. Not possible for phase sweep.

Remote-control command:  
(must be entered separately for each sweep parameter used)

```
SOURce:SWEep:FREQuency:SPACing
LOGSteps
SOURce:SWEep:VOLTage:SPACing LOGSteps
SOURce:SWEep:ONTime:SPACing LOGSteps
SOURce:SWEep:INTerval:SPACing LOGSteps
```

**Start** Used to enter the start value for the sweep parameter set in the parameter field above. Only visible for activated generator sweep system. It is set separately for each sweep parameter.

Start	20000.0	Hz
-------	---------	----

The start and stop value implicitly determine the sweep direction: If the start value is less than the stop value, an upward sweep is performed, otherwise a downward sweep will be performed. If a start value identical to the stop value is entered, the stop value is automatically loaded with the old start value. In this way, it is possible to change the sweep direction by entering just one value.

Remote-control command:  
 SOURce:SWEep:FREQuency:START <nu>  
 SOURce:SWEep:PHASe:START <nu>  
 SOURce:SWEep:VOLTage:START <nu>  
 SOURce:SWEep:ONTime:START <nu>  
 SOURce:SWEep:INTerval:START <nu>

**Stop** Used to enter the stop value for the sweep parameter set in the parameter field above. Only visible for activated generator sweep system. It is set separately for each sweep parameter.

Stop	20.0000	Hz
------	---------	----

The start and stop value implicitly determine the sweep direction: If a stop value identical to the start value is entered, the start value is automatically loaded with the old stop value.

Remote-control command:  
 SOURce:SWEep:FREQuency:STOP <nu>  
 SOURce:SWEep:PHASe:STOP <nu>  
 SOURce:SWEep:VOLTage:STOP <nu>  
 SOURce:SWEep:ONTime:STOP <nu>  
 SOURce:SWEep:INTerval:STOP <nu>

**Points**

Used to enter the number of sweep points for the sweep parameter set in the parameter field above. Only visible for activated generator sweep system if "Lin Points" or "Log Points" is set for "Spacing". It is set separately for each sweep parameter.

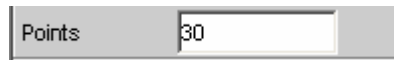

The sweep range is divided into "Points – 1" (linear or logarithmic) equidistant steps. At least 2 points (start and stop value) are required.

A maximum of 1024 points can be selected for each sweep parameter.

---

**Note:**

*If the Z-axis contains more than 20 points, only the last 20 scans are available as the data set (for saving and rescaling the graph). If a two-dimensional sweep is to be saved as a complete trace data set, the number of points on the Z-axis must not exceed 20.*

*The number of points on the Z axis (20 maximum) is copied to the Sweep Graph Config panel as "History" if it is larger than the value specified there and the X source of the current window is set to "Sweep".*

---

Remote-control command:

```
SOURce:SWEEp:FREQuency:POINts <nu>  
SOURce:SWEEp:PHASe:POINts <nu>  
SOURce:SWEEp:VOLTage:POINts <nu>  
SOURce:SWEEp:ONTime:POINts <nu>  
SOURce:SWEEp:INTerval:POINts <nu>
```

**Step**

Used to enter the (linear or logarithmic) step size for the sweep parameter set in the parameter field above. Only visible for activated generator sweep system if "Lin Steps" or "Log Steps" is set for "Spacing". It is set separately for each sweep parameter.

The entry range is limited automatically so that at least one and at most 1023 steps exist (corresponding to 1024 sweep points).

With *linear* step, the size of the step must always be entered, i.e. the numeric value is positive even if the start value is greater than the stop value. The physical unit is the same as that used when specifying "Start" and "Stop".

 (Example for lin. frequency sweep)

With *logarithmic* step, the factor must be entered by which each sweep point is to be multiplied in order to move to the next sweep point. The logarithmic step size of level sweeps can also be specified in dB. Swapping the start and stop value (reversal of the sweep direction), therefore produces the reciprocal value and changes the sign of the dB value. The closer the numeric value is to 1.0 or 0 dB, the more sweep steps will be performed.

 (Example for log. downward sweep)

**Note:**

*Since the last step of the sweep is automatically adapted such that it corresponds exactly to the stop value, it may deviate by max. 50 % from the selected step size. If this is to be avoided, either the start / stop value must be corrected accordingly or the sweep spacing must be set using the "Points" parameter.*

*The number of points on the Z axis (resulting from the Start, Stop and Step values) is copied to the Sweep Graph Config panel as "History" if it is larger than the value specified there and the X source of the current window is set to "Sweep".*

Remote-control command:

```
SOURce:SWEep:FREQuency:STEP <nu>
SOURce:SWEep:PHASe:STEP <nu>
SOURce:SWEep:VOLTage:STEP <nu>
SOURce:SWEep:ONTime:STEP <nu>
SOURce:SWEep:INTerval:STEP <nu>
```



## List Sweep

With list-controlled sweeps, any sweep axis can be defined. The sweep points may be any distance apart, but must be in ascending or descending order ("Random sweep"). The sweep points are processed by the sweep system in the order in which they exist in the list. To define the list sweep as an upward or downward sweep, the sweep points must be entered in the appropriate order. Whereas in a normal sweep each sweep point is measured once only within a scan, the list sweep also offers the ability to measure individual sweep points a multiple number of times. This is achieved by entering the relevant sweep point in the list an appropriate number of times.

The list is usually loaded as a file. It must contain at least two (different) points.

A maximum of 1024 points are available for each sweep axis; if the list contains more than 1024 values, only the first 1024 points are loaded. The first and last points in the list define the sweep direction. If the list contains a point which does not comply with this direction, the point and all subsequent points are ignored.

---

**Note:**

*Since the first and last (valid) points in the sweep list indicate the part of the X axis that is of interest, they are used to scale the X axis in the sweep graphs if the X axis scaling is "Auto".*

---

When the sweep list is being loaded, a check is made to see whether the actual basic measurement unit of the sweep file matches the sweep parameter. In addition to the R&S UPV list format (preferably with the extension \*.SWL), files originating from earlier instruments (R&S UPL and R&S UPD) are also accepted.

---

**Note:**

*If the Z-axis of the two-dimensional sweep is defined as a list containing more than 20 points, only the last 20 scans are available as the data set (for saving and rescaling the graph). If a two-dimensional sweep is to be saved as a complete trace data set, the number of points on the Z-axis must not exceed 20.*

---

### Tot Volt File

Used to enter the file name for the list of the level sweep parameter (level sweep list). Only visible for activated generator list sweep.



Which signal parameter is actually swept (the level of a single sine wave line or the total level of a multi-tone signal) depends on the selected generator function.

Remote-control command:  
 MMEemory:LOAD:VOLTage 'filename'

**Freq File**

Used to enter the file name for the list of the frequency sweep parameter (frequency sweep list). Only visible for activated generator list sweep.



Which signal parameter is actually swept (the frequency of a single sinewave line or the center frequency of a two-tone signal) depends on the selected generator function.

Remote-control command:  
MMEMory:LOAD:FREQuency 'filename'

**Phase File**

Entry of file name for the phase sweep list. Only visible with generator list sweep activated.

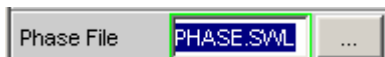

Remote-control command :  
MMEMory:LOAD:PHASe 'filename'

**On Time File**

Used to enter the file name for the list of the burst-duration sweep (burst-duration sweep list). Only visible for activated generator list sweep in the generator functions "Burst" and "Sine<sup>2</sup> Burst".

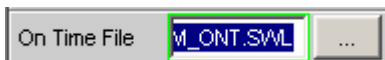

Remote-control command:  
MMEMory:LOAD:ONTime 'filename'

**Interval File**

Used to enter the file name for the list of the burst-interval sweep (burst-interval sweep list). Only visible for activated generator list sweep in the generator functions "Burst" and "Sine<sup>2</sup> Burst".



Remote-control command:  
MMEMory:LOAD:INTerval 'filename'

## Sweep Speed

The time required for a sweep cycle is only relevant for automatic sweeps and is determined by the following factors:

- Setting time of the generator
- Required dwell time; depends on the characteristics of the DUT (e.g. settling time)
- Only with synchronous sweeps (i.e. when using the internal analyzer): measurement speed

The setting times of the generator and, if necessary, the measurement time should be minimized in order to ensure the shortest possible cycle time and thus a high sweep speed. A series of optimization options are provided for this purpose:

### Minimizing the generator setting time

The setting time of the digital generator part is just a few microseconds and can therefore be disregarded. However, configuration of the analog software in the analog generator (which involves settling procedures) requires a number of milliseconds and should therefore be avoided for sweeps wherever possible.

- Using the **universal generator** instead of the low-distortion generator for *frequency* sweeps. With low frequencies in particular, the low-distortion generator requires long settling times for frequency changes. The universal generator is superior to the low-distortion generator with respect to frequency setting time and accuracy and is therefore preferable as a sweep generator. The low-distortion generator should only be used if the DUT and the measurement function require its extremely good distortion properties or large frequency range.



- Using a **fixed level range** for *level* sweep and with active precorrection; the level should be set to the highest value occurring in the sweep. The automatic operating mode controls the level of the analog hardware to maximize the signal-to-noise value of the generator at every level. This mode should only be used if sweeping is to be performed over several decades and both the DUT and the measurement function require a high S/N value.

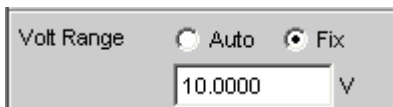

- Deactivating filtering.** An activated filter needs a short settling time for every frequency or level change.

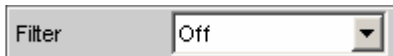

- Deactivating frequency response precorrection** for *frequency* sweeps. If the equalizer is activated, a new level must be set for each new frequency. An alternative method of frequency response correction is to use suitable reference curves when recording the measurement values.



- Reducing the dwell time** when using an *external* analyzer. The dwell time required by the DUT and the external analyzer must be determined by trial and error and can be specified as a fixed value or separately for each sweep point as a list.

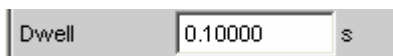

- **Synchronizing** the generator to the analyzer when using an *internal* analyzer. If the generator and analyzer of the R&S UPV are operated together, a generator sweep should always be synchronized to the analyzer. This ensures that the generator is advanced precisely at the point when all measurement results are available and have settled (where applicable also frequency, level monitor and input measurements on the active channels).

Next Step

- Reducing the measurement points for **low frequencies**. Low frequencies require longer measurement times than higher frequencies. The sweep axis should therefore be divided in such a way that only a few low tones are used. This can be achieved in the following ways:

Spacing  Linear instead of logarithmic spacing

Start  Hz  
Stop  Hz  
Increasing the lower sweep limit

Sweep Ctrl  List sweep

- Reducing the measurement points. The duration of the sweep cycle increases more or less linearly with the number of sweep points. The list sweep allows the intervals between the individual sweep points to be freely selected. This means that it is possible to group sweep points together at points of interest without needing to drastically increase their number.

Sweep Ctrl  List sweep

Step  Hz  
Avoiding an unnecessarily small step size

Points   
Avoiding an unnecessarily large number of sweep points

### Minimizing the measurement time

When using the internal analyzer, the required measurement time depends on the selected measurement functions. Generally speaking, every measurement function used should wherever possible be configured for high measurement speed; this, of course, depends on the specific measurement function. For this reason, only a few generally applicable rules are given below:

- Only activate those measurement channels which are to be measured. An unconnected measurement input can increase the measurement time considerably because measurement is only completed when a measurement value exists for this channel. A number of measurement functions require considerably more time to measure a signal with a low level (noise). Even if there is a signal on the second channel, the measurement time will still be at least slightly longer than for single-channel mode since the second channel must be fully evaluated and displayed.

Channel

- Only activate those measurement functions which are required for the specific measurement task.

Post FFT	<input type="checkbox"/>
Level Monitor	Off
Input Monitor	Off
Freq/Phase	Off
FFT Monitor	<input type="checkbox"/>
Waveform	<input type="checkbox"/>

- Deactivate any traces that are not required. In 4 sweep windows, 2 traces can be activated in each window. Only those traces that are required for measurement value recording should be active.

TRACE A	Track	TRACE B
Source		Off

- If the internal generator is used, many measurement functions allow reference to its settings ("Gen Track"). These functions should be used since they not only shorten the measurement time (because, for example, the frequency does not have to be measured) but can also increase the measurement accuracy (e.g. sample-precise setup and measurement over entire periods without errors due to measurement termination in the case of RMS).

Meas Time	Gen Track	(With RMS and RMS Selective)
-----------	-----------	------------------------------

Fundamental	Gen Track	(With THD+N and THD)
-------------	-----------	----------------------

Freq Mode	Gen Track	(With RMS Selective)
-----------	-----------	----------------------

Notch Freq	Gen Track	(With activated notch filter)
------------	-----------	-------------------------------

- Deactivating unnecessary filters. The filters must resettle whenever generator settings are changed. Measurement is not possible during this time. The start of measurement is delayed by the sum of settling times for all activated filters.

Pre Filter	Off
------------	-----

Filter	Off
Filter	Off
Filter	Off

- Reducing the order and/or attenuation with user-defined high-pass and low-pass filters. This reduces the settling time.

Filter 01: Low Pass

Order:  8  4

Attenuation: 60.0000 dB

- Deactivating the settling functions. The settling function does not need to be activated for the majority of measurement signals. If the DUT supplies a stable signal, the R&S UPV will return settled measurement values making the settling function unnecessarily. Using the settling (or averaging) function *multiplies* the measurement time by at least the number of set "samples".

Fnc Settling: Off

- Deactivating the measurement start delay. The measurement start delay is intended to compensate delays of the DUT. Whenever generator or analyzer settings are changed, the start of the 1<sup>st</sup> measurement (and consequently every single sweep point) is delayed by the specified time. This time should be set to 0.0 if no start delay is required.

Delay: 0.00000 s

- Manual selection of the analyzer level range (only with analog measurement signals). If the level of the measurement signal is known and a limitation of the dynamic response is acceptable, the analyzer level range should be selected manually. It should be set to the highest anticipated level; an "UNDERRANGE" must be expected and tolerated in this case; a new measurement with corrected range setting is not performed. "Range LOWER" can be selected to make sure that a higher level which would invalidate the measurement does not occur. This mode allows the measurement to correct the measuring range in the case of "OVERRANGE".

Ch1 Range: Lower

1.0 V RMS

# Selecting the Analyzer

## Analyzer Configuration Panel

The Analyzer Config panel enables you to enter settings for the analog or digital analyzer.

To adapt the R&S UPV analyzer to the measurement task at hand, first define the settings in the Analyzer Config panel. These settings will influence which capabilities are available in the Analyzer Function panel.

The first step is to select one of the two analyzers (analog or digital).

**Instrument** Used to selection the analyzer.

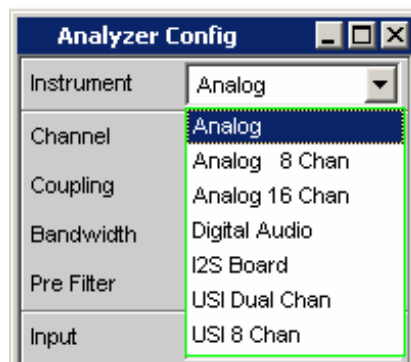

**Analog** The user can choose between analyzers of various bandwidths.

Remote-control command:  
INSTRUMENT2[:SElect] ANLG

**Analog 8 Chan** Up to 8 channels can be synchronously measured.

Remote-control command:  
INSTRUMENT2[:SElect] A8Channel

**Analog 16 Chan** Up to 16 channels can be measured.

Remote-control command:  
INSTRUMENT2[:SElect] A16Channel

**Digital Audio** Either audio data, amplitude, jitter and phase or a common signal can be measured, see section "Configuring the Digital Analyzer" on page 4.166.

Remote-control command:  
INSTRUMENT2[:SElect] DIG

**I<sup>2</sup>S Board** The I<sup>2</sup>S audio analyzer can measure audio data (8 bit to 32 bit) in I<sup>2</sup>S format.

Remote-control command:  
INSTRUMENT2[:SElect] I2SBoard

**USI Dual Chan** Audio data in a serial format can be measured with the USI Dual channel analyzer.

```
Remote-control command::  
INSTRument2[:SElect] U2Channel
```

**USI 8 Chan** Audio data in a serial format can be measured with the USI 8 channel analyzer.

```
Remote control command:  
INSTRument2[:SElect] U8Channel
```



# Configuring the Analog Analyzer

## Analog Analyzer Configuration Panel

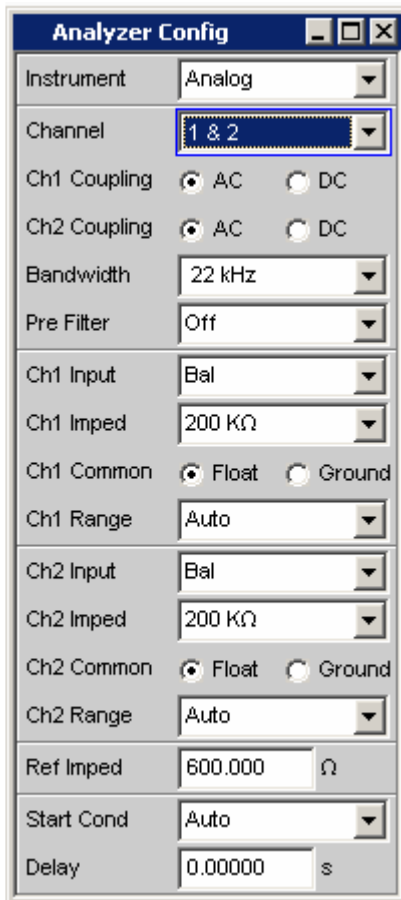
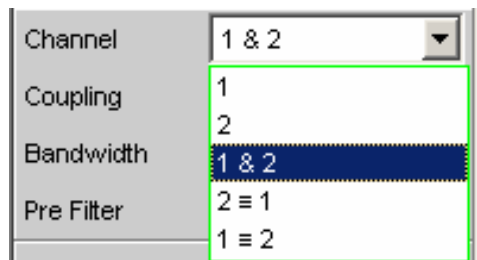

Figure 4-11 Analyzer Config panel

The Config panel is used to set up the analog and digital analyzer. The configuration options for the analog analyzer are described below.

**Channel**

Used to select the active XLR sockets in the bottom right-hand part of the R&S UPV front panel.



If a single-channel measurement is selected (1 or 2), the channel not being measured is disabled. Disabled inputs are floating; they are terminated with the set input impedances (300 Ohm, 600 Ohm or 200 kOhm).

- |                  |   |
|------------------|---|
| <b>1</b>         | <p>Only the signal applied at XLR socket 1 is measured.</p> <p>Remote-control command:<br/>INPut:CHANnel CH1</p>  |
| <b>2</b>         | <p>Only the signal applied at XLR socket 2 is measured.</p> <p>Remote-control command:<br/>INPut:CHANnel CH2</p>  |
| <b>1 &amp; 2</b> | <p>Both XLR sockets are available for analysis of the applied signals.<br/>Channel 1 and Channel 2 can have different settings.</p> <p>Remote-control command:<br/>INPut:CHANnel CH1And2</p>                |
| <b>2 ≡ 1</b>     | <p>Both XLR sockets are available for analysis of the applied signals.<br/>Here, however, the setting for Channel 1 is also used for Channel 2.</p> <p>Remote-control command:<br/>INPut:CHANnel CH2Is1</p> |
| <b>1 ≡ 2</b>     | <p>Both XLR sockets are available for analysis of the applied signals.<br/>Here, however, the setting for Channel 1 is also used for Channel 2.</p> <p>Remote-control command:<br/>INPut:CHANnel CH1Is2</p> |

**Coupling**

Used to select the input coupling.  
 AC or DC coupling can be selected. The coupling can be selected separately for both channels if "Channel 1&2" is set.  
 DC coupling should be selected if input voltages with very low-frequency signal components are to be measured.

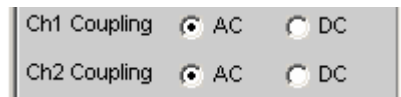

Remote-control command:  
 INPut[1]|2:COUPling AC|DC

**AC** The DC component of the measurement signal is removed at the input using a high-pass filter and therefore cannot affect the measurement result.

Remote-control command:  
 INPut:COUPling AC

**DC** Measurement signals up to 0 Hz are recorded and taken into consideration in the measurement results of RMS, RMS Selective, Peak, Quasi Peak, DC, FFT and Waveform.

---

**Caution:**  
*If the input signal contains a large DC component, this results in a reduced dynamic response for the AC component since the measuring range of the input amplifier is based on the overall signal.*

---

Remote-control command:  
 INPut:COUPling DC

**Bandwidth**

4 different analyzer bandwidths are available; the selected bandwidth determines the upper frequency limit for the measurement signal.

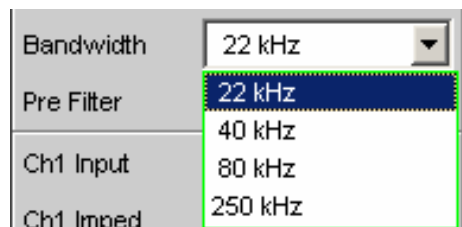

**22 kHz** The maximum signal frequency is 22 kHz. The signal is sampled at 48 kHz.

**Note:**

*At this bandwidth it is possible to observe the input signal continuously (in particular via FFT and waveform).*

```
Remote-control command:
INPut:BAWdwidth:MODE B22
```

**40 kHz** The maximum signal frequency is 40 kHz. The signal is sampled at 96 kHz.

```
Remote-control command:
INPut:BAWdwidth:MODE B40
```

**80 kHz** The maximum signal frequency is 80 kHz. The signal is sampled at 192 kHz.

```
Remote-control command:
INPut:BAWdwidth:MODE B80
```

**250 kHz** The maximum signal frequency is 250 kHz. The signal is sampled at 768 kHz.

```
Remote-control command:
INPut:BAWdwidth:MODE B250
```

**Pre Filter**

The selected prefilter affects all measurement functions. This means that prefiltering is possible without having to select the required filter for every single measurement function.



The description or characteristic of the various filters is found in section *"Filters"* on page 4.416.

```
Remote-control comand:
INPut:FILTer<parameter>
```

List of <parameter> see section *"Filter Table"* on page 4.419.

**Ch1 Input**  
(Ch2 Input)

Used to select the signal source for Channel 1.  
 If both channels have the same settings (2 = 1 or 1 = 2), only the text "Input" appears to the left of the selection field.  
 If Channel 1 & 2 is selected, the fields "Ch2 Input" to "Ch2 Range" also appear in which settings different to those for Channel 1 can be made for Channel 2.

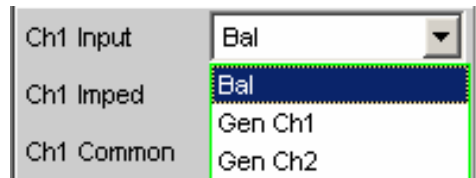

**Bal**                      **Balanced** = Balanced-to-ground measurement inputs.

Unbalanced DUTs can be connected using XLR/BNC adapters (R&S UPL-Z1 option).

Remote-control command:  
 INPut [1] | 2:TYPE BALanced

**Gen Ch1**                      Internal connection of analyzer channel 1 to generator output 1. The analyzer input impedance is 200 kOhm.

Remote-control command:  
 INPut [1] | 2:TYPE GEN1

**Gen Ch2**                      Internal connection of analyzer channel 1 to generator output 2. The analyzer input impedance is 200 kOhm.

Remote-control command:  
 INPut [1] | 2:TYPE GEN2

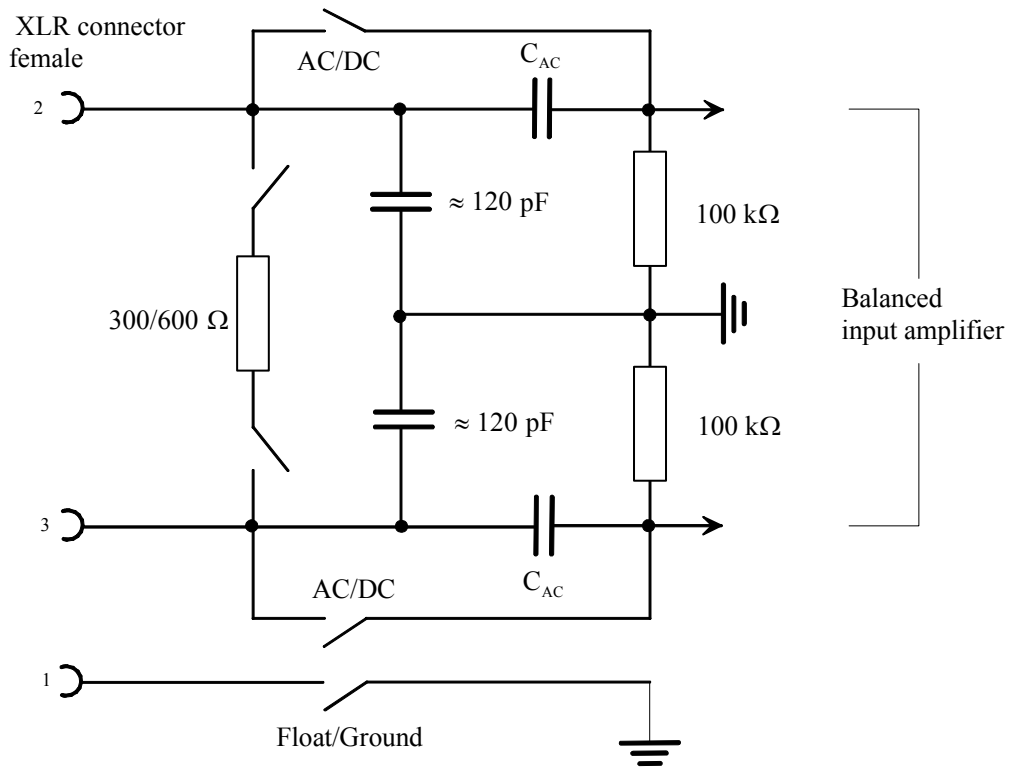

Figure 4-12 Balanced analyzer input

The two analyzer inputs can be connected to the XLR sockets to allow external signals to be measured. They can, however, also be freely connected to the outputs of the internal R&S UPV generator, as shown in the diagram below (the ground symbol represents the floating generator ground, and the earth symbol represents the analyzer and housing ground):

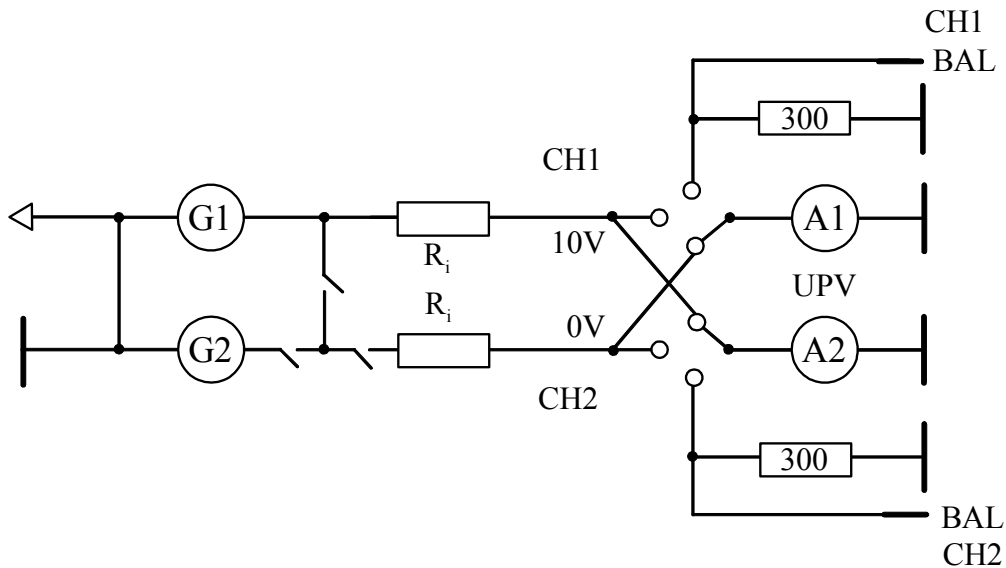

Figure 4-13 Possible connections for analyzer inputs

The sources labelled G1 and G2 represent generators 1 and 2 if the R&S UPV-B3 option (Second Generator) is installed. S1 and S2 represent the input selectors of the two analyzer inputs. They are used to switch the analyzer to an external signal or to set up an internal connection to the R&S UPV generator.  $R_{out}$  represents the generator output resistors and  $R_i$  represents the analyzer input resistors. The circles labelled A1 and A2 symbolize the R&S UPV analyzers.

### Ch1 Imped (Ch2 Imped)

Used to select the input impedance; can only be selected if Input is set to "Bal".

If both channels have the same settings (2 = 1 or 1 = 2), only the text "Impedance" appears to the left of the selection field.

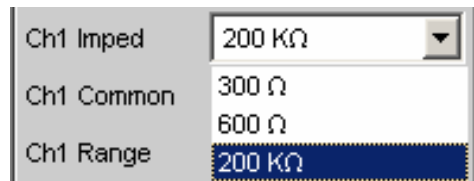

With impedances of 300 Ohm and 600 Ohm, only voltages up to 25 V can be applied (this applies to both DC and AC coupling because the low input impedances are located upstream of the coupling capacitors). In the case of voltages > 25 V, the input is protected against overloading: The input impedance is switched to 200 kOhm and the generator output is disabled (see *Chapter 3 Manual Operation, Rapid Deactivation of the Outputs*). The "OVLd" LEDs on the front panel of the R&S UPV (immediately next to the generator outputs and analyzer inputs) indicate the status.

**300 Ohm**      The input impedance is 300 Ohm.

Remote-control command:  
INPut[1]|2:IMPedance R300

**600 Ohm**      The input impedance is 600 Ohm.

Remote-control command:  
INPut[1]|2:IMPedance R600

**200 kOhm**      The input impedance is 200 kOhm.

Remote-control command:  
INPut[1]|2:IMPedance R200K

**Ch1 Common**  
(Ch2 Common)

Potential reference of Pin 1 of the XLR inputs; can only be selected if Input is set to "Bal".

"Float" must always be set if the analyzer inputs are disabled or connected to the internal generator.

If both channels have the same settings (2 = 1 or 1 = 2), only the text "Common" appears to the left of the selection field.

**Float**

The connection between XLR Pin 1 and instrument ground is interrupted by means of a tripped contact. The permissible voltage to EN 61010-1 is 30 V AC or 70 V DC with respect to the instrument housing.

Remote-control command:  
INPut[1]|2:COMMON FLOat

**Ground**

XLR Pin 1 is connected to the instrument ground (PE conductor).

The ground reference is cancelled if the analyzer is later switched to the internal generator or the set balanced channel is disabled.

**Important:**

Measurement potential reference only; not a safety connection to VDE 0411!

**Note:**

*If an XLR/BNC adapter (R&S UPL-Z1) is used, XLR Pins 1 and 3 are connected by means of the adapter. Float/Ground switching therefore allows the potential reference of the BNC outer conductor to be selected, (see also Figure 4-14).*

**Warning:**

*If dangerous contact voltages  $U_{rms} > 30$  V are to be measured, the user must ensure that the outer conductor of the used BNC/XLR adapter is safely connected to protective earth.*

Remote-control command:  
INPut[1]|2:COMMON GROund



If the signal is to be supplied via unbalanced analyzer inputs, it is advisable to use the XLR/BNC adapter R&S UPL-Z1. The internal connection of this adapter is shown in the illustration below.

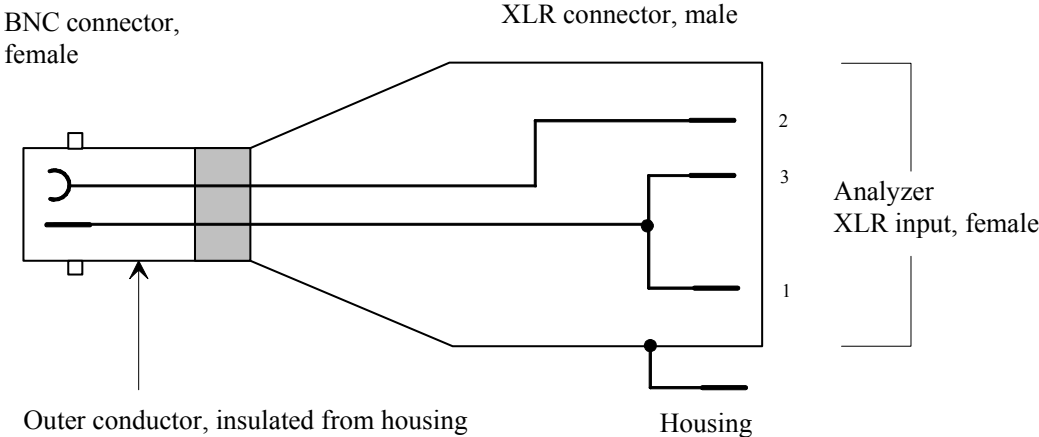
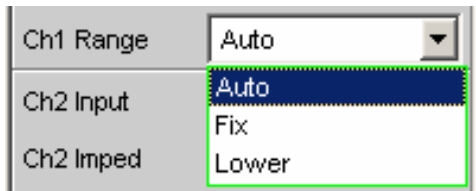

Figure 4-14 XLR/BNC adapter UPL-Z1

### Ch1 Range (Ch2 Range)

The possibility of selecting the measuring range allows optimum adaptation to a voltage range required for a specific measurement task. When the selection window is opened, the user can toggle between 3 modes.

If both channels have the same settings (2 = 1 or 1 = 2), only the text "Range" appears to the left of the selection field.



If the Fix or Lower mode is selected, the set nominal range value appears in the next field where a new range can be set by opening the selection window.

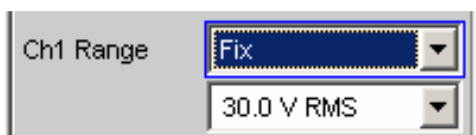

Remote-control command:

```
SENSe[1]:VOLTage:RANGe[1]|2:VALue <nu> [V]
```

**..nu = range nominal value or any voltage value**

nu = 18 mV	(0.0 ... 0.01979 V)
nu = 30 mV	(0.0198 ... 0.03299 V)
nu = 60 mV	(0.033 ... 0.06599 V)
nu = 100 mV	(0.066 ... 0.10999 V)
nu = 180 mV	(0.11 ... 0.19799 V)
nu = 300 mV	(0.198 ... 0.32999 V)
nu = 600 mV	(0.33 ... 0.65999 V)
nu = 1 V	(0.66 ... 1.09999 V)
nu = 1.8 V	(1.1 ... 1.97999 V)
nu = 3 V	(1.98 ... 3.29999 V)
nu = 6 V	(3.3 ... 6.59999 V)
nu = 10 V	(6.6 ... 10.9999 V)
nu = 18 V	(11.0 ... 19.7999 V)
nu = 30 V	(19.8 ... 32.9999 V)
nu = 60 V	(33.0 ... 65.9999 V)
nu = 100 V	(66.0 ... 110.0 V)

The query response to this command returns the range nominal value in volts, e.g.

```
SENSe:VOLTage:RANGe2:VALue?
```

Response = 0.18

For the 180 mV RMS range

Any voltage value can be specified instead of the range nominal value to specifically set the respective measurement range. This range is shown in brackets.

**Auto** Automatic measuring range selection. The optimum range is set separately for each channel; this also applies to the channel settings "2 = 1" or "1 = 2".

Remote-control command:  
`SENSE[1]:VOLTage:RANGe[1]|2:MODE AUTO`

**Fix** The set measuring range is fixed.

---

**Note:**

*If a voltage exceeding the selected level range is applied, the analyzer status display is shown as "Overrange" and the measurement values are shown as invalid ("---").*

*On switching from Auto to Fix, the currently valid range in the channel is taken over. In the configuration channels "2 = 1" or "1 = 2" the less sensitive range of Channels 1 and 2 is adopted.*

---

Remote-control command:  
`SENSE[1]:VOLTage:RANGe[1]|2:MODE FIXEd`

**Lower** The set measuring range is fixed as the lowest range; in the case of overranging, this range is automatically substituted by higher ranges.

---

**Note:**

*On switching from Auto to Lower, the currently valid range in the channel is taken over. In the configuration channels "2 = 1" or "1 = 2" the less sensitive range of Channels 1 and 2 is adopted.*

---

Remote-control command:  
`SENSE[1]:VOLTage:RANGe[1]|2:MODE LOWEr`

If Channel 1 & 2 is selected, the fields "Ch2 Input" to "Ch2 Range" appear after this parameter block. In these fields, settings different to those for Channel 1 can be made for Channel 2.

The ranges are graduated in steps of 5 dB from 18 mV to 100 V and allow optimum dynamic response when measuring non-linear distortion. If "Auto" (automatic range selection) is set, overranging or underranging of the limits in a current measuring range causes the instrument to switch to the next step. This is also the case for the "Lower" range setting; here, however, the instrument only goes down to the selected range limit.

The range values are RMS values for sinewaves or other signal shapes up to a crest factor of  $\sqrt{2}$ .

**Ref Imped**

Reference value for impedance.

 A screenshot of a control panel for 'Ref Imped'. It features a text box containing the value '600.0000' and a unit selector button with the Greek letter Omega (Ω) next to it.

Reference impedance for the indicated power in the units dBm, W, Δ%W, ΔW, P/Pr and %P/Pr.

The power is calculated using the following formula:

$$P = \frac{U^2}{R}$$

where U is the measured voltage and R is the set reference impedance. The indicated power is only correct if the reference impedance is identical to the resistance of the DUT.

Remote-control command:

SENSe[1]:POWer:REFerence:RESistance <nu>

**Start Cond**

Indicates the event which triggers a measurement.

 A screenshot of a control panel for 'Start Cond'. It features a dropdown menu with 'Auto' selected.

Depending on the selected "Start Cond", measurement begins either immediately (Auto) or not until the desired trigger condition has been satisfied. For details, see section "Start Conditions" on page 4.221.

**Delay**

Delay for Start Cond.

 A screenshot of a control panel for 'Delay'. It features a text box containing the value '0.000000' and a unit selector button with the letter 's' next to it.

A delay can be entered if "Auto" is selected as the Start Cond. For details, see section "Start Conditions" on page 4.221.

# Configuring the Analog Multichannel Analyzer

## Multichannel Analyzer Configuration Panel

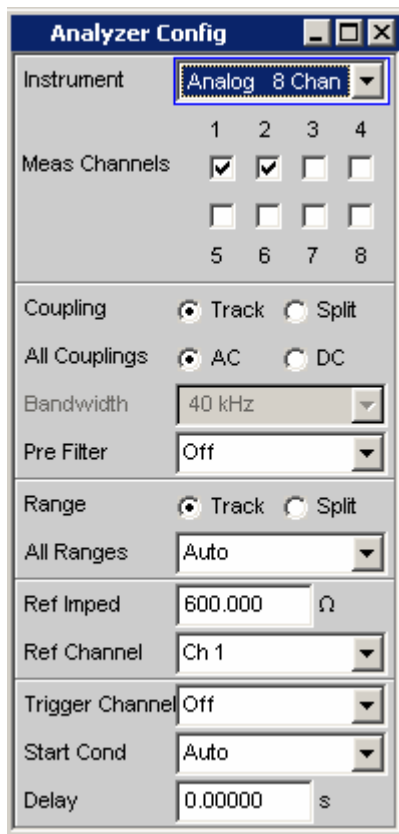
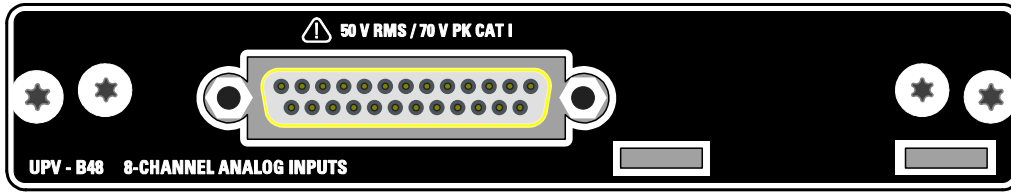

Figure 4-15 Multichannel Analyzer Config panel

The Config panel allows you to make settings for the analog analyzers and the digital analyzer. The configuration options for the analog multichannel analyzer are described in the following. When the multichannel analyzer is called for the first time, channels Ch1 and Ch2 are activated and all ranges are set to "Auto" in order to avoid overranging when creating a user-defined input signal. For safety reasons the inactive channels are set to the most sensitive measurement range (50 V).

Input connector of the option R&S UPV-B48:



**NOTICE!**

The instrument complies with measuring category I; make sure that the input voltage at the connectors of the analog analyzers does not exceed 50 V (effective, sinusoidal) and 70 V (peak value).

Do not use the instrument in measuring categories II, III and IV.

*Explanation:*

Measuring circuits as defined in section 6.7.4 of EN61010-1: Measuring category I is intended for measurements on circuits which are not connected to the high-voltage current system.

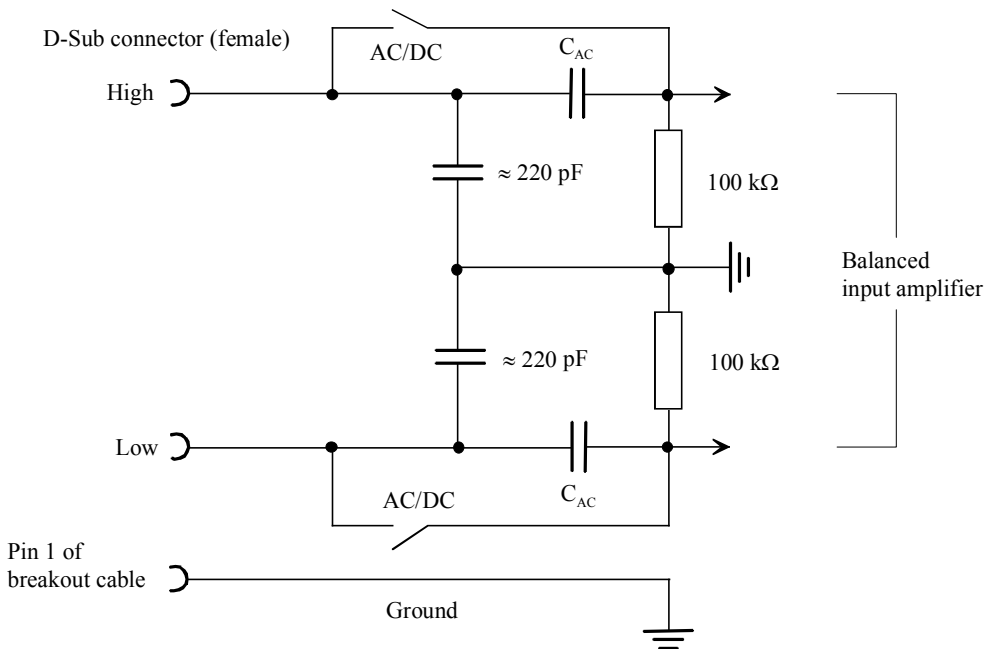

Figure 4-16 Balanced analyzer input

The eight analyzer inputs are available on the pins of a 25-contact D-Sub female connector. To adapt to the XLR connectors conventionally used in the audio world, a breakout cable with eight XLR input sockets on one side and a 25-contact D-Sub male connector on the other side must be connected to the D-Sub female connector (option R&S UPV-Z48).

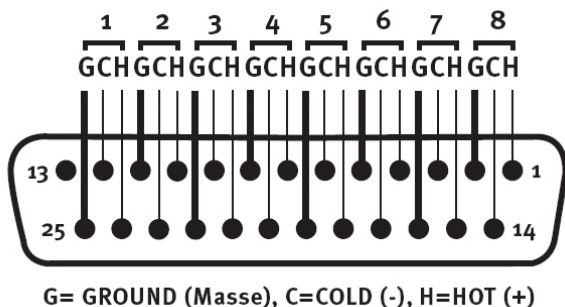

Figure 4-17 Pin assignment of the 25-contact D-Sub male connector

To enable unbalanced feed to the analyzer inputs, it is advisable to use the R&S UPL-Z1 XLR/BNC adapter in addition to the breakout cable described above. The internal wiring of this adapter is shown in the following diagram.

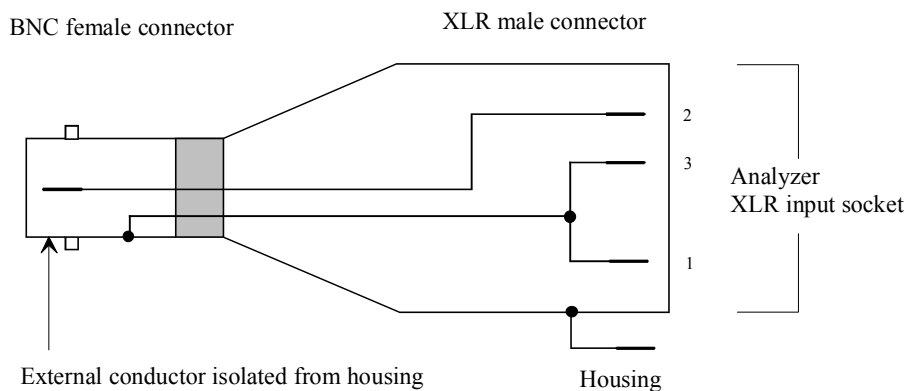

Figure 4-18 R&S UPL-Z1 XLR/BNC adapter

**Meas Channels**

Used to select the active inputs on the R&S UPV rear panel (25-contact D-Sub connector).



The active measurement channels are selected by enabling the desired channels. All inputs are floating; they are terminated with an input impedance of 200 kOhm.

If the R&S UPV is equipped with two R&S UPV-B48 options, 16 channels will be available:

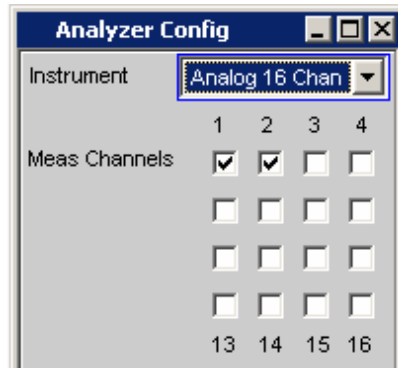

Remote-control command:  
 INPut:MCChannels<n> ON|OFF



**Coupling**

Used to select the input coupling.

AC or DC coupling can be selected. The coupling can be selected for all channels together (Track) or separately from each other (Split).



Remote-control command:

```
INPut:COUPling:CHANnels TRACK|SPLit
```

If Track is selected in the top line, you see the following line:



The reference channel for the Track function is always the reference channel. The coupling of the inactive channels does not change.

If Split is set, coupling can be selected for each channel individually:

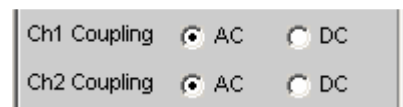

The number of new displayed control lines depends on the number of activated measurement channels.

DC coupling should be selected if input voltages with very low-frequency signal components are to be measured.

**AC**

The DC component of the measurement signal is removed at the input using a high-pass filter and therefore cannot affect the measurement result.

**Track mode**

Remote-control command:

```
INPut:COUPling AC
```

**Split mode**

Remote-control command:

```
INPut<n>:COUPling AC
```

**DC** Measurement signals up to 0 Hz are recorded and taken into consideration in the measurement results of RMS, RMS Selective, Peak, Quasi Peak, DC, FFT and Waveform.

**Caution:**

If the input signal contains a large DC component, this results in a reduced dynamic response for the AC component, since the measurement range of the input amplifier is based on the overall signal.

**Track mode**

Remote-control command:  
INPut:COUPling DC

**Split mode**

Remote-control command:  
INPut<n>:COUPling DC

**Bandwidth**

The analyzer bandwidth is permanently set at 40 kHz. This line is a pure display window for informing the user of the maximum possible measurement bandwidth.

**Pre Filter**

The selected prefilter affects all measurement functions. This means that prefiltering is possible without having to select the required filter for every single measurement function.

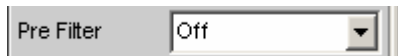

The description or characteristic of the various filters is found in section *"Filters"* on page 4.416.

Remote-control command:  
INPut:FILTer <parameter>

List of <parameter>, see section *"Filter Table"* on page 4.419.

**Ch1 Range**  
(Ch2 to Ch16 Range)

The possibility of selecting the measurement range allows optimum adaptation to a voltage range required for a specific measurement task.

As with the switch-over between AC and DC coupling, it is also possible to select between two options for range setting: either a common setting function for all ranges of the active channels or independent setting of individual channels.



The reference channel for the Track function is always the active channel. Independent of this, the inactive channels always remain in the most insensitive range.

Remote-control command:  
INPut:RANGe:CHANnels TRACk|SPLit

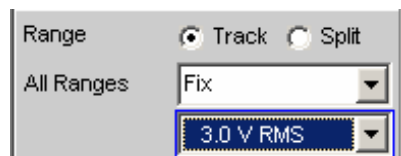

To prevent overranging of one or more active channels, the least sensitive range of all active channels is set by the following manual switch-overs:

- In Track mode when switching over from Auto to Lowest, or from Fix to Lowest
- When switching over from Split to Track if the reference channel is set to Fix or Lowest.

If Split was selected in the top line, the range settings can be selected separately for each activated channel above.

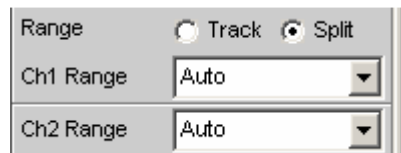

The number of newly displayed lines depends on the number of activated measurement channels.

After opening the selection window, you can toggle between three modes. If all channels have the same setting (Track), only the text "All Ranges" appears to the left of the selection box.

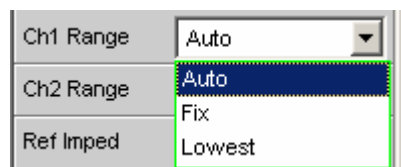

If the Fix or Lowest mode is selected, the set nominal range value appears in the next line, where a new range can be set by opening the selection window.

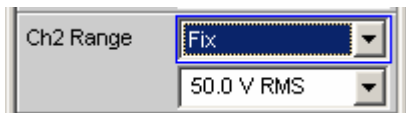

Remote-control command:

```
SENSe:VOLTage:RANGe<ch>:VALue <nu>
```

ch = channel number 1 ... 16

..nu = **range nominal value** or **any voltage value**

nu = 200 mV (0.00 ... 0.21999 V)

nu = 800 mV (0.22 ... 0.87999 V)

nu = 3 V (0.88 ... 3.29999 V)

nu = 12 V (3.3 ... 13.19999 V)

nu = 50 V (13.2 ... 55.00 V)

The query response to this command returns the range nominal value in volts, e.g.

```
SENSe:VOLTage:RANGe<n>:VALue?
```

Response = 0.8

For the 800 mV RMS range

Any voltage value can be specified instead of the range nominal value to specifically set the respective measurement range. This range is shown in brackets.

**Auto** Automatic measurement range selection. The optimum range is set separately for each channel.

#### Track mode

Remote-control command:

```
SENSe:VOLTage:RANGe:MODE AUTO
```

#### Split mode

Remote-control command:

```
SENSe:VOLTage:RANGe<n>:MODE AUTO
```

**Fix** The set measurement range is fixed.

---

**Note:**

*If a voltage exceeding the selected level range is applied, the analyzer status is displayed with a red digit in the lower status line (the digit indicates the channel that is overranged) and the measurement values are shown as invalid ("---"). On switching from Auto to Fix, the currently valid range in the channel is taken over.*

---

**Track mode**

Remote-control command:  
SENSe:VOLTage:RANGe:MODE FIXed

**Split mode**

Remote-control command:  
SENSe:VOLTage:RANGe<n>:MODE FIXed

**Lowest** The set measurement range is fixed as the lowest range; in the case of overranging, this range is automatically substituted by higher ranges.

---

**Note:**

*On switching from Auto to Lowest, the currently valid range in the channel is taken over.*

---

**Track mode**

Remote-control command:  
SENSe:VOLTage:RANGe:MODE LOWer

**Split mode**

Remote-control command:  
SENSe:VOLTage:RANGe<n>:MODE LOWer

The ranges are graduated in steps of 12 dB from 200 mV to 50 V and allow very good dynamic response when measuring nonlinear distortion. If "Auto" (automatic range selection) is set, overranging or underranging of the limits in a current measurement range causes the instrument to switch to the next step. This is also the case for the "Lowest" range setting; here, however, the instrument only goes down to the selected range limit.

The range values are RMS values for sinewaves or other signal shapes up to a crest factor of  $\sqrt{2}$ .

**Ref Imped**

Reference value for impedance.

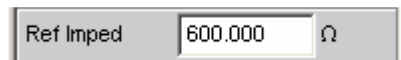

Reference impedance for the indicated power in the units dBm, W, Δ%W, ΔW, P/Pr and %P/Pr.

The power is calculated using the following formula:

$$P = \frac{U^2}{R}$$

where U is the measured voltage and R is the set reference impedance. The indicated power is only correct if the reference impedance is identical to the resistance of the DUT.

Remote-control command:

SENSE[1]:POWER:REFERENCE:RESistance <nu>

**Ref Channel**

Reference channel for phase measurements, channel-specific measurements such as common-channel selectivity and the like.

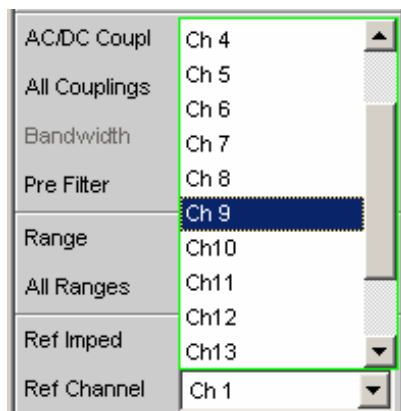

Any measurement channel can be chosen as the reference channel. If a channel that is not yet active (i.e. switched off) is selected as the reference channel, this channel is automatically switched on.

Switching off a channel that was selected as the reference channel is prevented, and the user is advised of this by the following warning:

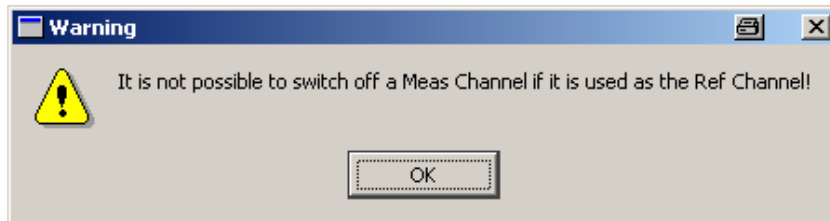

Remote-control command:

SENSE:REFERENCE:CHANNEL CH<n>

**Trigger Channel**

Allows the channel whose event triggers a measurement to be selected.

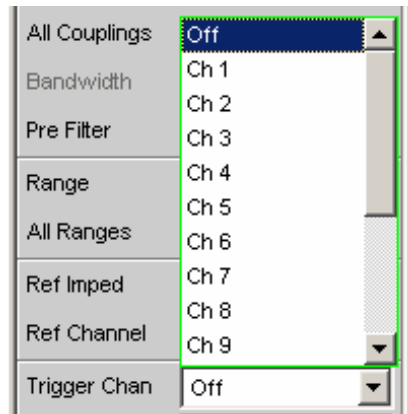

If a measurement channel that has been inactive up to now has been selected as the trigger channel, it is automatically switched on. If the channel selected as the trigger channel is switched off, the following warning appears:

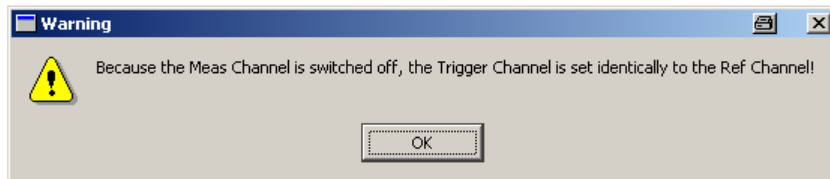

Switching off the measuring channel, which was selected as the trigger channel, therefore changes the trigger channel after this warning has been acknowledged.

Remote-control command:  
 TRIGger:CHANnel CH<n>  
 TRIGger:CHANnel OFF

**Start Cond**

Indicates the event that triggers a measurement.



Depending on the selected "Start Cond", measurement begins either immediately (Auto) or not until the desired trigger condition has been satisfied. For details, see section "Start Conditions" on page 4.221.

Remote-control command:  
 TRIGger:SOURce AUTO|TIM

**Delay**

Delay for Start Cond.

A delay can be entered if "Auto" is selected as the Start Cond. For details, see section "Start Conditions" on page 4.221.

Remote-control command:  
TRIGGER:DELAY <nu>



# Configuring the Digital Analyzer

## Digital Analyzer Configuration Panel

The configuration panel is used to set up the analog and digital analyzer. The configuration options for the digital analyzer are described below.

**Meas Mode**  
(with R&S UPV-B2 only)

Meas Mode specifies what is to be measured at the digital interfaces. With digital audio interfaces, there are basically two signal types which have to be measured, i.e. the interface signal and the encoded audio signal itself.

Apart from the encoded audio signal (Audio Data), the R&S UPV can also measure various noise signals (impairments) at the interface: Shifting of the signal edges (jitter) or superimposition of a common-mode voltage on the balanced digital lines (common mode). The internal analog analyzer is used for measuring such signals.

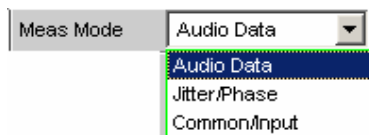

### Audio Data

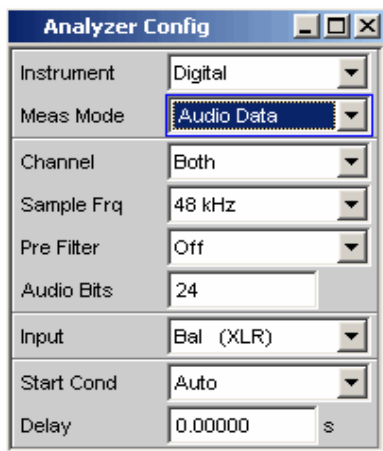

The data content of the selected digital audio input is extracted from the digital audio signal and analyzed. The Analyzer Config panel contains the selection fields relevant for this Meas Mode.

Remote-control command:  
SENSe:DMODE ADATa

### Jitter/Phase

(with R&S UPV-B2 only)

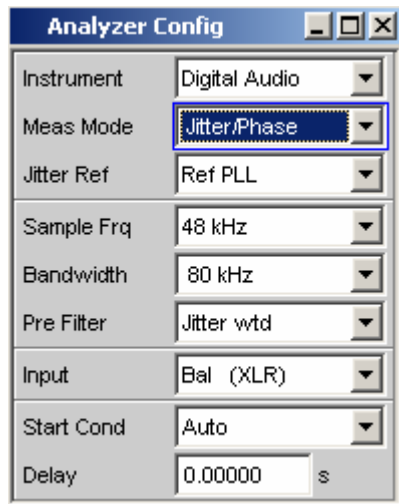

Measurement of jitter signals at the digital audio inputs.

Measurement of a frame phase offset of the digital audio signal between the front input and AUX input.

The digital interface signal has analog parameters on which, for example, noise or other interference signals can be superimposed – this interference is also noticeable as shifting of the signal edges. When this effect (known as "jitter") exceeds a certain magnitude, it becomes impossible to decode or regenerate the audio signal correctly. Here, the decoders used in practice often behave differently which means that it may be advisable to perform measurements across the entire range of jitter compatibility, for example.

The value of the jitter and delay fault is normally given in UI (Unit Interval). One UI is defined as the smallest pulse width of the digital audio signal (eye width) and does not depend on the selected sampling rate. One UI corresponds to the clock period with which the digital signal is clocked ("biphase clock"). With digital audio signals, one UI corresponds to 128<sup>th</sup> of the sampling period; at 48 kHz, one UI is 163 ns.

If several digitally encoded signals are merged (common practice in, for example, studio engineering), the phase position of the frames in the digital audio signals (i.e. the components which contain the sample value of the left and right-hand channel) plays a significant role. Using the R&S UPV, this shift can be measured as the phase between the digital input (on the front panel) and the reference channel (AUX input on the rear panel).

Remote-control command:  
SENSe:DMODE JPHase

### Common/Input

(with R&S UPV-B2 only)

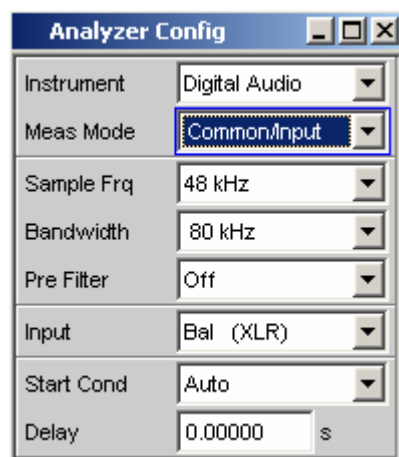

Measurement of the common signal at the digital Bal input.

The DIGITAL INPUT amplitude can be measured at the Bal or Unbal input.

As is customary in analog technology, balanced cables are also used for digital audio signal links. Here, interference (e.g. from ground loops) occurs as common-mode voltage at the interfaces.

Remote-control command:  
SENSe:DMODE CINPut

**Channel**

Used to set the active measurement channel in the Meas Mode "Audio Data".  
 Used to select the audio data for the left-hand channel (Channel = 1), right-hand channel (Channel = 2) or both channels (Channel = Both).

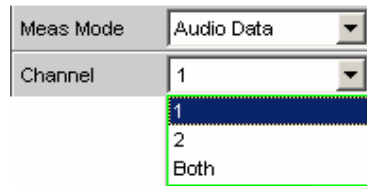

If a single-channel measurement is selected (Ch1 or Ch2), the data content of the other channel is not taken into consideration.

- 1** Only the signal on the left-hand channel is measured.

Remote-control command:  
 INPut:CHANnel CH1

- 2** Only the signal on the right-hand channel is measured.

Remote-control command:  
 INPut:CHANnel CH2

- Both** Both channels are measured (stereo).

Remote-control command:  
 INPut:CHANnel BOTH

**Jitter Ref**  
 (with R&S UPV-B2 only)

Used to select the jitter reference clock (only available for jitter measurement).

If jitter is to be measured, a reference clock must be available. The internal oscillator (generator clock) can be used for this purpose. Alternatively, a reference PLL (Phase Locked Loop) can also be used if the DUT is not synchronized to the generator of the R&S UPV. The PLL has a lower limit frequency for the obtained jitter signal; if the frequency drops below this limit, the PLL changes with the jitter signal. The clock rate of the jitter reference must be the same as the clock rate of the digital audio signal at the input. The clock of the digital audio generator or the clock obtained from the jitter reference PLL of the analyzer is provided for this purpose.

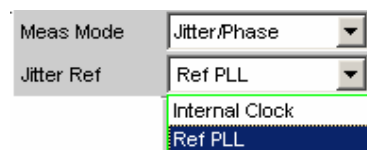

**Internal CLK** The internal clock generator is used for the jitter reference. It is always best to use this setting if the digital audio signal to be measured is supplied by the digital audio generator of the R&S UPV and this generator is running at the internal clock rate. In this case, no lower limit frequency has to be taken into consideration for the jitter measurement.

```
Remote-control command:
SENSe:JITTer:REFEreNce INTClock
```

**Ref PLL** The reference signal is the clock signal obtained from the digital audio input signal using the jitter reference PLL. The lower limit frequency of this PLL must be taken into consideration for the jitter measurement; if the frequency drops below this limit, the reference signal changes with the jitter signal and a low jitter value is measured. The limit frequency of the jitter reference PLL is approx. 500 Hz.

```
Remote-control command:
SENSe:JITTer:REFEreNce REFPl1
```

**Sample Freq**

Used to set the clock rate of the digital audio signal for the analyzer. The sample frequency setting is used as a reference for all audio data frequency measurements.

R&S UPV-B2:

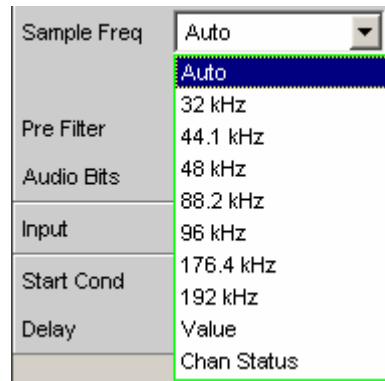

R&S UPV-B20:

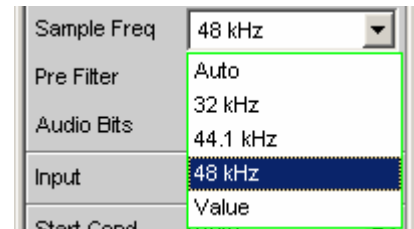

If the entered frequency does not correspond to the applied frequency, all filters and frequency measurements are shifted accordingly with respect to frequency.

When jitter measurements are performed and the jitter-reduced digital audio signal is output at the AUX output (reclock function), this parameter is used to select the correct range for the reference PLL (only with R&S@UPV-B2).

Value range for numeric entries:

30 kHz to 200 kHz (30 kHz to 55 kHz with R&S@UPV-B2)

Standard sampling frequencies can be set directly in the selection field.

---

**Note:**

*Sampling rates below 50 kHz allow the input signal to be monitored across the entire frequency range (particularly via FFT and waveform).*

---

Synchronization ranges for the jitter reference PLL:

30 kHz to 64 kHz (Base Rate range)

65 kHz to 128 kHz (High Rate range)

129 kHz to 200 kHz (Extended Rate range)

<b>Auto</b>	The sampling rate is measured, adjusted and displayed in the next menu line. In the event of a change of the input sampling rate, the value is automatically updated.
-------------	---

---

**Note:**

*The digital analyzer has to be re-initialized each time a new sampling frequency is set. To avoid this time-consuming procedure being repeated an unnecessary number of times, minor variations (below 3 Hz) are ignored.*

---

Remote-control command:  
 INPut:SAMPlE:FREQuency:MODE AUTO

<b>32 kHz</b>	Standard sampling rate 32 kHz
---------------	-------------------------------

Remote-control command:  
 INPut:SAMPlE:FREQuency:MODE F32

<b>44.1 kHz</b>	Standard sampling rate 44.1 kHz
-----------------	---------------------------------

Remote-control command:  
 INPut:SAMPlE:FREQuency:MODE F44

<b>48 kHz</b>	Standard sampling rate 48 kHz
---------------	-------------------------------

Remote-control command:  
 INPut:SAMPlE:FREQuency:MODE F48

<b>88.2 kHz</b>	Standard sampling rate 88.2 kHz
-----------------	---------------------------------

Remote-control command:  
 INPut:SAMPlE:FREQuency:MODE F88

<b>96 kHz</b>	Standard sampling rate 96 kHz  Remote-control command: INPut:SAMPlE:FREQuency:MODE F96
<b>176.4 kHz</b>	Standard sampling rate 176.4 kHz  Remote-control command: INPut:SAMPlE:FREQuency:MODE F176
<b>192 kHz</b>	Standard sampling rate 192 kHz  Remote-control command: INPut:SAMPlE:FREQuency:MODE F192
<b>Value</b>	Variable entry for sampling rate  Remote-control command: INPut:SAMPlE:FREQuency:MODE VALue INPut:SAMPlE:FREQuency <nu>
<b>Chan Status</b>	The sampling rate is determined by decoding the corresponding channel status bits in the AES/EBU protocol of the measured signal. Different bits (24 to 27 or 6 to 7 and 35 to 38) are decoded, depending on the format used ( <i>consumer</i> or <i>professional</i> ). The sampling rate is updated when a different sampling rate is decoded from the channel status bits. If the channel status bits do not supply any information (" <i>not indicated</i> "), the sampling rate last determined remains active.  Remote-control command: INPut:SAMPlE:FREQuency:MODE CHStatus

**Bandwidth**  
(with R&S UPV-B2 only)

With impairment analysis, jitter and common signals are measured up to this bandwidth setting.

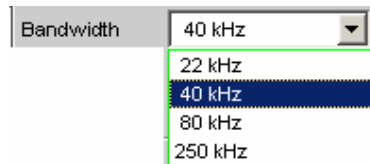

<b>22 kHz</b>	Analog analyzer bandwidth 22 kHz  Remote-control command: INPut:BANDwidth:MODE B22
<b>40 kHz</b>	Analog analyzer bandwidth 40 kHz  Remote-control command: INPut:BANDwidth:MODE B40

**80 kHz** Analog analyzer bandwidth 80 kHz

Remote-control command:  
INPut:BA<sup>ND</sup>width:MODE B80

**250 kHz** Analog analyzer bandwidth 250 kHz

Remote-control command:  
INPut:BA<sup>ND</sup>width:MODE B250

**Pre Filter**

The selected prefilter affects all measurement functions. This means that prefiltering is possible without having to select the required filter for every single measurement function.



The description or characteristic of the various filters is found in section "Filters" on page 4.416.

Remote-control command:  
INPut:FI<sup>L</sup>Ter

**Audio Bits**

Wordwidth used by the digital audio analyzer in the Meas Mode "Audio Data".

Value range: 8 to 24

If the wordwidth is reduced, the values of the audio samples are trimmed down to the specified wordwidth. Reduced wordwidth results in a corresponding reduction in dynamic response.

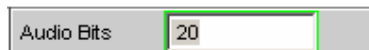

Remote-control command:  
INPut:AUDIobits <n>

**Input**

Used to select the input interface for the digital audio analyzer:

In the Meas Mode "Common/Input" (R&S UPV-K22 option), the common-mode signal is always measured at the XLR socket (Bal) regardless of which digital input is selected.

The "DIG INP AMP" measurement is performed at the selected input (Bal or Unbal).

The Common/Input measurement is not possible for the optical input or if "Intern" is selected.

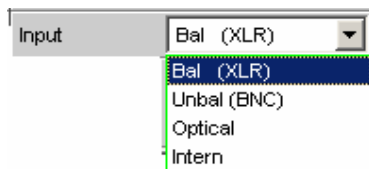

- Bal (XLR)**      Balanced digital audio input (XLR).

Remote-control command:  
INPut:TYPE AESebu
- Unbal (BNC)**    Unbalanced digital audio input (BNC).

Remote-control command:  
INPut:TYPE SPDif
- Optical**        Optical digital audio input (TOSLINK).

Remote-control command:  
INPut:TYPE OPTical
- Intern**         Internal at digital audio generator output.  
Loop measurement possible without connected cable.

Remote-control command:  
INPut:TYPE INTern

**Start Cond**

Indicates the event which triggers a measurement.

The screenshot shows a control panel with two fields. The top field is labeled 'Start Cond' and contains a dropdown menu with 'Auto' selected. The bottom field is labeled 'Delay' and contains a text input with '0.00000' and a unit 's' to its right.

Depending on the "Start Cond" selected, the measurement starts either immediately (Auto) or only once the required trigger condition is met. For details, see section "Start Conditions" on page 4.221.

**Delay**

Delay for Start Cond.

The screenshot shows a control panel with a single field labeled 'Delay' containing a text input with '0.00000' and a unit 's' to its right.

The "Delay" setting determines the time which must elapse between the above-mentioned events and restarting of the measurement so that, for example, a DUT has sufficient time to settle.

You can enter a delay for menu item Start Cond "Auto". For details, see section "Start Conditions" on page 4.221.



# Configuring the I<sup>2</sup>S Analyzer

## I<sup>2</sup>S Analyzer Configuration Panel

The Analyzer Config panel enables you to enter settings for the analog or digital analyzer. The configuration options for the I<sup>2</sup>S analyzer are described below.

### Channel

Used to set the currently active measurement channel.  
Used to select the audio data for the left channel (Ch1), right channel (Ch2) or both channels.

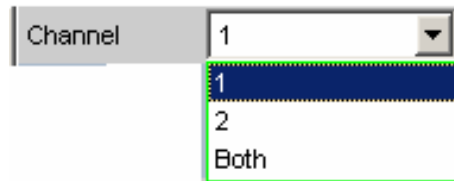

If a single-channel measurement is selected (Ch1 or Ch2), the data content of the other channel is not taken into consideration.

- |             |   |
|-------------|---|
| <b>1</b>    | Only the signal on the left channel is measured.  |
|             | Remote-control command:<br>INPut:CHANnel CH1      |
| <b>2</b>    | Only the signal on the right channel is measured. |
|             | Remote-control command:<br>INPut:CHANnel CH2      |
| <b>Both</b> | Both channels are measured (stereo).              |
|             | Remote-control command:<br>INPut:CHANnel BOTH     |

### Word Length

Word length of a data frame for each channel.

Value range: 16, 24, 32

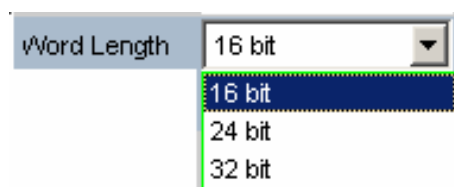

- |               |  |
|---------------|--|
| <b>16 bit</b> | Word length 16 bits                          |
|               | Remote-control command:<br>INPut:WLENgth W16 |

<b>24 bit</b>	Word length 24 bits  Remote-control command: INPut:WLENgth W24
<b>32 bit</b>	Word length 32 bits  Remote-control command: INPut:WLENgth W32

**Sample Frequency**

Used to set the sampling frequency.

The sampling frequency corresponds to the frequency of the FSYNC signal. All frequency information of generated audio data is with reference to this setting.

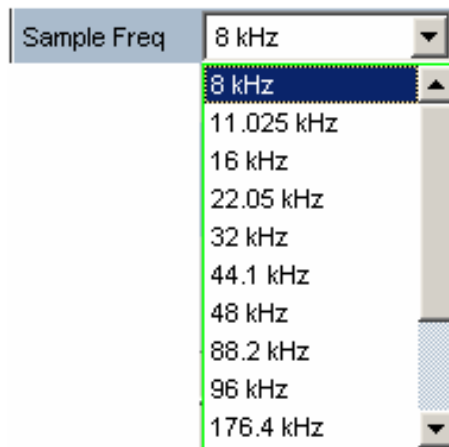

If the selected frequency does not correspond to the applied frequency, all filters and frequency measurements are shifted accordingly with respect to frequency.

Value range for numeric entry:  
6.75 kHz to 410 kHz

Standard sampling frequencies can be set directly in the selection field.

<b>Auto</b>	The sampling rate is measured, adjusted and displayed in the next menu line. In the event of a change of the input sampling rate, the value is automatically updated.
-------------	---

**Note:**

*The digital analyzer has to be re-initialized each time a new sampling frequency is set. To avoid this time-consuming procedure being repeated an unnecessary number of times, minor variations (below 3 Hz) are ignored.*

Remote-control command:  
INPut:SAMPlE:FREQuency:MODE AUTO

<b>8 kHz</b>	Standard sampling rate 8 kHz  Remote-control command: INPut:SAMPlE:FREQuency:MODE F08
<b>11.025 kHz</b>	Standard sampling rate 11.025 kHz  Remote-control command: INPut:SAMPlE:FREQuency:MODE F11
<b>16 kHz</b>	Standard sampling rate 16 kHz  Remote-control command: INPut:SAMPlE:FREQuency:MODE F16
<b>22.05 kHz</b>	Standard sampling rate 22.05 kHz  Remote-control command: INPut:SAMPlE:FREQuency:MODE F22
<b>32 kHz</b>	Standard sampling rate 32 kHz  Remote-control command: INPut:SAMPlE:FREQuency:MODE F32
<b>44.1 kHz</b>	Standard sampling rate 44.1 kHz  Remote-control command: INPut:SAMPlE:FREQuency:MODE F44
<b>48 kHz</b>	Standard sampling rate 48 kHz  Remote-control command: INPut:SAMPlE:FREQuency:MODE F48
<b>88.2 kHz</b>	Standard sampling rate 88.2 kHz  Remote-control command: INPut:SAMPlE:FREQuency:MODE F88
<b>96 kHz</b>	Standard sampling rate 96 kHz  Remote-control command: INPut:SAMPlE:FREQuency:MODE F96
<b>176.4 kHz</b>	Standard sampling rate 176.4 kHz  Remote-control command: INPut:SAMPlE:FREQuency:MODE F176
<b>192 kHz</b>	Standard sampling rate 192 kHz  Remote-control command: INPut:SAMPlE:FREQuency:MODE F192
<b>384 kHz</b>	Standard sampling rate 384 kHz  Remote-control command: INPut:SAMPlE:FREQuency:MODE F384

**Value:** Variable sampling rate entry

```
Remote-control command:
INPut:SAMPlE:FREQuency:MODE VALue
INPut:SAMPlE:FREQuency <nu>
```

### Pre Filter

The selected prefilter affects all measurement functions. This means that prefiltering is possible without having to select the required filter for every single measurement function.

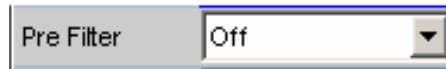

```
Remote-control command:
INPut:FILTEr <parameter>
```

### Input

Used to select the data source for the I<sup>2</sup>S audio analyzer:

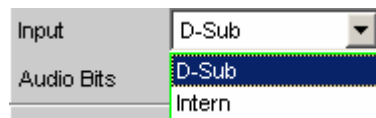

**D-Sub** The D-Sub connector at the rear of the instrument is selected as the input.

```
Remote-control command:
INPut:INPut DSUB
```

**Intern** The internal generator is selected as the input. A loop measurement can be performed without a connected cable being required (loopback test).

```
Remote-control command:
INPut:INPut INTern
```

### Format

Selection of the I<sup>2</sup>S analyzer format.



**Standard I2S** The I<sup>2</sup>S analyzer receives in the standard I<sup>2</sup>S format. The following format-influencing parameters are assigned a fixed default:

```
Fsync Slope    Left(1) = Falling
Word Offset    -1
```

```
Remote-control command:
INPut:FORMat SI2S
```

**User-definable** The I<sup>2</sup>S analyzer receives in I<sup>2</sup>S-like format. The following format-influencing parameters are additionally available:

Fsync Slope  
Word Offset

Remote-control command:  
INPut:FORMat USERdefined

**Fsync Slope**

Polarity of the Fsync signal.

Fsync Slope  Rising  Falling

**Rising** With a word offset of 0 a rising signal edge indicates the word beginning of the left data word (channel 1).

Remote control command:  
INPut:FSLoPe LFTRising

**Falling** With a word offset of 0 a falling signal edge indicates the word beginning of the left data word (channel 1).

Remote control command:  
INPut:FSLoPe LFTFalling

**Word Offset**

By using Word Offset, you can set the number of the SCK cycles by which the Fsync signal is analyzed with delay with respect to the audio data.

Value range: -"Word Length"... 0 ... +"Word Length"-1

Word Offset

Remote-control command:  
INPut:WOffset <n>

**Audio Bits**

Word width of audio data that is analyzed.

If the word width is reduced, the values of the audio samples are rounded off to the specified word length. A reduced word length leads to a reduction in the dynamic range.

Value range: 8 ... "Word Length"

Audio Bits

Remote-control command:  
INPut:AUDiobits <n>

**Start Cond**

Specifies the event that leads to a measurement.



Depending on the selected "Start Cond", the measurement either starts immediately (Auto) or not until the required trigger condition has been fulfilled. For details, refer to section "Start Conditions" on page 4.221.

**Delay**

Delay time for Start Cond.

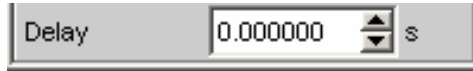

A delay can be entered for the Start Cond "Auto" menu item. For details, refer to section "Start Conditions" on page 4.221.

## Timing Diagrams

A number of configuration examples are shown in the timing diagrams below which illustrate the effect of some parameters.

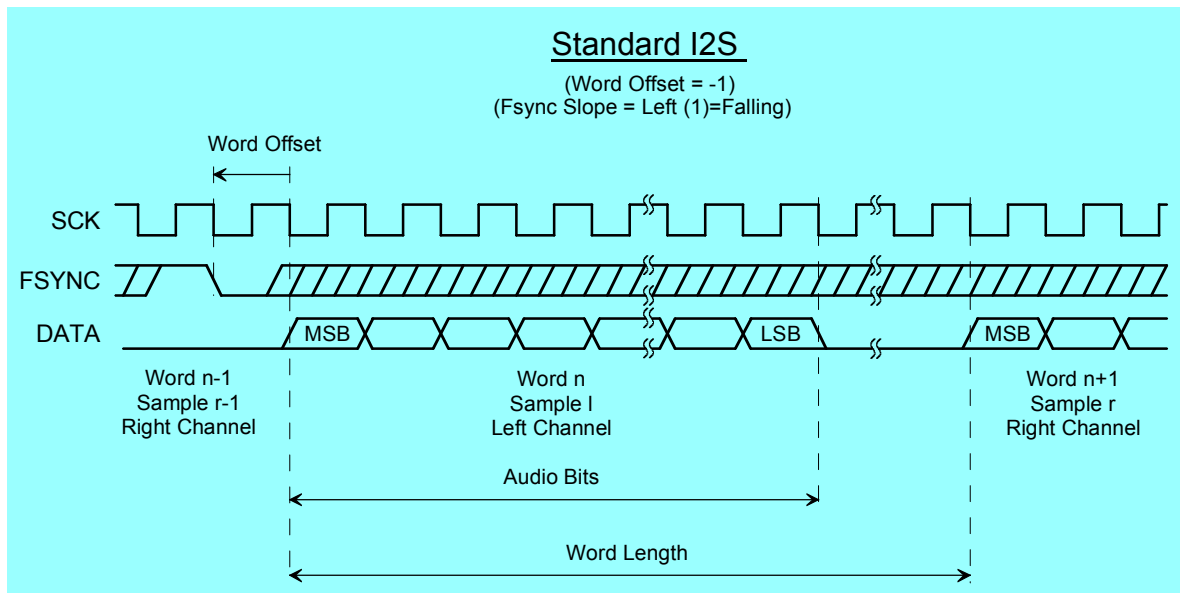

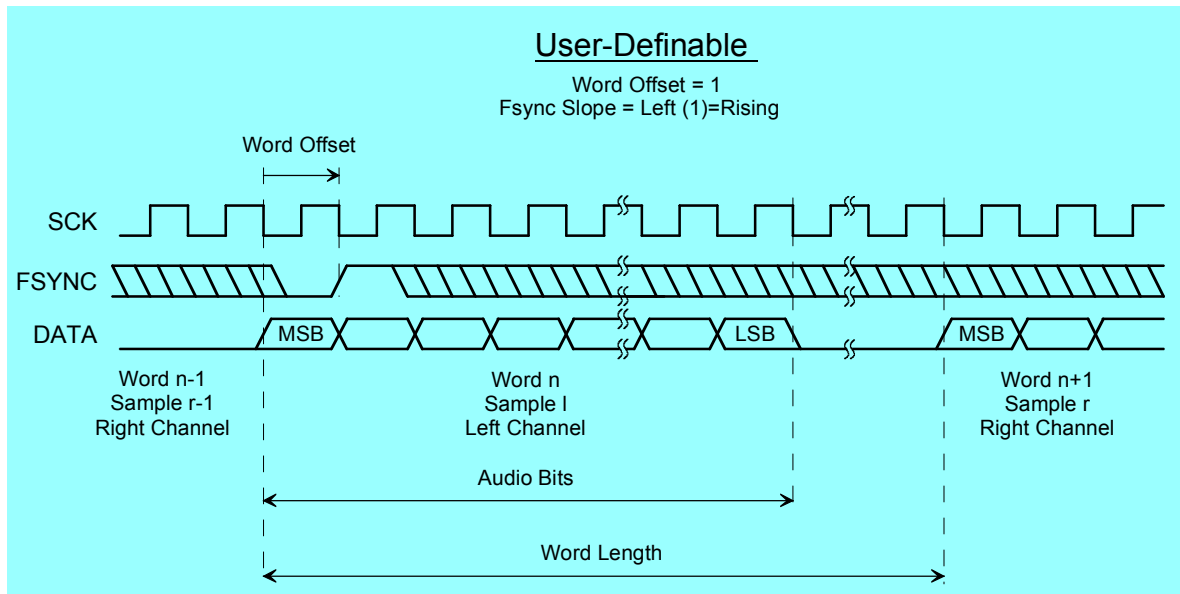

## Interface Assignment

I<sup>2</sup>S connector (25-contact D-Sub connector)

Zum Anschluss des R&S UPV über die RS 232-C-Schnittstelle wird die Verwendung eines sehr gut geschirmten Kabels empfohlen.

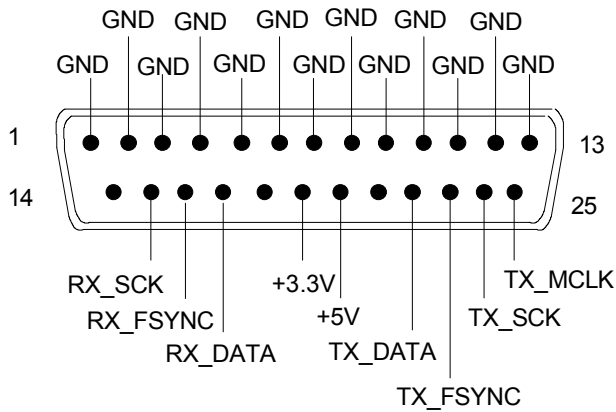

Pin	Signal	Input (I) Output (O)	Data direction
1	GND		Ground connection
2	GND		Ground connection
3	GND		Ground connection
4	GND		Ground connection
5	GND		Ground connection
6	GND		Ground connection
7	GND		Ground connection
8	GND		Ground connection
9	GND		Ground connection
10	GND		Ground connection
11	GND		Ground connection
12	GND		Ground connection
13	GND		Ground connection
14	not connected		
15	RX_SCK	I	Serial Clock Analyzer
16	RX_FSYNC	I	Frame Sync Analyzer
17	RX_DATA	I	Serial Data Analyzer
18	not connected		
Pin	Signal	Input (I) Output (O)	Data direction
19	+3.3 V (500 mA)	O	Power Supply
20	+5 V (500 mA)	O	Power Supply
21	not connected		
22	TX_DATA	O	Serial Data Generator
23	TX_FSYNC	O	Frame Sync Generator
24	TX_SCK	O	Serial Clock Generator
25	TX_MCLK	O	Master Clock Output Generator



**TX CLK IN (BNC connector)**

Pin	Signal	Input (I) Output (O)	Data direction
1	GND		Ground connection
2	TX_CLK	I	Master Clock Input Generator

# Configuring the USI Dual Channel Analyzer

## USI Dual Channel Analyzer Configuration Panel

The Config panel is used to set the analog and digital analyzer. The configuration options for the USI dual channel analyzer are described below.

### Meas Channels

Used to set the active measurement channel.



**1** Measurement channel 1 is switched on or off.

Remote control command:  
INPut:MCChannels[1] ON|OFF

**2** Measurement channel 2 is switched on or off.

Remote control command:  
INPut:MCChannels[2] ON|OFF

### Clock

Used to set the continuous clock or gated clock operating mode.

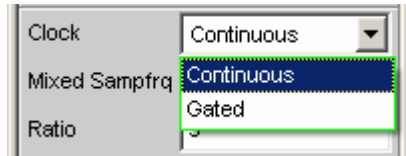

**Continuous** Prerequisite for the continuous clock mode is a continuous clock for the analyzer. The clock source may be internal or external. If synchronization is external, several types of synchronization are available for selection.

Remote control command:  
INPut:CLOCK CONTInous

**Gated** The gated clock mode must be selected if the externally supplied bit clock (BClk) and FrameSync (Fsync) are discontinuous or have such a large jitter that the internal PLL can no longer follow this clock. In this operating mode, synchronisation is limited to the external FrameSync & bit clock (Ext Fsync&BClk) option. The audio signal generated cannot be monitored.

Remote control command:  
INPut:CLOCK GATed

**Mixed Sampfrq**

Permits simultaneous analysis of data streams at varying sampling rates. The pre-filter is not available when this is activated.



Remote control command:  
INPut:MSAMplefrequency ON|OFF

**Ratio**

Up-sampling factor for the slower data stream. The input data with the lower sampling rate is characterised by correspondingly fewer entries in the Slots input field.

Value range: 2 to 6

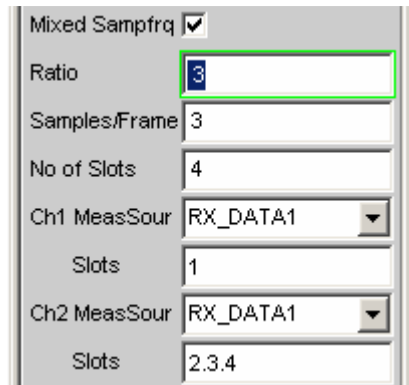

Example:

The sampling rate of the input data differs by a factor of 3. This means that one frame always contains 3 samples of the channels with the higher sampling rate and just 1 sample of the channel with the lower sampling rate. The sample of the channel with the lower data rate is in channel 1 on line 1, whilst the samples of the channel with the higher data rate are in chanel 2, 3 and 4 of the same data line.

Remote control command:  
INPut:RATio <n>

**Samples/Frame**

Used to define the number of samples per frame. The parameter simultaneously determines the minimum settable sampling rate according to the relationship:  $fs\_min = 843.75 \text{ Hz} / \text{samples/frame}$ .

Value range: 1 to 32



Remote control command:  
INPut:SPFRame <n>

**No of Slots**

Used to define the number of slots in a frame.

Value range: 1 to 256

$\text{No\_of\_Slots} * \text{Slot\_Length} \leq 2048$

$\text{Slot\_Length} * \text{No\_of\_Slots} * \text{Sample\_Freq} \leq 55.926 \text{ MHz}$



Remote control command:

INPut:NOSlots <n>

**Ch1 MeasSour**

Used to select the input data line for measuring channel 1.

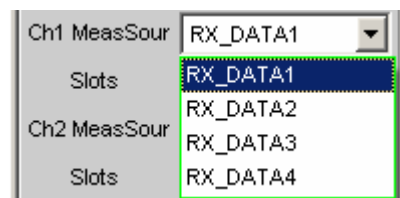

**RX\_DATA1** Measuring channel 1 analyzes the RX\_DATA1 data line.

Remote control command:

INPut:MCHSource RX1Data

**RX\_DATA2** Measuring channel 1 analyzes the RX\_DATA2 data line.

Remote control command:

INPut:MCHSource RX2Data

**RX\_DATA3** Measuring channel 1 analyzes the RX\_DATA3 data line.

Remote control command:

INPut:MCHSource RX3Data

**RX\_DATA4** Measuring channel 1 analyzes the RX\_DATA4 data line.

Remote control command:

INPut:MCHSource RX4Data

**Slots**

Used to select the audio frame slots to be analyzed for measuring channel 1.  
 (Selection of several slots is only possible with multi-sample formats! In this case a frame contains several consecutive samples from the same signal source).

Value range: 1 to no of slots

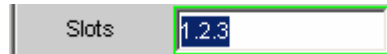

Remote control command:  
 INPut:SLOTs 'a.b.c. ... .z'

**Ch2 MeasSour**

Used to select the input data line for measuring channel 2.

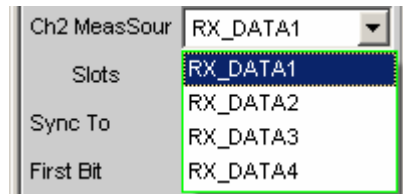

**RX\_DATA1** Measuring channel 2 analyzes the RX\_DATA1 data line.

Remote control command:  
 INPut:MCHSource2 RX1Data

**RX\_DATA2** Measuring channel 2 analyzes the RX\_DATA2 data line.

Remote control command:  
 INPut:MCHSource2 RX2Data

**RX\_DATA3** Measuring channel 2 analyzes the RX\_DATA3 data line.

Remote control command:  
 INPut:MCHSource2 RX3Data

**RX\_DATA4** Measuring channel 2 analyzes the RX\_DATA4 data line.

Remote control command:  
 INPut:MCHSource2 RX4Data

**Slots**

Used to select the audio frame slots to be analyzed for measuring channel 2.  
 (Selection of several slots only possible with multi-sample formats! In this case a frame contains several consecutive samples from the same signal source).  
 Value range: 1 no No of slots



Remote control command:  
 INPut:SLOTs2 'a.b.c. ... .z'

**Sync To**

Used to select the source on which the USI analyzer is synchronised.

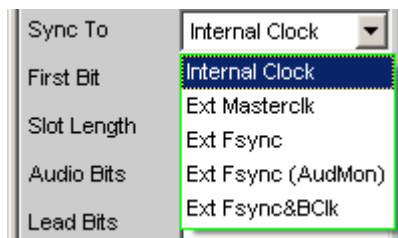

**Internal Clock** The analyzer uses the device's internal clock.

Remote control command:  
 INPut:SYNCto IClock

**Ext Masterclk** Synchronisation to an external master clock (TX\_MCLK\_IN).

Remote control command:  
 INPut:SYNCto EMASterclock

**Ext Fsync** Synchronisation to an external FrameSync signal (TX\_FSYNC\_IN). Audio monitoring of the analyzer signal is not possible. A master clock is additionally generated and output.

Remote control command:  
 INPut:SYNCto EFSync

**Ext Fsync (AudMon)** Synchronisation to an external FrameSync signal (TX\_FSYNC\_IN). It is not possible to audio monitor the analyzer signal. No master clock is output.

Remote control command:  
 INPut:SYNCto EFAMon

**Ext Fsync&BClk** Synchronisation to the external FrameSync signals (TX\_FSYNC\_IN) and the bit clock (TX\_BCLK\_IN).

Remote control command:  
 INPut:SYNCto EFBClk

Overview of the various synchronisation modes:

	Internal clock	External master clock	External frame sync	External frame sync with audiomonitor	External frame sync, bit clock	External frame sync, bit clock (gated)
Master clock Output	o	tri	o	tri	tri	tri
Master clock Input	--	x	--	--	--	--
Bit clock Output	o	o	o	o	tri	tri
Bit clock Input	--	--	--	--	x	x
Frame sync Output	o	o	o	o	tri	tri
Frame sync Input	--	--	x	x	x	x

- x Input Signal must be present
- o Output Signal is available
- tri Output in tristate mode (high impedance)
- Unused Input

**First Bit**

Used to define the data bit receiving sequence



**MSB**

The most significant data bit is received first.

Remote control command:  
INPut:FBIT MSB

**LSB**

The least significant data bit is received first.

Remote control command:  
INPut:FBIT LSB

**Slot Length**

Slot length of a slot including gaps (0 bits)

Value range: 1 to 256  
 $No\_of\_Slots * Slot\_Length \leq 2048$   
 $Slot\_Length * No\_of\_Slots * Sample\_Freq \leq 55.926\text{ MHz}$



Remote control command:  
INPut:SLTLength <n>

**Audio Bits**

Slot length of the audio data within a slot.  
 Only the specified number of data bits are analyzed.  
 Value range: 8 to slot length(max 32)

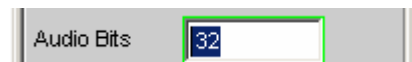

Remote control command:  
INPut:AUDIobits <n>

**Lead Bits**

Determines the offset of the audio bits within a slot relative to the start of the slot.

If LSB is selected as the first bit, the setting for lead bits is automatically corrected if the setting for audio bits is changed so that the MSB is received at the same location. This has the advantage that the resolution and not the amplitude of the measured signal is changed if the audio bits are changed.

**Example:**

Slot length: 32

Audio bits: 24 → 23 (setting changed by user)

Lead bits: 8 → 9 (automatic correction)

Value range: 0 to slot length-audio bits



Remote control command:

```
INPut:LBITS <n >
```

**Timeout**

Only available in Gated Clock mode. This parameter defines the maximum time span for which external clocks are allowed to discontinue before the measurement is declared as invalid.

Value range: 1 to 500ms

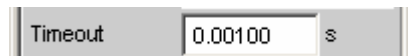

Remote control command:

```
INPut:TIMEout <nu>
```



**Sample Freq**

Used to set the sample frequency.

All received audio data frequency specifications relate to this setting. If the USI analyzer is operated with external synchronisation and the frequency of the external clock does not correspond to the set sampling frequency, the analyzer displays incorrect frequency values.

For data formats with one sample per frame, the sampling frequency corresponds to the frequency of the Fsync signal. In case of several audio data samples from one source within a frame, the frequency of the Fsync signal is the product of the sampling frequency divided by the factor of samples/frame.

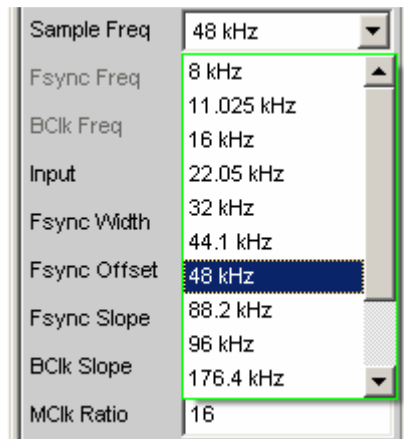

Value range for numeric input:

0.84375 kHz to 400 kHz

$\text{No\_of\_Slots} * \text{Slot\_Length} \leq 2048$

$\text{Slot\_Length} * \text{No\_of\_Slots} * \text{Sample\_Freq} \leq 55.926 \text{ MHz}$

Standard sampling rates can be directly set in the selection field.

**Auto**

The sampling rate is measured and displayed in the following line. If the sampling rate applied changes, the set value is automatically updated.

**Note:**

*the digital analyzer must be re-initialised for every new sampling frequency. So that this time-consuming task does not have to be performed too often, small deviations or fluctuations (below 3 Hz) are ignored.*

Remote control command:  
INPut:SAMPlE:FREQuency:MODE AUTO

**8 kHz**

8 kHz standard sampling rate

Remote control command:  
INPut:SAMPlE:FREQuency:MODE F08

**11,025 kHz**

11.025 kHz standard sampling rate

Remote control command:  
INPut:SAMPlE:FREQuency:MODE F11

<b>16 kHz</b>	16 kHz standard sampling rate  Remote control command: INPut:SAMPlE:FREQuency:MODE F16
<b>22,05 kHz</b>	22.05 kHz standard sampling rate  Remote control command: INPut:SAMPlE:FREQuency:MODE F22
<b>32 kHz</b>	32 kHz standard sampling rate  Remote control command: INPut:SAMPlE:FREQuency:MODE F32
<b>44,1 kHz</b>	44.1 kHz standard sampling rate  Remote control command: INPut:SAMPlE:FREQuency:MODE F44
<b>48 kHz</b>	48 kHz standard sampling rate  Remote control command: INPut:SAMPlE:FREQuency:MODE F48
<b>88,2 kHz</b>	88.2 kHz standard sampling rate  Remote control command: INPut:SAMPlE:FREQuency:MODE F88
<b>96 kHz</b>	96 kHz standard sampling rate  Remote control command: INPut:SAMPlE:FREQuency:MODE F96
<b>176,4 kHz</b>	176.4 kHz standard sampling rate  Remote control command: INPut:SAMPlE:FREQuency:MODE F176
<b>192 kHz</b>	192 kHz standard sampling rate  Remote control command: INPut:SAMPlE:FREQuency:MODE F192
<b>384 kHz</b>	384 kHz standard sampling rate  Remote control command: INPut:SAMPlE:FREQuency:MODE F384

**Value** Sampling rate numeric input



Remote control command:  
INPut:SAMPlE:FREQuency:MODE VALue

**Fsync Freq**

Is only displayed for multi-sample formats. The Frame Sync frequency corresponds to the sampling rate divided by the factor of samples/frame.

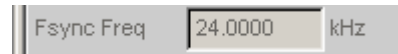

Remote control command:  
INPut:FSYnc:FREQuency?

**Bclk Freq**

Displays the bit clock frequency. Is calculated from the product of slot length \* no of slots \* sample freq / samples/frame.

Value range: 6.75 kHz ... 55.296 MHz



Remote control command:  
INPut:BCLk:FREQuency?

**Input**

Selection of the analyzer source. In internal mode, the probe is run in short circuit operation with the generator. For this the generator must be operated in internal clock synchronization mode and the analyzer in ExtFsync&Bclk mode. The signals produced by the generator can thus be analyzed without using an external plug connection. If the probe is selected as a source, the analyzer analyzes the signals at the connector.

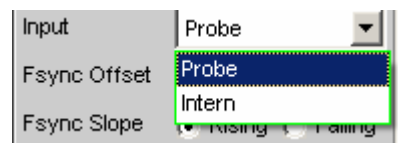

Remote control command:  
INPut:INPut INTern|PROBe

**Fsync Width**

Fsync pulse width



<b>1 bit</b>	Fsync is one data bit in length (BClk period)  Remote control command: INPut:FWIDth ONEBit
<b>1 Slot</b>	The FSYNC pulse is one slot in length (= slot length)  Remote control command: INPut:FWIDth ONESlot
<b>Square</b>	The FSYNC pulse has the shape of a symmetrical rectangle. If the number of bit clock (BClk) cycles is odd, the high phase is one cycle longer than the low phase (with Fsync Slope = Rising)  Remote control command: INPut:FWIDth SQUare
<b>Value</b>	The length of the FSYNC pulse corresponds to the numeric value in data bits (1 BClk period) Value range: 1 to (slot length*no of slots)-1  Remote control command: OUTPut:FWIDth VALue OUTPut:FWIDth:VALue <n>

**Fsync Offset**

Determines the offset of the Fsync pulse relative to the reference point (start of the first slot).  
Vaue range: -(slot length \*no of slots) to (slot length\*no of slots) -1

Fsync Offset

Remote control command:  
INPut:FOFFset <n>

**Fsync Slope**

FSYNC pulse polarity

Fsync Slope  Rising  Falling

**Rising** The FSYNC pulse begins with a positive edge.

Remote control command:  
INPut:FSLope RISing

**Falling** The FSYNC pulss begins with a negative edge.

Remote control command:  
INPut:FSLope FALLing

**BClk Slope**

Bit clock (BClk) polarity

BClk Slope  Rising  Falling

**Rising** The RX\_FSYNC\_IN, RX\_DATA1, RX\_DATA2, RX\_DATA3 and RX\_DATA4 signals are synchronized with a rising bit clock edge (RX\_BCLK\_IN if the analyzer is synchronised externally, or RX\_BCLK\_OUT if it is internally synchronised). The FrameSync (RX\_FSYNC\_OUT) generated in master mode changes, however, with a falling bit clock edge (RX\_BCLK\_OUT).

Remote control command:  
INPut:BSLope RISing

**Falling** The RX\_FSYNC\_IN, RX\_DATA1, RX\_DATA2, RX\_DATA3 and RX\_DATA4 signals are synchronised with a falling bit clock edge (RX\_BCLK\_IN if the analyzer is synchronised externally, and RX\_BCLK\_OUT if it is internally synchronised). The FrameSync (RX\_FSYNC\_OUT) generated in master mode changes, however, with a rising bit clock edge (RX\_BCLK\_OUT).

Remote control command:  
INPut:BSLope FALLing

**MClk Ratio**

Relationship between the master clock (MCLK) and FrameSync (FSYNC).  
Value range: 16 to 768 (max. 110.592 MHz)

A screenshot of a control interface for 'MClk Ratio'. It features a grey rectangular background with the text 'MClk Ratio' on the left. To the right is a white input field with a blue border, containing the number '16'. The input field is highlighted with a green rectangular border.

Remote control command:  
INPut:MRATio <n>

**Sampling Del**

This parameter permits a delay of the RX\_FSYNC\_IN, RX\_DATA1, RX\_DATA2, RX\_DATA3 and RX\_DATA4 input signal sampling times in relation to the RX\_BCLK\_IN or RX\_BCLK\_OUT clocks. Positive values delay the sampling to a later time. This feature is used above all if TCO delays, in other words response times of a device under test being operated in slave mode at high frequencies, reach the size of a bit clock period. In order to compensate for bit shifts when analyzing in the analyzer these delay times are compensated by a later sampling point.  
Value range: -10 to +10 ns

A screenshot of a control interface for 'Sampling Del'. It features a grey rectangular background with the text 'Sampling Del' on the left. To the right is a white input field with a blue border, containing the value '0.00000'. To the right of the input field is the unit 'ns'. The input field is highlighted with a green rectangular border.

Remote control command:  
INPut:SDElay <nu>

**Logic Voltage**

Used for setting the analyzer logic voltage. Changing the voltage level causes the probe to be reloaded. The probe can be attached and disconnected and put back into operation during operation with this mechanism.

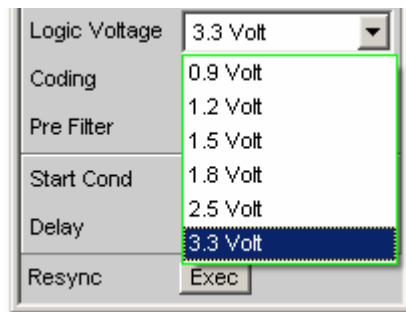

**0.9 Volt**      0.9 volts CMOS logic voltage

Remote control command:  
INPut:LOGVoltage MV0900

**1.2 Volt**      1.2 volts CMOS logic voltage

Remote control command:  
INPut:LOGVoltage MV1200

**1.8 Volt**      1.8 volts CMOS logic voltage

Remote control command:  
INPut:LOGVoltage MV1800

**2.5 Volt**      2.5 volts CMOS logic voltage

Remote control command:  
INPut:LOGVoltage MV2500

**3.3 Volt**      3.3 volts LVTTTL logic voltage

Remote control command:  
INPut:LOGVoltage MV3300

**Coding**

Generator data coding regulation. A Law and  $\mu$  Law quantification characteristics are available for telephony applications.

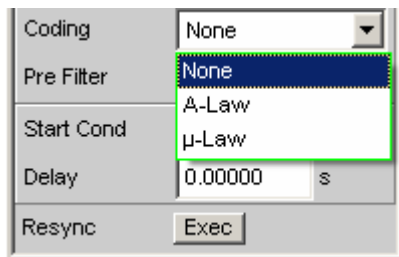

<b>None</b>	<p>Input data is analyzed linearly PCM coded.</p> <p>Remote control command: INPut:CODing NONE</p>
<b>A-Law</b>	<p>Input data is analyzed according to A Law.</p> <p>Remote control command: INPut:CODing ALAW</p>
<b>μ-Law</b>	<p>Input data is analyzed according to μ Law.</p> <p>Remote control command: INPut:CODing ULAW</p>

**Pre Filter**

The selected pre-filter affects all measuring functions. This makes desired pre-filtering possible without selecting the appropriate filter for the individual measuring functions.

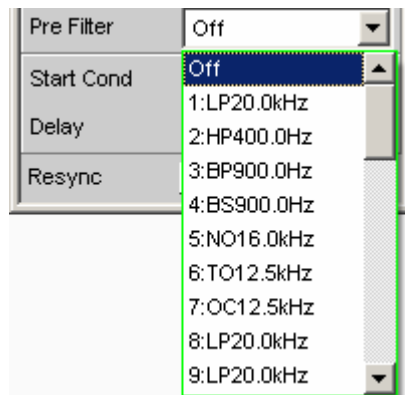

Remote control command:  
INPut:FILTer <parameter>

For a list of the <parameters> see the *Filter Table* section, Page 4.419.

**Start Cond**

Specifies the event which triggers a measurement.

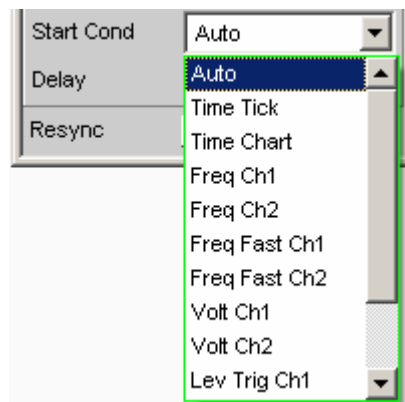

Depending on the Start Cond selected the measurement either begins immediately (Auto) or only when the desired trigger condition is fulfilled; for details see the *Start Conditions* section, Page 4.221.

**Delay**

Delay time for Start Cond.



A screenshot of a control panel element. It consists of a rectangular frame containing the text 'Delay' on the left, a numerical input field with the value '0.00000' in the center, and a small 's' symbol on the right, indicating seconds.

A delay time can be entered under the Start Cond Auto menu item; for details see the *Start Conditions* section, Page 4.221.

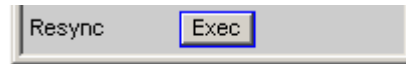
**Resync**

A screenshot of a control panel element. It is a rectangular button labeled 'Resync'. Inside this button, there is a smaller, highlighted rectangular button labeled 'Exec'.

This button causes a complete renewed synchronisation of the analyzer. If the analyzer is synchronised by external signals in slave mode the resync mechanismus should be performed once after the application and synchronisation of the external cocks.

Remote control command:  
INPut:RESYnc ONCE



## Timing Diagrams

Parameters: Sync to:EXT Wclk&Bitclk No of Slots: 2 Slot Length: 10 Audiobits:8  
 Bitclk Slope: Rising Fsync Offset: 1 Fsync Slope: Rising Lead Bits 1 Bit Order: LSB first

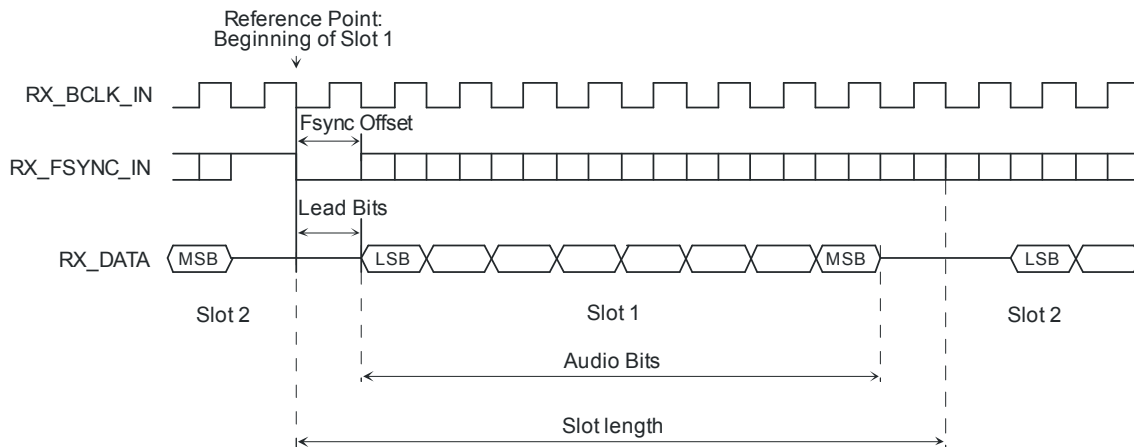

I<sup>2</sup>S Format

Parameters: Sync to:EXT Wclk&Bitclk No of Slots: 2 Slot Length: 32 Audiobits:32  
 BClk Slope: Rising Fsync Offset: -1 Fsync Slope: Falling Lead Bits 0 Bit Order: MSB first

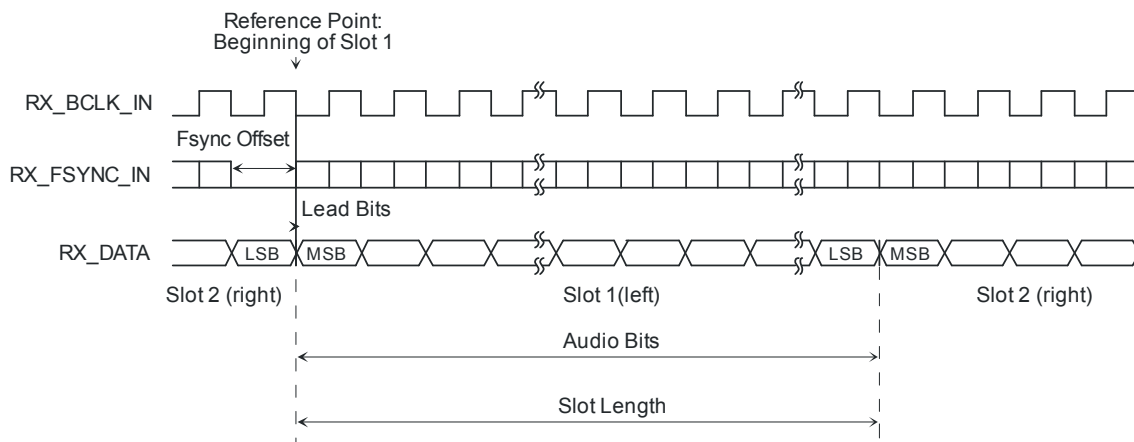

## Set-up and hold times

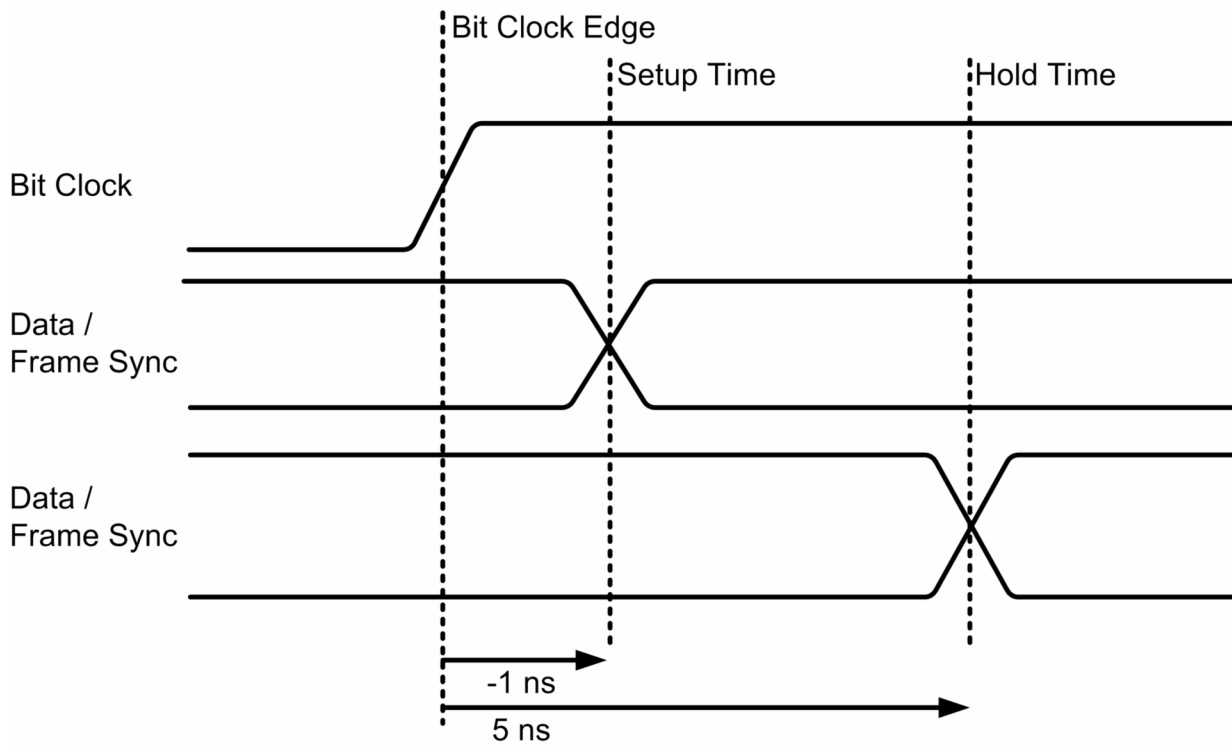

## Interface allocation

Pin	Signal	(I)input (O)utput	Signal description	Pin	Signal	(I)input (O)utput	Signal description
1	RX_MCLK_OUT	A	Master clock output analyzer	14	GND		Ground connection
2	GND		Ground connection	15	RX_DATA2	E	Serial data 2 analyzer
3	RX_MCLK_IN	E	Master clock input analyzer	16	GND		Ground connection
4	GND		Ground connection	17	RX_DATA3	E	Serial data 3 analyzer
5	RX_BCLK_OUT	A	Serial clock output analyzer	18	GND		Ground connection
6	GND		Ground connection	19	RX_DATA4	E	Serial data 4 analyzer
7	RX_BCLK_IN	E	Serial clock input analyzer	20	GND		Ground connection
8	GND		Ground connection	21	RX_RESERVED1		Reserved for future expansion
9	RX_FSYNC_OUT	A	Frame Sync output analyzer	22	RX_RESERVED2		Reserved for future expansion
10	GND		Ground connection	23	RX_RESERVED3		Reserved for future expansion
11	RX_FSYNC_IN	E	Frame Sync input analyzer	24	RX_RESERVED4		Reserved for future expansion
12	GND		Ground connection	25	RX_RESERVED5		Reserved for future expansion
13	RX_DATA1	E	Serial data 1 analyzer	26	RX_RESERVED6		Reserved for future expansion

**CLK IN (BNC connector)**

Pin	Signal	Input (I) Output (O)	Signal description
	CLK_IN	E	Reserved for future expansion

**CLK OUT (BNC connector)**

Pin	Signal	Input (I) Output (O)	Signal description
	CLK_OUT	A	Reserved for future expansion

**Probe Generator/Analyzer Layout:**

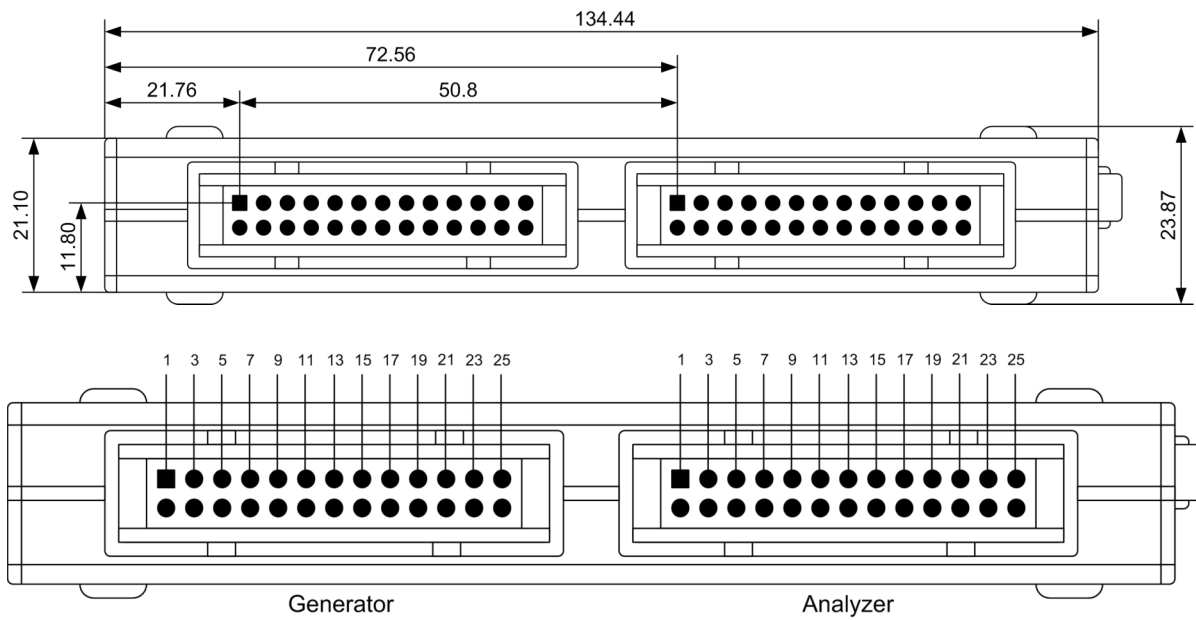

**Recommended PCB push-fit connector:**

TYCO AMP LATCH 2-827745-6

# Configuring the USI 8 Channel Analyzer

## USI 8 Channel Analyzer Configuration Panel

The Config panel is used to set the analog and digital analyzer. The configuration options for the USI 8 channel analyzer are described below.

### Meas Channels

Used to set the active measurement channel.



**1,2,3,4,5,6,7,8** Measurement channel <n> is switched on or off.

Remote control command:  
INPut:MCChannels<n> ON|OFF

### Clock

Used to select the continuous clock or gated clock operating mode.

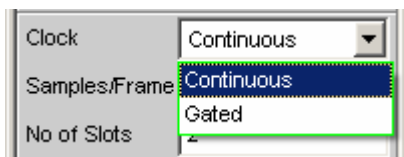

**Continuous** The continuous clock operating mode requires a continuous clock for the analyzer. The clock source may be internal or external. Several types of synchronisation are available if external synchronisation is selected.

Remote control command:  
INPut:CLOCK CONTInous

**Gated** The gated clock operating mode must be selected if the externally supplied bit clock (BClk) and FrameSync (Fsync) are discontinuous or have such a large jitter that the internal PLL can no longer follow this clock. In this operating mode, synchronisation is limited to the external word clock and bit clock (Ext Fsync&BClk) option. Audio monitoring of the generated audio signal is not possible.

Remote control command:  
INPut:CLOCK GATed

**Samples/Frame**

Used to set the number of samples per frame. The parameter simultaneously determines the minimum settable sampling rate according to the designation:  $fs\_min = 843.75 \text{ Hz} * \text{samples/frame}$ .

Value range: 1 to 32

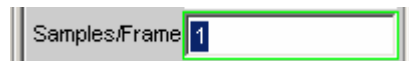

Remote control command:  
INPut:SPFRame <n>

**No of Slots**

Used to define the number of slots in a frame.

Value range: 1 to 256

$No\_of\_Slots * Slot\_Length \leq 2048$

$Slot\_Length * No\_of\_Slots * Sample\_Freq \leq 55.926\text{MHz}$

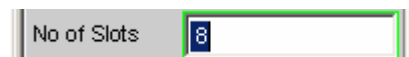

Remote control command:  
INPut:NOCHannels <n>

**Ch<n> MeasSour**

Used to select the input data line for the measuring channel <n>.

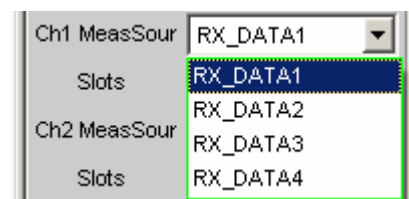

**RX\_DATA1** The RX\_DATA1 data line is selected for measurement channel <n>.

Remote control command:  
INPut:MCHSource<n> RX1Data

**RX\_DATA2** The RX\_DATA2 data line is selected for measurement channel <n>.

Remote control command:  
INPut:MCHSource<n> RX2Data

**RX\_DATA3** The RX\_DATA3 data line is selected for measurement channel <n>.

Remote control command:  
INPut:MCHSource<n> RX3Data

**RX\_DATA4** The RX\_DATA4 data line is selected for measurement channel <n>.

Remote control command:  
INPut:MCHSource<n> RX4Data

**Slots**

Used to select the audio frame channel for measurement channel <n>. (More than one channel can only be selected with multi-sample formats! In this case a frame contains several consecutive samples from one signal source)  
Value range: 1 to no of slots



Remote control command:  
INPut:SLOTs<n> 'a.b.c. ... .z'

**Sync To**

Used to select the clock source with which the USI analyzer is synchronised.

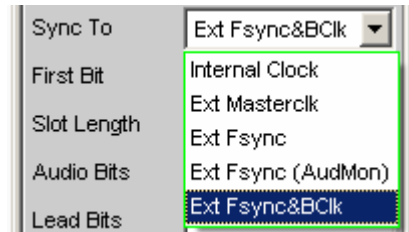

**Internal Clock** The analyzer uses the internal device clock.

Remote control command:  
INPut:SYNCto IClock

**Ext Masterclk** Synchronisation with the externally supplied master clock signal (TX\_MCLK\_IN).

Remote control command:  
INPut:SYNCto EMASterclock

**Ext Fsync** Synchronisation with an external FrameSync signal (TX\_FSYNC\_IN). The analyzer signal cannot be audio monitored. A master clock is additionally supplied.

Remote control command:  
INPut:SYNCto EFSync

**Ext Fsync (AudMon)** Synchronisation with an external FrameSync signal (TX\_FSYNC\_IN). The analyzer signal can be audio monitored. No master clock signal is supplied.

Remote control command:  
INPut:SYNCto EFAMon

**Ext Fsync&BClk** Synchronisation with the external FrameSync (TX\_FSYNC\_IN) and bit clock (TX\_BCLK\_IN) signals.

Remote control command:  
INPut:SYNCto EFSync

Overview of the various synchronisation modes:

	Internal clock	External master clock	External frame sync	External frame sync with audiomonitor	External frame sync, bit clock	External frame sync, bit clock (gated)
Master clock Output	o	tri	o	tri	tri	tri
Master clock Input	--	x	--	--	--	--
Bit clock Output	o	o	o	o	tri	tri
Bit clock Input	--	--	--	--	x	x
Frame sync Output	o	o	o	o	tri	tri
Frame sync Input	--	--	x	x	x	x

- x Input Signal must be present
- o Output Signal is available
- tri Output in tristate mode (high impedance)
- Unused Input

**First Bit**

Used to define the sequence in which the data bits are received.



**MSB**

The most significant data bit is received first.

Remote control command:  
INPut:FBIT MSB

**LSB**

The least significant data bit is received first.

Remote control command:  
INPut:FBIT LSB

**Slot Length**

Word length of a slot including gaps (0 bits)

Value range: 1 to 256  
 $No\_of\_Slots * Slot\_Length \leq 2048$   
 $Slot\_Length * No\_of\_Slots * Sample\_Freq \leq 55.926\text{ MHz}$

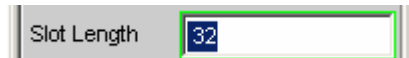

Remote control command:  
INPut:SLTLength <n>

**Audio Bits**

Slot length of the audio data within a slot.  
 Only the specified number of data bits are analyzed.  
 Value range: 8 to slot length(max 32)

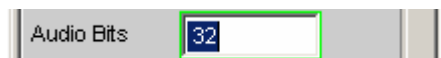

Remote control command:  
INPut:AUDIobits <n>

**Lead Bits**

Defines the offset for the audio bits within a slot relative to the start of the slot.

If LSB is selected as first bit the setting for lead bits is automatically corrected if the setting for audio bits is changed so that the MSB is transmitted at the same location. This has the advantage that the resolution of the signal transmitted is changed but not the amplitude if the audio bits are changed.

**Example:**

Slot Length: 32

Audio Bits: 24 → 23 (setting changed by user)

Lead Bits: 8 → 9 (automatic correction)

Value range: 0 to audio bits slot length



Remote control command:

OUTPut:LBITS <n >

**Timeout**

Only available in Gated Clock mode. This parameter defines the maximum time span for which external clocks are allowed to discontinue before the measurement is declared as invalid.

Value range: 1 to 500ms

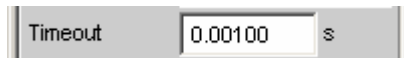

Remote control command:

INPut:TIMEout <nu>



**Sample Freq**

Setting the sampling frequency.

All frequency specifications of the generated audio data refer to this setting. If the USI analyzer is operated with external synchronisation and the frequency of the external clock signal does not correspond to the set sampling frequency the analyzer displays incorrect frequency values.

For data formats with one sample per frame, the sampling frequency corresponds to the frequency of the Fsync signal. In case of several audio data samples from one source within one frame, the frequency of the Fsync signal is the product of the sampling frequency divided by the factor of samples/frame.

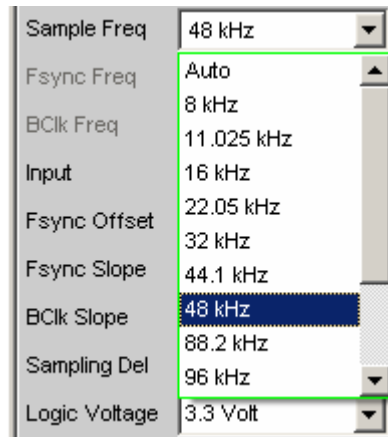

Value range for numeric input: 0.84375 kHz to 400 kHz

$\text{No\_of\_Slots} * \text{Slot\_Length} \leq 2048$

$\text{Slot\_Length} * \text{No\_of\_Slots} * \text{Sample\_Freq} \leq 55.926 \text{ MHz}$

Standard sampling frequencies can be set directly in the selection field.

**Auto**

The sampling rate is measured, set and displayed in the following line. If the applied sampling rate is changed the set value is automatically updated.

**Note:**

*The digital analyzer must re-initialised with every new sampling frequency. Small deviations (below 3 Hz) are ignored to prevent this time-consuming process having to be performed more often than necessary.*

```
Remote control command:
INPut:SAMPlE:FREQuency:MODE AUTO
```

**8 kHz**

8 kHz standard sampling rate

```
Remote control command:
INPut:SAMPlE:FREQuency:MODE F08
```

**11,025 kHz**

11.025 kHz standard sampling rate

```
Remote control command:
INPut:SAMPlE:FREQuency:MODE F11
```

<b>16 kHz</b>	16 kHz standard sampling rate  Remote control command: INPut:SAMPlE:FREQuency:MODE F16
<b>22,05 kHz</b>	22.05 kHz standard sampling rate  Remote control command: INPut:SAMPlE:FREQuency:MODE F22
<b>32 kHz</b>	32 kHz standard sampling rate  Remote control command: INPut:SAMPlE:FREQuency:MODE F32
<b>44,1 kHz</b>	44.1 kHz standard sampling rate  Remote control command: INPut:SAMPlE:FREQuency:MODE F44
<b>48 kHz</b>	48 kHz standard sampling rate  Remote control command: INPut:SAMPlE:FREQuency:MODE F48
<b>88,2 kHz</b>	88.2 kHz standard sampling rate  Remote control command: INPut:SAMPlE:FREQuency:MODE F88
<b>96 kHz</b>	96 kHz standard sampling rate  Remote control command: INPut:SAMPlE:FREQuency:MODE F96
<b>176,4 kHz</b>	176.4 kHz standard sampling rate  Remote control command: INPut:SAMPlE:FREQuency:MODE F176
<b>192 kHz</b>	192 kHz standard sampling rate  Remote control command: INPut:SAMPlE:FREQuency:MODE F192
<b>384 kHz</b>	384 kHz standard sampling rate  Remote control command: INPut:SAMPlE:FREQuency:MODE F384

**Value** Variable sampling rate input



Remote control command:  
 INPut:SAMPlE:FREQuency:MODE VALue  
 INPut:SAMPlE:FREQuency <nu>

**Fsync Freq**

Is only displayed for multi-sample formats. The Frame Sync frequency corresponds to the sampling rate divided by the samples/frame factor.

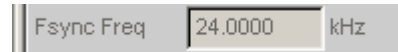

Remote control command:  
 INPut:FSYnc:FREQuency?

**Bclk Freq**

Displays the bit clock frequency. Is the product of slot length \* no of slots \* sample freq / samples/frame.

Value range: 6.75 kHz ... 55.296 MHz

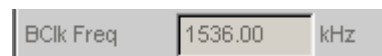

Remote control command:  
 INPut:BCLk:FREQuency?

**Input**

Selection of the analyzer source. In internal mode, the probe is run in short circuit operation with the generator. For this the generator must be operated in internal clock synchronization mode and the analyzer in ExtFsync&Bclk mode. The signals produced by the generator can thus be analyzed without using an external plug connection. If the probe is selected as a source, the analyzer analyzes the signals at the connector.

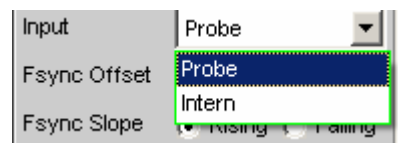

Remote control command:  
 INPut:INPut INTern|PROBe

**Fsync Width**

FSYNC pulse length

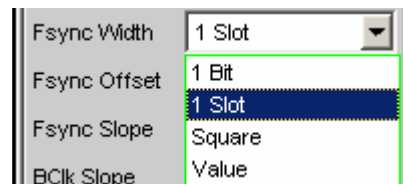

- 1 bit**                    The FSYNC pulse is one data bit in length (1 BClk period)

Remote control command:  
INPut:FWIDth ONEBit
- 1 Slot**                    FSYNC is one audio slot in length (= slot length)

Remote control command:  
INPut:FWIDth ONEChannel
- Square**                    FSYNC pulse has the shape of a symmetrical rectangle. If the number of the bit clock (BClk) cycles is odd the high phase is one cycle longer than the low phase (if Fsync slope = rising)

Remote control command:  
INPut:FWIDth SQUare
- Value**                    The FSYNC length corresponds to the numeric value in data bits (1 BClk period)  
Value range: 1 to (slot length\*no of slots)-1

Remote control command:  
INPut:FWIDth VALue  
INPut:FWIDth:VALue <n>

**Fsync Offset**

Used to define the offset of the Fsync pulse relative to the reference point (the start of the first slot)  
Value range: -slot length to+slot length-1



Remote control command:  
INPut:FOFFset <n>

**Fsync Slope**

FSYNC pulse polarity



**Rising**                    The FSYNC pulse begins with a positive edge.

Remote control command:  
INPut:FSLope RISing

**Falling**                    The FSYNC pulse begins with a negative edge.

Remote control command:  
INPut:FSLope FALLing

**BClk Slope**

Bit clock polarity (BClk)



**Rising**

RX\_FSYNC\_IN, RX\_DATA1, RX\_DATA2, RX\_DATA3 and RX\_DATA4 are sampled and the RX\_FSYNC\_OUT signal is output with a rising bit clock edge (the bit clock signal to which this setting refers is either RX\_BClk\_IN if the analyzer is operated as a slave, or RX\_BClk\_OUT if the analyzer is clocked internally).

Remote control command:  
INPut:BSlope RISING

**Falling**

RX\_FSYNC\_IN, RX\_DATA1, RX\_DATA2, RX\_DATA3 and RX\_DATA4 are sampled and the RX\_FSYNC\_OUT is output with a falling bit clock edge (the bit clock signal to which this setting refers is either RX\_BClk\_IN if the analyzer is operated as a slave, or RX\_BClk\_OUT if the analyzer is clocked internally).

Remote control command:  
INPut:BSlope FALLING

**MClk Ratio**

Relationship between the master clock (MCLK) and FrameSync (FSYNC).  
Value range: 16 to 768 (max. 110,592 MHz)



Remote control command:  
INPut:MRATio <n>

**Sampling Del**

This parameter permits the sampling time for RX\_FSYNC\_IN, RX\_DATA1, RX\_DATA2, RX\_ATA3 and RX\_DATA4 input signals to be delayed relative to the RX\_BClk\_IN or RX\_BClk\_OUT clock. Positive values move the sampling towards a later time. This feature is used above all if TCO delays, in other words response times of a device under test being operated in slave mode at high frequencies, reach the size of a bit clock period. In order to compensate for bit shifts when analyzing in the analyzer these delay times are compensated by a later sampling point.  
Value range: -10 to +10 ns



Remote control command:  
INPut:SDElay <nu>

**Logic Voltage**

Used for setting the analyzer logic voltage. Changing the voltage level causes the probe to be reloaded. This mechanism permits the probe to be detached and attached and put back into operation during operation.

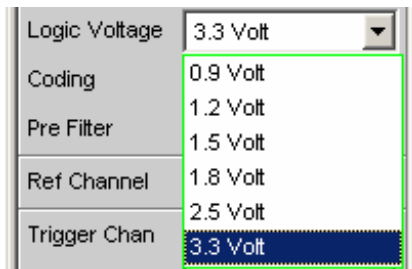

<b>0.9 Volt</b>	0.9 Volt CMOS logic voltage  Remote control command: INPut:LOGVoltage MV0900
<b>1.2 Volt</b>	1.2 Volt CMOS logic voltage  Remote control command: INPut:LOGVoltage MV1200
<b>1.5 Volt</b>	1.5 Volt CMOS logic voltage  Remote control command: INPut:LOGVoltage MV1500
<b>1.8 Volt</b>	1.8 Volt CMOS logic voltage  Remote control command: INPut:LOGVoltage MV1800
<b>2.5 Volt</b>	2.5 Volt CMOS logic voltage  Remote control command: INPut:LOGVoltage MV2500
<b>3.3 Volt</b>	3.3 Volt LVTTTL logic voltage  Remote control command: INPut:LOGVoltage MV3300

**Coding**

Input data decoding regulation. A Law and  $\mu$  Law quantification characteristics are available for telephony applications.

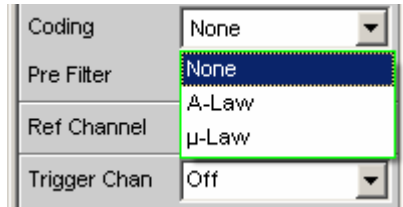

**None** Input data is analyzed linearly PCM-coded.

Remote control command:  
INPut:CODing NONE

**A-Law** Input data is analyzer according to A Law.

Remote control command:  
INPut:CODing ALAW

**$\mu$ -Law** Input data is analyzed according to  $\mu$  Law.

Remote control command:  
INPut:CODing ULAW

**Pre Filter**

The selected pre-filter affects all measuring functions. This permits desired pre-filtering without selecting appropriate filters for the individual measuring functions.

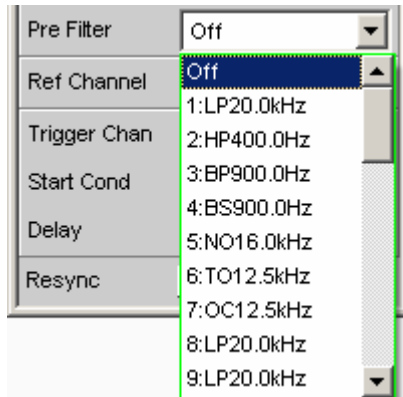

Remote control command:  
INPut:FILTer <parameter>

For a list of <parameters> see the *Filter Table* section, Page 4.419.

**Ref Channel**

Reference channel for phase measurements or other channel-related measurements.

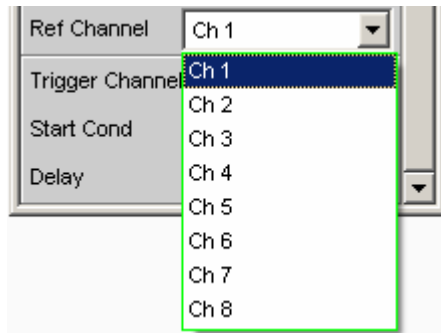

Each measurement channel can be selected as a reference channel. If a channel which is selected as a reference channel is not yet active (switched off) the channel is automatically switched on. Switching off a measurement channel which has been selected as a reference channel is prevented and the user is made aware of this by a warning:

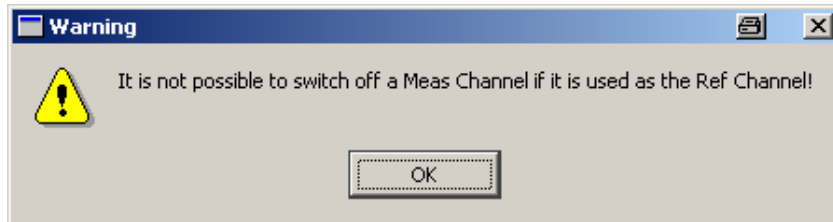

**Ch <n>** Channel <n> is selected as a reference channel

Remote control command:  
SENSe:REFerence:CHANnel CH<n>



**Trigger Channel**

Used to select the channel whose event triggers a measurement.

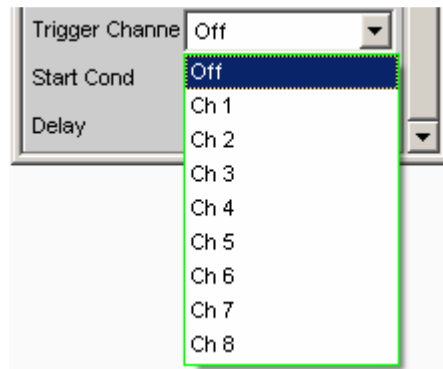

If a measuring channel which was inactive is selected as a trigger channel it is automatically switched on.  
If the channel selected as a trigger channel is switched off the following warning appears:

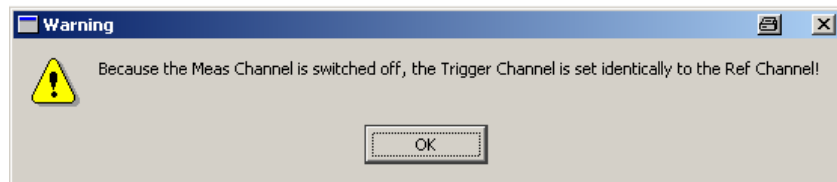

The trigger channel can be switched off; however, this causes the reference channel to automatically become the trigger channel.

**Off**                    Triggering is not active.

Remote control command:  
TRIGger:CHANnel OFF

**Ch <n>**                Triggering is active. Channel <n> is selected as trigger channel.

Remote control command:  
TRIGger:CHANnel CH<n>

**Start Cond**

Specifies the event which triggers a measurement.

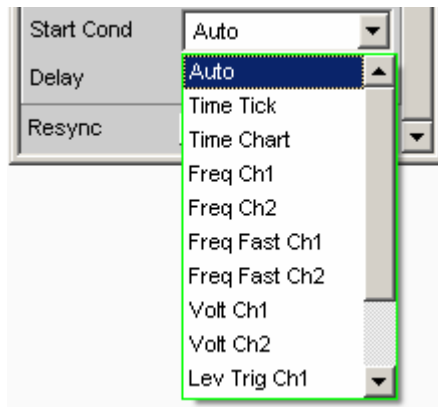

After the Start Cond has been selected the measurement either begins immediately (Auto) or only when the desired trigger condition is fulfilled; for details see the *Start Conditions* section, Page 4.221.

**Delay**

Delay time for Start Cond.

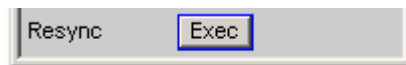

A delay time can be entered under the Auto Start Cond menu item; for details see the *Start Conditions* section, Page 4.221.

**Resync**

This button causes a complete re-synchronisation of the analyzer. If the analyzer is synchronised by external signals whilst in slave mode the resync mechanism should be performed once after the external clock has been applied and attuned.

Remote control command:

INPut:RESYnc ONCE

## Timing Diagrams

Identical to the Dual Channel Analyzer (see page 4.198)

## Interface assignment

Identical to the Dual Channel Analyzer (see page 4.199)

## Starting Measurements

In manual operating mode, measurements are started (and also stopped) using the keys "START", "SINGLE" and "STOP/CONT" in the "CONTROL" panel. The effect of these keys depends on whether or not the sweep system is active:

- The measurement system can only be directly controlled using the keys if the sweep system is *inactive*.
- If, however, the sweep system is *active*, the measurement system is controlled by the sweep system and the keys are used to control the sweep system.

## Overview of the Measurement System

The following information refers to a **deactivated sweep system**, i.e. a sweep is not activated in either the generator or the analyzer.

A measurement, in a narrower sense, is the one-off or continuous **recording of measurement values** for all activated measurement types. It can take the form of a *single* measurement value or a *data set* (sample in the time domain, spectral lines in the frequency domain).

The one-off recording of measurement values is referred to as a **single measurement** (see section "Single measurement" on page 4.219 and continuous recording as a **continuous measurement** (see section "Continuous measurement" on page 4.218).

The measurement system is controlled

- explicitly using the **control keys** START (Ctrl F5), SINGLE (Ctrl F6) and STOP/CONT (Ctrl F7).
- implicitly by means of "**termination events**". These are events (user entries) which invalidate the measurement currently being performed, i.e. changes in the generator, analyzer or filter bank. Following a termination event, the current measurement is restarted automatically. This ensures that the displayed measurement data is not corrupted by internal switching operations. Since it takes a few milliseconds to terminate and restart a measurement in progress, settings should not be entered in remote-control mode unless measurement has stopped.

## Activating and Deactivating Measurement Types

With the R&S UPV it is possible to record up to 8 different **measurement values** simultaneously and display them numerically and/or graphically. These measurement values are

- selected measurement function for channel 1 and 2
- level monitor (RMS or DC downstream of the prefilter) for channel 1 and 2
- input monitor (peak measurement upstream of the prefilter) for channel 1 and 2
- frequency on channel 1; frequency, phase or group delay on channel 2

It is also possible to record a large number of **data sets** which can also be displayed numerically and/or graphically:

- Post FFT and/or bargraph for channel 1 and 2 with distortion measurements; FFT as measurement function
- FFT Monitor (4 k FFT) for channel 1 and 2
- Waveform (display of the measurement signal in the time domain) for channel 1 and 2

Although the measurement types mentioned above are performed simultaneously and therefore affect each other only slightly with respect to time, it is only possible to display the results of these measurements in sequence. It is therefore recommended to deactivate any measurement types that are not required in order to reduce the total measurement time:

- Switching over to single-channel measurement (in the "Analyzer Config" panel) stops the other measurement channel from being measured and displayed.



- Deactivating individual measurement types (in the "Analyzer Function" panel) stops measurement results which are not required from being recorded and displayed.

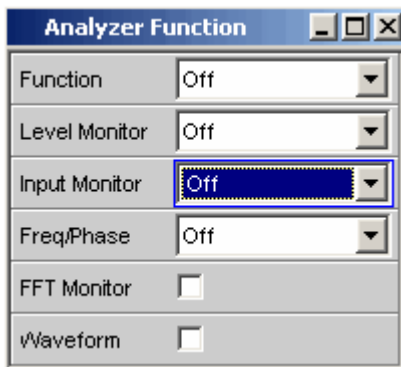

(with distortion measurements)

All activated measurement types are measured in each (single) measurement. The measurement is not regarded as having been completed until all of the desired results (possibly also with settling) are available. Only then can the sweep be stepped or a triggered measurement result be retrieved by the remote control station. Consequently, the slowest measurement type determines the measurement speed of the entire instrument.

## States of the Measurement System

The states of the measurement system are displayed above the softkeys (channel 1 above the 5<sup>th</sup> softkey and channel 2 above the 6<sup>th</sup> softkey). The current state is also indicated by the two LEDs above the START and SINGLE key.

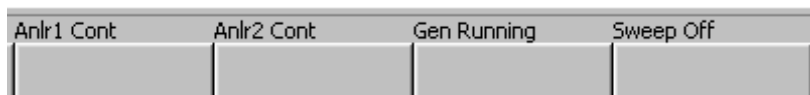

The following states are possible:

Off	Channel is deactivated; measurement values are not recorded on this channel.
Single	Single measurement is being performed.
Cont	Continuous measurement is being performed.
Terminated	(Single) measurement has been terminated.
Stopped	Measurement has been terminated; continuous measurement has been stopped.

The state of a current measurement (e.g. "Rang") or of the terminated measurement (e.g. "Over" if no measurement result is available due to "OVERRANGE") is also indicated.

More detailed information on these status displays can be found in *chapter 3, "Overview of Status Messages"*.

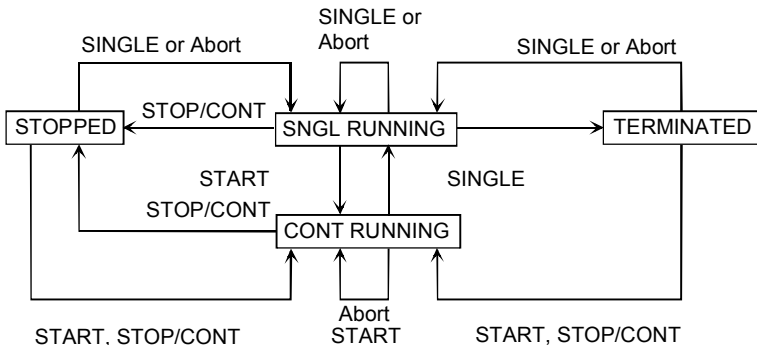

### Continuous measurement

This is the standard operating mode of the measurement system and is set each time the R&S UPV is switched on. With continuous measurement, only the **START LED** lights up. The R&S UPV measures all activated measurement types continuously until one of the following events occurs:



Pressing the **START** key stops the current measurement immediately, resets the MIN/MAX indicator, the MIN/MAX values, the limit violations of the measurement displays and the highlighting of the protocol analysis, and causes the continuous measurement to be restarted.

Furthermore, starting or restarting a measurement also causes certain generator functions to restart:

- Burst signals (sine burst and sine<sup>2</sup> burst) are reset, that is, they start at the burst phase or "Burst on Delay".
- The Play function starts again at the first sample in the WAV file.
- The Arbitrary function also starts again at the beginning.

Remote-control command:  
 INIT:CONT ON  
 INIT:FORCe START



Pressing the **SINGLE** key switches the instrument to single measurement mode. Each measurement type first completes the measurement that has already been started; when all measurement types have been completed, the measurement system is in the "Term" (terminated) state. Continuous measurement can be reactivated by pressing the START or STOP/CONT key.

Remote-control command:  
 INIT:CONT OFF



Pressing the **STOP/CONT** key stops the current measurement immediately and causes the measurement system to enter the "Stop" state. Continuous measurement can be reactivated using the START key or by pressing the STOP/CONT key again.

Remote-control command:

INIT:FORCe STOP

INIT:FORCe CONT

#### Termination event

... stops the current measurement immediately and causes the continuous measurement to be restarted (see section "Overview of the Measurement System" on page 4.216).

#### Single measurement

Each measurement type is performed once only; the measurement system then assumes the "Term" (terminated) state. The measurement does not necessarily have to produce a real result: if an error occurs during the measurement, the measurement result is classed as invalid. "----" appears in the associated measurement window instead of the measurement value; a NAN value ("not a number", 9.97e37) is read out by the remote-control station.

Each single measurement must be triggered again by pressing the SINGLE key or by means of a termination event. The **START LED** and **SINGLE LED** light up in the case of a single measurement. The control keys have the following function *while* a single measurement is being performed:



Pressing the **START** key stops the current single measurement immediately, resets the MIN/MAX indicator, the MIN/MAX values, the limit violations of the measurement displays and the highlighting of the protocol analysis, and causes continuous measurement to be started.

Furthermore, starting or restarting a measurement also causes certain generator functions to restart:

- Burst signals (sine burst and sine<sup>2</sup> burst) are reset, that is, they start at the burst phase or "Burst on Delay".
- The Play function starts again at the first sample in the WAV file.
- The Arbitrary function also starts again at the beginning.

Remote-control command:

INIT:CONT ON

INIT:CONT ON

INIT:FORCe START



Pressing the **SINGLE** key stops the current measurement immediately and causes the single measurement to be restarted.

Furthermore, restarting a single measurement also causes a restart of the burst signals (sine burst and sine<sup>2</sup> burst), that is, they start at the burst phase or "Burst on Delay".

Remote-control command:

INIT:CONT OFF

INIT:FORCe SINGLE



Pressing the **STOP/CONT** key stops the current measurement immediately and causes the measurement system to enter the "Stop" state. The single measurement is reactivated by pressing the SINGLE key.

Remote-control command:  
INIT:FORCe STOP

#### Termination event

... stops the current measurement immediately and causes the single measurement to be restarted (see section *"Overview of the Measurement System"* on page 4.216).

#### Terminated measurement

The measurement system only assumes this state when a single measurement is terminated. No further measurements are performed; the measurement values and data sets are frozen until the next measurement is started. Measurement values should only be read out via the remote-control station when the system is in this state. **None of the LEDs** light up when a measurement has been terminated. The control keys have the following function:



Pressing the **START** key resets the MIN/MAX indicator, the MIN/MAX values, the limit violations of the measurement displays and the highlighting of the protocol analysis, and causes continuous measurement to be started.

Furthermore, starting or restarting a measurement also causes certain generator functions to restart:

- Burst signals (sine burst and sine<sup>2</sup> burst) are reset, that is, they start at the burst phase or "Burst on Delay".
- The Play function starts again at the first sample in the WAV file.
- The Arbitrary function also starts again at the beginning.

Remote-control command:  
INIT:CONT ON  
INIT:FORCe START



Pressing the **SINGLE** key causes a single measurement to be started.

Furthermore, starting a single measurement also causes a restart of the burst signals (sine burst and sine<sup>2</sup> burst), that is, they start at the burst phase or "Burst on Delay".

Remote-control command:  
INIT:CONT OFF  
INIT:FORCe SINGLE



Pressing the **STOP/CONT** key causes continuous measurement to be started.

Remote-control command:  
INIT:FORCe CONT

#### Termination event

... causes a single measurement to be started (see section *"Overview of the Measurement System"* on page 4.216). In remote-control mode, the automatic measurement start is disabled so that setting commands can be dealt with at maximum speed.

**Stopped measurement**

The measurement system only assumes this state when the STOP/CONT key is pressed while a measurement is being performed. No currently valid measurement values or data sets are available. Measurement values should *not* be read out via the remote-control station when the system is in this state. The control keys have the same function as for a terminated measurement (see "*Terminated measurement*").

## Start Conditions

The Analyzer Config panel is used to define which conditions trigger the start of a measurement.

The menu item "Start Cond" defines when, how often or under what conditions measurement values are to be recorded. In addition to continuous operation, the following operating modes for recording measurement values can be selected from this panel:

- Time-controlled measurement value recording
- Externally controlled measurement value recording (i.e. controlled by altering the measurement signal), known for short as "external sweeps"
- Level-controlled measurement value triggering

When the conditions for measurement value recording are met, the measurement value is triggered, displayed in the measurement results panel and if appropriate stored in a measurement value buffer internal to the R&S UPV. The measurement value list can be displayed numerically or graphically in one or more "sweep graphs" out of the available total of four.

---

**Note:**

*In order for the measurement value list to be recorded, the measurement values of interest must be selected as traces (Y source) in the "Sweep Graph Config" panels. "X-Axis" ("X-Source") should be set to "Sweep". Four sweep graphs with two traces each are available for measurement value recording, so that a maximum of eight measurement values can be recorded simultaneously.*

---



## Setting Start Condition

**Ref Channel**

Indicates the reference channel ; only appears on multichannel analyzers.



The "Ref Channel" is the reference channel for measurements between two channels. They include the following measurements:

- Phase and group-delay measurement (the frequency measurement result is shown on the reference channel)



- Crosstalk measurements (ratio of two level measured values)



- Frequency tracking of selective RMS measurement



The reference channel cannot be switched off. If a reference channel that is not yet active is selected, then this channel is automatically switched on. Conversely, the attempt to switch off a channel that has been selected as the reference channel is rejected with a corresponding error message.

**Note:**

*If the trigger channel is used in the 16-channel analyzer, the reference and trigger channel must be in the same channel range (both channels either on channels 1 to 8 or 9 to 16).*

- Ch 1 Selection of the reference channel from the
- Ch 2 parameter list.
- Ch 3

...

```
Remote-control command:
SENSe:REFerence:CHANnel CH<i>
<i> = 1, 2, 3, ...
...
```

**Trigger Channel**

Indicates the trigger channel; only appears on multichannel analyzers.



The "Trigger Channel" determines on which channel the trigger condition is tested. The following are affected:

- The "Start Condition"
- The trigger source of the waveform monitors

If a channel that is not yet active is selected as the trigger channel, this channel is switched on automatically. If the measurement channel that is selected as the trigger channel is deactivated, then the trigger channel is automatically switched over to the reference channel.

**Note:**

The reference and trigger channel in the 16-channel analyzer must be in the same channel range (both channels either on channel 1 to 8 or 9 to 16).

The parameter field for the trigger channel which is visible in the waveform monitor is identical with the parameter field in the "Start Condition" menu.

**Off**

No trigger channel is defined; the following restrictions apply:

- The waveform monitor operates in untriggered mode; "Trigger Source" is unavailable.



- Only "Auto" or "Time Tick" can be selected as "Start Cond".

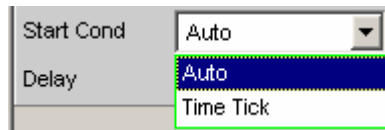

```
Remote-control channel:
TRIGger:CHANnel OFF
```

- Ch 1** Selection of the trigger channel from the parameter
- Ch 2** list.
- Ch 3**

...

```
Remote-control channel:
TRIGger:CHANnel CH<i>
<i> = 1, 2, 3, ...
```

...

**Start Cond**

Indicates the event that triggers a measurement.

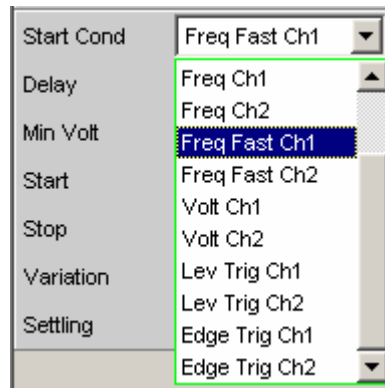

Depending on the "Start Cond" selected, the measurement starts either immediately (Auto) or only once the required trigger condition is met.

**Note:**

*With the two-channel analyzers, the trigger conditions combined with the possible trigger channels appear in the parameter list; only the active channels are available as trigger channels.*

In the **multichannel analyzers**, first a trigger channel must be specified so that all start conditions are available. If the trigger channel is switched off, only "Auto" or "Time Tick" can be selected.

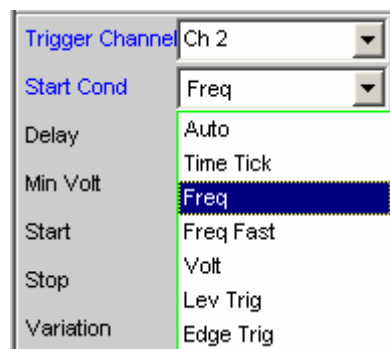

**Note:**

*With the multichannel analyzers, the trigger conditions without explicit channel specification appear in the parameter list.*

**Auto** Continuous measuring mode without trigger condition.  
Values are recorded in the measurement value buffer only if the frequency sweep for the selective RMS measurement or any type of generator sweep is active at the same time.  
Pressing the "Single" or "Start" key toggles between single and continuous measurement if no sweep is active.

```
Remote-control command:  
TRIGger:SOURce AUTO
```

**Time Tick** Time-controlled measurement value recording; measurement value *triggering* at fixed intervals. In the gap between time ticks, measurements are started, the measurement results are entered in the measurement value buffer and displayed in the measurement results panel.

This start condition *cannot* be combined with a time-triggered generator sweep.

If time tick is combined with the frequency sweep of the selective RMS measurement or with a synchronous generator sweep, sweep stepping is performed as usual, but measurement starts only after the time tick has expired.

If *neither* the frequency sweep of the selective RMS measurement *nor* any generator sweep is active, the time tick defines the sweep X axis:

- During the time tick sweep, the time stamps on the X axis are updated and corrected if necessary (e.g. if a measurement lasts longer than the set time tick) and the individual measurement values are entered according to their correct times.
- When the "START" button is pressed a series of periodic measurement value recordings begins, and when the number of sweep points specified under "Points" is reached the series starts again from the beginning.
- When the "SINGLE" button is pressed a single series of periodic measurement value recordings begins. When the number of sweep points specified under "Points" is reached the sweep goes to "terminated" status.

```
Remote-control command:  
TRIGger:SOURce TIMer
```

**Time Chart**

Time-controlled measurement value recording; measurement value *acquisition* at fixed intervals; *not* available in the multichannel analyzers.

Measurement values (from the currently running continuous measurement) are entered in a time chart in the timescale that can be entered under "Time". In contrast to "Time Tick", where at each tick a new (single) measurement starts and the result is only entered when the measurement ends, with "Time Chart" intermediate results can also be displayed. This is particularly desirable in the case of quasi peak measurements.

---

**Note:**

*If the chosen time grid (update rate) is shorter than the measurement time required for the measurement function, intermediate results are displayed. Otherwise end results are displayed.*

---

This start condition *cannot* be combined with a frequency sweep of the selective RMS measurement or a generator sweep. The time stamps of the measurement value acquisition define the sweep X axis:

- When the "START" button is pressed and immediately after the time chart sweep is switched on, a series of periodic measurement value recordings begins. When the number of sweep points specified under "Points" is reached the series starts again from the beginning.
- When the "SINGLE" button is pressed a single series of periodic measurement value recordings begins. When the number of sweep points specified under "Points" is reached the sweep goes to "terminated" status.

---

**Note:**

*The sweep starts as soon as time chart is switched on, that is, intermediate or end results of the selected continuous measurement are displayed and recorded at fixed intervals.*

---

Remote-control command:  
TRIGger:SOURceTCHart

**Freq Ch1**  
**Freq Ch2**  
**Freq**  
**Freq Fast Ch1**  
**Freq Fast Ch2**  
**Freq Fast**

Externally controlled measurement value recording; measurement value triggering when a significant frequency change occurs on the trigger channel (external frequency sweep); available in the multichannel analyzers *only if* the trigger channel is switched on.

The measurement results are entered in the measurement value buffer and displayed in the measurement results panel. The measured *frequency* is entered as an X value of the sweep.

This start condition *cannot* be combined with the frequency sweep of the selective RMS measurement. The sweep X axis is always predefined by the external frequency sweep, even if the internal generator is generating the sweep signal.

---

**Note:**

*For particularly fast frequency sweeps with a clean signal (e.g. from a CD) the fast variant can be selected. However, if the signal contains a high noise component it will be necessary to switch to the slower measurement method FREQ CH1/2.*

---

```
Remote-control command:
TRIGger:SOURce CH1Freq
TRIGger:SOURce CH2Freq
TRIGger:SOURce FREQuency
TRIGger:SOURce CH1Rapidfreq
TRIGger:SOURce CH2Rapidfreq
TRIGger:SOURce RAPidfreq
```

**Volt Ch1**  
**Volt Ch2**  
**Volt**

Externally controlled measurement value recording; measurement value triggering when a significant level change occurs on the trigger channel (external level sweep); available in the multichannel analyzers *only if* the trigger channel is switched on.

The measurement results are entered in the measurement value buffer and displayed in the measurement results panel. The measured *level* is entered as an X value of the sweep.

This start condition *cannot* be combined with the frequency sweep of the selective RMS measurement. The sweep X axis is always predefined by the external level sweep, even if the internal generator is generating the sweep signal.

```
Remote-control command:
TRIGger:SOURce CH1Level
TRIGger:SOURce CH2Level
TRIGger:SOURce LEVel
```

**Lev Trig Ch1**  
**Lev Trig Ch2**  
**Lev Trig**

Measurement value triggering due to a level detected at the analyzer input on the trigger channel; available in the multichannel analyzers *only if* the trigger channel is switched on.

This start condition can be combined with any sweep and has no effect on the sweep X axis.

Sweep stepping or, if the sweep system is inactive, pressing the START or SINGLE key, alerts level monitoring to wait until a level in the range between start and stop is measured (level triggering). When this occurs a single measurement is started, if necessary after a specified delay.

In the case of continuous measurement, a further triggering in the specified range occurs only if the level has gone over or under the set range in the interim. This means that level monitoring is not put on alert again until a level outside of the specified range is detected.

```
Remote-control command:
TRIGger:SOURce CH1Trigger
TRIGger:SOURce CH2Trigger
TRIGger:SOURce TRIGger
```

**Edge Trig Ch1**  
**Edge Trig Ch2**  
**Edge Trig**

Measurement value triggering due to a voltage *edge* detected at the analyzer input on the trigger channel; available in the multichannel analyzers *only if* the trigger channel is switched on.

This start condition can be combined with any sweep and has no effect on the sweep X axis.

Sweep stepping or, if the sweep system is inactive, pressing the START or SINGLE key, starts the level monitoring function. However, it is not put on alert until a level beyond the start level (outside of the start-stop interval) is measured. Triggering occurs at the moment when the level first enters the range between start and stop (edge triggering). When this occurs a single measurement is started, if necessary after a specified delay.

In the case of continuous measurement, a further triggering in the specified range occurs only if in the interim the level has left the set range and moved in the direction of the start level. This means that level monitoring is not put on alert again until a level beyond the start level is detected.

```
Remote-control command:
TRIGger:SOURce CH1Edgetrigger
TRIGger:SOURce CH2Edgetrigger
TRIGger:SOURce EDGetrigger
```

**Note:**

If the reference points of a sweep are modified under the influence of the start condition during the sweep (e.g. due to over long measurement times during a time tick sweep), some sweep points may be outside of the visible X axis of the sweep graphs. A further Autoscale call at the end of the sweep will enter the new X limits in the sweep graph.

**Delay**

Delay for Start Cond.

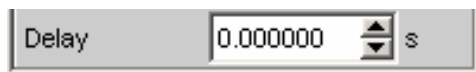

You can enter a delay for menu item Start Cond "Auto". It applies under the following conditions:

- Signal change on the generator (value entry, value change via rotary knob)
- Performance of sweeps
- Pressing of Stop/Cont or Start key (continuous measurement)
- Pressing of Single key (single measurement)
- Change in the Analyzer panels
- Change in the Generator panels
- Change in the Filter panel

The "Delay" setting determines the time that must elapse between the above events and restarting of the measurement so that, for example, a DUT has sufficient time to settle. The total measuring time – i.e. the time that elapses until the measuring result is available – is thus increased by the specified delay.

**Note:**

*In the case of continuous measurement, a delay is only applied to the first measurement after the start. No delay is applied to subsequent measurements.*

*If the overall delay (including internal delays) is greater than 2 s, the measurement will not be restarted automatically if modifications are performed in the generator, analyzer or in the filter bank.*

*The delay is applied to all measured channels. In the case of multichannel analyzers, the delay only extends the total measuring time of the first partial measurement (first pair of channels); all further (measured offline) channel pairs can be measured without an additional time loss.*

Remote-control command:  
TRIGger:DELAy <nu>



## Time-Controlled Measurement Value Recording

In time-controlled measurement value recording, the *estimated* total recording time is derived from the product of the time interval per measurement and the number of measurement value acquisitions. The *actual* duration of the measurement value recording may be considerably longer in the case of the time tick start condition if the value entered for the time tick is shorter than the required measurement time.

Start Cond	Time Tick
Time	1.00000 s
Points	30

### Time

Used for entering the time grid in which it is intended measurements should be started ("time tick") or measurement values should be read ("time chart").

Time	1.00000	s
------	---------	---

When the start condition is "**Time Tick**" the measurement has priority over the start of a new measurement. If the time tick is *longer* than the measurement time, the system waits for the next time tick after each single measurement. During this waiting time no measurement is performed. If the time tick is *shorter* than the measurement time, any time ticks occurring during a running measurement will be ignored. This means that measurements will be started at time intervals corresponding to an integer multiple ( $\geq 1$ ) of the selected time tick.

When the start condition is "**Time Chart**" (*not available in the multichannel analyzers*) the measurement value is read in the specified time grid, regardless of whether a new measurement value is present. If the chosen time grid (update rate) is *longer* than the measurement time for the measurement function, then only end results are displayed. If the time grid is *shorter* than the measurement time, intermediate results are displayed if available. If no intermediate results are yet available, the last valid results are entered in the time chart again.

Remote-control command:  
TRIGger:TIMer <nu>

**Points**

For entering the number of measurement value recordings.

Time-controlled measurement value recording ends as soon as the number of measured data items specified here are available.

**Note:**

*If the start condition "Time Tick" is combined with a frequency sweep of the selective RMS measurement or a synchronous generator sweep, the number of sweep points is taken from there and cannot be entered separately.*

Remote-control command:  
TRIGger:COUNT <nu>

## External Sweeps and Level-Controlled Measurement Value Triggering

External sweeps are usually controlled by means of an external signal source. The internal sweep generator should be deactivated in this case. A warning message is output if the internal sweep generator is still active when an external sweep is activated.

Basically, the internal sweep generator can be used as a signal source also with **external sweeps**. This is meaningful, for example, if the delay of the DUT is not known or not constant and it is, therefore, not possible to couple the generator stepping permanently to the measurement start. Sweep stepping is performed as usual, but measurement does not start until a trigger event occurs.

Generator stepping should be time controlled (dwell sweep; generator setting: "Next Step Dwell ..."), in order to make generator sweep stepping independent of measurement.

In the case of analyzer-synchronous stepping (generator setting: "Next Step Anlr Sync") it is important to ensure that each sweep step overwrites the chosen start condition "Variation". If this condition is not met, the external sweep comes to a stop. The following **generator setting rules for external sweeps** must be followed:

- "Spacing" must be set to "Log Steps" (optional for dwell sweep).
- The sweep direction (specified by the sequence between "Start" and "Stop") must agree with the recording direction chosen in the analyzer.
- The sweep range must be within the recording range (optional for dwell sweep).
- The step width, or increment (specified in the generator as a factor under "Step") must be greater than "Variation" in the analyzer (optional for dwell sweep).

The following applies to an upward sweep (Start < Stop):  $\text{Step} > 1 + \text{Variation} / 100$   
and the following at a downward sweep (Start > Stop):  $\text{Step} < 1 - \text{Variation} / 100$

Voltage		Start Cond	Volt Ch1
Spacing	Log Steps	Delay	0.00000 s
Start	0.90000 mV	Start	1.00000 mV
Stop	1.10000 V	Stop	1.00000 V
Step	1.13500 *	Variation	13.0000 %

The sweep X axis is always predefined by the external sweep, even if it is the internal generator that generates the sweep signal.

In the case of external sweeps the start and stop values define the sweep direction: If the start value is less than the stop value, the sweep is upward, otherwise it is downward. Signal changes *counter* to the sweep direction affect continuous mode and single mode differently:

- If an external continuous sweep was started using the "START" key, any significant change of frequency in the stop to start direction causes the sweep to restart.
- If an external single sweep was started using the "SINGLE" key, changes in in the stop to start direction are interpreted as interference and ignored. A measurement value beyond the stop value terminates the sweep.

Though using the internal generator for **level-controlled measurement value triggering** is not actually prohibited, in most cases it gives no advantage.

Start Cond	Lev Trig Ch1
Delay	0.00000 s
Start	0.01000 V
Stop	1.00000 V

In the case of **edge-sensitive triggering**, the triggering edge is defined by the start and stop values: If the start value is less than the stop value, triggering occurs on a positive edge, that is, at the exact moment when a value *below* "Start" is followed by a value *above* "Start".

### Min Volt

This is used to enter a minimum level for external frequency sweeps. If the signal is below this threshold, no triggering occurs.

Min Volt	1.00000	mV
----------	---------	----

It prevents triggering at pauses in the signal. An excessively low minimum level would cause even frequency values measured in the noise to be used for triggering.

Remote-control command:  
ARM:LEVel:MIN <nu>

**Start**

This is used to enter the start value for the recording interval (in the case of external sweeps) or for the trigger range (in the case of level triggering).



If the start value is less than the stop value, the external sweep runs as an *upward* sweep; in the case of edge triggering the system awaits a *positive* edge. Measurement values that are lower than "Start" are ignored.

If the present stop value is entered as the start value, the sweep direction is automatically reversed and the stop value is given the old start value.

Remote-control command:  
 ARM:FREQuency:STARt <nu>  
 ARM:VOLTage:STARt <nu>

**Stop**

This is used to enter the stop value for the recording interval (in the case of external sweeps) or for the trigger range (in the case of level triggering).



If the stop value is less than the start value, the external sweep runs as a *downward* sweep; in the case of edge triggering the system awaits a *negative* edge. Measurement values that are lower than "Stop" are ignored.

If the present start value is entered as the stop value, the sweep direction is automatically reversed and the start value is given the old stop value.

**Note:**

*In the case of single sweeps the stop value is used to detect the end of the sweep. It should therefore be somewhat lower than the expected signal range.*

Remote-control command:  
 ARM:FREQuency:STOP <nu>  
 ARM:VOLTage:STOP <nu>

**Variation**

For entering the relative change of frequency or level in the form of a percentage with effect from which a new measurement is triggered in the case of external sweeps. For external level sweeps the value can also be entered in dB.



The variation chosen should be some 5% to 10% smaller than the expected changes, so that on the one hand triggering will occur reliably and on the other hand will not occur on intermediate values.

The entered value is used to calculate the internal variationfactor

- For upward sweeps:  $1 + \text{var}/100$
- For downward sweeps:  $1 - \text{var}/100$

---

**Note:**

*Due to the different variation factors for upward and downward sweeps, the number of sweep points in an upward sweep (given identical values for "Start", "Stop" and "Variation") is somewhat higher than in a downward sweep.*

---

In the case of continuous sweeps, a change by at least this value in the stop to start direction (i.e. counter to the sweep direction) causes measurement value recording to restart.

The lower entry value takes account of the current start and stop values and is automatically limited so that regardless of the sweep direction a maximum of 1024 measurement values can be recorded. Values of less than 0.1% cannot generally be entered.

Remote-control command:  
TRIGger:FREQuency:VARiation <nu>  
TRIGger:VOLTage:VARiation <nu>

## Sweep Options

Apart from the measurement system, the R&S UPV also has a comprehensive sweep system. This sweep system is enabled as a generator sweep system by activating a generator sweep or as an analyzer sweep system by activating the RMS selection sweep, and then takes control of the measurement system.

When a sweep system is activated, sweeps are started and also stopped in manual operating mode using the keys "START", "SINGLE" and "STOP/CONT" in the "CONTROL" panel.

Starting or restarting a sweep (via the START key) also causes certain generator functions to restart:

- Burst signals (sine burst and sine<sup>2</sup> burst) are reset, that is, they start at the burst phase or "Burst on Delay".
- The Play function starts again at the first sample in the WAV file.
- The Arbitrary function also starts again at the beginning.

## Overview of the Sweep Options

The following information refers to an **activated sweep system**, i.e. a sweep is activated in either the generator or the analyzer.

Sweeps are measurement cycles in which the individual measurements are triggered by predefined generator and analyzer settings. The generator and analyzer sweeps can be defined either by entering the start value, stop value, spacing and points/step or by specifying a sweep list. Both methods ultimately define a **table of settings** (X axis) which is processed when the sweep is started.

A one-off sweep is referred to as a **single sweep** and a continuously repeated sweep as a **continuous sweep**.

The **active sweep system** is **controlled**

- explicitly using the **control keys** START (Ctrl F5), SINGLE (Ctrl F6) and STOP/CONT (Ctrl F7).
- implicitly by means of "**termination events**". These are events (user entries) which invalidate the current measurement and, therefore, the current sweep, i.e. changes in the generator, analyzer or filter bank. Following a termination event, the current sweep is restarted automatically. This ensures that the recorded data sets are based on the same settings.

It is *not* possible to **control** the **measurement system** if the sweep system is activated. Exception: If a sweep is terminated, "continuous *measurement*" is activated by pressing the **STOP/CONT** key or by means of a termination event (see section "*Terminated sweep*" on page 4.238).

The R&S UPV provides a large number of different sweep options. These options are summarized below:

- Generator sweep system: time-synchronous sweeps (DWELL sweeps) and analyzer-synchronous sweeps (AUTO sweeps). They can also be 2-dimensional (provided that more than one sweepable parameter exists for the selected generator function), i.e. 2 generator parameters are varied. This is then referred to as a Z sweep because the Z axis is swept in addition to the X axis.
- Analyzer sweep system: analyzer-synchronous sweep of the RMS selection frequency.

All sweeps can be performed either as parameter sweeps with constant increment or as list sweeps.

## Activating and Deactivating Sweeps

In the R&S UPV, the desired sweep system is activated/deactivated directly in the associated function panel:



- generator sweep under "Sweep Ctrl" in the "Generator Function" panel.
- sweep of the tracking filter for the "RMS Selective" measurement function under "Sweep Ctrl" in the "Analyzer Function" panel.

Only one of the two sweep systems can be active at any one time. If the user activates a sweep while another sweep is already active, the *already active* sweep is deactivated and a warning is issued. If an instrument or function which contains a sweep is activated while another sweep is already active, the new sweep is deactivated and an appropriate warning is issued.

When a sweep is *activated*, the measurement system first continues to run in continuous or single-measurement mode; the sweep system does not assume control of the measurement system until the sweep is started.

When the active sweep is *deactivated*, the measurement system switches back to continuous measurement.

## States of the Sweep System

The state of the sweep system is indicated above the 8<sup>th</sup> softkey. If the sweep system is activated, the current state is also indicated by the two LEDs above the START and SINGLE key.



The following states are possible:

<b>Off</b>	Sweep is deactivated; the measurement system is controlled directly by the user.
<b>Single</b>	Single sweep is being performed
<b>Cont</b>	Continuous sweep is being performed
<b>Waiting</b>	Sweep is waiting for a (re)start; has been reactivated or has been run at least once as a single sweep.
<b>Stopped</b>	Sweep has been stopped; can be continued or restarted.

### Continuous sweep

Continuous sweeps are started with the **START** key. The sweep state is indicated by "Sweep Cont" and illuminated **START LED**. When the sweep reaches the stop value of the X axis or the end of the X sweep list, it starts again at the start value. This is repeated until one of the following events occurs:



Pressing the **START** key

- interrupts the currently running sweep at once
- deletes the sweep curves (in multiscan mode all scans are deleted) including the min/max curves
- resets the min/max data and limit violations of the sweep curves as well as the highlighting of the protocol analysis
- causes the continuous sweep to restart

Remote-control command:

```
INIT:CONT ON
INIT:FORCe START
```



Pressing the **SINGLE** key switches the instrument to single sweep mode. The remaining points are plotted on the trace and the sweep system then enters the "Sweep Waiting" state. The continuous sweep is reactivated by pressing the **START** key.

Remote-control command:

```
INIT:CONT OFF
INIT:FORCe SINGLE
```



Pressing the **STOP/CONT** key causes the current measurement to be completed and then stops the sweep system ("Sweep Stopped" state). The continuous sweep is reactivated either using the **START** key (sweep starts from the beginning) or by pressing the **STOP/CONT** key again (sweep continues from the point at which it was stopped).

Remote-control command:

```
INIT:FORCe STOP
```

### Termination event

... stops the current sweep immediately and causes the continuous sweep to be restarted (see section "Overview of the Sweep Options" on page 4.235).

### Z stop value reached

The continuous sweep is stopped; the sweep system changes to the "Sweep Waiting" state (only with 2-dimensional generator sweeps, see section "Two-Dimensional Sweep" on page 4.124).

### Single sweep

Single sweeps are started by pressing the **SINGLE** key and are performed once only. When the stop value (of the X axis) has been reached, the sweep system switches to the "Sweep Waiting" state. With a 2-dimensional sweep, every new Z point (and the associated sweep over the X axis) must therefore be retriggered.

The sweep state is indicated by "Sweep Single"; the **START LED** and **SINGLE LED** light up. A current single sweep is interrupted or terminated by the following events:





Pressing the **START** key

- interrupts the currently running sweep at once
- deletes the sweep curves (in multiscan mode all scans are deleted) including the min/max curves
- resets the min/max data and limit violations of the sweep curves as well as the highlighting of the protocol analysis
- starts a *continuous* sweep

Remote-control command:  
 INIT:CONT ON  
 INIT:FORCe START



Pressing the **SINGLE** key stops the current sweep immediately and causes the single sweep to be restarted.

Remote-control command:  
 INIT:CONT OFF  
 INIT:FORCe SINGLE



Pressing the **STOP/CONT** key causes the current measurement to be completed and then stops the sweep system ("Sweep Stopped" state). The single sweep is reactivated either using the SINGLE key (sweep starts from the beginning) or by pressing the STOP/CONT key again (sweep continues from the point at which it was stopped).

Remote-control command:  
 INIT:FORCe STOP

#### Termination event

... stops the current sweep immediately and causes the single sweep to be restarted (see section "Overview of the Sweep Options" on page 4.235).

#### X stop value reached

The single sweep is stopped; the sweep system changes to the "Sweep Waiting" state.

Remote-control command: -

#### Terminated sweep

The sweep system only enters this state if a single sweep or a 2-dimensional continuous sweep is terminated. No further measurements are performed; the measurement values, data sets and sweep traces are frozen. Sweep traces should only be read out via the remote-control station when the system is in this state.

The sweep state is indicated by "Sweep Waiting"; **none of the LEDs** light up.

A terminated single sweep is affected by the following events:



Pressing the **START** key

- deletes the sweep curves (in multiscan mode all scans are deleted) including the min/max curves
- resets the min/max data and limit violations of the sweep curves as well as the highlighting of the protocol analysis
- starts a *continuous sweep*

Remote-control command:  
 INIT:CONT ON  
 INIT:FORCe START



Pressing the **SINGLE** key causes a single sweep to be restarted.

Remote-control command:  
 INIT:CONT OFF  
 INIT:FORCe SINGLE



Pressing the **STOP/CONT** key starts "continuous *measurement*". The single sweep is reactivated by pressing the SINGLE key.

Remote-control command: -

#### Termination event

... starts "continuous *measurement*" (see section "Overview of the Sweep Options" on page 4.235).

#### Stopped sweep

The measurement system only assumes this state when the STOP/CONT key is pressed while a measurement is being performed. Valid measurement values and data sets from the sweep point last set are available. However, only some of the measurement values of the sweep trace are available. Sweep traces should *not* be read out via the remote-control station when the system is in this state.

The sweep state is indicated by "Sweep Stopped"; **none of the LEDs** light up.

A stopped sweep is affected by the following events:



Pressing the **START** key

- deletes the sweep curves (in multiscan mode all scans are deleted) including the min/max curves
- resets the min/max data and limit violations of the sweep curves as well as the highlighting of the protocol analysis
- starts a *continuous sweep*

Remote-control command:  
 INIT:CONT ON  
 INIT:FORCe START



Pressing the **SINGLE** key causes a single sweep to be restarted.

Remote-control command:  
 INIT:CONT OFF  
 INIT:FORCe SINGLE



Pressing the **STOP/CONT** key restarts the sweep from the point at which it was stopped.

Remote-control command: -

#### Termination event

... starts "continuous *measurement*" (see section "Overview of the Sweep Options" on page 4.235).

## Several Sweep Traces in One Diagram

Up to 2 traces can be displayed in every sweep window. There are two options for displaying the sweep traces. These options can be selected in the individual sweep windows:

- Each new sweep cycle deletes the old trace; only one trace (or trace pair) is visible at any one time (single-scan mode).

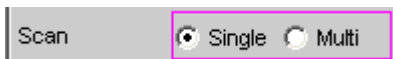

- Each new sweep cycle plots a new trace without deleting the old trace; all recorded traces are visible (multi-scan mode).

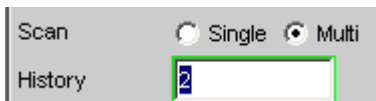

Since only a finite number of traces (i.e. the last 20 traces) can be stored in multi-scan mode, all the traces only remain visible until rescaling is performed. When rescaling is performed, the graphical display is deleted and the most recent traces are replotted making the graph easier to read. The number of traces to be replotted can be set in the "History" entry field.

## Level Measurements

The R&S UPV provides various level measurements which can be used to determine the AC or DC voltage component of a measurement signal using various methods.

- "RMS" determines the RMS of any given signal using a broadband analysis, optionally with suppression of a DC component contained in the signal.
- "RMS Selective" determines the RMS of a specific frequency inside or outside a selectable frequency band (by using a band-pass filter or a band-stop filter). Once again, it is possible to suppress a DC component contained in the signal.
- "Rub & Buzz" determines the RMS value above a selectable harmonic of the signal frequency (by using a tracking highpass filter).
- "DC" determines the DC component of any given signal.
- "Quasi Peak" determines the peak value of any given signal, the rise and fall of the measurement value occur with defined time constants.
- "Peak" determines the peak value of any given signal, the measurement value changes with the peak value without a delay.

The voltage of an analog signal is determined in volts and the amplitude of a digital signal is determined in FS. According to AES-17, a full-scale digital sinewave signal has a peak value *and* an RMS of 1.0 FS, i.e. in contrast to the analog signal, the RMS determined for a digital signal is higher by a factor of  $\sqrt{2}$ .

---

### Note:

Level measurement is also possible using the FFT analysis by means of integration via the frequency lines. If the measurement function FFT is selected, the RMS determined in this way is displayed as the function measurement value.

---

The interval during which the level of the measurement signal is monitored can be specified by the user as the measurement time or the interval time.

With AC measurements, other digital filters or (in the two-channel analog analyzer) an analog notch filter can be looped into the measurement path in addition to the input filter.

## Filter Settings

### DC Suppress

Used to activate DC suppression (only with RMS measurements in the digital analyzer).



With the level measurements "RMS" and "RMS Selective", the user can decide whether DC levels are to be taken into consideration or suppressed in the RMS.

This parameter field is not available in the analog analyzer because the suppression function is already provided by the AC coupling which can be set up using the hardware.



DC suppression deactivated.  
The DC component of the measurement signal is *not* suppressed ("DC coupling") and is included in the measurement result.

Remote-control command:  
SENSE[1]:FUNCTION:DCSuppression OFF



DC suppression activated.  
The DC component of the measurement signal is suppressed ("AC coupling"); the measurement result includes the AC component only.  
For DC suppression in the digital analyzer, the DC level is measured and subtracted from the total RMS value.

Remote-control command:  
SENSE[1]:FUNCTION:DCSuppression ON

**Notch(Gain)**

Used to activate/deactivate the analog notch filter and select the post-gain. Available only in the two-channel analog analyzer for the two types of RMS measurements and with "Quasi Peak".

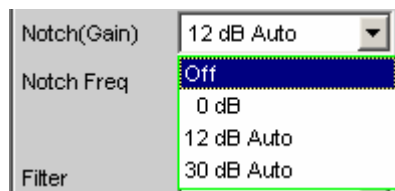

The second-order analog notch filter can be activated for narrowband suppression of an unwanted frequency line. If the fundamental is suppressed with the notch filter, the residual signal can be amplified in order to increase the dynamic response. Three notch gain levels are available.

**Note:**

*If frequency components occur outside the analyzer frequency range (out-of-band signals), the notch gain could cause overloading of the analyzer. In this case, the notch gain is reduced automatically, which is indicated by "Auto" in the list items 12 dB and 30 dB.*

**Off**

The notch filter is *deactivated*; no additional parameter fields are displayed.

Remote-control command:  
SENSE[1]:NOTCh OFF

**0 dB**

The notch filter is *activated*; the notch gain is *deactivated*. The notch frequency can be selected in the next parameter field.

Remote-control command:  
SENSE[1]:NOTCh DB0

**12 dB Auto** The notch filter is *activated*; the notch gain is 12 dB (is deactivated if out-of-band signals occur). The notch frequency can be selected in the next parameter field.

Remote-control command:  
SENSE[1]:NOTCh DB12

**30 dB Auto** The notch filter is *activated*; the notch gain is 30 dB (is reduced gradually to 12 or 0 dB if out-of-band signals occur). The notch frequency can be selected in the next parameter field.

Remote-control command:  
SENSE[1]:NOTCh DB30

### Notch Freq

Used to select the center frequency of the notch filter (notch frequency); only with activated analog notch filter.

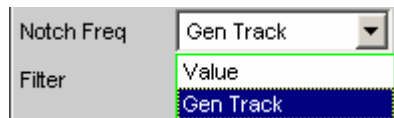

**Value** The user can enter the notch-filter center frequency in the next parameter field. If "Value" is selected, the center frequency last active is displayed.



Remote-control commands:  
SENSE[1]:NOTCh:FREQuency:MODE VALue  
SENSE[1]:NOTCh:FREQuency <nu>

**Gen Track** The notch-filter center frequency is adopted from the generator panel (if possible). If the generator frequency is changed, the notch frequency also changes. If an unsuitable generator signal (e.g. noise) is set, an error message is output and the center frequency last valid is retained.



#### Note:

*If the Low-Distortion Generator option is used, "Gen Track" should be avoided on account of the rigid coupling to the generator's nominal frequency, otherwise measuring inaccuracy resulting from slight frequency offset could occur.*

Remote-control command:  
SENSE[1]:NOTCh:FREQuency:MODE GENTrack

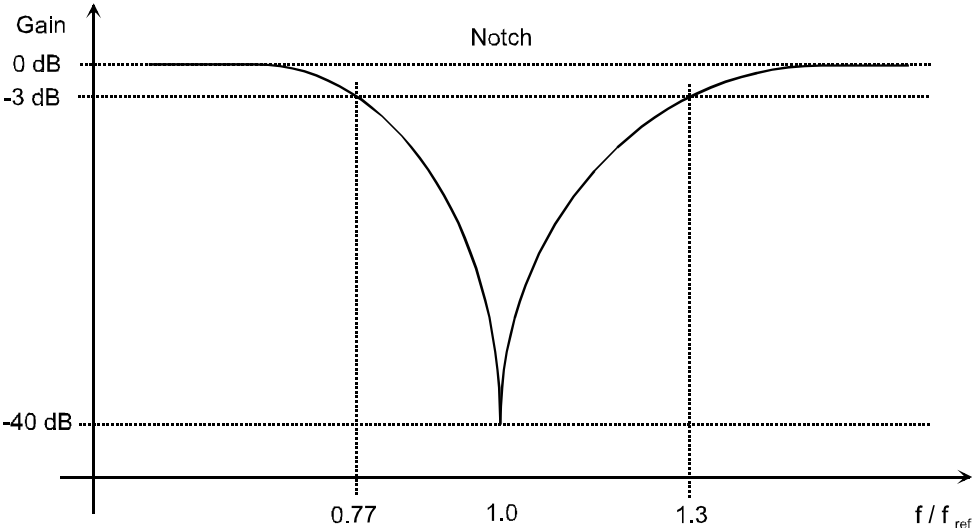
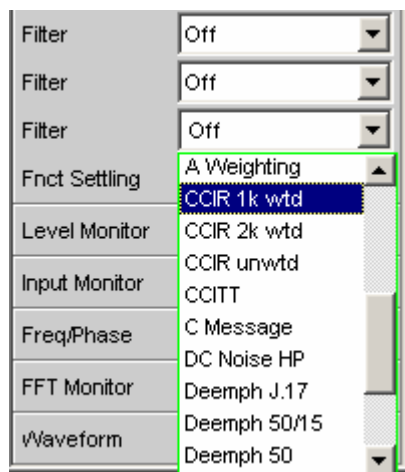

Figure 4-19 Characteristic of analog notch filter

**Filter**

Used to activate a digital filter in the measurement path. Depending on the selected level measurement method, up to 3 user-defined filters or weighting filters can be looped into the measurement path:

- RMS: max. 3 filters
- RMS Selective: max. 1 filter in addition to selection filter
- Rub & Buzz: max. 2 filters in addition to the tracking highpass filter
- Peak: max. 3 filters
- Quasi Peak: max. 3 filters
- DC: *no* filters
- FFT: max. 3 filters



The user-defined filters are configured as Filter 01 to 09 in the Filter panel (see section *"User-Definable Filters"* on page 4.420) and can then be used in the analyzer (more than once if required).

The selectable weighting filters are described in section *"Weighting Filters"* on page 4.428.

**Note:**

*Irrespective of the digital filters selected here, it is also possible to loop an additional input filter ("Pre Filter") into the measurement path. Furthermore, the analog bandwidth can be limited using the "Bandwidth" parameter field, which has the same effect as an additional low-pass filter.*

```
Remote-control command:
SENSe[1]:FILTer[1] <parameter>
SENSe[1]:FILTer2 <parameter>
SENSe[1]:FILTer3 <parameter>
```

List of <parameter> see section *"Filter Table"* on page 4.419.



## RMS Measurement, Broadband

Method used to measure the RMS of an AC voltage, either taking account of or disregarding a superimposed DC voltage. Any given signal shape can be measured.

### Digital operation:

The true RMS value of the signal content is displayed as a full-scale value from 0.0 to 1.0. Depending on whether "DC Suppress" is activated or deactivated, a superimposed DC component is measured (deactivated) or suppressed (activated).

### Analog operation:

Depending on the selected coupling, a superimposed DC component is measured (DC coupling) or suppressed (AC coupling).

Remote-control command:  
SENSE[1]:FUNCTION RMS

### Meas Time

Used to select the measurement time for adapting the measurement speed to the signal shape or (with single-tone signals) to the signal frequency.

Short measurement times or a high degree of accuracy can be given priority according to the specific measurement requirements.

With the automatic measurement modes, the measurement time is adapted to the (measured) signal frequency, provided that a sufficiently strong AC signal with not too low a frequency ( $f = 10$  Hz) is available.

---

### Note:

*With severely noise-corrupted or distorted signals and multi-tone signals, the automatic measurement modes (especially "Auto Fast") may no longer be able to clearly detect the signal period. To prevent measurement errors, such signals should therefore be measured using "Gen Track" or (if an external generator is used) using the "Value" measurement mode.*

---

**Auto Fast**

Where possible, the RMS measurement is performed over entire AC periods; with *high* frequencies, the measurement time is increased so that the maximum algorithmic error does not exceed **1 %**.

With very weak, low-frequency or pure DC signals, the maximum measurement time is limited to 100 ms (corresponding to 1 period at 10 Hz).



Recommended for single-tone measurements using the low-distortion generator or an unknown external signal source if maximum measurement *speed* is desired.

**Note:**

*Infrasound (below 10 Hz) can only be measured using a fixed measurement time (Value or Gen Track).*

Remote-control command:

```
SENSe[1]:FUNCTION:APERTure:MODE AFAST
```

**Auto**

Where possible, the RMS measurement is performed over entire AC periods; with *medium or high* frequencies, the measurement time is increased so that the maximum algorithmic error does not exceed **0.05 %**.

With very weak, low-frequency or pure DC signals, the maximum measurement time is limited to 200 ms (corresponding to 2 periods at 10 Hz).



Recommended for single-tone measurements using the low-distortion generator or an unknown external signal source if maximum measurement *accuracy* is desired.

**Note:**

*Infrasound (below 10 Hz) can only be measured using a fixed measurement time (Value or Gen Track).*

Remote-control command:

```
SENSe[1]:FUNCTION:APERTure:MODE AUTO
```

**Value**

The RMS measurement is performed over a preset time which must be entered in the parameter field below.

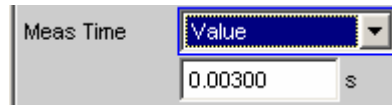

To *prevent* errors due to termination of measurements, the selected measurement time should be an integer multiple of the period. If the frequency of the signal to be measured is unknown or not constant, the selected measurement time should be as long as possible in order to *minimize* such errors.

---

**Note:**

*If a multichannel analyzer is used, max. 1.44 million samples can be observed. In these analyzers, the maximum measuring time is therefore dependent on the sampling rate and the analog bandwidth; at 40 kHz analog bandwidth, for example, it is 15 s. If a longer measuring time is required, one of the two-channel analyzers must be used for the measurement (max. 100 s).*

---

## Recommended for

- AC measurements of a known external signal source
- measurements of severely noise-corrupted or distorted signals of unknown frequency
- measurements of noise signals or multi-tone signals

Remote-control command:

```
SENSE[1]:FUNCTION:APERTure:MODE VALue  
SENSE[1]:VOLTage:APERTure <nu>
```

**Gen Track**

The RMS measurement is performed over (at least) 1 whole period of the generator signal; to allow this, the generator frequency is adapted to the sampling rate of the analyzer, if necessary. With high frequencies, the measurement time is increased to several periods in order to improve measurement accuracy.



Recommended for all AC measurements using the R&S UPV universal generator; particularly suitable for measuring severely noise-corrupted or distorted signals and for fast sweeps.

**Note:**

*If the Low-Distortion Generator option is used, "Gen Track" should be avoided on account of the rigid coupling to the generator's nominal frequency, otherwise measuring inaccuracy resulting from slight frequency offset could occur.*

*If the "Mod Dist" signal is used as the generator signal, the measurement time is based on the (usually dominant) "Lower Frequency".*

*If "Stereo Sine" is used as the generator signal, measurement channel 1 tracks generator channel 1 and measurement channel 2 tracks generator channel 2.*

*If "Arbitrary" is used as the generator signal, the measurement time is synchronized to the number of samples in the loaded file. As a result, measurement is always performed over a complete period of the (repeatedly output) ARB signal.*

```
Remote-control command:
SENSe[1]:FUNCTION:APERTure:MODE
GENTrack
```

See section "Level Measurements" on page 4.241 for further settings.

## RMS Measurement, Selective

Selective RMS measurement with narrowband band-pass filter or narrowband band-stop filter, either taking account of or disregarding a superimposed DC voltage. If a band-pass filter is used, the desired frequency component is *measured*; if a band-stop filter is used, this component is *suppressed*. Any given signal shape can be measured.

```
Remote-control command:
SENSe[1]:FUNCTION RMSSelect
```

**Meas Time**

Used to select the measurement time for adapting the measurement speed to the signal shape or (with single-tone signals) to the signal frequency.

Short measurement times or a high degree of accuracy can be given priority according to the specific measurement requirements.

With the automatic measurement modes, the measurement time is adapted to the (measured) signal frequency, provided that a sufficiently strong AC signal with not too low a frequency ( $f = 10$  Hz) is available.

---

**Note:**

*With severely noise-corrupted or distorted signals and multi-tone signals, the automatic measurement modes (especially "Auto Fast") may no longer be able to clearly detect the signal period. To prevent measurement errors, such signals should therefore be measured using "Gen Track" or (if an external generator is used) using the "Value" measurement mode.*

---

**Auto Fast**

Where possible, the RMS measurement is performed over entire AC periods; with *high* frequencies, the measurement time is increased so that the maximum algorithmic error does not exceed **1 %**.

With very weak, low-frequency or pure DC signals, the maximum measurement time is limited to 100 ms (corresponding to 1 period at 10 Hz).



Recommended for single-tone measurements using the low-distortion generator or an unknown external signal source if maximum measurement *speed* is desired.

---

**Note:**

*Infrasound (below 10 Hz) can only be measured using a fixed measurement time (Value or Gen Track).*

---

Remote-control command:

```
SENSE[1]:FUNCTION:APERTURE:MODE AFAST
```

**Auto**

Where possible, the RMS measurement is performed over entire AC periods; with *medium or high* frequencies, the measurement time is increased so that the maximum algorithmic error does not exceed **0.05 %**.

With very weak, low-frequency or pure DC signals, the maximum measurement time is limited to 200 ms (corresponding to 2 periods at 10 Hz).



Recommended for single-tone measurements using the low-distortion generator or an unknown external signal source if maximum measurement *accuracy* is desired.

---

**Note:**

*Infrasound (below 10 Hz) can only be measured using a fixed measurement time (Value or Gen Track).*

---

Remote-control command:

```
SENSe[1]:FUNCTION:APERture:MODE AUTO
```

**Value**

The RMS measurement is performed over a preset time which must be entered in the parameter field below.

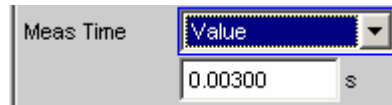

To *prevent* errors due to termination of measurements, the selected measurement time should be an integer multiple of the period. If the frequency of the signal to be measured is unknown or not constant, the selected measurement time should be as long as possible in order to *minimize* such errors.

---

**Note:**

*If a multichannel analyzer is used, max. 1.44 million samples can be observed. In these analyzers, the maximum measuring time is therefore dependent on the sampling rate and the analog bandwidth; at 40 kHz analog bandwidth, for example, it is 15 s. If a longer measuring time is required, one of the two-channel analyzers must be used for the measurement (max. 100 s).*

---

## Recommended for

- AC measurements of a known external signal source
- measurements of severely noise-corrupted or distorted signals of unknown frequency
- measurements of noise signals or multi-tone signals

Remote-control command:

```
SENSE[1]:FUNCTION:APERTure:MODE VALue  
SENSE[1]:VOLTage:APERTure <nu>
```

**Gen Track**

The RMS measurement is performed over (at least) 1 whole period of the generator signal; to allow this, the generator frequency is adapted to the sampling rate of the analyzer, if necessary. With high frequencies, the measurement time is increased to several periods in order to improve measurement accuracy.



Recommended for all AC measurements using the R&S UPV universal generator; particularly suitable for measuring severely noise-corrupted or distorted signals and for fast sweeps.

**Note:**

*If the Low-Distortion Generator option is used, "Gen Track" should be avoided on account of the rigid coupling to the generator's nominal frequency, otherwise measuring inaccuracy resulting from slight frequency offset could occur.*  
*If the "Mod Dist" signal is used as the generator signal, the measurement time is based on the (usually dominant) "Lower Frequency".*  
*If "Arbitrary" is used as the generator signal, the measurement time is synchronized to the number of samples in the loaded file. As a result, measurement is always performed over a complete period of the (repeatedly output) ARB signal.*

Remote-control command:  
 SENSE[1]:FUNCTION:APERture:MODE  
 GENTrack

**Bandwidth**

Used to select the bandwidth and filter type (band-pass filter **BP...** or band-stop filter **BS...**).

- BP 1 %**
- BS 1 %**

Band-pass filter / band-stop filter with the relative width of 1 % (geometrically symmetrical around the center frequency).



Remote-control command:  
 SENSE[1]:BANDwidth:MODE PPCT1  
 SENSE[1]:BANDwidth:MODE SPCT1



**BP 3 %**  
**BS 3 %**

Band-pass filter / band-stop filter with the relative width of 3 % (geometrically symmetrical around the center frequency).

Bandwidth  (Band-Pass filter)

Bandwidth  (Band-Stop filter)

Remote-control command:

SENSE[1]:BANDwidth:MODE PPCT3

SENSE[1]:BANDwidth:MODE SPCT3

**BP 1/12 Oct**  
**BS 1/12 Oct**

Band-pass filter / band-stop filter with the relative width of one twelfth octave (geometrically symmetrical around the center frequency).

Bandwidth  (Band-Pass filter)

Bandwidth  (Band-Stop filter)

The relative bandwidth of one twelfth octave is ~ 6 %.

(Calculated from  $\sqrt[24]{2} - \frac{1}{\sqrt[24]{2}} = 0.0577 = 5.77\%$ )

Remote-control command:

SENSE[1]:BANDwidth:MODE PPCT12

SENSE[1]:BANDwidth:MODE SPCT12

**BP 1/3 Oct**  
**BS 1/3 Oct**

Band-pass filter / band-stop filter with the relative width of one third octave (geometrically symmetrical around the center frequency).

Bandwidth  (Band-Pass filter)

Bandwidth  (Band-Stop filter)

The relative bandwidth of one third octave is ~ 23 %.

(Calculated from  $\sqrt[6]{2} - \frac{1}{\sqrt[6]{2}} = 0.2315 = 23.15\%$ )

---

**Note:**

*With the third-octave filter, the 0.1 dB bandwidth is reduced until an attenuation of approx. 3 dB is obtained for the cutoff frequencies. The effective bandwidth is therefore smaller than the precise bandwidth determined by calculation.*

---

Remote-control command:

SENSE[1]:BANDwidth:MODE PTOC

SENSE[1]:BANDwidth:MODE STOC

**BP 1/3 Oct  
Fast  
BS 1/3 Oct  
Fast**

Very fast settling third-octave filter (see above) with only 40 % attenuation.

Bandwidth  (Band-Pass filter)

Bandwidth  (Band-Stop filter)

Remote-control command:  
 SENSE[1]:BANDwidth:MODE PFAS  
 SENSE[1]:BANDwidth:MODE SFAS

**BP Fix  
BS Fix**

Band-pass filter / band-stop filter with selectable, arithmetically symmetrical bandwidth which must be entered in the parameter field below.

Bandwidth   
 Hz (Band-Pass filter)

Bandwidth   
 Hz (Band-Stop filter)

**Note:**  
 For infrasound measurements, the bandwidth can be reduced down to a sampling rate/48000 (but at least 1 Hz). As very long filter settling times occur in the range below 10 Hz, measurement results can only be viewed after several seconds.

Remote-control command:  
 SENSE[1]:BANDwidth:MODE PFI  
 SENSE[1]:BANDwidth:MODE SFI  
 SENSE[1]:BANDwidth <nu>

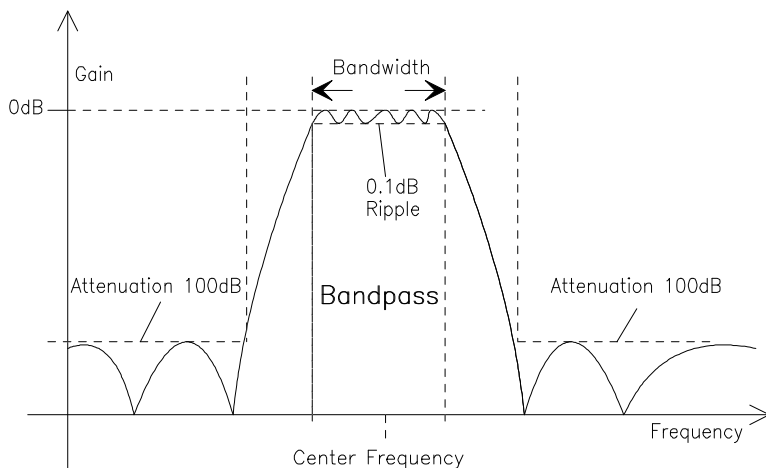
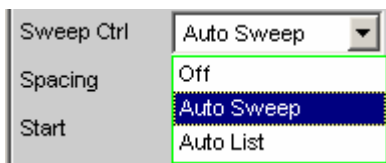

Figure 4-20 Filter characteristic of an RMS Selective band-pass filter

**Sweep Ctrl**

Used to activate and configure or deactivate the band-pass sweep / band-stop sweep in the analyzer sweep system.



In the two channel analog analyzer, the notch frequency of the analog notch filter (which can be enabled if required) is also swept.

**Note:**

*The sweeps are also deactivated implicitly when the generator sweep is activated and when certain start conditions are selected (e.g. external sweeps or "Time Chart").*

**Off**

The band-pass sweep / band-stop sweep is *deactivated*; the band center frequency can be specified in the "Freq Mode" parameter field. If the generator sweep system is also deactivated, the START, SINGLE and STOP/CONT keys affect the measurement system:

- START starts a continuous measurement
- SINGLE starts a single measurement or continues an already started continuous measurement as a single measurement.
- STOP/CONT stops an active measurement or starts a stopped or completed measurement as a continuous measurement.

Remote-control command:  
SENSE:SWEEP:CONTROL OFF

**Auto Sweep**

The band-pass sweep / band-stop sweep is *activated*; the sweep stepping is performed automatically; the sweep axis is calculated from the start value, stop value and step size or point number.

Remote-control command:  
SENSE:SWEEP:CONTROL ASWEEP

**Auto List**

The band-pass sweep / band-stop sweep is *activated*; the sweep stepping is performed automatically; the sweep axis is determined from the predefined list of sweep points (usually loaded as a file).

Remote-control command:  
SENSE:SWEEP:CONTROL ALIST

**Spacing**

Used to select the sweep range spacing, i.e. the way in which the sweep points are distributed on the sweep axis. Only visible for activated band-pass / band-stop sweep.

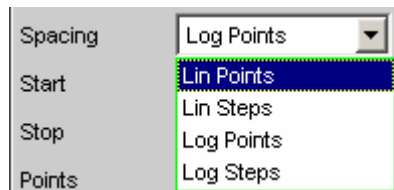

**Lin Points** The sweep range is divided linearly by specifying a number of points (linear sweep). This number is entered in the "Points" parameter field.

Should be selected if equidistant, linear spacing of *all* points is required.

Remote-control command:  
SENSe:SWEEp:SPACing LINPoints

**Lin Steps** The sweep range is divided into intervals of a specified linear step size starting at "Start" (linear sweep). This step size is entered in the "Step" parameter field.

Remote-control command:  
SENSe:SWEEp:SPACing LINSteps

**Log Points** The sweep range is divided logarithmically by specifying a number of points (logarithmic sweep). This number is entered in the "Points" parameter field.

Should be selected if equidistant, logarithmic spacing of *all* points is required.

Remote-control command:  
SENSe:SWEEp:SPACing LOGPoints

**Log Steps** The sweep range is divided into intervals of a specified logarithmic step size starting at "Start" (logarithmic sweep). Each sweep point is calculated by multiplying the previous point by a constant factor. This factor is entered in the "Step" parameter field.

Remote-control command:  
SENSe:SWEEp:SPACing LOGSteps

**Start**

Used to enter the start value for the band-pass / band-stop center frequency. Only visible for activated band-pass / band-stop sweep.

Start	<input type="text" value="20000.0"/>	Hz
-------	--------------------------------------	----

The start and stop value implicitly determine the sweep direction: If the start value is less than the stop value, an upward sweep is performed, otherwise a downward sweep will be performed. If a start value identical to the stop value is entered, the stop value is automatically loaded with the old start value. In this way, it is possible to change the sweep direction by entering just one value.

Remote-control command:  
SENSe:SWEep:START <nu>

**Stop**

Used to enter the stop value for the band-pass / band-stop center frequency. Only visible for activated band-pass / band-stop sweep.

Stop	<input type="text" value="20.0000"/>	Hz
------	--------------------------------------	----

The start and stop value implicitly determine the sweep direction: If a stop value identical to the start value is entered, the start value is automatically loaded with the old stop value.

Remote-control command:  
SENSe:SWEep:STOP <nu>

**Points**

Used to enter the number of sweep points for the band-pass / band-stop center frequency. Only visible for activated band-pass / band-stop sweep if "Lin Points" or "Log Points" is set for "Spacing".

Points	<input type="text" value="30"/>
--------	---------------------------------

The sweep range is divided into "Points – 1" (linear or logarithmic) equidistant steps. At least 2 points (start and stop value) are required.

A maximum of 1024 points can be selected.

Remote-control command:  
SENSe:SWEep:POINTs <nu>

**Step**

Used to enter the (linear or logarithmic) step size for the band-pass / band-stop center frequency. Only visible for activated band-pass / band-stop sweep if "Lin Steps" or "Log Steps" is set for "Spacing".

The entry range is limited automatically so that at least one and at most 1023 steps exist (corresponding to 1024 sweep points).

With *linear* step, the size of the step must always be entered, i.e. the numeric value is positive even if the start value is greater than the stop value. The physical unit is the same as that used when specifying "Start" and "Stop".

 (Example for lin. frequency sweep)

With *logarithmic* step, the factor must be entered by which each sweep point is to be multiplied in order to move to the next sweep point. Swapping the start and stop value (reversal of the sweep direction) therefore produces the reciprocal value. The closer the numeric value is to 1.0, the more sweep steps will be performed.

 (Example for log. downward sweep)

**Note:**

*Since the last step of the sweep is automatically adapted such that it corresponds exactly to the stop value, it may deviate by max. 50 % from the selected step size. If this is to be avoided, either the start / stop value must be corrected accordingly or the sweep spacing must be set using the "Points" parameter.*

Remote-control command:

SENSe:SWEep:STEP <nu>

**Filename**

Used to enter the file name for the list of band-pass / band-stop center frequencies (frequency sweep list). Only visible for activated band-pass / band-stop list sweep.



Remote-control command:

MMEMemory:LOAD:FILE 'filename'

**Freq Mode**

Used to determine the band-pass / band-stop center frequency. In the two channel analog analyzer, this field is used to determine the notch frequency of the analog notch filter (which can be enabled if required).

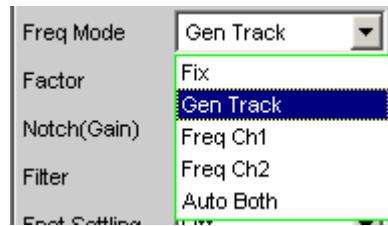

**Fix**

Fixed band-pass / band-stop center frequency – in the two channel analog analyzer, also the notch frequency if notch is activated. The center frequency must be entered in the parameter field below.

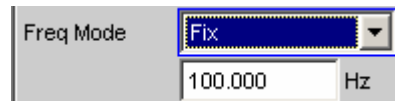

**Note:**

*For infrasound measurements, the center frequency can be reduced down to a sampling rate/48000 (but at least 1 Hz). As very long filter settling times occur in the range below 10 Hz, measurement results can only be viewed after several seconds.*

Remote-control command:  
SENSE:FREQUENCY:SELECT FIX

**Gen Track**

The bandpass/band-stop center frequency – in the two-channel analog analyzer, also the notch frequency if notch is activated – changes with the generator (*nominal*) frequency. This can be changed by means of manual entry in the Generator Function panel or owing to a generator frequency sweep. If the internal stereo generator is used, measurement channel 1 tracks generator channel 1 and measurement channel 2 tracks generator channel 2. By entering a factor in the next parameter field, the user can select whether the center frequency is to be identical to the generator frequency (factor = 1) or a multiple of the generator frequency. Setting a whole number for this factor will allow individual harmonics to be measured.

**Note:**

*If the Low-Distortion Generator option is used, "Gen Track" should be avoided on account of the rigid coupling to the generator's nominal frequency, otherwise measuring inaccuracy resulting from slight frequency offset could occur.*

An error message is output if an unsuitable signal function is selected in the generator (e.g. a multi-tone signal or noise signal).

Recommended when using the internal R&S UPV universal generator.

```
Remote-control command:
SENSe:FREQuency:SElect GENTrack
```

**Freq Ch1**

The bandpass/band-stop center frequency – in the two-channel analog analyzer, also the notch frequency if notch is activated – changes with the frequency measured in Channel 1; *not* available in the multichannel analyzers.

Recommended when using the low-distortion generator or an external signal source.

```
Remote-control command:
SENSe:FREQuency:SElect CH1F
```

**Freq Ch2**

The bandpass/band-stop center frequency – in the two-channel analog analyzer, also the notch frequency if notch is activated – changes with the frequency measured in Channel 2; *not* available in the multichannel analyzers.

Recommended when using the low-distortion generator or an external signal source.

```
Remote-control command:
SENSe:FREQuency:SElect CH2F
```



**Auto Each** In each channel the bandpass/band-stop center frequency tracks the measured frequency in the channel concerned, as does the notch frequency when notch is active in the two-channel analog analyzer.

If one of the channels does not provide unambiguous frequency information (e.g. in the case of multitone signals or noise signals), or if there is no input signal, the measurement for this channel is marked as invalid. This does not have any negative impact on the measured *value* for the other (valid) channel, but the measurement *time* is considerably longer. It is thus recommended to use the appropriate mode ("Freq Ch1" or "Freq Ch2") in such cases.

This is to be recommended when using an external stereo signal source.

```
Remote-control command:
SENSe:FREQuency:SElect AUTO
```

**Freq RefCh** The bandpass/band-stop center frequency tracks the frequency measured in the reference channel; only available in the multichannel analyzers.

Recommended when using the low-distortion generator or an external signal source.

```
Remote-control command:
SENSe:FREQuency:SElect REFFrequency
```

**Factor** Used to enter the factor by which the center frequency of the band-pass filter or band-stop filter is to be higher than the generator frequency. Only visible in "Freq Mode Gen Track".



Setting an integer factor greater than 1 will therefore allow an individual harmonic to be measured. If the fundamental is to be selected, the factor must be set to 1.

---

**Note:**  
*The factor does not affect the notch filter frequency. In "Freq Mode Gen Track", the notch filter is set to exactly the generator frequency without taking "Factor" into consideration so that a higher dynamic response can be achieved by means of (analog) suppression of the fundamental irrespective of the measurement task.*

---

```
Remote-control command:
SENSe:FREQuency:FACTor <nu>
```

See section "Level Measurements" on page 4.241 for further settings.

## Rub & Buzz Measurement

This is an RMS measurement with a tracking highpass filter whose passband starts above a selectable harmonic of the signal frequency.

This measurement function is available only if the R&S UPV-K6 option (*Extended Analysis Functions*) is installed and only for the two-channel analog analyzer. It is meaningful only if used in conjunction with the sinewave signal of the internal universal generator. When you switch on the "Rub & Buzz" measurement function, the corresponding **generator** settings will automatically be made:

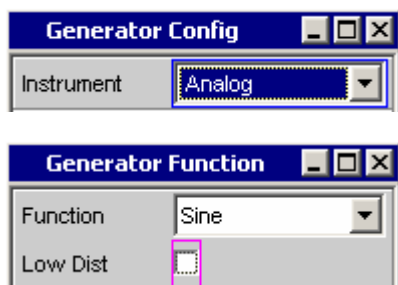

The purpose of the rub & buzz measurement is to pinpoint manufacturing defects on (single) loudspeakers, such defects being noticeable as nonharmonic noise or harmonics with a high amplitude. THDN measurements are not suitable for this purpose, since loudspeakers free from defects also produce k2 and k3 harmonics. What is needed is a measurement function that suppresses not only the fundamental but also the first harmonics and measures the remaining signal.

---

### Note:

An RMS measurement that takes into account the prefilter only can be performed with the level monitor function simultaneously with the rub & buzz measurement. It is thus possible to determine and display the frequency response and the rub & buzz characteristic simultaneously for two channels.

---

Remote-control command:  
 SENSE[1]:FUNCTION RUBBuzz

### Meas Time

Used to select the measurement time to match the measurement speed to the signal frequency.

In most cases – especially with sweeps – selecting "Gen Track" will be the most appropriate thing, since the rub & buzz measurement requires the use of the internal function generator.

With the *automatic* measurement modes, the measurement time is adapted to the (measured) signal frequency, provided that an AC signal is detected that is sufficiently strong and whose frequency is not too low ( $f \geq 10$  Hz). However, since the fundamental is filtered out, these measurement modes are meaningful only in exceptional cases, e.g. where modification of the generator frequency cannot be accepted, such modification being unavoidable with "Gen Track".

**Auto Fast**

The rub & buzz measurement is performed, as far as possible, over complete AC periods of the strongest harmonic detected. With *high* frequencies, the measurement time is extended so that the maximum algorithmic error does not exceed **1 %**.

With very weak or low-frequency signals or pure DC signals, the measurement time is limited to a maximum of 100 ms (corresponding to one period at 10 Hz).



Remote-control command:  
`SENSE[1]:FUNCTION:APERTure:MODE AFASt`

**Auto**

The rub & buzz measurement is performed, as far as possible, over complete AC periods of the strongest harmonic detected. With *high* frequencies, the measurement time is extended so that the maximum algorithmic error does not exceed **0.05 %**.

With very weak or low-frequency signals or pure DC signals, the measurement time is limited to a maximum of 200 ms (corresponding to two periods at 10 Hz).



Remote-control command:  
`SENSE[1]:FUNCTION:APERTure:MODE AUTO`

**Value**

The rub & buzz measurement is performed for a fixed period of time, which is to be entered in the next menu line.

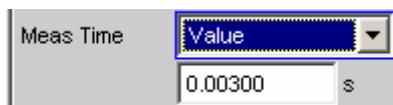

This option is recommended for measurement tasks in which a modification of the generator frequency cannot be accepted, such modification being unavoidable with "Gen Track".

The longer the measurement time, the more accurate the rub & buzz measurement results and, optionally, the RMS results obtained with the level monitor.

Remote-control command:  
`SENSE[1]:FUNCTION:APERTure:MODE VALue`  
`SENSE[1]:VOLTage:APERTure <nu>`

**Gen Track**

The RMS measurement is performed over (at least) one complete period of the generator signal. If necessary, the generator frequency is adapted to the analyzer sampling rate. For high frequencies, the measurement is performed over several periods in order to increase measurement accuracy.



In conjunction with the R&S UPV universal generator, this measurement mode ensures maximum accuracy at minimum measurement time.

This mode is recommended for the rub & buzz measurement, since this measurement uses the R&S UPV universal generator as a signal source.

```
Remote-control command:
SENSe[1]:FUNction:APERTure:MODE
GENTrack
```

**Freq Mode**

Used to define the highpass filter frequency or band. The following options are possible:

- The highpass filter can be assigned a fixed frequency.
- The highpass filter can track the generator with n times the generator frequency.
- A combination of the above can be selected. This is done by defining a tracking range by entering an upper and a lower frequency; outside this range, the pass frequency of the filter is maintained at the respective limit frequency.

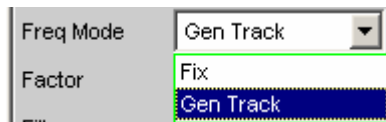
**Fix**

Use of a highpass filter with a fixed pass frequency, which is to be entered in the next menu line.

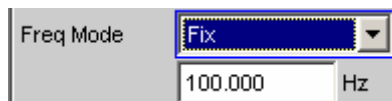

```
Remote-control command:
SENSe:FREquency:SElect FIX
```

**Gen Track**

Use of a tracking highpass filter whose pass frequency follows a multiple of the generator (*nominal*) frequency, which is to be entered in the next menu line.

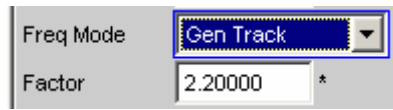

Moreover, the frequency limits for the tracking range can be selected. On attaining the lower or upper limit (FrqLim Low or Upp), the filter frequency is maintained at the limit frequency. This yields a tracking highpass filter that becomes a fixed-frequency highpass filter below FrqLim Low and above FrqLim Upp.

If the filter is to act as a tracking filter over the entire frequency range, the frequency limits are to be set to the minimum and maximum values.

Remote-control command:  
 SENSE:FREQUENCY:SELECT GENTrack

**Factor**

Used to enter the factor by which the pass frequency should be higher than the generator frequency. Meaningful values for rub & buzz measurements would be around approx. 5. The factor can be displayed only under "Freq Mode: Gen Track".



The following should be noted:

- If the product of the generator frequency and the factor attains the value of "FrqLim Upp", the highpass filter becomes a fixed-frequency filter operating at the upper limit frequency.
- If the product of the generator frequency and the factor attains the upper limit frequency of the analyzer used, no rub & buzz value will be determined. Any other measurement performed simultaneously (e.g. frequency response measurement with the level monitor function) is carried out at a correspondingly higher speed.

Remote-control command:  
 SENSE:FREQUENCY:FACTOR <nu>

**Frq Lim Low**

Lower limit of the highpass filter tracking range.  
Can be displayed only under "Freq Mode: Gen Track".



If the product of the generator frequency and the factor is lower than the limit entered here, the highpass filter becomes a fixed-frequency filter operating at the lower limit frequency.

This setting does not affect the rub & buzz measurement, i.e. the rub & buzz measurement will be performed.

Remote-control command:  
`SENSe[1]:FREQUENCY:LIMit:LOWer <nu>`

**Frq Lim Upp**

Upper limit of the highpass filter tracking range.  
Can be displayed only under "Freq Mode: Gen Track".



If the product of the generator frequency and the factor is higher than the limit entered here, the highpass filter becomes a fixed-frequency filter operating at the upper limit frequency.

This setting does not affect the rub & buzz measurement, i.e. the rub & buzz measurement will be performed.

Remote-control command:  
`SENSe[1]:FREQUENCY:LIMit:UPPer <nu>`

For further settings see section "Level Measurements" on page 4.241.

## Peak Measurement

Measurement of the peak value of any given signal, and the rise and fall of the measurement value all occur without a delay. The measurement value contains both AC and DC components.

Remote-control command:  
SENSE[1]:FUNCTION PEAK

### Note:

If a squarewave signal is applied, it is limited with respect to bandwidth by the upper measurement limit of the selected analyzer, whereby the overshoots occur at the edges (Gibbs phenomenon). The overshoots are also measured during the peak analysis, which means that the returned measurement value may be greater than the input peak. FS values greater than 1 may be measured, especially in the digital range.

### Meas Mode

Used to select the measurement mode.

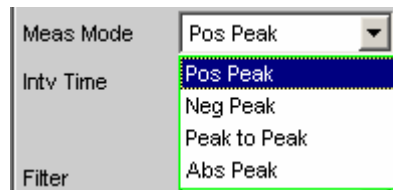

#### Pos Peak

The highest positive voltage value is measured.

Remote-control command:  
SENSE[1]:FUNCTION:MMODE PPEak

#### Neg Peak

The (numerically) highest negative voltage value is measured.

Remote-control command:  
SENSE[1]:FUNCTION:MMODE NPEak

#### Peak to Peak

The difference between the highest and lowest level is measured (peak-to-peak voltage).

Remote-control command:  
SENSE[1]:FUNCTION:MMODE PTOPEak

#### Abs Peak

The numerically highest (positive or negative) voltage value is measured.

Remote-control command:  
SENSE[1]:FUNCTION:MMODE PABSolut

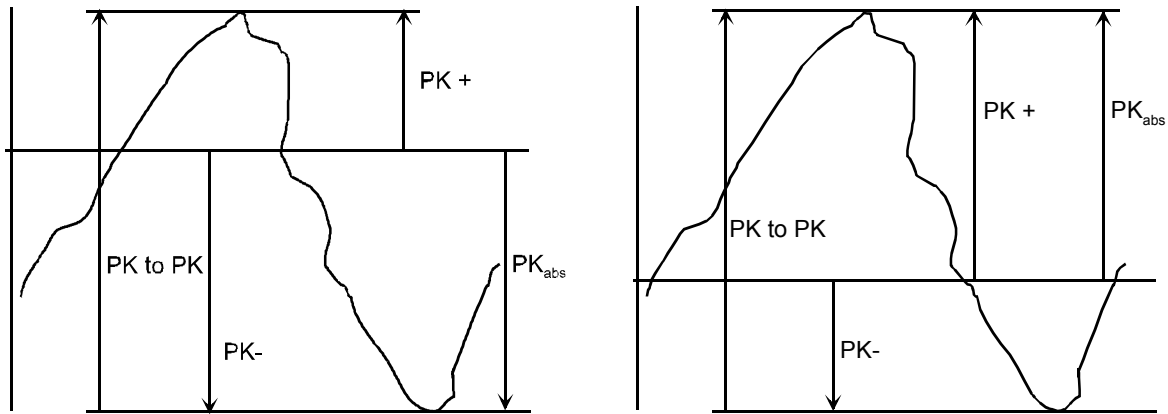
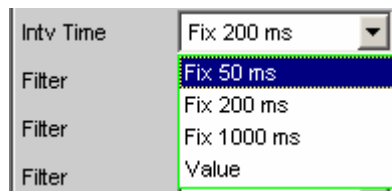

Figure 4-21 Result of Peak measurement on 2 example signals depending on selected measurement mode

### Intv Time

Used to select the measurement interval within which the peak search is to be performed. When the interval time has expired, the peak value memory is reset and the next peak value is sought.



**Fix 50 ms** Measurement interval 50 ms.

Remote-control command:  
SENSE[1]:VOLTage:INTVtime:MODE SFast

**Fix 200 ms** Measurement interval 200 ms.

Remote-control command:  
SENSE[1]:VOLTage:INTVtime:MODE FAST

**Fix 1000 ms** Measurement interval 1000 ms.

Remote-control command:  
SENSE[1]:VOLTage:INTVtime:MODE SLOW



**Value**

The interval time is entered in the parameter field below.

**Note:**

*If a multichannel analyzer is used, max. 1.44 million samples can be observed. In these analyzers, the maximum measuring time is therefore dependent on the sampling rate and the analog bandwidth; at 40 kHz analog bandwidth, for example, it is 15 s. If a longer measuring time is required, one of the two-channel analyzers must be used for the measurement (max. 100 s).*

Remote-control command:

```
SENSE[1]:VOLTage:INTVtime:MODE VALue
SENSE[1]:VOLTage:INTVtime <nu>
```

See section "Level Measurements" on page 4.241 for further settings.

## Quasi Peak Measurement

Measurement of the peak value of any given signal, and the rise and fall of the measurement value, all occur with defined time constants. The measurement is implemented as an RFI voltage measurement to CCIR 468-4 and DIN 45405.

Due to the constants for rise time and fall time, the measured quasi peak value is frequency-dependent. The displayed level is adjusted internally to 1 kHz sinusoidal, that is, in the settled state the quasi peak value at this frequency corresponds to the measurement value of a RMS measurement.

**Note:**

*This measurement requires uninterrupted monitoring of the measurement signal over an extended period of time. When using a multichannel analyzer, which only performs single measurements that are limited by time, it does not yield meaningful results. It is therefore only available with two-channel analyzers.*

Remote-control command:

```
SENSE[1]:FUNction QPEak
```

**Intv Time**

Used to select the measurement interval within which the Quasi Peak measurement is to be performed. Once this interval has expired, the peak hold is deleted and the next peak value is determined, starting with the instantaneous value.

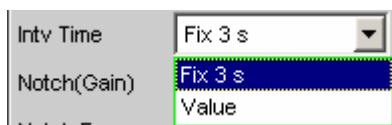
**Fix 3 s**

Measurement interval 3000 ms.

Remote-control command:  
SENSE[1]:VOLTage:INTVtime:MODE FIXed

**Value**

The interval time is entered in the parameter field below.

**Note:**

*In order to obtain settled measurement values, the measurement time should not be less than 3 seconds for triggered measurements and sweeps.*

Remote-control command:  
SENSE[1]:VOLTage:INTVtime:MODE VALue  
SENSE[1]:VOLTage:INTVtime <nu>

See section "Level Measurements" on page 4.241 for further settings.

## DC Voltage Measurement

Measurement of the DC voltage component of an analog or digital signal. The DC measurement is not a separate measurement function, but a measurement method that can be selected under "Level Monitor". This makes it possible to perform any other desired measurement function at the same time as a DC level measurement.

The level is acquired at the Monitor level, which means *after* the prefilter and the analog notch filter that can optionally be switched on (in the two-channel analog analyzer).

The measurement is performed using zero-crossing detection to eliminate the level component of any superimposed periodic AC signal that may be present. As a result, the measurement time is not constant, but instead is an integer multiple of the period of the superimposed AC signal.

In the case of very weak signals or signals with no AC component, the upper measurement time limit is 100 ms.

If "DC" is selected as a measurement function, a reference to the Level Monitor is shown and the previously configured measurement function is maintained.

## Signal-to-Noise Measurements

The R&S UPV provides signal-to-noise measurements (S/N measurements) according to a number of weighting methods. Each of these measurement functions measures the level with and without a signal: For measurement of the signal the set generator signal is output; for noise measurement the generator signal is turned off and the noise level of the DUT is measured. The measured signal-to-noise ratio is displayed as the measurement result.

The S/N sequence consists of two complete level measurement cycles that are performed and displayed independently of one another.

- The measurement values for level monitor, input monitor, post FFT and waveform are displayed for signal measurement first, and then for noise measurement.
- The frequency and phase are measured only during signal measurement. The measurement values remain unchanged during noise measurement.
- The result of the function can be determined only at the end of noise measurement. In continuous measurement mode the display shows the latest valid result or "---" during signal measurement.

The internal generator (universal or low distortion) must be used during noise measurements, since an external generator cannot be controlled by the measurement function. If the DUT is inadvertently not connected to the internal generator, measurement values of around 0 dB would be determined.

The signal for noise measurement is generated by an analog or digital generator depending on the DUT:

- In the case of an analog generator instrument, the generator output voltage is switched off and the output impedance remains unchanged.
- In the case of digital generator instruments with unchanged clock rates, a level value of 0,0 fullscale is output (all bits 0)

---

**Note:**

*When the analog universal generator is used, care should be taken to make the right choice of "Volt Range" in the "Generator Config" panel: In Auto mode the analog gain is canceled during noise measurement, which on the one hand brings about an improvement in the inherent noise (and therefore in the S/N dynamic response), but on the other hand results in a longer measurement time.*

---

The level weighting method can be chosen from the following:

- "RMS": root-mean-square broadband measurement
- "Peak": peak-value measurement.
- "Quasi Peak": peak-value measurement with quasi-peak weighting; measurement values rise and fall with defined time constants.

When the analog analyzer is used, switching off the generator causes a DC jump at the analyzer input, and this must not be allowed to affect the highly sensitive noise measurement. There are two measures which will solve this problem:

- The S/N measurement should preferably be carried out using a low-frequency highpass or comparable weighting filter. Failing to use a suitable filter will result in an error message.
- For measurement at low frequencies, where a highpass filter cannot be used, the recommended alternative is a file-defined delay filter with around 1.5 s of delay. This allows the DC jump to decay before the noise measurement starts.

S/N measurement can be performed via the S/N measurement function. This measurement function is found at menu item "Meas Mode" and offers a choice of level weighting methods.

Conversely it is also possible, as in the case of the earlier instruments R&S UPD and R&S UPL, to activate the S/N sequence during level measurements. This alternative operating mode ensures compatibility with the earlier models mentioned, and in particular enables remote-control programs to be used unchanged.

## S/N Measurement Function

Measurement function for determining the signal to noise of a DUT.

Remote-control command:  
SENSE[1]:FUNCTION SN

### Meas Mode

Used for choosing the level weighting method for signal measurement and noise measurement.

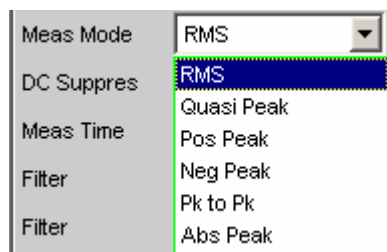

### RMS

Both level measurements are carried out in the form of broadband RMS measurements.

Remote-control command:  
SENSE[1]:FUNCTION:MMODE RMS

### Quasi Peak

Both level measurements are carried out in the form of peak value measurements with the aid of a quasi peak rectifier, that is, the level measurement value tracks the signal trace using defined rise and fall times.

Remote-control command:  
SENSE[1]:FUNCTION:MMODE QPE

### Pos Peak

Both level measurements are carried out in the form of peak value measurements of the highest positive level.

Remote-control command:  
SENSE[1]:FUNCTION:MMODE PPE

### Neg Peak

Both the level measurements are carried out in the form of peak value measurements of the highest negative level

Remote-control command:  
SENSE[1]:FUNCTION:MMODE NPE

**Pk to Pk**

Both level measurements are carried out in the form of peak to peak measurements

Remote-control command:  
SENSE[1]:FUNCTION:MMODE PTOP

**Abs Peak**

Both the level measurements are carried out in the form of peak value measurements of the absolute magnitude of the highest level.

Remote-control command:  
SENSE[1]:FUNCTION:MMODE PABS

**DC Suppress**

For activating DC suppression (in the digital analyzer only)



You can decide whether any DC level which may be present in the RMS value should be taken into account or suppressed.

This parameter field is not available in the analog analyzer, because the corresponding functionality is already provided by the hardware-controlled AC coupling.



DC suppression is disabled.

The DC component of the measurement signal is *not* suppressed ("DC coupling") and is included in the measurement result.

Remote-control command:  
SENSE[1]:FUNCTION:DCSuppression OFF



DC suppression is enabled.

The DC component of the measurement signal is suppressed ("AC coupling"); the measurement result includes the AC component only.

DC suppression is achieved by measuring the DC level in the digital analyzer and deducting this level from the total RMS value.

Remote-control command:  
SENSE[1]:FUNCTION:DCSuppression ON

**Filter**

For activating a digital filter in the test channel. Up to three user-defined or weighting filters can be looped into the test channel. At least one of the three filters in the analog analyzer should be a highpass or comparable weighting filter in order to filter out the DC jump when the generator is turned off. For this purpose the "HighPass 22 Hz" is enabled in filter #1 as standard.

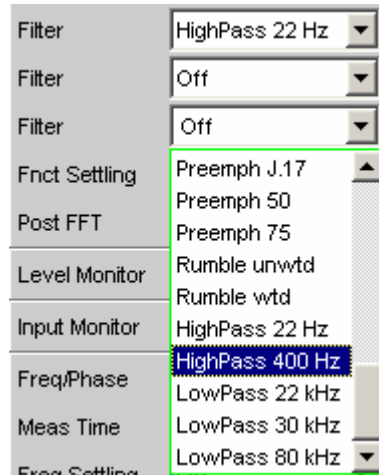

The user-definable filters are configured as filters 01 to 09 in the filter panel (see section "User-Definable Filters" on page 4.420) and can then be used (repeatedly if necessary) in the analyzer.

The selectable weighting filters are described in the section "Weighting Filters" on page 4.428.

The filters chosen in this way work during noise measurement only. During signal measurement they are bypassed. This makes it possible to apply a deliberate weighting to the noise signal without affecting the other signal level.

**Note:**

*The input filter (or "prefilter") in the configuration part of the analyzer affects both signal measurement and noise measurement. Thus if there is a need for a filter that also filters the signal component, it can be chosen as a prefilter. Moreover the analog bandwidth can be restricted with the aid of the "Bandwidth" parameter field, which corresponds to an additional low pass filter.*

```
Remote-control command:
SENSe[1]:FILTer[1] <parameter>
SENSe[1]:FILTer2 <parameter>
SENSe[1]:FILTer3 <parameter>
```

For a <parameter> list see section "Filter Table" on page 4.419.

**Meas Time**

This is used for choosing the measurement time for the purpose of adapting the measurement speed to the waveform or, in the case of single tone signals, to the signal frequency.

Priority can be given to short measurement time or high accuracy, depending on the measurement requirements.

In automatic measurement modes the measurement time is adapted to the measured signal frequency, provided an AC signal that is sufficiently strong and not too low in frequency is present ( $f \geq 10$  Hz).

---

**Note:**

*In the case of very strong signals that are noisy or distorted, and in the case of multitone signals, the automatic measurement modes, in particular "Auto Fast", are unable to detect the signal period with certainty. For the avoidance of measurement errors, such signals should therefore preferably be measured using "Gen Track" or "Value".*

---

**Auto Fast**

For use with the "RMS" measurement mode only. Level measurements are performed as far as possible over whole AC periods. In the case of *high* frequencies the measurement time is extended so that a maximum algorithmic error of 1 % is not exceeded.

In the case of low-noise DUTs the upward measurement time for noise measurement is limited to 100 ms (corresponding to 1 period at 10 Hz).



This setting is recommended when the excitation (in signal measurements) is a single tone signal, particularly when the low-distortion generator is being used, if the aim is to achieve the highest measurement *speed*.

Remote-control command:

```
SENSE[1]:FUNCTION:APERTure:MODE AFAST
```

**Auto**

For use with the "RMS" measurement mode only. Level measurements are performed as far as possible over whole AC periods. In the case of *center or high* frequencies the measurement time is extended so that a maximum algorithmic error of **0.05 %** is not exceeded.

In the case of low-noise DUTs the upward measurement time for noise measurement is limited to 200 ms (corresponding to 2 periods at 10 Hz).



This setting is recommended when the excitation (in signal measurements) is a single tone signal, particularly when the low-distortion generator is being used, if the aim is to achieve the highest measurement *accuracy*.

Remote-control command:  
`SENSE[1]:FUNCTION:APERTure:MODE AUTO`

**Gen Track**

For use with the "RMS" measurement mode only. Level measurements are performed over at least 1 whole period of the generator signal. For this purpose the generator frequency is adapted as necessary to the sampling rate of the analyzer. In the case of high frequencies the measurement time is extended to several periods in order to increase the measurement accuracy.



This setting is recommended when the excitation (in signal measurements) is a single tone signal and the R&S UPV universal generator is being used.

**Note:**

*If the Low-Distortion Generator option is used, "Gen Track" should be avoided on account of the rigid coupling to the generator's nominal frequency, otherwise measuring inaccuracy resulting from slight frequency offset could occur.*

*If "Stereo Sine" is used as the generator signal, measurement channel 1 tracks generator channel 1 and measurement channel 2 tracks generator channel 2.*

*If "Arbitrary" is used as the generator signal, the measurement time is synchronized to the number of samples in the loaded file. As a result, measurement is always performed over a complete period of the (repeatedly output) ARB signal.*

Remote-control command:  
`SENSE[1]:FUNCTION:APERTure:MODE  
 GENTrack`



**Value** Measurement is performed inside a predefined time which has to be entered in the following parameter field.

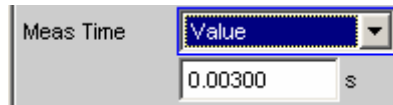

In order to *avoid* errors caused by the termination of measurements, the chosen measurement time should be an integer multiple of the period and, due to the noise measurement, should not be too short.

In the "Quasi Peak" measurement mode, the measurement time should not be significantly less than 3 s on account of the long rise time constants.

This setting is recommended when the excitation (in signal measurements) consists of noise signals or multitone signals.

Remote-control command:  
`SENSE[1]:FUNCTION:APERTure:MODE VALue`  
`SENSe[1]:VOLTagE:APERTure <nu>`

**Fix 50 ms** For use with the peak measurement mode only.  
 The measurement time is 50 ms.

Remote-control command:  
`SENSe[1]:FUNCTION:APERTure:MODE SFAST`

**Fix 200 ms** For use with the peak measurement mode only.  
 The measurement time is 200 ms.

Remote-control command:  
`SENSe[1]:FUNCTION:APERTure:MODE FAST`

**Fix 1000 ms** For use with the peak measurement mode only.  
 The measurement time is 1000 ms.

Remote-control command:  
`SENSe[1]:FUNCTION:APERTure:MODE SLOW`

**Fix 3 s** For use with the "Quasi Peak" measurement mode only.  
 3000 ms is the recommended measurement time for quasi peak measurements.

Remote-control command:  
`SENSe[1]:FUNCTION:APERTure:MODE FIXed`

For further settings see section "Level Measurements", page 4.241.

## S/N Sequence in Level Measurements

In order to retain compatibility with the earlier models R&S UPD and R&S UPL, the R&S UPV also provides the option to activate the S/N sequence during level measurements, in particular enabling remote-control programs to be used unchanged.

### S/N Sequence

Used for activating the S/N sequence in order to determine the signal to noise.



Signal-to-noise measurement can thus be performed in the "RMS", "Peak" and "Quasi Peak" level measurement modes.



The S/N sequence is disabled.  
A pure level measurement is carried out.

Remote-control command:  
`SENSe[1]:FUNCTION:SNSequence OFF`



The S/N sequence is enabled.  
Level measurement is performed with the generator signal switched on and then with it switched off. The S/N measurement result is determined from this.

Remote-control command:  
`SENSe[1]:FUNCTION:SNSequence ON`

For further settings see section "*Level Measurements*", page 4.241.

## Distortion Measurements

The R&S UPV provides various methods for measuring distortions. These methods can be used to determine harmonic and intermodulation distortions of a DUT. The measurement signals required in each case can be generated by the internal generator (recommended) or by an external signal source.

- "THD" ("total harmonic distortion") is a distortion measurement over the first 8 harmonics or over any given combination of the first 8 harmonics. The noise between the harmonics is *not* measured. An ultra-pure sinewave signal is required as the measurement signal.
- "THD+N & SINAD" ("total harmonic distortion + noise") is a distortion measurement which measures the energy of the broadband noise *and* (optionally) of all harmonics within a selectable frequency band. An ultra-pure sinewave signal is required as the measurement signal.
- "Mod Dist" is a modulation factor analysis which determines the *total* intermodulation factor of the 2nd and 3rd order a low-frequency interfering signal to a high-frequency useful signal. The interfering signal should have the same or a higher amplitude than the useful signal (preferably an amplitude ratio of 4 : 1).
- "DFD" is a difference-tone factor analysis which determines the 2nd and 3rd order intermodulation products generated by two sinewave signals of the same amplitude.
- "DIM" is a dynamic intermodulation measurement for which a low-frequency squarewave signal and a sinewave signal of a higher frequency are used.

---

**Note:**

*The individual distortion components can be assessed visually using the "bargraph" or (Post) FFT. The measurement values can only have the full dynamic range if both the signal source and the analyzer are at full-scale level. If the measurement values are worse than expected, the following rules should be checked and observed.*

---

- The *digital generator* should use all available audio bits, the (overall) signal should have a level of 1.0 FS and as little dither as possible.
- The *analog generator* should be operated in the optimum "Volt Range", preferably in the "Auto" mode. If the "Fix" mode is used, it is important to ensure that the selected range is not significantly higher than the set (total) voltage.
- The *digital analyzer* should use all available audio bits.
- The *analog analyzer* should be operated in the optimum "Range", preferably in the "Auto" mode. If the "Fix" or "Lower" mode is used, it is important to ensure that the selected range is not significantly higher than the applied total voltage.

Calculation of the individual distortion component (harmonics or intermodulation products) and thus of the distortion measurement values is carried out using FFT. The FFT value is automatically adapted to the measurement signal. The longer the required FFT, the longer the necessary integration and therefore the longer the total measurement time. You can choose the *minimum* FFT value when Post FFT is enabled:

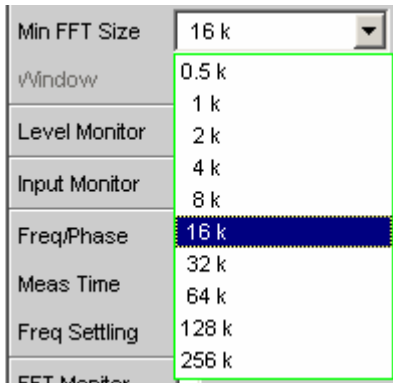

By increasing the minimum FFT value you can increase the ratio of measurement accuracy to measurement speed loading, since the distortion components are then measured in a narrower band.

If the selected FFT value is not large enough to capture the measurement signal, increase the FFT gradually by a factor of 2. The maximum FFT value depends on the bandwidth or sampling rate:

- at a 22 kHz bandwidth (analog) the FFT value can be increased to a maximum of 64 k,
- at sampling rates of less than 50 kHz (digital) or at a 40 kHz bandwidth (analog) the FFT value can be increased to a maximum of 128 k,
- at sampling rates of more than 50 kHz (digital) or a bandwidth of 80 or 250 kHz (analog) the FFT value can be increased to a maximum of 256 k.

The maximum integration time in the analog analyzer (fast mode) is therefore around 1.4 s.

## General Settings

This chapter contains the settings that occur in a number of distortion measurements where they have the same meaning.

### Dynamic Mode

Only available in the two-channel analog analyzer; the digital analyzers and the multichannel analog analyzers always perform measurements with the full dynamic range (without any reduction in speed).



Measurements performed with a high dynamic range ("**P**recision") take longer. Conversely, the dynamic range of the R&S UPV analyzer is not fully utilized if a short measurement time is selected ("**F**ast"). The decision as to whether a fast measurement would be sufficient or whether a precision measurement is required should therefore be made depending on the DUT (by comparing the fast and precision measurement). If the measurement value from the precision measurement is not better than that from the fast measurement, the user can decide against a high dynamic range in favour of a shorter measurement time.

---

#### **Note:**

*Since notch measurement is not meaningful for dynamic intermodulation measurement (DIM) or for 3rd order (d3) difference frequency distortion (DFD) analysis, it is not made available.*

---



A fast measurement with low dynamic range is performed (fast measurement).

This is recommended in the case of signals with poor dynamic response (less than 30 dB).

It is necessary when measuring total harmonic distortion in signals with fundamentals higher than 115 kHz.

Remote-control command:  
SENSE[1]:FUNCTION:DMODE FAST



A precision measurement with maximum dynamic range but a longer measurement time is performed. Following preliminary measurement to determine the fundamental frequency and the total level (in the case of total harmonic distortion measurements) or the single signal components (in the case of intermodulation measurements), the main measurement is performed with activated analog filter and post-gain of the residual signal (to increase the dynamic range).

The analog filter reduces the modulation of the fed-in signal components to make it possible to amplify the residual signal to be measured without the danger of overloading.

Either a notch filter (for narrowband suppression of the harmonic with total harmonic distortion measurements or of the dominant interferer with Mod Dist) or a lowpass filter (for suppressing the dual tone in the case of DFD d2) is used as analog filter.

The total measurement time is just over twice that required for the "Fast" dynamic mode.

---

**Note:**

*When measuring total harmonic distortion (THD and THD+N), precision measurements with fundamentals higher than 115 kHz are identified as invalid because the notch filter does not work in this frequency range. Fast mode must then be used for such measurements.*

*If the dynamic range of the measurement signal (including any out-of-band signals) is lower than 30 dB, the post-gain is reduced step by step to 12 or 0 dB in order to prevent overranging. This "notch-ranging" once again increases the measurement time; the measurement value is, however, no more accurate than that obtained using the "Fast" measurement. The "Fast" dynamic mode should therefore be selected in such cases.*

---

Remote-control command:  
SENSe[1]:FUNctIon:DMODE PRECision

**Equalizer**

Used for activating/deactivating a precorrector table for the FFT bins.

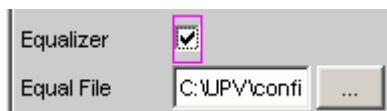

In this way the frequency response of a transmission link can be precorrected, for example, and in so doing the measurement point is transformed into another reference point.

When precorrection is enabled the computed FFT bins are multiplied by a frequency-dependent factor after which they are used to calculate the distortion measurement and applied to the display.

The factor is determined by interpolation between the two adjacent frequency reference points in the precorrector table.

Precorrection of the FFT spectrum is an attractive alternative to filtering the input signal, since the precorrector file can simply be generated from the frequency response requiring precorrection and need not be in the form of a coefficient file or pole/zero file.

**Application:**

*In the case of acoustic measurements (e.g. involving mobile telephones) on artificial ears of type 3.2 or higher, it is possible to compensate for the transfer function ERP (ear reference point) to DRP (drum reference point). Measurement of the sound waves by the microphone applied to the "eardrum" can thus be referred to the required measurement point (at the auricle).*

**Note:**

*The precorrector table is created after acquiring or reading in the trace data from the DUT in the "DispConfig" panels.*



The precorrector is disabled. The FFT bins are used and displayed without change. The measurement value is calculated from the *original* FFT spectrum.

Remote-control command:  
SENSe[1]:VOLtage:EQualize OFF



The precorrector is enabled. The next entry field, which is "Equal File", for the file name of the precorrector table, is activated and the file shown there is loaded. The measurement value is calculated from the *precorrected* FFT spectrum.

Remote-control command:  
SENSe[1]:VOLtage:EQualize  
ONMMEMory:LOAD:IEQualize 'filename'

**Bargraph**

Used for activating bargraph computation and display. In addition the "Bargraph1" window can be opened from here.



Configuration of the bargraphs is reserved for the "Bargraph1 Config" and/or "Bargraph2 Config" windows. The actual display takes place in the "Bargraph1" or "Bargraph2" windows.

**Note:**

*When measuring total harmonic distortion (THD+N or SINAD) there is no point in having a bargraph display, since the measurement does not involve discrete harmonics but rather the entire harmonic spectrum complete with noise. Therefore "Bargraph" is not available and the graph is not updated.*



Bargraph computation (and update) disabled. Recommended for increasing the measurement speed (e.g. for sweeps or remote control).

Remote-control command:  
SENSe:FUNction:BARGraph OFF



Bargraph computation (and update) enabled. The associated measurement function defines the remaining settings dynamically.

Remote-control command:  
SENSe:FUNction:BARGraph ON

**Post FFT**

Activation of the Post FFT; furthermore, the graphics window "FFT Graph1" can be opened from here.



For details, see section "Post FFT".

**THD**

THD (Total Harmonic Distortion) is a distortion measurement over the first 8 harmonics or over any given combination of the first 8 harmonics (d2 to d9) whereby the amplitudes of the individual harmonics are measured selectively. The root from the squared sum of the harmonics can be displayed either as an RMS or as a ratio to the total RMS. Unlike with the THD+N measurement, the noise between the harmonics is *not* measured.

An ultra-pure sinewave signal is required as the measurement signal. The selected frequency of this sinewave signal should be such that the significant components of the distortion spectrum are still below the upper measurement limit.



The "Sine" signal function of the internal generator is recommended as the *signal source*. If the optional low-distortion generator is available, it should be activated for measurements on low-distortion DUTs. The sinewave level and frequency can be varied or swept.

Remote-control command:  
SENSE[1]:FUNCTION THD

See section "*THD+N / SINAD*" on page 4.291 for alternative distortion measurement.  
See section "*Signal-to-Noise Measurements*" on page 4.280 for further distortion measurements.

### Meas Mode

Used to select the harmonics to be taken into consideration in the THD measurement value and to select the calculation formula for the measurement value.

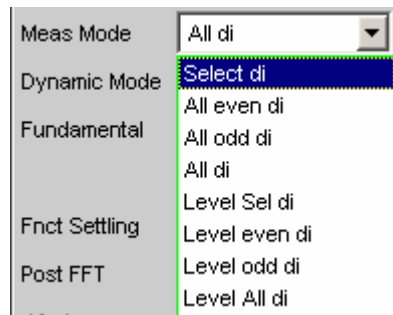

#### Note:

All 8 harmonics (and the fundamental) are always displayed in the graphic irrespective of the selected measurement mode.

The term "**Level**" indicates that the measurement result is displayed as an RMS and is *not* referenced to the total RMS (as is customary with distortion measurements).

#### Select di

The distortion of any given combination of harmonics d2 to d9 (root from the squared sum of the selected harmonics) is measured *referenced* to the total RMS.

$$U_{THD} [dB] = 20 * \log \frac{\sqrt{U_{d2}^2 + U_{d3}^2 + \dots}}{\text{Gesamteffektivwert}}$$

The measurement value can be displayed in % as well as in dB.

Remote-control command:  
SENSE[1]:FUNCTION:MMODE SElectdi

**All even di** The distortion of all *even* harmonics d2 to d8 (root from the squared sum of the even harmonics) is measured *referenced* to the total RMS.

$$U_{THD}[dB] = 20 * \log \frac{\sqrt{U_{d2}^2 + U_{d4}^2 + U_{d6}^2 + U_{d8}^2}}{\text{Gesamteffektivwert}}$$

The measurement value can be displayed in % as well as in dB.

Remote-control command:  
SENSe[1]:FUNCTION:MMODE DEVEN

**All odd di** The distortion of all *odd* harmonics d3 to d9 (root from the squared sum of the odd harmonics) is measured *referenced* to the total RMS.

$$U_{THD}[dB] = 20 * \log \frac{\sqrt{U_{d3}^2 + U_{d5}^2 + U_{d7}^2 + U_{d9}^2}}{\text{Gesamteffektivwert}}$$

The measurement value can be displayed in % as well as in dB.

Remote-control command:  
SENSe[1]:FUNCTION:MMODE DODD

**All di** The distortion of all harmonics d2 to d9 (root from the squared sum of all 8 harmonics) is measured *referenced* to the total RMS.

$$U_{THD}[dB] = 20 * \log \frac{\sqrt{U_{d2}^2 + U_{d3}^2 + \dots + U_{d8}^2 + U_{d9}^2}}{\text{Gesamteffektivwert}}$$

The measurement value can be displayed in % as well as in dB.

Remote-control command:  
SENSe[1]:FUNCTION:MMODE DALL

**Level Select di** The *distortion voltage* of any given combination of harmonics d2 to d9 (root from the squared sum of the selected harmonics) is measured.

$$U_{THD}[V] = \sqrt{U_{d2}^2 + U_{d3}^2 + \dots}$$

The measurement value is displayed in voltage units (volts or FS).

The desired harmonics are selected in the parameter fields below.

Remote-control command:  
SENSe[1]:FUNCTION:MMODE LSElectdi

**Level even di** The *distortion voltage* of all *even* harmonics d2 to d8 (root from the squared sum of the even harmonics) is measured.

$$U_{THD}[V] = \sqrt{U_{d2}^2 + U_{d4}^2 + U_{d6}^2 + U_{d8}^2}$$

The measurement value is displayed in voltage units (volts or FS).

Remote-control command:  
SENSe[1]:FUNCTION:MMODE LDEVen

**Level odd di** The *distortion voltage* of all *odd* harmonics d3 to d9 (root from the squared sum of the even harmonics) is measured.

$$U_{THD}[V] = \sqrt{U_{d3}^2 + U_{d5}^2 + U_{d7}^2 + U_{d9}^2}$$

The measurement value is displayed in voltage units (volts or FS).

Remote-control command:  
SENSe[1]:FUNCTION:MMODE LDODd

**Level all di** The *distortion voltage* of all harmonics d2 to d9 (root from the squared sum of all 8 harmonics) is measured.

$$U_{THD}[V] = \sqrt{U_{d2}^2 + U_{d3}^2 + \dots + U_{d8}^2 + U_{d9}^2}$$

The measurement value is displayed in voltage units (volts or FS).

Remote-control command:  
SENSe[1]:FUNCTION:MMODE LDALl

**Even Harmonics**

Used to select the desired *even* harmonics; only available if "(Level) Select di" is selected under "Meas Mode".

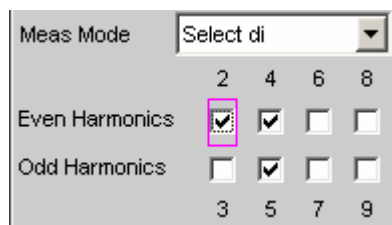

Remote-control command:  
SENSe[1]:FUNCTION:DISToRtion<i> ON | OFF  
<i> designates the harmonic 2, 4, 6, 8

**Odd Harmonics**

Used to select the desired *odd* harmonics; only available if "(Level) Select di" is selected under "Meas Mode".

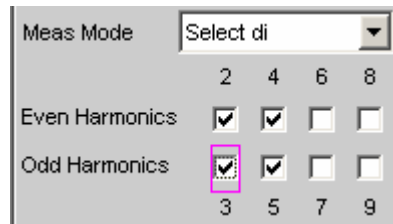

Remote-control command:

```
SENSE[1]:FUNCTION:DISTortion<i> ON | OFF
<i> designates the harmonic 3, 5, 7, 9
```

**Fundamental**

Used to determine the fundamental frequency. With precision measurement (in the two-channel analog analyzer only), this field is also used to determine the notch frequency of the automatically activated analog notch filter.

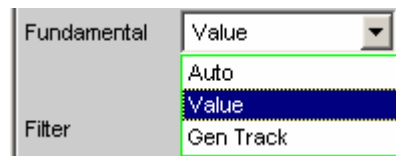
**Auto**

The fundamental frequency is determined (separately for each channel) by means of internal frequency measurement.

Recommended when using the low-distortion generator or an external signal source.

Remote-control command:

```
SENSE[1]:VOLTage:FUNDamental:MODE AUTO
```

**Value**

Fixed fundamental frequency; the value must be entered in the parameter field below.



Recommended for signals with a high noise component if an external generator is used as the signal source.

Remote-control commands:

```
SENSE[1]:VOLTage:FUNDamental:MODE
VALue
SENSE[1]:VOLTage:FUNDamental <nu>
```

**Gen Track**

The fundamental frequency changes with the generator (*nominal*) frequency. The generator frequency may change as a result of manual entries in the Generator Function panel or owing to a generator frequency sweep. Setting reliability in the case of signals with a high noise component is thus improved and measurement speed is increased.

**Note:**

*If the Low-Distortion Generator option is used, "Gen Track" should be avoided on account of the rigid coupling to the generator's nominal frequency, otherwise measuring inaccuracy resulting from slight frequency offset could occur.*

An error message is output if an unsuitable signal function is selected in the generator (e.g. a multi-tone signal or interfering signal). Recommended when using the internal universal generator.

Remote-control command:  
 SENSE[1]:VOLTage:FUNDamental:MODE  
 GENTrack

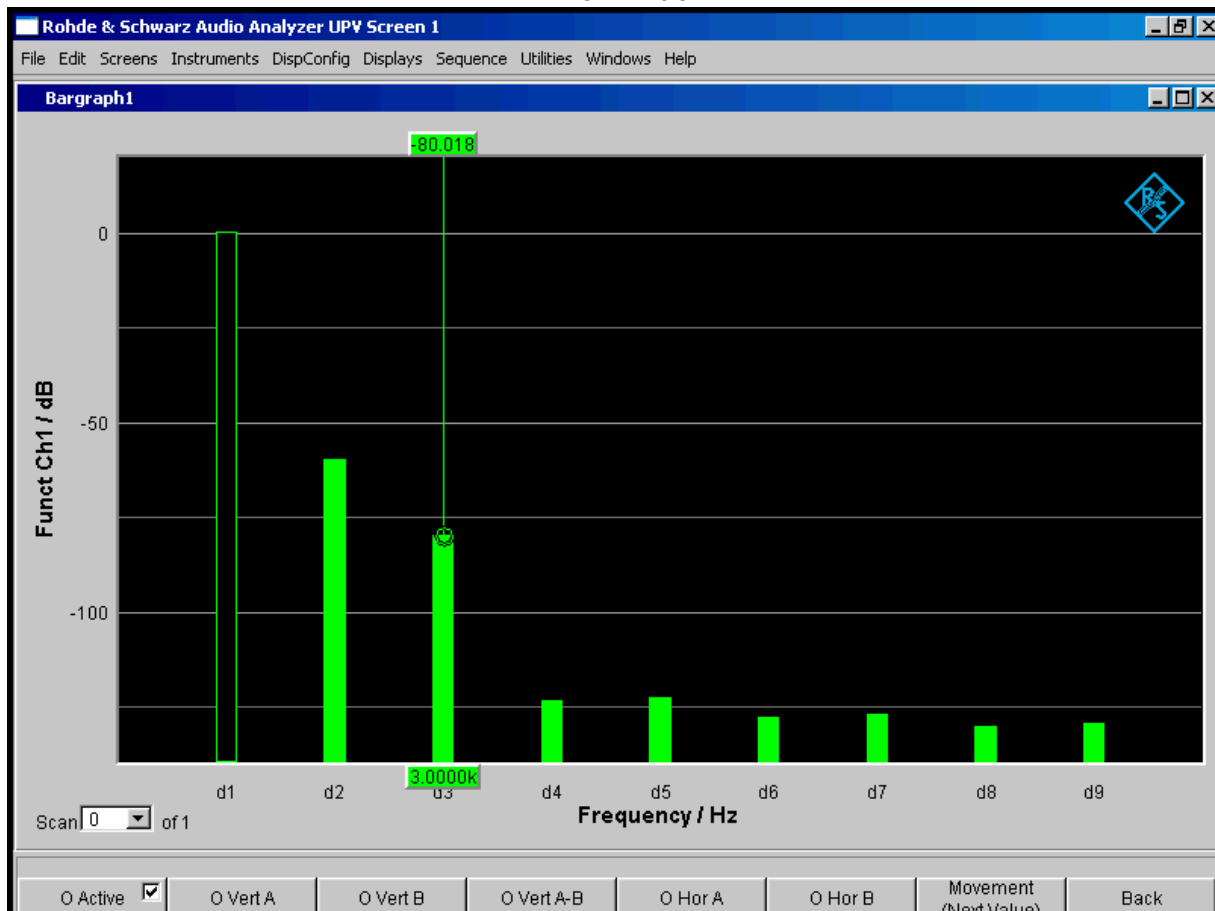

Figure 4-22 THD measurement of a 1 kHz sinewave signal with two harmonics of -60 dB and -80 dB

See section "Signal-to-Noise Measurements" on page 4.280 for further distortion measurements.

## THD+N / SINAD

THD+N & SINAD (Total Harmonic Distortion + Noise) is a distortion measurement which measures and displays the energy of the broadband noise *without the fundamental* (residual signal) within a selectable frequency band (optionally, the energy can also be displayed referenced to the total energy). This measurement function allows different measurement modes; it is also possible to eliminate the harmonics, except for the fundamental, so that the measurement value only contains non-harmonic components and noise.

An FFT is used to record the spectrum, filter out the fundamental and calculate the total remaining energy (residual spectrum) – comprising of harmonics and broadband noise – within the band limits specified with "Frq Lim Low" and "Frq Lim Upp". The FFT value is automatically adapted to the measured fundamental frequency; the lower the frequency is, the longer the required FFT and, therefore, the integration time will be. The user can select the *minimum* FFT value:

- implicitly by selecting the rejection bandwidth (with deactivated Post FFT)

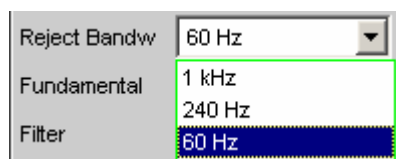

- explicitly by selecting the minimum FFT length ("Min FFT Size"; with activated Post FFT)

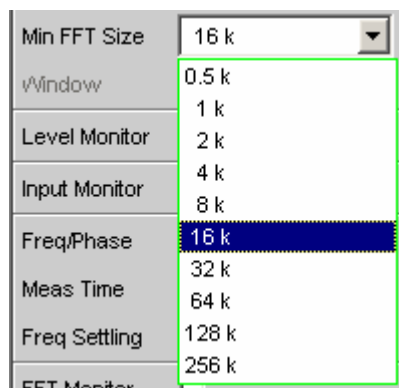

Here a compromise must be made between measurement speed and measurement accuracy:

- A small (initial) FFT length and a large rejection bandwidth ("Rejection Bandwidth") mean a short measurement time; the filtered-out sideband of the fundamental is, however, relatively large. Non-harmonic signal components close to the fundamental are not measured.
- A large (initial) FFT length means a long sampling time; the filtered-out sideband of the fundamental is, however, relatively small so that signal components (non-harmonics and noise) close to the fundamental are also measured.

If the selected FFT value is not large enough to determine the fundamental of the measurement signal, the length of the FFT is increased gradually by a factor of 2. The maximum FFT value depends on the bandwidth or sampling rate:

- at a 22 kHz bandwidth (analog) the FFT value can be increased to a maximum of 64 k,
- at sampling rates of less than 50 kHz (digital) or at a 40 kHz bandwidth (analog) the FFT value can be increased to a maximum of 128 k,
- at sampling rates of more than 50 kHz (digital) or a bandwidth of 80 or 250 kHz (analog) the FFT value can be increased to a maximum of 256 k.

The maximum integration time in the two-channel analog analyzer (fast mode) is therefore around 1.4 s.

**Note:**

Sideband suppression is designed for the shortest possible measurement time. In the case of very low-frequency signals (less than 12 Hz), sideband suppression can be improved at the expense of longer measurement time by increasing "Min FFT Size" to 128 K (at a sampling rate of 48 kHz or a bandwidth of 22 kHz) or 256 K (at a sampling rate of 96 kHz or a bandwidth of 40 kHz).

The energy of the noise and (if applicable) the harmonics can be displayed either as an RMS or as a ratio to the total RMS. The total RMS is band-limited to "Frq Lim Upp".

An ultra-pure sinewave signal is required as the measurement signal. The selected frequency of this sinewave signal should be such that the significant components of the distortion spectrum are still below the upper measurement limit.

The "Sine" signal function of the internal generator is recommended as the *signal source*. If the optional low-distortion generator is available, it should be activated for measurements on low-distortion DUTs. The sinewave level and frequency can be varied or swept.

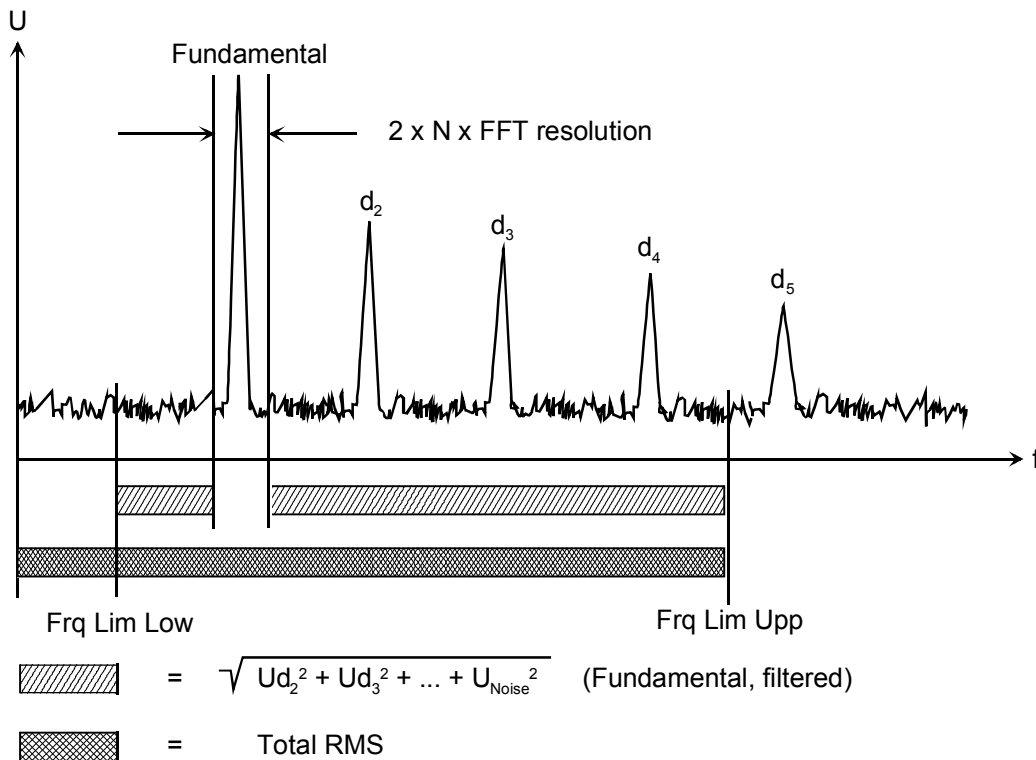

```
Remote-control command:
SENSE[1]:FUNCTION THDNs ndr
```

See section "THD" on page 4.285 for alternative distortion measurement.  
 See section "Signal-to-Noise Measurements" on page 4.280 for further distortion measurements.

**Meas Mode**

Used to select the THD+N measurement method and the calculation formula for the measurement value.

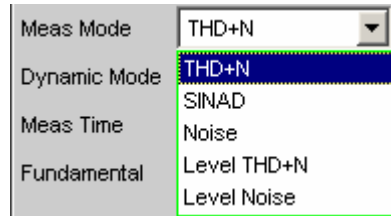

The term "**Level**" indicates that the measurement result is displayed as an RMS and is *not* referenced to the total RMS (as is customary with distortion measurements).

With the **Noise** measurements, it is also possible to filter all harmonics (except the fundamental) out of the overall signal.

**Note:**

*The noise energy of the respective sideband is also filtered out with each harmonic so that with very low frequencies (and, theoretically, with large numbers of harmonics) a large part of the noise energy is lost. To counter this, measurement is performed with a very fine frequency resolution, which (compared to the THD+N measurement) results in a considerably longer measurement time. The Level measurement modes should therefore only be used for high frequencies.*

**THD+N**

The *total* distortion (broadband noise *and* harmonics, *referenced* to the total RMS) is measured.

$$U_{THD+N} [dB] = 20 \cdot \log \frac{\sqrt{U_{d2}^2 + U_{d3}^2 + \dots + U_{Noise}^2}}{\text{Gesamteffektivwert}}$$

The total RMS is band-limited to "Frq Lim Upp".  
The measurement value can be displayed in % as well as in dB.

Remote-control command:  
SENSE[1]:FUNCTION:MMODE THDN

**SINAD**

Measurement *method* similar to THD+N, but the result is displayed as a *positive* dB value, i.e. the total RMS is referenced to the residual signal (overall spectrum without fundamental).

$$U_{SINAD} [dB] = 20 \cdot \log \frac{\text{Gesamteffektivwert}}{\sqrt{U_{d2}^2 + U_{d3}^2 + \dots + U_{Noise}^2}}$$

The total RMS is band-limited to "Frq Lim Upp."

Remote-control command:  
SENSE[1]:FUNCTION:MMODE SNDRatio



**Noise**

The *noise factor* (broadband noise *without* harmonics, *referenced* to the total RMS) is measured.

$$U_{Noise} [dB] = 20 * \log \frac{\sqrt{U_{Noise}^2}}{Gesamteffektivwert}$$

The total RMS is band-limited to "Frq Lim Upp".  
The measurement value can be displayed in % as well as in dB.

Remote-control command:  
SENSE[1]:FUNCTION:MMODE NOISE

**Level THD+N**

The *total distortion voltage* (comprising of broadband noise *and* the harmonics) is measured.

$$U_{THD+N} [V] = \sqrt{U_{d2}^2 + U_{d3}^2 + \dots + U_{Noise}^2}$$

The measurement value is displayed in voltage units (volts or FS).

Remote-control command:  
SENSE[1]:FUNCTION:MMODE LTHDn

**Level Noise**

The *noise voltage* (broadband noise *without* the harmonics) is measured.

The measurement value is displayed in voltage units (volts or FS).

Remote-control command:  
SENSE[1]:FUNCTION:MMODE LNOISE

**Rejection**

Used to select the fundamental rejection. Only available in "Dynamic Mode Fast" as well as in multichannel analog and digital analog analyzers.

**Narrow**

The fundamental is suppressed extremely narrowly. As a result, it is also possible to detect noise components which are immediately next to the carrier.

Remote-control command:  
SENSe[1]:THDN:REJection NARRow

**Wide**

A digital notch filter with properties identical to those previously implemented in analog measuring instruments is used to reject the fundamental. The broader filtering range produces slightly better measurement values since noise components close to the carrier are also suppressed. Recommended if the measurement results are to be comparable to those of analog measuring instruments.

Remote-control command:  
SENSe[1]:THDN:REJection WIDE

**Reject Bandw**

Used to select the rejection bandwidth ("Rejection Bandwidth") by implicitly entering the *initial* FFT value. Only functions with deactivated Post FFT; with activated Post FFT, the initial FFT value must be specified explicitly by the user.

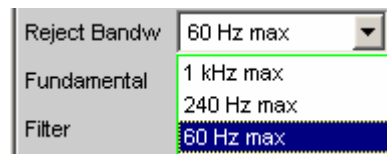

The larger the bandwidth is (absolute frequency band around the fundamental), the smaller the initial FFT and the higher the measurement speed will be.

The actual initial value of the FFT is determined automatically taking the sampling rate, the analog bandwidth and the dynamic range of the used analyzer into consideration.

The *final* value of the FFT is determined by the frequency of the measurement signal; it is increased automatically with low frequencies. Apart from the measurement frequency, the actual measurement time also depends on the analog bandwidth and sampling frequency.

**Note:**

When the Post FFT is activated, the internally calculated initial FFT value is entered in the "Min FFT Size" parameter field. It can then be freely changed by the user.

**1 kHz max** The rejection bandwidth is max. 1 kHz, i.e. 500 Hz below and above the fundamental. The initial FFT value is very small (e.g. 1 k at 22 kHz analog bandwidth and 48 kHz sampling rate) and the measurement time is very short (especially at high frequencies). Non-harmonic signal components close to the fundamental are not measured. Recommended for fast measurement of the harmonics.

Remote-control command:  
`SENSe[1]:FUNction:APERTure:MODE WIDE`

**240 Hz max** The rejection bandwidth is max. 240 Hz, i.e. 120 Hz below and above the fundamental. The initial FFT value is at least 4 k. Compromise between measurement time and loss of sideband energy.

Remote-control command:  
`SENSe[1]:FUNction:APERTure:MODE MEdium`

**60 Hz max** The rejection bandwidth is max. 60 Hz, i.e. only 30 Hz below and above the fundamental. The initial FFT value is not below 16 k. Recommended for measuring signal components close to the fundamental and especially for noise measurements as this bandwidth ensures that the fundamentals and harmonics are suppressed as narrowly as possible.

Remote-control command:  
`SENSe[1]:FUNction:APERTure:MODE NARROW`

**Fundamental**

Used to determine the fundamental frequency. With precision measurement (in the analog analyzer only), this field is also used to determine the notch frequency of the automatically activated analog notch filter.

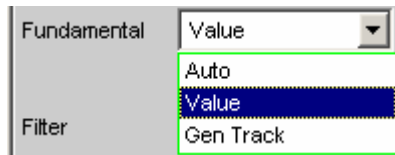

**Auto** The fundamental frequency is determined (separately for each channel) by means of internal frequency measurement.

Recommended when using the low-distortion generator or an external signal source.

Remote-control command:  
`SENSe[1]:VOLTage:FUNDamental:MODE AUTO`

**Value**

Fixed fundamental frequency; the value must be entered in the parameter field below.



Recommended for signals with a high noise component if an external generator is used as the signal source.

Remote-control command:  
 SENSE[1]:VOLTage:FUNDamental:MODE  
 VALue  
 SENSE[1]:VOLTage:FUNDamental <nu>

**Gen Track**

The fundamental frequency changes with the generator (*nominal*) frequency. The generator frequency may change as a result of manual entries in the Generator Function panel or owing to a generator frequency sweep. Setting reliability in the case of signals with a high noise component is thus improved and measurement speed is increased.

**Note:**

*If the Low-Distortion Generator option is used, "Gen Track" should be avoided on account of the rigid coupling to the generator's nominal frequency, otherwise measuring inaccuracy resulting from slight frequency offset could occur.*

An error message is output if an unsuitable signal function is selected in the generator (e.g. a multi-tone signal or interfering signal).

Recommended when using the internal universal generator.

Remote-control command:  
 SENSE[1]:VOLTage:FUNDamental:MODE  
 GENTrack

**Filter**

Used to activate a digital filter (user-definable filter or weighting filter) in the measurement path.

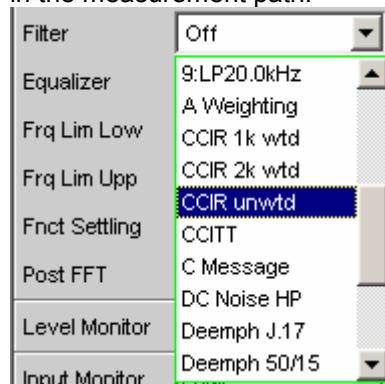

The filter used here only affects the residual signal. In other words, the THD+N reference value is always the RMS signal at the Monitor level, regardless of the filter selected here.

By contrast, the input filter ("Pre Filter") affects the residual signal *and* the total RMS value.

Five measurement scenarios for THD+N, SINAD and noise can thus be distinguished based on the selected input and function filters:

1. Both filters *off*.  
The reference value is the *unweighted* input signal, band-limited to "Freq Lim Upp" (such as with the R&S UPL or R&S UPD without a weighting filter).
2. Prefilter *off*, function filter *on*:  
The reference value is the *unweighted, wideband* input signal.
3. Prefilter used as a *weighting* filter, function filter *off*.  
The reference value is the *weighted* input signal, band-limited to "Freq Lim Upp."
4. Prefilter used as a *weighting* filter, function filter *on*:  
The reference value is the *weighted, wideband* input signal.
5. Prefilter used as a *low-pass* filter with a stop frequency corresponding to "Freq Lim Upp," function filter used as a *weighting* filter:  
The reference value is the *unweighted* input signal, band-limited to "Freq Lim Upp" (such as with the R&S UPL or R&S UPD *with* a weighting filter).

The available weighting filters are described in section "*Weighting Filters*" on page 4.428.

**Note:**

*The previous generation of instruments (R&S UPL and R&S UPD) did not allow a prefilter to be selected. Consequently, only measurement scenarios 1 and 5 were possible with these instruments.*

*The upper band limit can be limited in the analog analyzer using the "Bandwidth" parameter field, which has the same effect as an additional low-pass filter.*

Remote-control command:  
SENSe[1]:FILTer <parameter>

List of <parameter> see section "*Filter Table*" on page 4.419.

**Frq Lim Low**

Used to enter the lower band limit for calculating the distortion voltage; this limit does not affect calculation of the total RMS.

Frq Lim Low  Hz

Remote-control command:  
SENSe[1]:FREQuency:LIMit:LOWer <nu>

**Frq Lim Upp**

Used to enter the upper band limit for calculating the distortion voltage and the total RMS.

Frq Lim Upp  Hz

**Note:**

*If the fundamental of the measurement signal is above "Frq Lim Upp", the referenced measurements (THD+N, SINAD and Noise) should not be performed because the energy of the fundamental is filtered out in the reference value. An error message appears in the user info line and the measurement value is identified as invalid ("---").*

Remote-control command:  
SENSe[1]:FREQuency:LIMit:UPPer <nu>

See section "Signal-to-Noise Measurements" on page 4.280 for further distortion measurements.

**MOD DIST**

Mod Dist is a modulation factor analysis which determines the intermodulation of a low-frequency (dominant) interfering signal to a high-frequency useful signal. According to IEC 60268 Part 3, the interfering signal should be 60 Hz, the useful signal 7 kHz and the amplitude ratio 4 : 1. The R&S UPV measures the 2<sup>nd</sup> and 3<sup>rd</sup> order intermodulation products selectively (measurements are therefore largely unaffected by noise) and calculates their squared sum. Contrary to the recommendation in IEC 60268, the *total* intermodulation factor is therefore measured to ensure that this measurement method is comparable to the customary SMPTE measurement method.

**Note:**

*The measurement algorithm is highly tolerant with respect to the level ratio of the noise signal to the useful signal. The level of the noise signal may be 48 dB lower than the level of the (higher-frequency) useful signal. The level of the useful signal may be max. 68 dB lower than that of the noise signal.*

The "Mod Dist" signal function of the internal universal generator is recommended as the *signal source*. This allows the frequencies of the interfering and useful signal as well as their amplitude ratio to be varied. Furthermore, it is also possible to sweep the total level and useful frequency.

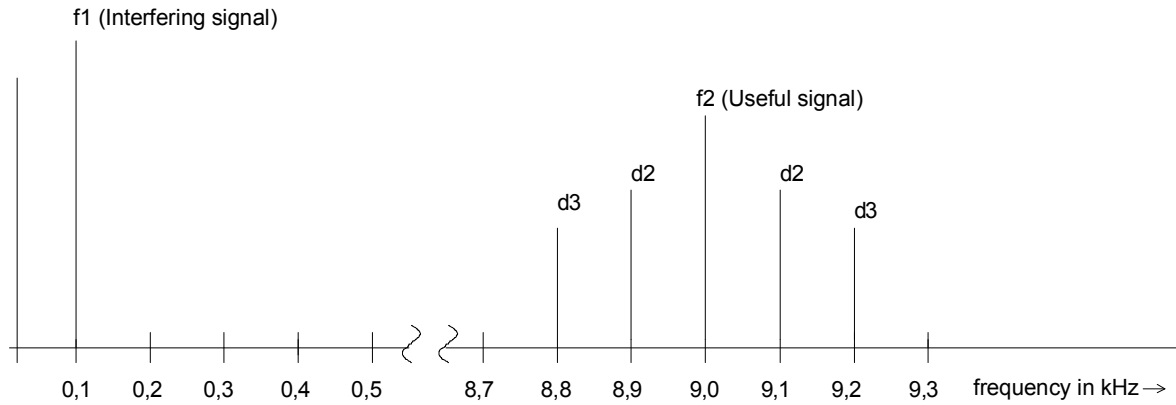

$$d2 = \frac{|U_{(f1+f2)}| + |U_{(f2-f1)}|}{U_{(f2)}} \quad 2^{\text{nd}} \text{ order intermodulation product}$$

$$d3 = \frac{|U_{(f2-2f1)}| + |U_{(f2+2f1)}|}{U_{(f2)}} \quad 3^{\text{rd}} \text{ order intermodulation product}$$

$$\text{MOD DIST [dB]} = 20 * \lg (\sqrt{d2^2 + d3^2}) \quad \text{Total intermodulation factor in dB}$$

Remote-control command:  
 SENSE[1]:FUNCTION MDIST

See section "DFD" on page 4.301 for alternative intermodulation measurement.

See section "Signal-to-Noise Measurements" on page 4.280 for further distortion measurements.

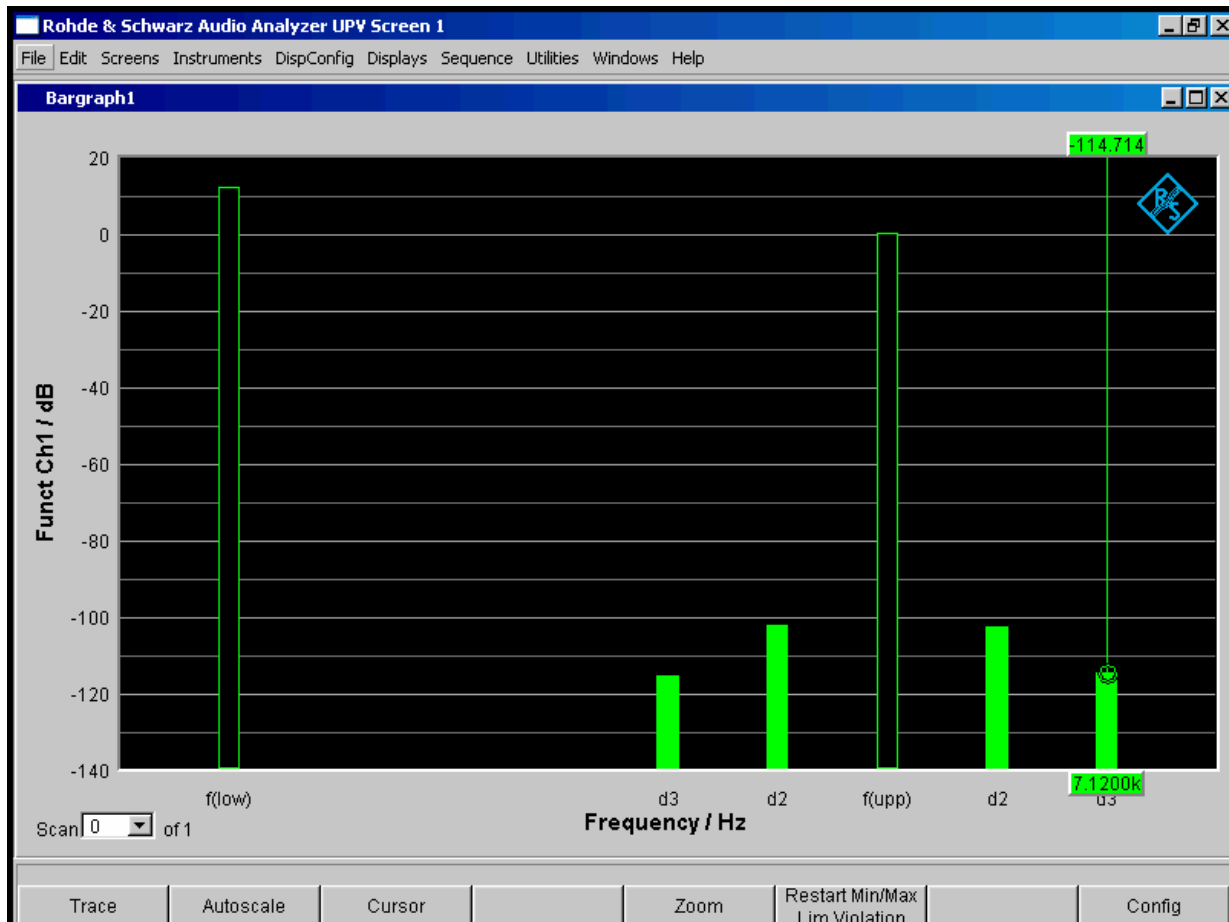

Figure 4-23 Mod-Dist measurement with 7 kHz useful signal and quadrupled interferer at 60 Hz

## DFD

DFD is a difference-tone factor analysis which determines the intermodulation products generated by two sinewave signals of the same amplitude. Depending on the selected measurement mode, the R&S UPV measures the 2<sup>nd</sup> or 3<sup>rd</sup> intermodulation products selectively in accordance with DIN IEC 60268 Part 3 (measurements are therefore largely unaffected by noise). The arithmetic center frequency of the double-tone signal should be selected from the third-octave band (5, 6.3, 8, 10, 12.5, 16, 20 kHz) and the frequency difference should be 80 Hz.

The "DFD" signal function of the internal universal generator is recommended as the *signal source*. This allows the center frequency and difference frequency (for IEC 60268) and the upper frequency and difference frequency (for IEC 60118) to be varied. Furthermore, it is also possible to sweep the center frequency and upper frequency.

Remote-control command:  
 SENSE[1]:FUNCTION DFD

See section "MOD DIST" on page 4.299 for alternative intermodulation measurement.

See section "Signal-to-Noise Measurements" on page 4.280 for further distortion measurements.



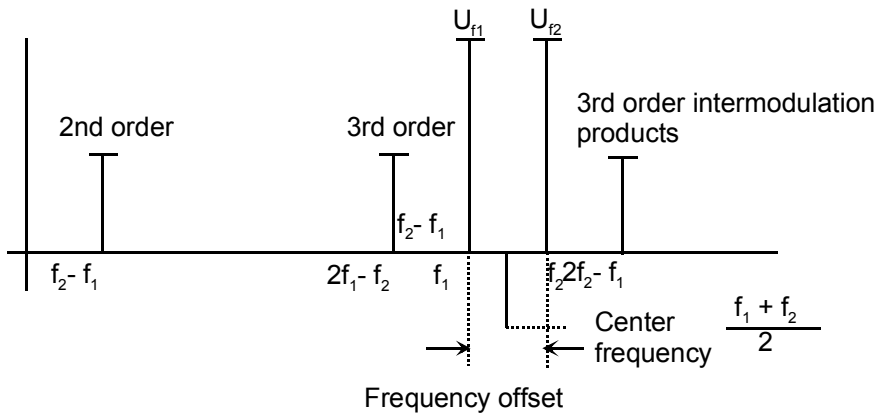

**Meas Mode**

Used to select the order of the intermodulation products and the measurement standard.

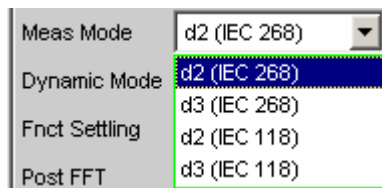

With IEC 60268, the measured intermodulation products are referenced to double the upper frequency; with IEC 60118, the measured intermodulation products are referenced to the undoubled upper frequency only. The results to IEC 60268 are therefore approx. 6 dB better than the results to IEC 60118.

**d2 (IEC 268)** Measurement of the 2<sup>nd</sup> order intermodulation product referenced to *double* the upper frequency level (to IEC 60268):

$$d_2[dB] = 20 \times \lg \frac{|U_{(f_2-f_1)}|}{2 \times U_{(f_2)}}$$

Remote-control command:  
SENSE[1]:FUNCTION:MMODE D2\_268

**d3 (IEC 268)** Measurement of the 3<sup>rd</sup> order intermodulation products referenced to *double* the upper frequency level (to IEC 60268):

$$d_3[dB] = 20 \times \lg \frac{|U_{(2f_2-f_1)}| + |U_{(2f_1-f_2)}|}{2 \times U_{(f_2)}}$$

Remote-control command:  
SENSE[1]:FUNCTION:MMODE D3\_268

**d2 (IEC 118)** Measurement of the 2<sup>nd</sup> order intermodulation product referenced to the *undoubled* upper frequency level (to IEC 60118):

$$d_2 [dB] = 20 \times \lg \frac{|U_{(f_2 - f_1)}|}{U_{(f_2)}}$$

Remote-control command:  
SENSE[1]:FUNCTION:MMODE D2\_118

**d3 (IEC 118))** Measurement of the lower 3<sup>rd</sup> order intermodulation product referenced to the *undoubled* upper frequency level (to IEC 60118):

$$d_3 [dB] = 20 \times \lg \frac{|U_{(2f_1 - f_2)}|}{U_{(f_2)}}$$

Remote-control command:  
SENSE[1]:FUNCTION:MMODE D3\_118

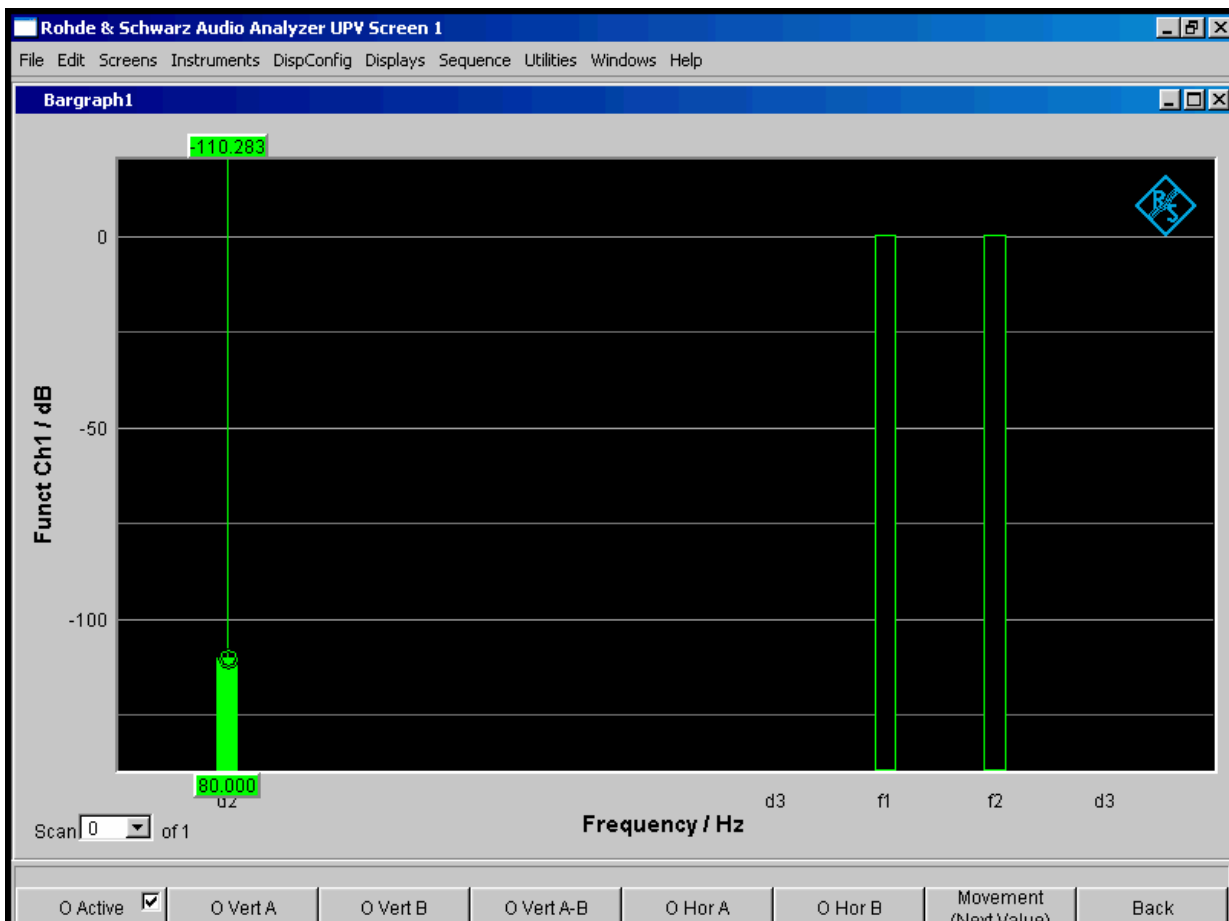

Figure 4-24 DFD-d2 measurement in accordance with IEC 60118

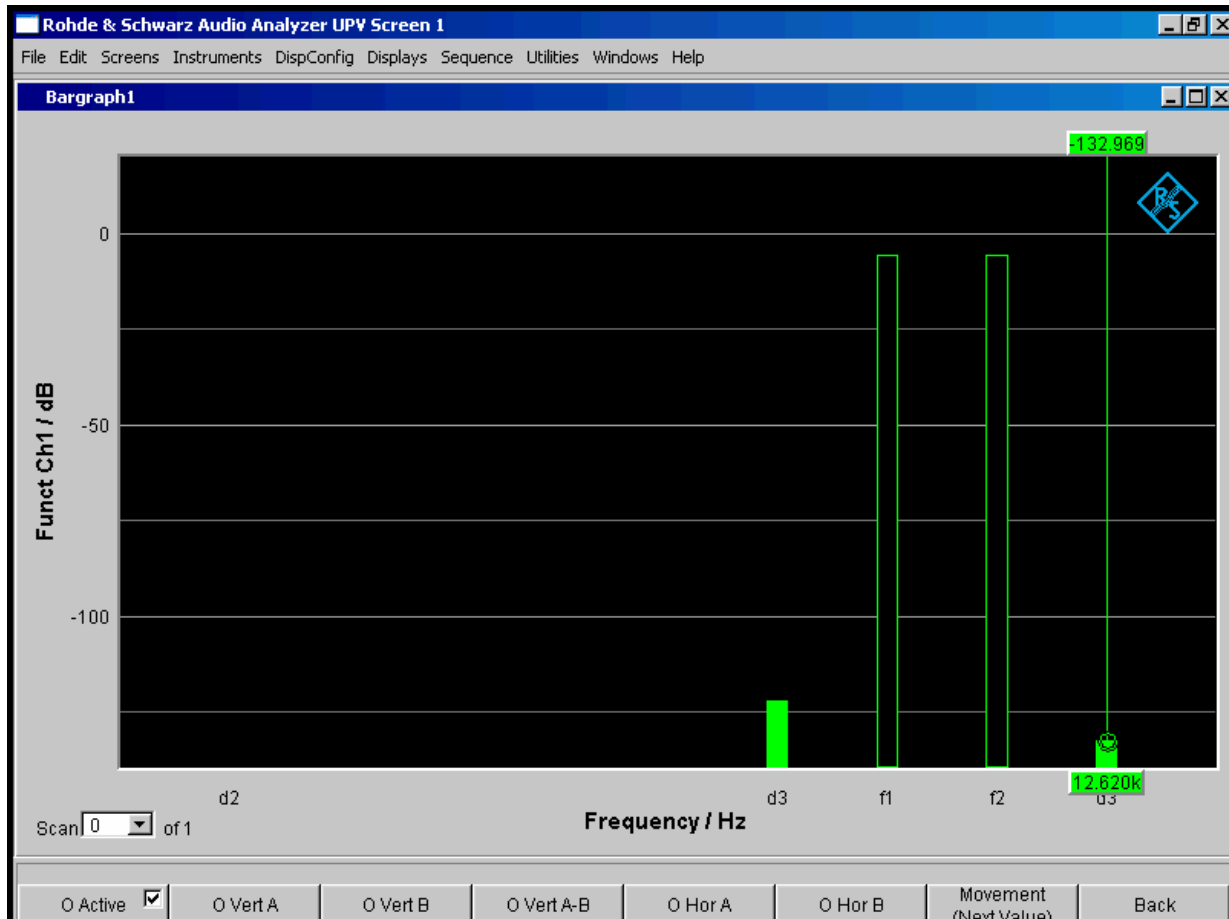

Figure 4-25 DFD-d3 measurement in accordance with IEC 60268

See section "Signal-to-Noise Measurements" on page 4.280 for further distortion measurements.

## DIM (dynamic intermodulation distortion analysis)

DIM is an analysis of intermodulation distortion that determines the nine components of dynamic intermodulation in the audio range caused by a mixture of a low-frequency squarewave signal and a high-frequency sine signal. It is mainly used to determine the nonlinear distortion of amplifiers that are forced to operate up to their maximum rise speed due to the short rise time of the squarewave signal.

According to Part 3 of IEC 60268, the amplifier is to be operated under nominal conditions (fully loaded). The squarewave signal with the basic frequency of 3.15 kHz has to be limited to 30 kHz (or, optionally, 100 kHz) via a one-contact lowpass filter. The peak amplitude of the sinwave signal with a frequency of 15 kHz must be 12 dB below the squarewave signal. In sound broadcasting, the squarewave/sinwave combination of 2.96 kHz/14 kHz is used. A mode with a reduced sinwave frequency (2.96/8 kHz) is often used for making measurements on narrowband DUTs.

The Audio Analyzer R&S UPV supports both frequency pairs and automatically determines the combination that is created in each case provided that the frequency drift is within the tolerance range stipulated by DIN IEC. This is only possible if the DUT can transfer the sinewave frequency without significant attenuation. The allowable deviation of the sinewave signal from the nominal level is 20%. The DIM signal function of the internal basic generator is recommended as the *signal source* (reference). This signal function provides a standard-compliant frequency setting – including with respect to frequency accuracy.

Remote-control command:  
SENSe[1]:FUNCTION DIM

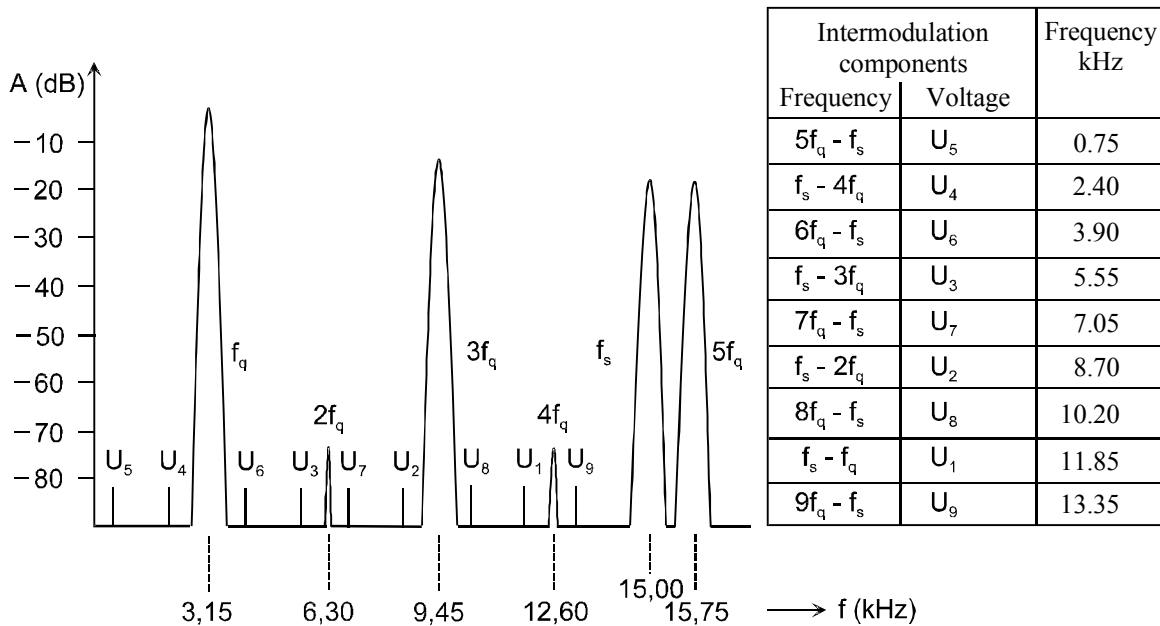

The measurement result is the rms value of the selectively measured intermodulation components (up to 9th order) relative to the rms value of the sinewave signal and is displayed in dB (or, optionally, in %).

$$d[dB] = 20 \times \lg \frac{\sqrt{U_1^2 + U_2^2 + U_3^2 \dots + U_9^2}}{U_s}$$

See section "MOD DIST" on page 4.299 for alternative intermodulation measurement.

See section "Signal-to-Noise Measurements" on page 4.280 for further distortion measurements.

Since the used frequency pair is recognized automatically, you do not have to make any *special* settings.

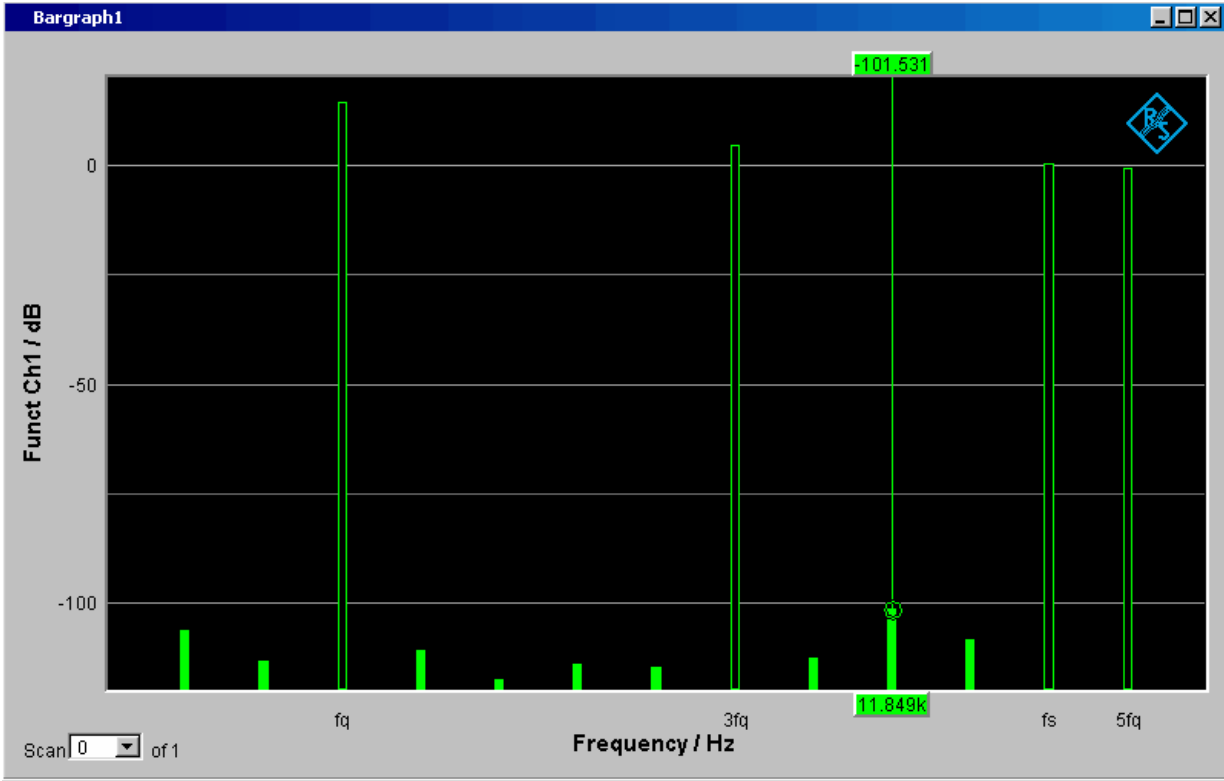

Figure 4-26 DIM measurement with 3.15 Hz squarewave signal and 15 kHz sinwave signal

See section "Signal-to-Noise Measurements" on page 4.280 for further distortion measurements.

## Polarity Measurement

Polarity measurement is used to test whether a DUT (such as a cable) forwards an applied signal with the identical or reversed polarity.

To determine the polarity, a peak measurement is performed for a measurement time of 20 ms and the highest positive peak is compared with the highest negative peak. The signal applied to the DUT must therefore fulfill the following requirements:

- The positive amplitude must be greater than the negative amplitude.
- The repetition rate must be 50 Hz or an integer multiple thereof.

The "Polarity" signal function of the internal universal generator is recommended as the *signal source*. However, the polarity signals of other R&S audio analyzers (e.g. R&S UPL, R&S UPD) can also be used. If using an external signal source, something like a sine<sup>2</sup> burst signal with 50 % duty cycle can be applied.

**Function** For switching the measurement function to polarity measurement.

The measurement result for the function is displayed as

- "+ 1.0 Pol" for a *non*-reversed signal and
- "- 1.0 Pol" for a reversed signal.

No further settings are needed.



---

**Note:**

*When using polarity signals that are not DC free (e.g. sine<sup>2</sup> burst) measurements in the analog analyzer should preferably be performed using DC coupling in order to keep the negative amplitude as low as possible.*

---

Remote-control command:  
SENSE[1]:FUNCTION POLarity

# Frequency Band Analysis

## Nth Octave Analysis

This measurement function is only available when option R&S UPV-K6 (extended analysis functions) is installed. It is not provided in the multichannel analyzers.

Nth octave analysis is a selective level measurement performed simultaneously in a number of adjacent frequency bands. The levels of the individual frequency bands are, however, not measured by narrow bandpass filters as in the case of conventional octave or third analysis, but instead with the aid of a special high-resolution FFT by integration of the FFT bins (frequency lines) in the respective band.

The advantage compared to the filter method is the significantly higher frequency resolution, which enables bandwidths down to 1/24th of an octave. The bandwidth of the subbands is theoretically fully scaleable by varying "n" or using frequency tables such as the "Critical Bands" defined by means of the Bark scale. The advantage compared to pure FFT is the logarithmic or user-definable stepping of the frequency range.

Each subband has the relative bandwidth of  $\frac{2^{n\sqrt{2}} - 1}{2^{n\sqrt{2}}}$  (upper band limit – lower band limit).

Referred to the band center this gives the following results:

- Octave analysis 70.71 %,
- Third octave analysis (third analysis) 23.16 %,
- Sixth octave analysis 11.56 %,
- Twelfth octave analysis 5.78 %,
- Twenty-fourth octave analysis 2.89 %,

The reference frequency is 1 kHz. All other band center frequencies are computed by reference to this frequency by multiplying or dividing by  $2^{1/n}$ .

Selecting the frequency bands to be measured involves specifying the upper and lower limit frequencies. A separate RMS value is determined for each selected frequency band by integrating all the FFT bins in the said band together with the attenuated bins in the adjacent band. The total RMS value of all the selected frequency bands is applied to the display of measurement results for the function.

The measurement range of the nth octave analysis starts at a nominal band center frequency of 16 Hz and ends at half the sampling rate or the bandwidth of the analog analyzer.

The exact, computed frequency bands are used in measurements and for numerical displays (e.g. with the X value displayed graphically as a cursor or for values displayed in the "Data List"). The nominal band center frequencies (in line with DIN 323) are given only for the numerical display of the third and the twelfth octave. Only the octave frequencies are captioned in the graphical display due to space restrictions.

---

**Note:**

*Since nth octave analysis is usually performed in the audio range only, the bandwidth in the analog analyzer should be set to 22 kHz. This avoids not only needlessly large FFTs but also long computation times.*

---

The recommended trigger signal for nth octave analysis is the frequency-defined pink noise which can be generated with the aid of the R&S UPV generator (Reference). Unlike white noise, its level roll-off  $\sqrt{1/f}$  compensates for the apparent level increase encountered with nth octave analysis, which results from the absolute bandwidth increasing as the frequency increases. If possible the spacing of the frequency lines on the FFT size should be synchronized ("Spacing Anlr Track").

**Function** For selecting FFT based nth octave analysis.

The RMS value of the signal is displayed in the range "Frq Lim Low" to "Frq Lim Upp" as the measurement result for the function.



Remote-control command:  
SENSE[1]:FUNCTION NOCTave

### Meas Mode

This defines the measurement mode and thus implicitly the center frequencies and relative bandwidth of the bandpass filters.

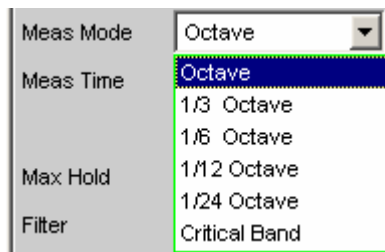

The center frequencies of the subbands are spaced at intervals of  $2^{1/n}$  from the 1 kHz reference frequency. The exact values can be taken from the "Bargraph Data List" (Reference).

The band limits of a subband are separated from the center frequency by  $2^{1/(2^n)}$ .

The larger the chosen value of "n" the narrower the bands and the longer the minimum measurement time.

**Octave** The audio range is divided into octave bands.

Remote-control command:  
SENSE[1]:FUNCTION:MMODE OCT1

**1/3 Octave** The audio range is divided into third octave bands.

Remote-control command:  
SENSE[1]:FUNCTION:MMODE OCT3

**1/6 Octave** The audio range is divided into sixth octave bands.

Remote-control command:  
SENSE[1]:FUNCTION:MMODE OCT6



<b>1/12 Octave</b>	<p>The audio range is divided into twelfth octave bands.</p> <p>Remote-control command: SENSE[1]:FUNCTION:MMODE OCT12</p>
<b>1/24 Octave</b>	<p>The audio range is divided into twenty-fourth octave bands. Due to the extremely narrow bands, analysis is only possible with effect from 21.5 Hz.</p> <p>Remote-control command: SENSE[1]:FUNCTION:MMODE OCT24</p>
<b>Critical Bands</b>	<p>The audio range is divided into "critical bands" according to the Bark scale. The band limits are on the Bark scale and the center frequencies are 0.5 Bark above the lower band limit in each case. Due to the division into "critical bands" the low frequency bands are wider than in the case of the comparable third octave analysis, for which reason both the required FFT size and the measurement time are smaller.</p> <p>Remote-control command: SENSE[1]:FUNCTION:MMODE CBAND</p>

**Meas Time**

For selecting the measurement time.

The minimum measurement time is the same as the sampling time of the FFT and is therefore defined by the FFT size used. When a longer measurement time is selected, a greater number of FFTs is performed and averaged, reducing both the update rate and fluctuations in the measurement values.

In turn the required FFT size is dependent on the sampling rate or the analog bandwidth and the width of the narrowest subband, that is, on the measurement mode and the lower band limit.

**Auto** This sets the minimum possible measurement time.



This setting is recommended for the purpose of measuring independently of the lower band limit and measurement mode, and always using the highest measurement speed.

Remote-control command:  
SENSE[1]:FUNCTION:APERTURE:MODE AUTO

**Value** A numerical value for the measurement time is entered in the next parameter field.

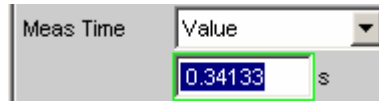

The measurement time entered is rounded to an integer multiple of the minimum measurement time and thus implicitly defines the number of averages. This setting is recommended for the purpose of reducing the update rate and fluctuations in the measurement values.

Remote-control command:  
 SENSE[1]:FUNCTION:APERTure:MODE  
 VALueSENSe[1]:VOLTage:APERTure <nu>

## Filter

For activating a digital filter in the test channel. Up to three user-defined or weighting filters can be looped into the test channel:

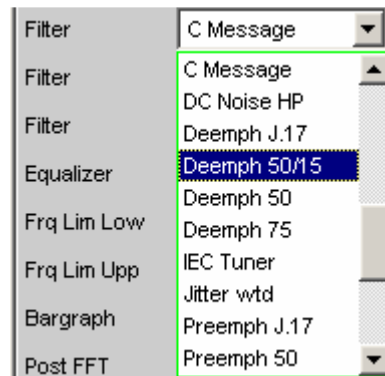

The user-definable filters are configured as filters 01 to 09 in the filter panel (see section "User-Definable Filters" on page 4.420) and can then be used (repeatedly if necessary) in the analyzer.

The selectable weighting filters are described in section "Weighting Filters" on page 4.428.

---

### Note:

Regardless of the digital filters selected here, a further input filter ("prefilter") can be looped into the test channel. Moreover the analog bandwidth can be restricted with the aid of the "Bandwidth" parameter field, which corresponds to an additional low pass filter.

---

Remote-control command:  
 SENSE[1]:FILTer[1] <parameter>SENSe[1]:FILTer2  
 <parameter>SENSe[1]:FILTer3 <parameter>

For a <parameter> list see section "Filter Table" on page 4.419.

**Equalizer**

Used for activating/deactivating a precorrector table for the FFT bins.

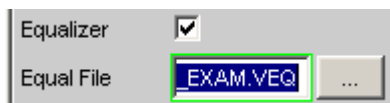

In this way the frequency response of a transmission link can be precorrected, for example, and in so doing the measurement point is transformed into another reference point.

When precorrection is enabled the computed FFT bins are multiplied by a frequency-dependent factor after which they are used to calculate the nth octave bands and applied to the display.

The factor is determined by interpolation between the two adjacent frequency reference points in the precorrector table.

Precorrection of the FFT spectrum is an attractive alternative to filtering the input signal, since the precorrector file can simply be generated from the frequency response requiring precorrection and need not be in the form of a coefficient file or pole/zero file.

---

**Application:**

*In the case of acoustic measurements (e.g. involving mobile telephones) on artificial ears of type 3.2 or higher, it is possible to compensate for the transfer function ERP (ear reference point) to DRP (drum reference point). Measurement of the sound waves by the microphone applied to the "eardrum" can thus be referred to the required measurement point (at the auricle).*

---



---

**Note:**

*The precorrector table is created after acquiring or reading in the trace data from the DUT in the "DispConfig" panels.*

---



The precorrector is disabled. The FFT bins are used and displayed without change. The levels of the subbands are calculated from the *original* FFT spectrum.

```
Remote-control command:
SENSe[1]:VOLTage:EQualize OFF
```



The precorrector is enabled. The next entry field, which is "Equal File", for the file name of the precorrector table, is activated and the file shown there is loaded. The levels of the subbands are calculated from the *precorrected* FFT spectrum.

```
Remote-control command:
SENSe[1]:VOLTage:EQualize ON
MMEMory:LOAD:IEQualize 'filename'
```

**Frq Lim Low**

For entering the lower band limit for computing the subbands and the total RMS value.



Display and computation of the subbands starts at the band in which the lower limit frequency is located. The lower subband is measured in full, that is, the limit frequency entered does *not* alter the energy content of the lower band.

The lower the frequency of the lower limit frequency, the narrower the frequency bands which have to be measured. In order to not to drop below a minimum number of bins per band, the FFT resolution and the FFT size must be increased in the narrower frequency bands.

The lower limit frequency therefore has a decisive influence on the measurement speed and should therefore not be lower than the measurement task requires.

Remote-control command:  
`SENSe[1]:FREQUENCY:LIMit:LOWer <nu>`

**Frq Lim Upp**

For entering the upper band limit for computing the subbands and the total RMS value.



Display and computation of the frequency bands ends at the band in which the upper limit frequency is located. The upper subband is measured in full, that is, the limit frequency entered does *not* alter the energy content of the upper band.

The upper limit frequency has no effect on the measurement speed.

Remote-control command:  
`SENSe[1]:FREQUENCY:LIMit:UPPer <nu>`

**Bargraph**

Used for activating bargraph computation and display. In addition the "Bargraph1" window can be opened from here.



Configuration of the bargraphs is reserved for the "Bargraph1 Config" and/or "Bargraph2 Config" windows. The actual display takes place in the "Bargraph1" or "Bargraph2" windows.



Bargraph computation (and update) disabled. Only the band-limited total RMS value is measured.

Remote-control command:  
`SENSe:FUNCTION:BARGraph OFF`



Bargraph computation (and update) enabled.

Remote-control command:  
`SENSe:FUNCTION:BARGraph ON`

**Post FFT**

For activating/deactivating Post FFT. At the same time it is possible to switch between automatic and manual selection of the FFT size and window. In addition the "FFT Graph1" window can be opened from here.

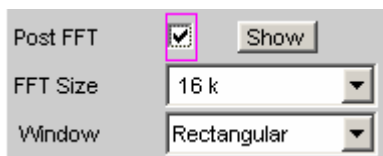

Configuration of the FFT *Graph* is reserved for the "FFT Graph1 Config" and/or "FFT Graph2 Config" windows. The actual display takes place in the "FFT Graph1" or "FFT Graph2" windows.



Post FFT is disabled.  
 The necessary Post FFT size is computed automatic from the sampling rate and the width of the narrowest subband (defined by the lower limit frequency and the measurement mode).  
 The received samples are weighted using the Hann window function.

Remote-control command:  
`SENSe[1]:FUNction:FFT:STATe OFF`



Post FFT is enabled and can be displayed. The FFT size and window can be selected manually.

---

**Note:**  
*When Post FFT is turned on the FFT size and window are loaded with the recommended standard settings. The manual settings are discarded when Post FFT is turned off.*

---

Remote-control command:  
`SENSe[1]:FUNction:FFT:STATe ON`

**FFT Size**

This is the FFT size to be used in computing the subbands, and is adjustable in powers of 2 from 512 (0.5 k) to 256 k. (FFT Function)

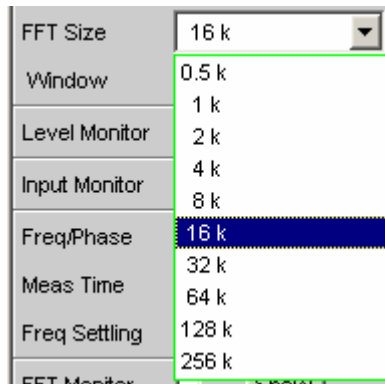

When using manual selection the FFT size should not be less than the recommended value (which is produced when Post FFT is activated), otherwise there will be too few FFT bins in the lower subbands.

With every increase in FFT size the measurement accuracy and stability increase, particularly in the relatively narrow lower subbands. At the same time, however, the measurement time doubles. In the interests of shorter measurement times it would be best to avoid an unnecessarily large FFT size.

Remote-control command:  
`SENSe[1]:FUNCTION:FFT:Size <parameter>`

The <parameter> list:

S512, S1K, S2K, S4K, S8K, S16K, S32K, S64K, S128K, S256K

**Window**

Selection of the window function.

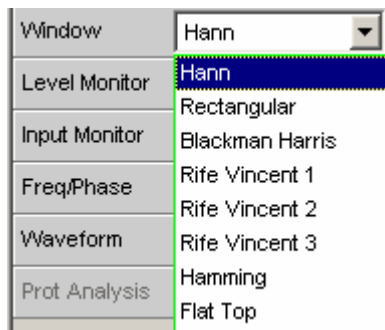

For details, see section *"Window Function"*.

## FFT Analysis

The FFT analysis (**F**ast **F**ourier **T**ransformation) allows the input signal to be displayed in the spectral range (frequency range). The (digitalized) input signal is recorded over a selectable time period and transformed into the frequency range by means of a fast DFT (**D**iscrete **F**ourier **T**ransformation). The result is a "list" of equidistant frequency lines (bins) which indicate the magnitude or the phase of the respective frequency components. The graphical display of the magnitude or phase bins is referred to as a spectrum or spectral display.

According to system theory, the FFT analysis assumes that the signal is periodic, i.e. it continues continuously beyond the observed time period. Since this ideal state only exists in a few exceptional cases, the input signal can if required be weighted using a window which attenuates both ends of the observed signal section with respect to zero.

The recording time for the FFT, i.e. the length of the measurement interval (integration time), is determined using the FFT size and, like the frequency resolution, also depends on the used sampling rate and bandwidth.

2 different types of FFT can be selected in the R&S UPV:

- The **Post FFT** for distortion measurements are calculated with double precision with up to 256 k points thus ensuring a very high frequency resolution and dynamic response. The size of the FFT and the used window cannot be selected, but instead are preset according to the requirements of the respective measurement function. The Post FFT is displayed in the "FFT Function" graphical window.
- The **FFT as measurement function** (Function FFT) is, like the Post FFT, also calculated with double precision but additionally allows a number of other functions such as averaging and undersampling (limiting the frequency range to increase the frequency resolution) as well as free selection of the FFT size and window. The Function FFT is displayed in the "FFT Function" graphical window.

## FFT Size

The size of the FFT (FFT Size) together with the sampling rate and bandwidth determines the length of the measurement interval (integration time) and thus the frequency resolution of the calculated spectrum. The following correlations apply:

- Integration time = FFT size / Sampling rate
- Number of lines = FFT size / 2
- Frequency resolution = Sampling rate / FFT size = 1 / Integration time

Therefore, if a higher sampling rate and bandwidth are used, a higher FFT size will be required to produce the same frequency resolution.

---

**Note:**

*In the analog analyzer, the internal sampling rate is determined by the selected bandwidth.*

---

**FFT Size (Function FFT)**

Size of the Function FFT, can be set in powers of 2 from 512 (0.5 k) to 256 k.

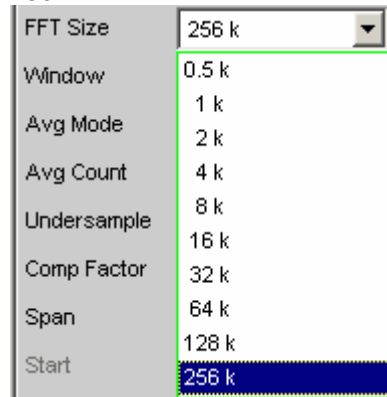

The measurement time also doubles with each increase in FFT size. Unnecessarily high FFT sizes should be avoided in order to reduce measurement times.

Remote-control command:  
SENSe[1]:FUNCTION:FFT:Size <parameter>

List of <parameter>:  
S512, S1K, S2K, S4K, S8K, S16K, S32K, S64K, S128K, S256K

For the **Post FFT**, no fixed FFT size but only a (variable) lower limit ("Min FFT Size") can be entered. The measurement function carried out in each case can dynamically increase the FFT size as a function of the measurement signal frequency.

Other variables which appear as display fields in the group of FFT parameter fields are derived from the FFT size:

**Resolution**

Displays the frequency resolution.



The frequency resolution is the quotient of sampling rate and FFT size.

Remote-control command: (query only)  
SENSe[1]:FUNCTION:FFT:RESolution?

**Meas Time**

Displays the integration time.



The integration time is the quotient of FFT size and sampling rate.

Remote-control command: (query only)  
SENSe[1]:FUNCTION:FFT:MTIME?

**Note:**

*Not only the integration time but also the time required to calculate the transformation and graphical display increase with increasing FFT size. This results in an overproportional increase in the total measurement time. Unnecessarily high FFT sizes should therefore be avoided in order to reduce the measurement time.*



## Window Function

According to system theory, the FFT analysis requires a periodic signal which continues continuously beyond the observed time period. Normally, however, there is no continuous continuation (even with periodic signals). The FFT would interpret any discontinuity at the boundaries of the signal section as a pulse whose (white) spectrum would be superimposed on the useful signal spectrum.

In order to prevent this "leakage" effect, the input signal is weighted using a window which attenuates both ends of the observed signal section with respect to zero. As a result, the signal is continuous for the FFT; there is, however, a reduction in selectivity, indicated by a relatively wide bell-shaped curve. By selecting the window function, the user makes a compromise between selectivity (frequency selectivity, width of bell-shaped curve at top), crosstalk between adjacent lines (width of bell-shaped curve at bottom), slope of the bell-shaped curve and "leakage" suppression in the far-off range. Selecting the rectangular window deactivates windowing.

### Window

Used to select the window function.

With the Post FFT of the distortion and level measurements, the window cannot be selected by the user but instead is preset by the respective measurement function and displayed here.

Only the "Hann" and "Rife Vincent" windows can be selected for the Monitor FFT.

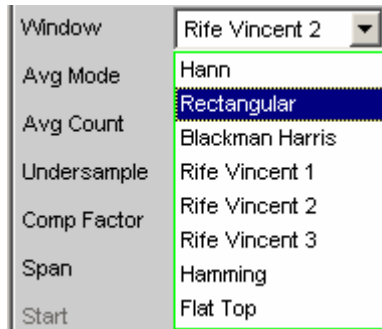

### Hann

This window combines selectivity with good leakage suppression in the "far-off range " but has a relatively wide bell-shaped curve around the signal lines.

Recommended application: Standard window.

Remote-control command:

```
SENSE[1]:FUNCTION:FFT:WINDOW HANNing
```

**Rectangular** Window function deactivated (by using a rectangular window with a constant weighting of 1). If the signal fits in the section for the FFT exactly with an integer multiple of periods, there is no discontinuity at the section boundaries. A window is then not required and the maximum frequency resolution is possible. This feature may be of advantage when using a special generator signal ("FFT noise") as it allows fast measurement of frequency responses at specific frequencies. (see Noise, Fast Frequency Response Measurement) Recommended application: Only suitable for special signals.

```
Remote-control command:
SENSe[1]:FUNCTION:FFT:WINDow
RECTangular
```

**Blackman  
Harris** Only for Function FFT. The slope of the bell-shaped curve up to approx. 80 dB is very steep; however, this window has considerable "leakage" for values under 80 dB.

```
Remote-control command:
SENSe[1]:FUNCTION:FFT:WINDow
BLACKman_harris
```

**Rife Vincent 1  
Rife Vincent 2  
Rife Vincent 3** The suppression of far-off interference is very good for all 3 windows. The width of the bell-shaped curve at the bottom of the individual lines drops and the width at the top increases as the Rife Vincent number increases. It is therefore possible to set various compromises between frequency resolution and the suppression of adjacent lines. Recommended application: For precise frequency determination.

```
Remote-control commands:
SENSe[1]:FUNCTION:FFT:WINDow RIF1
SENSe[1]:FUNCTION:FFT:WINDow RIF2
SENSe[1]:FUNCTION:FFT:WINDow RIF3
```

**Hamming** This window does not provide any significant advantages; it was implemented simply to complete the range.

```
Remote-control command:
SENSe[1]:FUNCTION:FFT:WINDow HAMMING
```

**Flat Top**

Only for Function FFT.  
 Here, the region around the carrier is deliberately distorted to such an extent that at least two adjacent lines (in the case of excitation with one sinewave line only) always have roughly the same magnitude.  
 This allows the amplitude to be read off very precisely from the graph. In contrast, the frequency selectivity is rather poor.  
 Recommended application: For precise level determination.

```
Remote-control command:  
SENSe[1]:FUNction:FFT:WINDow FLATtop
```

**Post FFT**

For distortion measurements, the Post FFT displays the frequency spectrum recorded for calculating the measurement values. It can be activated for the measurement functions THD+N & SINAD, THD, DFD, Mod Dist, DIM, and RMS measurements.

*Measurement* is performed in the same level as the associated measurement function, i.e. downstream of all filters.

The respective measurement function adjusts the FFT size and window to its specific requirements. For example, the required FFT size increases as the signal frequency decreases. The settings for the Post FFT cannot therefore be selected by the user and can vary from measurement to measurement.

The Post FFT is *calculated* with double precision with up to 256 k points thus ensuring a very high frequency resolution and dynamic response.

The Post FFT of a measurement channel is *displayed* in the graphical windows "FFT, Panel 1" or "FFT, Panel 2" either as a magnitude or phase. Since 2 traces are displayed in each graphical window, the magnitude *and* phase of *both* channels can be recorded simultaneously.

**Post FFT**

Used to activate the Post FFT. In addition the "FFT Graph1" window can be opened from here.



Configuration of the FFT *Graph* is reserved for the "FFT Graph1 Config" and/or "FFT Graph2 Config" windows. The actual display takes place in the "FFT Graph1" or "FFT Graph2" windows.



Post FFT deactivated.  
 Recommended for increasing the measurement speed (e.g. for sweeps or remote-control mode).

```
Remote-control command:  
SENSe[1]:FUNction:FFT:STATe OFF
```



Post FFT activated; all other settings are determined dynamically by the associated measurement function.

```
Remote-control command:  
SENSe[1]:FUNction:FFT:STATe ON
```

In measurement functions for which users cannot select Post FFT, this line of the menu is grayed out:



FFT is not needed by any currently selected measurement and is therefore not computed in order to save time. There is no *live* FFT in the FFT graph.



FFT is needed by at least one selected measurement (e.g. phase measurement, precision frequency measurement) and cannot be deactivated. The internally used FFT can be displayed in the FFT graph.

## FFT Measurement Function

The FFT can be selected as a separate measurement function (Function FFT). Unlike the other FFT analyses, all FFT parameters can be determined by the user. The following additional functions are also available:

- Delay compensation
- DC suppression (digital only)
- Filtering (3 user-definable filters and – in the two-channel analog analyzer – 1 analog notch)
- Averaging

*Measurement* is performed in the same level as the other measurement functions, i.e. downstream of all filters.

The Function FFT is *calculated* with double precision with up to 256 k points thus ensuring a very high frequency resolution and dynamic response.

The Function FFT of a measurement channel is *displayed* in the graphical windows "FFT, Panel 1" or "FFT, Panel 2" either as a magnitude or phase. Since 2 traces are displayed in each graphical window, the magnitude *and* phase of *both* channels can be recorded simultaneously.

The FFT can be generated continuously if the sampling rate is less than 100 kHz or the analog bandwidth is 40 kHz. It is also necessary to ensure that no special functions (such as delay compensation) are enabled and that no "supplementary" measurement (such as waveform monitoring or frequency measurement) takes longer than the actual FFT. To ensure this, it is advisable to switch off all other measurements.

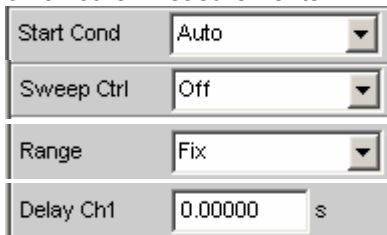

(in generator and analyzer)

(analog only)

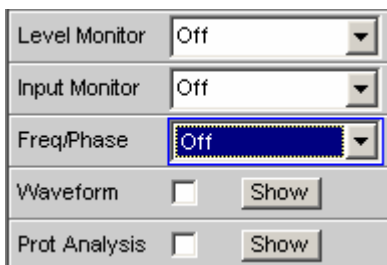

**Function**

Used to change the measurement function to FFT analysis. The band-limited and, possibly, filtered RMS is displayed as the function measurement result. The RMS is calculated by means of integration over all magnitude frequency lines from "Start" to "Stop". The frequency and phase value derived from the FFT is displayed as the "Freq/Phase" measurement result if "Precision" is set as "Meas Time" for the frequency measurement.

With AC coupling (analog) or "DC Suppress" (digital), the DC component (bell-shaped curve) is not included in the measurement. *If the window function is selected*, this curve has a width of five bins, which means that the lower six bins are not included in the RMS result.

**Note:**

*To include signals of very low frequency in the RMS measurement, the size of the FFT must be selected sufficiently large (so that the signal components to be included are above the 6th bin), or the square window must be used (which ignores only the DC bin).*

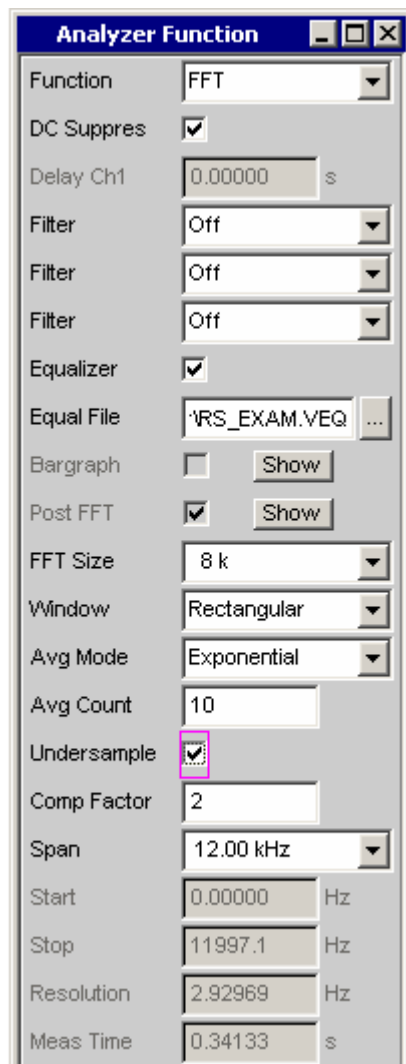

The panel segment shown here represents a digital FFT that is band-limited to 12 kHz (which means it is undersampled with a compression factor of 2).

The “Start” value of this FFT is always 0.0 Hz, and the “Stop” value is set to the resulting bandwidth. “Resolution” and “Meas Time” are determined by the selected “FFT Size” and the compression factor.

Remote-control command:  
SENSe[1]:FUNction FFT

### Delay Ch1

Used to activate the delay compensation.



This compensates delay differences of the DUT. The time by which Channel 1 is to be delayed relative to Channel 2 is entered. If the delay of Channel 2 is shorter than that of Channel 1, this can be compensated by entering a negative time. The compensation of delay differences is particularly useful for phase measurements since a time offset of both measurement signals causes a frequency-dependent phase displacement and can thus invalidate the phase measurement result.

#### Note:

*Delay compensation cannot be selected when the “Compressed” or “Undersample” waveform mode is used, or when “Undersample” is enabled.*

*Delay compensation must also be switched off (set to 0.0 s) for continuous FFT generation.*

Remote-control command:  
SENSe[1]:CHANnel:DELay <nu>

### DC Suppress

Used to activate DC suppression (in the digital analyzer only).



For DC suppression in the digital analyzer, the DC level is measured in the Monitor level and subtracted from the input samples. This parameter field is not available in the analog analyzer because the suppression function is already provided by the AC coupling which can be set up using the hardware.



DC suppression deactivated.

The DC component of the measurement signal is *not* suppressed (“DC coupling”) and is included in the measurement result and the graphical display. Recommended when using a high-pass or band-pass filter because additional DC suppression is not necessary in these cases and would increase the calculation time (slightly).

Remote-control command:  
SENSe[1]:FUNction:DCSuppression OFF



DC suppression activated.  
The DC component of the measurement signal is suppressed ("AC coupling"); the measurement result and the graphical display only include the AC component.

Remote-control command:  
SENSe[1]:FUNction:DCSuppression ON

**Notch(Gain)**

Used to activate the analog notch filter and select the notch gain. Only available in the two-channel analog analyzer.

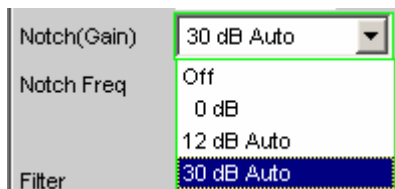

In the two-channel analog analyzer, a second-order analog notch filter can be activated for narrowband suppression of unwanted frequency lines. When the notch filter is activated, the user can choose between 3 different gain factors.

---

**Note:**  
*If frequency components occur outside the analyzer frequency range, the notch gain could cause overloading of the analyzer. In this case, the notch gain is reduced step by step, which is indicated by "Auto" in the list items 12 dB and 30 dB.*

---

**Off** Analog notch filter deactivated.

Remote-control command:  
SENSe[1]:NOTCh OFF

**0 dB** Analog notch filter activated; no gain in effect.

Remote-control command:  
SENSe[1]:NOTCh DB0

**12 dB Auto** Analog notch filter activated; gain 12 dB.

Remote-control command:  
SENSe[1]:NOTCh DB12

**30 dB Auto** Analog notch filter activated; gain 30 dB.

Remote-control command:  
SENSe[1]:NOTCh DB30

**Notch Freq**

Numeric or automatic selection of the notch-filter center frequency; only appears in the two-channel analog analyzer if "Notch(Gain)" is activated.

**Value** The user can enter the notch-filter center frequency in the next parameter field. If "Value" is selected, the center frequency last active is displayed.

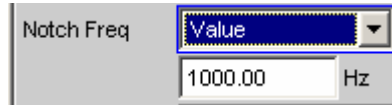

Remote-control command:  
 SENSE[1]:NOTCh:FREQUency:MODE FIXEd  
 SENSE[1]:NOTCh:FREQUency <nu>

**Gen Track** The notch-filter center frequency is adopted from the generator panel (if possible). If the generator signals are unsuitable (e.g. noise), an error message is output and the center frequency last valid is retained.



Remote-control command:  
 SENSE[1]:NOTCh:FREQUency:MODE GENTrack

## Filter

3 separate filters can be looped into the measurement path. Apart from those filters which can be user-defined in the filter panel, filters can also be selected from a set of supplied weighting filters. Selecting "OFF" deactivates the respective filter.

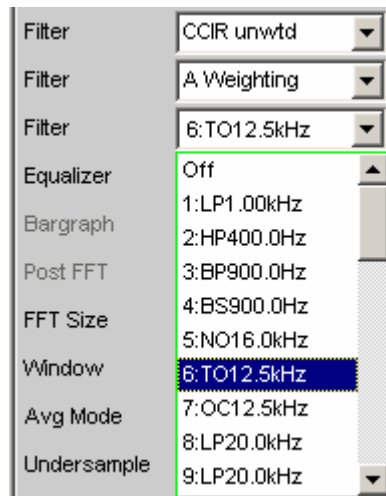

Remote-control command:  
 SENSE[1]:FILTEr[1] <parameter>  
 SENSE[1]:FILTEr2 <parameter>  
 SENSE[1]:FILTEr3 <parameter>

List of <parameter> see section "Filter Table" on page 4.419.



**Equalizer**

Used for activating/deactivating a precorrector table for the FFT bins.

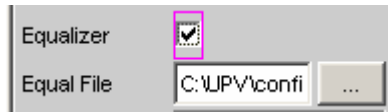

In this way the frequency response of a transmission link can be precorrected, for example, and in so doing the measurement point is transformed into another reference point.

When precorrection is enabled the computed FFT bins are multiplied by a frequency-dependent factor after which they are used to calculate the total RMS value and applied to the display.

The factor is determined by interpolation between the two adjacent frequency reference points in the precorrector table.

Precorrection of the FFT spectrum is an attractive alternative to filtering the input signal, since the precorrector file can simply be generated from the frequency response requiring precorrection and need not be in the form of a coefficient file or pole/zero file.

**Application:**

*In the case of acoustic measurements (e.g. involving mobile telephones) on artificial ears of type 3.2 or higher, it is possible to compensate for the transfer function ERP (ear reference point) to DRP (drum reference point). Measurement of the sound waves by the microphone applied to the "eardrum" can thus be referred to the required measurement point (at the auricle).*

**Note:**

*The precorrector table is created after acquiring or reading in the trace data from the DUT in the "DispConfig" panels.*



The precorrector is disabled. The FFT bins are used and displayed without change.

Remote-control command:  
SENSE[1]:VOLTage:EQualize OFF



The precorrector is enabled. The next entry field, which is "Equal File", for the file name of the precorrector table, is activated and the file shown there is loaded.

Remote-control commands:  
SENSE[1]:VOLTage:EQualize ON  
MMEMory:LOAD:IEQualize 'filename'

**Avg Mode**

Used to activate the averaging function and select the averaging method.

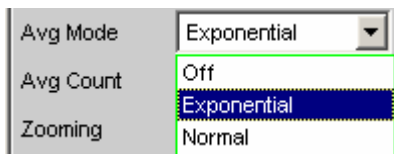

When averaging is activated, an additional parameter field appears in which the average count can be specified.

**Note:**

*The level is not averaged, but rather the energy of the individual bins. This is necessary so that the displayed RMS value, which is computed by integration over all bins (of the averaged FFT), can be correctly determined.*

**OFF**

No averaging; each FFT analysis result is displayed immediately and is independent of previous analyses.

Remote-control command:

```
SENSE[1]:FUNCTION:FFT:AVERAge:MODE OFF
```

**Exponential**

Averaging is performed continuously and displayed. When the current result is calculated, the previous measurements are taken into consideration using a constant factor. The weighting of the current measurement (n) and of the previous measurements (n-1) is determined by the selectable average count (k); the displayed result of the n<sup>th</sup> measurement (n =2) is derived using the following formula:

$$AVG(n) = \frac{1}{k} \cdot FFT(n) + \frac{k-1}{k} \cdot AVG(n-1)$$

Remote-control command:

```
SENSE[1]:FUNCTION:FFT:AVERAge:MODE  
EXponential
```

**Normal**

The specified number of FFT cycles is performed, the partial results added together and then divided by this number. The result does not appear until all "k" cycles have been completed.

Remote-control command:

```
SENSE[1]:FUNCTION:FFT:AVERAge:MODE  
NORMAL
```

**Avg Count**

Used to enter the average count; only if averaging is activated.



With "normal averaging", the number entered here determines how many consecutive FFTs are used for averaging.

With "exponential averaging", the number "k" entered here determines the extent to which the previous measurements are taken into consideration in the result. The weighting of the previous measurements is  $(k-1)/k$ .

If, for example, 20 is entered as the average count (k), the current analysis result is weighted with 5 % and the previous measurements with 95 %.

Remote-control command:  
`SENSe[1]:FUNCTION:FFT:AVERAge <n>`

**Undersample**

Enables undersampling for the FFT.

This function is only available if the R&S UPV-K6 option (Extended Analysis Functions) is installed.

It is used to increase the frequency resolution for low frequencies so that measurements can be made on extremely low-frequency signals (deep into the infrasonic range) and they can be visualized (along with their harmonics).

Undersample	<input checked="" type="checkbox"/>
Comp Factor	16
Span	1.50 kHz
Start	0.00000 Hz
Stop	1499.63 Hz
Resolution	0.36621 Hz
Meas Time	2.73067 s

In contrast to graphic zooming of a wideband FFT (Undersample OFF), an undersampled FFT analyzes a selectable frequency segment with the *full* FFT size. The compression factor can be adjusted by powers of 2. The frequency resolution is doubled with each change in the compression factor (with a constant FFT size). However, the measurement time also doubles in parallel. In the interest of short measurement times, unnecessarily high compression factors (and unnecessarily large FFT sizes) should be avoided.

There are two ways to achieve a particular frequency resolution:

- Wideband FFT with large FFT size
- Undersampled FFT over a limited frequency band (“Span”) with a small FFT size

The time required to acquire the measurement data is the same in both cases. The total time is slightly less with an undersampled FFT, since the smaller number of points means that it takes less time to perform the FFT computation and generate the graphic display. A smaller number of points is also advantageous for external processing of the bins. If the desired frequency resolution is higher than what can be achieved with the maximum FFT size, an undersampled FFT is the only way this requirement can be met.

A frequency resolution of 178  $\mu$ Hz (with an FFT bandwidth of 23 Hz) can be achieved with the two-channel analog analyzer by using the maximum FFT size and compression value. However, the sampling time is around 1.5 hours (5592 seconds) in this case. The same values apply for the digital analyzer with a 48 kHz sampling rate.

Undersampling disabled; a wideband FFT analysis is performed.

```
Remote-control command:
SENSe:FUNcTion:FFT:USAMple OFF
```

Undersampling enabled; the FFT analysis is performed using a reduced bandwidth but higher frequency resolution.

The setting times shown above are displayed.

Cannot be selected if the bandwidth of the (analog) analyzer is set to 250 kHz.

If “Undersample FFT” is enabled, some instrument settings are configured to **fixed default values** that cannot be changed by the user:

- “Waveform Monitor” is enabled and configured with fixed settings. The FFT compression factor is copied to the Waveform Compression factor. Although “Trace Length” can be entered by the user, its minimum value is limited to the FFT measurement time.

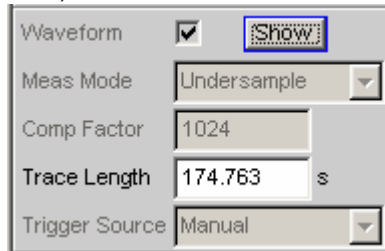

- FFT delay compensation is disabled.

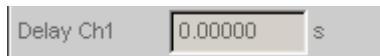

The following **recommendations** also apply:

- The analog analyzer should be set to DC coupling and the narrowest bandwidth

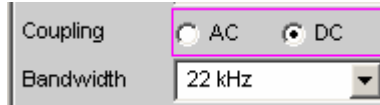

- Autoranging in the analog analyzer should be disabled (for both channels)



- If signal components outside the selected FFT bandwidth (see “Span”) can be expected to be present, they must be blocked by using a digital low-pass filter in order to avoid corrupting the measurement.

This filter can be enabled as a function filter or a prefilter. Its cutoff frequency should be less than or equal to the selected FFT bandwidth.



**Note:**

Continuous processing of the measured data over a relatively long time is only guaranteed for sampling rates up to 96 kHz or analog bandwidths up to 40 kHz. If the sampling rate is too high or the bandwidth is too large, the measurement will be terminated with a suitable error message. If this happens, it may be necessary to reduce the number of analyzer filters that are being used.

Remote-control command:

SENSe:FUNCTion:FFT:USAMple ON

**Comp Factor**

Numeric entry of the compression factor; only possible if “Undersample FFT” is enabled.

Comp Factor	16
-------------	----

The compression factor entered is adjusted to the closest integer power of 2 (2, 4, 8, ..., 1024).

The number specified here determines the reduction factor for the total band (sampling frequency / 2). The resulting frequency band corresponds to the “Span” value.

**Note:**

If a multichannel analyzer is used, max. 1.44 million samples can be observed. Compression is therefore possible only up to the factor 4.

Remote-control command:

SENSe:FUNCTion:FFT:CMpFactor <n>

<n> = 2 .. 1024

**Span**

FFT bandwidth selection; only active if “Undersample FFT” is enabled.

Span	1.50 kHz
Start	12.00 kHz
Stop	6.00 kHz
Resolution	3.00 kHz
Meas Time	1.50 kHz
Level Monitor	750 Hz
Input Monitor	375 Hz
Freq/Phase	188 Hz
	94 Hz
	47 Hz
	23 Hz

The displayed parameter list is generated dynamically as a function of the current sampling rate (or bandwidth). The selected value is directly related to the compression factor; reducing the span by a factor of two thus corresponds to doubling the compression factor.

**Note:**

*If a multichannel analyzer is used, max. 1.44 million samples can be observed. Therefore, only two compression levels are available here; with 40 kHz analog bandwidth, for example, 24 kHz and 12 kHz.*

In the case of an undersampled FFT, the selected “Span” value determines the frequency band that is analyzed by the FFT. The start and end values of the frequency band are shown under “Start” (always 0.0 Hz) and “Stop”.

The frequency range that is actually shown (“Stop” value) is one bin smaller than the selected “Span” value.

Remote-control command:

SENSe:FUNCTion:FFT:SPAN R<n>  
 <n> = 2, 4, 8, 16, 32, 64, 128, 256, 512, 1024 -

**Start**

Start value of the FFT frequency band (display only)

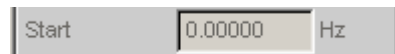

Remote-control command (query only):  
 SENSe[1]:FUNCTion:FFT:START?

**Stop**

End value of the FFT frequency band (display only)

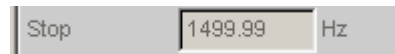

In the case of a wideband FFT in the digital analyzer, this is 23 or 48 times the sampling frequency; in the case of an undersampled FFT, the value here is the “Span” value less one bin.

Remote-control command (query only):  
 SENSe[1]:FUNCTion:FFT:STOP?

## Speech Quality Measurements (PESQ)

This measurement function is only available if the R&S UPV-K61 option is installed, and it is provided as single-channel measurement for the Analog Analyzer only.

The “Perceptual Evaluation of Speech Quality” (PESQ) measurement method, which was published by the *International Telecommunications Union* in 2001 as *Recommendation ITU-T P.862*, enables measurements to be made on the quality of speech signals that are transmitted at low bit rates using highly compressive psychoacoustic coding methods. PESQ employs an algorithm that enables these signals to be evaluated by comparing them with reference signals. The R&S UPV provides this measuring method, which is licensed by *OPTICOM Dipl.-Ing. M. Keyhl GmbH*, Erlangen, Germany. PESQ® is a registered trademark of said company and of Psytechnics Ltd., UK.

A common feature of all psychoacoustic coding methods is that they utilize the properties of the human hearing to modify the transmitted signal so that the portions of the signal that would in any case not be perceived are removed from the signal. Compression can be made even simpler with speech signals, since they occupy considerably less bandwidth than other types of signals such as music. When speech compression is used, it is necessary to be able to determine objectively, with the aid of psychoacoustic measuring methods, whether such speech transmission paths produce unacceptable changes to the signal.

PESQ was developed using a large number of recordings containing sentences spoken by a variety of speakers in a variety of languages. The recordings were made using several different speech encoders having different levels of quality and with typical network transmission disturbances. In a series of listening tests, a adequate number of test listeners classified these examples on the well-known speech quality scale ranging from 1 (*bad*) to 5 (*excellent*).

The goal in the development of PESQ was to develop a method for determining an objective measurement value MOS (mean opinion score) that correlates very well with the listening test results, based on comparing the original, undegraded speech signal (the reference signal) with the degraded signal (the measured signal). This means that in order to perform a PESQ measurement, the reference signal must be connected to the input of the system under test and the measurement signal must be taken from the output of the system under test.

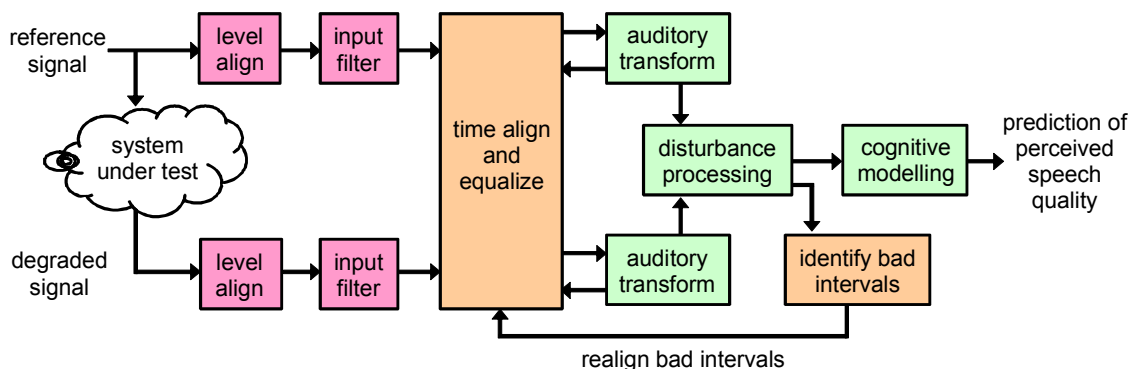

Remote-control command:  
SENSe[1]:FUNCTION PESQ



## PESQ Value and MOS Value

With recommendation P.862 the ITU has standardized a method for calculating objective measurement values to match the subjective MOS values of the listening test results. The calculation of the objective MOS value is based on the PESQ value and is performed by using a mapping function such as the example shown below.

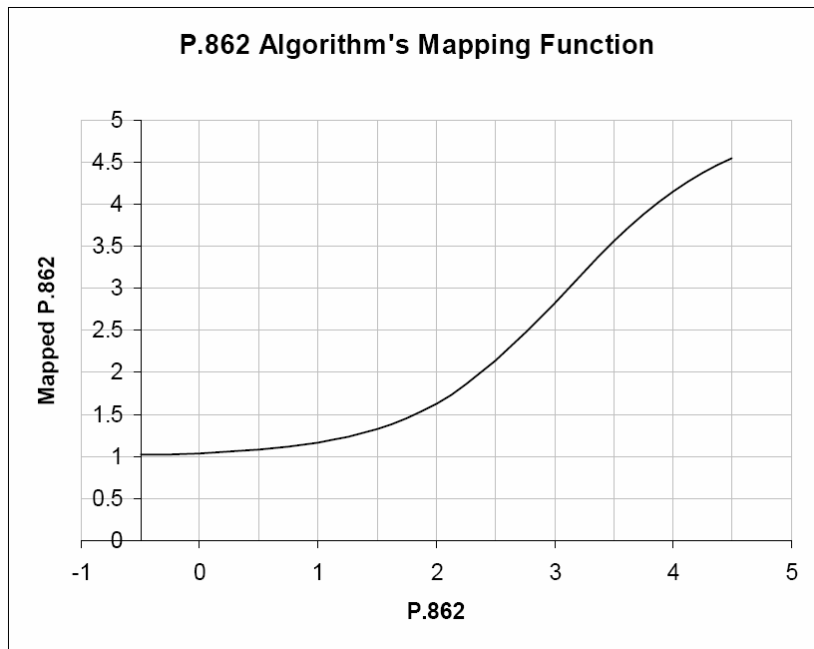

The Mos values according to P.862.1 are plotted on the Y axis, and the associated PESQ values according to P.862.1 are shown on the X axis.

The R&S UPV implements the three most important measuring methods, which differ only slightly from each other and have been approved by the ITU:

- **ITU-T P.862:**  
The measured value is the PESQ Score. The range of values extends from  $-0.5$  (worst) to  $+4.5$  (best).
- **ITU-T P.862.1:**  
The measured value is the MOS-LQON (Listening Quality Objective Narrowband). The range of values extends from  $-0.5$  (worst) to  $+4.5$  (best).
- **ITU-T P.862.2:**  
This is the wideband extension of P.862. The measured value is the MOS-LQOW (Listening Quality Objective Wideband). The range of values extends from  $-0.5$  (worst) to  $+4.5$  (best). Note that measurements obtained using this option cannot be compared with results obtained in accordance with P.862 or P.862.1!

The measurement values can be displayed for the total signal or made with reference to the speech component or the silence component of the signal. The latter is particularly interesting because it shows how well a codec substitutes background noise.

## Electrical PESQ Measurements

Producers of new psychoacoustic coding methods wish to optimize their algorithms for speech transmission, and network operators need suitable test tools that supplement the already commonly used signal and distortion measurements. This type of measurement is typically performed electrically, directly at the input and output ports of the R&S UPV.

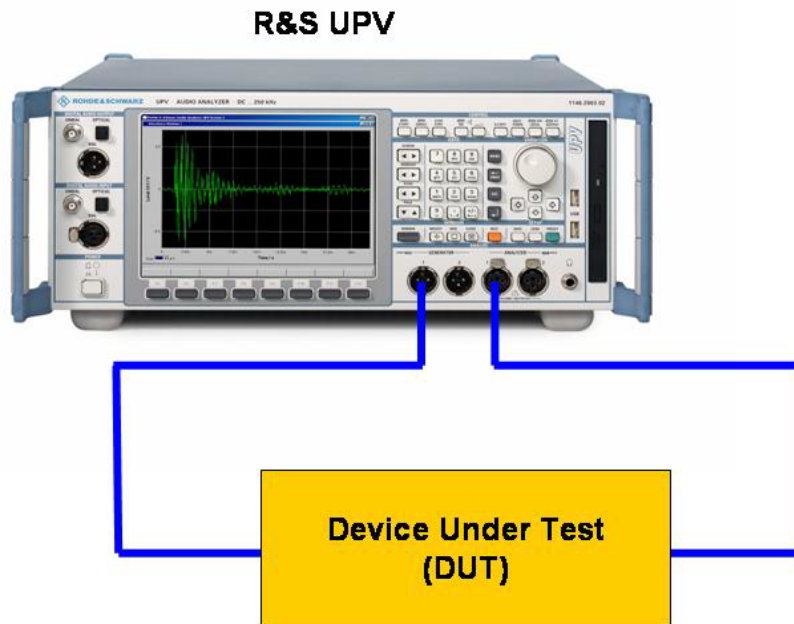

The figure shows how the reference signal is routed directly from the generator output to the device under test, and the output of the device under test is fed back to the analyzer as the measurement signal. At the same time, the original reference signal is routed internally to the analyzer so it can access both signals for the evaluation.

## Acoustic PESQ Measurements

Manufacturers of mobile telephones increasingly wish use speech quality as a way to make their products stand out from the competition. Speech quality is essentially influenced by the coding method used in the mobile telephone. In this case, PESQ measurements are made under realistic conditions by using an acoustic link to the mobile telephone. The measurement setup consists of a combination of the R&S CMU radio communication tester and the R&S UPV audio analyzer.

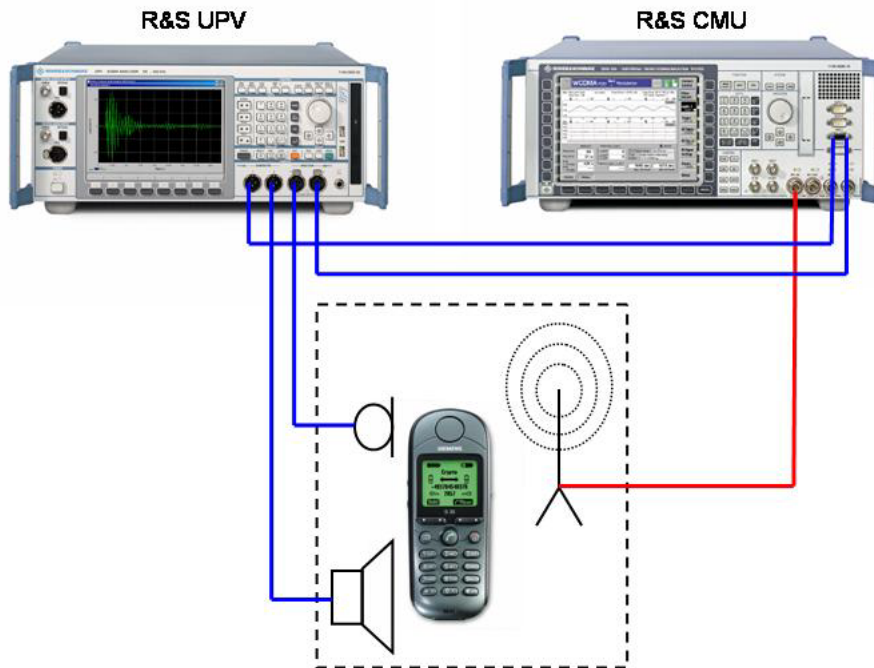

The reference signal is sent to the mobile telephone via an acoustic transducer (artificial mouth). It is coded in the mobile telephone and then sent to the R&S CMU via a radio link. It is decoded in the CMU and sent to the input of the analyzer as the measurement signal. As with electrical measurement, the original reference signal is also routed internally to the analyzer so that it can access both signals for the evaluation. In the opposite direction, the reference signal is sent to the R&S CMU, where it is coded and transmitted to the mobile telephone via the radio link. Another acoustic transducer (artificial ear) converts the speech signal emerging from the speaker of the mobile telephone into the measurement signal.

Good acoustic coupling between mobile phone and artificial ear is needed for measurements in receiving direction of the phone. Any background noise should be as low as possible. Thus acoustic measurements should be conducted in a sound isolated chamber.

PESQ measurements should not be used for handsfree measurements or to assess the influence of background noise.

The advantages of the R&S UPV can be fully exploited with acoustic measurements. Due to the outstanding characteristics of the analog hardware, no PESQ-relevant quality impairments arise in the measured signal even when there are large differences in signal level between the output and input signals. In addition, a simple application running in the R&S UPV can utilize the dual-channel capability of the R&S UPV to make measurements in both directions (transmit and receive) without any changes to the test setup. The results can then be displayed in a single graph.

## PESQ Graphs

For PESQ measurements, the **Waveform Monitor** is used to check the signal in the time domain. In particular, the specified silence periods at the start and end of the test signal can be checked, as well as correct signal amplitude.

- The Waveform Monitor is enabled in the Analyzer Function panel and configured with regard to the trigger condition and memory depth. The “Waveform” graphics window can also be opened from this panel.
- The scaling (including limit checking and the reference source) are selected in the Waveform Config panel.
- The graph is shown in the “Waveform” graphics window.

With the **PESQ Graph** windows, the R&S UPV provides two additional types of graphs associated with PESQ measurements. This is because the measurement process analyzes the signals in small increments and determines the measured value (PESQ\_MOS) and the time delay (Delay) between the reference signal and the measured signal for each increment. For the measurement display always shows the selected measurement value referenced to the entire signal. Using the graphs, it is also possible to see the regions of the reference signal where the measured codec deviates from the expected behavior. The values plotted against time are displayed in the “PESQ Graph” graphical systems. In wideband mode P862.2 the MOS value against time can not be displayed with the current version of the PESQ software.

- The desired signal (PESQ or MOS versus time or delay versus time) in “PESQ Graph Config”, as well as the scaling – including the limit test – is selected.
- The graph is shown in the “PESQ Graph” graphics window.

In addition, the traces of reference and/or measurement signal, as well as display of the dropouts, can be shown in in the "PESQ Graph" windows. Depending on the signal selected on the other axis, the resolution on the x-axis is selected automatically so that both signals can always be displayed in the same graphic. For example, the resolution of "MOS versus time" is much smaller than "reference signal versus time", so the graph shows the reference signal in reduced resolution – but without swallowing samples. In contrast, in the display of "delay versus time" vis-à-vis "reference signal versus time" there is a much higher resolution on the x-axis; it corresponds to the resolution of the WAV file.

- In "PESQ Graph Config" the desired comparison signal (reference signal versus time or measurement signal versus time or dropouts versus time) and the scaling is selected.
- The graphic representation is shown in the "PESQ Graph" graphics window.
- "Reference signal versus time" corresponds to the waveform of the reference signal.
- "Measurement signal versus time" corresponds to the waveform of the measurement signal. This waveform can also be shown in full resolution in a separate graphic via the "Waveform Monitor" function.
- "Dropouts versus time" corresponds to a hypothetical representation in which the values of an amplitude- and time-corrected measurement signal and the reference signal are subtracted from each other in proper phase relation and thus only the stray signals deviate from the zero line.

The **Numeric Display** shows the PESQ or MOS value.

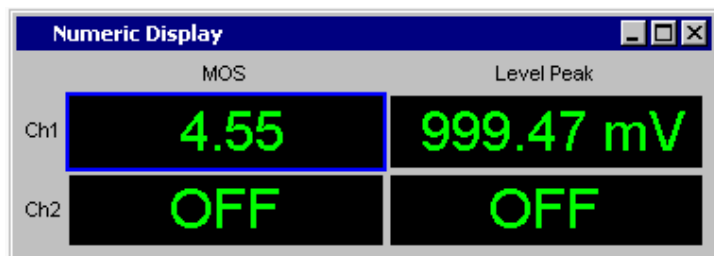

The Level Monitor indicates the RMS or peak value of the total test signal (after the measurement). During measurement intermediate values are displayed. The peak indication should be used to check the correct level for the selected measurement range. The peak value must not be more than 3 dB above the nominal value of the measurement range.

## **PESQ Measurement Function**

The "Perceptual Evaluation of Speech Quality" (PESQ) measurement method, which was published by the *International Telecommunication Union* in 2001 as *Recommendation ITU-T P.862*, enables measurements to be made on speech signals that are transmitted at low bit rates using highly compressive psychoacoustic coding methods. PESQ employs an algorithm that enables these signals to be evaluated by comparing them with reference signals.

In Recommendation P.862.3, the ITU defined the criteria by which reference signals for the PESQ measurement must be generated:

- The reference signal must be mono and have a sample rate of 8 kHz or 16 kHz.
- There should be at least 0.5 seconds of silence at the beginning and at the end of the signal. Silence of up to 2 seconds is recommended for devices under test with large delay.
- In realtime mode of R&S UPV the length of the test signal is identical to the length of the reference signal. The delay of the device under test must not be longer than the silence at the end of the reference signal, because otherwise the end of the speechsignal is not measured.
- The ratio between speech and silence must be suitable for the particular application. The duration of the speech portion should be at least 3.2 seconds and should be within 40 % to 80 % of the total signal length.
- The speakers must come as close as possible to the application in pitch and cadence, e.g. "at least one female and one male voice should dictate representative texts in the target language".

It is strongly recommended to follow ITU-T P.862.3 paper.

**Function** Switches the measurement function to PESQ.

**Note:**

*PESQ measurements require the generator settings "Bandwidth = Play Auto", generator function "Play" and analyzer settings „single channel with "Fix Range".*

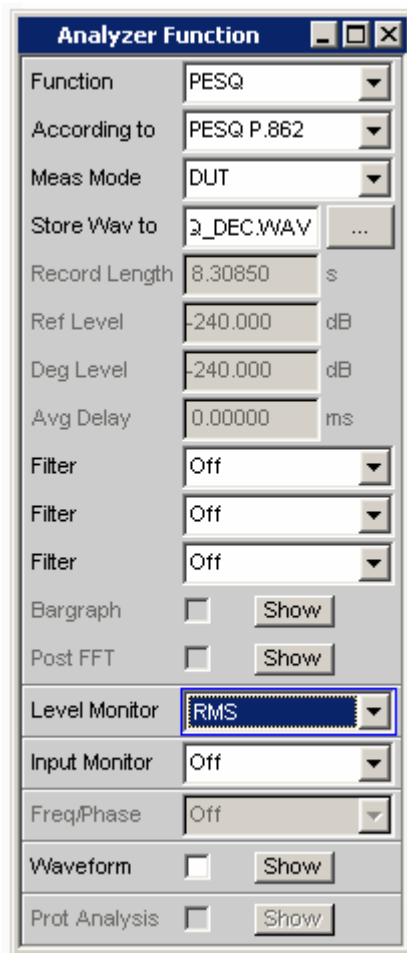

The measurement plays the WAV file that is selected for the generator and compares its content with the measured signal. Only files with a sample rate of 8 or 16 kHz can be used.

**Note:**

*The PESQ measurement is always performed as a single measurement, i.e. even when the START button is pressed the measurement is also automatically ended as soon as the measurement values are available.*

Remote-control command:  
SENSE[1]:FUNCTION PESQ

According to

Select the display mode for the PESQ or MOS value

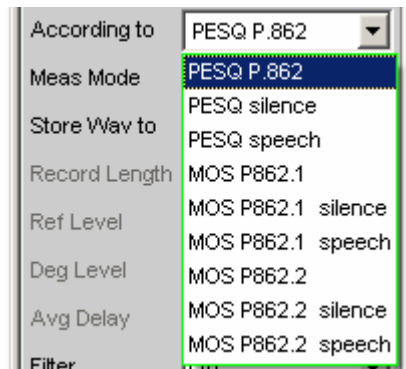

This setting specifies whether the PESQ value or MOS value should be referenced to the entire signal or only to the speech portion or the silence portion.

Switching over the display mode does not trigger a new measurement but calculates the desired PESQ or MOS value from the last logged record according to the selected process. The respective measurement result is thus immediately available.

**PESQ P.862** The measured PESQ value is referenced to the entire reference signal. The calculation conforms to the ITU-T P.862 standard.

Remote-control command:  
SENSe[1]:FUNction:PESQ:ACCording PP862

**PESQ Silence** The measured PESQ value is referenced to the silence portion of the reference signal. The calculation conforms to the ITU-T P.862 standard.

Remote-control command:  
SENSe[1]:FUNction:PESQ:ACCording  
PPSI862

**PESQ Speech** The measured PESQ value is referenced to the speech portion of the reference signal. The calculation conforms to the ITU-T P.862 standard.

Remote-control command:  
SENSe[1]:FUNction:PESQ:ACCording  
PPSP862

**MOS P862.1** The measured MOS value is referenced to the entire reference signal. The mapping of the measurement conforms to the ITU-T P.862.1 standard.

Remote-control command:  
SENSe[1]:FUNction:PESQ:ACCording  
MP8621

**MOS P862.1  
silence** The measured MOS value is referenced to the silence portion of the reference signal. The mapping of the measurement conforms to the ITU-T P.862.1 standard

Remote-control command:  
SENSE[1]:FUNCTION:PESQ:ACCording  
MPSI8621

**MOS P862.1  
speech** The measured MOS value is referenced to the speech portion of the reference signal. The mapping of the measurement conforms to the ITU-T P.862.1 standard

Remote-control command:  
SENSE[1]:FUNCTION:PESQ:ACCording  
MPSP8621

**MOS P862.2** The measured MOS value is referenced to the entire reference signal. The mapping of the measurement conforms to the ITU-T P.862.2 standard

Remote-control command:  
SENSE[1]:FUNCTION:PESQ:ACCording  
MP8622

**MOS P862.2  
silence** The measured MOS value is referenced to the silence portion of the reference signal. The mapping of the measurement conforms to the ITU-T P.862.2 standard

Remote-control command:  
SENSE[1]:FUNCTION:PESQ:ACCording  
MPSI8622

**MOS P862.2  
speech** The measured MOS value is referenced to the speech portion of the reference signal. The mapping of the measurement conforms to the ITU-T P.862.2 standard

Remote-control command:  
SENSE[1]:FUNCTION:PESQ:ACCording  
MPSP8622

## Meas Mode

Select the measurement mode for PESQ measurement

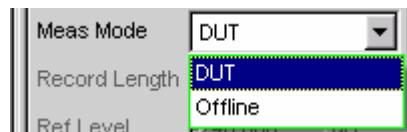

This setting specifies whether a measurement is to be made in realtime (DUT) or whether an offline evaluation of a previously stored WAV file is to be performed (“Offline”).



**DUT** The PESQ measurement is to be made in realtime. The reference WAV file will be played back, and the measurement signal will be recorded by the analyzer at the same time. The measurement signal has the same length as the reference signal. If there is a delay in the device under test, the silence at the end of the reference signal must be longer than this delay to make sure that the speech portion is completely recorded. The evaluation is performed immediately after playback of the reference signal is finished.

Remote-control command:  
SENSe[1]:FUNction:MMODE DUT

**Offline** The PESQ measurement is to be performed on previously stored WAV files. After the files containing the reference signal and the measurement signal are specified, the evaluation can be started by pressing the START button. Possible sample rate of the stored WAV files can be 8, 16, 48 or 96 kHz. The length of the recorded signal must be at least the length of the generator reference signal.

Remote-control command:  
SENSe[1]:FUNction:MMODE OFFL

#### Store WAV to

Allows the measured signal to be stored as a WAV file (only if Meas Mode="DUT").

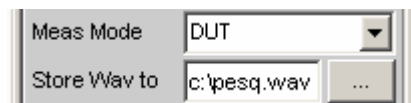

The WAV file is always stored in the same sample rate in which the reference signal is present.

Remote-control command:  
MMEMory:STORE:PWAVEform 'filename'

#### Filename

Selects the WAV file containing the stored measurement data (only if Meas Mode = "Offline")

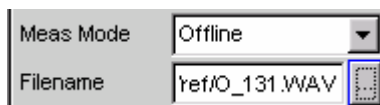

Remote-control command:  
MMEMory:LOAD:PWAVEform 'filename'

**Record Length**

Shows the length of the WAV file selected for the reference signal in the generator function panel.

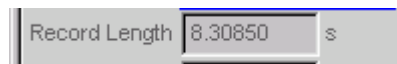

Remote-control command:  
SENSe[1]:FUNCTION:REC:LENGth?

**Ref Level**

Shows the RMS value of the reference signal (after the measurement)

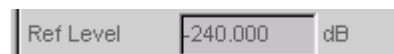

The RMS value of the reference signal is shown in dB referenced to the full scale value of the reference signal file.

Remote-control command:  
SENSe[1]:FUNCTION:PESQ:REFLevel?

**Deg Level**

Shows the RMS value of the measurement signal (after the measurement)



The RMS value of the measurement signal is shown in dB referenced to the full scale value of the measurement signal file.

The PESQ algorithm is configured properly if the difference between Ref Level and Deg Level is as small as possible, less than 10 dB is recommended. PESQ measurement can compensate for differences of up to 30 dB.

Remote-control command:  
SENSe[1]:FUNCTION:PESQ:DEGLLevel?

**Avg Delay**

Shows the average time offset between the reference signal and the measurement signal (after the measurement)

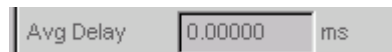

The reference and measurement signals are internally divided into small time frames. The time offset between the two signal paths is measured for each of these frames. The displayed value is the average of all of the measured offset values for the entire signal.

Remote-control command:  
SENSe[1]:FUNCTION:PESQ:AVGDelay?

**Filter**

Used to activate a digital filter in the measurement path. Up to 3 user-defined filters or weighting filters can be looped into the measurement path:

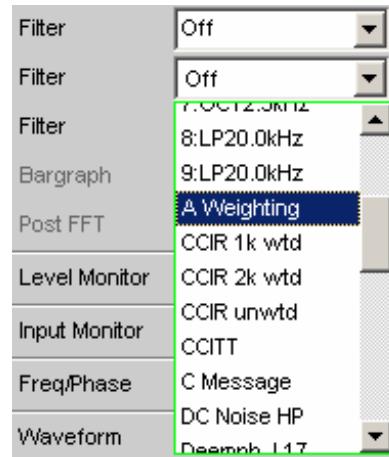

The user-defined filters are configured as Filter 01 to 09 in the Filter panel (see section *"User-Definable Filters"* on page 4.420) and can then be used in the analyzer (more than once if required).

The selectable weighting filters are described in section *"Weighting Filters"* on page 4.428.

**Note:**

*Irrespective of the digital filters selected here, it is also possible to loop an additional input filter ("Pre Filter") into the measurement path.*

Remote-control command:

```
SENSe[1]:FILTer[1] <parameter>
SENSe[1]:FILTer2 <parameter>
SENSe[1]:FILTer3 <parameter>
```

List of <parameter> see section *"Filter Table"* on page 4.419.

## Audio quality measurements (PEAQ)

This measurement function is only available if the R&S UPV-K62 option is installed. It is not provided in the multi-channel analyzers.

The Perceptual Evaluation of Audio Quality (PEAQ) measurement process, which was published by the *International Telecommunication Union* in 1998 as *Recommendation ITU-R BS.1387*, permits the measurement of the quality of sound signals which are transmitted at a low bit rate with the assistance of compressing psycho-acoustic coding processes. PEAQ is an algorithm which permits these signals to be analyzed by comparing them with the reference signal. The R&S UPV provides this measurement – licensed by *OPTICOM Dipl.-Ing. M. Keyhl GmbH*, Erlangen, Germany. PEAQ® is a registered trademark of said company.

A common feature of all psychoacoustic coding methods is that they utilize the properties of the human hearing to modify the transmitted signal so that the portions of the signal that would in any case not be perceived are removed from the signal. Whether such a transmission link for general sound signals such as music causes impermissible changes to the signal must be objectively verifiable with the assistance of suitable psycho-acoustic measurement procedures.

A large number of recordings containing music signals of different kinds were used for developing PEAQ. The recordings were overlaid with interference typically caused by filters and also by using various coders and thus qualities. A sufficiently large number of test listeners classified these examples in a series of listening tests on the familiar scale for audio quality from 1 (*bad*) to 5 (*excellent*). In contrast to the measurement of speech quality also available in the R&S UPV (PESQ), with PEAQ the listeners have always had the comparison with the original signal. A negative scale, the so-called SDG value (Subjective Difference Grade) emerges from the comparison for the difference between the quality of the test signal and the quality of the reference signal. The worse the test signal becomes compared to the reference signal, the more negative the SDG value.

$$SDG = Grade_{\text{Signal Under Test}} - Grade_{\text{Reference Signal}}$$

Impairment	Grade	SDG
Imperceptible	5.0	0.0
Perceptible, but not annoying	4.0	-1.0
Slightly annoying	3.0	-2.0
Annoying	2.0	-3.0
Very annoying	1.0	-4.0

The objective for the development of PEAQ was to develop a process which compares the original, undistorted music signal (reference signal) with the distorted signal (measurement signal) to establish an objective measurement value which correlates very well with the mean values of the listening results. Though the results of subjective and objective assessment correlate very well, is it not possible to directly compare the numeric results of SDG and ODG.

The PEAQ measurement is then performed in such a way that the system to be tested is connected at its input to the reference signal and the measurement signal is measured at its output.

The next figure shows the block diagram of the PEAQ algorithm's Basic model.

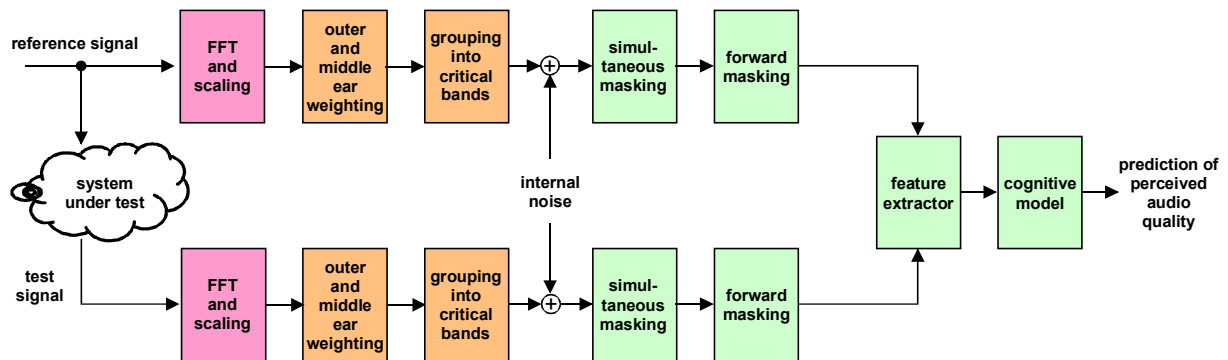

At first the PEAQ measurement process was designed for signals with small impairments (almost transparent studio quality) and a constant delay. But it is nevertheless suitable for the assessment of signals with larger impairments.

It is not suitable, for example, for assessing loudspeakers, cables, speech codecs, and IP-based interference (variable delay and packet losses).

It was not yet validated for codecs with extremely low bit rates, e.g. those ones using the method of spectral band replication.

```
Remote control command:
SENSE[1]:FUNCTION PEAQ
```

## DI value and ODG value

The ODG value (Objective Difference Grade) directly corresponds to the result of the objective measurement and correlates with the SDG value of the listening test. The calculation is done using a so-called mapping function, as shown here in the example.

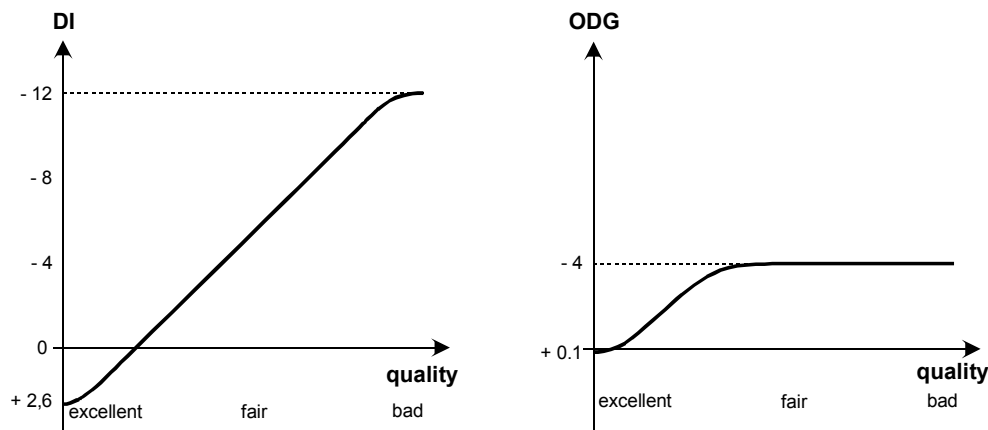

Distortion Index (DI) and Objective Difference Grade (ODG)

The ODG or DI value calculated by the PEAQ algorithm is depicted on the Y axis; the X axis points in the direction of sinking SDG values, i. e. lower quality.

The R&S UPV calculates both the ODG and the DI value for each measurement and displays them in channels 1 and 2 of the function column of the Numeric Display respectively. Since the saturation of the mapping functions for ODG and DI are different, the following basic rule applies when reading them off:

- ODG should be read off as long as ODG is greater than -3.6
- DI should be read off as soon as ODG becomes smaller than -3.6

## PEAQ measurements

The manufacturers of psycho-acoustic compression processes such as MP3 or also surround coders want to optimize their algorithms for sound transmission; manufacturers of playback devices are able to assess the audio quality in addition to the usual signal and distortion measurements.

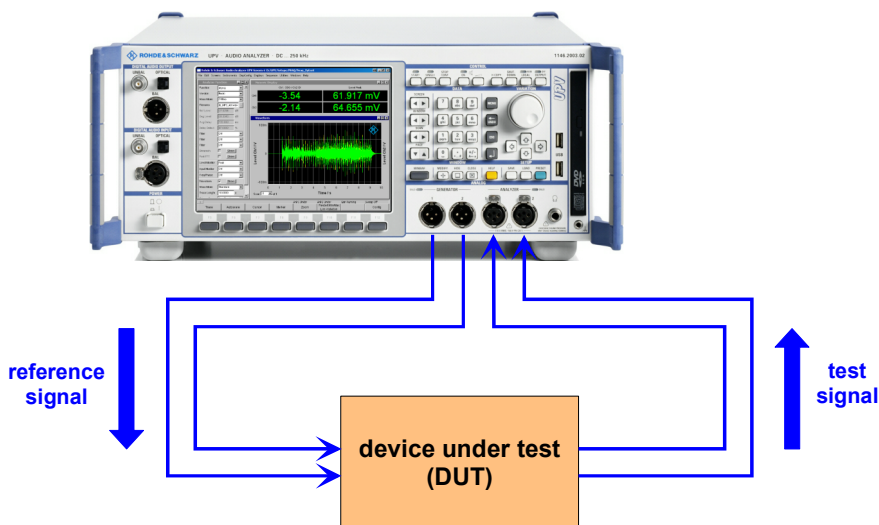

The illustration shows how the reference signal is guided to the device under test from the generator output and fed into the analyzer again from the device's output as a measurement signal. The original reference signal is simultaneously fed internally to the analyser so that the analysis can access both signals.

## PEAQ graphics

With PEAQ measurement, the **Waveform Monitor** is used to check the signal in the time domain. The recommended periods of silence at the beginning and the end of the test signal and also the correct level range can be checked here.

- The wave form is activated in the analyzer function panel and configured with regard to the trigger condition and storage depth. The wave form graphics dialog can also be opened from here.
- The scaling – including the limit check and reference basis – is selected in the wave form configuration panel.
- The graphic display is shown in the wave form graphics dialog.

The **Numeric Display** shows the ODG and the DI value.

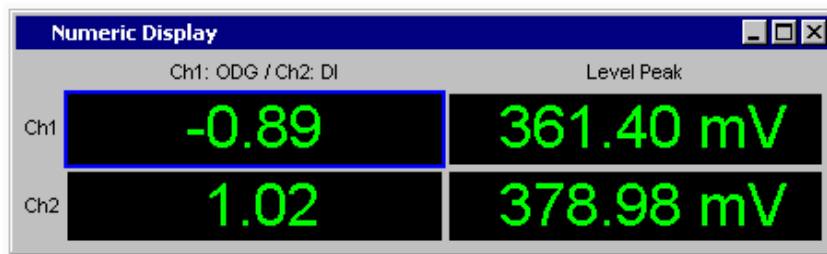

The Level Monitor indicates the RMS or peak values of both channels of the total test signal (after the measurement). During measurement intermediate values are displayed. The peak indication should be used to check the correct level for the selected measurement range. The maximum peak value must not be more than 3 dB above the nominal value of the measurement range.

## PEAQ measurement function

The Perceptual Evaluation of Audio Quality (PEAQ) measurement process, which was published by the *International Telecommunication Union* in 1998 as *Recommendation ITU-R BS.1387*, permits the measurement of the quality of sound signals which are transmitted at a low bit rate with the assistance of compressing psycho-acoustic coding processes. PEAQ is an algorithm which permits these signals to be analysed by comparing them with the reference signal. A general introduction to PEAQ can be found in the chapter on "*Audio quality measurements (PEAQ)*". PEAQ is available in the R&S UPV as a digital and an analogue measurement and mixed operation is also possible.

- The reference signal must be dual-channel and available with a sample rate of 48 kHz.
- The signal should begin and end with at least 0.5 seconds of silence.
- In realtime mode of UPV (Meas Mode = DUT) the length of the test signal is identical to the length of the reference signal. The delay of the device under test must not be longer than the silence at the end of the reference signal, because otherwise the end of the music signal is not measured.
- The ODG value is displayed in channel 1 and the DI value in channel 2. Both values are, however, respectively based on the overall dual-channel signal.

## Function

Switching over the measurement function to PEAQ.

**Please note:**

The PEAQ measurement requires the settings bandwidth = PlayAuto or a fixed bandwidth of 22 kHz and generator function Play for the analog generator. The analogue analyzer must be set to dual-channel, with 22 kHz bandwidth and with fixed range (the same for both channels). In digital domain generator and analyzer must be set to dual-channel and 48 kHz sample rate.

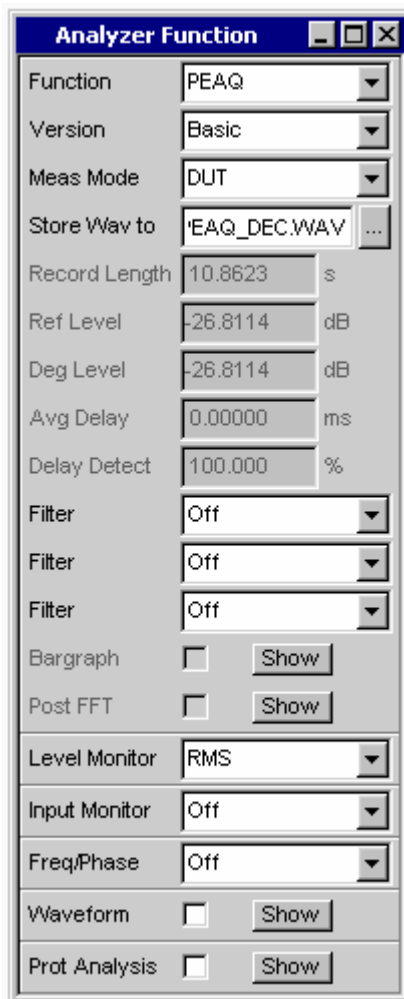

The measurement plays the WAV file selected by the generator and compares its content with the measured signal. Only files with a sample rate of 48 kHz can be used as a source.

Remote control command:  
SENSE[1]:FUNCTION PEAQ



**Version** Selection of the model version for the calculation of ODG and DI value

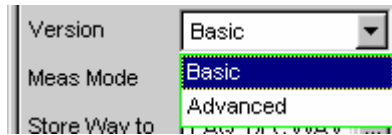

This setting specifies whether the Basic or the Advanced model is to be used.

**Basic** The measurement value is based on the ITU-R BS-1387 basic procedure with just one ear model.

Remote control command:  
`SENSe[1]:FUNCTION:PEAQ:VERSION BASIC`

**Advanced** The measurement value is based on the advanced procedure with a second ear model for refining the time resolution.

Remote control command:  
`SENSe[1]:FUNCTION:PEAQ:VERSION ADVANCED`

**Meas Mode** Selection of the measurement mode for the PEAQ measurement

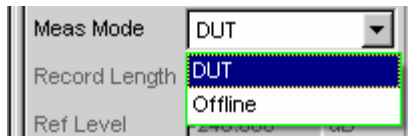

This setting defines whether the measurement is to be performed in real time (DUT) or with an analysis using previously stored WAV files (Offline).

**DUT** The PEAQ measurement is to be performed in real time. The reference WAV file is run; the measurement signal is simultaneously recorded at the analyzer. The analysis takes place as soon as the reference signal has been run completely

Remote control command:  
`SENSe[1]:FUNCTION:MMODE DUT`

**Offline** The PEAQ measurement is to be performed on previously stored WAV files. After the files containing the reference signal and the measurement signal are specified, the evaluation can be started by pressing the START button. The sample rate of the stored WAV files must be 48 kHz. The length of the recorded signals must not be shorter than that of the reference signal selected in the generator

Remote control command:  
`SENSe[1]:FUNCTION:MMODE OFFL`

**Store WAV to**

Permits the measured signals to be stored as a WAV file (with Meas Mode = DUT only)

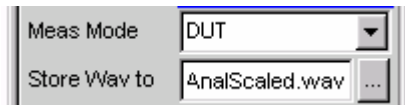

The WAV file is always stored with a sampling rate of 48 kHz.

Remote control command:  
MMEMory:STORE:PWAVEform 'filename'

**Filename**

Selects the WAV file with the stored measurement data (with Meas Mode = DUT only)

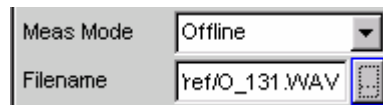

Remote control command:  
MMEMory:LOAD:PWAVEform 'filename'

**Record Length**

Shows the length of the WAV file selected for the reference signal in the generator function panel.

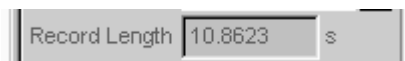

Remote control command:  
SENSE[1]:FUNCTION:REC:LENGTH?

**Ref Level**

Displays the RMS value of the reference signal after measurement.

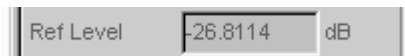

The RMS value of the reference signal is shown in dB referenced to the full scale value of the reference signal file. Both channels are averaged.

Remote control command:  
SENSE[1]:FUNCTION:PEAQ:REFLevel?

**Deg Level**

Displays the RMS value of the measurement signal after measurement.

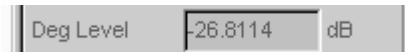

The RMS value of the measurement signal is shown in dB referenced to the full scale value of the measurement signal file for the PEAQ algorithm. Both channels are averaged.

The PEAQ algorithm is configured properly if the difference between Ref Level and Deg Level is as small as possible, less than 10 dB is recommended. PEAQ measurement can compensate for differences of up to 30 dB

Remote control command:  
SENSE[1]:FUNCTION:PEAQ:DEGLLevel?

**Avg Delay**

Displays the time offset between the reference and the measurement signals after measurement.



The PEAQ algorithm can only correctly process signals with a constant time offset of less than 1 second.

Remote control command:  
SENSe[1]:FUNction:PEAQ:AVGDelay?

**Delay Detect**

Displays (after the measurement) how good the algorithm could compensate the time offset between the reference and the measurement signal.

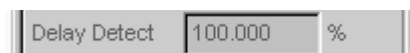

The value should be close to 100 %. For strongly periodic signals and/or signals with severe distortions this value can be significantly lower. Values below 70 % indicate that the ODG and DI values may become uncertain. In this case a subjective verification – by listening to the signals - is recommended.

Remote control command:  
SENSe[1]:FUNction:PEAQ:DELDetect?

**Filter**

Used to activate a digital filter in the measurement path. Up to 3 user-defined filters or weighting filters can be looped into the measurement path:

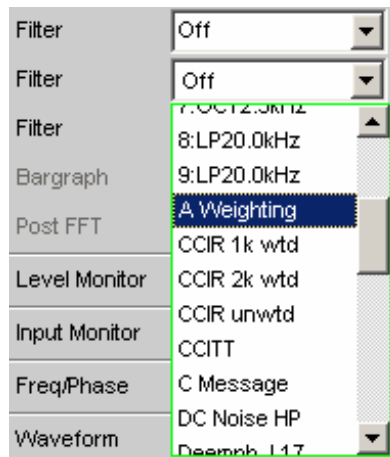

The user-defined filters are configured as Filter 01 to 09 in the Filter panel (see section "User-Definable Filters" on page 4.420) and can then be used in the analyzer (more than once if required).

The selectable weighting filters are described in section "Weighting Filters" on page 4.428.

**Note:**

*Irrespective of the digital filters selected here, it is also possible to loop an additional input filter ("Pre Filter") into the measurement path.*

```
Remote-control command:
SENSe[1]:FILTer[1] <parameter>
SENSe[1]:FILTer2 <parameter>
SENSe[1]:FILTer3 <parameter>
```

List of <parameter> see section "Filter Table" on page 4.419.

## Analysis in the Time Domain

In addition to analysis in the frequency domain, the R&S UPV can also be used to analyze input signals in the time domain. Time and frequency-domain analyses can be performed simultaneously and irrespective of the selected measurement function.

### Waveform Monitor

The waveform monitor is used for signal analysis in the time domain. Both channels of the active analyzer can be measured and displayed simultaneously and synchronously.

- The "Analyzer Function" panel is used to activate the waveform monitor and to configure its trigger condition and memory depth. In addition the "Waveform" window can be opened from here.
- The "Waveform Config" panel is used to select the scaling (incl. limit check and reference).
- The measurement results are displayed graphically in the "Waveform" graphical window.

**Waveform**

Used to activate the waveform monitor; the *graphic* is configured and displayed in the configuration and graphical window "Waveform (Config)".

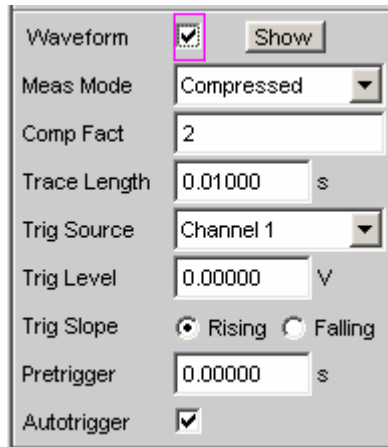

Click the Show button to open the Waveform graphic. You can close the graphic – as with any other window – by means of the **CLOSE** button or by clicking on the X button in the title bar, provided it is the active window.



Waveform monitor deactivated.  
Recommended for increasing the measurement speed (e.g. for sweeps or remote-control mode).

Remote-control command:  
SENSE7:FUNCTION OFF



Waveform monitor activated; the parameter fields shown above appear.

Remote-control command:  
SENSE7:FUNCTION ON

**Meas Mode**

Used to select the operating mode.

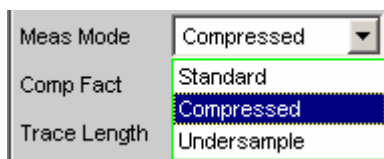

**Note:**

If "Undersample FFT" is enabled, the waveform mode cannot be selected. Instead, it is automatically set to "Undersample".

In certain measurement functions (e.g. "Record") "Meas Mode" cannot be selected, but instead stays at "Standard".

**Standard** Uncompressed recording of all samples. A maximum of 480000 samples can be stored. The possible recording length depends only on the bandwidth (analog) or sampling rate (digital). At a sampling rate of 48 kHz or an analog bandwidth of 22 kHz, the probable time is 10 s.

Recommended for short recordings (maximum of a few seconds) and for periodic signals.

Remote-control command:  
SENSe7:MMODE STANDard

**Undersample** Compressed recording of the samples produced by undersampling. Specifying a value (n) for the "Comp Fact" (compression factor) in the next operator field means that only every nth sample is recorded. The maximum recording time increases in proportion to the factor n.

Recommended for recording low-frequency signals if the Standard recording time is too short and the aspect of interest is the *signal trace* over time.

---

**Note:**

*"Delay Ch1" (only for the FFT measurement function) cannot be used in this mode and is thus set to 0 s.*

*Continuous processing of the measured data over a relatively long time is only guaranteed for sampling rates up to 96 kHz or analog bandwidths up to 40 kHz. If the sampling rate is too high or the bandwidth is too large, the measurement will be terminated with a suitable error message. If this happens, it may be necessary to reduce the number of analyzer filters that are being used.*

---

Remote-control command:  
SENSe7:MMODE USAMple

**Compressed** Compressed recording of the samples produced by peak value rectification. Specifying a value (n) for the "Comp Fact" (compression factor) in the next operator field means that the highest value out of every n consecutive samples is determined and this peak value is used as the input signal for the waveform function. The maximum recording time increases in proportion to the factor n.

Since this waveform contains only positive data, a logarithmic display is possible.

Recommended for recording low-frequency signals if the Standard recording time is too short or the only aspect of interest is the *peak value trace* (envelope).

---

**Note:**

*"Delay Ch1" (only for the FFT measurement function) cannot be used in this mode and is thus set to 0 s.*

*Continuous processing of the measured data over a relatively long time is only guaranteed for sampling rates up to 96 kHz or analog bandwidths up to 40 kHz. If the sampling rate is too high or the bandwidth is too large, the measurement will be terminated with a suitable error message. If this happens, it may be necessary to reduce the number of analyzer filters that are being used.*

---

Remote-control command:  
SENSe7:MMODE COMPRESSED

**Comp Factor**

Used for entering the compression factor in compressed recording.

Comp Factor	1024
-------------	------

The factor entered here is the factor by which

- the maximum recording and pretrigger times increase compared to standard recording
- the time resolution deteriorates compared to standard recording

The size of the trace memory (480000 samples) and pretrigger memory (19200 samples) remains unaffected.

A reduction in the compression factor reduces the maximum possible recording time and therefore where appropriate also the set recording and pretrigger times.

An increase in the compression factor does not alter the *set* recording time, but only the *maximum possible* recording and pretrigger times. You can then set a longer recording time ("Trace Length") and a longer pretrigger time.

---

**Note:**

*If Undersample FFT is enabled, the waveform compression factor cannot be selected. Instead, it is automatically set to match the FFT compression factor.*

---

Remote-control command:  
SENSe7:CMPFactor <n>



**Trace Length**

Used to enter the recording length (memory depth), including an optional pretrigger, in seconds.



A maximum of 480000 samples can be stored. Apart from the bandwidth (analog) and sampling rate (digital), the possible recording length also depends on the selected operating mode (the compression factor):

- The higher the bandwidth or sampling rate is, the shorter the maximum possible recording length will be.
- The recording length can be multiplied by using one of the compression modes.

---

**Note:**

*If a multichannel analyzer is used, max. 1.44 million samples can be observed. This is equivalent to e.g. 15 s at 40 kHz analog bandwidth. Therefore, if one of the compression modes is used, the recording length is automatically limited to this time.*

---

The recording length does not depend on the length of the time axis (selected in the "Waveform Config" panel).

The *lower* the selected recording length is, the higher the update rate for the graphic will be.

If a *long* recording duration is set, any section of the recorded samples can be analyzed by reducing the graphical time axis (also possible at a later stage).

---

**Note:**

*The selected "Trace Length" (and not the length of the displayed trace section) determines the recording duration for each measurement and therefore the total measurement time. If a high measurement speed is required (e.g. for sweeps or remote-control mode), the memory depth should not be longer than the measurement time of the measurement function.*

*If "Undersample FFT" is enabled, the lower limit of the waveform recording length is set to the FFT measurement time.*

---

Remote-control command:

```
SENSe7:TRIGger:TRCLength <nu>
```

**Trigger Source**

Used to activate the trigger and to select the trigger source.

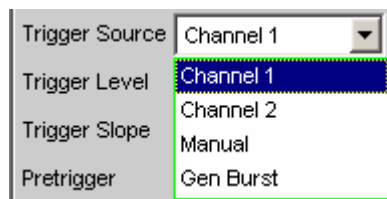
**Note:**

*If Undersample FFT is enabled, the waveform trigger source cannot be selected. Instead, it is automatically set to Manual.*

Selects the source (usually one of the measurement channels) which is to trigger measurement recording if the trigger threshold is overranged or underranged.

**Note:**

*In the case of multichannel analyzers, the trigger channel must be defined before it can be used as trigger source for the waveform. If no trigger channel is activated, the trigger source is automatically set to "Manual".*

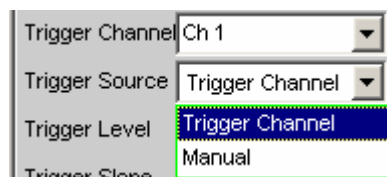
**Channel 1**

Measurement channel 1 triggers recording. Only available in the two-channel analyzers if measurement channel 1 (or both channels) is activated.

Remote-control command:  
SENSe7:TRIGger:SOURce CH1

**Channel 2**

Measurement channel 2 triggers recording. Only available in the two-channel analyzers if measurement channel 2 (or both channels) is activated.

Remote-control command:  
SENSe7:TRIGger:SOURce CH2

**Trigger Channel**

The measurement channel selected as "Trigger Channel" triggers the recording. Only available in the multichannel analyzers if the trigger channel is not deactivated.

**Note:**

*If the trigger channel is deactivated, the "Trigger Source" is not operable.*



Remote-control command:  
SENSe7:TRIGger:SOURce TRGChannel

**Manual**

Recording is triggered as soon as the measurement starts.

Remote-control command:  
SENSe7:TRIGger:SOURce MAN

**Gen Burst**

Recording is synchronized to the start of the generator signal (preferably Sine Burst). Not available in multichannel analyzers.

The generator signal is first muted briefly (approx. 3 ms) and then restarted with zero-degree phase ("Burst On" phase). Measurement data recording is started at the same time, taking internal signal delays into account.

It is thus possible to graphically determine the signal delay of the device under test from the waveform display by selecting "Gen Burst" and using a suitable signal from the internal generator (see "Delay Measurement").

**Note:**

*In this mode, the settling time of any filter that may be enabled is not taken into account for starting the measurement. In other words, the measurement starts without any delay and thus includes the settling time response of the filter.*

Remote-control command:  
SENSe7:TRIGger:SOURce GENBurst

**Trigger Level**

Used to enter the trigger threshold.

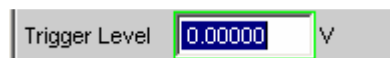

Recording is triggered according to the "Trigger Slope" when this level is overranged or underranged.

When measurement has been started or recording has been triggered (in the case of continuous measurement), a new recording cycle is not armed again until the trigger threshold is violated in the opposite direction.

Remote-control command:  
SENSe7:TRIGger:LEVel <nu>

**Trigger Slope**

Used to select the signal edge on which measurement is to be triggered (trigger slope).

**Rising**

**Triggering** occurs when the level on the measurement channel selected as the "Trigger Source" *exceeds* the trigger threshold for the first time.

(Re-) **arming** occurs as soon as a level *below* the trigger threshold exists.

Remote-control command:  
SENSe7:TRIGger:SLOPe RISing

**Falling**

**Triggering** occurs when the level on the measurement channel selected as the "Trigger Source" *drops below* the trigger threshold for the first time.

(Re-) **arming** occurs as soon as a level *above* the trigger threshold exists.

Remote-control command:  
SENSe7:TRIGger:SLOPe FALLing

**Pretrigger**

Used to activate the pretrigger and to enter the pretrigger interval in seconds:

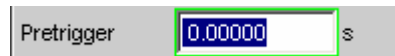

The pretrigger is *deactivated* by entering a pretrigger time of 0.0 s.

Entering a pretrigger time moves the instant known as the trigger time within the recording time selected as the "Trace Length".

The pretrigger memory is 19200 samples in size, that is, 4 % of the maximum possible trace length. With a compressed waveform display ("Compressed" or "Undersample"), the maximum possible pretrigger time (and the trace length) is increased by the compression factor.

The pretrigger memory is filled from the start of the measurement and always contains the latest samples of the time frame selected as the pretrigger, before triggering occurs. For so long as the pretrigger is not completely full, triggering remains locked. It is only armed when the pretrigger memory is full and is at least one sample below the trigger threshold.

The pretrigger memory is filled from the front in the manner of a shift register, so that the older samples move back one position as each new sample is added:

- If the pretrigger time is longer than the total trace length, triggering takes place when the trace length is reached. The pretrigger memory (which is only partially full) is then displayed.
- If the desired pretrigger interval has expired, the older samples in the back part are replaced by newer samples.

The *trigger time* is always  $t = 0.0$  s; the pretrigger time is given as a negative time.

**Note:**

*The total length of the waveform trace is 480000 samples and is entered under "Trace Length". If the pretrigger is used, the recording duration for the triggered section of the signal is reduced.*

Remote-control command:  
SENSe7:TRIGger:PRE <nu>

**Autotrigger**

For activating the autotrigger, that is, forced triggering, when the trigger condition is not fulfilled ("true") within the time selected as "Trace Length".

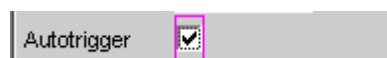



Autotrigger off.  
 The triggering of waveform recording – and thus the termination of a single measurement that has been started – occurs only when the trigger event has occurred (i.e. has changed to "true").  
 If an unfavorable trigger condition is chosen (e.g. the trigger level is too high) the measurement continues indefinitely and must be interrupted manually (STOP key).  
 This setting is recommended if the waveform is to be displayed only if the trigger condition is fulfilled.

Remote-control command:  
 SENSE7:TRIGger:AUTO OFF



Autotrigger on.  
 When the trace length has expired, forced triggering occurs, that is, the waveform is then displayed untriggered, as in the case of manual triggering.  
 This setting is recommended if you wish to ensure that the measurement terminates, or in the case of an unknown signal trace.

Remote-control command:  
 SENSE7:TRIGger:AUTO ON

**Note:**

*With sampling rates below 100 kHz or an analog bandwidth up to 40 kHz, a continuous waveform measurement can be performed. For this it must be ensured that neither the selected measurement function nor any other measurement performed at the same time (e.g. a level monitor or a frequency measurement) requires more time than the waveform measurement. To ensure this, it is advisable to switch off all other measurements and to use manual triggering.*

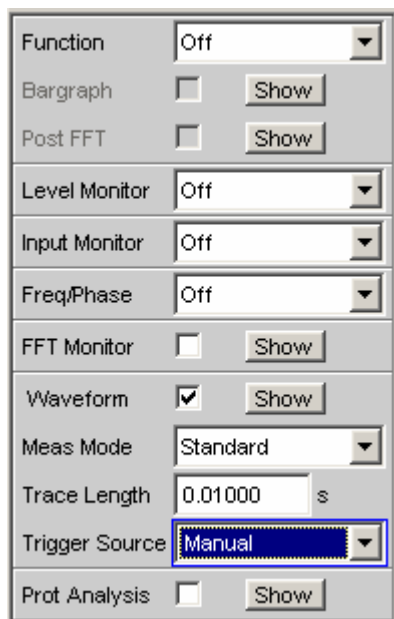

## Delay Measurement

The delay measurement function is used to measure signal propagation delay in a DUT (e.g. between the input and the output). For this purpose, a known signal is applied to the input of the DUT and the time required for the signal to appear at the output of the DUT is measured.

With this type of measurement, it is essential for the time measurement to be started exactly when the signal appears at the input of the DUT, i.e. at the output of the generator. The internal delays of the generator and the analyzer must be taken into account automatically. To allow measurements to be made at the D/A and A/D converters, this synchronization must effectively extend over both domains – from analog to digital and from digital to analog.

Just like the previous UPD and UPL instruments, the R&S UPV provides a specific waveform measurement mode for this measurement task: the “Gen Burst” mode. In this operating mode, the start of the measurement (and thus the start of waveform recording) is synchronized to the start of the generator signal (preferably Sine Burst):

- The generator signal is muted briefly (approximately 3 ms) and then restarted with zero-degree phase (in the case of a burst signal with “Burst On”).
- The analyzer does not start recording until it receives an internal trigger signal from the generator and the internal signal delays of the generator and analyzer being used have expired.

---

**Note:**

*As the generator signal contains an (intentional) signal dropout and reset at the start of each measurement cycle in this operating mode, it should only be used for measuring delays and not for measuring signal quality.*

---

The delay of the DUT can be read directly from the waveform display by comparison with the start of the generator signal. A sine burst signal is particularly suitable for this type of measurement, since it has a zero level before and after the burst if the “Low Level” value, burst duration and burst interval parameters are suitably configured.

---

**Note:**

*Internal triggering to the generator signal cannot be applied if a multichannel analyzer is used. Instead, however, one of the measurement channels – as reference and trigger channel – can record the generator signal and trigger the waveform measurement while two other channels are displayed as waveform.*

---

Sine Burst is equally suitable for single and continuous measurements, since the trigger for the next measurement is automatically re-armed by the burst pause. However, any other type of generator signal can also be used for single measurements, since the start of the signal can be recognized from the brief signal blanking interval. The settings for operation with a sine burst signal are described below:

---

**Note:**

*To run the delay measurement as a constant measurement or sweep Burst must be selected as the generator function with Low Level = 0 (no offset) so that arming can be performed by the burst pause.*

---

- The measurement can be made using **one or two channels**. If only one signal is to be observed, the unused channel should be disabled in the *Analyzer Config* panel and Trace B should be disabled in the *Waveform Config* panel.
- The **Filter** and **Equalizer** should not be used unless absolutely necessary. If a filter or filters are used, it must be borne in mind that the settling of the filter will be visible in the waveform trace, since in this case the start of the measurement cannot be delayed by the filter settling time as is otherwise usual.
- In the case of **analog measurement**, the two-channel analog analyzer must be used, autoranging must be disabled (“Range Fix” for the measurement channel(s) used) and the input coupling must be set to “DC”. A range that is large enough to acquire the expected signal level without overranging must be selected. A bandwidth of 80 kHz should be selected to obtain the highest possible time resolution; 250 kHz is not supported for delay measurement. The only case in which the bandwidth must be reduced is when the delay is very long (more than 2 s).

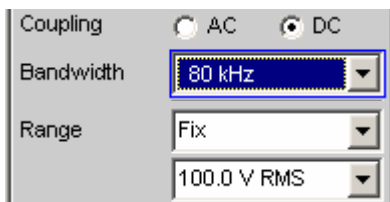

- With **pure analog measurements** (analog generator and analog analyzer), the generator and analyzer should be configured with the same bandwidth. With **D/A measurements**, it is recommended that you adapt the generator bandwidth to the analyzer sampling rate (i.e. 22 kHz bandwidth at a 48 kHz sampling rate, 40 kHz bandwidth at a 96 kHz sampling, or 80 kHz bandwidth at a 192 kHz sampling rate).

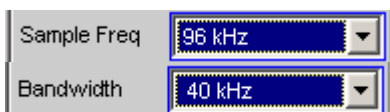

- For evaluation of the measurement, the **waveform window** must be visible and a vertical graphic cursor (or two cursors for two-channel measurements) must be enabled (“Movement Next Sample”). With a two-channel measurement, this allows the relative delay of the two measurement signals to be read in addition to the absolute delay of each signal.

$\Delta X$  2.5417m

The X-axis should initially be scaled automatically so that the entire waveform trace can be seen. The graphic zoom function can then be used for more precise examination of the signal start.

- A **measurement function** with a short measurement time (such as FFT with a size of 1 K) should be selected in the *Analyzer Function* panel, and all unnecessary supplementary measurement functions (especially frequency and level monitoring) should be disabled. The Waveform Monitor must be enabled.

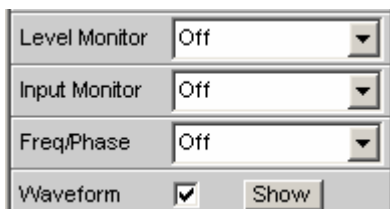



- “Meas Mode Standard” should be selected in the **Waveform menu** of the *Analyzer Function* panel. It is not necessary to select “Undersample” except for very long delays (more than 9 s). “Trigger Source” must be set to “Gen Burst.”

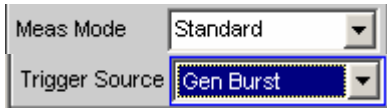

- The **generator function** should always be set to “Sine Burst,” although other types of signals from the internal generator can also be used for single measurements.
- The “**Low Level**” of the burst signal must be set to “0.0” (V or FS), especially for continuous measurements, so that the burst pause can arm the trigger for the next measurement. The voltage must be greater than 0.0; otherwise the message “No Generator Signal” will be displayed and it will not be possible to trigger the measurement.
- “Burst on Delay” is normally not necessary. It can be used to lengthen the standard generator mute time (3 ms) at the start of the measurement.

The following settings depend on the length of the expected delay and apply to the generator “Sine Burst” function:

- The **recording length** (“Trace Length”) should be around 110% of the maximum expected delay, but in any case at least 10 ms. Reducing the recording time increases the update rate with continuous measurements and the time resolution of the graphic display.
- The **burst interval** should be 110% to 200% of the recording time, but at least 100 ms *longer* than the recording time. The interval can be set to any desired value for single measurements. The maximum allowable interval for continuous measurements is 2 s. If the selected value is too large, a timeout will occur during continuous measurement and the message “No Generator Signal” will be displayed. The shorter the interval, the higher the update rate with continuous measurement.
- The **frequency** of the burst signal should be selected such that the period of the signal is approximately 2% to 10% of the recording length. If possible, it should be a subharmonic of the generator sampling frequency.
- The **burst duration** should not exceed 10% of the recording time, and it should be set to an integer multiple of the period (1 to 5 cycles) so that the test signal will not have a DC component.

The following two examples show configurations for very short (1 ms) and very long (1 s) delays.

DUT delay 1 ms



DUT delay 1 s



Generator Function		
Function	Sine Burst	
Sweep Ctrl	Off	
Frequency	1000.00	Hz
Voltage	1.00000	FS
Low Level	0.00000	FS
On Time	1.00000	cyc
Interval	110.000	ms
Burst on Delay	0.00000	s
Filter	Off	
Equalizer	<input type="checkbox"/>	
DC Offset	<input type="checkbox"/>	
	0.00000	FS

Generator Function		
Function	Sine Burst	
Sweep Ctrl	Off	
Frequency	25.0000	Hz
Voltage	1.00000	FS
Low Level	0.00000	FS
On Time	2.00000	cyc
Interval	2.00000	s
Burst on Delay	0.00000	s
Filter	Off	
Equalizer	<input type="checkbox"/>	
DC Offset	<input type="checkbox"/>	
	0.00000	FS

## Offline Analysis

All R&S UPV measurement functions can of course be executed online (in realtime), which produces results quickly and is indispensable particularly for use in production and in adjustment procedures. They can all, however, be used offline as well.

This is done by recording the signal that needs to be measured and playing it back and analysing it at a later time.

The R&S UPV provides the RECORD function for the purpose of recording the signal. Since the standard WAV format is used for playback, in principle any recording instrument that creates WAV files can be used. When recording analog signals the R&S UPV analyzer or a similar high-quality 24 bit A/D converter should preferably be used, in order to take full advantage of the extensive dynamic response of the R&S UPV during offline measurements.

---

**Note:**

*This measurement requires uninterrupted monitoring of the measurement signal over an extended period of time. When using a multichannel analyzer, which only performs single measurements that are limited by time, it does not yield meaningful results. RECORD is therefore only available with two-channel analyzers.*

---

These files are played back for analysis with the aid of the PLAY generator function (Reference), while the R&S UPV analyzer – connected internally to the generator – executes all the required measurements one after the other. All available interfaces can be used for this. For instance an analog measurement signal can be analyzed loss-free via one of the optional R&S UPV digital interfaces during offline analysis.

The maximum recording time depends on the required format (mono/stereo, 8/16/32 bit), the sampling rate and the available memory, and can last up to one day (8 bit mono recording at 48 kHz). In the case of a two channel analog recording with a 22 kHz bandwidth the maximum is three hours.

---

**Note:**

*Due to considerations of memory space and performance, the smallest possible bandwidth or sampling rate should be used.*

---

Data partition of the hard disk (D:) or a network drive can be used as the storage location for the WAV file, and a USB stick can also be used for short files.

In order to synchronize the start of the recording on a certain level (e.g. interference peak), a trigger system can be activated. A pretrigger optionally also records the events leading up to the trigger event.

The signal is stored unchanged or filtered according to choice. As with all level measurements, a maximum of three further filter banks with user-definable filters is available in addition to the prefilter, and can be used to weight and band-limit the signal.

## Applications

The following situations or applications call for offline measurement and the use of the Record function:

- The signal to be measured does not occur cyclically or occurs only sporadically.
- The DUT is available for only a short time.
- The intention is to use a single signal to carry out more different measurements than the Audio Analyzer can carry out *simultaneously*.
- The signal to be measured needs to be analyzed with the aid of an external diagnostics program.
- The place or time of the measurement value acquisition are not favorable to technical assessment.

## Recording Format

Measurement signals can be recorded as WAV files in PCM format at a sampling rate of up to 192 kHz (digital) or at a bandwidth of 80 kHz (analog)

The WAV format supported during Record and Play is based on the RIFF (Resource Interchange File Format) specification developed by Microsoft and IBM in 1991. This standard is virtually a container for all possible multimedia resources such as video, audio, bitmaps or even text in RTF format. RIFF has meanwhile become an interchange format which is now cross-platform (Windows, Unix/Linux, Mac OS). This means that the analysis of a PCM coded audio stream acquired with the aid of the R&S UPV is not limited to tools that will run in Windows. The one thing to be aware of is that some older audio analysis software supports only the standard WAV format with up to 16 bit resolution.

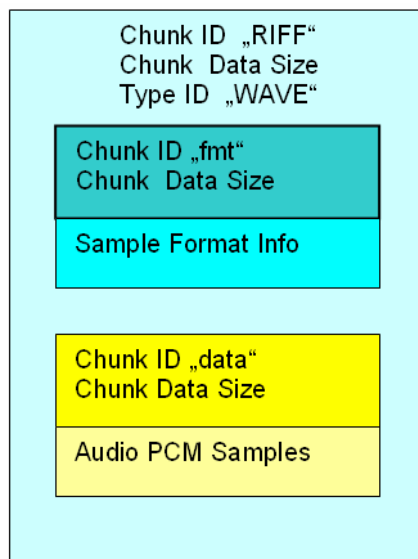

Recording takes place in standard or extended WAV format, depending on the word width. The extended format (with 32 bit integer) is necessary in the case of analog signals and in the case of more than 16 audio bits in the digital analyzer. The R&S UPV automatically determines the smallest possible format and all header entries on the basis of sampling rate or bandwidth, number of channels (mono or stereo) and word width (number of audio bits).

Acquisition is in dual-channel mode in the stereo format, but if only one channel is switched on the system switches automatically to a suitable mono format.

Playback and offline measurement can take place regardless of the word width during acquisition. In the case of the larger word widths, audio bits that are not present are zero-filled and in the case of the smaller word widths unused audio bits are rounded. In this way recorded signals (analog or digital) can be played back and measured via one of the optional digital interfaces (e.g. I<sup>2</sup>S) with a narrower word width in order to examine what effect different word widths may have. In the case of stereo acquisitions the two channels can also be played back and examined individually (mono).

---

**Note:**

*So that analog signals acquired in dual-channel mode can be played back as stereo signals, either option R&S UPV-B3 or a digital option must be installed. Otherwise the two channels must be played back and examined in sequence.*

---

The sampling rate set for the acquisition should also be used on playback. In the analog analyzer and generator, the set bandwidth implicitly defines the sampling rate:

- Bandwidth 22 kHz: Record / playback with a sampling rate of 48 kHz
- Bandwidth 40 kHz: Record / playback with a sampling rate of 96 kHz
- Bandwidth 80 kHz: Record / playback with a sampling rate of 192 kHz

When the WAV file is loaded, the generator issues an appropriate warning if the generator sampling rate does not match the sampling rate entered in the WAV file.

---

**Note:**

*For analog playback of digital signals that have been acquired using a sampling rate that is not suited to analog (e.g. audio CDs with 44.1 kHz), the generator provides the bandwidth setting "Play Auto". When this setting is used the generator sampling rate is automatically set to the sampling rate of the WAV file.*

---

## Monitoring the Recording

Important signal parameters are measured and displayed during the actual recording. These include:

- Frequency and in some cases the sampling rate
- Peak value at input level (prior to prefilter)
- Peak or RMS value at monitor level (after prefilter)
- RMS value at function level (after the function filters)

In addition the following are displayed so that the signal can be assessed graphically:

- The waveform monitor, continuously, from the start of the Record function to the triggering of recording,
- The start of the recording, if necessary taking into account the pretrigger, in the time and frequency domains (waveform monitor and post FFT).

Additional acoustic monitoring of the acquisition is available via the audio monitor.

## Recording Modes of the Record Function

Depending on the application, the RECORD function can be for a continuous or single measurement, and may be either triggered or started manually:

- The recommended method for examining a signal at a later time or with an external analysis program is **manual single recording** over a fixed time period.
- To look for a seldom occurring event the most suitable method is **triggered single recording**, provided the event is capable of being triggered.
- To analyze sporadically occurring events that can be triggered, the recommended method is **triggered continuous recording**. Create a separate file for each trigger event. This then receives the time stamp of the event concerned.
- To look for interference that cannot be triggered but can certainly be detected by the user (acoustically or from the measurement values), the method to use is **manual continuous recording**: Choose a maximum recording time and stop recording as soon as the event in question has occurred. The starting time of the acquisition is deferred so that the desired recording time is not exceeded even if the event takes a very long time to occur.

A continuous recording is started in the usual way with the START key, and a single recording is started with the SINGLE key. Once started, a continuous recording can be terminated at any time with the aid of the SINGLE key as with a single recording. When the STOP key is used, a continuous recording *must* be halted and terminated, whereas a single recording *may* be halted and terminated in this way.

---

**Note:**

*After closing a manual continuous recording a short merge procedure is required in order to shorten the recording to the desired length. The file is not ready for playback or copying until the relevant message has disappeared from the status line.*

*A triggered continuous recording which deliberately or otherwise has not been stopped keeps writing to the data medium until it is full. This means that no data is lost except for the last incompletely written WAV file. However, in order to continue working with the data medium (e.g. to store trace data or setups), the data medium should be "tidied up" as soon as possible.*

---

## Operating the Record Function

In preparation for recording, select any file name from the hard drive or network drive. Short files may also be stored on a USB stick. The R&S UPV then checks how much storage is available on the medium and determines the maximum recording time according to the sampling rate or bandwidth, the number of channels and the word width. You then only need to enter the length of the acquisition and you can start recording straight away ("Trig Source Manual").

In order to synchronize the start of recording with a particular level, a trigger system can be activated ("Trig Source Channel 1 / Channel 2). In this case the length of an optional pretrigger can also be specified in addition to the trigger conditions (trigger channel, exceeding or dropping below a selectable trigger threshold). This makes it possible to record the history of events leading up to the trigger event.

The settings cannot be changed after the recording function has been started. Any user entry or change of the sampling rate (if "Sample Freq Auto" is enabled) causes recording to stop immediately (the same as pressing the STOP button). In contrast to online measurements, recording is not restarted automatically after a user entry. It must be triggered explicitly by the user.

There are one or two restrictions on the permitted settings compared to online measurements. These are checked when the Record function starts, and an error message is issued if necessary:

- Autoranging is not possible in the analog analyzer. "Range" must be set to "Fix"
- "Auto" must be set as the "Start Condition"; the Record function provides a dedicated trigger system for triggering.
- Only time triggered automatic sweeps ("dwell sweeps") are permitted in the generator. WAV files for external sweeps can be created with the aid of these sweeps (Reference).
- The sampling rate must not exceed 200 kHz, and the bandwidth of the analog analyzer must not be set to 250 kHz.
- Only one analyzer filter should be enabled at high sampling rates (digital sampling rates greater than 100 kHz or analog bandwidths greater than 40 kHz).

---

**Note:**

*Continuous processing of the measured data over a relatively long time is only guaranteed for sampling rates up to 96 kHz or analog bandwidths up to 40 kHz. If the sampling rate is too high or the bandwidth is too large, the measurement will be terminated with a suitable error message. If this happens, it may be necessary to reduce the number of analyzer filters that are being used.*

---

**Function**

For activating offline analysis by switching the measurement function to "Record".

The RMS value of the signal is displayed as the result of the measurement function.



Remote-control command:  
SENSE[1]:FUNCTION RECORD

**Record File**

For entering the drive, path and file name of the WAV file. The recommended data medium is the data partition of the hard disk (default setting "D:\UPV\USER") or a fast network drive (at least 100 Mb/s). Due to their low transfer rate, USB sticks and USB drives should be used for short files only.

**Note:**

*When Record and Play are operated simultaneously, you should take care that the same file is not used. This way of operating is not actually prohibited, but the results are not usually meaningful.*

Once the file name is entered (acquisition does not start yet) a check is made to see how much storage is available on the data medium. An existing WAV file having the name you specified is deemed to be free memory space, since it will be overwritten during recording. The size of the available storage together with the required formats are used to compute the maximum possible recording length and this is entered as the upper limit in the following menu item "Record Length".

**Note:**

*The maximum size of a WAV file is 4 GByte. Only 30 % of the available storage is provided for a single WAV file. The remainder is kept free for a second temporary WAV file and for other user files (e.g. setups, trace data, screenshots).*

In the "**triggered continuous recording**" mode, the file names of the individual WAV files must be generated automatically. For this the selected file name is given a numeric name extension which starts at 0 and is incremented for each subsequent acquisition. This counter is only reset when a new file name is entered in "Record File" or you quit the R&S UPV, in order to avoid inadvertently overwriting the generated WAV files when starting a new recording.

Remote-control command:  
SENSe:FUNCTion:RECORD:FILE 'filename'



**Record Length**

For entering the recording time.



The maximum recording time depends on the following parameters:

- The amount of memory available on the proposed data medium; around 30 % of the current storage capacity can be used
- The maximum size of a WAV file, being around 4 GByte ( $2^{32}-1$  bytes for samples plus header information)
- The number of channels to be acquired (1 or 2)
- The sampling rate (in the analog analyzer this is determined from the selected bandwidth)
- The word width (8, 16, or 32; always 32 in the analog analyzer)

If these parameters are subsequently changed, the recording time is reduced as necessary.

For a dual-channel analog acquisition (22 kHz bandwidth → 48 kHz sampling rate) the maximum time is three hours due to the size restriction on the WAV files (186.414 min).

---

**Note:**

*In the case of triggered continuous recording the recording lengths are summed, as are also the storage requirements of the individual WAV files, so that in the worst case the data medium becomes completely filled. It is therefore best to work with only short recording times in this recording mode.*

---

Remote-control command:

SENSe:FUNction:RECOrd:LENGth <nu>

**File Length**

This displays the file length in bytes



The file length depends on the following parameters:

- The selected recording time
- The number of channels to be acquired (1 or 2)
- The sampling rate (in the analog analyzer this is determined from the selected bandwidth)
- The word width (8, 16, or 32; always 32 in the analog analyzer)

In the case of maximum recording time and sufficient storage capacity this comes to 4 GByte.

In **triggered continuous recording** mode the number specified here is the length of *each individual* file. The total storage needed for this operating mode is therefore n times greater.

**Note:**

*If recording is terminated prematurely, the actual length of the WAV file is correspondingly less.*

**Trigger Source**

For activating / deactivating the Record trigger system and selecting the trigger source.

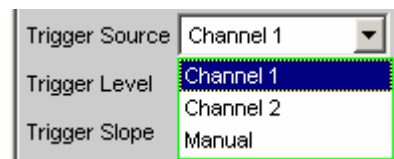

Selects the source which is intended to trigger recording on exceeding or dropping below the trigger level.

**Channel 1**

For activating the Record trigger system; measurement channel 1 triggers recording. Only selectable if measurement channel 1 is switched on (or both channels).

Remote-control command:  
SENSe:FUNCTION:RECORD:TRIGGER:SOURce  
CH1

**Channel 2**

For activating the Record trigger system; measurement channel 2 triggers recording. Only selectable if measurement channel 2 is switched on (or both channels).

Remote-control command:  
SENSe:FUNCTION:RECORD:TRIGGER:SOURce  
CH2

**Manual** For deactivating the Record trigger system; recording starts immediately the Record function starts.

Remote-control command:  
 SENSE:FUNCTION:RECORD:TRIGGER:SOURCE  
 MANUAL

### Trigger Level

For entering the trigger threshold; appears only when the trigger system is active.

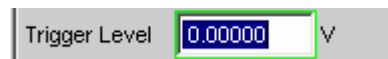

Depending on the trigger slope, recording is triggered on exceeding this level threshold (Trigger Slope Rising) or dropping below it (Trigger Slope Falling).

Once the Record function has started or (in **triggered continuous recording** mode) once the old recording has ended, a new recording is only alerted (armed) again if at least one sample is below the trigger threshold (for Trigger Slope Rising) or above the trigger threshold (for Trigger Slope Falling).

Remote-control command:  
 SENSE:FUNCTION:RECORD:TRIGGER:LEVEL <nu>

### Trigger Slope

For selecting the signal edge on which it is intended triggering shall take place (Trigger Slope); appears only when the trigger system is active.



**Rising** **Triggering** takes place when the level on the measurement channel selected as the trigger source first *exceeds* the trigger threshold. **Arming** takes place again as soon as a level *below* the trigger threshold occurs.

Remote-control command:  
 SENSE:FUNCTION:RECORD:TRIGGER:SLOPE  
 RISING

**Falling** **Triggering** takes place when the level on the measurement channel selected as the trigger source first *falls below* the trigger threshold. **Arming** takes place again as soon as a level *above* the trigger threshold occurs.

Remote-control command:  
 SENSE:FUNCTION:RECORD:TRIGGER:SLOPE  
 FALLING

**Pretrigger**

For activating / deactivating the pretrigger and entering the pretrigger interval in seconds.



The pretrigger is *deactivated* by entering a pretrigger time of 0.0 s.

Specifying a pretrigger time shifts the instant of triggering within the selected recording time; the total recording time stays unchanged.

The size of the pretrigger memory is 19200 samples, which is therefore 100 to 400 ms depending on the sampling rate.

When the waveform monitor is on, the pretrigger time is visible as a negative time segment of the time axis.

Remote-control command:  
 SENSE:FUNCTION:RECORD:TRIGGER:PRE <nu>

**Filter**

For activating a digital filter in the acquisition data stream. Up to three user-defined or weighting filters can be looped into the acquisition data stream in order to apply a weighting to the acquired samples or to carry out band limiting.

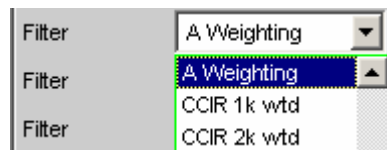

If the intention is to acquire the samples as raw data, all three filters and the prefilter (in the "Analyzer Config" panel) must be off. Filtering can then take place during offline measurement.

The user-definable filters are configured as filters 01 to 09 in the filter panel (see section "User-Definable Filters" on page 4.420) and can then be used (repeatedly if necessary) in the analyzer.

The selectable weighting filters are described in section "Weighting Filters" on page 4.428.

**Note:**

*Regardless of the digital filters selected here, a further input filter ("prefilter") can be looped into the acquisition data stream. Moreover the analog bandwidth can be restricted with the aid of the "Bandwidth" parameter field, which corresponds to an additional low pass filter. Due to considerations of memory space and performance, the Record function should always be operated using the smallest possible bandwidth.*

Remote-control command:  
 SENSE[1]:FILTER[1] <parameter>  
 SENSE[1]:FILTER2 <parameter>  
 SENSE[1]:FILTER3 <parameter>

For a <parameter> list see section "Filter Table" on page 4.419.

## Creating WAV Files for External Sweeps

When there is an internal connection between the generator and the analyzer, the Record function can be used in conjunction with the internal generator to create WAV files for external sweeps. This should preferably take place in a digital domain (via a digital audio or I<sup>2</sup>S interface), because then any format can be generated (8 or 16 bit standard, 32 bit extended) using any sampling rate (e.g. 44.1 kHz) without the need for D/A and A/D conversion. In fact even an analog interface is suitable if need be, for instance if there is no digital option installed; but then only the 32 bit extended format can be generated.

Select the desired signal form from the generator and activate a time triggered automatic sweep,

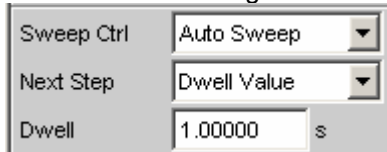

or a list sweep.

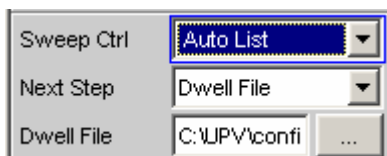

The sweep can be one-dimensional or two-dimensional (z sweep); the dwell time may be specified as a constant value or with the aid of a dwell list.

The Record function should be set as an untriggered single or continuous recording; a triggered (single) recording is also allowed.



If you wish filters to be used, you may switch them on in the generator or analyzer.

Using the START key begins a continuous sweep in the generator at the same time as the untriggered *single* recording in the analyzer. When the set recording time is reached, acquisition stops and the generator sweep keeps running unchanged until halted by the STOP key or, in the case of two-dimensional sweeps, until the z axis has been processed.

Using the SINGLE key starts a single sweep in the generator at the same time as the untriggered single recording in the analyzer. If the set recording time is shorter than the sweep time, acquisition stops and the generator sweep keeps running until the end of the sweep. If the sweep ends before the set recording time is reached, recording is also stopped (prematurely).

Using the STOP key halts the sweep and the recording immediately in all cases.

In order to create a WAV file containing exactly one sweep scan, "Record Length" should be set to the maximum value and a single sweep should then be started with the SINGLE key. If a two-dimensional sweep needs to be recorded, the START key should be used.

---

### Note:

*The special mode "triggered continuous measurement" is not useful and is therefore not to be used; instead the trigger system should be activated so that a normal single recording can be triggered.*

---

## Infrasound Measurements

“Infrasound” refers to the frequency range extending from the lower limit of the human auditory range (16 Hz) down to the low millihertz region.

Although the R&S UPV is primarily designed for use in the audible frequency range, it can work with frequencies much lower than 10 Hz (i.e. generate and acquire such signals for measurement). It is recommended that the R&S UPV-K6 option (Extended Analysis Functions) is installed in order to take full advantage of the infrasound functionality of the R&S UPV.

## Infrasound Signals

The following types of signals can be used for simulations in the infrasound range:

- Multisine for frequencies down to 1 Hz, with a frequency resolution of 1 Hz
- Sine for frequencies down to 100 mHz, or down to 10 mHz if the R&S UPV-K6 option (Extended Analysis Functions) is installed.
- Stereo Sine for frequencies down to 100 mHz, or down to 10 mHz if the R&S UPV-K6 option (Extended Analysis Functions) is installed.

These signals can be output via any desired digital or analog interface.

## Infrasound Analysis

The measurement options with infrasound are limited to the following types of measurements:

- RMS measurement (wideband, without S/N sequencer) with a fixed measurement time or generator tracking

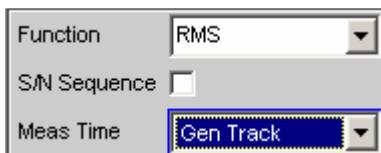

- RMS measurement (selective with fixed bandwidth) with fixed measurement time or generator tracking down to a sampling rate / 48000 (limited to 1 Hz).

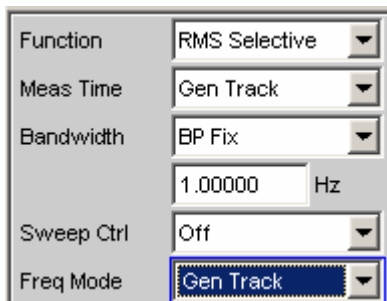

- Waveform display (recommended operating mode: “Undersample”)

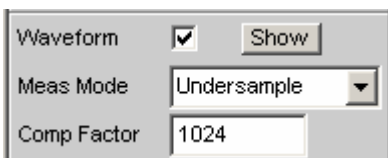

- Frequency measurement (the “Precision” measuring mode is only available if the R&S UPV-K6 option is installed and “Undersample FFT” is enabled)

The frequency resolution can be increased considerably by undersampling if the R&S UPV-K6 option (Extended Analysis Functions) is installed. In this case, the following types of measurements are also possible:

- FFT in the ‘Undersample’ operating mode
- Phase measurement (only if ‘Undersample FFT’ is enabled)
- Level monitor measurements (only if ‘Undersample FFT’ is enabled)
- Input peak measurement (only if ‘Undersample FFT’ is enabled)

The automatic operating modes, which are optimized for the audible frequency range, cannot be used for analyzing infrasonic signals. Consequently, the following restrictions must be observed:

- Analog analyzer:** The autoranger must be switched off, the input coupling must be set to DC, and the smallest possible bandwidth should be selected.

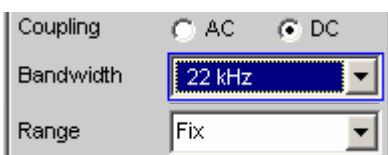

- RMS measurement:** The only modes that can be used for “Meas Time” are “Gentrack” and “Value.” The longest measurement time is 100 s, which means that signals as low as 10 mHz can be captured.



**Undersampling** can be used to visualize extremely low-frequency signals in an FFT and distinguish them from DC. With undersampling, the compression factor can either be entered directly (in which case it is automatically rounded to the nearest power of 2) or set by entering the desired FFT bandwidth. If the FFT bandwidth is entered, the compression factor is calculated automatically from the FFT bandwidth. The following aspects must always be taken into account when selecting the compression factor:

- The **measurement bandwidth** is *decreased* by the selected compression factor.

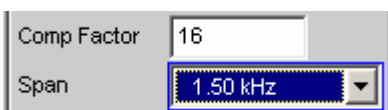

- The **measurement time** is *increased* by the selected compression factor.

Meas Time	87.3813	s
-----------	---------	---

- The **FFT size** should be as large as possible. For a given frequency resolution, reducing the FFT size causes the compression factor to increase, which unnecessarily limits the FFT bandwidth. Although the computation time is somewhat less with a smaller FFT size, this is far more than offset by the increased sampling time.

FFT Size	256 k
----------	-------

- High-frequency signal components** (outside the selected FFT bandwidth) will be visible in the observed frequency band as image frequencies. Consequently, it is necessary to use a suitable **low-pass filter** with a cutoff frequency that adequately suppresses signal components outside the selected FFT bandwidth. It can be configured as an input filter or as a function filter selected from the FFT menu. If the analog analyzer is used, it is of course also possible to use an external analog filter.

Pre Filter	1:LP1.00kHz
Filter	1:LP1.00kHz

Filter 01	Low Pass
Order	<input checked="" type="radio"/> 8 <input type="radio"/> 4
Passband	1000.00 Hz
Stopband	1601.21 Hz
Attenuation	90.0000 dB
Delay	0.04181 s
Short Name	1:LP1.00kHz

---

**Note:**

*If the low-pass filter is configured as a prefilter, it also affects the level monitor and fast frequency measurements. If it is configured as a function filter, it only affects the FFT and waveform displays and precision frequency measurements.*

---

Bearing these aspects in mind, the compression factor or FFT bandwidth (span) should be dimensioned according to the signal components to be examined, as follows:

- Generally speaking, the compression factor should be as small as possible in order to minimize the measurement time.
- The FFT size should be set to 256 K.
- The compression factor must be large enough to allow the signal components under investigation to be visualized with sufficient frequency resolution.
- The FFT bandwidth must be large enough to acquire the highest frequencies under investigation.



The following sample measurement of a stereo signal with offset shows the maximum frequency resolution that can be achieved in the analog domain (0.18 mHz). The measurement time is approx. 93 minutes. After the measurement data has been recorded, the graphic zoom function can be used to examine selected regions of the 256 K FFT (e.g. the range of 0 to 40 mHz as shown in the example).

**Note:**

The measurements described here should be performed as single measurements due to their long measurement times.

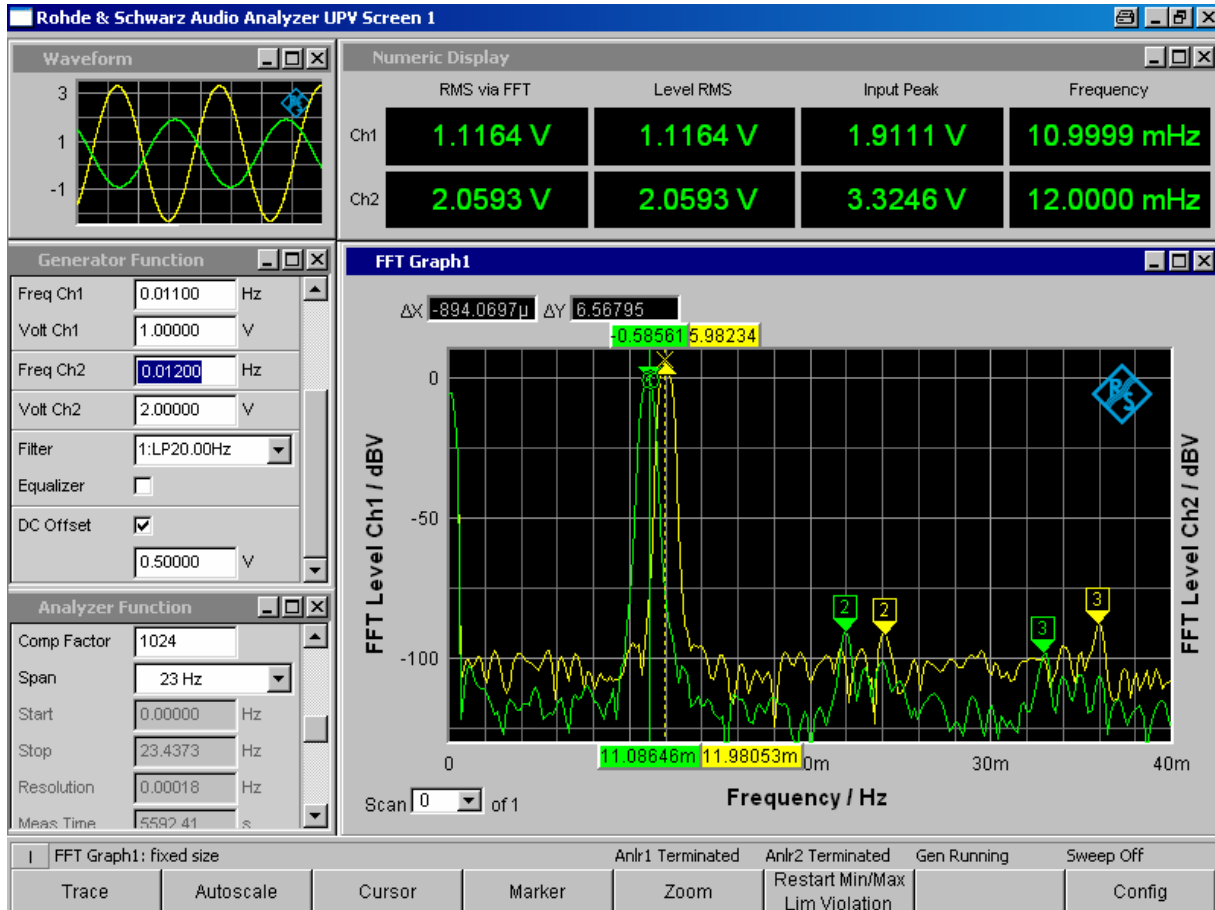

## Protocol Analysis

In order for it to be possible to select protocol analysis from the Digital Audio instrument, the options R&S UPV-B2 (digital audio I/O 192 kHz) and R&S UPV-K21 (digital audio protocol) must be installed; the R&S UPV-K21 option *cannot* be used if the R&S UPV-B20 option is installed.

The Digital Audio interface can be used not only to analyze the audio data content of both channels, but also at the same time to decode the channel-status information and display transmission errors by means of error flags.

## Activating and Configuring the Protocol Analysis

The protocol analysis is configured in the Analyzer Function panel. The channel-status information and error flags are displayed in a separate window known as the "Dig Analyzer Protocol" window. This window can be opened via the main menu (at "Displays") or from the "Analyzer Function" panel.

### Prot Analysis

For activating the protocol analyzer.

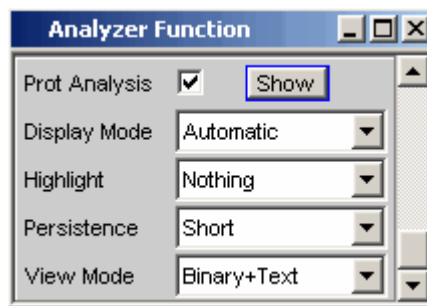

Click the Show button to open the "Dig Analyzer Protocol" window. You can close the window, as with any other, by means of the **CLOSE** button or by clicking on the X button in the title bar.



The protocol analyzer is off.

This setting is recommended for increasing the measurement speed (e.g. in the case of sweeps or in remote-control mode), if protocol data is not currently needed.

The current channel-status information is frozen when this feature is switched off.

Remote-control command:  
SENSe8:FUNction OFF



The protocol analyzer is on. The parameter fields shown above are displayed.

The channel-status information is read out from *both* channels at the end of a single measurement. When a continuous measurement is running the channels are read in sequence, that is, only one channel is updated each measurement cycle.

**Note:**

The internal hardware determines the channel-status information for channels 1 and 2 on a sequential basis only. This information is therefore available only after 2\*192 samples at the earliest. A single measurement must therefore capture at least 384 samples, which can lengthen the measurement time during fast measurements.

```
Remote-control command:
SENSe8:FUNCTion ON
```

**Display Mode**

For selecting the display format of the channel-status information.

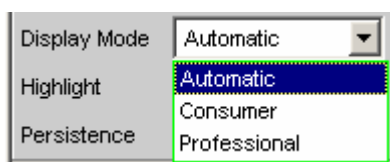

Depending on the format bit (bit #0 of the channel-status bits), the following bit fields have a different meaning. This menu item defines whether the channel-status information is interpreted according to the Consumer format or the Professional format.

**Automatic** The channel-status bits are interpreted in the format specified by bit #0. If this bit changes, the format is changed automatically to the correct one.

```
Remote-control command:
SENSe8:PROTOcol:MODE AUTOMATIC
```

**Consumer** The channel-status bits are always interpreted in Consumer format in accordance with the IEC 60958-3 standard regardless of the state of bit #0. This avoids the possibility that a bit error in bit #0 might cause the display format to switch over.

```
Remote-control command:
SENSe8:PROTOcol:MODE CONSUMER
```

**Professional** The channel-status bits are always interpreted in Professional format in accordance with the IEC 60958-4 standard regardless of the state of bit #0. This avoids the possibility that a bit error in bit #0 might cause the display format to switch over.

```
Remote-control command:
SENSe8:PROTOcol:MODE PROFESSIONAL
```

**Highlight**

For defining whether and if so when channel-status information is to be highlighted.

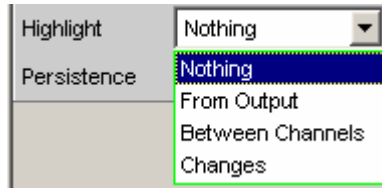

Highlighted channel-status information is displayed in red instead of black.

**Nothing**

Channel-status information is not highlighted.

Remote-control command:  
SENSe8:PROTOcol:HIGHLIGHT NOTHING

**From Output**

Changes compared to the channel-status information generated by the R&S UPV generator are highlighted.

This setting is only worthwhile when the internal generator is used and channel-status information is being generated.

Remote-control command:  
SENSe8:PROTOcol:HIGHLIGHT FOUTput

**Between Channels**

Differences between the two channels are highlighted. The differences are displayed on both channels.

Remote-control command:  
SENSe8:PROTOcol:HIGHLIGHT BETWEEN

**Changes**

This is for highlighting all changes since the start of the measurement, that is, since the START key was last used.

Remote-control command:  
SENSe8:PROTOcol:HIGHLIGHT FSTART

**Persistence**

For defining how long a highlight should stay.

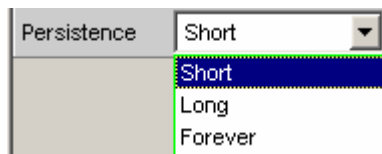

Regardless of the setting selected here, all highlighting is reset when the START key is used.

<b>Short</b>	<p>Highlighting is only brief and is reset after one second.</p> <p>Remote-control command: SENSe8:PROTOcol:PERSistence SHORT</p>
<b>Long</b>	<p>Highlighting is reset after five seconds.</p> <p>Remote-control command: SENSe8:PROTOcol:PERSistence LONG</p>
<b>Forever</b>	<p>Highlighting is never reset.</p> <p>Remote-control command: SENSe8:PROTOcol:PERSistence FOREver</p>

**View Mode**

For defining how the channel-status information should appear.

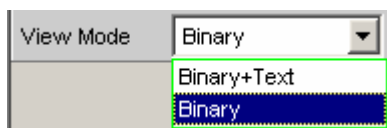

**Binary+Text** The bit fields are displayed both as binary values (MSB first) and in plain text.

Remote-control command:  
SENSe8:PROTOcol:VIEW BINT

**Binary** The bit fields are displayed only as binary values (MSB first). This reduces the space required by the "Dig Analyzer Protocol" window.

Remote-control command:  
SENSe8:PROTOcol:VIEW BIN

## Channel-Status Information Display

The R&S UPV decodes the first five bytes of each channel and displays the current information from the individual bit fields in a readable form for both channels in the "Dig Analyzer Protocol" window.

**Note:**

*Channel information is always decoded and displayed for both channels, regardless of whether only one or both audio channels are being measured.*

There are two different formats, defined by the value of the first bit:

- The format for general use (Consumer format); bit #0 = 0
- The format for Professional use (Professional format); bit #0 = 1

In the Automatic display mode the correct format (Consumer or Professional) is set for each channel according to its format bit, so that even data streams with a different format in channels 1 and 2 can be displayed.

The screenshot shows the 'Dig Analyzer Protocol' window with two channels of data. Channel 1 is in 'Consumer' format, and Channel 2 is in 'Professional' format. Both channels are in 'Linear PCM' audio mode. Channel 1 has a 'Copy Bit' of 1 (No Copyright) and a 'Pre-emphasis' of 000 (No pre-emph). Channel 2 has a 'Pre-emphasis' of 011 (Pre-emph 50/15) and a 'Source Freq Lock' of 1 (Unlocked). Both channels have a 'Sample Frequency' of 48 kHz. Channel 1 has a 'Category Code' of 0001000 (Solid state rec) and an 'L-bit' of 1 (Pre-rec SW). Channel 2 has a 'Channel Mode' of 0100 (Mono) and 'User Bits' of 1000 (192 bit block). Both channels have a 'Max Word Length' of 20 bits and a 'Word Length' of 18 bits. Channel 1 has a 'Clock Accuracy' of Level II. Channel 2 has an 'Alignment Level' of 10 (SMPTE RP155 (20 dB)) and a 'Multichannel Mode' of 1 (Defined). Both channels have a 'Channel Number' of 0000 (Channel 1) and a 'Mode Number' of 000 (Mode 0). Channel 1 has a 'Reference Signal' of 00 (Not a ref signal) and a 'Sample Frequency' of 0000 (Not indicated). Channel 2 has a 'Reference Signal' of 00 (Not a ref signal) and a 'Sample Frequency' of 0000 (Not indicated). Both channels have a 'Frequency Scaling' of 0 (No scaling).

Channel 1:				Channel 2:			
	Byte/Bit				Byte/Bit		
Format	0 / 0	0	Consumer	Format	0 / 0	1	Professional
Audio Mode	0 / 1	0	Linear PCM	Audio Mode	0 / 1	0	Linear PCM
Copy Bit	0 / 2	1	No Copyright	Pre-emphasis	0 / 4..2	011	Pre-emph 50/15
Pre-emphasis	0 / 5..3	000	No pre-emph	Source Freq Lock	0 / 5	1	Unlocked
Chan Status Mode	0 / 7..6	00	Mode 0	Sample Frequency	0 / 7..6	10	48 kHz
Category Code	1 / 6..0	0001000	Solid state rec	Channel Mode	1 / 3..0	0100	Mono
L-bit	1 / 7	1	Pre-rec SW	User Bits	1 / 7..4	1000	192 bit block
Source Number	2 / 3..0	0001	Source 01	Aux / Audio Bits	2 / 2..0	010	Coord sig / 20
Channel Number	2 / 7..4	0001	A Left channel	Word Length	2 / 5..3	010	18 bits
Sample Frequency	3 / 3..0	0010	48 kHz	Alignment Level	2 / 7..6	10	SMPTE RP155 (20 dB)
Clock Accuracy	3 / 5..4	00	Level II	Multichannel Mode	3 / 7	1	Defined
Max Word Length	4 / 0	0	20 bits	Channel Number	3 / 3..0	0000	Channel 1
Word Length	4 / 3..1	000	Not indicated	Mode Number	3 / 6..4	000	Mode 0
Orig Sample Freq	4 / 7..4	0000	Not indicated	Reference Signal	4 / 1..0	00	Not a ref signal
				Sample Frequency	4 / 6..3	0000	Not indicated
				Frequency Scaling	4 / 7	0	No scaling

**Error Flags**

Channel 1: PCM  parity  lock  CRC  Ch 1 invalid

Channel 2: PCM  parity  lock  CRC  Ch 2 invalid

When the format is predefined the meaning of the individual bit fields, as well as the interpretation of the content and even of the position and length of the bit fields depend on other, preceding bit fields. These formats are continually being developed by the IEC standardization committee, for which reason new and previously reserved bit combinations are added. The "Dig Analyzer Protocol" window can be upgraded to the latest state with the aid of updates to the R&S UPV software.

The values and meanings currently available for a bit field can be found in IEC standard 60958-3 (Consumer Applications) or IEC 60958-4 (Professional Applications), or the "Protocol Generator" panel.

## Error Flag Display

In addition to channel-status information, the "Dig Analyzer Protocol" window also displays the error flags which indicate errors in the data stream. When an error occurs the color of the "LED" changes from green to red. As soon as the error disappears the "LED" goes back to green.

### Note:

*Just as with the channel-status information, the error flags are read at the end of a measurement cycle. The error flag update rate therefore depends on the measurement time of the function that has been set. In the case of single measurement the status read at the end of the measurement stays unchanged until a new measurement has started and finished.*

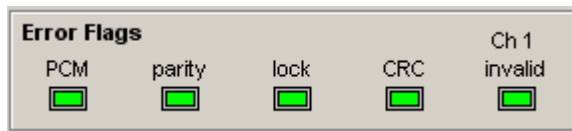

- "PCM" indicates whether the signal is Linear PCM-coded (green) or not (red). This error flag corresponds to audio mode (bit #1 of the channel-status data).
- "parity" indicates whether parity checking has detected an error (red).
- "lock" indicates whether a valid digital signal is present (green); if the DUT delivers no clock or the input is open, "lock" is red.
- "CRC" indicates that CRC checking has detected an error (red).
- "CH1 invalid" or "CH2 invalid" indicates the status of the validity bit in the protocol. Red means that the corresponding channel is invalid.

---

**Note:**

*All error flags will be set (red) if a Lock error occurs.*

---

## Frequency, Phase and Group Delay Measurement

The frequency measurement and combined frequency/phase/group delay measurement are performed *upstream* of the function-specific digital filters, but downstream of the prefilter. In the two-channel analog analyzer, the frequency is measured *downstream* of the notch filter (if the analog notch filter is activated). If the fundamental is rejected with the notch filter, the frequency meter determines the frequency of the residual signal.

### Freq/Phase

Used to activate the frequency measurement (for the reference channel) and to select the measurement value for the other channels.

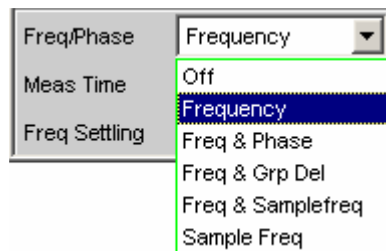

With 1-channel measurements, it is only possible to select the frequency measurement here; measurement of the sampling frequency can be selected here in the digital analyzer.

With 2-channel or multichannel measurements, the frequency on the other channels is often the same as the frequency on the reference channel. In such cases, it is advisable to display a frequency-related measurement value instead of the frequency in the measurement window of the other channels.

#### Note:

*In two-channel analyzers, the **reference channel** is always **channel 1**; in multichannel analyzers, the reference channel is user-definable in the analyzer Config panel.*

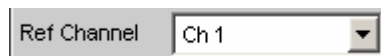

### Off

Frequency measurement is deactivated.



#### Note:

*For signals for which no zero-axis crossing can be detected (e.g. weak noise signals, pure DC signals or AC signals of extremely low frequency), the frequency measurement can be switched off, which will considerably reduce the total measurement time.*

Remote-control command:  
SENSe3:FUNction OFF



**Frequency** Frequency measurement is performed on all activated channels.

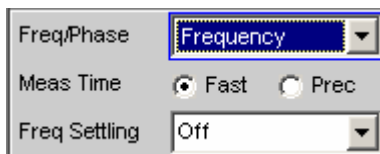

Remote-control command:  
SENSe3:FUNCTION FREQUENCY

**Freq & Phase** Only available for two-channel measuring mode or in a multichannel analyzer.

Frequency measurement is performed on the reference channel; the measurement windows of the other channels contain the phase of the other channel referenced to the reference channel.

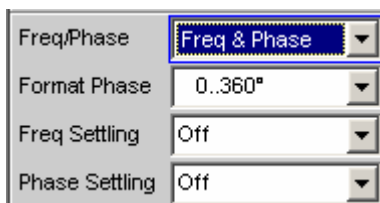

If a phase is shown as invalid, the frequencies of this channel and the reference channel are different or one of the channels does not have an input signal.

---

**Note:**

*This measuring mode should only be selected if the frequency on the reference channel is identical with the frequency on at least one other measurement channel.*

---

Remote-control command:  
SENSe3:FUNCTION FQPHase

**Freq & Grp Del**

Only available for two-channel measuring mode or in a multichannel analyzer.

Frequency measurement is performed on the reference channel; the measurement windows of the other channels contain the group delay of the respective channel referenced to the reference channel.

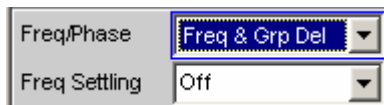
**Note:**

*This measuring mode should only be selected if the frequency on the reference channel is identical with the frequency on at least one other measurement channel. The group delay measurement should only be used in the case of frequency changes (e.g. with frequency sweeps); a group delay is not defined in the case of constant frequency.*

The group delay is measured by differentiation of phase with respect to frequency, i.e. by evaluating the difference quotient.

$$t_2 [s] = \frac{\Delta\varphi}{2\pi \cdot \Delta f} \quad \text{where} \quad \Delta\varphi = \varphi_{2mes} - \varphi_{1mes}$$

The following points must be taken into consideration when selecting a frequency sweep for measuring the group delay:

- The frequency step size and the number of sweep points must be selected such that no phase shifts of more than 180° occur between two consecutive sweep points.
- The spacing should be linear; with logarithmic spacing the frequency increments at the bottom could become too small and the phase shifts at the top could become too large.
- In the case of group delay measurement over frequency (e.g. by means of a generator frequency sweep), the first sweep point is undefined because a reference point for calculating the delta values of frequency and phase is only available as of the 2<sup>nd</sup> frequency value.

**Note:**

*For signals with a poor S/N ratio, the quality of the group delay measurement can be improved by increasing the FFT size or by FFT averaging (Avg Normal). To this effect, the measurement function is to be set to FFT.*

**Freq & Samplefreq**

Only available for two-channel or multichannel measuring mode in the digital analyzer.

The sampling frequency is measured on the channel last activated. On all other channels (i.e. channel 1 in two-channel analyzers), a frequency measurement is performed.

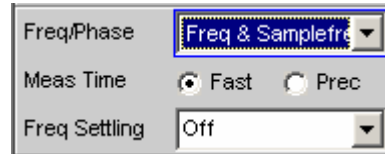

**Note:**

*In this measuring mode, the audio frequency of the last channel is not measured.*

The sampling frequency is measured with a resolution of 22.9 mHz and an update interval of approx. 700 ms.

Remote-control command:  
SENSe3:FUNction FQSamplefrequency

**Sample Freq**

Only available in the digital analyzer. The measurement windows contain the sampling frequency.



**Note:**

*In this measuring mode, the audio frequency is not measured.*

The sampling frequency is measured with a resolution of 22.9 mHz and an update interval of approx. 700 ms.

Remote-control command:  
SENSe3:FUNction SFrequency

**Note:**

*If the sampling frequency varies by at least 3 Hz, a precision measurement is performed that takes max. 1.5 s. If the "Sampl Freq" measurement is activated, therefore, the total time required by a single measurement may be extended to up to 1.5 s.*

*For frequency measurements, the input signal – beginning in the zero crossing – must be observed over one complete period, but with at least 100 samples. For function measurements with an extremely short measurement time (e.g. peak measurement 1 ms interval), the frequency measurement should therefore be deactivated.*

**Meas Time**

Used to select the measurement speed.

**Fast**

The frequency and (if applicable) phase measurement is optimized with respect to *speed*. A 4 k FFT is used as the measurement basis for high frequencies and the phase; low frequencies are determined by means of an evaluation of period (with interpolation). This measuring mode does not require any additional processing performance, i.e. the total measurement time of all activated measurement functions does not increase.

Recommended for pure frequency measurements on single-tone signals or for phase measurements on signals whose frequency is not too low (higher than 2 % of the bandwidth and 1 % of the sampling frequency).

**Note:**

*In the case of distortion measurements the frequency must be very accurately determined. The accurate result of this frequency measurement is then displayed. The frequency accuracy in fast mode therefore depends on the measurement function selected.*

Remote-control command:

```
SENSe3:FREQuency:APERTure:MODE FAST
```

**Prec** The frequency and (if applicable) phase measurement is optimized with respect to *precision*. A precision FFT with up to 256 k points is used as the measurement basis. The FFT length is automatically adapted to the measured signal frequency so that measurement can always be performed with the smallest possible FFT (and, therefore, in the shortest possible time). Depending on the activated measurement function, the total measurement time can increase in this measuring mode since it may be necessary to calculate an (additional) FFT.

---

**Note:**  
 Digital or analog filters which are active in the activated function measurement are also used in the frequency measurement. If only the unfiltered frequency or phase measurement result is required, the function measurement should be deactivated.

---

Recommended for signals with a high noise component, multi-tone signals and for measuring the phase of low frequencies.

Remote-control command:  
 SENSE3:FREQUENCY:APERTURE:MODE  
 PRECISION

**Format Phase**

Used to select the phase display format; only available if phase measurement is activated.

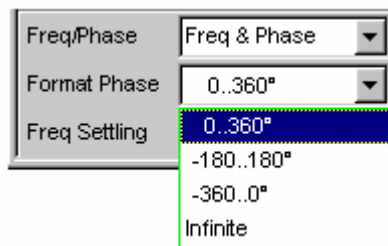

or

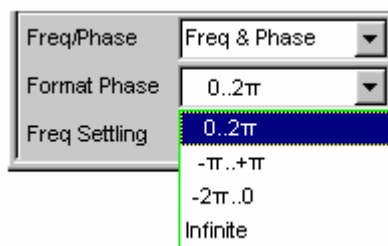

depending on whether degrees or RAD has been selected for the phase unit.

<b>0..360°</b>	<p>The phase is displayed in the range 0° to 360°; only available if "" has been selected for the phase unit.</p> <p>Remote-control command: SENSe3:PHASe:FORMat POSitive</p>
<b>-180..180°</b>	<p>The phase is displayed in the range +/- 180°; only available if "" has been selected for the phase unit.</p> <p>Remote-control command: SENSe3:PHASe:FORMat POSNegative</p>
<b>-360..0°</b>	<p>The phase is displayed in the range -360° to 0°; only available if "" has been selected for the phase unit.</p> <p>Remote-control command: SENSe3:PHASe:FORMat NEGative</p>
<b>0..2π</b>	<p>The phase is displayed as a radian from 0 to 2π; only available if "RAD" has been selected for the phase unit.</p> <p>Remote-control command: SENSe3:PHASe:FORMat RAD</p>
<b>-π..+π</b>	<p>The phase is displayed as a radian from -π to +π; only available if "RAD" has been selected for the phase unit.</p> <p>Remote-control command: SENSe3:PHASe:FORMat RADBipolar</p>
<b>-2π..0</b>	<p>The phase is displayed as a radian from -2π to 0; only available if "RAD" has been selected for the phase unit.</p> <p>Remote-control command: SENSe3:PHASe:FORMat RADNegative</p>

**Infinite**

The phase is displayed continuously ( $-\infty$  to  $+\infty$ ).

**Note:**

*The continuous phase display is mainly used for frequency sweeps to allow the phase characteristic to be displayed even in the case of phase displacement above  $360^\circ$ . This measuring mode is usually unsuitable for measurements without frequency variation since such measurements do not have a valid previous value.*

The continuous phase is measured by adding the phase difference between two consecutive phase measurement results to the phase measurement value of the first measurement result:

$$\varphi_2 = \varphi_1 + \Delta\varphi \quad \text{where} \quad \Delta\varphi = \varphi_{2mes} - \varphi_{1mes}$$

When configuring a frequency sweep for measuring the continuous phase, the frequency step size and the number of sweep points must be selected such that no phase shifts of more than  $180^\circ$  occur between two consecutive sweep points.

Remote-control command:  
SENSe3:PHASe:FORMat INFinite

## Input Monitor

The input monitor is a level meter which determines the input level upstream of *all* digital filters (i.e. also *upstream* of the prefilter). In the two-channel analog analyzer, only the analog notch filter (if activated) is located upstream of the measurement point of the input monitor.

### Input Monitor

Used to activate the input level meter and to select the measurement method.

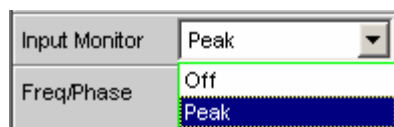

**Off** The input monitor is deactivated.

Remote-control command:  
SENSe2:FUNCTION OFF

**Peak** The peak input value is measured. The numerically highest input sample is determined within a preset interval.

---

**Note:**

*Unlike the peak measurement, which (like all measurement functions) is performed downstream of the filters, no interpolation filter (oversampling filter) is used.*

---

Remote-control command:  
SENSe2:FUNCTION IPEAK

**Phase To Ref** Measurement of the phase between the selected digital input and the reference input. Selectable only in the digital analyzer when the jitter/phase measurement mode is activated.

The jitter measurement data (function, level and frequency) is simultaneously displayed in the other measurement windows.

Remote-control command:  
SENSe2:FUNCTION PHASetoref

**Dig Inp Amp** Measurement of the digital input amplitude at the selected digital input ("Bal" or "Unbal"). Selectable only in the digital analyzer when the common/input measurement mode is activated.

The common-mode voltage data (function, level and frequency) is simultaneously displayed in the other measurement windows.



---

**Note:**

*The common-mode voltage can be measured only at the balanced input connector ("Bal"). If the unbalanced ("Unbal") input has been selected as "Input", only the digital input amplitude can be displayed. The measurement values for the common measurement (function, level and frequency values) are not displayed.*

---

Remote-control command:  
SENSe2:FUNction DIGinpampl

See section "*Level Measurements*" on page 4.241 and section "*Level Monitor*" on page 4.399 for further level measurement options.

## Level Monitor

The level monitor is a level meter which is used to determine the level *downstream* of the prefilter but *upstream* of the function-specific digital filters. In the two-channel analog analyzer, the analog notch filter (if activated) is also located upstream of the measurement point of the level monitor.

### Level Monitor

Used to activate the level monitor and to select the measurement method.

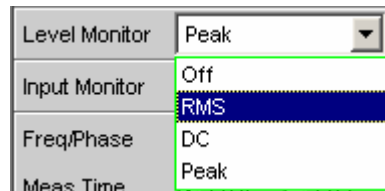

**Off** The level monitor is deactivated.

Remote-control command:  
SENSe6:FUNCTION OFF

**RMS** A broadband RMS measurement is performed which – with the frequency measurement switched on – uses automatic period detection. (The measurement method in this case corresponds to the RMS measurement function in the "Meas Time Auto" mode). With weak signals, measurement is performed over a fixed period of 100 ms. Any superimposed DC components are also measured but (in the analog analyzer) are suppressed by the system hardware if the AC coupling is activated.

---

**Note:**

*In the case of multi-tone signals without dominant components, period detection cannot deliver reliable results; in this case, the RMS result will exhibit slightly larger fluctuations.*

---

Remote-control command:  
SENSe6:FUNCTION LRMS

**DC** A DC voltage measurement with automatic AC suppression is performed. With weak signals, measurement is performed over a fixed period of 100 ms. In the analog analyzer, DC coupling should be selected for this measurement mode because the DC component of the measurement signal is filtered out with AC coupling. A suitable warning will be displayed if the coupling is switched to AC with DC measurement enabled or if the mode is switched to DC measurement with AC coupling selected; however, the measurement will be performed.

---

**Note:**

*In the case of multi-tone signals without dominant components, AC period detection cannot deliver reliable results; in this case, the DC result will exhibit slightly larger fluctuations.*

---

Remote-control command:  
SENSe6:FUNCTION DC

**Peak** A measurement of the input peak value is performed. The input sample with the highest magnitude is determined within a predefined time interval. This time interval is obtained from the period length of the measurement signal. A fixed time of 100 ms is required in order to measure weak signals.

---

**Note:**

*In contrast to the peak measurement, which, like all measurement functions, is performed after the filters, no interpolation filter (oversampling filter) is required.*

---

Remote-control command:  
SENSe6:FUNCTION PEAK

See section "Level Measurements" on page 4.241 and section "Input Monitor" on page 4.397 for further level measurement options.

---

**Note:**

*The level monitor uses period detection and measures the input signal – beginning in the zero crossing – over one complete period, but with at least 100 samples. For function measurements with an extremely short measurement time (e.g. peak measurement 1 ms interval), the level monitor should therefore be deactivated.*

---

# Settling Methods

## Applications

Each signal that is output by the R&S UPV generator passes through several delay elements until – after being applied to the DUT – it returns to the R&S UPV analyzer, where it is measured. The delay times must be taken into account in order to prevent a new measurement being started – after a signal change – before the new signal becomes visible on the analyzer. The total measurement time, therefore, is made up of the actual measurement time and the delay time.

The internal delays of the R&S UPV are known and taken into account automatically upon starting a measurement. The R&S UPV delays are in the range of a few milliseconds, depending on the sampling rate. What may actually cause problems are delays and settling times that occur in the DUT and, possibly, also on the transmission lines from the generator to the DUT and from the DUT to the analyzer.

If these delays and settling times are **known** and **constant** for all signal changes that may occur, the total delay can be entered as "Delay" under "Start Condition", and will then be treated as a waiting time prior to the start of the measurement – same as the internal delays of the R&S UPV.

If external delays and settling times are **known but not constant**, the worst-case value can be entered as the total delay. In the case of most measurements, however, this will unduly extend total measurement time, especially where the actual measurement time is significantly shorter than the waiting time. Conditions are particularly difficult if external waiting or settling times are **unknown** or if an external signal source is used.

For the latter two cases it is advantageous to determine – by way of measurement – the time at which the DUT has settled and start the measurement only then.

The purpose of the settling method described here is to determine the settling time by means of a measurement. The basic idea is to perform as many measurements as possible while settling is still in progress and to determine the time at which the signal has settled to an extent that the measured value can be regarded as stable. This time is determined based on the – continuously decreasing – difference between successive measured values.

The settling method is particularly reliable when combined with a trigger condition, as with an external sweep or an external level trigger. In such cases, the trigger condition will not be fulfilled until a *signal change* is detected of the measured parameter and the *new signal* has stabilized over several measurements.

If no such trigger condition is active (e.g. with manually started single measurements), it may happen – in the case of very long delays or very short measurement times – that the desired number of measurements has been completed *before* the signal change (new signal) becomes visible on the analyzer. With manually started single measurements, therefore, the external signal delay should be entered as exactly as possible as "Delay" under "Start Condition", while the settling method is activated as well.

- The external signal delay is entered as a fixed delay under "Start Condition".
- The settling time is dynamically measured with the settling method.

The following types of settling can be activated and also combined with one another as desired (i.e. several types of settling can be used simultaneously):

- Settling in the "Start Condition" menu, i.e. with an external level or frequency sweep or with an external level trigger. An additional delay is not required.

- Function settling in the case of distortion measurements and (most) level measurements; in multichannel analyzers, only "Averaging" can be selected. As the measurement time becomes shorter relative to the signal delay, it becomes more important to compensate for the signal delay.
- Frequency Settling (not for multichannel analyzers)
- Phase Settling (not for multichannel analyzers)

## Settling Algorithms

The R&S UPV offers two different settling algorithms. As a feature common to both algorithms, each current measured value is compared to up to five of the immediately preceding measured values and will be accepted as valid only if the differences between the current value and the preceding values are within specified tolerances.

In addition, an averaging function is available in order to reduce measured-value variations.

**Flat Settling** employs a tolerance mask with a completely flat characteristic (tolerance **band**). The "capture range" of this mask is determined by fixed tolerance limits. In the case of very small tolerance values, this algorithm supplies a result only if the DUT has almost completely settled.

**Exponential Settling** uses a tolerance mask with an exponential characteristic (tolerance **funnel**, whose "capture range" enlarges toward the earlier measured values, i.e. larger deviations are tolerated for the earlier values. This algorithm is suitable for level and distortion measurements, where most DUTs likewise exhibit an exponential settling characteristic.

### Tolerance characteristic

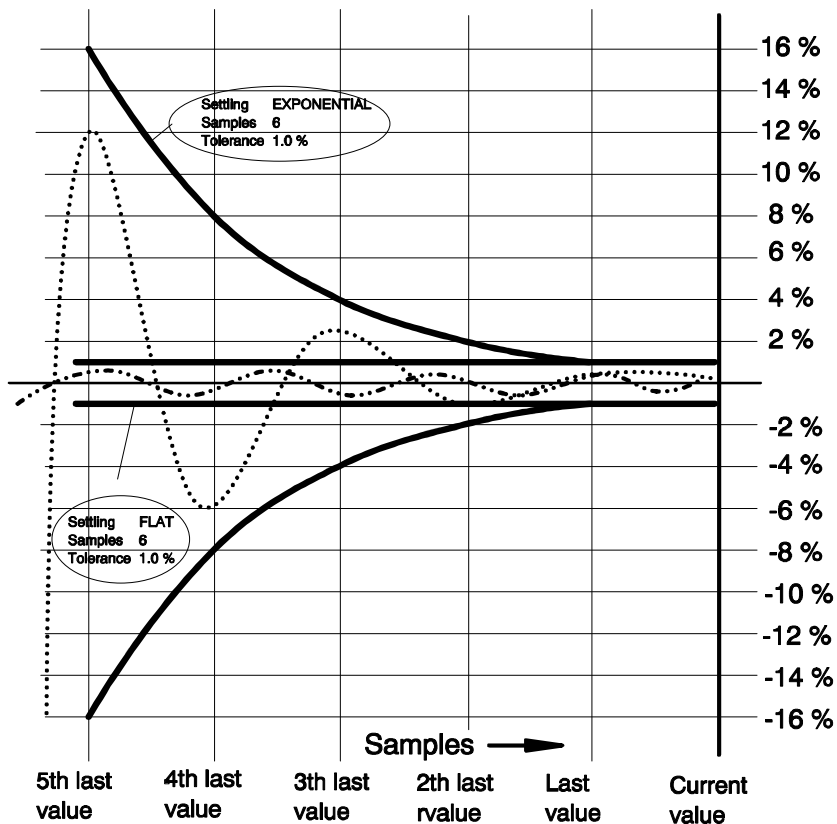

## Settling for Measurement Functions

### Funct Settling

Used to activate the settling measurement for results of measurement functions and to select the settling method; for multichannel analyzers, only "Averaging" is available.

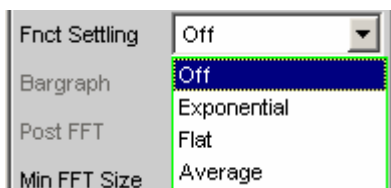

Results of measurement functions are valid only if the selected settling condition is fulfilled.

With the S/N measurement function and with level measurement functions in the S/N mode, the instrument determines the settling times separately for the useful signal plus noise and for the noise signal only. This yields two level values, of which the signal-to-noise quotient is formed.

*Function Settling* is available for most level measurement functions (except rub & buzz) and for distortion measurements.

The following applies to settling measurements, irrespective of the selected unit:

- With level measurements, the settling measurement is based on the results in volts (analog) or FS (digital).
- With distortion measurements, the settling measurement is based on the results in %.

---

#### **Note:**

*For the FFT measurement function, averaging of FFT data is available instead of a settling measurement, which is possible for measured values only (see section "Avg Mode" on page 4.327).*

---

#### **Off**

*Function Settling* is switched off. The measurement time is very short, since only a single measurement is performed.

This setting is recommended if the DUT settling time

- can be ignored.
- is known and taken into account by entering a fixed delay.

Remote-control command:  
SENSe:FUNCTION:SETTling:MODE OFF

**Exponential**     *Function Settling* is switched on and the *exponential method* is employed; this function is *not* available for multichannel analyzers. Several measurements have to be performed. The measurement time is, therefore, considerably longer than with *Function Settling* switched off.

This setting is recommended if the DUT settling time cannot be taken into account by entering a fixed delay because

- it is not known.
- it is not constant.

```
Remote-control command:  
SENSe:FUNction:SETTling:MODE  
EXPonential
```

**Flat**     *Function Settling* is switched on and the *flat method* is employed; this function is *not* available for multichannel analyzers. All measurement samples should fall within a tolerance band of uniform width. This method, therefore, usually requires a higher number of measurements than the *exponential method*, which allows for greater tolerance.

This setting is recommended if it must be ensured that the results of several successive measurements have settled.

```
Remote-control command:  
SENSe:FUNction:SETTling:MODE FLAT
```

**Average**     The arithmetic average of a selectable number of successive results (obtained with a measurement function) is formed.

This setting is recommended in order to compensate for measured-value variations. Where possible, the DUT settling time should additionally be taken into account by entering a corresponding delay under "Start Condition".

```
Remote-control command:  
SENSe:FUNction:SETTling:MODE AVERAge
```

**Samples**

Designates the number of measured values to be covered by the settling algorithm, i.e. it defines how many measured values are to be used in the settling measurement or for averaging.

 A screenshot of a control panel with a label 'Samples' on the left and a numeric input field on the right. The input field contains the number '3' and is highlighted with a green border.
**Note:**

*In this exceptional case, the term "sample" is used to designate an internal measurement result instead of a digital sample.*

Remote-control command:  
`SENSe:FUNction:SETTling:COUNT <n>`

**Tolerance**

The tolerance value designates the maximum permissible value by which the current measured value may differ from the preceding measured values so that it will be accepted as having settled.

 A screenshot of a control panel with a label 'Tolerance' on the left and a numeric input field on the right. The input field contains the value '0.10000' followed by a '%' symbol and is highlighted with a green border.

With *exponential settling*, the selected tolerance value applies only to the difference between the current and the last preceding measured value; for each earlier measured value, the tolerance value will increase by a factor of 2.

Remote-control command:  
`SENSe:FUNction:SETTling:TOLerance <nu>`

**Resolution**

The resolution value designates the maximum permissible *absolute* value by which the current measured value may differ from the preceding measured values in order to be accepted as having settled, *although the tolerance condition may have been violated*. This means that a measured value will be regarded as not having settled only if it fails to meet both the tolerance and the resolution condition.

 A screenshot of a control panel with a label 'Resolution' on the left and a numeric input field on the right. The input field contains the value '0.00100' followed by a 'V' symbol and is highlighted with a green border.

With *exponential settling*, the selected resolution value applies only to the difference between the current and the last preceding measured value; for each earlier measured value, the resolution value will increase by a factor of 2.

Remote-control command:  
`SENSe:FUNction:SETTling:RESolution <nu>`



**Timeout**

Defines the maximum time that a settling algorithm is allowed to detect a settled result after the start of a measurement.



If no stable measurement value is detected during this time, the measurement is aborted. An invalid result is output in the numeric and the sweep display and also via the remote line.

Defining a timeout is important especially with the "true" settling methods, because with these methods a settled value may never be detected if tolerance limits are too narrow. If averaging is employed, on the other hand, the number of measurements and thus the measurement time are finite, and the timeout may be deactivated, as it were, by entering the maximum value of 2000 s.

**Note:**

*If a multichannel analyzer is used, max. 1.44 million samples can be observed. In these analyzers, the maximum timeout is therefore dependent on the sampling rate and the analog bandwidth; at 40 kHz analog bandwidth, for example, it is 15 s.*

Remote-control command:  
 SENSE:FUNCTION:SETTLing:TOUT <nu>

## Settling for Frequency Measurements

**Freq Settling**

Used to activate the settling function for frequency measurements and to select the settling method (not for multichannel analyzers).

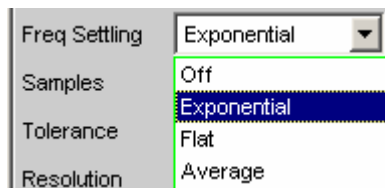

Results of frequency measurements are valid only if the selected settling condition is fulfilled.

The settling measurement is always based on Hz irrespective of the selected unit.

**Note:**

*The settling function is not performed for the sampling rate (digital analyzers). Even if "Sample Freq" is selected as the frequency measurement, the settling function is performed for the signal frequency.*

<b>Off</b>	<p><i>Frequency Settling</i> is switched off. There will be no extension of the overall measurement time due to the settling procedure, since only a single measurement will be performed.</p> <p>This setting is recommended if the signal delay in the DUT</p> <ul style="list-style-type: none"> <li>• can be ignored.</li> <li>• is known and taken into account by entering a fixed delay.</li> </ul> <p>Remote-control command: SENSE:FREQUENCY:SETTLING:MODE OFF</p>
<b>Exponential</b>	<p>Frequency Settling is switched on and the exponential method is employed. This method requires several measurements to be performed. The overall measurement time is, therefore, longer than with the settling function switched off.</p> <p>Frequency settling of a DUT does however not follow an exponential characteristic. In the event of a frequency change, only one invalid intermediate value will maximally be obtained in most cases. The exponential method is, therefore, usually not in line with practical requirements. It is more advisable to use the flat algorithm and a reduced number of samples.</p> <p>Remote-control command: SENSE:FREQUENCY:SETTLING:MODE EXPONENTIAL</p>
<b>Flat</b>	<p><i>Frequency Settling</i> is switched on and the <i>flat method</i> is employed.</p> <p>This setting is recommended if it must be ensured that the results of several successive measurements have settled.</p> <p>Remote-control command: SENSE:FREQUENCY:SETTLING:MODE FLAT</p>
<b>Average</b>	<p>The arithmetic average of a selectable number of successive frequency results is formed.</p> <p>This setting is recommended in order to compensate for measured-value variations. Where possible, the DUT signal delay should additionally be taken into account by entering a corresponding delay under "Start Condition".</p> <p>Remote-control command: SENSE:FREQUENCY:SETTLING:MODE AVERAGE</p>

**Samples**

Designates the number of measured values to be covered by the settling algorithm, i.e. it defines how many measured frequency values are to be used in the settling measurement or for averaging.

**Note:**

*In this exceptional case, the term "sample" is used to designate an internal measurement result instead of a digital sample.*

Remote-control command:  
SENSe:FREQuency:SETTling:COUNT <n>

**Tolerance**

The tolerance value designates the maximum permissible value by which the current measured value may differ from the preceding measured values so that it will be accepted as having settled.

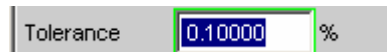

With *exponential settling*, the selected tolerance value applies only to the difference between the current and the last preceding measured value; for each earlier measured value, the tolerance value will increase by a factor of 2.

Remote-control command:  
SENSe:FREQuency:SETTling:TOLerance <nu>

**Resolution**

The resolution value designates the maximum permissible *absolute* value by which the current measured value may differ from the preceding measured values in order to be accepted as having settled, *although the tolerance condition may have been violated*. This means that a measured value will be regarded as not having settled only if it fails to meet both the tolerance and the resolution condition.

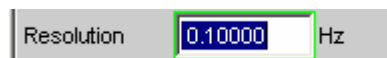

With *exponential settling*, the selected resolution value applies only to the difference between the current and the last preceding measured value; for each earlier measured value, the resolution value will increase by a factor of 2.

Remote-control command:  
SENSe:FREQuency:SETTling:RESolution <nu>

**Timeout**

Defines the maximum time that a settling algorithm is allowed to detect a settled result after the start of a measurement.



If no stable measurement value is detected during this time, the measurement is aborted. An invalid result is output in the numeric and the sweep display and also via the remote line.

Defining a timeout is important especially with the "true" settling methods, because with these methods a settled value may never be detected if tolerance limits are too narrow. If averaging is employed, on the other hand, the number of measurements and thus the measurement time are finite and the timeout may be deactivated, as it were, by entering the maximum value of 2000 s.

Remote-control command:  
 SENSE:FREQuency:SETTling:TOUT <nu>

## Settling for Phase Measurements

**Phase Settling**

Used to activate the settling function for phase measurements and to select the settling method (not for multichannel analyzers).

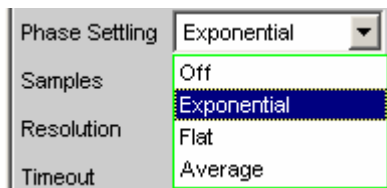

Results of phase measurements are valid only if the selected settling condition is fulfilled.

The settling measurement is always based on ° irrespective of the selected unit.

**Off**

*Phase Settling* is switched off. There will be no extension of the overall measurement time due to the settling procedure, since only a single measurement will be performed.

This setting is recommended if the signal delay in the DUT

- can be ignored.
- is known and taken into account by entering a fixed delay.

Remote-control command:  
 SENSE:PHASe:SETTling:MODE OFF

**Exponential** *Phase Settling* is switched on and the *exponential method* is employed. This method requires several measurements to be performed. The overall measurement time is, therefore, longer than with the settling function switched off.

Phase settling of a DUT does however not follow an exponential characteristic. In the event of a phase change, only one invalid intermediate value will maximally be obtained in most cases. The exponential method is, therefore, usually not in line with practical requirements. It is more advisable to use the flat algorithm and a reduced number of samples.

Remote-control command:  
SENSe:PHASe:SETTling:MODE EXPonential

**Flat** *Phase Settling* is switched on and the *flat method* is employed.

This setting is recommended if it is to be ensured that the results of several successive measurements have settled.

Remote-control command:  
SENSe:PHASe:SETTling:MODE FLAT

**Average** The arithmetic average of a selectable number of successive phase results is formed.

This setting is recommended in order to compensate for measured-value variations. Where possible, the DUT signal delay should additionally be taken into account by entering a corresponding delay under "Start Condition".

Remote-control command:  
SENSe:PHASe:SETTling:MODE AVERAge

## Samples

Designates the number of measured values to be covered by the settling algorithm, i.e. it defines how many measured phase values are to be used in the settling measurement or for averaging.



### Note:

*In this exceptional case, the term "sample" is used to designate an internal measurement result instead of a digital sample.*

Remote-control command:  
SENSe:PHASe:SETTling:COUNT <n>

**Resolution**

The resolution value designates the maximum permissible *absolute* value by which the current measured value may differ from the preceding measured values so that it will be accepted as having settled.

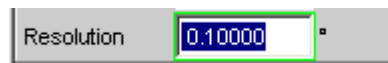

For phase measurements, specifying the resolution value is meaningful only. This is the absolute value by which the current measured phase value may differ – in ° – from the preceding measured phase values. Specifying a tolerance value for phase results would not be meaningful, since minimal phase variations in the order of around 0 ° would result in major relative tolerance variations, which would mean a constant violation of the tolerance condition.

With *exponential settling*, the selected resolution value applies only to the difference between the current and the last preceding measured value; for each earlier measured value, the resolution value will increase by a factor of 2.

Remote-control command:  
 SENSE:PHASe:SETTling:RESolution <nu>

**Timeout**

Defines the maximum time that a settling algorithm is allowed to detect a settled result after the start of a measurement.



If no stable measurement value is detected during this time, the measurement is aborted. An invalid result is output in the numeric and the sweep display and also via the remote line.

Defining a timeout is important especially with the "true" settling methods, because with these methods a settled value may never be detected if tolerance limits are too narrow. If averaging is employed, on the other hand, the number of measurements and thus the measurement time are finite and the timeout may be deactivated, as it were, by entering the maximum value of 2000 s.

Remote-control command:  
 SENSE:PHASe:SETTling:TOUT <nu>

## Settling for Start Conditions (Event-Triggered Measurements)

The settling procedure can also be applied to all event-triggered measurements – i.e. measurements that are measured-value-triggered rather than time-triggered.

With external sweeps, the value of a measured parameter never changes simultaneously with the start of the frequency or level measurement that monitors the measured parameter for changes. In the event of a value change, therefore, the monitoring routine usually does not measure the new frequency or level value but an intermediate value, i.e. a value between the old and the new value. If the trigger threshold (variation) is smaller than the actual value change, it may happen that even the measured *intermediate value* triggers the next measurement in a sweep. This does not produce an errored result (Y value of the sweep display) since the next measurement is *not started until* the value change is detected. However, the sweep parameter (X value of the sweep display) that triggers the next measurement is too close to the preceding X value.

To ensure that the X values of an external sweep are also measured with great accuracy, the settling procedure should be applied to external sweeps as well.

With some DUTs, it takes a long time until the level has settled upon a frequency change (e.g. hearing aids with a sound level limiter or compander/expander circuits with short level rise times and long decay times). With such DUTs, it will not be sufficient to apply the settling procedure to the trigger routine only. Rather should a start delay or *Function Settling* be activated in addition.

---

**Note:**

*Timeout monitoring is not meaningful in settling procedures applied to event triggers (i.e. not time triggers), since it takes an indefinite period of time until the external event triggering a measurement occurs, and an early abortion of the monitoring routine would be of no avail.*

*If a multichannel analyzer is used, max. 1.44 million samples can be observed. In these analyzers, the maximum measuring time for detecting (and settling to) the external trigger condition is therefore dependent on the sampling rate and the analog bandwidth; at 40 kHz analog bandwidth, for example, it is 15 s.*

---

**Settling**

Used to activate the settling measurement for the frequency/level monitoring routine in the case of external sweeps and external level/edge triggering, and to select the settling method.

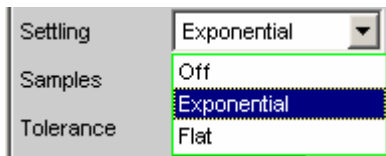

Results of trigger signal measurements are valid only if the selected settling condition is fulfilled.

The following applies to settling measurements, irrespective of the selected unit:

- With external level sweeps and external level/edge triggering, the settling measurement is based on the results of the trigger signal measurement in volts (analog) or FS (digital).
- With external frequency sweeps, the settling measurement is based on the results of the trigger signal measurement in Hz.

**Note:**

*Averaging the results of trigger signal measurements would not provide conclusive information and has therefore not been implemented.*

**Off**

The frequency/level monitoring routine is performed without the settling function. This setting offers the shortest possible response time to a detected signal change. It is not sure, however, whether the nominal trigger value (X value of the sweep display) is actually attained.

```
Remote-control command:
SENSe:TRIGger:SETTling:MODE OFF
```

**Exponential**

The settling function is switched on for the frequency/level monitoring routine, and the exponential method is employed. Several measurements have to be performed, which extends the response time to a detected signal change.

This setting is recommended for external level sweeps and external level/edge triggering since most DUTs exhibit an exponential level settling characteristic.

```
Remote-control command:
SENSe:TRIGger:SETTling:MODE
EXponential
```



**Flat** The settling function is switched on for the frequency/level monitoring routine, and the flat method is employed. Several measurements have to be performed, which extends the response time to a detected signal change.

This setting is recommended for external frequency sweeps if the actual trigger value (X value of the sweep display) is to be determined very accurately. In the event of a frequency change, the DUT will maximally supply one invalid intermediate frequency value. It is, therefore, sufficient to set the number of samples to a value of "2", so that only two or three measurements of the trigger signal are performed.

Remote-control command:  
SENSe:TRIGger:SETTling:MODE FLAT

### Samples

Designates the number of measured values to be covered by the settling algorithm, i.e. it defines how many measured frequency values are to be used in the settling measurement.



For "n samples" selected, the following number of trigger-value measurements will be performed:

- With frequency triggering and flat settling: n or n+1
- With level triggering and *exponential settling*: > n

---

**Note:**

*In this exceptional case, the term "sample" is used to designate an internal measurement result instead of a digital sample.*

---

Remote-control command:  
SENSe:TRIGger:SETTling:COUNT <n>

### Tolerance

The tolerance value designates the maximum permissible value by which the current trigger value may differ from the preceding trigger values so that it will be accepted as having settled.

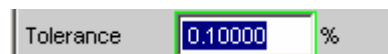

With *exponential settling*, the selected tolerance value applies only to the difference between the current and the last preceding trigger value; for each earlier trigger value, the tolerance value will increase by a factor of 2.

Remote-control command:  
SENSe:TRIGger:SETTling:TOLerance <nu>

**Resolution**

The resolution value designates the maximum permissible *absolute* value by which the current trigger value may differ from the preceding trigger values in order to be accepted as having settled, *although the tolerance condition may have been violated*. This means that a trigger value will be regarded as not having settled only if it fails to meet both the tolerance and the resolution condition.

Resolution  Hz (for external frequency sweeps)

Resolution  FS (for external digital level sweeps)

Resolution  V (for external analog level sweeps)

With *exponential settling*, the selected resolution value applies only to the difference between the current and the last preceding trigger value; for each earlier trigger value, the resolution value will increase by a factor of 2.

Remote-control command:  
SENSe:TRIGger:SETTling:RESolution <nu>

**Examples of Settling**

The examples below are based on the following settings:

Settling	<input type="text" value="Exponential"/>
Samples	<input type="text" value="6"/>
Tolerance	<input type="text" value="1.00000"/> %
Resolution	<input type="text" value="0.00100"/> V

With the above settings, the current measured value may deviate

- from the last measured value by maximally +/- 1 % (or +/- 0.086 dB).
- from the 2nd last measured value by maximally +/- 2 % (or +/- 0.172 dB).
- from the 3rd last measured value by maximally +/- 4 % (or +/- 0.340 dB).
- from the 4th last measured value by maximally +/- 8 % (or +/- 0.668 dB).
- from the 5th last measured value by maximally +/- 16 % (or +/- 1.289 dB).

For an analog level measurement with a result of 1 V this means that

- the last measured value must be between 0.99 V and 1.01 V.
- the 2nd last measured value must be between 0.98 V and 1.02 V.
- the 3rd last measured value must be between 0.96 V and 1.04 V.
- the 4th last measured value must be between 0.92 V and 1.08 V.
- the 5th last measured value must be between 0.84 V and 1.16 V.

For a distortion measurement with a result of 0.01 % this means that

- the last measured value must be between 0.0099 % and 0.0101 %.
- the 2nd last measured value must be between 0.0098 % and 0.0102 %.
- the 3rd last measured value must be between 0.0096 % and 0.0104 %.
- the 4th last measured value must be between 0.0092 % and 0.0108 %.
- the 5th last measured value must be between 0.0084 % and 0.0116 %.

If all of the above conditions are fulfilled, the result will be indicated as having settled.

## Filters

This section describes the setting options for *User-Definable Filters* and the available *Weighting Filters*.

The user-definable filters are configured in the Filter panel. They can then be used in the analyzer as prefilters and function filters and also in the generator.

The weighting filters and the fixed highpass and lowpass filters are not selected in the Filter panel. They are selected together with the user-configurable filters in the selection fields of the analyzer and generator.

The section "Filter Table" provides an overview of the filters which can be set up in the analyzer and generator, together with the remote-control parameters.

## Analyzer Prefilter

A filter which influences all measurement functions can be selected in the Analyzer Config panel. One of the user-definable filters in the Filter panel or a weighting filter can be selected. This means that prefiltering is possible without having to select the required filter for every single measurement function.

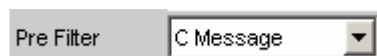

Remote-control command:  
INPut:FILTer CMES

## Analyzer Function Filters

In the Analyzer Function panel, up to 3 of the user-definable filters in the Filter panel or weighting filters can be looped into the measurement path regardless of which level measurement method is selected.

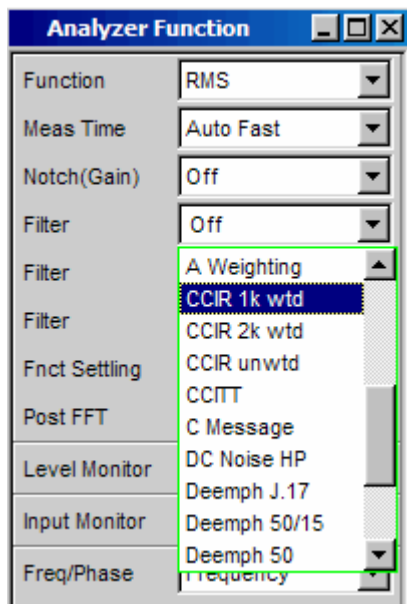

Remote-control command:  
 SENSE[1]:FILTER[1] CCIR  
 SENSE[1]:FILTER2 UFIL5  
 SENSE[1]:FILTER3 OFF

## Generator Filters

Most of the generator signals can be filtered in the time domain. A user-defined filter, a weighting filter, or a high-pass or low-pass filter can be selected in the *Function* panel.

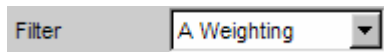

Remote-control command:  
 SOURCE:FILTER AWE

If a filter with gain is used (such as the “CCIR 1k wtd” weighting filter), the generator signal level must be selected as described below in such a way that overranging cannot occur with the maximum filter gain.

### Analog generator:

In the *Generator Config* panel, set “Voltage Range” to “Fix”, and in the *Generator Function* panel set the level low enough to ensure that the amplified level will always be less than the selected fixed voltage range.

Example:

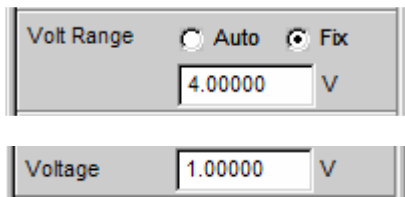

Here the maximum allowable gain of the filter is 4 (12 dB).

**Digital generator:**

Select a level that is low enough to ensure that the level plus the maximum gain of the filter will always be less than the full-scale level.

With both types of generator (analog and digital), any DC offset that has been configured must be taken into account when setting the level.

## Filter Table

Overview of the filters which can be set up in the analyzer and generator, together with the remote-control parameters.

<b>Filter deactivated</b>	<b>Display in selection field</b>	<b>Remote-control parameter</b>
	Off	OFF
<b>User-definable filters</b>	<b>Defined in Filter panel as</b>	<b>Remote-control parameter</b>
	Filter 01	UFIL1
	Filter 02	UFIL2
	Filter 03	UFIL3
	Filter 04	UFIL4
	Filter 05	UFIL5
	Filter 06	UFIL6
	Filter 07	UFIL7
	Filter 08	UFIL8
	Filter 09	UFIL9
<b>Weighting filter</b>	<b>Display in selection field</b>	<b>Remote-control parameter</b>
	A Weighting	AWE
	C Weighting	CWE
	CCIR 1k wtd	CCIR
	CCIR 2k wtd	CARM
	CCIR unwtd	CCIU
	CCITT	CCIT
	C Message	CMES
	DC Noise HP	DCN
	Deemph J.17	DEMP17
	Deemph 50/15	DEMP5015
	Deemph 50	DEMP50
	Deemph 75	DEMP75
	IEC Tuner	IECT
	Jitter wtd	JITT
	Preemph 50/15	PEMP5015
	Preemph 50	PEMP50
	Preemph 75	PEMP75
	Rumble unwtd	URUM
	Rumble wtd	WRUM

Highpass and lowpass	Display in selection field	Remote-control parameter
	HighPass 22 Hz	HP22
	HighPass 400 Hz	HP400
	LowPass 22 kHz	LP22
	LowPass 30 kHz	LP30
	LowPass 80 kHz	LP80
	AES 17	AES17

## User-Definable Filters

In the Filter panel, 9 filters (defined as Filter 01 to Filter 09) can be defined individually as low-pass filters, high-pass filters, bandpass filters, band-stop filters, notch filters, third-octave filters or octave filters.

These filters are implemented as recursive, elliptical eighth-order digital filters (exception: fourth order is also possible for low-pass and high-pass filters). All filters are calculated by means of frequency transformation from a database with standardized reference low-pass filters. The ripple in the passband is 0.1 dB; stopband attenuation is available in steps of approx. 10 dB.

The user only has to enter the passband and the minimum stopband attenuation. The frequencies of the stopband are calculated and displayed taking the required stopband attenuation into consideration. The implemented stopband attenuation is always equal to or greater than the specified value.

Apart from the parameters entered in the Filter panel, the sampling rate must also be known to allow calculation of the filter. The other parameters (stop frequency, delay and the attenuation actually implemented) can therefore only be calculated and displayed after the filter has been activated in the analyzer or generator.

### Filter 0i

Filter 0i

Used to select the filter type for Filter i, where i = 1 to 9.

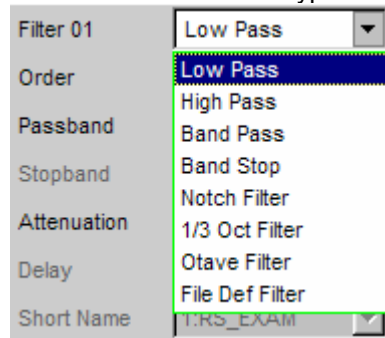

```

Remote-control command:
SENSe[1]:UFILter<i>
LPASs
HPASs
BPASs
BSTOp
NOTCh
TOCTave
OCTave
FILE
    
```

## Low-Pass Filter and High-Pass Filter

### Order

Used to specify the filter order. Only available for low-pass and high-pass filters. Low-order filters have edges with a lower rate of rise, but settle more quickly.

**4** 4<sup>th</sup> order filter.

Remote-control command:  
SENSE:UFILter<i>:ORDER N4

**8** 8<sup>th</sup> order filter.

Remote-control command:  
SENSE:UFILter<i>:ORDER N8

### Passband

Used to specify the cutoff frequency (-0.1 dB) of the passband in the case of low-pass and high-pass filters.

Remote-control command:  
SENSE[1]:UFILter<i>:PASSb <nu>

### Stopband

Displays the cutoff frequency of the stopband in the case of low-pass and high-pass filters; the cutoff frequency is derived from the selected passband and the stopband attenuation. This value is only updated after the filter is activated.

Remote-control command:  
SENSE[1]:UFILter<i>:STOPb?

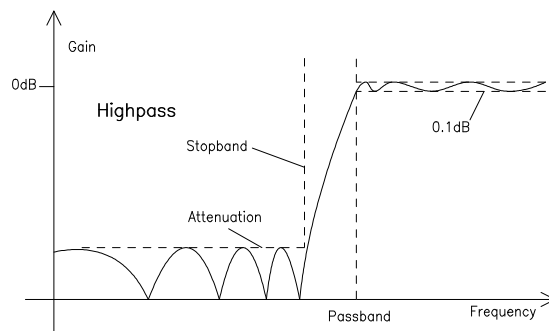
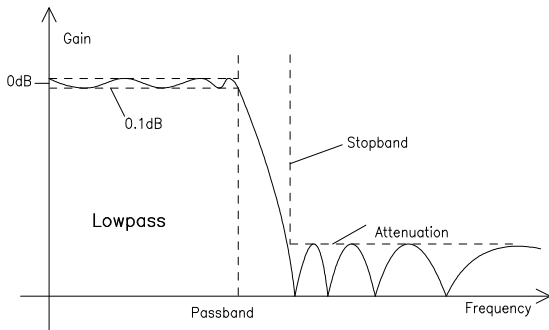

Figure 4-27 Low-pass and high-pass frequency response with filter parameters



## Band-Pass Filters and Band-Stop Filters

### Passb Low

Used to specify the lower cutoff frequency (-0.1 dB) of the passband in the case of bandpass and band-stop filters.

Remote-control command:  
SENSe[1]:UFILter<i>:PASSb:LOWer <nu>

### Passb Upp

Used to specify the upper cutoff frequency (-0.1 dB) of the passband in the case of bandpass and band-stop filters.

Remote-control command:  
SENSe[1]:UFILter<i>:PASSb:UPPer <nu>

### Stopb Low

Displays the lower cutoff frequency of the stopband in the case of bandpass and band-stop filters; the cutoff frequency is derived from the selected passband and the stopband attenuation. This value is only updated after the filter is activated.

Remote-control command:  
SENSe[1]:UFILter<i>:STOPb:LOWer?

### Stopb Upp

Displays the upper cutoff frequency of the stopband in the case of bandpass and band-stop filters; the cutoff frequency is derived from the selected passband and the stopband attenuation. This value is only updated after the filter is activated.

Remote-control command:  
SENSe[1]:UFILter<i>:STOPb:UPPer?

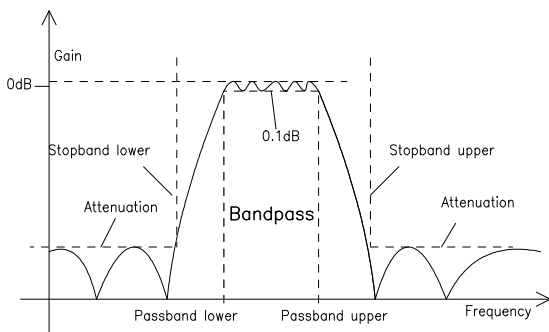

Figure 4-28 Band-pass frequency response with filter parameters

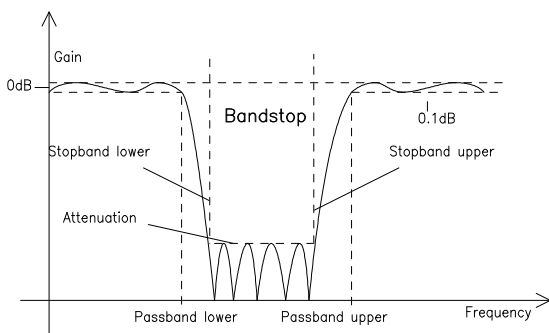

Figure 4-29 Band-stop frequency response with filter parameters

## Notch Filter, Third-Octave Filter and Octave Filter

### Center Freq

Used to specify the center frequency. The notch filter has a transmission zero at the center frequency; the attenuation at this frequency is considerably greater than the specified stopband attenuation.

Remote-control command:  
SENSe[1]:UFILter<i>:CENTer <nu>

### Width

For notch filter: used to *specify* the difference between the upper and lower cutoff frequency (-0.1 dB) of the passband.

Remote-control command:  
SENSe[1]:UFILter<i>:WIDTh <nu>

For third-octave and octave filter: *displays* the width of the passband.

Remote-control command:  
SENSe[1]:UFILter<i>:WIDTh?

### Stopb Low

Displays the lower cutoff frequency of the stopband; the cutoff frequency is derived from the selected passband and the stopband attenuation (only for the notch filter). This value is only updated after the filter is activated.

Remote-control command:  
SENSe[1]:UFILter<i>:STOPb:LOWer?

### Stopb Upp

Displays the upper cutoff frequency of the stopband; the cutoff frequency is derived from the selected passband and the stopband attenuation (only for the notch filter). This value is only updated after the filter is activated.

Remote-control command:  
SENSe[1]:UFILter<i>:STOPb:UPPer?

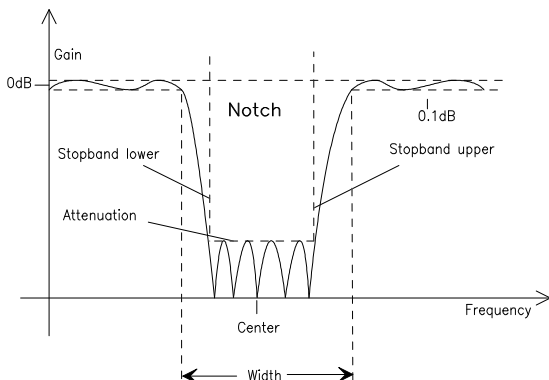

Figure 4-30 Notch-filter frequency response with filter parameters

Third-octave and octave filters are bandpass filters whose passband is geometrically symmetrical to the center frequency, whereby the passband frequencies are derived from the center frequency as follows:

Third-octave filter: Passband low = CenterFreq /  $\sqrt[3]{2}$

Passband upp = CenterFreq ·  $\sqrt[3]{2}$

Bandwidth =  $\sqrt[3]{2} - \frac{1}{\sqrt[3]{2}} = 0.2315 = 23.15\%$

Oktave filter: Passband low = CenterFreq /  $\sqrt{2}$

Passband upp = CenterFreq ·  $\sqrt{2}$

Bandwidth =  $\sqrt{2} - \frac{1}{\sqrt{2}} = \frac{1}{\sqrt{2}} = 0.7071 = 70,71\%$

---

**Note:**

With the third-octave and octave filters, the 0.1 dB bandwidth is reduced until an attenuation of approx. 3 dB is obtained for the cutoff frequencies. The displayed numeric value for "Width" is therefore less than the 3 dB bandwidth of the third-octave and octave filter.

---

## File-Defined Filter

If the filters installed on the instrument do not satisfy the requirements of the application concerned, it is possible to read in a filter from a file. Two file formats are supported in which the filter is described either by means of the coefficients of the transmission function (\*.coe) or using the poles and zeros (\*.zpz or \*.npz and \*.xpz) on the Z level.

### File Def Filter

The screenshot shows a dialog box titled 'File Def Filter'. It contains the following fields:

- Filter 01: File Def Filter (dropdown menu)
- Filename: C:\UPV\Conf (text field with a browse button '...')
- Delay: 41.6667 (text field) µs (unit)
- Short Name: 1:RS\_EXAM (dropdown menu)

A file can be loaded in which the filter is described either by means of the coefficients of the transmission function (\*.coe) or using the poles and zeros (\*.zpz or \*.npz and \*.xpz) on the Z level.

The  button opens a browser which can be used to select the filter file.

Remote-control command:  
SENSe[1]:UFILter<i>:FNAME 'filename'

### Coefficients of the transmission function

The filter in the file must be an IIR filter with four pairs of poles and zeros in the form of four consecutive biquads.

The transmission function  $S(z)$  is then derived as follows:

$$S(z) = \text{gain} * \frac{\prod_{i=0}^3 (z^2 + z \cdot b1i + b2i)}{\prod_{i=0}^3 (z^2 - z \cdot a1i - a2i)}$$

**Example:** See the file RS\_EXAM.COE in the directory D:\UPV\USER

---

#### Note:

*The coefficient file \*.COE is only valid for the sampling rate determined during the design stage, i.e. the frequency response of the filter is standardized to this sampling rate. If a different sampling rate is set in the R&S UPV, the frequency response changes accordingly.*

---

### Poles and zeros of the transmission function

The filter is defined by specifying the poles and zeros on the Z level. Four pairs of poles and zeros are permitted. Unused poles and zeros must be placed at the origin of the Z level.

The transmission function  $S(z)$  is then derived as follows:

$$S(z) = \text{gain} * \frac{\prod_{i=0}^3 (z - z_{0i})(z - z_{0i}^*)}{\prod_{i=0}^3 (z - z_{pi})(z - z_{pi}^*)}$$

where:  $z_0$  = zeros,  $z_p$  = poles,  $z^*$  = conjugate complex number.

#### File format \*.zpz

**Example:** See the file RS\_EXAM.ZPZ in the directory D:\UPV\USER

---

#### Note:

*The pole/zero file \*.ZPZ is only valid for the sampling rate determined during the design stage, i.e. the frequency response of the filter is standardized to this sampling rate. If a different sampling rate is set in the R&S UPV, the frequency response changes accordingly.*

---

#### File format \*.npz

**Example:** See the file RS\_EXAM.NPZ in the directory D:\UPV\USER

**Note:**

Poles and zeros in the \*.NPZ file are standardized to the sampling frequency specified there. If a different sampling rate is set in the R&S UPV, poles and zeros are converted to this rate so that the frequency response of the filter remains unchanged. A reference point for the frequency response (defined by the reference frequency and reference gain at this frequency) must be specified in the file.

**File format \*.xpz**

This file format is an extension of the “npz” format. The file can contain multiple parameter sets for the pole and zero locations. For each parameter set, the associated sampling frequency must be specified, along with the sampling frequency range within which the pole and zero locations can be transformed such that the frequency response of the filter remains within the specified tolerance. This file format allows filters with tight tolerances to be used over a wide range of sampling frequencies.

**Note:**

The pole and zero locations in the \*.xpz file are normalized to the sampling frequencies specified for the individual parameter sets. If a different sampling frequency is configured in the R&S UPV, the pole and zero locations in the allowable frequency range are transformed to correspond to the actual sampling frequency so the frequency response of the filter remains unchanged. A reference point for the frequency response, defined in terms of a reference frequency and the reference gain at this frequency, must be specified in the file.

## Parameters Common to All Filters

**Attenuation**

Used to specify the desired filter attenuation of the stopband in dB. When the filter is activated, the attenuation actually implemented must be entered here (this attenuation is normally greater than the entered value). Filter attenuation in steps of approx. 10 dB is possible.

```
Remote-control command:
SENSe[1]:UFILter<i>:ATTenuation <nu>
```

**Delay**

Displays the estimated settling time of the filter. This value is only updated after the filter is activated.

```
Remote-control command:
SENSe[1]:UFILter<i>:DElAY?
```

Exception: With file-defined filters, a settling time is calculated and displayed after the coefficients are read in. This settling time can then be changed manually.

```
Remote-control command:
SENSe[1]:UFILter<i>:DElAY <nu>
```

**Short Name** Displays a short name under which the filter can be called up in the analyzer or generator. The short name consists of the filter type code (2 letters) and the frequency. (LP = low-pass filter, HP = high-pass filter, BP = bandpass filter, BS = band-stop filter, TZ = third-octave filter, OC = octave filter, NO = notch filter).  
The name of the file is shown here in the case of file-defined filters.

## Filter Settling Time

The settling time of the filter can be estimated from the filter parameters. Certain filters (e.g. filters with steep edges and narrowband bandpass filters) have longer settling times.

When measurement is started (e.g. by making new settings, pressing the start key or in the case of a sweep), the R&S UPV waits until this settling time expires for every filter before performing the actual signal integration. If (in exceptional cases) the calculated time is too short, the filters cannot settle properly before the measurement is started. This can result in unstable measurement values.

The following trick can be used to remedy this problem:

If the file-defined filter "DELAY.COE" (in the directory D:\UPV\USER) is selected, a settling time can be entered there which is then added to the settling time of the other filters when measurement is performed. The DELAY.COE filter has no other function.

---

**Note:**

*If a multichannel analyzer is used, the total settling time of all activated analyzer filters is limited to 150 000 samples (at 40 kHz analog bandwidth, this corresponds to a settling time of approx. 1.5 s). If this is not long enough (e.g. if four very steep-edged filters are used), an additional delay may be entered under "Start Condition".*

---

With continuous measurement, the filter settling time is added only with the (re)start of the first measurement. All further measurements in this case are performed without delay.

---

**Note:**

*If a multichannel analyzer is used, the signal is not observed continuously during continuous measurement; the filter settling time is therefore added with each subsequent measurement as well.*

---

# Weighting Filters

In addition to the user-definable filters, the R&S UPV also offers a large number of weighting filters which conform to the relevant standards.

Filter: A Weighting  
 Standards: DIN 45412, DIN 45633  
 IEC 179, IEC 651  
 ANSI S1.4  
 Application: Weighted  
 noise measurement

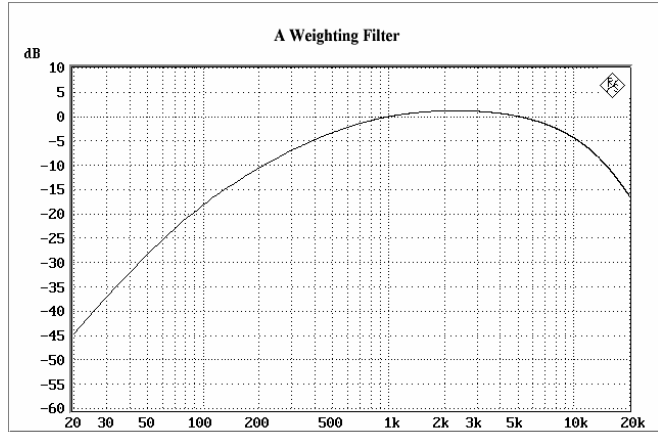

Filter: C Weighting  
 Standards: IEC 179, IEC 651  
 ANSI S1.4  
 Application: Weighted  
 noise measurement

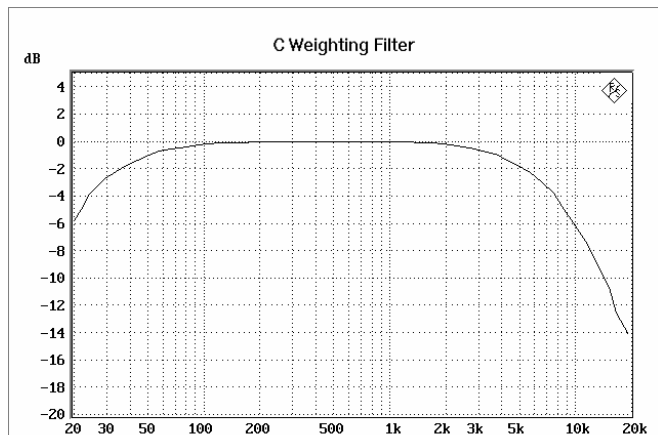

Filter: CCIR 1k wtd  
 Standards: CCIR Rec. 468-4  
 DIN 45405  
 CCITT Rec. N21  
 CISPR 6-76  
 ITU-T J.16  
 Application: Weighted  
 noise measurement

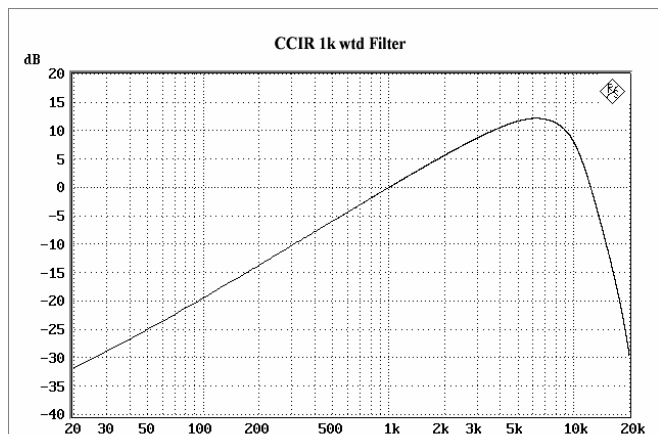

Filter: CCIR 2k wtd  
 Standard: Dolby  
 Application: NAB Standard

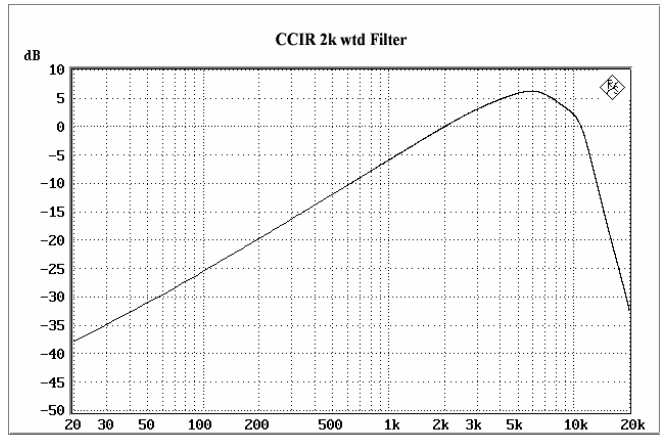

Filter: CCIR unwttd  
 Standards: CCIR Rec. 468-4  
 ITU-T J.16  
 Application: Band-pass filter from 20 Hz to 20 kHz for band-limited unweighted measurement to CCIR

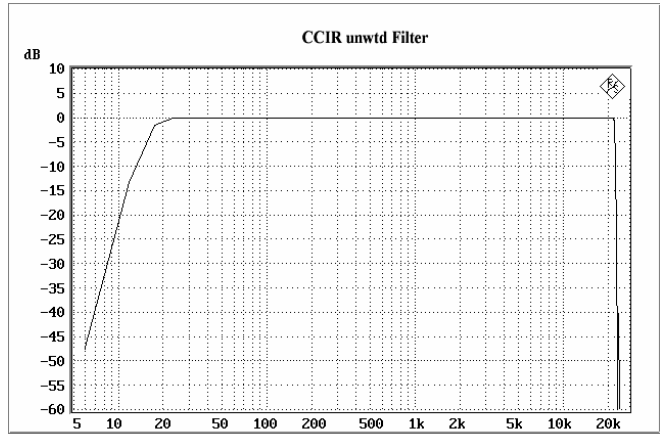

Filter: CCITT  
 Standards: ITU-T Rec. O.41  
 CISPR 6-76  
 ITU-T Rec. P.53  
 Application: Psophometric weighting

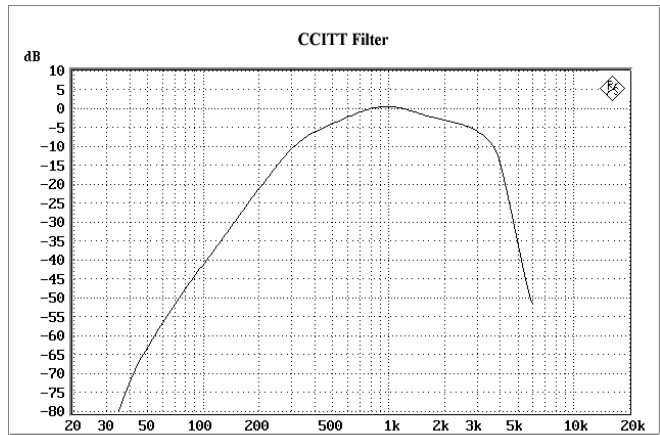



Filter: C Message  
 Standard: IEEE 743-1995  
 Application: Weighted noise measurement

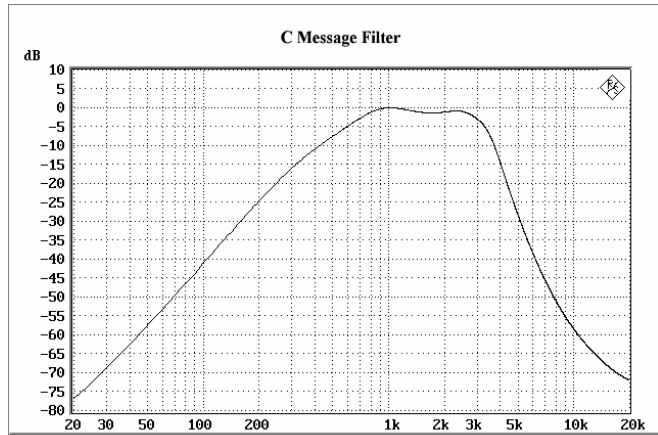

Filter: DC Noise HP  
 Standard: ARD Spec. 3/4  
 ARD Spec. 12/2  
 Application: High-pass filter for measurement of DC noise (tape recorders)

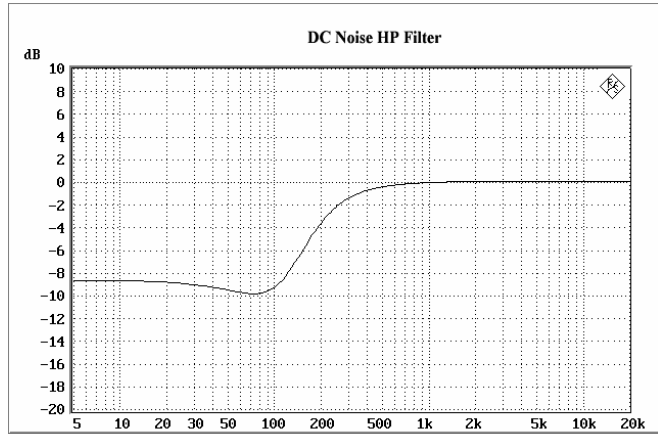

Filter: Deemph J.17  
 Standard: ITU-T J.17  
 Application: Weighted noise measurement

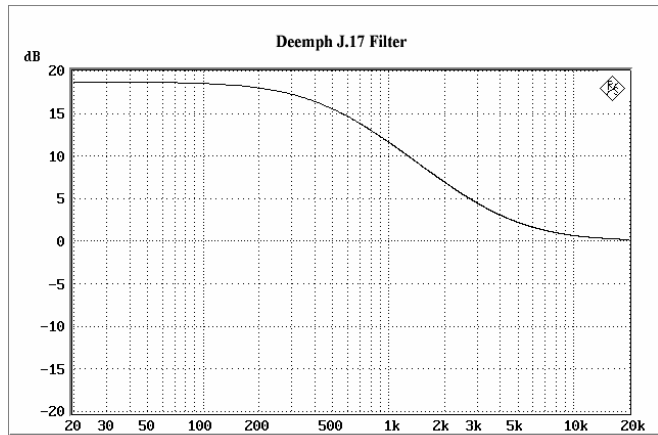

Filter: Deemph 50/15  
Standard: CCIR Rec. 651  
Application: Compact disc

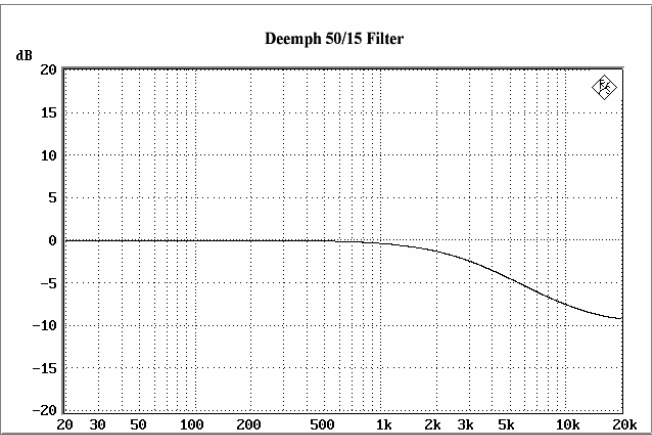

Filter: Deemph 50  
Standard: ARD Spec. 5/3.1  
Application: Weighted noise measurement

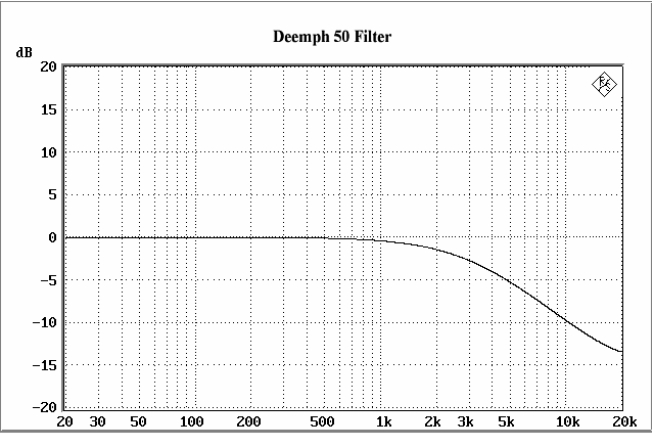

Filter: Deemph 75  
Standard: ARD Spec. 5/3.1  
Application: Weighted noise measurement

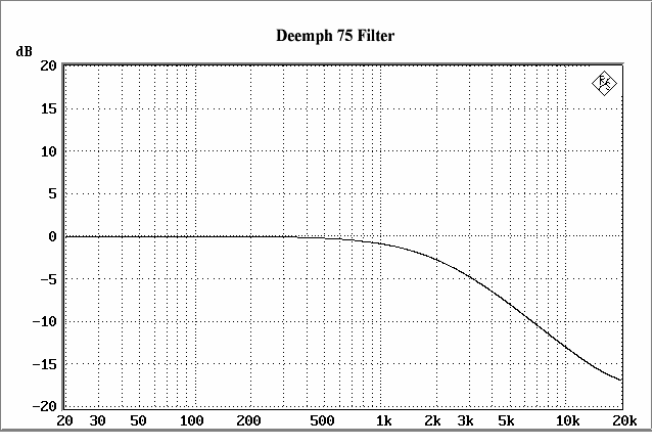

Filter: IEC Tuner  
 Standard: DIN/IEC 60315-4  
 Application: Measurements on FM tuners

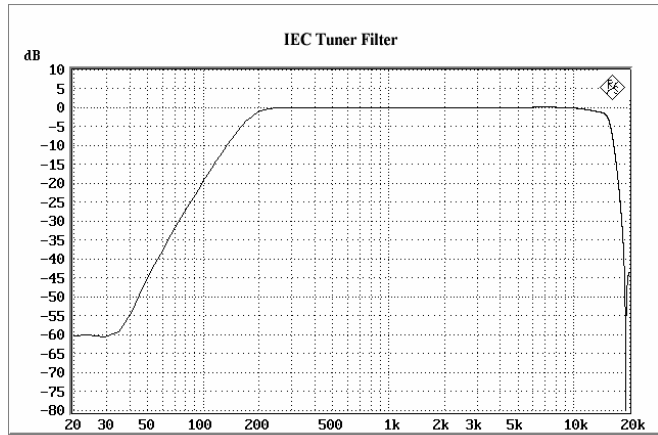

Filter: Jitter wtd  
 Standard: AES 3  
 Application: Weighting of jitter transmission function 1st order HP  
 -3 dB at 700 Hz  
 -20 dB at 70 Hz

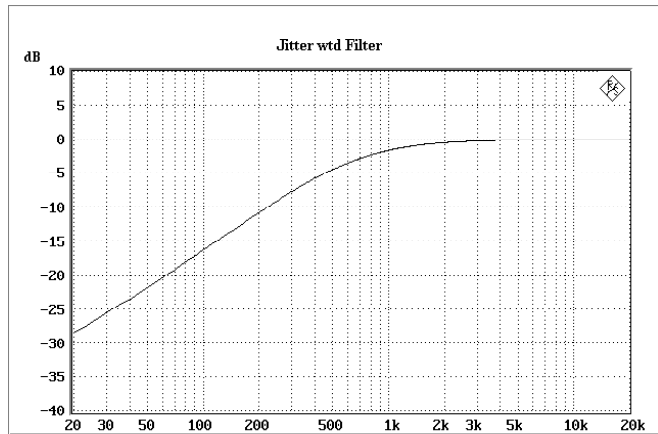

Filter: Preemph 50/15  
 Standard: CCIR Rec. 651  
 Application: Compact Disc

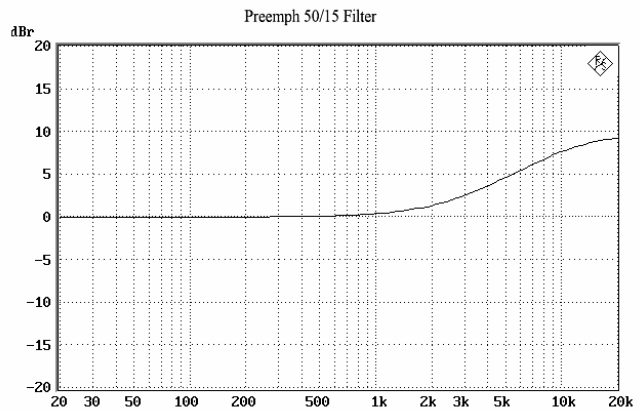

Filter: Preemph 50  
 Standard: ARD Spec. 5/3.1  
 Application: Weighted noise measurement

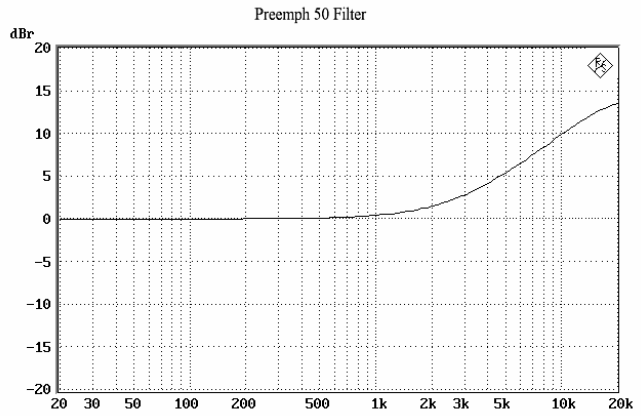

Filter: Preemph 75  
 Standard: ARD Spec. 5/3.1  
 Application: Weighted noise measurement

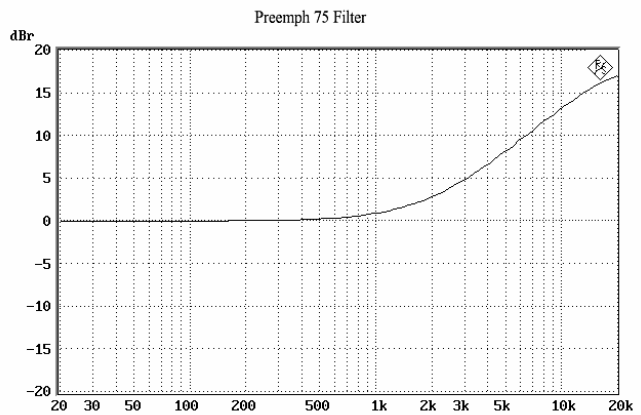

Filter: Rumble unwt'd  
 Standards: DIN 368.3  
 DIN 45539  
 Application: Testing of record players  
 Unweighted noise measurement

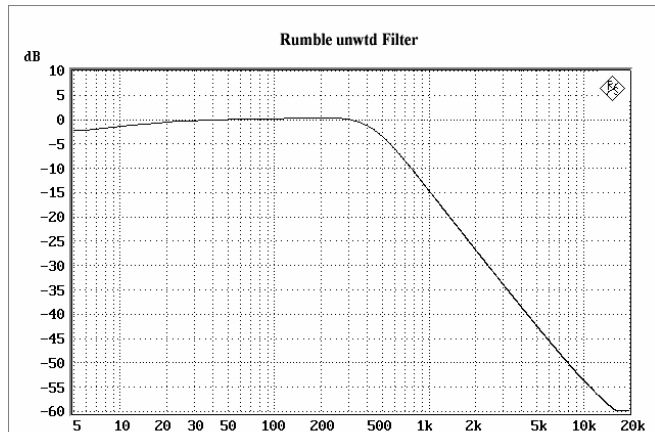

Filter: Rumble wtd  
Standard: DIN 45539  
Application: Testing of record players  
Weighted noise measurement

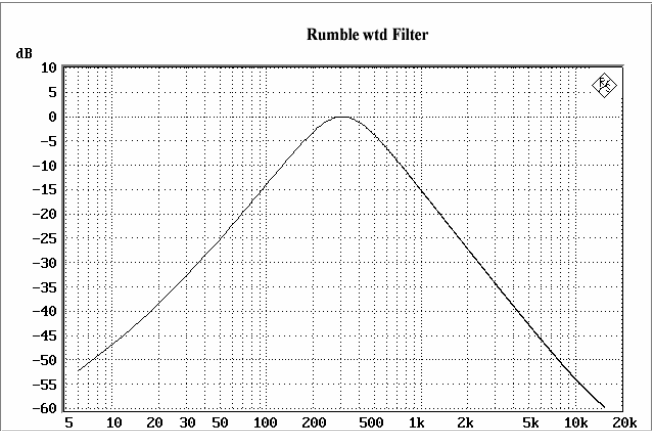

## Highpass and Lowpass Filters

In addition to the user-definable filters and the weighting filters, the R&S UPV also offers a selection of preset highpass and lowpass filters.

<b>HighPass 22 Hz</b>	Highpass (3rd-order Butterworth) with 3 dB cutoff frequency at 22.4 Hz
<b>HighPass 400 Hz</b>	Highpass (3rd-order Butterworth) with 3 dB cutoff frequency at 400 Hz
<b>LowPass 22 kHz</b>	Lowpass (4th-order Butterworth) with 3 dB cutoff frequency at 22.4 kHz
<b>LowPass 30 kHz</b>	Lowpass (3rd-order Butterworth) with 3 dB cutoff frequency at 30 kHz
<b>LowPass 80 kHz</b>	Lowpass (3rd-order Butterworth) with 3 dB cutoff frequency at 80 kHz
<b>AES 17</b>	20 kHz low-pass (8th-order elliptic) in accordance with the AES 17 standard. Passband: maximum ripple $\pm 0.1$ dB below 20 kHz Stopband: attenuation $> 60$ dB above 24 kHz

# Audio Monitoring

## Auxiliaries Panel

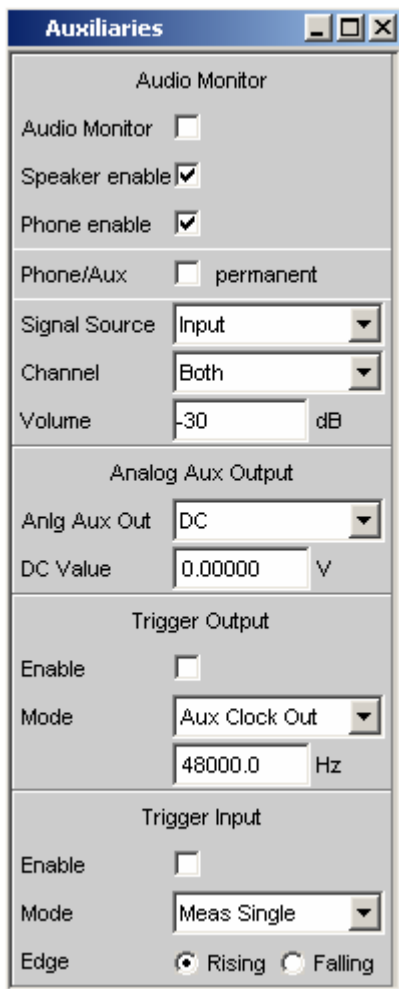

Figure 4-31 Auxiliaries panel

Various functionalities are brought together in the Auxiliaries panel:

### Audio Monitor

The Audio Monitor allows audio monitoring of many different sources inside the R&S UPV. Applied and measured analog signals, external digital signals and also analog input signals which have been converted into digital signals and processed can all be monitored by ear.

### Analog Aux Output

Optionally a DC voltage for powering e.g. hearing aids or channel 1 of the signal being monitored by ear can be output via the Analog Aux Output.

### Trigger Output

Trigger Output delivers a clock signal or a pulse triggered by a measurement, depending on the "Mode" setting.

### Trigger Input

Various measurements can be started or the internal trigger system can be tested via the Trigger Input.

You can monitor a signal by ear at many different points on the signal path with the aid of the "Audio Monitor" control panel in the Auxiliaries panel. The signal to be monitored can be an analog or digital signal, or an externally applied or internally generated signal.

To allow audio monitoring of digital signals, the Audio Monitor output has an audio-monitoring D/A converter which converts the digital signals into analog signals.

The audio monitoring signal is output from a loudspeaker integrated in the R&S UPV, at a 6.3 mm jack socket at the bottom right-hand side of the R&S UPV front panel, or at the BNC socket labelled "Anlg Aux Out" at the rear of the R&S UPV. The maximum output voltage can be up to 5 V, depending on the selected configuration.

---

#### Note:

*Audio monitoring is not possible with sampling rates exceeding 200 kHz nor generally if multichannel analyzers are used.*

---

## WARNING

**Possible Hearing Damage!**

*High sound pressure levels may cause hearing damage:*

*The output voltage of the built-in headphones amplifier is influenced by the incoming signal, by instrument settings such as the selected measurement range and test function, as well as by the set volume. If the volume is set to maximum, the headphones amplifier may generate high output voltages with an RMS value of up to 8 V. Depending on the headphones' sensitivity, this may produce very high sound pressure levels that may cause hearing damage. To monitor varying input signals, therefore, it is advisable to reduce the volume and take off the headphones until the signal has settled.*

**Audio Monitor**

Activates/deactivates the audio monitoring function.



If the tick box is empty, the audio monitoring function is deactivated. If the audio monitoring function is activated, a tick is shown in the tick box. The monitoring signal is then output using the volume or voltage set at "Volume", and in the subsequent parameter fields you can select whether the internal loudspeaker, the headphone jack or both are to be used for playback.

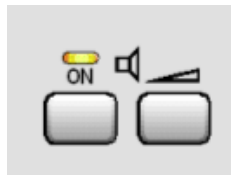

The illustration above shows a section of the R&S UPV front-panel keypad. The internal loudspeaker can be operated directly via these keys. The left-hand key has a toggle function, i.e. the audio monitor is activated/deactivated alternately each time the key is pressed. The ON key on the frontpanel therefore equates to the "Audio Monitor" tick box in the Auxiliaries panel. Pressing the right-hand key opens the window used for setting the volume.

Remote-control command:  
AUXiliaries:AUDMonitor ON | OFF

**Speaker enable**

The internal loudspeaker plays back the signal selected at "Signal Source" with the volume that was set at "Volume", provided the monitoring option has been enabled by ticking the "Audio Monitor" tick box.

If the internal loudspeaker was earlier disabled and is made active by ticking, the Audio Monitor tick box in the field above is also provided with a tick. At the same time the Speaker LED on the front panel begins to shine.

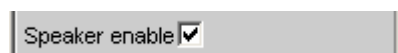

Remote-control command:  
AUXiliaries:SPEaker ON | OFF



**Phone enable**

The signal selected at "Signal Source" is output with the volume that was set at "Volume" on the front phone jack, provided the monitoring option has been enabled by ticking the "Audio Monitor" tick box. If the phone output was earlier disabled and is made active by ticking, the Audio Monitor tick box in the field above is also provided with a tick. At the same time the Speaker LED on the front panel begins to shine.



Remote-control command:  
 AUXiliaries: PHONe ON | OFF

**Phone/Aux permanent**

If the tick box in this field is ticked, Phone Out and Anlg Aux Out are always active. Enabling Audio Monitor via the tick box in the first parameter field of the Auxiliaries panel or the front panel key with the speaker symbol then affects only the internal loudspeaker. The tick box "Phone enable" is ticked in this setting and displayed with a gray background, which means it cannot be altered. If the "OUTPUT OFF" key on the front panel is operated, Phone Out and Anlg Aux Out are also turned off at the same time.

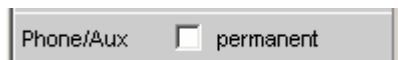

Remote-control command:  
 AUXiliaries:PHPermanent ON | OFF

**Signal Source**

Used to select the audio monitoring point along the signal path.

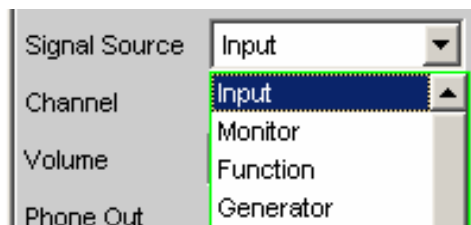

**Input**

Audio monitoring of a signal applied at the analyzer inputs. The input signal of the activated analyzer is automatically switched to the audio monitoring output.

Remote-control command:  
 AUXiliaries:SPEaker:SOURce INPut

**Monitor**

Audio monitoring downstream of the digital prefilter.

Remote-control command:  
 AUXiliaries:SPEaker:SOURce MONitor

**Function** The input signal can undergo digital post-processing (processing type depends on the set measurement function) before it is listened to by the user. So as to avoid overloading in the active filter, level attenuation is carried out in the case of certain weighting filters in order to compensate for the increase in the frequency response. This attenuation is of course taken into account in the measurement value display, but is just noticeable in the level of the monitor output.

---

**Note:**

*If high requirements are placed on the internal processing of measurement values (sample rates of 192 kHz or more while using several filters), the audio monitoring output is muted in this operating mode in order not to slow down the measurement. This deactivation does not corrupt the measurement result. Pressing the START button automatically reactivates the audio monitoring output.*

---

Remote-control command:  
AUXiliaries:SPEaker:SOURce FUNCtion

**Generator** The digital data signal from the DSP for the currently activated generator is fed to the audio monitoring output via the audio monitoring D/A converter. If the analog generator is being monitored, the audio monitoring D/A converter is actuated using the same digital signals as those fed to the main D/A converter of the analog generator. Audio monitoring is **not** possible with the generator functions "DIM" or "Sine" with activated Low Dist. After one of these functions has been switched on, the following message will appear: "Speaker not available for generator function DIM or Low Dist activated!"

Remote-control command:  
AUXiliaries:SPEaker:SOURce GENerator

The block diagram below shows the points along the signal processing path at which the signal is tapped and fed to the audio monitoring output:

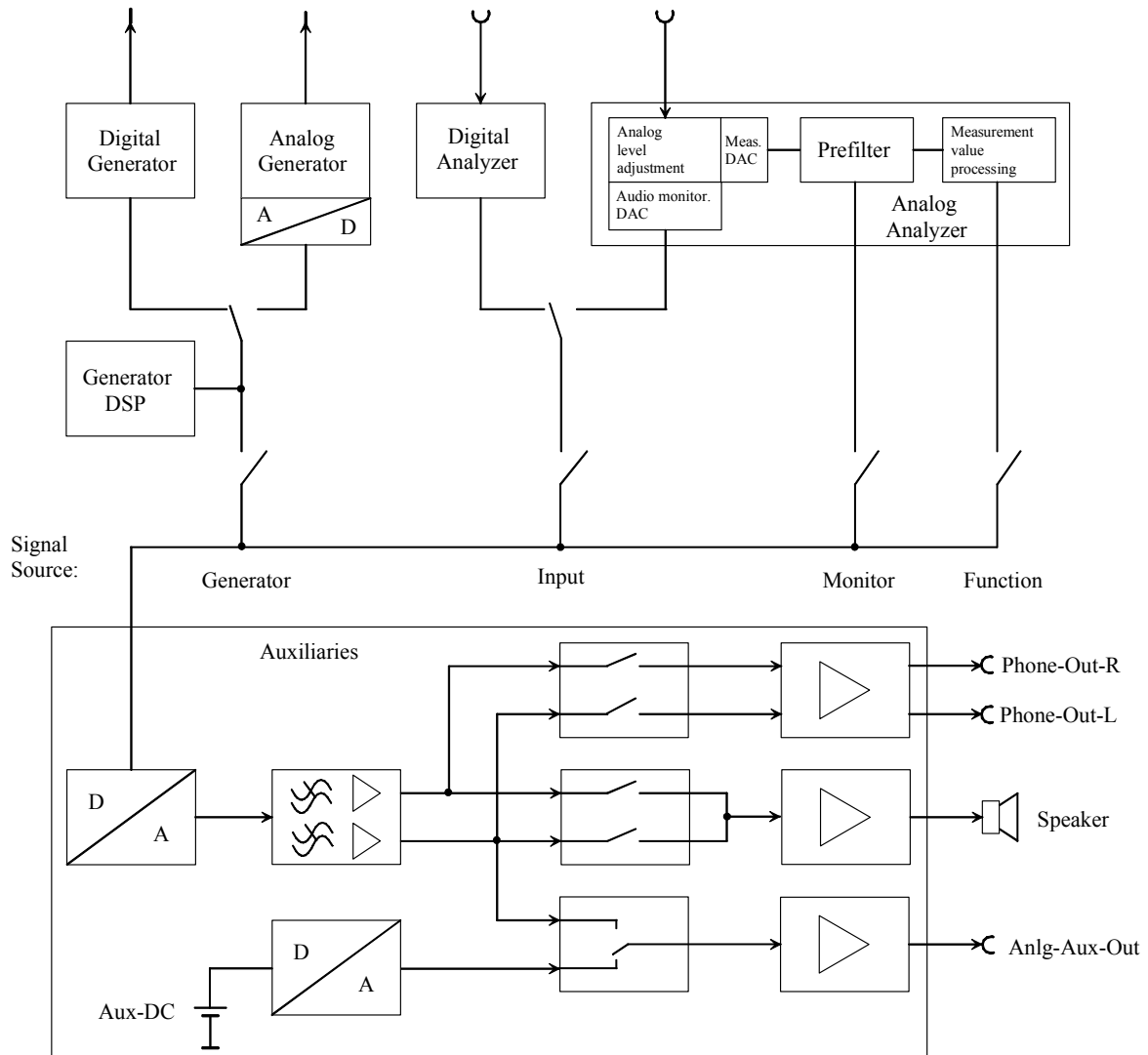
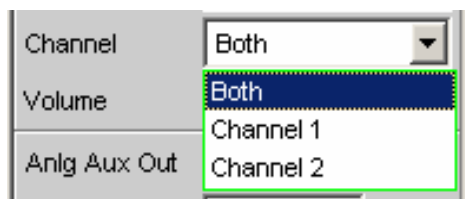

Figure 4-32 Connection to audio monitoring output

**Channel**

Used to select the audio monitoring channel.



This menu item is used to decide whether both channels (Stereo) or just one channel (either Channel 1 or 2) are to be monitored.

**Both** The audio monitoring signal is output on both channels at the audio monitoring output. The internal loudspeaker outputs the signal from both channels.

Remote-control command:  
 AUXiliaries:SPEaker:CHANnel STEReo

**Channel 1** Only the signal applied and analyzed via Channel 1 or generated internally is output at the audio monitoring output.

Remote-control command:  
 AUXiliaries:SPEaker:CHANnel CH1

**Channel 2** Only the signal applied and analyzed via Channel 2 or generated internally is output at the audio monitoring output.

Remote-control command:  
 AUXiliaries:SPEaker:CHANnel CH2

**Volume**

Used to set the volume.



Setting range from 0 dB (highest volume or output voltage) to -120 dB (lowest volume or output voltage). This setting affects all three internal signal paths: the internal loudspeaker, the jack socket on the front panel of the instrument, and the BNC socket (Anlg Aux Out) at the rear of the instrument.

If "Function" was selected as signal source, the volume can be increased up to +120 dB. This is done by multiplying the digital signal by a corresponding factor prior to D/A conversion. Signals of low digital modulation can then also be heard at sufficient volume.

---

**Note:**  
*Volume settings above 0 dB may cause the enlarged digital signal to be overdriven and thus the audio monitoring signal to be distorted. For this reason, the selected gain must not be higher than the underdrive of the digital signal.*

---

The output voltage can be adjusted by entering values directly in the panel. If Direct mode is active (the entry field has a magenta frame when the field is selected and the selection is confirmed with "Enter"), the output voltage can be adjusted almost steplessly using the cursor keys or the rotary knob.

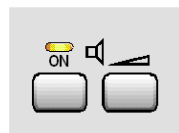

If the loudspeaker volume symbol (right-hand key) on the R&S UPV keypad is pressed, the following panel appears on the screen:

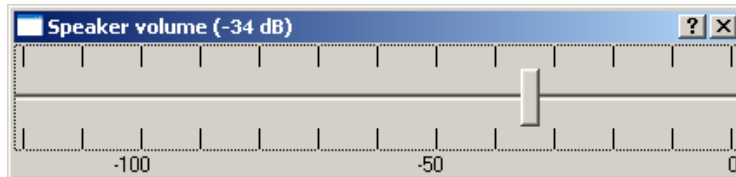

In this panel, the volume can be adjusted in steps of 1 dB using the rotary knob or cursor keys  $\Rightarrow$  /  $\Leftarrow$  or in steps of 10 dB using the keys "Page  $\Uparrow$ " and "Page  $\Downarrow$ ".

If a mouse is connected to the R&S UPV, the horizontal slider can be operated directly.

On an external keyboard, this panel can be called up by pressing "Ctrl F9". The output voltage can then be adjusted using the same keys as on the R&S UPV front-panel keypad. The keys "Tab" and "Shift Tab" are used to adjust the output voltage in steps of 1 dB.

The entry window is closed again by pressing the ENTER  $\rightarrow$  key, the Escape key or by pressing the loudspeaker volume symbol again. If a mouse is used, the window is closed by simply clicking the cross in the top right-hand corner.

Remote-control command:  
 AUXiliaries:SPEaker:VOLume <n>

**Anlg Aux Out**

Auxiliary BNC output at the rear of the R&S UPV.

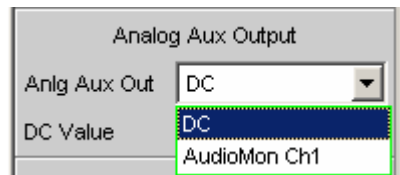

**DC** The auxiliary output supplies DC voltage to the BNC socket at the rear of the instrument. This voltage can be used to power an external DUT (Device Under Test, e.g. a hearing aid).

Attention:  
 The „Output OFF“ key on the front panel is without effect if Anlg Aux Out is set to „DC“. The DC current is still provided at the output to ensure that the DUT keeps the operating voltage/point!

Remote-control command:  
 AUXiliaries:AAUXout DC

**AudioMon Ch1** The left-hand channel of the audio monitoring signal is output at the rear BNC socket.

If you select this setting and the Audio Monitor (top line) is still not enabled, the message below appears (only if Phone/Aux = permanent is **not** ticked):

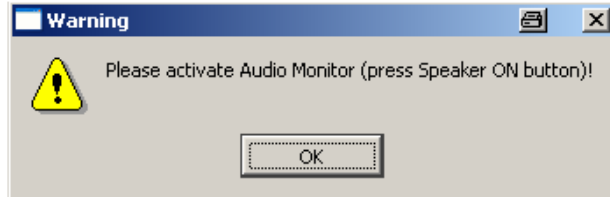

This requests you to activate the Audio Monitor so that a signal is output from the BNC output on the rear of the R&S UPV.

Remote-control command:  
AUXiliaries:AAUXout AUDM1

**DC Value**

Magnitude of the DC voltage level at the rear BNC socket.

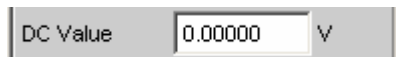

The DC output voltage can be adjusted between -2.5 V and +2.5 V. This line appears only if "DC" has been set as Anlg Aux Out in the parameter field above.

Remote-control command:  
AUXiliaries:DCValue <nu>

**Trigger Output**

Additional BNC output on the rear of the R&S UPV.

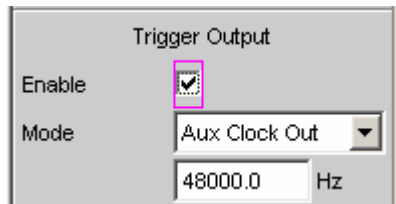

**Enable**

For enabling or disabling the trigger output.



Remote-control command:  
AUXiliaries:TRIGger:OUTPut:ENABle ON | OFF

**Mode**

The R&S UPV outputs either a pulse, while a measurement is running, or a squarewave signal.

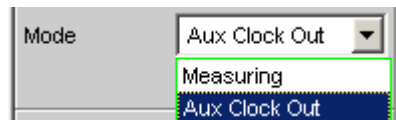

**Measuring** While a measurement is being performed in a 2-channel analyzer, the R&S®UPV outputs a low or high level, depending on the setting in the Edge line. In multichannel analyzers, the trigger signal is not available and is muted. A corresponding warning will then be output.

Remote-control command:  
 AUXiliaries:TRIGger:OUTPut:MODE MEAS

**Aux Clock Out** The frequency of the internal DDS oscillator on the Digital Mainboard (DMB) is output as a squarewave signal.

Remote-control command:  
 AUXiliaries:TRIGger:OUTPut:MODE AUXC

If "Aux Clock Out" is selected as the Mode in Trigger Output, an additional line appears so that you can enter a frequency:

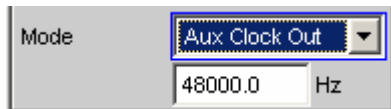

The frequency of the DDS oscillator can be used for synchronization purposes. At the bandwidths 22, 40 and 80 kHz (in the Generator Config panel) the frequency is independent of the sampling frequency of the generator.

If "Play Auto" is selected, the frequency is 512 times the sampling frequency (master clock) with which a waveform signal has been acquired by the analyzer (recorded waveforms) and can be played back via the generator ("Play Auto" bandwidth in the Generator Config panel and "Play" function in the Generator Function panel).

Remote-control command:  
 AUXiliaries:TRIGger:OUTPut:FREQuency <parameter>

**Edge**

This line defines whether you want the R&S UPV to output a high or low level during measurement. This parameter field appears only if "Measuring" was set as the Mode.



Remote-control command:  
 AUXiliaries:TRIGger:OUTPut:EDGE FALL | RIS

**Trigger Input**

Additional BNC input on the rear of the R&S UPV.

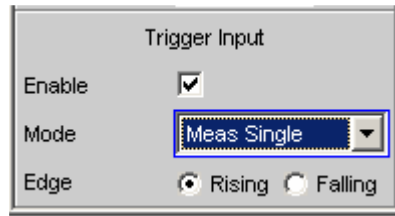
**Enable**

For enabling or disabling the trigger input.



Remote-control command:  
 AUXiliaries:TRIGger:INPut:ENABle ON | OFF

**Mode**

The presence of a pulse on the "Trigger In" BNC connector can trigger various events.

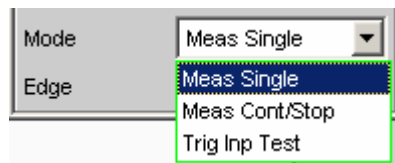
**Meas Single**

The trigger pulse launches a single measurement. The "START", "SINGLE" and "STOP/CONT" keys on the front panel are disabled.

Remote-control command:  
 AUXiliaries:TRIGger:INPut:MODE MSIN

**Meas Cont/Stop**

The trigger pulse launches a continuous measurement. Due to the toggle function the measurement can be started or stopped while running. The "START", "SINGLE" and "STOP/CONT" keys on the front panel are disabled.

Remote-control command:  
 AUXiliaries:TRIGger:INPut:MODE MCON

**Trig Inp Test**

All LEDs light up according to the voltage that is present (TTL level).  
 Low = Off  
 High = On

Remote-control command:  
 AUXiliaries:TRIGger:INPut:MODE TRIG

**Edge**

This is for defining whether you want the R&S UPV to react on the rising or falling edge of the input signal. This line is not visible if the "Trig Inp Test" mode has been selected.





# Switcher Panel

This section describes how to connect and operate the R&S UPZ Switcher on the R&S UPV.

## Connecting the Switcher to the R&S UPV

R&S UPZ Audio Switchers can be connected to the R&S UPV. An R&S UPZ may be an input switcher or an output switcher. An input switcher makes it possible to connect up to eight different DUTs to the two analyzer inputs without having to change connectors each time. An output switcher can supply up to eight DUTs with the generator channels delivered by the R&S UPV.

Up to 16 input and 16 output switchers can be connected to the R&S UPV, making up to 128 channels available.

The two busbar connections A and B on the front panel of the R&S UPZ have to be connected to the R&S UPV. In the case of an input switcher the XLR connectors on the busbar are connected to the analyzer inputs, and in the case of an output switcher the XLR connectors on the busbar are connected to the generator outputs.

For further information see the operating manual for the R&S UPZ.

The R&S UPZ is controlled via the COM interface of the R&S UPV, which is not only used for operating the R&S UPZ but can also be used to remotely control the R&S UPV.

The function of the COM interface is set in the Config Panel (in the utilities menu):

### COM Interface Used for

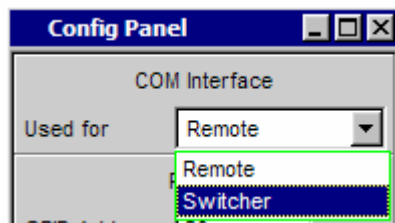

A new selection becomes effective as soon as the R&S UPV is restarted.

**Remote**      The COM interface can be used for the remote control of the R&S UPV.

**Switcher**      The COM interface is used for the control of the switchers R&S UPZ.

## Default Setting

If the switcher is operated for the first time after loading the R&S UPV default setup (preset), the channels are set to a defined default state: All channels of the two switcher types are set to "0", i.e. open. If additionally tracking is activated for the first time, tracking B vs A is set to "-1" and tracking Out vs Inp is set to "0". This ensures that when the user interface is opened all channels are open and thus prohibited states in the test setup are avoided.

If you wish to obtain the same setting as in the default state manually, simply enter All as the Tracking setting and set any channel to "0". All the others are then also adapted.

## Operation

Open the panel for operating the switcher as follows:

### Menu – Instruments – Switcher Panel

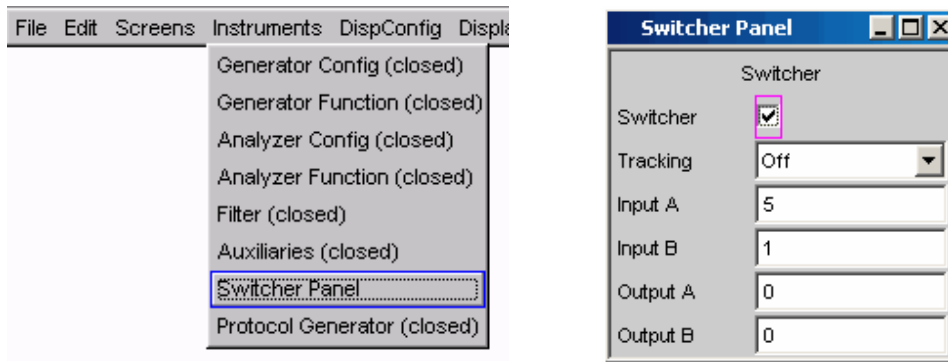

### Switcher



The checkbox activates or deactivates the operation of the switcher. This status is not dependent on whether the panel itself is open or not. Operation can only be activated if a setting was previously made in the Config Panel to specify that the COM interface is to be used to control the switcher. If not, the following note appears

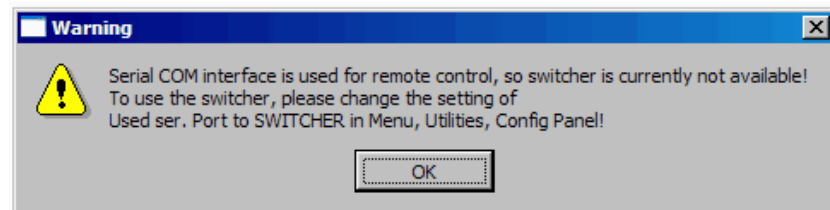

Operation of the switcher is activated.

Remote control command:

SWITcher:STATe ON



Operation of the switcher is deactivated.

Remote control command:

SWITcher:STATe OFF

**Tracking**

The channels of the connected switchers can be used not only independently of one another (Tracking Off), but also in common. This makes it possible to select a channel offset between the two busbars and/or between input and output switchers. When one of the parameter fields Input A/B or Output A/B is then used, the other one(s) is/are automatically adapted by the R&S UPV in accordance with the offset that has been set. Channels < 0 are set to 0, that is, the busbar is switched off.

**Off** Tracking is off and the channels can be connected independently of one another.

Remote-control command:  
SWITcher:TRACking OFF

**B vs A** The channels are switched to an offset between the busbars A and B. This offset can be set in the parameter field B vs A.

Application:  
Measurements of multichannel DUTs.

Remote-control command:  
SWITcher:TRACking BVSA

**Out vs Inp** The channels of input and output switchers are switched to an offset that can be set in the parameter field Out vs Inp.

Application:  
Crosstalk measurements in the adjacent channel.

Remote-control command:  
SWITcher:TRACking OVSI

**All** Combines both tracking options described above.

Remote-control command:  
SWITcher:TRACking ALL

**B vs A**

For entering the channel offset between the busbars A and B, in common for input and output switchers. This parameter field only appears when Tracking B vs A or All is selected.

Remote-control command:  
SWITcher:OFFSet:BVSA <n>

**Out vs Inp**

For entering the channel offset between input and output switchers. This parameter field only appears when Tracking Out vs Inp or All is selected.

Remote-control command:  
SWITcher:OFFSet:OVSI <n>

**Input A** For entering the channel number of the input switcher that is to be connected to busbar A.

Remote-control command:  
SWITcher:INPA <n>

**Input B** For entering the channel number of the input switcher that is to be connected to busbar B.

Remote-control command:  
SWITcher:INPB <n>

**Output A** For entering the channel number of the output switcher that is to be connected to busbar A.

Remote-control command:  
SWITcher:OUTA <n>

**Output B** For entering the channel number of the output switcher that is to be connected to busbar B. Here it is possible to enter "-1" as the channel number. The effect of this is that in busbar B **all** channels of **all** connected switchers are closed with the exception of the one selected in busbar A.

This setting is useful for worst-case crosstalk measurements. If no channel is selected in busbar A (Output A = 0), all channels in busbar B are closed.

Remote-control command:  
SWITcher:OUTB <n>

---

**Note:**

*It is not possible to set the same channel to busbars A and B. If an attempt is made to do this, the R&S UPV skips the set channel.*

---

# Traces, Spectrum Displays and Bargraphs

The most informative method of displaying measurement results is usually a two-dimensional graphic. Measurement values as a function of frequency, measurements over a time axis and so on are just a few examples of the many possible applications. The Audio Analyzer R&S UPV makes a distinction between the following graphical windows: Sweep Graph, FFT Graph, Waveform, Bargraph and PESQ. These windows are set up and modified using the associated configuration panel and displayed as traces or bargraphs.

## Graphical Display, Explanation of the Elements

Whether a graphical display is shown as a trace or a bargraph depends on the selected display configuration panel.

- The sweep graphs, FFT graphs, waveform and PESQ graphical windows are displayed as traces, whereas

the bargraphs display the measurement results of the analyzer measurement functions THD, THD+N & SINAD, Mod Dist, DFD, DIM, Third Octave or 1/n Octave as bargraphs.

See the section "Calling Up" on page 4.457 for information on how to set up the various display configurations.

The individual elements in the trace and bargraph displays are virtually identical but for one or two exceptions. Only a bargraph which requires a symbolic X axis (that is, the bargraph for the analyzer measurement functions THD, THD+N & SINAD, Mod Dist, DFD and DIM) does not offer certain elements, such as markers or grid lines for the X axis.

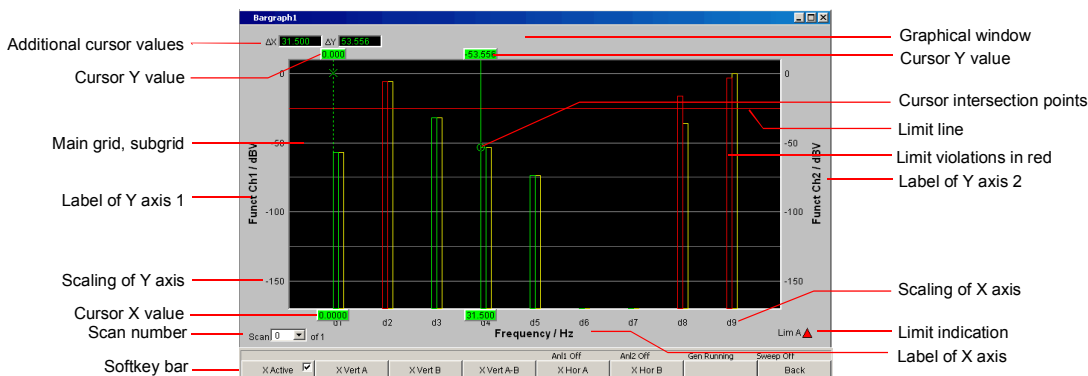
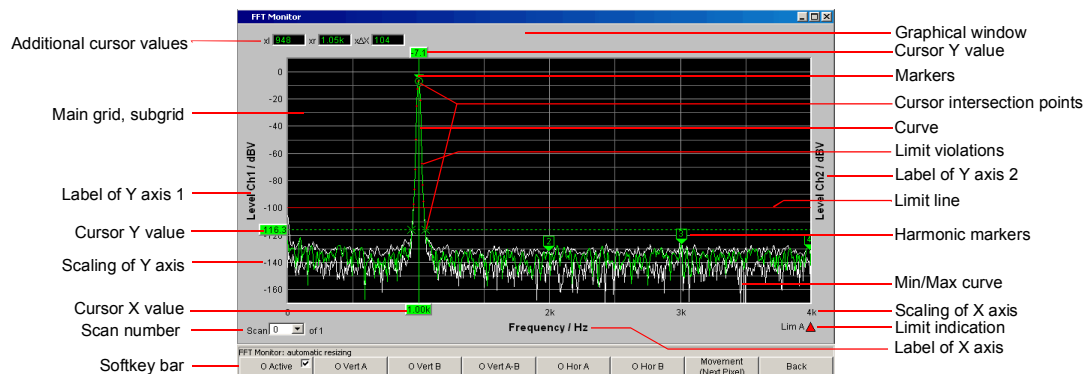

Cursor intersection points	The points <b>O</b> or <b>X</b> at which the cursor line intersects the trace / lines identify the cursor so that a reference to the labels in the softkey bar (e.g. <b>O Vert A</b> or <b>X Hor A</b> ) is provided.
Cursor X value	X value for vertical cursors.
Cursor Y value	Vertical cursors: Y value, or if O Vert A-B / X Vert A-B is set, the difference between the Y values for the A and B trace / A and B line.  Horizontal cursors: Y value on the Y1 and/or Y2 axis.
Additional cursor values $\Delta X$ , $\Delta Y$ , ol, or, o $\Delta X$ , xl, xr, x $\Delta X$	$\Delta X$ : Difference between the X values if the o and x cursor are both activated as the vertical cursor at the same time. $\Delta Y$ : Difference between the Y values if the o and x cursor are both activated as the vertical cursor at the same time.  Only for traces (not for bargraphs): ol: The point to the left of the marker at which the o cursor intersects the trace. or: The point to the right of the marker at which the o cursor intersects the trace. o $\Delta X$ : Difference between ol and or. xl: The point to the left of the marker at which the x cursor intersects the trace. xr: The point to the right of the marker at which the x cursor intersects the trace. x $\Delta X$ : Difference between xl and xr.
Graphical window	The graphical window for the respective graphic subsystem, opened with

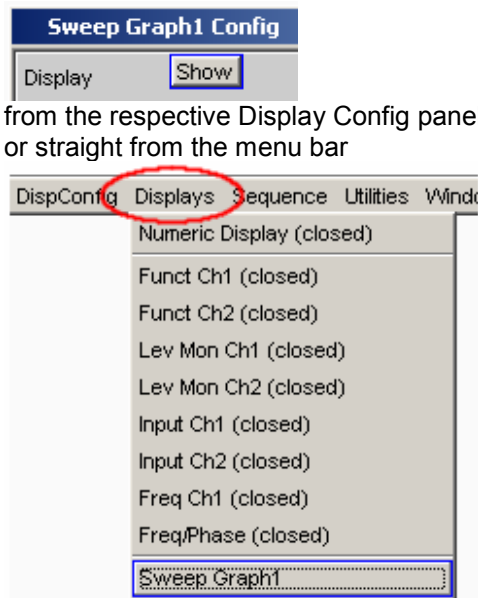

from the respective Display Config panel, or straight from the menu bar

Harmonic markers

In the following example the harmonics (2 kHz and 3 kHz) are marked, starting from the X position of the marker (1 kHz).

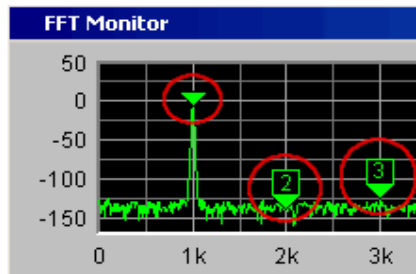

The harmonic markers are activated using the softkeys:

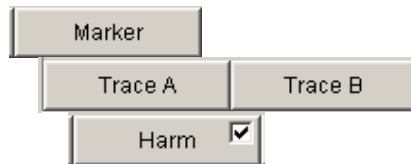

---

**Available in the graphics subsystems**  
**FFT**

---

Main grid, subgrid

Set in the associated DispConfig panel using the parameter fields



in the sections Trace A, Trace B and X Axis.

In graphic systems Bargraph1 | 2 a grid cannot be set for the X axis, since this makes no sense for an unscaled X axis.

Limit line







Fixed limit value or fixed limit value curve from a file, for activation in the associated DispConfig panel via the parameter fields



in sections Trace A and Trace B.

Limit indication



-  "Limit Upper" is activated and there is no "limit violation".
-  "Limit Lower" is activated and there is no "limit violation".
-  The "Limit Upper" value has been violated in the past but there is currently no "limit violation". The violation is indicated until the **START** key is pressed again.
-  The "Limit Lower" value has been violated in the past but there is currently no "limit violation". The violation is indicated until the **START** key is pressed again.
-  The "Limit Upper" value is currently being violated.
-  The "Limit Lower" value is currently being violated.

Limit violations

Limit violations are indicated by red dots on traces or by red bars in bargraphs:

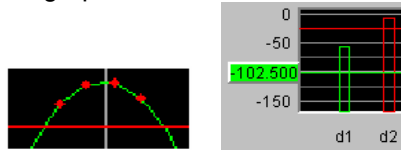

Markers

Marking of the value on the X axis from which the left and right intersections of a horizontal cursor will be displayed with the curve.

Additionally for the graphic systems FFT Graph1 | 2:  
Marking of a value on the X axis from which harmonics are calculated.

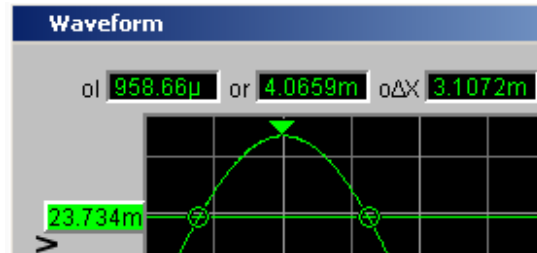

The marker is set using the softkeys:



---

**Available in the graphics subsystems**  
Sweep, FFT, Waveform, PESQ

---



Min/Max curve

The min/max curves are displayed in white. The min curve represents the lowest value of Y in a measurement sequence and the max curve represents the highest.

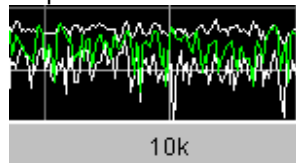

In the graphic system Bargraph1 | 2 the minimum and maximum values are shown as small white blocks.

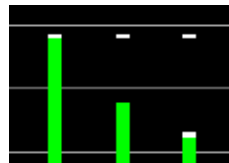

To be set in the upper part of the associated panel via the parameter field.



The min/max curves are to be thought of as scans of a multiscan display. If "Show Min Max" is on, there is a single scan from three scans.

Scan number

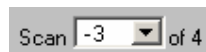

Multiscan mode:

The number of the current scan is displayed here by scrolling through the scans using the **Next Scan** rocker key. The number 0 indicates the most recent scan; the more negative the number, the older the scan.

"of 4" shown in the example indicates the currently set history and informs the user how many scans are stored in the memory or saved in the file. This value is set in the associated DispConfig panel using



See section "History" on page 4.463.

The entries Min and Max denote the min/max curves, provided these are switched on and are also available in single-scan mode.

Right-clicking the arrow opens a box

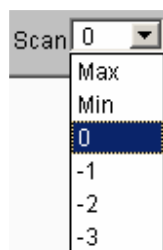

in which the desired scan can be selected by clicking the appropriate number. The cursors, markers, limit values and so on are then referenced to this scan.

Softkey bar

The softkey menu for the graphical window allows quick configuration of all the important and frequently used settings, especially cursor, marker and zoom functions by means of the keys provided below the menu.  
 The softkeys can also be operated with the mouse.  
 See section "Softkey Menu" on page 4.539 for a detailed description of functionality.

Label of X axis

Consists of the label and unit; set with



See section "Parameter Fields of the Panel" on page 4.458.

Scaling of X axis

Only for displaying curves, not in graphic system Bargraph1 | 2:

Automatic or manually set scaling of the X axis; set with

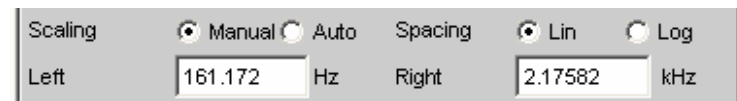

See section "Parameter Fields of the Panel" on page 4.458.

Label of Y axis 1  
 Label of Y axis 2

Consists of the label and unit; set with



and

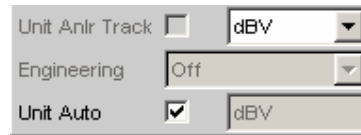

See section "Parameter Fields of the Panel" on page 4.458.

Scaling of Y axis

Automatic or manually set scaling of the Y axis; set with

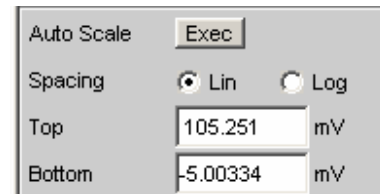

See section "Parameter Fields of the Panel" on page 4.458.

Config

Right-clicking anywhere in the graphical display calls up a button labeled "Config". Left-clicking on this Config button opens the associated DispConfig panel.

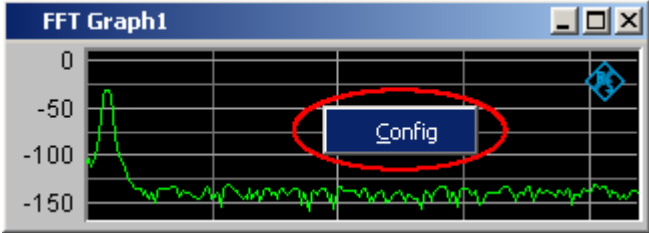

## Calling Up

The Display Configuration panel is used to set how measurement results will be graphically **displayed**. **What** will be measured **and how** is set in the "Analyzer Config" and "Analyzer Function" panels or, in the case of sweeps, defined in "Generator Config" and "Generator Function".

The display configuration panels are opened via the menu bar of the R&S UPV. The menu bar is opened by pressing the **MENU** key on the front panel or, with mouse operation, by moving the pointer to the left-hand edge of the R&S UPV application window; the menu bar then appears at the top left-hand edge of the R&S UPV application.

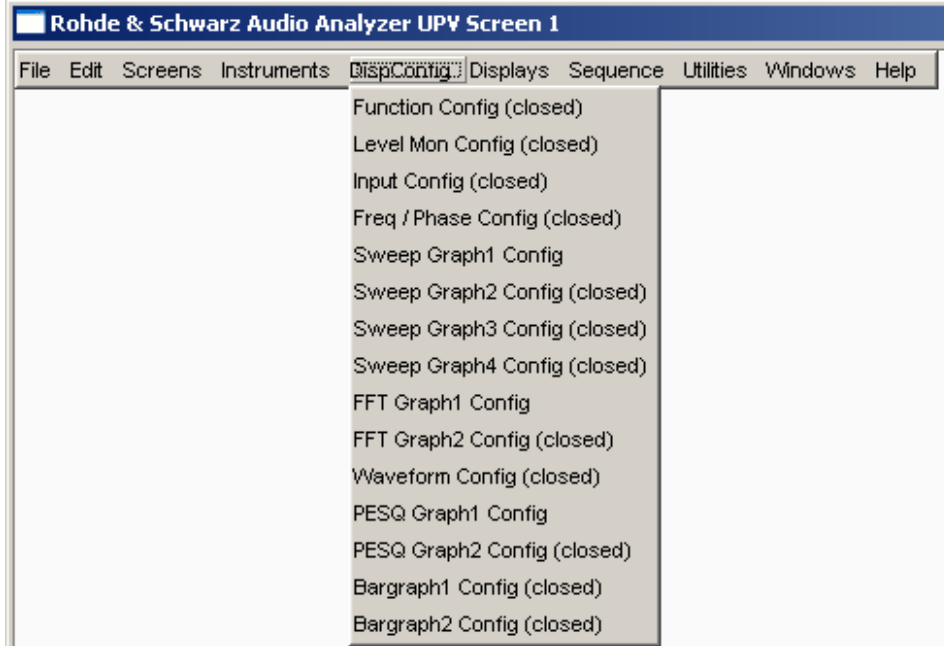

11 different display configuration panels are available, some with two or four windows; i.e. the measurement data sets for the analyzer measurement function RMS

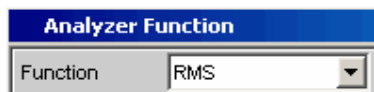

and the measurement data sets for the additional measurement functions Level Monitor, Input Monitor, Freq/Phase Measurement and Waveform

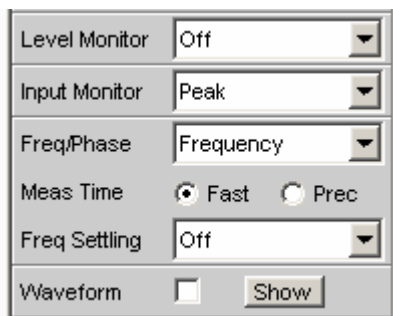

can be displayed at the same time.

**Sweep** in 4 windows

Listed in the menu as **Sweep Graph1 Config** to **Sweep Graph4 Config**.

The panel is used to configure the display of measurement results from a measurement sequence (sweep) as a diagram in the Cartesian co-ordinate system. Two dependent values can be displayed as TRACE A and TRACE B over an independent X axis.

**FFT Graph** in two windows

Listed in the menu as **FFT Graph1 Config** and **FFT Graph2 Config**.

The panel offers the configuration for displaying a frequency spectrum if the measurement function FFT or the measurement function RMS, RMS Selective, S/N, THD, THD & SINAD, Mod Dist, DFD, DIM and Record **with post-FFT** is selected in the analyzer panel.

**Waveform**

Listed in the menu as **Waveform Config**

The panel is used to configure the display of a waveform (trace of the signal over time) if Waveform is selected as the additional measurement function in the analyzer panel.

**Bargraph** in two windows

Listed in the menu as **Bargraph1 Config** and **Bargraph2 Config**.

The panel offers the configuration for displaying a bargraph **with symbolic, i.e. non-scaled X axis** if the measurement function THD, THD+N & SINAD, Mod Dist, DFD or DIM is selected in the analyzer panel.

The panel offers the configuration for displaying a bargraph **with an X axis in Hz** if the measurement function Third Octave or 1/n Octave gewählt is selected in the analyzer panel.

**PESQ** in two windows

Listed in the menu as PESQ Graph1 Config and PESQ Graph2 Config.

The panel offers the configuration for displaying the PESQ measurement if the PESQ measurement function is selected in the analyzer panel.

## Parameter Fields of the Panel

The layout of the display configuration panels is almost identical for all of the graphic systems. Depending on the graphic system, parameter fields may be omitted or different parameter lists may appear in the selection fields.

For example, the display configuration panels for FFT and Sweep offer various choices for the sources of the measurement results. The differences are explained for the individual fields.

**FFT**  
for two-channel instrument

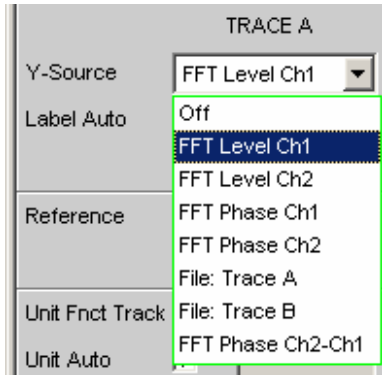

The source of the measurement results (FFT Level) and the channel number (Ch1) are combined in the selection list (FFT Level Ch1).

**Sweep**  
for two-channel instrument

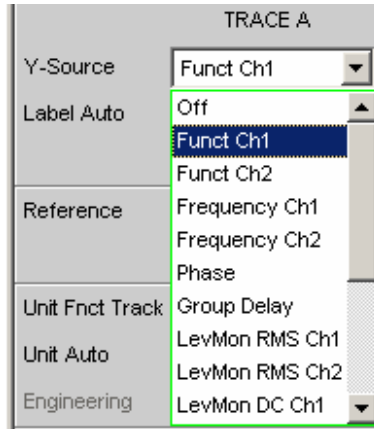

The source of the measurement results (Funct Level) and the channel number (Ch1) are combined in the selection list (Funct Level Ch1).

**Sweep**  
for a multichannel instrument

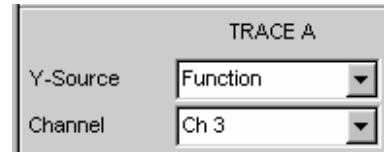

The source of the measurement results and the channel number are separated, since the manifold possible combinations could no longer be displayed in a selection box.

**Display**



Clicking this button in the Display parameter field activates the graphical display of traces or bargraphs.

The display is deactivated by pressing the **[CLOSE]** key or by clicking the X button in the title bar using the mouse, provided that the display window has the focus (see section "Traces, Spectrum Displays and Bargraphs" on page 4.450).

A duplicate of this Show button can also be found in the Analyzer Function panel so that you can conveniently call up the graphical display for Bargraph, FFT or Waveform from there.

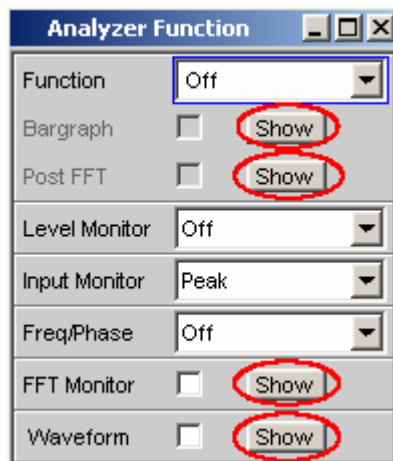

**Data List**

Clicking the button opens a separate window in which the measurement results for Trace A, Trace B and the values to the corresponding X axis are displayed numerically. The display is deactivated by pressing the **CLOSE** key or by clicking the X button in the title bar using the mouse, provided that the display window has the focus (see section "Result List" on page 4.547).

**Copy to other Window**

The Copy to other Window function is available for the respective first window of the Sweep, FFT, Bargraph and PESQ sub-systems; in other words, for all sub-systems which have more than one window. As the name says, settings from the first window are copied into all the sub-system's other windows. This happens **once** when the Exec button is pressed.

This copying process is performed for almost all commands following a new installation of the R&S UPV.

If only specific command areas are to be transferred from the first window to the subsequent windows, limitations can be set in the dialog box which opens when the Config button is pressed.

The ticks in the dialog can easily be assigned to the respective panel areas, which are marked by thin lines, by means of their labels.

The selection of command areas made here is unaffected by preset or by loading a setup; it is therefore bound to the device.

**Scan**

For the graphics subsystems Sweep Graph 1 to 4

Used to specify whether **one** (Single) or **several** (Multi) measurement sequences are recorded or loaded from a file.

---

**Available in the graphics sub-systems****Sweep**

---

If a Z sweep is set in the generator, Scan will automatically be set to Multi, provided that X-Source = Sweep is set in the display panel.

**Single**

Only one trace (measurement sequence) or one trace pair (TRACE A and B) is to be recorded or loaded (see section "*Measurement value sequences*" on page 4.580).

The display can be in the form of a trace or a bargraph.

The following parameter fields are hidden:

History  
New Scan  
Import From

If the "Show Min Max" tick box is ticked, two scans are added to the single measurement sequence, and the toggle key Next Scan can be used to choose between three scans.

Remote-control command:  
DISPlay:SWEp<i>:SMODE SINGLE



**Multi**

With this setting, **not just one** measurement sequence or pair of measurement sequences (Trace A and Trace B) is recorded/loaded and displayed but any number of sequences and sequence pairs (see section "Measurement value sequences" on page 4.580).

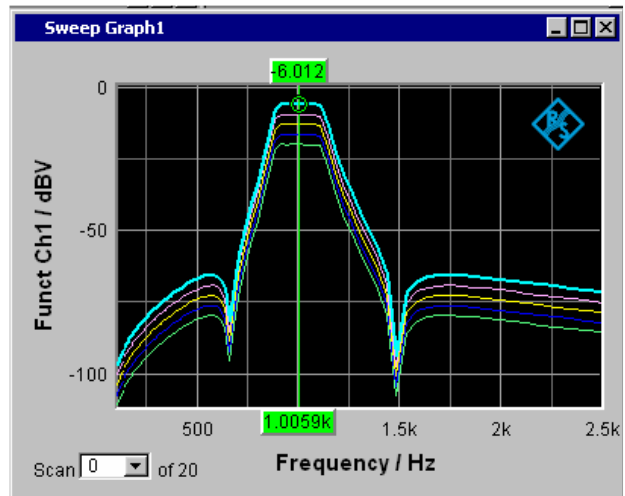

However, only the number selected in the **History** parameter field (max. 20) is stored internally and written to a file (see Saving) or read from a file (see Loading). The scans that are not stored are only available in the graphic and are lost if the graphical window is moved or resized, if rescaling is performed, if trace files are stored/loaded, or if setups are stored/loaded.

The following parameter fields become available:

History  
New Scan  
Import From

Remote-control command:  
DISPlay:SWEEp<i>:SMODE MULTiscan

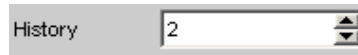
**History**

Only available if "Scan" is set to "Multi" and therefore only for the graphic systems Sweep Graph 1 to 4.

---

***Available in the graphics sub-systems  
Sweep***

---

History determines how many scans are stored in the memory or saved in the file. It is not possible to select "1" as this number represents single-scan mode.

When the x-source in the display panel is set to Sweep, and when a z-sweep is set in the generator, and when the number of z-sweep points in the generator is larger than the number of scans set in History, the number of sweep points from the generator will be entered in the History field.

When the x-source in the display panel is set to Sweep, and when a z-sweep is set in the generator, and when the number of z-sweep points is larger than the number of scans set in History, the number of sweep points will be transferred from the generator to the History field.

Remote-control command:  
DISPlay:SWEep<i>:HISTory <n>

**Show Min Max**

If the tick box is activated, the Min/Max curves will be displayed. The Min curve represents the lowest value of a measurement sequence and the Max curve the highest value. Recording of Min/Max values will be restarted each time the **START** key is pressed.

If Min/Max scans have already been recorded and measurement is stopped, the Min/Max curves can be hidden and shown by turning the tick on and off.

A MIN/MAX display is also possible for graphic systems which do not have any scans (e.g. FFT Graph), i.e. a MIN scan and a MAX scan are recorded. The Show MIN/MAX function is available for the following graphic systems:

---

**Available in the graphics subsystems**

*Sweep, FFT, Bargraph, PESQ*

---

The "Show Min Max" function is not available in the Waveform graphic system only.

The min/max curves are to be thought of as scans of a multiscan display. If "Show Min Max" is on, there is a single scan from three scans.

If a trace file containing Min/Max scans is loaded by using the y-source command: "File: Trace A" or "File: Trace B", the "Show Min Max" check box will automatically be enabled so that these scans are displayed in the graphic.

```
Remote-control command:  
DISPlay:SWEep<i>:MINMax ON | OFF  
DISPlay:FFT<i>:MINMax ON | OFF  
DISPlay:BARgraph<i>:MINMax ON | OFF  
DISPlay:PESQ<i>:MINMax ON | OFF
```

## Y-Source

## Sweep Graph graphic system



Used to select which sweep measurement results (obtained from one of the sweep functions listed below) are to be collected as TRACE A or TRACE B and displayed graphically on the left-hand or right-hand Y axis.

**Example:**

The frequency response of a DUT is determined by means of a generator frequency sweep and the analyzer measurement function "RMS" and displayed in the Sweep Graph 1 graphic system as TRACE A.

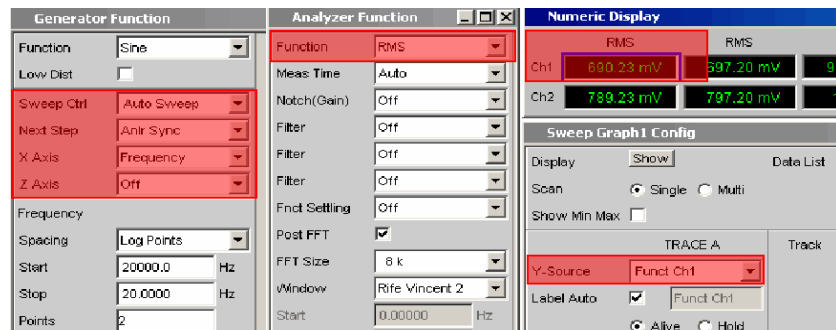

For more information on Y Source see section "Measurement value sequences" on page 4.580.

**Off**

No trace is displayed or an available trace is deleted.

Remote-control command:

```
DISPlay:SWEEp<i>:A|B:YSource OFF
```

**Funct Ch1**  
**Funct Ch2**  
**Function**

The **function** measurement result obtained by means of a generator sweep with the set analyzer measurement function for

- channel 1 or
- channel 2 or
- the channel number specified under the following "Channel" parameter field in the case of a multichannel instrument



is displayed as Trace A or Trace B versus a basic physical quantity selected under "X Axis" on page 4.123.

The measurement result is displayed in the numeric display:

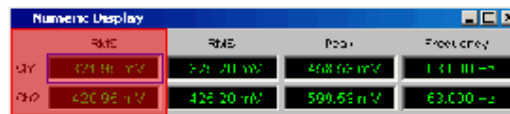

Remote-control command:

DISPlay:SWEEp<i>:A|B:YSource FUNC1

DISPlay:SWEEp<i>:A|B:YSource FUNC2

DISPlay:SWEEp<i>:A|B:YSource

FUNCTion

**Frequency Ch1  
Frequency Ch2  
Frequency**

The **frequency** measurement result obtained by means of a generator sweep with the additional measurement function Freq/Phase for

- channel 1 or
- channel 2 or
- the channel number specified under the following "Channel" parameter field in the case of a multichannel instrument



is displayed as Trace A or Trace B versus a basic physical quantity selected under "X Axis" on page 4.123.

The measurement result is displayed in the numeric display:



Remote-control command:

```
DISPlay:SWEEp<i>:A|B:YSource FREQ1
DISPlay:SWEEp<i>:A|B:YSource FREQ2
DISPlay:SWEEp<i>:A|B:YSource
FREQuency
```

**LevMon RMS Ch1  
LevMon RMS Ch2  
LevMon RMS**

The **RMS** measurement result obtained by means of a generator sweep with the additional measurement function Level Monitor = RMS for

- channel 1 or
- channel 2 or
- the channel number specified under the following "Channel" parameter field in the case of a multichannel instrument



is displayed as Trace A or Trace B versus a basic physical quantity selected under "X Axis" on page 4.123.

The measurement result is displayed in the numeric display:

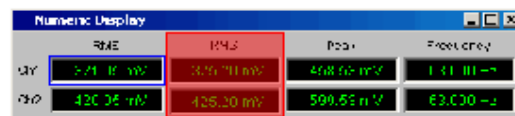

Remote-control command:

```
DISPlay:SWEEp<i>:A|B:YSource LMRM1
DISPlay:SWEEp<i>:A|B:YSource LMRM2
DISPlay:SWEEp<i>:A|B:YSource LMRMS
```

LevMon DC Ch1  
 LevMon DC Ch2  
 LevMon DC

The **DC** measurement result obtained by means of a generator sweep with the additional measurement function Level Monitor = DC for

- channel 1 or
- channel 2 or
- the channel number specified under the following "Channel" parameter field in the case of a multichannel instrument

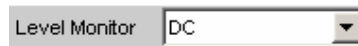

is displayed as Trace A or Trace B versus a basic physical quantity selected under "X Axis" on page 4.123.

The measurement result is displayed in the numeric display:

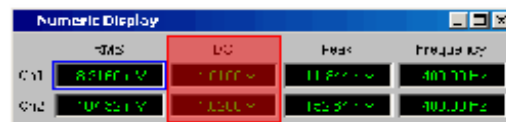

Remote-control command:

```
DISPlay:SWEEp<i>:A|B:YSource LMDc1
DISPlay:SWEEp<i>:A|B:YSource LMDc2
DISPlay:SWEEp<i>:A|B:YSource LMDc
```

LevMon Peak Ch1  
 LevMon Peak Ch2  
 LevMon Peak

The **peak** measurement result obtained by means of a generator sweep with the additional measurement function Level Monitor = Peak for

- channel 1 or
- channel 2 or
- the channel number specified under the following "Channel" parameter field in the case of a multichannel instrument

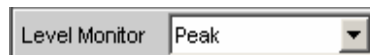

is displayed as Trace A or Trace B versus a basic physical quantity selected under "X Axis" on page 4.123.

The measurement result is displayed in the numeric display:

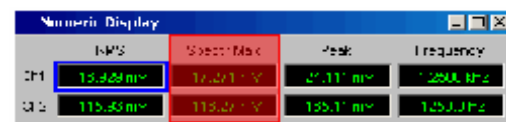

Remote-control command:

```
DISPlay:SWEEp<i>:A|B:YSource LMPK1
DISPlay:SWEEp<i>:A|B:YSource LMPK2
DISPlay:SWEEp<i>:A|B:YSource LMPK
```

Inp Peak Ch1  
 Inp Peak Ch2  
 Inp Peak

The **Peak** measurement result obtained by means of a generator sweep with the additional measurement function Input Monitor = Peak for

- channel 1 or
- channel 2 or
- the channel number specified under the following "Channel" parameter field in the case of a multichannel instrument



is displayed as Trace A or Trace B versus a basic physical quantity selected under "X Axis" on page 4.123.

The measurement result is displayed in the numeric display:



Remote-control command:

```
DISPlay:SWEEp<i>:A|B:YSource INPP1
DISPlay:SWEEp<i>:A|B:YSource INPP2
DISPlay:SWEEp<i>:A|B:YSource
INPPeak
```



**Phase**

The **phase** measurement result obtained by means of a generator sweep with the additional measurement function Freq/Phase = Freq & Phase

If you are using a multichannel instrument, set the channel reference by means of the following "Channel" parameter field.



is displayed as Trace A or Trace B versus a basic physical quantity selected under "X Axis" on page 4.123.

In the case of a multichannel instrument, the channel reference is made by means of the following "Channel" parameter field.

The measurement result is displayed in the numeric display:

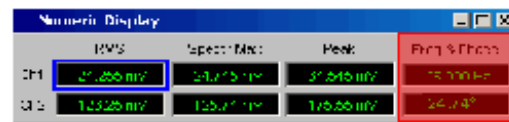

Remote-control command:

DISPlay:SWEp<i>:A|B:YSource PHASE

**Group Delay**

The **group delay** measurement result obtained by means of a generator sweep with the additional measurement function Freq/Phase = Freq & Grp Del

If you are using a multichannel instrument, set the channel reference by means of the following "Channel" parameter field.



is displayed as Trace A or Trace B versus a basic physical quantity selected under "X Axis" on page 4.123.

In the case of a multichannel instrument, the channel reference is made by means of the following "Channel" parameter field.

The measurement result is displayed in the numeric display:

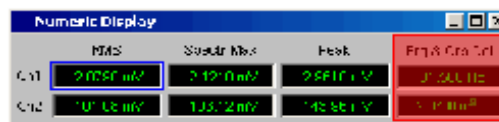

Remote-control command:  
 DISPlay:SWEEp<i>:A|B:YSource  
 GROupdelay

**File: Trace A**

Trace A is loaded from a file, see section "Measurement value sequences" on page 4.580.

The file name is entered in the subsequent parameter field.

Remote-control command:  
 DISPlay:SWEEp<i>:A|B:YSource FILEA  
 DISPlay:SWEEp<i>:A|B:YSource:FILE  
 'filename'

**File: Trace B**

Trace B is loaded from a file, see section "Measurement value sequences" on page 4.580.

The file name is entered in the subsequent parameter field.

Remote-control command:  
 DISPlay:SWEEp<i>:A|B:YSource FILEB  
 DISPlay:SWEEp<i>:A|B:YSource:FILE  
 'filename'

## Y-Source

## FFT Graph graphic system



Used to select which measurement results obtained with the analyzer measurement function **FFT** or **Post-FFT** are displayed graphically.

Section of the Analyzer Function panel:



For more information on Y Source see section "*Measurement value sequences*" on page 4.580.

**Off** No trace is displayed or an available trace is deleted.

Remote-control command:  
 DISPLAY:FFT<i>:A|B:YSource OFF

**FFT Level Ch1**  
**FFT Level Ch2**  
**FFT Level**

The level characteristic versus the frequency of

- channel 1 or
- channel 2 or
- the channel number specified under the following "Channel" parameter field in the case of a multichannel instrument

of the **FFT** or **Post-FFT** analyzer measurement function is displayed as Trace A or Trace B versus a frequency X-axis.

Remote-control command:  
 DISPLAY:FFT<i>:A|B:YSource FFTL1  
 DISPLAY:FFT<i>:A|B:YSource FFTL2  
 DISPLAY:FFT<i>:A|B:YSource FFTLevel

**FFT Phase Ch1**  
**FFT Phase Ch2**  
**FFT Phase**

The FFT phase is the phase characteristic versus the frequency of

- channel 1 or
- channel 2 or
- the channel number specified under the following "Channel" parameter field in the case of a multichannel instrument

of the **FFT** or **Post FFT** analyzer measurement function that is obtained from the calculation of the complex FFT. The phase characteristic is displayed as Trace A or Trace B along a frequency X-axis.

Remote-control command:

```
DISPlay:FFT<i>:A|B:YSource FFTP1
```

```
DISPlay:FFT<i>:A|B:YSource FFTP2
```

```
DISPlay:FFT<i>:A|B:YSource FFTPhase
```

**FFT Phase Ch2-Ch1  
FFT Phase to  
Refch**

The phase **difference** between the phase characteristic of

- channel 2 and channel 1
- the channel number specified under the following "Channel" parameter field and the reference channel specified in the "Ref Channel" parameter field in the Analyzer Config panel in the case of a multichannel instrument

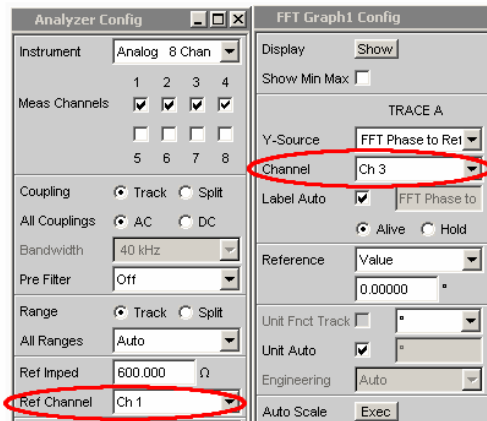

obtained from the calculation of the complex FFT by means of the **FFT** or **Post FFT** analyzer measurement function. The phase characteristic is displayed as Trace A or Trace B along a frequency x-axis.

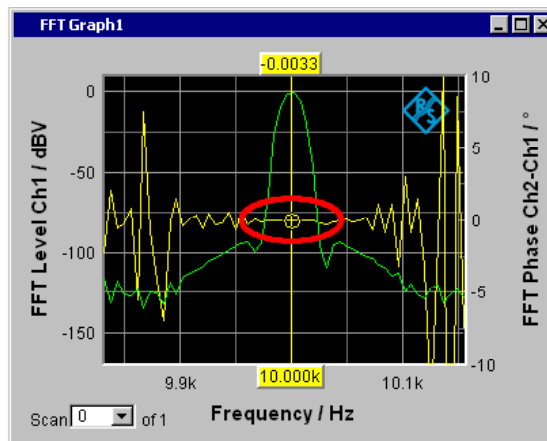

The yellow trace shows the phase characteristic near the 10 kHz frequency line.

Remote-control command:

```
DISPlay:FFT<i>:A|B:YSource FFTP21
DISPlay:FFT<i>:A|B:YSource
FFTRefchphase
```

**File: Trace A** Trace A is loaded from a file, see section *"Measurement value sequences"* on page 4.580. The file name is entered in the subsequent parameter field.

```
Remote-control command:
DISPlay:FFT<i>:A|B:YSource FILEA
DISPlay:FFT<i>:A|B:YSource:FILE
'filename'
```

**File: Trace B** Trace B is loaded from a file, see section *"Measurement value sequences"* on page 4.580. The file name is entered in the subsequent parameter field.

```
Remote-control command:
DISPlay:FFT<i>:A|B:YSource FILEB
DISPlay:FFT<i>:A|B:YSource:FILE
'filename'
```

**Y-Source**

**Waveform graphic system**



Used to select which measurement results obtained with the additional measurement function **Waveform** are to be collected as TRACE A or TRACE B and displayed graphically on the left-hand or right-hand Y axis.

Section of the Analyzer Function panel:

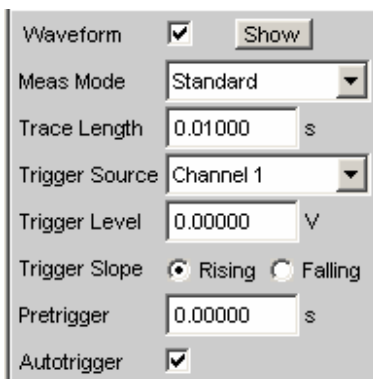

For more information on Y Source see section *"Measurement value sequences"* on page 4.580.

**Off** No trace is displayed or an available trace is deleted.

```
Remote-control command:
DISPlay:WAVEform:A|B:YSource OFF
```

<b>Level Ch1</b>	The level measurement result for
<b>Level Ch2</b>	
<b>Level</b>	<ul style="list-style-type: none"><li>• channel 1 or</li><li>• channel 2 or</li><li>• the channel number specified under the following "Channel" parameter field in the Analyzer Config panel in the case of a multichannel instrument</li></ul>

with the waveform measurement function is displayed as Trace A or Trace B along a time X-axis.

```
Remote-control command:  
DISPlay:WAVeform:A|B:YSource LEV1  
DISPlay:WAVeform:A|B:YSource LEV2  
DISPlay:WAVeform:A|B:YSource LEV1
```

**File: Trace A**

Trace A is loaded from a file, see section "*Measurement value sequences*" on page 4.580.

The file name is entered in the subsequent parameter field.

```
Remote-control command:  
DISPlay:WAVeform:A|B:YSource FILEA  
DISPlay:WAVeform:A|B:YSource:FILE  
'filename'
```

**File: Trace B**

Trace B is loaded from a file, see section "*Measurement value sequences*" on page 4.580.

The file name is entered in the subsequent parameter field.

```
Remote-control command:  
DISPlay:WAVeform:A|B:YSource FILEB  
DISPlay:WAVeform:A|B:YSource:FILE  
'filename'
```

## Y-Source

## Bargraph graphic system



Used to select whether the measurement result for channel 1 or channel 2 obtained with the analyzer measurement function THD, THD+N & SINAD, Mod Dist, DFD Third Octave or 1/n Octave is to be collected as TRACE A or TRACE B and displayed graphically on the left-hand or right-hand Y axis.

Section of the Analyzer Function panel:

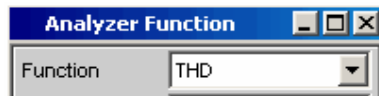

For more information on "Y Source" see section "Measurement value sequences" on page 4.580.

**Off** No trace is displayed or an available trace is deleted.

Remote-control command:  
 DISPlay:BARgraph<i>:A|B:YSource OFF

**Funct Ch1**  
**Funct Ch2**  
**Function** The measurement result for

- channel 1 or
- channel 2 or
- the channel number specified under the following "Channel" parameter field in the Analyzer Config panel in the case of a multichannel instrument

obtained for the THD, THD+N & SINAD, Mod Dist, DFD and DIM analyzer measurement functions is displayed as Trace A or Trace B versus an X-axis that is not true to scale; the result for the Third Octave and 1/n Octave measurement functions versus an X-axis that is true to scale.

Remote-control command:  
 DISPlay:BARgraph<i>:A|B:YSource  
 FUNC1  
 DISPlay:BARgraph<i>:A|B:YSource  
 FUNC2  
 DISPlay:BARgraph<i>:A|B:YSource  
 FUNCtion



<b>File: Trace A</b>	<p>Trace A is loaded from a file, see section "Measurement value sequences" on page 4.580.</p> <p>The file name is entered in the subsequent parameter field.</p> <p>Remote-control command:  DISPlay:BARgraph&lt;i&gt;:A B:YSource  FILEA  DISPlay:BARgraph&lt;i&gt;:A B:YSource:FILE  E 'filename'</p>
<b>File: Trace B</b>	<p>Trace B is loaded from a file, see section "Measurement value sequences" on page 4.580.</p> <p>The file name is entered in the subsequent parameter field.</p> <p>Remote-control command:  DISPlay:BARgraph&lt;i&gt;:A B:YSource  FILEB  DISPlay:BARgraph&lt;i&gt;:A B:YSource:FILE  E 'filename'</p>

**Y-Source****PESQ graphics system**

Used to select which measurement results of the **PESQ** measurement function are to be collected as TRACE A or as TRACE B and displayed graphically on the left-hand or right-hand y-axis. Perceptual evaluation of speech quality (PESQ) is a method for assessing the speech quality of transmission systems.

**Off** No trace is displayed or an available trace is deleted.

Remote-control command:  
DISPlay:PESQ<i>:A|B:YSource OFF

**PESQ & MOS** Function value of the PESQ MOS measurement. Depending on the setting in the "According to" field in the Analyzer panel, a PESQ or a MOS measurement result is displayed graphically.

**MOS**

MOS (mean opinion score) is described in the ITU Recommendation P.862.1 or P.862.2.

**PESQ**

PESQ (perceptual evaluation of speech quality) is described in the ITU Recommendation P.862.

Remote-control command:  
DISPlay:PESQ<i>:A|B:YSource PEMO

<b>Delay</b>	<p>The delay measurement shows the time offset between the reference and the measurement signal. The signal is divided into a specific number of time intervals. Each time interval is displayed as a point, and all points taken together form a trace.</p> <p>Remote-control command: DISPlay:PESQ&lt;i&gt;:A B:YSource DELAY</p>
<b>Ref Signal</b>	<p>Waveform of the signal output on the generator.</p> <p>Remote-control command: DISPlay:PESQ&lt;i&gt;:A B:YSource REFSignal</p>
<b>Deg Signal</b>	<p>Waveform of the measured signal in the resolution of the reference signal.</p> <p>Remote-control command: DISPlay:PESQ&lt;i&gt;:A B:YSource DEGSignal</p>
<b>Dropouts</b>	<p>Measured dropouts displayed in such a way as if the difference between the reference signal and the time-corrected measurement signal would be displayed.</p> <p>Remote-control command: DISPlay:PESQ&lt;i&gt;:A B:YSource DROPOuts</p>
<b>File: Trace A</b>	<p>Trace A is loaded from file, (see section "<i>Measurement value sequences</i>", on page 4.580). The file name is entered in the subsequent parameter field.</p> <p>Remote-control command: DISPlay:PESQ&lt;i&gt;:A B:YSource FILEA DISPlay:PESQ&lt;i&gt;:A B:YSource:FILE 'filename'</p>
<b>File: Trace B</b>	<p>Trace B is loaded from file, (see section "<i>Measurement value sequences</i>", on page 4.580). The file name is entered in the subsequent parameter field.</p> <p>Remote-control command: DISPlay:PESQ&lt;i&gt;:A B:YSource FILEB DISPlay:PESQ&lt;i&gt;:A B:YSource:FILE 'filename'</p>

**Channel**

**Channel number**  
for multichannel instrument

For multichannel instruments it is no longer possible to show the source of the measurement results and the channel numbers in a combined display, due to the large number of possible combinations in the selection list for the Y-source. The source of the measurement results (Y-Source) and the channel number (Channel) are therefore offered in separate parameter fields.

For Y-Source = "OFF", "File: Trace A" or "File: Trace B", a channel specification has no significance, and this parameter field disappears.

---

**Available in the graphics subsystems**

Sweep, FFT, Waveform, Bargraph

---

**Ch1 to Ch8**                      Channel number 1 to 8

```
Remote-control command:
DISPlay:SWEep<i>:A|B:CHANnel
CH1...CH8
DISPlay:FFT<i>:A|B:CHANnel CH1...CH8
DISPlay:WAVEform:A|B:CHANnel
CH1...CH8
DISPlay:BARgraph<i>:A|B:CHANnel
CH1...CH8
```

**Trace File**

**All graphic systems**

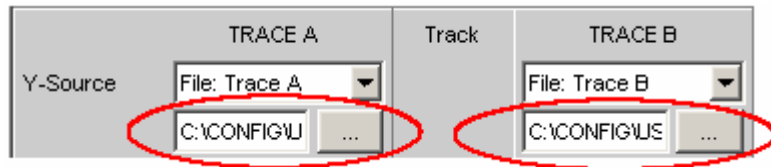

File name of the trace files to be loaded at parameter fields "Y-Source" = "File: Trace A" and/or "File: Trace B".

If a file cannot be loaded because it does not match the current graphic system or is defective, "not loaded" is displayed. For the file format see section "Random" on page 4.84.

If a trace file that contains Min/Max scans is loaded, "Show Min Max" is enabled automatically so that these scans are displayed in the graphic.

If files with different x-axes are loaded one after the other, the last file that was loaded always determines the x-axis. If a sweep with a different x-axis is then loaded, it will determine the x-axis.

## Track

## Track

If a tick box is available in the "Track" column, the settings for the parameters concerned can be transferred from TRACE A to TRACE B. The horizontal partition lines in the panel indicate the parameters for which tracking applies. Tracking capabilities are available for the Reference, Scaling and Limit functions.

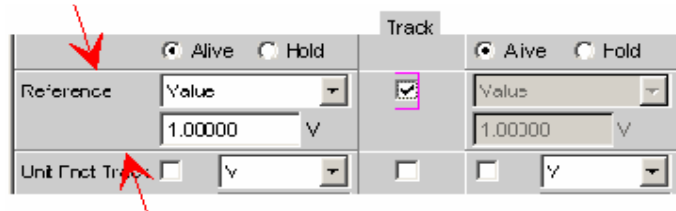
**Available in the graphics subsystems**

Sweep, FFT, Waveform, Bargraph, PESQ



The content of the parameter fields for TRACE A are transferred to TRACE B. The parameter fields for TRACE B then appear grey and cannot be accessed.

**Changes** made to the settings in TRACE A are transferred immediately to TRACE B.

Example:



```
Remote-control command:
DISPlay:SWEEp<i>:TRACk
LIMit|REFerence|SCALing ON
DISPlay:FFT<i>:TRACk
LIMit|REFerence|SCALing ON
DISPlay:WAVEform:TRACk
LIMit|REFerence|SCALing ON
DISPlay:BARgraph<i>:TRACk
LIMit|REFerence|SCALing ON
DISPlay:PESQ<i>:TRACk
LIMit|REFerence|SCALing ON
```



The parameter fields for TRACE A and TRACE B can be accessed and changed separately.  
Example:



```
Remote-control command:  
DISPlay:SWEEp<i>:TRACk  
LIMit|REFerence|SCALing OFF  
DISPlay:FFT<i>:TRACk  
LIMit|REFerence|SCALing OFF  
DISPlay:WAVEform:TRACk  
LIMit|REFerence|SCALing OFF  
DISPlay:BARgraph<i>:TRACk  
LIMit|REFerence|SCALing OFF  
DISPlay:PESQ<i>:TRACk  
LIMit|REFerence|SCALing OFF
```

**Label Auto**

This setting is for whether the label for the left (Trace A) or right (Trace B) Y axis is oriented on the setting in the "Y-Source" parameter field, or is freely configurable.

---

**Available in the graphics subsystems**  
 Sweep, FFT, Waveform, Bargraph, PESQ

---



The label (which is selected under TRACE A or TRACE B), i.e. the name of the measurement result which is displayed as TRACE A or TRACE B, is displayed in grey (cannot be accessed) in the text field to the right of the tick box and also on the Y axis in the graphical display.



Here rotated by 90°.

```

Remote-control command:
DISPlay:SWEEp<i>:A|B:LABel:AUTO ON
DISPlay:FFT<i>:A|B:LABel:AUTO ON
DISPlay:WAVEform<i>:A|B:LABel:AUTO ON
DISPlay:BARgraph<i>:A|B:LABel:AUTO ON
DISPlay:PESQ<i>:A|B:LABel:AUTO ON
    
```



A user-definable label appears on the Y axis of the graphical display.



Here rotated by 90°.

Remote-control command:

```
DISPlay:SWEEp<i>:A|B:LABEL:AUTO OFF
DISPlay:FFT<i>:A|B:LABEL:AUTO OFF
DISPlay:WAVEform<i>:A|B:LABEL:AUTO OFF
DISPlay:BARgraph<i>:A|B:LABEL:AUTO OFF
DISPlay:PESQ<i>:A|B:LABEL:AUTO OFF
```

```
DISPlay:SWEEp<i>:A|B:LABEL:USER
'string'
DISPlay:FFT<i>:A|B:LABEL:USER 'string'
DISPlay:WAVEform<i>:A|B:LABEL:USER
'string'
DISPlay:BARgraph<i>:A|B:LABEL:USER
'string'
DISPlay:PESQ<i>:A|B:LABEL:USER
'string'
```

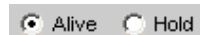

Used to enable or freeze the display of new measurement values for Trace A or Trace B.

**Alive** New measurement values are displayed, see section *"Measurement value sequences"* on page 4.580.

```
Remote-control command:
DISPlay:SWEEp<i>:A|B:UPDATE ALIVE
DISPlay:FFT<i>:A|B:UPDATE ALIVE
DISPlay:WAVEform:A|B:UPDATE ALIVE
DISPlay:BARgraph<i>:A|B:UPDATE ALIVE
DISPlay:PESQ<i>:A|B:UPDATE ALIVE
```

**Hold** The last trace remains in the display, see section *"Measurement value sequences"* on page 4.580.

```
Remote-control command:
DISPlay:SWEEp<i>:A|B:UPDATE HOLD
DISPlay:FFT<i>:A|B:UPDATE HOLD
DISPlay:WAVEform:A|B:UPDATE HOLD
DISPlay:BARgraph<i>:A|B:UPDATE HOLD
DISPlay:PESQ<i>:A|B:UPDATE HOLD
```

**Reference**

Used to select the reference for referenced units (e.g. dBr, V/Vr or  $\Delta$ Hz) for Trace A or Trace B. Can be a single integer value or a reference trace. The reference can be a sequence of measurement values, the current generator frequency or voltage, or it can be loaded from a file (e.g. as a reference trace).

The reference value applies to all integer values in the trace, i.e. measurement values, top, bottom and limit values, as well as to all scans of a trace. The same reference value thus applies to all scans.

The "Reference" setting line will be hidden, if you select the function measurement result under Y source by using Funct Ch1 | Funct Ch2 and if an intermodulation measurement is set in the analyzer function panel. Intermodulation measurement results are measurement results that have already been referenced and cannot be referenced again.

---

***Available in the graphics subsystems***  
*Sweep, FFT, Waveform, Bargraph*

---



**Meas Panel**

The reference value from the associated measurement function configuration panel is used.

Example:

The additional measurement function Input Monitor = Peak is activated in the analyzer panel:

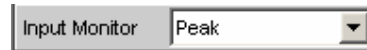

In the Sweep Graph1 graphic system, the result of the Input Peak measurement for channel 1 is selected as the source for Trace A:



The measurement results of the additional measurement function "Input Monitor Peak" are therefore plotted as Trace A on the Y1 axis.

In the Input Config panel, the reference value for the additional measurement function is set to 0.2222 V.

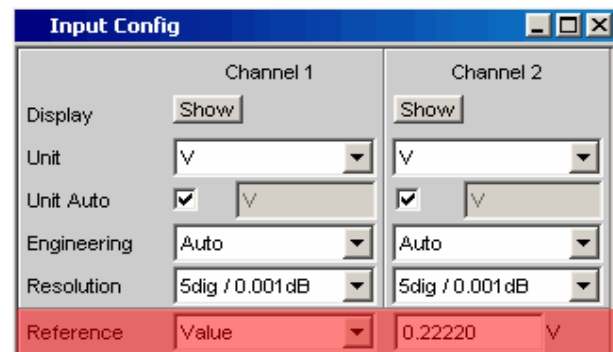

If Reference is now set to Meas Panel,

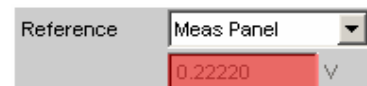

the reference value from the Input Config panel is entered here and used if referenced units are selected.

This transfer of the reference value allows, in the case of **referenced units**, to compare measured values in the numerical display field or the combined display (Combi display) with measured values in the graphical display.

**Available in the graphics subsystems**

*Sweep, FFT, Bargraph*

```
Remote-control command:
DISPlay:SWEep<i>:A|B:REFErence
MEASpanel
DISPlay:FFT<i>:A|B:REFErence MEASpanel
DISPlay:BARgraph<i>:A|B:REFErence
MEASpanel
```

<b>Value</b>	<p>A numeric value with unit must be entered as the reference value in the parameter field below.</p> <p>Remote-control command:          DISPlay:SWEep&lt;i&gt;:A B:REFerence VALue          DISPlay:FFT&lt;i&gt;:A B:REFerence VALue          DISPlay:WAVEform:A B:REFerence VALue          DISPlay:BARgraph&lt;i&gt;:A B:REFerence VALue</p>
<b>Max</b>	<p>The maximum Y value of the measurement sequence is actuated once as the reference value. The display then returns to Value and the maximum Y value is displayed as the new reference value in the parameter field below.</p> <p>Remote-control command:          DISPlay:SWEep&lt;i&gt;:A B:REFerence MAXimum          DISPlay:FFT&lt;i&gt;:A B:REFerence MAXimum          DISPlay:BARgraph&lt;i&gt;:A B:REFerence MAXimum</p>
<b>* Cursor</b>	<p>The Y value of the * Cursor is actuated once as the reference value. The display then returns to Value and the Y value of the * Cursor is displayed as the new reference value in the parameter field below.</p> <p>Remote-control command:          DISPlay:SWEep&lt;i&gt;:A B:REFerence XCURsor          DISPlay:FFT&lt;i&gt;:A B:REFerence XCURsor          DISPlay:BARgraph&lt;i&gt;:A B:REFerence XCURsor</p>
<b>o Cursor</b>	<p>The Y value of the o Cursor is actuated once as the reference value. The display then returns to Value and the Y value of the o Cursor is displayed as the new reference value in the parameter field below.</p> <p>Remote-control command:          DISPlay:SWEep&lt;i&gt;:A B:REFerence OCURsor          DISPlay:FFT&lt;i&gt;:A B:REFerence OCURsor          DISPlay:BARgraph&lt;i&gt;:A B:REFerence OCURsor</p>
<b>Ref 997 Hz</b>	<p>The Y value at 997 Hz is actuated once as the reference value. The display then returns to Value and the Y value at 997 Hz is displayed as the new reference value in the parameter field below. If the X axis is not a frequency axis (e.g. in the case of level sweeps or waveform displays), an error message is displayed and the reference value remains unchanged.</p> <p>Remote-control command:          DISPlay:SWEep&lt;i&gt;:A B:REFerence REF997          DISPlay:FFT&lt;i&gt;:A B:REFerence REF997          DISPlay:BARgraph&lt;i&gt;:A B:REFerence REF997</p>

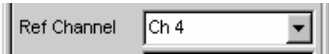
<b>Ref 1000 Hz</b>	<p>As for Ref 997 but with 1000 Hz</p> <p>Remote-control command:  DISPlay:SWEp&lt;i&gt;&lt;/i&gt;:A B:REFEreNce REF1000  DISPlay:FFt&lt;i&gt;&lt;/i&gt;:A B:REFEreNce REF1000  DISPlay:BARgraph&lt;i&gt;&lt;/i&gt;:A B:REFEreNce REF1000</p>
<b>Meas Ref Ch</b>	<p>This selection option is only displayed for multichannel instruments. Every level measurement result of the channel specified in the Analyzer Config panel under Ref Channel is saved as a reference value.</p>  <p>If a reference-specific unit was selected in the "Unit" parameter field, the measurement result is referenced to this floating reference value and displayed.</p>
<b>Meas Ch1</b>	<p>Each level measurement value of channel 1 is stored as reference value and is used for referenced display, provided you have selected a referenced unit. These selection choices are only available for two-channel measurement.</p> <p>Remote-control command:  DISPlay:SWEp&lt;i&gt;&lt;/i&gt;:A B:REFEreNce CH1Meas  DISPlay:FFt&lt;i&gt;&lt;/i&gt;:A B:REFEreNce CH1Meas  DISPlay:BARgraph&lt;i&gt;&lt;/i&gt;:A B:REFEreNce CH1Meas</p>
<b>Meas Ch2</b>	<p>As for Meas Ch1 but with channel 2</p> <p>Remote-control command:  DISPlay:SWEp&lt;i&gt;&lt;/i&gt;:A B:REFEreNce CH2Meas  DISPlay:FFt&lt;i&gt;&lt;/i&gt;:A B:REFEreNce CH2Meas  DISPlay:BARgraph&lt;i&gt;&lt;/i&gt;:A B:REFEreNce CH2Meas</p>
<b>Gen Track</b>	<p>The reference trace is deleted and the currently applicable generator voltage, and then each newly set generator voltage, is used as the reference value.</p> <p>Remote-control command:  DISPlay:SWEp&lt;i&gt;&lt;/i&gt;:A B:REFEreNce GENTrack  DISPlay:FFt&lt;i&gt;&lt;/i&gt;:A B:REFEreNce GENTrack  DISPlay:BARgraph&lt;i&gt;&lt;/i&gt;:A B:REFEreNce GENTrack</p>

**File** The reference trace is loaded from a file. The file name is entered in the parameter field below, see section "Measurement value sequences" on page 4.580.

```
Remote-control command:
DISPlay:SWEEp<i>:A|B:REFerence FILE
DISPlay:FFT<i>:A|B:REFerence FILE
DISPlay:BARgraph<i>:A|B:REFerence FILE
```

**File Intern** "File Intern" has to be offered and displayed only if "File: Trace A or File: Trace B is set at "Y-Source" and a trace file containing a reference value scan in addition to the data scan is loaded.

```
Remote-control command:
DISPlay:SWEEp<i>:A|B:REFerence IFILE
DISPlay:FFT<i>:A|B:REFerence IFILE
DISPlay:BARgraph<i>:A|B:REFerence IFILE
```

**Noise Density** Noise density measurement.

Offered only in the FFT subsystem.

If you perform an FFT analysis via a noise signal, the level of a bin will change with respect to its width. The width of a bin, which is also called analysis bandwidth, depends on the FFT size. Thus, the level of a bin changes with respect to the FFT size.

To relativize this effect, i.e. to become independent of the actual analysis bandwidth, you calculate the noise density. This is the noise power that would occur in an intended analysis bandwidth of 1 Hz. The noise density depends on the FFT window. When calculating the noise density, the set window is taken into consideration to eliminate the effect of the window.

Thus, the noise-density measurement is not an independent measurement function but a referenced level display, based on the relative unit  $V/V_r$ .

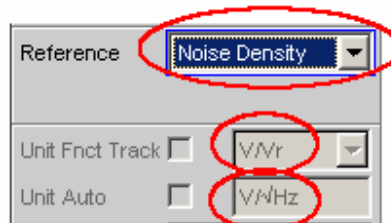

In the FFT graphic, the result is displayed in the usual  $V/\sqrt{\text{Hz}}$  unit.

```
Remote-control command:
DISPlay:FFT<i>:A|B:REFerence
NOISedensity
```

**Hold**

No further changes are made to the reference value or reference trace.

If a trace file having a reference value or reference trace is loaded, the reference values from the file have no effect, and the reference value or reference trace last set is used.

If a floating reference value (Meas Ch1, Meas Ch2 or Gen Track) was set before the switchover to "Hold", this reference trace is used.

If "Hold" is selected in the absence of any valid reference trace data, a warning is issued and the last chosen valid reference is set again.

Remote-control command:

```
DISPlay:SWEEp<i>:A|B:REFerence HOLD
```

```
DISPlay:FFT<i>:A|B:REFerence HOLD
```

```
DISPlay:WAVEform:A|B:REFerence HOLD
```

```
DISPlay:BARgraph<i>:A|B:REFerence HOLD
```

## Reference Value

Reference	Value
	0.00000 V

Reference value with unit for the reference parameter Value.

Regardless of the graphic system, the value range allows the value 0 V or negative values to be entered. A reference value of 0 V or a negative reference value makes good sense for display units such as  $\Delta V$  or  $\Delta W$ , but causes problems in the case of logarithmic units such as dBr and in the case of units that have the reference value in the denominator, such as  $V/V_r$ .

To get round these problems, a reference value around 0.0 (or more exactly: between  $-1.0E-12$  and  $0.0 E-12$ ) is always computed using the value  $1.0E-12$ .

Negative reference values  $< -1.0E-12$  are computed using their magnitude, that is, they are made into positive values.

As a result, trace displays in the referenced unit dBr, for instance, at a reference value of 0.0 V have very high values for the upper limit, since the trace data is computed within the R&S UPV using the reference value  $1.0E-12$ .

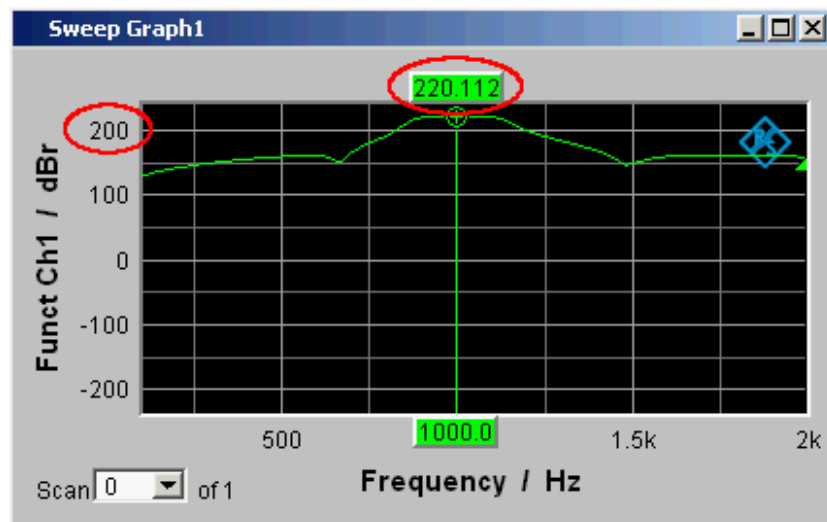

**Available in the graphics subsystems**  
Sweep, FFT, Waveform, Bargraph

Remote-control command:

DISPlay:SWEEp<i>:A|B:REFerence:VALue <nu>

DISPlay:FFT<i>:A|B:REFerence:VALue <nu>

DISPlay:WAVEform:A|B:REFerence:VALue <nu>

DISPlay:BARgraph<i>:A|B:REFerence:VALue <nu>

**Reference File**



File name for the reference parameter File.

---

**Available in the graphics subsystems**  
*Sweep, FFT, Waveform, Bargraph*

---

Remote-control command:  
 DISPlay:SWEEp<i>:A|B:REFerence FILE 'filename'  
 DISPlay:FFT<i>:A|B:REFerence FILE 'filename'  
 DISPlay:BARgraph<i>:A|B:REFerence FILE 'filename'

**Normalize**

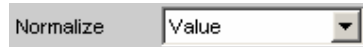

If a referenced unit (e.g. dBr or V/Vr) and a floating reference value, as in Reference = Meas Ch1, Meas Ch2, Gen Track, or a reference trace held in a file, as in "File" or "File Intern", are used, the displayed trace is normalized with the aid of the above by shifting the whole curve, that is, multiplying it by the normalization value.

The normalization value is transferred to all scan data sets; the same normalization value therefore applies to all scans.

The "Normalize" setting line will be hidden if you select the function measurement result under Y source by using Funct Ch1 | Funct Ch2 | Function and if an intermodulation measurement is set in the analyzer function panel. Intermodulation measurement results are measurement results that have already been referenced and cannot be referenced again.

---

**Available in the graphics subsystems**  
*Sweep, FFT, Bargraph*

---

Remote-control command:  
 DISPlay:SWEEp<i>:A|B:NORMAlize OFF | VALue | OCURsor | XCURsor  
 DISPlay:FFT<i>:A|B:NORMAlize OFF | VALue | OCURsor | XCURsor  
 DISPlay:BARgraph<i>:A|B:NORMAlize OFF | VALue | OCURsor | XCURsor

- OFF** Normalization is deactivated.
- Value** Fixed normalization value which is entered as a multiplication factor or a dB value in the parameter field below.
- o Cursor** The trace is normalized once only at the o cursor to 0 dBr or V/Vr = 1. For this purpose, the referenced trace value is read out and the reciprocal value is entered in the parameter field below. The parameter then changes back to VALUE.
- \* Cursor** As for the o cursor.

## Normalize Value



Used to enter a fixed normalization value as a factor.  
This value applies to all scans.

**Available in the graphics subsystems**  
*Sweep, FFT, Bargraph*

Remote-control command:

DISPlay:SWEEp<i>:A|B:NORMAlize:VALue <nu>

DISPlay:FFT<i>:A|B:NORMAlize:VALue <nu>

DISPlay:BARgraph<i>:A|B:NORMAlize:VALue <nu>

## Unit Fnc Track

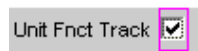

Used to determine whether the unit is the same as that set in the analyzer or whether it can be user-selected. This parameter field is displayed only for graphics systems that are referenced to the measurement function in the analyzer and whose display unit can be set in the corresponding Config panel.

Example 1:

In the sweep subsystem, "y-source" is set to "Funct Ch1".

In the Analyzer panel, RMS has been set as measurement function for which dBV has been selected as the unit in the Function Config panel.

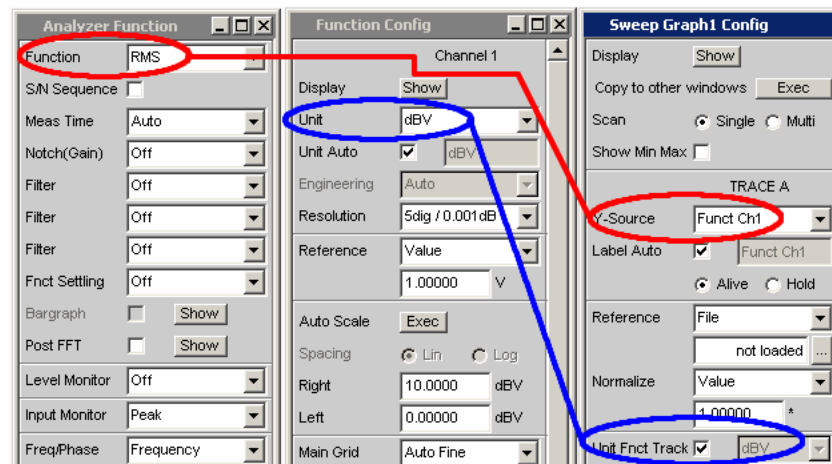

The dBV display unit for the RMS measurement function can be transferred to the Display panel if "Unit Fnc Track" is enabled.

Example 2:

For the additional measurement function Waveform, there is no individually assigned unit that may be set in a Config panel. Thus, no unit can be transferred from the analyzer for the Waveform graphics subsystem and the check box for Unit Fnc Track is not offered here.

**Available in the graphics subsystems**  
*Sweep, FFT, Bargraph*



 Unit Fnct Track  dBV

The unit selected in the analyzer is used for the measurement data displayed on the Y axis and for the displayed top, bottom and limit values. It is displayed in grey (cannot be accessed) next to the tick box and also on the Y axis of the graphical display.

If a logarithmic unit (dBu, dBV, dBr, dBm, dBFS or dBUI) appears here, the parameter field below (Spacing) cannot be accessed and its parameter is set to Lin (it would be pointless to display measurement values with a logarithmic unit on an axis with logarithmic spacing).



Here rotated by 90°.

The unit which appears here depends on the parameter selected under Trace A or Trace B e.g. "Level Ch1", "Phase Ch1" and on the analyzer instrument e.g. "Analog" or Digital Audio.

In the event of changing between similar units (e.g. dBu → dBV → dBm → dBr) a new value is computed for the subsequent parameter fields "Top", "Bottom", "Main Grid Steps", "Limit Lower Value", "Limit Upper Value", "Limit Shift Parallel", "Limit Shift Symmetrical"; in the event of changing between different units (e.g. dBV → W) a value entered earlier is retrieved.

Remote-control command:

DISPlay:SWEEp<i>:A|B:UNIT:TRACk ON

DISPlay:FFT<i>:A|B:UNIT:TRACk ON

DISPlay:BARgraph<i>:A|B:UNIT:TRACk ON



The unit can be user-selected from the list of available parameters.  
 If a logarithmic unit (dBu, dBV, dBr, dBm, dBFS or dBUI) is selected here, the parameter field below (Spacing) cannot be accessed and its parameter is set to Lin (it would be pointless to display measurement values with a logarithmic unit on an axis with logarithmic spacing).

```
Remote-control command:
DISPlay:SWEEp<i>:A|B:UNIT:TRACk OFF
DISPlay:FFT<i>:A|B:UNIT:TRACk OFF
DISPlay:BARgraph<i>:A|B:UNIT:TRACk OFF
```

## Unit



This parameter field without the "Unit Funct Track" (see above) is displayed only for the graphic system Waveform, since this additional measurement function is independent of a function setting in the analyzer and even deliver measurement results when the measurement function is turned off. Therefore tracking the unit of the measurement function is meaningless.

The list of units offered at this point is dependent on whether the analog or digital analyzer is selected and in the digital case, on whether the Meas Mode = Audio Data, Jitter/Phase and Common/Input.

The unit can be user-selected from the parameter list.  
 If a logarithmic unit (dBu, dBV, dBr, dBm, dBFS, dBUI) is selected, or linear units in which negative numbers can occur (e.g.  $\Delta V$ ,  $\Delta W$ ), the following parameter field "Spacing" is displayed as not user-accessible and its parameter is set to Lin, since it makes no sense / is not possible to display measurement values with a logarithmic unit or negative values on a logarithmically scaled axis.

In the event of changing between similar units (e.g. dBu  $\rightarrow$  dBV  $\rightarrow$  dBm  $\rightarrow$  dBr) a new value is computed for the subsequent parameter fields

"Top", "Bottom",  
 "Main Grid Steps",  
 "Limit Lower Value", "Limit Upper Value",  
 "Limit Shift Parallel", "Limit Shift Symmetrical";

in the event of changing between different units (e.g. dBV  $\rightarrow$  W) a value entered earlier is retrieved.

---

### **Available in the graphics subsystems**

*Sweep, FFT, Waveform, Bargraph*

---

```
Remote-control command:
DISPlay:SWEEp<i>:A|B:UNIT V | DBV | DBU ...
DISPlay:FFT<i>:A|B:UNIT V | DBV | DBU ...
DISPlay:WAVEform:A|B:UNIT V | DBV | DBU ...
DISPlay:BARgraph<i>:A|B:UNIT V | DBV | DBU ...
```

Unit Auto

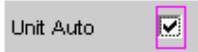

Used to determine whether the unit label displayed on the Y axis for Trace A or Trace B is the same as the unit set in the "Unit Funct Track" or "Unit" parameter field or whether it can be user-selected.

**Available in the graphics subsystems**

Sweep, FFT, Waveform, Bargraph



The unit label displayed on the Y axis for Trace A or Trace B is the same as the unit set in the "Unit Funct Track" or "Unit" parameter field and is therefore generated automatically by the R&S UPV.

Remote-control command:

```
DISPlay:SWEEp<i>:A|B:UNIT AUTO ON
DISPlay:FFT<i>:A|B:UNIT AUTO ON
DISPlay:WAVEform:A|B:UNIT AUTO ON
DISPlay:BARgraph<i>:A|B:UNIT AUTO ON
```



A user-defined unit label can be entered.

**Practical example:**

The output level  $U_{0dBspl}$  which is output at a sound pressure of 0 dBspl (spl = sound pressure level) is specified for high-quality microphones. If the measured microphone output level is displayed in the referenced unit dBr and entered for the reference value  $U_{0dBspl}$ , the level displayed on the R&S UPV will be in dBr but corresponds to the sound pressure in dBspl. In the graphical display, however, an axis label in dBspl is desirable. To allow this, the unit label can be changed from dBr to dBspl.

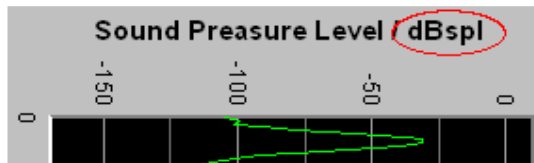

Here rotated by 90°.

Remote-control command:

```
DISPlay:SWEEp<i>:A|B:UNIT AUTO OFF
DISPlay:FFT<i>:A|B:UNIT AUTO OFF
DISPlay:WAVEform:A|B:UNIT AUTO OFF
DISPlay:BARgraph<i>:A|B:UNIT AUTO OFF
```

Unit User String



User-defined unit designation if Unit Auto is not selected. The specified designation appears on the Y-axis label instead of the usual units.

---

**Available in the graphics subsystems**  
Sweep, FFT, Waveform, Bargraph

---

```
Remote-control command:
DISPlay:SWEEp<i></i>:A|B:UNIT:USER 'string'
DISPlay:FFT<i></i>:A|B:UNIT:USER 'string'
DISPlay:WAVEform:A|B:UNIT:USER 'string'
DISPlay:BARgraph<i></i>:A|B:UNIT:USER 'string'
```

Engineering



Conversion of the Trace A or Trace B-related cursor and scaling values in the graphical display by a factor of 1000. This parameter field cannot be accessed if a dB or % unit is selected in the "Unit Funct Track" or "Unit" parameter field above since these units do not have an engineering function.

---

**Available in the graphics subsystems**  
Sweep, FFT, Waveform, Bargraph

---

**Auto**

Automatic engineering assignment from p to M. The cursor and scaling values are displayed **with** the engineering symbol. The Y axis is labelled with the unit **without** engineering.

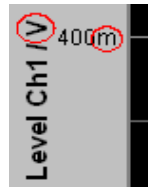

**Off**

Engineering is deactivated. Values are always displayed in 1.0 E<sup>0</sup> format.

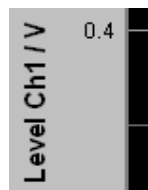

$\mu$	Engineering fixed to $\mu$ , m or k.
m	
k	The cursor and scaling values are displayed <b>without</b> engineering symbol. The Y axis is labelled <b>with</b> engineering and unit.

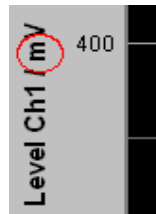

### Auto Scale

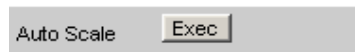

One-off automatic scaling of the Y axes for Trace A or Trace B.

---

**Available in the graphics subsystems**  
Sweep, FFT, Waveform, Bargraph, PESQ

---

<b>Exec</b>	Clicking this button triggers a <b>one-off</b> scaling process which uses the minimum and maximum values of the existing measurement sequence for TRACE A or TRACE B. The end values of the new scaling are approx. 5% less or greater than the exact values. The determined values are entered in the Top and Bottom parameter fields below. If the "Track" tick box is enabled for this range, then using "Exec" causes automatic scaling of both Y axes in trace A, taking the highest maximum value and the lowest minimum value of <b>both</b> traces into account. If the Min/Max curves are switched on, these are used for the autoscaling.
-------------	---

### Spacing



Linear or logarithmic spacing of the Y axis for Trace A or Trace B.

For logarithmic units (dB units) and linear units in which negative numbers can occur (e.g.  $\Delta V$ ,  $\Delta W$ ), this parameter field is displayed as not user-accessible and is set to "Lin", since it would be pointless to display dB values or negative values logarithmically.

---

**Available in the graphics subsystems**  
Sweep, FFT, Waveform, Bargraph, PESQ

---

**Lin** Linear spacing of the Y axis.  
If a logarithmic unit (dB unit) has been selected in the "Unit Fnct Track" line, this line is displayed as not user-accessible and its parameter is set to "Lin", since it would be pointless to display measured values with a logarithmic unit on an axis with logarithmic spacing.

```
Remote-control command:
DISPlay:SWEEP<i>:A|B:SPACing LINear
DISPlay:FFT<i>:A|B:SPACing LINear
DISPlay:WAVEform:A|B:SPACing LINear
DISPlay:BARgraph<i>:A|B:SPACing LINear
DISPlay:PESQ<i>:A|B:SPACing LINear
```

**Log** Logarithmic spacing of the Y axis.  
  
This parameter is available only if in the "Unit Fnct Track" line a linear unit has been selected whose value range cannot contain any negative numbers (e.g. V, W, etc).

Example:  
 $\Delta V$  is a linear unit, yet measured values obtained with this unit may be negative, which means that logarithmic spacing is not possible.

```
Remote-control command:
DISPlay:SWEEP<i>:A|B:SPACing
LOGarithmic
DISPlay:FFT<i>:A|B:SPACing LOGarithmic
DISPlay:WAVEform:A|B:SPACing
LOGarithmic
DISPlay:BARgraph<i>:A|B:SPACing
LOGarithmic
DISPlay:PESQ<i>:A|B:SPACing
LOGarithmic
```

**Top**

Top  dBu

Used to set the top value of the Y axis for Trace A or Trace B.

If Auto Scale has been triggered, the value is reset on the basis of the current trace data.

Negative values or the value 0.00000 are not permitted if Spacing is set to Log.

---

**Available in the graphics subsystems**  
*Sweep, FFT, Waveform, Bargraph, PESQ*

---

```
Remote-control command:
DISPlay:SWEEP<i>:A|B:TOP <nu>
DISPlay:FFT<i>:A|B:TOP <nu>
DISPlay:WAVEform:A|B:TOP <nu>
DISPlay:BARgraph<i>:A|B:TOP <nu>
DISPlay:PESQ<i>:A|B:TOP <nu>
```

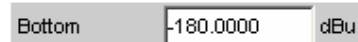
**Bottom**

Used to set the bottom value of the Y axis for Trace A or Trace B.

If Auto Scale has been triggered, the value is reset on the basis of the current trace data.

This value must always be lower than the top value.  
Negative values or the value 0.0000 are not permitted if Spacing is set to Log.

---

**Available in the graphics subsystems**  
*Sweep, FFT, Waveform, Bargraph, PESQ*

---

Remote-control command:  
 DISPlay:SWEep<i>:A|B:BOTTom <nu>  
 DISPlay:FFT<i>:A|B:BOTTom <nu>  
 DISPlay:WAVEform:A|B:BOTTom <nu>  
 DISPlay:BARgraph<i>:A|B:BOTTom <nu>  
 DISPlay:PESQ<i>:A|B:BOTTom <nu>

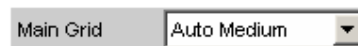
**Main Grid**

Division of the graphical display with horizontal main gridlines.

---

**Available in the graphics subsystems**  
*Sweep, FFT, Waveform, Bargraph, PESQ*

---

- |                    |   |
|--------------------|---|
| <b>Off</b>         | No main gridlines are used in the graphical display.  |
| <b>On</b>          | With Spacing = Log:<br>Decadic division of a <b>logarithmically</b> divided Y axis with the aid of main gridlines.  |
| <b>Auto Coarse</b> | With Spacing = Lin:   |
| <b>Auto Medium</b> | Coarse, medium or fine division of a Y axis with main gridlines. One or two, 3 or 4, 8 or 9 main gridlines are displayed depending on the scale end values.   |
| <b>Auto Fine</b>   | Main gridlines may be <b>hidden</b> if the graphical window is reduced in size.   |
| <b>Divisions</b>   | With Spacing = Lin:<br>Preset division of a Y axis with main gridlines.<br>The desired number of divisions is set in the parameter field below.<br>These main gridlines are <b>not</b> hidden if the graphical window is reduced in size. |
| <b>Steps</b>       | With Spacing = Lin:<br>Preset division of a Y axis in a fixed step size.<br>The step size is set in the parameter field below.<br>These main gridlines are <b>not</b> hidden if the graphical window is reduced in size.                  |

**Division**

With Spacing = Lin:

Main Grid Divisions  
20

Used to enter the number of main gridline divisions for a Y axis. If, for example, **2** is entered, the Y axis is divided into **two sections**, i.e. **one** main gridline is displayed.

**Available in the graphics subsystems**

Sweep, FFT, Waveform, Bargraph, PESQ

**Steps**

With Spacing = Lin:

Main Grid Steps  
10.00000 dBV

Used to enter the main gridline step size for a Y axis.

**Available in the graphics subsystems**

Sweep, FFT, Waveform, Bargraph, PESQ

**Sub Grid**

Sub Grid 2

Subdivision of the main gridlines in a graphical display using subgridlines.

**Available in the graphics subsystems**

Sweep, FFT, Waveform, Bargraph, PESQ

**Off**

Subgridlines are deactivated.

**2**

With Spacing = Lin:

**4**

Subdivision of the main gridlines of a Y axis into 2, 4 or 5 sections.

**5**

If, for example, **2** is selected, the area between two main gridlines is divided into **2** sections, i.e. **one** subgridline appears between the main gridlines. These subgridlines are **not** hidden if the graphical window is reduced in size.



**Coarse**  
**Fine**

With Spacing = Log:  
Coarse or fine subdivision of the main gridlines of a Y axis with subgridlines.

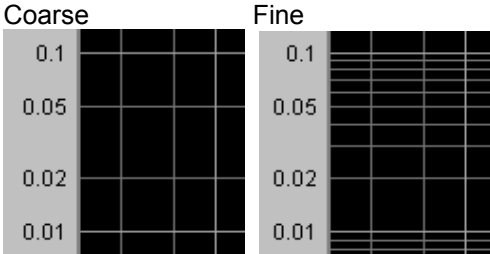

Only  
subgridlines  
2 and 5

All  
subgridlines

## Limit Upper

Limit Upper

It is possible to define for a measurement an upper limit / limit curve, such that each measured value is compared with the upper limit or limit curve. The limit / limit curve is plotted in red in the co-ordinate system of the graphical display.

Limit violations are marked by red dots on a curve or by red bars on a bargraph.

The **upward**-pointing arrow in the bottom right-hand corner of the graphical display indicates **overranging** of the **upper** limit or the limit line.

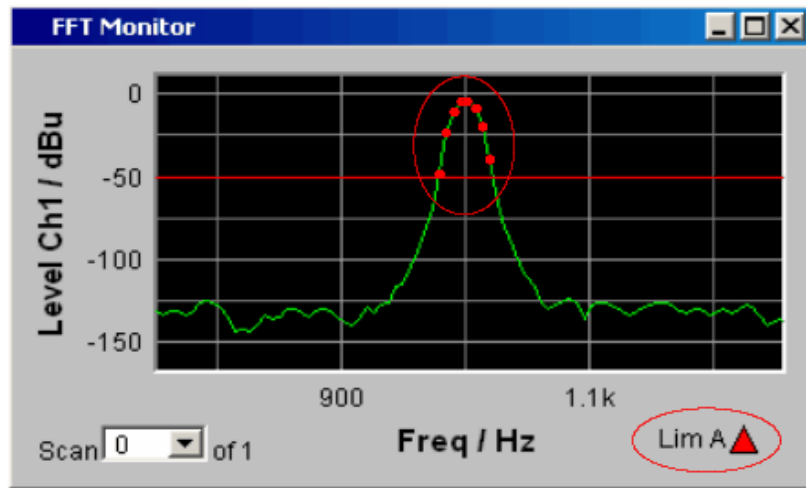

See section "Graphical Display, Explanation of the Elements", page 4.547 for the meaning of the limit violation symbols.

Pressing the **START** key causes the existing limit overranging to be reset and new violations to be recorded.

---

**Available in the graphics subsystems**

Sweep, FFT, Waveform, Bargraph, PESQ

---

Remote-control command:

```
DISPlay:SWEEP<i>:A|B:LIMUpper ON | OFF
DISPlay:FFT<i>:A|B:LIMUpper ON | OFF
DISPlay:WAVEform:A|B:LIMUpper ON | OFF
DISPlay:BARgraph<i>:A|B:LIMUpper ON | OFF
DISPlay:PESQ<i>:A|B:LIMUpper ON | OFF
```

## Source

Source

Used to determine how the upper limit is set.

---

**Available in the graphics subsystems**

Sweep, FFT, Waveform, Bargraph, PESQ

---

Value

Source	Value	▼
	10.0000	mFS

**Available in the graphics subsystems***Sweep, FFT, Waveform, Bargraph, PESQ*

A fixed limit can be entered (Source must be set to Value).

In the parameter field below, an upper limit constant for all X values is entered in the unit which has been selected in the Unit Funct Track parameter field. If a relative unit is selected, the associated reference value (a few parameter fields higher up) is used. All scans of a trace (except the Min/Max scans) are compared to this common limit and the limit violations are marked.

Remote-control command:

```
DISPlay:SWEEP<i>:A|B:LIMUpper:SOURce
VALue
DISPlay:SWEEP<i>:A|B:LIMUpper:SOURce
VALue <nu>
```

```
DISPlay:FFT<i>:A|B:LIMUpper:SOURce
VALue
DISPlay:FFT<i>:A|B:LIMUpper:SOURce
VALue <nu>
```

```
DISPlay:WAVEform:A|B:LIMUpper:SOURce
VALue
DISPlay:WAVEform:A|B:LIMUpper:SOURce
VALue <nu>
```

```
DISPlay:BARgraph<i>:A|B:LIMUpper:SOURc
e VALue
DISPlay:BARgraph<i>:A|B:LIMUpper:SOURc
e VALue <nu>
```

```
DISPlay:PESQ<i>:A|B:LIMUpper:SOURce
VALue
DISPlay:PESQ<i>:A|B:LIMUpper:SOURce
VALue <nu>
```

## File

**Available in the graphics subsystems**

Sweep, FFT, Bargraph, PESQ

Limits are checked by using a limit file.

The name of the limit file is entered in the parameter field below.

This limit file contains reference values for a limit curve in a special format.

Each new scan interpolates the entries in the limit file to the X values of the scan.

All scans of a trace (except the Min/Max scans) are compared to this common limit curve and the limit violations are marked.

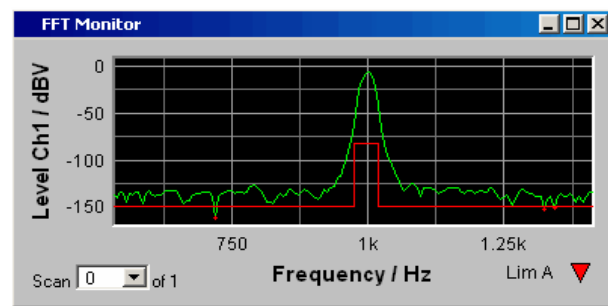

Remote-control command:

```
DISPlay:SWEEP<i>:A|B:LIMUpper:SOURce
FILE
```

```
DISPlay:FFT<i>:A|B:LIMUpper:SOURce
FILE
```

```
DISPlay:BARgraph<i>:A|B:LIMUpper:SOURce
FILE
```

```
DISPlay:PESQ<i>:A|B:LIMUpper:SOURce
FILE
```

**File Intern**

"File Intern" has to be offered and displayed only if "File: Trace A or File: Trace B is set at "Y-Source" and a trace file containing a limit scan in addition to the data scans is loaded.

The Limit Upper curve from the trace file is displayed in the graph and all scans are compared to this limit curve (except the Min/Max scans).

Remote-control command:

```
DISPlay:SWEEP<i>:A|B:LIMUpper:SOURce
IFILE
```

```
DISPlay:FFT<i>:A|B:LIMUpper:SOURce
IFILE
```

```
DISPlay:BARgraph<i>:A|B:LIMUpper:SOURce
IFILE
```

```
DISPlay:PESQ<i>:A|B:LIMUpper:SOURce
IFILE
```

**Hold** The limit value or limit trace is no longer changed. If a trace file is loaded with limit value or limit trace, the limit values from the file are not applied but instead, the previously set limit value or limit trace is used.

If "Hold" is selected without valid limit trace data already being present, a warning is issued and the last valid Limit selection is reset.

```
Remote-control command:
DISPlay:SWEEP<i>:A|B:LIMUpper:SOURce
HOLD
DISPlay:FFT<i>:A|B:LIMUpper:SOURce
HOLD
DISPlay:WAVEform:A|B:LIMUpper:SOURce
HOLD
DISPlay:BARgraph<i>:A|B:LIMUpper:SOURce
HOLD
DISPlay:PESQ<i>:A|B:LIMUpper:SOURce
HOLD
```

### Source Value

Upper limit value if "Value" has been selected under "Source".

---

#### **Available in the graphics subsystems** Sweep, FFT, Waveform, Bargraph, PESQ

---

```
Remote-control command:
DISPlay:SWEEP<i>:A|B:LIMUpper:SOURce:VALue <nu>
DISPlay:FFT<i>:A|B:LIMUpper:SOURce:VALue <nu>
DISPlay:WAVEform:A|B:LIMUpper:SOURce:VALue <nu>
DISPlay:BARgraph<i>:A|B:LIMUpper:SOURce:VALue <nu>
DISPlay:PESQ<i>:A|B:LIMUpper:SOURce:VALue <nu>
```

### Source Filename

File name for an upper limit curve if "File" has been selected under "Source".

---

#### **Available in the graphics subsystems** Sweep, FFT, Bargraph, PESQ

---

```
Remote-control command:
DISPlay:SWEEP<i>:A|B:LIMUpper:SOURce:FILE
'filename'
DISPlay:FFT<i>:A|B:LIMUpper:SOURce:FILE 'filename'
DISPlay:BARgraph<i>:A|B:LIMUpper:SOURce:FILE
'filename'
DISPlay:PESQ<i>:A|B:LIMUpper:SOURce:FILE 'filename'
```

## Limit Lower

Limit Lower 

A lower limit / limit curve can be defined for the measurement, whereby each measurement value is compared with the limit / limit curve. The limit / limit curve is plotted in red in the co-ordinate system of the graphical display.

Limit violations are marked by red dots on a curve or by red bars on a bargraph.

The **downward**-pointing arrow in the bottom right-hand corner of the graphical display indicates **underranging** of the lower limit or the limit line.

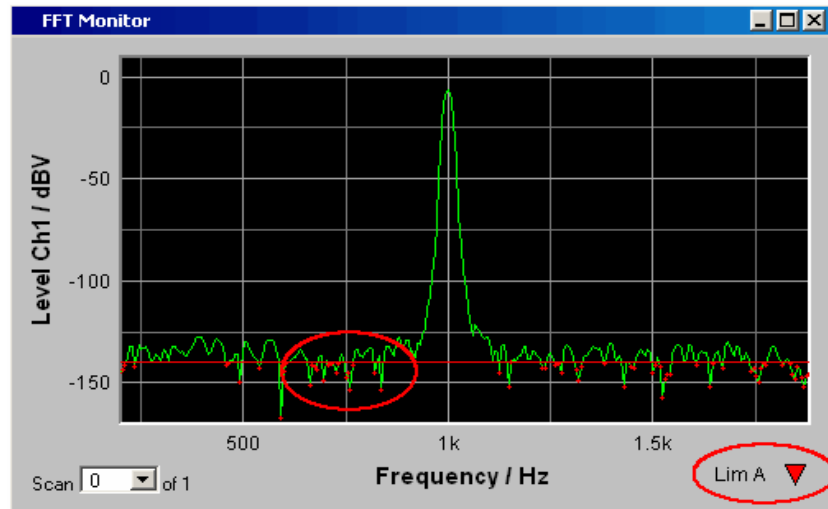

Pressing the **START** key causes the existing limit underranging to be reset and new violations to be recorded.

---

**Available in the graphics subsystems:**  
Sweep, FFT, Waveform, Bargraph, PESQ

---

Remote-control command:

```
DISPlay:Sweep<i>:A|B:LIMLower ON | OFF
DISPlay:FFT<i>:A|B:LIMLower ON | OFF
DISPlay:WAVEform:A|B:LIMLower ON | OFF
DISPlay:BARgraph<i>:A|B:LIMLower ON | OFF
DISPlay:PESQ<i>:A|B:LIMLower ON | OFF
```

## Source

Source Value: 

Used to determine how the lower limit is set.

---

**Available in the graphics subsystems:**  
Sweep, FFT, Waveform, Bargraph, PESQ

---

**Value**

Source	Value	▼
	10.0000	mFS

A fixed limit can be entered (Source must be set to Value).

In the parameter field below, a lower limit constant for all X values is entered in the unit which has been selected in the Unit Funct Track parameter field. If a relative unit is selected, the associated reference value (a few parameter fields higher up) is used.

All scans of a trace are compared to this common limit and the limit violations are marked.

Remote-control command:

```
DISPlay:SWEEP<i>:A|B:LIMLower:SOURce  
VALue
```

```
DISPlay:FFT<i>:A|B:LIMLower:SOURce  
VALue
```

```
DISPlay:WAVEform:A|B:LIMLower:SOURce  
VALue
```

```
DISPlay:BARgraph<i>:A|B:LIMLower:SOURc  
e VALue
```

```
DISPlay:PESQ<i>:A|B:LIMLower:SOURce  
VALue
```

**File**

Available to all graphic systems except Waveform.

Limits are checked by using a limit file.

The name of the limit file is entered in the parameter field below.

This limit file contains reference values for a limit curve in a special format.

Each new scan interpolates the entries in the limit file to the X values of the scan.

All scans of a trace are compared to this common limit curve and the limit violations are marked.

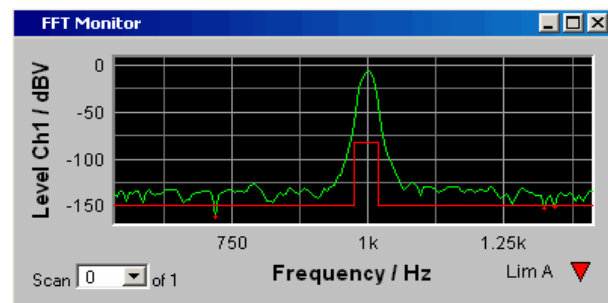

Remote-control command:

```
DISPlay:SWEEP<i>:A|B:LIMLower:SOURce
FILE
```

```
DISPlay:FFT<i>:A|B:LIMLower:SOURce
FILE
```

```
DISPlay:BARgraph<i>:A|B:LIMLower:SOURce
FILE
```

```
DISPlay:PESQ<i>:A|B:LIMLower:SOURce
FILE
```

**File Intern**

"File Intern" has to be offered and displayed only if "File: Trace A or File: Trace B is set at "Y-Source" and a trace file containing limit scans in addition to the data scans is loaded.

The Limit Lower curve from the trace file is displayed in the graph and all scans (except the Min/Max scans) are compared to this limit curve.

Remote-control command:

```
DISPlay:SWEEP<i>:A|B:LIMLower:SOURce
IFILE
```

```
DISPlay:FFT<i>:A|B:LIMLower:SOURce
IFILE
```

```
DISPlay:BARgraph<i>:A|B:LIMLower:SOURce
IFILE
```

```
DISPlay:PESQ<i>:A|B:LIMLower:SOURce
IFILE
```



**Hold** The limit value or limit trace is no longer changed. If a trace file is loaded with limit value or limit trace, the limit values from the file are not applied but instead the previously set limit value or limit trace is used. If "Hold" is selected when no valid limit trace data is already available, a warning is issued and the last valid Limit selection is reset.

Remote-control command:  
 DISPlay:SWEEP<i></i>:A|B:LIMLower:SOURce  
 HOLD  
 DISPlay:FFT<i></i>:A|B:LIMLower:SOURce  
 HOLD  
 DISPlay:WAVEform:A|B:LIMLower:SOURce  
 HOLD  
 DISPlay:BARgraph<i></i>:A|B:LIMLower:SOURce  
 HOLD  
 DISPlay:PESQ<i></i>:A|B:LIMLower:SOURce  
 HOLD

### Source Value

The image shows a graphical user interface element with a label 'Source' on the left. To its right is a dropdown menu currently displaying 'Value'. Below the dropdown is a text input field containing the number '10.0000', followed by a small box containing the unit 'mFS'.

Lower limit value if "Value" has been selected under "Source".

---

**Available in the graphics subsystems:**  
*Sweep, FFT, Waveform, Bargraph, PESQ*

---

Remote-control command:  
 DISPlay:SWEEP<i></i>:A|B:LIMLower:SOURce:VALue <nu>  
 DISPlay:FFT<i></i>:A|B:LIMLower:SOURce:VALue <nu>  
 DISPlay:WAVEform:A|B:LIMLower:SOURce:VALue <nu>  
 DISPlay:BARgraph<i></i>:A|B:LIMLower:SOURce:VALue <nu>  
 DISPlay:PESQ<i></i>:A|B:LIMLower:SOURce:VALue <nu>

## Source Filename



Filename for a lower limit curve if "File" has been selected under "Source".

---

**Available in the graphics subsystems:**

*Sweep, FFT, Bargraph, PESQ*

---

Remote-control command:

```
DISPlay:SWEEP<i>:A|B:LIMLower:SOURce:FILE
'filename'
```

```
DISPlay:FFT<i>:A|B:LIMLower:SOURce:FILE 'filename'
```

```
DISPlay:BARgraph<i>:A|B:LIMLower:SOURce:FILE
'filename'
```

```
DISPlay:PESQ<i>:A|B:LIMLower:SOURce:FILE 'filename'
```

## Limit Shift



Not for the PESQ graphics subsystem.

This enables limit lines or limit curves to be shifted according to the parameters in the subsequent parameter fields "Parallel" and "Symmetrical".

If the Limit Shift function is enabled without activating limit monitoring, the subsequent parameter fields should be regarded as default settings.

---

**Available in the graphics subsystems:**

*Sweep, FFT, Waveform, Bargraph*

---

Remote-control command:

```
DISPlay:SWEEP<i>:A|B:LIMShift ON | OFF
```

```
DISPlay:FFT<i>:A|B:LIMShift ON | OFF
```

```
DISPlay:WAVEform:A|B:LIMShift ON | OFF
```

```
DISPlay:BARgraph<i>:A|B:LIMShift ON | OFF
```

**Parallel**

This enables limit lines or limit curves to be parallel shifted.

In this way limit curves derived from a "golden unit", for example, can be adapted very easily to new circumstances (see section "Editing", on page 4.598).

Parallel  dBV

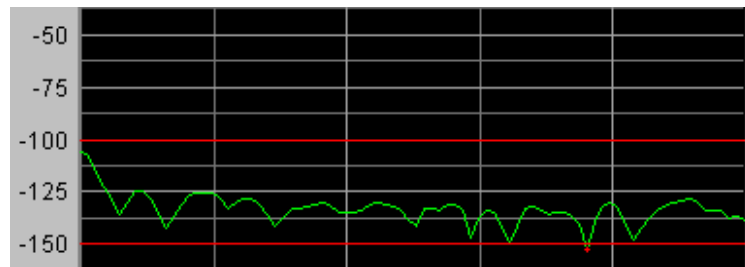

The limit lines, which were determined using -100 dBV and -150 dBV, are to be parallel shifted by a value of 25 dBV to -75 dBV and -125 dBV.

Parallel  dBV



---

**Available in the graphics subsystems:**  
Sweep, FFT, Waveform, Bargraph

---

Remote-control command:

```
DISPlay:Sweep<i>:A|B:LIMShift PARAllel <nu>
DISPlay:FFT<i>:A|B:LIMShift PARAllel <nu>
DISPlay:WAVEform:A|B:LIMShift PARAllel <nu>
DISPlay:BARgraph<i>:A|B:LIMShift PARAllel <nu>
```

**Symmetrical**

This enables a tolerance band formed from two limit lines or limit curves to be made broader or narrower (see section "Editing", on page 4.598).

In this way a tolerance band derived from a "golden unit", for example, can be very easily narrowed or broadened.

Although a single limit curve may be symmetrically shifted it is not very meaningful, and would be better done using the "Parallel" parameter field.

Symmetrical 0.00000 dBV

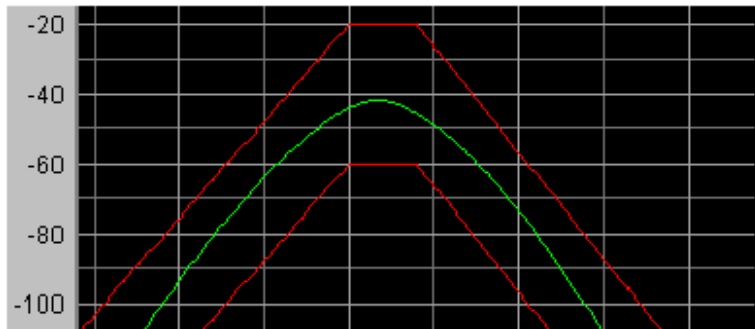

The limit curves which, after loading from a file, have a separation of 40 dBV, are **in each case** to be shifted by 10 dBV

Symmetrical 10.0000 dBV

and their signs are to be reversed. This produces a symmetrical shift in both curves.

Following the symmetrical shift the two curves have a separation of only 20 dBV.

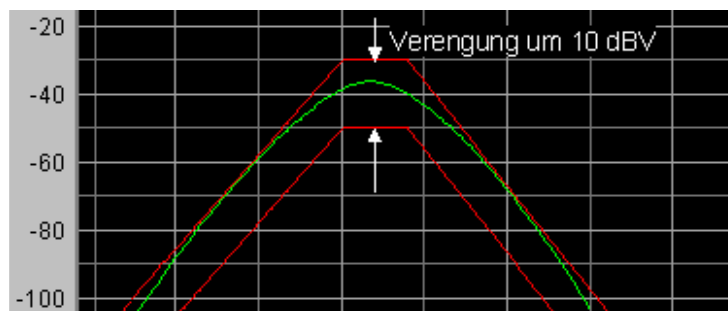

---

**Available in the graphics subsystems:**  
Sweep, FFT, Waveform, Bargraph, PESQ

---

Remote-control command:

```
DISPlay:SWEep<i>:A|B:LIMShift SYMMetrical <nu>
DISPlay:FFT<i>:A|B:LIMShift SYMMetrical <nu>
DISPlay:WAVEform:A|B:LIMShift SYMMetrical <nu>
DISPlay:BARgraph<i>:A|B:LIMShift SYMMetrical <nu>
```

## New scan



This parameter field appears only for graphic systems that allow multiscans ("Scan" = "Multi"), and is therefore available to the following graphic system:  
Sweep Graph1 to 4

"Replace" means that a selected scan of the current trace will be replaced.

"Append" means that a selected scan will be appended to the current trace.

Here it is irrelevant whether the scan originates from a **measurement** or is imported from a trace file specified in the **Import from** parameter field below.

Details see section "*Measurement value sequences*" on page 4.580.

---

**Available in the graphics subsystem:**

*Sweep*

---

- Replace**      The scan (selected using the Next Scan rocker key or by means of the scan number in the graphical display) is replaced by the scan from a **measurement** or from the trace file specified in the **Import from** parameter field below.  
See section "*Measurement value sequences*" on page 4.580 for further details.
- Append**      The scans from a **measurement** or from the trace file specified in the **Import from** parameter field below are appended to the current trace.  
See section "*Measurement value sequences*" on page 4.580 for further details.

**Import from**

This parameter field appears only for graphic systems that allow multiscans ("Scan" = "Multi"), and is therefore available to the following graphic system:  
Sweep Graph1 to 4

It is used to enter the name of a trace file whose scans are to replace a current scan or are to be appended to the current trace. Whether scans are to be replaced or appended is determined in the **New scan** parameter field above:  
Replace: "New scan" must be set to "Replace".  
Append: "New scan" must be set to "Append".

---

**Available in the graphics subsystem:***Sweep*

---

See section "*Measurement value sequences*" on page 4.580 for further details.

**X-Source**

Determines the response of the X axis parameter field.

---

**Available in the graphics subsystem:***Sweep*

---

**Sweep**

The X Axis parameter field is not available in a sweep that is switched on in the Generator Function panel; the X axis in the DispConfig Panel Sweep is thus automatically adapted to the X axis sweep setting in the generator.

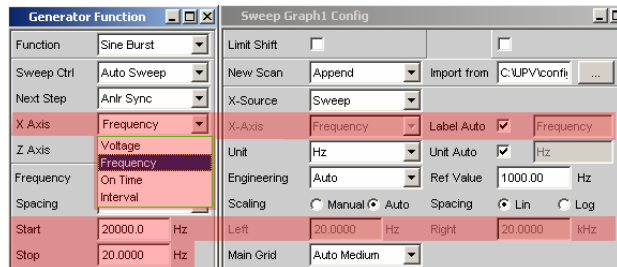

The sweep is turned off in the generator

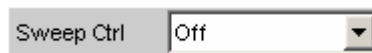

the X Axis parameter field is operable and the user can select the functionality.

When the x-source in the display panel is set to Sweep, and when a z-sweep is set in the generator, and when the number of z-sweep points in the generator is larger than the number of scans set in History, the number of sweep points from the generator will be entered in the History field.

Remote-control command:  
 DISPlay:SWEEP<i></i>:X:SOURce SWEEP

**Hold**

The X Axis parameter field is not available. The X axis retains the current setting at the time of the switchover to Hold and helps prevent the X axis from being unintentionally destroyed.

Remote-control command:  
 DISPlay:SWEEP<i></i>:X:SOURce HOLD

**Manu** The X Axis parameter field is operable and completely independent of a sweep setting in the generator. It is reserved for the special case of graphically displaying self-generated or manipulated test data records that are transferred from the controller via the IEC/IEEE bus to the R&S UPV (see "Transferring trace data").

Example:

The distortion of an amplifier versus its output voltage is to be graphically displayed by means of a generator sweep.

At first glance, this does not seem to be possible, for normally only the generator voltage supplied by the R&S UPV (i.e. the amplifier's input voltage) can be swept and projected onto the X axis.

However, to be able to evaluate how the distortion changes when the amplifier clips, the user wants to display the distortion versus the output voltage on the amplifier.

To be able to display the output voltage on the X axis, this voltage must be measured in addition to the distortion. From these two series of measurements, it is possible to generate a trace data set and save it as a trace file using Visual Basic, for example, in order to graphically display the data set with the setting "Manu" and the "X Axis" = "Voltage" parameter field.

```
Remote-control command:
DISPlay:SWEEP<i>:X:SOURce MANual
```

**LevMon RMS** The measured level monitor RMS value is plotted on the X-axis if the level monitor is on.

```
Remote-control command:
DISPlay:SWEEP<i>:X:SOURce LRMS
```

**LevMon DC** The measured level monitor DC value is plotted on the X-axis if the level monitor is on.

```
Remote-control command:
DISPlay:SWEEP<i>:X:SOURce LDC
```

**LevMon Peak** The measured level monitor peak value is plotted on the X-axis if the level monitor is on.

```
Remote-control command:
DISPlay:SWEEP<i>:X:SOURce LPEak
```

**Frequency** The measured frequency is plotted on the X-axis.

```
Remote-control command:
DISPlay:SWEEP<i>:X:SOURce FREQuency
```



**X Axis**

The parameter displayed in the selection field depends on the graphic subsystem in which the parameter field is offered.

For the graphic subsystem FFT Graph, the parameter is always **Frequency** and cannot be changed.



For the graphic subsystems Waveform and PESQ, the parameter is always **Time** and can also not be changed.



Any other X axis functionality is impractical for these subsystems.

The Bargraph graphics subsystem has an unscaled x-axis that is not displayed, and thus cannot be changed.

In contrast, for the graphic subsystem Sweep Graph1 ... 4, the functionality of this parameter field is determined by the X-Source parameter field above it, which is only offered in the display configuration panel Sweep Graph1 ... 4, and by the sweep setting of the generator.

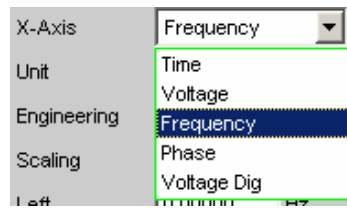

See section "X-Source" on page 4.515.

---

**Available in the graphics subsystems:**  
Sweep, FFT, Waveform, PESQ

---

**Time**

Depending on the current sweep setting in the generator, the X-axis is displayed as the time axis.



Remote-control command:  
DISPlay:SWEEP<i></i>:X:AXIS TIME

**Voltage**

Depending on the current sweep setting in the generator, the X-axis is displayed as the analog level axis.

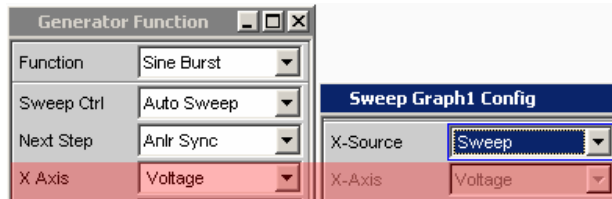

Remote-control command:  
DISPlay:SWEEP<i></i>:X:AXIS VOLTage

**Frequency**

Depending on the current sweep setting in the generator, the X-axis is displayed as the frequency axis.

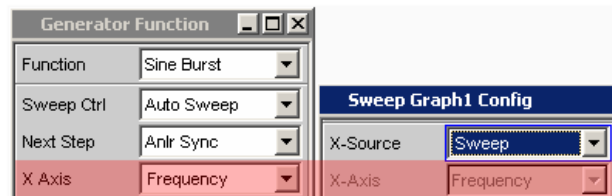

Remote-control command:  
DISPlay:SWEEP<i></i>:X:AXIS FREQuency

**Phase**

Depending on the current sweep setting in the generator, the X-axis is displayed as the phase axis. Only available if the generator function Stereo Sine is selected.

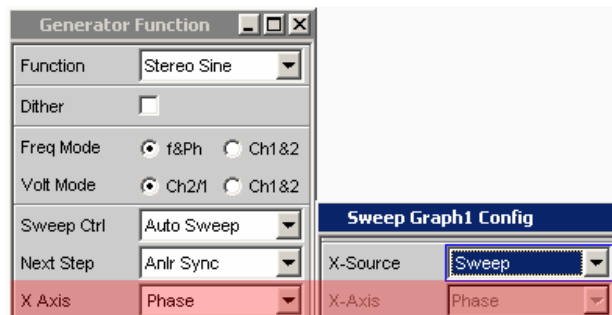

Remote-control command:  
DISPlay:SWEEP<i></i>:X:AXIS PHASe

**Voltage Dig** Depending on the current sweep setting in the digital generator instruments, the X-axis is displayed as the digital phase axis.

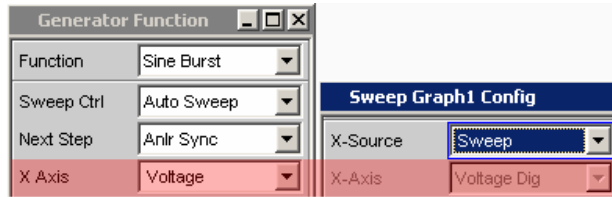

Remote-control command:  
 DISPlay:SWEEP<i></i>:X:AXIS VDIGital

**Jitter Pk Ampl** Depending on the current sweep setting in the generator instrument "Digital Impairment", the X-axis is displayed as **Jitter Peak Amplitude**.

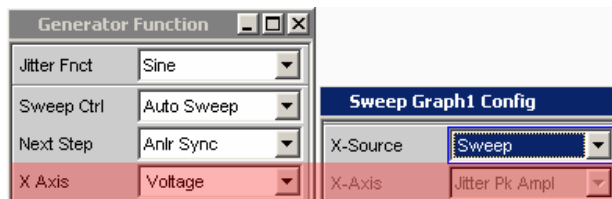

Remote-control command:  
 DISPlay:SWEEP<i></i>:X:AXIS JPKamplitude

**Unit**

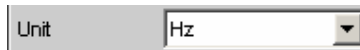

This defines the unit of the values for measurement results, cursor scaling and left/right scaling of the X axis as well as the units offered for the Ref Value for referenced units. The list of units is determined by the setting in the "X Axis" parameter field. If "Frequency" is selected in that field, frequency units are offered here. If "voltage" is selected in that field, volt units are offered, and so on.

Recorded measurement sequences can be redisplayed with different units at any time.

---

**Available in the graphics subsystems:**  
 Sweep, FFT, Waveform

---

Remote-control command:  
 DISPlay:SWEEP<i></i>:X:UNIT HZ | DHZ | ...  
 DISPlay:FFT<i></i>:X:UNIT HZ | DHZ | ...  
 DISPlay:WAVEform:X:UNIT HZ | DHZ | ...

Engineering



Displays the cursor and scaling values of the X axis in the graphical display.  
 This parameter field cannot be accessed if a dB or % unit is selected in the Unit Funct Track parameter field above since these units do not have an engineering function.

---

**Available in the graphics subsystems:**  
 Sweep, FFT, Waveform

---

**Auto** Automatic engineering assignment from p to M. The cursor and scaling values are displayed **with** the engineering symbol.  
 The X axis is labelled with the unit **without** engineering.

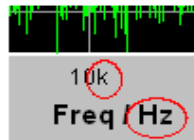

**Off** Engineering is deactivated.  
 Values are always displayed in 1.0 E<sup>0</sup> format.



**μ** Engineering fixed to μ, m or k.  
**m** The values to be displayed are multiplied by the  
**k** factor 1.0 E<sup>6</sup>, 1.0 E<sup>3</sup> or 1.0 E<sup>-3</sup>.

The cursor and scaling values are displayed **without** engineering symbol.  
 The X axis is labelled **with** engineering and unit.



**Label Auto**

Used to determine whether the X axis label is the same as that set in the X Axis parameter field or whether the label can be user-selected.

---

**Available in the graphics subsystems:**  
 Sweep, FFT, Waveform, PESQ

---



The label in the X Axis parameter field is displayed in grey (cannot be accessed) in the text field to the right of the tick box and also on the X axis in the graphical display.



Remote-control command:  
 DISPlay:SWEEp<i></i>:X:LABEl:AUTO ON  
 DISPlay:FFT<i></i>:X:LABEl:AUTO ON  
 DISPlay:WAVEform<i></i>:X:LABEl:AUTO ON  
 DISPlay:PESQ<i></i>:X:LABEl:AUTO ON



A user-definable label appears on the X axis of the graphical display.

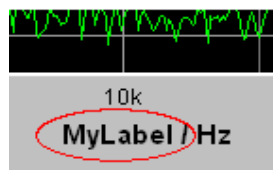

Remote-control command:  
 DISPlay:SWEEp<i></i>:X:LABEl:AUTO OFF  
 DISPlay:FFT<i></i>:X:LABEl:AUTO OFF  
 DISPlay:WAVEform<i></i>:X:LABEl:AUTO OFF  
 DISPlay:PESQ<i></i>:X:LABEl:AUTO OFF

**Unit Auto**

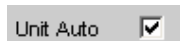

Used to determine whether the unit label displayed on the X axis is the same as the unit set in the Unit parameter field or whether it can be user-selected.

---

**Available in the graphics subsystems:**  
 Sweep, FFT, Waveform, PESQ

---



The unit label displayed on the X axis is the same as the unit set in the Unit parameter field and is therefore generated automatically by the R&S UPV.

```
Remote-control command:
DISPlay:SWEEP<i>:X:UNIT:AUTO ON
DISPlay:FFT<i>:X:UNIT:AUTO ON
DISPlay:WAVEform:X:UNIT:AUTO ON
DISPlay:PESQ<i>:X:UNIT:AUTO ON
```



A user-defined unit label can be entered.

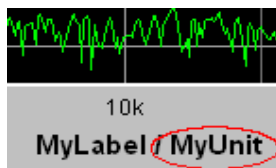

```
Remote-control command:
DISPlay:SWEEP<i>:X:UNIT:AUTO OFF
DISPlay:FFT<i>:X:UNIT:AUTO OFF
DISPlay:WAVEform:X:UNIT:AUTO OFF
DISPlay:PESQ<i>:X:UNIT:AUTO OFF
```

### Unit User String



User-defined unit designation if Unit Auto is not selected. This designation appears on the Y-axis label instead of the usual unit.

---

**Available in the graphics subsystems:**  
Sweep, FFT, Waveform

---

```
Remote-control command:
DISPlay:SWEEP<i>:X:UNIT:USER 'string'
DISPlay:FFT<i>:X:UNIT:USER 'string'
DISPlay:WAVEform:X:UNIT:USER 'string'
DISPlay:PESQ<i>:X:UNIT:USER 'string'
```

**Ref Value**

Ref Value  Hz

Reference value with unit for referenced units of the X-axis.

---

**Available in the graphics subsystems:**

*Sweep, FFT, Waveform*

---

Remote-control command:

DISPlay:SWEEp<i>:X:REFEreNce:VALue <nu>

DISPlay:FFT<i>:X:REFEreNce:VALue <nu>

DISPlay:WAVEform:X:REFEreNce:VALue <nu>

**Scaling**

Scaling  Manual  Auto

Manual or automatic scaling of the X axis.

---

**Available in the graphics subsystems:**

*Sweep, FFT, Waveform, PESQ*

---

**Manu**

Manual scaling

The scaling of a graphical display is determined using the "Left" and "Right" parameter fields below.

Each time the "Manu" parameter is set, the graphical display is deleted and then replotted with the scale end values entered under Left and Right.

Remote-control command:

DISPlay:SWEEp<i>:X:SCALing MANual

DISPlay:FFT<i>:X:SCALing MANual

DISPlay:WAVEform:X:SCALing MANual

DISPlay:WAVEform:X:SCALing

MANualDISPlay:PESQ:X:SCALing MANual

**Auto**

Automatic scaling

Auto Scale uses suitable default values for **one-off** scaling of the X axis. These values depend on the measurement task and the subsystem (e.g. the start/stop values of the sweep or FFT are used in the generator and analyzer panel).

The entry fields for the Left and Right parameter fields below are displayed in grey (cannot be accessed) with the obtained values.

```
Remote-control command:
DISPlay:SWEEP<i>:X:SCALing AUTO
DISPlay:FFT<i>:X:SCALing AUTO
DISPlay:WAVEform:X:SCALing AUTO
DISPlay:PESQ:X:SCALing AUTO
```

**Spacing**

Spacing  Lin  Log

Linear or logarithmic spacing of the X axis.

For logarithmic units (dB units) and linear units in which negative numbers can occur (e.g.  $\Delta V$ ,  $\Delta W$ ), this parameter field is displayed as not user-accessible and is set to "Lin", since it makes no sense / is not possible to display dB values or negative values logarithmically.

---

**Available in the graphics subsystems:**

*Sweep, FFT, Waveform, PESQ*

---

**Lin**

Linear spacing of the X axis.

```
Remote-control command:
DISPlay:SWEEP<i>:X:SPACing LINear
DISPlay:FFT<i>:X:SPACing LINear
DISPlay:WAVEform:X:SPACing LINear
DISPlay:PESQ:X:SPACing LINear
```

**Log**

Logarithmic spacing of the X axis.

```
Remote-control command:
DISPlay:SWEEP<i>:X:SPACing LOGarithmic
DISPlay:FFT<i>:X:SPACing LOGarithmic
DISPlay:WAVEform:X:SPACing LOGarithmic
DISPlay:PESQ:X:SPACing LOGarithmic
```



**Left**

 A screenshot of a control panel element. On the left, the text "Left" is displayed. To its right is a rectangular input field containing the numerical value "0.00000". To the right of the input field is the unit "Hz".

Used to set the left-hand value on the X axis.

This parameter field can only be accessed if Scaling is set to Manu. Negative values or the value 0.00000 are not permitted if "Spacing" is set to "Log".

---

**Available in the graphics subsystems:**  
Sweep, FFT, Waveform, PESQ

---

Remote-control command:  
DISPlay:SWEEP<i><nu>:X:LEFT <nu>  
DISPlay:FFT<i><nu>:X:LEFT <nu>  
DISPlay:WAVEform:X:LEFT <nu>  
DISPlay:PESQ:X:LEFT <nu>

**Right**

 A screenshot of a control panel element. On the left, the text "Right" is displayed. To its right is a rectangular input field containing the numerical value "22.0000". To the right of the input field is the unit "kHz".

Used to set the right-hand value on the X axis.

This parameter field can only be accessed if Scaling is set to Manu. This value must always be higher than the Left value. Negative values or the value 0.0000 are not permitted if "Spacing" is set to "Log".

---

**Available in the graphics subsystems:**  
Sweep, FFT, Waveform, PESQ

---

Remote-control command:  
DISPlay:SWEEP<i><nu>:X:RIGHT <nu>  
DISPlay:FFT<i><nu>:X:RIGHT <nu>  
DISPlay:WAVEform:X:RIGHT <nu>  
DISPlay:PESQ:X:RIGHT <nu>

**Main Grid**

 A screenshot of a control panel element. On the left, the text "Main Grid" is displayed. To its right is a dropdown menu with a small downward-pointing arrow on the right side. The text "Auto Medium" is visible within the dropdown menu.

Division of the graphical display with vertical main gridlines.

---

**Available in the graphics subsystems:**  
Sweep, FFT, Waveform, PESQ

---

- Off** No main gridlines are used in the graphical display.
- On** With Spacing = Log:  
Decadic division of an X axis with main gridlines.
- Auto Coarse** With Spacing = Lin:  
**Auto Medium** Coarse, medium or fine division of an X axis with  
**Auto Fine** main gridlines. One to two, 3 to 4 or 8 to 9 main gridlines are displayed depending on the scale end values.  
Main gridlines may be **hidden** if the graphical window is reduced in size.
- Divisions** With Spacing = Lin:  
Preset division of an X axis with main gridlines. The desired number of divisions is set in the parameter field below. These main gridlines are **not** hidden if the graphical window is reduced in size.
- Steps** With Spacing = Lin:  
Preset division of an X axis in a fixed step size. The step size is set in the parameter field below. These main gridlines are **not** hidden if the graphical window is reduced in size.

**Division**

With Spacing = Lin:

Used to enter the number of main gridline divisions for an X axis. If, for example, **2** is entered, the X axis is divided into **two sections**, i.e. **one** main gridline is displayed.

**Available in the graphics subsystems:**

*Sweep, FFT, Waveform, PESQ*

**Step**

With Spacing = Lin:

Used to enter the main gridline step size for an X axis. The unit of the value is linked to the unit selected in the "Unit Funct Track" parameter field.

**Available in the graphics subsystems:**

*Sweep, FFT, Waveform, PESQ*

Sub Grid

Sub Grid

Subdivision of the main gridlines in a graphical display using subgridlines.

**Available in the graphics subsystems:**

Sweep, FFT, Waveform, PESQ

- Off** Subgridlines are deactivated.
- 2** With Spacing = Lin:
- 4** Subdivision of the main gridlines of an X axis into 2, 4 or 5 sections.
- 5** If, for example, **2** is selected, the area between two main gridlines is divided into **2** sections, i.e. **one** subgridline appears between the main gridlines. These subgridlines are **not** hidden if the graphical window is reduced in size.
- Coarse** With Spacing = Log:
- Fine** Coarse or fine subdivision of the main gridlines of an X axis with subgridlines.

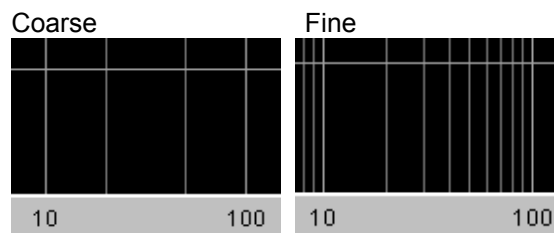

Only subgridlines 2 and 5

All subgridlines

Show A, Show B

Legend

Show A  Show B

Description A

Permits or prevents the display of free texts in the graphical displays.

**Available in the graphics sub-systems**

Sweep, FFT, Waveform, Bargraph, PESQ



Permits the display of free texts in the graphical displays.

Remote control commands:

```
DISPlay:SWEEp<i>:A|B:LEGend:SHOW ON
DISPlay:FFT<i>:A|B:LEGend:SHOW ON
DISPlay:WAVEform:A|B:LEGend:SHOW ON
DISPlay:BARgraph<i>:A|B:LEGend:SHOW ON
DISPlay:PESQ<i>:A|B:LEGend:SHOW ON
```



Prevents the display of free texts in the graphical displays.

Remote control commands:

```
DISPlay:SWEEp<i>:A|B:LEGend:SHOW OFF
DISPlay:FFT<i>:A|B:LEGend:SHOW OFF
DISPlay:WAVEform:A|B:LEGend:SHOW OFF
DISPlay:BARgraph<i>:A|B:LEGend:SHOW OFF
DISPlay:PESQ<i>:A|B:LEGend:SHOW OFF
```

**Description A,  
Description B**



Input fields for free text for display in the graphical displays.

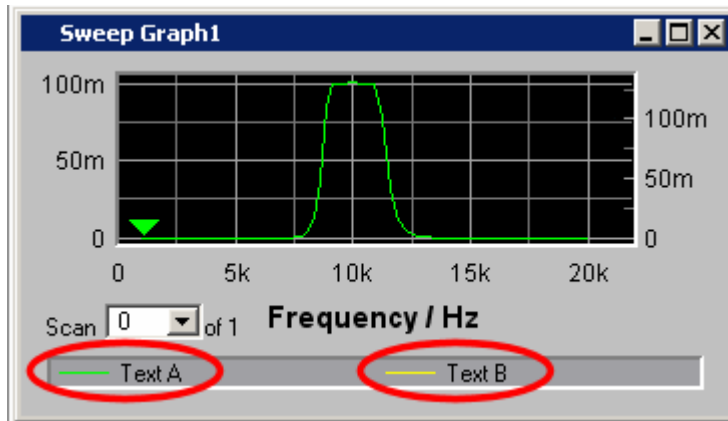

---

**Available in the graphics sub-systems**  
Sweep, FFT, Waveform, Bargraph, PESQ

---

Remote control commands:

```
DISPlay:SWEEp<i>:A|B:LEGend:DESCRiption 'string'
DISPlay:FFT<i>:A|B:LEGend:DESCRiption 'string'
DISPlay:WAVEform:A|B:LEGend:DESCRiption 'string'
DISPlay:BARgraph<i>:A|B:LEGend:DESCRiption 'string'
DISPlay:PESQ<i>:A|B:LEGend:DESCRiption 'string'
```

## Store Trace as

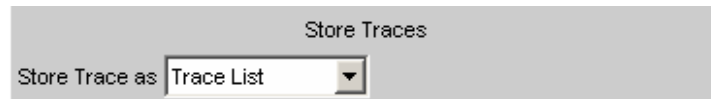

This specifies the format in which the current trace is to be stored.

Depending on this setting, further command lines for modifying the data set that has to be stored are added or removed.

---

**Available in the graphics subsystems:**

*Sweep, FFT, Waveform, PESQ*

---

**Trace List**

A trace is stored complete with all its scans, X and Y data, limit data and reference values (see "Trace Files").

This file can be loaded as a trace file at parameter field "Y-Source" "File: Trace A" or "File: Trace B" and can be displayed.

Remote-control command:

```
MMEemory:SWEep<i>:STAS TRCList
```

```
MMEemory:FFT<i>:STAS TRCList
```

```
MMEemory:WAVEform:STAS TRCList
```

```
MMEemory:BARgraph<i>:STAS
```

```
TRCListMMEemory:PESQ<i>:STAS TRCList
```

**Equalization List**

A trace is stored as an equalization file in order to make it available to the generator as a preemphasis file.

Each time an equalization file is stored the generator equalization file is loaded again, regardless of whether or not Modify Equ. is enabled. Then whenever a new equalization file is saved the precorrector becomes immediately effective on the next sweep scan.

If the name of the stored equalization file and of the equalization file used in the generator are not identical, a warning is issued to notify that the newly created equalization file will now be used in the generator (see "Equalization").

---

**Available in the graphics subsystems:**

*Sweep, FFT, Bargraph*

---

Remote-control command:

```
MMEemory:SWEep<i>:STAS EQUList
```

```
MMEemory:FFT<i>:STAS EQUList
```

```
MMEemory:BARgraph<i>:STAS EQUList
```

**Sweep List**

Available in all graphic systems except for "Waveform".

A trace is stored as a sweep list.  
If an Auto List Sweep or Manu List Sweep is set in the generator, the sweep parameters are read from this file.

---

**Available in the graphics subsystems:**  
*Sweep, FFT, Bargraph*

---

```
Remote-control command:  
MMEMoRY:SWEep<i>:STAS SWPList  
MMEMoRY:FFT<i>:STAS SWPList  
MMEMoRY:BARgraph<i>:STAS SWPList
```

**Limit List**

Available in all graphic systems except for "Waveform".

A trace is stored as a limit list.  
This file can be loaded at "Limit Upper" or "Limit Lower". It can then be displayed as a limit curve and used for limit monitoring.

---

**Available in the graphics subsystems:**  
*Sweep, FFT, Bargraph, PESQ*

---

```
Remote-control command:  
MMEMoRY:SWEep<i>:STAS LLIST  
MMEMoRY:FFT<i>:STAS LLIST  
MMEMoRY:BARgraph<i>:STAS LLIST  
MMEMoRY:PESQ<i>:STAS LLIST
```

**DataList  
Select**

The **filtered** data of a trace is stored complete with all its scans, X and Y data, limit data and reference values.

Data filtering is set in the measurement value list via softkey menu item "Selection". The following filters can be selected:

- Upper limit violations only
- Lower limit violations only
- Upper and lower limit violations
- Harmonics only
- Peaks only.

The IEC/IEEE bus command is as follows:

```
DISPlay:Subsys<i>:DLIST:FILTer ALL |
LIMUpper | LIMLower | LIMBoth |
HARMonics | PEAKs
```

A trace file stored in the "DataList Select" mode in conjunction with filters enabled in the measurement value list usually consists of significantly fewer data sets than when unfiltered and the number of data sets for Trace A and Trace B is usually different.

---

**Available in the graphics subsystems:**  
*Sweep, FFT, Bargraph, PESQ*

---

Remote-control command:

```
MMEMemory:SWEep<i>:STAS DSElect
MMEMemory:FFT<i>:STAS DSElect
MMEMemory:BARgraph<i>:STAS DSElect
MMEMemory:PESQ<i>:STAS DSElect
```

**Trace**

This is offered for "Store Trace as" "Equalization List" or "Limit List" and specifies whether the data set of Trace A or Trace B will be used for creating the corresponding lists.

---

**Available in the graphics subsystems:**  
*Sweep, FFT, Bargraph, PESQ*

---

Remote-control command:

```
MMEMemory:SWEep<i>:TRACe A | B
MMEMemory:FFT<i>:TRACe A | B
MMEMemory:BARgraph<i>:TRACe A | B
MMEMemory:PESQ<i>:TRACe A | B
```

## Norm Freq

This is offered for “Store Trace = Equalization List”.

This specifies the frequency whose voltage value is used for normalization. If the frequency selected is that at which the frequency response curve is at its maximum, the precorrector file contains only values from 0.0 to 1.0. If a different frequency is selected, factors greater than 1.0 also occur.

---

**Available in the graphics subsystems:**

Sweep, FFT, Bargraph

---

Remote-control command:

MMEMory:SWEEp<i>:EQUalization:NORMfrequency <nu>

MMEMory:FFT<i>:EQUalization:NORMfrequency <nu>

MMEMory:BARgraph<i>:EQUalization:NORMfrequency <nu>

## Invert

 Invert 

This is offered for “Store Trace = Equalization List”.

The effect of inverting the frequency response in the generator by means of an equalization file created with the "Invert" setting is that the same DUT - with the precorrector enabled - now receives an undistorted frequency response (see “*Equalization*”).

Application: Constant (i.e. frequency response independent) power output, preemphasis/deemphasis.

If there is no tick in the tick box, the equalization data set that is acquired corresponds to the frequency response of the DUT. If the DUT is removed and a generator sweep is carried out using this equalization data set, the DUT can be simulated since a frequency response arises as if the DUT were present.

---

**Available in the graphics subsystems:**

Sweep, FFT, Bargraph

---

Remote-control command:

MMEMory:SWEEp<i>:EQUalization:INVert ON | OFF

MMEMory:FFT<i>:EQUalization:INVert ON | OFF

MMEMory:BARgraph<i>:EQUalization:INVert ON | OFF



**Modify Equ.**Modify Equ. 

This is offered for "Store Trace as" "Equalization List".

The current generator equalization data set is taken into account when the new equalization list is stored in order to obtain a significantly more accurate precorrection.

**What is the purpose of multistage preemphasis?**

Example:

At high frequencies a loudspeaker frequency response has a rolloff of approx. 10 dB.

The intention is to compensate the frequency response by means of a generator preemphasis (equalization). For this purpose a generator sweep is started and the frequency response curve is acquired. An equalization file is created from this trace and made available to the generator. Another sweep is started using the equalization file and the frequency response is acquired.

The frequency response now seems considerably better, though the expected straight line has not appeared and there are inaccuracies in regions showing greater generator level increases.

The causes for this are **non-linearities** in the loudspeaker system. An increase in the generator level of 10 dB has not, as first expected, also increased the loudspeaker sound pressure by 10 dB but rather by only some 9.8 dB due to non-linearities.

In order to compensate for these inaccuracies a further equalization using **Modify Equ.** can be performed. This second scan, based on the data set of the equalization file loaded in the generator, usually produces the expected level frequency response.

If "Modify Equ." is enabled and a new equalization file is created but equalization is not yet enabled in the generator, equalization is turned on by default using the newly created file name (see "*Equalization*").

---

**Available in the graphics subsystems:**

*Sweep, FFT, Bargraph*

---

Remote-control command:

MMEMory:SWEEp<i>:EQUalization:MODify ON | OFF

MMEMory:FFT<i>:EQUalization:MODify ON | OFF

MMEMory:BARgraph<i>:EQUalization:MODify ON | OFF

## Offset

 Offset 

This is offered for "Store Trace as" "Limit List".

When a limit file is generated, an offset value is added to the Y data. This value is specified in the following parameter field.

Offset allows for example two limit files to be generated from a "golden unit", together forming a tolerance band, by generating a limit file for Upper Limit with an offset value of say 10 dBV and a limit file for Lower Limit with an offset value of -10 dBV. This produces a tolerance band with a width of 20 dBV so that the ideal frequency response of a selected DUT can be compared with the currently different DUT (see "Editing").

---

**Available in the graphics subsystems:**

*Sweep, FFT, Bargraph, PESQ*

---

Remote-control command:

```
MMEMory:SWEEp<i>:LIMit:OFFSet ON | OFF
MMEMory:FFT<i>:LIMit:OFFSet ON | OFF
MMEMory:BARgraph<i>:LIMit:OFFSet ON | OFF
MMEMory:PESQ<i>:LIMit:OFFSet ON | OFF
```

## Offset Value

 dBV

This is offered for Store Trace as Limit List, when the Offset tick box is enabled.

It is an additive value for generating limit files based on the trace data set of an ideal DUT. Generating two limit files, one with a positive and the other with a negative offset, allows a tolerance band to be generated (see "Editing").

---

**Available in the graphics subsystems:**

*Sweep, FFT, Bargraph, PESQ*

---

Remote-control command:

```
MMEMory:SWEEp<i>:LIMit:OFFSet:VALue <nu>
MMEMory:FFT<i>:LIMit:OFFSet:VALue <nu>
MMEMory:BARgraph<i>:LIMit:OFFSet:VALue <nu>
MMEMory:PESQ<i>:LIMit:OFFSet:VALue <nu>
```

**Store Trace to**

Store Trace to

This stores the current trace, complete with all scans, in the format specified by Store Trace as, under the specified file name.

---

**Available in the graphics subsystems:**  
*Sweep, FFT, Bargraph, Waveform, PESQ*

---

Remote-control command:  
MMEMory:SWEEp<i>:STORE 'filename'  
MMEMory:WAVEform:STORE 'filename'  
MMEMory:FFT<i>:STORE 'filename'  
MMEMory:BARgraph<i>:STORE 'filename'  
MMEMory:PESQ<i>:STORE 'filename'

**Resolution**

Resolution

Used to set the number of digits used to display the cursor and scaling values in the graphical window.

If "Engineering" is set to "Auto", the Resolution setting only applies to the cursor values and not to the scale values.

---

**Available in the graphics subsystems:**  
*Sweep, FFT, Bargraph, Waveform, PESQ*

---

- 3 dig. / 0.1 dB
- 4 dig. / 0.01 dB
- 5 dig. / 0.001 dB
- 6 dig. / 0.0001 dB
- 7 dig. / 0.00001 dB

The parameters are explained below using an example:

**5 dig. / 0.001 dB**

**5 dig.:** Values which are displayed with a linear unit (V, Hz, etc) are output with 5 digits:

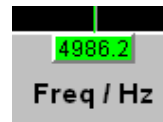

**0.001 dB:** Values which are displayed with a logarithmic unit (dBV, dBu, etc) are output to three decimal places:

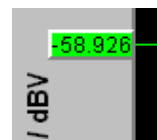

If the numeric values can no longer be displayed with the selected resolution, they are rounded off and shown as an exponent:



## Scan

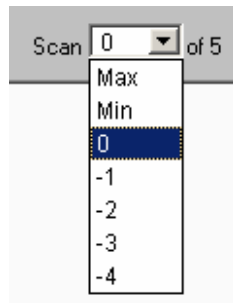

This is a display for the current scan and an opportunity to select a scan in the graphical display. For those graphic system that allows multiscan recording (Sweep Graph1 to 4) the desired scan can be selected. Number 0 means the most recent scan. The lower the negative number, the older the scan.

Scans identified as Min and Max are available to all graphic systems, provided they are enabled by ticking the



tick box.

When you use the `Next Scan` toggle key to scroll through the scans the current value is entered here.

---

**Available in the graphics subsystems:**

*Sweep, FFT, Bargraph, Waveform, PESQ*

---

Remote-control command:

DISPlay:SWEEp<i>:SCANoffset <n>

DISPlay:FFT<i>:SCANoffset <n>

DISPlay:WAVEform:SCANoffset <n> (nur n = 0 möglich)

DISPlay:BARgraph<i>:SCANoffset <n>

DISPlay:PESQ<i>:SCANoffset <n>

## Softkey Menu

Using an extensive softkey menu the display can be, among other things,

- automatically scaled (Autoscale)
- expanded (Zoom)
- measured using vertical and horizontal cursor (Cursor) or
- provided with markers (Marker).

**Explanation of the individual softkey menu items:**



Level 1	Level 2	Level 3	Level 4	Brief description
Trace				
	Show A <input checked="" type="checkbox"/>			(Temporarily) show/hide graphical display of Trace A
	Show B <input checked="" type="checkbox"/>			Ditto for Trace B
	Back			Move back by one menu level
Autoscale				Single scaling of co-ordinate system using minimum and maximum values
	A			For Trace A
	B			Ditto for Trace B
	A&B			Ditto for Trace A and B
	X Axis			Ditto for X axis
	All			Ditto for Trace A, B and X axis
	Back			Move back by one menu level
Cursor				Cursor settings
	O ↔ X			Used to determine whether O or X cursor is moved with rotary knob
	O-Cursor			O cursor settings
		O Active <input checked="" type="checkbox"/>		Activate/deactivate O cursor
		O Vert A		O cursor becomes vertical cursor on Trace A
		O Vert B		Ditto on Trace B
		O Vert A-B		Ditto on Trace A and Trace B and shows difference between Y values.
		O Hor A		O cursor becomes horizontal cursor on Trace A

Level 1	Level 2	Level 3	Level 4	Brief description
		O Hor B		Ditto on Trace B
		Movement (Next Pixel)		Movement behaviour of O cursor when it is moved using rotary knob
			Next Pixel	Pixel-by-pixel movement
			Next Bin Next Sample Next Value Next Step	Between reference points With FFT With Waveform and PESQ With Bargraph With Sweep
			Next Peak	Movement between partial curve peaks
			Next Harmonic	FFT display: movement between harmonics
		Back		Move back by one menu level
	X-Cursor			X cursor settings
		X Active <input checked="" type="checkbox"/>		Activate/deactivate X cursor
		X Vert A		X cursor becomes vertical cursor on Trace A
		X Vert B		Ditto on Trace B
		X Vert A-B		Ditto on Trace A and Trace B and shows difference between Y values.
		X Hor A		X cursor becomes horizontal cursor on Trace A
		X Hor B		Ditto on Trace B
		Movement (Next Pixel)		Movement behaviour of X cursor when it is moved using rotary knob
			Next Pixel	Pixel-by-pixel movement
			Next Bin Next Sample Next Value Next Step	Between reference points With FFT With Waveform With Bargraph With Sweep
			Next Peak	Movement between partial curve peaks
			Next Harmonic	FFT display: movement between harmonics

Level 1	Level 2	Level 3	Level 4	Brief description
		Back		Move back by one menu level
	Set O Cursor			Sets O cursor ...
		Max		... to trace maximum
		Min		... to trace minimum
		Marker A		... to position of Marker A
		Marker B		... to position of Marker B
		Value		... to a value that can be entered later
		Back		Move back by one menu level
	Set X Cursor			Sets X cursor ...
		Max		... to trace maximum
		Min		... to trace minimum
		Marker A		... to position of Marker A
		Marker B		... to position of Marker B
		Value		... to a value that can be entered later
		Back		Move back by one menu level
	Back			Move back by one menu level
Marker				Marker settings
	Trace A			Marker settings for Trace A
		Off		Marker deactivated
		Set to O Cursor		Set marker to position of O cursor
		Set to X Cursor		Set marker to position of X cursor
		Set to Value		Set marker to a value that can be entered later
		Track to <input checked="" type="checkbox"/> Max		Set marker to maximum of Trace A; marker changes with maximum
		Harm <input checked="" type="checkbox"/>		Harmonics are calculated and displayed based on X position of marker
		Back		Move back by one menu level



Level 1	Level 2	Level 3	Level 4	Brief description
Zoom				Increase / reduce size of graphical display
	Act Curs In			Size of graphical display is increased around active cursor (solid line). If active cursor is a vertical cursor, a section of X axis is displayed; if it is a horizontal cursor, a section of Y axis is displayed. In both cases, displayed section is adjusted so that cursor appears at center of display.
	Act Curs Out			Ditto for reducing size of graphical display
	Betw V Curs			Zooming between two vertical cursors
	Betw H Curs			Zooming between two horizontal cursors
	Unzoom			Undoes all zoom operations
	Undo			Undoes zoom operation last performed. Several zoom operations can be undone. Entering new axis limits (Top, Bottom, Left, Right) resets undo memory.
	Autoscale			Automatic scaling of coordinate system using minimum and maximum values
		A		For Trace A
		B		Ditto for Trace B
		A&B		Ditto for Trace A and B
		X Axis		Ditto for X axis
		All		Ditto for Trace A, B and X axis
		Back		Move back by one menu level
Restart Min/Max Lim Violation				Deletes Min/Max curves and limit violation symbols for graphical display and restarts collection of Min/Max data and checking of limit violations.
	MinMax A			Min/Max curves of Trace A
	MinMax B			Ditto for Trace B

Level 1	Level 2	Level 3	Level 4	Brief description
	MinMax A+B			Ditto for Trace A and Trace B
	Lim Viol A			Limit violation symbols for Trace A, i.e. red dots which indicate limit violations on trace, and red triangular symbols for limit violations are deleted and only a grey triangle is displayed.  or  ? 
	Lim Viol B			Ditto for Trace B
	Lim Viol A+B			Ditto for Trace A and Trace B
	Back			Move back by one menu level
Config				Opens associated Config panel

## Single Sweep

Scan  Single  Multi

For the two independent Y axes (Trace A and Trace B) on the graphical display, the user can display two out of eight simultaneously acquired measurement values. These can include not only level measurement results, frequencies or total harmonic distortions from the left and right channels, but also physically different values such as voltage and phase. The measurement function relevant to the measurement value display is set in the Analyzer Function panel, and the measurement function relevant to the trace display is selected from the Gfx-Configuration panel at "Y-Source".

The graph shows a single sweep on Trace A (green) and Trace B (yellow).

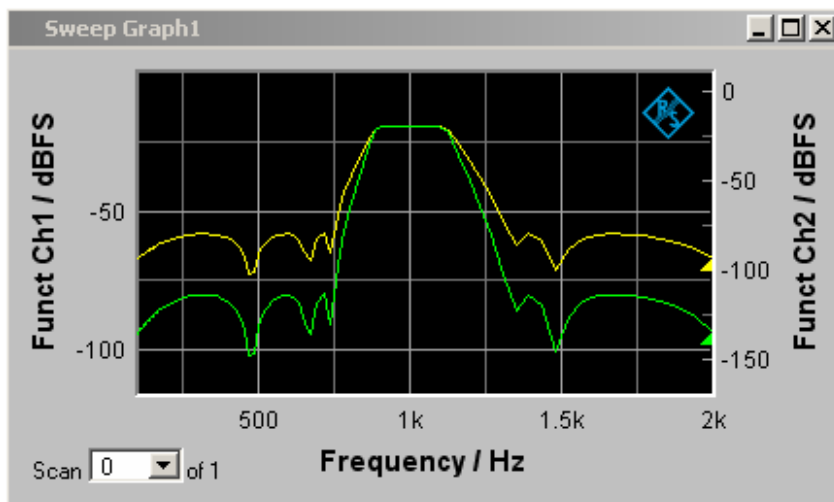

In addition the setting

Show Min Max

produces two further scans in which the Min and Max curves are generated, exactly as in the following graph which shows a crowded set of curves.

## Trace Group

With the R&S UPV, the number of measurement sequences is not restricted to x number of scans. Instead, between 2 and 20 can be set for the FFT Monitor and the Sweep Graphs 1 to 4 using the Scan and History parameter field (see section "Graphical Display, Explanation of the Elements" on page 4.450).

Scan  Single  Multi History

in the appropriate configuration panels. Additionally, two other scans (the Min and Max curves) can be generated using the setting

Show Min Max

A trace group is shown as the graphical display.

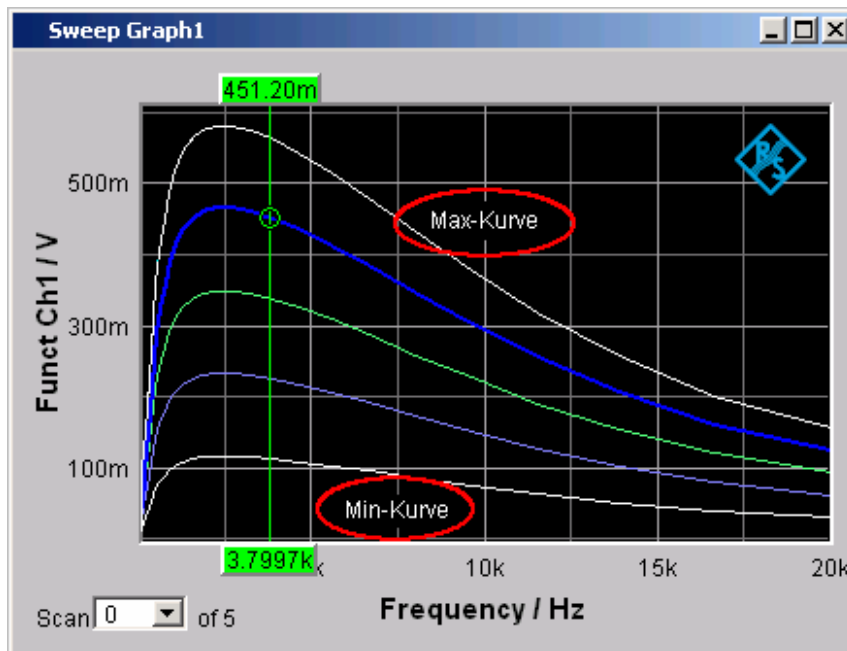

All of the recorded measurement sequences are saved (both internally and, if the user requires, as a file) and can be displayed, rescaled and reloaded as a single unit.

With the generator, a second sweep (the Z sweep) is possible in addition to the X sweep. It is called the Z sweep because it is usually displayed on the Z axis of a 3D co-ordinate system.

Generally, in a graphical window which allows scans to be recorded, a trace group or a trace pair consisting of Trace A and Trace B each with one trace group will be displayed in the respective graphical window if History is set to  $\geq 2$ .

If History is set to the maximum value of 20 and "Show Min Max" is activated: a maximum of 44 scans are displayed.,

- Trace A, 20 scans
- Trace A 1 Min curve
- Trace A 1 Max curve
- Trace B, 20 scans
- Trace B 1 Min curve
- Trace B 1 Max curve

-----  
44 curves

As long as a measurement is running and scans are performed, they are displayed in gray. When the measurement is completed or the scan was stopped by means of Hold, the scans are displayed in automatically assigned colors.

In the case of automatic scaling of the Y axis

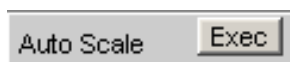

all available traces are taken into account in order to determine the maxima and minima.

All other actions, e.g. setting the cursor to the Min or Max value, always relate to the current scan. For limit violation monitoring, which is set up using

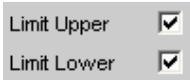

all traces are checked against the same two limit curves. The symbol for limit violation



always relates to the current trace pair.

The current scan (one trace if only Trace A or Trace B is activated, two traces if both traces are activated) is changed in the graphical window or result list using the Next Scan rocker key or the "Scan" selection field.

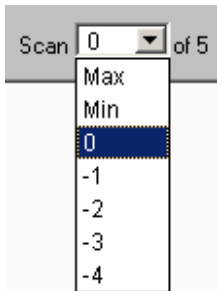

The number in the "Scan" selection field

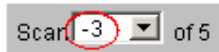

displays for graphic systems that allow multiscan recording (Sweep Graph1 to 4) the current value, the so-called scan index . Number 0 means the most recent scan. The lower the negative number, the older the scan.

Scans identified as Min and Max are available to all graphic systems, provided they are enabled by ticking the



tick box.

If Cursor is switched on in the graph, an O or X identifies the intersection of the cursor with the current trace or trace pair. If the scan index changes, this marking jumps to the next scan.

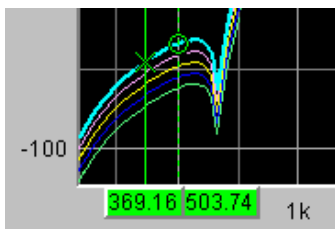

If the measurement value list is enabled,

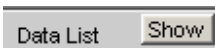

the lists are reconfigured after every change in the scan index, because only one scan is displayed in the measurement value list.

## Interpolation on the Common X Axis

So that any traces can be used as reference or displayed simultaneously for comparison and measured with the cursors, such traces should actually all have the same X values. The R&S UPV, however, can use any X divisions, by interpolating the measurement value sequences, reference traces and limit curves onto the current X axis.

Likewise the equalization lists are interpolated onto the X axis of the generator sweep (see "Equalization") as are waiting time curves for sweep stepping.

Reference traces, limit curves and waiting time curves therefore need consist of only a few interpolation points.

The interpolation takes into account whether the X and Y axes are divided on a linear or logarithmic basis, because segments of ellipses are generally produced from straight lines in the other display.

## Result List

All measurement values from all graphic subsystems can also be displayed in lists instead or in combination with the graphical windows.

## Graphical Display, Explanation of the Elements

The screenshot shows the "FFT Monitor Data List" window. It contains a table with the following data:

	X A (Hz)	Y A (dBV)	X B (Hz)	Y B ()
167	972.66	-71.580	972.66	
168	978.52	-49.804	978.52	
169	984.38	-24.968	984.38	
170	990.23	-12.766	990.23	
171	996.09	-7.001	996.09	
172	1.0020 k	-6.402	1.0020 k	
173	1.0078 k	-10.863	1.0078 k	
174	1.0137 k	-21.284	1.0137 k	
175	1.0195 k	-41.523	1.0195 k	
176	1.0254 k	-67.302	1.0254 k	
177	1.0313 k	-82.990	1.0313 k	
178	1.0371 k	-95.093	1.0371 k	

Annotations in the image point to various elements:

- Columns with measurement values:** Points to the table columns.
- Arrow:** Points to the green triangle cursor marker above row 167.
- Measurement value with limit violation:** Points to the red value -24.968 in row 169.
- Cursor markers:** Points to the green triangles above rows 171 and 173.
- Numbering of measurement values:** Points to the row numbers 167-178.
- Scan number:** Points to the "Scan 0 of 1" field at the bottom left.
- Selection List:** Points to the "Selection: All" dropdown at the bottom.
- Display filter:** Points to the "Lim A" button at the bottom right.
- Symbols indicating limit violations:** Points to the red triangle cursor marker above row 171.

### Display filter







If the result list has the focus, a softkey menu appears. Pressing the "Selection" button opens the next softkey level where it is possible to select the measurement values according to the following criteria, i.e. to list only those rows which satisfy the selection criteria:

- All
- Lim upper
- Lim lower
- Lim upp&low
- Harmonics
- Peaks

**Selection frame** Used to scroll through the result list using the rotary knob. When the selection frame reaches the top or bottom of the result list, the list is scrolled below the window.

**Symbols indicating limit violations**



-  "Limit Upper" is activated and there is no limit violation.
-  "Limit Lower" is activated and there is no limit violation.
-  The "Limit Upper" value has been violated in the past but there is currently no limit violation. The violation is indicated until the **[START]** key is pressed again.
-  The "Limit Lower" value has been violated in the past but there is currently no limit violation. The violation is indicated until the **[START]** key is pressed again.
-  The "Limit Upper" value is currently being violated.
-  The "Limit Lower" value is currently being violated.

**Columns with measurement values** Trace A, Trace B and the associated X axes are displayed as numeric values in a maximum of four columns.

**Cursor markers** A coloured rectangular marking indicates the row containing the value at which the cursor is located (also applies to traces and bargraphs). "o" or "x" to the left of the measurement number indicates the O or X cursor.

168	978.52
<b>o</b> 169	984.38
170	990.23
<b>x</b> 171	996.09
172	1.0020 k

Pressing the **Find Cursor** softkey adjusts the display window so that the active cursor appears at the center of the display.

**Arrow** Coloured arrow symbols indicate the direction in which a cursor left the display window.

**Measurement value with limit violation** A limit violation, which is identified by red dots / red bars on the traces and bargraphs, is indicated by red measurement values in the result list.

**Numbering of measurement values** The individual measurement values are numbered consecutively from 1 to n.

**Scan number** If a trace consists of several scans, the desired scan can be selected here by pressing the **[Next Scan]** rocker key or using the mouse. In the result list, only the values of the selected scans are shown. The scan number shown in this display field indicates which scan is listed.

## Calling Up

A data list button can be found in the first line of every display configuration panel



and can be used to open a measurement value list for each graphic system or for additional graphic display.

Trace A, Trace B and the associated X axes are displayed as numeric values in a maximum of four columns.

The column on the left-hand side contains the number of the measurement value, a coloured marking indicating the row containing the value at which the cursor is located and may also contain coloured arrow symbols indicating the direction in which a cursor left the display window. Pressing the **Find Cursor** softkey adjusts the display window so that the data set appears together with the cursor at the center of the display.

In the columns for the Y values of Trace A and Trace B, digits highlighted in colour by pressing the **Selection** softkey indicate whether the measurement result is violating the "Limit Upper" and/or "Limit Lower" parameters or whether the value is a harmonic or a peak.

Hidden sections of the data set can be shown in the display window using the scroll bar on the right-hand side of the panel or using the blue selection frame.

## Parameter Fields of the Panel

The result list does not have its own panel; it is configured according to the settings in the display configuration panel from which it was opened.

The following parameter fields and softkey functions affect the result list (and, at the same time, the traces and bargraphs):

### Unit Fnc Track



Used to determine whether the unit is the same as that set in the analyzer or whether it can be user-selected.

### Unit



The unit set here is displayed above the measurement result column for Trace A / Trace B or above the values on the X axis:

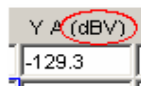



Engineering

Engineering

The measurement values for Trace A or Trace B and the values on the X axis are displayed with the engineering selected in this parameter field:

Y A (V)
0.641 μ
0.338 μ

Unit Auto

Unit Auto  dBspl

Used to determine whether the unit label displayed above the measurement result column for Trace A / Trace B or above the values on the X axis is the same as the unit set in the "Unit Funct Track" or Unit parameter field, or whether it can be user-selected.

	X A (MyFrg)	Y A (dBspl)
1	0.000	-143.4
2	5.859	-143.5

Limit Upper

Limit Upper

If a "Limit Upper" value or scan is set here, the measurement values which violate the limit are displayed in red if "Limit Upper" or "LimUp&Low" is set under the "Selection" softkey.

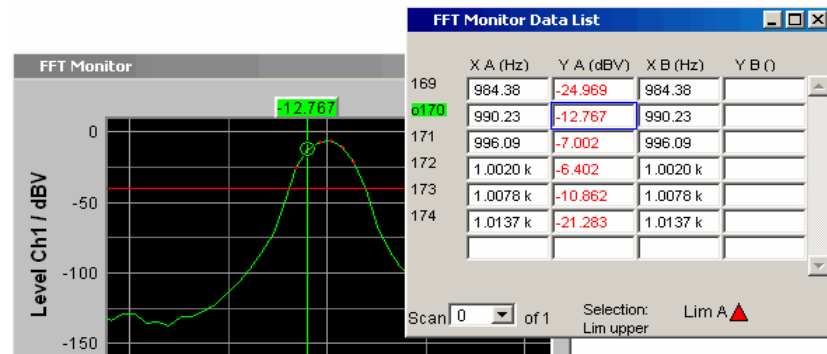

Limit Lower

Limit Lower

If a "Limit Lower" value or scan is set here, the measurement values which violate the limit are displayed in red if "Limit Lower" or "LimUp&Low" is set under the "Selection" softkey.

Resolution

Resolution 4dig / 0.01dB

Used to set the number of digits used to display the measurement results for Trace A and Trace B and the values on the X axis.

Y A (dBr)  
-143.86  
-149.42

Marker  
Trace A Trace B  
Track to Max  Harm

If harmonics are shown in the graphical display (activated using the softkey menu), a display filter which only shows the values of the harmonics can be applied to the list display by setting "Harmonics" under the "Selection" softkey. There are gaps in the numbering of the values on the left side of the window.

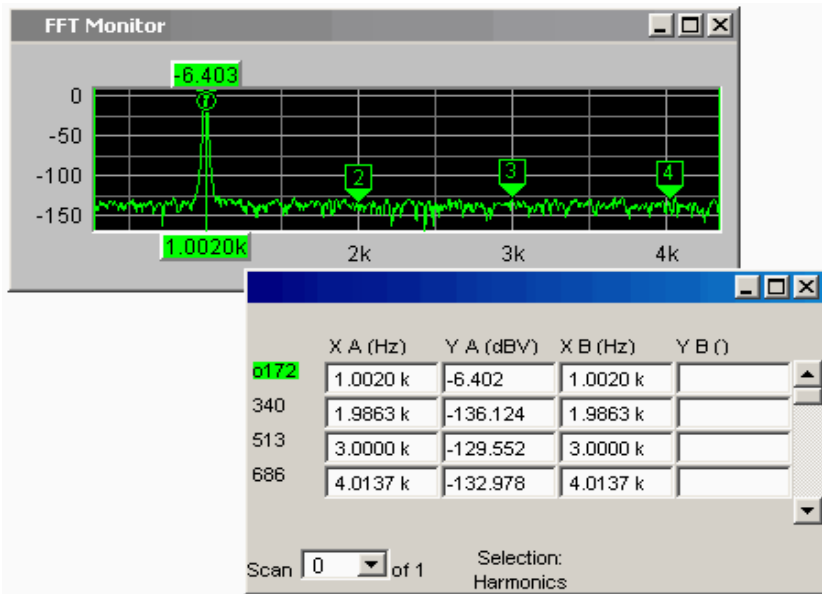

Scan 0 of 4

in graphical display

This field and selection option in the graphical display also appears in the result list. It indicates the selected scan for Sweep Graph1 to 4 graphic subsystems which have multi-scan recording.

The current value for the respective scan is entered here by scrolling through the scans using the **Next Scan** rocker key; this value can then be changed.

Scan 0 of 5

- Max
- Min
- 0
- 1
- 2
- 3
- 4

Number 0 means the most recent scan. The lower the negative number, the older the scan. The number 2 identifies the Max scan, and 1 means the Min scan.

## Softkey Menu

Explanation of the individual menu items:

Level 1	Level 2	Brief description
Close		Used to close the result list.
Find Cursor		Used to adjust the display window containing the result list so that the data set appears together with the cursor at the center of the display. If both cursors are activated, this button is used to toggle between the two cursors.
Selection		The following values are listed in the result list:
	All	All
	Lim upper	Only those values which overrange the upper limit
	Lim lower	Only those values which underrange the lower limit
	Lim upp&low	Only those values which overrange the upper limit and underrange the lower limit
	Harmonics	Only harmonics
	Peaks	Partial trace maxima

## Numeric Display

The numeric display provides a clear overview of max. 8 measurement results (two-channel instruments) or max. 32 measurement results (multichannel instruments) from max. four analyzer measurement functions from the Analyzer Function panel. If all of the analyzer measurement functions are activated, the individual columns are assigned the measurement functions in the following sequence (from left to right):

Measurement results for Analyzer Function, Level Monitor, Input Monitor, Freq/Phase.

	RMS	Lev RMS	Input Peak	Frequency
Ch1	495.59 mV	500.60 mV	705.85 mV	1000.0 Hz
Ch2	594.59 mV	600.60 mV	846.85 mV	1000.0 Hz

If certain analyzer measurement functions in the Analyzer Function panel are deactivated, the associated measurement results are hidden. The name of the measurement function, however, clearly indicates which column refers to which measurement function.

	RMS	Frequency
Ch1	6.2370 mV	1.6000 kHz
Ch2	105.24 mV	1600.0 Hz

For more detailed information on the assignment of the individual measurement results to the analyzer measurement functions see "Combi Display" on page 4.555.

# Graphical Display, Explanation of the Elements

The explanation of the elements is based on the numeric display for two-channel instruments.

Labels and their corresponding elements in the screenshot:

- Name of measurement function: Points to the column headers (RMS, Lev RMS, Inp Peak, Frequency).
- Measurement result for Ch1: Points to the first row of data.
- Measurement result for Ch2: Points to the second row of data.
- Meas. result for Function: Points to the RMS column.
- Meas. result for Level Monitor: Points to the Lev RMS column.
- Limit violation display: Points to the red 'x' on the Ch1 Lev RMS value.
- Measurement result for Freq/Phase: Points to the Frequency column.
- Meas. result for Input Monitor: Points to the Inp Peak column.
- Selection frame: Points to the window border.

For multichannel instruments, the only difference are the additional lines Ch3 to Ch8.

	RMS	Level RMS	Input Peak	Frequency
Ch1	67.507 $\mu$ V	68.189 $\mu$ V	96.146 $\mu$ V	2.0057 kHz
Ch2	87.759 $\mu$ V	88.646 $\mu$ V	124.99 $\mu$ V	2.0057 kHz
Ch3	67.507 $\mu$ V	68.189 $\mu$ V	96.146 $\mu$ V	2.0057 kHz
Ch4	87.759 $\mu$ V	88.646 $\mu$ V	124.99 $\mu$ V	2.0057 kHz
Ch5	67.507 $\mu$ V	68.189 $\mu$ V	96.146 $\mu$ V	2.0057 kHz
Ch6	87.759 $\mu$ V	88.646 $\mu$ V	124.99 $\mu$ V	2.0057 kHz
Ch7	67.507 $\mu$ V	68.189 $\mu$ V	96.146 $\mu$ V	2.0057 kHz
Ch8	87.759 $\mu$ V	88.646 $\mu$ V	124.99 $\mu$ V	2.0057 kHz

Name of measurement function

Name of the current measurement function from left to right: Function, Level Monitor, Input Monitor, Freq/Phase  
If the measurement function is changed in the analyzer panel, the labels here also change.

Measurement result for Channel 1

In the sequence specified above.

Measurement result for Channel 2

In the sequence specified above.

Measurement result for Function

**Column 1:** Measurement results for the function which is set in the **Function** field of the **Analyzer Function** panel.

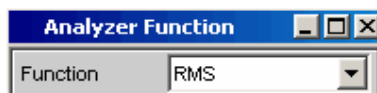

Measurement result for Level Monitor

**Column 2:** Measurement results for the set **Level Monitor** function.



Measurement result for Input Monitor

**Column 3:** Measurement results for the **Input Monitor** function.

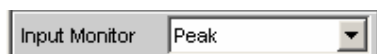

Measurement result for Freq/Phase

**Column 4:** Measurement result for the Freq/Phase measurement function.

Display of the frequency measurement result in the first row for **Frequency** or **Freq & Phase** / **Freq & GrpDel**, and display of the phase or group delay measurement in the second row.



Selection frame

If the numeric display has the focus, measurement results can be selected by moving the blue selection frame with the rotary knob or by clicking with the mouse. Clicking with the rotary knob or double-clicking with the mouse opens the associated combi display (see "Combi Display" on page 4.555).

Limit violation display

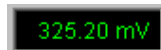

Measurement result displayed in green: Limit monitoring is deactivated or the measurement result is within the preset limits.



Measurement result displayed in red: A limit has been violated. See "Combi Display" on page 4.555 for information on how to set the limits.

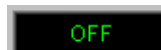

The measurement is deactivated in the analyzer panel.



No measurement result is available (yet).

Config

Right-clicking in a field displaying measurement results calls a popup menu with the entry "Config". Left-clicking on this entry opens the associated DispConfig panel.



## Calling Up

The numeric display is opened via the menu bar by pressing the **MENU** key on the front panel or, with mouse operation, by moving the pointer to the left-hand edge of the R&S UPV application window.

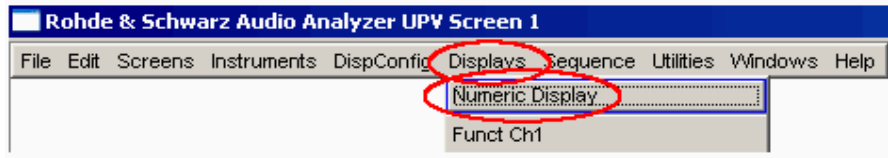

## Parameter Fields of the Panel

The numeric display does not have its own panel; however, a number of settings made in the measurement result configuration panels in the combi displays affect the way in which the measurement results are displayed:

- Unit
- Unit Auto
- Resolution
- Engineering
- Reference
- Limit Lower
- Limit Upper

See "*Combi Display*" on page 4.555 for more detailed information.

## Softkey Menu

The numeric display does not have its own softkey menu; however, the softkey functions of the combi displays affect the way in which the measurement results are displayed.

See "*Combi Display*" on page 4.555 for more detailed information.

## Combi Display

It is often the case that the measurement results in the numeric display do not contain adequate information. Additional features such as analog bargraphs, limit monitoring or the storage of maximum and minimum values are frequently required.

The combi display is used for this purpose. Additional information can be displayed for every measurement shown in the numeric display.

The free selection and free scalability mean that especially important or critical results can be monitored and tracked even when viewing the R&S UPV screen from a relatively long distance.

## Graphical Display, Explanation of the Elements

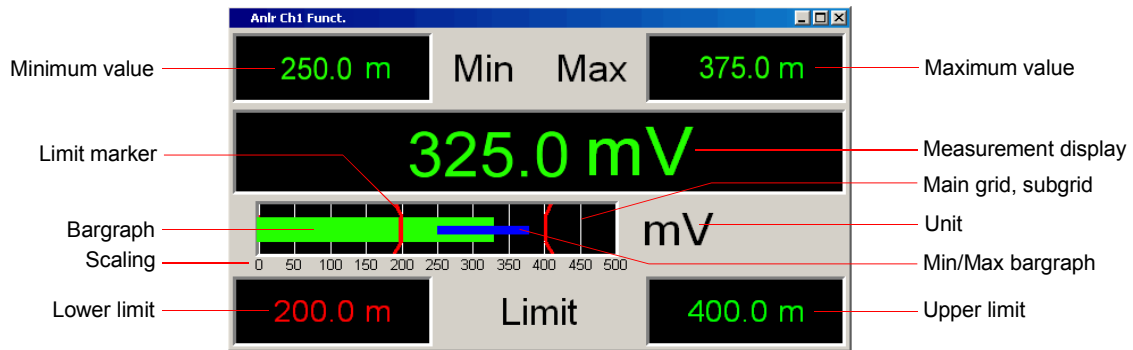

Bargraph

Displays the measurement result as a bar on a scale. If the bar changes to red, there is a limit violation.

Unit

Unit of the bargraph; set with

Unit	V
Unit Auto	<input checked="" type="checkbox"/> V
Engineering	m

Limit marker

Displays the lower and upper limit specified under

Limit Lower	<input checked="" type="checkbox"/>	200.000	mV
Limit Upper	<input checked="" type="checkbox"/>	400.000	mV

in the bargraph.

Main grid, subgrid

Main grid and subgrid; set with

Main Grid	Auto Fine
Sub Grid	Off

Maximum value Maximum value measured since the **START** key was pressed; set with



Measurement display Current measurement value.  
If the measurement value changes to red, there is a limit violation.

Min/Max bargraph The ends of the blue bar indicate the lowest and highest measurement value since the **START** key was pressed.

Minimum value Minimum value measured since the **START** key was pressed; set with



Upper limit Displays the upper limit specified under

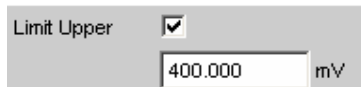

as a numeric value.  
If the right value changes to red,



this means that a violation of the upper limit occurred after the **START** key was pressed. This limit violation is indicated until the hold function is reset by pressing the **START** key again or by entering a new upper limit.

Scaling Measurement range of the bargraph; set with

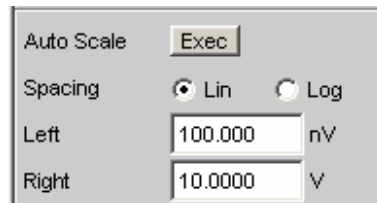

Lower limit Displays the lower limit specified under



as a numeric value.  
If the left value changes to red,



this means that a violation of the lower limit occurred after the **START** key was pressed. This limit violation is indicated until the hold function is reset by pressing the **START** key again or by entering a new lower limit.



Config

Right-clicking anywhere in the combi display calls up a button labeled "Config". Left-clicking on this Config button opens the associated DispConfig panel.

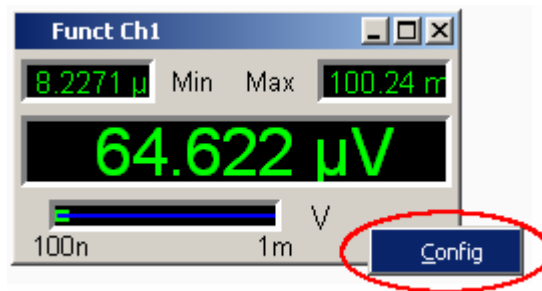

## Calling Up

There are several ways to open the combi display:

- Open the Display menu.

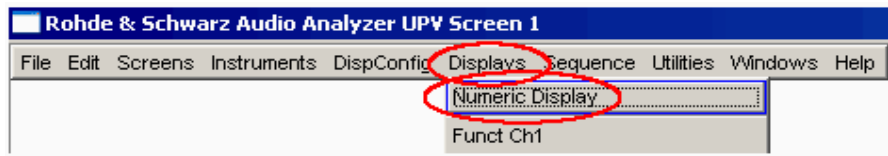

Select the Numeric Display menu item.

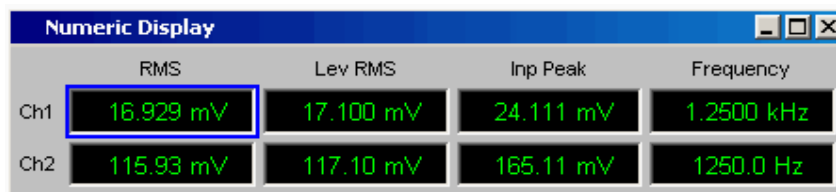

Move the blue selection frame to the desired measurement result using the rotary knob and then click with the rotary knob or, with mouse operation, double-click the desired measurement result in the numeric display.

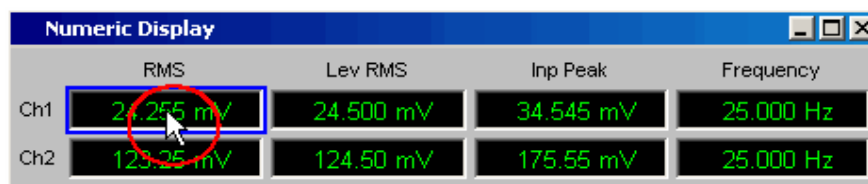

- Open the combi display directly via the menu bar.

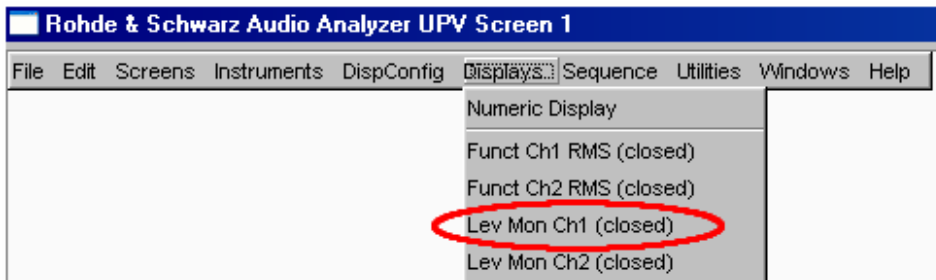

- Select a measurement result configuration panel from the menu field as follows:



Click the **Show** button in the Display field of the configuration panel (only for two-channel instruments).

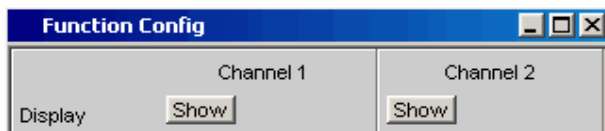

The measurement result configuration panels are used to determine how measurement results are **displayed** in the numeric display and the combi display. **What** is measured and **how** measurement is performed is configured in the analyzer panel.

The measurement result configuration panels are opened by pressing the **[MENU]** key on the front panel or, with mouse operation, by moving the pointer to the top left-hand edge of the R&S UPV application window.

4 different measurement result configuration panels are available.

#### Function Config

The panel is used to configure how the measurement results for the analyzer measurement function "Function" are displayed.

#### Level Mon Config

The panel is used to configure how the measurement results for the additional measurement function "Level Monitor" are displayed.

#### Input Config

The panel is used to configure how the measurement results for the additional measurement function "Input Peak" are displayed.

#### Freq / Phase Config

The panel is used to configure how the measurement results for the additional measurement function "Freq/Phase" are displayed.

The illustration below shows the assignment of the analyzer measurement functions to the measurement result configuration panels and the measurement result displays.

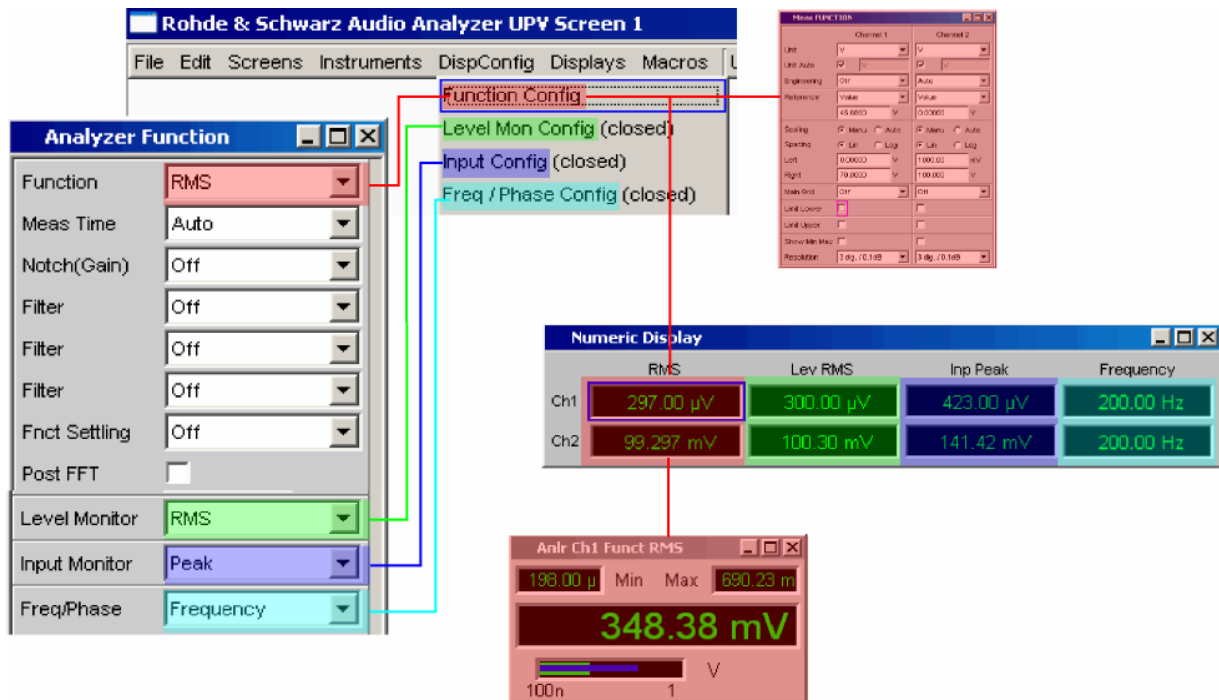

## Parameter Fields of the Panel

The layout of the measurement result configuration panels is almost identical for all of the displays. The differences are explained in the respective setting function description.

The individual setting lines of the various measurement result configuration panels are addressed with remote control commands which differ by one **figure** in accordance with the SENSE lettering on the basis of SCPI.

Function: SENSE[1]  
 Input: SENSE2  
 Freq / Phase: SENSE3  
 Level Mon: SENSE6

**Measurement result configuration panels for two-channel instruments**

For two-channel instruments, channel 1 and channel 2 can be configured separately for each measurement function. For this reason, both columns are always provided for the Function, Level Monitor and Input Peak measurement results.

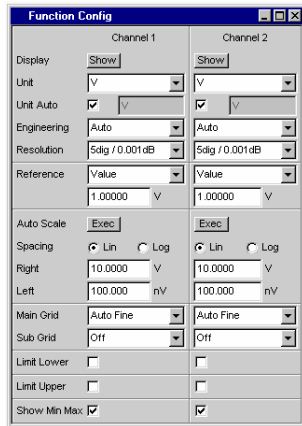

**Measurement result configuration panels for multichannel instruments**

For the configuration of the measurement result displays of Function, Level Monitor and Input Monitor in the case of multichannel instruments,

**All channels are configured fully identically.**

Therefore, only one column is provided.

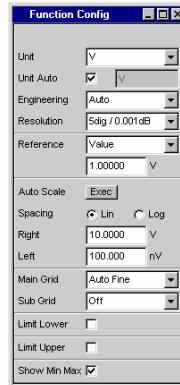

Configuring the Freq/Phase measurement result displays for multichannel instruments also requires two columns:

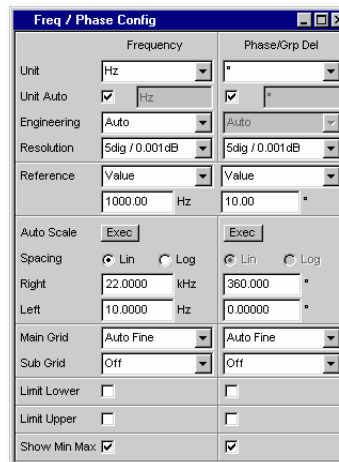

**Display**

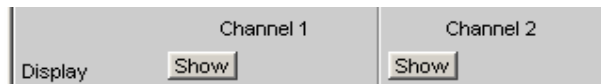

Not for multichannel instruments:  
 Clicking the **Show** button activates the combi display for a measurement value.  
 To close it, provided it has the focus, click on the **CLOSE** button or on the X in the title bar.

## Copy to Ch2

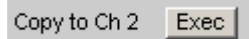

Not for multi-channel instruments:  
The Copy to Ch2 function exists for two-channel measurements for the Function Config, Level Mon Config and Input Config measurement result configuration panels.

As the name says, the setting lines from the first channel are transferred to the second channel. This happens **once** for almost all setting lines when the Exec button is pressed.

In the Freq/Phase configuration panel this setting line is not available as the transfer of frequency setting lines makes no sense in the phase area.

## Unit



This parameter field is used to determine the unit in which the measurement results are to be displayed.  
The parameter list available in this parameter field depends on whether the analog or digital analyzer instrument has been selected and under which of the 4 analyzer measurement functions

- Function
- Level Monitor
- Input measurement
- Frequency/phase measurement

the panel was opened.

Approx. 30 different units are available to allow all measurement functions of the analyzer to be displayed.

If a logarithmic unit (dBU, dBV, dBr, dBm, dBFS, dBUI) is selected, or a linear unit in which negative numbers can occur (e.g.  $\Delta V$ ,  $\Delta W$ ), the following parameter field "Spacing" is displayed as not user-accessible and its parameter is set to Lin, since it makes no sense to display measurement values with a logarithmic unit or negative values on a logarithmically scaled axis.

```
Remote-control command:
SENSe[1]:UNIT[1]|2 V|DBV| ...
SENSe6:UNIT[1]|2 V|DBV| ...
SENSe2:UNIT[1]|2 V|DBV| ...
SENSe3:FREQuency:UNIT HZ|DHZ| ...
SENSe3:PHASe:UNIT DEG|DDEG| ...
```

## Unit Auto

Used to determine whether the unit label displayed in the numeric display and in the combi display is the same as that set in the Unit parameter field above or whether it can be user-selected.

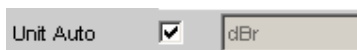

The unit label displayed in the numeric display and in the combi display is the same as the unit set in the Unit parameter field and is therefore generated automatically by the R&S UPV.

```
Remote-control command:
SENSE[1]:UNAuto[1]|2 ON
SENSE6:UNAuto[1]|2 ON
SENSE2:UNAuto[1]|2 ON
SENSE3:FREQuency:UNAuto ON
SENSE3:PHASe:UNAuto ON
```



A user-defined unit label can be entered.

#### Practical example:

The output level  $U_{0\text{dBspl}}$  which is output at a sound pressure of 0 dBspl (spl = sound pressure level) is specified for high-quality microphones. If the measured microphone output level is displayed in the referenced unit dBr and entered for the reference value  $U_{0\text{dBspl}}$ , the level displayed on the R&S UPV will be in dBr but corresponds to the sound pressure in dBspl. For the measurement result display, however, a numeric value in dBspl is desirable. To allow this, the unit label can be changed from dBr to dBspl.

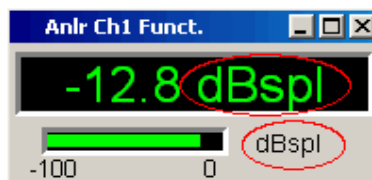

```
Remote-control command:
SENSE[1]:UNAuto[1]|2 OFF
SENSE6:UNAuto[1]|2 OFF
SENSE2:UNAuto[1]|2 OFF
SENSE3:FREQuency:UNAuto OFF
SENSE3:PHASe:UNAuto OFF
```

```
SENSE[1]:USERunit[1]|2 'string'
SENSE6:USERunit[1]|2 'string'
SENSE2:USERunit [1]|2 'string'
SENSE3:FREQuency:USERunit [1]|2
'string'
SENSE3:PHASe:USERunit [1]|2 'string'
```

## Engineering



Computes the measurement results in the numeric display field and in the combi display using a power of ten that is divisible by three.

This parameter field cannot be accessed if a dB or % unit is selected in the Unit parameter field above since these units do not usually have an engineering function.

**Auto**                    **Automatic** engineering assignment from p to M, for the measurement result, limits and Min/Max values; depends on the magnitude of the respective value.

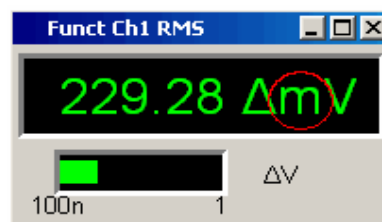

**Off**                        Engineering is **deactivated**. Measurement result, limits and Min/Max values are always displayed in 1.0 E<sup>0</sup> format.

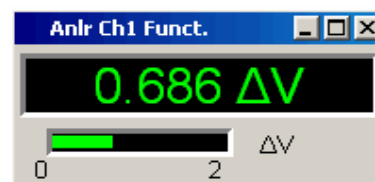

**μ**  
**m**  
**k**                        Engineering **fixed** to μ, m or k. The values to be displayed are multiplied by the factor 1.0 E<sup>6</sup>, 1.0 E<sup>3</sup> or 1.0 E<sup>-3</sup>.

Measurement results, limits and Min/Max values are displayed with the selected engineering.



## Resolution

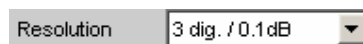

Used to set the number of digits used to display the measurement result, limits and Min/Max values.

- 3 dig. / 0.1 dB
- 4 dig. / 0.01 dB
- 5 dig. / 0.001 dB
- 6 dig. / 0.0001 dB
- 7 dig. / 0.00001 dB

Significance of the parameter list using an example:

**5 dig. / 0.001 dB**

**5 dig.:** Values which are displayed with a linear unit (V Hz, ...) are displayed with 5 digits:



**0.001 dB:** Values which are displayed with a logarithmic unit (dBV, dBu, ...) are displayed with three decimal points:



If the numerical values can no longer be displayed with the selected resolution (e.g. because the number of places is too high with the selected engineering setting) the display is rounded in exponential style:



**Reference**

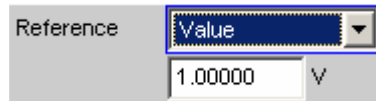

Used to select the reference for referenced units for the measurement result.



**Value**

A numeric value with unit must be entered as the reference value in the parameter field below.

The image shows a control panel interface. On the left, there is a label 'Ref'. To its right is a dropdown menu labeled 'Value:'. Below the dropdown is a text input field containing the number '1.234500'. To the right of the input field is a small icon representing a unit, which appears to be 'V'.

**Note:**

*If manual switchover is made from a variable reference value (Meas Ch1, Meas Ch2, Gen Track), to Value, the fixed reference value (Value) last valid will be restored.*

Remote-control command:

```
SENSe[1]:REFerence:MODE[1]|2 VALue
SENSe6:REFerence:MODE VALue
SENSe2:REFerence:MODE VALue
SENSe3:FREQuency:REFerence:MODE VALue
SENSe3:PHASe:REFerence:MODE VALue
```

```
SENSe[1]:REFerence[1]|2 <nu>
SENSe6:REFerence <nu>
SENSe2:REFerence <nu>
SENSe3:FREQuency:REFerence <nu>
SENSe3:PHASe:REFerence <nu>
```

**Store**

The current measurement result of a single-channel measurement is stored under Value when the ENTER key is pressed or the rotary knob/mouse key is clicked; this measurement result is then displayed as the new reference value. The reference value does not change while measurements are being performed. This selection option is only available for 1-channel measurement.

Remote-control command:

```
SENSe[1]:REFerence:MODE[1]|2 STORE
SENSe6:REFerence:MODE STORE
SENSe2:REFerence:MODE STORE
SENSe3:FREQuency:REFerence:MODE STORE
SENSe3:PHASe:REFerence:MODE STORE
```

**Store Ch1**  
**Store Ch2**  
**Store Ch3**  
**Store Ch4**  
**Store Ch5**  
**Store Ch6**  
**Store Ch7**  
**Store Ch8**  
**Store Ch9**  
**Store Ch10**  
**Store Ch11**  
**Store Ch12**  
**Store Ch13**  
**Store Ch14**  
**Store Ch15**  
**Store Ch16**

The current measurement result for the specified channel is stored under Value when the ENTER key is pressed or the rotary knob/mouse key is clicked; this measurement result is then displayed as the new reference value. The reference value does not change while measurements are being performed. These selection options are only available for two-channel or multichannel measurement.

Remote-control command:  
SENSE[1]:REFERENCE:MODE CH1Store |...  
SENSE6:REFERENCE:MODE CH1Store |...  
SENSE2:REFERENCE:MODE CH1Store |...  
SENSE3:FREQUENCY:REFERENCE:MODE CH1Store |...

**Meas Ch1**  
**Meas Ch2**

These selection options are only available for two-channel measurement. Every level measurement result for Channel 1 and Channel 2 is stored as the reference value. If a referenced unit has been selected in the Unit parameter field, the measurement result is referenced to this variable reference value and displayed. This selection option is only available for 2-channel measurement.

Remote-control command:  
SENSE[1]:REFERENCE:MODE CH1Meas | CH2Meas  
SENSE6:REFERENCE:MODE CH1Meas | CH2Meas  
SENSE2:REFERENCE:MODE CH1Meas | CH2Meas  
SENSE3:FREQUENCY:REFERENCE:MODE CH1Meas | CH2Meas

**Meas Ref Ch**

This selection option is only available for multichannel instruments. Every level measurement result of the channel specified in the Analyzer Config panel under Ref Channel is saved as a reference value.

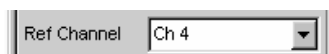

If a reference-specific unit was selected in the "Unit" parameter field, the measurement result is referenced to this floating reference value and displayed.

Remote-control command:  
SENSE[1]:REFERENCE:MODE MREFchannel  
SENSE6:REFERENCE:MODE MREFchannel  
SENSE2:REFERENCE:MODE MREFchannel  
SENSE3:FREQUENCY:REFERENCE:MODE MREFchannel

**Gen Track** The currently valid and every newly set generator voltage is stored as the reference value and can then be used for referenced display (by both channels). If a referenced unit has been selected in the Unit parameter field, the measurement result is referenced to this reference value and displayed.

```
Remote-control command:
SENSE[1]:REFERENCE:MODE[1]|2 GENTrack
SENSE6:REFERENCE:MODE GENTrack
SENSE2:REFERENCE:MODE GENTrack
SENSE3:FREQUENCY:REFERENCE:MODE
GENTrack
SENSE3:PHASE:REFERENCE:MODE GENTrack
```

## Auto Scale

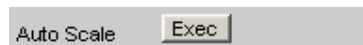

One-off automatic scaling of the bargraph.

**Exec** Clicking this button triggers **one-off** scaling of the bargraph; the current minimum and maximum values are used for the scaling process. The determined values are entered in the Left and Right parameter fields below.

For multichannel instruments the **lowest minimum value** and the **highest maximum value of all open combi displays** are determined and entered for all channels in the Left and Right right parameter fields below.

## Spacing



Linear or logarithmic spacing of the bargraph.

**Lin** Linear spacing of the bargraph.

If a logarithmic unit (dB unit) was selected in the "**Unit**" parameter field, this field is displayed as not user-accessible and is set to "Lin", since it makes no sense / is not possible to use a logarithmic bargraph to display negative values, or measurement values that have a logarithmic unit.

**Log** Logarithmic spacing of the bargraph.

This parameter is only available if a linear unit (V, W, etc) has been selected in the Unit parameter field and its value range cannot contain negative numbers.

Example:  
Although  $\Delta V$  is a linear unit, the measurement results can be negative which means that logarithmic display is not possible.

**Left**
  

Used to set the left-hand value on the bargraph.

Negative values or the value 0.00000 are not allowed when Spacing = Log, in which case they cannot be entered.

**Right**
  

Used to set the right-hand value on the bargraph.

This value must always be higher than the Left value. Negative values or the value 0.00000 are not allowed when Spacing = Log, in which case they cannot be entered.

**Main Grid**
  

Division of the bargraph with vertical main lines.

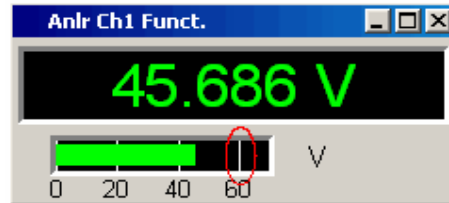

- |  |   |
|--|---|
| <b>Off</b>   | No main lines are used in the bargraph.   |
| <b>On</b>  | With Spacing = Log:<br>Decadic division of a bargraph with main lines.  |
| <b>Auto Coarse</b><br><b>Auto Medium</b><br><b>Auto Fine</b> | With Spacing = Lin:<br>Coarse, medium or fine division of a bargraph with main lines. One to two, 3 to 4 or 8 to 9 main lines are displayed depending on the scale end values. Main lines may be <b>hidden</b> if the combi display is reduced in size. |
| <b>Divisions</b>   | With Spacing = Lin:<br>Preset division of a bargraph with main lines. The desired number of divisions is set in the parameter field below. These main lines are <b>not</b> hidden if the combi display is reduced in size.                              |
| <b>Steps</b>   | With Spacing = Lin:<br>Preset division of a bargraph in a fixed step size. The step size is set in the parameter field below. These main lines are <b>not</b> hidden if the combi display is reduced in size.   |

**Division**

With Spacing = Lin:



Used to enter the number of main line divisions for a bargraph. If, for example, **2** is entered, the bargraph is divided into **two sections**, i.e. **one** main line is displayed.

**Step**

With Spacing = Lin:



Used to enter the main line step size for a bargraph. The unit of the value is not linked to the unit selected in the Unit parameter field; the value can be given in different units.

**Sub Grid**

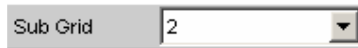

Subdivision of the main lines in a bargraph using sublines.

- Off** Sublines are deactivated.
- 2** With Spacing = Lin:
- 4** Subdivision of the main lines of a bargraph into 2, 4
- 5** or 5 sections.  
If, for example, **2** is selected, the area between two main lines is divided into **2** sections, i.e. **one** subline appears between the main lines.  
These sublines are **not** hidden if the combi display is reduced in size.
- Coarse** With Spacing = Log:
- Fine** Coarse or fine subdivision of the main lines of a bargraph with sublines.

Coarse:

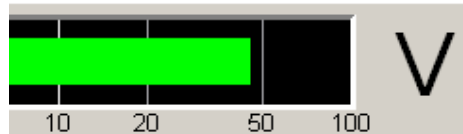

Sublines 2 and 5 only

Fine:

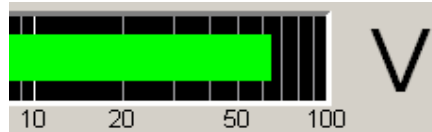

All sublines

Limit Lower

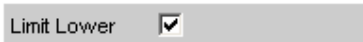

Used to activate/deactivate the lower limit check.



The lower limit check is activated.

The parameter field below is used to enter a lower limit in the units selected in the Unit parameter field.

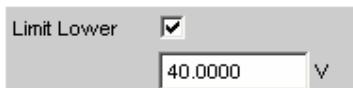

A lower limit can be defined for the measurement result; every measurement value is then compared with this limit.

If a relative unit is selected, the associated reference value (a few parameter fields higher up) is used.

The lower limit is displayed as a value (bottom left) and as a red limit marker in the bargraph.

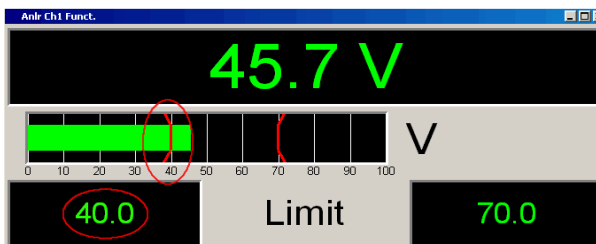

As soon as a limit is underranged, the measurement result and bargraph change from green to red; if the limit violation no longer exists, the measurement result and bargraph are displayed in green again.

A red measurement value in the numeric display also indicates a limit violation:

In order to monitor limit violations over a long period of time without having to watch the measurement result display continuously, the lower limit is displayed permanently in red as soon as the limit is underranged after the **[START]** key has been pressed.

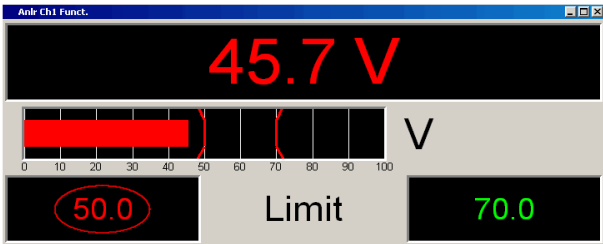

Pressing the **START** key or re-entering the limit resets the hold function.

This hold function is not visible in the numeric display.



The lower limit check is deactivated.

**Limit Upper**



Used to activate/deactivate the upper limit check.



The upper limit check is activated.

The parameter field below is used to enter an upper limit in the units selected in the Unit parameter field.

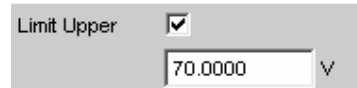

An upper limit can be defined for the measurement result; every measurement value is then compared with this limit.

If a relative unit is selected, the associated reference value (a few parameter fields higher up) is used.

The upper limit is displayed as a value (bottom right) and as a red limit marker in the bargraph.

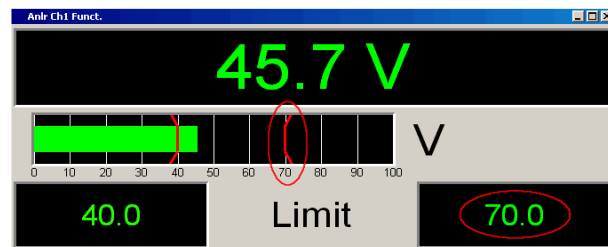

As soon as a limit is overranged, the measurement result and bargraph change from green to red; if the limit violation no longer exists, the measurement result and bargraph are displayed in green again.

A red measurement value in the numeric display also indicates a limit violation:

In order to monitor limit violations over a long period of time without having to watch the measurement result display continuously, the upper limit is displayed permanently in red as soon as the limit is overranged after the **[START]** key has been pressed.

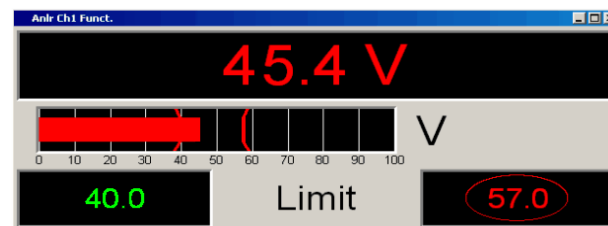

Pressing the **[START]** key or re-entering the limit resets the hold function.

This hold function is not visible in the numeric display.



The upper limit check is deactivated.



Show Min Max

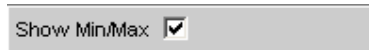

Used to activate/deactivate the Min/Max display.  
Two numeric values and the ends of the blue bar inside the green bar indicate the lowest and highest values measured.



The lowest and highest value measured since the **START** key was pressed are displayed.  
The Min/Max values are shown in the top left and right-hand corners of the combi display.

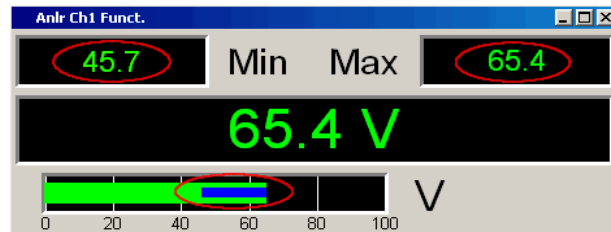

The ends of the blue Min/Max bar indicate the lowest and highest values measured since the **START** key was pressed.

Pressing the **START** key resets Min/Max value recording and the collection of measurement values begins again.



The Min/Max display is deactivated.

## Softkey Menu





**Two-channel instruments:**

Every combi display has its own softkey menu. The settings selected in the menu apply exclusively to the associated combi display and affect no other combi display.

**Multichannel instruments:**

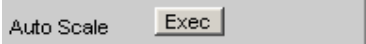
If a softkey menu from a combi display of a specific measurement function (e.g. Level Monitor) was used, the chosen setting affects **all** open combi displays for this measurement function. In the case of multichannel instruments, there are no customized settings for individual channels.  
The settings for "Store Reference", "Show Min/Max", "Show Lim Low" and "Show Lim Upp" can therefore be immediately displayed 1 to 1 in the associated measurement result configuration panel .



Store Reference	The current measurement value is stored as a reference value. If, for example, the reference unit dBr is selected as the unit, the next measurement value is 0.0 dBr.
Autoscale	One-time scaling of the bargraph on the basis of the minimum and maximum values. Corresponds to  in the associated configuration panel.
Show Min Max	If the tick is set, the min/max values are displayed. Corresponds to  in the associated configuration panel.
Show Lim Low	If the tick is set, the lower limit value is displayed. Corresponds to  in the associated configuration panel.
Show Lim Upp	If the tick is set, the upper limit value is displayed. Corresponds to  in the associated configuration panel.
Restart Min/Max	Resets min/max value recording in order to restart measurement. Equates to using the <b>START</b> key
Restart Lim Violation	Resets the red colour marking (measurement value, bar and limit value) for indicating a limit violation and restarts a test for a limit violation.
Config	Opens the configuration panel for this combi display.

# Limit Monitoring

Both traces/bargraphs and measurement results can be monitored to determine whether limits or limit curves have been overranged or underranged.

## Traces and Bargraphs

Upper and lower limits or a limit curve can be entered separately for Trace A and Trace B in every display configuration panel for every graphic subsystem.

Limit entered as a value:



The limit in a graphical display is shown as a straight line.

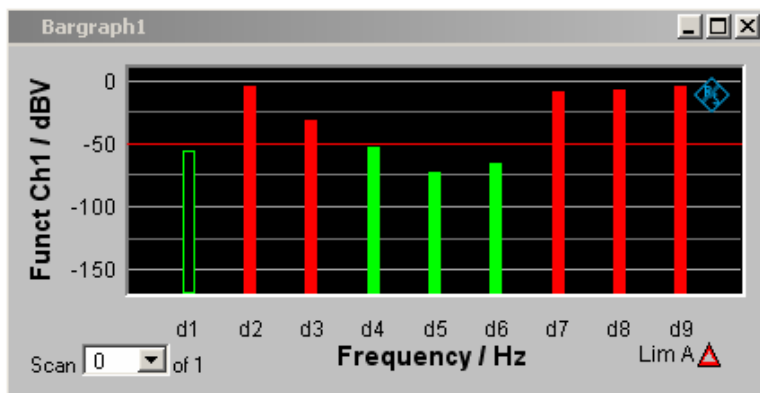
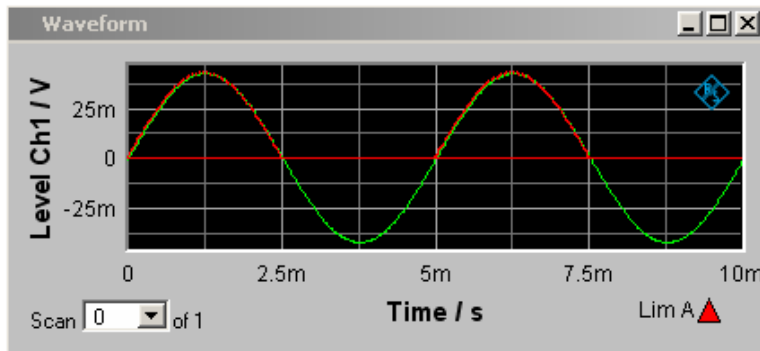
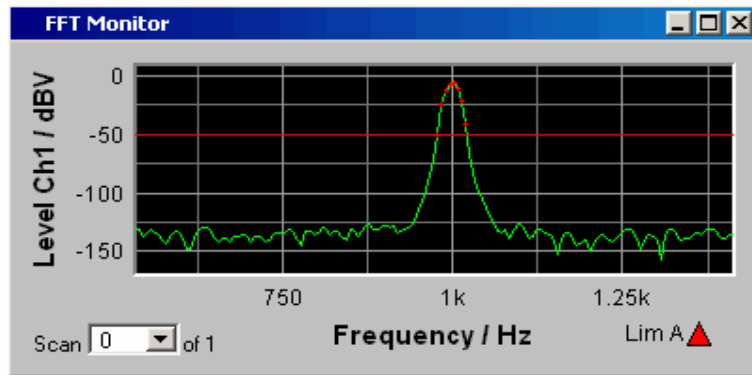

**Limit entered as a curve:**

A limit curve can be entered only for the graphic systems Sweep, FFT Function, Bargraph and PESQ. A limit curve makes no sense for the Waveform graphic system and is not offered.

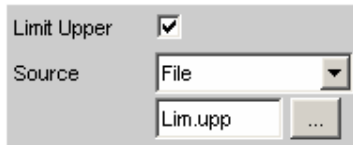

The limit in a graphical display is shown as a user-defined curve.

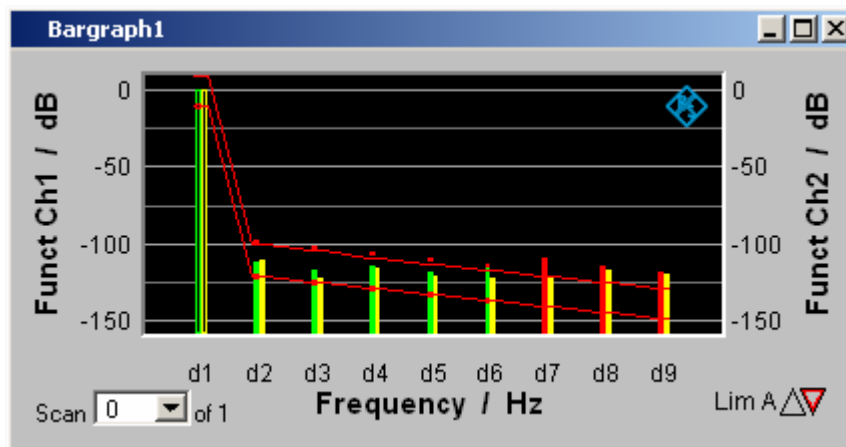
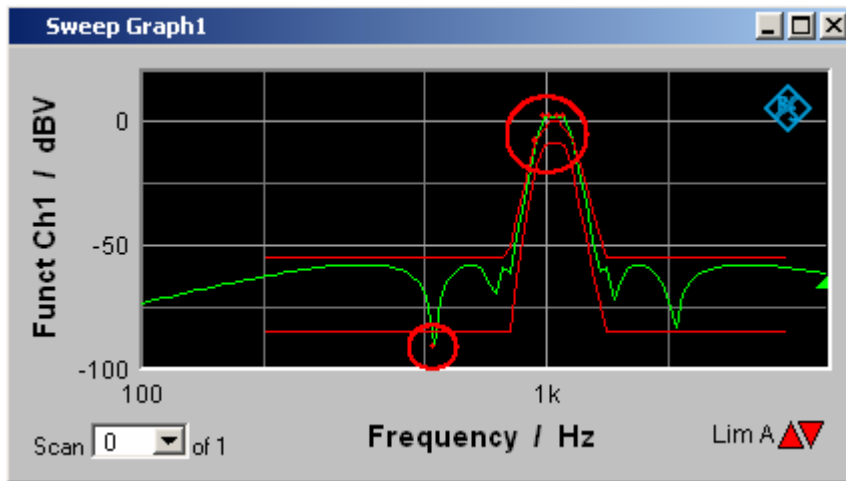

Each measurement value is compared with the limit value or the limit curve and in the event of a limit violation is identified as a red dot in the trace display or as a red bar in the bargraph.

If multi-scan recording is performed in the Sweep Graph 1...4 graphic subsystems, all of the scans of a trace are checked against the associated limit or limit curve.

In the result list (see section "Result List" on page 4.547), rows containing measurement values which violate the specified limits are displayed in red.

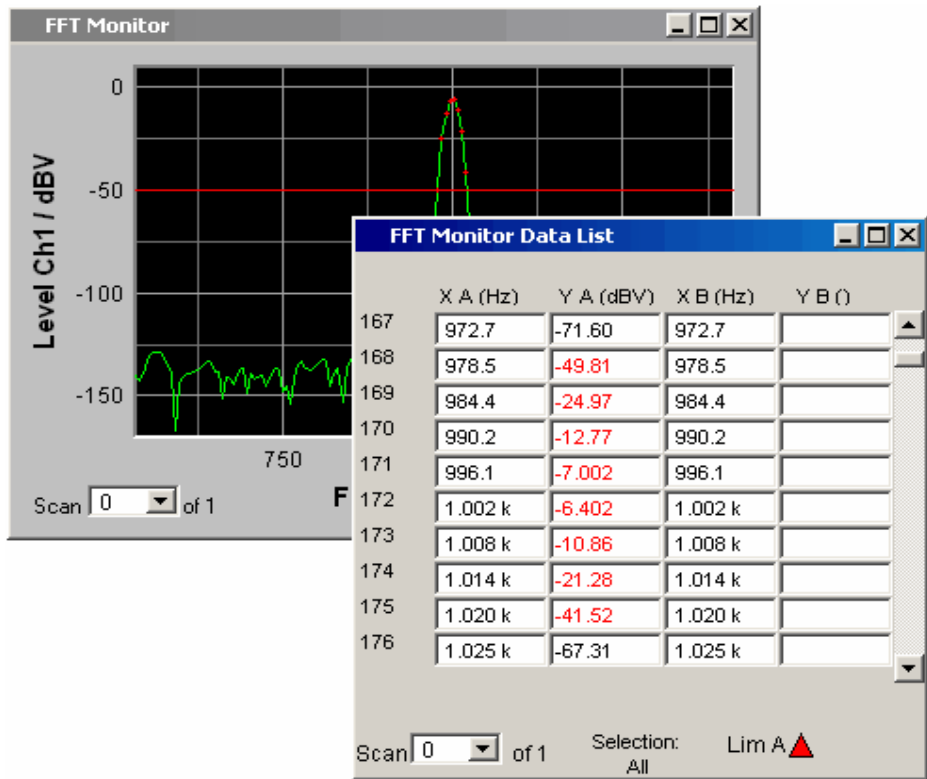

In addition to the red dots in the trace or the red bars in the bargraph, in the lower right corner of the graphic display and the measurement value list there is an indicator of limit violations, so that it is possible to see at a glance whether any limit violation exists. The interpretation is as follows:

- Lim A Lim B Symbols indicating limit violations
- "Limit Upper" is activated and there is no limit violation.
  - "Limit Lower" is activated and there is no limit violation.
  - The "Limit Upper" value has been violated in the past but there is currently no limit violation. The violation is indicated until the **START** key is pressed again.
  - The "Limit Lower" value has been violated in the past but there is currently no limit violation. The violation is indicated until the **START** key is pressed again.
  - The "Limit Upper" value is currently being violated.
  - The "Limit Lower" value is currently being violated.

## Measurement Results

A lower and upper limit can be specified in any measurement result configuration panel:

Limit Lower    V  V

In the combi display, the limits are displayed as red limit markers (brackets) in the bargraph and as numeric values:

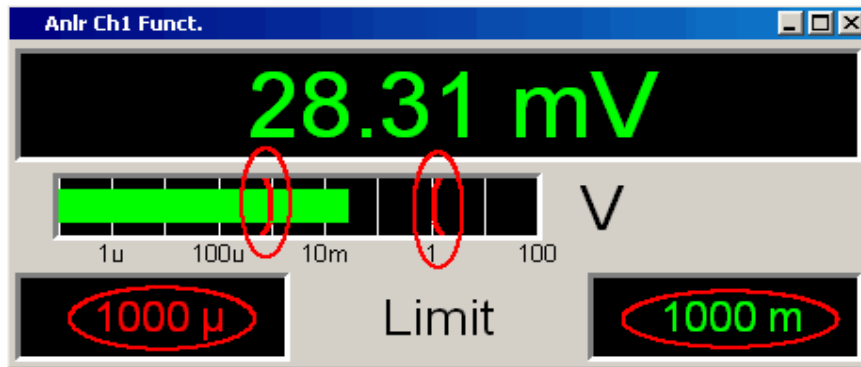

A red measurement value and bar indicate that there is a limit violation:

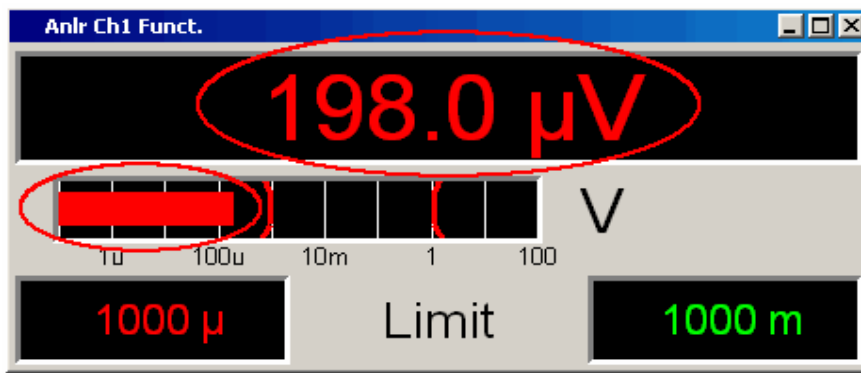

A red measurement value in the numeric display also indicates a **current** limit violation:

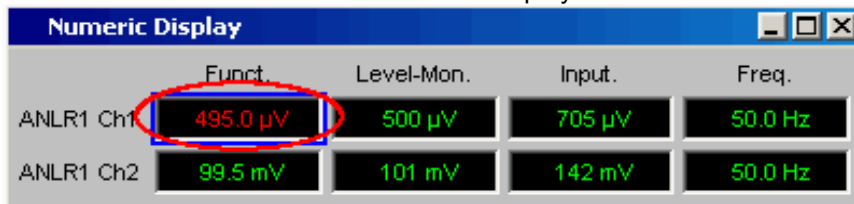

In order to indicate that the lower or upper limit was violated in the past, the lower or upper limit is displayed in red until the [START] key is pressed, which resets the hold function and restarts monitoring of the measurement values:

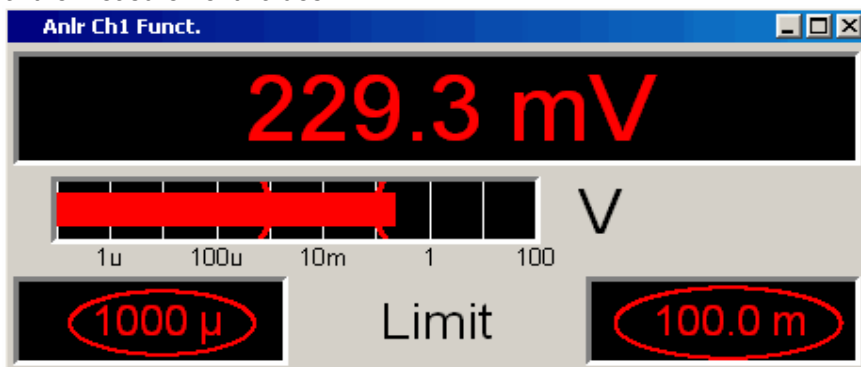

This hold function is not visible in the numeric display.

## Measurement value sequences

Measurement value sequences consisting of acquired function measurement results, sweeps, FFT data, Waveform data, Bargraph data or PESQ data can be stored in a file for different purposes:

- To load the measurement values again as a report, to permit comparison or to allow processing at a later stage. When loaded using commands in the display panel, the series of measurement values are initially displayed exactly as they were when saved. They can, however, be rescaled or, for example, converted into different units.
- The files are stored in ASCII format so that they can be easily imported into other programs where the data can be processed further (e.g. Microsoft Excel). See section "Format" on page 4.590 for information on the ASCII format and how data can be imported into other programs.

## Saving

### Trace files

When a **Trace list** is saved no distinction is made between Trace A or Trace B.

Both traces are always stored to the file, provided that both traces are switched on. In the multiscan mode, all scans selected by means of the "History" line are stored to the file. If "Show Min Max" is enabled, these scans are stored too.

In addition to measurement value sequences, a further range of information is stored since it is needed so that on loading the trace list the graph is displayed just as when it was saved:

- Functionality on the X and Y axes
- Axis labeling
- Display units on the axes
- Scaling on the axes (lin/log)
- Left/right and top/bottom values of the axis scaling
- Limit values for the Y axes
- Reference values on the axes

When the trace file is loaded, this information affects the corresponding DispConfig panel so that the parameter fields reproduce the information stored in the file.

Exception: If "Hold" is set in the parameter fields "Reference", "Limit Upper" and "Limit Lower", the current settings are not overwritten.

The format in which the trace list is stored is the same for all subsystems.

If the file name is specified without an extension, the suggested file name extension is .TRC, but any desired extension can be specified.

For a detailed description of the storage format, see section "Trace Files" on page 4.590).

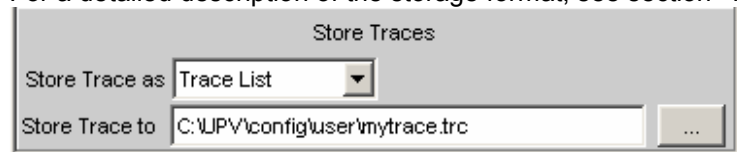

## Equalization files

An **equalization list** is a table that contains frequency points and associated gain factors. The list can be used to apply a predefined frequency response to the generator. The set amplitude of the generator is changed as a function of frequency in accordance with the values specified in the table (see section "Equalization", on page 4.111). Frequency values are stored to the list in the basic unit of Hz, irrespective of the unit used for X-axis value display.

An equalization list in ASCII format is generated from the current measurement value sequence, taking into account the settings made under "Trace", "Norm Freq", "Invert" and "Modify Equ.". The list is stored to a file, which can be loaded by selecting it in the "Equalizer" line in the Generator Function panel.

An equalization file may contain up to 1024 X/Y pairs, because a generator sweep can have a maximum of 1024 sweep points. If a measurement value sequence contains more than 1024 X/Y pairs, data will be compressed automatically such that only every 2nd, 4th, 8th X/Y pair and so forth is stored to the equalization file.

If an equalization list is generated from a multiscan display (including also the Min/Max scans of a single-scan display), the Y values of the currently selected scan are taken to generate the list.

If a file name is specified without an extension, .VEQ is suggested as a default extension, but any other extension can be used instead.

For a detailed description of the storage format, see section "Equalization Files" on page 4.594).

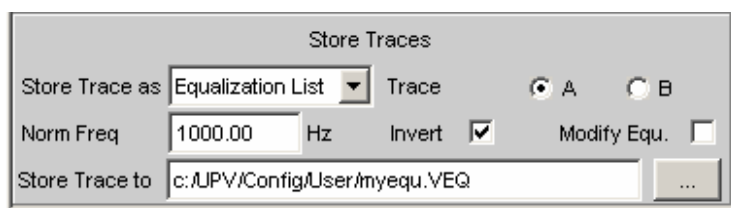

## Sweep list

A **sweep list** contains any desired sweep axis. Since the individual values of X are extracted from a current measurement value sequence, they are in ascending order. If the file is then manually processed, the **separations** of the sweep points can be freely selected in order to place a greater number at places of particular interest without drastically increasing the total number of sweep points. The sweep points must, however, be specified in ascending or descending order – they must not change direction. The sweep points are processed by the sweep system in the order in which they are listed, . There must be at least two different points in the list.

The file can contain a maximum of 1024 X values, because a generator sweep can have a maximum of only 1024 sweep points. If a measurement value sequence has more than 1024 X/Y pairs, the data is compressed automatically by saving only every 2nd, 4th, 8th, etc. value for the sweep list.

If a sweep list is saved from a multiscan display (including the Min/Max scans in the case of a single scan display), the currently selected scan plays no role, since the X values are the same for all scans.

If the file name is specified without an extension, the suggested file name extension is .SPL, but any desired extension can be specified.

For a precise description of the storage format, see section "Sweep Lists" on page 4.595).





## Limit files

A **limit list** contains X and Y data that has been extracted from the current measurement value sequence. When it is saved, no distinction is made about whether the file will be used later as an Upper Limit or as a Lower Limit. This depends on whether the file is **loaded** as an Upper Limit file or as a Lower Limit file. A limit list that has been obtained from a measurement value sequence usually has more interpolation points than necessary, and it is therefore often necessary to process the file further. For information on how to do this see section *"Editing"* on page 4.598).

A limit list must contain at least two different points forming a straight line.

If a limit list is saved from a multiscan display (including the Min/Max scans in the case of a single scan display), the Y values are extracted from the currently selected scan.

The file can contain a maximum of 1024 X/Y pairs.

If the file name is specified without an extension, the suggested file name extension is .LIM, but any desired extension can be specified.

For a precise description of the storage format, see section *"Limit Files"* on page 4.597).



# Loading

## Trace files

When **traces** are loaded, unlike when they are saved, a distinction is made between Trace A or Trace B. Since the trace file always contains both traces, provided both traces were enabled when saved, a decision is made via the parameter field "Y-Source" = "File: Trace A" or "File: Trace B" about which trace to load from the file.

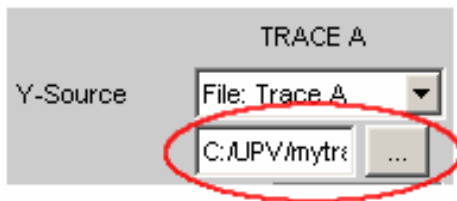
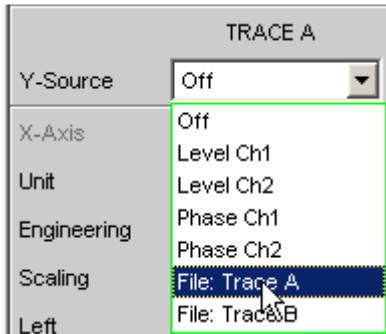

All trace files have the file name extension \*.TRC as a default setting, that is, if the file name only is specified, without an extension, this extension is automatically added. Other extensions are allowed. Clicking the ... button opens the file selector with all known properties (see chapter 3).

During the loading procedure, the system tests whether the trace file can be loaded. When trace files are stored an identifier is entered so that it is obvious from which graphic system the file was saved. Trace files can only be loaded into the graphic system from which they were saved; in all other cases the attempt to load is ignored and an error message is issued (see section "Trace Files", on page 4.590). When Bargraph trace files are being loaded, the system recognizes from the number of stored lines whether the file matches the set measurement function. For example a Bargraph trace file with 9 frequency lines in a bargraph display would be rejected for the measurement function DFD, because only 5 lines are expected there.

However, if there is ever a need to load a trace file of a different type into a graphic system, acceptance of the file can be forced through by changing the trace file identifier in an ASCII editor; see section "Editing" on page 4.598).

If a trace file cannot be loaded, or if "Y-Source" = "File: Trace A" or "File: Trace B" addresses a trace file in which the required trace does not exist, an appropriate warning is issued and the loading procedure is terminated. The previous trace in the graphical display remains unchanged.

The content of the trace files defines the appearance of the DispConfig panel and the associated display panel.

The appropriate scan is loaded from the trace file, depending whether "Scan" = "Single" or "Multi" in the parameter field and whether "Show Min Max" is set.

The following figure shows the parameter fields and wordings which are influenced by the file content.

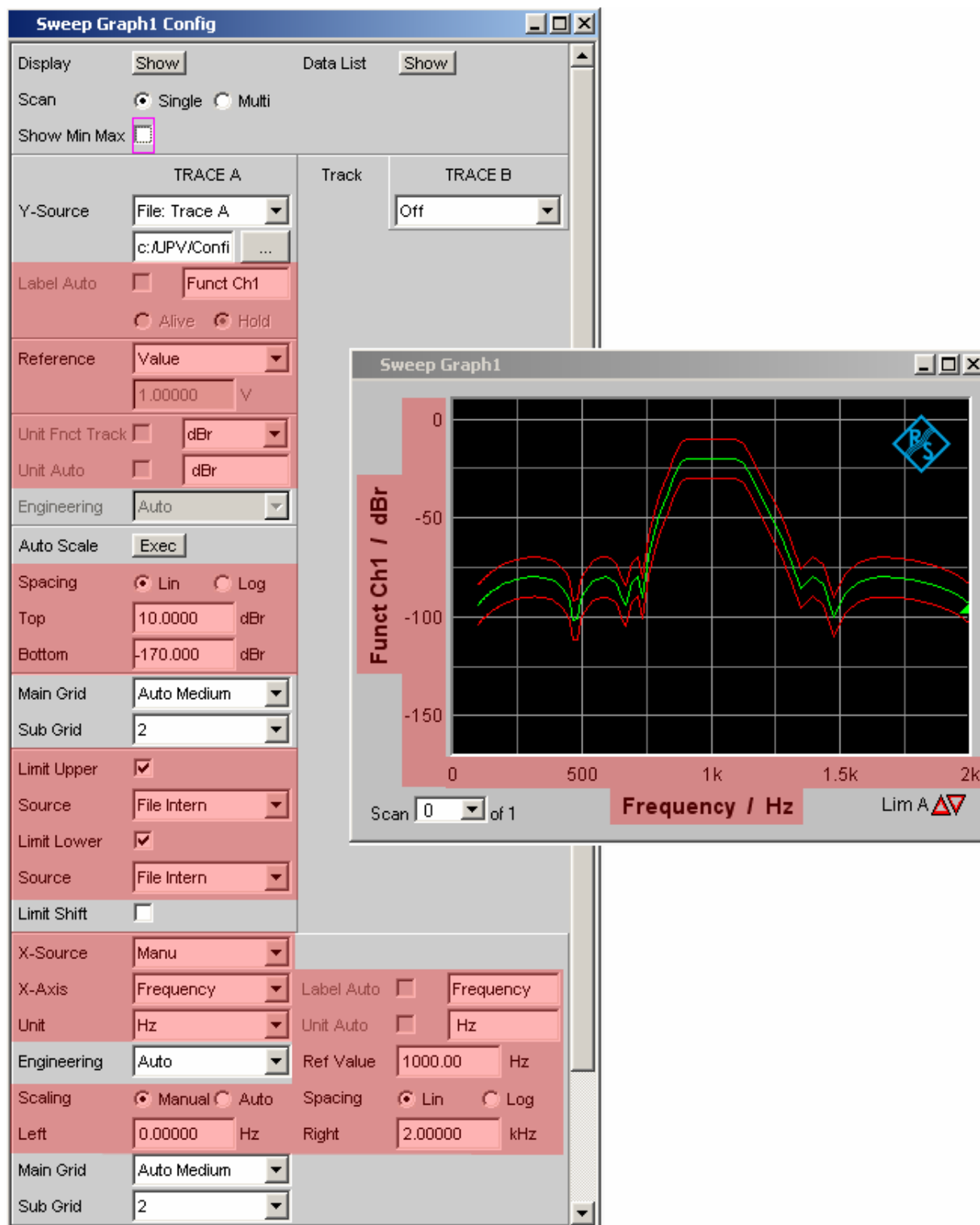

If the file contains both reference traces and limit traces, "File Intern" is displayed in the corresponding parameter fields. "File Intern" means that there is no individual value (for example in the case of a "Reference", this would be "Limit Upper" or "Limit Lower" with the setting Value) but instead a trace, and that this trace has been taken from a file loaded at "Y-Source" = "File: Trace A" or "File: Trace B".

Furthermore all Auto and Tracking tick boxes such as Label Auto, Unit Func Track, Unit Auto etc. are deactivated and grayed out so that they cannot be used. All parameter fields that allow Auto settings, such as "X-Source" or "Scaling", are set to "Manual", since they are preset by the file content.

If "Hold" is selected in the parameter fields "Reference", "Limit Upper" and/or "Limit Lower", the **current settings** remain the unchanged and are **not** altered by loading a trace file.

### Switching the Y-Source:

The display and deletion of traces largely depends on switching the "Y-Source", that is, the source of the traces.

The "Y-Source" parameter field offers two sources for the recording and display of traces:

**Traces from measurements** are all settings other than "File: Trace A" or "File: Trace B", such as "Funct CH1", "Level Ch1", "Phase Ch1" etc.

**Traces** can be loaded **from file** by means of "File: Trace A" or "File: Trace B".

"Off" deletes the trace.

### Deleting traces:

Traces are generally always deleted either by using the  key or by switching the "Y-Source" to "Off".

When the "Y-Source" is switched between measurement (e.g. "Funct Ch1") and file (e.g. "File: Trace A"), a trace is always deleted when the basic unit changes.

### Switching measurements in multiscan mode:

The reaction of the R&S UPV depends largely on whether or not the basic unit changes.

#### Example, basic unit does not change:

The RMS measurement function is set in the analyzer. The selected display unit is dBV. "Funct CH1" is set in the Sweep Graph Config panel as the "Y-Source", which means that the results of the RMS measurement are displayed on the Y axis. Also in the analyzer the Level Monitor is set with the measurement function "Peak" and the display unit "dBu".

If the "Y-Source" is now switched in the Sweep Graph Config panel from "Funct CH1" to "Level Mon Peak Ch1", the basic unit does not change, since in both cases the basic unit of dBV and dBu is Volt.

The current scan is retained.

If the switch takes place during a measurement, the new scan is linked to the old scan already drawn. If the measurement was halted, the new scan is drawn after the  button is pressed.

The scans in the other channel are unaffected.

#### Example, basic unit changes:

The RMS measurement function is set in the analyzer. The selected display unit is dBV. "Funct CH1" is set in the Sweep Graph Config panel as the "Y-Source", which means that the results of the RMS measurement are displayed on the Y axis. Also in the analyzer the phase measurement is set with the display unit Rad.

If the "Y-Source" is now switched in the Sweep Graph Config panel from "Funct CH1" to Phase, the basic unit changes, since the basic unit of dBV is Volt and the basic unit of Rad is °.

The current scans are deleted.

If the switch takes place during a measurement, the new scan is redrawn in the cleared graphic window. If the measurement was halted, the new scan is drawn after the **Single** button is pressed.

The scans in the other channel are unaffected.

#### **The last file that was loaded determines the x-axis**

If files with different x-axes are loaded one after the other, the last file always determines the x-axis. If a sweep with a different x-axis is then loaded, it will determine the x-axis.

#### **Loading a trace file with measurement in progress or halted:**

On switching from a measurement to loading a trace from a file (e.g. "Y-Source" from "Funct CH1" to "File: Trace A"), deletion takes place and the trace from the file is displayed immediately, provided the basic unit is permitted in the current graphic subsystem and the basic unit is suitable for the X axis. The panel content changes according to the parameters stored in the trace file, as described above.

Any attempt to load a trace file containing the results of a phase measurement into the Waveform graphic system would be ignored with an appropriate warning, since a phase measurement result is not provided for in the Waveform graphic system. The current trace is retained.

#### **Switching from a loaded trace file to measurement:**

On switching from a **trace loaded from file to measurement** (e.g. "Y-Source" from "File: Trace A" to "FFT Level Ch1"), the current scan is retained, provided the basic unit is suitable. The new scan is drawn when the **Single** button is pressed. This reaction is particularly important, since in this way new measurement value scans can be appended to the scans loaded from a file. If the basic unit is not suitable, the current scans are deleted.

#### **Loading trace files, depending on the single scan or multiscan setting:**

Depending whether "Scan = Single" or "Scan = Multi" the appearance changes when loading or recording scans.

##### **Scan = Multi**

If a trace is loaded from a file which contains a multiscan, either all scans are taken from the file or only as many as the number specified in the "History" parameter field. If the file contains only a single scan, this scan is interpreted as a multiscan with only one scan. If Show Min Max is ticked and Min/Max scans are stored in the trace file, these are also loaded.

##### **Scan = Single**

If a scan is loaded from a file which contains a multiscan, the first scan is loaded from it. If Show Min Max is ticked and Min/Max scans are stored in the trace file, these are also loaded. A single scan is then displayed with a maximum of three scans per channel. If Min/Max scans are stored in the trace file, "Show Min Max" will be enabled automatically so that these scans will be displayed in the graphic. If Min/Max scans are stored in the trace file, "Show Min Max" will be enabled automatically so that these scans will be displayed in the graphic.

If "Y-Source" is switched to "File: Trace A" or "File: Trace B", the "Alive/Hold" parameter field is shown as not user-accessible and has the setting "Hold", since an Alive/Hold option makes no sense for a trace loaded from file.

If "Y-Source" is switched to measurement, the "Alive/Hold" parameter field is again accessible and has the setting "Alive".

On switching from "Scan = Single" to "Scan = Multi" the single scan is retained and "New Scan" is forced to the Append mode. New scans are added each time the **Single** button is pressed.

On switching from "Scan = Multi" to "Scan = Single" the last scan of the current multiscan is retained.

### Appending or substituting scans

The parameter field "New Scan" = "Append" or "Replace" defines whether scans are appended to existing scans or whether a single scan replaces another.

The parameter fields "New Scan" and "Import from" are offered only for multiscan ("Scan" = "Multi"), since new scans can be appended or substituted only in multiscan recording.

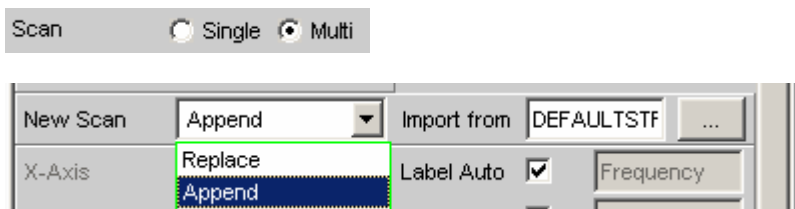

The scans to be appended or substituted may come from a measurement or a file. By far the most frequently used setting is "New Scan" = "Append".

There are a number of options for appending or substituting scans. These options depend on the following settings and conditions:

Alive/Hold setting

Append or substitute measurement scan

Append or substitute scan from file

Is a measurement in progress or halted?

Which scans and how many scans are stored in a file?

Does the scan from the file suit the current setting?

The following section should cover the most important possibilities.

### Appending measurement scans to existing scans

Parameter field "New Scan" = "Append"

Parameter field "Alive/Hold" to "Alive".

Each time the **Single** button is pressed a measurement is launched and the new measurement scan is appended to the existing scans.

### Measurement scan replaces an existing scan

Parameter field "New Scan" = "Replace"

Parameter field "Alive/Hold" to "Alive".

Use the **Next Scan** toggle key to select the scan to be replaced.

Each time the **Single** button is pressed a measurement is launched and replaces the selected scan with the new measurement scan.

### Importing scans from a file and appending them to existing scans

Parameter field "New Scan" = "Append"

Parameter field "Alive/Hold" to "Hold".

If the parameter field "Alive/Hold" is on "Alive" and a measurement is in progress (single measurement not yet finished or continuous measurement), any attempt to import a file is ignored and a message is issued.

If the parameter field "Alive/Hold" is on "Alive" and a measurement is finished, a scan / multiple scans can be imported from a file and appended to the existing scans.

If an import is allowed, it largely depends on the content of the source file whether and how the operation proceeds.

A file will be imported only if the basic units from the file match the "Y-Source" setting, or if the unit is allowed in the graphic subsystem. For example if "Y-Source" = "Funct Ch1" and the set analyzer measurement function = "RMS", a trace file with the basic unit Volt is suitable. A trace file with the basic unit % would be ignored and an error message would be issued.

When loading a trace file it must be clearly specified which trace is to be loaded from the file ("File: Trace A" or "File: Trace B").

This choice is not needed when importing. Provided the basic units are suitable for the current setting, the file content defines what and how much will be imported:

If only Trace A or only Trace B is activated in "Y-Source" and the file to be imported contains only one trace and it does not matter whether it is Trace A or Trace B, then this trace is imported.

If Trace A and Trace B are both activated and the file to be imported contains only one trace, and it does not matter whether it is Trace A or Trace B, this trace is imported to Trace A **and** Trace B.

If only Trace A or only Trace B is activated and the file to be imported contains a stereo trace, that is, Trace A and Trace B, the corresponding trace is imported, namely A to A or B to B.

If Trace A and Trace B are both activated and the file to be imported contains a stereo trace, then both traces are imported, namely A to A and B to B.

The following applies to all the cases listed:

All suitable scans from the file are appended. Starting from the first scan, all scans are appended from the file until the maximum number of 20 scans is reached.

If "**Hold**" is selected in the parameter fields "Reference", "Limit Upper" and "Limit Lower", the current settings are not changed by the imported scans.

### **Importing scans from a file and replacing an existing scan**

Parameter field "New Scan" = "Replace"

Parameter field "Alive/Hold" to "Hold".

If the parameter field "Alive/Hold" is on "Alive" and a measurement is in progress (single measurement not yet finished or continuous measurement), any attempt to import a file is ignored and a message is issued.

If the parameter field "Alive/Hold" is on "Alive" and a measurement is finished, a scan can be imported from a file and replace a scan.

If the default settings agree, it largely depends on the content of the import file whether and how the operation proceeds.

A file will be imported only if the basic units from the file match the "Y-Source" setting, or if the unit is allowed in the graphic subsystem. For example if "Y-Source" = "Funct Ch1" and the set analyzer measurement function = "RMS", a trace file with the basic unit Volt is suitable. A trace file with the basic unit % would be ignored and an error message would be issued.

When loading a trace file it must be clearly specified which trace is to be loaded from the file ("File: Trace A" or "File: Trace B").

This choice is not needed when importing. Provided the basic units are suitable for the current setting, the file content defines what and how much will be imported:

If only Trace A or only Trace B is activated in "Y-Source" and the file to be imported contains only one trace and it does not matter whether it is Trace A or Trace B, then this trace is imported.

If Trace A and Trace B are both activated and the file to be imported contains only one trace, and it does not matter whether it is Trace A or Trace B, this trace is imported to Trace A **and** Trace B.

If only Trace A or only Trace B is activated and the file to be imported contains a stereo trace, that is, Trace A and Trace B, the corresponding trace is imported, namely A to A or B to B.

If Trace A and Trace B are both activated and the file to be imported contains a stereo trace, then both traces are imported, namely A to A and B to B.

The following applies to all the cases listed:

If the file contains more than one scan a warning is given and the **first scan** from the file is taken for the Replace function.

If "**Hold**" is selected in the parameter fields "Reference", "Limit Upper" and "Limit Lower", the current settings are not changed by the imported scan.

## Equalization Files

The loading of **equalization files** takes place in the generator; see section "*Generator Signals*" on page 4.63.

Equalization files from the R&S UPL can still be used.

## Sweep Lists

The loading of **sweep lists** takes place in the generator; see section "*Generator Signals*" on page 4.63. Sweep lists from the R&S UPL can still be used. Sweep lists from the R&S UPL have different file name extensions:

- .SPF for frequency values in Hz
- .SPV for level values in V, FS or UI
- .SPO for on-time values in s
- .SPI for interval values in s
- .DWL for dwell time values in s

From these file name extensions the R&S UPV recognizes whether the loading procedure is allowed. It is therefore recommended that the file name extensions of the old R&S UPL files should not be changed!

## Limit Files

The loading of **limit files** takes place in the DispConfig panels in the parameter fields "Limit Upper", "Source" = "File" and "Limit Lower", "Source" = "File".

The Y values of the limit files are always interpolated onto the current X axis, so that the desired trace is always produced regardless of the number of interpolation points in the limit file.

Limit files from the R&S UPL can also be used but, in contrast to limit files from the R&S UPV, there is no plausibility check as to whether the numerical values in the file match the current setting, since R&S UPL files do not contain the associated units.



# Format

## Trace Files

All trace data is stored in plain text in ASCII format . The format has been selected so that the data can be processed without a problem in EXCEL (see section “Exporting” on page 4.604).

### Structure of the trace file:

```

Subsystem: UPV FFT TRACE FILE
Title: Titletext
Comment: Commenttext
X Axis;      Trace A;      Trace B;
X Function    Trace A Function    Trace B Function
Frequency   Funct Ch1        Funct Ch2
X-Axis-Label: Y1-Axis-Label:    Y2-Axis-Label:
Frequency   Input RMS analog Ch1    THD+N digital CH2
X-Unit: Hz      A-Unit: dBV          B-Unit: dB
X-Spacing:    A-Spacing: LIN       B-Spacing: LIN
LOG
X-Left: Value  A-Bottom: Value      B-Bottom: Value
X-Right:      A-Top: Value         B-Top: Value
Value
VOID         A-LimLow: Value, FILE or VOID    B-LimLow: Value, FILE or VOID
VOID         A-LimUpp: Value, FILE or VOID    B-LimUpp: Value, FILE or VOID
Scan #1     A-Comment: Scan Labeltext        B-Comment: Scan Labeltext
X-Basic-Unit: A-Basic-Unit: V          B-Basic-Unit: V
Hz
X-Ref: Value  A-Ref: Value, FILE or VOID        B-Ref: Value, FILE or VOID
A-X/      A-Y      A-      A-      A-RefY    B-X/      B-Y      B-      B-      B-RefY
Data      LimLow   LimUpp   in V    datacount  LimLow   LimUpp   V
count
20.0000     0.201    0.2       0.3      1.01     20.0000   -98.8     -98.5    -90      VOID
..
20000.0    0.203    0.25     0.4      2.03     -98.1     -98.5    -90      VOID
Scan #2   A-Comment: Scan Labeltext        B-Comment: Scan Labeltext
X-Ref:      A-Ref: Value or VOID          B-Ref: Value or VOID
Value
X/datacou A-Y      A-      A-      A-RefY    B-X/      B-Y      B-      B-      B-RefY
nt        LimLow   LimUpp   in V    datacount  LimLow   LimUpp   in V
20.0000     0.201    0.2       0.3      1.01     20.0000   -98.8     -98.5    -90      VOID
..
20000.0    0.203    0.25     0.4      2.03     -98.1     -98.5    -90      VOID
    
```

The individual parameters are TAB separated.

- black: Explanation of fields. These explanations are not stored in the trace file.
- green: Fixed entries in ASCII format to facilitate assignment of the following data.
- red: Entries which change. These entries are depending on the graphic system and the settings in the corresponding DispConfig panel.
- FILE: Not a fixed value, but a trace. Can occur in the case of Limit and Reference.
- VOID: No value present because the trace is turned off, or in order to fill a missing range in the event that Trace A and Trace B have different lengths.

Explanation of terms:

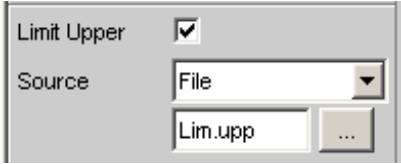
Subsystem identifier			Identifier of the subsystem which was created from this trace file: UPV LIMIT FILE UPV EQUALIZATION FILE UPV SWEEPLIST FILE UPV FFT TRACE FILE UPV WAVEFORM TRACE FILE UPV BARGRAPH TRACE FILE UPV PESQ TRACE FILE
Title			Reserved for future R&S UPV program versions
Comment			Reserved for future R&S UPV program versions
<b>X Axis</b>	<b>Trace A</b>	<b>Trace B</b>	Fixed entries in the trace file in ASCII format to facilitate assignment of the following data
X Funct	Trace A Funct	Trace B Funct	Measurement function that is set on the corresponding axis, e.g. X axis: Frequency Trace A: "Funct CH1" Trace B: "Funct CH2"
X-Axis-Label	Y1-Axis-Label	Y2-Axis-Label	Label for the X axis, the left Y axis (Trace A), and the right Y axis (Trace B) in the graphical display.
X-Unit	A-Unit	B-Unit	Unit for the X axis, the left Y axis (Trace A), and the right Y axis (Trace B) in the graphical display.
X-Spacing	A-Spacing	B-Spacing	Linear or logarithmic spacing for the X axis, the left Y axis (Trace A), and the right Y axis (Trace B).
X-Left	A-Bottom	B-Bottom	Left value for the X axis, lower value for the left Y axis (Trace A) and the right Y axis (Trace B).
X-Right	A-Top	B-Top	Right value for the X axis, upper value for the left Y axis (Trace A) and the right Y axis (Trace B).
	A-LimLow	B-LimLow	Lower limit for the left Y axis (Trace A) and the right Y axis (Trace B). If the word VOID is entered here, limit monitoring is turned off. If a value is entered here, the value from the configuration panel of the graphic system is used for limit monitoring:  If the word FILE is entered here, the limit values come from a limit file. The limit values interpolated onto the X axis are listed under A-LimLow and B-LimLow of the scan data sets. 
	A-LimUpp	B-LimUpp	Ditto upper limit of the left Y axis (Trace A) and the right Y axis (Trace B).

<p><b>Scan #Nr</b></p>	<p>A-Comment</p>	<p>B-Comment</p>	<p><b>Scan #Nr</b>: Scan number for the following data set, numbered sequentially 2, 1, 0, -1 to -19. Scan number 2 designates the maximum scan, scan number 1 the minimum scan, provided that</p> <p>Show Min Max <input checked="" type="checkbox"/></p> <p>is activated. Scan number 0 designates the most recent scan. The more negative the scan number, the older the scan. A-Comment and B-Comment are reserved for future R&amp;S UPV program versions.</p>
<p>X-Basic-Unit</p>	<p>A-Basic-Unit</p>	<p>B-Basic-Unit</p>	<p><b>Basic unit</b> of the X axis, the left Y axis (Trace A), and the right Y axis (Trace B) in the graphical display. If the following reference values are present, (that is != VOID), these units are identical to the basic unit of the following reference values.</p>
<p>X-Ref</p>	<p>A-Ref</p>	<p>B-Ref</p>	<p>Reference values for referenced units of the X axis, the left Y axis (Trace A), and the right Y axis (Trace B) <b>in the basic unit</b>. The value entered here is taken into the configuration panel of the graphic system as a fixed reference value when the trace file is loaded:</p> <p>Reference Value 1.000000 V</p> <p>If the word <b>FILE</b> is entered for A-Ref and / or B-Ref, the reference values come from a reference file or it is a floating reference value. The reference values interpolated onto the X axis are listed under "A-RefY in <i>unit</i>" and "B-RefY in <i>unit</i>" of the scan data sets. <b>VOID</b> is used as a placeholder for the reference value of a scan which is turned off. Special case: If the intention is to display the result of an intermodulation measurement in % or dB on the Y axis in the Bargraph graphic system, then no further reference is possible for this unit since it is already referenced. The "Reference" parameter field is displayed as inaccessible. Since no X axis is offered there is no X reference value either. In such cases the value <b>3.402823466385e+038</b> is entered in the trace file instead of a reference value and stands for NaN (Not a Number).</p>

<p><b>A-X/datacount</b>  <b>A-Y</b>  <b>A-LimLow</b>  <b>A-LimUpp</b>  <b>A-RefY in unit</b>  <b>B-X/datacount</b>  <b>B-Y</b>  <b>B-LimLow</b>  <b>B-LimUpp</b>  <b>B-RefY in unit</b></p> <p>This wording is arranged horizontally in the trace file.</p>	<p><b>A-X/datacount:</b> Datacount identifies the number of following data sets (lines) for this scan. The number of data sets for Trace A can be different to the number for Trace B.</p> <p><b>A-X:</b> X value in the unit specified at X Unit.</p> <p><b>A-Y:</b> Y value of Trace A in the unit specified at A Unit.</p> <p><b>A-LimLow:</b> Lower limit of Trace A from a limit file in the unit specified at A Unit. If VOID is entered here, there are no limit values from a file.</p> <p><b>A-LimUpp:</b> Likewise upper limit.</p> <p><b>A-RefY in unit:</b> Unit of the reference values of Trace A interpolated onto the X axis from a reference file, e.g. dBV.  Caution: The reference values themselves are stored in the basic unit, e.g. V.</p> <p><b>A-RefY:</b> Reference values of Trace A in the basic unit.</p> <p><b>B-X/datacount:</b> Datacount identifies the number of following data sets (lines) for this scan. The number of data sets for Trace A can be different to the number for Trace B.</p> <p><b>B-Y:</b> Y value of Trace B i in the unit specified at B Unit.</p> <p><b>B-LimLow:</b> Lower limit of Trace B from a limit file in the unit specified at B Unit. If VOID is entered here, there are no limit values from a file.</p> <p><b>B-LimUpp:</b> Likewise upper limit.</p> <p><b>B-RefY in unit:</b> Unit of the reference values of Trace B interpolated onto the X axis from a reference file, e.g. dBV.  Caution: The reference values themselves are stored in the basic unit, e.g. V.</p> <p><b>B-RefY:</b> Reference values of Trace B in the basic unit.</p>
---	---

### Example of a trace data set:

The trace data set was generated from the FFT Graph subsystem.

```
UPV FFT TRACE FILE
Heading String
Commenttext
X Axis Trace A      Trace B
Frequency           FFT Level Ch1  FFT Level Ch2
Frequency / Hz      FFT Level Ch1 / dBV  FFT Level Ch2 / V
Hz      dBV      V
LIN     LIN     LIN
0       -170    0
22000  10      1
VOID   VOID   VOID
VOID   VOID   VOID
Scan #0      Labeltext Labeltext
Hz      V      V
1000  1.00e+000 1.00e+000
```

```
A-X/256 A-Y A-LimLow A-LimUpp A-RefY in dBV B-X/256 B-Y B-LimLow B-LimUpp B-
RefY in dBV
0.00e+000 -1.08e+002 VOID VOID 1.00e+000 VOID VOID VOID VOID VOID
9.37e+001 -9.93e+001 VOID VOID 1.00e+000 VOID VOID VOID VOID VOID
1.87e+002 -1.01e+002 VOID VOID 1.00e+000 VOID VOID VOID VOID VOID
:
:
2.37e+004 -1.36e+002 VOID VOID 1.00e+000 VOID VOID VOID VOID VOID
2.38e+004 -1.37e+002 VOID VOID 1.00e+000 VOID VOID VOID VOID VOID
2.39e+004 -1.34e+002 VOID VOID 1.00e+000 VOID VOID VOID VOID VOID
```

The individual parameters are stored in the original with a considerably greater number of points. Due to the restricted page width the data set for this display has been reduced in size.

If a data set is subsequently edited manually, comment lines can be inserted at any position **ahead of** the data lines. **Comment lines must begin with the character '#'. In no case must a data set be interrupted by comments!**

## Equalization Files

The equalization data is stored in plain text in ASCII format. The format has been selected so that the data can be processed without a problem in EXCEL (see section “Exporting” on page 4.604).

### Structure of the equalization file:

```
Identifier UPV EQUALIZATION FILE
Number of following X/Y pairs: 100 # Datacount
Inverted or Not inverted: # Inverted
Norm frequency: # 1000.000000 Hz # Norm frequency
Normalization value: # 0.100177 V # Norm value
100.000000000000      4891.695800781250
103.072242736816      4622.376953125000
106.238868713379      4368.537597656250
:
:
1027.808593750000      1.006141066551
:
:
2000.000000000000      4583.853027343750
```

The individual parameters are TAB separated.

- black: Explanation of fields. These explanations are not stored in the equalization file.
- green: Fixed entries in ASCII format.
- red: Entries which change depending on the settings in the corresponding DispConfig panel.

**Explanation of terms:**

Identifier	Identifies the file as an equalization file. During loading this identification is used to decide whether the file concerned can be loaded.
Number of following X/Y pairs	Self-explanatory
Inverted or Not inverted	A comment which states whether the equalization factors have been stored inverted or not inverted. The effect of inverting the frequency response in the generator by means of an equalization file created with the "Invert" setting is that the same DUT - with the precorrector enabled - now receives an undistorted frequency response (see section "Equalization", on page 4.111).
Norm frequency	A comment which states the frequency whose voltage value has been used for normalization.
Normalization value	A comment which states the normalization value with which the Y values were computed as factors.
X/Y pairs	Frequency value in Hz followed by the normalization factor. If the frequency selected on saving the equalization file was that at which the frequency response curve is at its maximum, the precorrector file contains only values from 0.0 to 1.0. If a different frequency is selected, factors greater than 1.0 also occur.

**Example of an equalization data set:**

```
UPV EQUALIZATION FILE
100 # Datacount
# Inverted
# 1000.000000 Hz # Norm frequency
# 0.100177 V # Norm value
100.0000000000000 4891.695800781250
103.072242736816 4622.376953125000
106.238868713379 4368.537597656250
      :
1027.808593750000 1.006141066551
      :
1940.386596679688 2496.481933593750
2000.000000000000 4583.853027343750
```

If a data set is subsequently edited manually, comment lines can be inserted at any position **ahead of** the X/Y pairs. **Comment lines must begin with the character '#'. In no case must a data set be interrupted by comments!**

## Sweep Lists

The sweep list data is stored in plain text in ASCII format. The format has been selected so that the data can be processed without a problem in EXCEL (see section "Exporting" on page 4.604).

Sweep points must be specified in ascending or descending order – they must not change direction, for example due to editing (see section "List Sweep", on page 4.134).

Identifier: **UPV SWEEPLIST FILE**  
 Number of following X values: **9 # Datacount**  
 Basic unit: **Hz # Basic unit**  
**16.000000000000**  
**20.000000000000**  
**25.000000000000**  
**31.500000000000**  
**40.000000000000**  
**50.000000000000**  
**63.000000000000**

- black: Explanation of fields. These explanations are not stored in the sweep list.
- green: Fixed entries in ASCII format.
- red: Entries which change depending on the settings in the corresponding DispConfig panel.

**Explanation of terms:**

Identifier	Identifies the file as a sweep list. During loading this identification is used to decide whether the file concerned can be loaded.
Number of following X values	Self-explanatory
Basic unit	The X values in the sweep list are always stored in the basic unit. If for instance the X values in the trace from which the sweep list was derived are in ΔHz, the basic unit is entered as Hz and the X values are recomputed and stored in Hz. Basic units can occur as Hz, V, FS, UI, s and DEG (°). The R&S UPV uses this entry to recognize whether the loading operation is allowed for this file having regard to the current setting. If for example an attempt was made to load a sweep list with the basic unit Hz for a voltage list sweep, such a file would be ignored (see section “List Sweep”, on page 4.134).
X values	X values for a list sweep

**Example of a sweep list data set:**

```
UPV SWEEPLIST FILE
9 # Datacount
Hz # Basic unit
16.000000000000
20.000000000000
25.000000000000
31.500000000000
40.000000000000
50.000000000000
63.000000000000
80.000000000000
100.000000000000
```

If a data set is subsequently edited manually, comment lines can be inserted at any position **ahead of** the frequency values. **Comment lines must begin with the character '#'**.  
**In no case must a data set be interrupted by comments!**

## Limit Files

The limit data is stored in plain text in ASCII format. The format has been selected so that the data can be processed without a problem in EXCEL (see section “Exporting” on page 4.604).

### Structure of the limit file:

Identifier: **UPV LIMIT FILE**  
 Number of following X/Y pairs: **9 # Datacount**  
 Offset ON/OFF: **# Offset ON**  
 Offset value: **# Offset value = 10 dBV**  
 X and Y unit: **Hz dBV**

<b>100</b>	<b>-70</b>
<b>711</b>	<b>-70</b>
<b>789</b>	<b>-45</b>
<b>875</b>	<b>-10</b>
<b>970</b>	<b>-10</b>
<b>1076</b>	<b>-10</b>
<b>1193</b>	<b>-30</b>
<b>1323</b>	<b>-70</b>
<b>2000</b>	<b>-70</b>

black: Explanation of fields. These explanations are not stored in the limit file.  
 green: Fixed entries in ASCII format.  
 red: Entries which change depending on the settings in the corresponding DispConfig panel.

### Explanation of terms:

Identifier	Identifies the file as a limit file. During loading this identification is used to decide whether the file concerned can be loaded.
Number of following X/Y pairs	Self-explanatory
Offset ON/OFF	A comment which states whether, during the generation of a limit file from a measurement value sequence, an offset value was added (ON) or not (OFF) to the Y data (see section “Offset” on page 4.535).
Offset value	A comment which states which offset value was added to the Y data during the generation of a limit file from a measurement value sequence (see section “Offset Value” on page 4.535).
X and Y unit	Depending on the selected X axis and the measurement function, a very diverse range of units can be entered here for the X / Y values. Examples for the X values: Hz, °, s, V, FS or UI. Examples for the Y values: V, dBV, dBr, ... V/Vr, °, s, db, % etc.
X/Y pairs	X/Y pairs in the specified units.



**Example of a limit data set:**

```

UPV LIMIT FILE
9 # Datacount
# Offset ON
# Offset value = 10.0 dBV
Hz      dBV
100     -70
711     -70
789     -45
875     -10
970     -10
1076    -10
1193    -30
1323    -70
2000    -70

```

If a data set is subsequently edited manually, comment lines can be inserted at any position **ahead of** the X/Y pairs. **Comment lines must begin with the character '#'**.  
**In no case must a data set be interrupted by comments!**

## Editing

The editing of trace files, equalization files, sweep lists and limit files is always carried out in the same way and is illustrated by two examples.

The procedure is not explained point by point in the examples – this would be beyond the scope of this description. The examples are really intended for the trained user.

**Example 1:**

The intention is to generate a tolerance band from the frequency response of an ideal DUT. This tolerance band will be compared to the other DUTs.

The measurement value sequence of this ideal DUT is generated by means of a 30 point sweep.

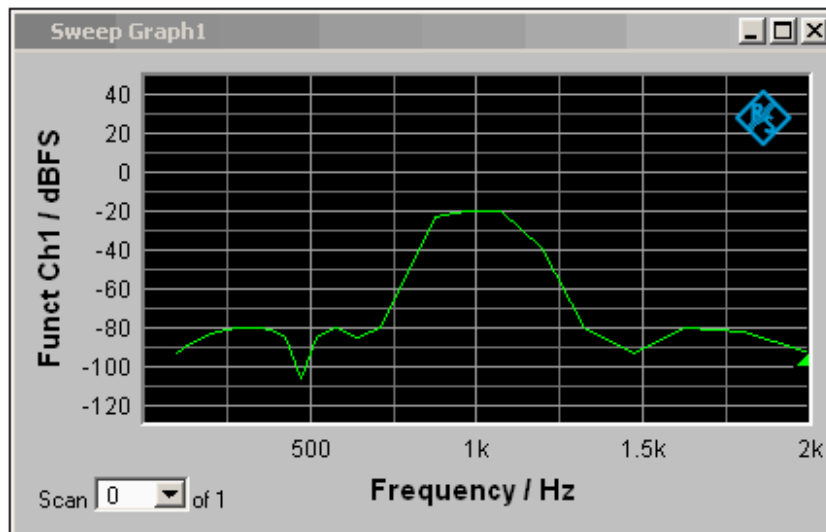

Using "Store Trace as" "Limit List", a limit file with 30 pairs of X/Y values is generated from this measurement value sequence and stored as LH\_30\_up.lim. The Y values of the limit curve are provided with an additive offset of 10 dBV, producing a limit curve that is parallel shifted by 10 dBV compared to the measurement value sequence.



If the limit curve is loaded as Limit Upper, the parallel shift can be seen to be upward.

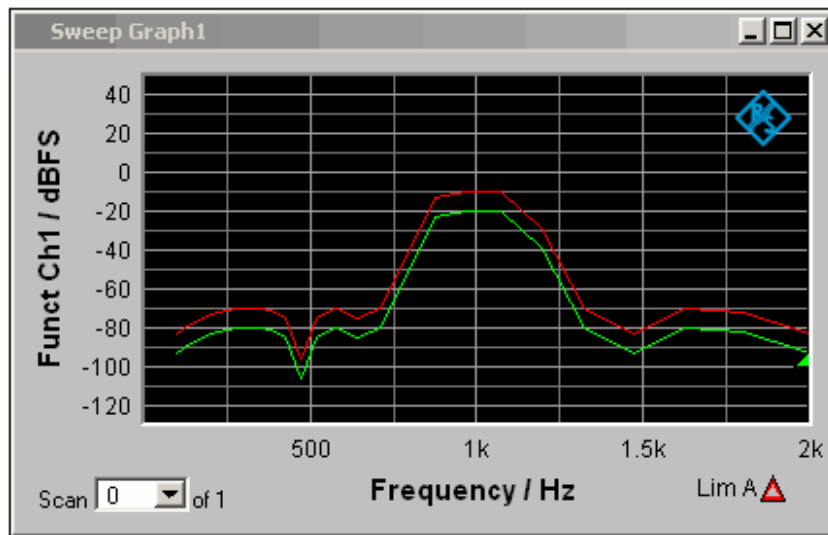
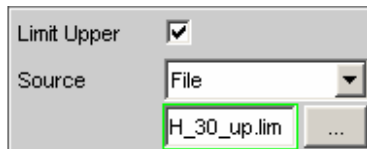

However, the limit curve derived from a measurement value sequence is unsuitable as the upper limit of a tolerance band, since horizontal lines should appear to left and right of the passband in the bandpass display. This makes it necessary to modify the limit file.

For this purpose the file named LH\_30\_up.lim is loaded into an ASCII editor, such as the Windows Editor, which is present as an accessory on every Windows operating system for the R&S UPV. The editor displays a data set as shown in the lefthand column below.

This data set is then modified as shown in the righthand column.

#### Original data set from file LH\_30\_up.lim

##### UPV LIMIT FILE

```

30 # Datascount
# Offset ON
# Offset value = 10.000000 dBV
Hz      dBV
100.000000000000 -83.702377319336
110.882522583008 -82.031776428223
122.949340820313 -80.389442443848
136.329330444336 -78.784820556641
151.165405273438 -77.228446960449
167.616012573242 -75.734764099121
185.856872558594 -74.320167541504
206.082794189453 -73.010757446289
228.509796142578 -71.841300964355
253.377426147461 -70.862701416016
280.951293945313 -70.152404785156
311.525878906250 -69.837203979492
345.427764892578 -70.144065856934
383.019012451172 -71.554283142090
424.701171875000 -75.466735839844
470.919372558594 -96.235939025879
522.167297363281 -75.033081054688
578.992248535156 -69.949821472168
642.001220703125 -75.313186645508
711.867187500000 -69.820259094238
789.336303710938 -44.014369964600
875.236022949219 -13.052226066589
970.483764648438 -9.946021080017
1076.096923828125 -9.984798431396
1193.203369140625 -28.528638839722
1323.054077148438 -70.569931030273
1467.035766601563 -82.768814086914
1626.686279296875 -70.306480407715
1803.710693359375 -71.739479064941
2000.000000000000 -83.138786315918

```

#### Modified data set saved to file LH\_9\_up.lim

##### UPV LIMIT FILE

```

9 # Datascount
# Offset ON
# Offset value = 10.000000 dBV
Hz      dBV
100      -70
711      -70
789      -45
875      -10
970      -10
1076     -10
1193     -30
1323     -70
2000     -70

```

When altering the number of X/Y values it is important to make sure that the Datascount entry is adapted accordingly. The identifier UPV LIMIT FILE must not be changed.

If the tabulator (TAB) is used as a separator between various entries in a line, the file can be processed in EXCEL without any problem. Other separators are also permissible, e.g. ';', '|' or ' '.

If the new limit curve named LH\_9\_up.lim is then loaded as "Limit Upper", the result of the modification can be assessed and further processing can be performed if necessary.

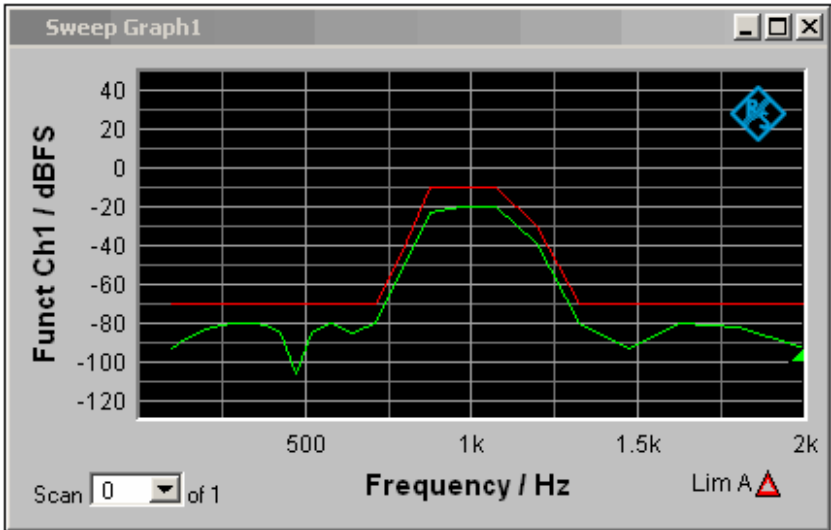

A limit file for the lower limit of a tolerance band can be generated in much the same way as the procedure for modifying a limit file for the upper limit of a tolerance band. The two limit files together produce the desired tolerance band.

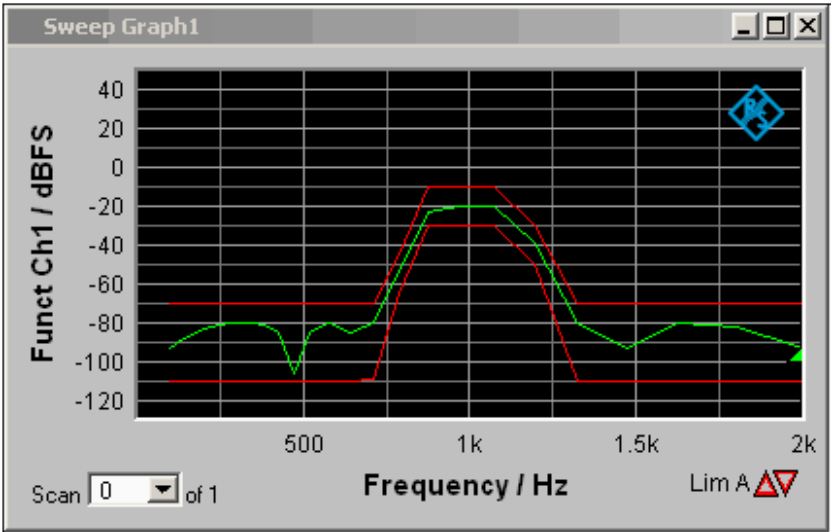

**Example 2:**

The intention is to create a sweep file from the trace data set of a waveform file. Leave to one side the matter of whether this serves any purpose. The example is intended to show that any trace file can be created by editing.

The X values in the waveform trace file are expressed in seconds. But the X axis in the sweep trace file needs to be displayed in Hz. The level values on the Y axis are to stay unchanged.

Line	Original waveform trace file	The sweep trace file created by editing
1	UPV <b>WAVEFORM</b> TRACE FILE	UPV <b>SWEEP</b> TRACE FILE
2	Heading String	Heading String
3	Commenttext	Commenttext
4	X Axis            Trace A            Trace B	X Axis            Trace A            Trace B
5	<b>Time</b> <b>Level</b> <b>Ch1</b> VOID	<b>Frequency</b> <b>Funct</b> <b>Ch1</b> VOID
6	<b>Time / s</b> <b>Level</b> <b>Ch1 / V</b> VOID	<b>Frequency / Hz</b> <b>Funct</b> <b>Ch1 / V</b> VOID
7	<b>s</b> V   VOID	<b>Hz</b> V   VOID
8	LIN   LIN   VOID	LIN   LIN   VOID
9	0   -0.000273702   VOID	0   -0.000273702   VOID
10	<b>0.0001</b> 0.000946001   VOID	<b>10</b> 0.000946001   VOID
11	VOID   VOID   VOID	VOID   VOID   VOID
12	VOID   VOID   VOID	VOID   VOID   VOID
13	Scan #0   Labeltext   VOID	Scan #0   Labeltext   VOID
14	<b>s</b> V   VOID	<b>Hz</b> V   VOID
15	1   1.00e+00   VOID	1   1.00e+00   VOID
16	A-X/6                            A-Y	A-X/6                            A-Y
17	<b>0.00000e+00</b> 1.01179e-004	<b>0.00000</b> 1.01179e-004
18	<b>2.08333e-05</b> 6.25051e-004	<b>2.08333</b> 6.25051e-004
19	<b>4.16666e-05</b> 8.90560e-004	<b>4.16666</b> 8.90560e-004
20	<b>6.25000e-05</b> 7.87767e-004	<b>6.25000</b> 7.87767e-004
21	<b>8.33333e-05</b> 3.59082e-004	<b>8.33333</b> 3.59082e-004
22	<b>1.04166e-04</b> -2.1826e-004	<b>10.4166</b> -2.1826e-004

The data sets are displayed in abbreviated form

**Explanation of the changes:**

- Line 1   **UPV SWEEP TRACE FILE**  
The identifier is changed so that the file will be accepted in the sweep graphic system. For information on identifiers see table entry "Subsystem identifier" in section "Trace Files", on page 4.590
- 2   unchanged
- 3   unchanged
- 4   unchanged
- 5   **Frequency**  
The desired function of the X axis is entered here. The wording must be exacty the same as the entry in the parameter list of the X axis selection field.



**Funct Ch1**

The desired function of the Y axis is entered here. The wording must be exacty the same as the entry in the parameter list of the "Y-Source" selection field.

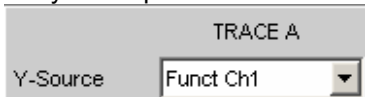

6 **Frequency / Hz**

The desired label for the X axis is entered here:

**Funct Ch1 / V**

The desired label for the Y axis is entered here:

7 **Hz**

The desired unit for the X axis is entered here. The wording must be exactly the same as the entry in the parameter list of the Unit selection field.

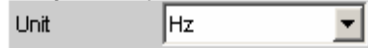

8 unchanged

9 unchanged

10 **10**

The righthand final value of the X axis is entered here.

11 unchanged

12 unchanged

13 unchanged

14 **Hz**

The **basic** unit of the unit selected in line 7 is entered here. If for example ΔHz had been entered in line 7, then Hz would still have to be shown here.

15 unchanged

16 unchanged

17

18

19 **Modified X values**

20

21

22

In order to make the changes, the waveform trace file (e.g. mywav.trc) is loaded into an ASCII editor, such as the Windows Editor, which is present as an accessory on every Windows operating system for the R&S UPV. The editor displays a data set as shown in the lefthand column above. This data set is then modified as shown in the righthand column. The amended data set is saved with another name (e.g. myswp.trc).

After the new data set is loaded in the Sweep graphic system

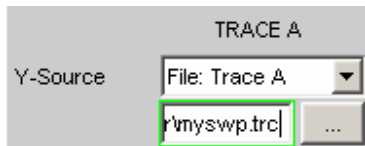

a trace identical to that of the waveform must be seen, though its X axis will be totally different.

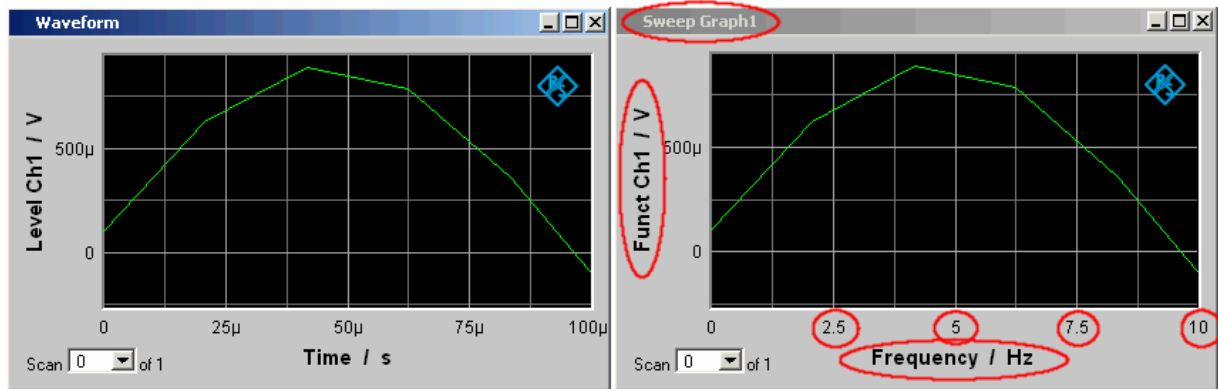

# Exporting

The most frequent reason for needing to export trace files, equalization files, sweep lists and limit files is without doubt so that they can be further processed in Microsoft Excel.

The procedure is explained in broad terms in the following example. The examples are really intended for the trained user. A point by point description would be beyond the scope of this description.

## Changing the language option:

It is a prerequisite that Microsoft Excel is installed on the R&S UPV, or that a PC is available on which Excel is already installed.

If a PC is to be used, the trace file being exported must be copied to this PC by means of a USB stick, for example.

The PC must be changed over to the English language option if this has not already been done. This is usually not necessary in the case of the R&S UPV, since the R&S UPV is delivered with the language option "English (United Kingdom)".

If it is necessary to change the language option, proceed as follows:

Using the operating menu sequence

Start, Settings, Control Panel, open the window for "Regional and Language Options" and set the language "English (United Kingdom)".

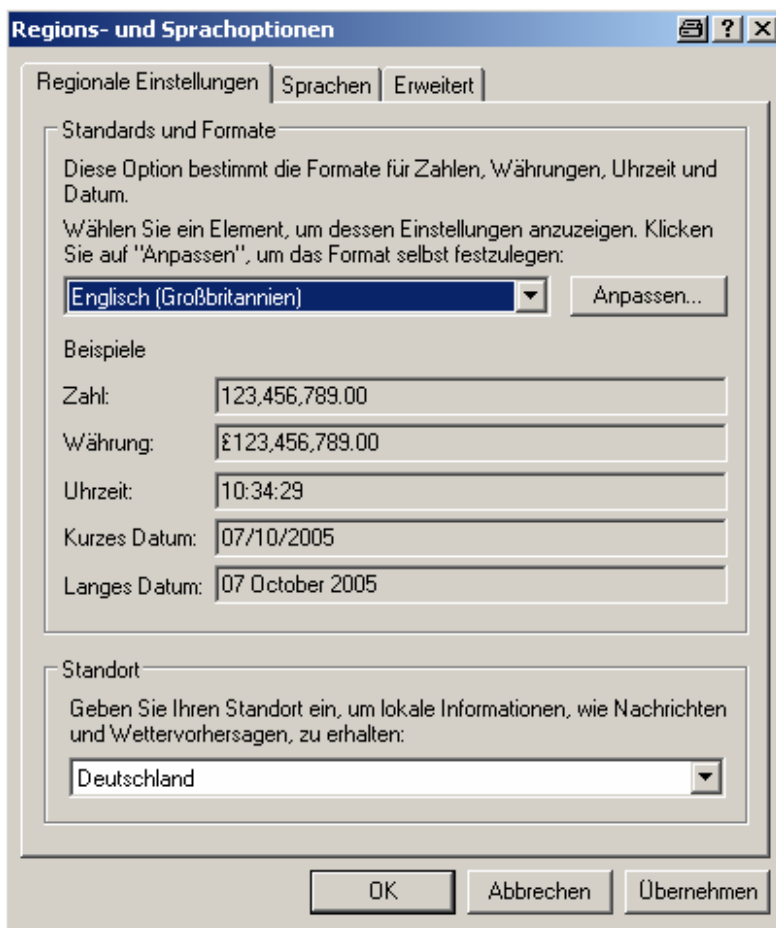

This conversion ensures that in Excel the decimal separator within numbers is interpreted as the decimal point.

Since the R&S UPV is delivered with an English-language operating system for English-speaking regions, the trace files are generated within the R&S UPV exclusively in the English number format (decimal point rather than decimal comma) and can therefore be processed in Excel without the slightest need for post-processing.

### Reading the trace file into Excel:

Open Excel and open the file selector via the menu item File Open.

Go to the directory containing the trace file that is to be exported.

In the File name field type the file name extension \*.TRC and all files with the extension \*.TRC will appear.

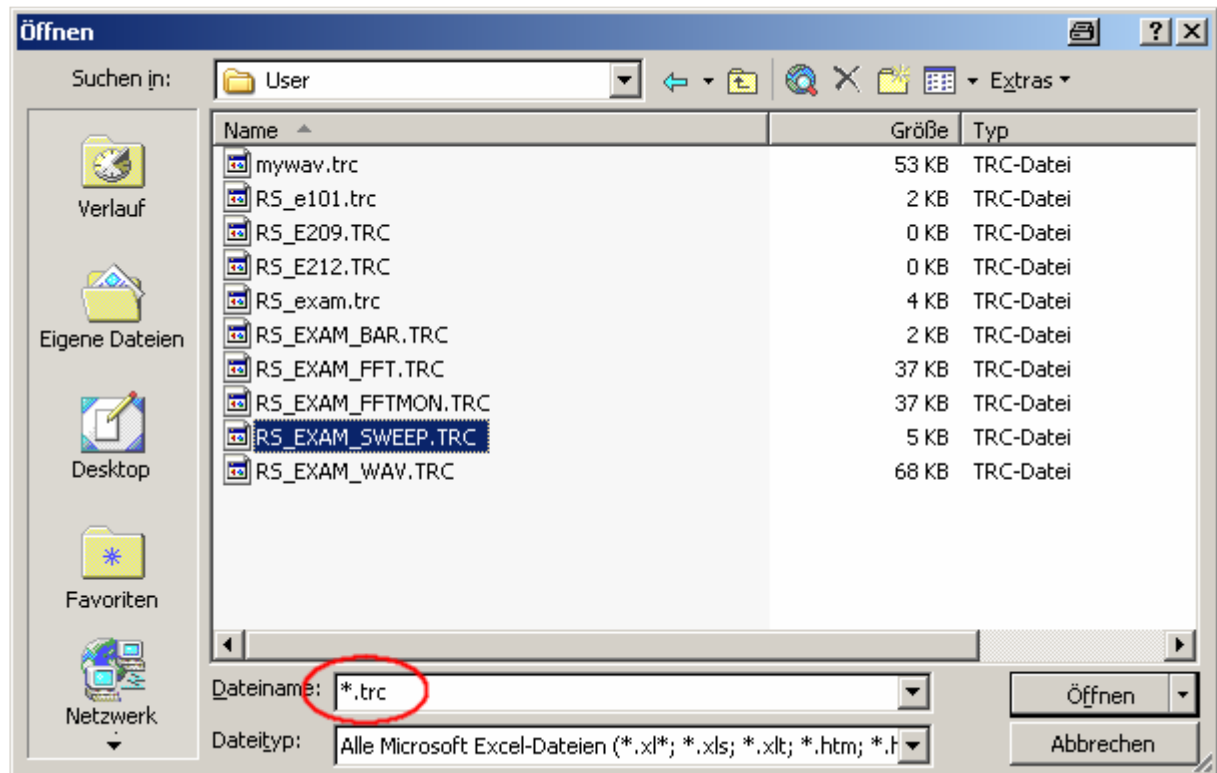

Select the file that is to be exported.

A dialog box opens in which no changes must be made.



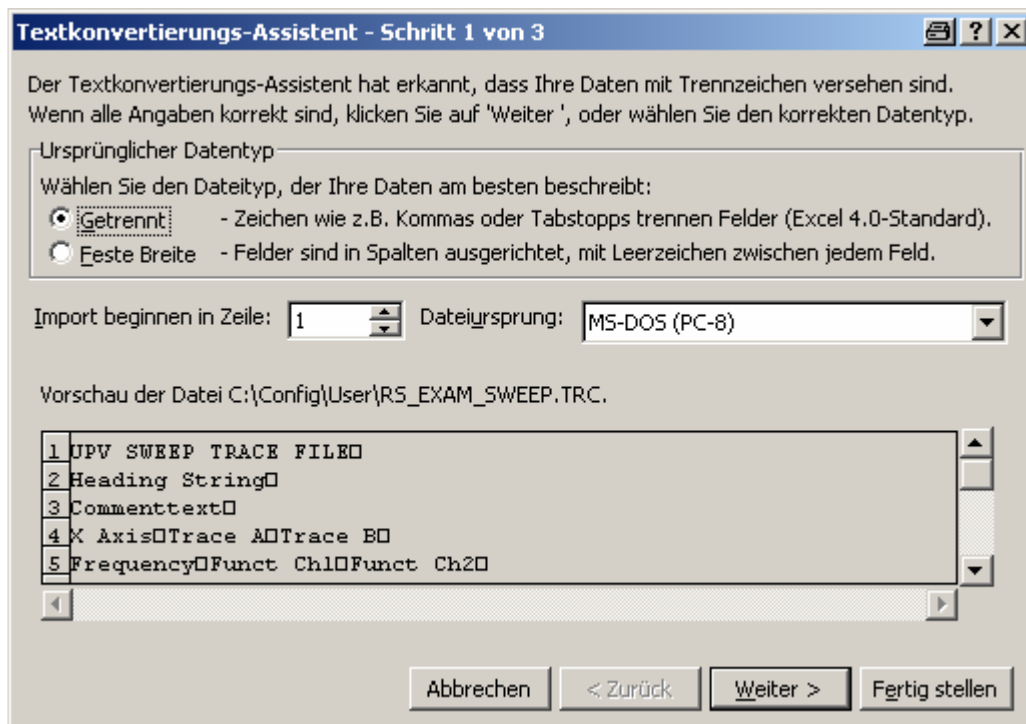

Finish.

The trace files have been dsigned by R&S so that without a single entry the data set appears in Excel and can be processed further.

If necessary change the number format (number of places after the decimal point).

	A	B	C	D	E	F	G	H	I	J
1	UPV SWEEP TRACE FILE									
2	Heading String									
3	Commenttext									
4	X Axis	Trace A	Trace B							
5	Frequency	Funct Ch1	Funct Ch2							
6	Frequency / Hz	Funct Ch1 / V	Funct Ch2 / V							
7	Hz	V	V							
8	LIN	LIN	LIN							
9	100	0	0							
10	20000	0.15	0.17							
11	VOID	VOID	VOID							
12	VOID	VOID	VOID							
13	Scan #0	Labeltext	Labeltext							
14	Hz	V	V							
15	1000	1.00E+00	1.00E+00							
16	A-X/30	A-LimLow	A-LimUpp	A-RefY in V	B-X/30	B-LimLow	B-LimUpp	B-RefY in V		
17	1.00E+02	1.12E-02	VOID	VOID	1.00E+00	1.00E+02	1.12E-02	VOID	VOID	1.00E+00
18	1.20E+02	1.48E-02	VOID	VOID	1.00E+00	1.20E+02	1.49E-02	VOID	VOID	1.00E+00
19	1.44E+02	1.92E-02	VOID	VOID	1.00E+00	1.44E+02	1.92E-02	VOID	VOID	1.00E+00
20	1.73E+02	2.44E-02	VOID	VOID	1.00E+00	1.73E+02	2.44E-02	VOID	VOID	1.00E+00
21	2.08E+02	3.04E-02	VOID	VOID	1.00E+00	2.08E+02	3.04E-02	VOID	VOID	1.00E+00
22	2.49E+02	3.73E-02	VOID	VOID	1.00E+00	2.49E+02	3.73E-02	VOID	VOID	1.00E+00
23	2.99E+02	4.50E-02	VOID	VOID	1.00E+00	2.99E+02	4.50E-02	VOID	VOID	1.00E+00
24	3.59E+02	5.34E-02	VOID	VOID	1.00E+00	3.59E+02	5.35E-02	VOID	VOID	1.00E+00

## Loading and Saving

This section tells you how to load and save different kinds of data sets in the R&S UPV. The file name is chosen through a central file selection box; its type is defined by the extension. The style of the file selection box can be defined in the configuration menu. The integrated file selection box is set as standard. It enables front panel control and is described below. Optionally the usual Windows file selection box can be used.

### Integrated File selection box

The file selection box is split into three or four areas. At the top (Recent area) is a list of the file names last selected. This list will always contain the last ten entries. Below this and split into two is space for selecting the required directory (Directory area, left) and the required file (File area, right). If a data set is to be saved, you will also find an entry field at the bottom for the file name.

At the bottom edge of the file selection box are two buttons "Select" and "File Manager". You can work these buttons either with the rotary knob or the softkey below.

To change between the areas, use the rotary knob or the cursor keys. Each of the areas appears with a blue frame when you select it with the rotary knob. Pressing the rotary knob or the **[ENTER]** key changes your selection to the content of the selected area, and an entry within this area is selected; the **[ESC]** key takes you back to selection of an area.

---

**Important:**

*The Directory area and the File area are comprised within the same frame. So to change between the two areas you use the **[LEFT]** and **[RIGHT]** cursor keys and not the rotary knob.*

---

If a selection is in the Recent area or File area, the **[RETURN]** key or a click of the rotary knob will complete selection of the file name and execute the required function. When you are storing data sets, ending entry of the file name with **[RETURN]** will complete selection of the file name.

For the creation of new directories when saving or organizing saved data sets during loading, the file selection box has a "File Manager" button to open a functionality which is similar to Windows Explorer except that, like the internal file selection box, it is optimized to be operated with no mouse or keyboard.

### File manager

The file manager is split into three areas. At the top is a selection of the possible types of data sets. These are distinguished by their extensions in the file name. Below this and split into two is space for selecting the required directory (Directory area, left) and the required file (File area, right).

At the bottom edge of the file manager are the buttons "Cut", "Copy", "Paste", "Remove", "Rename" and "Create Dir". You can work these buttons either with the rotary knob or the softkey below them. These are a substitute for the popup menu in Windows Explorer on the right mouse key.

To change between the areas, use the rotary knob or the cursor keys. Each of the areas appears with a blue frame when you select it with the rotary knob. Pressing the rotary knob or the **[ENTER]** key changes your selection to the content of the selected area, and an entry within this area is selected; the **[ESC]** key takes you back to selection of an area.

**Important:**

The Directory area and the File area are comprised within the same frame. So to change between the two areas you use the **LEFT** and **RIGHT** cursor keys and not the rotary knob.

Once a file is selected, you activate a button at the edge of the dialog to trigger the required function.

If you want to shift a file from one directory to another for example, you first select the source directory in the Directory area, and then the particular file in the File area. The "Cut" button notes the file to be shifted. Then you select the destination directory in the Directory area and choose the "Paste" button. This moves (pastes) the file from the source directory to the destination directory.

## Windows file selection box

The Windows file selection box is divided into three areas: On the left is a selection bar of icons which can be used to jump to different drives and personal directories.

In the upper area are the navigation buttons for such things as changing directories or creating new directories. Directly below is a list of the displayed files.

In the lower area is the entry field for the file name and the buttons for confirming the selection. If files have already been selected in previous steps, the file selection box remembers their names and offers the first matching name from the history as a preselection when a file name is being typed.

As usual in Windows programs, this file selection box is best operated with the mouse only.

## Loading and Saving Setups

Setups can be loaded and saved at any time. The front panel keys **LOAD** and **SAVE** trigger the required function, opening the appropriate file selection box.

**Note:**

Loading and saving setups is also possible through the menu bar. The related entries are in the File menu.

### Saving setups

When saving setups, the R&S UPV distinguishes between two types of setups: complete setups (\*.set) and current setups (\*.sac).

Saving a complete setup saves the entire instrument settings, plus the position and size of all windows in all screens. Saving a current setup, in contrast, only saves the instrument settings. A setup saved in this way can be loaded much faster, since the panels do not have to be restored.

Complete setups have the file suffix ".set"; current setups have the suffix ".sac".

```
Remote-control command:  
MMEMoRY:STORe:STATe 'setupfile'
```

**Loading setups**

Loading a setup overwrites the settings of the instrument with the settings that were active when setup was saved. Depending on the type of setup to be loaded, only the current settings are overwritten ("current" setup) or the entire settings, including the position and size of all windows in all screens ("complete" setup). Windows that were open when the setup was saved are opened, and windows that were closed when the setup was saved are closed again. This is also done for the screens that are not visible.

```
Remote-control command:
MMEMemory:LOAD:STATe 'setupfile'
```

**Note:**

*The loading of setups has been considerably optimized as of version 1.4.0 of the R&S UPV software. Above all, setups with a high-resolution FFT or waveform setting are now loaded much faster.*

## Printing and Saving the Display Screen

The R&S UPV enables you, at any time, to make and keep an extract of the displayed results for later use. You do this either by a direct printout or by saving to a file or the Windows clipboard. You make the necessary settings, e.g. selection of the result to be output (source) and where it is to be output (destination), in a configuration panel.

## Configuring Print and Save Operations

The "Utilities → Hardcopy" menu opens a configuration panel for you to specify the output parameters.

**Source**

Selection of the screen content to be output.

**UPV Window (Bitmap)**

This setting outputs the entire screen of the R&S UPV as a bitmap. This is the default after firmware installation.

```
Remote-control command:
HCOPY:SOURce WINDow
```

**Active Panel (Bitmap)**

This setting outputs the currently active panel as a bitmap. It is available for all parameter windows, measurement value displays and graphical windows.

```
Remote-control command:
HCOPY:SOURce PANel
```

**Active Graphics (Vector)** This setting outputs the momentarily active graphical window as a vector graphic. This is for the graphics "FFT Monitor", "FFT Graph", "Waveform", "Bargraph" and "Sweep Graph".

Remote-control command:  
 HCOpy:SOuRce GRAPhics

**Destination** Selection of the destination for the screen content to be output.

**Printer** The screen content selected under "Source" is output direct to the printer set as the default printer under Windows XP.

Remote-control command:  
 HCOpy:DEStination PRINter

**File** The screen content selected under "Source" is output to a file specified under "File Name".

Remote-control command:  
 HCOpy:DEStination FILE

**Clipboard** The screen content selected under "Source" is output direct to the Windows clipboard and can be used direct in other applications.

Remote-control command:  
 HCOpy:DEStination CLIPboard

**Graph Size** Resolution for vector graphs

A change to the resolution is only provided for the Source = Act. Graphic and Destination = File | Clipboard settings. These settings produce a vector graph whose resolution can be specified.

For the Source = UPV Window or Destination = Printer settings, bitmaps are produced whose resolution cannot be changed without a major loss of quality, which is the reason why an option to define the resolution is not available.

The setting made here remains unaffected by preset or by loading a setup; it is therefore bound to the device.

Remote control command:  
 HCOpy:GSIZe 'string'  
 string = Auflösung in Pixel z.B. 800x600

---

**Important:**  
 If the instrument is being remotely controlled from the Windows XP Remote Desktop, the "Clipboard" setting allows you to transport graphics direct between the instrument and the host computer.

---

**Orientation** Selection of the orientation wished on the Windows printer (only if "Destination" is configured as "Printer").

**Portrait** Output on the printer is in portrait format.

Remote-control command:  
HCOpy:PRINter:ORIEntation PORTrait

**Landscape** Output on the printer is in landscape format.

Remote-control command:  
HCOpy:PRINter:ORIEntation LANDscape

**Header/Footer** Selection of the required header and footer in the output.

**On** The header and footer are visible.

Remote-control command:  
HCOpy:PRINter:ADDition ON

**Off** The header and footer are not visible.

Remote-control command:  
HCOpy:PRINter:ADDition OFF

**Define Header** Selection of the required text for the header (only if "Header/Footer" is "On"). This text forms the title in the middle of the header line.

Remote-control command:  
HCOpy:PRINter:HEADer 'text'

**Define Footer** Selection of the required text for the footer (only if "Header/Footer" is "On"). This text forms the legend in the middle of the footer line.

Remote-control command:  
HCOpy:PRINter:FOOTer 'text'

**Store Mode** Selection of the mode for output to a file (only if "Destination" is configured as "File").

**New** Press H Copy to open the file selection box and enter the name of the destination file. See also section "Saving setups" on page 4.608.

Remote-control command:  
HCOpy:FILE:MODE NEW

**Overwrite** Output is always to the file of "File Name", which is overwritten without asking you each time.

Remote-control command:  
HCOpy:FILE:MODE OVERwrite

**AutoIncrement** Output is to a file whose name is composed of two parts: The beginning of the file name is that name entered as "File Name", followed by a consecutive number that is incremented by 1 every time you press **H Copy**.

Remote-control command:  
 HCOpy:FILE:MODE INCRement

**File Name** Selection of the name of the file for output to a file (only if "Destination" is configured as "File" and "Store Mode" is not "New"). The file selection box opens for you to change the file name (see section *"Integrated File selection box"* on page 4.607). Enter the file name without an extension; the "File Type" setting in the file selection box defines the file type.

Remote-control command:  
 HCOpy:FILE 'filename'

## Starting Print and Save Operations

Press the **H Copy** key to trigger the function for output of measured results. The required action is immediately executed according to your settings in the configuration panel (see section *"Configuring Print and Save Operations"* on page 4.609).

Remote-control command:  
 HCOpy[:IMMEDIATE]

---

**Important:**  
*If you trigger H Copy during an ongoing measurement, the measurement is first halted and then the action is executed.*

---

## Contents Chapter 5 - Remote Control - Fundamentals

<b>5 Remote Control - Fundamentals</b> .....	5.1
<b>Introduction - Remote Control Fundamentals</b> .....	5.1
<b>Brief Instructions</b> .....	5.2
IEC/IEEE Bus .....	5.2
<b>Changing to Remote Control</b> .....	5.3
Remote Control via IEC/IEEE Bus .....	5.4
Remote Control via LAN Interface .....	5.5
Remote control via the USB device interface .....	5.10
<b>Messages</b> .....	5.13
Interface Messages .....	5.13
Device-Dependent Messages .....	5.13
<b>SCPI Command Structure and Syntax</b> .....	5.14
Structure of a Program Message .....	5.17
Responses to Queries .....	5.17
Parameters .....	5.19
Overview of Syntax Elements .....	5.20
<b>Device Model and Command Processing</b> .....	5.21
Input Unit .....	5.21
Command Identification (Parser) .....	5.22
Database and Device Hardware .....	5.22
Command Sequence (IEC/IEEE) .....	5.22
Status Reporting System .....	5.24
Output Unit .....	5.24
Triggering Measurement or Sweep .....	5.24
Command Synchronization .....	5.25
<b>Command Recording</b> .....	5.26
Starting Recording .....	5.26
Recording Commands .....	5.27
Editing Commands .....	5.27



<b>Status Reporting System</b> .....	5.28
Structure of SCPI Status Register .....	5.29
Overview of Status Registers.....	5.31
Status Byte (STB) and Service Request Enable (SRE) Register .....	5.32
IST Flag and Parallel Poll Enable (PPE) Register .....	5.34
STATus:EVENT Register (ESR) .....	5.34
STATus:OPERation Register .....	5.35
STATus:QUESTionable Register.....	5.37
STATus:QUESTionable:UNDERrange Register.....	5.38
STATus:QUESTionable:OVERrange Register .....	5.39
STATus:QUESTionable:MEASuring Register.....	5.40
STATus:XQUESTionable Register .....	5.41
Use of Status Reporting System.....	5.43
Initializing the Status Reporting System .....	5.46

# 5 Remote Control - Fundamentals

## Introduction - Remote Control Fundamentals

In this chapter you will find:

- instructions on starting the Audio Analyzer R&S UPV by remote control,
- a general introduction to the remote control of programmable instruments, including details of command structure and syntax, command processing and the status registers,
- a graphic and tabular presentation of the status registers used in the Audio Analyzer R&S UPV.

The remote control commands of the Audio Analyzer R&S UPV are included in the details of the *instrument functions* in Chapter 4.

To standard the instrument comes with the following interfaces for remote control:

- IEC/IEEE bus interface in line with the IEC 625.1/IEEE 488.2 standard.
- LAN interface; the network card uses 100 MHz Ethernet IEEE 802.3u; the protocol is based on the VXI-11 standard.
- USB interface (device USB)

A controller can be connected on the remote control interfaces, either direct or through a network (LAN). The connectors are located on the rear panel of the instrument.

These connectors are detailed in chapter 8, "*Maintenance and Interfaces*".

SCPI commands (messages) are used for remote control. Commands not derived from the standard nevertheless follow SCPI syntax rules. The instrument supports SCPI version 1999 (**S**tandard **C**ommands for **P**rogrammable **I**nstruments). The SCPI standard sets up on the IEEE 488.2 standard, and aims at standardization of device-specific commands, error handling and status registers. For more information on the SCPI concept and definitions, refer to the book "Automatic Measurement Control – A tutorial on SCPI and IEEE 488.2" by John M. Pieper, R&S ordering code 0002.3536.00.

For the purposes of this chapter it is assumed that you are familiar with the programming and operation of the controller. Refer to the appropriate manuals for details of the interface commands.

The requirements of the SCPI standard in terms of command syntax, error handling and configuration of status registers are explained in detail in the respective sections. Tables give you a fast overview of the bit assignments in the status registers. The tables are supplemented by a detailed description of the status registers.

All program examples for IEC/IEEE bus control are written in Visual Basic. A requisite for Visual Basic programming is that the modules NIGLOBAL (Niglobal.bas) and VBIB32 (Vbib\_32.bas) are added to the projects.

---

**Note:**

*Manual control aims at the greatest possible operating ease. The focus in remote control is the predictability of device status after a command. Consequently, remote control programs should always produce a default status to start with (e.g. by the \*RST command) and then make the required settings.*

---

## Brief Instructions

The following short and simple operating sequence allows rapid setup of the instrument on the IEC/IEEE bus and setting of its basic functions. It is assumed that the IEC/IEEE bus address, factory-set to 20, has not yet been altered.

### IEC/IEEE Bus

- Interconnect the instrument and the controller by the IEC/IEEE bus cable and power them on.
- Generate and start the following program on the controller:

CALL IBFIND("DEV1", analyzer%)	Open channel to device.
CALL IBPAD(analyzer%, 20)	Send device address to controller.
CALL IBWRT(analyzer%, "*RST;*CLS")	Reset device.
	Analog generator is set dual-channel to 1 kHz, 0.1 V.
	Measurement function of analog analyzer is set dual-channel to RMS measurement.
CALL IBWRT(analyzer%, "INPut:TYPE GEN1")	Connect analyzer input internally to generator output channel 1.
CALL IBWRT(analyzer%, "INIT:CONT OFF;*WAI")	Trigger single measurement result.
CALL IBWRT(analyzer%, "SENS1:DATA1?")	Request function measurement result (i.e. result of RMS measurement) from channel 1.
CALL IBRD (analyzer%, M\$)	Read in measurement result.
PRINT M\$	Output measurement result onscreen.

The screen shows the RMS function measurement result in V of the generator signal measured by internal coupling.

- Return to manual control: Press the LOCAL key on the front panel.

## Changing to Remote Control

After powering on, the instrument is always in manual control status (LOCAL) and can be controlled from the front panel or a mouse and external keyboard.

To operate the instrument by remote control via an IEC/IEEE bus, you have to switch it to the REMOTE mode by sending an addressed command while the REN line is set. Otherwise, the instrument will remain in the LOCAL mode. If the REN line is cleared while the instrument is in the REMOTE mode, the instrument automatically resets to LOCAL.

For remote control on an Ethernet (LAN) remote control is not automatically set by sending a command. Instead, the instrument must be explicitly set to REMOTE status, e.g. by sending the interface command `&GTR` (Go To Remote).

In REMOTE status, instrument control from the front panel or by a mouse and keyboard is disabled. But the panels can be opened by the mouse and keyboard to verify settings for example. In the Config Panel (in the menu Utilities) you can choose whether or not panels are to be updated during remote control.

A screenshot of a software interface showing a checkbox labeled "SCPI Update". The checkbox is currently unchecked, indicated by an empty square box to the right of the text.

For reasons of speed this updating should be disabled. The panels then show the device status **before** changing to remote control. While generating a remote control program it can be useful to enable updating so that you can see the effect of the remote control commands.

In the middle of the screen you see the message "Remote Operation Active". On the front panel the LED labeled REM illuminates over the `LOCAL` key.

Messages appearing during remote control are shown in the status line over the softkeys.

The instrument remains in REMOTE status until local control is selected either manually with the `LOCAL` key on the front panel or by the interface command `&GTL` on the remote control interface. Then the panels are updated.

The interface command `&LLO` can be used to lock out the `LOCAL` key.

Changing from manual control to remote control and vice versa does not change the instrument settings.

## Remote Control via IEC/IEEE Bus

To be able to control the instrument on the IEC/IEEE bus interface, the instrument and controller must be linked by an IEC/IEEE bus cable. The controller must have an IEC/IEEE bus card, the card drivers and the program libraries for the programming language that is used.

The controller must address the instrument by the set IEC/IEEE bus address. The IEC/IEEE bus address of the instrument is factory-set to 20. It can be altered in the Config Panel (in the Utilities menu). Addresses from 0 to 30 are permissible. After setting a new address, the device status of the R&S UPV is saved with the new address. This prevents the R&S UPV from „forgetting“ the new address if switched OFF with the power switch rather than being properly shut down.

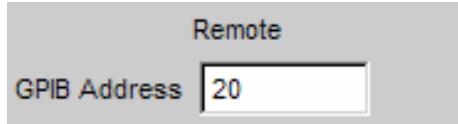

Sending the first command starts remote control.

Returning to manual control is possible from the front panel or on the IEC/IEEE bus.

**Manual:** ➤ Press the **LOCAL** key.

---

### Notes:

*Processing of a command must be completed before changing, otherwise there is an immediate return to remote control.*

*The **LOCAL** key can be locked out by the interface command &LLO (see section "Instrument Interfaces") to prevent accidental changeover.*

*Changing to manual control is then only possible on the IEC/IEEE bus.*

*Lockout of the **LOCAL** key can be canceled by deactivating the REN line of the IEC/IEEE bus (see section "Instrument Interfaces").*

---

### Via IEC/IEEE bus:

...

CALL IBLOC(generator%) Set instrument to manual control.

...

## Remote Control via LAN Interface

For remote control through a network, the controller and the instrument must be connected via the LAN interface to a common network with TCP/IP network protocol.

Connection of the R&S UPV to a network and querying of the computer name is explained in section "Connecting the R&S UPV to a Network (LAN)".

The R&S UPV is supplied with an activated WindowsXP® firewall already installed. In contrast to file transfer via a LAN or manual remote operation with Remote Desktop, which requires only partial disablement (exception) in the firewall, remote control via a LAN is possible only if the firewall is completely deactivated.

Setting remote control:

**Start - Programs - Windows Firewall - Off (not recommended):**

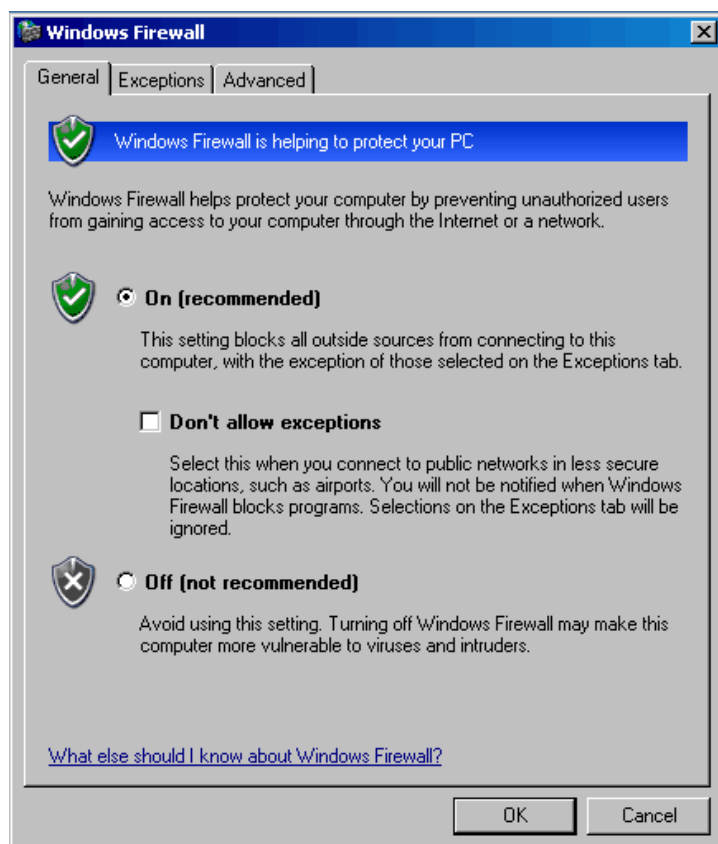

---

**NOTICE** To protect the instrument from users and programs that can access a computer via the network, reactivate the Windows XP firewall after you terminate VISA Remote Control (setting On (recommended)).

---

Software for instrument control and the VISA program library must be installed on the controller. Instrument control is by the VXI-11 standard protocol.

Only the IP address or the computer name is required for connection setup. The IP address/computer name is part of the "resource name" used by programs to identify and control the instrument. The resource name has the form:

**TCPIP::ipaddr::inst0::INSTR**

**ipaddr** has to be replaced by the IP address or the computer name of the instrument. For instance, if the instrument has the IP address 192.1.2.3, TCPIP::192.1.2.3::inst0::INSTR is the valid resource name. Specification of **inst0** in the resource name is optional. So in this example TCPIP::192.1.2.3::INSTR is also a valid resource name. A resource name with computer name could be TCPIP::RSUPV1::INSTR for example.

**Note:**

The IP address of the instrument can also be determined easily by using a Web browser if LXI is installed (standard with the R&S UPV66, optional with the R&S UPV). For more information, see the "Configuration via LXI" section in Chapter 1 of the manual.

**TCPIP** designates the network protocol used and **INSTR** indicates that the VXI-11 protocol is used. If several instruments are connected to a network, each instrument has its own IP address and associated resource name. The controller distinguishes these instruments by their resource name.

In the example below, the Measurement & Automation Explorer program from National Instruments is used to set up an Ethernet remote control connection. Connection setup with this program is simple and first tests can be performed. The R&S UPV is ready configured for networks using DHCP (dynamic host configuration protocol). If this configuration is used, the computer name must be entered at the position of the IP address. It is also possible to assign the R&S UPV a fixed IP address (see section "Connecting the R&S UPV to a Network (LAN)").

**Configuring control of the R&S UPV in the Measurement & Automation Explorer program**

- Start the program on the controller.
- Open the **Create new TCP/IP device** menu with the right mouse key.

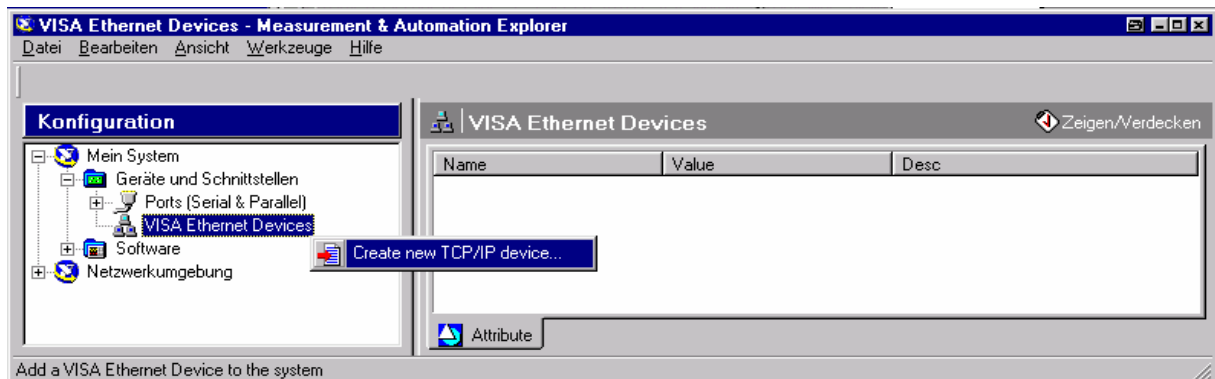

- Enter the IP address of the R&S UPV and select **VXI-11 Instrument**. (You can also enter the computer name.)

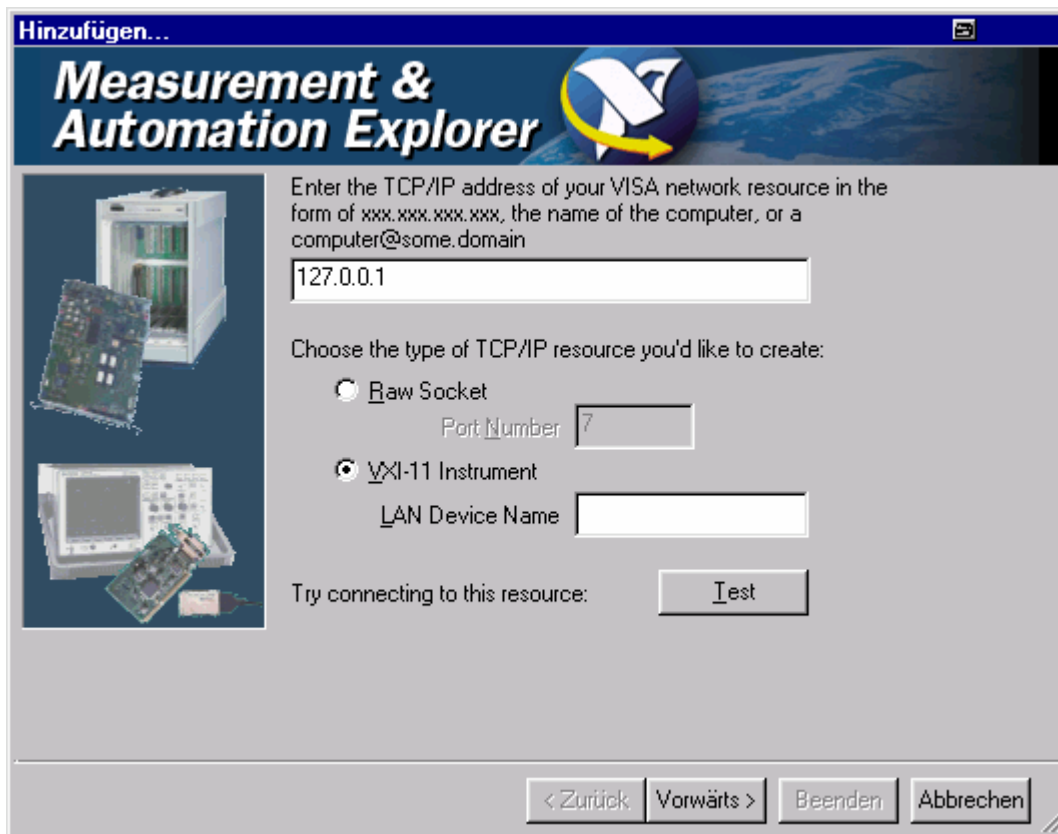

- Press the **Test** button.  
A message indicates whether the connection to the R&S UPV can be set up or not. If a connection cannot be set up, check whether the controller and the instrument are connected to the network (network cable) and powered on. Correct spelling of the IP address or the computer name can also be checked. For further troubleshooting it is advisable to inform the network administrator. Large networks require specification of additional addresses for connection setup, e.g. gateway and subnet mask, which are known to the network administrator.

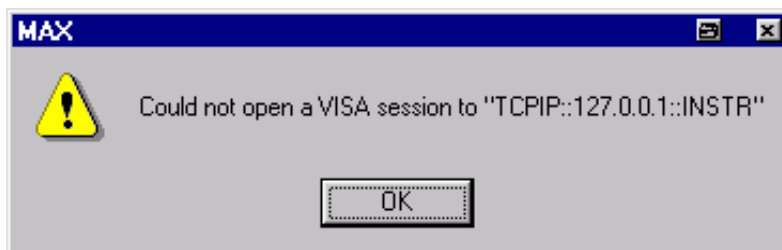
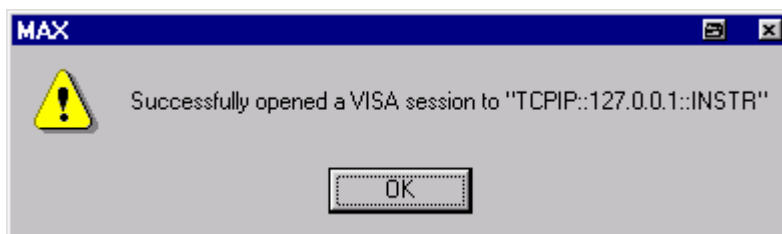



- Press the **Next** button. In the next window you can enter an alias for the instrument. This name must not be mistaken for the computer name. It is only used for instrument identification within the program and displayed in the menu as an option in case of an Ethernet link.

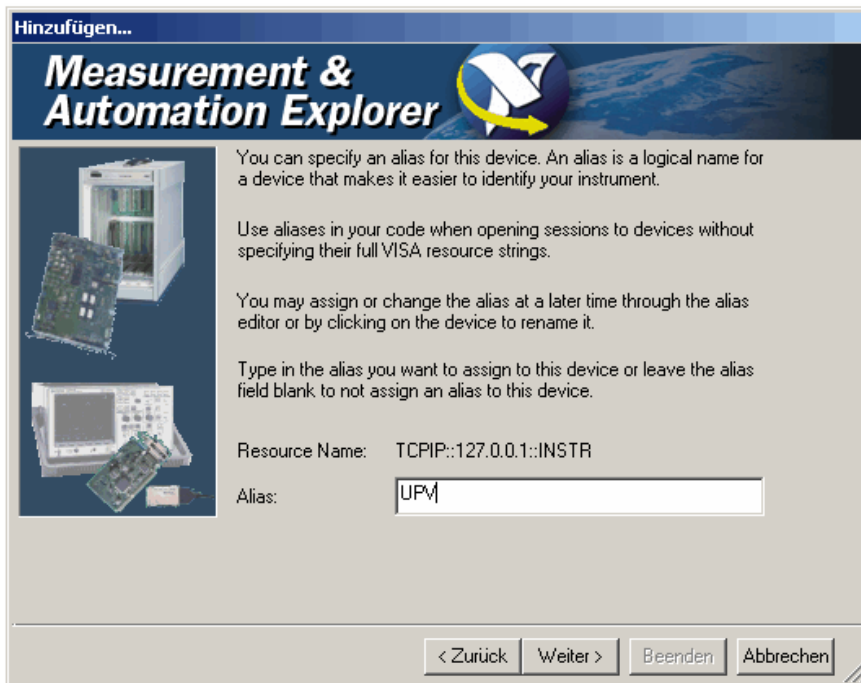

- Press **Next** and then the **Finish** button. The instrument is now configured in the program and can be addressed by the resource name or alias.

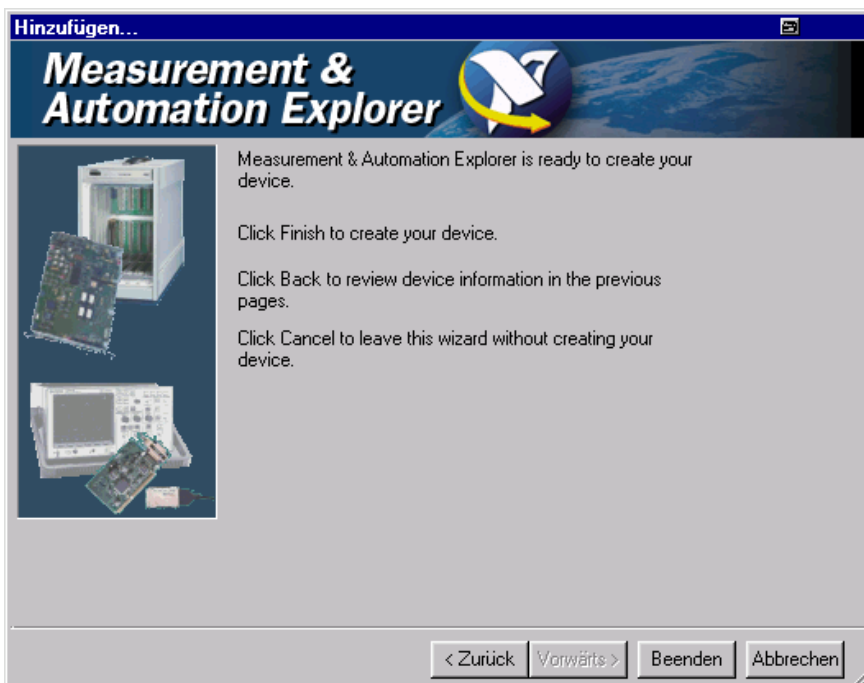

**Starting the Measurement & Automation Explorer program for remote control of the R&S UPV**

- Start the program on the controller.
- In the **Configuration** window, open **Devices and Interfaces** and select R&S UPV (= alias) under **VISA TCP/IP Resources**.
- Open the **Open VISA Session** menu with the right mouse key.

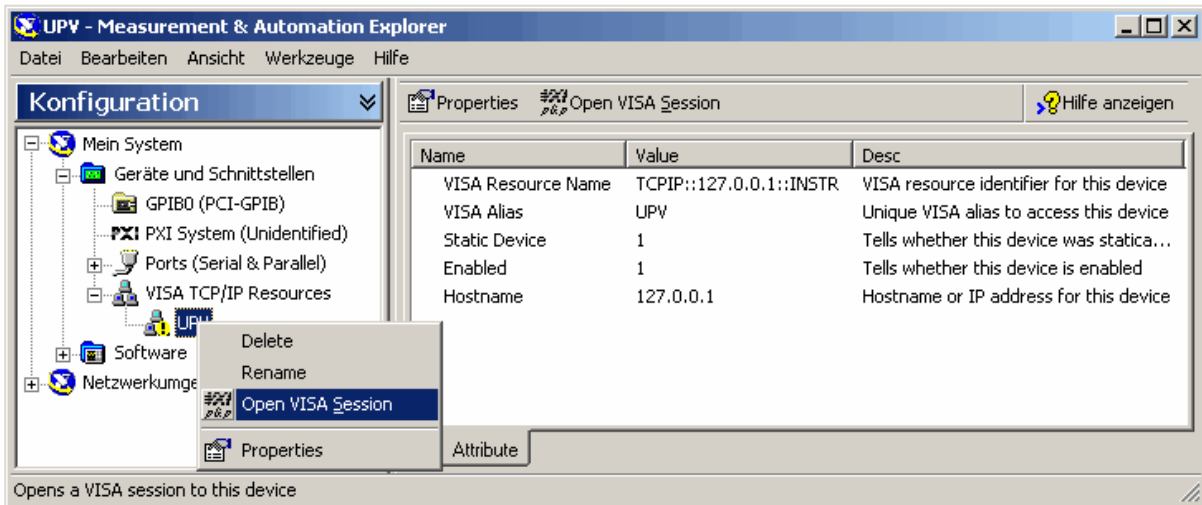

- On the **viWrite** tab under **Basic I/O**, commands can be sent to the instrument; instrument responses are displayed on the **viRead** tab (for further program operation refer to the online help).

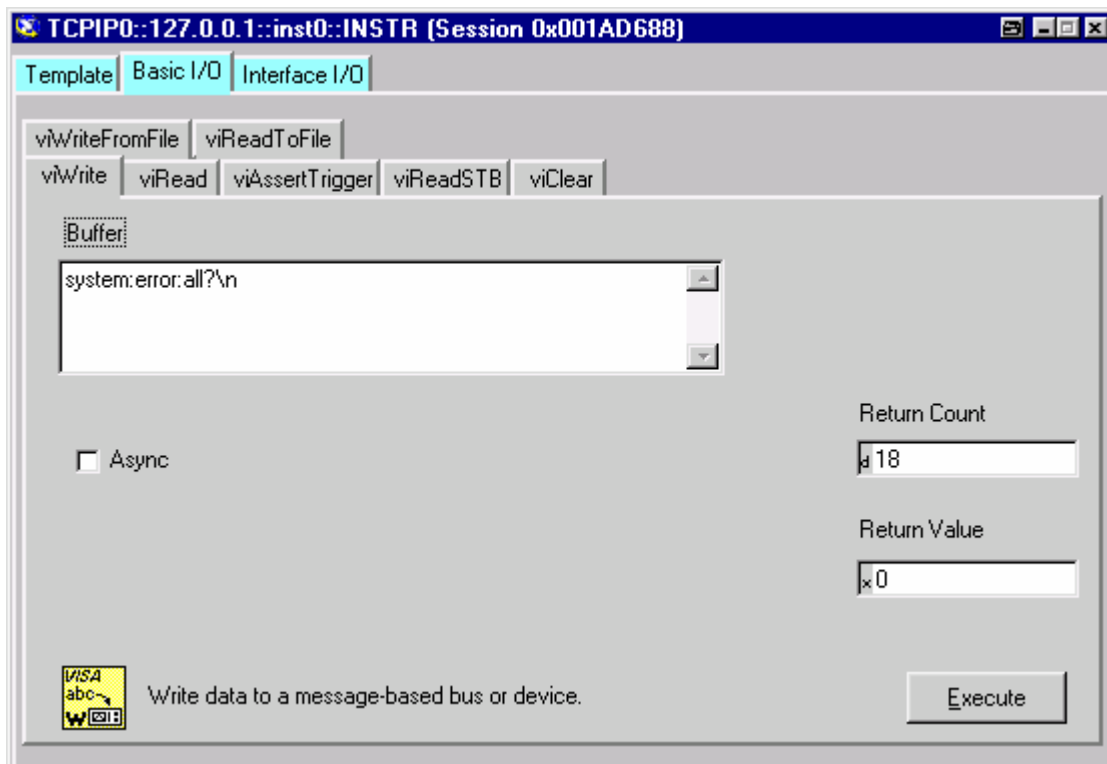

Returning to manual control is possible from the front panel or on the LAN interface.

**Manual:** ➤ Press the `LOCAL` key.

---

**Notes:**

The `LOCAL` key can be locked out by the interface command `&LLO` to prevent accidental changeover. Changing to manual control is then only possible by remote control.

Lockout of the `LOCAL` key can be canceled by the interface command `&NREN`.

---

**Via Ethernet:**

...

`CALL IBLOC(generator%)` Set instrument to manual control.

...

## Remote control via the USB device interface

For remote control via the USB bus, the control computer and the instrument must be connected by a USB cable. A program for controlling instruments, such as the VISA program library with USB support (Version 3.4 or later) must be installed in the control computer. The instrument is controlled via the standardized USB protocol.

The only information necessary for establishing a link is the USB Vendor ID of Rohde&Schwarz (0x0AAD), the Class ID of the R&S UPV (0x004D), and the serial number of the instrument. These IDs form part of the resource name, which the programs use to identify and control the instrument. The resource name has the following format:

**USB::0x0AAD::0x004D::serialnum::INSTR**

Here **serialnum** must be replaced by the serial number of the instrument. For example, if the serial number of the instrument is 100534, the valid resource name is **USB::0x0AAD::0x004D::100534**.

**USB** designates the interface that is used. If multiple instruments are connected to the USB bus, each instrument has its own serial number and thus its own associated resource name. The controller uses the resource names to distinguish the individual instruments.

The National Instruments “Measurement & Automation Explorer” program is used in the following example of USB remote control setup. This program makes it easy to establish a connection and get started with testing.

### Configuring the Measurement & Automation Control program for controlling the R&S UPV

- Launch the program on the control computer.
- Open “**USB Devices**” in the “Instruments and Interfaces” window.
- Select “UPV”.

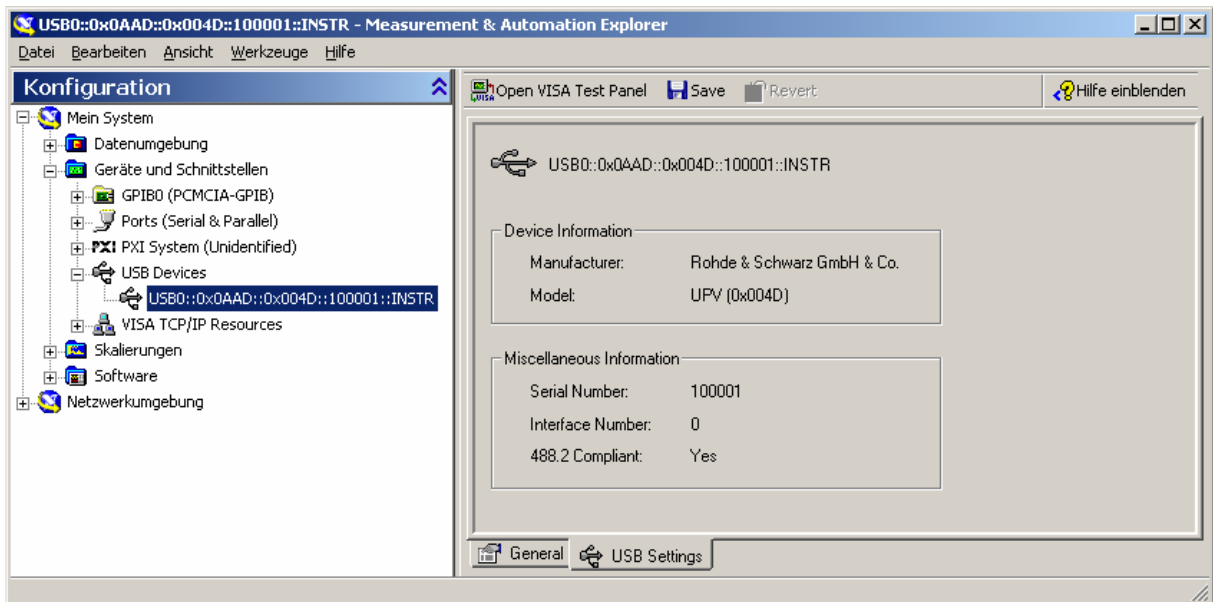

- Press the **Open VISA Test Panel** button.
- Select the **Write** tab and press the **Execute** button.

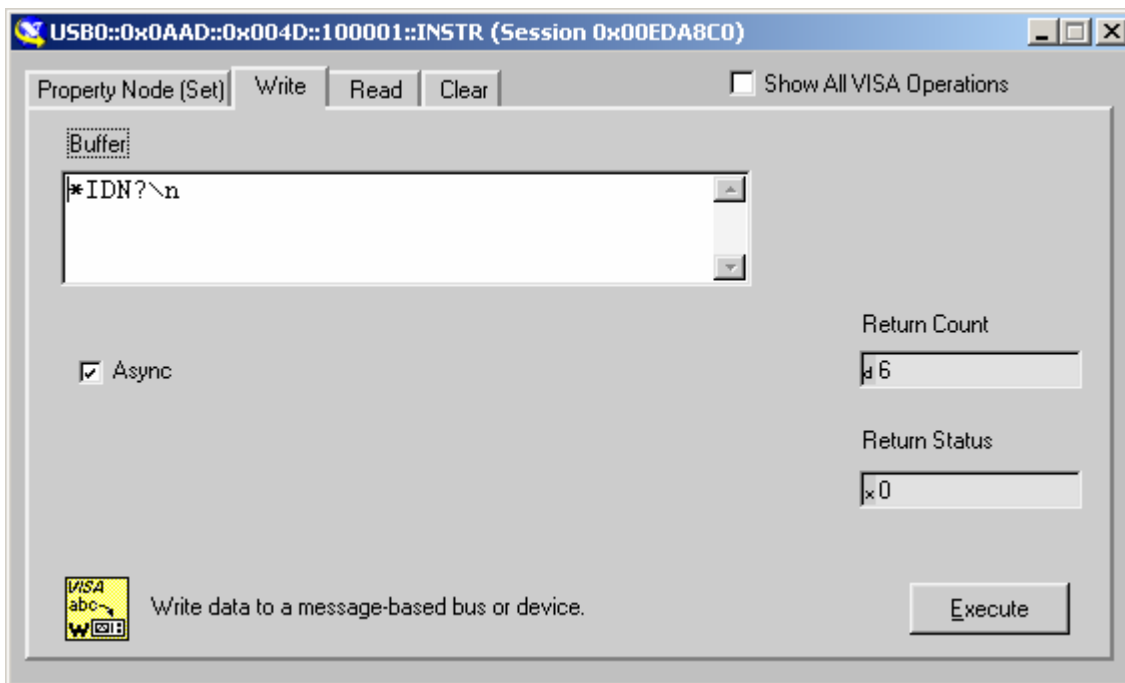

- Select the **Read** tab and press the **Execute** button.

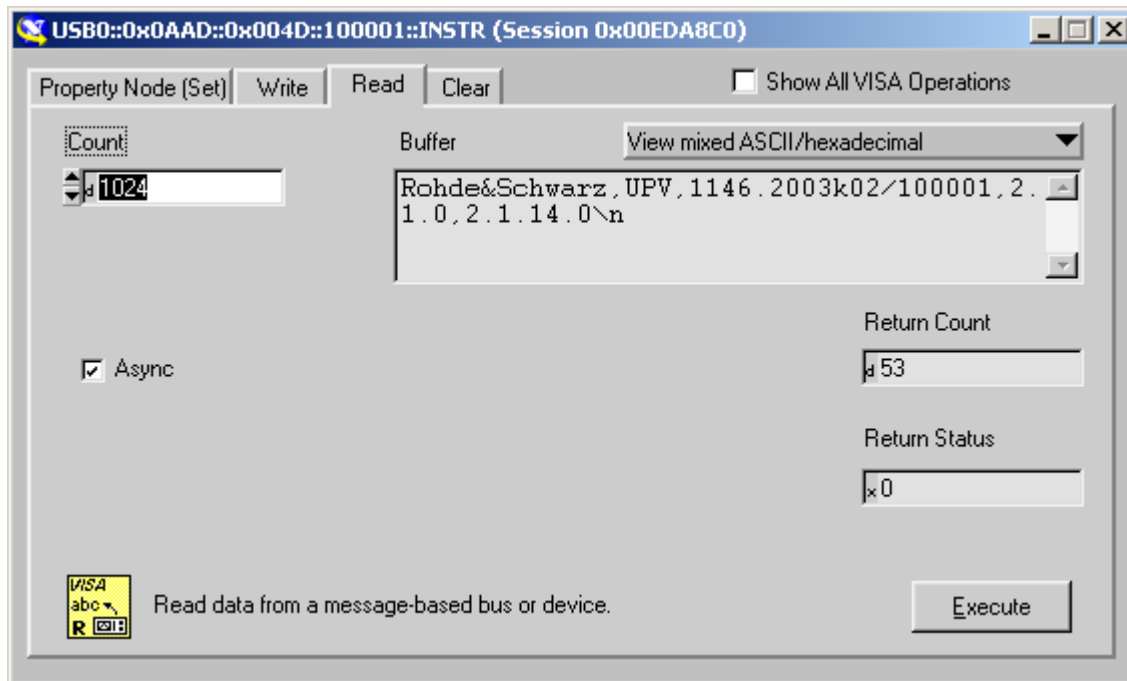

If the link is working properly, the identification string of the R&S UPV will be displayed here.

# Messages

The messages transmitted on the data lines of the IEC/IEEE bus or on a TCP/IP network can be divided into two groups:

- **Interface messages**
- **Device-dependent messages**

## Interface Messages

Interface messages are transmitted on the data lines of the IEC/IEEE bus when the ATN control line is active. They are used for communication between the controller and the instrument and can only be sent by a controller which has controller functionality on the IEC/IEEE bus.

Interface messages can be further classified as

- **Universal commands**
- **Addressed commands**

Universal commands affect all devices connected to the IEC/IEEE bus without requiring an address, whereas addressed commands only affect devices addressed as a listener. The interface messages relevant for a device are listed in section "*Instrument Interfaces*".

If an Ethernet connection is present, signalling on a hardware control line is not required. The IEC/IEEE bus interface commands are emulated (see section "*Instrument Interfaces*").

## Device-Dependent Messages

Device-dependent messages are transmitted on the data lines of the IEC/IEEE bus when the ATN control line is not active. ASCII code is used for data transmission.

If an Ethernet connection is present, signalling on a hardware control line is not required.

Device-dependent messages are identical for the two interfaces (IEC/IEEE bus and Ethernet). They are differentiated by the direction in which they are sent:

**Commands** (program messages) are messages sent by the controller to a device. They operate device functions and request information.

These commands are in turn differentiated by two criteria:

1. The effect they have on the device:

**Setting commands** trigger device settings, e.g. a device reset or setting of the generator frequency.

**Queries** cause data to be put in the output queue, e.g. for device identification or querying a setting. These commands are formed by adding a question mark to the setting command.

2. Their definition in the IEEE 488.2 and SCPI standard:

**Common commands** are precisely defined by the IEEE 488.2 standard in function and notation. They relate to functions such as the management of standard status registers, reset and selftest.

**Device-specific commands** relate to functions that are dependent on device properties, e.g. frequency setting. A large number of these commands are also standardized by the SCPI consortium. Device-specific extensions following SCPI rules are permitted by the standard.

**Device responses** (response messages and service request) are messages sent by a device to the controller after a query. They can include measurement results, device settings or information about device status (see section *"Responses to Queries"* on page 5.17).

The structure and syntax of device-dependent messages are explained in the following section.

## SCPI Command Structure and Syntax

Commands consist of a header and usually one or more parameters. The header and parameters are separated by a "white space" (ASCII code 0 to 9, 11 to 32 decimal, e.g. space). Headers may be composed of several keywords. Queries are formed by adding a question mark direct to the header.

---

### Note:

*The commands used in the following examples are not implemented in the instrument in every case.*

---

**Common commands** Non-device-specific commands consist of a header preceded by an asterisk "\*" and possibly one or more parameters.

<b>Examples</b>	*RST	RESET, resets the device.
:		
	*ESE 253	EVENT STATUS ENABLE, sets the bits of the Event Status Enable register.
	*ESR?	EVENT STATUS QUERY, queries the content of the Event Status register.

### Device-specific commands

Hierarchy: Device-specific commands have a hierarchic structure (see figure below). The different levels are represented by compound headers. Headers at the highest level (root level) have one keyword only. This keyword identifies a whole command system.

**Example:** SOURce

This keyword identifies the SOURce command system.

For commands at lower levels the whole path has to be stated. This starts left with the highest level, and the individual keywords are separated by a colon ":".

**Example:** `SOURce:VOLTage:OFFSet:STATe ON`

This command is on the fourth level of the SOURce system. It sets the DC offset of the generator signal.

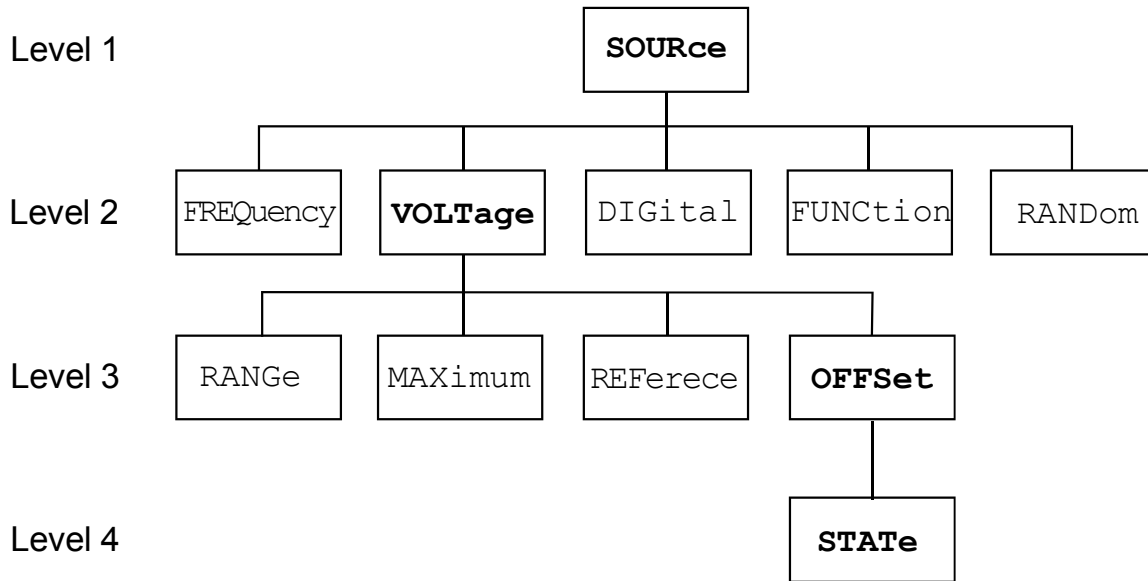

Fig. 5-1 Tree structure of SCPI command systems taking SOURce system as example (extract)

Some keywords appear at several levels within a command system. Their effect then depends on the command structure, i.e. where they are inserted in the command header.

**Examples:**

`SENSe:REFerece:MODE VALue | ...`

This command contains the keyword `REFerece` in the second command level.

It specifies that the reference value for referenced units in the function measurement system is entered as a value (by a separate command).

`SOURce:DIGital:REFerece AZERo | AONE`

This command contains the keyword `REFerece` in the third command level.

It specifies that the data of the digital reference generator are all 0 or 1.

**Optional keywords:** In some command systems it is possible to insert certain keywords in the header or omit them. These keywords are identified in the manual by square brackets. For reasons of compatibility with the SCPI standard, the device must be able to recognize the full length of the command. Some commands become considerably shorter when the optional keywords are omitted.

**Example:**

`INSTRument[1][:SElect] ANLG | DIG`

This command sets the generator to analog or digital signal generation. The following command has the same effect:

`INSTRument ANLG | DIG`



**Note:**

An optional keyword cannot be omitted if its effect is specified in more detail by a numeric suffix. In the R&S UPV this applies to the keyword `SENSe` for example, which can always be omitted for the function measurement = `SENSe1`, but must always be entered for the input measurement = `SENSe2`, frequency/phase measurement = `SENSe3` and `SENSe4`, FFT monitor = `SENSe5`, level monitor = `SENSe6`, waveform monitor = `SENSe7`.

Long and short form: The keywords have a long form and a short form. Keywords may be entered in long or in short form; other abbreviations are not allowed.

**Example:** `SENSe:POWer:REFEreNce:RESistance <nu> =`  
`SENS:POW:REF:RES <nu>`

**Note:**

Upper- and lower-case letters are only used to identify the long and short form in the manual; the device itself does not differentiate between the two types of characters.

Parameters: Parameters must be separated from the header by a "white space". If a command contains several parameters, they are separated by a comma ",".

**Example:** `OUTPut:SAMPlE:FREQuency 48000 HZ`

Numeric suffix: If an instrument has several identical functions or features, e.g. inputs, the desired function can be selected by a suffix to the command. Entries without a suffix are interpreted as having a suffix 1. Optional keywords must be specified if they select a function with the suffix.

**Example:**

```
SENSe[1]:FUNctIon RMS
SENSe2:FUNctIon IPE
SENSe6:FUNctIon LRMS
```

These commands activate the measurement functions Function, Input and Level Monitor. The keyword `SENSe` and the numeric suffixes 2 and 6 must be entered in the command.

**Note:**

In case of remote control, suffix counting may differ from the numbers of the corresponding selection used in manual control. SCPI prescribes that suffix counting starts with 1. Suffix 1 is the default state and used when no specific suffix is stated.

## Structure of a Program Message

A program message can contain one or more commands. It is terminated by a <New Line> (ASCII code 10 decimal) or <EOI> (EOI line active) together with the last useful character of the program message. Seeing as the <Carriage Return> character (ASCII code 13 decimal) has no effect as a filler before the end character, the combination <Carriage Return><New Line> is also admissible.

Several commands in a program message are separated by a semicolon ";". If the next command belongs to a different command system, the semicolon is followed by a colon. A colon ":" at the beginning of a command marks the root node of the command tree, but can be omitted.

**Example:** `":SENSe:VOLTage:RANGe:MODE FIX;:INPut:CHANnel CH1"`

This program message contains two commands. The first command belongs to the SENSE system and is used to set a fixed range. The second command belongs to the INPUT system and activates channel 1.

If the successive commands belong to the same system and therefore have one or more common levels, the program message may be shortened. The second command following the semicolon then starts at the level below the common levels (Fig. 5-1). The colon after the semicolon must then be omitted.

**Example:** `":OUTP:DIG:UNB:OUTP AOUT;:OUTP:DIG:CSIM SIM"`

This program message is shown in full length and contains two commands separated by a semicolon. Both commands belong to the OUTPUT system and its DIG subsystem, i.e. they have two common levels.

In the shortened program message the second command starts at the level below OUTPUT:DIG. The colon after the semicolon is omitted.

The shortened form of the program message is:

`":OUTP:DIG:UNB:OUTP AOUT;CSIM SIM"`

A new program message always starts with the full path however.

**Example:** `":OUTP:DIG:UNB:OUTP AOUT"  
":OUTP:DIG:CSIM SIM"`

## Responses to Queries

Unless expressly specified otherwise, a query is defined for each setting command, which returns the current **value**. It is formed by adding a question mark to the associated setting command. The question mark can be supplemented with MIN or MAX to query the current **value range** of a numeric parameter. The commands with which measurement results are read out have a **special status**. These commands are query only commands which do not permit any settings. The extension of the question mark with MIN or MAX returns the lowest and highest measurement value which is displayed in the combined display above the measurement value.

If the MIN and MAX extension is used on text parameters, strings and query only commands which do not retrieve measurement values a timeout occurs, followed by an error message in the error queue. Some of the SCPI rules for query responses are stricter than those of the IEEE 488.2 standard:

### 1. Numeric parameter

Example: <code>:OUTPut:SAMPle:FREQuency?</code>	Response: 48 KHZ
<code>:OUTPut: SAMPle:FREQuency? MIN</code>	Response: 30 KHZ
<code>:OUTPut: SAMPle:FREQuency? MAX</code>	Response: 200 KHZ

2. Measurement results

Example: :SENSe:DATA?

Response: -82.341 DBFS

:SENSe:DATA? MIN

Response: -101.695 DBFS

:SENSe:DATA? MAX

Response: -19.979 DBFS

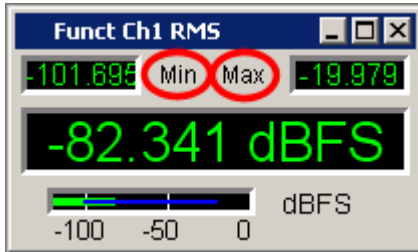

3. Strings are returned in single quotation marks.

Extension with MIN AND MAX is not permissible.

Example: :MMEMory:STORE:MON\_AB?

Response: 'MYTRACE.TRC'

4. Text parameters (character data) are returned in short form.

Extension with MIN AND MAX is not permissible.

Example: :SENSe:FUNCTion?

Response (for RMSSelectiv): RMSS

## Parameters

Most commands require the entry of a parameter. Parameters must be separated from the header by a "white space". Parameters may be numeric values, Boolean parameters, text, character strings or block data. The type of parameter required for the particular command is stated in the details of the command.

**Numeric values** Numeric values may be entered in any customary form, i.e. with sign, decimal point and exponent. The range of values is -9.9E37 to 9.9E37. The exponent is denoted by "E" or "e". The exponent alone must not be used.

**Numeric strings** The format specified under "Numeric values" also applies to the individual values of a numeric string. Numeric values are to be separated from each other by means of a comma. Numeric strings are not entered between quotation marks.

**Example:**

```
TRACe:SWEep:STORe:AY 0.1,0.2,0.3,0.4,0.5
```

**Units** Physical quantities may be stated with the unit. Permissible prefixes for units are MA (mega, MOHM and MHZ are also allowed), K (kilo), M (milli), U (micro) and N (nano). If no unit is specified, the basic unit is assumed.

**Example:**

```
SOURce:FREQuency 1.5 kHz = SOURce:FREQuency 1.5E3
```

**Text** Text parameters follow the syntax rules for keywords, i.e. they also have a long and a short form. They must be separated from the header by a "white space" like any other parameter. A query returns the short form of the text. If a text parameter is set which is already set in the data basis of the R&S UPV the internal R&S UPV setting routine is not performed. This behaviour increases the speed of the IEC bus control program.

**Example:**

```
Setting command: :SOURce:SWEep:CONTRol ASweep
Query: :SOURce:SWEep:CONTRol? Response: ASW
```

**Character strings** Character strings must always be entered between single or double quotation marks. Filenames also count as strings. Normally, however, single quotation marks are used, as double quotation marks are used to mark the complete IEC bus command as a string. String commands can be written via IEC bus command, even if the respective setting line is not visible in the panel.

**Example:**

```
MMEMoRY:LOAD:STATe 'c:\Config\setup\default.xml'
```

## Overview of Syntax Elements

The following list gives you an overview of the syntax elements.

- : The colon separates the keywords of a command.  
In a command line, the colon following a semicolon identifies the highest command level.
  
- ; The semicolon separates two commands in a command line. It does not change the path.
  
- , The comma separates several parameters of a command.
  
- ? The question mark forms a query.
  
- \* The asterisk identifies a common command.
  
- " Quotation marks denote the beginning of a character string and terminate it.
  
- # The double cross denotes the beginning of block data.
  
- A "white space" (ASCII code 0 to 9, 11 to 32 decimal, eg space) separates header and parameter.
  
- . Decimal point of numeric values.

## Device Model and Command Processing

The device model shown in the following figure was created from the point of view of processing SCPI commands. The individual components operate independently of each other and simultaneously. They communicate with each other by means of messages.

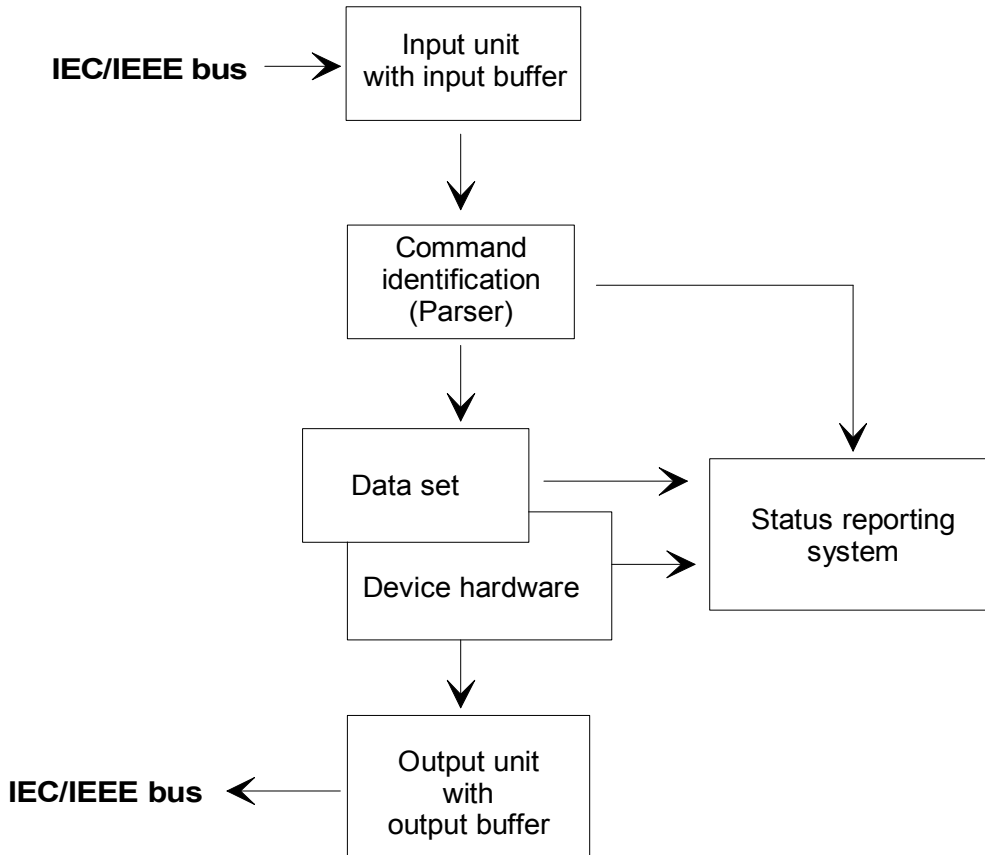

Fig. 5-2 Device model for remote control via IEC/IEEE bus or TCP/IP network

### Input Unit

The input unit receives commands in the form of characters from the IEC/IEEE bus or Ethernet and collects them in the input buffer. The input unit sends a message to the parser as soon as it detects an end character, <PROGRAM MESSAGE TERMINATOR> according to IEEE 488.2, the interface message DCL or a full input buffer.

If the input buffer is full, the IEC/IEEE bus or Ethernet transfer is halted and the data received until then are processed. Then the IEC/IEEE bus or Ethernet transfer is continued. If the buffer is not yet full when the end character is received however, the input unit can receive the next command while the previous command is parsed and executed. Reception of a DCL clears the input buffer and immediately triggers a message to the parser.

## Command Identification (Parser)

The parser analyzes the data received from the input unit. Data are processed in the sequence in which they were received. Only a DCL is given priority; a GET (Group Execute Trigger) for example is not processed until after the previously received commands. Every command detected as correct is immediately forwarded to the database and executed.

Syntax errors are recognized by the parser and forwarded to the status reporting system. The remainder of a program message after a syntax error is, in as much as possible, further analyzed and processed. After the syntax test, the value range of the parameter may be checked.

## Database and Device Hardware

The term "device hardware" refers to that part of the device which performs the actual instrument function, e.g. generator setting, analyzer setting. This does not include the controller.

The term "database" denotes a database that manages all the parameters and associated settings required for setting the device hardware.

Setting commands lead to a change in the data set of the database. The database administration enters the new values (e.g. frequency) and immediately sets the hardware.

An IEC/IEEE bus program message that may contain several setting commands is sent to the parser, which examines the IEC/IEEE bus commands for syntax and semantic errors. Once a command is identified as correct, a check is immediately made with current settings to see whether the command is admissible. If the command is admissible, it is transferred to the database of the R&S UPV and the device hardware is set. If existing settings show that the command is illegal, it is rejected, an execution error is sent to the status reporting system and the device hardware is not set for this command. Subsequent commands that are admissible on the basis of the existing settings are executed (see following section).

This strictly hierarchic procedure ensures that no illegal device status can occur at any time.

## Command Sequence (IEC/IEEE)

Every IEC/IEEE bus command received by the R&S UPV is immediately checked for its admissibility. This is only possible if the R&S UPV knows for which instrument or function the command is intended, i.e. the appropriate instrument or function was activated **before**.

### Example:

For a balanced output it is possible to select an impedance of 600 ohms, but not for an unbalanced output.

If these checks and the appropriate error messages were omitted, measurements would be performed with erroneous settings, or even be impossible, and the user would not know why.

Identical menu items in different instruments or functions are addressed by the same command in remote control, so they can only be distinguished by reference to the particular instrument or function.

**Example:**

The command "INPut:SElect CH1" is admissible for all analyzer instruments.

To be able to preset individual parameters of functions that are not yet active, each IEC/IEEE bus command would have to be told to which instrument and which function it refers. The internally managed addressing of commands by the R&S UPV would then be the job of the IEC/IEEE bus programmer, who would have to handle a multiple number of commands.

A major feature in operation of the R&S UPV is its ability to note the settings for individual generator and analyzer functions and to restore all required parameters when one of these functions is selected. This does away with the need to reset all parameters when a function is changed.

**Example:**

The generator function Mod Dist is set with frequencies of 400 Hz and 7 kHz. When you switch to the DFD function, the frequency pair 11 kHz and 12 kHz last used with the DFD function is automatically restored.

This functionality is also available under IEC/IEE bus control, i.e. even in remote control all parameters are **automatically** set when the function is changed. This is much faster and surer than the user having to set the parameters each time on the IEC/IEEE bus.

If the R&S UPV did not have this ability, the user could overwrite parameters for instruments that are not active, and the parameters of the function last used would no longer be available.

Since manual and remote control work with the same internal data sets and a mixture of manual and remote control must be possible, only one uniform method of internal parameter processing can be used for the two modes. Automatic parameter restoration is indispensable for manual control, so it must also be used for remote control.

To relieve the user of the need to watch out for relationships that are in part not apparent, the following applies to both remote control and manual control of the R&S UPV:

---

*Nothing can be set on the R&S UPV that is not admissible.*

---

The disadvantage of this is that sometimes a certain operating sequence has to be adhered to even in remote control. But this is more than compensated by the fact that possible setting errors are immediately indicated by the instrument.



## Status Reporting System

The status reporting system collects information about the device status and makes it available to the output unit on request. The structure and function are explained in section "*Status Reporting System*" on page 5.28.

## Output Unit

The output unit collects the information requested by the controller and which it obtains from database administration. It processes the information in line with SCPI rules and makes it available in the output buffer.

If the device is addressed as a talker and the output buffer does not contain any data or expect data from the database, the output unit sends the error message "Query UNTERMINATED" to the status reporting system. No data are sent on the IEC/IEEE bus or Ethernet, and the controller waits for the set time limit. This procedure is prescribed by SCPI.

## Triggering Measurement or Sweep

There are three ways of triggering a measurement or a sweep :

- By the SCPI-specific command " **INIT** "
- By the common command " **\*TRG** "
- By the addressed command **Group Execute Trigger** " **GET** "

All three possibilities are equivalent and similar in the time they take to execute.

There are also three ways of waiting for a triggered measurement result, which are looked at in the next section. To demonstrate the three trigger possibilities together with singly triggered measurement results, command synchronization with \*WAI is used in what follows.

## Command Synchronization

To ensure that commands are executed in a certain sequence, one of the commands \*OPC, \*OPC? or \*WAI must be used. As a result of these commands, a certain action is not triggered until the hardware is set and settled. The controller can be forced through appropriate programming to wait for the appearance of an action.

Table 5-1 Synchronization with \*OPC, \*OPC? and \*WAI

Command	Effect	Programming of controller
*OPC	Sets the Operation Complete bit in the ESR after all previous commands have been executed.	- Set bit 0 in ESE. - Set bit 5 in SRE. - Wait for Service Request.
*OPC?	Stops further command processing until 1 is returned. This is not the case until the Operation Complete bit is set in the ESR. This bit indicates that the previous setting has been completed.	Send *OPC? directly after the command whose processing should be terminated before other commands can be executed.
*WAI	Stops further command processing until all commands sent before *WAI have been executed.	Send *WAI directly after the command whose processing should be terminated before other commands are executed.

In remote control of the R&S UPV it is essential to wait for the end of a measurement or sweep before the measured results are fetched and the hardware is newly set.

The following table explains the effect of different combinations of measurement or sweep triggering in conjunction with a synchronization command.

Table 5-2 Trigger command with/without synchronization

Trigger command with/without synchronization	Description
"INIT:CONT OFF; *WAI"	A single measurement or sweep is triggered. Subsequent commands are processed after the measurement or sweep is completed. Generator and analyzer setting commands <b>do not</b> trigger a new measurement. A new measurement must be triggered with "INIT; *WAI"  <i>This command is the simplest to use and should preferably be used to trigger a measurement.</i>
"INIT:CONT ON; *WAI"	A continuous measurement or continuous sweep will be triggered. Subsequent commands will not be processed until the first measurement or the first sweep cycle has been completed. Generator and analyzer configuration commands <b>immediately</b> trigger a restart of the continuous measurement.
"INIT:CONT OFF" <b>without</b> *WAI	When a generator or analyzer setting command is sent <b>during a single measurement</b> , i.e. before the measurement is completed, the measurement is restarted to avoid incorrect results (incorrect results could be obtained, for instance, if the generator voltage is varied during the measurement). Generator or analyzer setting commands sent <b>after the single measurement has been terminated</b> will <b>not</b> trigger a new measurement. A new measurement must be triggered with "INIT".
"INIT:CONT ON" <b>without</b> *WAI	Each generator or analyzer setting command restarts a measurement to avoid incorrect measurement results (incorrect results could be obtained, for instance, if the generator voltage is varied during the measurement).

## Command Recording

The R&S UPV offers the possibility of recording the equivalent IEC/IEEE bus commands in a separate window during manual control. Recording begins as soon as the window has been opened. Recording continues after the window is closed and until the R&S UPV is powered off. The contents of the window can be edited (also deleted) and copied to the clipboard.

In this way it is very easy to produce the matching IEC/IEEE bus control program from a manual control sequence without having to look up the commands in the manual. This also eliminates malfunctions through the wrong notation.

From the Config Panel (Menu → Utilities → Config Panel), you can select whether to use the short or long form of the command parameters when recording commands or querying parameters (Query).

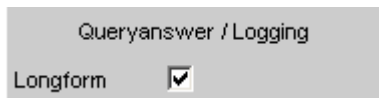

Remote control command:

```
SYSTem:QLONG ON | OFF
```

Example:

If the analog generator has been set to "balanced", the query `OUTPut:TYPE?` will return 'BAL' in the short form and 'BALanced' in the long form.

## Starting Recording

Open the window through the menu by Sequence → SCPI Recording.

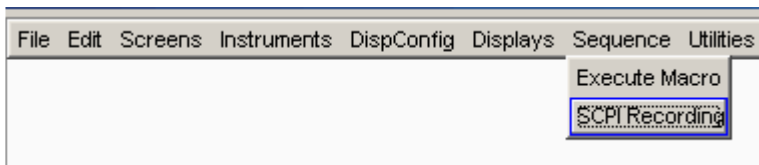

Opening the window starts the recording. The window is visible on all screens.

### Recording Commands

As soon as the SCPI Recording window is opened, all settings of manual control are recorded. In this example the generator frequency was set to 1024.5 Hz and the level to 0.5 V.

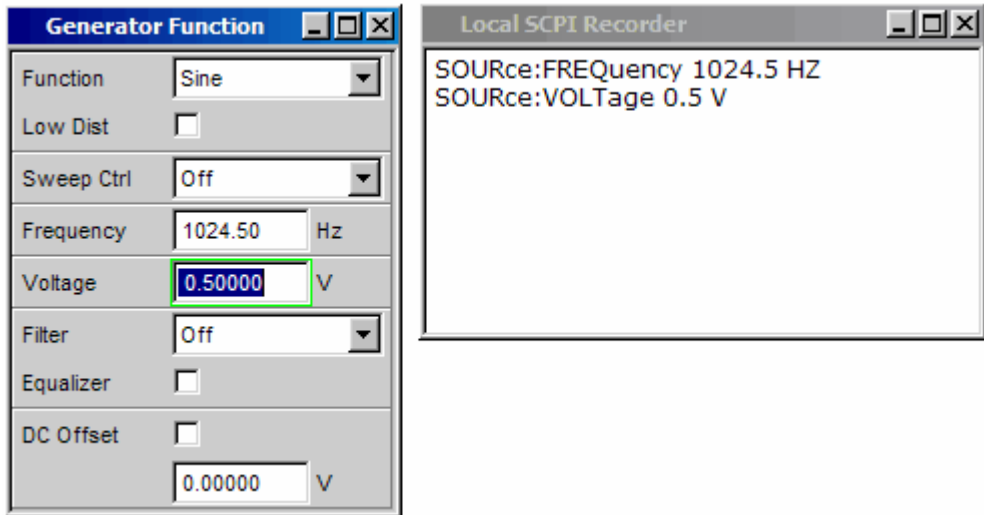

### Editing Commands

The contents of the SCPI Recording window can be edited and copied through the clipboard into a file. From the commands in this file it is possible to generate an IEC/IEEE bus control program. Open the context menu by clicking on the right mouse key. To operate the SCPI Recorder you need an external keyboard and mouse.

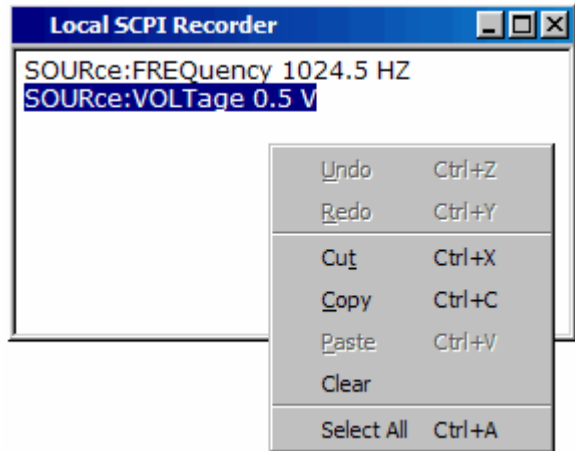

## Status Reporting System

The status reporting system stores all information about the current operating status of the device, e.g. that it is performing system error correction, and about occurred errors. This information is stored in the status registers and the error queue. The contents of status registers and the error queue can be queried on the IEC/IEEE bus or via the LAN or USB interface.

Information is hierarchically structured.

The highest level is formed by the

**Status Byte (STB)** register, defined in IEEE 488.2, and the associated **Service Request Enable (SRE)** register.

The STB receives information from the following registers:

**Standard Event Status (ESR)**, also defined in IEEE 488.2, and the associated **Standard Event Status Enable (ESE)** register;

from the SCPI-defined registers named

**STATus:OPERation** and

**STATus:QUESTionable**;

and from the device-specific registers named

**STATus:XQUESTionable**,

**STATus:QUESTionable:UNDERrange**,

**STATus:QUESTionable:OVERrange** and

**STATus:QUESTionable:MEASuring**,

which contain detailed information about the device.

The status reporting system also includes the IST (Individual Status) flag and the Parallel Poll Enable (PPE) register assigned to it. The IST flag, like the SRQ, combines the complete device status in a single bit. The PPE has the same function for the IST flag as the SRE has for the service request.

The output buffer contains messages that the device sends back to the controller. It is not part of the status reporting system but determines the value of the MAV bit in the STB.

## Structure of SCPI Status Register

Each SCPI register consists of five 16 bit parts with different functions (see figure below). The individual bits are independent of each other, i.e. each hardware status is assigned a bit number that is the same for all five parts. For instance, bit 5 of the STATUS:OPERation register is assigned to the Wait for Trigger hardware status in all five parts.

Bit 15 (the most significant bit) is set to 0 in all parts for the **STATUS:OPERation**, **STATUS:QUESTIONable** and **STATUS:XQUESTIONable** registers, except for the device-specific registers **STATUS:QUESTIONable:UNDERrange**, **STATUS:QUESTIONable:OVERrange** and **STATUS:QUESTIONable:MEASuring**.

For these registers, bit 15 may be given a meaning in the future.

Queries return the current value of the particular part register to allow a check of the device status. A decimal value between 0 and 32767 ( $= 2^{15} - 1$ ), or between 0 and 65535 ( $= 2^{16} - 1$ ), is returned.

The configuration commands set the respective part register, thus determining which status changes of the R&S UPV cause a change in status registers. A decimal value between 0 and 32767 ( $= 2^{15} - 1$ ), or between 0 and 65535 ( $= 2^{16} - 1$ ), is set.

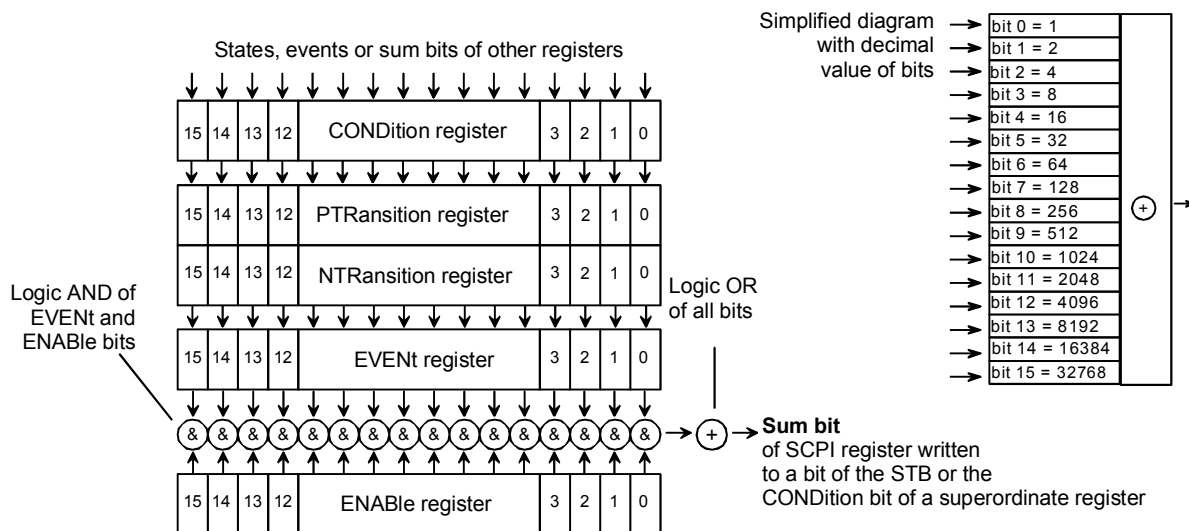

Fig. 5-3 Standard SCPI status register

**CONDition part** The CONDition part is written direct by the hardware or the summary bit of the subordinate register. Its contents indicate current device status. This register part can only be read, not written or cleared. Reading the register does not change its contents.

**PTRansitionpart** The Positive TRansition part acts as an edge detector. On transition of a bit of the CONDition part from 0 to 1, the associated PTR bit decides whether the EVENT bit is set to 1.  
 PTR bit = 1: the EVENT bit is set.  
 PTR bit = 0: the EVENT bit is not set.  
 This part can be written and read. Reading does not change its contents.

- NTRansition part** The Negative TRansition part also acts as an edge detector. On transition of a bit of the CONDition part from 1 to 0, the associated NTR bit decides whether the EVENT bit is set to 1.  
NTR bit = 1: the EVENT bit is set.  
NTR bit = 0: the EVENT bit is not set.  
This part can be written and read. Reading does not change its contents.
- These two transition register parts enable you to define the status change of the CONDition part (none, 0 to 1, 1 to 0 or both) that is to be held in the EVENT part.
- EVENT part** The EVENT part indicates whether there has been an event since last readout – it is the "memory" of the CONDition part. It only indicates events passed through the transition filters. The EVENT part is continuously updated by the device. This part is read-only. Reading clears its contents. This part is often equated with the overall register.
- ENABLE part** The ENABLE part determines whether the associated EVENT bit contributes to the summary bit (see below). Each bit of the EVENT part is ANDed (symbol '&') with the associated ENABLE bit. The results of all logical operations of this part are ORed (symbol '+') and passed on to the summary bit.
- ENABLE bit = 0:  
the associated EVENT bit does not contribute to the summary bit.
- ENABLE bit = 1:  
if the associated EVENT bit is 1, the summary bit is also set to 1.
- This part can be written and read as required. Reading does not change its contents.
- Summary bit** As stated above, the summary bit for each register is derived from the EVENT and ENABLE parts. The result is then entered into a bit of the CONDition part of the superordinate register.
- The device automatically generates the summary bit for each register. An event, e.g. a non-locking PLL, can thus produce a service request through all hierarchical levels.

---

**Note:**

*The Service Request Enable (SRE) register defined by IEEE 488.2 can be understood as the ENABLE part of the STB if the STB is structured to SCPI. By analogy, the ESE can be understood as the ENABLE part of the ESR.*

---

# Overview of Status Registers

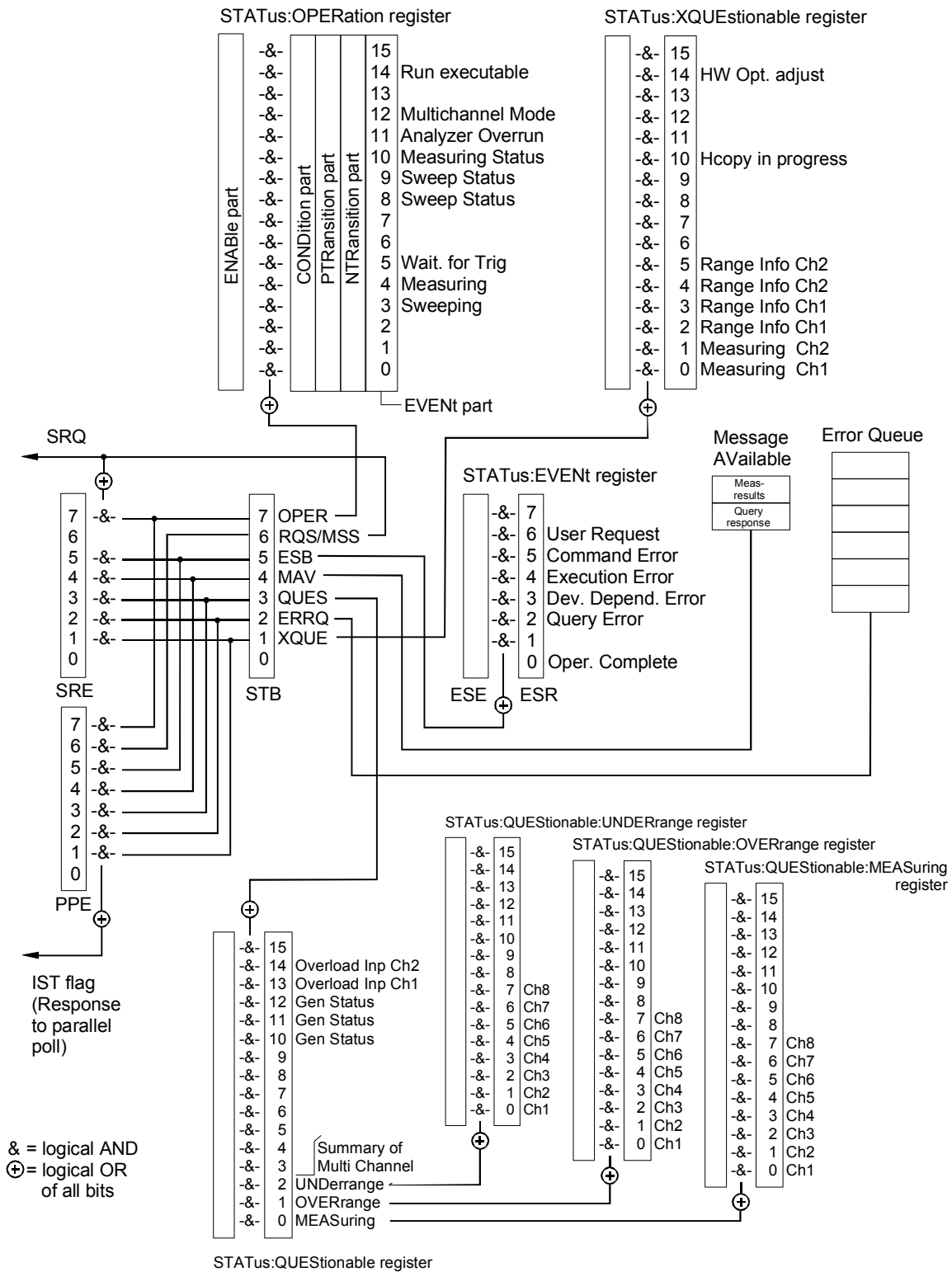

Fig. 5-4 Overview of status registers



## Status Byte (STB) and Service Request Enable (SRE) Register

The STB is already defined in IEEE 488.2. It gives a rough overview of the device status, collecting information from the lower-level registers. So it is comparable with the CONDition part of an SCPI register and is at the highest level of the SCPI hierarchy. It is special in that bit 6 acts as the summary bit of all other bits of the status byte.

The status byte is read by the command \*STB? or a serial poll.

Associated with the STB is the SRE. The function of the SRE corresponds to that of the ENABLE part of the SCPI registers. Each bit of the STB is assigned a bit in the SRE. Bit 6 of the SRE is ignored. If a bit is set in the SRE and the associated bit in the STB changes from 0 to 1, a service request (SRQ) will be generated on the IEC/IEEE bus or Ethernet, which triggers an interrupt in the controller configured for this purpose, and can be further processed by the controller.

The SRE can be set by the command \*SRE and read by the query \*SRE?.

Reading the EVENT part of a status register deletes the associated bit in the status byte register (e.g. "STAT:OPER:EVEN?" deletes the OPER bit (d7) in the OPERation register).

Table 5-3 Meaning of bits in status byte

Bit no.	Meaning
0	<b>Not used</b>
1	<b>XQUEstionable status summary bit</b> This bit is set if an EVENT bit is set in the XQUEstionable status register and the associated ENABLE bit is set to 1. The register can be read by the queries STATUS:XQUESTionable:CONDition? or STATUS:XQUESTionable[:EVENT]?
2	<b>Error queue not empty</b> The bit is set if the error queue has an entry. This can be fetched by the command SYSTem:ERRor?. If this bit is enabled by the SRE, each entry of the error queue will generate a service request. An error can thus be recognized and specified in more precisely by querying the error queue.
3	<b>QUEstionable status summary bit</b> This bit is set if an EVENT bit is set in the QUESTionable status register and the associated ENABLE bit is set to 1. A set bit denotes a questionable device status, which can be specified more precisely by querying the QUESTionable status register with STATus:QUESTionable:CONDition? or STATus:QUESTionable[:EVENT]?
4	<b>MAV bit (message available)</b> This bit is set if there is a readable message in the output buffer. A measurement result or response to a query (i.e. IEC/IEEE bus command with '?') is present and can be read.
5	<b>ESB bit</b> Summary bit of the event status register. This bit is set if one of the bits in the event status register is set and enabled in the event status enable register. A set bit indicates an error or event that can be specified more precisely by querying the event status register by the command "**ESR?".
6	<b>MSS bit (master status summary bit)</b> This bit is set if the device triggers a service request. This is the case if one of the other bits of this register is set together with its mask bit in the service request enable register.

Bit no.	Meaning
7	<b>OPERation status register summary bit</b> This bit is set if an EVENT bit is set in the OPERation status register and the associated ENABLE bit is set to 1. A set bit indicates that the device is executing an action. The type of action can be determined by querying the OPERation status register with STATus:OPERation:CONDition? or STATus:OPERation[:EVENT]?

## IST Flag and Parallel Poll Enable (PPE) Register

Similar to the SRQ, the IST flag combines the complete status information in a single bit. It can be queried by a parallel poll (see section "Parallel Poll" on page 5.45) or the `*IST?` command.

The parallel poll enable (PPE) register determines which bits of the STB contribute to the IST flag. The bits of the STB are ANDed with the corresponding bits of the PPE, bit 6 also being used - in contrast to the SRE. The IST flag is the product of ORing all results. The PPE can be set by the `*PRE` command and read by the `*PRE?` query.

## STATus:EVENT Register (ESR)

The ESR is already defined in the IEEE 488.2 standard. It is comparable to the EVENT part of an SCPI register. The event status register can be read out by the `*ESR?` query.

The ESE is the associated ENABLE part. It can be set by the `*ESE` command and read out by the `*ESE?` query.

Table 5-4 Meaning of bits in event status register

Bit no.	Meaning
7	<b>Not used</b>
6	<b>User request</b> This bit is set on pressing the <b>LOCAL</b> key, i.e. when the device is switched to manual control.
5	<b>Command error</b> This bit is set if an undefined command or a command with incorrect syntax is received. An error message describing the error more precisely is entered in the error queue.
4	<b>Execution error</b> This bit is set if the syntax of a received command is correct but the command cannot be executed due to various marginal conditions. An error message describing the error more precisely is entered in the error queue.
3	<b>Device-dependent error</b> This bit is set if a device-dependent error occurs. An error message describing the error more precisely is entered in the error queue.
2	<b>Query error</b> This bit is set in either of the two following cases: the controller wants to read data from the device but has not sent a query, or it sends new commands to the device before it retrieves existing requested data.
1	<b>Not used</b>
0	<b>Operation complete</b> When the <code>*OPC</code> command is received, this bit is set if all previous commands have been executed.

## STATus:OPERation Register

The CONDition part of this register contains information about the actions being performed by the device, and the EVENT part about the actions performed by the device since the last readout. It can be read by the query STATus:OPERation:CONDition? or STATus:OPERation[:EVENT]?

Table 5-5 Meaning of bits in STATus:OPERation register

Bit no.	Meaning
15	<b>Not used</b>
14	<b>Run executable</b> If an executable program (*.exe) is started manually or by means of the SYSTem:PROGramm:EXECute 'filename' command, this bit is set to 1; when the program is completed, this bit is reset to 0. The change from 1→0 can be checked by means of a Serial poll and Parallel poll, or it can trigger an SRQ in order to fetch measurement data, for example.
13	<b>Not used</b>
12	<b>Multichannel mode</b> 0 = Two-channel operation Analyzer Instrument Analog, Digital Audio, I2S Board, USI Dual Chan 1 = Multichannel operation Analyzer Instrument Analog 8 Chan
11	<b>Analyzer overrun</b> The sampling rate on the input is too high for the selected digital instrument. Samples are lost.
10	<b>Measuring status</b> Together with bit 4, this bit results in the following statuses: Bit 4, 10 0 0 = Measuring Terminated                      Single measurement completed 0 1 = Measuring Stopped                            Measurement is halted 1 0 = Measuring Single                              Single measurement is being performed 1 1 = Measuring Cont                                Continuous measurement is being performed
8 and 9	<b>Sweep status</b> Together with bit 3, this bit results in the following statuses: Bit 3, 9, 8 0 0 0 = Sweep Off                                    No sweep is being performed 0 0 1 = Not used 0 1 0 = Sweep Stopped                              Sweep was halted and can be continued 0 1 1 = Sweep Waiting                               Sweep is waiting to (re)start 1 0 0 = Sweep Run Manual                            Manual sweep is being performed 1 0 1 = Sweep Run Single                            Single sweep is being performed 1 1 0 = Sweep Run Cont                               Continuous sweep is being performed 1 1 1 = Not used
7	<b>Not used</b>
6	<b>Not used</b>
5	<b>Waiting for trigger</b> This bit is set while the R&S UPV waits for a trigger event.

Bit no.	Meaning																
4	<p><b>Measuring</b></p> <p>This bit is set while the R&amp;S UPV is performing a measurement. Bit 10 indicates the measuring status.</p> <p>Together with bit 10, this results in the following statuses:</p> <p>Bit 4, 10</p> <table border="0"> <tr> <td>0 0 = Measuring Terminated</td> <td>Single measurement completed</td> </tr> <tr> <td>0 1 = Measuring Stopped</td> <td>Measurement is halted</td> </tr> <tr> <td>1 0 = Measuring Single</td> <td>Single measurement is being performed</td> </tr> <tr> <td>1 1 = Measuring Cont</td> <td>Continuous measurement is being performed</td> </tr> </table> <p>Bits 0 and 1 in the STATUS:QUESTIONABLE register indicate which channel this information refers to:</p> <table border="0"> <tr> <td>0 0 = Not used</td> <td>Measuring Ch1 (bit 0)</td> </tr> <tr> <td>0 1 = The information refers only to channel 2</td> <td>Measuring Ch2 (bit 1)</td> </tr> <tr> <td>1 0 = The information refers only to channel 1</td> <td></td> </tr> <tr> <td>1 1 = The information refers to both channels</td> <td></td> </tr> </table>	0 0 = Measuring Terminated	Single measurement completed	0 1 = Measuring Stopped	Measurement is halted	1 0 = Measuring Single	Single measurement is being performed	1 1 = Measuring Cont	Continuous measurement is being performed	0 0 = Not used	Measuring Ch1 (bit 0)	0 1 = The information refers only to channel 2	Measuring Ch2 (bit 1)	1 0 = The information refers only to channel 1		1 1 = The information refers to both channels	
0 0 = Measuring Terminated	Single measurement completed																
0 1 = Measuring Stopped	Measurement is halted																
1 0 = Measuring Single	Single measurement is being performed																
1 1 = Measuring Cont	Continuous measurement is being performed																
0 0 = Not used	Measuring Ch1 (bit 0)																
0 1 = The information refers only to channel 2	Measuring Ch2 (bit 1)																
1 0 = The information refers only to channel 1																	
1 1 = The information refers to both channels																	
3	<p><b>Sweeping</b></p> <p>This bit is set while the R&amp;S UPV is performing a sweep. Bits 8 and 9 indicate the sweep status.</p>																
2	<p><b>Not used</b></p>																
1	<p><b>Not used</b></p>																
0	<p><b>Not used</b></p>																

## STATus:QUESTionable Register

This register contains information about questionable device statuses. These may occur when the device is operated beyond its specifications. The register can be read by the query `STATus:QUESTionable:CONDition?` or `STATus:QUESTionable[:EVENT]?`.

Table 5-6 Meaning of bits in STATus:QUESTionable register

Bit no.	Meaning																								
15	<b>Not used</b>																								
14 13	<p><b>Analyzer status</b> for measurement with the two-channel analog instrument</p> <p>Bit 14, 13</p> <table> <tr> <td>0 0</td> <td>= No Overload</td> <td>Normal operating status (none of the input channels are overloaded)</td> </tr> <tr> <td>0 1</td> <td>= Anlr1 Overload</td> <td>Input channel 1 is overloaded</td> </tr> <tr> <td>1 0</td> <td>= Anlr2 Overload</td> <td>Input channel 2 is overloaded</td> </tr> <tr> <td>1 1</td> <td>= Anlr1, Anlr2 Overload</td> <td>Both input channels are overloaded</td> </tr> </table> <p>One or both input channels with input impedance 300 <math>\Omega</math> or 600 <math>\Omega</math> are overloaded. To protect the analyzer input, the input is switched to high impedance and the generator output is disabled. Measurement is continued.</p> <p><b>Ways to recover from overload:</b> Remove overvoltage (maximum input voltage on 300 <math>\Omega</math> and 600 <math>\Omega</math> is 25 V) and reactivate the generator using the OUTPUT ON command. The input impedance is reset to the previous value.</p>	0 0	= No Overload	Normal operating status (none of the input channels are overloaded)	0 1	= Anlr1 Overload	Input channel 1 is overloaded	1 0	= Anlr2 Overload	Input channel 2 is overloaded	1 1	= Anlr1, Anlr2 Overload	Both input channels are overloaded												
0 0	= No Overload	Normal operating status (none of the input channels are overloaded)																							
0 1	= Anlr1 Overload	Input channel 1 is overloaded																							
1 0	= Anlr2 Overload	Input channel 2 is overloaded																							
1 1	= Anlr1, Anlr2 Overload	Both input channels are overloaded																							
12 11 10	<p><b>Generator status</b> Bit 12, 11, 10</p> <table> <tr> <td>0 0 0</td> <td>= Not used</td> <td></td> </tr> <tr> <td>0 0 1</td> <td>= Generator Off</td> <td>Both generator channels are off</td> </tr> <tr> <td>0 1 0</td> <td>= Generator Running</td> <td>Generator outputs signal</td> </tr> <tr> <td>0 1 1</td> <td>= Not used</td> <td></td> </tr> <tr> <td>1 0 0</td> <td>= Not used</td> <td></td> </tr> <tr> <td>1 0 1</td> <td>= Generator Overrun</td> <td>The sampling rate on the external input is too high for the selected digital instrument. Samples missing in signal</td> </tr> <tr> <td>1 1 0</td> <td>= Generator Overload</td> <td>Generator overloaded, output disabled</td> </tr> <tr> <td>1 1 1</td> <td>= Output Off</td> <td>Output disabled</td> </tr> </table>	0 0 0	= Not used		0 0 1	= Generator Off	Both generator channels are off	0 1 0	= Generator Running	Generator outputs signal	0 1 1	= Not used		1 0 0	= Not used		1 0 1	= Generator Overrun	The sampling rate on the external input is too high for the selected digital instrument. Samples missing in signal	1 1 0	= Generator Overload	Generator overloaded, output disabled	1 1 1	= Output Off	Output disabled
0 0 0	= Not used																								
0 0 1	= Generator Off	Both generator channels are off																							
0 1 0	= Generator Running	Generator outputs signal																							
0 1 1	= Not used																								
1 0 0	= Not used																								
1 0 1	= Generator Overrun	The sampling rate on the external input is too high for the selected digital instrument. Samples missing in signal																							
1 1 0	= Generator Overload	Generator overloaded, output disabled																							
1 1 1	= Output Off	Output disabled																							
9, 8, 7, 6, 5, 4, 3	<b>Not used</b>																								
2	<p><b>Summary of multichannel UNDerrange</b> for multichannel operation</p> <p>Summary bit for the lower-order STATus:QUESTionable:UNDerrange register, which makes the underrange information for the individual channels available during multichannel operation.</p>																								
1	<p><b>Summary of multichannel OVERrange</b> for multichannel operation</p> <p>Summary bit for the lower-order STATus:QUESTionable:OVERrange register, which makes the overrange information for the individual channels available during multichannel operation.</p>																								
0	<p><b>Summary of multichannel MEASuring</b> for multichannel operation</p> <p>Summary bit for the lower-order STATus:QUESTionable:MEASuring register, which returns the activated channels during multichannel operation.</p>																								

## STATUS:QUESTIONABLE:UNDERrange Register

This register only contains underrange information concerning the individual channels of multichannel operation.

The register can be queried with the  
 STATUS:QUESTIONABLE:UNDERrange:CONDition? and  
 STATUS:QUESTIONABLE:UNDERrange[:EVENT]?  
 commands.

Tabelle 5-7 Meaning of bits in STATUS:QUESTIONABLE:UNDERrange register

Bit no.	Meaning
15	Not used
14	Not used
13	Not used
12	Not used
10	Not used
9	Not used
8	Not used
9	Not used
7	Ch8
6	Ch7
5	Ch6
4	Ch5
3	Ch4
2	Ch3
1	Ch2
0	Ch1

0 = The channel in question is not underranged.  
 1 = The channel in question is underranged; the measurement result is inaccurate and no longer in line with the specifications of the R&S UPV.

The associated summary bit is in the STATUS:QUESTIONABLE register bit 2

## STATUS:QUESTIONABLE:OVERrange Register

This register only contains overrange information concerning the individual channels of multichannel operation.

The register can be queried with the

STATUS:QUESTIONABLE:OVERrange:CONDition? and

STATUS:QUESTIONABLE:OVERrange[:EVENT]? commands.

Tabelle 5-8 Meaning of bits in STATUS:QUESTIONABLE:OVERrange register

Bit no.	Meaning
15	Not used
14	Not used
13	Not used
12	Not used
10	Not used
9	Not used
8	Not used
9	Not used
7	Ch8
6	Ch7
5	Ch6
4	Ch5
3	Ch4
2	Ch3
1	Ch2
0	Ch1

0 = The channel in question is not overranged.  
 1 = The channel in question is overranged.  
 If the measurement result of an overranged channel is requested with the SENSx:DATAy? command, the value "3.40282346639e+038" (represents NaN = Not a Number) is returned.

The associated summary bit is in the STATUS:QUESTIONABLE register bit 1



## STATUS:QUESTIONABLE:MEASURING Register

This register only contains information about which channels are activated or deactivated during multichannel operation.

It can be queried with the

STATUS:QUESTIONABLE:MEASURING:CONDITION? and  
 STATUS:QUESTIONABLE:MEASURING[:EVENT]?  
 commands.

Tabelle 5-9 Meaning of bits in STATUS:QUESTIONABLE:MEASURING register

Bit no.	Meaning
15	Not used
14	Not used
13	Not used
12	Not used
10	Not used
9	Not used
8	Not used
9	Not used
7	<b>Ch8</b>
6	<b>Ch7</b>
5	<b>Ch6</b>
4	<b>Ch5</b>
3	<b>Ch4</b>
2	<b>Ch3</b>
1	<b>Ch2</b>
0	<b>Ch1</b>

Returns the setting of channels of multichannel operation in the Analyzer Config panel.

0 = The channel in question is deactivated  
 1 = The channel in question is activated

The associated summary bit is in the STATUS:QUESTIONABLE register bit 0

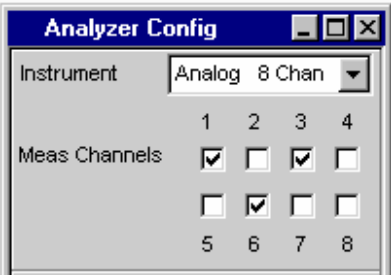

## STATus:XQUEstionable Register

This register contains extra information to the status operation register and seldom occurring status information. It can be read by the query `STATus:XQUEstionable:CONDition?` or `STATus:XQUEstionable[:EVENT]?`.

Table 5-10 Meaning of bits in STATus:XQUEstionable register

Bit no.	Meaning
15	Not used
14	HW option adjust
13	Not used
12	Not used
11	Not used
10	Hardcopy in progress
9	Not used
8	Not used
7	Not used
6	Not used
5 4	<b>Range info Ch 2</b> for the two-channel measurement mode d3 d2 0 0 = Measurement result valid 0 1 = Not used 1 0 = Underrange (measurement result possibly inaccurate) on channel 2 1 1 = Overrange (measurement result invalid) on channel 2
3 2	<b>Range Info Ch 1</b> for the two-channel measurement mode d3 d2 0 0 = Measurement result valid 0 1 = Not used 1 0 = Underrange (measurement result possibly inaccurate) on channel 1 1 1 = Overrange (measurement result invalid) on channel 1
1	<b>Measuring Ch2</b> for the two-channel measurement mode Bit set: The information of the MEASuring bit (d4) and the measuring status bit (d10) of the <b>STATus OPERation</b> register refers to <b>Channel 2</b> . ┌─── Measuring bit (d4) of the <b>STATus OPERation</b> register │ ┌── Measuring status bit (d10) of the <b>STATus OPERation</b> register 0 0 = Measuring Terminated      Single measurement completed 0 1 = Measuring Stopped          Measurement is halted 1 0 = Measuring Single            Single measurement is being performed 1 1 = Measuring Cont              Continuous measurement is being performed

Bit no.	Meaning												
0	<p><b>Measuring Ch1</b> for the two-channel measurement mode</p> <p>Bit set: The information of the MEASuring bit (d4) and the measuring status bit (d10) of the <b>STATus OPERation</b> register refers to <b>Channel 1</b>.</p> <table><tr><td>┌───</td><td>Measuring bit (d4) of the <b>STATus OPERation</b> register</td></tr><tr><td>  ┌───</td><td>Measuring status bit (d10) of the <b>STATus OPERation</b> register</td></tr><tr><td>0 0 =</td><td>Measuring Terminated      Single measurement completed</td></tr><tr><td>0 1 =</td><td>Measuring Stopped            Measurement is halted</td></tr><tr><td>1 0 =</td><td>Measuring Single              Single measurement is being performed</td></tr><tr><td>1 1 =</td><td>Measuring Cont                Continuous measurement is being performed</td></tr></table>	┌───	Measuring bit (d4) of the <b>STATus OPERation</b> register	┌───	Measuring status bit (d10) of the <b>STATus OPERation</b> register	0 0 =	Measuring Terminated      Single measurement completed	0 1 =	Measuring Stopped            Measurement is halted	1 0 =	Measuring Single              Single measurement is being performed	1 1 =	Measuring Cont                Continuous measurement is being performed
┌───	Measuring bit (d4) of the <b>STATus OPERation</b> register												
┌───	Measuring status bit (d10) of the <b>STATus OPERation</b> register												
0 0 =	Measuring Terminated      Single measurement completed												
0 1 =	Measuring Stopped            Measurement is halted												
1 0 =	Measuring Single              Single measurement is being performed												
1 1 =	Measuring Cont                Continuous measurement is being performed												

## Use of Status Reporting System

For efficient use of the status reporting system, the information it contains has to be transferred to the controller and further processed. There are various methods, which are described below. Detailed program examples can be found in Chapter 7, Program Examples.

### Service Request, Use of Hierarchical Structure

Under certain conditions the device may send a service request to the controller. This service request usually triggers an interrupt on the controller to which the control program can respond by suitable actions. As seen from section "Overview of Status Registers" on page 5.31, an SRQ is always triggered when one or more of the bits 1, 2, 3, 4, 5 or 7 of the status byte are set and enabled in the SRE. Each of these bits combines the information from another register, from the error queue or the output buffer. If the ENABLE registers of the status registers are set accordingly, any bit in any status register will be able to trigger an SRQ.

Example:

Use the \*OPC command to generate an SRQ.

```
➤ CALL IBWRT(analyzer%, "*ESE 1") Set bit 0 (operation complete) in the ESE
  CALL IBWRT(analyzer%, "*SRE 32") Set bit 5 (ESB) in the SRE
```

The device generates an SRQ on completion of its settings.

The SRQ is the only way for the device to become active on its own. Each controller program should set the device such that a service request is triggered in case of malfunctions. The program should respond accordingly to the service request. A detailed example of a service request routine can be found in Chapter 7, Program Examples.

### Serial Poll

Serial poll is mainly used for a fast overview of the status of several devices connected to the IEC/IEEE bus or LAN/USB.

Like the \*STB? command, the serial poll is used to query the status byte of a device. Querying is implemented by interface messages, however, making it much faster. The serial poll method is already defined in the IEEE 488.1 standard, and used to be the only uniform method of querying the status byte. This method also works with devices that conform neither to SCPI nor to IEEE 488.2.

The Visual Basic command for executing a serial poll is `IBRSP()`.

**Program Example:**

```

Public UPV As Integer
Public Info As Integer
Dim StartT As Single
Dim Response As String * 1000

Private Sub ReadESR():
    'subroutine for readout of ESR
    Call ibwrt(UPV, "*ESR?") 'ask for ESR data
    Call ibrd(UPV, Response) 'read ESR data
    EventList.AddItem "ESR register is: " + Left(Response, ibcntl - 1)
    DoEvents
End Sub

'SRQ subroutine in case RQS was set
Private Sub GPIB_Notify(ByVal LocalUPV As Long, ByVal Localbsta As Long, ByVal Localberr As Long, ByVal Localbcntl As Long, RearmMask As Long)
    Call ibrsp(UPV, Info): 'do a serial poll and read STB
    EventList.AddItem "SRQ " + " was fired after " + Trim(Str(Timer - StartT)) + " s"
    EventList.AddItem "STB register is: " + Trim(Str(Info))
    Call ReadESR
    ibloc UPV 'switch UPV to local
    ibonl UPV, 0 'switch interface offline
End Sub

Private Sub Test_Click():
    'main program
    Call ibdev(0, 20, 0, T3s, 1, 0, UPV) 'attach instrument
    Call ibconfig(0, lbcAUTOPOLL, 1) 'enable auto serial polling
    Call ibconfig(0, lbcEndBitIsNormal, 1) 'set END bit on EOS match during read
    Call ibconfig(0, lbcEOScmp, 0) '7 bit EOS char
    Call ibconfig(0, lbcEOSrd, 1) 'terminate read by EOS char
    Call ibconfig(0, lbcEOSchar, 10) 'EOS character LF as terminator
    Call ibclr(UPV) 'device clear
    Call ibwrt(UPV, "*IDN?") 'ask for instrument identity
    Call ibrd(UPV, Response) 'read query result
    EventList.AddItem Left(Response, ibcntl - 1) 'display query result as message box
    DoEvents

    Call ibwrt(UPV, "*CLS") 'reset registers
    Call ibwrt(UPV, "*ESE 1") 'enable operation complete bit to set ESB
    Call ibwrt(UPV, "*SRE 32") 'ESB bit generates SRQ
    Call ReadESR 'reading clears ESR register

    GPIB.SetupMask = RQS 'set notify mask to Service Request
    GPIB.SetupNotify UPV 'call and enable notify function
    EventList.AddItem "SRQ enabled ..."
    DoEvents

    EventList.AddItem "sending INIT command ..."
    DoEvents
    StartT = Timer
    Call ibwrt(UPV, "INIT;*OPC") 'trigger measurement, rise OPC when ready
    EventList.AddItem "waiting for SRQ ..."
    EventList.AddItem "-----"
    DoEvents

    'here the program could do anything else until a SRQ is set
End Sub

```

## Parallel Poll

In the case of a parallel poll up to eight devices are simultaneously requested by a command from the controller to transmit one bit of information on the data lines, i.e. to set the data line assigned to each device to logic 0 or 1. Analogously to the SRE register, which determines the conditions for generating an SRQ, a parallel poll enable (PPE) register is present that is ANDed bit-by-bit with the STB (taking into account bit 6). The results are ORed and the result is then sent (possibly inverted) to the controller as a response to a parallel poll. The result can also be read without a parallel poll by the command \*IST.

The device must first be set for parallel poll by the Visual Basic command `IBPPC()`. This command assigns the device a data line and specifies whether the response is to be inverted. The parallel poll itself is performed with `IBRPP()`.

The parallel poll mode is mainly used to quickly find out which of the many devices connected to the IEC/IEEE bus or LAN/USB caused an SRQ. For this purpose, SRE and PPE must be set to the same value.

## Queries

Each part of a status register can be read out by queries. The queries are given in the description of the status commands (STATus subsystem). The queries always yield a number representing the bit pattern of the queried register. This number is evaluated by the controller program.

Queries are mainly used after the appearance of an SRQ to obtain more information about the cause of the SRQ.

## Error Queue Query

Each error in the device causes an entry in the error queue. The entries in the error queue are detailed error messages in plain text that can be read out on the IEC/IEEE bus or LAN/USB by the query `SYSTEM:ERROR?`. Each `SYSTEM:ERROR?` query is answered by an entry from the error queue. If there are no more error messages in the error queue, the device responds with 0 = "No error".

The error queue should be queried in the controller program after each SRQ since the queue entries provide a more precise description of the error cause than the status registers. In particular, in the test phase of a controller program the error queue should be queried at regular intervals since it also registers faulty commands from the controller to the device.

## Initializing the Status Reporting System

The commands \*RST, \*DCL and SYSTem:PRESet also influence the status reporting system. None of the commands, except \*RST and SYSTem:PRESet, influence functional device settings. \*DCL in particular does not alter device settings.

Table 5-11 Resetting device functions

Event	DCL, SDC (Device Clear, Selected Device Clear)	*RST or SYSTem:PRESet	SYSTem:PRESet	*CLS
<b>Effect</b>				
Clear STB, ESR	–	–	–	yes
Clear SRE, ESE	–	–	–	–
Clear PPE	–	–	–	–
Clear EVENT parts of registers	–	–	–	yes
Clear ENABLE parts of all OPERation and QUEStionable registers, fill ENABLE parts of all other registers with "1"	–	–	yes	–
Fill PTRansition parts with "1", clear NTRansition parts	–	–	yes	–
Clear error queue	–	–	–	yes
Clear output buffer	yes	1)	1)	1)
Clear command processing and input buffer	yes	–	–	–

1) Any command that is the first in a program message clears the output buffer.

## Contents - Chapter 6

### "Remote Control - Description of Commands"

<b>6 Remote Control - Commands</b> .....	6.1
<b>Notation of Commands</b> .....	6.1
<b>Common Commands</b> .....	6.4
<b>Triggering Measurements and Reading Results</b> .....	6.7
Starting Measurements .....	6.7
Reading Measurement Results .....	6.10
Output of trace data sets .....	6.12
Reading out multi-channel records .....	6.17
Output of protocol data .....	6.18
Output of protocol errors .....	6.19
<b>STATus Subsystem</b> .....	6.21
<b>SYSTEM Subsystem</b> .....	6.29
<b>MMEMory Subsystem</b> .....	6.31
<b>Generation of Protocol Data</b> .....	6.36
<b>Softkey commands of the graphical display</b> .....	6.37
<b>Transferring trace data</b> .....	6.45
<b>User-definable data buffers</b> .....	6.47
<b>Hardcopy</b> .....	6.49





## 6 Remote Control - Commands

A description of remote control commands together with the associated manual settings is given in section "Instrument functions". The meaning of the parameter setting fields and the effect of the individual parameters are explained in detail. The parameters shown in the panels can be unambiguously assigned to the parameters included in the remote control commands.

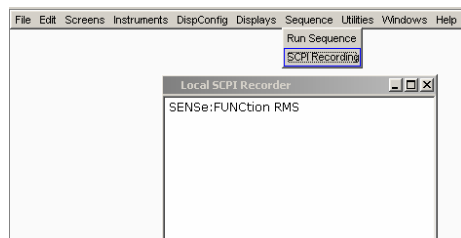

Moreover, the SCPI recording function (see section "Command Recording") offers a very convenient means of recording manual settings, thus allowing remote control commands to be assigned to the parameter fields in the panels. Since the panels do not provide for any settings relating to the triggering of measurements or reading of results, these functions are not recorded.

This chapter lists the following commands:

- Commands that are not available during manual operation and thus cannot be recorded, such as common commands, triggering and output of measurement values
- Commands for using the system, mass memory and status system
- Commands that can only be carried out by using the softkey menu, and thus can also not be recorded.

In section "Remote Control - Fundamentals", you will find a general introduction to remote control as well as a description of the status registers.

## Notation of Commands

### Upper/lowercase notation

Upper- and lowercase letters are used to identify the long form and the short form of the keywords of the commands given in the manual. The instrument itself does not distinguish between the two types of characters.

### Special characters |

**For a number of commands a vertical bar between keywords** in the header of an IEC/IEEE bus command characterizes for a number of commands various choices in the sense of "or" for otherwise identical IEC/IEEE bus commands.

#### Example 1:

```
DISPlay:WAVeform:A|B:TOP <nu>
```

This notation represents the two following commands:

```
DISPlay:WAVeform:A:TOP <nu>
```

```
DISPlay:WAVeform:B:TOP <nu>
```

The two commands are basically completely identical; the first command refers only to trace A, the second one refers to trace B.

**Example 2:**

```
DISPlay:SWEEp<i>:A|B:MARKer:SETTo:OCURsor|XCURsor ONCE
```

This notation represents the four following commands:

```
DISPlay:SWEEp<i>:A:MARKer:SETTo:OCURsor ONCE
```

```
DISPlay:SWEEp<i>:B:MARKer:SETTo:OCURsor ONCE
```

```
DISPlay:SWEEp<i>:A:MARKer:SETTo:XCURsor ONCE
```

```
DISPlay:SWEEp<i>:B:MARKer:SETTo:XCURsor ONCE
```

The four commands are basically completely identical; they differ only in the trace and cursor.

**A vertical line (pipe) in the parameter notation** indicates alternative parameter options and is to be read as an "or". The command has a different effect depending on the parameter chosen.

Example: Selecting a parameter for the following command:

```
INPut:COUPling AC | DC
```

If AC is selected, only the AC component is measured; if DC is selected, both the DC and the AC component are measured.

[ ]

Keywords in square brackets can be omitted in the header (see section "SCPI Command Structure and Syntax"). The command is accepted by the instrument as having the full length for reasons of compatibility with the SCPI standard.

Likewise, parameters in square brackets can be omitted or entered in the command.

Example: `INSTRument2[:SElect] ANLG | DIG`

The second instrument (analyzer) can be selected by either of the following commands:

```
INSTRument2 ANLG = INSTRument2:SElect ANLG
```

**Description of parameters**

<i>

By using this parameter, you can identify command extensions, such as different windows for a subsystem.

Example: `DISPlay:SWEEp<i>:A|B:REFerence VALue`

The sweep subsystem includes four independent windows. These windows are indicated with the numbers 1 to 4. The fourth window is thus addressed with `DISPlay:SWEEp4:...`

<n>

This argument indicates that an integer value is required.

Example: `OUTPut:AUDIobits <n>`

Setting command: `OUTPut:AUDIobits 24`

Query command: `OUTPut:AUDIobits? Response: 24`

**<n,n,n,n>**

This argument indicates a numeric string that may consist of integer values or floating-point values in ASCII form without a unit.

Example: SYST:MEM:DATA<i> <n, n, n, n>

Setting command: SYST:MEM:DATA11

1.2345, 2.3456, 3.4567, 4.5678

Query command: SYST:MEM:DATA11? Response:

1.2345, 2.3456, 3.4567, 4.5678

**<nu>**

This argument indicates that a numeric parameter is required to which a unit can be added.

Example: SOURCE:FREQUENCY:REFERENCE <nu>

Setting command: SOURCE:FREQUENCY:REFERENCE 1000 Hz

Query command: SOURCE:FREQUENCY:REFERENCE? Response: 1000 Hz

**Text parameters**

Text parameters are based on the syntax rules for keywords, i.e. they have a long form and a short form. Like all parameters, they must be separated from the header by a white space. In command recording (SCPI recording) or in response to a query command, the short form of the text parameter is used.

Example:

Setting command: INPUT:CHANNEL CH1And2

Query command: INPUT:CHANNEL? Response: CH1A

**'Character strings'**

Character strings must, in accordance with SCPI, always be given in single or double quotation marks. Filenames also count as strings. Normally, single quotation marks are used, since double quotation marks are employed to identify the entire IEC/IEEE bus command as a string.

Example:

Setting command: MEMORY:LOAD:STATE 'filename'

Query command: MEMORY:LOAD:STATE? Response: 'filename'

## Common Commands

The common commands are taken from the IEEE 488.2 (IEC 625.2) standard. Identical commands have an identical effect in different instruments. The header of these commands consists of an asterisk (\*) followed by three letters. Many common commands relate to the status reporting system, which is described in detail in section “*Status Reporting System*”.

Command	Parameters	Remarks
*CLS		Clear status; no query
*ESE	0 to 255	Event status enable
*ESR?	0 to 255	Standard event status query; query only
*IDN?		Identification query; query only
*IST?	0 to 255	Individual status query; query only
*OPC		Operation complete
*OPT?		Option identification query; query only
*PRE	0 to 255	Parallel poll register enable
*PSC	0   1	Power on status clear
*RST		Reset; no query
*SRE	0 to 255	Service request enable
*STB?		Status byte query; query only
*TRG		Trigger; no query
*TST?		Self-test query; query only
*WAI		Wait to continue; no query

### \*CLS

**CLEAR STATUS** sets the status byte (STB), the event status register (ESR) and the EVENT part of the OPERATION, the QUESTIONABLE and the XQUESTIONABLE registers to zero. The command does not change the mask and transition parts of the registers. It clears the output buffer.

### \*ESE 0...255

**EVENT STATUS ENABLE** sets the event status enable register to the specified value. The query command \*ESE? returns the content of the event status enable register in decimal form.

### \*ESR?

**STANDARD EVENT STATUS QUERY** returns the content of the event status register in decimal form (0 to 255) and sets the register to zero.

**\*IDN?**

**IDENTIFICATION QUERY** queries the instrument ID. The instrument type, the stock/serial number and the firmware version number.

Example:

```
Rohde&Schwarz,UPV,1146.2003k02/100001,2.1.60.0-2.3.0
```

```
Rohde&Schwarz,UPV           = instrument type
1146.2003k02/100001         = stock/serial number
2.1.60.0                    = COMPASS version
2.3.0                        = UPV version
```

**\*IST?**

**INDIVIDUAL STATUS QUERY** returns the content of the IST flag in decimal form (0 | 1). The IST flag is the status bit that is sent during a parallel poll query.

**\*OPC**

**OPERATION COMPLETE** sets bit 0 in the event status register when all previous commands have been processed. This bit can be used to trigger a service request.

**\*OPC?**

**OPERATION COMPLETE QUERY** returns a 1 when all previous commands have been processed. It is important that the timeout set on the IEC/IEEE bus is sufficiently long.

**\*OPT?**

**OPTION IDENTIFICATION QUERY** queries the options installed on the instrument and returns a list of the options installed. The options are separated by commas.

**\*PRE 0 ... 255**

**PARALLEL POLL REGISTER ENABLE** sets the parallel poll enable register to the specified value. The query command \*PRE? returns the content of the parallel poll enable register in decimal form.

**\*PSC 0 | 1**

**POWER ON STATUS CLEAR** determines whether the contents of the ENABLE registers are retained or reset on power on.

<b>Parameters:</b>	<b>0</b>	The contents of the status registers are retained on power on. With appropriate configuration of the ESE and SRE status registers, the contents may cause a service request to be triggered on power on.
	<b>1</b>	The contents of the status registers are reset on power on.

The **query command** \*PSC? returns the content of the Power On Status Clear flag. The answer may be either 0 or 1.

**\*RST**

**RESET** sets the instrument to a defined default state. The command has the same effect as pressing the PRESET key.

**\*SRE** 0 ... 255

**SERVICE REQUEST ENABLE** sets the service request enable register to the specified value. Bit 6 (MSS mask bit) remains 0. This command determines the conditions under which a service request is triggered. The query command \*SRE? returns the content of the service request enable register in decimal form. Bit 6 is always 0.

**\*STB?**

**READ STATUS BYTE QUERY** returns the content of the status byte in decimal form.

**\*TRG**

**TRIGGER** triggers a measurement or a sweep.

**\*TST?**

**SELF TEST QUERY** triggers the selftest of the instrument and, if an error is found, outputs an error code.

**\*WAI**

**WAIT-to-CONTINUE** does not allow subsequent commands to be processed until all previous commands have been eXEcuted.

# Triggering Measurements and Reading Results

This chapter describes how to start single measurements or continuous measurements and how to read results from the instrument by means of remote control commands.

These commands cannot be logged by means of the SCPI recording function.

## Starting Measurements

See also section "Starting Measurements" in chapter 4 Instrument Functions.

Command	Parameter	Default unit	Comment
INITiate:CONTInuous	ON   OFF   WAIT		
INITiate:CONTInuous:TIMEout	<nu>	s	
INITiate:FORCe	START   SINGle   STOP   CONTInuous		
INITiate[:IMMEDIATE]			No parameters
ABORT			No parameters

## Continuous measurement

This is the standard operating mode of the measurement system to which the R&S UPV is set on switch-on. All types of measurements that are activated are performed continuously. You can start a continuous measurement by pressing the **START** key. The **START LED** is on to indicate that the continuous measurement mode is active. In this operation mode, every change in the generator, analyzer or filter bank triggers a restart of the continuous measurement in progress. This also applies to the "\*RST" command and the loading of setups.

This ensures that the displayed measurement data is not corrupted by internal switching operations of the analyzer or by a change of the generator signal. The execution time of the setting commands in question takes a bit longer in comparison to a stopped measurement. To keep setting times as short as possible, you should execute longer command sequences in the "terminated" or "stop" state, i.e. during stopped measurements.

## Single measurement

The R&S UPV carries out a single measurement for all measurement types activated; then the measurement system goes to the "terminated" state. It is not mandatory that valid results be produced by the measurements: if an error occurs during a measurement, the result is indicated as being invalid. In such case, "----" rather than the measured value will be displayed in the associated result window. With remote control, a NAN ("not a number", >1.0e37) value will be returned. You can start a single measurement by pressing the **SINGLE** key. The **START LED** and the **SINGLE LED** are on to indicate that the single measurement mode is active. In this operation mode, all setting commands that occur after the measurement timing are executed without restart and therefore require less time than during a continuous measurement. This also applies to the "\*RST" command and the loading of setups.



## INITiate:CONTInuous ON | OFF | WAIT

<b>Parameters:</b>	<b>ON</b>	Switches to the "continuous measurement" mode. Any continuous or single measurement that is already active is terminated. A new <b>continuous measurement</b> is started. This parameter changes the "init" presetting to the "continuous" mode, i.e. every subsequent "Init" command (without parameter) starts a new continuous measurement and thus has the same effect as "init:cont on". Identical to the <code>[Start]</code> keystroke. This command includes various reset functions: Resets the MIN/MAX indicator, the MIN/MAX values and the limit violations of the measurement displays as well as the highlighting of the protocol analysis. Certain generator signals (burst signals, playback of WAV files by means of the Play function) are reset to the initial state. This command is recommended for continuous result reading.
	<b>OFF</b>	Switches to the "single measurement" mode. Any in-progress continuous or single measurement is stopped. A new <b>single measurement</b> is started. This parameter changes the "init" presetting to the "Single" mode, i.e. every subsequent "Init" command (without parameter) starts a new single measurement and thus has the same effect as "init:cont off". In the case of a <i>stopped measurement</i> or in-progress <i>single</i> measurement identical to the <code>[Single]</code> keystroke (during <i>in-progress continuous</i> measurement, the <code>[Single]</code> keystroke switches to single measurement <i>without</i> stopping the continuous measurement). Identical to INITiate:FORCe SINGLE. This command does not involve reset functions, which means that the measurement is started several milliseconds faster. Recommended for single triggered measurements.
	<b>WAIT</b>	CONTInuous measurement in which the SENSx:DATAy commands, which are used to query the measurement results, stop the IEC/IEEE bus until a measurement result is available.

**Example:** "INIT:CONT ON"  
 "INIT:CONT OFF"  
 "INIT:CONT WAIT"

## INITiate:CONTInuous:TIMEout &lt;nu&gt;

**Parameter:** <nu> 0 ... 1000 s  
 0 s corresponds to the INIT:CONT ON setting.

If timeout occurs without a new measurement result being available, the last measurement result that was read out is returned.

**Example:** "INIT:CONT:TIM 0.1s"

**INITiate:FORCe START | SINGle | STOP | CONTInuous**

<b>Parameters:</b>	<b>START</b>	Start of a continuous measurement. Identical to the <code>[Start]</code> keystroke. Identical to INITiate:CONTInuous ON; however, it has to be changed without the "Init" presetting.
	<b>CONTInuous</b>	Start of a continuous measurement; however without reset function. This retains the MIN/MAX values and limit violations, and measurement is started several milliseconds faster.
	<b>SINGle</b>	Start of a single measurement. In the case of a <i>stopped</i> measurement or an in-progress <i>single</i> measurement identical to the <code>[Single]</code> keystroke (during <i>in-progress continuous</i> measurement the <code>[Single]</code> keystroke switches to single measurement <i>without</i> stopping the continuous measurement). Identical to INITiate:CONTInuous OFF; however, without changing the "Init" presetting.
	<b>STOP</b>	Stops a measurement as if the STOP/CONT key was pressed while a measurement was in progress. (Identical to the "ABORT" command).

**Example:** "INIT:FORC SING"

**INITiate[:IMMEDIATE]**

**Parameter:** --- Measurement is started according to the mode preset by "INITiate:CONTInuous" (continuous or single measurement).

**Example:** "INIT:IMM"

**ABORT**

**Parameter:** --- Identical to INITiate:FORCe STOP  
Stops a measurement as if the STOP/CONT key was pressed while a measurement was in progress.

**Example:** "ABOR"

## Reading Measurement Results

Command	Parameters	Default unit	Comment
SENSe<n>:DATA[1]]2, 3,...16?	Current measurement result		Query only
SENSe<n>:DATA[1]]2, 3,...16? MIN	Lowest measurement result		
SENSe<n>:DATA[1]]2, 3,...16? MAX	Highest measurement result		

Depending on the measurements activated in the *Analyzer* panel, the R&S UPV indicates up to eight results in the numeric display in the case of a two-channel instrument and up to 64 results in the case of a multichannel instrument. The results are also available in buffers from where they can be read by remote control.

The remote control commands for reading measurement results are in general structured as follows:

### SENSe<n>:DATA[1]]2,3,...16?

The parameter <n> specifies the type of measurement whose result is queried.

- <n> = 1: Function measurement result from column 1
- 6: Level-monitor measurement result from column 2
- 2: Input-monitor measurement result from column 3
- 3: Frequency, phase or group-delay measurement result from column 4

Data 1, 2, 3, ... 16 selects channel 1, 2, 3, ... 16

The figure below shows the assignment of remote control commands to the results indicated in the numeric display for an 8-channel analyzer.

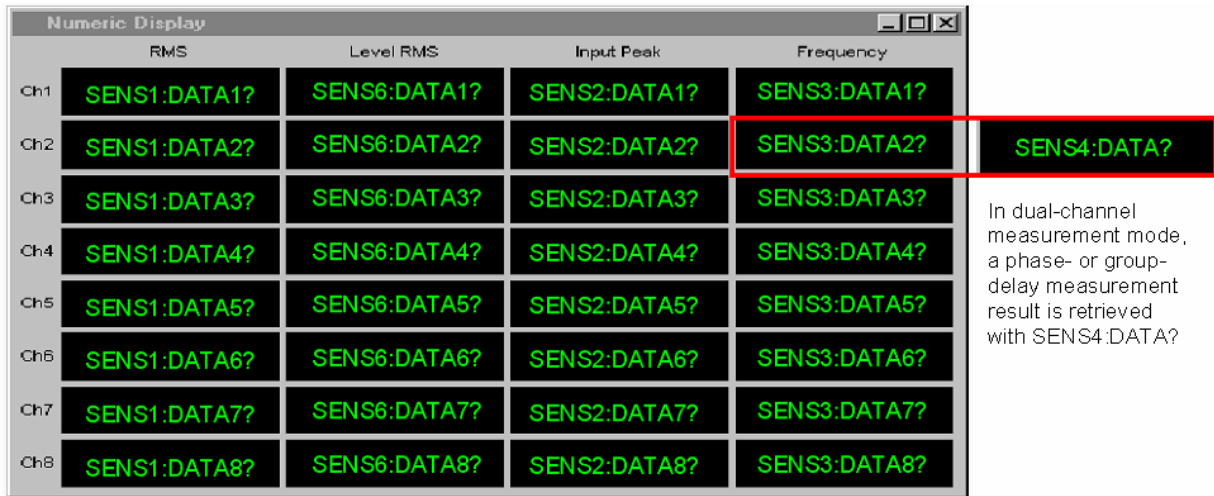

Figure 6-1 Indication of results in the numeric display and associated remote control commands

A question mark extended with MIN and MAX indicates the minimum and maximum measured value shown in the combi display above the measured value.

The return value comes in the unit (without engineering) in which it is displayed in the numeric display.

If the measurement result of an overranged channel is requested with the SENSx:DATAy? command, the value "3.40282346639e+038" (represents NaN = Not a Number) is returned.

Example:  
Read out the current frequency measurement result and the respective MIN/MAX values from channel 2:

Display of channel 2's current frequency measurement result in the numeric display.

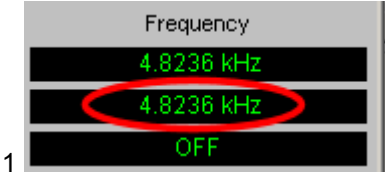

SENS3 : DATA2 ?  
Response: 4.8236 KHZ

Display of channel 2's current frequency measurement result in the combined display with min and max values.

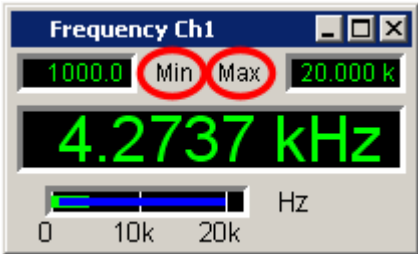

SENS3 : DATA2 ? **MIN**  
Response: 1 KHZ

SENS3 : DATA2 ? **MAX**  
Response: 20 KHZ

## Output of trace data sets

Command	Parameters	Default unit	Comment
FORMat[:DATA]	ASCIi   REAL		
DISPlay:Subsys<i>:SCANoffset <n>	<n> = 2, 1, 0, -1 ... -19		
TRACe:Subsys<i>:LOAD:AX?			Query only
TRACe:Subsys<i>:LOAD:AY?			Query only
TRACe:Subsys<i>:LOAD:BX?			Query only
TRACe:Subsys<i>:LOAD:BY?			Query only
TRACe:Subsys<i>:LOAD:COUNt:AX?			Query only
TRACe:Subsys<i>:LOAD:COUNt:AY?			Query only
TRACe:Subsys<i>:LOAD:COUNt:BX?			Query only
TRACe:Subsys<i>:LOAD:COUNt:BY?			Query only
TRACe:Subsys<i>:LDList:AX?			Query onl
TRACe:Subsys<i>:LDList:AY?			Query only
TRACe:Subsys<i>:LDList:BX?			Query only
TRACe:Subsys<i>:LDList:BY?			Query only
TRACe:Subsys<i>:LDList:COUNt:AX?			Query only
TRACe:Subsys<i>:LDList:COUNt:AY?			Query only
TRACe:Subsys<i>:LDList:COUNt:BX?			Query only
TRACe:Subsys<i>:LDList:COUNt:BY?			Query only

**Subsys** stands for the following terms: SWEep | FFT | MONitor | WAVEform | BARgraph

For the Subsystem Sweep: <i> = 1 ... 4

For the Subsystem FFT: <i> = 1 | 2

For the Subsystem BARgraph: <i> = 1 | 2

For the Subsystems WAVEform: <i> = 1

For the Subsystems PESQ: <i> = 1 | 2

### FORMat[:DATA]

Defines the number format for outputting trace data sets.

This setting is not stored in the setup and is set to ASCII each time the R&S UPV is switched on.

**Parameters:**     **ASCIi**           Output as an ASCII string, digits with sign, decimal point and any exponent, e.g. "-57.1647,-6.08881,-32.304,-53.6429 ..."

**REAL**           Binary form!

The trace data sets are returned in binary format. The binary data block has the following structure:  
 #<LängeDerLänge><Länge><block\_data>  
 e.g. #234<block\_data>  
 # always introduces the binary block  
 <LängeDerLänge> indicates how many positions the following length specification occupies (2 in example)  
 <Länge> indicates the number of subsequent bytes (34 in example)  
 <binary block data> binary block data of specified length

**Example:**           "FORM ASC"                           Output as ASCII string



```
TRACe:WAVeform:LOAD:AX?
TRACe:WAVeform:LOAD:AY?
TRACe:WAVeform:LOAD:BX?
TRACe:WAVeform:LOAD:BY?
```

Command for outputting waveform trace data sets

```
TRACe:BARgraph<i>:LOAD:AX?
TRACe:BARgraph<i>:LOAD:AY?
TRACe:BARgraph<i>:LOAD:BX?
TRACe:BARgraph<i>:LOAD:BY?
```

<i> = subsystem numbers 1 and 2

Command for outputting bargraph trace data sets

```
TRACe:PESQ<i>:LOAD:AX?
TRACe:PESQ<i>:LOAD:AY?
TRACe:PESQ<i>:LOAD:BX?
TRACe:PESQ<i>:LOAD:BY?
```

<i> = subsystem number 1 and 2

Command for outputting PESQ trace data records.

```
TRACe:SWEep<i>:LOAD:COUNT:AX?
TRACe:SWEep<i>:LOAD:COUNT:AY?
TRACe:SWEep<i>:LOAD:COUNT:BX?
TRACe:SWEep<i>:LOAD:COUNT:BY?
```

<i> = subsystem number 1 to 4

Command for outputting the number of sweep data

The following description shows the basic structure for the following examples:

**TRACe:Subsys<i>:LOAD:COUNT** and  
**TRACe:Subsys<i>:LDList:COUN** commands.

**Example:**           "TRAC:SWPep1:LOAD:COUNT:AY?"

Outputs the number of data of the Y-axis of channel A from the first sweep system

Response:

"50"

```
TRACe:FFT<i>:LOAD:COUNT:AX?
TRACe:FFT<i>:LOAD:COUNT:AY?
TRACe:FFT<i>:LOAD:COUNT:BX?
TRACe:FFT<i>:LOAD:COUNT:BY?
```

<i> = subsystem number 1 and 2

Command for outputting the number of FFT data

```
TRACe:WAVeform:LOAD:COUNT:AX?
TRACe:WAVeform:LOAD:COUNT:AY?
TRACe:WAVeform:LOAD:COUNT:BX?
TRACe:WAVeform:LOAD:COUNT:BY?
```

Command for outputting the number of WAVEFORM data

```
TRACe:BARgraph<i>:LOAD:COUNT:AX?
TRACe:BARgraph<i>:LOAD:COUNT:AY?
TRACe:BARgraph<i>:LOAD:COUNT:BX?
TRACe:BARgraph<i>:LOAD:COUNT:BY?
```

<i> = subsystem number 1 and 2

Command for outputting the number of bargraph data

```
TRACe:PESQ<i>:LOAD:COUNT:AX?
TRACe:PESQ<i>:LOAD:COUNT:AY?
TRACe:PESQ<i>:LOAD:COUNT:BX?
TRACe:PESQ<i>:LOAD:COUNT:BY?
```

<i> = subsystem number 1 and 2

Command for outputting the number of PESQ data.

The following IEC/IEEE bus commands are basically identical to the LOAD commands described above.

They query the data records of filtered trace data and their number.

Filtering is done with the following commands:

```
DISPlay:SWEep<i>:DLISt:FILTer ALL | LIMUpper | LIMLower | LIMBoth | HARMonics | PEAKs
DISPlay:FFT<i>:DLISt:FILTer ALL | LIMUpper | LIMLower | LIMBoth | HARMonics | PEAKs
DISPlay:WAVEform:DLISt:FILTer ALL | LIMUpper | LIMLower | LIMBoth | HARMonics | PEAKs
DISPlay:BARgraph:DLISt:FILTer ALL | LIMUpper | LIMLower | LIMBoth | HARMonics | PEAKs
```

```
TRACe:SWEep<i>:LDList:AX?
TRACe:SWEep<i>:LDList:AY?
TRACe:SWEep<i>:LDList:BX?
TRACe:SWEep<i>:LDList:BY?
```

```
TRACe:FFT<i>:LDList:AX?
TRACe:FFT<i>:LDList:AY?
TRACe:FFT<i>:LDList:BX?
TRACe:FFT<i>:LDList:BY?
```

```
TRACe:WAVEform:LDList:AX?
TRACe:WAVEform:LDList:AY?
TRACe:WAVEform:LDList:BX?
TRACe:WAVEform:LDList:BY?
```

```
TRACe:BARgraph<i>:LDList:AX?
TRACe:BARgraph<i>:LDList:AY?
TRACe:BARgraph<i>:LDList:BX?
TRACe:BARgraph<i>:LDList:BY?
```

```
TRACe:PESQ<i>:LDList:AX?
TRACe:PESQ<i>:LDList:AY?
TRACe:PESQ<i>:LDList:BX?
TRACe:PESQ<i>:LDList:BY?
```

```
TRACe:SWEep<i>:LDList:COUNT:AX?
TRACe:SWEep<i>:LDList:COUNT:AY?
TRACe:SWEep<i>:LDList:COUNT:BX?
TRACe:SWEep<i>:LDList:COUNT:BY?
```



**TRACe:FFT<i>:LDList:COUNT:AX?  
TRACe:FFT<i>:LDList:COUNT:AY?  
TRACe:FFT<i>:LDList:COUNT:BX?  
TRACe:FFT<i>:LDList:COUNT:BY?**

**TRACe:WAVeform:LDList:COUNT:AX?  
TRACe:WAVeform:LDList:COUNT:AY?  
TRACe:WAVeform:LDList:COUNT:BX?  
TRACe:WAVeform:LDList:COUNT:BY?**

**TRACe:BARgraph<i>:LDList:COUNT:AX?  
TRACe:BARgraph<i>:LDList:COUNT:AY?  
TRACe:BARgraph<i>:LDList:COUNT:BX?  
TRACe:BARgraph<i>:LDList:COUNT:BY?**

**TRACe:PESQ<i>:LDList:COUNT:AX?  
TRACe:PESQ<i>:LDList:COUNT:AY?  
TRACe:PESQ<i>:LDList:COUNT:BX?  
TRACe:PESQ<i>:LDList:COUNT:BY?**

## Reading out multi-channel records

Command	Parameter	Default unit	Remark
<code>DATA:Subsys:X?</code>			Query only
<code>DATA:Subsys:COUNT:X?</code>			Query only
<code>DATA:Subsys:Y&lt;ch&gt;?</code>			Query only
<code>DATA:Subsys:COUNT:Y&lt;ch&gt;?</code>			Query only

**Subsys** Stands for the terms: SWEep | FFT | BARgraph  
 The DATA command does not exist for the WAVEform and PESQ sub-systems because these sub-systems are designed with two channels. The TRACe commands from the previous chapter must be used to read out records from these sub-systems.

**<ch>**: Channel 1 ... 16

The DATA command is mainly used to read in multi-channel records. Only the traces which were available in the windows of the respective systems could be read out with the TRACe commands (see previous chapter). That is not enough for the 16-channel version; that is why the traces for all channels switched on in the **base unit** can be read out with the following commands.

**DATA:SWEep:X?**

**DATA:FFT:X?**

**DATA:BARgraph:X?**

Commands for reading out the X axis data of a sweep, an FFT or a bar graph. To read out the X axis there is no need to specify a channel, as there is only **one** X axis for all channels. Specifying a channel is nonetheless accepted as long as it is within the valid range.

The following example is exemplary for the FFT and bar graph sub-systems:

**Example:**      `DATA:SWEep:X?`      Reads out X axis data from the sweep system.

Response with the FORM ASC setting:

```
100,120.045,144.109,172.997,207.675,249.304,...
```

Response with the FORM REAL setting:

```
#<LängeDerLänge><Länge><block_data>
```

**DATA:SWEep:COUNT:X?**

**DATA:FFT:COUNT:X?**

**DATA:BARgraph:COUNT:X?**

Commands for reading out the number of X axis values of a sweep, an FFT or a bar graph. A channel need not be specified for reading out as there is only **one** X axis for all channels. Specifying a channel is nonetheless accepted as long as it is within the valid range.

The following example is exemplary for the FFT and bar graph sub-systems

**Example:**      `DATA:SWEep:COUNT:X?`      Reads out the number of X axis values from the sweep system.

Response:

```
100
```

**DATA:SWEp:Y<ch>?**  
**DATA:FFT:Y<ch>?**  
**DATA:BARgraph:Y<ch>?**

<ch> = channel 1 ... 16

Commands for reading out the Y axis values of a sweep, an FFT or a bar graph for the specified channel.

The following example is exemplary for the FFT and bar graph sub-systems

**Example:** DATA:SWEp:Y5? Reads out channel 5's Y axis data from the sweep system.

Response with the FORM ASC setting:

0.01110738,0.0146608,0.0189856,0.0240953,0.0300301,...

Response with the FORM REAL setting:

#<LängeDerLänge><Länge><block\_data>

**DATA:SWEp:COUNT:Y<ch>?**  
**DATA:FFT:COUNT:Y<ch>?**  
**DATA:BARgraph:COUNT:Y<ch>?**

Commands to read out the number of values on the Y axis of a sweep, an FFT or a bar graph.

The following example is exemplary for the FFT and bar graph sub-systems:

**Example:** DATA:SWEp:COUNT:Y<ch>? Reads out the number of Y axis values from the sweep system.

Response:

100

## Output of protocol data

Command	Parameters	Default unit	Comment
SENSe8:PROTocol:CH<x>:BYTE<y>?			Query only

**SENSe8:PROTocol:CH<x>:BYTE<y>?**

**Parameter:** <x> and <y> are suffixes

<x> channel 1 or 2

<y> byte 0 to 4

Return value = 0 to 255 (decimal bit equivalent)

**Example:** "SENSe8:PROTocol:CH1:BYTE2?" Outputs the protocol data of byte 2 (the third byte) of channel 1.

## Output of protocol errors

Command	Parameter	Default Unit	Comment
SENSe8:PROTocol:ERRor?			Query only
SENSe8:PROTocol:PCM<i>			Query only
SENSe8:PROTocol:PAR<i>			Query only
SENSe8:PROTocol:LOC<i>			Query only
SENSe8:PROTocol:CRC<i>			Query only
SENSe8:PROTocol:INV<i>			Query only

**SENSe8:PROTocol:ERRor?**

**Parameter:** none

Query only

Response:

0, "No error"

or

<n>, "PCM1,PCM2,PAR1,PAR2,..."

The entire string is not returned in quotation marks, but only the mnemonic range.

<n> represents 10 bits (d0 to d9)

<n> = 0 to 1023

The individual errors are represented by means of bits in the integer value <n>:

d0: PCM1

d1: PCM2

d2: PAR1

d3: PAR2

d4: LOC1

d5: LOC2

d6: CRC1

d7: CRC2

d8: INV1

d9: INV2

**Example:** "SENS8:PROT:Err?"

Response: "4"

Binary equivalent = 0000000100. Thus, d2 is set and the PAR1 error is output.

**SENSe8:PROTocol:PCM<i>?**  
**SENSe8:PROTocol:PAR<i>?**  
**SENSe8:PROTocol:LOC<i>?**  
**SENSe8:PROTocol:CRC<i>?**  
**SENSe8:PROTocol:INV<i>?**

**Parameter:** <i> 1 or 2 designates Ch1 or Ch2.

Specific query of protocol errors

Query only

Response:  
"0" = no error  
"1" = error

**Example:** "SENS8:PROT:PAR2?"

Response: "1" A PAR2 error is present.

## STATus Subsystem

This system contains the commands for the status reporting system. \*RST has no effect on status registers.

The query commands return the current value of the subregister in question, thus allowing a check of the device status.

STATus:OPERation STATus:QUEStionable STATus:XQUEStionable	Returns and sets a decimal value between 0 and 32767 ( $= 2^{15} - 1$ ). The most significant bit is set to zero in all registers. The register content can thus always be interpreted as a positive integer.
STATus:QUEStionable:UNDERrange STATus:QUEStionable:OVERrange STATus:QUEStionable:MEASuring	Returns and sets a decimal value between 0 and 65535 ( $= 2^{16} - 1$ ). For future applications, the most significant bit d15 may also be set.

The configuration commands set the subregister in question and thus determine which state changes of the R&S UPV are to cause a change in the status registers.

Command	Parameter	Remarks
STATus:PRESet		No query
STATus:OPERation:CONDition?		Query only
STATus:OPERation:ENABLE	<n> = 0 to 32767	
STATus:OPERation[:EVENT]?		Query only
STATus:OPERation:NTRansition	<n> = 0 to 32767	
STATus:OPERation:PTRansition	<n> = 0 to 32767	
STATus:QUEStionable:CONDition?		Query only
STATus:QUEStionable:ENABLE	<n> = 0 to 32767	
STATus:QUEStionable[:EVENT]?		Query only
STATus:QUEStionable:NTRansition	<n> = 0 to 32767	
STATus:QUEStionable:PTRansition	<n> = 0 to 32767	
STATus:QUEStionable:UNDERrange:CONDition?		Query only
STATus:QUEStionable:UNDERrange:ENABLE	<n> = 0 to 65535	
STATus:QUEStionable:UNDERrange[:EVENT]?		Query only
STATus:QUEStionable:UNDERrange:NTRansition	<n> = 0 to 65535	
STATus:QUEStionable:UNDERrange:PTRansition	<n> = 0 to 65535	
STATus:QUEStionable:OVERrange:CONDition?		Query only
STATus:QUEStionable:OVERrange:ENABLE	<n> = 0 to 65535	
STATus:QUEStionable:OVERrange[:EVENT]?		Query only
STATus:QUEStionable:OVERrange:NTRansition	<n> = 0 to 65535	
STATus:QUEStionable:OVERrange:PTRansition	<n> = 0 to 65535	
STATus:QUEStionable:MEASuring:CONDition?		Query only
STATus:QUEStionable:MEASuring:ENABLE	<n> = 0 to 65535	

Command	Parameter	Remarks
STATus:QUESTIONable:MEASuring[:EVENT]?		Query only
STATus:QUESTIONable:MEASuring:NTRansition	<n> = 0 to 65535	
STATus:QUESTIONable:MEASuring:PTRansition	<n> = 0 to 65535	
STATus:XQUESTIONable:CONDition?		Query only
STATus:XQUESTIONable:ENABLE	<n> = 0 to 32767	
STATus:XQUESTIONable[:EVENT]?		Query only
STATus:XQUESTIONable:NTRansition	<n> = 0 to 32767	
STATus:XQUESTIONable:PTRansition	<n> = 0 to 32767	
DIAGnostic:OPERation:BITNo	<n> = 0 to 15	No query
DIAGnostic:OPERation:VALue	<n> = 0   1	No query
DIAGnostic:QUESTIONable:BITNo	<n> = 0 to 15	No query
DIAGnostic:QUESTIONable:VALue	<n> = 0   1	No query
DIAGnostic:QUESTIONable:UNDERrange BITNo	<n> = 0 to 15	No query
DIAGnostic:QUESTIONable:UNDERrange VALue	<n> = 0   1	No query
DIAGnostic:QUESTIONable:OVERrange BITNo	<n> = 0 to 15	No query
DIAGnostic:QUESTIONable:OVERrange VALue	<n> = 0   1	No query
DIAGnostic:QUESTIONable:MEASuring BITNo	<n> = 0 to 15	No query
DIAGnostic:QUESTIONable:MEASuring VALue	<n> = 0   1	No query
DIAGnostic:XQUESTIONable:BITNo	<n> = 0 to 15	No query
DIAGnostic:XQUESTIONable:VALue	<n> = 0   1	No query

**STATus:PRESet**

The command resets the status registers.

STATus:OPERation STATus:QUESTIONable STATus:XQUESTIONable	All PTRansition parts are set to 7FFFh (32767), i.e. all transitions from 0 to 1 are detected.
STATus:QUESTIONable:UNDERrange STATus:QUESTIONable:OVERrange STATus:QUESTIONable:MEASuring	All PTRansition parts are set to FFFFh (65535) , i.e. all transitions from 0 to 1 are detected.

The NTRansition parts of all status registers are set to 0, i.e. a transition from 1 to 0 of a CONDition bit is not detected. The ENABLE parts of all status registers are set to 0, i.e. none of the events in these registers is passed on.

The command triggers an event and therefore has no query form and no \*RST value.

**STATus:OPERation:CONDition?**

The command queries the content of the CONDition part of the STATus:OPERation register. This part contains the information about the current instrument state.

Reading the information does not clear the register.

**STATus:OPERation:ENABLE 0...32767**

The command sets the bits of the ENABLE part of the STATus:OPERation register. This setting determines which events of the EVENT part of the STATus:OPERation register are to be passed on to the summary bit of the status byte. These events can be used to trigger a service request.

Reset value: all bits are reset (0)

**STATus:OPERation:EVENT?**

The command queries the content of the EVENT part of the STATus:OPERation register. This part contains the information about the current instrument state since the last readout.

A bit set in the EVENT register indicates a change of the corresponding bit in the CONDition register. Whether bits in the EVENT register are set due to a bit transition from 0 to 1 or from 1 to 0 depends on the bits set in the PTRansition and the NTRansition registers.

Reading the information clears the register.

**STATus:OPERation:NTRansition 0...32767**

The command sets the bits of the NTRansition part of the STATus:OPERation register. A bit set in the NTRansition register causes a bit transition from 1 to 0 in the CONDition register to produce an entry in the EVENT register.

Reading the information does not clear the register.

Reset value: all bits are reset (0)

**STATus:OPERation:PTRansition 0...32767**

The command sets the bits of the PTRansition part of the STATus:OPERation register. A bit set in the PTRansition register causes a bit transition from 0 to 1 in the CONDition register to produce an entry in the EVENT register. Reading the information does not clear the register.

Reset value: all bits are set (32767)

**STATus:QUEStionable:CONDition?**

The command queries the content of the CONDition part of the STATus:QUEStionable register. This part contains the information about the current instrument state.

Reading the information does not clear the register.

**STATus:QUEStionable:ENABLE 0...32767**

The command sets the bits of the ENABLE part of the STATus:QUEStionable register. This setting determines which events of the EVENT part of the STATus:QUEStionable register are to be passed on to the summary bit of the status byte. These events can be used to trigger a service request.

Reset value: all bits are reset (0)

**STATus:QUEStionable:EVENT?**

The command queries the content of the EVENT part of the STATus:QUEStionable register. This part contains the information about the current instrument state since the last readout.

A bit set in the EVENT register indicates a change of the corresponding bit in the CONDition register. Whether bits in the EVENT register are set due to a bit transition from 0 to 1 or from 1 to 0 depends on the bits set in the PTRansition and the NTRansition registers.

Reading the information clears the register.



**STATus:QUESTionable:NTRansition 0...32767**

The command sets the bits of the NTRansition part of the STATus:QUESTionable register. A bit set in the NTRansition register causes a bit transition from 1 to 0 in the CONDition register to produce an entry in the EVENT register.

Reading the information does not clear the register.

Reset value: all bits are reset (0)

**STATus:QUESTionable:PTRansition 0...32767**

The command sets the bits of the PTRansition part of the STATus:QUESTionable register. A bit set in the PTRansition register causes a bit transition from 0 to 1 in the CONDition register to produce an entry in the EVENT register.

Reading the information does not clear the register.

Reset value: all bits are set (32767)

**STATus:QUESTionable:UNDERrange:CONDition?**

The command queries the content of the CONDition part of the STATus:QUESTionable:UNDERrange register. This part contains the information about which channel of a multichannel instrument is underranged.

Reading the information does not clear the register.

**STATus:QUESTionable:UNDERrange:ENABLE 0...65535**

The command sets the bits of the ENABLE part of the STATus:QUESTionable:UNDERrange register. This setting determines which events of the status-event part are to be passed on to summary bit 2 of the STATus:QUESTionable register. These events can be used to trigger a service request.

Reset value: all bits are reset (0)

**STATus:QUESTionable:UNDERrange:EVENT?**

The command queries the content of the EVENT part of the STATus:QUESTionable:UNDERrange register. This part contains the information about the current instrument state since the last readout.

A bit set in the EVENT register indicates a change of the corresponding bit in the CONDition register. Whether bits in the EVENT register are set due to a bit transition from 0 to 1 or from 1 to 0 depends on the bits set in the PTRansition and the NTRansition registers.

Reading the information clears the register.

**STATus:QUESTionable:UNDERrange:NTRansition 0...65535**

The command sets the bits of the NTRansition part of the STATus:QUESTionable:UNDERrange register. A bit set in the NTRansition part causes a bit transition from 1 to 0 in the CONDition part to produce an entry in the EVENT part of the register.

Reading the information does not clear the register.

Reset value: all bits are reset (0)

**STATus:QUESTionable:UNDERrange:PTRansition 0...65535**

The command sets the bits of the PTRansition part of the STATus:QUESTionable:UNDERrange register. A bit set in the PTRansition part causes a bit transition from 1 to 0 in the CONDition part to produce an entry in the EVENT part of the register.

Reading the information does not clear the register.

Reset value: all bits are set (65535)

**STATus:QUESTionable:OVERrange:CONDition?**

The command queries the content of the CONDition part of the STATus:QUESTionable:OVERrange register. This part contains the information about which channel of a multichannel instrument is overranged.

Reading the information does not clear the register.

**STATus:QUESTionable:OVERrange:ENABLE 0...65535**

The command sets the bits of the ENABLE part of the STATus:QUESTionable:OVERrange register. This setting determines which events of the status-event part are to be passed on to summary bit 1 of the STATus:QUESTionable register. These events can be used to trigger a service request.

Reset value: all bits are reset (0)

**STATus:QUESTionable:OVERrange:EVENT?**

The command queries the content of the EVENT part of the STATus:QUESTionable:OVERrange register. This part contains the information about the current instrument state since the last readout.

A bit set in the EVENT register indicates a change of the corresponding bit in the CONDition register. Whether bits in the EVENT register are set due to a bit transition from 0 to 1 or from 1 to 0 depends on the bits set in the PTRansition and the NTRansition registers.

Reading the information clears the register.

**STATus:QUESTionable:OVERrange:NTRansition 0...65535**

The command sets the bits of the NTRansition part of the STATus:QUESTionable:OVERrange register. A bit set in the NTRansition part causes a bit transition from 1 to 0 in the CONDition part to produce an entry in the EVENT part of the register.

Reading the information does not clear the register.

Reset value: all bits are reset (0)

**STATus:QUESTionable:OVERrange:PTRansition 0...65535**

The command sets the bits of the PTRansition part of the STATus:QUESTionable:OVERrange register. A bit set in the PTRansition part causes a bit transition from 1 to 0 in the CONDition part to produce an entry in the EVENT part of the register.

Reading the information does not clear the register.

Reset value: all bits are set (65535)

**STATus:QUESTionable:MEASuring:CONDition?**

The command queries the content of the CONDition part of the STATus:QUESTionable:MEASuring register. This part contains the information about which channel of a multichannel instrument is activated or deactivated.

Reading the information does not clear the register.

**STATus:QUESTIONable:MEASuring:ENABLE 0...65535**

The command queries the content of the ENABLE part of the STATus:QUESTIONable:MEASuring register. This setting determines which events of the status-event part are to be passed on to summary bit 0 of the STATus:QUESTIONable register. These events can be used to trigger a service request.

Reset value: all bits are reset (0)

**STATus:QUESTIONable:MEASuring:EVENT?**

The command queries the content of the EVENT part of the STATus:QUESTIONable:MEASuring register. This part contains the information about the current instrument state since the last readout.

A bit set in the EVENT register indicates a change of the corresponding bit in the CONDITION register. Whether bits in the EVENT register are set due to a bit transition from 0 to 1 or from 1 to 0 depends on the bits set in the PTRansition and the NTRansition registers.

Reading the information clears the register.

**STATus:QUESTIONable:MEASuring:NTRansition 0...65535**

The command sets the bits of the NTRansition part of the STATus:QUESTIONable:MEASuring register. A bit set in the NTRansition part causes a bit transition from 1 to 0 in the CONDITION part to produce an entry in the EVENT part of the register.

Reading the information does not clear the register.

Reset value: all bits are reset (0)

**STATus:QUESTIONable:MEASuring:PTRansition 0...65535**

The command sets the bits of the PTRansition part of the STATus:QUESTIONable:MEASuring register. A bit set in the PTRansition part causes a bit transition from 1 to 0 in the CONDITION part to produce an entry in the EVENT part of the register.

Reading the information does not clear the register.

Reset value: all bits are set (65535)

**STATus:XQUESTIONable:CONDITION?**

The command queries the content of the CONDITION part of the STATus:XQUESTIONable register. This part contains the information about the current instrument state.

Reading the information does not clear the register.

**STATus:XQUESTIONable:ENABLE 0...32767**

The command sets the bits of the ENABLE part of the STATus:XQUESTIONable register. This setting determines which events of the EVENT part of the STATus:XQUESTIONable register are to be passed on to the summary bit of the status byte. These events can be used to trigger a service request.

Reset value: all bits are reset (0)

**STATus:XQUESTIONable:EVENT?**

The command queries the content of the EVENT part of the STATus:XQUESTIONable register. This part contains the information about the current instrument state since the last readout.

A bit set in the EVENT register indicates a change of the corresponding bit in the CONDITION register. Whether bits in the EVENT register are set due to a bit transition from 0 to 1 or from 1 to 0 depends on the bits set in the PTRansition and the NTRansition registers.

Reading the information clears the register.

**STATus:XQUEStionable:NTRansition 0...32767**

The command sets the bits of the NTRansition part of the STATus:XQUEStionable register. A bit set in the NTRansition register causes a bit transition from 1 to 0 in the CONDition register to produce an entry in the EVENT register.

Reading the information does not clear the register.

Reset value: all bits are reset (0)

**STATus:XQUEStionable:PTRansition 0...32767**

The command sets the bits of the PTRansition part of the STATus:XQUEStionable register. A bit set in the PTRansition register causes a bit transition from 0 to 1 in the CONDition register to produce an entry in the EVENT register.

Reading the information does not clear the register.

Reset value: all bits are reset (32767)

**DIAGnostic:OPERation:BITNo <n>**  
**DIAGnostic:OPERation:VALue <n>**  
**DIAGnostic:QUEStionable:BITNo <n>**  
**DIAGnostic:QUEStionable:VALue <n>**  
**DIAGnostic:QUEStionable:UNDERrange:BITNo <n>**  
**DIAGnostic:QUEStionable:UNDERrange:VALue <n>**  
**DIAGnostic:QUEStionable:OVERrange:BITNo <n>**  
**DIAGnostic:QUEStionable:OVERrange:VALue <n>**  
**DIAGnostic:QUEStionable:MEASuring:BITNo <n>**  
**DIAGnostic:QUEStionable:MEASuring:VALue <n>**  
**DIAGnostic:XQUEStionable:BITNo <n>**  
**DIAGnostic:XQUEStionable:VALue <n>**

The commands change the bits of the following registers:

STATus:OPERation,  
 STATus:QUEStionable,  
 STATus:QUEStionable:UNDERrange,  
 STATus:QUEStionable:OVERrange,  
 STATus:QUEStionable:MEASuring and  
 STATus:XQUEStionable.

**Note:**

*A compulsory change of the status registers via an external controller can cause the R&S UPV to malfunction in IEC/IEEE bus operation!*

The...BITNo command specifies the bit position to be changed in the status register; the ...VALue command enters the value.

**Example:**

In the XQUEstionable register, the additional range information for channel 1 is to be changed compulsorily. This information can be found in bits 2 and 3 of the XQUEstionable register and is thus addressed with BITNo 2. The information "overrange (measurement result invalid) on channel 1" is to be entered there. This means that bits 2 and 3 of the XQUEstionable register must be set, represented by the value 3.

This is done by using the following commands:

```
DIAGnostic:XQUEstionable:BITNo 2  
DIAGnostic:XQUEstionable:VALue 3
```

# SYSTEM Subsystem

This section describes the commands of the SYSTEM subsystem.

Command	Parameters	Remarks
SYSTEM:COMMunicate:GTL		
SYSTEM:COMMunicate:GPIB:ADDRess	1 to 30	
SYSTEM:ERRor?		Query only
SYSTEM:PRESet		
SYSTEM:VERSion?		Query only
SYSTEM:SHUtdown SYSTEM:SHTDown	No parameters entered corresponds to time of 0 s	No query form for this command.
SYSTEM:SHUtdown <nu> SYSTEM:SHTDown <nu>	<nu> time in seconds	No query form for this command.

## SYSTEM:COMMunicate:GTL

This command switches the instrument to local operation.

## SYSTEM:COMMunicate:GPIB:ADDRess 1 ... 30

This command sets the IEC/IEEE bus address.

**Example:**           "SYSTEM:COMM:GPIB:ADDR 14"           'Sets IEC/IEEE bus address to 14

## SYSTEM:ERRor?

The command queries the oldest entry in the error queue and deletes this entry. Positive error numbers denote device-specific errors, negative error numbers denote error messages defined by SCPI. If the error queue is empty, 0 ('no error') is returned. The command has the same effect as the command `STATUS:QUEUE:NEXT?`

**Example:**           ":SYSTEM:ERR?"           'Queries the oldest entry in the error queue.  
Response: "0, 'No error'"   'No error has occurred since the error queue was last  
output.

## SYSTEM:PRESet

This command triggers an instrument reset. The command has the same effect as the \*RST command or pressing the **PRESET** key on the instrument front panel.

## SYSTEM:VERSion?

This command queries the SCPI version with which the instrument is compliant. The SCPI version is returned in the form of a calendar year.

**Example:**           ":SYSTEM:VERS?"           'Queries the SCPI version.  
Response: '1991.0'       'The instrument is compliant with the 1991.0 SCPI  
version.

**SYSTEM:PROG:EXECute**

The command starts the specified Windows program and passes on additional call parameters. The command is normally used to remotely start Visual Basic programs in the R&S UPV-K1 software option (see also the description for the R&S UPV-K9x).

**Parameter:** "command line" Console command line for Windows

**Example:** :SYST:PROG:EXEC "'C:\Program Files\test.exe' arg1 arg2  
'arg3 and arg4'" starts the "test.exe"  
Windows program with the "arg1", "arg2" and "arg3  
and arg4" arguments and maintains execution until  
the program is ended.

**SYSTEM:SHUtdown**

**SYSTEM:SHUtdown <nu>**

**SYSTEM:SHTDown**

**SYSTEM:SHTDown <nu>**

This command shuts down the R&S UPV by remote control. <nu> is the time until shutdown in seconds. No entry for <nu> corresponds to a time of 0 seconds, i.e. immediate shutdown.

**Parameter:** <n> n = time in seconds

**Example:** "SYST:SHU" Shut down the R&S UPV by remote control.

## MMEMory Subsystem

The MMEMory subsystem (Mass Memory) contains the commands for the administration of files and directories and for loading and storing complete instrument settings in files.

The various drives can be selected via the "mass storage unit specifier" <msus>. The internal hard drive is selected with "D:", the CD drive with "E:", and a memory stick plugged in at the USB interface with "F:". The resources of a network can also be selected via <msus> in the syntax of the specific network, e.g. with the UNC format (Universal Naming Convention): '\\server\share'.

The default drive is defined with the command `MMEMory:MSIS <msus>`.

---

### Note:

*Drive C: is a protected system drive. Do not try to access this drive. Otherwise, the system partition cannot be reconstructed without the loss of data.*

---

To ensure that files can be used in different file systems, adhere to the following naming conventions: File names can be of any length, and no distinction is made between uppercase and lowercase letters. Use a period to separate the file name from any file extension that may be used. All letters and digits are permitted; however, digits cannot be used as the first character in the file name. Try to avoid using special characters, particularly the slash characters "\" and "/" since they are used in the path specification. Some names are reserved by the operating system, e.g. CLOCK\$, CON, AUX, COM1...COM4, LPT1 to LPT3, NUL and PRN.

In the R&S UPV, a characteristic extension is added to all files in which lists and settings are stored. A period separates the extension from the actual file name.

The two characters \* and ? function as wildcards, i.e. as placeholders for selecting multiple files. The character "?" represents exactly one character that can be anything. The character "\*" represents all characters in the remaining part of the file name. Thus, the combination "\*.\*" means all files in a directory.

The parameter <file\_name> is specified together with the commands as a string parameter enclosed in quotation marks. It can indicate either the complete path including the drive, only the path and file name, or only the file name. The same rule also applies to the parameters <directory\_name> and <path>. Depending on how complete the specification is, either the values specified in the parameter or the values specified with the commands `MMEM:MSIS` (default drive) and `MMEM:CDIR` (default directory) are used as the path and drive settings of the commands.

In the following example, the current instrument setting is always stored in the file 'test1.set' in the directory 'user' on the internal hard disk.

```
MMEM:STOR:STAT 'd:\upv\user\test1.set'
```

If a complete path specification, including drive designation, is used, the file is stored in the specified path.

```
MMEM:MSIS 'D:'
```

```
MMEM:STOR:STAT '\user\test1.set'
```

If the parameter contains only the path and file name, the default drive defined with the command `MMEM:MSIS` is used.

```
MMEM:MSIS 'D:'
```

```
MMEM:CDIR 'user'
```

```
MMEM:STOR:STAT 'test1.set'
```

If the parameter contains only the file name, the file is stored on the default drive `MMEM:MSIS` and in the default directory that was selected with the command `MMEM:CDIR`.





**MMEMory:CATalog:LENGth? <path>**

This command outputs the number of files in the specified directory. If you do not specify a directory, the default directory selected with the command `MMEM:CDIR` and located on the default drive selected with the command `MMEM:MSIS` is output.

This command is a query command and therefore has no \*RST value.

**Example:** `"MMEM:CAT:LENG? 'f:\'"` Outputs the number of files at the highest directory level on the memory stick

Response: "1" The highest directory level on the memory stick contains one file

**MMEMory:CDIRectory <directory\_name>**

This command changes the default directory. This directory will be used in all subsequent MMEM commands if no path is specified. You can also change to a higher-level directory by entering two periods '..'

**Example:** `"MMEM:CDIR 'test'"` Changes from the current directory level to the subdirectory 'test'.

**MMEMory:COPY <source>[,<destination>]**

This command copies the first specified file to the second specified file. You can also use this command to copy a complete directory, including all of its files, rather than a single file.

If you do not specify <destination>, <source> will be copied to the `MMEM:MSIS` drive and to the `MMEM:CDIR` directory. Any files in the destination directory that have the same name will be overwritten without an error message being generated.

You can also enter the path specification by using an additional parameter. The command will then read as follows:

```
MMEMory:COPY
<file_source><msus_source>[,<file_destination>,<msus_destination>]
```

The command triggers an event and therefore has no query form and no \*RST value.

**Example:** `"MMEM:COPY 'D:/user/test1.set','F:/'"`  
Copies the file 'test1.set' located in the USER directory of the internal hard disk to the memory stick using the same name

**MMEMory:DATA <file\_name>[,<binary block data>]****MMEMory:DATA? <file\_name>**

This command copies the block data <binary block data> to the file designated with <file\_name>.

The R&S UPV accepts the line message EOI and/or the ASCII character NL (0Ah) as an indication that data transmission has been completed.

The binary data stream must be concluded with EOI or NL or EOI followed by NL. If the data stream is not concluded with either EOI or NL, the R&S UPV will wait for additional data. In the case of a binary data transmission, the R&S UPV ignores the bit combination NL (0Ah) within the data stream.

The associated query command transmits the specified file from the R&S UPV to the controller via the IEC/IEEE bus. Make sure that the buffer on the controller is large enough to hold the file.

You can use this command to read stored instrument settings, trace files, waveform files, filter coefficient files, etc, directly from the R&S UPV or to transmit them directly to the R&S UPV.

The binary data block has the following structure: #<LängeDerLänge><Länge><block\_data>.

Example: #234<block\_data>

# always introduces the binary block

<LängeDerLänge> specifies how many positions the subsequent length specification occupies (two in the example)  
 <Länge> specifies the number of subsequent bytes (34 in the example)  
 <binary block data> binary block data of the specified length

**Example:** "MEM:DATA 'TEST1.WV',#3767<binary data>"  
 Writes the block data to file 'test1.wv'.  
 "MEM:DATA? 'TEST1.WV' Transmits the data in file 'Test1.wv' from the R&S UPV to the controller in the form of a binary block.

**MMEemory:DCATalog? <path>**

This command outputs the subdirectories of the specified directory. If you do not specify a directory, the default directory that is selected with the command MEM:CDIR is output. The directories are output in a comma-separated list.

This command is a query command and therefore has no \*RST value.

**Example:** "MEM:DCAT?" Outputs the subdirectories of the current directory.  
 Response: "'test', 'wave', 'digital'" The current directory contains the subdirectories 'test', 'wave' and 'digital'.

**MMEemory:DCATalog:LENGth? <path>**

This command outputs the number of subdirectories located in the specified directory. If you do not specify a directory, the directory selected with the command MEM:CDIR is output.

**Example:** "MEM:DCAT:LENG" Outputs the number of subdirectories located in the current directory.  
 Response: "3" The current directory contains three subdirectories.

**MMEemory:DELeTe <file\_name>**

This command deletes the specified file.

This command triggers an event and therefore has no query form and no \*RST value

**Example:** "MEM:DEL 'D:\UPV\USER\TEST1.set'"  
 Deletes file 'Test1.set' from directory USER on the internal hard disk.

**MMEemory:LOAD:STATe <file\_name>**

This command loads the specified instrument setting.

**MMEemory:MDIRectory <directory\_name>**

This command creates a new subdirectory for the specified directory. If no directory is specified, a subdirectory of the default directory is created. A directory tree can also be created by using this command

This command triggers an event and therefore has no query form and no \*RST value

**Example:** "MEM:MDIR 'carrier'" Creates subdirectory 'carrier' in the current directory.

**MMEMory:MOVE** <file\_source>,<file\_destination>

This command renames an existing file if <file\_destination> does not contain a path specification. Otherwise, the file is moved to the specified path and stored under the original file name or under a new file name if one is specified.

You can also enter the path specification by means of an additional parameter; the command then reads as follows:

```
MMEMory:MOVE
<file_source><msus_source>[,<file_destination>,<msus_destination>]
```

This command triggers an event and therefore has no query form and no \*RST value

**Example:**           "MMEM:MOVE 'test.set', 'keep.set'"                 Renames file 'test.set' to 'keep.set'.

                      "MMEM:MOVE 'test.set', '\user\keep.set'"         Moves file 'test.set' to subdirectory 'user' and stores it there under the name 'keep.set'

**MMEMory:MSIS** <msus>

This command sets the drive – the network resource in networks – with <msus> (MSIS = **M**ass **S**torage **I**dentification **S**tring). This setting applies to all MMEMory commands for which the drive is not explicitly specified in the parameter.

**Example:**           "MMEM:MSIS 'F: '"                         Selects the memory stick as the default drive.

**MMEMory:RDIRECTory** <directory\_name>

This command removes the specified subdirectory from the specified directory. If a directory is not specified, the subdirectory with the specified name is deleted from the default directory.

This command triggers an event and therefore has no query form and no \*RST value

**Example:**           "MMEM:RDIR 'carrier'"                    Removes the 'carrier' subdirectory from the current directory.

**MMEMory:STORe:STATe** <file\_name>

This command stores the current device setting in the specified file.



## Softkey commands of the graphical display

This section includes all commands of the softkey menu of the graphical and list displays. These commands cannot be recorded.

Only a few commands are allowed in all subsystems. Commands that are not allowed in a subsystem are not listed here.

In the BARgraph subsystem, for example, there are no markers.

The DISPLAY:BARgraph<i>:A|B:MARKer:HARMonics ON | OFF command is thus not allowed, and is not listed in the following command description.

Command	Parameters	Default unit	Remarks
DISPlay:FFT<i>:A B:MARKer:HARMonics	ON   OFF		
DISPlay:Subsys<i>:A B:MARKer:MODE	OFF   FIXed  TRKMax		
DISPlay:Subsys<i>:A B:MARKer:SETTo:OCURsor XCURsor	ONCE alias EXEC		No query
DISPlay:Subsys<i>:A B:MARKer:SETTo:XPOS	<nu>		
DISPlay:Subsys<i>:OCURsor XCURsor:MODE	VA   VB   VAB   HA   HB		
DISPlay:Subsys<i>:OCURsor XCURsor:POSMODE	PIXel   POINT   PEAK   HARMonic		
DISPlay:Subsys<i>:OCURsor XCURsor:SETTo:MAX	ONCE alias EXEC		No query
DISPlay:Subsys<i>:OCURsor XCURsor:SETTo:MIN	ONCE alias EXEC		No query
DISPlay:Subsys<i>:OCURsor XCURsor:SETTo:MRKA	ONCE alias EXEC		No query
DISPlay:Subsys<i>:OCURsor XCURsor:SETTo:MRKB	ONCE alias EXEC		No query
DISPlay:Subsys<i>:OCURsor XCURsor:SETTo:XPOS	<nu>		
DISPlay:Subsys<i>:OCURsor XCURsor:SETTo:YPOS	<nu>		
DISPlay:Subsys<i>:OCURsor XCURsor:STAtE	OFF   ACTive   INACTive		
DISPlay:Subsys<i>:OCURsor XCURsor:Y?			Query only
DISPlay:Subsys<i>:DLISt:FILTer	ALL   LIMUpper   LIMLower   LIMBoth   HARMonics   PEAKs		

**DISPlay:FFT<i>:A|B:MARKer:HARMonics ON | OFF**

Corresponds to softkey operation: Marker,  
Trace A | Trace B,  
Harm

**Parameters:**    **ON**            The harmonics are calculated and displayed, starting from the X position of the marker.

**OFF**            Display of the harmonics is switched off.

**Example:**            "DISPlay:FFT2:A:MARKer:HARMonics ON"

**DISPlay:SWEep<i>:A|B:MARKer:MODE OFF | FIXed |TRKMax**  
**DISPlay:FFT<i>:A|B:MARKer:MODE OFF | FIXed |TRKMax**  
**DISPlay:WAVEform:A|B:MARKer:MODE OFF | FIXed |TRKMax**  
**DISPlay:PESQ<i>:A|B:MARKer:MODE OFF | FIXed |TRKMax**

Corresponds to softkey operation: Marker,  
Trace A | Trace B,  
Off | Track to Max

**Parameters:**    **OFF**            Marker off

**FIXed**            Fix marker on the current X position

**TRKMax**        Set marker to maximum of trace A. Marker changes with maximum.

**Example:**            "DISPlay:FFT:B:MARKer:MODE TRKMax"

**DISPlay:SWEep<i>:A|B:MARKer:SETTo:OCURsor|XCURsor ONCE alias EXEC**  
**DISPlay:FFT<i>:A|B:MARKer:SETTo:OCURsor|XCURsor ONCE alias EXEC**  
**DISPlay:WAVEform:A|B:MARKer:SETTo:OCURsor|XCURsor ONCE alias EXEC**  
**DISPlay:PESQ<i>:A|B:MARKer:SETTo:OCURsor|XCURsor ONCE alias EXEC**

Corresponds to softkey operation: Marker,  
Trace A | Trace B,  
O Cursor | X Cursor

**Parameters:**    **ONCE**            Set marker to position of O cursor | X cursor

**EXEC**            Alias to ONCE.  
ONCE or EXEC can also be omitted.

**Example:**            "DISPlay:SWEep:A:MARKer:SETTo:OCURsor"  
                  "DISPlay:SWEep:A:MARKer:SETTo:OCURsor ONCE"  
                  "DISPlay:SWEep:A:MARKer:SETTo:OCURsor EXEC"  
                  "DISPlay:SWEep:A:MARKer:SETTo:XCURsor"  
                  "DISPlay:SWEep:A:MARKer:SETTo:XCURsor ONCE"  
                  "DISPlay:SWEep:A:MARKer:SETTo:XCURsor EXEC"

```
DISPlay:SWEEp<i>:A|B:MARKer:SETTo:XPOS <nu>
DISPlay:FFT<i>:A|B:MARKer:SETTo:XPOS <nu>
DISPlay:WAVEform:A|B:MARKer:SETTo:XPOS <nu>
DISPlay:PESQ<i>:A|B:MARKer:SETTo:XPOS <nu>
```

Corresponds to the softkey operation: Marker,  
Trace A | Trace B,  
Set to Value

**Parameter:**     <nu>           Set marker to a position on the X-axis. The unit for entering the value depends on the unit of the X-axis.

**Example:**           "DISPlay:FFT2:B:MARKer:SETTo:XPOS 12.345 Hz"

```
DISPlay:SWEEp<i>:OCURsor|XCURsor:MODE VA | VB | VAB | HA | HB
DISPlay:FFT<i>:OCURsor|XCURsor:MODE VA | VB | VAB | HA | HB
DISPlay:WAVEform:OCURsor|XCURsor:MODE VA | VB | VAB | HA | HB
DISPlay:BARgraph<i>:OCURsor|XCURsor:MODE VA | VB | VAB | HA | HB
DISPlay:PESQ<i>:OCURsor|XCURsor:MODE VA | VB | VAB | HA | HB
```

Corresponds to softkey operation: Cursor  
O Cursor  
O Vert A | O Vert B | O Vert A-B, O Hor A | O Hor B  
  
Cursor  
X cursor,  
X Vert A | X Vert B | X Vert A-B, X Hor A | X Hor B

**Parameters:**   **VA**           O cursor becomes vertical cursor on trace A  
                  **VB**           Same on trace B  
                  **VAB**          Same on trace A and trace B and shows difference between Y values.  
                  **HA**           O cursor becomes horizontal cursor on trace A  
                  **HB**           Same on trace B

**Example:**           "DISPlay:BARgraph:XCURsor:MODE VA"



```

DISPlay:SWEEp<i>:OCURsor|XCURsor:POSMoDe PIXel | POINt | PEAK
DISPlay:FFT<i>:OCURsor|XCURsor:POSMoDe PIXel | POINt | PEAK | HARMonic
DISPlay:WAVEform:OCURsor|XCURsor:POSMoDe PIXel | POINt
DISPlay:BARgraph<i>:OCURsor|XCURsor:POSMoDe POINt
DISPlay:PESQ<i>:OCURsor|XCURsor:POSMoDe PIXel | POINt

```

Corresponds to softkey operation: Cursor  
 O cursor | X cursor  
 Movement

Next Pixel | Next Bin | Next Sample | Next  
 Value | Next Step | Next Peak | Next Harmonic

<b>Parameters:</b>	<b>PIXel</b>	Pixel-by-pixel cursor movement
	<b>POINt</b>	Same between reference points. An easy-to-remember term is offered for each subsystem in the softkey menu, such as "Next Bin" for FFT, "Next Sample" for waveform, "Next Value" for bargraph and "Next Step" for sweep; the generic term POINt is used for IEC/IEEE bus control to simplify matters.
	<b>PEAK</b>	Same between partial curve peaks
	<b>HARMonic</b>	Same in the FFT display between harmonics

**Example:** "DISPlay:WAVEform:OCURsor:POSMoDe POINt"

```

DISPlay:SWEEp<i>:OCURsor|XCURsor:SETTo:MAX ONCE alias EXEC
DISPlay:FFT<i>:OCURsor|XCURsor:SETTo:MAX ONCE alias EXEC
DISPlay:WAVEform:OCURsor|XCURsor:SETTo:MAX ONCE alias EXEC
DISPlay:BARgraph<i>:OCURsor|XCURsor:SETTo:MAX ONCE alias EXEC
DISPlay:PESQ<i>:OCURsor|XCURsor:SETTo:MAX ONCE alias EXEC

```

Corresponds to softkey operation: Cursor  
 Set O-Cursor | Set X-Cursor,  
 Max

<b>Parameters:</b>	<b>ONCE</b>	Sets O cursor   X Cursor to the curve peak.
	<b>EXEC</b>	Alias to ONCE. ONCE or EXEC can also be omitted.

**Example:**

```

"DISPlay:SWEEp4:OCURsor:SETTo:MAX"
"DISPlay:SWEEp4:OCURsor:SETTo:MAX ONCE"
"DISPlay:SWEEp4:OCURsor:SETTo:MAX EXEC"
"DISPlay:SWEEp4:XCURsor:SETTo:MAX"
"DISPlay:SWEEp4:XCURsor:SETTo:MAX ONCE"
"DISPlay:SWEEp4:XCURsor:SETTo:MAX EXEC"

```

```

DISPlay:SWEep<i>:OCURsor|XCURsor:SETTo:MIN ONCE alias EXEC
DISPlay:FFT<i>:OCURsor|XCURsor:SETTo:MIN ONCE alias EXEC
DISPlay:WAVEform:OCURsor|XCURsor:SETTo:MIN ONCE alias EXEC
DISPlay:BARgraph<i>:OCURsor|XCURsor:SETTo:MIN ONCE alias EXEC
DISPlay:PESQ<i>:OCURsor|XCURsor:SETTo:MIN ONCE alias EXEC

```

Corresponds to softkey operation: Cursor  
 Set O cursor | Set X cursor,  
 Min

**Parameters:**    **ONCE**            Sets O cursor | X cursor to trace maximum  
                   **EXEC**            Alias to ONCE.  
                                      ONCE or EXEC can also be omitted.

**Example:**            "DISPlay:SWEep4:OCURsor:SETTo:MIN"  
                   "DISPlay:SWEep4:OCURsor:SETTo:MIN ONCE"  
                   "DISPlay:SWEep4:OCURsor:SETTo:MIN EXEC"  
                   "DISPlay:SWEep4:XCURsor:SETTo:MIN"  
                   "DISPlay:SWEep4:XCURsor:SETTo:MIN ONCE"  
                   "DISPlay:SWEep4:XCURsor:SETTo:MIN EXEC"

```

DISPlay:SWEep<i>:OCURsor|XCURsor:SETTo:MRKA ONCE alias EXEC
DISPlay:FFT<i>:OCURsor|XCURsor:SETTo:MRKA ONCE alias EXEC
DISPlay:WAVEform:OCURsor|XCURsor:SETTo:MRKA ONCE alias EXEC
DISPlay:PESQ<i>:OCURsor|XCURsor:SETTo:MRKA ONCE alias EXEC

```

Corresponds to softkey operation: Cursor  
 Set O cursor | Set X cursor,  
 Marker A

**Parameters:**    **ONCE**            Sets O cursor | X cursor to the position of marker A  
                   **EXEC**            Alias to ONCE.  
                                      ONCE or EXEC can also be omitted.

**Example:**            "DISPlay:SWEep4:OCURsor:SETTo:MRKA"  
                   "DISPlay:SWEep4:OCURsor:SETTo:MRKA ONCE"  
                   "DISPlay:SWEep4:OCURsor:SETTo:MRKA EXEC"  
                   "DISPlay:SWEep4:XCURsor:SETTo:MRKA"  
                   "DISPlay:SWEep4:XCURsor:SETTo:MRKA ONCE"  
                   "DISPlay:SWEep4:XCURsor:SETTo:MRKA EXEC"

```

DISPlay:SWEep<i>:OCURsor|XCURsor:SETTo:MRKB ONCE alias EXEC
DISPlay:FFT<i>:OCURsor|XCURsor:SETTo:MRKB ONCE alias EXEC
DISPlay:WAVEform:OCURsor|XCURsor:SETTo:MRKB ONCE alias EXEC
DISPlay:PESQ<i>:OCURsor|XCURsor:SETTo:MRKB ONCE alias EXEC

```

Corresponds to softkey operation: Cursor  
 Set O cursor | Set X cursor,  
 Marker B

**Parameters:**    **ONCE**            Sets O cursor | X cursor to the position of marker B  
                   **EXEC**            Alias to ONCE.  
                                  ONCE or EXEC can also be omitted.

**Example:**            "DISPlay:SWEep4:OCURsor:SETTo:MRKB"  
                   "DISPlay:SWEep4:OCURsor:SETTo:MRKB ONCE"  
                   "DISPlay:SWEep4:OCURsor:SETTo:MRKB EXEC"  
                   "DISPlay:SWEep4:XCURsor:SETTo:MRKB"  
                   "DISPlay:SWEep4:XCURsor:SETTo:MRKB ONCE"  
                   "DISPlay:SWEep4:XCURsor:SETTo:MRKB EXEC"

```

DISPlay:SWEep<i>:OCURsor|XCURsor:SETTo:XPOS <nu>
DISPlay:FFT<i>:OCURsor|XCURsor:SETTo:XPOS <nu>
DISPlay:WAVEform:OCURsor|XCURsor:SETTo:XPOS <nu>
DISPlay:BARgraph<i>:OCURsor|XCURsor:SETTo:XPOS <nu>
DISPlay:PESQ<i>:OCURsor|XCURsor:SETTo:XPOS <nu>

```

Corresponds to softkey operation: Cursor  
 Set O cursor | Set X cursor,  
 Value

**Parameters:**    <nu>                Sets O cursor | X cursor to the defined value if a **vertical** cursor  
                                  is involved.  
                                  The unit in which the value is entered depends on the **unit of  
                                  the X-axis.**

**Example:**            "DISPlay:WAVEform:OCURsor:SETTo:XPOS 12.345 Hz"

```

DISPlay:SWEep<i>:OCURsor|XCURsor:SETTo:YPOS <nu>
DISPlay:FFT<i>:OCURsor|XCURsor:SETTo:YPOS <nu>
DISPlay:WAVEform:OCURsor|XCURsor:SETTo:YPOS <nu>
DISPlay:BARgraph<i>:OCURsor|XCURsor:SETTo:YPOS <nu>
DISPlay:PESQ<i>:OCURsor|XCURsor:SETTo:YPOS <nu>

```

Corresponds to the softkey operation: Cursor  
 Set O cursor | Set X cursor,  
 Value

**Parameters:**    <nu>                Sets O cursor | X Cursor to the defined value, if a **horizontal**  
                                  cursor is involved.  
                                  The unit in which the value is entered depends on the **unit of  
                                  the Y-axis.**

**Example:**            "DISPlay:WAVEform:XCURsor:SETTo:YPOS -110 DBV"

**DISPlay:SWEEp<i>:OCURsor|XCURsor:STATe OFF | ACTive | INACTive**  
**DISPlay:FFT<i>:OCURsor|XCURsor:STATe OFF | ACTive | INACTive**  
**DISPlay:WAVEform:OCURsor|XCURsor:STATe OFF | ACTive | INACTive**  
**DISPlay:BARgraph<i>:OCURsor|XCURsor:STATe OFF | ACTive | INACTive**  
**DISPlay:PESQ<i>:OCURsor|XCURsor:STATe OFF | ACTive | INACTive**

Corresponds to softkey operation: Cursor  
 O cursor | X cursor,  
 O active | X active

**Parameter:**

<b>OFF</b>	O cursor   X cursor off
<b>ACTive</b>	O cursor   X cursor is visible and is controlled from the rotary knob
<b>INACTive</b>	O cursor   X cursor is visible but is controlled from the rotary knob

**Example:**

```
"DISPlay:BARgraph:OCURsor:STATe OFF"
"DISPlay:BARgraph2:XCURsor:STATe ACTive"
```

**DISPlay:SWEEp<i>:OCURsor|XCURsor:Y?**  
**DISPlay:FFT<i>:OCURsor|XCURsor:Y?**  
**DISPlay:WAVEform:OCURsor|XCURsor:Y?**  
**DISPlay:BARgraph<i>:OCURsor|XCURsor:Y?**  
**DISPlay:PESQ<i>:OCURsor|XCURsor:Y?**

No corresponding function in the softkey menu

**Parameters:**

<b>Query only</b>	Reads the current value of the O cursor or X cursor. The return value is a pure numeric value without unit. The numeric value is returned in the unit in which the Y-axis is displayed.
-------------------	---

**Example:**

```
"DISPlay:SWEEp:OCURsor:Y?"
"DISPlay:SWEEp:XCURsor:Y?"
```

Response:-19.4783

**DISPlay:SWEEp<i>:DLISt:FILTer ALL | LIMUpper | LIMLower | LIMBoth | HARMonics | PEAKs**  
**DISPlay:FFT<i>:DLISt:FILTer ALL | LIMUpper | LIMLower | LIMBoth | HARMonics | PEAKs**  
**DISPlay:WAVEform:DLISt:FILTer ALL | LIMUpper | LIMLower | LIMBoth | HARMonics | PEAKs**  
**DISPlay:BARgraph<i>:DLISt:FILTer ALL | LIMUpper | LIMLower | LIMBoth | HARMonics | PEAKs**  
**DISPlay:PESQ<i>:DLISt:FILTer ALL | LIMUpper | LIMLower | LIMBoth | HARMonics | PEAKs**

Corresponds to the softkey operation in the list editor:  
 Selection  
 All | Lim Upper | Lim Lower | Lim upp&low | Harmonics | Peaks

When saving a trace by setting "Store Trace as" to "DataList Select" (MMEMory:Subsys<i></i>:STAS DSElect) or when trace data is read in with the following IEC/IEEE bus commands:

TRACe:Subsys<i></i>:LDList:AX?

TRACe:Subsys<i></i>:LDList:AY?

TRACe:Subsys<i></i>:LDList:BX?

TRACe:Subsys<i></i>:LDList:BY?

The IEC/IEEE bus command specifies which data is saved/read.

**Parameters:** In the measurement value list the following values are used when saving or reading in trace data:

**All** all

**Lim Upper** Only those values that exceed the upper limit.

**Lim Lower** Only the values which are below the lower limit value.

**Lim upp&low** Only those values that exceed the upper limit and fall below the lower limit.

**Harmonics** Only harmonics.

**Peaks** Partial curve peaks.

**Example:** "DISPlay:FFT:DLISt:FILTer HARMonics"

## Transferring trace data

Transferring trace data from a controller via the IEC/IEEE bus to the R&S UPV allows you to display externally generated or manipulated trace data with the graphical display capabilities of the R&S UPV.

Example:

Assume that a fast frequency response measurement using a multisine signal and an FFT has been programmed in a K1 macro. The FFT shows different high lines in the multisine frequencies, with a noise floor between.

This is not the usual display mode of a frequency response curve.

The K1 macro now generates a sweep trace data set from the levels of the individual bins and their frequency values. This data set is transferred to the R&S UPV and is shown in the graphical display as a sweep trace, and thus as a frequency response curve.

When transferring trace data, pure numeric values without units are transferred. Thus, the presetting of the graph must **precede** the data transfer, and it determines the unit in which the values are interpreted. The number of the transferred X values should also comply with the currently set X-axis of the graphical display.

**The transfer of data for the X-axis (...:AX and ...:BX) is reserved exclusively for the sweep subsystem!**

**"X source" must be set to "Manual".**

The image shows a control panel with three dropdown menus. The first menu is labeled 'X-Source' and has 'Manual' selected, which is circled in red. The second menu is labeled 'X-Axis' and has 'Frequency' selected. The third menu is labeled 'Unit' and has 'Hz' selected.

**The Y-axes (...:AY and ...:BY) can be transferred for all subsystems without exception.**

Command	Parameters	Default unit	Remarks
TRACe:Subsys<i></i>:STORe:AX <n,n,n,n>			No query The command TRACe:Subsys<i></i> :LOAD:AX   AY   BX   BY? can be used instead of a query.
TRACe:Subsys<i></i>:STORe:AY <n,n,n,n>			
TRACe:Subsys<i></i>:STORe:BX <n,n,n,n>			
TRACe:Subsys<i></i>:STORe:BY <n,n,n,n>			

TRACe:SWEep<i></i>:STORe:AX <n,n,n,n>

TRACe:SWEep<i></i>:STORe:AY <n,n,n,n>

TRACe:SWEep<i></i>:STORe:BX <n,n,n,n>

TRACe:SWEep<i></i>:STORe:BY <n,n,n,n>

The following description provides the basic information used in the following examples of TRACe:Subsys<i></i>:STORe commands.

<i> = subsystem number 1 to 4

Command for saving sweep graph trace data sets.

AX designates the X-axis of trace A

AY designates the Y-axis of trace A

BX designates the X-axis of trace B

BY designates the Y-axis of trace B

In the case of a multiscan display or single display with MIN/MAX traces, the command DISPlay:SWEEp:SCANoffset <n> selects the desired scan.

**Example:** "TRAC:SWEEp1:STORe:AY <n,n,n,n>" Saves the data of the Y-axis for channel A in the first sweep system.

```
TRACe:FFT<i>:STORe:AX <n,n,n,n>
TRACe:FFT<i>:STORe:AY <n,n,n,n>
TRACe:FFT<i>:STORe:BX <n,n,n,n>
TRACe:FFT<i>:STORe:BY <n,n,n,n>
```

<i> = subsystem number 1 and 2

Command for saving sweep graph trace data sets.

```
TRACe:WAVeform:STORe:AX <n,n,n,n>
TRACe:WAVeform:STORe:AY <n,n,n,n>
TRACe:WAVeform:STORe:BX <n,n,n,n>
TRACe:WAVeform:STORe:BY <n,n,n,n>
```

Command for saving waveform trace data sets.

```
TRACe:BARgraph<i>:STORe:AX <n,n,n,n>
TRACe:BARgraph<i>:STORe:AY <n,n,n,n>
TRACe:BARgraph<i>:STORe:BX <n,n,n,n>
TRACe:BARgraph<i>:STORe:BY <n,n,n,n>
```

<i> = subsystem number 1 and 2

Command for saving bargraph trace data sets.

```
TRACe:PESQ<i>:STORe:AX <n,n,n,n>
TRACe:PESQ<i>:STORe:AY <n,n,n,n>
TRACe:PESQ<i>:STORe:BX <n,n,n,n>
TRACe:PESQ<i>:STORe:BY <n,n,n,n>
```

<i> = subsystem number 1 and 2

Command for saving PESQ trace data records.

## User-definable data buffers

The available data buffers are mainly used for communicating between K1 macros and IEC/IEEE bus control programs.

The K1 macro or the IEC/IEEE bus control program saves data in the form of strings or binary data in the available data buffers, from where it can be collected and further processed by the other program. However, these buffers can also be used as data buffers within one of the programs.

Command	Parameters	Default unit	Remarks
SYSTem:MEMory:STRing<i>	"String"		
SYSTem:MEMory:DATA<i> or SYSTem:MEMory:DATA<i>	<n,n,n,n> or #<Length><OfTheLength><Binary data as float[]>		
SYSTem:MEMory:FREE	STRing   DATA		

### SYSTem:MEMory:STRing<i> 'String'

<i> = 1 to 1024

Any strings up to a length of 540 bytes can be cached in up to 1024 memory locations.

**Parameter:**        **"String"**                               the maximum string length is 540 bytes

**Example:**           SYSTem:MEMory:STRing10 "Store this string in the buffer!"

Query:

SYSTem:MEMory:STRing10?

Response:

"Store this string in the buffer!"





# Hardcopy

Command	Parameters	Default unit	Remarks
HCOPY[:IMMEDIATE]			

## HCOPY[:IMMEDIATE]

Triggers the function to output measurement value results. Depending on the selected setting in the configuration panel, the desired action is immediately executed.

Note: If the HCopy function is triggered during an ongoing measurement, first the measurement is halted and then the set action is executed.

**Parameters:**     None

**Example:**        `HCOPY[:IMMEDIATE]`



## Contents - Chapter 8 "Maintenance and Interfaces"

<b>8 Maintenance and Instrument Interfaces</b> .....	8.1
<b>Introduction - Maintenance and Interfaces</b> .....	8.1
<b>Maintenance</b> .....	8.1
Cleaning the Outside of the Instrument and Storage.....	8.1
Changing the AC Supply Fuse.....	8.2
<b>Instrument Interfaces</b> .....	8.3
IEC/IEEE-Bus Interface (IEC 625 / IEEE 488).....	8.3
Ethernet Interface (LAN) .....	8.7
RS-232-C Interface (COM) .....	8.10
USB Connectors (USB).....	8.14
USB Device Port .....	8.14
Printer Connector (LPT).....	8.16
Monitor Connector (MONITOR).....	8.17



# 8 Maintenance and Instrument Interfaces

## Introduction - Maintenance and Interfaces

The following chapter contains information on maintaining the audio analyzer and also describes the instrument interfaces.

How to change a module and order spare parts is described in the service manual. The service manual also contains all the ID numbers required for ordering spare parts.

The address of our Support Center and a list of Rohde & Schwarz Service Centers are given at the beginning of this manual.

More detailed information (especially on troubleshooting, repairing the instrument, changing the modules and calibration) can also be found in the service manual.

## Maintenance

The audio analyzer does not require regular maintenance. Maintenance is essentially restricted to cleaning the instrument. It is, however, advisable to check the nominal data from time to time.

### Cleaning the Outside of the Instrument and Storage

The outside of the instrument should be cleaned using a suitable soft, lint-free cloth. It is important to make sure that the instrument vents are not obstructed.

**NOTICE**

---

*Instrument damage caused by cleaning agents!  
Cleaning agents contain substances that may damage the instrument, e.g. solvent-containing cleaning agents may damage the front panel labeling or plastic parts. Never use cleaning agents such as solvents (thinners, acetone, etc), acids, bases, or other substances. The outside of the instrument is suitably cleaned using a soft, lint-free dust cloth.*

---

The storage temperature range for the audio analyzer is specified in the data sheet. The instrument must be protected against dust if it is to be stored for a long period.

When transporting or shipping the instrument, it is advisable to use the original packing material (especially the two protective covers for the front and rear panel).

## Changing the AC Supply Fuse

**NOTICE**

---

*Only fuses of the type IEC 127-T4.0H/250V should be used.*

---

Changing the AC supply fuses:

- Make sure that the power cable is disconnected.
- Open the flap covering the voltage selector using a small screwdriver (or similar).
- Remove the cylinder labelled with the nominal voltages. Remove both fuses and fit new ones. Reinsert the cylinder so that the value visible through the hole in the cover flap is the same nominal voltage as before.
- Close the flap.

---

**Note:**

*The Audio Analyzer R&S UPV is operated with the same fuses for all of the specified nominal AC supply voltages.*

---

## Instrument Interfaces

The following section describes the remote-control interfaces of the audio analyzer and the pin assignment of the monitor socket. The other interfaces are described in Chapter 1 in the sections "Front Panel" and "Rear Panel".

### IEC/IEEE-Bus Interface (IEC 625 / IEEE 488)

As standard, the instrument is equipped with an IEC/IEEE-bus connector. The connector socket (conforming to IEEE 488) is at the rear of the instrument. The interface can be used to connect a controller to allow remote control of the instrument. A shielded cable is used for connection.

#### Features of the IEC/IEEE-bus interface

- 8-bit parallel data transfer
- Bidirectional data transfer
- Three-wire handshake
- High data transfer rate
- Up to 15 instruments can be connected
- Maximum length of connecting cables 15 m (single connection 2 m)
- Wired-Or operation with parallel connection of several instruments

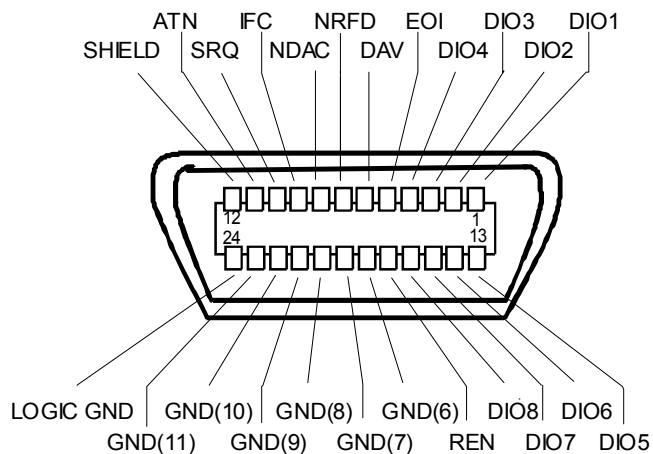

Figure 8-1 Pin assignment of IEC/IEEE-bus interface



## IEC/IEEE-bus lines

### 1. Data bus with 8 lines DIO 1...DIO 8

Data is transferred parallel by bit and serial by byte in ASCII/ISO code. DIO1 is the bit with the lowest value and DIO8 the bit with the highest value.

### 2. Control bus with 5 lines

<b>IFC</b> (Interface Clear)	Active LOW resets the interfaces of the connected instruments to their initial setting.
<b>ATN</b> (Attention)	Active LOW signals the transmission of interface messages. Active HIGH signals the transmission of instrument messages.
<b>SRQ</b> (Service Request)	Active LOW allows the connected instrument to send a service request to the controller.
<b>REN</b> (Remote Enable)	Active LOW allows switchover to remote-control mode.
<b>EOI</b> (End or Identify)	This has two functions in conjunction with ATN: ATN = HIGH Active LOW indicates the end of data transfer. ATN = LOW Active LOW triggers a parallel poll.

### 3. Handshake bus with three lines

<b>DAV</b> (Data Valid)	Active LOW signals a valid data byte on the data bus.
<b>NRFD</b> (Not Ready For Data)	Active LOW signals that one of the connected instruments is not ready to receive data.
<b>NDAC</b> (Not Data Accepted)	Active LOW while the connected instrument is receiving the data on the data bus.

**IEC/IEEE-bus interface functions**

Instruments which can be remote-controlled via the IEC/IEEE bus can be provided with various interface functions. The table below lists the interface functions which apply to the audio analyzer.

Table 8-1 Interface functions

Control character	Interface functions
SH1	Source handshake, full capability
AH1	Acceptor handshake, full capability
L4	Listener function, full capability, unaddressing by MTA
T6	Talker function, full capability, capability of responding to serial query, unaddressing by MLA
SR1	Service request function, full capability
PP1	Parallel poll function, full capability
RL1	Remote/local switchover function, full capability
DC1	Reset function (Device Clear), full capability
DT1	Trigger function (Device Trigger), full capability
C0	No controller function

## IEC/IEEE-bus interface messages

Interface messages are transferred to the instrument on the data lines, whereby the "attention" control line ("ATN") is active (LOW). They are used for communication between the process controller and the instrument and can only be sent by a process controller which has the controller functionality at the IEC/IEEE bus.

### Universal commands

The universal commands are in the code range 0x10 to 0x1F. They act on all instruments connected to the bus without previous addressing.

Table 8-2 Universal commands

Command	VISUAL BASIC command	Effect on instrument
DCL (Device Clear)	IBCMD (controller%, CHR\$(20))	Terminates processing of the commands that have just been received, and sets the command-processing software to a defined initial state. Does not change the instrument setup.
IFC (Interface Clear)	IBSIC (controller%)	Resets the interfaces to their initial setting.
LLO (Local Lockout)	IBCMD (controller%, CHR\$(17))	The manual LOCAL switchover function is disabled.
SPE (Serial Poll Enable)	IBCMD (controller%, CHR\$(24))	Ready for serial polling.
SPD (Serial Poll Disable)	IBCMD (controller%, CHR\$(25))	End of serial polling.
PPU (Par. Poll Unconfigure)	IBCMD (controller%, CHR\$(21))	End of parallel polling query status.

### Addressed commands

The addressed commands are in the code range 0x00 to 0x0F. They only act on instruments which are addressed as listeners.

Table 8-3 Addressed commands

Command	VISUAL BASIC command	Effect on instrument
SDC (Sel. Device Clear)	IBCLR (device%)	Terminates processing of the commands that have just been received, and sets the command-processing software to a defined initial state. Does not change the instrument setup.
GET (Group Exec. Trigger)	IBTRG (device%)	Initiates a measurement or a sweep.
GTL (Go to Local)	IBLOC (device%)	Transition to the "Local" state (manual operation).
PPC (Par. Poll Configure)	IBPPC (device%, data%)	Configure instrument for parallel polling. The VISUAL BASIC command also executes PPE / PPD.

## Ethernet Interface (LAN)

As standard, the instrument is equipped with an Ethernet interface. The connector socket is at the rear of the instrument. Network administrators with the appropriate rights can transfer files across the network and use network resources such as network directories or printers. The instrument can also be remote-controlled and manually operated in the network. A commercially available RJ45 cable is used for connection.

The network card operates with 100-MHz-Ethernet IEEE 802.3u. The TCP/IP network protocol and the associated network services are preconfigured. TCP/IP provides connection-mode communication where the sequence of the exchanged messages is retained and interrupted connections are detected. Furthermore, messages cannot be lost if this protocol is used.

Connection of the R&S UPV is described in Chapter 1 in the section *Connection to the Network* and remote control via Ethernet is described in Chapter 5 in the section *Remote Control via LAN Interface*. The architecture of a LAN remote-control connection is described in greater detail below.

Remote control of the instrument via a network is based on these standardized protocols which comply with the OSI reference model (see the figure below).

Application	SCPI	SCPI [3]
Presentation	XDR (VXI-11)	RFC 1014 [1,2]
Session	ONC-RPC	RFC 1057
Transport	TCP / UDP	RFC 793
Network	IP	RFC 791
Data Link	Ethernet/802.3	8802-3
Physical	802.3/10BASE-T	8802-3

Figure 8-2 Example of LAN remote control in compliance with OSI reference model

Based on TCP/UDP, the messages are exchanged between the controller and the instrument by means of Open Network Computing (ONC) Remote Procedure Calls (RPC). With XDR, the permitted RPC messages are known as the VXI-11 standard. Messages are exchanged between the controller and the instrument based on this standard. The messages are identical to the SCPI commands. They can be divided into four groups: program messages (control commands to the instrument), response messages (values returned by the instrument), service request (spontaneous requests by the instrument) and low-level control messages (interface messages).

A VXI-11 connection between a controller and an instrument is based on three channels: core, abort and interrupt channel. The instrument is controlled mainly via the core channel (program, response and low-level control messages). The abort channel is used for immediate termination of the core channel, and the interrupt channel transports spontaneous service requests from the instrument. The actual connection setup is complex. Further details can be found in the VXI-11 specification ('TCP/IP Instrument Protocol Specification VXI-11, Revision 1.0 VMEbus Extensions for Instrumentation, VXIbus' and 'TCP/IP-IEEE 488.2 Instrument Interface Specification VXI-11.3, Draft 0.3 VMEbus Extensions for Instrumentation, VXIbus').

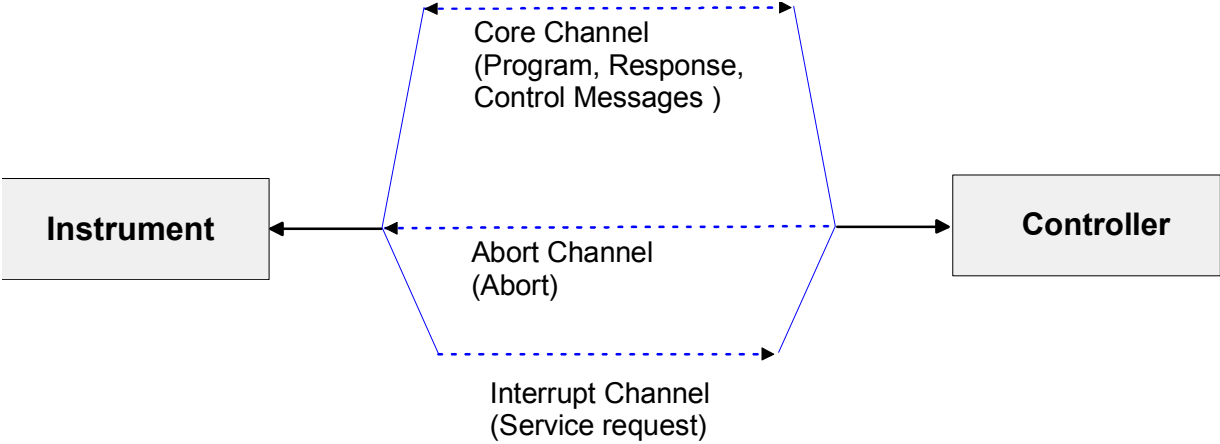

Figure 8-3 Channels between instrument and controller with VXI-11

The number of controllers which can access an instrument is virtually unlimited in the network. In the instrument, a clear distinction is made between the individual controllers. This distinction is continued down to one controller at application level, i.e. two applications on a PC are regarded as two different controllers by an instrument.

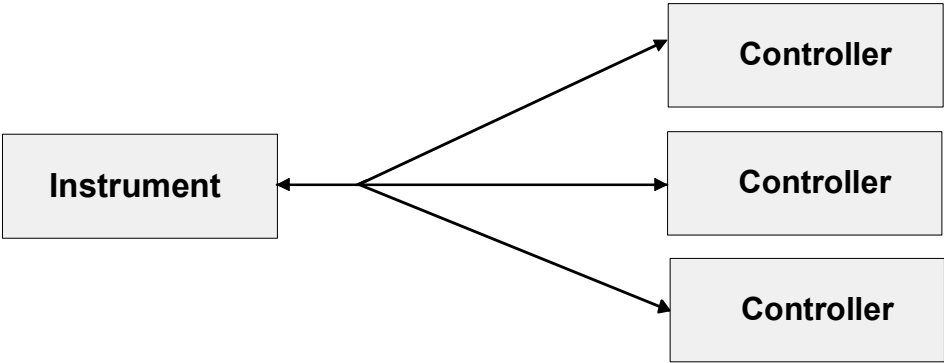
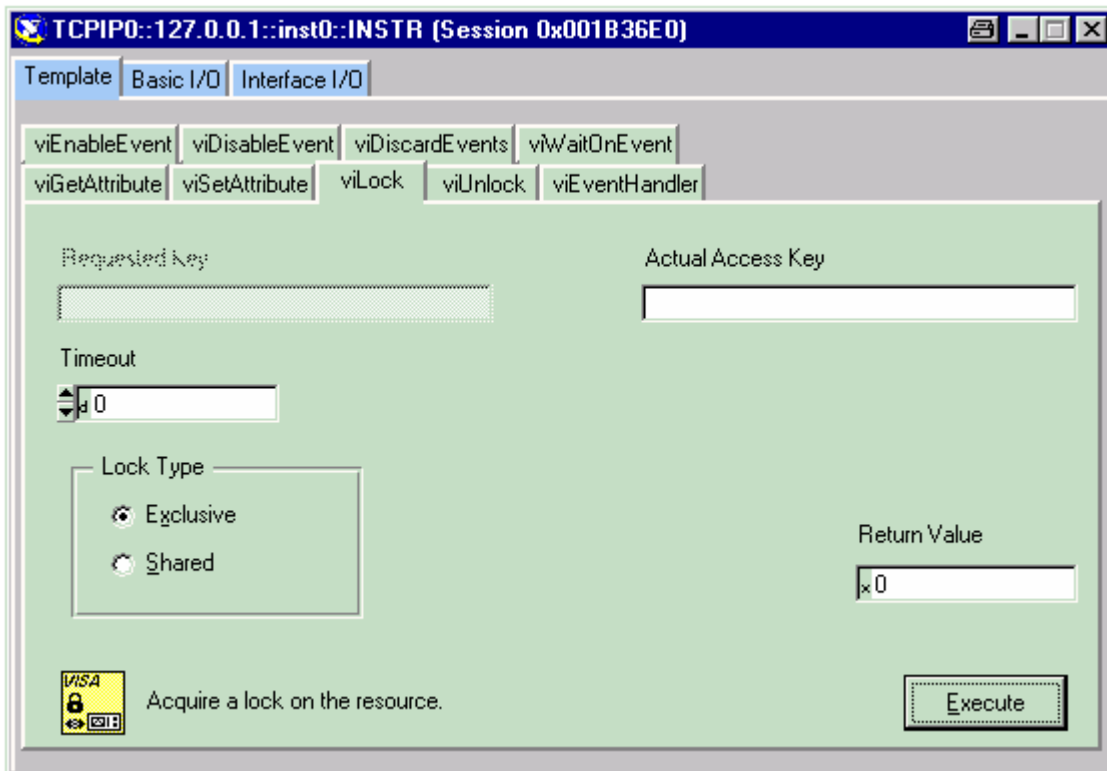

Figure 8-4 Remote control via LAN with several controllers

The controllers can lock and unlock the instrument to permit exclusive access. As a result, it is possible to control access from several controllers.

In the program '**Measurement & Automation Control**', this setting is made in the **Template** panel.



### VXI-11 interface messages

With Ethernet connections, the interface messages are referred to as low-level control messages. They can be used to emulate the interface messages of the IEC/IEEE bus.

Table 8-4 VXI-11 interface messages

Command	Effect on instrument
&ABO (Abort)	Terminates processing of the commands that have just been received.
&DCL (Device Clear)	Terminates processing of the commands that have just been received, and sets the command-processing software to a defined initial state. Does not change the instrument setup.
&GTL (Go to Local)	Transition to the "Local" state (manual operation).
&GTR (Go to Remote)	Transition to the "Remote" state (remote control).
&GET (Group Execute Trigger)	Initiates a measurement or a sweep.
&LLO (Local Lockout)	The manual LOCAL switchover function is disabled.
&POL (Serial Poll)	A serial poll is executed.
&NREN (Not Remote Enable)	The manual LOCAL switchover function is enabled.

## RS-232-C Interface (COM)

As standard, the instrument has an RS-232-C interface. The connector socket is at the rear of the instrument. The interface can be used to connect a controller to allow remote control of the instrument. A shielded cable is used for connection.

### Features of the interface

- Serial data transfer in asynchronous mode
- Bidirectional data transfer via two separate lines
- Selectable transfer speed from 110 to 19200 Baud
- Logic signal level '0' from +3 V to +15 V
- Logic signal level '1' from -15 V to -3 V
- External device (controller) can be connected

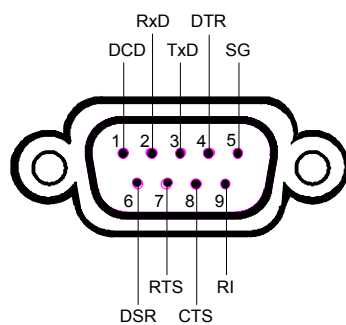

Figure 8-5 Pin assignment of RS-232-C interface

## Signal lines

### DCD (Data Carrier Detector)

*Not used in the instrument.*

Input (log. '0' = active); this signal tells the data terminal that the modem is receiving valid signals with adequate level from the remote station. DCD is used to disable the receiver in the data terminal and thus prevent incorrect data from being read in if the modem cannot interpret the signals from the remote station.

### RxD (Receive Data)

Data line; transfer direction: remote station to instrument.

### TxD (Transmit Data)

Data line; transfer direction: instrument to remote station.

### DTR (Data Terminal Ready)

Output (log. '0' = active); the instrument uses DTR to announce that it is ready to receive data.

### GND

Interface ground, connected to the instrument ground.

### DSR (Data Set Ready)

Input (log. '0' = active); DSR tells the instrument that the remote station is ready to receive data.

### RTS (Request To Send)

Output (log. '0' = active); RTS tells the remote station that the instrument is ready for data transfer. The RTS line remains active for as long as the serial interface is active.

### CTS (Clear To Send)

Input (log. '0' = active); CTS tells the instrument that the remote station is ready to receive data.

### RI (Ring Indicator)

*Not used by the instrument.*

Input; a modem uses RI to announce that a remote station wants to set up a connection with the modem.



### Transfer parameters

To ensure error-free and correct data transfer, the set transfer parameters must be identical for both the instrument and the controller. The R&S UPV is factory-configured with the default settings identified in the list. These values cannot be changed by the user.

- Transfer speed** 8 different baud rates can be set in the instrument:  
**(baud rate)** 110, 300, 600, 1200, 2400, 4800, 9600, 19200. The default value is 19200.
- Data bits** Data is transferred in 7 or 8-bit ASCII code. The LSB (Least Significant Bit) is the first bit to be transferred. The default value is 8.
- Start bit** Each data byte begins with a start bit. The falling edge of the start bit signals the beginning of the data byte.
- Parity bit** A parity bit can also be transferred to provide error protection. There are three parity settings: none, even and odd. Additionally, the parity bit can be set to logic '0' or logic '1'. The default value is no parity.
- Stop bits** Transfer of a data byte can be ended with 1, 1.5 or 2 stop bits. The default value is 1 stop bit.

**Example:**

Transfer of the letter 'A' (41 Hex) in 7-bit ASCII code, with even parity and two stop bits:

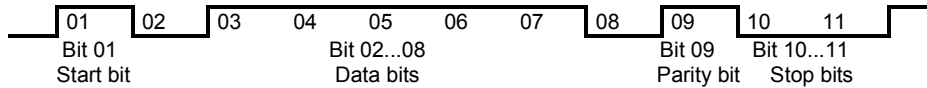

## Handshake

### Software handshake

With the software handshake, data transfer is controlled by the two control characters XON / XOFF:

The instrument signals that it is ready to receive data using the control character XON. If the input buffer is full, it sends the character XOFF to the controller via the interface. The controller then stops data output until it receives XON again from the instrument. In the same way, the controller informs the instrument that it is ready to receive data.

### Cable for local computer link for software handshake

With the software handshake, the instrument is connected to a controller by crossing the data lines. The wiring diagram below applies to a controller with 9-pin or 25-pin connection.

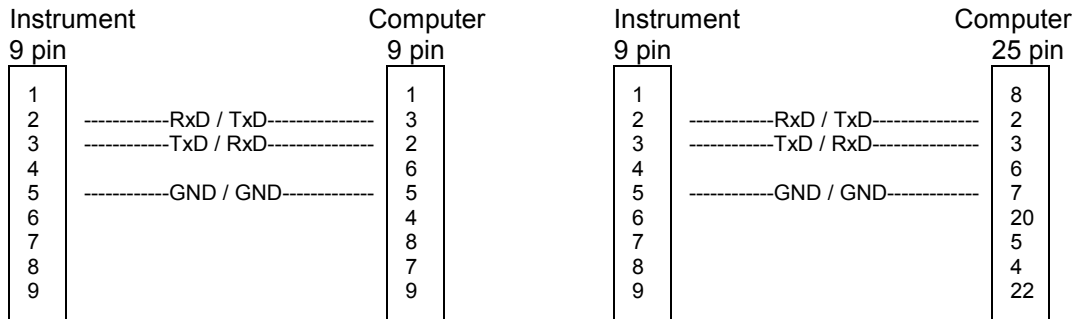

Figure 8-6 Wiring of data lines for software handshake

### Hardware handshake

With the hardware handshake, the instrument signals that it is ready to receive data via the lines DTR and RTS. A logic '0' on both lines means 'ready' and a logic '1' means 'not ready'. The RTS line is always active (logic '0') provided that the serial interface is switched on. The DTR line thus controls the R&S UPV's readiness to receive data.

The instrument is informed of the remote station's readiness to receive data via the lines CTS and DSR. A logic '0' on both lines activates the output of data and a logic '1' on both lines stops the output of data by the instrument. Data is output via the TxD line. This is the default configuration of the R&S UPV.

**Cable for local computer link for hardware handshake**

The instrument is connected to a controller using a "null modem" cable. With this cable, the data, control and signalling lines must be crossed. The wiring diagram below applies to a controller with 9-pin or 25-pin connection.

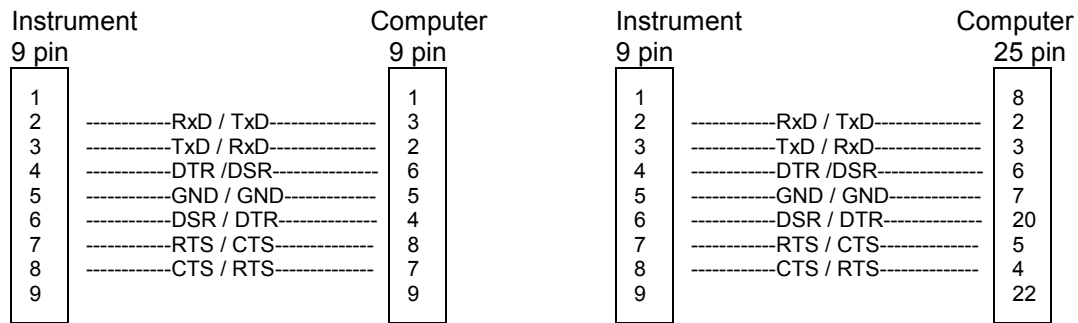

Figure 8-7 Wiring of data, control and signalling lines for hardware handshake

**USB Connectors (USB)**

As standard, the instrument has four USB interfaces (Universal Serial Bus) of type A (Master USB); they form a link with the internal processor. They can be used to connect peripherals such as a mouse and keyboard or to connect a USB stick for transferring files. Two of the USB interfaces are on the front of the instrument and two are on the rear of the instrument.

**USB Device Port**

Instruments of the new generation have a Type B USB device connector on the rear panel in addition to the normal USB connector. The Type B connector is commonly used for hubs and external hard disk drives. The R&S UPV can also be controlled via this port if the controller has the necessary drivers.

Remote control via USB is described in chapter 5, section "Remote control via the USB interface".

**USB device interface messages**

In the case of a USB device link, the interface messages are called "Low-Level Control Messages". They can be used to emulate the interface messages of the IEC/IEEE bus.

<b>Command</b>	<b>Effect on instrument</b>
&ABO (Abort)	Terminates processing of commands that have just been received.
&DCL (Device Clear)	Terminates processing of commands that have just been received and restores the processing software to a defined initial state. Does not modify the instrument configuration.
&GTL (Go to Local)	Transition to the Local state (manual operation).
&GTR (Go to Remote)	Transition to the Remote state (remote control).
&GET (Group Execute Trigger)	Triggers a measurement or a sweep.
&LLO (Local Lockout)	Manual switching to Local mode is blocked.
&POL (Serial Poll)	A serial poll is executed.
&NREN (Not Remote Enable)	Manual switching to Local mode is enabled.

### Printer Connector (LPT)

The 25-pin connector LPT on the rear panel of the R&S UPV allows a printer to be connected.

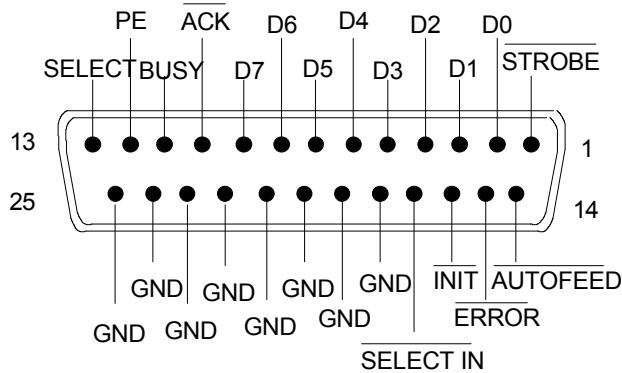

Connection	Signal	Input (I) / Output (O)	Meaning
1	STROBE	O	Pulse for transferring a data byte; min. 1µs pulse width (active LOW).
2	D0	O	Data line 0
3	D1	O	Data line 1
4	D2	O	Data line 2
5	D3	O	Data line 3
6	D4	O	Data line 4
7	D5	O	Data line 5
8	D6	O	Data line 6
9	D7	O	Data line 7
10	ACK	I	Indicates the printer's readiness to receive the next byte (active LOW).
11	BUSY	I	Signal active if the printer cannot receive any data.
12	PE	I	The signal becomes active if there is no paper in the printer (active HIGH).
13	SELECT	I	The signal becomes active if the printer has been selected (active HIGH).
14	AUTOFEED	O	If the signal is active, the printer automatically performs a line feed after each line (active LOW).
15	ERROR	I	This signal becomes active if there is no paper in the printer, the printer is not selected or the printer has an error status (active LOW).
16	INIT	O	Initialization of the printer (active LOW).
17	SELEct IN	O	If the signal is active, the codes DC1/DC3 are ignored by the printer (active LOW).
18 - 25	GND		Ground connections

Figure 8-8 Assignment of LPT connector

## Monitor Connector (MONITOR)

The 15-pin connector MONITOR on the rear of the instrument allows a VGA monitor to be connected.

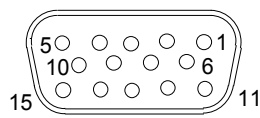

Pin	Signal	Pin	Signal	Pin	Signal
1	Red (output)	6	GND	11	(NC)
2	Green (output)	7	GND	12	(NC)
3	Blue (output)	8	GND	13	HSYNC (output)
4	(NC)	9	GND	14	VSYNC (output)
5	GND	10	GND	15	(NC)

Figure 8-9 Assignment of MONITOR connector



## Index

**&**

&GTL .....	5.3
&GTR .....	5.3
&LLO .....	5.3

**\***

*CLS .....	6.4
*ESE .....	6.4
*ESR .....	6.4
*IDN .....	6.5
*IST .....	6.5
*OPC .....	6.5
*OPT .....	6.5
*PRE .....	6.5
*PSC .....	6.5
*RST .....	6.5
*SRE .....	6.6
*STB .....	6.6
*TRG .....	6.6
*TST .....	6.6
*WAI .....	6.6

**0**

0 dB .....	4.324
0..2 $\pi$ .....	4.395
0..360° .....	4.395

**1**

1 kHz max .....	4.296
1/12 Octave .....	4.310
1/24 Octave .....	4.310
1/3 Octave .....	4.309
1/6 Octave .....	4.309
12 dB Auto .....	4.324
-180..180° .....	4.395

**2**

240 Hz max .....	4.296
-2 $\pi$ ..0 .....	4.395

**3**

30 dB Auto .....	4.324
-360..0° .....	4.395

**6**

60 Hz max .....	4.296
-----------------	-------

**A**

ABORT .....	6.9
Abs Peak .....	4.268, 4.274
AC coupling .....	4.242, 4.274, 4.324
AC supply voltage connector .....	1.15
According to .....	4.340
Acoustic coupling .....	4.335
Acoustical PESQ .....	4.335
Act Curs In button .....	3.80

Act Curs Out button .....	3.80
Activate panel .....	3.22
Activating cursor .....	3.71
Active cursor .....	3.71
Additional measurement functions .....	4.457
Addressed commands .....	8.6
Admissibility of commands (IEC/IEEE) .....	5.22
Adopting parameters .....	3.44
All di .....	4.287
All even di .....	4.287
All odd di .....	4.287
Alphanumeric entries .....	3.42
Amplitude .....	4.343
Analog .....	4.1
Analog analyzer .....	4.140
Analog Aux Out .....	1.14, 3.96
Analog Auxiliaries Out .....	4.442
Analyzer amplitude .....	4.343
Analyzer filter .....	4.245, 4.275, 4.298, 4.311, 4.344, 4.353, 4.377
Analyzer ground .....	4.149
Analyzer sweep system .....	4.256
Anr Sync .....	4.127
Artificial ear .....	4.336
Artificial mouth .....	4.336
Asterisk .....	5.20
Audio Monitor .....	3.94
Audio monitoring channel .....	3.95, 4.440
Audio monitoring tap .....	4.438
Audio quality measurements .....	4.345, 4.348
Audio signal measurement .....	4.345
Auto .....	4.170, 4.175, 4.247, 4.251, 4.264, 4.277, 4.289, 4.296, 4.310
Auto Each .....	4.262
Auto Fast .....	4.247, 4.250, 4.264, 4.276
Auto List .....	4.121, 4.256
Auto Scale .....	4.498, 4.568
Auto Sweep .....	4.121, 4.126, 4.256
Automatic .....	4.384
Automatic sweep .....	4.126
Autorange .....	4.151, 4.160
Autoscale button .....	3.70, 3.80
Autotrigger .....	4.362
AUX IN connector .....	1.14
AUX OUT connector .....	1.14
Auxiliaries panel .....	3.94
Auxiliaries Panel .....	4.443, 4.445
Auxiliary analog output .....	3.96
Average .....	4.404, 4.407, 4.410
Average count .....	4.328
Average mode .....	4.327
Averaging .....	4.327, 4.328
Avg Count .....	4.328
Avg Delay .....	4.343, 4.352
Avg Mode .....	4.327

**B**

Band-pass sweep .....	4.256
Band-stop sweep .....	4.256
Bandwidth .....	4.144, 4.253
Bargraph .....	3.58, 4.285, 4.313
Bargraph scaling .....	3.53
Basic unit .....	4.585
Betw H Curs button .....	3.80
Betw V Curs button .....	3.80
Between Channels .....	4.385
Binary .....	4.386
Binary+Text .....	4.386
Bins .....	4.316
Blackman Harris window .....	4.319



Blue selection frame.....	3.29
Bottom.....	4.500
BP 1 %.....	4.253
BP 1/12 Oct.....	4.254
BP 1/3 Oct.....	4.254
BP 1/3 Oct Fast.....	4.255
BP 3 %.....	4.254
BP Fix.....	4.255
Brief introduction, operation.....	2.4
BS 1 %.....	4.253
BS 1/12 Oct.....	4.254
BS 1/3 Oct.....	4.254
BS 1/3 Oct Fast.....	4.255
BS 3 %.....	4.254
BS Fix.....	4.255
Burst-duration sweep.....	4.123, 4.125
Burst-duration sweep list.....	4.135
Burst-interval sweep.....	4.124, 4.125
Burst-interval sweep list.....	4.135

**C**

CD drive.....	1.8
Chan Status.....	4.171
Change language option.....	4.604
Changes.....	4.385
Changing functions.....	3.30
Changing instrument.....	3.30
Changing unit.....	3.39
Channel.....	4.95, 4.100, 4.480
Channel 1.....	4.359, 4.375
Channel 2.....	4.359, 4.375
Character strings.....	5.19, 6.3
Checkbox.....	3.32
Clock frequency.....	4.6
Close All button.....	3.17
Close button.....	3.84
CLOSE key.....	1.8
Close panel.....	3.22
Collecting measurement values.....	4.484
Colon.....	5.20
Combined display.....	3.50
Comma.....	5.20
Command	
Addressed.....	8.6
Asterisk.....	5.20
Colon.....	5.20
Comma.....	5.20
Crosshatch.....	5.20
Header.....	5.14
Identification.....	5.22
Long form.....	5.16
Parameter.....	5.19
Program message.....	5.17
Query.....	5.17
Question mark.....	5.17
Quotation marks.....	5.20
Semicolon.....	5.20
Short form.....	5.16
Structure.....	5.14
Suffix.....	5.16
Synchronization.....	5.25
Syntax elements.....	5.20
Universal.....	8.6
White space.....	5.20
Command (IEC/IEEE)	
Admissibility.....	5.22
Command sequence (IEC/IEEE).....	5.22
Common.....	4.149
Common commands.....	6.4
Completing settings.....	3.45

Compressed.....	4.356
Compression factor.....	4.331
Compression factors.....	4.357
Computer name.....	1.40, 1.50
CONDition register part.....	5.29
Consumer.....	4.384
CONT key.....	1.5
Conversion formula for dig. phase meas. results.....	3.114
Conversion formula for group delay meas. results.....	3.114
Conversion formulae.....	3.110
Conversion formulae for absolute analog level units.....	3.115
Conversion formulae for absolute digital level units.....	3.115
Conversion formulae for absolute phase units.....	3.117
Conversion formulae for absolute time units.....	3.116
Conversion formulae for analog level meas. results.....	3.111
Conversion formulae for digital level meas. results.....	3.112
Conversion formulae for distortion meas. results.....	3.112
Conversion formulae for frequency meas. results.....	3.113
Conversion formulae for jitter measurement results.....	3.114
Conversion formulae for phase meas. results.....	3.113
Conversion formulae for relative analog level units.....	3.115
Conversion formulae for relative digital level units.....	3.116
Conversion formulae for relative frequency units.....	3.116
Converting units.....	3.39, 3.110
Copy.....	6.33
Copy to Ch2.....	4.562
Copy to other Window.....	4.460
Copying of files.....	6.33
Create new directory.....	6.34
Create New Directory.....	6.34
Critical Bands.....	4.310
Crossed.....	4.103
Crosshatch.....	5.20
Cursor key.....	1.7
Curve button.....	3.70

**D**

d2 (IEC 118).....	4.303
d2 (IEC 268).....	4.302
d3 (IEC 118).....	4.303
d3 (IEC 268).....	4.302
Data List.....	4.460
Data List button.....	3.83
Data lists.....	3.82
DC.....	4.271, 4.400
DC coupling.....	4.242, 4.274, 4.323
DC Offset.....	4.98, 4.105
DC Suppress.....	4.241, 4.274, 4.323
DC suppression.....	4.241, 4.274
DC voltage.....	4.271, 4.443
DCL.....	5.22
Default	
Status reporting system.....	5.46
Default instrument settings.....	6.29
Default settings - entire instrument.....	1.24
Deg Level.....	4.343, 4.351
Delay Ch1.....	4.323
Delay compensation.....	4.323
Delay Detect.....	4.352
Delay measurement.....	4.364
Delay versus time.....	4.337
Delayed triggering.....	4.153, 4.165
Delete.....	6.34
Deletion of files.....	6.34
Description A.....	4.529
Description B.....	4.529
DFD.....	4.301
DI value.....	4.346, 4.350
Difference cursor.....	3.72
Dig Inp Amp.....	4.397

Digital filter .4.245, 4.275, 4.298, 4.311, 4.344, 4.353, 4.377  
 DIM ..... 4.304  
 Direct mode ..... 3.37, 3.38, 3.45  
 Disp Config button ..... 3.87  
 Display ..... 3.12, 3.86, 4.459, 4.561  
 Display Configuration panel ..... 4.457, 4.458  
 Display fields ..... 3.43  
 Display Mode ..... 4.384  
 Display window ..... 3.21  
   TRACK ..... 4.494, 4.495  
   USER ..... 4.497  
   SOURce ..... 4.504, 4.506  
   USER ..... 4.497  
 Displays button ..... 3.88  
 Distortion ..... 4.286, 4.287  
 Distortion measurement ..... 4.280, 4.291  
 Distortion voltage ..... 4.287, 4.288  
 Division ..... 4.501, 4.527, 4.570  
 Downward sweep ..... 4.131, 4.134, 4.258  
 Dropouts versus time ..... 4.337  
 DUT ..... 4.342  
 DVD drive ..... 1.8  
 Dwell File ..... 4.128  
 Dwell sweep ..... 4.126  
 Dwell time ..... 4.127  
 Dwell Value ..... 4.127  
 Dwell-time list ..... 4.128  
 Dynamic intermodulation distortion analysis ..... 4.304  
 Dynamic Mode ..... 4.282  
 Dynamic response ..... 4.282

**E**

Edge Trig ..... 4.228  
 Edge Trig Ch1 ..... 4.228  
 Edge Trig Ch2 ..... 4.228  
 Edit button ..... 3.86  
 Edit mode ..... 3.42, 3.45  
 Editing trace files ..... 4.598  
 Electrical PESQ ..... 4.335  
 ENABle register part ..... 5.30  
 Engineering ..... 4.497, 4.521, 4.550, 4.564  
 ENTER key ..... 1.4  
 Enter strings (IEC/IEEE) ..... 6.3  
 Entering unit ..... 3.39  
 Entries during data output ..... 3.46  
 Entries during measurement ..... 3.46  
 Entry field, numeric ..... 3.36, 3.37, 3.38  
 Entry information ..... 3.44  
 Equalization  
   inverted frequency response ..... 4.533  
   multistage preemphasis ..... 4.534  
   normalization frequency ..... 4.533  
   offset ..... 4.535  
   offset value ..... 4.535  
 Equalizer ..... 4.284, 4.312, 4.326  
 Error messages ..... 3.20  
 Error queue query ..... 5.45, 6.29  
 ESC key ..... 1.4  
 ESE (event status enable) ..... 5.34  
 ESR (event status register) ..... 5.34  
 Ethernet ..... 1.36  
 Evaluating with cursors and markers ..... 3.69  
 Even Harmonics ..... 4.288  
 EVENT register part ..... 5.30  
 Example  
   Measuring frequency response ..... 2.20  
   Measuring harmonic distortion ..... 2.31  
 Example setups ..... 2.38  
 Examples of Settling for Start Conditions ..... 4.415  
 Excel ..... 4.604

Exponential ..... 4.327, 4.404, 4.407, 4.410, 4.413  
 Exponential averaging ..... 4.327, 4.328  
 Export ..... 4.604  
 External frequency sweep ..... 4.227  
 External keyboard ..... 1.26  
 External level sweep ..... 4.227  
 External sweep ..... 4.221, 4.231  
 Externally controlled measurement value recording ..... 4.221  
 Extreme values ..... 3.55, 3.65

**F**

Factor ..... 4.262, 4.266  
 Falling ..... 4.361, 4.376  
 Fast ..... 4.393  
 Fast Fourier Transformation ..... 4.316  
 Fast measurement ..... 4.282  
 FFT  
   Phase ..... 4.473  
   Phase difference ..... 4.474  
 FFT analysis ..... 4.316  
 FFT as measurement function ..... 4.316, 4.321  
 FFT bandwidth ..... 4.331, 4.332  
 FFT graph ..... 3.57, 4.458  
 FFT size ..... 4.315, 4.316, 4.317  
 FFT span ..... 4.331, 4.332  
 FFT start ..... 4.332  
 FFT stop ..... 4.332  
 FFT value ..... 4.315  
 File ..... 4.99  
 File button ..... 3.86  
 File extensions ..... 3.107  
 File Length ..... 4.375  
 File list ..... 6.32  
 File management ..... 3.102  
 File Select window ..... 3.104  
 Filename ..... 4.259, 4.342, 4.351  
 Filter ..... 4.97, 4.105, 4.245, 4.275, 4.298, 4.311,  
   ..... 4.325, 4.344, 4.353, 4.377  
 Filter button ..... 3.85  
 Filter characteristic ..... 4.255  
 Find Cursor button ..... 3.84  
 Firmware version ..... 6.5  
 Fix ..... 4.260, 4.265  
 Fix 1000 ms ..... 4.269, 4.278  
 Fix 200 ms ..... 4.269, 4.278  
 Fix 3 s ..... 4.271, 4.278  
 Fix 50 ms ..... 4.269, 4.278  
 Fix All Sizes button ..... 3.17  
 Fix Size button ..... 3.17  
 Fixed range ..... 4.151  
 Fixrange ..... 4.160  
 Flat ..... 4.404, 4.407, 4.410, 4.414  
 Flat Top window ..... 4.320  
 Fnct Settling ..... 4.403  
 Focus ..... 3.29  
 Forever ..... 4.386  
 Format Phase ..... 4.394  
 Formula for S/N measurements ..... 3.113  
 Free Text ..... 4.528, 4.529  
 Freezing graphic ..... 4.484  
 Freq ..... 4.227  
 Freq & Grp Del ..... 4.391  
 Freq & Phase ..... 4.390  
 Freq & Samplefreq ..... 4.392  
 Freq Ch1 ..... 4.227, 4.261  
 Freq Ch2 ..... 4.227, 4.261  
 Freq Fast ..... 4.227  
 Freq Fast Ch1 ..... 4.227  
 Freq Fast Ch2 ..... 4.227  
 Freq File ..... 4.135

Freq Mode.....	4.260, 4.265	Horiz Size button.....	3.16
Freq RefCh.....	4.262	Horizontal cursors.....	3.72
Freq Settling.....	4.406, 4.409	Hum loops, avoiding.....	2.3
Freq/Phase.....	4.389		
Frequency.....	4.123, 4.125, 4.390	<b>I</b>	
Frequency band analysis.....	4.308	IEC/IEEE bus	
Frequency measurement.....	4.389	Interface functions.....	8.5
Frequency range.....	4.316	IEC/IEEE bus adresse.....	6.29
Frequency resolution.....	4.317	IEC/IEEE bus commands	
Frequency sweep.....	4.123, 4.125	Preset.....	5.22
Frequency sweep list.....	4.135, 4.259	IEC-bus interface.....	1.15
From Output.....	4.385	Import from.....	4.515
Frq Lim Low.....	4.267, 4.299, 4.313	Infinite.....	4.396
Frq Lim Upp.....	4.267, 4.299, 4.313	Information.....	3.19
Full Screen button.....	3.16	Infrasound.....	4.329, 4.379
Function.....	4.307, 4.309, 4.322, 4.339, 4.349, 4.372	Infrasound analysis.....	4.379
Function FFT.....	4.316, 4.321	Infrasound signals.....	4.379
Function groups.....	3.24	INIT command (IEC/IEEE).....	5.25
Function level.....	3.5	INIT-Befehl (IEC).....	5.25
Fundamental.....	4.289, 4.296	Initializing	
Fundamental rejection.....	4.295	Status reporting system.....	5.46
		TIMEout.....	6.8
<b>G</b>		INPut	
Gen Burst.....	4.360	SYNCto.....	4.187
Gen Track.....	4.243, 4.249, 4.253, 4.261, 4.265,	Input buffer.....	5.21
	4.266, 4.277, 4.290, 4.297, 4.325	Input channel.....	4.143
Generator ground.....	4.5	Input configuration.....	4.146
Generator level control.....	4.6	Input coupling.....	4.144, 4.158
Generator output.....	4.4	Input Impedance.....	4.148
Generator sweep system.....	4.121	Input level.....	3.5, 4.397
Generator sweeps.....	4.119	Input Monitor.....	4.397
GET (Group Execute Trigger).....	5.22	Input resistor.....	4.148
Gibbs phenomenon.....	4.268	Installed options.....	6.5
Graphic		Instrument.....	4.1, 4.140
Freezing.....	4.484	Instrument settings - reset.....	1.24, 6.5
Graphic system		INSTrument2.....	4.140
Bargraph.....	4.480	Instruments button.....	3.87
FFT Graph.....	4.472	Integration time.....	4.317
Histogram.....	4.477	Interface - IEC-bus.....	1.15
Sweep Graph.....	4.465	Interface functions	
Waveform.....	4.475	IEC/IEEE bus.....	8.5
Graphical windows.....	3.56	Interface messages.....	5.13
Graphs with PESQ.....	4.337	Internal resistor.....	4.5
Green selection frame.....	3.29, 3.45	International Telecommunication Union.....	4.333, 4.345
Gridlines.....	3.54, 3.64, 3.67	Interpolation.....	4.547
Ground socket.....	1.8	Interrupt.....	5.43
		Interval.....	4.124, 4.125
<b>H</b>		Interval File.....	4.135
H COPY key.....	1.6	Intv Time.....	4.269, 4.271
Hamming window.....	4.319	Invert.....	4.533
Hann window.....	4.318	Inverted frequency response.....	4.533
Hardware options.....	6.5	IP address.....	1.40, 1.50
Harmonics button.....	3.79	IST flag.....	5.34, 6.5
Header.....	5.14	ITU.....	4.333, 4.345
Headlines in panels.....	3.24	ITU P.862.....	4.334
Headphone connector.....	1.8	ITU P.862.1.....	4.334
Help button.....	3.89	ITU P.862.2.....	4.334
HELP key.....	1.8		
Help system.....	3.99	<b>K</b>	
Help text language.....	3.100	Keyboard.....	1.26
HIDE key.....	1.8		
Hide panel.....	3.22	<b>L</b>	
Hiding parameter fields.....	3.31	Label Auto.....	4.483, 4.521
Hiding traces.....	3.70	LAN.....	1.36
Highlight.....	4.385	LAN interface.....	1.13
Highlighting control elements.....	3.32	Leakage.....	4.318
Histogram.....	4.458	Left.....	4.526, 4.569
History.....	4.463	Lev Trig.....	4.228
Horiz Move button.....	3.16		

- Lev Trig Ch1 ..... 4.228  
 Lev Trig Ch2 ..... 4.228  
 Level all di ..... 4.288  
 Level even di ..... 4.288  
 Level measurements ..... 4.241  
 Level meter ..... 4.397, 4.399  
 Level Monitor ..... 4.399  
 Level Noise ..... 4.294  
 Level odd di ..... 4.288  
 Level Select di ..... 4.287  
 Level sweep ..... 4.123, 4.125  
 Level sweep list ..... 4.134  
 Level THD+N ..... 4.294  
 Limit  
     parallel shifting ..... 4.512  
     symmetrical shift ..... 4.513  
 Limit curve ..... 4.577  
 Limit Lower ..... 4.507, 4.550, 4.571  
 Limit Shift ..... 4.511  
 Limit Upper ..... 4.503, 4.550, 4.572  
 Limit value curve ..... 4.577  
 Limits ..... 3.54, 3.64  
 Lin Points ..... 4.130, 4.257  
 Lin Steps ..... 4.130, 4.257  
 Linear step size ..... 4.133, 4.259  
 Linear sweep ..... 4.129, 4.130, 4.257  
 List display ..... 3.82  
 List sweep ..... 4.134  
 List-controlled sweep ..... 4.134  
 LOAD key ..... 1.8  
 Loading and saving traces / scans ..... 3.68  
 Loading predefined instrument setups ..... 2.38  
 Loading, saving instrument settings ..... 3.106  
 LOCAL key ..... 1.6, 5.4, 5.10  
 Log Points ..... 4.130, 4.257  
 Log Steps ..... 4.131, 4.257  
 Logarithmic step size ..... 4.133, 4.259  
 Logarithmic sweep ..... 4.129, 4.130, 4.131, 4.257  
 Long ..... 4.386  
 Loop Channel ..... 4.102  
 Loop Gain ..... 4.104  
 Loudspeaker ..... 4.437  
 Low-distortion generator ..... 3.2  
 Lower Limit ..... 4.558
- M**
- Macros button ..... 3.88  
 Magenta selection frame ..... 3.29, 3.37, 3.38, 3.45  
 Main Grid ..... 4.500, 4.526, 4.569  
 Maintenance ..... 8.1  
 Manual ..... 4.360, 4.376  
 Manual Control  
     Changing to ..... 5.4, 5.10  
 Manual List ..... 4.122  
 Manual remote operation ..... 3.109  
 Manual Sweep ..... 4.122  
 Marker ..... 4.453  
 Markers ..... 3.79  
 Maximum output voltage ..... 2.2  
 Meas Channels ..... 4.157  
 Meas Mode ..... 4.268, 4.273, 4.286, 4.293,  
     4.302, 4.309, 4.341, 4.354  
 Meas Time ..... 4.246, 4.250, 4.263, 4.276,  
     4.310, 4.317, 4.393  
 Measurement  
     Triggering (IEC/IEEE) ..... 5.24  
 Measurement delay ..... 4.153, 4.165  
 Measurement displays ..... 3.47  
 Measurement result display in combined fields ..... 3.51  
 Measurement result display in graphical windows ..... 3.60  
 Measurement result display in numeric display field ..... 3.49  
 Measurement scans  
     Append ..... 4.587  
     Replace ..... 4.587  
 Measurement signal versus time ..... 4.337  
 Measurement speed ..... 4.295, 4.393  
 Measurement value sequences ..... 4.580  
 Measurement value trigger ..... 4.153, 4.164  
 Memory depth ..... 4.358  
 Menu bar ..... 1.3  
 MENU key ..... 1.4  
 Microsoft Excel ..... 4.604  
 Min Volt ..... 4.232  
 Min/Max curve ..... 4.454  
 Min/Max curve display ..... 4.464  
 Min/Max values ..... 3.55  
 MOD DIST ..... 4.299  
 Modify Equ ..... 4.534  
 MODIFY key ..... 1.8  
 Monitor  
     Connecting ..... 1.27  
     Connector ..... 8.17  
 Monitor connector ..... 1.13  
 Monitor level ..... 3.5  
 Mono Left ..... 4.95, 4.100  
 Mono Right ..... 4.95, 4.100  
 MOS ..... 4.334  
 MOS LQO ..... 4.334  
 MOS P.862.1 ..... 4.340  
 MOS P.862.1 Silence ..... 4.341  
 MOS P.862.1 Speech ..... 4.341  
 MOS P.862.2 ..... 4.341  
 MOS P.862.2 Silence ..... 4.341  
 MOS P.862.2 Speech ..... 4.341  
 MOS value ..... 4.334  
 MOS versus time ..... 4.337  
 MOS-value ..... 4.340  
 Mouse ..... 1.26  
 Movement button ..... 3.72  
 Moving cursor ..... 3.73  
 Multi scan ..... 4.462  
 Multistage preemphasis ..... 4.534
- N**
- Narrow ..... 4.295  
 Navigating in lists ..... 3.84  
 Navigating in panels ..... 3.27  
 Navigation keys ..... 1.4  
 Neg Peak ..... 4.268, 4.273  
 Network connector ..... 1.36  
 New Scan ..... 4.514  
 Next Bin button ..... 3.75  
 Next Harmonic button ..... 3.75  
 Next Peak button ..... 3.74, 3.75  
 Next Pixel button ..... 3.74, 3.75, 3.76  
 Next Sample button ..... 3.76  
 Next Step ..... 4.126  
 Next Step button ..... 3.74  
 Next Value button ..... 3.77  
 Noise ..... 4.294  
 Noise Density ..... 4.489  
 Noise factor ..... 4.294  
 Norm Freq ..... 4.533  
 Normal averaging ..... 4.327, 4.328  
 Normalization ..... 4.492  
 Normalization frequency ..... 4.533  
 Normalization value ..... 4.492  
 Normalize Value ..... 4.493  
 Normalizing trace ..... 4.492  
 Notch characteristic ..... 4.244

Notch filter ..... 4.242, 4.243, 4.283, 4.324  
 Notch Freq ..... 4.243, 4.324  
 Notch frequency ..... 4.243, 4.324  
 Notch gain ..... 4.242  
 Notch(Gain) ..... 4.242, 4.324  
 Notch-filter center frequency ..... 4.243  
 Nothing ..... 4.385  
 Nth octave analysis ..... 4.308  
 NTRansition register part ..... 5.30  
 Number of displayed digits ..... 3.55  
 Numeric display ..... 4.552  
 Numeric display field ..... 3.48  
 Numeric entry field ..... 3.36, 3.37, 3.38  
 Numeric value (commands) ..... 5.19

**O**

Octave ..... 4.309  
 Odd Harmonics ..... 4.289  
 ODG value ..... 4.346, 4.350  
 Off... 4.103, 4.389, 4.397, 4.399, 4.403, 4.407, 4.409, 4.413  
 Offline ..... 4.342  
 Offline measurement ..... 4.350  
 Offset ..... 4.535  
 Offset Value ..... 4.535  
 ON key ..... 1.5  
 On Time ..... 4.123, 4.125  
 On Time File ..... 4.135  
 One-dimensional sweep ..... 4.122, 4.125  
 Open panel ..... 3.22  
 Opening combined display ..... 3.50  
 Opening graphical window ..... 3.59  
 Opening result list ..... 3.83  
 Operating cursor ..... 3.71  
 Operation examples ..... 2.20  
 Operation with mouse ..... 3.10  
 Out-of-band signals ..... 4.242, 4.283  
 Output channel ..... 4.3  
 Output impedance ..... 4.5  
 OUTPUT key ..... 1.6  
 Output level ..... 4.441  
 Output level limitation ..... 4.7  
 Overload protection ..... 4.148

**P**

PAGE key ..... 1.4  
 Panel ..... 3.21  
 Panel structure ..... 3.23  
 Panel types ..... 3.21  
 Panels for configuring measured value display ..... 3.47  
 Parallel ..... 4.512  
 Parallel poll) ..... 5.45  
 Parallel shifting ..... 4.512  
 Parameter  
   Character string ..... 5.19  
   Numeric value ..... 5.19  
   Text ..... 5.19  
 Parameter fields ..... 3.23  
 Parameter setting ..... 3.28  
 PC keyboard ..... 3.11  
 Peak ..... 4.268, 4.397, 4.400  
 Peak to Peak ..... 4.268  
 Peak Voltage ..... 4.97  
 PEAQ analogue ..... 4.348  
 PEAQ Device Under Test ..... 4.347  
 PEAQ digital ..... 4.348  
 PEAQ DUT ..... 4.347  
 PEAQ electrical ..... 4.347  
 PEAQ graphics ..... 4.347  
 PEAQ measurement signal ..... 4.345

PEAQ offline ..... 4.350  
 PEAQ reference signal ..... 4.345  
 PEAQ waveform ..... 4.347  
 Persistence ..... 4.385  
 PESQ ..... 4.458  
 PESQ application program ..... 4.336  
 PESQ Device Under Test ..... 4.335  
 PESQ DUT ..... 4.335  
 PESQ graph ..... 3.58  
 PESQ graphs ..... 4.337  
 PESQ measurement signal ..... 4.333  
 PESQ MOS ..... 4.334  
 PESQ Offline ..... 4.341  
 PESQ P.862 ..... 4.340  
 PESQ reference signal ..... 4.333  
 PESQ score ..... 4.334  
 PESQ Silence ..... 4.340  
 PESQ Speech ..... 4.340  
 PESQ value ..... 4.334, 4.340  
 PESQ versus time ..... 4.337  
 PESQ waveform ..... 4.337  
 Phase ..... 4.123, 4.125  
 Phase display format ..... 4.394  
 Phase File ..... 4.135  
 Phase sweep list ..... 4.135  
 Phase To Ref ..... 4.397  
 Phase-Sweep ..... 4.123, 4.125  
 Pk to Pk ..... 4.274  
 Play ..... 4.93, 4.342, 4.343  
 Play Mode ..... 4.96, 4.100  
 Play Peak ..... 4.104  
 Play+Anlr ..... 4.98  
 Plot ..... 4.561  
 Points ..... 4.132, 4.231, 4.258  
 Polarity measurement ..... 4.307  
 Poles ..... 4.425  
 Pos Peak ..... 4.268, 4.273  
 Post FFT ..... 4.314, 4.316, 4.320  
 Post-FFT ..... 4.285  
 Power supply connection ..... 1.20  
 PPE (parallel poll enable) ..... 5.34  
 Prec ..... 4.394  
 Precision ..... 4.394  
 Precision measurement ..... 4.282, 4.283  
 Preemphasis  
   inverted ..... 4.533  
   multistage ..... 4.534  
   offset ..... 4.535  
   offset value ..... 4.535  
 Prefiltering ..... 4.159  
 Preset ..... 6.5  
 PRESET key ..... 1.8, 1.24  
 Preset settings ..... 6.5, 6.29  
 Presets (IEC/IEEE) ..... 5.22  
 Pretrigger ..... 4.377  
 Printer  
   Connector ..... 8.16  
 Printer interface ..... 1.13  
 Professional ..... 4.384  
 Prot Analysis ..... 4.383  
 Protocol analysis ..... 4.383  
 Psychoacoustic coding ..... 4.333, 4.345  
 Psychoacoustic compression ..... 4.333, 4.345  
 PTRansition register part ..... 5.29

**Q**

Quasi Peak ..... 4.270, 4.273  
 Query ..... 5.17, 5.45  
 Question mark ..... 5.17  
 Quotation marks ..... 5.20

**R**

Rack installation	1.17
Radio button	3.33
Random sweep	4.134
Range	4.151
Rapid deactivation of outputs	4.148
Rear audio monitoring output	4.442
Record File	4.373
Record Length	4.343, 4.351, 4.374
Recording length	4.358
Rectangular window	4.318, 4.319
Ref Level	4.343, 4.351
Ref Voltage	4.26
Reference	4.485, 4.565
Reference channel	4.222, 4.262, 4.389
Reference File	4.492
Reference frequency	4.8, 4.27, 4.28, 4.37
Reference impedance	4.153, 4.163
Reference level	4.8, 4.26, 4.28, 4.37
Reference resistance	4.153, 4.163
Reference signal versus time	4.337
Reference value	3.40, 3.53, 3.63, 3.66, 4.485, 4.565
Reference voltage	4.8, 4.28, 4.37
Reject Bandw	4.295
Rejection	4.295
Remote Control - Changing to	5.3
Remote Control - Ethernet/LAN	5.5
Remote control - IEC/IEEE bus	5.4
Rename	6.35
Renaming of files	6.35
Reset	
Status reporting system	5.46
Reset - instrument settings	1.24
Reset – Instrument settings	6.5
Resetting Min/Max curves	4.464
Resolution	3.55, 3.68, 4.317, 4.405, 4.408, 4.411, 4.415, 4.536, 4.551, 4.564
Restart Min/Max, Lim Violation button	3.81
Result lists	3.83
Rife Vincent 1	4.319
Rife Vincent 2	4.319
Rife Vincent 3	4.319
Right	4.526, 4.569
Rising	4.361, 4.376
RMS	4.246, 4.273, 4.399
RMS measurement	4.246
RMS measurement, selective	4.249
RMS Selective	4.249
RMS, broadband	4.246
RMS, selective	4.249
Rotary knob	1.7, 3.9
RS-232-C interface	1.13
Rub & Buzz Measurement	4.263

**S**

S/N measurements	4.272
S/N Sequence	4.279
Sample Freq	4.392
Samples	4.405, 4.408, 4.410, 4.414
SAVE key	1.8
Scale for audio quality	4.345
Scale Pk to FS	4.94, 4.343
Scaling	4.524
Scaling graph	3.70, 3.80
Scan	4.460, 4.538
Index	4.546
SCAN key	1.4
Scan number	4.538

Scans	
Append	4.587
Import	4.587
Importing	4.588
Replace	4.587
SCPI	
Version	5.1
SCREEN key	1.4
Screens	3.12
Screens buttons	3.86
SDG value	4.345
Select di	4.286
Selection field	3.34
Selftest	6.6
Semicolon	5.20
Serial interface	8.10
Serial poll	5.43
Service request (SRQ)	5.32, 5.43, 6.6
Set cursor	3.71
Set to Cursors button	3.79
Setting AC supply voltage	1.20, 8.2
Setting parameters	3.28
Settings in menu bar	3.86
Settings in operating system	3.94
Settings in the Toolbar	3.91
Settling	4.413
Settling algorithms	4.402
Settling Applications	4.401
Settling for Frequency Measurements	4.406
Settling for Measurement Functions	4.403
Settling for Phase Measurements	4.409
Settling for Start Conditions	4.412
Settling Methods	4.401
Several individual scans	3.78, 3.85
Shape File	4.94
Short	4.386
Show	4.354, 4.383
Show A	4.528
Show A button	3.70
Show B	4.528
Show B button	3.70
Show Min/Max	4.464, 4.574
Showing traces	3.70
SHUT-DOWN key	1.6
Signal delay time axis	4.343
Signal source	4.438
Signal Source field	3.95
Signal to noise measurements	4.272
SINAD	4.291, 4.293
SINGLE key	1.5
Single scan	4.461, 4.544
Slope of bell-shaped curve	4.319
Softkey bar	1.3, 3.14
Softkey menu	
Combi display	4.574
Softkeys	1.3, 3.14
Software options	6.5
Source	3.62, 4.503, 4.507
Source Filename	4.506, 4.511
Source Value	4.506, 4.510
Spacing	4.129, 4.257, 4.498, 4.525, 4.568
Speaker	4.437
Spectral display	4.316
Spectral range	4.316
Spectrum	4.316
Speech quality measurements	4.333, 4.338
Speech quality scale	4.333
Speech signal measurement	4.333
SRE (service request enable)	5.32
SRQ (service request)	6.6
Standard	4.355
Start	4.131, 4.233, 4.258, 4.332



USB	
Connectors .....	8.14
USB interface .....	1.7, 1.13
User-defined unit designation .....	4.497
Utilities button .....	3.89

**V**

Valid value range .....	3.19
Value range .....	3.44
Variation .....	4.234
Version .....	4.350
Vert Move button .....	3.16
Vert Size button .....	3.17
Vertical cursors .....	3.72
View Mode .....	4.386
Virus-protection software .....	1.36
Volt .....	4.227
Volt Ch1 .....	4.227
Volt Ch2 .....	4.227
Voltage .....	4.123, 4.125
Volume .....	3.96, 4.441
Volume key .....	1.5, 3.96

**W**

Warnings .....	3.20
Waveform .....	3.57, 4.354, 4.458
Waveform monitor .....	4.223, 4.354
Weighting filter .....	4.245, 4.275, 4.298, 4.311, 4.344, 4.353, 4.377
White space .....	5.20
Wide .....	4.295
WINBAR .....	1.3, 3.15
Window .....	4.315, 4.318
Window function .....	4.315, 4.318
WINDOW key .....	1.4
Windows button .....	3.89
WindowsXP access .....	1.25
Wordwidth	
Digital analyzer .....	4.172

**X**

X Axis .....	4.123, 4.518
X-axis .....	3.66
X-axis scaling .....	3.67
X-Source .....	4.515

**Y**

Y-axis .....	3.62
Y-axis scaling .....	3.63
Y-Source .....	4.465, 4.472, 4.475, 4.477, 4.478
Bargraph .....	4.480

**Z**

Z Axis .....	4.124
Zeros .....	4.425
Zoom button .....	3.80
Zooming graph .....	3.80





# Alphabetical List of Commands

## A

ARM:FREQuency:START .....	4.236
ARM:FREQuency:STOP .....	4.236
ARM:LEVel:MIN .....	4.235
ARM:VOLTage:START .....	4.236
ARM:VOLTage:STOP .....	4.236
AUXiliaries: AUDMonitor .....	4.443
AUXiliaries: PHONe .....	4.444
AUXiliaries: PHPermanent .....	4.444
AUXiliaries:AAUXout .....	4.449
AUXiliaries:DCValue .....	4.450
AUXiliaries:SPEaker .....	4.444
AUXiliaries:SPEaker:CHANnel .....	4.447
AUXiliaries:SPEaker:SOURce .....	4.445
AUXiliaries:SPEaker:VOLume .....	4.448
AUXiliaries:TRIGger:INPut:ENABLE .....	4.451
AUXiliaries:TRIGger:INPut:MODE .....	4.452
AUXiliaries:TRIGger:OUTPut:EDGE .....	4.451
AUXiliaries:TRIGger:OUTPut:ENABLE .....	4.450
AUXiliaries:TRIGger:OUTPut:FREQuency .....	4.451
AUXiliaries:TRIGger:OUTPut:MODE .....	4.450

## D

DIAGnostic:OPERation:BITNo .....	6.24
DIAGnostic:OPERation:VALue .....	6.24
DIAGnostic:QUESTionable:BITNo .....	6.24
DIAGnostic:QUESTionable:MEASuring:BITNo .....	6.24
DIAGnostic:QUESTionable:MEASuring:VALue .....	6.24
DIAGnostic:QUESTionable:OVERrange:BITNo .....	6.24
DIAGnostic:QUESTionable:OVERrange:VALue .....	6.24
DIAGnostic:QUESTionable:UNDERrange:BITNo .....	6.24
DIAGnostic:QUESTionable:UNDERrange:VALue .....	6.24
DIAGnostic:QUESTionable:VALue .....	6.24
DIAGnostic:XQUESTionable:BITNo .....	6.24
DIAGnostic:XQUESTionable:VALue .....	6.24
DISPlay:BARgraph<i>:A B:BOTTom .....	4.504
DISPlay:BARgraph<i>:A B:LIMLower .....	4.512
DISPlay:BARgraph<i>:A B:LIMLower:SOURce .....	4.513, 4.514, 4.515, 4.516
DISPlay:BARgraph<i>:A B:LIMShift .....	4.516, 4.517, 4.518
DISPlay:BARgraph<i>:A B:LIMUpper .....	4.507
DISPlay:BARgraph<i>:A B:NORMalize .....	4.495
DISPlay:BARgraph<i>:A B:NORMalize:VALue .....	4.496
DISPlay:BARgraph<i>:A B:REFerence .....	4.489, 4.490, 4.491, 4.492, 4.493, 4.495
DISPlay:BARgraph<i>:A B:REFerence:VALue .....	4.494
DISPlay:BARgraph<i>:A B:SPACing .....	4.503
DISPlay:BARgraph<i>:A B:TOP .....	4.504
DISPlay:BARgraph<i>:A B:UNIT .....	4.499, 4.500
DISPlay:BARgraph<i>:A B:UPDate .....	4.487, 4.488
DISPlay:BARgraph<i>:A B:YSource .....	4.481, 4.482
DISPlay:BARgraph<i>:DLISt:FILTer .....	6.38
DISPlay:BARgraph<i>:OCURsor XCURsor:MODE .....	6.34
DISPlay:BARgraph<i>:OCURsor XCURsor:POSMode .....	6.35
DISPlay:BARgraph<i>:OCURsor XCURsor:SETTo:XPOS .....	6.37
DISPlay:BARgraph<i>:OCURsor XCURsor:SETTo:YPOS .....	6.37
DISPlay:BARgraph<i>:OCURsor XCURsor:STATe .....	6.38
DISPlay:BARgraph<i>:OCURsor XCURsor:Y? .....	6.38
DISPlay:BARgraph<i>:SCANoffset .....	4.541
DISPlay:BARgraph<i>:TRACk:LIMit .....	4.485, 4.486
DISPlay:FFT<i>:A B:CHANnel .....	4.484
DISPlay:FFT<i>:A B:LIMLower .....	4.512
DISPlay:FFT<i>:A B:LIMLower:SOURce .....	4.513, 4.514, 4.515, 4.516
DISPlay:FFT<i>:A B:LIMShift .....	4.516, 4.517, 4.518
DISPlay:FFT<i>:A B:LIMUpper .....	4.507

DISPlay:FFT<i>>:A|B:MARKer:HARMonics ..... 6.33

DISPlay:FFT<i>>:A|B:MARKer:MODE ..... 6.33

DISPlay:FFT<i>>:A|B:MARKer:SETTo:XPOS ..... 6.34

DISPlay:FFT<i>>:A|B:NORMalize ..... 4.495

DISPlay:FFT<i>>:A|B:NORMalize:VALue ..... 4.496

DISPlay:FFT<i>>:A|B:REFerence ..... 4.489, 4.490, 4.491, 4.492, 4.493, 4.495

DISPlay:FFT<i>>:A|B:REFerence:VALue ..... 4.494

DISPlay:FFT<i>>:A|B:SPACing ..... 4.503

DISPlay:FFT<i>>:A|B:UNIT ..... 4.499, 4.500

DISPlay:FFT<i>>:A|B:UPDate ..... 4.487, 4.488

DISPlay:FFT<i>>:A|B:YSource ..... 4.477, 4.478, 4.479

DISPlay:FFT<i>>:DLISt:FILTer ..... 6.38

DISPlay:FFT<i>>:OCURsor|XCURsor:MODE ..... 6.34

DISPlay:FFT<i>>:OCURsor|XCURsor:POSMode ..... 6.35

DISPlay:FFT<i>>:OCURsor|XCURsor:SETTo:XPOS ..... 6.37

DISPlay:FFT<i>>:OCURsor|XCURsor:SETTo:YPOS ..... 6.37

DISPlay:FFT<i>>:OCURsor|XCURsor:STATe ..... 6.38

DISPlay:FFT<i>>:OCURsor|XCURsor:Y? ..... 6.38

DISPlay:FFT<i>>:SCANoffset ..... 4.541, 6.13

DISPlay:FFT<i>>:TRACk:LIMit ..... 4.485, 4.486

DISPlay:FFT<i>>:X:LEFT ..... 4.530

DISPlay:FFT<i>>:X:REFerence:VALue ..... 4.528

DISPlay:FFT<i>>:X:RIGHT ..... 4.530

DISPlay:FFT<i>>:X:SCALing ..... 4.529

DISPlay:FFT<i>>:X:SPACing ..... 4.529, 4.530

DISPlay:FFT<i>>:X:UNIT ..... 4.525

DISPlay:FFT<i>>:X:UNIT:AUTO ..... 4.527, 4.528

DISPlay:FFT<i>>:X:UNIT:USER ..... 4.528

DISPlay:FFT:A|B:BOTTom ..... 4.504

DISPlay:FFT:A|B:TOP ..... 4.504

DISPlay:PESQ<i>>:A|B:BOTTom ..... 4.504

DISPlay:PESQ<i>>:A|B:LIMLower ..... 4.512

DISPlay:PESQ<i>>:A|B:LIMLower:SOURce ..... 4.513, 4.514, 4.515, 4.516

DISPlay:PESQ<i>>:A|B:LIMUpper ..... 4.507

DISPlay:PESQ<i>>:A|B:MARKer:MODE ..... 6.33

DISPlay:PESQ<i>>:A|B:MARKer:SETTo:XPOS ..... 6.34

DISPlay:PESQ<i>>:A|B:SPACing ..... 4.503

DISPlay:PESQ<i>>:A|B:TOP ..... 4.504

DISPlay:PESQ<i>>:A|B:UPDate ..... 4.487, 4.488

DISPlay:PESQ<i>>:A|B:YSource ..... 4.482, 4.483

DISPlay:PESQ<i>>:DLISt:FILTer ..... 6.38

DISPlay:PESQ<i>>:OCURsor|XCURsor:MODE ..... 6.34

DISPlay:PESQ<i>>:OCURsor|XCURsor:POSMode ..... 6.35

DISPlay:PESQ<i>>:OCURsor|XCURsor:SETTo:XPOS ..... 6.37

DISPlay:PESQ<i>>:OCURsor|XCURsor:SETTo:YPOS ..... 6.37

DISPlay:PESQ<i>>:OCURsor|XCURsor:STATe ..... 6.38

DISPlay:PESQ<i>>:SCANoffset ..... 4.541, 6.13

DISPlay:PESQ:X:LEFT ..... 4.530

DISPlay:PESQ:X:RIGHT ..... 4.530

DISPlay:PESQ:X:SCALing ..... 4.529

DISPlay:PESQ:X:SPACing ..... 4.529, 4.530

DISPlay:Subsys<i>>:DLISt:FILTer ..... 4.535

DISPlay:SWEep<i>>:A|B:BOTTom ..... 4.504

DISPlay:SWEep<i>>:A|B:CHANnel ..... 4.484

DISPlay:SWEep<i>>:A|B:LIMLower ..... 4.512

DISPlay:SWEep<i>>:A|B:LIMLower:SOURce ..... 4.513, 4.514, 4.515, 4.516

DISPlay:SWEep<i>>:A|B:LIMShift ..... 4.516, 4.517, 4.518

DISPlay:SWEep<i>>:A|B:LIMUpper ..... 4.507

DISPlay:SWEep<i>>:A|B:MARKer:MODE ..... 6.33

DISPlay:SWEep<i>>:A|B:MARKer:SETTo:XPOS ..... 6.34

DISPlay:SWEep<i>>:A|B:NORMalize ..... 4.495

DISPlay:SWEep<i>>:A|B:NORMalize:VALue ..... 4.496

DISPlay:SWEep<i>>:A|B:REFerence ..... 4.489, 4.490, 4.491, 4.492, 4.493, 4.495

DISPlay:SWEep<i>>:A|B:REFerence:VALue ..... 4.494

DISPlay:SWEep<i>>:A|B:SPACing ..... 4.503

DISPlay:SWEep<i>>:A|B:TOP ..... 4.504

DISPlay:SWEep<i>>:A|B:UNIT ..... 4.499, 4.500

DISPlay:SWEep<i>>:A|B:UPDate ..... 4.487, 4.488

DISPlay:SWEep<i>>:A|B:YSource ..... 4.471, 4.472, 4.473, 4.474, 4.475, 4.476

DISPlay:SWEep<i>>:DLISt:FILTer ..... 6.38

DISPlay:SWEep<i>>:OCURsor|XCURsor:MODE ..... 6.34

DISPlay:SWEep<i>>:OCURsor|XCURsor:POSMode ..... 6.35

DISPlay:SWEEp<i>:OCURsor\XCURsor:SETTo:XPOS .....	6.37
DISPlay:SWEEp<i>:OCURsor\XCURsor:SETTo:YPOS .....	6.37
DISPlay:SWEEp<i>:OCURsor\XCURsor:STAtE .....	6.38
DISPlay:SWEEp<i>:OCURsor\XCURsor:Y? .....	6.38
DISPlay:SWEEp<i>:SCANOffset .....	4.541, 6.13
DISPlay:SWEEp<i>:TRACk:LIMit .....	4.485, 4.486
DISPlay:SWEEp<i>:X:AXIS .....	4.523, 4.524, 4.525
DISPlay:SWEEp<i>:X:LEFT .....	4.530
DISPlay:SWEEp<i>:X:REFerence:VALue .....	4.528
DISPlay:SWEEp<i>:X:RIGHT .....	4.530
DISPlay:SWEEp<i>:X:SCALing .....	4.529
DISPlay:SWEEp<i>:X:SOURce .....	4.521, 4.522
DISPlay:SWEEp<i>:X:SPACing .....	4.529, 4.530
DISPlay:SWEEp<i>:X:UNIT .....	4.525
DISPlay:SWEEp<i>:X:UNIT:AUTO .....	4.527, 4.528
DISPlay:SWEEp<i>:X:UNIT:USER .....	4.528
DISPlay:WAVEform:[A]B:YSource .....	4.480
DISPlay:WAVEform:A B:BOTTom .....	4.504
DISPlay:WAVEform:A B:CHANnel .....	4.484
DISPlay:WAVEform:A B:LIMLower .....	4.512
DISPlay:WAVEform:A B:LIMLower:SOURce .....	4.513, 4.515
DISPlay:WAVEform:A B:LIMShift .....	4.516, 4.517, 4.518
DISPlay:WAVEform:A B:LIMUpper .....	4.507
DISPlay:WAVEform:A B:MARKer:MODE .....	6.33
DISPlay:WAVEform:A B:MARKer:SETTo:XPOS .....	6.34
DISPlay:WAVEform:A B:REFerence .....	4.490, 4.493
DISPlay:WAVEform:A B:REFerence:VALue .....	4.494
DISPlay:WAVEform:A B:SPACing .....	4.503
DISPlay:WAVEform:A B:TOP .....	4.504
DISPlay:WAVEform:A B:UNIT .....	4.499, 4.500
DISPlay:WAVEform:A B:UPDate .....	4.487, 4.488
DISPlay:WAVEform:A B:YSource .....	4.479, 4.480
DISPlay:WAVEform:DLISt:FILTer .....	6.38
DISPlay:WAVEform:OCURsor\XCURsor:MODE .....	6.34
DISPlay:WAVEform:OCURsor\XCURsor:POSMode .....	6.35
DISPlay:WAVEform:OCURsor\XCURsor:SETTo:XPOS .....	6.37
DISPlay:WAVEform:OCURsor\XCURsor:SETTo:YPOS .....	6.37
DISPlay:WAVEform:OCURsor\XCURsor:STAtE .....	6.38
DISPlay:WAVEform:OCURsor\XCURsor:Y? .....	6.38
DISPlay:WAVEform:SCANOffset .....	4.541, 6.13
DISPlay:WAVEform:TRACk:LIMit .....	4.485, 4.486
DISPlay:WAVEform:X:LEFT .....	4.530
DISPlay:WAVEform:X:REFerence:VALue .....	4.528
DISPlay:WAVEform:X:RIGHT .....	4.530
DISPlay:WAVEform:X:SCALing .....	4.529
DISPlay:WAVEform:X:SPACing .....	4.529, 4.530
DISPlay:WAVEform:X:UNIT .....	4.525
DISPlay:WAVEform:X:UNIT:AUTO .....	4.527, 4.528
DISPlay:WAVEform:X:UNIT:USER .....	4.528

**F**

FORMat[:DATA] .....	6.12
---------------------	------

**H**

HCOPy[:IMMediate] .....	4.616
HCOPy:DESTination .....	4.614, 4.615
HCOPy:FILE .....	4.616
HCOPy:FILE:MODE .....	4.616
HCOPy:PRINter:ADDition .....	4.615
HCOPy:PRINter:FOOTer .....	4.615
HCOPy:PRINter:HEADer .....	4.615
HCOPy:PRINter:ORientation .....	4.615
HCOPy:SOURce .....	4.614

**I**

INIT:CONT .....	4.220, 4.221, 4.222, 4.240, 4.241, 4.242, 4.243
-----------------	---

INIT:FORCe ..... 4.220, 4.221, 4.222, 4.223, 4.240, 4.241, 4.242, 4.243

INITiate[:IMMediate] ..... 6.9

INITiate:CONTInuous ..... 6.8

INITiate:FORCe ..... 6.9

INPut[1] /2:COUPling ..... 4.148

INPut[1]2:COMMon ..... 4.153

INPut[1]2:IMPedance ..... 4.152

INPut[1]2:TYPE ..... 4.150

INPut<n>:COUPling ..... 4.160, 4.161

INPut:AUDIobits ..... 4.174, 4.181, 4.190, 4.207

INPut:BANDwidth:MODE ..... 4.149, 4.173

INPut:BCLk:FREQuency? ..... 4.194, 4.211

INPut:BSLope ..... 4.195, 4.212, 4.213

INPut:CHANnel ..... 4.147, 4.170, 4.176

INPut:CLOCK ..... 4.185, 4.203

INPut:CODing ..... 4.197, 4.214

INPut:COUPling ..... 4.148, 4.160

INPut:COUPling:CHANnels ..... 4.160

INPut:FBIT ..... 4.190, 4.207

INPut:FILTer ..... 4.149, 4.161, 4.173, 4.179, 4.198, 4.215, 4.421

INPut:FOFFset ..... 4.195, 4.212

INPut:FORMat ..... 4.180

INPut:FSLope ..... 4.180, 4.195, 4.212

INPut:FSYnc:FREQuency? ..... 4.194, 4.211

INPut:FWIDth ..... 4.194, 4.211

INPut:FWIDth:VALue ..... 4.212

INPut:INPut ..... 4.179

INPut:LBITs ..... 4.191

INPut:LOGVoltage ..... 4.196, 4.197, 4.214

INPut:MCHannels ..... 4.159

INPut:MCHannels[1] ..... 4.185

INPut:MCHannels[2] ..... 4.185

INPut:MCHannels<n> ..... 4.203

INPut:MCHSource ..... 4.187

INPut:MCHSource<n> ..... 4.204

INPut:MCHSource2 ..... 4.188

INPut:MRATio ..... 4.196, 4.213

INPut:MSAMplefrequency ..... 4.186

INPut:NOCHannels ..... 4.204

INPut:NOSLots ..... 4.186

INPut:RANGe:CHANnels ..... 4.162

INPut:RATio ..... 4.186

INPut:RESYnc ..... 4.156, 4.175, 4.199, 4.217

INPut:SAMPlE:FREQuency ..... 4.172, 4.179

INPut:SAMPlE:FREQuency:MODE ..... 4.172, 4.173, 4.178, 4.179, 4.192, 4.193, 4.209, 4.210

INPut:SDElay ..... 4.196, 4.213

INPut:SLOTS ..... 4.187, 4.205

INPut:SLOTS2 ..... 4.188

INPut:SLTLength ..... 4.190, 4.207

INPut:SPFRame ..... 4.186, 4.204

INPut:SYnc ..... 4.189, 4.206

INPut:TIMEout ..... 4.191, 4.208

INPut:TYPE ..... 4.174

INPut:WLENgth ..... 4.176, 4.177

INPut:WOFFset ..... 4.181

INSTRument[1][:SElect] ..... 4.1, 4.2

INSTRument2[:SElect] ..... 4.144

**M**

MMEMory: STORe:STATe ..... 4.613

MMEMory:BARgraph<i>:EQUalization:INVert ..... 4.536

MMEMory:BARgraph<i>:EQUalization:MODify ..... 4.537

MMEMory:BARgraph<i>:EQUalization:NORMfrequency ..... 4.536

MMEMory:BARgraph<i>:LIMit:OFFSet ..... 4.538

MMEMory:BARgraph<i>:LIMit:OFFSet:VALue ..... 4.538

MMEMory:BARgraph<i>:STAS ..... 4.533, 4.534, 4.535

MMEMory:BARgraph<i>:STORe ..... 4.539

MMEMory:BARgraph<i>:TRACe ..... 4.535

MMEMory:CATalog? ..... 6.28

MMEMory:CATalog:LENgth? ..... 6.29

MMEMory:CDIRectory .....	6.29
MMEMory:COpy .....	6.29
MMEMory:DATA .....	6.29
MMEMory:DCATalog? .....	6.30
MMEMory:DCATalog:LENGth? .....	6.30
MMEMory:DELeTe .....	6.30
MMEMory:FFT<i><i>:EQUalization:INVert .....	4.536
MMEMory:FFT<i><i>:EQUalization:MODify .....	4.537
MMEMory:FFT<i><i>:EQUalization:NORMfrequency .....	4.536
MMEMory:FFT<i><i>:LIMit:OFFSet .....	4.538
MMEMory:FFT<i><i>:LIMit:OFFSet:VALue .....	4.538
MMEMory:FFT<i><i>:STAS .....	4.533, 4.534, 4.535
MMEMory:FFT<i><i>:STORe .....	4.539
MMEMory:FFT<i><i>:TRACe .....	4.535
MMEMory:LOAD:ARBitrary .....	4.96, 4.102
MMEMory:LOAD:ARBitrary 'filename' .....	4.93
MMEMory:LOAD:FILE .....	4.263
MMEMory:LOAD:FREQuency .....	4.139
MMEMory:LOAD:IEQualize .....	4.288, 4.317, 4.333
MMEMory:LOAD:INTerval .....	4.139
MMEMory:LOAD:LIST .....	4.90
MMEMory:LOAD:OEQualize 'filename' .....	4.67, 4.71, 4.75, 4.78, 4.85, 4.92
MMEMory:LOAD:ONTime .....	4.139
MMEMory:LOAD:PHASe .....	4.139
MMEMory:LOAD:PWAVeform .....	4.350
MMEMory:LOAD:STATe .....	4.613, 6.30
MMEMory:LOAD:VOL TAge .....	4.138
MMEMory:MDIRectory .....	6.30
MMEMory:MOVE .....	6.31
MMEMory:MSIS .....	6.31
MMEMory:PESQ<i><i>:LIMit:OFFSet .....	4.538
MMEMory:PESQ<i><i>:LIMit:OFFSet:VALue .....	4.538
MMEMory:PESQ<i><i>:STAS .....	4.533, 4.534, 4.535
MMEMory:PESQ<i><i>:STORe .....	4.539
MMEMory:PESQ<i><i>:TRACe .....	4.535
MMEMory:RDIRectory .....	6.31
MMEMory:STORe:PWAVeform .....	4.349
MMEMory:STORe:STATe .....	6.31
MMEMory:SWEEp<i><i>:EQUalization:INVert .....	4.536
MMEMory:SWEEp<i><i>:EQUalization:MODify .....	4.537
MMEMory:SWEEp<i><i>:EQUalization:NORMfrequency .....	4.536
MMEMory:SWEEp<i><i>:LIMit:OFFSet .....	4.538
MMEMory:SWEEp<i><i>:LIMit:OFFSet:VALue .....	4.538
MMEMory:SWEEp<i><i>:STAS .....	4.533, 4.534, 4.535
MMEMory:SWEEp<i><i>:STORe .....	4.539
MMEMory:SWEEp<i><i>:TRACe .....	4.535
MMEMory:WAVeform:STAS .....	4.533
MMEMory:WAVeform:STORe .....	4.539

## O

OUTPut: FSHape .....	4.37
OUTPut: POLarity .....	4.37, 4.38
OUTPut:AUDiobits .....	4.25, 4.36, 4.47
OUTPut:AUXiliary .....	4.20, 4.21
OUTPut:BANdwidth:MODE .....	4.6, 4.7
OUTPut:BClk:FREQuency? .....	4.50
OUTPut:BCLock:JITAmplitude .....	4.54
OUTPut:BCLock:JITFrequency .....	4.54
OUTPut:BSLope .....	4.52
OUTPut:CHANnel .....	4.3, 4.4, 4.17, 4.30, 4.185
OUTPut:CLOCK .....	4.44
OUTPut:CODing .....	4.56
OUTPut:CSIMulator .....	4.26
OUTPut:FBIT .....	4.47
OUTPut:FOFFset .....	4.51
OUTPut:FORMat .....	4.36, 4.37
OUTPut:FSHape .....	4.37
OUTPut:FSLope .....	4.52
OUTPut:FSYNc:FREQuency? .....	4.50
OUTPut:FWIDth .....	4.51

OUTPut:FWIDth:VALue ..... 4.51, 4.194  
 OUTPut:IMPedance ..... 4.5  
 OUTPut:INTClockfreq ..... 4.19  
 OUTPut:LBITS ..... 4.48, 4.208  
 OUTPut:LOGVoltage ..... 4.55  
 OUTPut:LOW ..... 4.6  
 OUTPut:MCLKratio ..... 4.35, 4.36  
 OUTPut:MCLock:JITAmplitude ..... 4.55  
 OUTPut:MCLock:JITFrequency ..... 4.54  
 OUTPut:MRATio ..... 4.54  
 OUTPut:MSAMplefrequency ..... 4.44  
 OUTPut:NOSLots ..... 4.45  
 OUTPut:RATio ..... 4.45  
 OUTPut:SAMple:FREQuency ..... 4.24, 4.33, 4.50, 4.211  
 OUTPut:SAMple:MODE ..... 4.24, 4.32, 4.33, 4.49, 4.50  
 OUTPut:SIGNal:BALanced:LEVel ..... 4.25  
 OUTPut:SIGNal:LEVel ..... 4.25  
 OUTPut:SLCOffset ..... 4.53  
 OUTPut:SLCSlope ..... 4.53  
 OUTPut:SLCWidth ..... 4.53  
 OUTPut:SLCWidth:VALue ..... 4.53  
 OUTPut:SLTLength ..... 4.47  
 OUTPut:SPFRame ..... 4.45  
 OUTPut:SYNC:OUTPut ..... 4.18, 4.19  
 OUTPut:SYNC:TYPE ..... 4.20  
 OUTPut:TXData ..... 4.45  
 OUTPut:TXData2 ..... 4.45  
 OUTPut:TXData3 ..... 4.45  
 OUTPut:TXData4 ..... 4.46  
 OUTPut:TYPE ..... 4.4, 4.5  
 OUTPut:UNBalanced:OUTPut ..... 4.26  
 OUTPut:WLENgth ..... 4.31  
 OUTPut:WOFFset ..... 4.38

**S**

SENSe[1]e:FUNcTion:PESQ:ACCording ..... 4.347  
 SENSe[1]:BANDwidth ..... 4.258  
 SENSe[1]:BANDwidth:MODE ..... 4.257, 4.258  
 SENSe[1]:CHANnel:DELay ..... 4.329  
 SENSe[1]:FILTer ..... 4.304  
 SENSe[1]:FILTer[1] ..... 4.248, 4.279, 4.316, 4.332, 4.379, 4.422  
 SENSe[1]:FILTer2 ..... 4.248, 4.279, 4.316, 4.332, 4.379, 4.422  
 SENSe[1]:FILTer3 ..... 4.248, 4.279, 4.316, 4.332, 4.379, 4.422  
 SENSe[1]:FREQuency:LIMit:LOWer ..... 4.271, 4.304, 4.318  
 SENSe[1]:FREQuency:LIMit:UPPer ..... 4.271, 4.304, 4.318  
 SENSe[1]:FUNcTion ..... 4.249, 4.253, 4.267, 4.272, 4.274, 4.277, 4.290, 4.296, 4.305, 4.306, 4.310, 4.312, 4.314, 4.329, 4.340, 4.346, 4.373  
 SENSe[1]:FUNcTion:APERture:MODE ..... 4.250, 4.251, 4.252, 4.253, 4.254, 4.255, 4.256, 4.268, 4.269, 4.280, 4.281, 4.282, 4.300, 4.301, 4.315, 4.316  
 SENSe[1]:FUNcTion:DCSuppression ..... 4.245, 4.278, 4.330  
 SENSe[1]:FUNcTion:DISToRtion<i> <i> designates the harmonic 2, 4, 6, 8 ..... 4.292  
 SENSe[1]:FUNcTion:DISToRtion<i> <i> designates the harmonic 3, 5, 7, 9 ..... 4.293  
 SENSe[1]:FUNcTion:DMODE ..... 4.286, 4.287  
 SENSe[1]:FUNcTion:FFT:AVERage ..... 4.335  
 SENSe[1]:FUNcTion:FFT:AVERage:MODE ..... 4.334  
 SENSe[1]:FUNcTion:FFT:MTIME? ..... 4.322  
 SENSe[1]:FUNcTion:FFT:RESolution? ..... 4.322  
 SENSe[1]:FUNcTion:FFT:Size ..... 4.320, 4.322  
 SENSe[1]:FUNcTion:FFT:START? ..... 4.339  
 SENSe[1]:FUNcTion:FFT:STATe ..... 4.319, 4.326  
 SENSe[1]:FUNcTion:FFT:STOP? ..... 4.339  
 SENSe[1]:FUNcTion:FFT:WINDow ..... 4.324, 4.325, 4.326  
 SENSe[1]:FUNcTion:MMODE ..... 4.349  
 SENSe[1]:FUNcTion:MMODE ..... 4.272, 4.277, 4.278, 4.290, 4.291, 4.292, 4.297, 4.298, 4.307, 4.308, 4.314, 4.315, 4.349  
 SENSe[1]:FUNcTion:PESQ:ACCording ..... 4.347, 348  
 SENSe[1]:FUNcTion:PESQ:AVGDelay? ..... 4.351  
 SENSe[1]:FUNcTion:PESQ:DEGLLevel? ..... 4.351  
 SENSe[1]:FUNcTion:PESQ:REFLevel? ..... 4.350  
 SENSe[1]:FUNcTion:REC:LENgth? ..... 4.350  
 SENSe[1]:FUNcTion:SNSequence ..... 4.283

SENSe[1]:NOTCh	4.245, 4.246, 4.330, 4.331
SENSe[1]:NOTCh:FREQuency	4.246, 4.331
SENSe[1]:NOTCh:FREQuency:MODE	4.246, 4.247, 4.331
SENSe[1]:POWer:REFeRence:RESistance	4.156, 4.164
SENSe[1]:THDN:REJection	4.299
SENSe[1]:UFILter<i>	4.425
SENSe[1]:UFILter<i>:ATTenuation	4.432
SENSe[1]:UFILter<i>:CENTer	4.428
SENSe[1]:UFILter<i>:DELay	4.432
SENSe[1]:UFILter<i>:DELay?	4.432
SENSe[1]:UFILter<i>:FNAMe	4.430
SENSe[1]:UFILter<i>:PASSb	4.425
SENSe[1]:UFILter<i>:PASSb:LOWer	4.427
SENSe[1]:UFILter<i>:PASSb:UPPer	4.427
SENSe[1]:UFILter<i>:STOPb?	4.426
SENSe[1]:UFILter<i>:STOPb:LOWer?	4.427, 4.428
SENSe[1]:UFILter<i>:STOPb:UPPer?	4.427, 4.428
SENSe[1]:UFILter<i>:WIDTh	4.428
SENSe[1]:UFILter<i>:WIDTh?	4.428
SENSe[1]:VOLTagE:APERture	4.251, 4.255, 4.268, 4.282, 4.316
SENSe[1]:VOLTagE:EQUalize	4.288, 4.317, 4.333
SENSe[1]:VOLTagE:FUNDamental	4.293, 4.301
SENSe[1]:VOLTagE:FUNDamental:MODE	4.293, 4.294, 4.301, 4.302
SENSe[1]:VOLTagE:INTVtime	4.274, 4.275
SENSe[1]:VOLTagE:INTVtime:MODE	4.273, 4.274, 4.275
SENSe[1]:VOLTagE:RANGe[1]2:MODE	4.154, 4.155
SENSe[1]:VOLTagE:RANGe[1]2:VALue	4.154
SENSe[1]:VOLTagE:RANGe<n>:VALue	4.163
SENSe<n>:DATA[1]2,3,...8?	6.10
SENSe:DMODE	4.168, 4.169
SENSe:FREQuency:FACTor	4.266, 4.270
SENSe:FREQuency:SELect	4.264, 4.265, 4.266, 4.269, 4.270
SENSe:FREQuency:SETTLing:COUNT	4.411
SENSe:FREQuency:SETTLing:MODE	4.410, 4.411
SENSe:FREQuency:SETTLing:RESolution	4.412
SENSe:FREQuency:SETTLing:TOLerance	4.412
SENSe:FREQuency:SETTLing:TOUT	4.412
SENSe:FUNCTion:BARGraph	4.289, 4.318, 4.319
SENSe:FUNCTion:FFT:CMPPFactor	4.338
SENSe:FUNCTion:FFT:USAMple	4.337, 4.338
SENSe:FUNCTion:RECORD:FILE	4.374
SENSe:FUNCTion:RECORD:LENGth	4.375
SENSe:FUNCTion:RECORD:TRIGGer:LEVel	4.377
SENSe:FUNCTion:RECORD:TRIGGer:PRE	4.378
SENSe:FUNCTion:RECORD:TRIGGer:SLOPe	4.377
SENSe:FUNCTion:RECORD:TRIGGer:SOURce	4.376, 4.377
SENSe:FUNCTion:SETTLing:COUNT	4.408
SENSe:FUNCTion:SETTLing:MODE	4.406, 4.407
SENSe:FUNCTion:SETTLing:RESolution	4.408
SENSe:FUNCTion:SETTLing:TOLerance	4.408
SENSe:FUNCTion:SETTLing:TOUT	4.409
SENSe:JITTer:REFeRence	4.171
SENSe:PHASe:SETTLing:COUNT	4.414
SENSe:PHASe:SETTLing:MODE	4.413, 4.414
SENSe:PHASe:SETTLing:RESolution	4.415
SENSe:PHASe:SETTLing:TOUT	4.415
SENSe:REFeRence:CHANnel	4.165, 4.216
SENSe:SWEEp:CONTRol	4.259, 4.260
SENSe:SWEEp:POINts	4.262
SENSe:SWEEp:SPACing	4.261
SENSe:SWEEp:STARt	4.262
SENSe:SWEEp:STEP	4.263
SENSe:SWEEp:STOP	4.262
SENSe:TRIGGer:SETTLing:COUNT	4.418
SENSe:TRIGGer:SETTLing:MODE	4.417, 4.418
SENSe:TRIGGer:SETTLing:RESolution	4.419
SENSe:TRIGGer:SETTLing:TOLerance	4.418
SENSe:UFILter<i>:ORDER	4.425
SENSe:VOLTagE:RANGe<n>:MODE	4.163, 4.164
SENSe:VOLTagE:RANGe:MODE	4.163
SENSe2:FUNCTion	4.400, 4.401
SENSe3:FREQuency:APERture:MODE	4.396, 4.397



SENSe3:FUNCTION	4.392, 4.393, 4.394, 4.395
SENSe3:PHASe:FORMat	4.398, 4.399
SENSe6:FUNCTION	4.402, 4.403
SENSe7:CMpFactor	4.356
SENSe7:FUNCTION	4.352
SENSe7:MMODE	4.353, 4.354, 4.355
SENSe7:TRIGger:AUTO	4.362
SENSe7:TRIGger:LEVel	4.360
SENSe7:TRIGger:PRE	4.361
SENSe7:TRIGger:SLOPe	4.360
SENSe7:TRIGger:SOURce	4.358, 4.359
SENSe7:TRIGger:TRCLength	4.357
SENSe8:FUNCTION	4.385, 4.386
SENSe8:PROTOcol:CH<x>:BYTE<y>	6.16
SENSe8:PROTOcol:CRC<i>?	6.17
SENSe8:PROTOcol:ERRor?	6.16
SENSe8:PROTOcol:HIGHLight	4.387
SENSe8:PROTOcol:INV<i>?	6.17
SENSe8:PROTOcol:LOC<i>?	6.17
SENSe8:PROTOcol:MODE	4.386
SENSe8:PROTOcol:PAR<i>?	6.17
SENSe8:PROTOcol:PCM<i>?	6.17
SENSe8:PROTOcol:PERsistence	4.388
SENSe8:PROTOcol:VIEW	4.388
SOURce:AM:MODE	4.112, 4.113
SOURce:BANDwidth	4.86, 4.87
SOURce:DIGital:SYNC:TO	4.31
SOURce:DIM	4.86
SOURce:FILTer	4.67, 4.422
SOURce:FRAMePhase	4.22
SOURce:FREQUency[1]	4.66, 4.70, 4.76, 4.79, 4.82, 4.84, 4.109, 4.110
SOURce:FREQUency<i>	4.73
SOURce:FREQUency:AM	4.113
SOURce:FREQUency:CH2Stereo	4.71
SOURce:FREQUency:DIFFerence	4.84
SOURce:FREQUency:MEAN	4.84, 4.91
SOURce:FREQUency:REFerence	4.8, 4.27, 4.29, 4.39, 4.56
SOURce:FREQUency:SElect	4.69
SOURce:FREQUency2	4.82, 4.110
SOURce:FUNCTION[:SHAPE]	4.65, 4.68, 4.72, 4.76, 4.78, 4.81, 4.83, 4.86, 4.87, 4.93, 4.95, 4.101, 4.109, 4.110, 4.112
SOURce:FUNCTION:MODE	4.73, 4.83, 4.110
SOURce:IMPairment	4.16
SOURce:INTerval	4.77, 4.79, 4.113
SOURce:LOOP:CHANnel	4.106
SOURce:LOOP:GAIN	4.107
SOURce:LOWDistortion	4.65
SOURce:MULTisine:COUNT	4.73
SOURce:ONTime	4.77, 4.79, 4.113
SOURce:ONTime:DELay	4.77, 4.80, 4.113
SOURce:PHASe	4.70
SOURce:PHASe<i>	4.73
SOURce:PLAY:CHANnel	4.97, 4.98, 4.103
SOURce:PLAY:MODE	4.98, 4.99, 4.103, 4.104
SOURce:PLAY:SCALepktofs	4.96, 4.97
SOURce:PLAY:TIME	4.99, 4.105
SOURce:PROTOcol:CH<x>:BYTE<y>	6.32
SOURce:PROTOcol:CHANnels	4.119
SOURce:PROTOcol:CRC	4.116
SOURce:PROTOcol:MODE	4.115
SOURce:PROTOcol:NUMerical	4.116, 4.117
SOURce:PROTOcol:VALidity	4.116
SOURce:PTORef	4.22
SOURce:RANDom:DOMain	4.88
SOURce:RANDom:FREQUency:LOWer	4.91
SOURce:RANDom:FREQUency:UPPer	4.91
SOURce:RANDom:PDF	4.66, 4.68, 4.81, 4.84, 4.89
SOURce:RANDom:SHAPE	4.90
SOURce:RANDom:SPACing:FREQUency	4.72, 4.91
SOURce:RANDom:SPACing:MODE	4.72, 4.91
SOURce:REFerence	4.21
SOURce:RESYnc	4.56
SOURce:SINusoid:DITHer	4.66, 4.68, 4.81, 4.84

SOURce:SINusoid:DITHer:STATe	4.66, 4.68, 4.81, 4.84
SOURce:SRCMode	4.28
SOURce:SWEEp:CONTRol	4.123
SOURce:SWEEp:DWELL	4.130
SOURce:SWEEp:FREQUency:POINts	4.136
SOURce:SWEEp:FREQUency:SPACing	4.133, 4.134
SOURce:SWEEp:FREQUency:STARt	4.135
SOURce:SWEEp:FREQUency:STEP	4.137
SOURce:SWEEp:FREQUency:STOP	4.135
SOURce:SWEEp:INTerval:POINts	4.136
SOURce:SWEEp:INTerval:SPACing	4.133, 4.134
SOURce:SWEEp:INTerval:STARt	4.135
SOURce:SWEEp:INTerval:STEP	4.137
SOURce:SWEEp:INTerval:STOP	4.135
SOURce:SWEEp:NEXtstep	4.129, 4.130, 4.131
SOURce:SWEEp:ONTime:POINts	4.136
SOURce:SWEEp:ONTime:SPACing	4.133, 4.134
SOURce:SWEEp:ONTime:STARt	4.135
SOURce:SWEEp:ONTime:STEP	4.137
SOURce:SWEEp:ONTime:STOP	4.135
SOURce:SWEEp:PHASe:POINts	4.136
SOURce:SWEEp:PHASe:SPACing	4.133
SOURce:SWEEp:PHASe:STARt	4.135
SOURce:SWEEp:PHASe:STEP	4.137
SOURce:SWEEp:PHASe:STOP	4.135
SOURce:SWEEp:VOLTag:e:POINts	4.136
SOURce:SWEEp:VOLTag:e:SPACing	4.133, 4.134
SOURce:SWEEp:VOLTag:e:STARt	4.135
SOURce:SWEEp:VOLTag:e:STEP	4.137
SOURce:SWEEp:VOLTag:e:STOP	4.135
SOURce:SWEEp:XAXis	4.124, 4.125
SOURce:SWEEp:ZAXis	4.126, 4.127
SOURce:SYNC:TO	4.17, 4.18, 4.46
SOURce:VOLTag:e[1]	4.67, 4.70, 4.76, 4.79, 4.109, 4.110
SOURce:VOLTag:e<i>	4.74
SOURce:VOLTag:e:AM	4.113
SOURce:VOLTag:e:CH2Stereo	4.71
SOURce:VOLTag:e:CREStfactor:MODE	4.73
SOURce:VOLTag:e:EQALize:STATe	4.67, 4.71, 4.75, 4.78, 4.85, 4.92
SOURce:VOLTag:e:LOWLevel	4.77
SOURce:VOLTag:e:MAXimum	4.8
SOURce:VOLTag:e:OFFSet	4.68, 4.72, 4.75, 4.78, 4.82, 4.85, 4.93, 4.94, 4.100, 4.109, 4.111
SOURce:VOLTag:e:OFFSet:STATe	4.68, 4.72, 4.75, 4.78, 4.82, 4.85, 4.93, 4.94, 4.100, 4.109, 4.111
SOURce:VOLTag:e:RANGe	4.7
SOURce:VOLTag:e:RATio	4.71, 4.82
SOURce:VOLTag:e:REFerence	4.8, 4.27, 4.29, 4.38, 4.56
SOURce:VOLTag:e:RMS	4.92, 4.94
SOURce:VOLTag:e:RMS?	4.74
SOURce:VOLTag:e:SElect	4.69
SOURce:VOLTag:e:TOTAL	4.82, 4.85, 4.87, 4.92, 4.94, 4.99, 4.108, 4.112
SOURce:VOLTag:e:TOTAL?	4.74, 4.109
SOURce:VOLTag:e:TOTAL:GAIN	4.74
SOURce:VOLTag:e2	4.111
STATus:OPERation:CONDition?	6.19
STATus:OPERation:ENABle	6.20
STATus:OPERation:EVENT?	6.20
STATus:OPERation:NTRansition	6.20
STATus:OPERation:PTRansition	6.20
STATus:QUESTionable:CONDition?	6.20, 6.23
STATus:QUESTionable:ENABle	6.20, 6.23
STATus:QUESTionable:EVENT?	6.20, 6.23
STATus:QUESTionable:MEASuring:CONDition?	6.22
STATus:QUESTionable:MEASuring:ENABle	6.22
STATus:QUESTionable:MEASuring:EVENT?	6.23
STATus:QUESTionable:MEASuring:NTRansition	6.23
STATus:QUESTionable:MEASuring:PTRansition	6.23
STATus:QUESTionable:NTRansition	6.21, 6.23
STATus:QUESTionable:OVERrange:CONDition?	6.22
STATus:QUESTionable:OVERrange:ENABle	6.22
STATus:QUESTionable:OVERrange:EVENT?	6.22
STATus:QUESTionable:OVERrange:NTRansition	6.22
STATus:QUESTionable:OVERrange:PTRansition	6.22

STATus:QUESTionable:PTRansition ..... 6.21, 6.24  
 STATus:QUESTionable:UNDErrange\$EVENT? ..... 6.21  
 STATus:QUESTionable:UNDErrange:NTRansition ..... 6.21  
 STATus:QUESTionable:UNDErrange:PTRansition ..... 6.21  
 STATus:QUESTionable:UNDErrangeCONDition? ..... 6.21  
 STATus:QUESTionable:UNDErrangeENABle ..... 6.21  
 SWITcher:INPA ..... 4.456  
 SWITcher:INPB ..... 4.457  
 SWITcher:OFFSet ..... 4.456  
 SWITcher:OUTA ..... 4.457  
 SWITcher:OUTB ..... 4.457  
 SWITcher:STATe ..... 4.455  
 SWITcher:TRACking ..... 4.456  
 SYSTem:COMMunicate:GPIB:ADDReSS ..... 6.25  
 SYSTem:COMMunicate:GTL ..... 6.25  
 SYSTem:ERRor? ..... 6.25  
 SYSTem:MEMory:DATA ..... 6.42  
 SYSTem:MEMory:FREE ..... 6.43, 6.44  
 SYSTem:MEMory:STRing ..... 6.42  
 SYSTem:PRESet ..... 6.25  
 SYSTem:SHTDown ..... 6.26  
 SYSTem:SHUtdown ..... 6.26  
 SYSTem:VERSIon? ..... 6.25

**T**

TRACe:BARgraph<i>:LDList:AX? ..... 6.15  
 TRACe:BARgraph<i>:LDList:AY? ..... 6.15  
 TRACe:BARgraph<i>:LDList:BX? ..... 6.15  
 TRACe:BARgraph<i>:LDList:BY? ..... 6.15  
 TRACe:BARgraph<i>:LDList:COUNT:AX? ..... 6.16  
 TRACe:BARgraph<i>:LDList:COUNT:AY? ..... 6.16  
 TRACe:BARgraph<i>:LDList:COUNT:BX? ..... 6.16  
 TRACe:BARgraph<i>:LDList:COUNT:BY? ..... 6.16  
 TRACe:BARgraph<i>:LOAD:AX? ..... 6.14  
 TRACe:BARgraph<i>:LOAD:AY? ..... 6.14  
 TRACe:BARgraph<i>:LOAD:BX? ..... 6.14  
 TRACe:BARgraph<i>:LOAD:BY? ..... 6.14  
 TRACe:BARgraph<i>:LOAD:COUNT:AX? ..... 6.15  
 TRACe:BARgraph<i>:LOAD:COUNT:AY? ..... 6.15  
 TRACe:BARgraph<i>:LOAD:COUNT:BX? ..... 6.15  
 TRACe:BARgraph<i>:LOAD:COUNT:BY? ..... 6.15  
 TRACe:BARgraph<i>:STORe:AX ..... 6.40  
 TRACe:BARgraph<i>:STORe:AY ..... 6.40  
 TRACe:BARgraph<i>:STORe:BX ..... 6.40  
 TRACe:BARgraph<i>:STORe:BY ..... 6.40  
 TRACe:FFT<i>:LDList:AX? ..... 6.15  
 TRACe:FFT<i>:LDList:AY? ..... 6.15  
 TRACe:FFT<i>:LDList:BX? ..... 6.15  
 TRACe:FFT<i>:LDList:BY? ..... 6.15  
 TRACe:FFT<i>:LDList:COUNT:AX? ..... 6.15  
 TRACe:FFT<i>:LDList:COUNT:AY? ..... 6.16  
 TRACe:FFT<i>:LDList:COUNT:BX? ..... 6.16  
 TRACe:FFT<i>:LDList:COUNT:BY? ..... 6.16  
 TRACe:FFT<i>:LOAD:AX? ..... 6.13  
 TRACe:FFT<i>:LOAD:AY? ..... 6.13  
 TRACe:FFT<i>:LOAD:BX? ..... 6.13  
 TRACe:FFT<i>:LOAD:BY? ..... 6.13  
 TRACe:FFT<i>:LOAD:COUNT:AX? ..... 6.14  
 TRACe:FFT<i>:LOAD:COUNT:AY? ..... 6.14  
 TRACe:FFT<i>:LOAD:COUNT:BX? ..... 6.14  
 TRACe:FFT<i>:LOAD:COUNT:BY? ..... 6.14  
 TRACe:FFT<i>:STORe:AX ..... 6.40  
 TRACe:FFT<i>:STORe:AY ..... 6.40  
 TRACe:FFT<i>:STORe:BX ..... 6.40  
 TRACe:FFT<i>:STORe:BY ..... 6.40  
 TRACe:PESQ<i>:LDList:AX? ..... 6.15  
 TRACe:PESQ<i>:LDList:AY? ..... 6.15  
 TRACe:PESQ<i>:LDList:BX? ..... 6.15  
 TRACe:PESQ<i>:LDList:BY? ..... 6.15  
 TRACe:PESQ<i>:LDList:COUNT:AX? ..... 6.16

TRACe:PESQ<i>:LDList:COUNT:AY?	6.16
TRACe:PESQ<i>:LDList:COUNT:BX?	6.16
TRACe:PESQ<i>:LDList:COUNT:BY?	6.16
TRACe:PESQ<i>:LOAD:AX?	6.14
TRACe:PESQ<i>:LOAD:AY?	6.14
TRACe:PESQ<i>:LOAD:BX?	6.14
TRACe:PESQ<i>:LOAD:BY?	6.14
TRACe:PESQ<i>:LOAD:COUNT:AX?	6.15
TRACe:PESQ<i>:LOAD:COUNT:AY?	6.15
TRACe:PESQ<i>:LOAD:COUNT:BX?	6.15
TRACe:PESQ<i>:LOAD:COUNT:BY?	6.15
TRACe:PESQ<i>:STORE:AX	6.41
TRACe:PESQ<i>:STORE:AY	6.41
TRACe:PESQ<i>:STORE:BX	6.41
TRACe:PESQ<i>:STORE:BY	6.41
TRACe:SWEEp<i>:LDList:AX?	6.15
TRACe:SWEEp<i>:LDList:AY?	6.15
TRACe:SWEEp<i>:LDList:BX?	6.15
TRACe:SWEEp<i>:LDList:BY?	6.15
TRACe:SWEEp<i>:LDList:COUNT:AX?	6.15
TRACe:SWEEp<i>:LDList:COUNT:AY?	6.15
TRACe:SWEEp<i>:LDList:COUNT:BX?	6.15
TRACe:SWEEp<i>:LDList:COUNT:BY?	6.15
TRACe:SWEEp<i>:LOAD:AX?	6.13
TRACe:SWEEp<i>:LOAD:AY?	6.13
TRACe:SWEEp<i>:LOAD:BX?	6.13
TRACe:SWEEp<i>:LOAD:BY?	6.13, 6.40
TRACe:SWEEp<i>:LOAD:COUNT:AX?	6.14
TRACe:SWEEp<i>:LOAD:COUNT:AY?	6.14
TRACe:SWEEp<i>:LOAD:COUNT:BX?	6.14
TRACe:SWEEp<i>:LOAD:COUNT:BY?	6.14
TRACe:SWEEp<i>:STORE:AX	6.40
TRACe:SWEEp<i>:STORE:AY	6.40
TRACe:SWEEp<i>:STORE:BX	6.40
TRACe:SWEEp<i>:STORE:BY	6.40
TRACe:WAVEform:LDList:AX?	6.15
TRACe:WAVEform:LDList:AY?	6.15
TRACe:WAVEform:LDList:BX?	6.15
TRACe:WAVEform:LDList:BY?	6.15
TRACe:WAVEform:LDList:COUNT:AX?	6.16
TRACe:WAVEform:LDList:COUNT:AY?	6.16
TRACe:WAVEform:LDList:COUNT:BX?	6.16
TRACe:WAVEform:LDList:COUNT:BY?	6.16
TRACe:WAVEform:LOAD:AX?	6.14
TRACe:WAVEform:LOAD:AY?	6.14
TRACe:WAVEform:LOAD:BX?	6.14
TRACe:WAVEform:LOAD:BY?	6.14
TRACe:WAVEform:LOAD:COUNT:AX?	6.14
TRACe:WAVEform:LOAD:COUNT:AY?	6.14
TRACe:WAVEform:LOAD:COUNT:BX?	6.14
TRACe:WAVEform:LOAD:COUNT:BY?	6.14
TRACe:WAVEform:STORE:AX	6.40
TRACe:WAVEform:STORE:AY	6.40
TRACe:WAVEform:STORE:BX	6.40
TRACe:WAVEform:STORE:BY	6.40
TRIGger:CHANnel	4.166, 4.216
TRIGger:COUNT	4.234
TRIGger:DElay	4.167, 4.232
TRIGger:FREquency:VARiation	4.237
TRIGger:SOURce	4.166, 4.228, 4.229, 4.230, 4.230, 4.231
TRIGger:TIMer	4.233
TRIGger:VOLTag:e:VARiation	4.237