

VESSEL MADE IN JAPAN

Cheap tools are plentiful everywhere and some are disguised as expensive. We have expanded our range of tools to include the following items for the technician and/or hobbyist who wants better; VESSEL and APEX. They are of the best quality and are designed for comfort and durability. Cheap drivers wear quickly and can damage screws. These tools use registered and patented designs for absolute fit. The handles are comfortable moulded (some double moulded) ensuring excellent grip & less fatigue and will not break from the shaft. For individual screwdrivers, or screwdriver sets, see page 14-3+. The following are 1/4" Hex drivers & are to be used with the tips next page. Tips are heat hardened & made by APEX. All APEX items are made in the USA.

VESSEL

AND

APEX

VESSEL RATCHET DRIVER KIT 1/4"HEX

Power grip for a comfortable strong grip. Suitable for all 1/4" (6.35mm) Hex tips/bits. Quality ratchet construction from Japan for reliability. Comes complete with 5 brass-plated bits and hollow handle for storing.



Code HTD60

VESSEL T-BAR DRIVER 1/4"HEX

Can fasten & remove a screw with correct wrist control, giving better torque & grip. Beware of cheap imitations without the 'L' shape shaft. This shaft won't slip! Magnetic tip holder. Soft handle, Chrome Vanadium. 170mm long inc' handle, not tip. Original patent design. Tips supplied separately.

Code HT9600

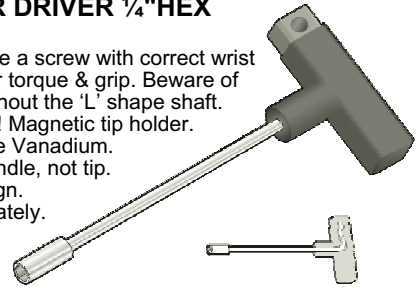

MADE IN JAPAN

VESSEL STUBBY RATCHET 1/4"HEX

Cushion grip with double ended bit included. Suitable for all 1/4" bits. Ball bearing lock system. One touch switch, left/right/fixed. Quality Japan construction, small compact design.

Code HTD50



MADE IN JAPAN

APEX SCREWDRIVER 1/4"HEX

Quality construction by Apex USA from chrome vanadium steel for tough reliable tool action. Non-magnetic tip holder suits all 6mm Hex tips.

Code HT1500P

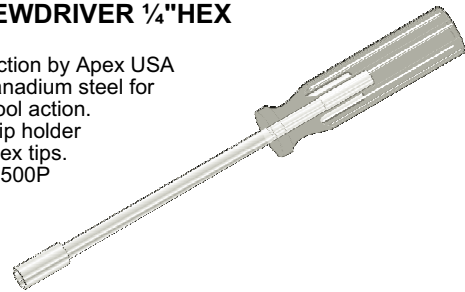

MADE IN USA

VESSEL RATCHET DRIVER 1/4"HEX

Flat plate ratchet design for precise controlled torque action to remove any stubborn screws, etc' with the correct action and reduced risk of damage. Comes complete with 10 tips mounted in a belt clip. 125mm long.

Code HTD70



MADE IN JAPAN

APEX MAGNETIC 1/4"HEX WITH STORAGE

Handle is hollow and capped for storing some tips. Quality construction from chrome vanadium steel for tough reliable tool action. Magnetic tip holder for holding screw on head. Suits all 6mm Hex tips.

Code HT1025

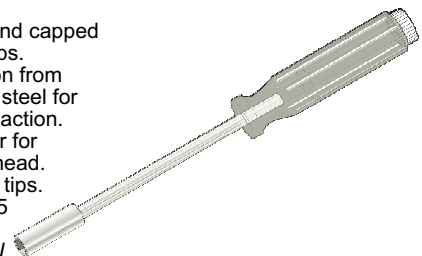

MADE IN TAIWAN

VESSEL MAGNETIC DRIVER 1/4"HEX

Can fasten & remove a screw with correct wrist action, giving better torque, grip, comfort and control. Japan quality construction, this handle will not slip of the shaft! Patented. 110mm long. Magnetic. Suit all 1/4" tips. Chrome Vanadium. Comes with 5 Philips/blade bits.

Code HTD90



MADE IN JAPAN

VESSEL 1/4" HEX WITH FLEXIBLE SHAFT

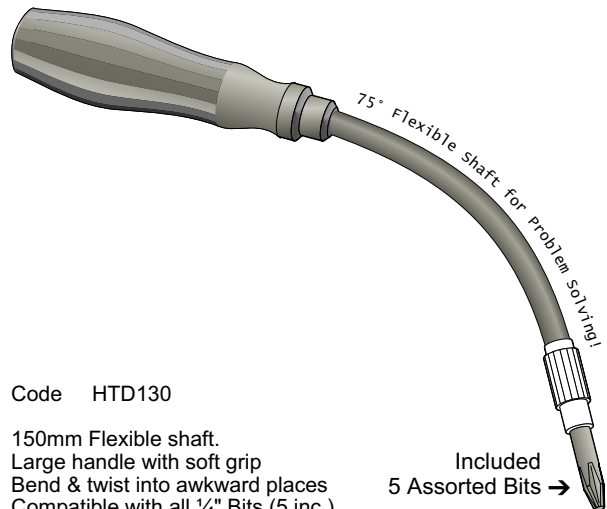

Code HTD130

150mm Flexible shaft. Large handle with soft grip. Bend & twist into awkward places. Compatible with all 1/4" Bits (5 inc.) Highest quality in feel and construction.

Included
5 Assorted Bits →

VESSEL T-BAR RATCHET 1/4"HEX

Comfortable grip & action with repeated wrist turns. Left/Right/Fixed ratchet. Reliable multi-purpose hand tool kit with T-grip. Suit 1/4". Supplied with 5 Philips/Blade bits. 100mm long.

Code HTD80



MADE IN JAPAN

BLADE 1/4" HEX TIPS

Code	Size	Diam.
HEX204	4F / 5R	6.2x.85mm
HEX208	8F / 10R	6.2x1mm
HEX210	10F / 12R	6.2x1.3mm

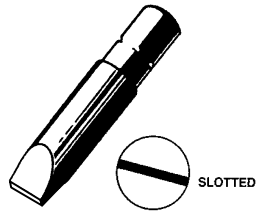

SOCKET PIN HEAD 1/4" HEX TIPS (Metric)

Code	Size
HEX625	2.5mm
HEX630	3mm
HEX640	4mm
HEX650	5mm

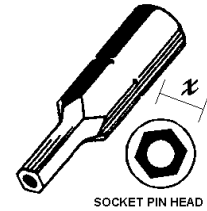

PHILIPS 1/4" HEX TIPS

Code	Size
HEX402	#2
HEX403	#3

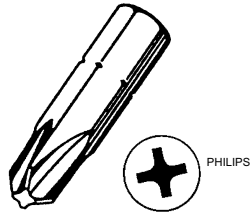

SOCKET PIN HEAD 1/4" HEX TIPS (Imperial)

Code	Size	~mm
HEX633	3/32"	2.3
HEX618	1/8"	3.1
HEX653	5/32"	4.0
HEX631	3/16"	4.7
HEX673	7/32"	5.5

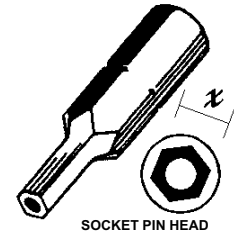

POZI-DRIVE 1/4" HEX TIPS

Code	Size
HEX442	#2
HEX443	#3

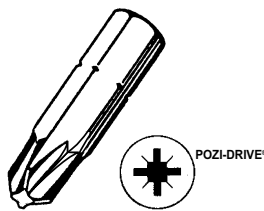

TORX TAMPERPROOF 1/4" HEX TIPS

Code	Size	Diam.
HEX803#3		0.9mm
HEX804#4		1.1mm
HEX805#5		1.3mm
HEX806#6		1.5mm
HEX807#7		1.7mm
HEX808#8		2.0mm
HEX809#9		2.2mm
HEX810#10		2.5mm
HEX815#15		3.0mm
HEX820#20		3.6mm
HEX825#25		4.0mm
HEX827#27		4.3mm
HEX830#30		4.8mm

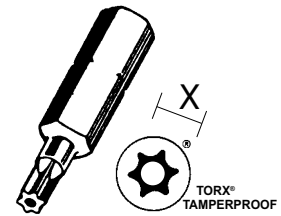

PHILIPS PIN-HEAD 1/4" HEX TIPS

Code	Size
HEX482	#2
HEX483	#3

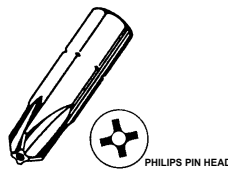

MAGNETIC DRILL BIT ADAPTOR

Allows quick connection of 1/4" Hex bits with drills. Magnetized. USA. 76mm long. Code HTCM40

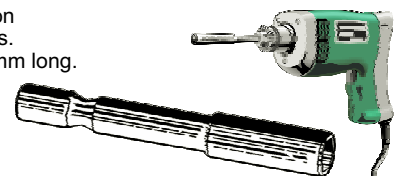

TRI-WING 1/4" HEX TIPS

Code	Size	Diam.
HEX301	W1	4.7mm
HEX302	W2	4.7mm
HEX303	W3	4.7mm
HEX304	W4	6.3mm
HEX305	W5	6.3mm

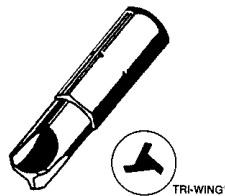

MINI SECURITY DRIVER SET

Jeweller screwdriver set for dismantling smaller electronic items. Actually fabricated specifically for cellular phone servicing. Includes Philips, Blade, Torx tamper proof drivers and others for antenna release, etc. All packaged in a plastic case. 7 drivers +more. See Section 17 for details. Please note that stock may vary slightly depending on supplier.

Code HT882



SNAKE EYE 1/4" HEX TIPS

Code	Size	Gap
HEX704	#4	1.5mm
HEX706	#6	2.0mm
HEX708	#8	2.5mm
HEX710	#10	3.3mm
HEX712	#12	4.0mm
HEX714	#14	4.5mm

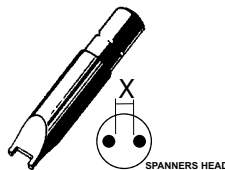

PHILIPS HEAD SCREWDRIVERS

Chrome Vanadium Hardened.
Sold individually with SOFT
rubber handle for easy grip.

CODE	SHAFT	POINT
HT600	10cm	4mm,00
HT605	10cm	4mm,0
HT610	15cm	4mm,1
HT650	10cm	5.5mm,1
HT655	10cm	6.5mm,2

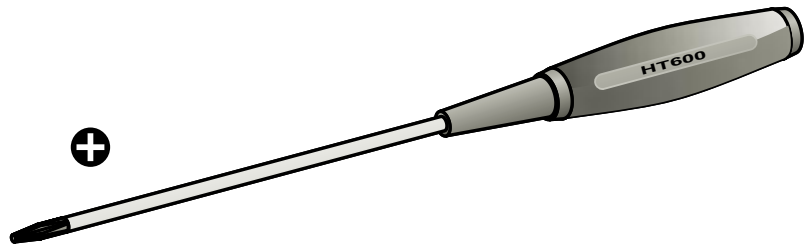

FLAT BLADE SCREWDRIVERS

Chrome Vanadium Hardened.
Sold individually with SOFT
rubber handle for easy grip.

CODE	SHAFT	DIAMETER
HT620	10cm	4.0mm
HT625	20cm	4.0mm
HT680	10cm	5.5mm
HT690	15cm	6.0mm

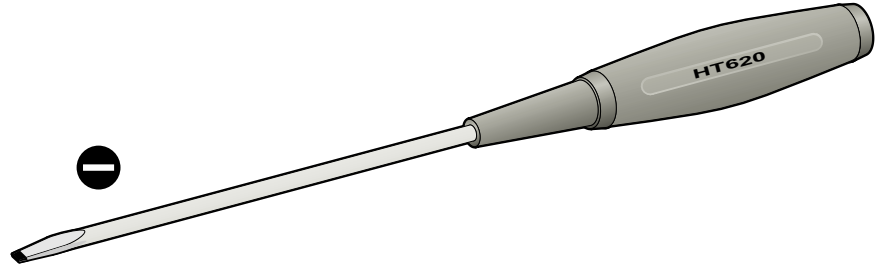

TORX SCREWDRIVERS

Sold individually.
10cm long shaft

CODE	SIZE	DIAMETER
HT5H	T5	1.4mm
HT6H	T6	1.8mm
HT7H	T7	2.0mm

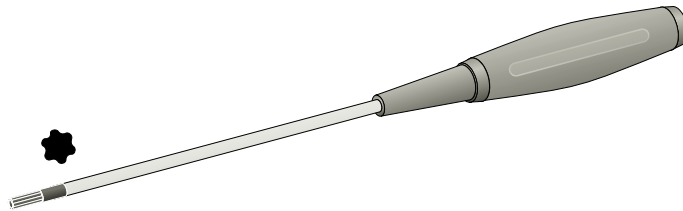

TORX TAMPER PROOF

Sold individually. **10cm** long shaft

CODE	SIZE	DIAMETER
HT8H	T8	2.25mm
HT9H	T9	2.50mm
HT10H	T10	2.70mm
HT15H	T15	3.25mm
HT20H	T20	3.80mm
HT25H	T25	4.40mm
HT27H	T27	5.00mm
HT30H	T30	5.50mm

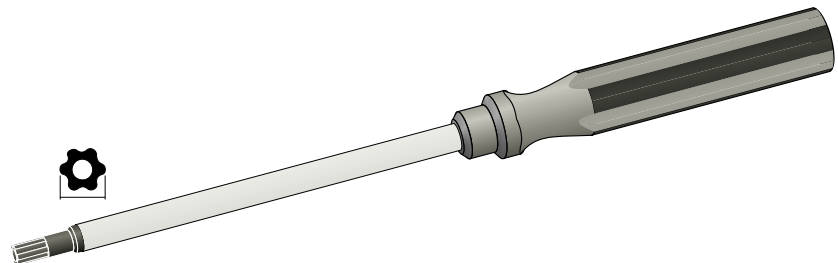

TORX TAMPER PROOF - LONG SHAFT

Chrome Vanadium Hardened.
Sold individually. **20cm** long shaft

CODE	SIZE	DIAMETER
HT8HLG	T8	2.25mm
HT9HLG	T9	2.50mm
HT10HLG	T10	2.70mm
HT15HLG	T15	3.25mm
HT20HLG	T20	3.80mm
HT25HLG	T25	4.40mm
HT27HLG	T27	5.00mm
HT30HLG	T30	5.50mm

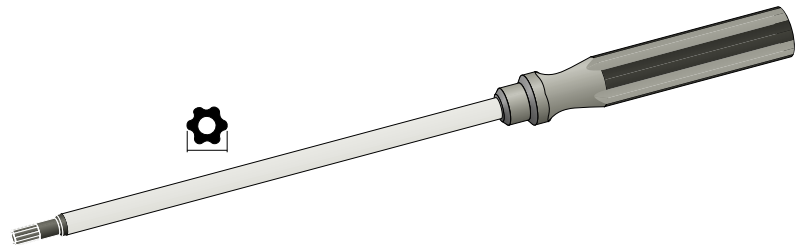

TRI WING SCREWDRIVERS

Chrome Vanadium Hardened.
Sold individually with SOFT
rubber handle for easy grip.

CODE	SIZE	SHAFT	DIAM'
HTW1	TW1	10cm	4.8mm
HTW2	TW2	10cm	4.8mm
HTW3	TW3	10cm	4.8mm
HTW4	TW4	15cm	6.4mm
HTW5	TW5	15cm	6.4mm

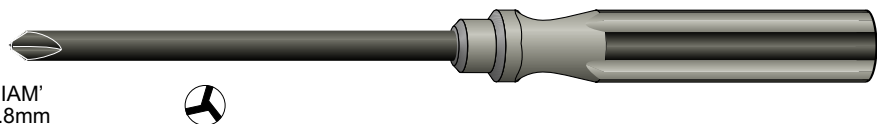

VERY LONG SCREWDRIVERS

Point 4.5mm
No. 1
Shaft 250mm
Code HT1250



Point 5.5mm
No. 2
Shaft 250mm
Code HT2250

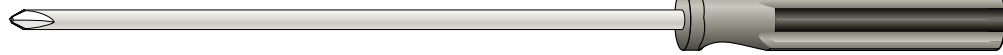

VESSEL CUSHION GRIP SCREWDRIVER KIT

5 Piece kit in a vinyl pouch. Chrome-vanadium hardened. Comfortable cushion rubber grip for non-slip, greater torque & control with less fatigue. Highest Quality. Made in Japan. Shaft lengths may vary slightly.

Shaft 100mm Philips No. 1
150mm Philips No. 2
150mm Philips No. 3
75mm Slotted 5.5mm Blade
100mm Slotted 6mm Blade

Code HT5600



Buy 5 and Save!

INSULATED SCREWDRIVER KIT 1,000 V

Contains 4 blade type & 3 Philips type drivers. 1000V fully insulated. Various shaft lengths and tip sizes. Chrome-vanadium steel for extended wear. Also contains a neon 100V - 500V AC tester.

Code HT550



ELECTRONIC TEST SCREWDRIVER

140mm long with indicator lamp in handle and clip. 250 Volt.

CODE HT500



SECURITY LABELS

Disintegrating sticker. Place over screw holes and unit seals to stop tampering. Suit repairs with warranty, etc. Roll of 500 stickers. Code WL500



25 PIECE METRIC TOOL COMBINATION SET

SET CONTAINS:

8 HEX KEYS: 1.5,2,2.5,3,4,5,5.5,6 mm
5 NUT: 5.0,4.5,4.0,3.5,3.0 mm
4 BLADE: 3.0,2.3,1.8,1.4 mm
3 PHILIPS HEAD: No. 00, 0, 1
3 HEX WRENCHES: 2.5,2.0,1.5 mm
PLUS TWEEZERS, 1 AWL and 1 TOMMY BAR

CODE HT450

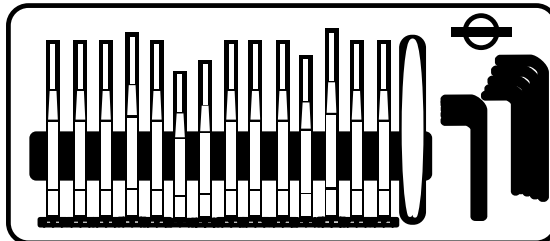

SCOPE CERAMIC ALIGNMENT DRIVERS

Zirconium fine ceramic tips are durable, non-conductive, anti-static and anti-magnetic. Hard and rigid for alignment of RF circuits, CD players and other sensitive applications. Rotating top head and protective cap.

4 types available separately.

TYPE	CODE
Philips No.0	CD100
Blade 1.3x0.4mm	CD15
Blade 1.8x0.4mm	CD20
Blade 2.6x0.4mm	CD25



THRIFTY CERAMIC ALIGNMENT DRIVERS

Precision, non-conductive, ceramic tipped plastic handle screw drivers suitable for alignment pots where a metal driver will cause interference. Swivel handle-head.

0.4x1.8mm TIP HT418

0.4x1.3mm TIP HT413

0.4x0.9mm TIP HT409



BLADE SCREWDRIVER SET

High quality precision 6 piece screwdriver set. Metal handle, Swivel tops, medium carbon steel tips. Sizes: 1, 1.4, 2, 2.4, 3, 3.8mm
CODE HT400

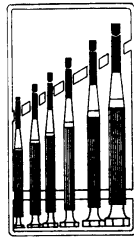

ALIGNMENT SCREWDRIVER

Plastic body for insulation with a metal tip for extra strength. Ideal for alignment and adjustments.
Code HT525

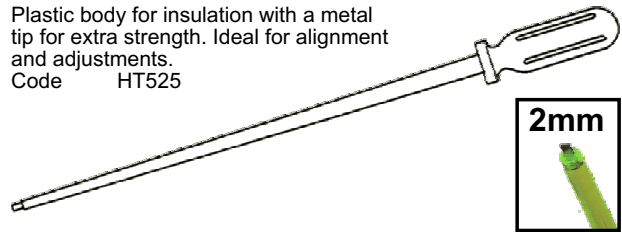

PHILIPS HEAD SCREWDRIVER SET

High quality precision 5 piece Philips head screwdriver set. Metal handle, Swivel tops, medium carbon steel tips. Sizes: 00, 0, 1, 1, 2,
CODE HT410

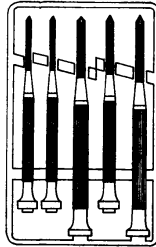

LONG R SCREWDRIVER KIT

Consists of 3 Philips head and 3 blade type screwdrivers. An extra long shaft allows you to reach even the most difficult screws. The swivel cap handles allow single handed use
Code HT535

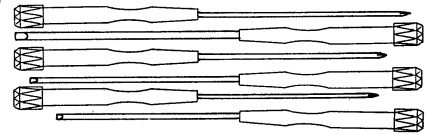

SCREWDRIVER SET

6 piece Swivel tops Metal tip Sizes: Flat 1.2, 1.8, 2.4, 2.9mm Philips 0, 1
PLASTIC HANDLE
CODE HT420

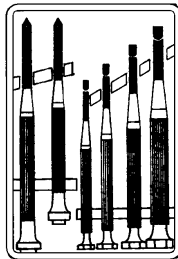

PRECISION ALIGNER TOOL SET

4 Tools plus extension giving 19 different profiles to suit trim pots, IFT, HFcoils etc. Insulated. Japan.
Code SCD10

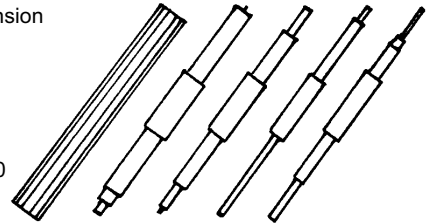

NUT DRIVER SET

High quality precision 5 piece nut driver set. Metal handle, swivel tops, medium carbon steel tips. Sizes 3, 3.5, 4, 4.5, 5mm
CODE HT430

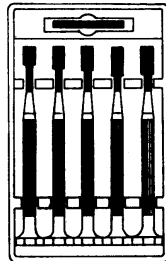

VCR ALIGNMENT TOOLS

For adjusting audio/control heads, tape guide path and other transport mechanism parts. 3 types.

CODE HT36
HT87
HT89

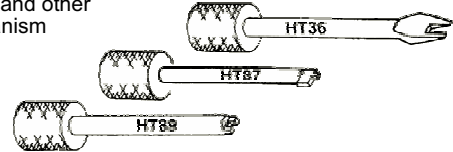

ALLEN KEYS

This pouch contains the miniature keys not usually found in normal kits. These unique keys are required for guide posts, heads, motor pulleys, etc. 0.7, 0.9, 1.3, 1.5, 2.0, 2.5, 3.0mm.
Code HV70



DIAMOND NEEDLE FILES

A good investment not only for the extended wear life but also the wider range of uses. 5 assorted blades can reshape glass panels etc. Also available in standard. 140mm long.

DIAMOND
Code NFD141

STANDARD
Code NF140

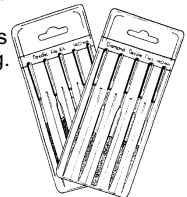

UNIVERSAL TOOL SET

Flat (blade) and nut drivers as well as hex keys and open wrenches. Compact case.
Code HT440

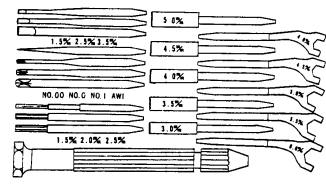

MINIATURE TOOL BITS

For PCB work, etc. Arlec.

ET669 3 Engraving/ Milling cutters
ET688 Diamond Engraver With designs
ET689 6 Cutting/ Slitting discs
ET627 3 GP Grindstones
ET625 0.6, 0.8, 1.0, 1.2mm HSS Drill bits
ET722 3 Steel Wire Brush

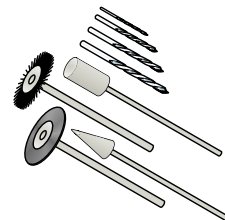

UNIVERSAL CABLE STRIPPER

Patented device for stripping the covers off today's modern cable styles, eg. STP/UPT 4P/6P/8P Speaker, Coax, etc.
Code HTS501A

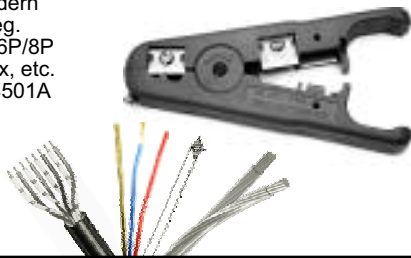

HEAVY DUTY SOLDERLESS CRIMPING TOOL

Ratchet type for insulated terminals. Heavy duty construction and is designed to apply the correct amount of pressure so as to obtain a perfect result. See Section Seven for plugs.
NOTE: This is not for RG58/59 crimp connectors (OT500).
CAST IRON TIP
Longer lasting, more accurate.
Code HT301H

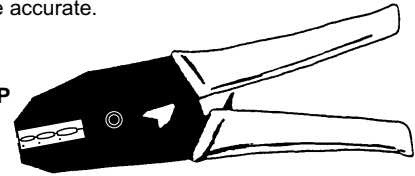

REPLACEMENT TIP
Code JAW301H

COAXIAL CABLE STRIPPER

This compact precision tool strips various types of coaxial cables.
Code HT377

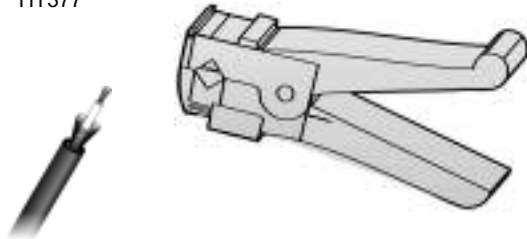

PROFESSIONAL CRIMPING TOOL

Ratchet type for RG58U and RG59U type connectors. BNC, "F", etc., Steel Body with Die Cast Head.
Code HT336A

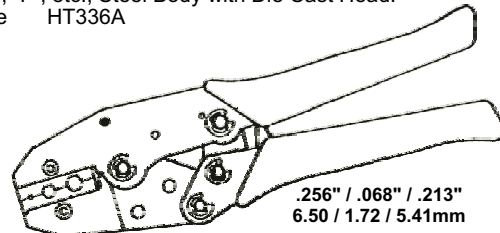

CABLE TIE GUN

Designed to tie & cut THE cable tie in one simple operation. This professional tool is a must for your tool box. With tension adjustment.
Code HT381

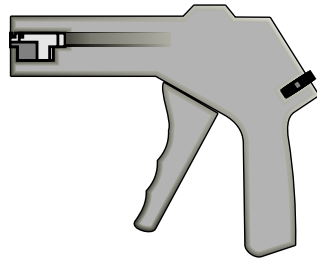

PROFESSIONAL CRIMPING TOOL MULTI

Ratchet type for RG58U and RG59U type connectors. BNC, TNC, F, etc., Steel Body with Die Cast Head.
Code HT336G

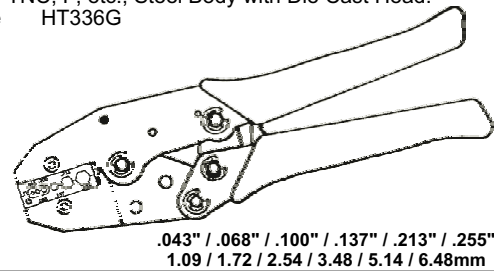

MULTI-PURPOSE CRIMPING TOOL

This combined multi-purpose tool will crimp non-solder type insulated terminals. Ideal for every tool box.
Code OT400

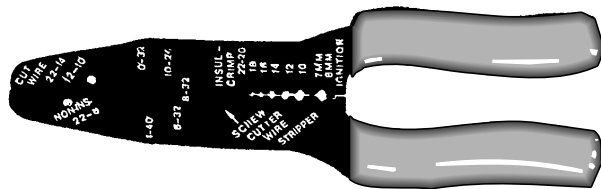

HEAVY DUTY CRIMP

9" for F6, F59, RG6, etc.
Our parts eg. ;
F322, F325, P545
P541, S521, etc.
Strong construction for these larger crimps.
HEX 1 8mm(0.322")
HEX 2 9mm(0.359")
Code HT106H

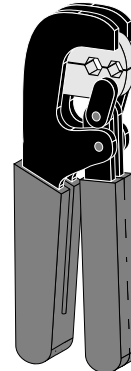

HEAVY DUTY SOLDERLESS CRIMPING TOOL

Ratchet type for insulated terminals. Heavy duty construction and is designed to apply the correct amount of pressure so as to obtain a perfect result. See Section Seven for plugs.
NOTE: This is not for RG58/59 crimp connectors (OT500).
STEEL PLATE TIP
Code HT301

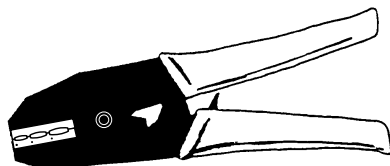

MODULAR CRIMPING TOOLS

Professional, all metal construction with stripping blades & spring load lever action. See section 7 for crimp plugs.
Code To Suit
OT245 4 pin, 7.5 mm type
OT250 4 & 6 pin std types
OT256 8 pin type



CUTTING NIPPERS

Designed for electronic applications.
All have insulated handles & spring return

MICRO NIPPER JAPAN

CODE NS04
SIZE 115mm

NIPPER JAPAN

CODE NS03
SIZE 125 mm

MICRO NIPPER TAIWAN

CODE HT205
SIZE 115mm

MICRO NIPPER TAIWAN

CODE HT109
SIZE 127mm



LONG NOSE PLIERS

Designed for electronic applications.
All have insulated handles.

MICRO PLIER JAPAN

Flat 1mm Tip
with spring return.
CODE PS04
SIZE 115 mm

MINI PLIER JAPAN

Serrated tip
with spring return.
CODE HT305
SIZE 125mm

PLIER JAPAN

Serrated tip for heavy
duty applications.
CODE HT306
SIZE 150mm



HEAVY DUTY FLUSH CUTTER 115mm

Superior high quality
cutters reduce
fatigue with sharp
strong action and
comfortable grip.
Spring return
WITH CATCHER
Code HT175

Safety Cutoff Catcher



WITHOUT CATCHER

Code HT170

MICRO LONG NOSE PLIER

Long reach
serrated
Strengthened
to resist jaw
crossover. Spring
return. Cushion
grip. Light weight
Code HT378



HEAVY DUTY FLUSH CUTTER 150mm

Extra hard
Chrome plated
Long life blades
Scissor action cut
Spring return
Cushion grip
Code HT178



CUTTER AND PLIER KIT

Diamond®/Xcelite® (USA)
from Cooper Tools.
Superior high quality
hand tools reduce
fatigue with sharp
strong action and
comfortable grip.
Shear Cutter 175mm
Long noze Plier
Code HT1300
Both



HEAVY DUTY DIAGONAL CUTTERS 200mm

Large cutters for heavy
cutting of cable, etc.
High leverage design.
Long 20mm jaws.
Hardened/Toughened.
Made in the USA by
Crescent/Cooper-Tools.
Insulated handles.
Code HT5428



PROFESSIONAL CUTTER

Made in Switzerland
by Erem™ for Precision
and long life.
115mm Soft Grip
Small oval head
Full-flush action.
The Best
Code HT522N

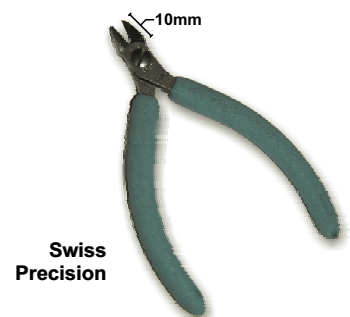

Swiss
Precision

XURON MICRO-SHEAR FLUSH CUTTER

Micro-Shear®
US Pat 3774301
"Blade by-pass
Shear cutting".
No glare black finish.
Xuro-rubber grip.
Drop forged and
computer cut.
Cut 20AWG copper
Length 130mm
Blade 9mm
Code HT1702

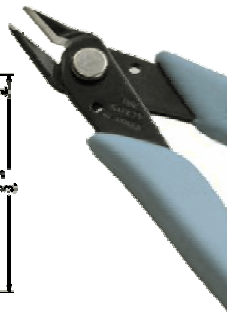
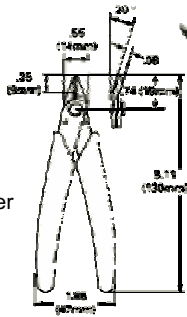

NUT REMOVER PLIERS

REMOVE DAMAGED SCREWS!
Screws that have stubborn
heads that are stripped
or rust encrusted, etc.
This unique plier will
grip with its elaborate
vertical & horizontal
serated jaw and make
removal possible.
Length 150mm
Code PZ55



XURON MAXI-SHEAR FLUSH CUTTER

TRACK-CUTTER
Tough shear action
for general electronic
applications like cutting
Harnesses & cables, etc.
Xuro-rubber grip handles.
Low fatigue design for
longer working use.
Cut 14AWG copper
Length 150mm
Blade 12mm
Code HT2175



19 PIECE METRIC DRILL SET

High speed drill set in a metal box.
Quality and professional.
19 Metric drills for drilling
wood, metal and plastic, etc.
1.00mm → 10.00mm
(0.5mm increments)
Code KZ19

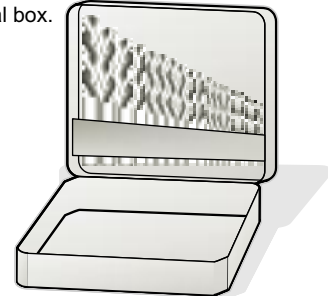

XURON TAPERED HEAD SHEAR CUTTER

Sub-miniature head
25 micron to 14AWG
Durable Alloy Steel
Xuro-rubber grip
"Micro-Shear cutter"
with lead retainer.
Low fatigue cutting
with ultra-durability.
Cut 14AWG copper
Length 125mm
Blade 9mm
Code HT9200

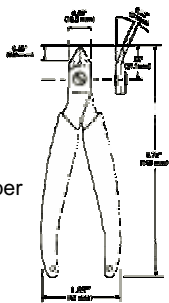

MINIATURE DRILL BITS

4x High Speed
Steel drill bits.
Suit PCB work, etc.
From Arlec Super drill.
Size 0.6mm
0.8mm
1.0mm
1.2mm
Code ET625



XURON TWEEZER NOSE PLIERS

SMOOTH JAW TYPE
Precision, ergonomic,
durable hand tool.
Strong carbon steel
extra thin profile.
Drop forged and
computer tooled
with comfortable
Xuro-rubber grips.
Length 129mm
Nose 20mm
Code HT485



MINIATURE TOOL BITS

ET669 3 Engraving/
Milling cutters
ET688 Diamond Engraver
With designs
ET689 6 Cutting/
Slitting discs
ET627 3 GP Grindstones
ET625 0.6,0.8,1.0,1.2mm
HSS Drill bits
ET722 3 Steel Wire Brush

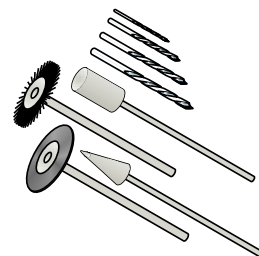

XURON TWEEZER NOSE PLIERS

SERRATED JAW TYPE
As HT485, but serrated.
Perpendicular teeth.
Light weight.
Length 129mm
Nose 20mm
Code HT486



ARLEC MINI-DRILL

Compact pencil drill
for engraving type
precision work.
Includes case with
grinding wheel
steel wire brush
and 4 drill bits.
Code ET571

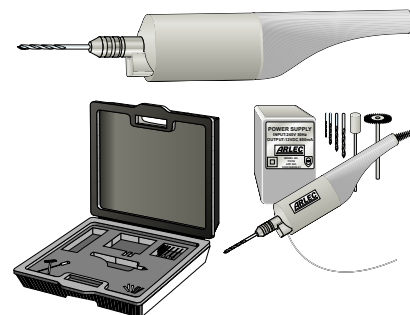

FUSE REMOVER

Remove and insert fuses with ease. Compatible with most fuse sizes. Code FRT3

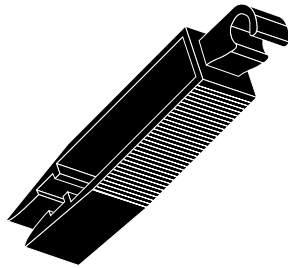

PLCC IC EXTRACTOR

For those delicate ICs with pins on all sides. This extractor first hooks under the diagonal corners then with further hand pressure, the tool pulls upward evenly, removing the package without damage. Code CY850

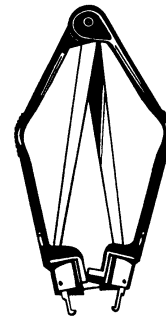

PEARL CATCHER PARTS PICKER

For removing small screws and other parts from hard to get at places. Spring loaded, all metal construction. Approx. 100mm long. CODE PU5

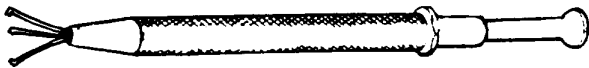

IC TOOL SET

Consists of three insertion tools and one extraction tool for static free handling of sensitive IC's. Code ICT4



DELUXE RETRACTABLE KNIFE

All metal body, 140mm long supplied with two spare cutting blades. Code HT315

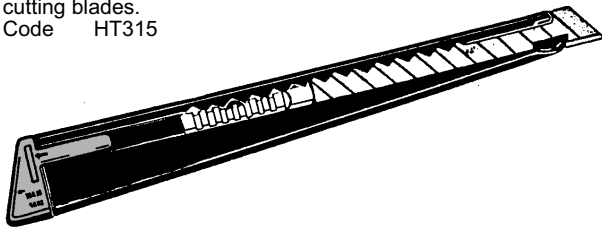

SEIZER CLAMP

Clamps firmly to hold wires for soldering, etc. Acts as a heatsink. Retrieve small parts. 3 position snap-lock. Stainless. **100mm Smooth Jaws Straight** Code HT32H **120mm Serrated Jaws Straight** Code HT42H **100mm Smooth Jaws** Code HT33H **120mm Serrated Jaws** Code HT43H

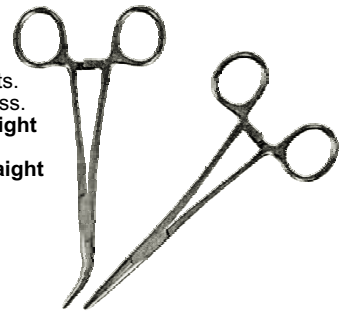

RETRACTABLE KNIFE

Plastic lockable pocket size With Snap Off Blades 140mm Long. Code HT310

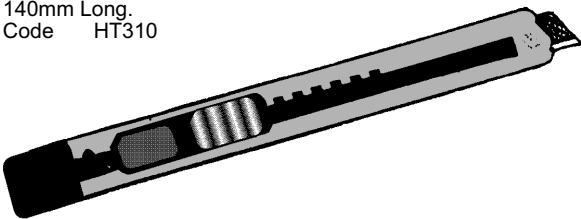

DENTIST MIRROR

"Say Ahh!" Excellent assistant for inspecting components, etc. in hard-to-reach places. Plastic. 20mm mirror. 150mm handle. 135° angled. Code HT922



CIRCLIP REMOVER

Designed for removal & insertion of 2-4mm circlips. Code P790



THE THIRD HAND!

Quality made in USA Very sturdy Highly adjustable The base is made from 1/2Kg DieCast. Parts are metal or fibre reinforced plastics. Jaws open to 120mm. Rotates, Pivots, Swivels, Locks. Code PV201



TWEEZERS STAINLESS STEEL

Erop™ Surgical Quality, Anti-acid, Anti-Magnetic, Non-serrated. Polished. Non-slip. Long Life. Won't distort. Force = Pressure at normal finger position to close (Approx.).

Code Length Weight Force

HT908 123mm 22g 150g



HT903 120mm 18g 220g



HT902 110mm 12g 120g



HT914 120mm 17g 100g



HT906 115mm 16g 150g



HT905 122mm 19g 160g



HT915 120mm 18g 260g



TWEEZERS ANTISTATIC PLASTIC

Precision tweezers for electrostatic sensitive devices. Black, Chemical resistant. 220°C. Won't distort.

Code Length

HTJ201 120mm

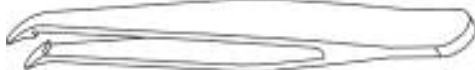

HTJ202 120mm



HTJ203 120mm



HTJ204 120mm



HTJ205 120mm



HTJ206 120mm



HTJ207 120mm



VIDEO TOOL KIT

Convenient leather bound case with 22 pieces of hand tools for repairing VCRs, etc. Includes head puller, allen keys, circlip remover, screwdrivers, and all the special adjustment drivers you should ever require! Code FV1



COTTON GLOVES

Required for protecting equipment from finger prints. Ideal for VCR head replacement. Very light but good quality for using again n' again. One size fits all! Supplied in pairs. Code GLV2 Pair.

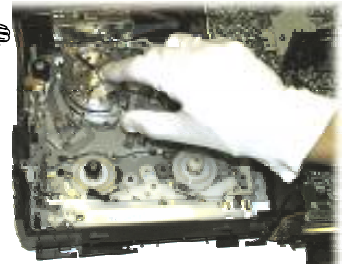

VIDEO HEAD EXTRACTOR

Adjustable to suit many brands. Code HT800

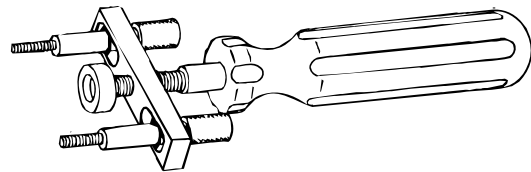
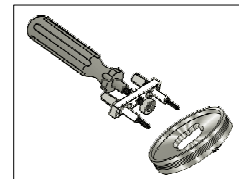

VIDEO ALIGNMENT TOOLS

For adjusting audio/control heads, tape guide path and other transport mechanism parts. 3 types.

CODE
HT36
HT87
HT89

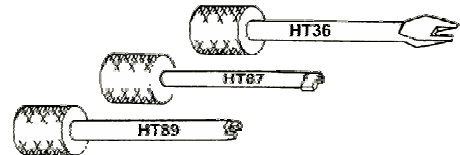

HAND ASSIST TOOLS

A collection of assorted hand tools Scribes, hooks, blades, brushes, etc. designed to assist technicians in repair and servicing. Premium quality. Made in Japan. Code SA10



50mm ILLUMINATED MAGNIFIER

Lens is *NOT* Acrylic but proper coated glass! Illuminated. Ideal for component identification, etc. Requires 2 x 'AA' batteries. Glass Lens 3.5X Code IMG50



REPLACEMENT GLOBE

2.5V 0.3A

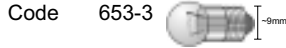

ESD EARTH PLUG

Suitable for eliminating Electro-Static from units during repair, earthing a work bench, etc. Approved. Green.

PIGGY-BACK PLUG

Code ACP463AS



75mm ILLUMINATED MAGNIFIER

Large, easy grip handle. Easy to clean, scratch resistant glass lens. Suitable for reading and component ID, etc. Illuminated. 4 x 'AA' Req' Code IMG75



REPLACEMENT GLOBE

2.5V 0.3A

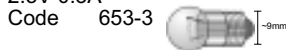

ANTI-STATIC FIELD SERVICE KIT

The tough, long lasting work mat measures 600x600mm with handy pockets and folds easily for transportation and storage. The field service kit comprises of one mat, a 5M earth lead, a 2M coil cord, a wrist band and connectors. Heel strap optional. Code ASK110

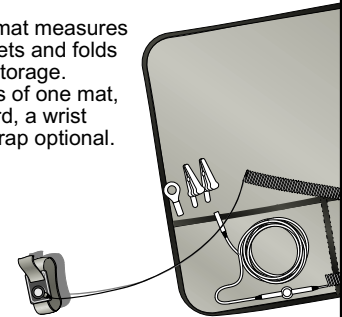

110mm HANDS-FREE MAGNIFIER

Hangs around your neck so your hands are free to work. Ideal for intricate work, reading, etc. Quality Construction, large coated glass lens. Easy to clean, Scratch resistant. Clip-on illuminator included for optional assisted viewing. Requires 2 x 'AA' batteries. Code IMG110



ANTI-STATIC SERVICE KIT

A stiffer design enabling a more stable bench or floor application. Non slip surface ensures the mat and appliance will not move inadvertently. High quality construction. Will not tear and is resistant to chemicals and heat. Includes earth strap and wrist band. Size 600 x 400mm Code ASK120

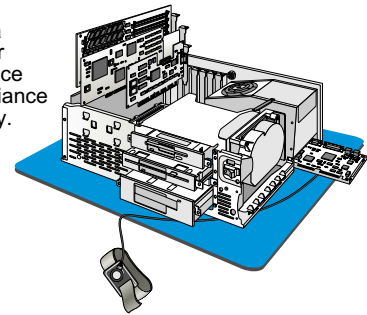

HANDS-FREE HEADSET MAGNIFIER

Cushioned headband Reduce eye strain Worn with/without your eye-glasses. Light weight, comfortable. 2.0x Medium Magnification lenses included. Interchangeable lens. Flips up out of the way. Acrylic no-scratch lens. Made USA www.mageyes.com Code IMG384



WRIST BAND AND CORD

This fabric adjustable wrist band features an inner layer of silver plated conductive monofilaments providing 90% skin to thread contact. This assures a reliable connection while the outer layer remains non-conductive. The wrist bands' detachable cord is very flexible and durable with strain relief and a coiled section. This comfortable wrist band and cord combination guarantees constant electro-static discharge. Includes one wrist strap, a 2 metre coil cord and an alligator clip. 1MegΩ Resistor inline for safety. Code ASW115

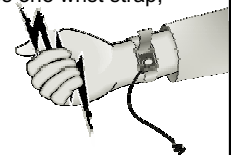

MAG-EYES LENS ONLY

Upgrade your magnification. Original USA made MagEyes. Optical quality acrylic. Suit IMG384 MagEyes above.

2.25x MEDIUM STRONG MAG'

Code IMG255

2.75 STRONGEST MAG'

Code IMG257



HEEL STRAP

Extremely reliable shoe grounding system developed for unrestricted use. Designed to accommodate all sorts of footwear using fully adjustable velcro straps. Connection is made via the tough black conductive rubber under the heel and a comfortable conductive cloth strap that is simply tucked into your sock. A 1 meg resistor is inserted in the loop for safety. Now a reliable connection is made between you and the conductive mat. Code ASH120

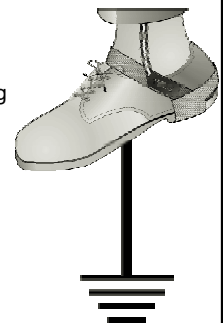

12V SOLDERING IRON

12 volt DC soldering iron 40 watt with 4.5M cord to cigarette lighter plug. Ideal for in-field work on the car or boat, etc.
CODE SI4

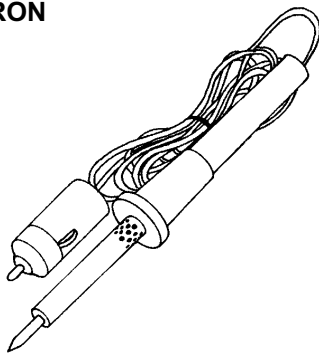

TIPS.
CODE SIT40

20 WATT HAKKO SOLDERING IRON

High quality Light Weight (40g) Suitable for all general applications Ideal Hobby Iron or spare in the tool box, etc.
Code HK500W



Tip 500-BB3

25 WATT SCOPE SOLDERING IRON

240 VAC with long life plated tips for electronic soldering at around 380°C. Stainless steel barrel. Impact resistant handle.
CODE MH25

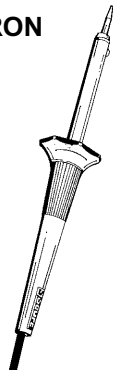

REPLACEMENT TIPS
MH25ZF MH25DF
MH25SF MH25DFB
TIPS



WELLER SOLDERING STATION

42 Watt 24 Volt Lightweight Standard Iron 1.2M non-burning iron lead and "Closed-Loop" stable/constant Temperature controlled. Gives excellent soldering results. Comfortable use. Ideal for OEM, Production lines, User-Lock-out, etc. Long life design.
Code WTCPT



TIPS TO SUIT
Choose the temperature by which tip is used. Supplied with PTA tip V10-700 (700°F/371°C)
See TIPS page → → → →

WELLER SOLDERING STATIONS

Weller is a popular name in soldering because: They are made in Australia, and are of premium quality. Weller support their products with spare parts and service.



COOPER TOOLS 80W IRON

High power for those temperature hungry jobs. Special Price! Includes bonus tip. Blunt conical (pen) & Flat wedge (Screw driver)
Code SI-N80D

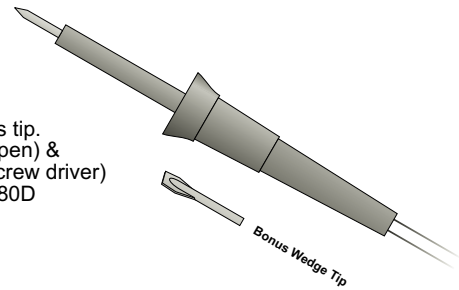

40 WATT SCOPE SOLDERING IRON

240 VAC with longer plated tips for sustained heating at around 380°C. Stainless steel barrel. Impact resistant.
Code MH40



TIPS
MH40ZF MH40DF
MH40SF MH40DFB
TIPS

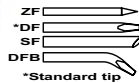

WELLER HEAVY DUTY 175W IRON

SUPER HIGH POWER!
16mmØ tip iron plated. 320mm long. 450g +Cord. Australian Made.
Code SP175D



REPLACEMENT TIP
MTG40 Chisel 16mm

60 WATT HAKKO SOLDERING IRON

High quality Light Weight (40g) Suitable for all general applications Ideal Hobby Iron or spare in the tool box, etc. Super-quick heatup and better temp' hold.
Code HK503W



Tip 503-BB6

SOLDERING IRON STANDS

Metal Base & Spring. Standard Iron Size.
Code HTA5

Heavy cast Base. Standard Iron Size.
Code HTA10



HTA5 Sponge: SPG3455
HTA10 Sponge: SPG5052

CORDLESS SOLDERING IRON



Made in the USA, Light & convenient
 Press for instant heat! Up to 480°C.
 ½Hr Continuous Usage (~200 joints).
 Very quick heat response.
 Low / Safe voltage. Isolated tip.
 Quick charges by simply
 replacing it to its stand.
 Torch lamp for easy
 view of soldering.
 Excellent quality. Ideal
 for the bench or tool box.
 Code WH7764
 Cost



TIPS TO SUIT WH7764

Code
 WH7571
 WH7566
 WH7535
 WH7546
 WH7577
 WH7545
 WH7569

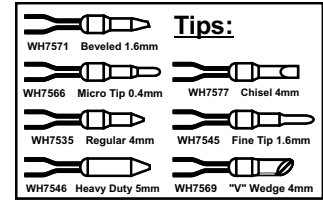

EDSYN COMPACT PENCIL IRON

400°C to 1200°C
 Safety cap with
 flint ignitor
 190mm~ long
 Up to 1HR use.
 Hot blow nozzle
 Blowtorch nozzle
 Mini stand. Case.
 Code EB100K



2.4mm tip BT2100
 4.8mm tip BT3100

WELLER PYRO-PEN SOLDERING IRON

Runs up to 3Hrs on one
 fill of lighter fluid.
 Lightweight. Comfortable.
 Metal storage box.
Piezo Ignition. Includes
 Soldering & Hot-Blow tips.
 Spare parts available.
 Code WPA2



TIPS TO SUIT WPA2 & WPA3

WPT1 Taper 1mm
 WPT2 Chisel 2mm
 WPT3 Spade 2mm



EDSYN HIGH POWER GAS IRON

400°C to 1200°C
 Up to 180 min
 20 to 135 Watts
 Piezo ignition
 270mm~ long
 Hot blow nozzle
 Blowtorch nozzle
 Cap/Stand, etc.
 Code EB200K



2.4mm tip BP2200
 4.8mm tip BP4200

WELLER PYRO-PEN SOLDERING IRON

Professional service tool.
 This iron is identical
 to the WPA2 butane iron
 with solder & hot-blow
 but with a controllable
Flame-torch instead
 of the piezo ignition.
 Code WPA3



TIPS TO SUIT WPA2 & WPA3

WPT1 Taper 1mm
 WPT2 Chisel 3mm

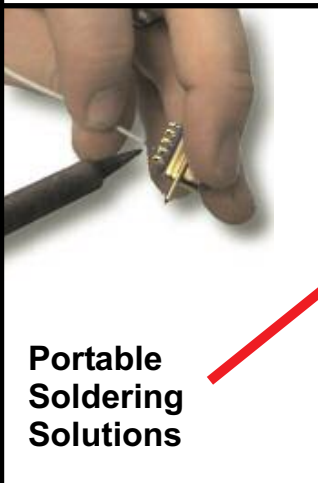

**Portable
 Soldering
 Solutions**

WELLER POWERED POCKET IRON

Dont be caught with-
 out an iron again!
 Truly compact, fits
 in your shirt pocket!
 Quality product that
 Solders & Hot-blows.
 Spare parts available.
 Code WSTA6



TIPS TO SUIT

WPT01 Taper 1mm
 WPT03 Bevel 2mm

SUPERSCOPE SOLDERING IRON

SUPERSCOPE FAST POWERFUL LOW VOLTAGE

Adjust heat instantly whilst soldering.
200-500°C 20-100 Watt.
For medium to heavy duty soldering.
Requires PSU10
Code SI75



SCOPE POWER SUPPLY

3.3 volts high current.
Code PSU10

MINISCOPE SOLDERING IRON

Light weight Pencil iron for push button instant heat with adjustable temp' whilst soldering.
200-500°C. 10-70 Watt.
For light to medium duty Precision soldering.
Requires PSU10
Code SI85

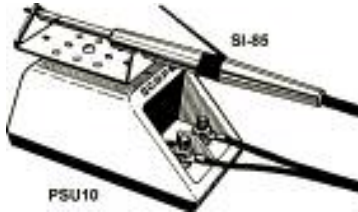

SCOPE POWER SUPPLY

Code PSU10

MINISCOPE & SUPERSCOPE SPARE PARTS

SS1A	10x SuperScope tips,	6.4mm,	1A
SS1B	10x SuperScope tips,	3.2mm,	1B
SS3	10x SuperScope heater elements.		
05PS	3x tips & 2x elements	Kit	1A/1B
SS02	1x SuperScope barrel		
SS05	1x Ceramic Bead		
MS21A	10x MiniScope tips,	6.4mm,	1A
MS21B	10x MiniScope tips,	2.5mm,	1B
MS22D	MiniScope Barrel		
MS23	10x MiniScope heater elements.		



Order One To Receive Ten!

SCOPE TIPS TO SUIT OLDER SOLDERING IRONS

Code	Iron	Type
ZF0.8/59	ETC30W/8	S
DF1.6/504	ETC30W2	H
DF2.0/505	ETC30W2	H
DF0.4/23	ETC60W/8	S
SF0.8/21	ETC60W/8	S
DF0.8/22	ETC60W/8	S
DF1.2/26	ETC60W/8	S
SF1.2/27	ETC60W/8	S
DF1.6/24	ETC60W/8	S
SF2.0/57	ETC60W/8	S
DF3.2/25	ETC60W/8	S
DF0.4/03	ETC60W9	H
DF0.8/02	ETC60W9	H
DF1.2/06	ETC60W9	H
DF1.6/04	ETC60W9	H
DF3.2/05	ETC60W9	H
DF5.0/10	ETC60W9	H
DF1.0/B	PX10	H
DF2.0/2D	PX10	H
DF5.0/5K	PX10	H
DF16	TC60	-
DF32	TC60	-
DF64	TC60	-
SF16	TC60	-
SF32	TC60	-
SF64	TC60	-
SF1.0/BC	PX10	H
SF2.0/2C	PX10	H
SF3.0/3C	PX10	H
SF5.0/11	PX10	H
SF2475	PH20, MH25	-
DF3475	PH20, MH25	-
SF4475	PH20, MH25	-
ZF0475	PH20, MH25	-

Supersceded Soldering Iron still require replacement tips! Here are the tips we have stock of. If you require a tip not listed, please enquire



Type "H" = Hollow
Type "S" = Solid

ETC60W/8 is for ETC60W & ETC60W



HAKKO SOLDERING IRON - RED

High quality Light Weight (40g)
Suitable for all general applications
Ideal Hobby Iron or spare in the tool box, etc.

20W IRON

Code HK500W
Tip 500-BB3



60W IRON

Similar to above but quicker heatup and better temp' hold.
Code HK503W
Tip 503-BB6



MADE IN JAPAN

HAKKO SOLDERING IRON MACH-1

Super Fast Thermal Recovery!

Hollow tip ceramic heater technology.
Compact, comfortable, foam handle grip, light weight (50g), flexible 240V cord.
120W heatup, 55W normal. 370°C. Thermal IC controlled.
Excellent solution for those who don't want a big station.
Code HK921



HK921

MADE IN JAPAN

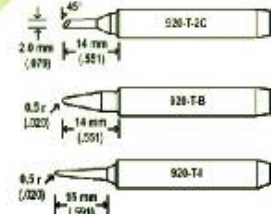

REPLACEMENT TIPS

Code 920-T-2C Small Bevel
Code* 920-T-B Blunt Conical
Code 920-T-I Sharp Conical
*Default Tip Supplied with HK921

HAKKO SOLDERING STATIONS

QUALITY, SAFETY AND OUTSTANDING PERFORMANCE.

- *Super quick heat-up and fast thermal recovery for high quality soldering at lower tip temperature.
- *Built-in ceramic heater sensor up in tip. Maintains temp quickly, within +/-5°C of setting.
- *Fully adjustable 200-480°C
- *Supplied with 50W iron.
- *Now available in Earthed OR NEW Isolated-Floating Earth for modern static sensitive electronics.
- *24VAC zero-cross switched.
- *Micro Iron available for more intricate work.
- *Tweezer Iron Available for SMD Rework.
- *Specialised tips available For SMD ICs, etc.

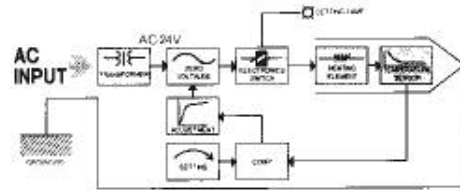

EARTHED VERSION

Code HK936

FLOATING EARTH

Code HK936ESD

REPLACEMENT SPONGE

Code A1042

REPLACEMENT IRON (M)

Code HK907

MINI IRON (S)

Code HK900S

LARGE IRON (L)

Code HK908

TIPS - NEXT PAGE

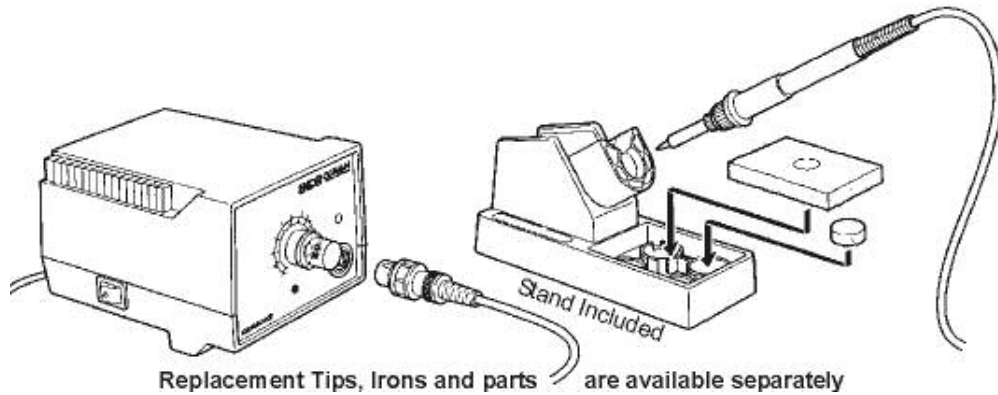

Replacement Tips, Irons and parts are available separately

NOTE: Please retain the manual supplied with your iron. This is essential for ordering replacement parts and tips in the future! The HK936 range replaces the HK900 & 926 Stations. However Replacement parts, as found in their manuals, are still available.

EARTHED IRONS FOR HK900 & HK926 STATIONS

MICRO IRON 50W Code HK900S **STANDARD 50W IRON** Code HK900M

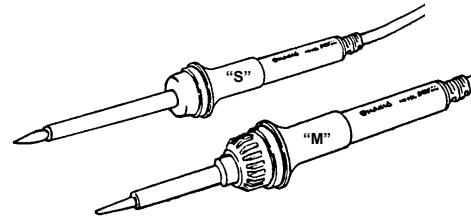

EARTHED IRONS FOR HK936 STATION

MICRO IRON 50W Code HK900S **STANDARD 50W IRON** Code HK907 **LARGE 50W IRON** Code HK908

FLOATING EARTH IRONS FOR HK900ESD & HK936ESD STATIONS

MICRO IRON 50W Code HK900SESD **STANDARD 50W IRON** Code HK900MESD

FLOATING EARTH IRONS FOR HK936ESD STATION

MICRO IRON 50W Code HK900SESD **STANDARD 50W IRON** Code HK907ESD **LARGE 50W IRON** Code HK908ESD



HAKKO SMD HOT TWEEZER

**THE HK950 CANNOT FUNCTION BY ITSELF
IT MUST BE CONNECTED TO A HAKKO STATION.**
Suit HK700, 701, HK926, 927, 928, 936, 937, ESD, etc.
Designed for SMD rework of tiny
SMD capacitors and resistors, etc.
Heats solder and removes in one
clear action. Comfortable grip.
INCLUDES STAND AND TIPS
Code HK950

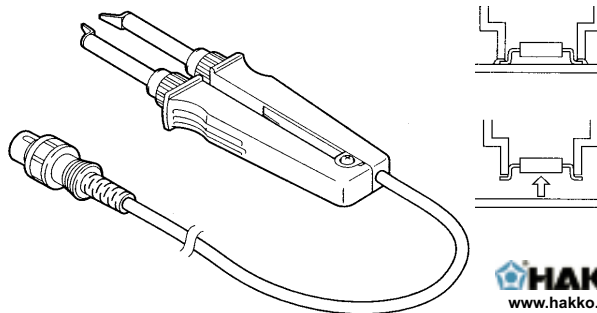

HAKKO
www.hakko.com

HAKKO SMD HOT TWEEZER ACCESSORIES

SPONGE TO SUIT STAND

Code A1386

REPLACEMENT TIPS (2 Supplied)

A1379	1.0x1.0	
A1378	2.0x1.0	(Orig.)
A1380	8.0x1.0	
A1381	10.0x1.0	
A1382	13.0x1.0	
A1383	18.0x1.0	
A1384	20.0x1.0	
A1385	25.0x1.0	

REPLACEMENT HEATING ELEMENT

A1377 One Supplied

HK950

See Above.
Requires Station
HK701, HK936, etc.

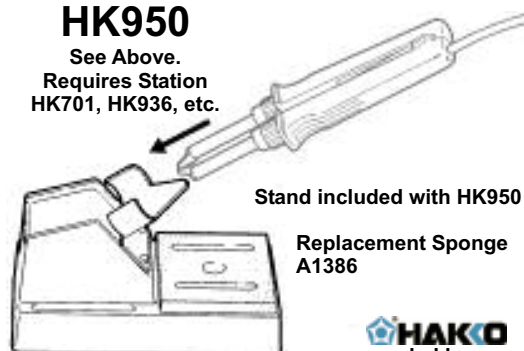

HAKKO
www.hakko.com

ALL-IN-ONE SOLDERING & DESOLDERING STATION

Combine the powerful desoldering
tool and the high performance
soldering station for accurate
control and more effective and
efficient work. Suitable for
production & rework situations.
New compact station using less
desk space. Includes HK907ESD
Iron (200°C → 480°C) and stand.
HK809 Desolder Gun (380→480°C)
and Stand, tools, etc.
Code HK701

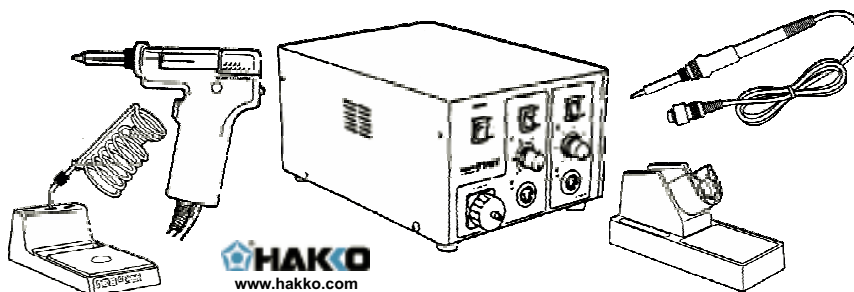

HAKKO
www.hakko.com

HAKKO DESOLDERING/REWORK STATION ESD SAFE

Separate air compressor type for superior vacuum pressure
and lighter handle control. The iron is temperature
controlled and provides protection from electrostatic, etc.
Electro Static Discharge Safe soldering and desoldering.
For more information, please enquire or www.hakko.com
Includes tip, filters, cleaners, stand, manual, etc.
Spare parts and other tips available, see manual for #.
Code HK474

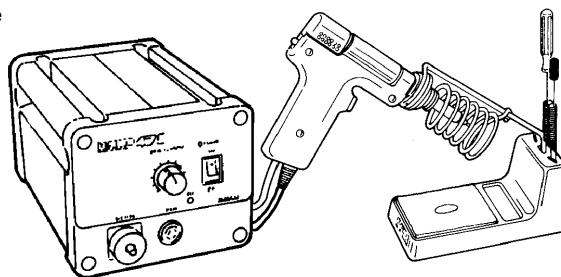

HAKKO
www.hakko.com

REPLACEMENT TIPS AVAILABLE

A1002 / 3 / 4 / 5 / 6 / 7
All each.

HAKKO SMD REWORK STATION

A wide range of adjustment to air volume & temperature
permits soldering of QFP's and SOP's. The same nozzle can
be used for both soldering and desoldering. Static free.
For more information, please enquire or www.hakko.com
Tips and spare parts are available on request.
UNIT SUPPLIED WITHOUT TIPS See manual for #.
Code HK850B

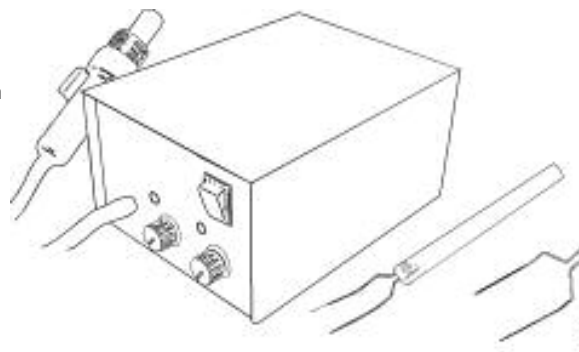

HAKKO
www.hakko.com

REQUIRES TIPS

All tips are available. We have in stock:
Code A1130 4.4mm blower
Code A1124 2.2mm blower

SOLDERING IRON PARTS

Manufacturers of quality equipment will support their products with a good range of spare parts for current and superceded models.



For part listings, be sure to keep the units manual!

We stock a range of replacement parts and accessories.

In addition, we stock some popular spare parts, as requested by our customers.

More are available. If we don't have stock we can order them in with minimal delay.

Due to space limitations we have not listed the tips and parts we hold for past product lines, and the extensive range for Hakko or Scope, etc. But parts are available. *Please Enquire*



WELLER WTCPT / TC201

Suit WTCP, WTCPL, WTCPL, WTCPLN, WTCPS, WTCPT, WTCPZ, etc., TCP1 & TCP12.



SCOPE PARTS

SUPER-SCOPE and MINI-SCOPE

For parts to suit older or other Scope products, Please enquire.



HEATER ELEMENT

SUPER-SCOPE
10 pcs
SS3

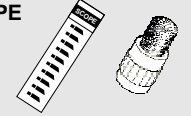

WTCPT / TC201 HEATER

24V 60W
Code HE60

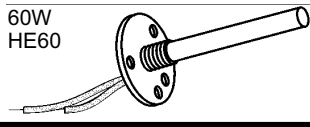

SUPERSCOPE 3.2mm

Conical
10 pcs.
SS1B

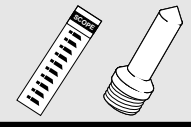

TC201 HEATER-SWITCH

Code SW60D

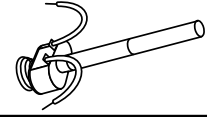

SUPERSCOPE 6.4mm

Chisel
10 pcs.
SS1A

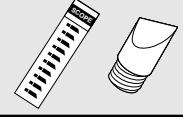

WTCPT / TC201 BARREL-NUT

Code BA60

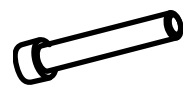

HEATER ELEMENT

MINI-SCOPE
10 pcs
MS23

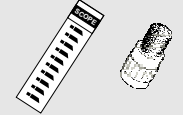

WELLER EC1201 IRON

Temperature Controlled Stations
EC1000, C1001, EC1002, EC2000, EC2001, DS1003, WEC-P, WEC-24, etc.



SPONGE

Sponge Only
Suit Weller
Iron Stand
Code TC205

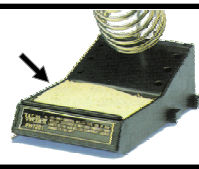

MINI-SCOPE 2.5mm

Conical
10 pcs.
MS21

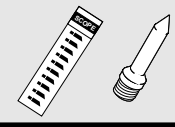

PTA - WEDGE 1.6

371°C V10-700
427°C V10-800

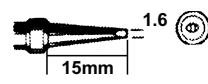

MINI-SCOPE 6.4mm

Chisel
10 pcs.
MS21A

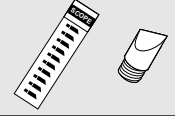

ETA - WEDGE 1.6mm

E40

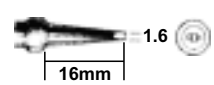

PTH - WEDGE 0.8

371°C V16-700
427°C V16-800

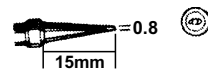

MISCELLANEOUS

We support parts for Scope products past and present. Too many to list here. MH15, MH25, = 4mm SIT40, MH40, = 5mm



ETK - LONG 1.2mm

E47

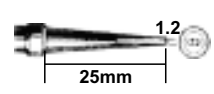

PTK - LONG 1.2

371°C V17-700
427°C V17-800

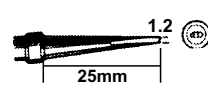

SCOPE - ZERO FLAT

4mm MH25ZF 6.5mm (MH25)
5mm MH40ZF 7.5mm (MH40)

ETP - CONICAL 0.8mm

E50

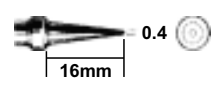

PTP - CONICAL 0.8

371°C V20-700
427°C V20-800

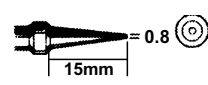

SCOPE - SINGLE FLAT

4mm MH25SF
5mm MH40SF

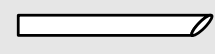

ETO - SHARP 0.4mm

E56

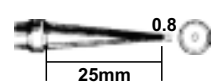

PTCC - WEDGE 3.2

371°C V23-700
427°C V23-800

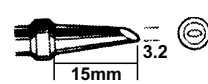

SCOPE - DOUBLE FLAT

4mm MH25DF
5mm MH40DF

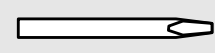

ETS - SHARPER 0.4mm

E57

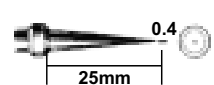

PTO - SHARP 0.4



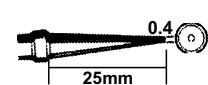





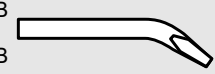

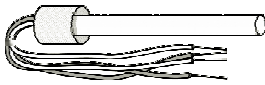
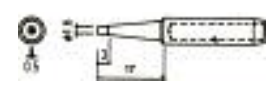
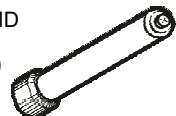

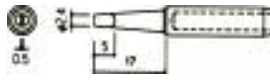
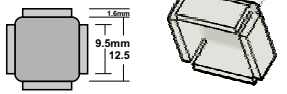
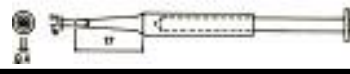
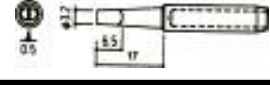
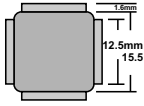

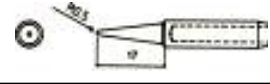
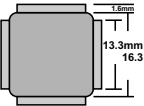
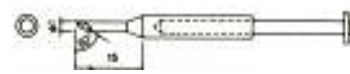

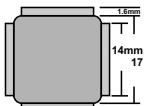
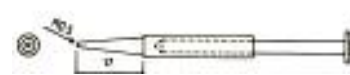
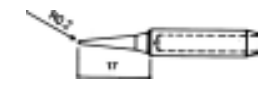
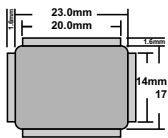

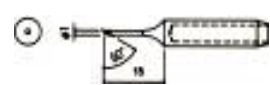
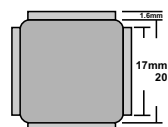
371°C V26-700
427°C V26-800

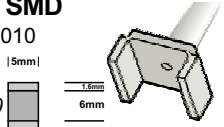
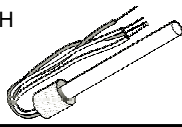

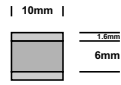
SCOPE - BENT

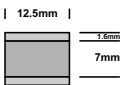
4mm MH25DFB
5mm MH40DFB

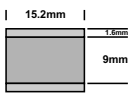

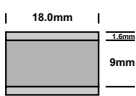
HAKKO 900S HEATER 50W Code 900S-H 	HAKKO 900M SMALL CHISEL Code 900M-T-1.6D 	HAKKO 900M SMD BARREL Required for the SMD tips listed below. Code 900M-1000 
HAKKO 900S NUT Code 900S-006 	HAKKO 900M MEDIUM CHISEL Code 900M-T-2.4D 	PLCC/MP 9x9mm SMD Code 924-T-1002 
HAKKO 900S TINY CHISEL Code 900S-T-1.2D 	HAKKO 900M LARGE CHISEL Code 900M-T-3.2D 	PLCC/MP 12x12mm Code 924-T-1003 <i>Req' 900M-1000</i> 
HAKKO 900S SMALL CHISEL Code 900S-T-1.6D 	HAKKO 900M BLUNT CONICAL Code 900M-T-B 	PLCC/MP 13x13mm Code 924-T-1004 <i>Req' 900M-1000</i> 
HAKKO 900S TINY BEVEL Code 900S-T-1C 	HAKKO 900M LONG CONICAL Code 900M-T-LB 	PLCC/MP 14x14mm Code 924-T-1005 <i>Req' 900M-1000</i> 
HAKKO 900S SMALL BEVEL Code 900S-T-2C 	HAKKO 900M SHARP CONICAL Code 900M-T-I 	PLCC/MP 20x14 Code 924-T-1006 <i>Req' 900M-1000</i> 
HAKKO 900S BLUNT CONICAL Code 900S-T-B 	HAKKO 900M TINY BEVEL Code 900M-T-1C 	PLCC/MP 17x17 Code 924-T-1007 <i>Req' 900M-1000</i> 
HAKKO 900S SHARP CONICAL Code 900S-T-I 	HAKKO 900M BEVEL (X=Size) 2mm 900M-T-2C 3mm 900M-T-3C 4mm 900M-T-4C 	DIP/DIL 6mm SMD Code 924-T-1010 <i>Req' 900M-1000</i> 
HAKKO 900M HEATER 50W Code 900M-H 	HAKKO 900M CHISEL SPECIAL Code 900M-T-K 	DIP/DIL 6mm Code 924-T-1011 <i>Req' 900M-1000</i> 
HAKKO 900M NIPPLE Code 900M-044 	HAKKO 900M BENT SPECIAL Code 900M-T-H 	DIP/DIL 7mm Code 924-T-1012 <i>Req' 900M-1000</i> 
HAKKO 900M BARREL Code 900M-002 	HAKKO 900M CUP STYLE TIP Code 900M-T-VK50 	DIP/DIL 9mm Code 924-T-1013 <i>Req' 900M-1000</i> 
HAKKO 900M NUT Code 900M-006 	HAKKO 900M CUP STYLE TIP Code 900M-T-VK51 	DIP/DIL 9mm Code 924-T-1014 <i>Req' 900M-1000</i> 

SOLDERING IRON

Metal Base & Spring.
Standard Iron Size.
Code HTA5

Heavy cast Base.
Standard Iron Size.
Code HTA10



HTA5 Sponge: SPG3455
HTA10 Sponge: SPG5052

IRON TIP CLEANER

Metal bin with a metal alloy sponge.
Clean tips without losing temperature and as a result, tips last longer.
Code HK599B



MENDA FLUID DISPENSERS

Designed to be used with evaporative or dangerous fluids. Simply push down & a measured amount is transferred to the top to use as required. Made of high density polyethylene and is suitable for alcohol, ether, acetone, M.E.K, polish remover, flux remover, stripper, thinner, etc., etc.
Available as standard or with locking cap for easy transportation.
H80 X W50 X W50mm.
MENDA612 Standard
MENDA712 Locking

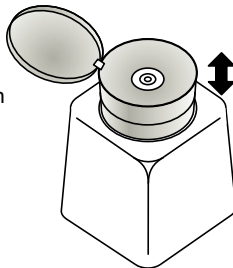

SYRINGE BOTTLE - EMPTY

Squeeze to "eye drop".
Empty. For non-volatile, flux, cleaner fluids, etc.
Holds 55ml
Code BOT55E



55ml BOTTLE OF FLUX
Flux for soldering.
Code BS550

FELT-TIP DISPENSER

Just like a felt tip pen!
Supplied empty with a push-to-release flow tip.
Re-usable, cleanable tip.
Suitable for accurate dispensing of flux, etc.
Size 140x14mm
Code PEN200



55mL FLUX TO SUIT
Code BS550

GENERAL PURPOSE 60/40 SOLDER WITH ROSIN CORE

0.3mm 100g
Code RS103

0.5mm 100g
Code RS105

0.8mm 200g
Code RS208

0.8mm 500g
Code RS508

1.0mm 200g
Code RS210

1.0mm 500g
Code RS510

SOLDER PENCIL 17g
Resin cored solder in handy dis
Code RS171



SYNTHETIC CLEAN FLUX SOLDER

This solder functions exactly the same as normal solder except it leaves a *Low Flux Residue*. The flux has been replaced with a special formula synthetic that cleans and leaves bright, clear solder joints. No tacky resin residues on the PCB. Halide free, environmentally friendly, pleasant soldering. Eliminates post solder cleaning.

ALL NEW
LOW FLUX RESIDUE
SOLDER



500g Rolls
0.5mm RS505C
0.7mm RS507C
1.0mm RS510C
1.2mm RS512C

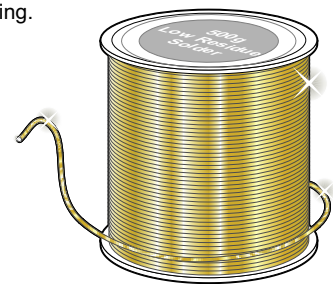

LEAD-FREE SOLDER

Made from a patented formula alloy that is environmentally friendly and without toxins harmful to humans! Also uses a natural rosin core flux. Use lead-free solder and look after the environment and yourself! Melts 227°C. No performance loss.



CODE	Ø	WEIGHT
LFS203	.3mm	200g
LFS503	.3mm	500g
LFS205	.5mm	200g
LFS505	.5mm	500g
LFS207	.7mm	200g
LFS507	.7mm	500g
LFS210	1mm	200g
LFS510	1mm	500g

SOLDER PENCIL 17g
17g of 1.0mm solder.
Code LFS171

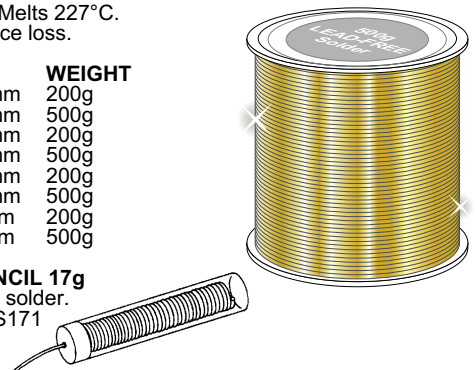

SCOPE TECH-WICK® DESOLDERING BRAID

Code	Width	Length
STW1.5	1.5mm	1.5M
STW2	2.0mm	1.5M
STW3	3.0mm	1.5M
STW3.5	3.5mm	1.5M

Windback dispenser.
2M Wick. Save fingers.
Metal tipped nose.
SB2 2mm wide
SB3 3mm wide

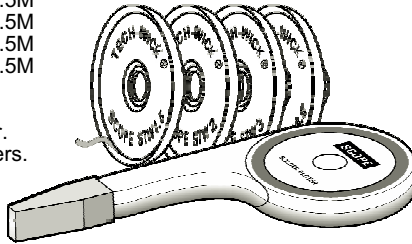

EDSYN SOLDAPULLT ORIGINAL ES SUCKER

Popular original USA, Metal barrel. Lightweight. 250mm.
Code SS350



REPLACEMENT TIP
LS363
O RING
OS130

CHEM-WIK® LITE DESOLDERING BRAID

Quality Desoldering Braid Manufactured in USA

Code	Width	Length	ID Colour
CHEM5-5L	1.3	1.5M	Yellow
CHEM7-5L	2.0	1.5M	Green
CHEM10-5L	2.5	1.5M	Blue
CHEM5-25L	1.3	7.6M	Yellow
CHEM7-25L	2.0	7.6M	Green
CHEM10-25L	2.5	7.6M	Blue

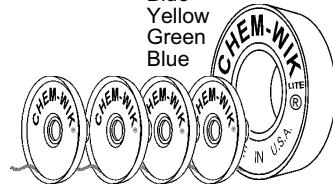

DESOLDERING TOOL

For general PCB desoldering work. 230mm length.
Code SS104



REPLACEMENT TIP
SRT104
O RING
ODS100

SODER-WICK® DESOLDERING BRAID

Quality Desoldering Braid manufactured in USA

Code	Width	Length	ID Colour
SOD50-2-5	1.5mm	1.5M	Yellow
SOD50-3-5	2mm	1.5M	Green
SOD50-4-5	3mm	1.5M	Blue
SOD50-2-25	1.5mm	7.6M	Yellow
SOD50-3-25	2mm	7.6M	Green
SOD50-4-25	3mm	7.6M	Blue

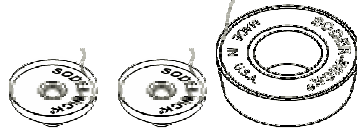

EDSYN SOLDAPULLT ORIGINAL ES SUCKER

Heavy duty original USA safety sucker. 330mm Long.
Code DS017LS



REPLACEMENT TIP
SRT12
ANTI-STATIC TIP
LS197
O RING
ODS31

DESOLDERING BRAIDS

HAKKO® Made in the USA.

Code	Width	Length
HAK102	1.5mm	1.8M
HAK103	2.0mm	1.8M
HAK104	2.5mm	1.8M
HAK105	3.0mm	1.8M

ECONOMY COPPER WICK
CW5 2.5mm 1.5M

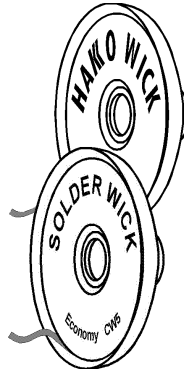

LOW STATIC DES

Heavy-duty PCB desol
Large capacity. Teflon t
Safety plunger. China.
Code SS108

TIP SRT108
O RING ODS100



SOLDERING AID TOOLS

Contains 6 double sided tools designed to carry out repairs professionally & quickly. Suitable for surface mount applications.
Code SA10

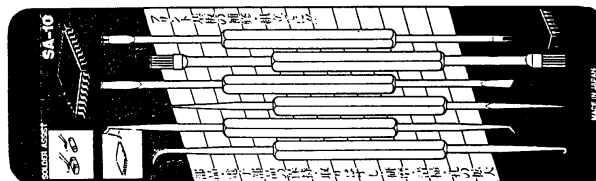

DESOLDERING TOOL "O" RING LUBRICANT

Ensure correct action just like new with better suction and reduced solder sticking.
CODE OL111



MOTOR ACTUATED DESOLDERING PISTOL

The SC7000Z. It is a light weight, compact, pistol shaped device incorporating a built-in diaphragm type vacuum pump and 60 watt soldering iron. It is designed for general purpose field and workshop applications. (For heavy duty rework and production, see Hakko Re-work stations.) The combination of suction nozzle and trigger action increases efficiency and productivity. Also very effective on PCB's with through holes due to the direct heat and high suction power. The high power, ceramic heated tip is remote temperature sensed to give fast recovery and exact temperature control to prevent damage to IC, LSI and PCB tracks. Can also be used as a hot blow gun. Hot blow is suitable for removal of SMD components, heat shrink, etc. Code SC7000Z



Replacement Tips

CODE NO.	SPIC.	STAMPED	φ-F	φ-B	φ-DZ	Len.
50-01-11	0.89NE	8.8	8.8	2.5	7.0	12.5
50-01-12	0.89SLM	8.8	8.8	2.0	8.0	14.0
50-01-13	0.89 SLUM	5.8	8.8	1.5	3.0	11.5
50-01-14	1.0 S8	1.0	1.0	2.5	7.0	12.5
50-01-15	1.5S8	1.5	1.5	3.0	7.0	12.5
50-01-16	1.8 SLUM	1.8	1.8	2.0	8.0	14.0
50-01-17	1.5 SLUM	1.5	1.5	2.2	8.0	14.0



TIPS, ACCESSORIES & SPARE PARTS SC7000Z

DIAG	DESCRIPTION	CODE
-	Stand to suit	ST800
1	Tip assembly 0.8mm	SIT80
1	Tip assembly 1.0mm	SIT100
1	Tip assembly 1.5mm	SIT150
3	Heater holder	70-03-00
6	Heater assembly	70-06-50
6A	Heater protector	70-06-10
7	Pipe setter	5000A-7
8	Filter Cartridge(5pcs)	70-08-00
10	Rear Seal	70-10-00
11	Rear Pipe Setter	70-11-00
	Diaphragm	70-26-00
	Isolation Rubber	70-29-00
19	Gasket	70-19-00
22	Set Valve	70-22-00
37a	MAIN PCB	70-37-50
37b	Power PCB	70-37-51
51	Cleaning Pin Set	70-51-00

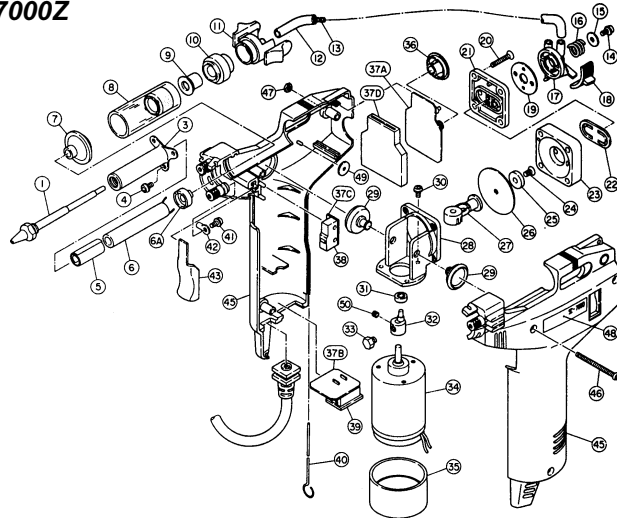

SURFACE MOUNT DESOLDERING AND REMOVAL KIT

Surface Mount Device Removal Kit. Special Tip and assorted tools to suit SC7000Z. Code DICSMDKIT

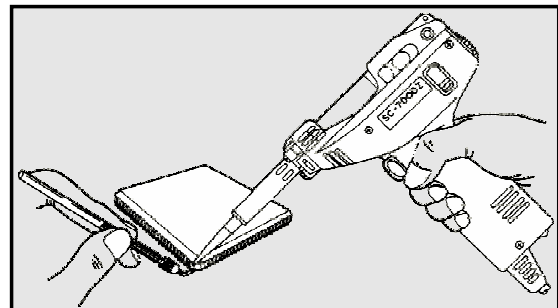

SMD REMOVAL KIT

Innovative new system for removing Surface Mount Devices.

Present methods using standard desoldering equipment are unreliable and potentially damaging to PCBs and components due to excessive heat and mechanical strain. Surface mount devices come in many shapes and sizes. Specific SMD type removal methods required numerous special desoldering devices and tips, heated air rework stations, etc. The cost of this inventory is astronomical and now no longer necessary!

Chip-Quick. Regardless of whatever the chips lead configuration, the removal process is relatively easy and inexpensive. By applying the special flux and alloy to the pins of the SMD, the solders melting point is reduced and it remains molten for a much longer time. This makes for very easy SMD extraction. The only tools required are a standard soldering iron and a dental pick (SA10, 14-10) or tweezers. This kit comprises the Special Removal Alloy, Special Flux and instructions. Good for 8-10 removals.

Now SMD replacing can be much simpler and more reliable.
Code SMD1

Chip-Quick Surface Mount Device Removal Kit



**SMD
RE-WORK
KIT**



ARLEC SUPER TOOL

Designed in Australia the Arlec ET571 is a compact, precision power tool which has a multitude of uses in and around the home, the office, factory, workshop, etc. It is ideal for miniature and electronic engineering, educational projects and drawing office work. The robust 10 Watt motor operates at 7,500 RPM via a plug-pack 240VAC adaptor. This plugs directly into the mains and reduces it to a safe 12VDC. Particular emphasis has been applied to the design of the casing to ensure optimum balance and ease of handling.

The start/stop control gives feather touch or locked on power. The unit is supplied with 4 drill bits, six erasers, a grinding wheel and a collet chuck with 5 collets for a variety of tasks including drilling, shaping, cleaning, engraving, grinding and erasing.
Code ET571

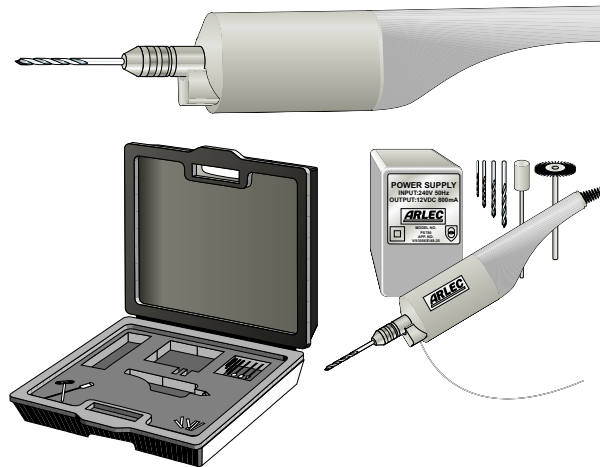

REPLACEMENT & ADDITIONAL TOOLS

- ET669 3 Engraving/
Milling cutters
- ET688 Diamond Engraver
With designs
- ET689 6 Cutting/
Slitting discs
- ET627 3 GP Grindstones
- ET625 0.6, 0.8, 1.0, 1.2mm
HSS Drill bits
- ET722 3 Steel Wire Brush

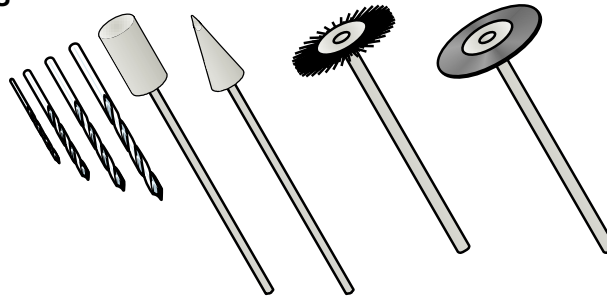

FUMINATOR - FUME EXTRACTOR

10cm Fan with a carbon filter and a rotating part for extracting dust particles, solder fumes, resid. Ultra-quiet in operation. Creates a safe and heal environment. The rotating filter captures 8x better stationary one. Power switch. Adjustable neck. Sturdy 140mm metal base with a solder despen.
Code FXF11

REPLACEMENT FILTERS X5

5x Carbon round 92mmØ
Code XF03

5x Rotating filter 88mmØ
Code XF02



PC MONITOR FUNCTION GENERATOR

Professional Quality by Promax.
Digital Picture Test for computer monitors. LCD panel.
With Syncro controls.
212W x 102H x 241D 2.4Kg.
Eight test patterns.
Four types of connections.
D9 CGA, EGA, Hercules.
D15 MacII, etc.,
HD15 VGA, SVGA, etc.
BNC R, G, B,
CVS (No Sync')
HS (Horz Sync')
VS (Vert Sync')
CS (Composite Sync')



Code GV241

POCKET COLOUR GENERATOR WITH CIRCLE

There are 7 colour & 4 mono test patterns with circle for alignment and testing.
Powered by a rechargeable battery, it is ideal for the field or workshop.
Includes soft case, lead and charger.
TUNABLE RF VERSION
Code GC981B



DATA SHEET AVAILABLE ON APPLICATION

TV PAL GENERATOR PROFESSIONAL

Mains operated, recommended for tradesmen in workshop applications.
Has 8 test patterns, circle, colour and disengageable burst pulse.
Plus many more features.
Code GV298



DATA SHEET AVAILABLE ON APPLICATION

COLOUR TV PATTERN GENERATOR

Compact unit includes full field colour bar, stair case & cross-hatch patterns for convergence.
Red output for purity.
Both with a 1KHz tone.
RCA Audio/Video and "F" RF CH1 output.
625 lines/50Hz Pal.
15625Hz Interlaced.
7.5Vdc Power Pack
RF & RCA cables included.
Code CG200P

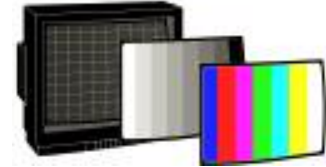

TV MULTI-SYSTEM PATTERN GENERATOR

NEW high grade from Cypress.
Component, Composite & SVHS outputs for testing todays multi-system TVs, VCRs, etc.
Full NTSC, PAL or Secam options.
Moving white block for testing motion jitters, recording, etc.
14 basic patterns that are combined for more than 100 different test signals.
Compact desk-top with carry handle.
Code LPM55



www.cypress.com.tw/

TV & MONITOR SPLITTERS

TEST MULTIPLE UNITS
Ideal for soak testing monitors and TV sets.

PC MONITOR SPLITTERS
HD15 VGA/XGA/Multi-Sync
2way VGAMS2
4way VGAMS4
8way VGAMS8

TV VIDEO SPLITTERS
Premium AVC Quality
3way VADA300
6svhs SVDA600
10way VADA1010

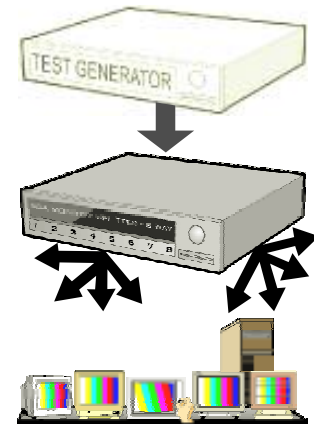

AUDIO TEST CD & TAPES

SCRATCH TEST CD
Measured physical scratches.
CDT016

GENERAL TEST CD
Test tones and the like...
CDTEST2

TRACK & FOCUS CD
Alignments with CRO.
LASERCD

TEST CASSETTE
General Test tape.
AAC9



VCR TEST TAPES

SEE-THRU CASSETTE
Dummy tape for VCR repair.
VID5041

GP VHS TEST TAPE
Colour bar.
VID50

PRECISION VHS TAPE
Master copy. Premium Q.
VID70

HIFI ALIGNMENT TAPE
Includes picture tests.
VID75



For details, see section 4.

PICTURE TUBE REJUVENATOR

This CRT-Rejuvenator is designed for measuring and rejuvenating colour picture tubes.
Supplied are six of the most popular adaptors.
DATA SHEET AVAILABLE
Code TA901



L.O.P.T. TESTER

This handy instrument will simulate the horizontal output section of a TV to accurately test LOPT's and Diode Split Flyback Transformers. 90 & 110°. By connecting two leads to the primary and monitoring the HV lead output, a reading in Kilovolts is given. An LED will alert to any problem and a fault code will appear on the display to confirm your diagnosis. A fully professional unit, comes with instructions and the Diemen CD-ROM cross-reference for pin outs, etc.
Code STVDST01



PICTURE TUBE REJUVENATOR

Three instruments in one. Measures, analyzes and rejuvenates any tube. All three guns are tested at one time. Fully featured, portable and a professional unit. The 6 most common adaptors are supplied. Those not so popular are also available. See Optional Accessories.
For a mail out with more complete information, please contact us.
Code TA903B



HIGH VOLTAGE PROBE

Allows voltages up to 40KVdc to be measured. Its main purpose is to measure the anode voltage of picture tubes or microwave oven magnetrons, etc.
Input impedance 1 GigaOhm (Approx.)
Output impedance 1.1 MegaOhm.
Meter should be 10M input at least.
Max Voltage 40KVdc, 40KVac, 28KVrms.
Accuracy 1KV→20KVdc ±1%
20KV→40KVdc ±2%
1KV→15KVrms ±2%
15KV→28KVrms ±3%
1000:1 Ratio.
Code HV40



OPTIONAL ADAPTORS TA901/TA903B

- | | |
|----------|----------|
| Code A0 | Code A21 |
| Code A1 | Code A22 |
| Code A2 | Code A23 |
| Code A3 | Code A24 |
| Code A6 | Code A26 |
| Code A7 | Code A27 |
| Code A8 | |
| Code A9 | |
| Code A10 | |
| Code A11 | |
| Code A12 | |
| Code A14 | |
| Code A16 | |
| Code A17 | |
| Code A18 | |
| Code A20 | |



POWER MAINS ISOLATOR

Isolation transformer for protecting yourself from the 240Vac mains. Ideal for TV repair of mains chassis units. Allows connection of CROs to equipment. Essential for the technicians bay.

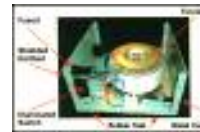

FOR TECHNICIANS
HIGH VOLTAGE
PROTECT YOURSELF



1 Amp TDB240-240

2 Amp TDB240-500

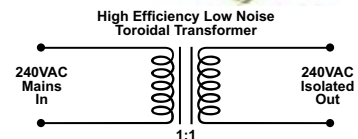

CRT DEGAUSSING WAND

This powerful wand does the job right the first time, every time. Manufactured in Australia and it plugs straight into 240V.
Code XT8150



VARIAC

VARIABLE AC SUPPLY
Adjust the output of your mains for testing and diagnostics, etc.
!! WARNING !!
This is not an isolation transformer. Mains thru. Neutrals are common.
"Auto-Transformer"



FOR TECHNICIANS
HIGH VOLTAGE
TEST EQUIPMENT REPAIRS



2 Amp VRC2

4 Amp VRC4

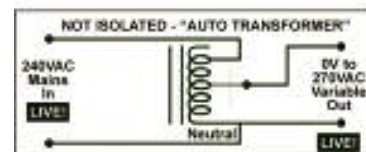

TEST & MEASUREMENT - PROMAX

If you are interested in this area of test instruments including: Terrestrial TV, FM, Radio, Cable TV, Satellite TV, Digital TV, with Spectrum analyzers, Noise generators, Sub-band converters, Reference antennae, Level meters and more, We have access to all Promax products for you. If you require any item, please contact us. We can get it in, with minimal delay.



DVB-T SIGNAL LEVEL METER

Digital Terrestrial TV
Signal Quality measurement.



Analogue & Digital
Signal Level Meter

Data sheet; www.promax.se

Powerful, intuitive, robust display & control interface.
Portable (rechargeable)
Auto-id, CH select,
Level, Power, C/N ratio,
6dB margin test, 45-862MHz.
Selectable driver voltage O/P.
Backlit LCD, Case protected.
Code PRODIG2
Please Enquire.



FIELD STRENGTH METER - PROMAX

This compact "Terrestrial" meter covers VHF LOW, VHF HIGH, VHF SUPER & UHF and more. Battery operated for complete portability. Tough metal casing. 2Kg. Comes with protective carry case and easy to use controls, etc. Requires a DCA1317 power pack and/or 6 x "C" 2Ah Ni-Cd (CAD185 or better) Suitable for antenna & cable TV systems.
Code MC160B



DATA SHEET AVAILABLE ON APPLICATION

SATELLITE FINDER - DAI-CHI

This handy test device is used to adjust the satellite dish for optimum positioning. Connects inline with the cable. Has 2 x "F" connector sockets female. Frequency range 1000MHz - 1600MHz. May be purchased tax exempt if used for Homestead and Community Broadcasting Satellite Service.
Code SAT2100



FIELD STRENGTH METER - PROMAX WITH SATELLITE FUNCTION

Same compact featured unit above plus an IF range of 950-2050MHz for satellite. Also does MDS.
Code MC360B



DATA SHEET AVAILABLE ON APPLICATION

SATELLITE FINDER WITH TONE - PROMAX

Similar to SAM360 but with a tone that varies with signal strength for easy alignment. Also includes a Voltage Test. Has 2 x "F" connector sockets female. Frequency range 950MHz - 2050MHz.
Code MS250



FIELD STRENGTH SPECTRUM MONITORS

Several types available. Please enquire!
For further info: www.promax.es



Professional, portable for terrestrial & satellite reception analyzer. With a B&W TV for visual reception viewing or switch to the spectrum monitor for on-screen frequency analyzing. Digital frequency readout. Suitable for TV, cable TV and SAT 48MHz→855MHz and 950MHz→2050MHz Can supply phantom line voltage. Includes carry pouch and connectors. Requires a DCA1317 power pack and/or 6 x "C" 2Ah Ni-Cd (CAD185 or better)
Code MC377



DIGITAL TV TEST EQUIPMENT

NEW test equipment for this technology is due soon from Promax.

Please Enquire...





WAVETEK



Wavetek manufactures and markets worldwide a range of test equipment for professional and industrial applications. Wavetek is US based and now owns and distributes the Beckman industrial products under its own brand. We stock a range of five Wavetek meters for their outstanding quality, reliability and accuracy for the technician who demands total confidence from a measurement device.

All meters come with "Safety" leads. Each multimeter has full-function voltage, current and resistance, but also offers additional functions important to trouble-shooting the electronics you work with. Input warning beeper alerts to incorrect meter settings. eg. measuring voltage with the lead in the current jack. etc. Safety tester allows ACV measurement without using the DMM's battery. A bank of LED's indicates up to 440V. Helpful in dim room measurements. Other available features include Inductance, Capacitance and Frequency.

WAVETEK WITH LOGIC & ACI RANGES

Large 0.7" 3.5 digit display
Warning & continuity beeper
Safety test leads.
logic probe,
Diode test,
AC/DC Current
29 ranges inc.
DCV(+/-0.5%)
200mV to 1000V
ACV(+/-1.0%)
200mV to 750V
AC/DCI(+/-1.2%)
200uA to 10A
Resistance
200Ω to 2000MΩ
Code DM15XL



WAVETEK POCKET DIGITAL MULTIMETER

Large 0.7" 3.5 digit display
Input warning beeper
Safety test leads
Continuity beeper
17 ranges inc.
Diode test.
DCV(+/-0.8%)
200mV to 1000V
ACI(+/-1.2%)
up to 500V
DCI(+/-1.2%)
200uA to 200mA
And Resistance
200Ω to 2MΩ
Code DM5XL



TRU-RMS PROFESSIONAL DMM - LCR

10,000 count 4 digit
backlit display with
analogue bar graph.
Inc. rubber holster,
hanging strap, etc.
Full manual/auto-range.
Peak hold, min max avg.
Excellent component &
logic test instrument.
Field, factory or workshop.
Relative and dBm ranges
for easy CCT analysis.
CMOS/TTL Logic test.
DCV (±0.25%) 1000V
ACV True-RMS 750V
ACI/DCI 10A
Temp' -20°C→1300°C
Ω (+/- 0.5%) 1KΩ→40MΩ
Frequency 10MHz
Capacitance 40nF→400μF
Inductance 4mH→40H
Continuity & Diode test.
CAT-III, CAT-IV rated.
Code DM37XR



www.metermantesttools.com

WAVETEK WITH SAFETY TESTER

Large 0.7" 3.5 digit display.
Rugged, quality constructed.
7 LED Display Bar meter,
for quick V test.
Safety test leads.
Continuity beeper.
20 ranges inc.
Diode test
DCV(+/-0.7%)
200mV to 1000V
ACV(+/-1.0%)
up to 750V
DCI(+/-1.2%)
200uA to 10A
Resistance
200Ω to 20MΩ
Code DM10XL



TRU-RMS INDUSTRIAL DMM - RS232

10,000 count 4 digit
backlit display with
analogue bar graph.
Inc. rubber holster,
hanging strap, etc.
A trully professional
meter for industrial use.
Full manual/auto-range.
Peak hold, min max avg.
DCV (±0.25%) 1000V
ACV True-RMS 750V
ACI/DCI 10A
4-20mA Loop-I with %
Temp' -20°C→1300°C
Ω (+/- 0.5%) 1KΩ→40MΩ
Frequency 10MHz
Capacitance 400μF
Continuity & Diode test.
CAT-III, CAT-IV rated.
Code DM38XR



OPTIONAL RS232 INTERFACE

PC Interface with software.
[Code = 38SW]

www.metermantesttools.com



www.lutron-electronic.com

Lutron is an ISO-9001 approved company and was founded in 1976 as the leading manufacturer of Test and Measuring Instruments of Taiwan. Various approved and pending patents in Taiwan, Germany, USA, China, etc. make Lutron a World-Classed manufacturer.

Exportation to more than 65 countries, Lutron's reputation for stable, durable and reliable products is world-wide. A professional instruments manufacturer with a comprehensive product range.

3.5 DIGIT MULTIMETER

This Multimeter offers everything for today's technician. including 10MΩ in, hFE, up to 20 amp AC/DC current, Large 18mm LCD, beep continuity, frequency, capacitance, temperature V protection & rugged construction. Safety lead system compatible. Yellow in colour. hFE test leads, Temp probe & Rubber holster are optional extras.
DCV (+/- 0.8%) 200mV to 600V
ACV (+/- 1.0%) 200mV to 600V
DCI (+/- 1.0%) 200uA to 10A
ACI (+/- 1.2%) 200uA to 10A
Resistance 200Ω to 20MΩ
Capacitance 2nF to 20uF
Frequency 200Hz to 20KHz
Temperature -20 to 750°C and 0 to 1400°F
HFE and DIODE TEST
CODE DM9090



TEMPERATURE PROBE TO SUIT
CODE TP01

RS232 MULTIMETER

WITH SOFTWARE

Looks and operates like a normal multi-meter, but is actually a computer to technicians-world interface! The included CD-Rom (Win9X), gives you the power of expensive data-logging equipment. Data is sampled (System Sample Rate 2s → 36 and stored in a popular spreadsheet format for easy external application uses. Viewable on screen in digital, analogue and time graph formats. Excellent for intermittent faults, research, development, remote monitoring, or just as a general purpose meter. Includes atache' Case, software, D9 com lead, etc.
Code DM9680



3.5 DIGIT MULTIMETER

This accurate measuring instrument is modern in design & functions. Many features include 10M input, hFE, up to 20 amp AC/DC current, diode test, large 18mm LCD Display, over V protection and rugged compact construction makes this multimeter a valuable instrument. Safety lead system compatible. Yellow colour. Carry case, hFE test lead & rubber holster optional.
RANGES:
DCV (+/- 0.8%) 200mV to 1000V
ACV (+/- 1.0%) 200mV to 750V
DCI (+/- 1.0%) 200uA to 10A
ACI (+/- 1.2%) 200uA to 10A
Resistance 200 to 20M
HFE and DIODE TEST
CODE DM9080



TRUE RMS 4½ DIGIT MULTIMETER

28 Range with a large display. Bench-top-meter performance. Housed in a tough yellow casing. 15mm LCD ±19999 display. 10MΩ Sample time 0.4~sec. DCV:0.2/2/20/200/1000 ±0.1% ACV:0.2/2/20/200/750 ±0.8% Current:0.2/2/20/200mA (Fused) +10A ±0.5-2% (True RMS AC Tested at 50Hz) Ω:200/2k/20k/2M/20MΩ ±0.5-0.8% Diode check (100μV res.) Continuity buzzer (<250Ω) Transistor NPN/PNP 0-1000 hFE Data hold Switch. Self test & zero.
Code DM9027T

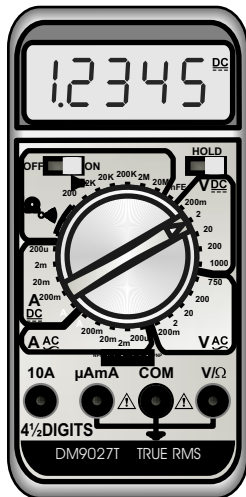

RUBBER PROTECTIVE HOLSTER DMPH01

AUTO RANGE BAR GRAPH MULTIMETER

3200 DISPLAY COUNT 4 DIGIT

32 Segment bar-graph display all housed in a tough yellow casing with safety test leads & auto power off. Sample time 0.5 sec for the digits AND 90mS for the bar graph display. Ultra low power consumption (0.6mA) Range hold and Data hold buttons. DCV, ACV, DCA, ACA, Ω, hFE, Diode/Continuity ranges. Auto or Manual ranges: 320μA-320mA +10A 320mV-750VAC/1000VDC 320Ω-32MΩ
Code DM9092



AUTORANGE WITH BARGRAPH!

GENERAL PURPOSE COMPACT METER

Although this meter is small and inexpensive, the features, accuracy & durability are that of a quality full sized meter. Includes AC/DC current with 2 Amp range. 20MΩ, Diode and hFE. Ideal for use as a second meter for the tool box etc. With Test leads, etc. Fits in your pocket. 3½ Digit 12mm Display.



17 RANGES:
 DCV: (1MΩ)2/20/200/600V ±0.8%
 ACV: (450kΩ)200/600V ±1.2%
 AC/DCI:2m/20m/200m/2A ±1.5%
 OHMS: 200/2k/20k/200k/2M/20MΩ ±1%
 Diode test.
 Full NPN/PNP hFE measure.
 2.5mA power consumption.
 Size: 120x72x37mm
 Code DM9020

MEGA-OHM INSULATION TESTER

Made by Kyoritsu. Analogue insulation & continuity tester. Dust & splash proof knock resistant case. Three test ranges: 250V / 100M ohm 500V / 200M ohm 1000V / 400M ohm. Continuity test 3 ohm & 500 ohm. Audible live circuit indication. Overload protected. Meets all regulatory requirements. (CE, IEE, IEC, VDE, etc.) Compact, convenient, compitnant instrument. 106 x 160 x 72mm Includes leads. Code ICT3132



DIGITAL CAPACITANCE METER

LSI-circuit allows high reliability and durability. Accuracy is provided from a crystal time base and fast sampling. Overall a precision instrument in portable form. 3.5 digit. Optional carry case available. CA03. Rubber holster. DMPH01.

RANGES:
 200pF 0.1pF +/-0.5%
 2nF 1pF +/-0.5%
 20nF 10pF +/-0.5%
 200nF 100pF +/-0.5%
 2uF 1000pF +/-0.5%
 20uF 0.01uF +/-0.5%
 200uF 0.1uF +/-0.5%
 2000uF 1uF +/-1.0%
 20,000uF 10uF +/-2.0%
 CODE DM9023

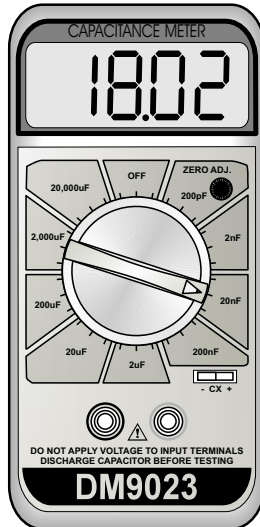

ANALOG MULTIMETER

Large 4" Mirrored Meter. Extra Rugged, Safety Design Overload Protected element. FUSE & Diode Protected. Automatically, Simultaneous Transistor Type & Quality Check. Battery Tester Polarity Reversing Switch Accuracy within +/-3% full scale on all ranges. AC/DC VOLT 3/10/30/100/300/1000V Sensitivity, 30KΩ per DCV 10KΩ ACV DC CURRENT 100u/3m/30m/300m/10A RESISTANCE Rx1 0-1K (10 Ohm Centre) Rx10 0-10K (100 Ohm Centre) Rx1K 0-1M (10K Ohm Centre) Rx10K 0-10M (100K Ohm Centre) CODE HC3030



DIGITAL LCR MULTIMETER

18 Range with large display housed in a tough yellow plastic casing. Measures passive components.

(Max.Res.)Ranges/ Accuracy(~mean)
CAPACITORS
 (1p)2n/20n/200n/2μ/20μ/200μ ±1%~
INDUCTORS
 (1μ)2m/20m/200m/2/20H ±2%~
RESISTORS
 (0.1)200/2K/20K/200K/2M/20M ±1%~
 Includes alligator test leads.
 Code LCR9053

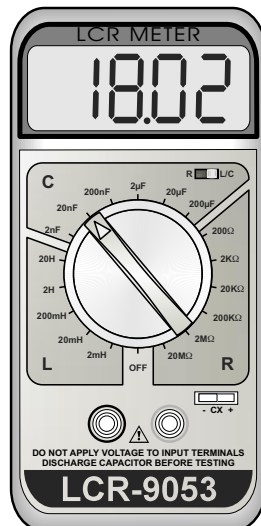

FET ELECTRONIC ANALOGUE MULTIMETER

4.5" Mirrored meter Extra Rugged, Safety Design Overload, Fuse & FET Protected All Inputs 10MΩ P→P & RMS Reading. Adjustable to Zero centre scale for Nulling and for +/- reading. Polarity Reversing SW. DC 0.3/1.2/12/30/120/300/1200V Or +/- 0.15/0.6/6/15/600V Centre 0 Within +/- 2.5% of full scale AC 3/12/30/120/300/1200Vrms 8.4/33/84/330/3300V P-P Within +/-3.5% of Full Scale AC/DC 0.01uA/0.3m/3m/300m/12A Within +/- 2.5% of full scale Ω 0-1K/10K/100K/10M/1000M Input Z=1MΩ 80pF SIZE 125 x 170 x 50mm CODE HC5050



MICROWAVE LEAKAGE MONITOR

Fully tested and calibrated for testing the integrity of seals for microwave leakage. Detects microwave energy with one range of 0-10mW/cm. Includes instructions, battery and carry pouch. With instrument failure indicator.
Code TM318

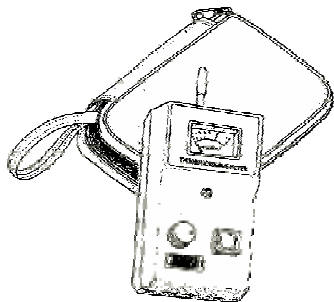

AC CLAMP METER ANALOGUE

KEW SNAP - KYORITSU
Easy to use and dependable, this instrument is designed to incorporate as many safety priorities as possible. Features a clamp meter that measures AC current 3A to 300A. Includes Safety leads for measuring ACV (Up to 600V), DCV (60V) and Resistance. Tear drop shaped jaws for use in crowded cable areas. Easy to read analogue display with locking feature to freeze needle for no-parallax reading. Very sturdy plastic case with a heavy-duty hard protective pouch. 20cm overall length. Requires 1x AA battery. Fuse protected. High quality for years of reliable service.
Code CM2608



EMF TESTER

ELECTROMAGNETIC FIELD RADIATION TESTER

The EMF tester is a quick, convenient reliable way to determine EMF radiation levels from electrical equipment, power lines, monitors, industrial machines, etc. Measurement ranges 20 μ 200 μ 2000 μ Tesla, max resolution of 10pT (10 milli-Gause). Also known as EMR (ElectroMagnetic Radiation) For specifics on exposure levels please enquire with the EPA (www.epa.nsw.gov.au) or Radiation Protection Agency (www.arpansa.gov.au). AU Recommended "Home 100 μ T" and "Work 500 μ T". Two styles of meter available. 9V Bat' Req'.



BUILT IN SENSOR

Place the head of the meter on or at the radiation source.
Code EMF823



EXTERNAL PROBE

Point the directional probe at the radiation source.
Code EMF827

AC CLAMP METER DIGITAL

KEW SNAP - KYORITSU
Easy to use and dependable, this instrument is designed to be safe and practical. This professional clamp meter AC Current 0.1A to 600A 40 \rightarrow 1000Hz with high accuracy. Includes Safety leads for measuring ACV (Up to 600V), Continuity and Resistance. Tear drop shaped jaws for use in crowded cable areas. Easy to read 3.5 digit display with Data Hold feature to freeze the display for easy reading. Sturdy plastic case with a protective pouch. 22cm overall length. Fuse protected. High quality for years of reliable service.
Code CM2017



UNIVERSAL REMOTE CONTROL TESTER

This is a very practical piece of equipment. In moments you can determine whether a remote control is functioning correctly. An audible buzzer and LED indicate reception on infrared remote controls as used in VCR, TV, videos, Hi Fi, CD, etc. Saves batteries too with an auto-off feature. Made by Pilot in Europe.
Code RCT100



RUBBER BOOT TO SUIT

Protective cover.
Code RCP10

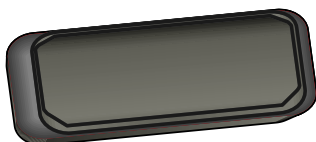

2.4GHz FREQUENCY COUNTER

High grade test instrument as required for professional workshop repairs and alignments. Advanced circuitry allows precise measurement of signal levels between 10mV to 250V. Overvoltage protection. Noise filter circuit (low pass). Manual resolution selection by gate time switching.
INPUT A
20MHz / 160MHz (switched)
15mV sensitivity
250V max
1M Ω / 35pF Zin
Low-pass switch for 20-20KHz only
INPUT B
100MHz / 2.4GHz
10mV sensitivity
100V max
10MHz time base



Code FZ510

LOGIC PULSER

Designed to assist in locating faults in digital circuits. The output waveforms include square and sync pulses. Two speeds, 0.5pps and 400pps. Code LP540H



DIGITAL LOGIC PROBE WITH MEMORY

Instantly recognizes high, low or intermediate logic level, open circuit and pulsating modes. Memory function stores single shot and low rep-rate events. Multi-family compatibility DTL/TTL/HTL/CMOS/ NMOS and more. Perfect for trouble-shooting and analysis of digital circuits. High voltage and reverse polarity protected. CODE LP2800

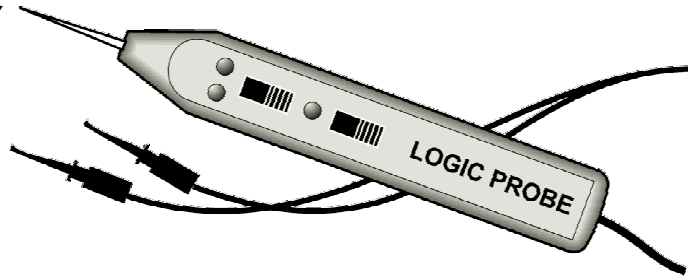

HIGH VOLTAGE PROBE

Input impedance 1 GigaOhm (Approx.)
Output impedance 1.1 MegaOhm.
Meter should be 10M input at least.
Max Voltage 40KVdc, 40KVac, 28KVrms.
1000:1 Ratio.
Code HV40



DIGITAL MULTIMETER CARRY CASE

SMALL SIZE
75x35x135mm (Approx.)
Code CA04

STANDARD SIZE
45x90x190mm (Approx.)
Code CA03



DIGITAL MULTIMETER PROTECTIVE HOLDER

Manufactured specifically for our DM range but will also suit similar sized meters. DM size Approx 180x85x35mm with rounded edges. Suit DM9023 DM9027T DM9090 LCR9053 Code DMPH01

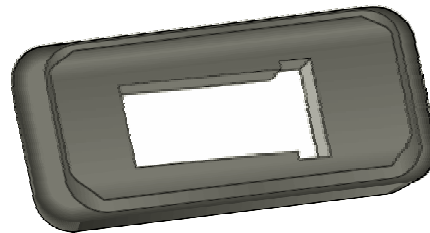

METRIC / IMPERIAL - METAL CALIPERS

High quality Digital measuring instrument with easy to read LCD screen that tells you the length in either Inches or mm with the push of a button! Highly accurate. 0.01 → 155.00mm 0.0005' → 6.0000' Stainless steel O/D and I/D jaws, Step and depth. Differential (zero). Hard plastic protective case. Code CLP111

Stainless Steel Construction



OSCILLOSCOPE PROBES

Professionally manufactured for long reliable service. All probes sold individually with accessories included. 1:1 or 10:1 (1MΩ or 10MΩ)
Cable length is 1.4M. OV reference selectable on probe

DC-60MHz

Code HP9060

DC-100MHz

Code HP9100

DC-250MHz

Code HP9250

NEW TIP

Code PA102

ACCESSORIES KIT

Code HP9000

Includes:

- TIP PA102 x 1
 - A CHANNEL ID CLIPS x 2
 - B SPRUNG HOOK
 - C GROUND LEAD
 - D INSULATING TIP
 - E IC ADAPTOR
 - F ADJUSTING TOOL
 - G BNC ADAPTOR - attaches end of probe
- (Note: BNC Not included with HP9060/9100:)

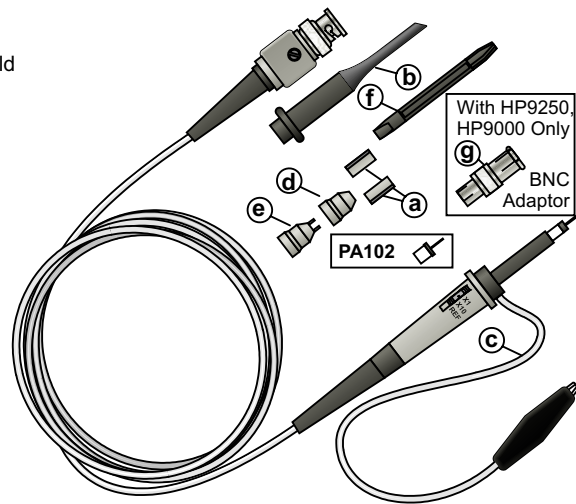

STACKABLE 4mm SILICONE CONNECTION LEADS

A well proven addition to the work bench with the advantage of being stackable. Very strong, highly flexible and soldering iron resistant, these jumper leads are ideal for where colour coded, temporary connections are required. There are three lengths available, 0.5, 1 and 1.5 metres. And in each length, six colours for quick I.D. HCK Silicone test leads with Polyamide plugs, silver plated steel contacts. Highly flexible!

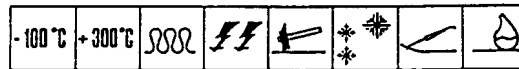

Length 0.5M 1.0M 1.5M

Colour Code No.

BLACK	HCK05BK	HCK10BK	HCK15BK
RED	HCK05R	HCK10R	HCK15R
BLUE	HCK05BL	HCK10BL	HCK15BL
YELLOW	HCK05Y	HCK10Y	HCK15Y
GREEN	HCK05G	HCK10G	HCK15G
VIOLET	HCK05V	HCK10V	HCK15V

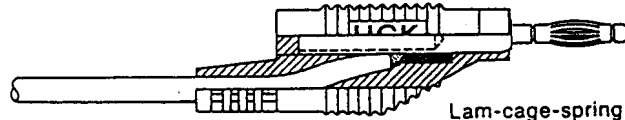
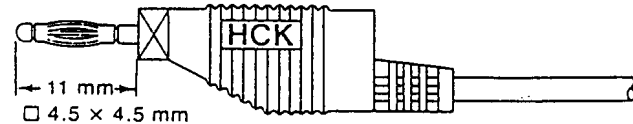

SAFETY TEST LEADS

Compatible with all meters & any 4mm banana socket. The long reach plugs have a spring safety return that covers the plug on release, restricting the possibility of accidental shorting of contacts. Optimum quality, high voltage, ultra-flexible cable/connections/probes. Includes detachable screw-on alligator clips. Sold in pairs (Red+Black)
Code TL40

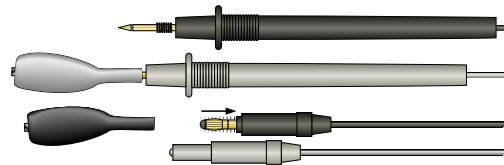

SAFETY TEST LEADS

Compatible with all meters & any 4mm banana socket. The long reach plugs have a spring safety return that covers the plug on release, restricting the possibility of accidental shorting of contacts. Optimum quality, high voltage, ultra-flexible cable/connections/probes. Terminated with heavy duty alligator claws (8mm wide). Sold in pairs (Red+Black)
Code TL50

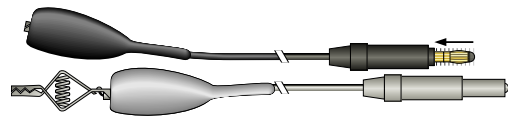

RIGHT ANGLE TEST LEADS

Right angle 4mm banana plugs. High quality, high voltage, flexible cable, connections and probes. Includes detachable screw-on alligator clips. Sold in pairs (Red+Black) 1M leads.
Code TL45

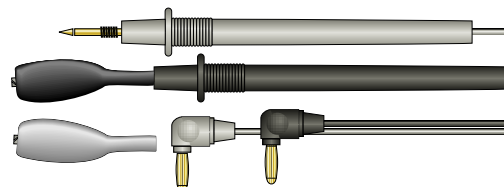

TEST LEAD SET

Banana plug to probe
CODE TL10

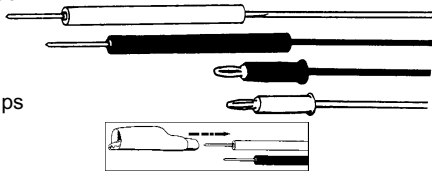

Plug-On Alligator Clips
RED AC12R
BLACK AC12B

hFE TEST LEAD

Suit many meters.
CODE PL03

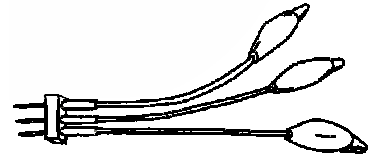

TEST LEAD SET

Pin plug to probe
CODE TL20

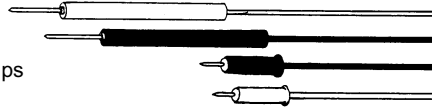

Plug-On Alligator Clips
RED AC12R
BLACK AC12B

IC CLIPS

Very handy to have in the workshop.
Please quote colour when ordering.

Codes.
Red ICC2R
Black ICC2B

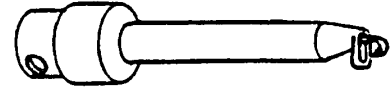

RIGHT ANGLE TEST LEAD SET

Banana plug to probe
CODE TL15

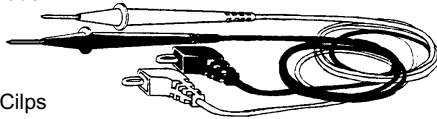

Plug-On Alligator Clips
RED AC12R
BLACK AC12B

BNC ADAPTOR

Use standard
test probes
with your
CRO, etc.
Code BP60



BNC Adaptors Section 07

RIGHT ANGLE TEST LEAD SET

Pin plug to probe
CODE TL25

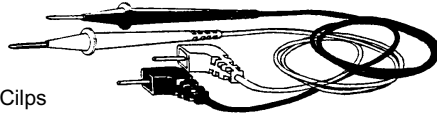

Plug-On Alligator Clips
RED AC12R
BLACK AC12B

4mm PLUG-ON ALLIGATOR TEST CLIP

Sharp toothed,
fully insulated
rated at 2A.
Will open 12mm wide.
Steel spring.

RED HCK9209R
BLACK HCK9209BK

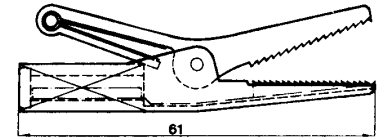

TEST LEAD SET - CURLY CORD

Banana plug to probe
CODE TL12

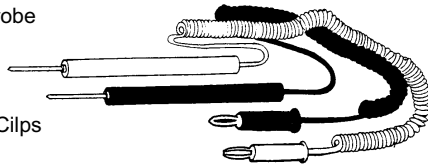

Plug-On Alligator Clips
RED AC12R
BLACK AC12B

PROBE EXTENSION

Push-on to the
end of the sharp
tipped type probes.

RED AC12R
BLACK AC12B



TEST LEAD SET - CURLY CORD

Pin plug to probe
CODE TL22

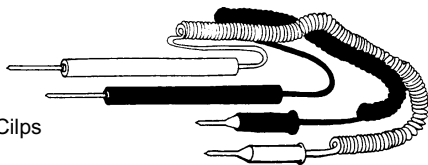

Plug-On Alligator Clips
RED AC12R
BLACK AC12B

JUMPER LEAD SET

Each 450mm long with
alligator clips
10 assorted colours.
CODE JLK10

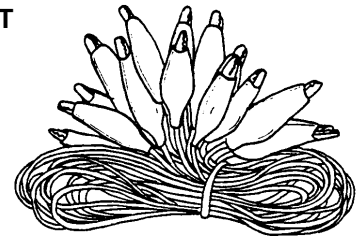

UNIVERSAL TEST LEAD SET - RIGHT ANGLE

Banana or pin plug to probe
CODE TL30

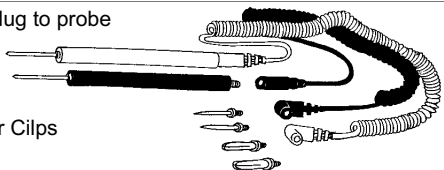

Plug-On Alligator Clips
RED AC12R
BLACK AC12B

See

Section
Seven

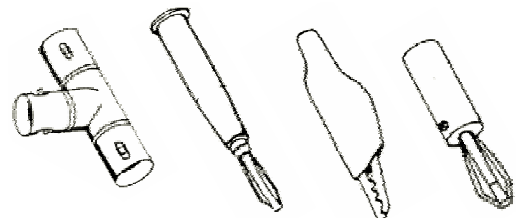

HCK SILICONE TEST LEADS

In the workshop it is necessary to have total confidence in your test equipment. Safety is also a major priority. The HCK range of plugs and sockets have rigid plastic sleeves, thereby making physical contact and shorts between leads impossible. To use these leads it is necessary to own equipment or meters that use the 'Safety' system, otherwise an adaptor (HCK9122) is required. The HCK safety test accessories are built to be used with up to 1000 volts. Probe tips are nickel-plated solid brass with a free rotating barrel spring strong positive contact with minimum resistance. All plastics are Polypropylene or polyamide material for strong durability and insulation. Silicone synthetic rubber is used for lead construction. This boasts extremely good qualities, such as tear and notch resistant and high insulating properties. They can be bent, twisted or flexed thousands of times subjected to extreme temperature (such as soldering iron tips), vibration, chemicals, with negligible cosmetic effect and will still maintain high current capacity for a long life. Enormous lead flexibility, range of attachments, safety standard and durability of these test leads make them a must for the serious, and safe, technician. All safety leads & attachments are sold separately and available in black or red. *Please, when ordering, indicate colour.*

4mm SAFETY TEST LEAD

Pre-assembled, highly flexible lead in a one metre length. Terminated at both ends with an axial 4mm safety plug. The attachments below are to be used with these leads.
Black HCK9014BK
Red HCK9014R

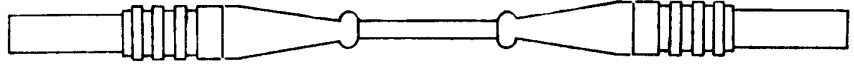

4mm SAFETY TEST LEAD

Pre-assembled, highly flexible lead in a one metre length. One end is right angle, the other axial 4mm safety plug. The attachments below are to be used with these leads.
Black HCK9016BK
Red HCK9016R

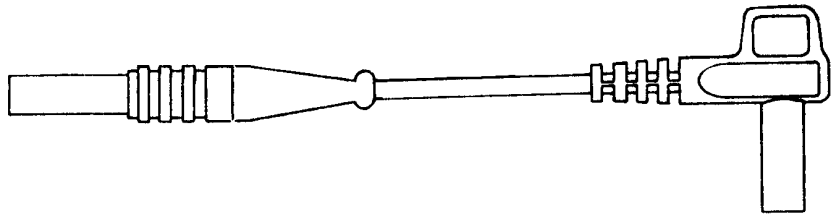

4mm SAFETY TEST PROBE

115mm in length.
Highly insulated body with protection collar.
The tip is equipped with a 4mm Plug for accessories.
RED HCK9112R
BLACK HCK9112BK

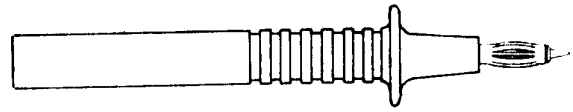

4mm SAFETY TEST PROBE

150mm in length with high collar for added safety when measuring High Voltages or hard to reach test points. Sharp tip for piercing insulation.
RED HCK9113R
BLACK HCK9113BK

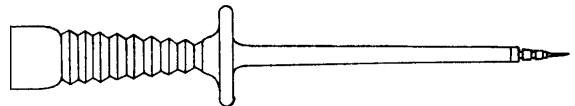

4mm SAFETY HOOK GRIP

A popular grip for IC connections. Wires & pins of up to 1.5mm thickness are held securely by the push to release spring pressure.
Length 125mm.
RED HCK9116R
BLACK HCK9116BK

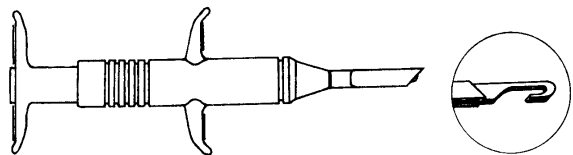

4mm SAFETY CLAMP GRIP

Two wire hooks open and spread to encircle the test point. 100mm long flexible tip for rigid contact of hard to reach contact points.
RED HCK9117R
BLACK HCK9117BK

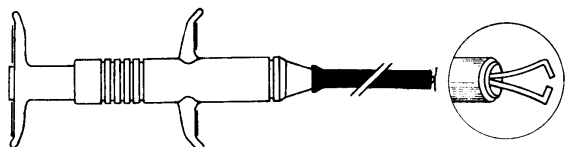

4mm SAFETY JAW GRIP

Heavy duty jaws open up to 20mm for a high current, strong rigid connection of motor terminals, fuse connections etc. Max 20A
130mm in length.
RED HCK9119R
BLACK HCK9119BK

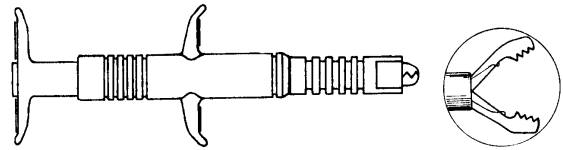

4mm SAFETY ALLIGATOR CLIP

For a sure strong connection of up to 20mm diameter. Will carry currents of up to 34A.
80mm in length. High tension metal spring.
RED HCK9755R
BLACK HCK9755BK

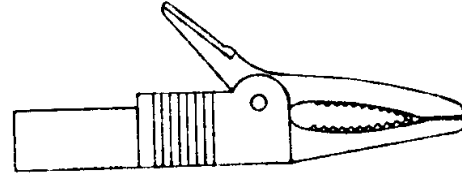

4mm SAFETY PROBE TEST LEAD

Ready assembled one piece probe with one metre silicone lead.
Axial 4mm safety plug.
The probe is 150mm long with a sharp steel tip and a 4mm plug for optional add-on accessories.
RED HCK9024R
BLACK HCK9024BK

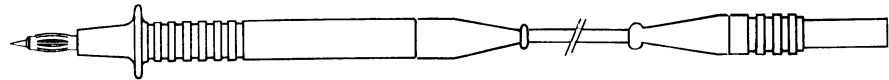

4mm SAFETY PROBE TEST LEAD

Ready assembled one piece probe with one metre silicone lead.
Right angle 4mm safety plug.
The probe is 150mm long with a sharp steel tip and a 4mm plug for optional add-on accessories.
RED HCK9026R
BLACK HCK9026BK

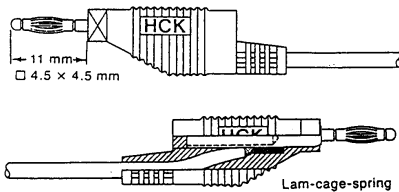
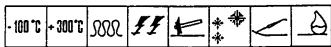
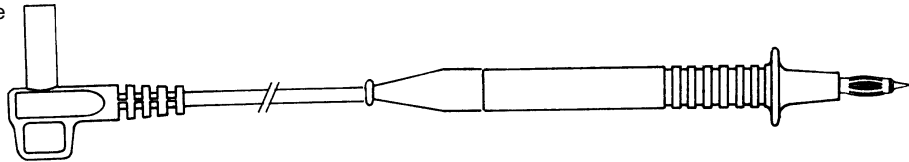

4mm PLUG-ON TEST PROBE

Designed for attachment on standard 4mm system. 130mm in length with sharp steel tip for piercing insulation and oxide layers
RED HCK9205R
BLACK HCK9205BK

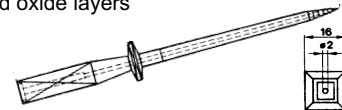

CHANGE OVER ADAPTOR

To make connection of safety plugs to standard 4mm system.
RED HCK9122R
BLACK HCK9122BK

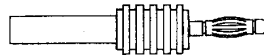

COUPLING CONNECTION

Female to female adaptor for safety lead extension etc. Will also accept standard 4mm.
RED HCK9123R
BLACK HCK9123BK



ADAPTOR 2mm TO 4mm

Standard 2mm system to the above 4mm.
RED HCK9226R
BLACK HCK9226BK



ADAPTOR 4mm TO 2mm

Standard 4mm system to the rare 2mm.
RED HCK9227R
BLACK HCK9227BK

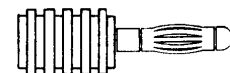

TOWERS TRANSISTOR SELECTOR

Popular Multinational transistor data with characteristics and substitutions listed. UK, USA, Asia, etc. 29,000 items listed. Code MAN34



WHITE GOODS MULTI-MANUALS

Information on white goods is hard to source so an independent has developed the following manuals:

FISHER & PAYKEL® WASHING MACHINES
Suit GW500,600,650,700,
GW501,501,701,703,
MW051,etc.
Code MAN-WM01

FISHER & PAYKEL® DRYERS
Suit ED52,53,54,
ED55,56,etc.
Code MAN-ED20

FISHER & PAYKEL® DISHWASHERS
Suit DW282,292,912,
DW913,918,920.
Code MAN-DW40



**CPU CONTROLLED
WHITE GOODS**

SEMICONDUCTOR COMPARISON TABLES

Complete Alpha-Numeric listing of semiconductor components including Diodes, Transistors, ICs, Triacs, plus much more. Consists of a short electronic description, diagram reference and where possible, substitutions. Very handy data books.

VOLUME ONE A→Z
eg. AD, BC, BCW, BCY,
CCS, LA, MC, MM,....
Code MAN36

VOLUME 2 1N→U
eg. 1N, 1S, 2N, 2SA,
2SB, 2SK, 3SK, UPC,....
Code MAN37



BUY BOTH FOR A DISCOUNT

DISHLEX DISHWASHER NOTES

Independent sourced information. 27 Page Book. Includes diagnostic codes and service notes, procedures, test modes, component tests, common problems with fault finding charts. With helpful diagrams and descriptions. All Dishlex washers from 500E onwards. 500E, ECO, 640HD, 750ECO, Milano, etc. Global Series, Dx200, 300, 450, 500.

Code MAN-DW500

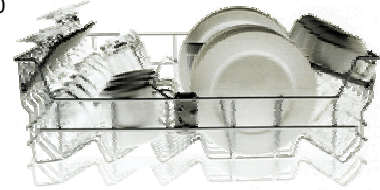

NEW! DIGITAL TV MANUAL

From EFIL Australia. Latest on the current system. COFDM, MPEG encoding / decoding, Satellite dish, set top boxes, digital reception, IRD, STB, Glossaries, plus much more! Written for the technician. Rod Humphris & Joe Aprile.

Code MANDTV



FAULT CURES - IKON with wes part codes!

UPDATED! Ikon Images. Australian. Logical, concise layout with thousands of cures listed. Ideal benchtop companion. Additional information is supplied to help you find your way around. Helpful tips for component substitution possibilities and use of WES code numbers for quicker parts ordering and identification. Clear descriptions and easy to search. Years of experience available at your finger tips. Improve your workshop output today!

TV FAULT CURES

Uses WES Code Numbers!
Lists over 4000
Australian model TVs'
faults and cures!
Now with DIGITAL-TV!
Code MAN-TV-IKON



VCR FAULT CURES

Written from the perspective of the technician, clearly. Over 7200 faults and cures! Includes handy additional info eg. pin voltages, WES codes, etc.
Code MAN-V-IKON



MICROWAVE MANUAL

There are many dangers involved in servicing microwave ovens. You should prepare yourself with information on the correct safety precautions and basic operations. This 66 page book offers all this information and much more including oven testing, door leakage, cooking sensors, common faults, diagnostic flow charts, popular circuits, and lots of general knowledge for microwave servicing. A must for every workshop.
Code MAN-MICRO

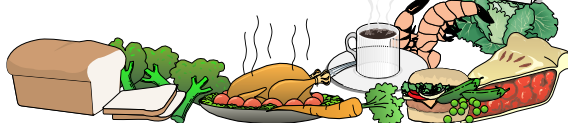
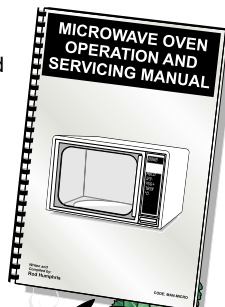

BOTH MANUALS ON CD-ROM

Now available for the "paperless-workshop"! Includes both manuals and some additional information including monitor repairs.
Code IKON-CDR



COMPACT DISC PLAYER SERVICING NEW!

A comprehensive 200 page manual. Covers Principles, Error correction, Laser assemblies, Servo, Signal Processing, Adjustments, Q & A, Troubleshooting and much more. Learn to fine tune a modern CD player and repair common faults. Full of diagrams, CRO Pictures, Schematics, Flow Charts, etc. Excellent references for the technical person with glossary and repair hints for the novice. Written in Australia, and published with the knowledge and resources of EFIL.

Code MANCD



VCR REMEDIES

A comprehensive listing of VCR faults & their remedies including Audio & Camera. 6½ thousand entries! 280 pages. Technical write ups & flow charts detailing diagnostic procedures, etc. This manual is not designed to teach you how to repair, it was developed to assist the qualified technician in improving the professionalism of the industry and increase turn around and profit, etc. An incredibly helpful tool in electronic repair.

Code EFILVID

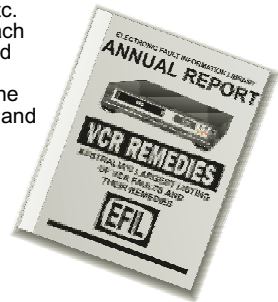

POWER SUPPLY MANUAL

Written by Rod Humphris of RMIT. Covers everything from basics to the complexities of today's switch mode supplies. A book to learn from as well as a wealth of reference to assist you in the repair of consumer electronics. Series regulators, Mains filtering, SMPS/SOPS, Fault listings, Circuit descriptions, Diagnostic charts, Self learning exercises, 170 pages of very useful information for understanding modern day power supplies.

Code MANPOWER



EFIL FAULT INFORMATION PROGRAM

Technicians are usually computer literate (even positively addicted to the machines) and supplying such information in the form of a computer program makes a lot of sense. The power of today's PC and depth of its programming is incredible and always improving. The information access of EFIL's new program is extremely user friendly with multiple menus and search systems. The program includes over ten thousand entries in repair remedies from the *Electronic Fault Information Library*. The program requires a Pentium PC with Windows 95+. The numerous features & possibilities are too many to list here! This program has the potential to be the heart of a technical data and product information centre. The range of information included spans of new and old products including TVs, Videos, Video cameras, microwave ovens, computer monitors and even some audio! You can easily add or modify any of the existing information or in addition you can use this data base as a journal to record all of your unique faults for your reference in the future, on any item. If you use your computer as a tool for saving time and storing information for easy retrieval then this is a product for you!

TV DEFLECTION CIRCUITS

Written by Rod Humphris of RMIT. Theory of operation and the repair procedure for CTV, monitors, etc. With references to new technologies (Digital TV, SVM, 100Hz). This publication will help you fix the difficult faults, or at least guide you towards the correct diagnosis of most problems experienced in the deflection circuitry. Covers Horizontal stage, Vertical Osc & Output, Fault finding and diagnostics techniques with a fault reference section covering popular items such as Picture wobble Anti flag waving, modifications, etc. This book will prove informative educative and will save you time & money. 150 pages with illustrations.

Code MANDEF

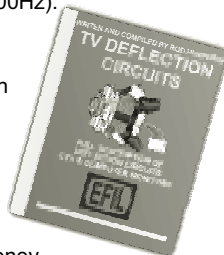

EFIL SOFTWARE CD-ROM

Code EFILCDR

EFIL SPECIALS!

Purchase both EFIL manuals & save!
Code EFILTV & EFILVID
225.00

Purchase both the EFIL Software plus the TV & VCR manuals & save!

SOFTWARE & EFILTV & EFILVID CDROM

Code EFILKITC



Use the Power of your PC!



TV REMEDIES

EFIL *Electronic Fault Information Library* AUSTRALIAN MADE 340 pages with 8138 faults & remedies plus lots of information and tips on the subject. Stop wasting time on the hard & frustrating faults, look the cure up in this manual! Save time, money and frustration. This manual was developed with the assistance of many companies in the best interest of helping improve the standard & professionalism in the electronic repair industry. A necessary tool, helpful & profitable.

Code EFILTV



SECURITY LABELS

Disintegrating sticker. Place over screw holes and unit seals to stop tampering. Suit repairs with warranty, etc. Roll of 500 stickers.

Code WL500



HEAT TRANSFER COMPOUND

SILICONE BASE TUBES

10g SIL10
150g SIL150

NON-SILICONE SYRINGES

10ml RF44
35ml HTC35SL

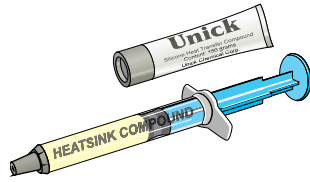

POLYGLIDE COLOURLESS

Grease for plastics.
Does not harden even after long immobility.
Free of silicone oils.
Electrically neutral.
Colourless lubricator.
Code GR5147



SILICONE HEATSINK COMPOUND

“OEM” Specified
Made in Japan.
Sets hard.
Improves thermal conductivity to the max! 150g.
Code TSE3843W



WHITE GREASE

For all metal and plastic lubrications.
Particularly synthetics.
Water resistant.
-35°→+150°C.
Code GR5148



OIL PEN

‘Sewing Machine Oil’
Highest Quality in a convenient application pen.
Press to release.
Size 5ml
Code EML05P



BEARING GREASE YELLOW

For roller bearings, friction bearings and toothed wheels.
Size 35g
Code GR5143



DOW CORNING SILASTIC

Original silicone elastomer for high voltage insulating.
Non corrosive and cures to a tough, rubbery solid.
Size 90ml tubes.
Code SIL738



EVERLASTING GREASE GREY

For mechanical tape feed guides, hinges, guidance pillars etc.
Size 35g
Code GR5144



LOCTITE ULTRA FAST

The Best Instant Adhesive
Cyanoacrylic Ester.
For bonding metals most plastics, rubber, etc.
Large 25ml bottle.
Code LOC401

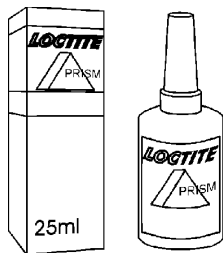

SILICONE GREASE COMPOUND

Highest quality electrical insulator, moisture repeller.
Eliminate HV tracking.
Lubricate joints, etc.
Non-toxic MIL-1-8660B.
eg. Car ignition switches, HV pix tube connections, etc.
35ml SCO35SL

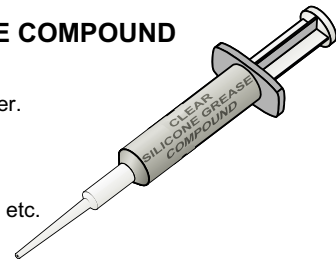

LOCTITE 454 GEL

Surface insensitive for porous materials inc' wood, ceramics, felt, cork, etc.
More suited than LOC401 for gluing pulleys onto capstan motors, etc.
Code LOC454



CONTACT TREATMENT GREASE 2X

An extra high quality non-melting grease for the most critical applications where long term performance and reliability are essential. High tenacity for vertical surfaces, sliding contacts.
Anti-static, safe on most plastics, paint and rubber.
35ml SGB35SL



INSTANT ADHESIVE GLUE

Cyanoacrylate
2 gram tube.
Bonds instantly.
Code ISG2

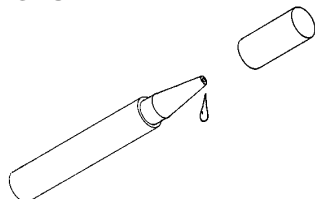

SPECIAL PLASTICS COMPATIBLE GREASE

Synthetic mechanical lubricant for thermoplastics, Polycarbonates, ABS, etc.
Also known as Montage grease. Ideal for switch contacts and Plastic → Plastic, Plastic → Metal friction points.
eg. Photocopiers, timers, etc...
Light-brown colour. Non-melting.
Code SPG35SL

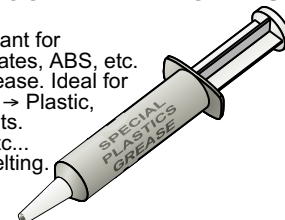

CONDUCTIVE PEN

Draws fine lines of conductive silver for design & repair of surface mount, standard & membrane type circuits. Self cleaning tip for smooth, highly conductive silver traces.
 Code CW2200STP
Super Fine Tip
 Code CW2200MTP

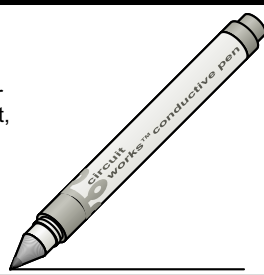

LIQUID HEAD CLEANING SOLUTION

Isopropyl Alcohol.
 VCR/Audio solvent.
BOTTLE 20ml
 Code CS500
SQUEEGEE 20ml
 Code CS505



OVER COAT PEN

Protective conformal overcoat paint in an easy applicator pen. 5g (0.16oz) Applies a tough coat for insulating and protecting against corrosion, shorting and high voltage arcing.
 Green CW3300G
 Clear CW3300C



FLUX SYRINGE

Multi-core 450-01 Rework SMD with this easy apply 10cc syringe. Contains resin. High grade quality.
 Code FLX450

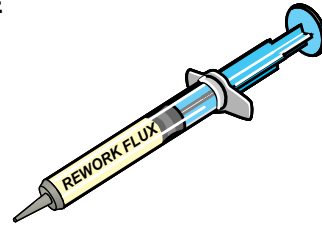

CONDUCTIVE EPOXY

Provides strong, highly conductive silver connections for solderless component bonding, trace repair, grounding & shielding. Two-part application for curing to high strength.
 Code CW2400

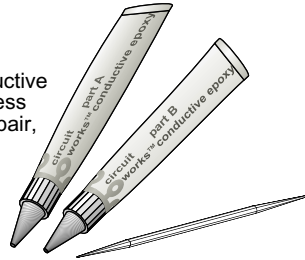

FELT-TIP DISPENSER

Supplied empty with a push-to-release flow tip. Dispense flux, etc.
 Code PEN200

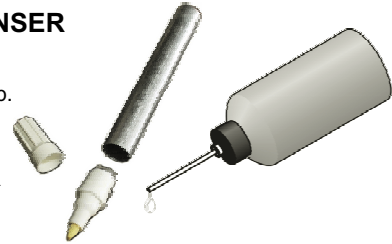

BOTTLE DISPENSER

55ml BOT55E

QUICK BOND GEL

Cyanoacrylate gel adhesive & accelerator for strong, instant bonding of rubbers, metals & plastics. Colourless. Fixture time 20-60sec or instant with accelerator.
 Code CW4300



FIBRE PCB TRACK CLEANING PEN

Clean PCBs at the track level for eliminating micro-fractures and other general repair & diagnosis. Removes all except the track. Better than scratching with a knife! German. 120mm
 Code PEN220



CONDUCTIVE SILVER GREASE

Pure silver & advanced silicone lubricants for premium electrical and thermal conductivity. Chemically inert, fully tested & suitable for metal rubber & plastic. Ideal for switch contacts, etc.
 Code CW7100

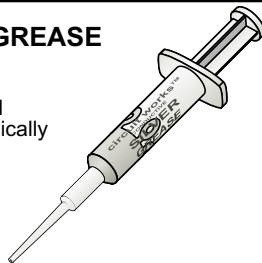

OFFICE WIPES

70x Pre-Moistened Multi-Surface Non-Scratch disposable cloths in a handy dispenser bottle. Commercial grade disinfectant. For cleaning office equipment, etc. Australian made by Kimberly-Clark.
 Code KIM4100



SILVER CONDUCTIVE PAINT

Dries to leave a conductive path. Suit PCB repair & connections to non-solderable materials, repairs rear demisters, etc. Excellent adhesion & conduction properties. Simply paint on. 3g Phial.
 Code SCP03B



RUBBER KEYPAD REPAIR KIT

Restores conductivity to worn carbon contacts on remote controls, keypads, etc... Repairs good for 500,000 keystrokes. Carbon/silver solution.
 Code CW2611



ADJUSTMENT LOCKING SEAL

Don't use my good Nail polish dear!
 Purpose made for locking adjustments, screws, etc. Tamper Evident Seal 15ml.
 Red EBLR15
 Green EBLV15



"Dangerous Goods"  Must be sent by road

SUPER QUALITY VIDEO HEAD CLEANERS

High quality synthetic chamois tipped with 45° angled shaft. Gives easy reach, non-abrasive cleaning for video heads and tape path components. Packaged in bags of ten.

Code VCS10

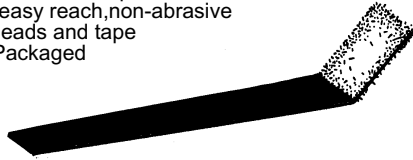

150mm CLEANING SWABS

100x COTTON

Code ACS100

20x FOAM

Code VCS20

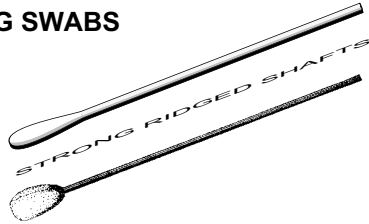

CONTACT CLEANING STRIPS

Unique cleaning, lubricating and protecting treatment. For relay and non-wiping contacts like edge connectors, etc.

20 pcs. 75mm strips.

Code CCS020

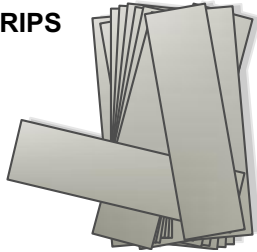

KIM-WIPES®

For light duty wiping of delicate precision parts such as Video heads, CD lasers, Camera lenses, Perspex, Glass, Plastic, etc. The fine soft tissue surface picks up and holds oils, dust and liquids. Suitable for use with cleaning solutions. Resists scratching sensitive surfaces. One-at-a-time, pop-up dispensing reduces waste and increases convenience. Kimberly-Clark Australia. 12 x 21cm singles in a tissue type box. 200x

Code KIMW4103



POLY-NO-STAT®

ANTI-STATIC DUSTING CLOTH

25x cloths 400x300mm
Ideal dusting cloth.
Strong fibre structure.
100% textile fibre.
Re-useable, machine washable.
Chemical & odor free.
Low-Lint, Cloud-free dusting.
Strong but soft to the touch.
Will not scratch surfaces.
Reduces the static spark.
Use them in the office, workshop or the home.
Made in Australia.
Code ASC778

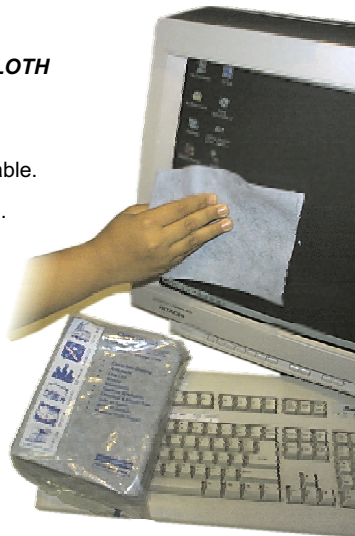

CHEMTRONICS® SWABS AND APPLICATORS

Professional products designed for servicing consumer electronics with a complete line of ultra-pure swabs and wipes engineered to be highly absorbent and precise. Supplied sealed packaged.



COTTONTIPS™

Pharmaceutical grade extremely soft, absorbent, rigid shaft.

Pieces 100
Code CT100



COTTONTIPS™ LOW LINT

Pharmaceutical grade, tightly wound absorbent, general P.

Pieces 1000
Code CT5000



COTTONTIPS™ 2 HEAD

Pharmaceutical grade extremely soft, absorbent, both ends.

Pieces 100
Code CT2000



CHAMOIS TIPS™

Ultra-Clean flat swab for Video Heads & Optical pick-ups.

Pieces 50
Code CC50



MICROTIPS™ MEDIUM

Non-abrasive fibre pinpoint for solvent & adhesive applications.

Pieces 50
Code CM502



FOAMTIPS™ #100

Lint-free non-abrasive cellular urethane cleaning swabs.

Pieces 50
Code CF50



FOAMTIPS™ #140

Small Circular Head. For tight hard to reach applications.

Pieces 50
Code CF4050



ATTACHE TOOL CASE

Tough aluminium case. Professional type like photographers, etc. Protect valuable test equipment and tools. Black with silver knock panels. Removable dividers. Removable tool pouch. 458 x 300 x 140mm
Code AT458

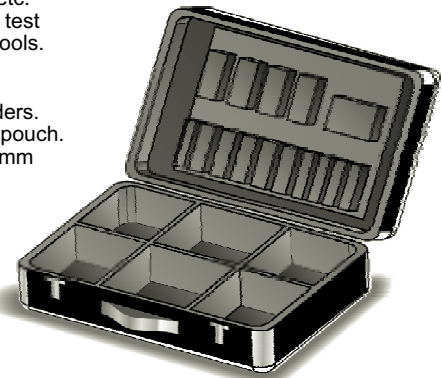

SECURITY LABELS

Disintegrating sticker.
Place over screw holes
and unit seals to stop
tampering. Suit repairs
with warranty, etc.
Roll of 500 stickers.
Code WL500

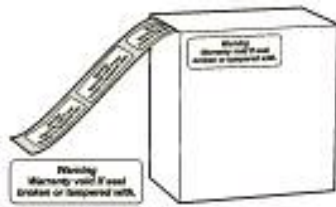

WARNING

This affects all aerosol
& pressure can products.
Government regulations
classify aerosols as
"dangerous goods".
As a result we can not send
aerosols by air freight or mail.
These products can only be transported by road courier.



SUPER-LUBE SYNTHETIC LUBRICANTS

Super Lube is a patented, multi-purpose, synthetic, exceptionally pure lubricant containing SYNCOLON® (PTFE) particles held in suspension. Super Lube lasts longer and outperforms conventional petroleum based greases and oils because there are no impurities or sediments left behind by a crude oil refinement process. It will not oxidize, form gummy carbon deposits or solidify. Temperature tolerance is extended (-43°C to 230°C continuous). Super-Lube also offers improved resistance to water, salt water, acids, alkalis, detergents, conduction and repels dirt, grit, grime, rust, corrosion, etc. It is odorless and non-toxic. Made by Synco in the USA. This new range of lubricant is suitable for the home, workshop or industry and is available in several convenient applicators; As a grease in tubes or slightly more malleable lubricant in a can or syringe.
PTFE = Polytetrafluoroethylene (Teflon)
www.super-lube.com



SUPER-LUBE IN A CAN 170g

Multi-purpose, compatible with most other lubricants.
Safe on most surfaces.
Heavy-duty, non-toxic, anti-corrosive shield.
Convenient 170g can.
Code SL31040

SUPER-LUBE IN A PEN 7ml

Synthetic lubricant in a convenient syringe applicator.
Penetrates, lubricates and extends the life of machinery and equipment. Bearings, chains, hinges, zippers, locks, toys, etc.
Code SL51010



SUPER-LUBE IN A TUBE 85g

Synthetic grease with Syncolon. Highly lubricious, clear and non-toxic.
Excellent dielectric.
Impervious to salt water.
Suit home to industry.
Code SL21030



SUPER-LUBE IN A TUBE 12g

Grease for people on the go!
Lubricates, protects, clear, will not stain, bio-degradable, impervious to salt water, etc.
Perfect for outdoor equipment, fishing, tools, tracks, etc.
Code SL21010



HELMAR SILICONE SPRAY

Industry leader
Lubricates & Protects
Non-staining. Suitable for home, sporting, automotive, industrial.
Size 300g (11fl.oz.)
Code H4000



FREEZER

-55°C for fault finding, etc.
Low residue. Spray cans.
Code Description
CRC2039 CRC 300g
RF59 RF 250g
FRE200 225g
FRE400H 450g
MCF200 225g ESD
MCF400 450g ESD



VIDEO HEAD CLEANER

NO RESIDUE CLEANERS
Test before use on plastics.
Code Description
CRC2012 CRC 200g
CRC2013 CRC 210ml
RF60 RF 250ml
VID100M Electrolube 100ml



CONTACT CLEANER

NON-SILICONE BASE
(protective film residue)
Code Description
CRC2004 2-26 150g
CRC2005 2-26 500g
RF64 RF 175g
RF68 Protec 175g
EML200F Electrolube 140g
SOB200M Electrolube 300g

CRC3040 Teflon 150g
CRC2001 Switch Cleaner 300g

SILICONE BASED (Si)
H4000 NEW 300g
CRC2094 CRC 300g

NON-RESIDUE TYPES
CRC2012 Contact 2000 200g
CRC2013 Head cleaner 210ml
CRC2016 CO 350g
IPA400H Isopropanol 325g
VID100M Compact Can 150g
ULS400D Ultrasolve 325g

Isopropanol is also available in bottles.
CS500 Bottle 20ml
CS505 Squeegee 20ml



www.electrolube.com
www.crcindustries.com.au
www.rfoot.com.au
Entire Range Next Page

WARNING!

This warning effects all aerosol / pressure can products. To comply with Australian government regulations regarding the elimination of ozone damaging CFC gases, the propellants used in some aerosol products may be flammable. Do Not spray at a Naked Flame! Government regulations classify aerosols as "dangerous goods". As a result we can not send aerosols by air freight or mail. Therefore please allow extra time for deliveries containing these products as they can only be transported by road.

CRC® RANGE OF SERVICE AIDS



SPECIAL from CRC
Buy Six Assorted and Receive a 10% Discount!



**Buy 6
Save 10%**

A long established company who has been manufacturing service aids for many years. Australian made. Complies with all CFC regulations. See Warning

Code	Description	Size
CRC2001	Switch cleaner/lubricant	300g
CRC2004	Popular contact cleaner lubricant 2-26	150g
CRC2005	Popular contact cleaner lubricant 2-26	500g
CRC2012	Precision Cleaner. No flash point. No resedue.	200g
CRC2013	Video or audio head cleaner	210ml
CRC2016	CO contact cleaner which evaporates completely	350g
CRC2018	Lectra clean. Heavy duty cleaner and degreaser	400g
CRC2039	Freeze spray. Inert coolant with many applications	300g
CRC2043	Plasticote 70. Dry flexible film on most surfaces	300g
CRC2044	Red urethane seal. Insulating and protective varnish	300g
CRC2049	Clear urethane seal. Insulating & protective varnish	300g
CRC2066	Air Brush for dry safe multi-purpose cleaning	300g
CRC2071	Antistatic VDU99 general dust & grease removal	200g
CRC2085	Zinc It. Forms a tough & flexible anti-rust coating	350g
CRC2094	Silicone lubricant Lubricates, waterproofs & leaves a clear film for continued protection.	300g
CRC3040	<i>Dry-Glide</i> Dry film lubricator with Teflon by Dupont	150g
CRC3055	NEW! Silicone 808 Multi-purpose Enhancer Lube' Protect 330g	



RF® SERVICE AIDS

Made in Australia, the RF range of service aids is COMPLETELY OZONE SAFE.

Code	Description	Size
RF44	Heat Sink Compound Syringe. <i>Non-Silicone</i> .	10ml/22.5g
RF58	Electronic Cleaning Solvent No1. Safe on plastics.	250ml/175g
RF59	Electronic Freezing Spray.	250ml/250g
RF60	Video Head Cleaner	250ml/175g
RF61	Circuit Board Lacquer. Forms a flexible coating.	250ml/175g
RF64	Contact Cleaner Lubricant.	250ml/175g
RF65	Circuit Board Cleaner. For heavy duty cleaning.	250ml/175g
RF67	Air Duster. For removal of dust and dirt.	250ml/250g
RF68	Protex. Displaces moisture, penetrates & lubricates	250ml/175g



ELECTROLUBE® MAINTENANCE PRODUCTS



ELECTROLUBE products are market leaders and are of the highest import quality. All products comply to Australian government CFC regulations and are ozone friendly. Please read the warning above.

Code	Description	Size
AFC400H	Anti-Static Foam Cleanser Aerosol	400ml/395ml
ASA250	Anti-Static Spray Bottle (Squeegee)	250ml
CCS020	Contact Cleaning Strips	20 strips/packet
CPL200H	Clear Protective Lacquer Aerosol	200ml/100g
DFL200D	Dry Film Lubricant Aerosol	200ml/160g
EAD400	Air Duster Aerosol	400ml/445g
ECSP200D	Electronic Cleaning Solvent Aerosol	200ml/135g
EML05P	Oil in an Application Pencil	5ml
EML200F	Contact Cleaner Lubricant Aerosol	200ml/140g
EPE200H	Permagard Aerosol	200ml/170g
ULC200D	Ultralene aerosol	200ml/250g
FLU400D	Flux Remover	400ml/325g
SWA400H	PCB Cleaner Foam with brush	400ml/390g
LRM200D	Label remover (lifts sticky goo)	200ml/165g
FRE200	Freezer Aerosol	200ml/225g
FRE400H	Freezer Aerosol	400ml/450g
MCF200	Freezer Aerosol <i>Anti-static</i>	200ml/225g
MCF400	Freezer Aerosol <i>Anti-static</i>	400ml/450g
HTC35SL	Heat Transfer Compound Syringe	35ml
IPA400H	Cleaning Solvent Isopropanol Aerosol	400ml/325g
ULS400D	Ultrasolve Aerosol	400ml/325g
SC035SL	Silicone Grease Compound Syringe	35ml
SCO200D	Silicone Grease Compound Spray Can	200ml/145g
SCP03B	Silver Conductive Paint Bottle	3g
SGB35SL	Contact Treatment Grease Syringe	35ml/35g
SMFL200D	Rework Solder Flux non-corrosive free flux	200ml/170g
SOB200M	Contact Treatment Oil Aerosol	200ml/300g
SPG35SL	Special Plastic Grease Syringe	35ml
VID100M	Audio/Video Head Cleaner Aerosol	100ml/150g
DCA200H	Conformal Coating Aerosol	200ml/160g
PRP200	Positive Photo Resist Aerosol	200ml/210g
PDN250	Developer Positive Photo Resist Bottle	250ml/300g

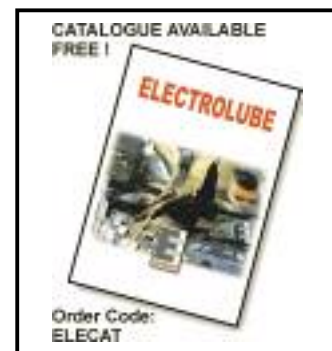

ALL CANS MUST GO BY ROAD! Please Read "Warning!" Above

