

Operating Instructions

Blu-ray Disc Home Theater Sound System

Model No. **SC-BT205**
SC-BT200

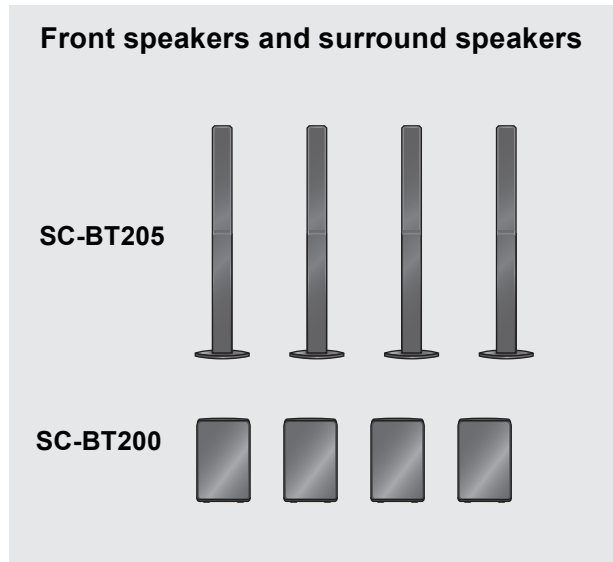
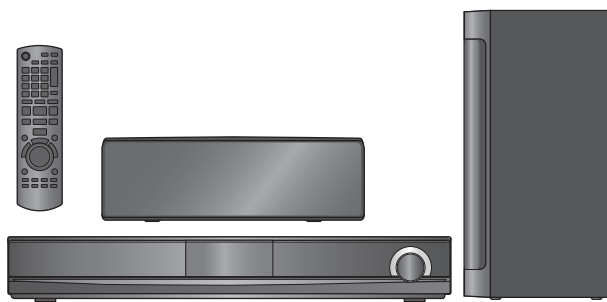

Dear customer

Thank you for purchasing this product.

For optimum performance and safety, please read these instructions carefully.

Before connecting, operating or adjusting this product, please read the instructions completely. Please keep this manual for future reference.

To update the firmware of this unit, refer to page 32.

Note: "EB" on the outer packaging indicates the United Kingdom.



Region management information

BD-Video

This unit plays BD-Video marked with labels containing the region code B.

Example:



DVD-Video

This unit plays DVD-Video marked with labels containing the region number "2" or "ALL".

Example:



- These operating instructions are applicable to models SC-BT200 and SC-BT205. Unless otherwise indicated, illustrations in these operating instructions are for SC-BT205.
- Please note that the actual controls and components, menu items, etc. of your Blu-ray Disc Home Theater Sound System may look somewhat different from those shown in the illustrations in these Operating Instructions.
- Operations in these instructions are described mainly with the remote control, but you can perform the operations on the main unit if the controls are the same.

Indicates features applicable to:

	BT205: SC-BT205 only	BT200: SC-BT200 only
System	SC-BT205	SC-BT200
Main unit	SA-BT205	SA-BT200
Front speakers	SB-HF770	SB-HF470
Centre speaker	SB-HC300	SB-HC300
Surround speakers	SB-HS870	SB-HS470
Subwoofer	SB-HW200	SB-HW200

Accessories



Please check and identify the supplied accessories. Use numbers indicated in parentheses when asking for replacement parts.

(Product numbers correct as of March 2009. These may be subject to change.)

- 1 Remote control (N2QAQB000073)



- 1 AC mains lead (K2CZ3YY00005)



- For use with this unit only. Do not use it with other equipment. Also, do not use cords from other equipment with this unit.

- 2 Remote control batteries (R6/LR6,AA)



- 1 Video cable (K2KA2BA00001)



- 1 FM indoor antenna (RSAX0002)



- 1 Speaker cable (centre)
BT200
[REEX0858-L (green)]

- BT205
[REEX0858-Q (green)]



- 2 Speaker cables (Front)
BT200
[REEX0859-L (white)]
[REEX0867A-L (red)]



- BT200
 2 Speaker cables (surround)
[REEX0860E-L (blue)]
[REEX0868E-L (grey)]



- BT205
 4 Speaker stands (with cable)
[RYPX0386-KL (white)]
[RYPX0386-KR (red)]
[RYPX0400-KL (blue)]
[RYPX0400-KR (grey)]



- BT205
 4 Bases (RYPX0389-K)



- BT205
 16 Screws (XTN5+10FFJK)



- 1 Sheet of speaker cable stickers



- 1 Auto speaker setup microphone (LOCBAY000034)



- 1 Antenna plug adaptor (K1YZ02000013)



■ Sales and Support Information

Customer Care Centre

- For customers within the UK: 0844 844 3852
- For customers within the Republic of Ireland: 01 289 8333
- Visit our website for product information
- E-mail: customer.care@panasonic.co.uk

Direct Sales at Panasonic UK

- For customers: 0844 844 3856
- Order accessory and consumable items for your product with ease and confidence by phoning our Customer Care Centre Monday–Thursday 9:00 a.m.–5:30 p.m., Friday 9:30 a.m.–5:30 p.m. (Excluding public holidays)
- Or go on line through our Internet Accessory ordering application at www.panasonic.co.uk.
- Most major credit and debit cards accepted.
- All enquiries transactions and distribution facilities are provided directly by Panasonic UK Ltd.
- It couldn't be simpler!
- Also available through our Internet is direct shopping for a wide range of finished products, take a browse on our website for further details.

Interested in purchasing an extended guarantee?

Please call 0870 240 6284 or visit our website www.panasonic.co.uk/guarantee.

Safety precautions

Placement

Set the unit up on an even surface away from direct sunlight, high temperatures, high humidity, and excessive vibration. These conditions can damage the cabinet and other components, thereby shortening the unit's service life. Do not place heavy items on the unit.

Voltage

Do not use high voltage power sources. This can overload the unit and cause a fire. Do not use a DC power source. Check the source carefully when setting the unit up on a ship or other place where DC is used.

AC mains lead protection

Ensure the AC mains lead is connected correctly and not damaged. Poor connection and lead damage can cause fire or electric shock. Do not pull, bend, or place heavy items on the lead. Grasp the plug firmly when unplugging the lead. Pulling the AC mains lead can cause electric shock. Do not handle the plug with wet hands. This can cause electric shock.

Foreign matter

Do not let metal objects fall inside the unit. This can cause electric shock or malfunction.

Do not let liquids get into the unit. This can cause electric shock or malfunction. If this occurs, immediately disconnect the unit from the power supply and contact your dealer.

Do not spray insecticides onto or into the unit. They contain flammable gases which can ignite if sprayed into the unit.

Service

Do not attempt to repair this unit by yourself. If sound is interrupted, indicators fail to light, smoke appears, or any other problem that is not covered in these instructions occurs, disconnect the AC mains lead and contact your dealer or an authorized service centre. Electric shock or damage to the unit can occur if the unit is repaired, disassembled or reconstructed by unqualified persons.

Extend operating life by disconnecting the unit from the power source if it is not to be used for a long time.



Caution for AC Mains Lead

For your safety, please read the following text carefully.

This appliance is supplied with a moulded three pin mains plug for your safety and convenience.

A 5-ampere fuse is fitted in this plug.

Should the fuse need to be replaced please ensure that the replacement fuse has a rating of 5-ampere and that it is approved by ASTA or BSI to BS1362.

Check for the ASTA mark  or the BSI mark  on the body of the fuse.

If the plug contains a removable fuse cover you must ensure that it is refitted when the fuse is replaced.

If you lose the fuse cover the plug must not be used until a replacement cover is obtained.

A replacement fuse cover can be purchased from your local dealer.

CAUTION!

IF THE FITTED MOULDED PLUG IS UNSUITABLE FOR THE SOCKET OUTLET IN YOUR HOME THEN THE FUSE SHOULD BE REMOVED AND THE PLUG CUT OFF AND DISPOSED OF SAFELY.

THERE IS A DANGER OF SEVERE ELECTRICAL SHOCK IF THE CUT OFF PLUG IS INSERTED INTO ANY 13-AMPERE SOCKET.

If a new plug is to be fitted please observe the wiring code as stated below.

If in any doubt please consult a qualified electrician.

IMPORTANT

The wires in this mains lead are coloured in accordance with the following code:

Blue: Neutral, Brown: Live.

As these colours may not correspond with the coloured markings identifying the terminals in your plug, proceed as follows:

The wire which is coloured Blue must be connected to the terminal which is marked with the letter N or coloured Black or Blue.

The wire which is coloured Brown must be connected to the terminal which is marked with the letter L or coloured Brown or Red.

WARNING: DO NOT CONNECT EITHER WIRE TO THE EARTH TERMINAL WHICH IS MARKED WITH THE LETTER E, BY THE EARTH SYMBOL  OR COLOURED GREEN OR GREEN/YELLOW.

THIS PLUG IS NOT WATERPROOF—KEEP DRY.

Before use

Remove the connector cover.

How to replace the fuse

The location of the fuse differ according to the type of AC mains plug (figures A and B). Confirm the AC mains plug fitted and follow the instructions below.

Illustrations may differ from actual AC mains plug.

1. Open the fuse cover with a screwdriver.

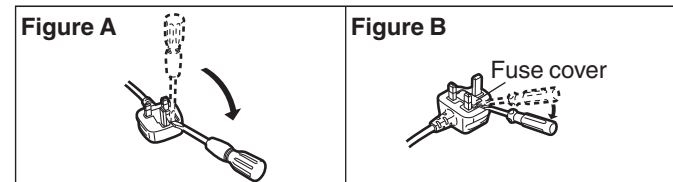

2. Replace the fuse and close or attach the fuse cover.

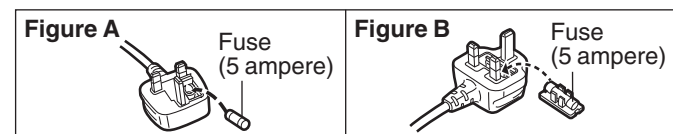

Unit and media care

Disc and card handling

Clean discs

DO **DO NOT**



Wipe with a damp cloth and then wipe dry.

Disc and card handling precautions

- Handle discs by the edges to avoid inadvertent scratches or fingerprints on the disc.
- Do not attach labels or stickers to discs (This may cause disc warping, rendering it unusable).
- Do not write on the label side with a ball-point pen or other writing instrument.
- Do not use record cleaning sprays, benzene, thinner, static electricity prevention liquids or any other solvent.
- Do not use scratch-proof protectors or covers.
- Clean any dust, water, or foreign matter from the terminals on the rear side of the card.
- Do not use the following discs:
 - Discs with exposed adhesive from removed stickers or labels (rented discs etc).
 - Discs that are badly warped or cracked.
 - Irregularly shaped discs, such as heart shapes.

Maintenance

Clean this unit with a soft, dry cloth

- Never use alcohol, paint thinner or benzene to clean this unit.
- Before using chemically treated cloth, carefully read the instructions that came with the cloth.

Observe the following points to ensure continued listening and viewing pleasure.

Dust and dirt may adhere to the unit's lens over time, making it impossible to play discs.

Use the lens cleaner (not included) about once every year, depending on frequency of use and the operating environment. Carefully read the lens cleaner's instructions before use.

Lens cleaner: RP-CL720E

- This lens cleaner is sold as specific for DIGA, but can be used without problem on this unit as well.

To dispose or transfer this unit

This unit may record information of your operating procedures. If you discard this unit either by disposal or transfer, then follow the procedures to return all the settings to the factory presets to delete the recorded information. (⇒ 48, "To return to the factory preset")

- When BD-Video is played back, the operation history may be recorded in the memory of this unit. The recorded contents differ depending on the disc.

Table of contents

Getting started

Playback

Radio

TV

Other devices

Advanced operations

Optional speaker settings

Reference

Getting started

Accessories	2
Safety precautions	2
Caution for AC Mains Lead	3
Unit and media care	3
Using the remote control	5
Batteries	5
Use	5
Control reference guide (remote control)	5
Control reference guide (main unit)	6
Front panel	6
Rear panel terminals	6

Assembling the speakers BT205	7
Positioning	8
Speaker connections	9
TV connections	10
Connections with an video cable	10
Connections with a component video cable	11
Connections with a HDMI cable	11
Connections to a Set Top Box, etc	12
Radio antenna connections	12
Network connection	13
AC mains lead connection	13
SMART SETUP	14
Basic setting for the system (SMART SETUP)	14

Showing START menu	15
Selecting the playback source	16
Selecting the source from the START menu	16
Selecting the source by the remote control	16
Enjoying sound from all speakers and various sound effects	17
Enjoying surround sound effects	17
Changing the sound modes	17
Adjusting speaker level during play	17

Playback

Basic operation	18
Other operations during play (These functions may not work depending on the media.)	19
Playing video recorded on a Video Camera or Video Recorder	20
Enjoying BD-LIVE or BONUSVIEW in BD-Video	21
Playing secondary video (picture-in-picture) and secondary audio	21
Enjoying BD-Live discs with Internet	21
Playing DivX® videos	22
Regarding DivX VOD content	22
Displaying subtitles text	22
Playing still pictures	23
Useful functions during still picture play	24
Playing music	25

Radio

Listening to the Radio	26
Setting up the radio	26
Listening/confirming the preset channels	26
RDS broadcasting	26

TV

Enjoying TV, etc. with this unit's speakers ...	27
Enjoying TV and other devices sound from this unit's speakers	27
Adjusting the sound	27
Making settings for digital audio input	27
Linked operations with the TV (VIERA Link "HDAVI Control™")	28
What is VIERA Link "HDAVI Control"?	28
What you can do with "HDAVI Control"	28
Easy control only with VIERA remote control	29

Other devices

Using the iPod	30
iPod Connection	30
iPod Playback	31

Advanced operations

Enjoying VIERA CAST™	32
Firmware updating	32
Network settings	33
Changing settings with the on-screen menu ...	35
On-screen menu operations	35
What you can change with the on-screen menu	35
Changing the unit's settings	37
Setup menu operations	37
Summary of settings	37
Speaker settings	41

Optional speaker settings

Wireless connections (optional)	42
Connecting the speakers with the optional wireless system (SH-FX70)	42
Speaker installation option	43

Reference

Media (Disc, card and USB device) information	44
Packaged discs	44
Recorded discs	44
SD cards	45
USB device	45
Regarding 24p output	45
Discs that cannot be played	45
About MP3/JPEG/DivX files	46
Troubleshooting guide	48
Messages	52
Frequently asked questions	53
Language code list	54
Licenses	54
Glossary	55
Specifications	57
Index	Back cover

Using the remote control

Batteries

- ② Insert so the poles (+ and -) match those in the remote control.

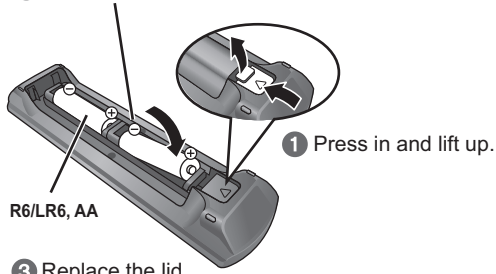

- ③ Replace the lid.
When closing the lid, insert it from the - (minus) side.

CAUTION

Danger of explosion if battery is incorrectly replaced. Replace only with the same or equivalent type recommended by the manufacturer. Dispose of used batteries according to the manufacturer's instructions.

- Use alkaline or manganese batteries.
- Do not mix old and new batteries.
- Do not use different types at the same time.
- Do not heat or expose to flame.
- Do not leave the battery(ies) in an automobile exposed to direct sunlight for a long period of time with doors and windows closed.

- Do not take apart or short circuit.
- Do not attempt to recharge alkaline or manganese batteries.
- Do not use batteries if the covering has been peeled off. Mishandling of batteries can cause electrolyte leakage which can damage items the fluid contacts and may cause a fire. Remove batteries if the remote control is not going to be used for a long period of time. Store in a cool, dark place.

Use

Aim at the remote control signal sensor (⇒ 6), avoiding obstacles, at a maximum range of 7 m directly in front of the unit.

- If you cannot operate the unit or other equipment using the remote control after changing the batteries, please re-enter the codes (⇒ 51).

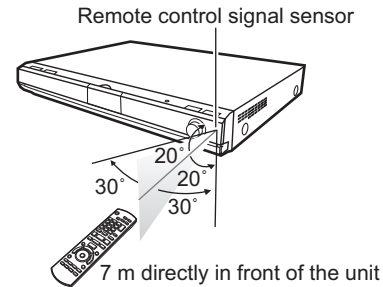

Control reference guide (remote control)

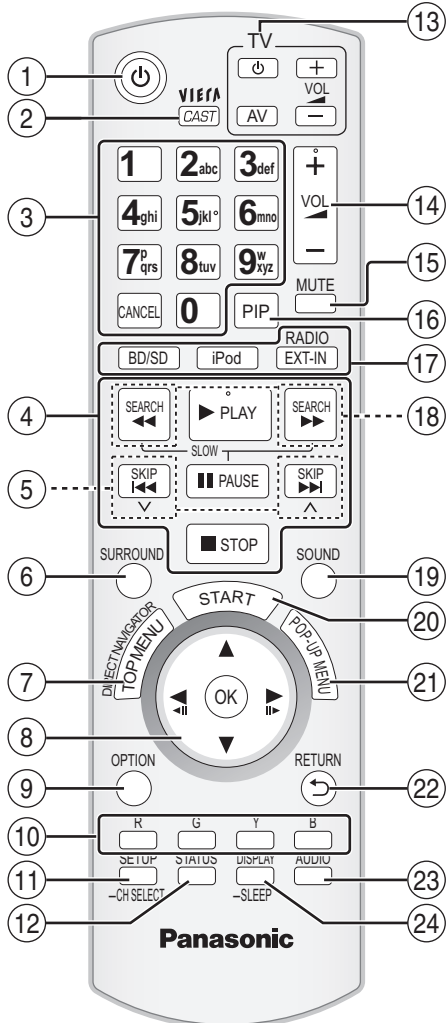

- Turn the unit on and off (⇒ 14)
- Display Home screen of VIERA CAST (⇒ 32)
- Select title numbers, etc./Enter numbers or characters (⇒ 19, 34)
(The character buttons may be used when operating VIERA CAST contents. ⇒ 32)
[CANCEL]: Cancel
- Basic playback control buttons (⇒ 18, 19)
- Select preset radio stations (⇒ 26)
- Select surround sound effects (⇒ 17)
- Show Top menu/Direct Navigator (⇒ 18)
- [▲, ▼, ◀, ▶]: Menu selection
[OK]: Selection
[◀, ▶]: Select preset radio station (⇒ 26)
[◀◀], [▶▶]: Frame-by-frame (⇒ 19)
- Show OPTION menu (⇒ 19)
- [R], [G], [Y], [B]
These buttons are used when;
 - Operating a BD-Video disc that includes Java™ applications (BD-J). For more information about operating this kind of disc, please read the instructions that came with the disc.
 - Displaying "Title View" and "Album View" screens. (Only the [R] and [G] buttons ⇒ 23)
 - Operating contents of VIERA CAST (⇒ 32)
- Show Setup menu (⇒ 37)/Select speaker channel (⇒ 17)
- Show status messages (⇒ 20)
- TV operation buttons
You can operate the TV through the unit's remote control.
[⏻]: Turn the television on and off
[AV]: Switch the input select
[+ - VOL]: Adjust the TV volume
- Adjust the volume of the main unit (⇒ 18)
- Mute the sound (⇒ 18)
- Switch on/off Secondary Video (Picture-in-picture) (⇒ 21)
- Select the source
[BD/SD]: Select disc drive or SD card drive (⇒ 16)
[iPod]: Select iPod as the source (⇒ 16, 30)
[RADIO/EXT-IN]: Select FM tuner, USB or external audio as the source (⇒ 16, 26, 27)
- Select radio stations manually (⇒ 26)
- Set the sound mode (⇒ 17)
- Show start menu (⇒ 15)
- Show Pop-up menu (⇒ 18)
- Return to previous screen
- Select audio (⇒ 19)
- Show on-screen menu (⇒ 35)/Set the sleep timer (⇒ 20)

Control reference guide (main unit)

Front panel

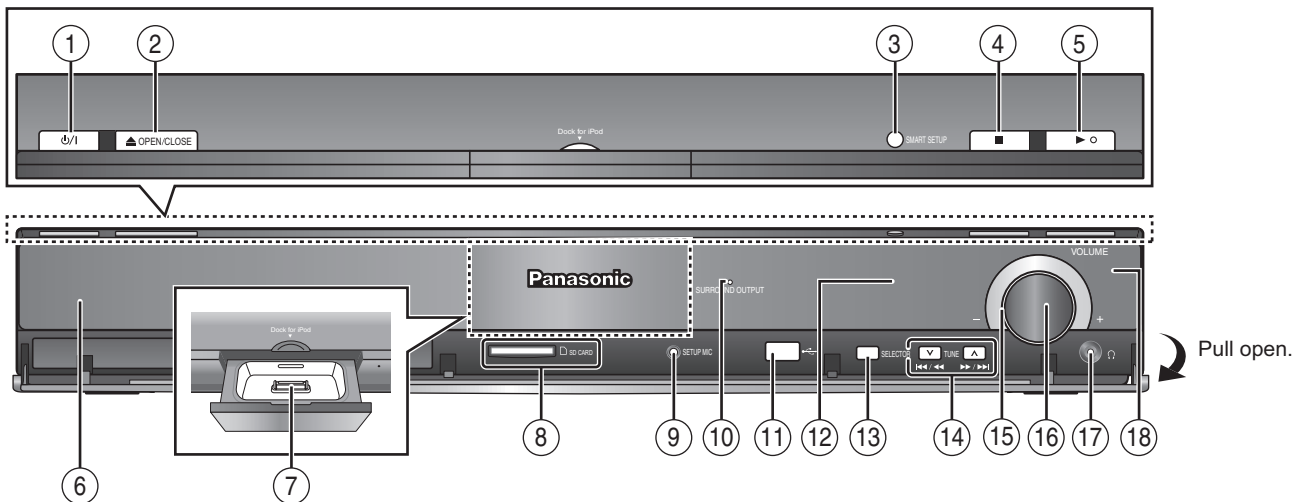

- ① **Standby/on switch (⏻/⏻)** (⇒ 14)
Press to switch the unit from on to standby mode or vice versa. In standby mode, the unit is still consuming a small amount of power.
- ② Open or close the disc tray (⇒ 18)
- ③ SMART SETUP button (⇒ 14)
- ④ Stop (⇒ 19)
- ⑤ Start play (⇒ 18)
- ⑥ Disc tray (⇒ 18)
- ⑦ Connect iPod (⇒ 30)
- ⑧ SD card slot (⇒ 18)
- ⑨ Connect Auto speaker setup microphone (⇒ 14)
- ⑩ The indicator lights when there is surround sound effect. (⇒ 17)
- ⑪ USB port (⇒ 18)
- ⑫ Display
- ⑬ Select the source (⇒ 16)
BD/DVD→SD→IPOD→FM→USB→AUX→D-IN 1→D-IN 2
↑
“SD” and “USB” on the unit’s display is not displayed when the SD card or USB is not in the SD card slot or USB port.
- ⑭ Skip or slow-search play (⇒ 19)/Select the radio stations (⇒ 26)
- ⑮ Volume indicator
It is possible to set the indicator to turn on/off. (⇒ 38, “FL Display”)
- ⑯ Adjust the volume of the main unit (⇒ 18)
•When pulled hard, the volume knob may come off.
•To prevent children from swallowing the volume knob, do not pull off the volume knob.
- ⑰ Connect headphones (not included) (⇒ 18)
- ⑱ Remote control signal sensor

Rear panel terminals

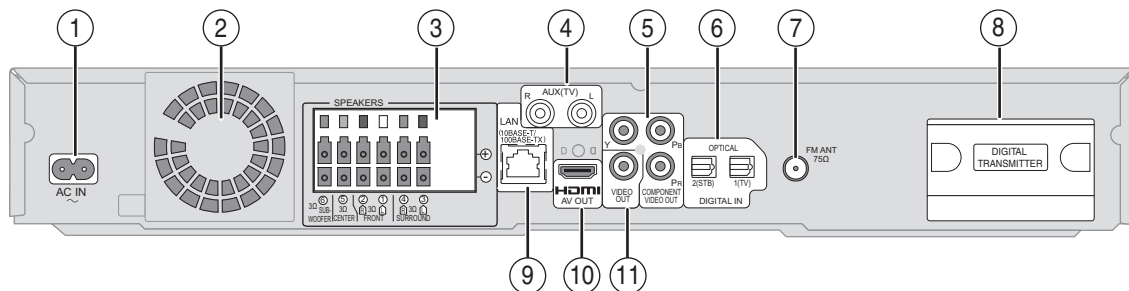

- ① AC IN terminal (⇒ 13)
- ② Cooling fan
- ③ SPEAKERS terminal (⇒ 9)
- ④ AUX (TV) terminal (⇒ 10, 11)
This terminal can also be used for equipment other than the TV.
- ⑤ COMPONENT VIDEO OUT terminal (⇒ 11)
- ⑥ OPTICAL DIGITAL IN terminals
Terminal 1(TV) is designated for connection with the TV. (⇒ 10, 11)
Terminal 2(STB) can be used for connection with devices other than the STB. (⇒ 12)
- ⑦ FM Radio antenna terminal (⇒ 12)
- ⑧ Digital transmitter dock (⇒ 42)
- ⑨ LAN port (⇒ 13)
- ⑩ HDMI AV OUT terminal (⇒ 11)
- ⑪ VIDEO OUT terminal (⇒ 10)

Assembling the speakers **BT205**

Front speakers and Surround speakers

Preparation

- To prevent damage or scratches, lay down a soft cloth and perform assembly on it.

- For assembly, use a Phillips-head screwdriver (not included).
- For wall mount, refer to page 43.

Make sure you have all the indicated components before starting assembly, setup, and connection.

- Keep the screws out of reach of children to prevent swallowing.

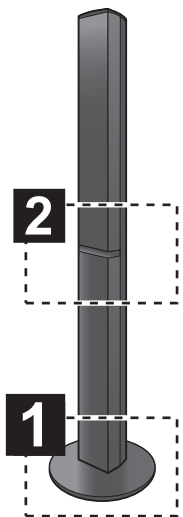
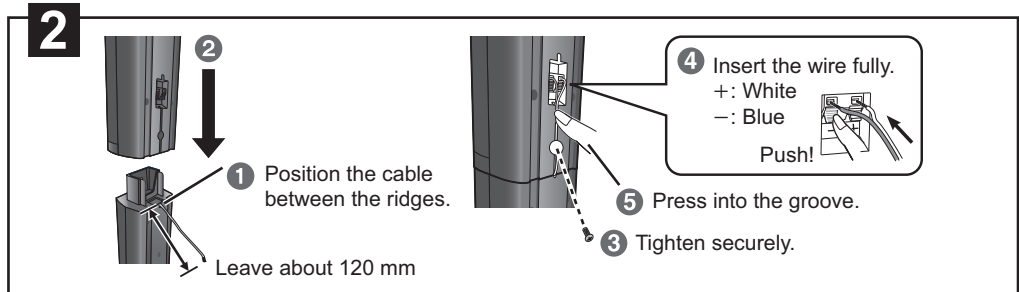
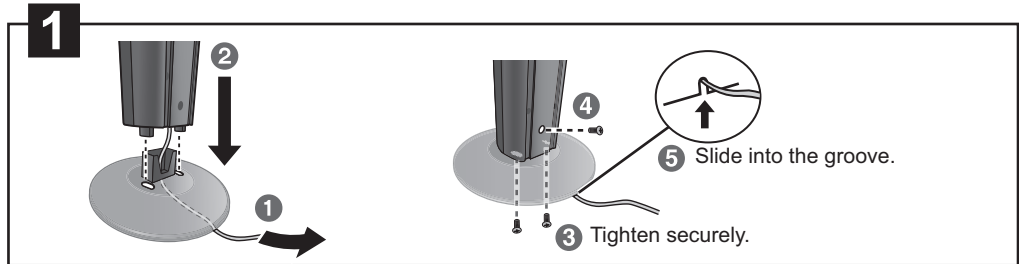
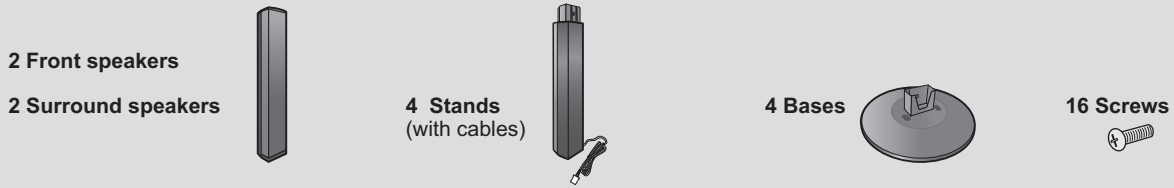

Speaker assembly option

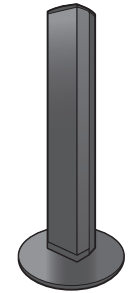
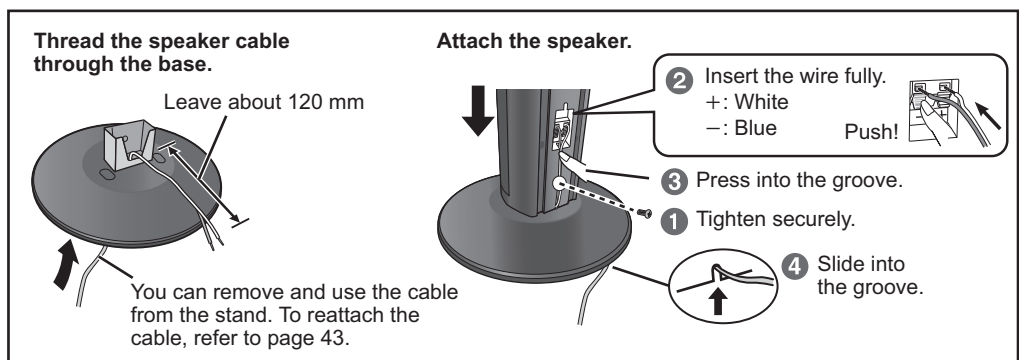

Do Not

- Be careful not to cross (short-circuit) or reverse the polarity of the speaker wires as doing so may damage the speakers.

Preventing the speakers from falling

- You will need to obtain the appropriate screw eyes to match the walls or pillars to which they are going to be fastened.
- Consult a qualified housing contractor concerning the appropriate procedure when attaching to a concrete wall or a surface that may not have strong enough support. Improper attachment may result in damage to the wall or speakers.

e.g.

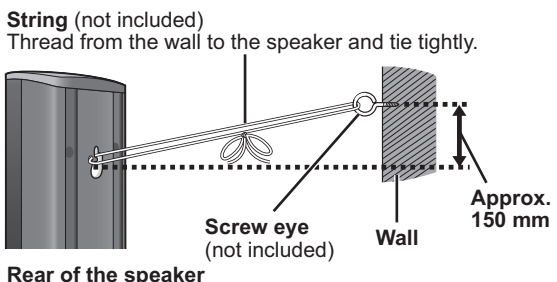

Caution

- Do not stand on the base. Be cautious when children are near.

e.g.



Positioning

How you set up your speakers can affect the bass and the sound field.



- This system is a 5.1ch sound system.
- Place speakers on flat secure bases.
- Placing speakers too close to floors, walls, and corners can result in excessive bass. Cover walls and windows with thick curtains.
- For optional wall mount, refer to page 43.
- Keep your speakers at least 10 mm away from the system for proper ventilation.

Setup example

Place the front, centre, surround speakers at approximately the same distance from the seating position. Using "SMART SETUP" (⇒ 14) is a convenient way to get the ideal surround sound from your speakers when you are unable to place them. The angles in the diagram are approximate.

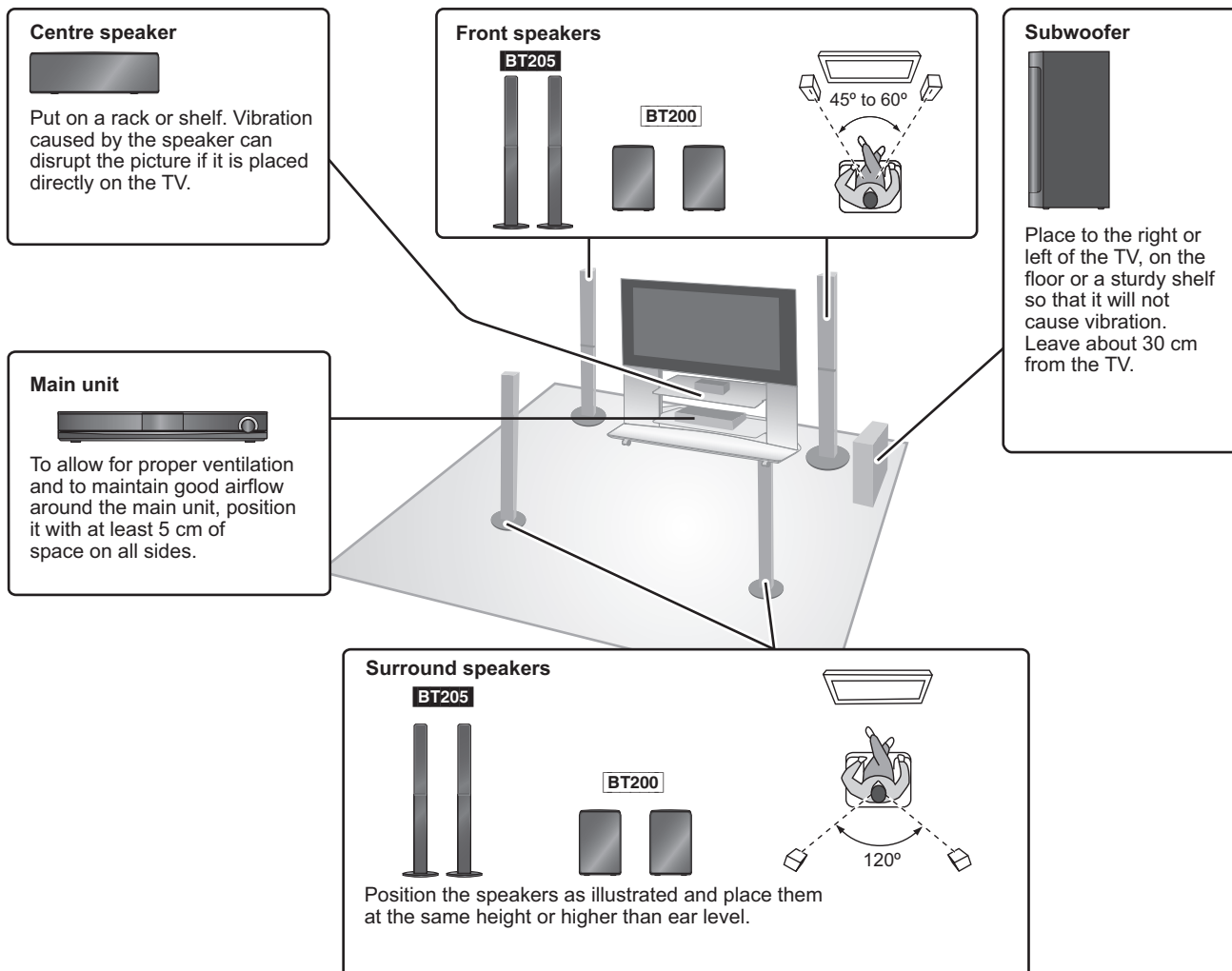

Set your surround sound free! Optional Panasonic wireless accessory (SH-FX70)

You can enjoy surround speaker sound wirelessly when you use the optional Panasonic wireless accessory (SH-FX70). (⇒ 42)

For details, please refer to the operating instructions for the optional Panasonic wireless accessory.



Use only supplied speakers

- Using other speakers can damage the unit, and sound quality will be negatively affected.
- You can damage your speakers and shorten their useful life if you play sound at high levels over extended periods.
- Reduce the volume in the following cases to avoid damage:
 - When playing distorted sound.
 - When the speakers are reverberating due to a record player, noise from FM broadcasts, or continuous signals from an oscillator, test disc, or electronic instrument.
 - When adjusting the sound quality.
 - When turning the unit on or off.

Positioning speakers in front

It is possible to locate all the speakers in front of the listening position. However the optimal surround sound effect may not be obtainable.



If irregular colouring occurs on your TV

The centre speaker is designed to be used close to a TV, but the picture may be affected with some TVs and setup combinations.

If this occurs, turn the TV off for about 30 minutes.

The demagnetising function of the TV should correct the problem. If it persists, move the speakers further away from the TV.

Caution

- The main unit and supplied speakers are to be used only as indicated in this setup. Failure to do so may lead to damage to the amplifier and/or the speakers, and may result in the risk of fire. Consult a qualified service person if damage has occurred or if you experience a sudden change in performance.
- Do not attempt to attach these speakers to walls using methods other than those described in this manual.

Caution

Do not touch the front netted area of the speakers. Hold by the sides. e.g. Centre speaker

DO NOT



DO



Speaker connections

Turn off all equipment before connection and read the appropriate operating instructions.
Do not connect the AC mains lead until all other connections are complete.

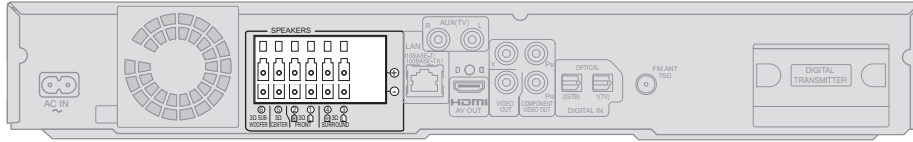

Main unit

Setup example

<p>BT200 Speaker cable for front speaker (L) (White)</p>	<p>BT200 Speaker cable for front speaker (R) (Red)</p>	<p>BT200 Speaker cable for surround speaker (L) (Blue)</p>	<p>BT200 Speaker cable for surround speaker (R) (Grey)</p>
<p>Speaker cable for centre speaker (Green)</p>	<p>Sheet of speaker cable stickers</p>		

BT205 : The speaker cables are attached to the speaker stands.

- Don't use a front speaker as a surround speaker or vice versa. Verify the type of speaker with label on the rear label of the speaker before connecting the appropriate cable.
- Pay attention to the type of speaker and the connector colour when you place the speakers.

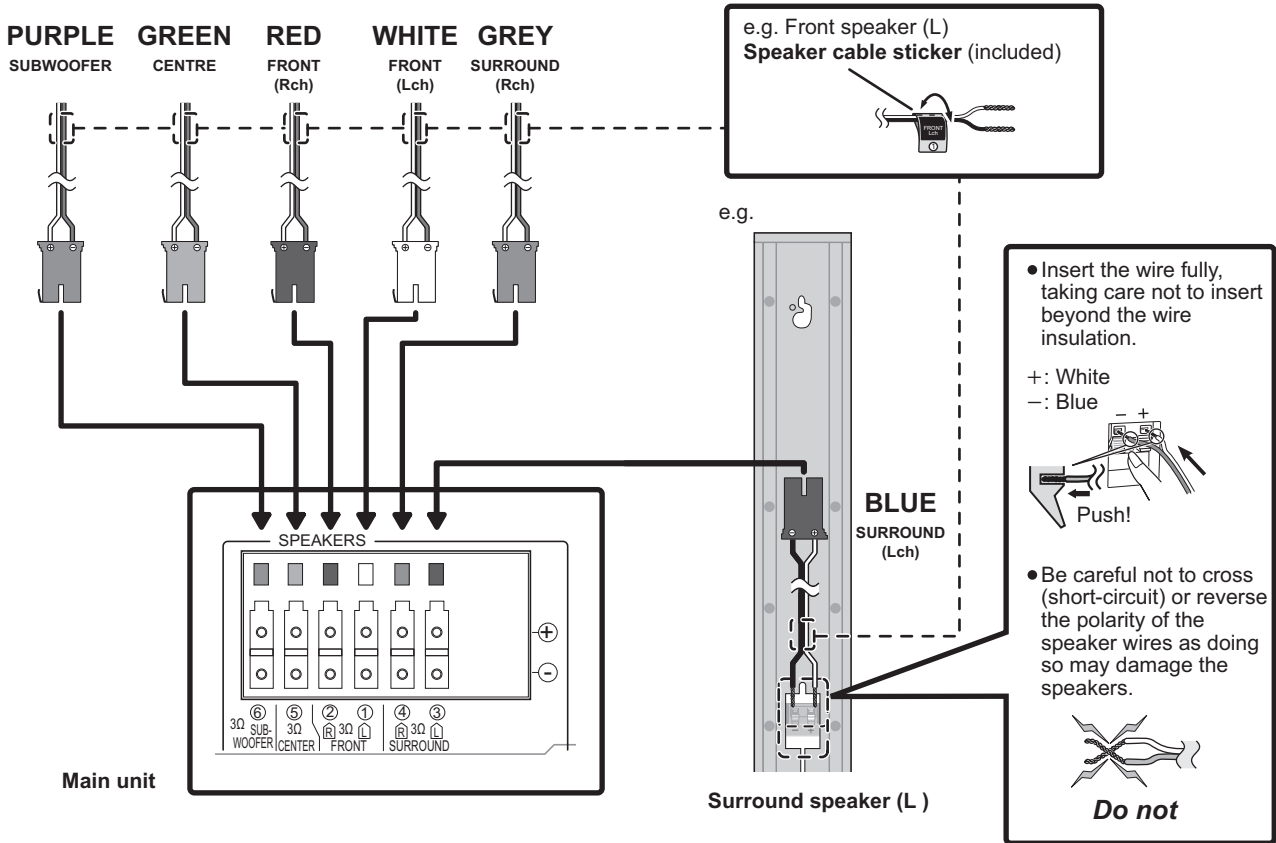

Connect to the terminals of the same colour.

Use of the speaker cable stickers is convenient when making cable connections.



- Match the connector colour and the type of speaker as shown above.
- Extending the speaker cables may damage the speakers and sound quality will negatively be affected.

TV connections

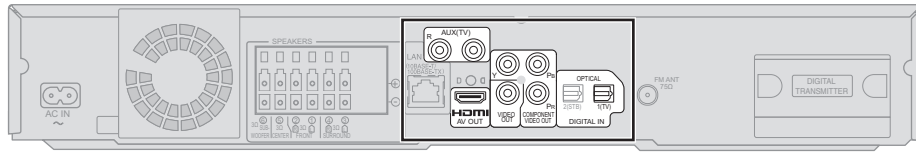

Main unit

My television has COMPONENT VIDEO IN terminals and HDMI IN terminal. Which should I connect with?

- The different levels of picture quality input are listed below in order from highest to lowest. HDMI IN → COMPONENT VIDEO IN → VIDEO IN. However, it will take longer for the picture output to start up when this unit is connected with the HDMI IN terminal.
- To enjoy all features of this unit, connect the video cable, even if the component video cable or the HDMI cable is used.

For connections with a video cable (⇒ below)

For connections with a component video cable (⇒ 11)

For connections with an HDMI cable (⇒ 11)

Connections with an video cable

Video cable

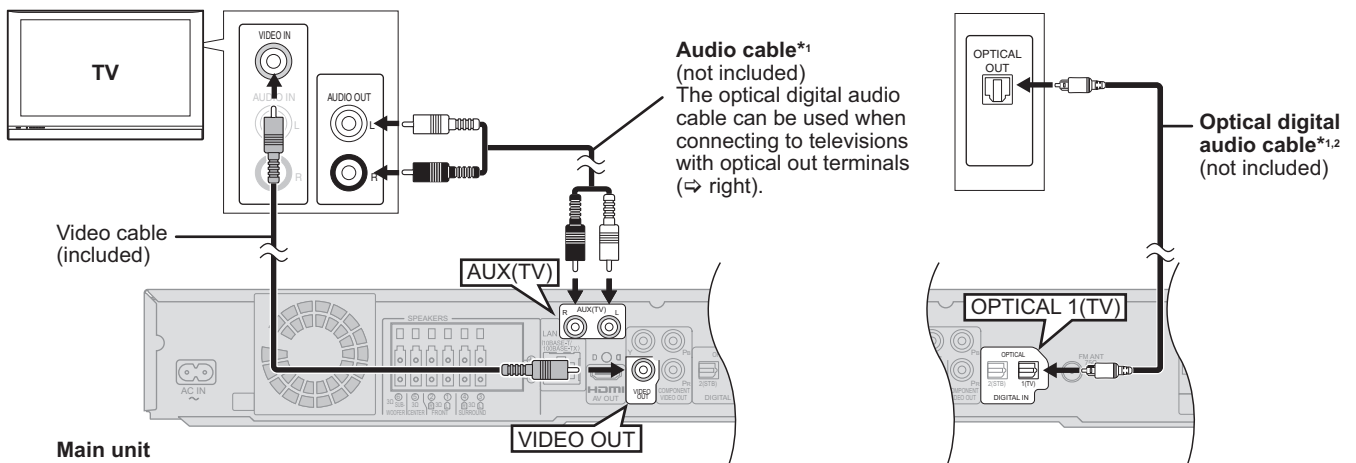

NOTE

- Set "High Clarity Sound" on the on-screen menu to "Off" (⇒ 36). (Otherwise, the video will not be output.)

Optional connections

- For those who want to enjoy higher picture quality and have a TV equipped with an HDMI terminal (⇒ 11)
- For those who want to enjoy higher picture quality and have a TV equipped with a COMPONENT VIDEO IN terminal (⇒ 11)
- For those who have a Set Top Box (Satellite receiver, Cable box, etc.) or video cassette recorder (⇒ 12)



TIPS

To enjoy TV audio from this home theatre system's speakers

*1You can enjoy the audio from your TV through this home theatre system's speakers by connecting to the "AUX(TV)" terminal or "OPTICAL 1(TV)" terminal. (⇒ 27)

*2This is the preferred connection for best sound and true surround sound depending on your television.

This unit can decode the surround signals received from your TV. Refer to the operating instructions for the TV for the settings necessary to output its audio from the digital audio output to your home theatre system. Only Dolby Digital and PCM can be played with this connection.

–After making this connection, make settings to suit the type of audio from your digital equipment (⇒ 27).

Connections with a component video cable

Do not disconnect the video cable even if the below is connected. Some features may not be displayed.

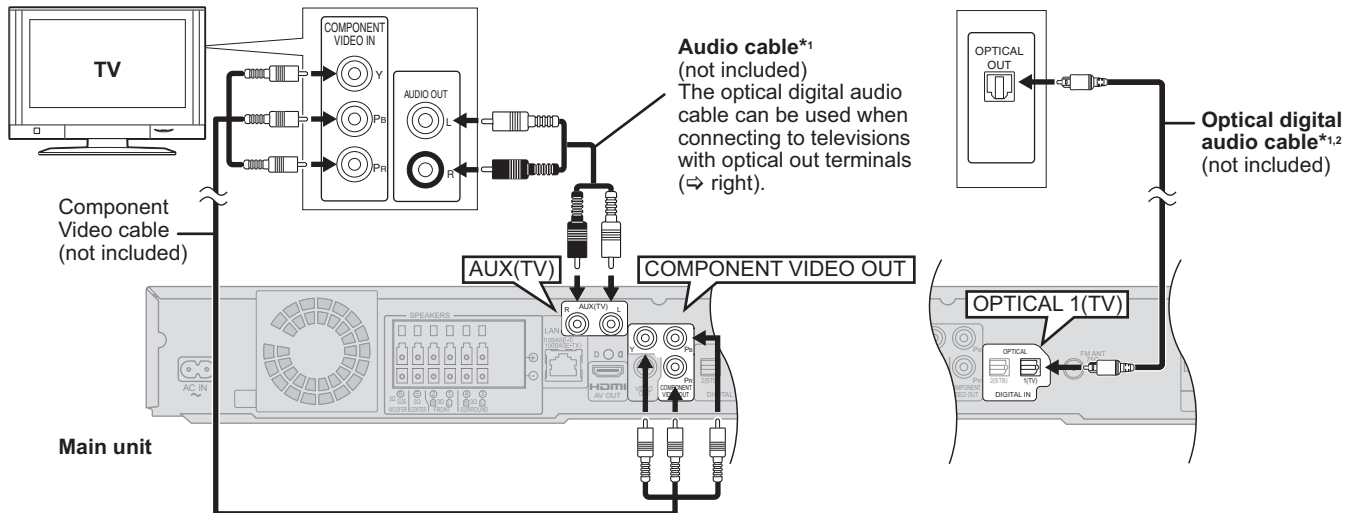

- Connect to terminals of the same colour.
- Set "High Clarity Sound" on the on-screen menu to "Off" (⇒ 36). (Otherwise, the video will not be output.)
- The video output resolution is restricted to "576p/480p" when DVD-Video discs, DivX and BD-Video discs recorded at a rate of 50 field per second are output from the COMPONENT VIDEO OUT terminals.



To enjoy high definition/progressive video

- Connect to a television that supports 576p/480p or higher.
- Set "Component Resolution" to "576p/480p", "720p" or "1080i". (⇒ 39)
- Set "HDMI Video Mode" to "Off". (⇒ 39) Otherwise, the video is output as 480i.

Connections with a HDMI cable

Do not disconnect the video cable even if the below is connected. Some features may not be displayed.

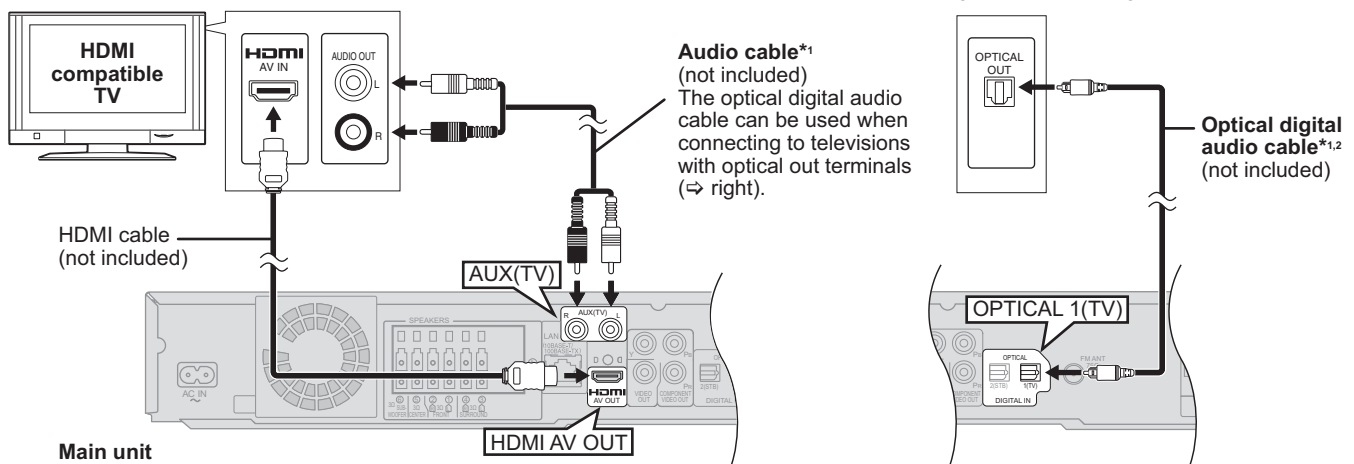

- If there is more than one HDMI terminal, refer to the operating instructions for the TV to determine terminal to connect to.
- **Non-HDMI-compliant cables cannot be utilized.**
- **Please use High Speed HDMI Cables that have the HDMI logo (as shown on the cover). It is recommended that you use Panasonic's HDMI cable.**
Recommended part number:
RP-CDHG10 (1.0 m), RP-CDHG15 (1.5 m), RP-CDHG20 (2.0 m), RP-CDHG30 (3.0 m), RP-CDHG50 (5.0 m), etc.
- This unit incorporates HDMI™ (V.1.3a with Deep Colour, x.v.Colour™, High Bit rate Audio) technology. (⇒ 55, 56)
- When outputting 1080p signal (⇒ 39, "HDMI Video Format"), please use HDMI cables 5.0 meters or less.



NECESSARY SETTINGS

"HDMI Video Mode" : "On"/"HDMI Audio Output" : "Off" (⇒ 39)
With this connection, you can use VIERA Link "HDAVI Control" (⇒ 28).



To enjoy TV audio from this home theatre system's speakers

- *1 You can enjoy the audio from your TV through this home theatre system's speakers by connecting to the "AUX(TV)" terminal or "OPTICAL 1(TV)" terminal. (⇒ 27)
- *2 This is the preferred connection for best sound and true surround sound.
This unit can decode the surround signals received from your TV. Refer to the operating instructions for the TV for the settings necessary to output its audio from the digital audio output to your home theatre system. Only Dolby Digital and PCM can be played with this connection.
–After making this connection, make settings to suit the type of audio from your digital equipment (⇒ 27).

Connections to a Set Top Box, etc.

Use the following connections when you want to output the original surround audio from your Set Top Box, cable TV, VCR, DVD recorder, etc. through this unit's speakers.

- **Do not connect through the video cassette recorder.**
Due to copy guard protection, the picture may not be displayed properly.
- Turn off all equipment before connection.

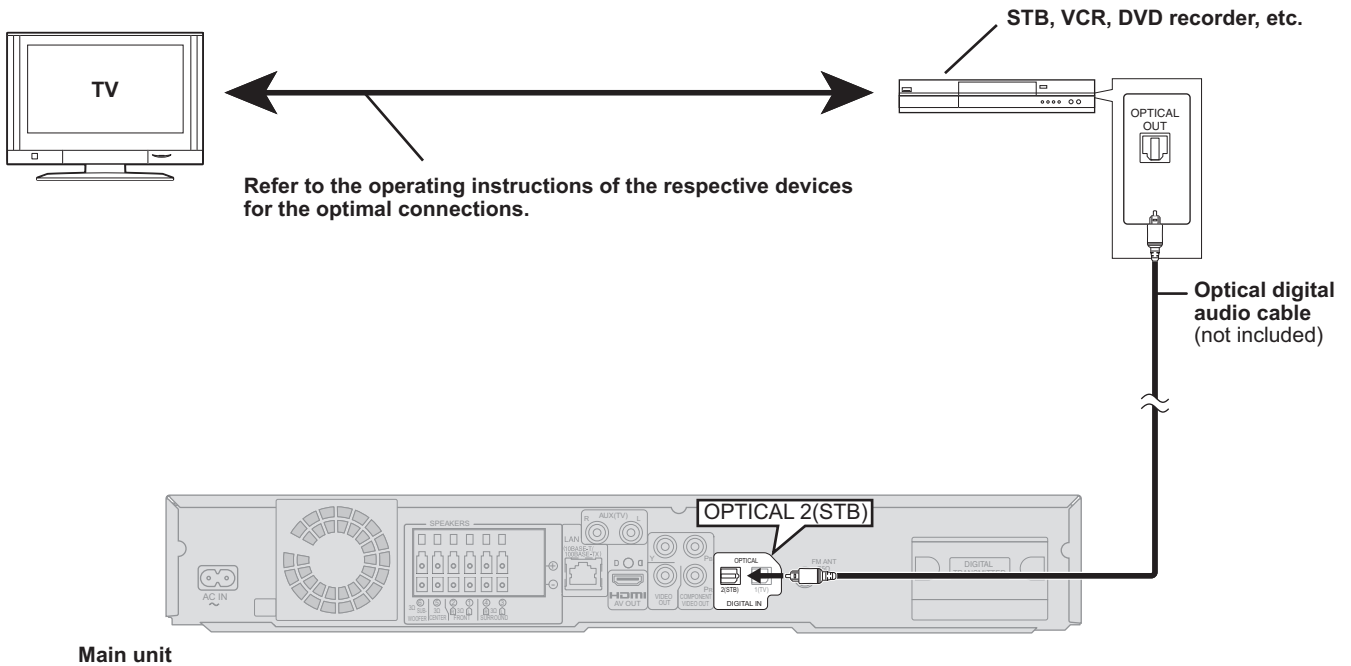

- This unit can decode the surround signal from the Set Top Box (Satellite receiver, Cable box, etc).
Press [EXT-IN] several times to select "D-IN 2" (DIGITAL IN 2*).
* "(CABLE/SAT)" is displayed next to DIGITAL IN 2 when set for CABLE/SAT AUDIO input. (⇒ 28, Setting the TV audio for VIERA Link "HDAVI Control")
- For connections between this unit and the TV, refer to "TV connections" (⇒ 10, 11).
- If you have various sound sources and this unit's terminals are not sufficient, connect them to the available inputs on the TV and the TV output should then be connected to the "AUX(TV)" or "OPTICAL 1(TV)" terminal of the main unit. Refer to the operating instructions of the TV, video cassette recorder, DVD recorder or Set Top Box for settings to output its audio via AUDIO OUT or OPTICAL OUT terminal of the TV.
– In some cases the audio signal will only be out as 2ch audio from the TV. In this case, connect the Set Top Box (Satellite receiver, Cable box, etc.) that will be used most commonly with multi-channel audio to this unit's "OPTICAL 2(STB)" terminal.

Radio antenna connections

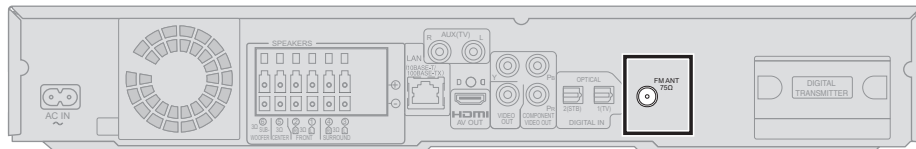

Using an indoor antenna

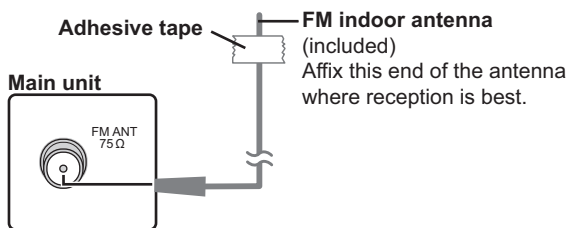

Using an outdoor antenna

Use outdoor antenna if FM radio reception is poor.

- Disconnect the antenna when the unit is not in use.
- Do not use the outdoor antenna during an electrical storm.

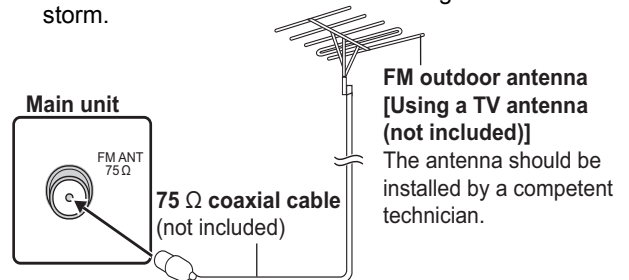

Use the antenna plug adaptor (included).



Network connection

The following services can be used when this unit is connected to the internet via a broadband connection.

- Firmware can be updated (⇒ 32)
- You can enjoy the BD-Live (⇒ 21)
- You can enjoy the VIERA CAST (⇒ 32)

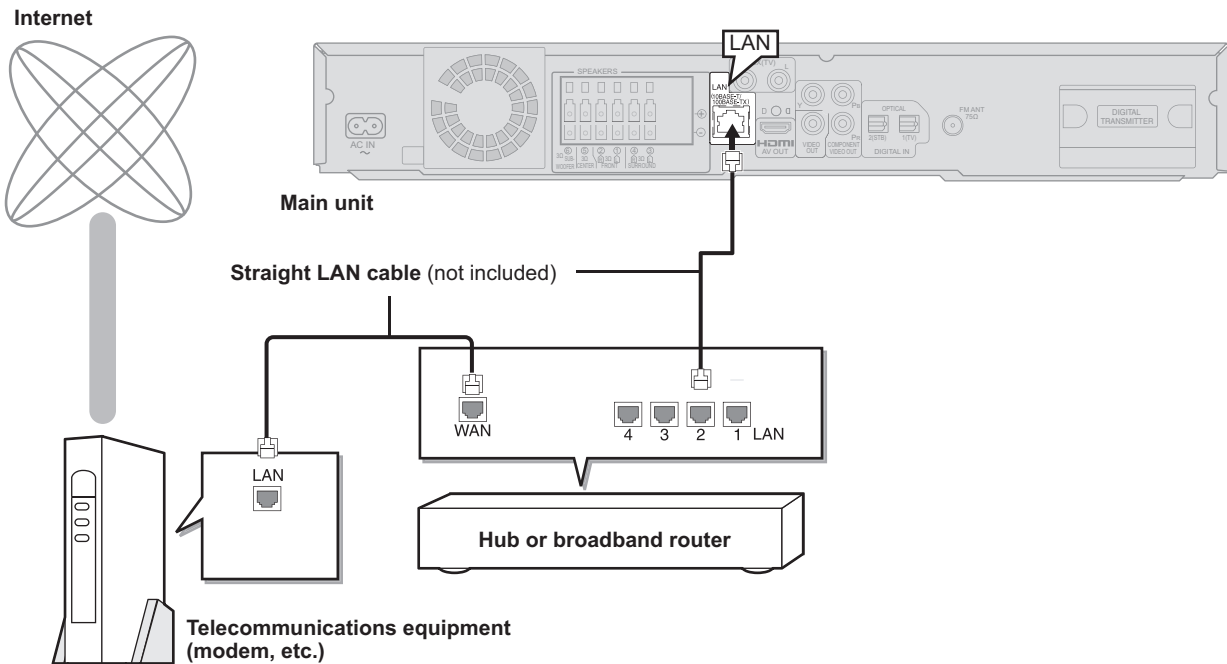

- When your communication equipment (modem), etc. has no broadband router functions: Connect a broadband router.
- When your communication equipment (modem), etc. has broadband router functions but there are no vacant ports: Connect a hub.
- Use shielded LAN cables when connecting to peripheral devices.
- Use a router that supports 10BASE-T/100BASE-TX.
- When operating the VIERA CAST, use high-speed internet service no less than 1.5 Mbps for SD (Standard Definition) and 6 Mbps for HD (High Definition) picture quality by your local broadband company.
 - If using slow Internet connection, the video may not be displayed correctly.
- After connecting to the Internet, perform necessary settings. (⇒ 33)
- Inserting any cable other than a LAN cable in the LAN terminal can damage the unit.

AC mains lead connection

- Before turning the power on for the first time, be sure to read the preparations for SMART SETUP. (⇒ 14)
- BE SURE TO READ THE CAUTION FOR THE AC MAINS LEAD ON PAGE 3 BEFORE CONNECTION.**

AC mains lead

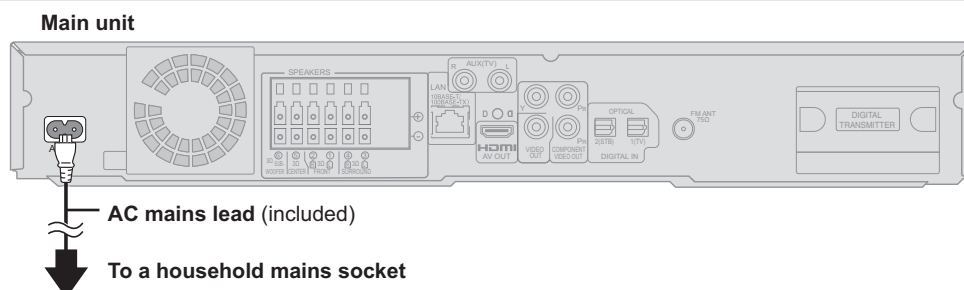
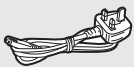

Connect only after all other connections are complete.



Conserving power

This unit consumes a small amount of power even when it is turned off (approx. 0.3 W). To save power when the unit is not to be used for a long time, unplug it from the household mains socket. You will need to reset some memory items after plugging in the main unit.

SMART SETUP

The **SMART SETUP** screen assists you to make necessary settings.

When the system is switched on for the first time, the SMART SETUP screen for the basic settings is displayed automatically. Follow the on-screen prompts to make basic settings for the system.

Preparation

To optimize the surround sound experience we recommend that you setup the speaker output level using the Auto speaker setup function.

Keep as quiet as possible during the Auto speaker setup. Excessive background noise may lead to incorrect settings. The speakers output loud test signals during setup.

Auto speaker setup microphone



- Place the Auto speaker setup microphone at actual seating position. (At ear level when seated.)
- A test signal is output from each speaker during the SMART SETUP.
- After the SMART SETUP is completed, unplug the Auto speaker setup microphone and keep it for future use.

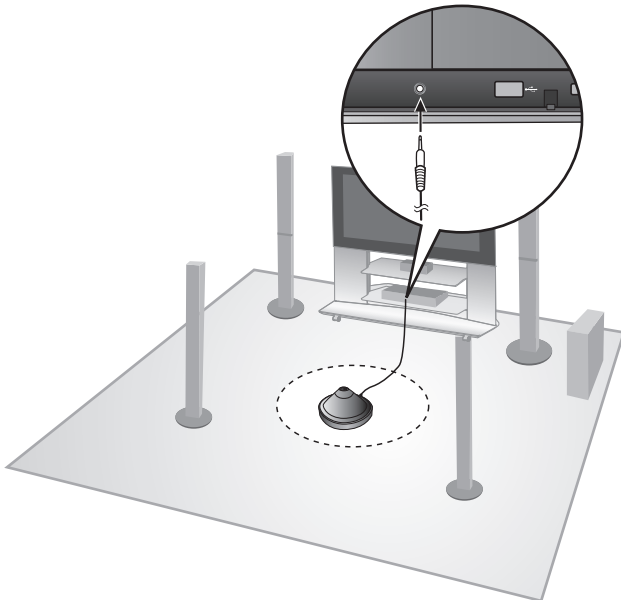

- Auto Speaker Setup can be activated through SMART SETUP only.
- Audio settings will be restored to default if Auto Speaker Setup is cancelled.

Basic setting for the system (SMART SETUP)

Preparation

Turn on your TV and select the appropriate video input mode (e.g. VIDEO 1, AV 1, HDMI, etc.) to suit the connections to this unit.

- To change your TV's video input mode, refer to its operating instructions.
- This remote control can perform some basic TV operations (⇒ 5).

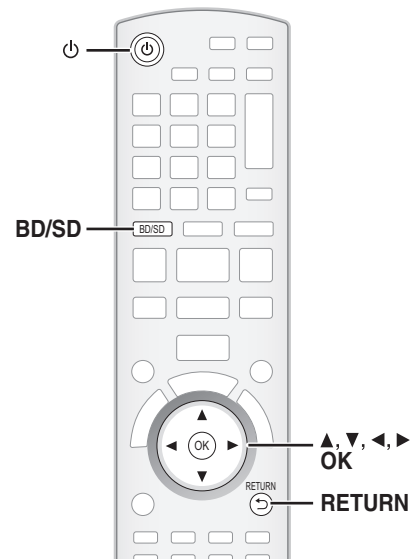

- 1 **Press [Power].**
 - When the SMART SETUP screen appears automatically, skip step 2 and 3.
- 2 **Press [BD/SD] to select "BD/DVD".**
- 3 **Press [SMART SETUP] on the main unit.**
 - The SMART SETUP screen appears.
- 4 **Follow the on-screen instructions and make the settings with [▲, ▼, ◀, ▶] and [OK].**
 - **Language** (⇒ below)
Select the language used on menu screen.
 - **TV Aspect** (⇒ below)
Select the aspect to suit your TV and preference.
 - **Speakers position**
Specify the positioning of the surround speakers.
 - **Auto Speaker Setup**
Adjust the speaker output level automatically.
 - **Speaker Output**
Make surround sound setting for speaker output.
 - **TV Audio**
Select the audio input connection from your TV.
For AUX connection (⇒ 10): Select "AUX".
For OPTICAL DIGITAL IN connection (⇒ 10): Select "DIGITAL IN 1".
This will be the TV Audio setting for VIERA Link "HDAVI Control". (⇒ 28)

To return to the previous screen, press [RETURN].
- 5 **Press [OK] to finish the SMART SETUP.**



- If this unit is connected to a "HDAVI Control 3 (or later)" compatible TV via HDMI cable, the menu language and TV aspect information will be retrieved via VIERA Link.
- If this unit is connected to a "HDAVI Control 2" compatible TV via HDMI cable, the menu language information will be retrieved via VIERA Link.
- Even if this unit is connected to a "HDAVI Control 2 (or later)" compatible TV via HDMI cable, the menu screen language will not be automatically retrieved if this unit does not support the language. In this case, set the language manually.
- Settings in the SMART SETUP can also be changed in the unit settings [e.g. language, TV aspect, speaker level and TV audio (⇒ 37)].
- Positioning examples for mounting all speakers in front. (⇒ 8)

Showing START menu

Some functions of this unit can be operated from the START menu.

- 1 Press [POWER] to turn on the unit.
- 2 Press [START].
 - Items displayed vary according to the chosen selector and media.
- 3 Press [▲, ▼] to select the item and press [OK].

e.g., **BD-V**

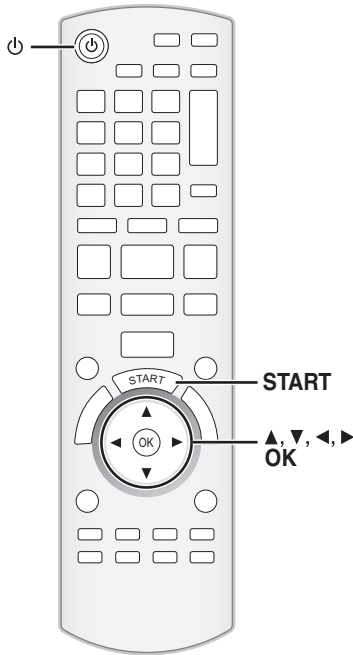
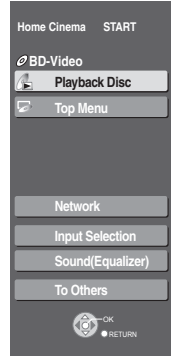

Items	Functions
Playback Disc Playback	Starts playing disc/USB device/SD Card.
Top Menu	Shows a disc top menu.
Menu	Shows a media menu. To play AVCHD (⇒ 20) To play MPEG2 (⇒ 20) To play MP3, CD (⇒ 25) To play JPEG (⇒ 23) To play DivX (⇒ 22) Shows the iPod menu. To play "Music" (⇒ 31) To play "Videos" (⇒ 31) To play "Use iPod display (All)" (⇒ 31) For "Play Mode" (⇒ 31)
Network	Displays Home screen of VIERA CAST (⇒ 32).
Input Selection	Select the source. e.g., BD-V BD/DVD/CD: To play BD-Video, DVD-Video, AVCHD (⇒ 18 to 21) To play JPEG (⇒ 23) To play DivX (⇒ 22) To play MP3, CD (⇒ 25) SD card: To play AVCHD (⇒ 20) To play MPEG2 (⇒ 20) To play JPEG (⇒ 23) iPod: To play iPod contents (⇒ 30) FM: To enjoy the FM radio (⇒ 26) USB device: To play MP3 (⇒ 25) To play JPEG (⇒ 23) To play DivX (⇒ 22) AUX (TV)*1: To enjoy TV broadcasts with this unit's speakers (⇒ 27) DIGITAL IN 1 (TV)*1: To enjoy TV broadcasts with this unit's speakers (⇒ 27) DIGITAL IN 2 (CABLE/SAT)*2: To enjoy audio from other devices with this unit's speakers (⇒ 27) *1“(TV)” is displayed next to items set for TV AUDIO input. (⇒ 28, Setting the TV audio for VIERA Link “HDAVI Control”.) *2“(CABLE/SAT)” is displayed next to DIGITAL IN 2 when set for CABLE/SAT AUDIO input. (⇒ 28, Setting the TV audio for VIERA Link “HDAVI Control”)
Sound(Equalizer)	Select the equalizer function. (⇒ 17)
To Others	Setup: You can change the unit's settings using Setup menu (⇒ 37). Card Management: Formatting SD cards/Deleting data (⇒ 21) Playlists: You can play playlists created on DVD-VR. Press [▲, ▼, ◀, ▶] to select the playlist and press [OK].

e.g., **BD-V**



Selecting the playback source

Selecting the source from the START menu

You can select sound modes, desired source, or access playback/menus by using the START menu.

- 1 Press [POWER] to turn on the unit.
- 2 Press [START] to show the START menu.
- 3 Press [▲, ▼] to select the item and then press [OK].
 - To exit, press [START].
- 4 Press [▲, ▼] to make the setting.

When "Input Selection" is selected

You can select a desired source from the menu.

- BD/DVD/CD, SD card, iPod, FM, USB device, AUX*1, DIGITAL IN 1*1, DIGITAL IN 2*2 (⇒ 15)

*1"TV" is displayed next to items set for TV AUDIO input. (⇒ 28, Setting the TV audio for VIERA Link "HDAVI Control")

*2"(CABLE/SAT)" is displayed next to DIGITAL IN 2 when set for CABLE/SAT AUDIO input. (⇒ 28, Setting the TV audio for VIERA Link "HDAVI Control")

When a disc is loaded, an USB device is connected or a SD card is inserted, you can also access playback or menus from the START menu.

e.g. **BD-V**

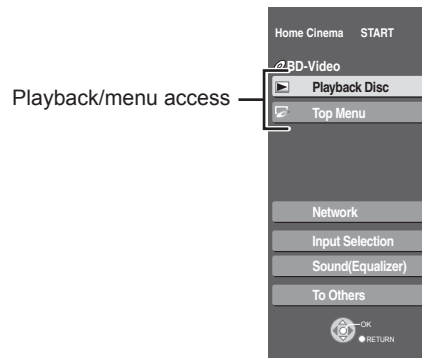
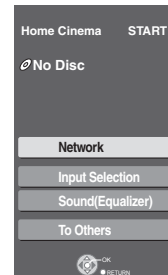
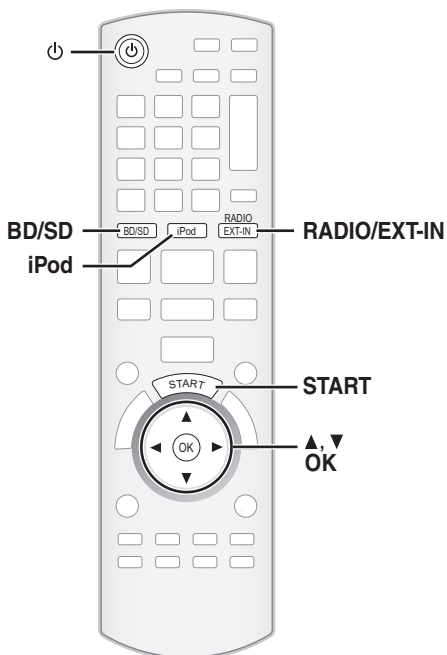

Selecting the source by the remote control

Press	To select
[BD/SD]	BD/DVD/CD or SD (⇒ 18)
[iPod]	IPOD (iPod) (⇒ 30)
[RADIO EXT-IN]	Each time you press the button: FM (⇒ 26) USB (⇒ 18) AUX*1: For audio input through the AUX terminal.(⇒ 27) D-IN1 (DIGITAL IN 1*1): (⇒ 27) D-IN2 (DIGITAL IN 2*2): (⇒ 27) *1"TV" is displayed next to items set for TV AUDIO input. (⇒ 28, Setting the TV audio for VIERA Link "HDAVI Control") *2"(CABLE/SAT)" is displayed next to DIGITAL IN 2 when set for CABLE/SAT AUDIO input. (⇒ 28, Setting the TV audio for VIERA Link "HDAVI Control")

Press [SELECTOR] on the main unit to select source from the main unit.



NOTE

- Confirm the audio connection to the AUX or OPTICAL DIGITAL IN terminals on the main unit when you select the corresponding sources (⇒ 10 to 12).
- Reduce the volume on the TV to its minimum, and then adjust the volume of the main unit.

Enjoying sound from all speakers and various sound effects

- The following sound effects/modes may not be available or have no effect with some sources, or when headphones are used (⇒ 18).
- You may experience a reduction in sound quality when these sound effects/modes are used with some sources. If this occurs, turn the sound effects/modes off.

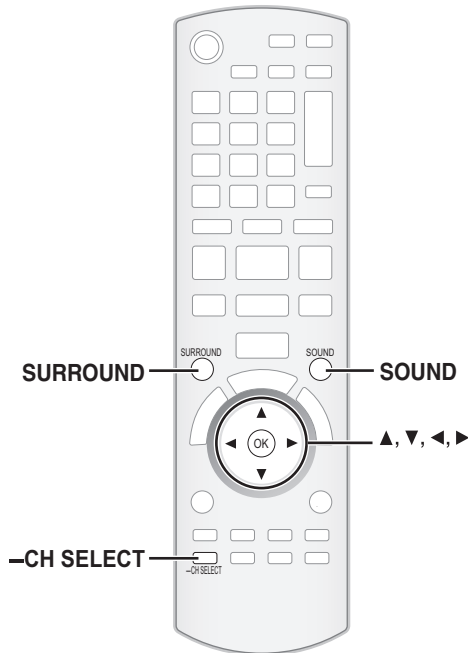

Enjoying surround sound effects

Available surround sound effects	
Effect	Setting
STANDARD:	Sound is output as it was recorded/encoded. Speaker output varies depending on the source.
MULTI-CH:	You can enjoy sound from the front speakers, as well as the surround speakers even when playing a 2-channel sound or non-surround sound.
MANUAL:	-DOLBY PL II MOVIE: Suitable for movie software, or the one recorded in Dolby Surround. (except DivX)
	-DOLBY PL II MUSIC: Adds 5.1-channel effects to stereo sources. (except DivX)
	-S.SURROUND: You can enjoy sound from all speakers with stereo sources.
	-2CH STEREO: You can play any source in stereo. Sound will be output to the front speakers and the subwoofer only.

Press **[SURROUND]** several times to select the effect.

- You can also press **[SURROUND]** and then **[▲, ▼]** to select the mode.
- The selected effect will only be displayed on the main unit.

When selecting the MANUAL effects.

While "MANUAL" is displayed

Press **[◀, ▶]** and select the desired effect.

- "NOT CONDITIONAL" is displayed on the main unit if the setting is not active.
- "DOLBY PL II MOVIE" and "DOLBY PL II MUSIC" do not work when audio is output from the HDMI AV OUT terminal.

Changing the sound modes

Available sound modes	
Mode	Setting
EQ: (Equalizer)	You can select sound quality settings. - FLAT(Flat): Cancel (no effect is added). - HEAVY(Heavy): Adds punch to rock. - CLEAR(Clear): Clarifies higher sounds. - SOFT(Soft): For background music.
SUB W: (Subwoofer level)	This unit will change the settings for the amount of bass depending on the source. However you can also adjust the amount of bass for the source being played. - 1 (Weakest effect) - 2 - 3 - 4 (Strongest effect) •The setting you make is retained, and recalled every time you play the same type of source.
CF: (Centre Focus)	(Effective when playing audio containing centre channel sound.) You can make the sound of the centre speaker seem like it is coming from within the TV. - ON - OFF
W.S.: (Whisper-mode Surround)	(Effective when playing video with 5.1ch audio.) You can enhance the surround effect for low volume 5.1-channel sound. (Convenient for late night viewing.) - ON - OFF

- 1 Press **[SOUND]** several times to select the mode.
 - You can also press **[SOUND]** and then **[▲, ▼]** to select the mode.
 - The selected effect will only be displayed on the main unit.
- 2 While the selected mode is displayed Press **[◀, ▶]** and select the desired setting.

Adjusting speaker level during play

- 1 Press and hold **[-CH SELECT]** for 3 seconds to activate the speaker setting mode.
- 2 Press **[-CH SELECT]** several times to select the speaker.

Each time you press the button:

L R → C → RS → LS → SW

L R: Front speaker (left and right)
 C: Centre speaker
 RS: Surround speaker (right)
 LS: Surround speaker (left)
 SW: Subwoofer

- The channels not included in the playing audio will not be displayed (subwoofer is displayed even if it is not included).

Adjusting the balance of the front speakers

(When "L R" selected)

- 3 Press **[◀, ▶]** to adjust the balance of the front speakers.

Adjusting the speaker level

(When other speakers are selected)

- 4 Press **[▲]** (increase) or **[▼]** (decrease) to adjust the speaker level for each speaker.
 -6 dB to +6 dB

Basic operation

Instructions for operations are generally described using the remote control in these operating instructions.

Preparation

Turn on the television and select the appropriate video input on the television.

Inserting or removing a disc

- 1 Press [▲ OPEN/CLOSE] to open the disc tray.
- 2 Insert or remove the disc.

Label facing up

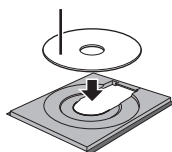

- Press [▲ OPEN/CLOSE] again to close the disc tray.
- DVD-RAM: Remove discs from their cartridges before use.
- Insert double-sided discs so the label for the side you want to play is facing up.

Inserting or removing an SD card

- 1 Pull to flip down the front panel.
- 2 Insert the SD card into the SD card slot.

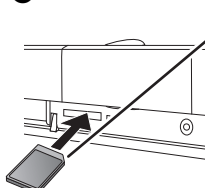

Insert the card label up with the cut-off corner on the right.

- Press on the centre of the card until it clicks into place.

- To remove the card, press on the centre of the card and pull it straight out.

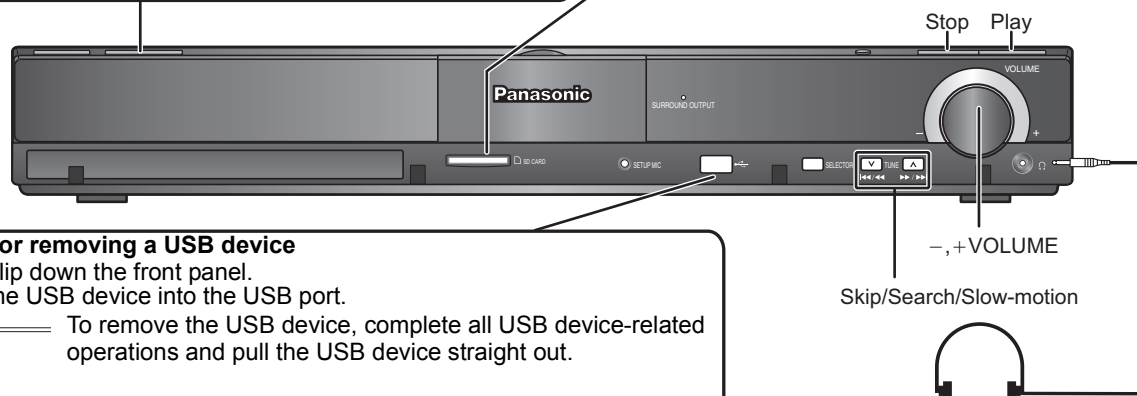

Inserting or removing a USB device

- 1 Pull to flip down the front panel.
- 2 Insert the USB device into the USB port.

To remove the USB device, complete all USB device-related operations and pull the USB device straight out.

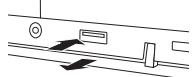

- Before inserting any USB device to this unit, ensure that the data stored therein has been backed up.
- Check the orientation of the USB connector and insert it straight in.
- Some USB devices inserted into this unit may cause this unit to stop operating. Such USB devices cannot be used on this unit.

About the use of USB device

Since the physical size of USB device can vary, please consider its width when connecting any USB device to this unit. It is possible that some devices may accidentally activate the playback button and cause this unit to not operate properly.

- In such cases we recommend using a USB extension cable (not included).

Stop Play
VOLUME
-, + VOLUME
Skip/Search/Slow-motion



Headphones (not included)

Headphone plug type: Ø3.5 mm stereo mini plug

- Reduce the volume before connecting.
- Audio is automatically switched to 2ch stereo.
- To prevent hearing damage, avoid listening for prolonged periods of time.

Excessive sound pressure from earphones and headphones can cause hearing loss.

- 1 Press [⏻] to turn on the unit.

- 2 Insert the media (⇒ above).

Play start.

- If play does not start, press [▶ PLAY].
- If the media with data in different file formats is inserted, the file selection menu is displayed. Press [▲, ▼] to select the desired file format and press [OK].
- If the menu is displayed, press [▲, ▼, ◀, ▶] to select the item and press [OK].
- If the screen prompting you to use the colour buttons appears, continue to operate with the colour buttons on the remote control.

■ To adjust the volume.



Press to adjust the volume

It is also possible to adjust the volume with the volume knob on the main unit.

■ To mute the sound.



Press to mute the sound

"MUTE" flashes on the unit's display. e.g., Display

- To cancel, press [MUTE] again or adjust the volume.
- Muting is cancelled if the unit is turned off.



NOTE

- Signal from PAL discs is output as PAL. Signal from NTSC discs is output as "NTSC" or "PAL60". You can select "NTSC" or "PAL60" in "NTSC Contents Output" for NTSC discs. (⇒ 37)
- DISCS CONTINUE TO ROTATE WHILE MENUS ARE DISPLAYED. Press [■ STOP] when you finish to preserve the unit's motor and your television screen.
- If a media is inserted while the unit is stopped, the drive switches automatically depending on the inserted media.
- The producers of the disc can control how discs are played. So you may not always be able to control play as described in these operating instructions. Read the disc's instructions carefully.
- When playing a set of two or more BD-Video discs, the menu screen may continue to display even if the disc has been ejected.



TIPS

To display menus

BD-V AVCHD DVD-VR DVD-V DivX

Press [TOP MENU/DIRECT NAVIGATOR].

To show Pop-up menu **BD-V**

The Pop-up menu is a special feature available with some BD-Video discs. This menu may vary with discs. For the operating method, refer to the instructions for the disc.

- 1) Press [POP-UP MENU].
 - 2) Press [▲, ▼, ◀, ▶] to select the item and press [OK].
- Pop-up menu also appears by pressing [OPTION] and selecting "Pop-up Menu".
 - Press [POP-UP MENU] to exit the screen.
 - It may take time to read BD-Video discs that include BD-J (⇒ 55).



1 **2** **3**
4 **5** **6**
7 **8** **9**
0

Direct Play

During playback, you can access specific recordings or scenes through direct entry of the numbered buttons. Play starts from the selected title or chapter.

BD-V AVCHD e.g., 5: [0] ⇒ [0] ⇒ [5]
 15: [0] ⇒ [1] ⇒ [5]
DVD-V e.g., 5: [0] ⇒ [5]
 15: [1] ⇒ [5]

- While stopped (the image on the right is displayed on the screen), the title is designated. While playing, the chapter is designated.



Frame-by-frame

While paused, press [◀] (◀||) or [▶] (||▶). Each press shows the next frame.

- Press and hold to change in succession forward or backward.
- Press [▶PLAY] to revert to normal playback speed.
- **BD-V AVCHD**: Forward direction [▶] (||▶) only.

STOP **Stop**

The stopped position is memorized.

Resume play function

Press [▶PLAY] to restart from this position.

- The position is cleared if the tray is opened or you press [■STOP] several times to display "STOP" on unit's display.
- **BD-V**: On BD-Video discs including BD-J (⇒ 55), the resume play function does not work.
- **CD MP3 DivX MPEG2**: The position is cleared if the unit is turned off.

PAUSE **Pause**

Press [||PAUSE] again or [▶PLAY] to restart play.

SEARCH **SEARCH** **Search/Slow-motion**

← SLOW →

The speed increases up to 5 steps.

- Press [▶PLAY] to revert to normal playback speed.
- For some discs, the speed may not change.

Search

While playing, press [SEARCH◀◀] or [SEARCH▶▶].

- **BD-V AVCHD DVD-VR DVD-V**: Audio is heard during first level of forward search.
- **DivX MPEG2**: Audio is not heard during all levels of search.
- **CD MP3**: The speed is fixed to a single step.

Slow-motion

While paused, press [SEARCH◀◀] or [SEARCH▶▶].

- **BD-V AVCHD**: Forward direction [SEARCH▶▶] only.
- **DVD-VR**: If continued for approx. 5 minutes, slow-motion play pauses automatically.

SKIP **SKIP** **Skip**

Skip to the title, chapter or track you want to play.

- Each press increases the number of skips.
- **DivX**: Backward direction [SKIP◀◀] only.

Changing audio during play

BD-V AVCHD DVD-V

e.g. **DVD-V**



English is selected.

You can change the audio channel each time you press the button. This allows you to change the soundtrack language (⇒ 35, Soundtrack), etc.

- **BD-V** When "BD-Video Secondary Audio" (⇒ 38) is set to "On", Dolby TrueHD, Dolby Digital Plus, DTS-HD Master Audio and DTS-HD High Resolution Audio are output as Dolby Digital or DTS Digital Surround regardless of this setting.

DVD-VR DivX MPEG2

AudioLR → AudioL → Audio R



"AudioLR" is selected

Chapter playback

DVD-VR

- 1 Insert a disc (⇒ 18).
- 2 While "Title View" screen is displayed Press [▲, ▼] to select the title and press [OPTION].

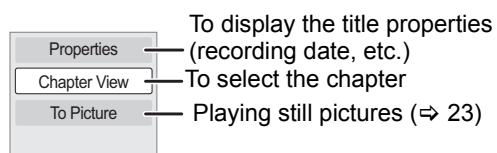

- 3 Press [▲, ▼] to select "Chapter View" and press [OK].
- 4 Press [◀, ▶] to select the chapter and press [OK].

Basic operation



Status messages

The status messages give you information about what is currently being played. Each time you press [STATUS], the information displayed will change.

e.g. **BD-V** Type of disc Play status

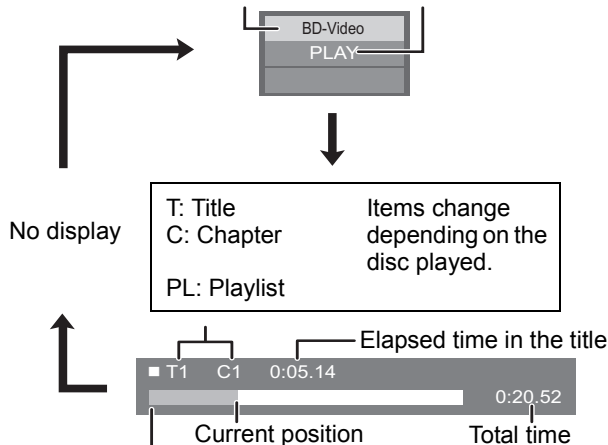

Depending on the kind of disc or the playback status, this display may not appear.

Screen Aspect

When black bars are shown at the top, bottom, left, and right sides of the screen, you can enlarge the image to fill the screen.

- Press [OPTION].
- Press [▲, ▼] to select "Screen Aspect" and press [OK].
- Press [◀, ▶] to select "Side cut" or "Zoom" and press [OK].

Normal: Normal output

Side cut: The black bars on the right and left sides of the 16:9 image disappear and the image is enlarged. Please note that the right and left sides of the image are cut off when the black bar is not displayed.

Zoom: The black bars on the top and bottom sides of the 4:3 image disappear and the image is enlarged. Please note that the top and bottom sides of the image are cut off when the black bar is not displayed.

- **BD-V DVD-V**: "Side cut" does not have any effect.
- When "TV Aspect" (⇒ 39) is set to "4:3" or "4:3 Letterbox", the "Zoom" effect is disabled.



Setting the sleep timer

- Press and hold [—SLEEP] for 3 seconds.
- While "SLEEP ✕✕" is displayed, Press [—SLEEP] several times to select the time (in minutes).
SLEEP 30 → SLEEP 60 → SLEEP 90 → SLEEP 120 → OFF

e.g., Display



To confirm the remaining time
Press and hold [—SLEEP] for 3 seconds.

- The sleep timer cannot be set while the Setup menu is displayed.
- The sleep timer will be cancelled in the following cases.
 - When the sleep timer is set to "OFF".
 - When this unit is turned off from the remote control, main unit or via the VIERA Link.

Playing video recorded on a Video Camera or Video Recorder

AVCHD MPEG2

It is possible to playback the High Definition (AVCHD format) video recorded on a Panasonic High definition Video Camera on a DVD-RAM/R/RW/R DL/+R/+RW/+R DL, or SD card and Standard Definition (MPEG2 format) Video recorded on the Panasonic SD Video Camera on a SD card.

1 Insert a disc or SD card. (⇒ 18)

- "Title View" or "Video (MPEG-2)" screen is displayed.
- If a media containing data in different file formats is inserted, the file selection menu may be displayed. Press [▲, ▼] to select "Play Video (AVCHD)" or "Play Video (MPEG-2)" and press [OK].

e.g. **SD**

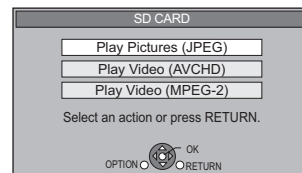

2 Press [▲, ▼, ◀, ▶] to select the title and press [OK].



- It may pause for a few seconds between images when editing such as partial deletion is performed.
- High definition video (transfer rate of 18 Mbps or faster) cannot be played back correctly if it was recorded on a DVD compatible to double speed or slower.



To return to the previous screen

Press [RETURN].

To exit the screen

Press [TOP MENU/DIRECT NAVIGATOR].

To switch from other menus to AVCHD or MPEG2 menu

(If the media contains data in different file formats)

- Press [START].
- Press [▲, ▼] to select "Menu" and press [OK].
- Press [▲, ▼] to select "Play Video (AVCHD)" or "Play Video (MPEG-2)" and press [OK].

Enjoying BD-LIVE or BONUSVIEW in BD-Video

BD-V

What is BONUSVIEW?

BONUSVIEW allows you to enjoy functions such as picture-in-picture or secondary audio etc., with BD-Video supporting BD-ROM Profile 1 version 1.1/ Final Standard Profile.

What is BD-Live?

In addition to the BONUSVIEW function, BD-Video supporting BD-ROM Profile 2 that has a network extension function allows you to enjoy more functions such as subtitles, exclusive images and online games by connecting this unit to the Internet. In order to use the Internet feature, you must have this unit connected to a broadband network (⇒ 13).

- These discs may not be on sale in certain regions.
- The usable functions and the operating method may vary with each disc, please refer to the instructions on the disc and/or visit their website.

Playing secondary video (picture-in-picture) and secondary audio

Secondary video can be played from a disc compatible with the picture-in-picture function. For the playback method, refer to the instructions for the disc.

To turn on/off secondary video

Press [PIP].

Secondary video is played.

- Press the button to turn it ON and OFF.

To turn on/off secondary audio

Set "Soundtrack" in "Secondary Video" to "On" or "Off" (⇒ 35, "Signal Type").

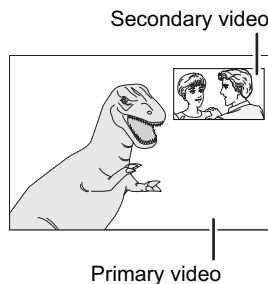

NOTE

- Discs may not always be played back according to the settings on this unit, as certain playback formats are prioritized on certain discs.
- Only the primary video is played during search/slow-motion or frame-by-frame.
- When "BD-Video Secondary Audio" in "Digital Audio Output" is set to "Off", secondary audio will not be played. Please check that "BD-Video Secondary Audio" is set to "On" (⇒ 38).
- When the secondary video is turned off, the secondary audio is not played.

Enjoying BD-Live discs with Internet

Many BD-Live compatible discs require content to be downloaded onto an SD card (⇒ 56, Local storage) in order to access the available BD-Live features.

- An SD card with 1 GB or more of free space (SD Speed Class Rating 2 or higher) needs to be inserted prior to inserting the BD-Live compatible disc.

Some BD-Live content available on the Blu-ray discs may require an Internet account to be created in order to access the BD-Live content. Follow the screen display or instruction manual of the disc for information on acquiring an account.

Preparation

- Connect to the network. (⇒ 13)

1 Insert an SD card (⇒ 18).

- If the SD card menu screen is displayed, press [BD/SD], select "BD/DVD".

2 Insert the disc (⇒ 18).

- For operation method, refer to the instructions on the disc.

To use the above functions, it is recommended that you format the card on this unit.

Format the card using the following procedures.

Formatting SD cards/Deleting data

It is impossible to restore data after formatting the card or erasing the data.

Once a card is formatted, all data including those recorded on the PC is erased as well, even if the data were protected with other equipment.

Confirm whether the card can be formatted.

- 1) Insert an SD card (⇒ 18).
- 2) Press [START].
- 3) Press [▲, ▼] to select "To Others" and press [OK].
- 4) Press [▲, ▼] to select "Card Management" and press [OK].
- 5) Press [▲, ▼] to select "BD-Video Data Erase" or "Format SD Card" and press [OK].
- 6) Press [◀, ▶] to select "Yes" and press [OK].
- 7) Press [◀, ▶] to select "Start" and press [OK].

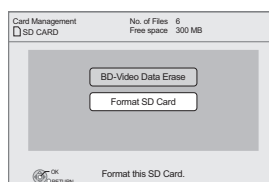

NOTE

- While using this feature, do not remove the SD card. Doing so will cause playback to stop.
- A message may be displayed when SD card doesn't have enough storage capacity for BD-Live content. Please make space available on the current SD card, or insert another SD card.
- For details about usable cards, refer to "Media (Disc, card and USB device) information" (⇒ 44)
- The unit must be connected to the Internet and set up (⇒ 33) to use the BD-Live functions. "BD-Live Internet Access" may need to be changed for certain discs (⇒ 37).
- When discs supporting BD-Live are played back, the player or disc IDs may be sent to the content provider via the Internet. You can restrict Internet access (⇒ 37, "BD-Live Internet Access").
- The unit is connected to the Internet when BD-Live functions are used, generating communication charges.
- The playback may be paused depending on the communication environment. Some functions may be disabled to prevent skipping to sections that have not been downloaded, etc.

Playing DivX® videos

DivX

ABOUT DIVX VIDEO:

DivX® is a digital video format created by DivX, Inc. This is an official DivX Certified device that plays DivX video.

You can play DVD-R/R DL, CD-R/RW discs and USB device which contain DivX video contents that have been recorded on a personal computer. (About structure of folders ⇒ 47, "Structure of folders that can play back on this unit")

● Because DivX format can use many different codecs, there is no guarantee that all DivX files will play. (⇒ 46, "About MP3/JPEG/DivX files")

1 Insert a disc or a USB device. (⇒ 18)

- If the disc containing data in different file formats is inserted, the file selection menu may be displayed. Press [▲, ▼] to select "Play Video (DivX)" and press [OK].

e.g., Display 

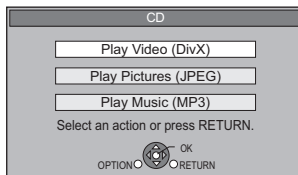

- The picture sizes set for recording may prevent the unit from showing pictures in the proper aspect. You may be able to adjust the aspect through the TV.
- Successive play is not possible.



- You can use search and skip functions. (⇒ 19)
- Press [SKIP ◀], [SKIP ▶] to show other pages.

DVD-R/R DL, CD-R/RW, USB device

To switch from other menus to DivX menu

(If the media contains data in different file formats)

- 1) Press [START].
- 2) Press [▲, ▼] to select "Menu" and press [OK].
- 3) Press [▲, ▼] to select "Play Video (DivX)" and press [OK].

2 Press [▲, ▼] to select the title and press [OK].

Play starts on the selected title.

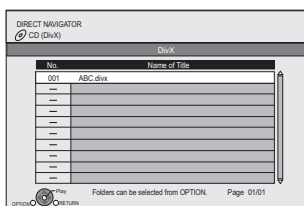

Playing a title in another folder

- 1 While the "DIRECT NAVIGATOR" is displayed Press [OPTION], press [▲, ▼] to select "Folder" and press [OK].

e.g.,

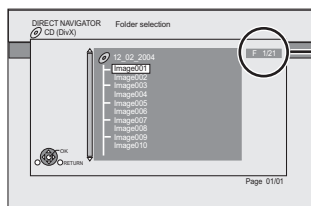

Selected folder No. /Total folders
If the folder has no title, "--" is displayed as folder number.



- You cannot select folders that contain no compatible files.



- To return to the previous screen Press [RETURN].

- 2 Press [▲, ▼] to select a folder and press [OK]. The "DIRECT NAVIGATOR" for the folder appears.

Regarding DivX VOD content

ABOUT DIVX VIDEO-ON-DEMAND:

This DivX® Certified device must be registered in order to play DivX Video-on-Demand (VOD) content.

First generate the DivX VOD registration code for your device and submit it during the registration process. [Important: DivX VOD content is protected by a DivX DRM (Digital Rights Management) system that restricts playback to registered DivX Certified devices. If you try to play DivX VOD content not authorized for your device, the message "Authorisation Error." will be displayed and your content will not play.] Learn more at www.divx.com/vod.

Display the unit's registration code.

(⇒ 40, "DivX Registration" in "General")

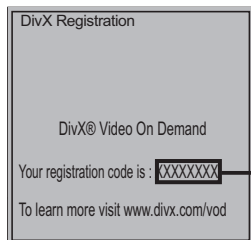

8 alphanumeric characters

- After playing DivX VOD content for the first time, another registration code is then displayed in "DivX Registration". Do not use this registration code to purchase DivX VOD content. If you use this code to purchase DivX VOD content, and then play the content on this unit, you will no longer be able to play any content that you purchased using the previous code.
- If you purchase DivX VOD content using a registration code different from this unit's code, you will not be able to play this content. ("Authorisation Error." is displayed.)

Regarding DivX VOD content that can only be played a set number of times

Some DivX VOD content can only be played a set number of times. When you play this content, the remaining number of plays is displayed. You cannot play this content when the number of remaining plays is zero. ("Rental Expired." is displayed.)

When playing this content

- The number of remaining plays is reduced by one if
 - you play the content to the end.
 - you press [⏻].
 - you press [■STOP] and play others.
 - you press [■STOP] twice. (except for content of USB device)
 - you press [▲ OPEN/CLOSE] or remove the USB device.

Displaying subtitles text

You can display subtitles text onto the DivX video disc on this unit. This function has no relation to the subtitles specified in DivX standard specifications and has no clear standard. The operation might be different or it may not operate properly depending on the way the file was made or the state of this unit (playing, stopped, etc.).

- 1 While playing, press [DISPLAY].
- 2 Press [▲, ▼] to select "Disc" and press [▶].
- 3 Press [▲, ▼] to select "Subtitle" and press [▶].
- 4 Press [▲, ▼] to select "On" and press [▶].
- 5 Press [▲, ▼] to select "Text".

- DivX video files that do not display "Text" do not contain subtitles text. Subtitles text cannot be displayed.
- If the subtitles text are not displayed correctly, try changing the language settings. (⇒ 37)

To exit the screen

Press [DISPLAY].

Playing still pictures

JPEG

Playback of the BD-RE, DVD-RAM/R/R DL or CD-R/RW with still pictures recorded. This unit can also play still pictures recorded on the SD card or USB memory. In addition, you can also connect Panasonic digital camera by USB connection.
(About structure of folders ⇒ 47, "Structure of folders that can play back on this unit")

Connecting a USB device

USB connection cable

Specified cable such as accessory of the USB equipment



Connect to USB terminal

Panasonic digital camera, etc.



NOTE

- Setup screen may be displayed on equipment connected with the USB. Set it to the mode for connecting to a PC.
- Also read the operating instructions of the connected equipment for details of connection and setup.
- Do not disconnect the USB connection cable while recognizing.

1 Insert a disc, SD card or USB device. (⇒ 18)

BD-RE, DVD-RAM

"Album View" screen is displayed

- When the "Title View" screen is displayed, press the [G] button to switch to the "Album View" screen.
- If the DVD-RAM containing both JPEG and AVCHD format is inserted, the file selection menu may be displayed.

DVD-R/R DL, CD-R/RW, SD card, USB device

- If the media containing data in different file formats is inserted, the file selection menu may be displayed.

e.g., Display



Press [▲, ▼] to select "Play Pictures (JPEG)" and press [OK].
"Picture View" screen is displayed

⇒ Go to step 3

e.g., SD

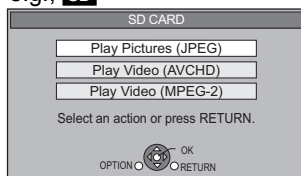

2 Press [▲, ▼, ◀, ▶] to select the album and press [OK].

e.g.,

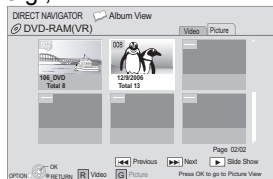

3 Press [▲, ▼, ◀, ▶] to select the still picture and press [OK].



TIPS

- Press [◀, ▶] to display the previous or next still picture.
- Press [SKIP ◀◀, SKIP ▶▶] to show other pages.

To return to the previous screen

Press [RETURN].

To exit the screen

Press [TOP MENU/DIRECT NAVIGATOR].

DVD-RAM/R/R DL, CD-R/RW, SD card, USB device

To switch from other menus to JPEG menu

(If the media contains data in different file formats)

- 1) Press [START].
- 2) Press [▲, ▼] to select "Menu" and press [OK].
- 3) Press [▲, ▼] to select "Play Pictures (JPEG)" and press [OK].



NOTE

- Small-sized still pictures are displayed with a frame.

Playing still pictures

Useful functions during still picture play

Start Slide Show

You can display still pictures one by one at a constant interval.

BD-RE, DVD-RAM

- While the "Album View" screen is displayed Press [▲, ▼, ◀, ▶] to select the album and press [OPTION].
 - Press [▲, ▼] to select "Start Slide Show" and press [OK].
- You can also start slideshow by pressing [▶PLAY] after selecting the album.

DVD-R/R DL, CD-R/RW, SD card, USB device

- While the "Picture View" screen is displayed Press [OPTION].
- Press [▲, ▼] to select "Start Slide Show" and press [OK].

To stop slideshow

Press [■STOP].

Slide Show Setting

After performing step ① in "Start Slide Show" above.

- Press [▲, ▼] to select "Slide Show Setting" and press [OK].
- To change the display interval**
Press [▲, ▼] to select "Display interval" and press [◀, ▶] to select the interval ("Long", "Normal" or "Short").
 - When a still picture with large number of pixels is played, the display interval may become longer. Even if the setting is changed, the display interval may not become shorter.

To set display method

Press [▲, ▼] to select "Transition Effect" and press [◀, ▶] to select "Fade", "Motion" or "Random".

- "Fade": Pictures are changed by fading out and fading in. This setting is factory preset.
- "Motion": Pictures are changed by fading out and fading in, while it is enlarged, reduced, or moved up or down.
- "Random": In addition to the "Motion", pictures are changed by various methods.

To repeat Slide Show

Press [▲, ▼] to select "Repeat Play" and press [◀, ▶] to select "On" or "Off".

To listen to a Background Music

Music files on an iPod, a USB device or a music CD can be played back as Background music during the slideshow. Press [▲, ▼] to select "Soundtrack" and press [◀, ▶] to select "On" or "Off".

- You cannot search or skip on a music.
- When the slideshow stops, the playback of the music also stops.
- Playback of the music files will be in the following order:
 - CD: Order of "Music list" display in repeat mode.
 - iPod: The music files will be played back in repeat mode.
- When a music CD, a USB device with MP3 recorded and an iPod is inserted/connected to this unit, the iPod has first priority to be played back as Background. To playback MP3 recorded on a USB device as Background music, remove the iPod and music CD from the main unit.

To select a folder

A folder to playback can be selected when a USB device with MP3 recorded is connected to this unit.

Press [▲, ▼] to select "Soundtrack Folder" and press [OK], and press [◀, ▶] to select folder and press [OK].

- Press [▲, ▼, ◀, ▶] to select "Set" and press [OK].

Rotate

- While playing (except for slideshows) Press [OPTION].
 - Press [▲, ▼] to select "Rotate RIGHT" or "Rotate LEFT" and press [OK].
- The rotation information will be stored until the unit is turned off or the media is removed.

Zoom out

This function is only available for small-sized still pictures.

- While playing (except for slideshows) Press [OPTION].
 - Press [▲, ▼] to select "Zoom out" and press [OK].
- To cancel "Zoom out", press [▲, ▼] to select "Zoom in" in step ② and press [OK].
 - The zoom-out information will not be stored.

To select the still pictures in another folder

BD-RE, DVD-RAM

To switch to another higher folder

(Only if there is a multiple number of higher folders recognizable)

- While the "Album View" screen is displayed Press [OPTION].
- Press [▲, ▼] to select "Select Folder" and press [OK].

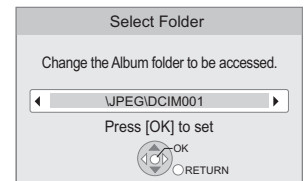

- Press [◀, ▶] to select the higher folder and press [OK].

DVD-R/R DL, CD-R/RW

- While the "Picture View" screen is displayed Press [OPTION].
- Press [▲, ▼] to select "Folder" and press [OK].
- Press [▲, ▼] to select a folder and press [OK]. The "Picture View" screen for the folder appears.

e.g.,

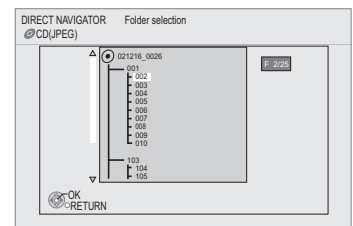

To show the picture properties

While playing
Press [STATUS] twice.

e.g. JPEG on DVD-RAM
Shooting date



To exit, press [STATUS].

Playing music

CD MP3

You can generally play available music CD or MP3 files recorded onto a DVD-R/R DL, CD-R/RW and USB device. (About structure of folders ⇒ 47, "Structure of folders that can play back on this unit")

1 Insert a disc or USB device. (⇒ 18) e.g. Display



- If the media containing data in different file formats is inserted, the file selection menu may be displayed. Press [▲, ▼] to select "Play Music (MP3)" and press [OK].

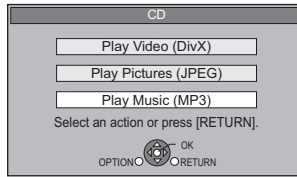

2 Press [▲, ▼] to select the track and press [OK]. Play starts on the selected track.

e.g. CD

"🎵" indicates the track currently playing.

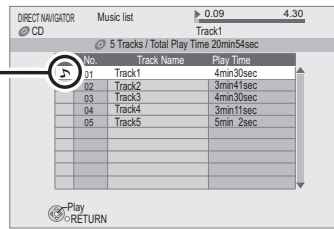

MP3 Playing a track in another folder

- While the "Music list" is displayed Press [OPTION], press [▲, ▼] to select "Select Folder" and press [OK].
- Press [▲, ▼] to select a folder and press [OK]. The "Music list" for the folder appears.

Selected folder No. /Total folders
If the folder has no track, "—" is displayed as folder number.

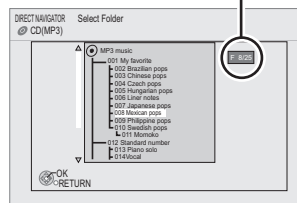

To switch from other menus to MP3 menu

(If the media contains data in different file formats)

- 1) Press [START].
- 2) Press [▲, ▼] to select "Menu" and press [OK].
- 3) Press [▲, ▼] to select "Play Music (MP3)" and press [OK].

- You can use search and skip functions. (⇒ 19)
- When the "Screen Saver Function" is set to "On" (⇒ 38), the screen switches to Screen Saver mode if there is no operation for 5 minutes after starting playback. (Playback continues.)



- You cannot select folders that contain no compatible tracks.

NOTE



To return to the previous screen

Press [RETURN].

TIPS

Playing music continuously even after turning off power to the television

When the unit is connected to a Panasonic TV (VIERA) that supports HDAVI Control 2 or later and another device supports VIERA Link, the unit is turned off if the power to the television is turned off, since "Power off link" (⇒ 29) operates.

The following operations make it possible to keep the power of the unit ON and to play music continuously.

Set "Power Off Link" to "Video" (⇒ 39).



- Sound may be discontinued for several seconds when the power to the television is turned off.

NOTE

Listening to the Radio

Setting up the radio

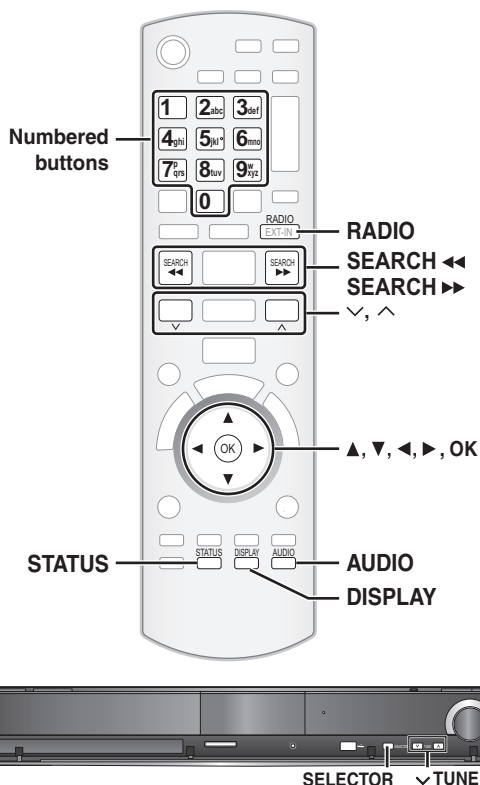

Presetting stations automatically

Up to 30 stations can be set.

1 Press [RADIO] to select "FM".

This unit: Press [SELECTOR].

2 Press [STATUS] to select the position to start the auto preset search.

Each time you press the button:

LOWEST (factory preset):

To begin auto preset with the lowest frequency (FM87.50).

CURRENT:

To begin auto preset with the current frequency.*

* To change the frequency, refer to "Manual tuning" (⇒ right).

3 Press and hold [OK].

Release the button when "AUTO" is displayed.



The tuner starts to preset all the stations it can receive into the channels in ascending order.

- "SET OK" is displayed when the stations are set, and the radio tunes to the last preset station.
- "ERROR" is displayed when automatic presetting is unsuccessful. Preset the stations manually (⇒ right).

Listening/confirming the preset channels

1 Press [RADIO] to select "FM".

2 Press the numbered buttons to select the channel.

To select a 1-digit number

e.g., 1: [1] ⇒ [OK].

To select a 2-digit number

e.g., 12: [1] ⇒ [2]

Alternatively, press [▲, ▼] or [◀, ▶].

When a stereo FM broadcast is being received, "ST" lights in the display.

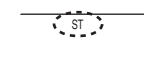
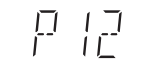

- The FM setting is also shown on the TV display.

■ If noise is excessive

When FM is selected

Press [AUDIO] to display "MONO".

Press the button again to cancel the mode.

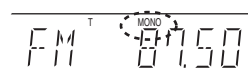

- The mode is also cancelled when you change the frequency.

- This setting can be preset for each broadcasting station. When "MONO" appears follow procedures **1** and **2** in "Presetting stations manually" (⇒ below).

Manual tuning

1 Press [RADIO] to select "FM".

2 Press [SEARCH◀◀] or [SEARCH▶▶] to select the frequency.

- Main unit:

Press [▼ TUNE ▲] to select the frequency.

- When a radio broadcast is being received, "T" lights in the display.



- To start automatic tuning, press and hold [SEARCH◀◀, SEARCH▶▶] (main unit: [▼ TUNE ▲]) until the frequency starts scrolling. Tuning stops when a station is found.

■ Presetting stations manually

Up to 30 stations can be set.

1 While listening to the radio broadcast

Press [OK].

2 While "P" is flashing on the display

Press the numbered buttons to select a channel.

To select a 1-digit number

e.g., 1: [1] ⇒ [OK].

To select a 2-digit number

e.g., 12: [1] ⇒ [2]

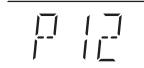

A station previously stored is overwritten when another station is stored in the same channel preset.

RDS broadcasting

The unit can display the text data transmitted by the radio data system (RDS) available in some areas.

If the station you are listening to is transmitting RDS signals, "RDS" will light up on the display.

While listening to the radio broadcast

Press [DISPLAY] to display the text data.

Each time you press the button:

PS: Programme service

PTY: Programme type

OFF: Frequency display

PTY displays

NEWS	VARIED	FINANCE	COUNTRY
AFFAIRS	POP M	CHILDREN	NATIONAL
INFO	ROCK M	SOCIAL A	OLDIES
SPORT	M.O.R. M*	RELIGION	FOLK M
EDUCATE	LIGHT M	PHONE IN	DOCUMENT
DRAMA	CLASSICS	TRAVEL	TEST
CULTURE	OTHER M	LEISURE	ALARM
SCIENCE	WEATHER	JAZZ	

* "M.O.R. M"=Middle of the road music



RDS displays may not be available if reception is poor.

Enjoying TV, etc. with this unit's speakers

You can enjoy TV broadcasts with this unit's speakers.

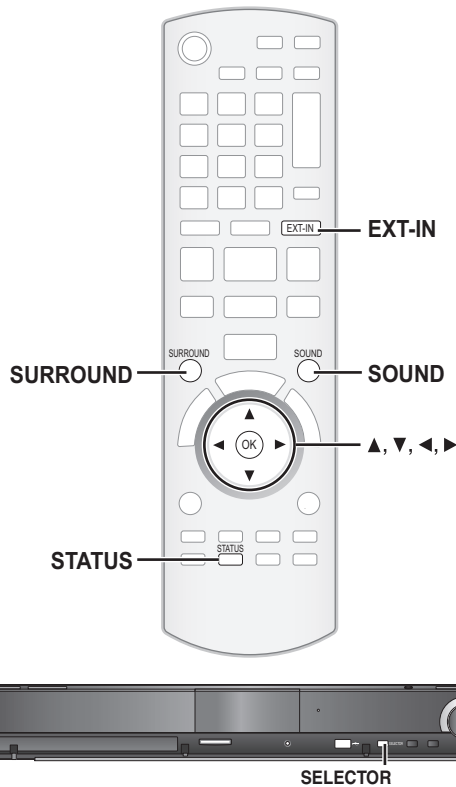

Preparation

Confirm the audio connection to the OPTICAL IN or AUX terminal on this unit (⇒ 10 to 12). Turn on the TV.

- Press [EXT-IN] several times to select "D-IN 1" (DIGITAL IN 1)*¹, "D-IN 2" (DIGITAL IN 2)*² or "AUX"*¹.

This unit: Press [SELECTOR].

- **D-IN 1 (DIGITAL IN 1)*¹:**
When connecting using OPTICAL 1(TV) terminal.
- **D-IN 2 (DIGITAL IN 2)*²:**
When connecting using OPTICAL 2(STB) terminal.
- **AUX*¹:**
When connecting using AUX terminal.

*¹For connections with the TV. (⇒ 10, 11)

*²For connections with other devices. (⇒ 12)

- When the system is connected to an HDAVI Control 2 or later-compatible TV via an HDMI cable, TV broadcast audio is output through the system speakers if the TV input is switched to TV tuner mode. See "Setting the TV audio for VIERA Link "HDAVI Control"" on page 28 for setting method.
- Reduce the volume on the TV to its minimum, and then adjust the volume of this unit.

Enjoying TV and other devices sound from this unit's speakers

You can enhance stereo sources with surround sound effect.

Press [SURROUND] several times to select the mode.

- You can also press [SURROUND] and then [▲, ▼] to select the mode.
- The selected effect will only be displayed on the main unit.

While "MANUAL" is displayed

Press [◀, ▶] and select the desired effect.

Recommended modes to enjoy TV audio:

- DOLBY PL II MOVIE
- DOLBY PL II MUSIC
- S.SURROUND

For more detailed information on this operation, please refer to the "Enjoying surround sound effects" section on page 17.

Adjusting the sound

You can adjust the mode depending on the source or situation.

- Press [SOUND] several times to select the mode.
 - You can also press [SOUND] and then [▲, ▼] to select the mode.
 - The selected effect will only be displayed on the main unit.
- While the selected mode is displayed Press [◀, ▶] and select the desired setting.

For more detailed information on this operation, please refer to the "Changing the sound modes" section on page 17.

Making settings for digital audio input

Select to suit the type of audio from the OPTICAL IN terminals on the main unit.

- Underlined items are the factory presets.

Available settings

Mode	Setting
DUAL:	(Only works with Dolby Dual Mono) - <u>M1</u> - <u>M2</u> - <u>M1+M2</u> (stereo audio) • If this is set to "M1" or to "M2", the "PCM FIX" will automatically be set to "OFF"(⇒ below).
DRC: (Dynamic Range Compression)	- <u>ON</u> Adjust for clarity even when the volume is low by compressing the range of the lowest sound level and the highest sound level. Convenient for late night viewing. (Only works with Dolby Digital) - <u>OFF</u> The full dynamic range of the signal is reproduced.
PCM FIX:	- <u>ON</u> Select when receiving only PCM signals. - <u>OFF</u> Select when receiving Dolby Digital and PCM signals. • When receiving true 5.1-channel surround sound, select "OFF".
TV AUDIO*³:	- <u>AUX</u> Select when receiving analogue sound from the TV to the AUX terminal. - <u>D-IN 1</u> Select when receiving digital sound from the TV to the OPTICAL 1(TV) terminal.
CABLE/SAT AUDIO*^{4,5}:	- <u>SET</u> Select when setting the main unit to switch to "D-IN 2" when the input channel of a HDMI connected STB is selected on the TV (⇒ 28, Setting the TV audio for VIERA Link "HDAVI Control"). - <u>OFF</u> Select to cancel this setting.

- Press [EXT-IN] several times to select "D-IN 1" (DIGITAL IN 1) or "D-IN 2" (DIGITAL IN 2).
Main unit: Press [SELECTOR].
- Press [STATUS] several times to select the mode.
 - You can also press [STATUS] and then [▲, ▼] to select the mode.
 - The digital audio input settings are to be set separately to each source, "D-IN 1" and "D-IN 2".
 - The selected effect will only be displayed on the main unit.
- While the selected mode is displayed Press [◀, ▶] and select the desired setting.

*³When "D-IN 1" is selected.

*⁴When "D-IN 2" is selected.

*⁵The device connected to the OPTICAL 2(STB) terminal must be connected to the TV via an HDMI cable. If it is not connected via an HDMI cable, "NOT CONDITIONAL" is displayed on the main unit.



• Audio that is input through the OPTICAL DIGITAL IN or AUX terminals are not output from the HDMI terminal.

Linked operations with the TV

(VIERA Link “HDAVI Control™”)

What is VIERA Link “HDAVI Control”?

VIERA Link “HDAVI Control” is a convenient function that offers linked operations of this unit, and a Panasonic TV (VIERA) under “HDAVI Control”. You can use this function by connecting the equipment with an HDMI cable. See the operating instructions for connected equipment for operational details.

Preparation

- 1 Connect this unit to your TV with an HDMI cable (⇒ 11).
- 2 Set “VIERA Link” to “On” (⇒ 39).
(The default setting is “On”.)
- 3 Set the “HDAVI Control” operations on the connected equipment (e.g., TV).
- 4 Turn on all “HDAVI Control” compatible equipment and select this unit’s input channel on the connected TV so that the “HDAVI Control” function works properly.

Also when the connection or settings are changed, repeat this procedure.

Setting the TV audio for VIERA Link “HDAVI Control”

You can set the main unit to link audio operations with the TV.

■ Setting the audio from the TV

Preparation

- Select between “AUX” and “D-IN 1” (DIGITAL IN 1) to work with the linked operations for the TV audio.
 - Confirm the audio connection to the AUX(TV) terminal (for “AUX”) or OPTICAL 1(TV) terminal (for “D-IN 1”) (⇒ 11).

With the remote control of the main unit;

- 1 Press [EXT-IN] to select “AUX” or “D-IN 1” (DIGITAL IN 1).
- 2 Press [STATUS].
- 3 Press [▲, ▼] to select “TV AUDIO”.
- 4 Press [◀, ▶] to switch “AUX” or “D-IN 1” (DIGITAL IN 1) and press [OK].

Whenever the connection or settings are changed, reconfirm the points above.

■ Setting the audio from the STB

This unit can be set to link operations with the TV so as to output audio from the connected STB, etc. when the TV input is set to the input channel designated for the STB, etc.

Preparation

- Select the STB input channel on the TV.
- Confirm the audio connection to the OPTICAL 2(STB) terminal (for “D-IN 2”) (⇒ 12).

With the remote control of this unit;

- 1 Press [EXT-IN] to select “D-IN 2” (DIGITAL IN 2).
- 2 Press [STATUS].
- 3 Press [▲, ▼] to select “CABLE/SAT AUDIO”.
- 4 Press [◀, ▶] to select “SET” and press [OK].

- If the input channel of the STB on the TV is changed or if you want to change the device allocated for the linked operations, select “OFF” in step 4 above and then repeat steps 1 to 4.



- VIERA Link “HDAVI Control”, based on the control functions provided by HDMI which is an industry standard known as HDMI CEC (Consumer Electronics Control), is a unique function that we have developed and added. As such, its operation with other manufacturers’ equipment that supports HDMI CEC cannot be guaranteed.

• This unit supports “HDAVI Control 4” function.

“HDAVI Control 4” is the newest standard (current as of December, 2008) for Panasonic’s HDAVI Control compatible equipment. This standard is compatible with Panasonic’s conventional HDAVI equipment.

- Please refer to individual manuals for other manufacturers’ equipment supporting VIERA Link function.

• It is recommended that you use Panasonic’s HDMI cable.

Recommended part number:
RP-CDHG10 (1.0 m), RP-CDHG15 (1.5 m), RP-CDHG20 (2.0 m), RP-CDHG30 (3.0 m), RP-CDHG50 (5.0 m), etc.

- Non-HDMI-compliant cables cannot be utilized.



- The connected STB must also be connected to the TV via an HDMI cable. Refer to the operating instructions of the respective device for details.



- It is also possible to connect an HDMI and optical output compatible Panasonic DVD, Blu-ray recorder in the place of the STB.

What you can do with “HDAVI Control”

Speaker Selection

You can select whether audio is output from the unit’s speakers or the TV speakers by using the TV menu settings. For details, refer to the operating instructions of your TV.

Home Cinema

This unit’s speakers are active.

- When this unit is in standby mode, changing the TV speakers to this unit’s speakers in the TV menu will automatically turn the unit on and select “AUX”^{*1}, “D-IN 1” (DIGITAL IN 1)^{*1} or “D-IN 2” (DIGITAL IN 2)^{*2} as the source.
- The TV speakers are automatically muted.
- You can control the volume setting using the volume or mute button on the TV’s remote control. (The volume level is displayed on the main unit’s FL display.)
- To cancel muting, you can also use the home theatre remote control (⇒ 18).
- If you turn off this unit, TV speakers will be automatically activated.

TV

TV speakers are active.

- The volume of this unit is set to “0”.
 - This function works when “BD/DVD”, “SD”, “USB”, “AUX”^{*1}, “D-IN 1” (DIGITAL IN 1)^{*1} or “D-IN 2” (DIGITAL IN 2)^{*2} is selected as the source on the home theatre system.
- Audio output is 2-channel audio.



- When “TV” is selected in “Speaker Selection”, the audio from an iPod will not be output from the TV’s speakers during slideshow background music playback. (⇒ 24)

Automatic input switching

When the following operations are performed, the television will automatically switch the input channel and display the corresponding action.

- When play starts on the unit
- When an action that uses the display screen is performed (e.g., Direct Navigator screen)
- **BD-V DVD-V** When playback stops, the TV will automatically return to TV tuner mode.
- When you switch the TV input to TV tuner mode, this unit will automatically switch to “AUX”^{*1}, “D-IN 1” (DIGITAL IN 1)^{*1} or “D-IN 2” (DIGITAL IN 2)^{*2}.
- This function does not work when the iPod selector (SIMPLE mode) or iPod Video menu (EXTENDED mode) is chosen. (⇒ 31)



- When [▶PLAY] is pressed, the playback image is not immediately displayed on the screen and it may not be possible to watch the contents from where playback started. In this case, press [SKIP◀◀] or [SEARCH◀◀] to go back to where playback started.

Automatic lip-sync function (for HDAVI Control 3 or later)

Delay between audio and video is automatically adjusted, enabling you to enjoy smooth audio for the picture (⇒ 39, Time Delay).

- This function works only when “BD/DVD”, “SD”, “USB”, “AUX”^{*1}, “D-IN 1” (DIGITAL IN 1)^{*1} or “D-IN 2” (DIGITAL IN 2)^{*2} is selected as the source on this unit.

Power off link

All connected equipment compatible with “HDAVI Control”, including this unit, automatically turns off when you switch the television off.

- This unit automatically turns off even during playback or any other operation.

To continue audio playback even when the TV is turned off, select “Video” in “Power Off Link” (⇒ 39).

Intelligent Auto Standby

Intelligent Auto Standby responsibly manages your power consumption.

This function is available with the TV that supports “HDAVI Control 4”.

- If connected with a TV (VIERA) with the “Intelligent Auto Standby” setting activated on the TV, when switching the TV input, the unit will be automatically turned to standby. For details please read the operating instructions of the TV.
- When “Speaker Selection” is set to “Home Cinema”, the main unit will not automatically turn to standby.

One touch play

You can turn on this unit and the TV, and start play with a single press of a button.

While the unit and the TV are in standby mode;

Press [▶PLAY].

- This unit’s speakers will automatically be activated. (⇒ 28)



- When [▶PLAY] is pressed, the playback image is not immediately displayed on the screen and it may not be possible to watch the contents from where playback started. In this case, press [SKIP◀◀] or [SEARCH◀◀] to go back to where playback started.

*1 “AUX” or “D-IN 1” works depending on the “TV AUDIO” setting (⇒ 28, Setting the TV audio for VIERA Link “HDAVI Control”).

*2 “D-IN 2” works depending on the “CABLE/SAT AUDIO” setting (⇒ 28, Setting the TV audio for VIERA Link “HDAVI Control”).

Easy control only with VIERA remote control

If you connect this unit to a TV that has “HDAVI Control 2” or later with an HDMI cable, you can operate this unit using buttons on the TV remote control.

The buttons that you can use for this unit vary depending on the TV. For details, refer to the operating instructions of the TV. Use the remote control supplied with this unit if you cannot operate this unit using buttons on the TV remote control.

- The operation of this unit may be interrupted when you press incompatible buttons on the TV remote control.

Using the START menu to operate this unit

By using the TV remote control, you can play media using the START menu.

- 1 **Press the button for VIERA Link on the TV remote control.**
- 2 **Select the home theatre.**
 - The START menu is displayed
- 3 **Select the desired items on the START menu (⇒ 15).**

e.g., **BD-V**

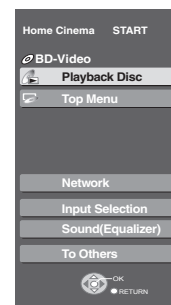

Using the option menu to operate this unit

By using the TV remote control, you can play discs using the “Control Panel” and display the Top Menu (for BD-Video and DVD-Video) or Pop-up Menu (for BD-Video).

- This works only during “BD/DVD” or “SD” playback and resume modes.

- 1 **Press [OPTION].**

- You cannot use the option menu while e.g., **BD-V** the Top Menu for BD-Video or DVD-Video is displayed.
- This can also be displayed by using the VIERA menu screen.

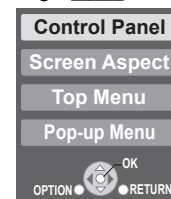

- 2 **Select an item, then press [OK].**

Control Panel	Control Panel is displayed. Follow the indications on the screen (⇒ below).
Screen Aspect	(⇒ 20)
Top Menu BD-V AVCHD DVD-V	Top menu is displayed.
Menu DVD-V	Menu is displayed.
Pop-up Menu BD-V	Pop-up menu is displayed.
Rotate RIGHT JPEG	Rotate the still picture.
Rotate LEFT JPEG	
Zoom in JPEG	Enlarge or shrink the still picture.
Zoom out JPEG	

Using the Control Panel

You can operate the playback with the indicated controls.

e.g.,

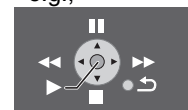

- Depending on the menu, some button operations cannot be performed from the TV’s remote control.
- You cannot input numbers with the numbered buttons on the TV’s remote control ([0] to [9]). Use this unit’s remote control to select the playlist etc.

When you want to leave the TV on and set only this unit to standby mode

Press [⏻] on this unit’s remote control and set to standby mode.

When not using “HDAVI Control”

Set “VIERA Link” in the Setup menu to “Off”. (⇒ 39)

TV

Using the iPod

You can enjoy iPod music through this unit's speakers or view iPod videos/photos on the TV.

iPod Connection

Preparation

● To view photos/videos from the iPod

- Ensure the video connection to the VIDEO OUT terminal on this unit (⇒ 10).
- Operate the iPod menu to make the appropriate photo/video output settings for your TV. (Refer to operating instructions of your iPod.)

● To display the picture, turn on the TV and select the appropriate video input mode.

● Before connecting/disconnecting the iPod, turn the main unit off or reduce the volume of the main unit to its minimum.

① Open the Dock for iPod.

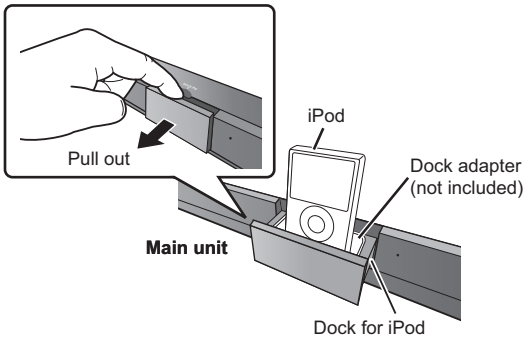

- Hold the dock when connecting/disconnecting the iPod.

② Connect the iPod (not included) firmly.

Recharging starts when the iPod is inserted.

While an iPod is connected

- Do not push the Dock for iPod.

DO NOT

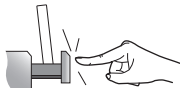

- Do not push or pull your iPod back and forth with great force.

DO NOT



About dock adapter

- Attach the dock adapter which should be supplied with your iPod to the dock for the stable use of the iPod. If you need an adapter, consult your iPod dealer.

About recharging the battery

- iPod will start recharging regardless of whether this unit is on or off.
- "IPOD *" will be shown on the main unit's display during iPod charging in main unit standby mode.
- Check iPod to see if the battery is fully recharged.
- If you are not using iPod for an extended period of time after recharging has completed, disconnect it from main unit, as the battery will be depleted naturally. (Once fully recharged, additional recharging will not occur.)

Compatible iPod

Name	Memory size
iPod touch 2nd generation	8 GB, 16 GB, 32 GB
iPod nano 4th generation (video)	8 GB, 16 GB
iPod classic	120 GB
iPod touch 1st generation	8 GB, 16 GB, 32 GB
iPod nano 3rd generation (video)	4 GB, 8 GB
iPod classic	80 GB, 160 GB
iPod nano 2nd generation (aluminum)	2 GB, 4 GB, 8 GB
iPod 5th generation (video)	60 GB, 80 GB
iPod 5th generation (video)	30 GB
iPod nano 1st generation	1 GB, 2 GB, 4 GB
iPod 4th generation (colour display)	40 GB, 60 GB
iPod 4th generation (colour display)	20 GB, 30 GB
iPod 4th generation	40 GB
iPod 4th generation	20 GB
iPod mini	4 GB, 6 GB



- Compatibility depends on the software version of your iPod.
- Audio/video cannot be recorded or transmitted to iPods via this system.
- Panasonic makes no warranty for iPod data management.
- **For more information, refer to the operating instructions for iPod.**
- The contents of the operating instructions and those displayed on iPod may differ partially, but this will not fundamentally affect use of playback.



■ To use the iPod touch features

- ① Press the Home button on the iPod touch.
- ② Select the iPod touch features on the touch screen to operate.

iPod Playback

This system features two different iPod playback modes.

The first of these is EXTENDED mode, for playback of music and video contents. With this mode, you can operate the iPod from the main unit. The second mode is SIMPLE mode, which can be used for playback of three types of contents – music, photos, and videos. With this mode, simple operations such as play, stop, and search can be performed on the display of your iPod.

Enjoy music/video (EXTENDED mode)

1 Press [iPod] to select "IPOD".

The iPod automatically switches to this unit's display mode.

- To switch the menu, press [STATUS] several times.

Music menu → Video menu
 ↑ iPod menu (iPod LCD) ←

- "MUSIC" or "VIDEOS" is displayed on the main unit.
 – When playing back video contents, ensure the video connection to the VIDEO OUT terminal on this unit (⇒ 10) and switch the TV input to video in.

e.g., music main menu screen

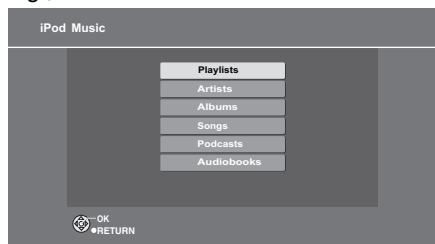

2 Press [▲, ▼] to select an item and press [OK].

- Play starts from the selected song or video.
- To display the previous or next page Press [◀, ▶].
- Press [RETURN] to return to the previous screen.

e.g., music playback screen

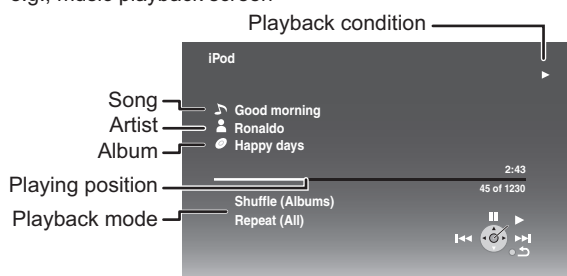

Clear/display iPod Music or Video menu during playback.

Press [TOP MENU/DIRECT NAVIGATOR].



NOTE

- If the Video menu (EXTENDED mode) is accessed, the video shuffle playback mode on the iPod is set to "Off" when the iPod is disconnected from the unit.

Enjoy photos (SIMPLE mode)

You can also play music and video using SIMPLE mode.

1 Press [iPod] to select "IPOD".

2 Press [STATUS] several times to select the iPod menu (iPod LCD).

- "ALL" is displayed on the main unit.
 Proceed operations through iPod display.

3 Switch the TV input to video in.

- Ensure the video connection to the VIDEO OUT terminal on this unit (⇒ 10).

4 Play a slideshow on your iPod.

The picture will be displayed on your TV.

You can use the remote control to operate the iPod menu.

- [▲, ▼]: To navigate menu items
- [OK]: To go to the next menu.
- [RETURN]: To return to the previous menu.

The remote control operation may vary between iPod models.

Other methods of playback

While in "MUSIC" or "VIDEOS" mode, it is possible to select the following playback modes.

Items	Selection/playback method
Play Mode	Shuffle* ¹
	• Off: Cancel
	• Songs: Play all songs on iPod in random order.
	• Albums: Play all songs on album in random order.
	Repeat
	• Off: Cancel
	• One: Play a single song/video repeatedly.
	• All: Play all songs/videos from selected items (e.g., Playlists, Albums, etc.) repeatedly.

*¹For music playback only.

1 Press [START].

2 Press [▲, ▼] to select "Menu" and then press [OK].

3 Press [▲, ▼] to select "Play Mode" and then press [OK].

4 Press [▲, ▼] to select an item and press [OK].

5 Press [▲, ▼] to select the setting and press [OK].



NOTE

Playback modes during and after connection.

- Music playback modes set on the iPod will be maintained when connected to the main unit. Changes made while the iPod is connected to the main unit be kept on the iPod after disconnecting it.
- If the Video menu (EXTENDED mode) is accessed, the video shuffle playback mode on the iPod is set to "Off" when the iPod is disconnected from the unit.



TIPS

To return to the previous screen

Press [RETURN].

Basic controls

While playing music or video it is possible to use the following buttons of the remote control.

Buttons	Functions
[▶] PLAY	Play
[■] STOP	Pause
[] PAUSE	<ul style="list-style-type: none"> • Press [▶] PLAY to restart play. • Playback start position may not be stored in memory in certain cases.
[SKIP] ◀◀, ▶▶	Skip
(Press and hold) [SEARCH] ◀◀, ▶▶	Search

- Use the controls on the iPod unit during photo playback.

You can select the surround sound effect when you press [SURROUND] (⇒ 17).

You can select the sound mode when you press [SOUND] (⇒ 17).

Enjoying VIERA CAST™

You can access a selection of Internet services from the Home screen with VIERA CAST, for example YouTube, Picasa Web Albums. (Current as of March 2009)

●VIERA CAST requires a broadband Internet connection. Dial-up Internet connections cannot be used.

Preparation

●Network connection (⇒ 13), Network setting (⇒ 33)

1 While stopped

Press [BD/SD] to select "BD/DVD".

2 Press [VIERA CAST].

●Message is displayed. Please read these instructions carefully and then press [OK] to start VIERA CAST function.

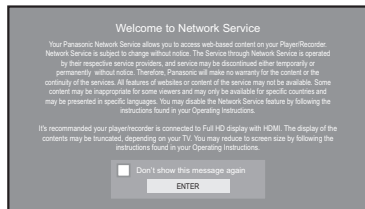

Images are for illustration purpose, message may change without notice.

3 Press [▲, ▼, ◀, ▶] to select the item and press [OK].

●You can operate VIERA CAST using the following buttons on the unit's remote control. [▲, ▼, ◀, ▶], [OK], [RETURN], coloured buttons and numbered buttons.

●To access more features on YouTube or Picasa Web Albums site, enter your user ID and password that you have previously set up with these sites through the internet on your PC. However, not all features may be accessible through VIERA CAST.

VIERA CAST Home screen;

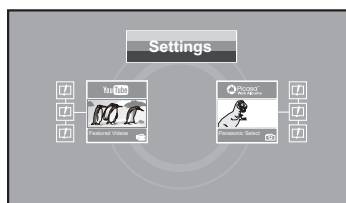

Images are for illustration purpose, contents may change without notice.

Regarding "Settings"

Set VIERA CAST Home screen.

- My Account:** You can remove your account from the unit.
- Lock:** Enter a password to lock YouTube and Picasa Web Albums.

●Notices

Firmware updating

When this unit remains connected to the Internet, it will automatically check for the latest firmware version when it is turned on.

When latest firmware version is available, the following screen is displayed. Select "Yes" or "No".

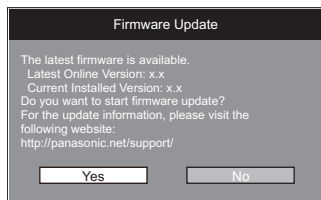

- If "Yes" is selected, then follow the on-screen instructions.
- If "No" is selected, then manually update the firmware later. (⇒ right)

After the latest firmware is downloaded, the system will be restarted and the firmware will be updated.

When the system is restarted, the screen display disappears and "START" is displayed on the unit's display.



After the firmware is updated and the system is restarted, the following screen indicates that the firmware update has been completed.

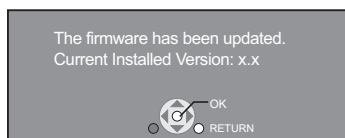

- During the update process, no other operations can be performed. Serious damage may occur if you turn off the unit and/or press any buttons.



NOTE

- Depending on the usage conditions, it may take a while to read all the data.
- The connection to the Internet may take time or the Internet may not be connected depending on the connection environment.
- The unit is connected to the Internet when VIERA CAST is used, generating communication charges.



TIPS

To return to VIERA CAST Home screen

Press [VIERA CAST].

To exit from VIERA CAST

Press [START] or [TOP MENU/DIRECT NAVIGATOR], then press [RETURN] to cancel the menu.

- Set the "Network Lock" to "On" to restrict using VIERA CAST. (⇒ 40)
- Set the "Audio Auto Gain Control" to "Off" when the audio is warped while using the VIERA CAST. (⇒ 40)
- When display of the contents is truncated, set the "Reduced Screen Display" to "On". (⇒ 40)
- Set the "On-Screen Language", to switch the language for Home screen. (⇒ 38)
- Set the "Time Zone" or "Summer Time" when wrong time is displayed on the screen. (⇒ 40)



NOTE

- VIERA CAST™ home screen is subject to change without notice.
- The services through VIERA CAST™ are operated by their respective service providers, and service may be discontinued either temporarily or permanently without notice. Therefore, Panasonic will make no warranty for the content or the continuity of the services.
- All features of websites or content of the service may not be available.
- Some content may be inappropriate for some viewers.
- Some content may only be available for specific countries and may be presented in specific languages.



NOTE

- Downloading will require several minutes. It may take longer or the Internet may not be connected depending on the connection environment. It is required that you use a broadband connection.



TIPS

- If downloading on this unit fails or this unit is not connected to the Internet, then you can download the latest firmware from the following website and burn it to a CD-R to update the firmware. <http://panasonic.net/support/> (This site is in English only.)
- When the unit is connected to the Internet, communication charges may be generated.
- If you do not want to check for the latest firmware version when the unit is turned on, set "Automatic Update Check" to "Off". (⇒ 40)

Manually updating the firmware

If the firmware update is not carried out when the unit is turned on, a message is displayed when displaying the START menu.

The latest firmware is available. Please update firmware in Setup.

- 1) Press [SETUP].
- 2) Press [▲, ▼] to select "General" and press [OK].
- 3) Press [▲, ▼] to select "Firmware Update" and press [OK].
- 4) Press [▲, ▼] to select "Update Now" and press [OK].
- 5) Press [◀, ▶] to select "Yes" and press [OK].

Network settings

These settings are used if you will connect this unit to the Internet.

- The connection to the Internet may take time or the Internet may not be connected depending on the connection environment. (⇒ 40)
It is required that you use a broadband connection.

Preparation

- Connect to a broadband network. (⇒ 13)

Testing of "IP Address / DNS Settings"

Always test the connection when a LAN cable is connected.

- 1 While stopped
Press [BD/SD] to select "BD/DVD".
- 2 Press [SETUP].
- 3 Press [▲, ▼] to select "Network Settings" and press [OK].
- 4 Press [▲, ▼] to select "IP Address / DNS Settings" and press [OK].
- 5 Press [▲, ▼] to select "Connection Test" and press [OK].

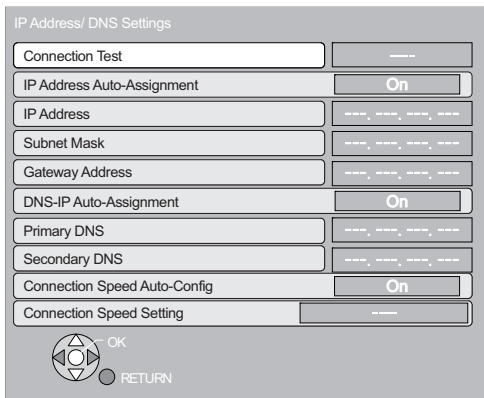

"Testing...": The test is in progress.

"Pass": The connection is completed.
Press [RETURN] to exit.

"Fail": Please check the connection and settings.



- Perform the "Connection Test" also when any change was made to the "IP Address / DNS Settings".

- If the connection test fails, it may be necessary to set the MAC address of this unit at the router side. The MAC address can be displayed by pressing [SETUP] and selecting "Network Settings".

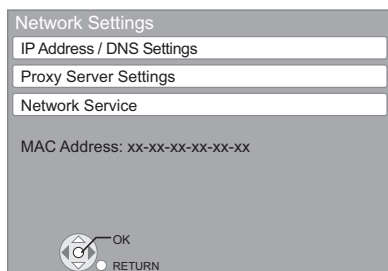

Setting the IP address

In most cases, default settings can normally be used without making any changes.

Set the IP address only when the router has no DHCP server functions or when the router's DHCP server function is disabled.

After performing steps 1-4 (⇒ left)

- 5 Press [▲, ▼] to select "IP Address Auto-Assignment" and press [◀, ▶] to select "Off".
- 6 Press [▲, ▼] to select "IP Address", "Subnet Mask" or "Gateway Address" and press [OK].
- 7 Enter numbers with the numbered buttons and press [OK].
 - After checking the specifications for your broadband router, enter each number.
If the number is unknown, then check the number of other devices such as personal computers connected via a LAN cable. Assign a different number from those of other devices for the "IP Address" and the same number for others.
 - If a wrong number is entered, then press [CANCEL].
- 8 Press [◀, ▶] to select "Yes" and press [OK].



- The numeric input range is between 0 and 255.

Setting the DNS-IP

In most cases, default settings can normally be used without making any changes.

When setting an assigned DNS server from your Internet service provider, perform the following settings.

After performing steps 1-4 (⇒ left)

- 5 Press [▲, ▼] to select "DNS-IP Auto-Assignment" and press [◀, ▶] to select "Off".
- 6 Press [▲, ▼] to select "Primary DNS" or "Secondary DNS" and press [OK].
- 7 Enter numbers with the numbered buttons and press [OK].
 - Follow the instructions given by your Internet service provider and enter the numbers.
If the number is unknown, then check the number of other devices such as personal computers connected via a LAN cable and assign the same number.
 - If a wrong number is entered, then press [CANCEL].

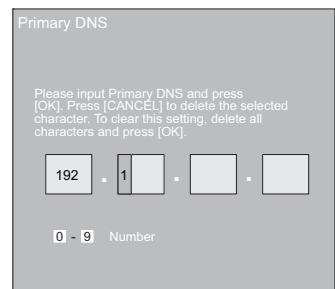

- 8 Press [◀, ▶] to select "Yes" and press [OK].



- The numeric input range is between 0 and 255.

Network settings

Setting the connection speed

When the connection test results displays “Fail” after the IP and DNS-IP addresses are assigned, perform the following settings.

After performing steps ①–④ (⇒ 33)

- ⑤ Press [▲, ▼] to select “Connection Speed Auto-Config” and press [◀, ▶] to select “Off”.
 - ⑥ Press [▲, ▼] to select “Connection Speed Setting” and press [◀, ▶] to select a connection speed.
- Select a connection speed in accordance with the environment of the network connected.
 - When the settings are changed, the network connection may be disabled depending on the device.

Testing of “Proxy Server Settings”

Always test the connection when new “Proxy Server Settings” have been made.

- ① While stopped Press [BD/SD] to select “BD/DVD”.
- ② Press [SETUP].
- ③ Press [▲, ▼] to select “Network Settings” and press [OK].
- ④ Press [▲, ▼] to select “Proxy Server Settings” and press [OK].
- ⑤ Press [▲, ▼] to select “Connection Test” and press [OK].

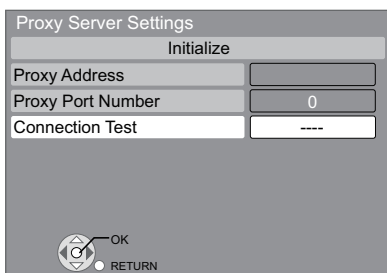

- “Testing...”: The test is in progress.
 “Pass”: The connection is completed. Press [RETURN] to exit.
 “Fail”: Please check the connection and settings.

Setting the proxy server

In most cases, default settings can normally be used without making any changes.

Please use this setting when instructed to by your Internet service provider.

After performing steps ①–④ (⇒ left)

- ⑤ Press [▲, ▼] to select “Proxy Address” and press [OK].
 - The text entry screen is displayed.
 - Text field: shows the text you have entered

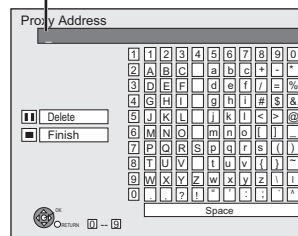

- ⑥ Press [▲, ▼, ◀, ▶] to select a character and press [OK]. Repeat this step to enter other characters.
 - Press [II PAUSE] to delete.
- ⑦ Press [■ STOP] when you complete the entry.
- ⑧ Press [▲, ▼] to select “Proxy Port Number” and press [OK].
- ⑨ Enter numbers with the numbered buttons and press [OK].

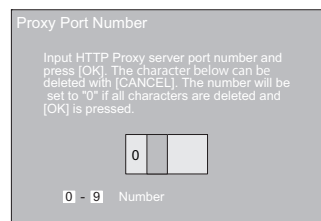

- ⑩ Press [◀, ▶] to select “Yes” and press [OK].



TIPS

- The specified ports may be blocked and not be able to be used depending on the network environment.

In order to restore the default settings
 After performing steps ①–④ (⇒ left)

- 1) Press [▲, ▼] to select “Initialize” and press [OK].
- 2) Press [◀, ▶] to select “Yes” and press [OK].

Using the numbered buttons to enter characters
 e.g., entering the letter “F”

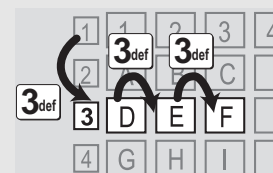

- 1) Press [3] to move to the 3rd row.
- 2) Press [3] twice to highlight “F”.
- 3) Press [OK].

Changing settings with the on-screen menu

On-screen menu operations

- 1 Press [BD/SD] to select "BD/DVD". e.g., BD-Video
- 2 Press [DISPLAY].
- 3 Press [▲, ▼] to select the menu and press [▶].
- 4 Press [▲, ▼] to select the item and press [▶].
- 5 Press [▲, ▼] to select the setting.

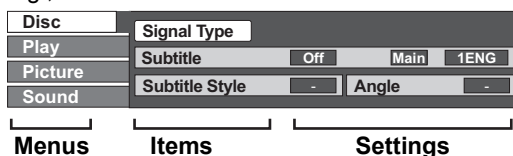

NOTE
• Depending on the condition of the unit (playing, stopped, etc.) and media contents, there may be some items that you cannot select or change.



TIPS
• Some items can be changed by pressing [OK].
To exit the on-screen menu
Press [DISPLAY].

What you can change with the on-screen menu

Menus	Items	Settings and details
Disc	Signal Type	BD-V •Primary Video Video: The video recording method appears. (⇒ below, Video attribute) Soundtrack: Select the type of audio or language. (⇒ below, Language, Audio attribute) •Secondary Video Video: Select on/off of images. The video recording method appears. (⇒ below, Video attribute) Soundtrack: Select on/off of audio and the language. (⇒ below, Language, Audio attribute)
	Video	AVCHD The video recording method appears. (⇒ below, Video attribute)
	Soundtrack	AVCHD DVD-V Select the type of audio or language. (⇒ below, Language, Audio attribute) DVD-VR MPEG2 The audio attributes appear. (⇒ below, Audio attribute) DivX Select the soundtrack number. • Soundtrack numbers are displayed even when there is only one audio type.
	Subtitle	BD-V AVCHD DVD-V Turn the subtitle on/off and select the language. (⇒ below, Language) DVD-VR (Only discs that contain subtitle on/off information) Turn the subtitle on/off. DivX Turn the subtitle on/off and select "Text" or the subtitle number. • Subtitle number is displayed even if there are not multiple subtitles.
	Subtitle Style	BD-V Select the subtitle style.
	Audio channel	DVD-VR DivX MPEG2 (⇒ 19, Changing audio during play)
	Angle	BD-V DVD-V Select the number of the angle.

Some items may be changed only on the disc specific menu. (⇒ 18)

Language

ENG: English	SVE: Swedish	CHI: Chinese	CES: Czech
FRA: French	NOR: Norwegian	KOR: Korean	SLK: Slovak
DEU: German	DAN: Danish	MAL: Malay	HUN: Hungarian
ITA: Italian	POR: Portuguese	VIE: Vietnamese	FIN: Finnish
ESP: Spanish	RUS: Russian	THA: Thai	*: Others
NLD: Dutch	JPN: Japanese	POL: Polish	

Audio attribute

LPCM/ <input type="checkbox"/> Digital/ <input type="checkbox"/> Digital+/ <input type="checkbox"/> TrueHD/DTS/DTS 96/DTS-HD HI RES/DTS-HD MSTR/MPEG	Signal type
ch (channel)	Number of channels
k (kHz)	Sampling frequency
b (bit)	Number of bits
bps (bit per second)	Transfer rate of bit

Video attribute

MPEG-2/MPEG-4 AVC/VC-1	Video recording method
480/576/720/1080	Video Format
24p/50i/60i/50p/60p	Video Frame rate
YCbCr4:2:2/YCbCr4:4:4/RGB	Colour Space
bps (bit per second)	Transfer rate of bit

Changing settings with the on-screen menu

To select these settings, perform steps ① – ⑤ (⇒ 35)

Menus	Items	Settings and details
Play	Repeat Play	(Only when the elapsed time is being displayed on the unit's display.) Selects the item which you want to repeat. The items displayed differ depending on the type of media. ●All tracks All tracks ●Chapter Chapter ●Playlists Playlist ●Title Title ●One track Track ●Off Select "Off" to cancel.
	Random	CD MP3 While playing, press [▲, ▼] to select "On". Random playback starts from the next track. ●On ●Off
	Playback Information Window	BD-V DVD-V Displays audio/video attribute information of disc (Ⓞ), settings status of "Digital Audio Output" (⇒ 38) (Ⓞ) and HDMI output information (HDMI). (⇒ 35 Audio attribute, Video attribute) – Depending on the disc, display method may be different. – The audio attribute information will be displayed following the "Digital Audio Output" settings. (⇒ 38) Press [RETURN] to exit.
Picture	Mode	BD-V AVCHD DVD-VR DVD-V DivX MPEG2 Select the picture quality mode during play. ●Normal: Default setting ●Cinema: Mellows movies, enhances detail in dark scenes. ●Fine: Details are sharper ●Soft: Soft picture with smoother video
	Progressive	Select the method of conversion for progressive output to suit the type of material being played (⇒ 55, Film and video). ●Auto: Automatically detects the film and video content, and appropriately converts it. ●Video: Select when using "Auto" and the content is distorted. ●Film: Select this if the edges of the film content appear jagged or rough when "Auto" is selected. However, if the video content is distorted as shown in the illustration to the right, then select "Auto".
	24p DVD-V	●On ●Off Only when you have selected "On" in "24p Output" (⇒ 39) and play discs recorded at a rate of 60 fields per second.
Sound	Sound Effects*1, 2	●Off Re-master *3 This feature gives you a more natural sound by adding higher frequency signals not recorded on the track. ●Re-master 1: When playing LPCM sound (Type of music): High tempo (e.g., pop and rock) Other types of sound (Effect level): Light ●Re-master 2: When playing LPCM sound (Type of music): Various tempos (e.g., jazz) Other types of sound (Effect level): Medium ●Re-master 3: When playing LPCM sound (Type of music): Low tempo (e.g., classical) Other types of sound (Effect level): Strong
	Dialog Enhancer*1	BD-V AVCHD DVD-VR DVD-V DivX MPEG2 (3 channels or more only, including a centre channel) The volume of the centre channel is raised to make dialog easier to hear. ●On ●Off
	High Clarity Sound	When the analogue video terminal is not being used, the electrical current that flows through the analogue video circuit can be stopped. This prevents adverse effects on the audio signals and produces clearer sound. Use this when outputting image via HDMI Audio Output terminal. Analogue image will not be output via COMPONENT VIDEO OUT terminal or VIDEO OUT terminal. ●On ●Off Only when you have selected "Enable" in "High Clarity Sound" (⇒ 38)

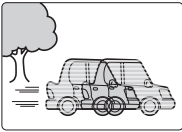

*1 When audio is output from the HDMI AV OUT terminal this function is effective only when "Dolby D/Dolby D +/Dolby TrueHD" or "DTS/DTS-HD" is set to "PCM" (⇒ 38)

*2 Not every function can be set individually.

*3 This function has no effect when the type of audio is Dolby Pro Logic II.

Changing the unit's settings

Change the unit's settings if necessary. The settings remain intact even if you switch the unit to standby.

Setup menu operations

- 1 While stopped
Press [BD/SD] to select "BD/DVD".
- 2 Press [SETUP].
- 3 Press [▲, ▼] to select the menu and press [OK].
- 4 Press [▲, ▼] to select the item and press [OK].
If there are any other items, repeat these steps.
- 5 Press [▲, ▼, ◀, ▶] to select the option and press [OK].

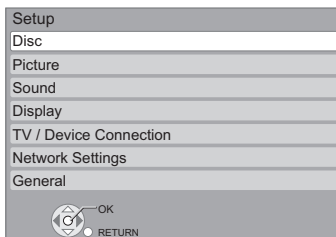

NOTE

- There may be differences in operation methods. If this happens, follow the on-screen instructions for the operation.



TIPS

To return to the previous screen

Press [RETURN].

To exit the screen

Press [SETUP].

Summary of settings

Underlined items are the factory presets.

"Disc"

DVD-Video Ratings Set a ratings level to limit DVD-Video play.	Follow the on-screen instructions. Enter a 4-digit password with the numbered buttons when the password screen is shown. It will be the common password for "DVD-Video Ratings", "BD-Video Ratings" and "Network Lock". Do not forget your password.	<ul style="list-style-type: none"> • <u>8 No Limit</u>: All DVD-Video can be played. • 1 to 7: Prohibits play of DVD-Video with corresponding ratings recorded on them. Prohibits play of all DVD-Video. • 0 Lock All: Prohibits play of all DVD-Video. Changing settings (When level 0 to 7 is selected) <ul style="list-style-type: none"> • Unlock Player • Change Password • Change Level • Temporary Unlock
BD-Video Ratings Set an age limit of BD-Video play.	Follow the on-screen instructions. Enter a 4-digit password with the numbered buttons when the password screen is shown. It will be the common password for "DVD-Video Ratings", "BD-Video Ratings" and "Network Lock". Do not forget your password.	<ul style="list-style-type: none"> • <u>No Limit</u>: All BD-Video can be played. • 0 to 254 year(s): Prohibits play of BD-Video with corresponding ratings recorded on them. Changing settings (When 0 to 254 year(s) is selected) <ul style="list-style-type: none"> • Unlock Player • Change Password • Change Level • Temporary Unlock
Soundtrack Preference	Choose the language for audio, subtitle and disc menus. BD-V DVD-V	<ul style="list-style-type: none"> • <u>English</u> • Italian • Other **** • German • Spanish • French • Dutch • Russian • Original: The original language of each disc will be selected.
Subtitle Preference	<ul style="list-style-type: none"> • Some discs start in a certain language despite any changes you make here. • When the selected language is not available on the disc, the default language is played. There are discs where you can only switch the language from the menu screen. (⇒ 18) • Enter a code (⇒ 54) with the numbered buttons when you select "Other ****". 	<ul style="list-style-type: none"> • <u>Automatic</u>: If the language selected for "Soundtrack Preference" is not available, subtitles of that language will automatically appear if available on that disc. • English • Italian • Other **** • German • Spanish • French • Dutch • Russian
Menu Preference	Choose the language for audio, subtitle and disc menus. BD-V DVD-V	<ul style="list-style-type: none"> • <u>English</u> • Italian • Other **** • German • Spanish • French • Dutch • Russian
BD-Live Internet Access BD-V (⇒ 21) You can restrict Internet access when BD-Live functions are used.	Choose the language for audio, subtitle and disc menus. BD-V DVD-V	<ul style="list-style-type: none"> • <u>Permit</u>: Internet access is permitted for all BD-Live contents. • <u>Limit</u>: Internet access is permitted only for BD-Live contents which have content owner certificates. Internet access is prohibited for all BD-Live contents without a certificate. • <u>Prohibit</u>: Internet access is prohibited for all BD-Live contents.
DivX Subtitle Text DivX Select a suitable item according to the language used for DivX subtitles text (⇒ 22). • This item is displayed only when pressing [SETUP] after playing back a file.	Choose the language for audio, subtitle and disc menus. BD-V DVD-V	<ul style="list-style-type: none"> • <u>Latin 1</u> • <u>Latin 2</u> • Cyrillic • English, German, Spanish, etc. • Polish, Czech, Hungarian, etc. • Russian, etc.

"Picture"

Still Mode BD-V AVCHD DVD-V Select the type of picture shown when you pause playback (⇒ 55, Frames and fields).	<ul style="list-style-type: none"> • <u>Automatic</u> • <u>Field</u>: Select if jittering occurs when "Automatic" is selected. (The picture is coarser.) • <u>Frame</u>: Select if small text or fine patterns cannot be seen clearly when "Automatic" is selected. (The picture is clearer and finer.)
Seamless Play DVD-VR Select the play mode between playlist chapter segments and partially deleted titles.	<ul style="list-style-type: none"> • <u>On</u>: The chapters in playlists are played seamlessly. This does not work while searching or when there are several audio types included on the playlist. Additionally, the positioning of chapter segments may change slightly. • <u>Off</u>: The points where chapters in playlists change are played accurately, but the picture may freeze for a moment.
NTSC Contents Output Select PAL60 or NTSC output when playing NTSC discs.	<ul style="list-style-type: none"> • <u>NTSC</u>: NTSC discs are played as NTSC. • <u>PAL60</u>: Select if picture is not displayed correctly when "NTSC" is selected.

Changing the unit's settings

To select these settings, perform steps ① – ⑤ (⇒ 37)

“Sound”

<p>Dynamic Range Compression BD-V AVCHD DVD-V DivX (Dolby Digital, Dolby Digital Plus and Dolby TrueHD only) Change the dynamic range (⇒ 55) for late night viewing.</p>	<ul style="list-style-type: none"> ● On ● Off ● Auto: Effective only when Dolby TrueHD is played.
<p>Digital Audio Output ● Press [OK] to show the following settings.</p> <p>Dolby D/Dolby D +/ Dolby TrueHD Select whether Dolby Digital, Dolby Digital Plus, Dolby TrueHD, DTS Digital Surround, DTS-HD High Resolution Audio or DTS-HD Master Audio is output in “Bitstream” or “PCM” format.</p> <ul style="list-style-type: none"> ● Not making the proper settings may result in noise. ● If the unit is connected with the HDMI AV OUT terminal, the specifications of the connected equipment take preference over this unit and audio selected in these items may not be output (e.g., when a television is connected, the HDMI audio output of this unit is limited to down-mixed 2ch.) <p>DTS/DTS-HD</p>	<ul style="list-style-type: none"> ● Bitstream: Select “Bitstream” when the connected equipment can decode the respective audio format. – Connect equipment supporting HDMI (High Bit rate Audio) and use a High Speed HDMI Cable in order to output high bit rate audio such as Dolby Digital Plus, Dolby TrueHD, DTS-HD High Resolution Audio or DTS-HD Master Audio. ● PCM: Select “PCM” when the connected equipment cannot decode the respective audio format. <p>Refer to the operating instructions for connected devices to verify whether or not they can decode each of the audio formats.</p>
<p>MPEG Audio</p>	<ul style="list-style-type: none"> ● Bitstream: When connected to equipment with a built-in MPEG decoder. ● PCM: When connected to equipment without a built-in MPEG decoder.
<p>BD-Video Secondary Audio BD-V Turn on/off the clicking sound on the menu and audio with secondary video in picture-in-picture mode. (⇒ 21)</p>	<ul style="list-style-type: none"> ● On: The primary audio and secondary audio are mixed and output. The sampling frequency is converted to 48 kHz. ● Off: The clicking sound on the menu and secondary audio are not output.
<p>PCM Down Conversion Select how to output audio with a sampling frequency of 96 kHz or more. ● Signals are converted to 48 kHz despite the settings across in the following cases: – when the signals have a sampling frequency of over 192 kHz – when the disc has copy protection – when “BD-Video Secondary Audio” is set to “On”</p>	<ul style="list-style-type: none"> ● On: Signals are converted to 48 kHz. (Choose when the connected equipment cannot process signals with sampling frequency of 96 kHz.) ● Off: Signals are output as 96 kHz. (Choose when the connected equipment can process signals with sampling frequency of 96 kHz.)
<p>Downmix Switch the downmix system for playing back multi-channel surround sound.</p> <ul style="list-style-type: none"> ● When “Dolby D/Dolby D +/Dolby TrueHD” or “DTS/DTS-HD” is set to “Bitstream”, there are no downmix effects for the outputted audio. ● The audio will be outputted in “Stereo” in the following cases. – AVCHD playback – Playback of clicking sound on the menu and audio with secondary video in picture-in-picture mode 	<ul style="list-style-type: none"> ● Stereo: When connected to equipment that does not support the virtual surround function. ● Surround encoded: When connected to equipment that supports the conversion from 2 channels to multi channel surround.
<p>High Clarity Sound When the analogue video terminal is not being used, the electrical current that flows through the analogue video circuit can be stopped. This prevents adverse effects on the audio signals and produces clearer sound.</p> <ul style="list-style-type: none"> ● This works only when “BD/DVD”, “SD” or “USB” is selected as the source. ● Set to “Enable” and then set “High Clarity Sound” on the on-screen menu to “On”. (⇒ 36) ● Use this when outputting image via HDMI AV OUT terminal. Analogue image will not be output via COMPONENT VIDEO OUT terminal or VIDEO OUT terminal. 	<ul style="list-style-type: none"> ● Enable ● Disable
<p>Speaker</p>	<p>Refer to page 41</p>
<p>“Display”</p>	
<p>On-Screen Messages Choose whether to show status messages automatically.</p>	<ul style="list-style-type: none"> ● <u>Automatic</u> ● Off
<p>On-Screen Language Choose the language for these menus and on-screen messages.</p>	<ul style="list-style-type: none"> ● <u>English</u> ● Français ● Español ● Deutsch ● Italiano ● Nederlands ● РУССКИЙ
<p>Screen Saver Function This is to prevent burn-in on the screen.</p> <ul style="list-style-type: none"> ● When this is set to “On”, the masked-off area on the screen becomes grey. [Only when connecting with an HDMI cable or a component video cable and “HDMI Video Format” (⇒ 39) is set to any other mode than “576p/480p”, or “Component Resolution” (⇒ 39) is set to “720p” or “1080i”] 	<ul style="list-style-type: none"> ● On: If there is no operation for 5 minutes or more, the displayed screen switches to the other states automatically. – When the Direct Navigator or START menu is displayed, the display returns to the screen saver mode. – When CD or MP3 is played, the display returns to the screen saver mode. (Playback continues.) – When still pictures are shown (except for slideshow), the display returns to the Direct Navigator screen. ● Off
<p>FL Display Changes the brightness of the unit's display. – The brightness of the volume indicator (⇒ 6) is also changed.</p>	<ul style="list-style-type: none"> ● <u>Bright</u> ● Dim: The display is dimmed. ● Automatic: The display is dimmed, but brightens when you perform some operations.
<p>Software Licence</p>	<p>Information about the software used by this unit is displayed.</p>

“TV/Device Connection”

<p>TV Aspect Set to match the type of television connected.</p>	<p>When connected to a 16:9 widescreen television: <ul style="list-style-type: none"> ● 16:9: Video recorded for 4:3 aspect screen is displayed as a 4:3 ratio image in the centre of the screen. <p>When connected to a 4:3 aspect television: <ul style="list-style-type: none"> ● 4:3: Video recorded for a widescreen is played as Pan & Scan (unless prohibited by the producer of the disc). When playing BD-Video, video is output as “4:3 Letterbox”. ● 4:3 Letterbox: Video recorded for a widescreen is played in the letterbox style. </p> </p>
<p>Time Delay*1 When connected with a Plasma display, adjust if you notice the audio is out of sync with the video.</p>	<p>● Auto ● 0ms ● 20ms ● 40ms ● 60ms ● 80ms ● 100ms ● 120ms ● 140ms When using VIERA Link “HDAVI Control” with “HDAVI Control 3” (or later) compatible TV (⇒ 29), select “Auto”. Audio and video will automatically be set in sync. – This works only when “BD/DVD”, “SD”, “USB”, “AUX”, “D-IN1” (DIGITAL IN 1) or “D-IN2” (DIGITAL IN 2) is selected as the source.(⇒ 29)</p>
<p>HDMI Connection ● Press [OK] to show the following settings.</p>	
<p>HDMI Video Mode Select “On” when video is output from HDMI AV OUT terminal.</p>	<p>● On: Images are output from the HDMI AV OUT terminal in the resolution set in “HDMI Video Format”. Video from COMPONENT VIDEO OUT terminal is output as “576i/480i”. ● Off: Images are output in the resolution set in “Component Resolution”.</p>
<p>HDMI Video Format*2 The items supported by the connected devices are indicated on the screen as “*”. When any item without “*” is selected, the images may be distorted.</p>	<p>● Automatic: Automatically selects the output resolution best suited to the connected television (1080p, 1080i, 720p or 576p/480p). ● 576p/480p ● 720p ● 1080i ● 1080p – When outputting 1080p signal, we recommend using High Speed HDMI Cables that have the HDMI logo (as shown on the cover) and are less than 5.0 meters to prevent video distortion etc. – To enjoy high definition video up-converted to 1080p, you need to connect the unit directly to 1080p compatible HDTV (High Definition Television). If this unit is connected to an HDTV through other equipment, it must also be 1080p compatible.</p>
<p>24p Output BD-V DVD-V When this unit is connected to a TV supporting 1080/24p output via an HDMI cable, this unit displays each frame at 1/24 second intervals – the same interval originally shot with the film camera. ● When playing DVD-Video, set to “On” and then set “24p” in “Picture” (⇒ 36) to “On”.</p>	<p>● On: Images in 24p are output in 24p as they are. However, – when video is being output at 24 frames, images from any other terminal than the HDMI AV OUT terminal may not be output properly. – BD-V: when images other than 24p are played, images are output at 60p. ● Off</p>
<p>HDMI Output Range Effective when connected to a device that only supports RGB output.</p>	<p>● Standard: The video is output as it is. ● Enhanced: When the black and white contrast of a video is low, the signal is enhanced to reproduce clear video.</p>
<p>HDMI Audio Output This setting selects whether or not to output audio from HDMI.</p>	<p>● On: To output audio through the TV’s speakers or other devices. ● Off: To output audio through system speakers. (The audio is output using the settings of the main unit.)</p>
<p>VIERA Link Set to use “HDAVI Control” function when connected with an HDMI cable to a device that supports “HDAVI Control”.</p>	<p>● On: ● Off: Select when you do not want to use “HDAVI Control”.</p>
<p>Power Off Link Select the desired power off link setting of this unit for VIERA Link operation (⇒ 29). (This works depending on the settings of the connected VIERA Link “HDAVI Control” compatible equipment.)</p>	<p>● Video/Audio: When the TV is turned off, this unit will turn off automatically. ● Video: When the TV is turned off, this unit will turn off except during the following conditions: – audio playback (CD MP3) – iPod mode – radio mode – “AUX” or “D-IN1” (DIGITAL IN 1) mode (non-selected TV audio setting for VIERA Link) – “D-IN2” (DIGITAL IN 2) mode (non-selected TV audio setting for CABLE/SAT)</p>
<p>Component Resolution*2 This sets the video output resolution when using the COMPONENT VIDEO OUT terminal.</p>	<p>● 576i/480i ● 576p/480p ● 720p ● 1080i 480i, 480p: When playing NTSC discs 576i, 576p: When playing PAL discs Even if you select “720p” or “1080i”, the video output resolution is restricted to “576p/480p” when DVD-Video discs, DivX and BD-Video discs recorded at a rate of 50 field per second are output from the COMPONENT VIDEO OUT terminals.</p>
<p>TV System Change the setting to match the equipment you are connecting with. ● If picture output is not smooth, change the setting. ● When NTSC contents are played, they are outputted in the signal format specified in the “NTSC Contents Output”, irrespective of the settings here.</p>	<p>● NTSC: Select when connecting to a NTSC television. ● PAL: Select when connecting to a PAL or multi-system television.</p>

*1 This function has no effect when S.SURROUND is selected during AUX (TV) playback.

*2 In this unit, a P4HD (⇒ 56) video processor is used to provide video of optimal resolution to the connected TV.

Changing the unit's settings

To select these settings, perform steps ①-⑤(⇒ 37)

“Network Settings”

IP Address / DNS Settings (⇒ 33)

●Press [OK] to show the following settings.

Connection Test	— — — —
IP Address Auto-Assignment	● <u>On</u> ●Off
IP Address	— — — — . — — — — . — — — — . — — — —
Subnet Mask	— — — — . — — — — . — — — — . — — — —
Gateway Address	— — — — . — — — — . — — — — . — — — —
DNS-IP Auto-Assignment	● <u>On</u> ●Off
Primary DNS	— — — — . — — — — . — — — — . — — — —
Secondary DNS	— — — — . — — — — . — — — — . — — — —
Connection Speed Auto-Config	● <u>On</u> ●Off
Connection Speed Setting This is enabled only when “Connection Speed Auto-Config” is turned “Off”.	●10BASE Half Duplex ●10BASE Full Duplex ●100BASE Half Duplex ●100BASE Full Duplex

Proxy Server Settings (⇒ 34)

●Press [OK] to show the following settings.

Initialize	●Yes ● <u>No</u>
Proxy Address	(The initial setting is blank.)
Proxy Port Number	(The initial setting is “0”.)
Connection Test	— — — —

Network Service (⇒ 32) (VIERA CAST)

●Press [OK] to show the following settings.

Network Lock You can restrict using VIERA CAST. Follow the on-screen instructions. Enter a 4-digit password with the numbered buttons when the password screen is shown. It will be the common password for “DVD-Video Ratings”, “BD-Video Ratings” and “Network Lock”. ●Do not forget your password.	● <u>On</u> ●Off Changing settings (When “On” is selected) ●Change Password
Audio Auto Gain Control Volume that is different depending on the contents is adjusted automatically to the standard volume while using the VIERA CAST. ●Depending on contents, this function effect will not work. ●Select “Off” when the audio is warped. ●This function has no effect when Dolby PL II is activated. (⇒ 17)	● <u>On</u> ●Off
Reduced Screen Display The screen is displayed reduced so the displayed screen of the VIERA CAST does not get truncated.	● <u>On</u> ●Off
Time Zone By selecting the time zone, it is possible to set the unit's time to match your location. ●Some VIERA CAST contents require the time zone to be set. Set the time zone if necessary.	●GMT -12 to +12 (The initial setting is “+1”.) GMT 0 = WET (Western European Time) GMT +1 = CET (Central European Time) GMT +2 = EET (Eastern European Time)
Summer Time Select “On” when using Daylight Saving time.	● <u>On</u> ●Off

MAC Address (⇒ 33)

Displays the “MAC Address” of this unit.

“General”

Remote Control (⇒ 51)	● <u>Set Code 1</u> ●Set Code 2
SMART SETUP (⇒ 14) You can execute some essential settings for the unit.	●Yes ● <u>No</u>
Default Settings This returns all values in the Setup menu and the on-screen menu, except for “Remote Control”, “On-Screen Language”, “IP Address / DNS Settings”, “Proxy Server Settings”, “Network Service”, “DVD-Video Ratings” and “BD-Video Ratings” to the default settings.	●Yes ● <u>No</u>
DivX Registration DivX (⇒ 22) You need this registration code to purchase and play DivX Video-on-Demand (VOD) content.	
Firmware Update (⇒ 32) ●Press [OK] to show the following settings.	
Automatic Update Check When this equipment remains connected to the Internet, it will check for the latest firmware version when it is turned on and you can update it if necessary.	● <u>On</u> ●Off
Update Now You can update the firmware manually.	●Yes ● <u>No</u>

Speaker settings

Adjusting the sound lag between speakers

Delay time (ms)

For optimum listening with 5.1-channel sound, all the speakers, except for the subwoofer, should be the same distance from the seating position.

If you have to place the centre, surround speakers closer to the seating position, adjust the delay time to make up for the difference.

If either distance (A) or (B) is less than (C) (⇒ below), find the difference in the relevant table and change to the recommended setting.

- Press [▲, ▼, ◀, ▶] to select the distance box (ms) and press [OK].
- Press [▲, ▼] to select the setting and press [OK].

Approximate room dimensions

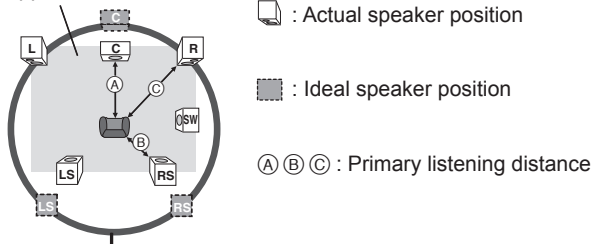

Circle of constant primary listening distance

(A) Centre speaker

Difference	Setting
Approx. 34 cm	1.0 ms
Approx. 68 cm	2.0 ms
Approx. 102 cm	3.0 ms
Approx. 136 cm	4.0 ms
Approx. 170 cm	5.0 ms

(B) Surround

Difference	Setting
Approx. 170 cm	5.0 ms
Approx. 340 cm	10.0 ms
Approx. 510 cm	15.0 ms

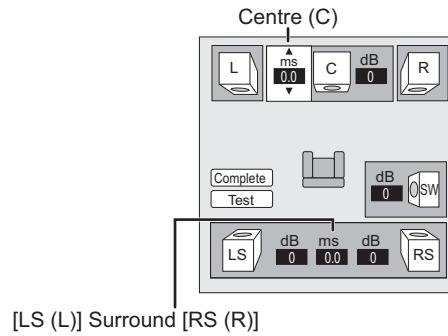

Adjusting speaker level

Volume (Channel balance) (dB) (Effective when playing multi-channel audio)

- Select "Test" and press [OK].
A test signal is output.
Front (L) → Centre (C) → Front (R)
Surround (LS) ← Surround (RS)
- While listening to the test signal, press [▲, ▼] to adjust the volume of each speaker.
The volume can be adjusted between +6 dB to -6 dB.
• Set each speaker level according to the volume of the Front (L) and Front (R) speaker volume respectively.
- Press [OK].
The test signal stops.

- No signal is output for the subwoofer. To adjust its volume, see page 17, Adjusting speaker level during play.

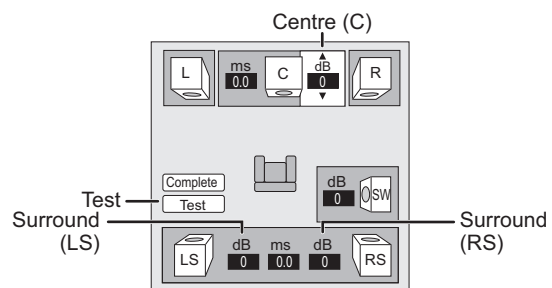

To finish the speaker setting

Press [▲, ▼, ◀, ▶] to select "Complete" and press [OK].

Wireless connections (optional)

Connecting the speakers with the optional wireless system (SH-FX70)

■ Wireless setup diagram

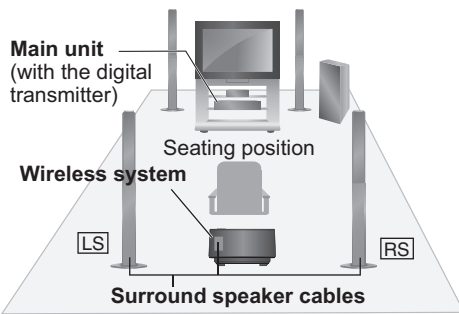

- **LS:** Surround (left), **RS:** Surround (right)
- Place on the side of the seating position.
- Place the speakers at the same height or higher than ear level.



NOTE

- Turn off all equipment before connection and read the appropriate operating instructions.
- **Connect the AC mains lead after all other connections are complete.**
- Do not use the wireless system and digital transmitter in a metal cabinet or bookshelf.
- Place the wireless system within approximately 15 m from the home theatre unit.

Connections

■ Digital transmitter

Do not insert or remove while the home theatre unit is on.

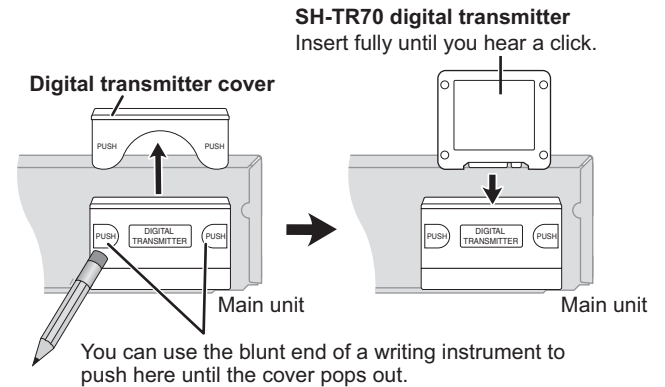

Remove the digital transmitter cover before installing any optional digital transmitter.

- Replace the cover when the digital transmitter is not in use.

Making the wireless link

■ Wireless system

Preparation

If the surround speaker cables (with a blue connector, with a grey connector) have already been connected, disconnect them from the main unit and the speakers.

Connecting the cables

Use the cables supplied with the wireless system.

- It is also possible to use the original cables supplied with the main unit.

Left side speakers

SURROUND (LS): Blue

Right side speakers

SURROUND (RS): Grey

Connecting the speakers to the wireless system

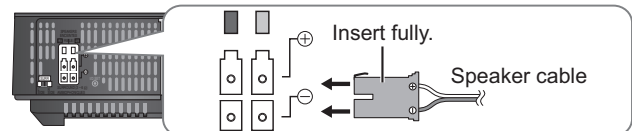

Connect to terminals of the same colour.

Setting the Surround selector

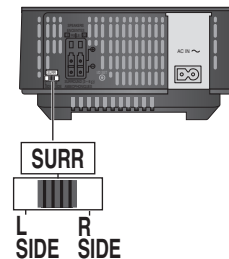

■ AC mains lead

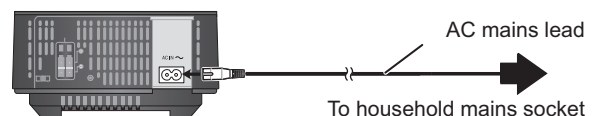

1 Turn on the wireless system.

Unit on/off button [I,]

Use this button to turn the unit on and off.

I: The unit is on. : The unit is off.

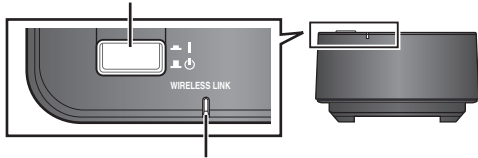

WIRELESS LINK indicator

Red: The unit is on and the wireless link is deactivated. Turn off and on the wireless system.

Green: The unit is on and the wireless link is activated.

2 Turn on the main unit.

The wireless link indicator on the main unit will be turned on.

e.g.



• If the indicator is flashing, refer to the "Optional wireless system (SH-FX70)" in the Troubleshooting guide. (⇒ 51).

3 Start play on the main unit.



NOTE

- For optimal audio output, it is recommended to re-configure the main unit using SMART SETUP. (⇒ 14)
- You cannot use the wireless system with SH-FX65T or SH-FX67T digital transmitter.

Speaker installation option

Attaching to a wall

You can attach all of the speakers (except subwoofer) to a wall.

- The wall or pillar on which the speakers are to be attached should be capable of supporting 10 kg per screw. Consult a qualified building contractor when attaching the speakers to a wall. Improper attachment may result in damage to the wall and speakers.

1 Drive a screw (not included) into the wall.

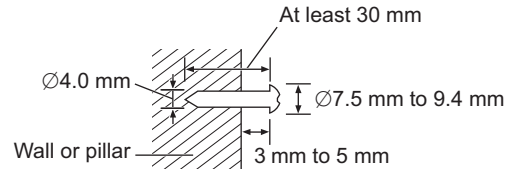

2 Fit the speaker securely onto the screw(s) with the hole(s).

BT205

Front and surround speaker

Attach to a wall without the base and the stand

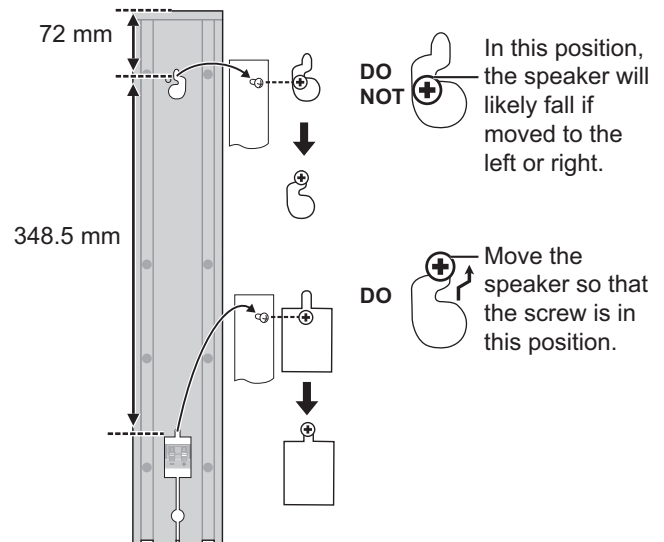

BT200

Front and surround speaker

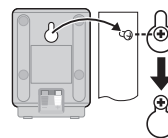

Centre speaker

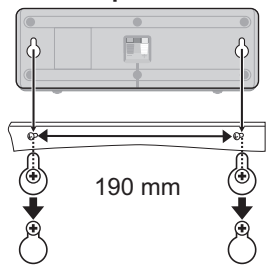

Reattaching the speaker cables **BT205**

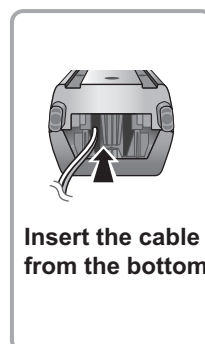

Insert the cable from the bottom.





Leave about 120 mm



Pull out the cable through the hole.

Media (Disc, card and USB device) information

Packaged discs

This chart shows the different type of retail/commercial discs you can use, and also includes the industry-standard logos that should appear on the discs and/or packaging.





Type of media/Logo	Features	Indicated as
BD-Video 	High Definition (HD) movie and music discs <ul style="list-style-type: none"> Discs supporting BD-Live (BD-ROM Profile 2) that allows interactive functions to be used when this unit is connected to the Internet in addition to the BONUSVIEW function.  <ul style="list-style-type: none"> Discs supporting BONUSVIEW (BD-ROM Profile 1 version 1.1/Final Standard Profile) that allows Picture-in-Picture functions to be used. BONUSVIEW™	BD-V

Type of media/Logo	Features	Indicated as
DVD-Video  	High quality movie and music discs	DVD-V
CD 	Compact Discs (CD's) that contain audio and music <ul style="list-style-type: none"> Operation and sound quality of CDs that do not conform to CD-DA specifications (copy control CDs, etc.) cannot be guaranteed. 	CD

Recorded discs

This chart shows the different type of discs recorded with other devices that you can use.

Finalized This mark means you must finalize the disc with the DVD recorder, etc. before playback. For details about finalizing, refer to the operating instructions for your equipment.

Type of media/Logo	Formats	Indicated as
BD-RE 	<ul style="list-style-type: none"> Version 3 of the BD-RE Recording Format JPEG format 	BD-V JPEG
BD-R 	<ul style="list-style-type: none"> Version 2 of the BD-R Recording Format 	BD-V
DVD-RAM 	<ul style="list-style-type: none"> Version 1.1 of the DVD Video Recording Format JPEG format AVCHD format 	DVD-VR JPEG AVCHD
DVD-R/RW Finalized  	<ul style="list-style-type: none"> DVD-Video Format Version 1.1 of the DVD Video Recording Format MP3 format (DVD-RW is not supported) JPEG format (DVD-RW is not supported) AVCHD format DivX format (DVD-RW is not supported) 	DVD-V DVD-VR MP3 JPEG AVCHD DivX

Type of media/Logo	Formats	Indicated as
DVD-R DL Finalized 	<ul style="list-style-type: none"> DVD-Video Format Version 1.2 of the DVD Video Recording Format MP3 format JPEG format AVCHD format DivX format 	DVD-V DVD-VR MP3 JPEG AVCHD DivX
+R/+RW/+R DL Finalized	<ul style="list-style-type: none"> +VR (+R/+RW Video Recording) Format AVCHD format 	DVD-V AVCHD
CD-R/RW Finalized	<ul style="list-style-type: none"> CD-DA format MP3 format JPEG format DivX format 	CD MP3 JPEG DivX

- It may not be possible to play the above discs in some cases due to the type of discs, the condition of the recording, the recording method and how the files were created.
- When a disc recorded in the AVCHD format is being played, the video may be paused for a few seconds at portions spliced, due to deletion or editing.

■ About playback compatibility for BD-R and BD-RE with high definition recordings of high definition broadcasts

With SC-BT200 or SC-BT205 purchased in the below countries, it is possible to playback discs with recordings of the high definition broadcasts listed to the right which were recorded with Panasonic Blu-ray Disc Recorder.

As high definition broadcasts are a new technology, areas confirmed as of March 2009 are as below.

Country	Digital Broadcast
France	TNT HD (Compatible models SC-BT200EG or SC-BT205EG)
United Kingdom	freesat (Compatible models SC-BT200EB or SC-BT205EB)

- This unit is not compatible with HE-AAC (High-Efficiency Advanced Audio Coding). Digital Broadcast programmes with HE-ACC audio that are recorded onto a BD-R or BD-RE in DR mode on a Panasonic Blu-ray Disc Recorder cannot be played on this unit.
- To playback titles recorded on a Panasonic Blu-ray Disc Recorder, be sure to change the recording mode.

SD cards

This chart shows the different type of cards recorded with other devices that you can use.

Type of media	Formats	Indicated as
SD Memory Card* (from 8 MB to 2 GB)	• JPEG format	JPEG
SDHC Memory Card (from 4 GB to 32 GB)	• AVCHD format • MPEG2 format	AVCHD MPEG2

* Including miniSD Card and microSD Card

In these operating instructions, the cards shown in the table (⇒ above) are comprehensively called SD cards.

- A miniSD Card and a microSD Card must be used with the attached adaptor that comes with the card.
- When using from 4 GB to 32 GB SD cards, only SD cards that display the SDHC logo can be used.
- This unit is compatible with SD Memory Cards that meet SD Card Specifications FAT12 and FAT16



formats, as well as SDHC Memory Cards in FAT32 format.

- Useable memory is slightly less than the card capacity.
- If the SD card is formatted on a PC, you may not be able to use it on this unit.
- We recommend using a Panasonic SD card. Please confirm the latest information on the following website.
<http://panasonic.co.jp/pavc/global/cs>
(This site is in English only.)
- Keep the Memory Card out of reach of children to prevent swallowing.
- When a card recorded in the AVCHD format is being played, the video may be paused for a few seconds at portions spliced, due to deletion or edition.
- Switch the write-protect switch to the "LOCK" position to protect the content from accidental erasure.

USB device

This unit can playback pictures by connecting the USB memory recorded with a PC or similar in following formats, and Panasonic digital cameras connected via USB cable.

Type of media	Formats	Indicated as
USB device	• MP3 format • JPEG format • DivX format	MP3 JPEG DivX

Compatible USB devices

- USB devices which are defined as USB mass storage class.
 - USB devices that support USB 1.0/1.1 and USB 2.0 Full Speed/High Speed.
- USB devices of up to 128 GB can be used.
- USB devices that support bulk only transfer. CBI (Control/Bulk/Interrupt) is not supported.
- Digital Cameras which require additional programme installation when connected to a PC are not supported.
- MTP (Media Transport Protocol) device is not supported.

- A multi-port USB card reader is not supported.

File system

- FAT12, FAT16 and FAT32 file systems are supported.
- UDF/NTFS/exFAT file system is not supported.
- Depending on the sector size, some files may not work.
- Only the first partition on USB devices with multi-partition is supported.

Despite meeting the conditions mentioned above, there may be USB device that cannot be used with this unit.

This unit does not support USB device charging.

Regarding 24p output **BD-V**

Many BD-Video movie contents are recorded in 24 frames/second in accordance with the film materials. However, they will normally be output in 60 frames/second in accordance with the display format.

These can be output in 24p as the original. Therefore, high-quality video can be enjoyed with improved clarity, enhanced perspective, etc.

NECESSARY CONNECTIONS

- Connect to a TV supporting 1080/24p input via an HDMI cable.

NECESSARY SETTINGS

- "24p Output": "On" (⇒ 39)

Discs that cannot be played

- BD-RE with the cartridge
- 2.6 GB and 5.2 GB DVD-RAM
- 3.95 GB and 4.7 GB DVD-R for Authoring
- DVD-RAM that cannot be removed from their cartridges
- Version 1.0 of DVD-RW
- DVD-ROM, CD-ROM, CDV, SACD, Photo CD, MV-Disc and PD
- DVD-Audio
- Video CD and SVCD
- WMA discs
- HD DVD
- Other discs that are not specifically supported

About MP3/JPEG/DivX files

File format	MP3	JPEG
Playable media	CD-R*1, CD-RW*1, DVD-R*1, DVD-R DL*1, USB device	CD-R*1, CD-RW*1, DVD-RAM*2, DVD-R*1, DVD-R DL*1, BD-RE*3, SD card, USB device
Extension	Files must have the extension “.mp3” or “.MP3”.	Files must have the extension “.jpg” or “.JPG”.
Picture resolution	—	between 34×34 and 8192×8192 pixels (sub sampling is 4:2:2 or 4:2:0)
Compression rate	32 kbps to 320 kbps	—
Sampling rate	44.1 kHz/48 kHz	—
Reference	ID3 tags: version 1, 2.2, 2.3, 2.4 ID3 is a tag embedded in MP3 track to provide information about the track. This unit supports the versions listed above but only titles and the names of artists can be displayed. ● If there is a large amount of still picture data etc. within a MP3 file, play may not be possible.	JPEG conforming DCF*4 is supported. Thawing Time: approx. 2 sec. (7M pixels) ● MOTION JPEG and Progressive JPEG is not supported.

File format	DivX	Subtitles text file of DivX
Playable media	CD-R*1, CD-RW*1, DVD-R*1, DVD-R DL*1, USB device	CD-R*1, CD-RW*1, DVD-R*1, DVD-R DL*1, USB device
File format	—	MicroDVD, SubRip, or TMPlayer
Extension	Files must have the extension “.DIVX”, “.divx”, “.AVI” or “.avi”.	Files must have the extension “.SRT”, “.srt”, “.SUB”, “.sub”, “.TXT”, or “.txt”
Picture resolution	between 32×32 and 720×576 pixels	—
Reference	<ul style="list-style-type: none"> ● Certified to the DivX Home Theatre Profile. <ul style="list-style-type: none"> Video <ul style="list-style-type: none"> – Number of stream: Up to 1 – Codec: DIV3, DIV4, DIVX, DV50, DIV6 – FPS (Frame Per Second): Up to 30 fps Audio <ul style="list-style-type: none"> – Number of stream: Up to 8 – Format: MP3, MPEG, Dolby Digital – Multi channel: Dolby Digital is possible. MPEG multi is 2 ch conversion. ● GMC (Global Motion Compensation) is not supported. 	<ul style="list-style-type: none"> ● The DivX video file and subtitles text file are inside the same folder, and the file names are the same except for the file extensions. ● If there are more than one subtitles text files inside the same folder, they are displayed in the following order of priority: “.srt”, “.sub”, “.txt” ● In the following situations, the subtitles cannot be displayed as recorded. Furthermore, depending on the methods used to create the file or the state of the recording, only parts of the subtitles may be displayed, or the subtitles may not be displayed at all. <ul style="list-style-type: none"> – When special text or characters are included in the subtitles text. – When the file size is larger than 256 KB. – When characters with specified styling are included in the subtitle data. – Codes that specify the character style within files are displayed as subtitle characters. – When data with a different format exists within the subtitle data. ● If the file name of the DivX video file is not displayed correctly on the menu screen (the file name is displayed as “_”), the subtitles text may not be displayed correctly. ● Depending on the disc, the subtitles text cannot be displayed when search and other such operations are being performed.

- English alphabet and Arabic numerals are displayed correctly. Other characters may not be displayed correctly.
- The display order on this unit may differ from how the order is displayed on a computer.
- Depending on how you create the media (writing software), files and folders may not play in the order you numbered them.
- Depending on how you create the structure of folders (writing software), files and folders may not play. (⇒ 47)
- This unit is not compatible with packet-write format.
- Depending on the recording conditions, the media may not play.
- Operation may take time to complete when there are many files and/or folders and some files may not display or be playable.

*1 ISO9660 level 1 or 2 (except for extended formats), Joliet

This unit is compatible with multi-session.

This unit is not compatible with packet writing.

*2 Discs must conform to UDF 2.0.

*3 Discs must conform to UDF 2.5.

*4 Design rule for Camera File system: unified standard established by Japan Electronics and Information Technology Industries Association (JEITA).

■ **Structure of folders that can play back on this unit**
 You can play files on this unit by structure of folders as shown below. However depending on the method of writing data (writing software), play may not be in the order you numbered the folders.

 : Folder which can be displayed with this unit

***: Numbers

XXX: Letters

*1 ***: from 001 to 999

*2 ***: from 100 to 999

XXX: up to 5 figures

*3 ***: from 0001 to 9999

Structure of MP3 folders in DVD-R/DVD-R DL/CD-R/CD-RW/USB device

Prefix the file names with 3-digit numbers in the order you want to play them.

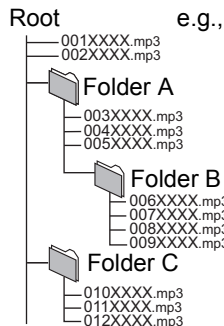

Structure of DivX folders in DVD-R/DVD-R DL/CD-R/CD-RW/USB device

Files inside a folder are displayed in the order they were updated or taken.

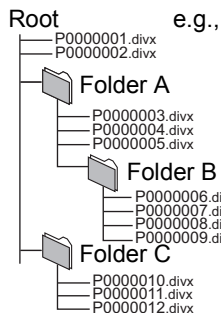

Structures of still picture (JPEG) folders

in DVD-R/DVD-R DL/CD-R/CD-RW

Files inside a folder are displayed in the order they were updated or taken.

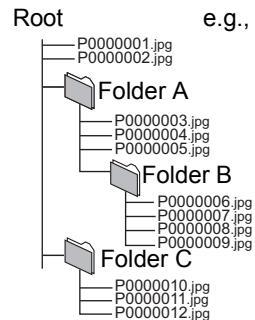

in BD-RE/DVD-RAM

● Folder structure is not displayed.

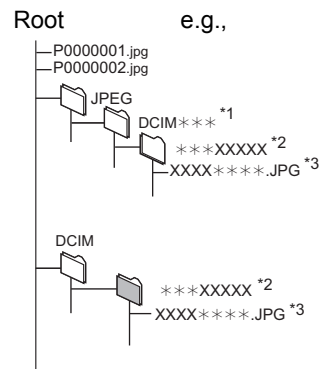

in SD card/USB device

Displays JPEG files in all folders.

● Folder structure is not displayed.

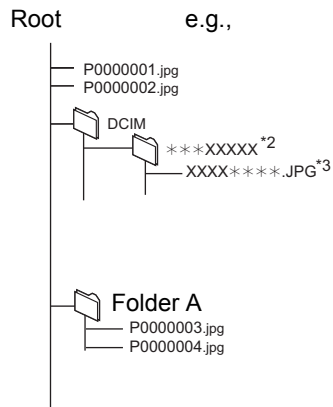

Troubleshooting guide

Before requesting service, make the following checks. If you are in doubt about some of the check points, or if the solutions indicated in the chart do not solve the problem, consult your dealer for instructions.

The following do not indicate a problem with this unit:

- Regular disc rotating sounds.
- Image disturbance during search.

To reset this unit

		Page
To restore the unit if it freezes due to one of the safety devices being activated	•Press and hold [⏻/⏻] on the main unit for 3 seconds. (The settings remain unchanged.)	—
To return all settings other than some settings to the factory preset	•Select “Yes” in “Default Settings” in the Setup menu. This returns all values in the Setup menu and the on-screen menu, except for “Remote Control”, “On-Screen Language”, “IP Address / DNS Settings”, “Proxy Server Settings”, “DVD-Video Ratings”, “BD-Video Ratings” and “Network Service” to the default settings.	40
To return to the factory preset (No setting)	•Reset the unit as follows: 1 Press [⏻/⏻] on the unit to turn off the unit. 2 Press and hold [▶▶/▶▶] and press [⏻/⏻] and [▲ OPEN/CLOSE] on the unit at the same time for more than 5 seconds until “PLEASE WAIT” is displayed on the unit. 3 The power is turned on and then turned off automatically.	—

Power

No power.	•Insert the AC mains lead securely into a household mains socket.	13
The unit switches to standby mode.	•When the time set for the sleep timer has passed, the power will be turned off. •One of the unit’s safety devices is activated. Press [⏻/⏻] on the main unit to turn the unit on.	20 —
Power of this unit is turned off when the input for the TV is changed.	•If connected with an HDAVI Control 4 compatible TV (VIERA) with the “Intelligent Auto Standby” setting activated on the TV, when switching the TV input, the unit will be automatically turned to standby if the TV audio is not output from the unit’s speakers. For details please read the operating instructions of the TV.	29

Operation

The remote control doesn’t work properly.	<ul style="list-style-type: none"> •The remote control and main unit are using different codes. Change the code on the remote control. Press and hold [OK] and the indicated number button at the same time for more than 5 seconds.  •The batteries are depleted. Replace them with new ones. •It may be necessary to set the code of the remote control again after changing the batteries for remote control. •You are not pointing the remote control at the main unit’s remote control signal sensor during operation. •Coloured glass may obstruct the signal reception/transmission. •Don’t place the signal sensor in direct sunlight or in areas that may be subject to sunlight exposure. 	51 5 5, 51 5 — —
The unit is on but cannot be operated.	<ul style="list-style-type: none"> •Confirm the correct drive is selected. •Some operations may be prohibited by the disc. •The unit is hot (“U59” appears on the display). Wait for “U59” to disappear. •One of the unit’s safety devices may have been activated. Reset the unit as follows: 1 Press [⏻/⏻] on the main unit to switch the unit to standby. If the unit doesn’t switch to standby, press and hold [⏻/⏻] on the main unit for about 3 seconds. The unit is forcibly switched to standby. Alternatively, disconnect the AC mains lead, wait one minute, then reconnect it. 2 Press [⏻/⏻] on the main unit to switch it on. If the unit still cannot be operated, consult the dealer. <ul style="list-style-type: none"> •Condensation has formed. Wait 1 to 2 hours for it to evaporate. 	16 — 53 — —
Play fails to start even when [▶PLAY] is pressed. Play starts but then stops immediately.	<ul style="list-style-type: none"> •Insert the disc correctly with the label facing up. •The disc is dirty. •You tried to play a blank media or unplayable media on this unit. •DivX If playing DivX VOD content, refer to the homepage where you purchased it. •The producers of the disc can control how discs are played. So you may not always be able to control play as described in these operating instructions. Read the disc’s instructions carefully. 	18 3 44, 45 22 —
Cannot eject disc.	•The unit may have a problem. While the unit is off, press and hold [▶▶/▶▶] and [▲ OPEN/CLOSE] on the main unit at the same time for about 5 seconds. Remove the disc and consult the dealer.	—
Startup is slow. It takes time before play starts.	•Startup takes time in the following situations. –Immediately after a power failure or the AC mains lead is connected. –When the unit is connected with an HDMI cable.	—
Played back image is distorted or does not playback correctly. (AVCHD)	•High definition video (transfer rate of 18 Mbps or faster) cannot be played back correctly if it was recorded on a DVD compatible to double speed or slower.	—
Cannot set “On” in “24p Output”.	•Only when the unit is connected to the HDMI terminal of a TV supporting 24p you can select “On”.	39

Displays

Page

The display is dim.	<ul style="list-style-type: none"> Change “FL Display” in the Setup menu. 	38
The elapsed time displayed is actually less than the play time.	<ul style="list-style-type: none"> The displayed play time is converted from the number of frames at 29.97 frames (equal to 0.999 seconds) to one second. There will be a slight difference between the time displayed and the actual elapsed time (e.g., actual one-hour elapsed time may display as approximately 59 minutes 56 seconds). 	—

TV screen and video

The images from this unit do not appear on the television.	<ul style="list-style-type: none"> Make sure that the television is connected to the VIDEO OUT terminal, COMPONENT VIDEO OUT terminals or HDMI AV OUT terminal on this unit. Make sure that the television’s input setting (e.g., AV 1) is correct. An incorrect resolution is selected in “HDMI Video Format”, when the television is connected to HDMI AV OUT terminals. While stopped, press and hold [▶PLAY] and [■STOP] on the main unit at the same time for more than 5 seconds to cancel this setting. Set the item again. However, Dolby Digital Plus, Dolby TrueHD, and DTS-HD audio are not output in bitstream. To output the bitstream, select “Default Settings” to restore the factory presets and make proper settings. 	10, 11
Picture is distorted.	<ul style="list-style-type: none"> To output video from a device connected with an HDMI cable, set “HDMI Video Mode” to “On” in the Setup menu. If “24p Output” is set to “On” when the unit is connected to a TV through any terminal other than HDMI, images may not display properly. In this case, set “24p Output” to “Off”. 	— 39
Jittering occurs.	<ul style="list-style-type: none"> When “24p Output” is set to “On”, HDMI authentication takes place where 24p images switch to other images, and a black screen is displayed. When “24p Output” is set to “On”, jittering may occur while playing DVD-Video. In this case, turn “24p Output” to “Off”. An incorrect resolution is selected in “Component Resolution”, when the television is connected to COMPONENT VIDEO OUT terminals. While stopped, press and hold [▶PLAY] and [■STOP] on the main unit at the same time for more than 5 seconds to cancel this setting. Set the item again. Picture may not be seen when more than 2 devices are connected with HDMI cables. Reduce the number of connected devices. The unit and television are using different video systems. While stopped, keep pressing [■STOP] and [▲OPEN/CLOSE] on the main unit for 5 or more seconds. The system switches from PAL to NTSC or vice versa. The system used on the disc doesn’t match your television. <ul style="list-style-type: none"> –PAL discs cannot be correctly viewed on an NTSC television. –This unit can convert NTSC signals to PAL60 for viewing on a PAL television (“NTSC Contents Output” in the “Picture”). DivX Images may not be output due to how files were created. If you are using an indoor TV antenna, change to an outdoor antenna. The TV antenna wire is too close to the unit. Move it away from the unit. 	39 39 39 39 39 — — — 37 — — —
Picture stops.	<ul style="list-style-type: none"> DivX Picture may stop if the DivX files are greater than 2 GB. 	—
The screen changes automatically.	<ul style="list-style-type: none"> When the “Screen Saver Function” in the Setup menu is set to “On”, the display may return to the screen saver mode automatically if there is no operation for 5 minutes or more. 	38
Video is not output.	<ul style="list-style-type: none"> An image is not output from the COMPONENT VIDEO OUT terminal or the VIDEO OUT terminal when the “High Clarity Sound” is enabled. Set the “High Clarity Sound” in the on-screen menu to “Off” to use the COMPONENT VIDEO OUT terminal or the VIDEO OUT terminal. 	36
Video is not output in high definition.	<ul style="list-style-type: none"> High definition video cannot be output through the VIDEO OUT terminal. Confirm that the “HDMI Video Mode”, “HDMI Video Format”, and “Component Resolution” in the Setup menu are set properly. The video output resolution is restricted to “576p/480p” when DVD-Video discs, DivX and BD-Video discs recorded at a rate of 50 field per second are output from the COMPONENT VIDEO OUT terminals. 	— 39 —
The Setup menu cannot be accessed.	<ul style="list-style-type: none"> Select “BD/DVD” as the source. 	—
Status messages do not appear.	<ul style="list-style-type: none"> Select “Automatic” in “On-Screen Messages” in the Setup menu. 	38
The 4:3 aspect ratio picture expands left and right. Screen size is wrong.	<ul style="list-style-type: none"> Use the television to change the aspect. Refer to your television’s operating instructions. When using a component video cable, set “Progressive” to “Video”. If the situation is not restored after that, set “TV Aspect” to “4:3”. When using an HDMI cable, set “TV Aspect” to “16:9”. 	— 36, 39 39
When playing DVD-Video using progressive output, one part of the picture momentarily appears to be doubled up.	<ul style="list-style-type: none"> When you use the HDMI AV OUT terminal for video output, follow the steps below for setting. <ol style="list-style-type: none"> Connect this unit to the TV with any cable except the HDMI cable. When you connect with the Component Video cable, set “HDMI Video Mode” to “Off” and “Component Resolution” to “576i/480i” in the Setup menu. 	39
There is no apparent change in picture quality when adjusted with the “Picture” menu in the on-screen menu.	<ul style="list-style-type: none"> The effect is less perceivable with some types of video. 	—
The masked-off area is masked in grey.	<ul style="list-style-type: none"> If the “Screen Saver Function” in the Setup menu is set to “Off”, the masked-off area is displayed in black. 	38
Still pictures (JPEG) do not playback normally.	<ul style="list-style-type: none"> The images that were edited on the PC, such as Progressive JPEG, etc., may not playback. 	46
After choosing “Home Cinema” in “Speaker Selection” with the TV’s remote control, the TV’s input selection also changes.	<ul style="list-style-type: none"> Disconnect the HDMI cable from the TV and reconnect it to a different HDMI terminal. 	—

Troubleshooting guide

Sound

		Page
No sound. Low volume. Distorted sound. Cannot hear the desired audio type.	• Turn the volume up.	18
	• Turn the muting off.	18
	• Check connections to speakers and other equipment.	9–12
	• Select the corresponding source.	16
	• Press [AUDIO] to select the audio.	19
	• Ensure the speaker settings for your speakers are correct.	41
	• To output audio from a device connected with an HDMI cable, set “HDMI Audio Output” to “On” in the Setup menu.	39
	• When “BD-Video Secondary Audio” is set to “On”, Dolby Digital Plus, Dolby TrueHD, and DTS-HD are converted to 48 kHz Dolby Digital or DTS Digital Surround and output. LPCM 7.1 channel audio is converted to 5.1 channel audio. In this case, set the “BD-Video Secondary Audio” to “Off”.	38
	• Audio may not be heard when more than 2 devices are connected with HDMI cables. Reduce the number of connected devices.	—
	• Re-master will not work when the bitstream signal is output from the HDMI AV OUT terminal.	36
• Depending on the connected equipment, the sound may be distorted if this unit is connected with an HDMI cable.	—	
• The multi-channel audio from a device connected to the TV is not output in its original multi-channel form.	12, 27	
– If the device has an optical audio output terminal, connect the device to this unit’s “OPTICAL IN 2(STB)” terminal.		
• DivX Audio may not be output depending on how files were created.	—	
Humming is heard during play.	• An AC mains lead or fluorescent light is near this unit. Keep other appliances and cables away from this unit.	—
No surround sound.	• Press [SURROUND] to select a surround effect.	17
Cannot switch audio.	• There are discs for which audio cannot be changed because of how the disc was created. • When audio is output from the HDMI AV OUT terminal, you cannot switch the audio if “Dolby D/Dolby D +/Dolby TrueHD” or “DTS/DTS-HD” is set to “Bitstream”. Set “Dolby D/Dolby D +/Dolby TrueHD” or “DTS/DTS-HD” to “PCM”.	— 38
No sound from the TV	• Press [EXT-IN] to select the corresponding source.	16

Card

The capacity of the SD card decreased.	• When a BD-Video that supports the BD-Live is used, and an SD card is in the slot, data may be written to the SD card. Erase the data by using “BD-Video Data Erase”, format the card or use a new card.	21
Music on an SD card cannot be played.	• Data that can be played from an SD card are AVCHD, MPEG2 and JPEG data.	45
The contents of the card cannot be read.	• The card is not compatible or the contents on the card may be damaged. • Turn off and then turn on the unit.	45 —

USB

The contents of the USB device cannot be read.	• Remove the USB device from the USB port and then insert again. If this does not solve the problem, turn off and turn on the unit again.	—
	• Check that the USB device is inserted correctly.	18
	• The format of the USB device or of its contents is not compatible with the unit. (The contents on the USB device may be damaged.)	45
	• The USB device contains a folder structure and/or file extensions that are not compatible with this unit.	47
	• Turn off and then turn on the unit again.	—
	• USB memories connected using a USB extension cable or a USB hub may not be recognized by this unit.	—
	• Some USB devices cannot be used with this unit. • If inserted during playback the USB device may not be recognized by this unit.	45 —
USB device cannot be operated.	• Turn the power of this unit off once, and turn it back on.	—

iPod operation

Cannot charge or operate.	• Check that the iPod is connected firmly. • The battery of the iPod is depleted. Charge the iPod, and then operate again.	30 —
Cannot display iPod videos/photos on the TV.	• Make sure that TV is connected to the VIDEO OUT terminal on this unit. • Operate the iPod menu to make the appropriate video/photo output settings for your TV. (Refer to operating instructions for your iPod.)	10 —
The TV input channel unintentionally changes to HDMI input.	• When the main unit is connected with an “HDAVI Control” compatible TV and VIDEO IN is selected for iPod video or photo playback, the TV input channel will automatically change to the HDMI input channel when [START] is pressed. – Re-select the TV’s VIDEO IN input channel.	—

Radio

Distorted sound or noise is heard. “ST” flickers or does not light.	• Adjust the position of the antenna. • Use an outdoor antenna.	— 12
A beat sound is heard.	• Turn the TV off or move it away from the unit.	—

No power.	<ul style="list-style-type: none"> • Ensure the AC mains lead of the wireless system is connected properly. 	—
The indicator on the wireless system does not turn green even though [I/D SET] is pressed and pairing completed.	<ul style="list-style-type: none"> • Turn the wireless system off and then back on. 	—
The wireless link indicator (e.g. “W1” or an indicator) is flashing.	<ul style="list-style-type: none"> • There is no link between the main unit and the wireless system. Turn the wireless system off and then back on. Alternatively, turn the wireless system off, disconnect the AC mains lead, and then reconnect it. 	—
The wireless link indicator (e.g. “W1” or an indicator) does not light.	<ul style="list-style-type: none"> • Check that the main unit is turned on, and the wireless system is turned on. • Ensure that the digital transmitter is fully inserted into the slot of the main unit. • Ensure the surround sound setting on the main unit. 	— 42
The wireless link indicator keeps flashing between red and green.	<ul style="list-style-type: none"> • There is a power supply problem. Consult the dealer. 	—

Network

I can't connect to the network.	<ul style="list-style-type: none"> • Has the LAN cable come unplugged? Check that the LAN cable is properly connected. 	13
	<ul style="list-style-type: none"> • Have you plugged in a modular cable for use with a telephone into the LAN terminal on this unit? Connect with a straight LAN cable. 	13
	<ul style="list-style-type: none"> • Is the power for the modem or broadband router turned on? Turn the power on for each device. 	—
	<ul style="list-style-type: none"> • Is there a mistake in the network settings? Follow any instructions you may have received from your ISP (Internet Service Provider) and make changes to the settings. 	—
	<ul style="list-style-type: none"> • Are the broadband router settings correct? Read the operating instructions for the broadband router. 	—
	<ul style="list-style-type: none"> • Is the broadband router and/or modem correctly connected? Check the operating instructions for each device and connect accordingly. • Check the “Network Settings” and “BD-Live Internet Access” settings. 	37, 40
While using my PC, I cannot connect to the network.	<ul style="list-style-type: none"> • Does your Internet Service Provider (ISP) or service contract prevent multiple terminals connecting at the same time? Check the content of your contract. 	—
VIERA CAST does not operate or connect.	<ul style="list-style-type: none"> • Is the network connection correct? • Image of the video contents may be incomplete or may not display depending on how busy the environment or the connected line is. 	13

Other difficulties with playback

Audio and video momentarily pause.	<ul style="list-style-type: none"> • This occurs between playlist chapters or scenes (AVCHD). • When playing a title recorded on both layers, the unit automatically switches between layers and plays the title in the same way as a normal programme. However, video and audio may momentarily cut out when the unit is switching layers. 	— —
BD-Video or DVD-Video is not played.	<ul style="list-style-type: none"> • Ensure the disc is for the correct BD-Video region code or DVD-Video region number, and is not defective. • You have set a ratings level to limit BD-Video or DVD-Video play. Change this setting. • Some BD-Video can only be output with HDMI. 	Cover 37
Picture-in-picture is not played with BD-Video.	<ul style="list-style-type: none"> • Confirm whether the disc supports picture-in-picture. 	—
The BD-Live is not played with BD-Video.	<ul style="list-style-type: none"> • Confirm whether the disc supports the BD-Live. • The inserted SD card does not have sufficient available capacity. • The SD card is write-protected. • Sub contents copied to an SD card are provided by the disc producer as a part of the BD-Video content. Even if you record images and audio onto an SD card, it cannot be played as a BD-Live. 	21 — 45 21
Alternative soundtrack and subtitles cannot be selected.	<ul style="list-style-type: none"> • The languages are not recorded on the disc. • You may not be able to use the on-screen menu to change the soundtrack and subtitles on some discs. Use the disc's menus to make changes. 	— 18
No subtitles.	<ul style="list-style-type: none"> • Subtitles are not recorded on the disc. • Turn the subtitles on. Set “Subtitle” on the on-screen menu to “On”. 	— 35
Angle cannot be changed.	<ul style="list-style-type: none"> • Angles can only be changed during scenes where different angles are recorded. 	—
The resume play function does not work.	<ul style="list-style-type: none"> • Memorized positions are cancelled when <ul style="list-style-type: none"> – pressing [STOP] several times. – opening the disc tray. • The resume play function may not work depending on the disc. • BD-LIVE: On BD-Video discs including BD-J, the resume play function does not work. 	— — —

When other Panasonic products respond to this remote control

Change the remote control code on the main unit and the remote control (the two must match) if you place other Panasonic products close together.

- 1 Press [BD/SD] to select “BD/DVD”.
- 2 While stopped, press [SETUP].
- 3 Press [▲, ▼] to select “General” and press [OK].
- 4 Press [▲, ▼] to select “Remote Control” and press [OK].
- 5 Press [▲, ▼] to select the code (1 or 2) and press [OK].
- 6 To change the code on the remote control While pressing [OK], press and hold the numbered button ([1] or [2]) for more than 5 seconds.
- 7 Press [OK].

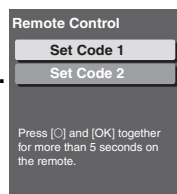

When the following indicator appears on the unit's display and you are unable to operate the unit

e.g., Display



The unit's remote control code
Press and hold [OK] and the indicated number button at the same time for more than 5 seconds.

Messages

The following messages or service numbers appear on the television or unit's display when something unusual is detected during startup and use.

On the television		Page
Authorisation Error. This unit is not authorised to play this title.	<ul style="list-style-type: none"> ● DivX You are trying to play the DivX VOD content that was purchased with a different registration code. You cannot play the content on this unit. 	22
Cannot play.	<ul style="list-style-type: none"> ● You inserted an incompatible disc. 	44, 45
Cannot play on this unit.	<ul style="list-style-type: none"> ● You tried to play a non-compatible image. 	45, 46
No disc is inserted.	<ul style="list-style-type: none"> ● The disc may be upside down. 	18
Rental Expired.	<ul style="list-style-type: none"> ● DivX The DivX VOD content has zero remaining plays. You cannot play it. 	22
⊙ This operation is not available.	<ul style="list-style-type: none"> ● Some operations are unsupported by the unit. For example; <ul style="list-style-type: none"> – BD-V: During play back, reverse slow-motion or reverse frame-by-frame is not possible. 	19
⊙ This operation is prohibited by this disc.	<ul style="list-style-type: none"> ● Depending on the disc, you may not be able to perform search or skip when film previews and warning screens are being played back. 	—
Cannot connect. Please check the connection of the LAN cable.	<ul style="list-style-type: none"> ● When a hub is used but its Link lamp does not light up, check the cable connection, LAN terminal connection, cable itself (a cross cable may be used by mistake), etc. 	13
IP address is not set.	<ul style="list-style-type: none"> ● The "IP Address" in "IP Address / DNS Settings" is "---. ---. ---. ---". Set the "IP Address", "Subnet Mask", and "Gateway Address". (Select the automatic address acquisition if necessary.) 	33
Cannot obtain IP address. Please check the connection or setting of the router.	<ul style="list-style-type: none"> ● If you use a hub, then check the connection between the hub and the router. <ul style="list-style-type: none"> – Use the UPLINK port of the hub to connect to a router. – Check whether or not the hub's Link lamp lights up. If it does not light up, then check the cable connection, LAN terminal connection, cable itself (a cross cable may be used by mistake), etc. ● If the above conditions are OK, then the router may not operate in DHCP mode. Check the router settings and operation. You may reset the router to restore it to normal. 	13
	<ul style="list-style-type: none"> ● This unit's IP address is used by another device. Check the IP addresses of this unit, personal computers, and routers, etc. If necessary, reconfigure them to avoid IP addresses from being duplicated. 	—
This IP address is already in use. Please check the setting.	<ul style="list-style-type: none"> ● Turn the unit off. Remove the AC mains lead and reconnect it and try again. If the same symptom persists, then consult your dealer. 	—
Connection test could not be conducted.	<ul style="list-style-type: none"> ● If you use a hub, then check the connection between the hub and the router. <ul style="list-style-type: none"> – Use the UPLINK port of the hub to connect to a router. – If the hub's Link lamp does not light up, then check the cable connection, LAN terminal connection, cable itself (a cross cable may be used by mistake), etc. ● Check the "IP Address", "Subnet Mask", and "Gateway Address" in the "IP Address / DNS Settings". ● If the MAC address information is required, then press [SETUP] to display the "Network Settings" menu. 	13
IP address is not set correctly.		33
Connection test was unsuccessful. No reply from Gateway. Please check the connection or setting of the router.		33
Network connection was rejected. Please confirm Setup "BD-Live Internet Access".	<ul style="list-style-type: none"> ● When you set "BD-Live Internet Access" to "Limit" and play BD-Live contents which do not have a content owner certificate, the Internet access of the content is not allowed. If you allow the content to connect to Internet, set "BD-Live Internet Access" to "Permit". 	37
Could not check for latest firmware version. Please try again later.	<ul style="list-style-type: none"> ● The firmware download server is currently unavailable. Please try again later. 	—
High Clarity Sound is effective. Analog video output is turned off when playback starts.	<ul style="list-style-type: none"> ● "High Clarity Sound" in setup menu is set to "Enable", and "High Clarity Sound" in on-screen menu is set to "On". 	36, 38
No Video	<ul style="list-style-type: none"> ● Depending on the connected iPod, video menu may not be available on the TV. Select the iPod menu (iPod LCD) mode and operate video playback from your iPod menu. 	31

On the unit's display		Page
F99	<ul style="list-style-type: none"> ● The unit fails to operate properly. Press [⏻/⏺] on the main unit to switch the unit to standby for 3 seconds. Now press [⏻/⏺] on the main unit again to turn the unit on. 	—
HDMI ONLY	<ul style="list-style-type: none"> ● Some BD-Video discs can only be output with HDMI. 	—
NET	<ul style="list-style-type: none"> ● Displays while VIERA CAST is starting up. 	—
No PLAY	<ul style="list-style-type: none"> ● There is a viewing restriction on a BD-Video or DVD-Video. 	37
No READ	<ul style="list-style-type: none"> ● The media is dirty or badly scratched. The unit cannot play. 	—
PLEASE WAIT	<ul style="list-style-type: none"> ● The unit is carrying out internal process. This is not a malfunction. You cannot operate the unit while "PLEASE WAIT" is displayed. ● When connected to TV (VIERA) with HDAVI Control 4, and power supply is turned off by the "Intelligent Auto Standby" function on the TV side. 	—
REMOVE	<ul style="list-style-type: none"> ● The USB device is drawing too much power. Remove the USB device. 	18
SET □ ("□" stands for a number.)	<ul style="list-style-type: none"> ● The remote control and main unit are using different codes. Change the code on the remote control. <p>Press and hold [OK] and the indicated number button at the same time for more than 5 seconds.</p> 	51
UNFORMAT	<ul style="list-style-type: none"> ● You inserted an unformatted DVD-RAM, DVD-RW, +RW, an unused +R, +R DL or DVD-RW (DVD-Video format). 	—

On the unit's display		Page
UNSUPPORT	<ul style="list-style-type: none"> You have inserted a media the unit cannot play. You tried to operate with a non-compatible USB device. 	44, 45 45
"W1" is flashing. (when using the optional wireless accessory: SH-FX70)	<ul style="list-style-type: none"> There is no link between this unit and the wireless system. Check that the wireless system is plugged into the household mains socket and is turned on. Ensure that the digital transmitter is fully inserted into the slot of this unit. If the wireless system is not used, disconnect the digital transmitter from this unit. 	42 42 —
U59	<ul style="list-style-type: none"> The unit is hot. The unit switches to standby for safety reasons. Wait for about 30 minutes until the message disappears. Select a position with good ventilation when installing the unit. Do not block the cooling fan on the rear of the unit. 	—
U72 U73	<ul style="list-style-type: none"> The HDMI connection acts unusually. <ul style="list-style-type: none"> The connected equipment is not HDMI compatible. Please use HDMI cables that have the HDMI logo (as shown on the cover). The HDMI cable is damaged. 	—
H□□ or F□□ (“□” stands for a number.)	<ul style="list-style-type: none"> Check and correct the speaker cable connections. There is something unusual. (The service number displayed after H and F depends on the unit's condition.) Check the unit using the troubleshooting guide. If the service number does not disappear, do the following. <ol style="list-style-type: none"> Disconnect the plug from the household mains socket wait a few seconds, then reconnect it. Press [⏻/⏻] to turn the power on. (The unit may be fixed.) If the service number does not disappear despite doing the above, request service from the dealer. Inform the dealer of the service number when requesting service. 	9 — 48–51
IPOD OVER CURRENT ERROR	<ul style="list-style-type: none"> The iPod is drawing too much power. Remove the iPod, and turn the unit off and on again. 	—
START	<ul style="list-style-type: none"> The system is being restarted during the firmware update. Please do not turn off power. 	32
UPD□/□	<ul style="list-style-type: none"> The firmware is being updated. 	32
FINISH	<ul style="list-style-type: none"> The firmware update is complete. 	32
NOT CONDITIONAL	<ul style="list-style-type: none"> The requested operation cannot be conducted. 	—
=====	<ul style="list-style-type: none"> The main unit could not save the modified settings. Some settings may need to be reset. 	—

Frequently asked questions



Setup		Page
Can I connect other speakers?	<ul style="list-style-type: none"> Speakers other than those supplied cannot be used. This system achieves ideal audio properties through the combination of the main unit and the supplied speakers. Using other speakers may damage the system and will not produce correct audio characteristics (e.g., no bass sounds). 	—
Can I extend the speaker cables?	<ul style="list-style-type: none"> Don't extend the speaker cables. Extending the speaker cables can damage the unit, and sound quality will be negatively affected. 	—
Can I make the system into a 7.1ch sound system?	<ul style="list-style-type: none"> You cannot make into a 7.1ch sound system. This system is a 5.1ch sound system. 	—
Can I connect the unit directly to a computer?	<ul style="list-style-type: none"> This unit cannot be connected directly to a computer. 	—
My television has COMPONENT VIDEO IN terminals and HDMI IN terminal. Which should I connect with?	<ul style="list-style-type: none"> The different levels of picture quality input are listed below in order from highest to lowest. HDMI IN→COMPONENT VIDEO IN→VIDEO IN. However, it will take longer for the picture output to start up when this unit is connected with the HDMI IN terminal. 	—
Disc		
Can I play BD-Video and DVD-Video bought in another country?	<ul style="list-style-type: none"> You cannot play: <ul style="list-style-type: none"> BD-Video discs that do not include region “B”. DVD-Video discs that do not include region “2” or “ALL”. Refer to the cover of these operating instructions for more information about your region code and number. Refer to the disc's jacket for more information. 	Cover
Can BD-Video/DVD-Video that does not have a region code/number be played?	<ul style="list-style-type: none"> The region management information for BD-Video/DVD-Video indicates that the disc conforms to industry standards. You cannot play discs that do not conform to industry standards or do not have a region code or number. 	—
Please tell me about disc compatibility with this unit.	<ul style="list-style-type: none"> Refer to “Media (Disc, card and USB device) information” and “About MP3/JPEG/DivX files”. You cannot write to a disc with this unit. 	44, 46 —
SD card		
What kinds of operations are available on the SD card slot on this unit?	<ul style="list-style-type: none"> The following operations are available. <ul style="list-style-type: none"> Play back JPEG data recorded with a digital camera etc. Play back AVCHD motion pictures recorded with Panasonic High Definition Video Camera. Play back MPEG2 motion pictures recorded with a Panasonic Standard Definition Video Camera, If a BD-Video disc supporting BD-Live or BONUSVIEW is used, it is possible to copy secondary video, etc. from the Internet or disc to the card and play it back together with the images on the disc, etc. 	— — — 21
What kinds of cards can be used?	<ul style="list-style-type: none"> SD Memory Cards (from 8 MB to 2 GB), SDHC Memory Cards (from 4 GB to 32 GB), miniSD Cards*, and microSD Cards* can be used. * A miniSD Card and a microSD Card must be used in the adaptor included with the memory card. Please confirm the latest information on the following website. http://panasonic.co.jp/pavc/global/cs (This site is in English only.) 	45

Language code list

Enter the code with the numbered buttons.

Abkhazian: 6566	Catalan: 6765	Gujarati: 7185	Lingala: 7678	Rhaeto-Romance: 8277	Tamil: 8465
Afar: 6565	Chinese: 9072	Hausa: 7265	Lithuanian: 7684	Romanian: 8279	Tatar: 8484
Afrikaans: 6570	Corsican: 6779	Hebrew: 7387	Macedonian: 7775	Russian: 8285	Telugu: 8469
Albanian: 8381	Croatian: 7282	Hindi: 7273	Malagasy: 7771	Samoan: 8377	Thai: 8472
Amharic: 6577	Czech: 6783	Hungarian: 7285	Malay: 7783	Sanskrit: 8365	Tibetan: 6679
Arabic: 6582	Danish: 6865	Icelandic: 7383	Malayalam: 7776	Scots Gaelic: 7168	Tigrinya: 8473
Armenian: 7289	Dutch: 7876	Indonesian: 7378	Maltese: 7784	Serbian: 8382	Tonga: 8479
Assamese: 6583	English: 6978	Interlingua: 7365	Maori: 7773	Serbo-Croatian: 8372	Turkish: 8482
Aymara: 6589	Esperanto: 6979	Irish: 7165	Marathi: 7782	Shona: 8378	Turkmen: 8475
Azerbaijani: 6590	Estonian: 6984	Italian: 7384	Moldavian: 7779	Sindhi: 8368	Twi: 8487
Bashkir: 6665	Faroese: 7079	Japanese: 7465	Mongolian: 7778	Sinhalese: 8373	Ukrainian: 8575
Basque: 6985	Fiji: 7074	Javanese: 7487	Nauru: 7865	Slovak: 8375	Urdu: 8582
Bengali; Bangla: 6678	Finnish: 7073	Kannada: 7578	Nepali: 7869	Slovenian: 8376	Uzbek: 8590
Bhutani: 6890	French: 7082	Kashmiri: 7583	Norwegian: 7879	Somali: 8379	Vietnamese: 8673
Bihari: 6672	Frisian: 7089	Kazakh: 7575	Oriya: 7982	Spanish: 6983	Volapük: 8679
Breton: 6682	Galician: 7176	Kirghiz: 7589	Pashto, Pushto: 8083	Sundanese: 8385	Welsh: 6789
Bulgarian: 6671	Georgian: 7565	Korean: 7579	Persian: 7065	Swahili: 8387	Wolof: 8779
Burmese: 7789	German: 6869	Kurdish: 7585	Polish: 8076	Swedish: 8386	Xhosa: 8872
Byelorussian: 6669	Greek: 6976	Laotian: 7679	Portuguese: 8084	Tagalog: 8476	Yiddish: 7473
Cambodian: 7577	Greenlandic: 7576	Latin: 7665	Punjabi: 8065	Tajik: 8471	Yoruba: 8979
	Guarani: 7178	Latvian, Lettish: 7686	Quechua: 8185	Zulu: 9085	

Licenses

Java and all Java-based trademarks and logos are trademarks or registered trademarks of Sun Microsystems, Inc. in the United States and other countries.	
Manufactured under license from Dolby Laboratories. Dolby, Pro Logic, and the double-D symbol are trademarks of Dolby Laboratories.	
Manufactured under license under U.S. Patent #'s: 5,451,942; 5,956,674; 5,974,380; 5,978,762; 6,226,616; 6,487,535; 7,392,195; 7,272,567; 7,333,929; 7,212,872 & other U.S. and worldwide patents issued & pending. DTS is a registered trademark and the DTS logos, Symbol, DTS-HD and DTS-HD Master Audio Essential are trademarks of DTS, Inc. © 1996-2008 DTS, Inc. All Rights Reserved.	
This product incorporates copyright protection technology that is protected by U.S. patents and other intellectual property rights. Use of this copyright protection technology must be authorized by Macrovision, and is intended for home and other limited viewing uses only unless otherwise authorized by Macrovision. Reverse engineering or disassembly is prohibited.	
HDMI, the HDMI logo and High-Definition Multimedia Interface are trademarks or registered trademarks of HDMI Licensing LLC.	
This product is licensed under the AVC patent portfolio license and VC-1 patent portfolio license for the personal and non-commercial use of a consumer to (i) encode video in compliance with the AVC Standard and VC-1 Standard ("AVC/VC-1 Video") and/or (ii) decode AVC/VC-1 Video that was encoded by a consumer engaged in a personal and non-commercial activity and/or was obtained from a video provider licensed to provide AVC/VC-1 Video. No license is granted or shall be implied for any other use. Additional information may be obtained from MPEG LA, LLC. See http://www.mpegla.com .	
HDAVI Control™ is a trademark of Panasonic Corporation.	
"AVCHD" and the "AVCHD" logo are trademarks of Panasonic Corporation and Sony Corporation.	
SDHC Logo is a trademark.	
Portions of this product are protected under copyright law and are provided under license by ARIS/SOLANA/4C.	
x.v.Colour™ is a trademark.	
VIERA CAST™ is a trademark of Panasonic Corporation.	
Plays DivX® video DivX® is a registered trademark of DivX, Inc., and is used under license.	
"Blu-ray Disc" is trademark.	
"BD-LIVE" logo is trademark of Blu-ray Disc Association.	
"BONUSVIEW" is trademark of Blu-ray Disc Association.	
YouTube and Picasa are trademarks of Google, Inc.	
"Made for iPod" means that an electronic accessory has been designed to connect specifically to iPod and has been certified by the developer to meet Apple performance standards. Apple is not responsible for the operation of this device or its compliance with safety and regulatory standards. iPod is a trademark of Apple Inc., registered in the U.S. and other countries.	

Glossary

AVCHD

AVCHD is a new format (standard) for high definition video cameras that can be used to record and play high-resolution HD images.

BD-J

Some BD-Video discs contain Java applications, and these applications are called BD-J. You can enjoy various interactive features in addition to playing normal video.

BD-Live

This is a BD-Video (BD-ROM Profile 2) that supports the new functions such as Internet connection, etc. in addition to the BONUSVIEW function.

Bitstream

This is the digital form of multi-channel audio data (e.g., 5.1 channel) before it is decoded into its various channels.

BONUSVIEW (Final Standard Profile)

This is a BD-Video (BD-ROM Profile 1 version 1.1) that supports the new functions such as Picture-in-picture and Secondary Audio, etc.

Deep Colour

This unit incorporates HDMI™ (V.1.3 with Deep Colour) technology that can reproduce greater colour gradation (4096 steps) when connected to a compatible TV. You can enjoy exceptionally rich, natural-looking colours, with smooth, detailed gradation and minimal colour banding. [A lower colour gradation (256 steps), without Deep Colour, will be reproduced if connected to a TV which does not support Deep Colour. The unit will automatically set appropriate output to suit the connected TV.]

DivX

DivX is a popular media technology created by DivX, Inc. DivX media files contain highly compressed video with high visual quality that maintains a relatively small file size.

DNS Server

A server which acts like a telephone directory and translates Internet domain names into IP addresses.

Dolby Digital

This is a method of coding digital signals developed by Dolby Laboratories. Apart from stereo (2-channel) audio, these signals can also be multi-channel audio.

Dolby Digital Plus

Multi-channel audio and higher audio quality is made possible using Dolby Digital Plus. BD-Video supports up to 7.1 channel output.

Dolby Pro Logic II

Dolby Pro Logic II enables you to play stereo sources on 5.1-channel.

Dolby TrueHD

Dolby TrueHD is a very high quality audio format that reproduces the studio master audio. BD-Video supports up to 7.1 channel output.

Down-mixing

This is the process of remixing the multi-channel audio found on some discs into fewer channels.

DTS (Digital Theater Systems)

This surround system is used in many movie theatres. There is good separation between the channels, so realistic sound effects are possible.

DTS-HD

DTS-HD is a high-quality, sophisticated audio format used in movie theatres. Previous DTS Digital Surround-compatible equipment can play DTS-HD as DTS Digital Surround audio. BD-Video supports up to 7.1 channel output.

DTS-HD High Resolution Audio

This is a signal format achieved by improving the previous DTS, DTS-ES and DTS 96/24 formats. It is compatible with sampling frequency 96 kHz/48 kHz. BD-Video supports up to 7.1 channel output.

DTS-HD Master Audio

This is a lossless audio format and compatible with 96 kHz/7.1ch or less. In addition, faithful reproduction of the master audio is enabled using lossless audio encoding technology. BD-Video supports up to 7.1 channel output.

Dynamic range

Dynamic range is the difference between the lowest level of sound that can be heard above the noise of the equipment and the highest level of sound before distortion occurs. Dynamic range compression means reducing the gap between the loudest and softest sounds. This means you can listen at low volumes but still hear dialog clearly.

Film and video

DVD-Video are recorded using either film or video. This unit can determine which type has been used, then uses the most suitable method of progressive output.

Film: Recorded at 25 frames per second (PAL discs) or 24 frames per second (NTSC discs). (NTSC discs recorded at 30 frames per second as well.) Generally appropriate for motion picture films.

Video: Recorded at 25 frames/50 fields per second (PAL discs) or 30 frames/60 fields per second (NTSC discs). Generally appropriate for TV drama programmes or animation.

Folder

This is a place on the disc, USB device or SD card where groups of data are stored together. Additional folders can be created within folders, and you can make detailed classifications depending on the folder structure. (⇒ 47)

Frames and fields

Frames refer to the single images that constitute the video you see on your television. Each frame consists of two fields.



Frame

Field

Field

- A frame still shows two fields, so there may be some blurring, but picture quality is generally better.
- A field still shows less picture information so it may be rougher, but there is no blurring.

Gateway

IP address of the electronic device providing Internet access. Usually called a router IP address. (e.g., 192.168.0.1)

HDMI (High-Definition Multimedia Interface)

HDMI is a digital interface for consumer electronic products. Unlike conventional connections, it transmits uncompressed digital video and audio signals on a single cable.

Hub

Used for connecting more than one device to the network.

IP address

A set of numbers which distinguish each device on the network when, for example, connected to the Internet. When using a PC in a LAN to access a PC or device that is not included in the LAN, the IP address is called the local IP address. (e.g., 192.168.0.10)

Glossary

JPEG (Joint Photographic Experts Group)

This is a system used for compressing/decoding colour still pictures. If you select JPEG as the storage system on digital cameras, etc., the data will be compressed to 1/10–1/100 of its original size. The benefit of JPEG is less deterioration in picture quality considering the degree of compression.

LAN (Local Area Network)

A group of linked devices in a company, school or home. Indicates the boundaries of a particular network.

Local storage

This storage area is used as a destination for sub contents for playing BD-Live on BD-Video.

LPCM (Linear PCM)

These are a kind of PCM format. These are uncompressed digital signals, similar to those found on CDs.

MPEG2 (Moving Picture Experts Group)

A standard for efficiently compressing and expanding colour video. MPEG2 is a compression standard used for DVD and satellite based digital broadcasting.

MPEG-4 AVC/H.264

A standard for efficiently compressing and expanding colour video. MPEG-4 AVC/H.264 is an encoding method used for recording of the high definition videos.

MP3 (MPEG Audio Layer 3)

An audio compression method that compresses audio to approximately one tenth of its size without any significant loss of audio quality.

Pan&Scan/Letterbox

In general, DVD-Video are produced with the intention that they be viewed on a widescreen television (16:9 aspect ratio), so images often don't fit regular (4:3 aspect ratio) televisions. Two styles of picture, "Pan & Scan" and "Letterbox", deal with this problem.

Pan&Scan: The sides are cut off so the picture fills the screen.



Letterbox: Black bands appear at the top and bottom of the picture so the picture itself appears in an aspect ratio of 16:9.



PCM (Pulse Code Modulation)

This is one format for converting analogue audio into digital audio, enabling you to enjoy digital audio with no hassle.

Picture-in-picture

This is a function of BD-Video that plays the primary video and secondary video simultaneously. For instance, the function is capable of playing the original movie as the primary video while playing video commentary from the film director on a small screen as a secondary video.

Progressive/Interlace

The PAL video signal standard has 625 (or 576) interlaced (i) scan lines, whereas progressive scanning, called 625p (or 576p), uses twice the number of scan lines. For the NTSC standard, these are called 525i (or 480i) and 525p (or 480p) respectively.

Using progressive output, you can enjoy the high-resolution video recorded on media such as DVD-Video. Your television must be compatible to enjoy progressive video. Panasonic televisions with 625 (576)/50i · 50p, 525 (480)/60i · 60p input terminals are progressive compatible.

4HD (Pixel Precision Progressive Processing for HD)

This is a processor which makes use of an exclusive Panasonic algorithm. Various processing is supported, including a high-level conversion of the TV scanning format from interlace to progressive and a high-level conversion of standard resolution (480i or 576i) video signal to a 1080 High Definition video signal.

Consequently, this unit is able to provide video of optimal resolution to the connected TV.

Router

Distinguishes the IP address assigned to each device, such as the PC, and relays the flow of data within the network.

Sampling frequency

Sampling is the process of converting the heights of sound wave (analogue signal) samples taken at set periods into digits (digital encoding). Sampling frequency is the number of samples taken per second, so larger numbers mean more faithful reproduction of the original sound.

Subnet mask

Enables efficient network use. A set of numbers which identify which part of the IP address allocated to every device connected to the router is the network portion.

USB (Universal Serial Bus)

An interface specification to connect peripherals. Playback of MP3, JPEG, or DivX recorded to a USB memory by PC or other equipment, or JPEG in the Panasonic digital camera or similar connected via USB connection cable is possible with this unit.

VIERA CAST

An information service unique with Panasonic where specific Web sites can be viewed on this unit by connecting to the Internet without using a PC.

x.v.Colour™

x.v.Colour™ is a name for devices that are compatible with the xvYCC format, an international standard for expanded colour in motion pictures, and that follow the rules for signal transmission.

You can enjoy vivid colours of wider colour ranges for a more realistic picture when connected to a TV that supports the x.v.Colour™ with HDMI cable.

1080i (1125i)

In one high definition image, 1080 (1125) alternating scan lines pass to create an interlaced image. Because 1080i (1125i) more than doubles current television broadcasts of 480i, the detail is much clearer and creates a more realistic and rich image.

1080p (1125p)

In one high definition image, 1080 (1125) scan lines pass at the same time to create a progressive image. Since progressive video does not alternate scan lines like interlace, there is a minimal amount of screen flicker.

24p

This is a progressive image recorded at a rate of 24 frames per second.

720p (750p)

In one high definition image, 720 (750) scan lines pass at the same time to create a progressive image. Since progressive video does not alternate scan lines like interlace, there is a minimal amount of screen flicker.

Specifications

SPEAKER SECTION

■ Front speakers

BT205 SB-HF770

Type	1 way 1 speaker system (Bass reflex)
Full range	6.5 cm Cone type (Bamboo Cone)
Impedance/Input power (IEC)	3 Ω/125 W (Max)*1
Output sound pressure	79 dB/W (1.0 m)
Frequency range	80 Hz to 25 kHz (−16 dB) 90 Hz to 22 kHz (−10 dB)
Dimensions (W×H×D)	255 mm×1020 mm×255 mm
Mass	Approx. 2.3 kg

BT200 SB-HF470

Type	1 way 1 speaker system (Bass reflex)
Full range	6.5 cm Cone type (Bamboo Cone)
Impedance/Input power (IEC)	3 Ω/125 W (Max)*1
Output sound pressure	79 dB/W (1.0 m)
Frequency range	100 Hz to 25 kHz (−16 dB) 120 Hz to 22 kHz (−10 dB)
Dimensions (W×H×D)	92 mm×128 mm×81 mm
Mass	Approx. 0.47 kg

■ Surround speakers

BT205 SB-HS870

Type	1 way 1 speaker system (Bass reflex)
Full range	6.5 cm Cone type
Impedance/Input power (IEC)	3 Ω/125 W (Max)*1
Output sound pressure	79 dB/W (1.0 m)
Frequency range	80 Hz to 25 kHz (−16 dB) 90 Hz to 22 kHz (−10 dB)
Dimensions (W×H×D)	255 mm×1020 mm×255 mm
Mass	Approx. 2.3 kg

BT200 SB-HS470

Type	1 way 1 speaker system (Bass reflex)
Full range	6.5 cm Cone type
Impedance/Input power (IEC)	3 Ω/125 W (Max)*1
Output sound pressure	79 dB/W (1.0 m)
Frequency range	100 Hz to 25 kHz (−16 dB) 120 Hz to 22 kHz (−10 dB)
Dimensions (W×H×D)	92 mm×128 mm×81 mm
Mass	Approx. 0.47 kg

■ Centre speaker SB-HC300

Type	1 way 2 speaker system (Bass reflex)
Full range	6.5 cm Cone type × 2 (Bamboo Cone)
Impedance/Input power (IEC)	3 Ω/250 W (Max)*1
Output sound pressure	82 dB/W (1.0 m)
Frequency range	82 Hz to 25 kHz (−16 dB) 99 Hz to 22 kHz (−10 dB)
Dimensions (W×H×D)	250 mm×94.5 mm×81 mm
Mass	Approx. 1.15 kg

■ Subwoofer SB-HW200

Type	1 way 1 speaker system (Kelton type)
1. Woofer	16 cm Cone type
2. Passive Radiator	25 cm
Impedance/Input power (IEC)	3 Ω/250 W (Max)
Output sound pressure	78 dB/W (1.0 m)
Frequency range	35 Hz to 200 Hz (−16 dB) 40 Hz to 198 Hz (−10 dB)
Dimensions (W×H×D)	181 mm×361 mm×315 mm
Mass	Approx. 4.7 kg

*1 Rating with the low cut filter equipped amplifier.

AMPLIFIER SECTION

RMS TTL Power Output	1000 W
Front Ch	125 W per channel (3 Ω), 1 kHz, 10 % THD
Surround Ch	125 W per channel (3 Ω), 1 kHz, 10 % THD
Centre Ch	250 W per channel (3 Ω), 1 kHz, 10 % THD
Subwoofer Ch	250 W per channel (3 Ω), 100 Hz, 10 % THD
DIN TTL Power Output	470 W
Front Ch	65 W per channel (3 Ω), 1 kHz, 1.0 % THD
Surround Ch	65 W per channel (3 Ω), 1 kHz, 1.0 % THD
Centre Ch	105 W per channel (3 Ω), 1 kHz, 1.0 % THD
Subwoofer Ch	105 W per channel (3 Ω), 100 Hz, 1.0 % THD
Audio Input	
AUX	× 1
Digital Audio Input	
Optical	× 2
Sampling frequency	32 kHz, 44.1 kHz, 48 kHz
Audio Format	PCM, Dolby Digital

FM TUNER SECTION

Frequency range	87.50 to 108.00 MHz (50-kHz step)
Antenna terminals	75 Ω (unbalanced)

Specifications

DISC SECTION

Playable disc:

- BD-Video:BD-ROM Version 2
 - BD-RE: Version 3 (Single Layer, Dual Layer), JPEG*⁶
 - BD-R Version 2 (Single Layer, Dual Layer)
 - DVD-RAM:
 - DVD Video Recording format,
 - AVCHD format*⁷, JPEG*⁴
 - DVD-R/DVD-R DL:
 - DVD-Video format*¹, DVD-Video Recording format*¹, AVCHD format*^{1,7}, JPEG*⁴, MP3, DivX*⁸
 - DVD-RW:
 - DVD-Video format*¹, DVD-Video Recording format*¹, AVCHD format*^{1,7}
 - +R/+RW/+R DL:
 - Video*¹, AVCHD format*^{1,7}
 - DVD-Video:
 - DVD-Video format
 - CD-Audio:
 - CD-DA
 - CD-R/CD-RW:
 - CD-DA, JPEG*⁵, MP3, DivX*⁸
- Optical pick-up: System with 2 lenses
Wave length: 782 nm (CDs)/662 nm (DVDs)/405 nm (BDs)
- LASER Specification:
Class 1 LASER Product
Wave length: 782 nm (CDs)/662 nm (DVDs)/405 nm (BDs)
Laser power:
No hazardous radiation is emitted with the safety protection

SD CARD SECTION

- SD card slot: Connector (1 system)
- SD card:
 - SD Memory Card*² formatted FAT12, FAT16, FAT32*³: JPEG*⁴, AVCHD format*⁷, MPEG2

- Usable capacity will be less (SD Card).

USB DEVICE SECTION

- USB slot: Connector (1 system)
- USB Standard:USB 2.0 High Speed MP3, JPEG*⁴, DivX*⁸
- Format: FAT12, FAT16, FAT32

*1 Finalizing is necessary.

*2 includes SDHC card

includes miniSD cards (need a miniSD Adaptor)

includes microSD cards (need a microSD Adaptor)

*3 Does not support long file name

*4 The total combined maximum number of recognizable picture contents and folders: 3000 picture contents and 300 folders.

*5 The total combined maximum number of recognizable picture contents and folders: 999 picture contents and 99 folders.

*6 The total combined maximum number of recognizable picture contents and folders: 9999 picture contents and 300 folders.

*7 AVCHD format V1.0

*8 The total combined maximum number of recognizable file contents and folders: 200 file contents and 300 folders.

VIDEO SECTION

- Signal system: PAL/NTSC
- Video output:
 - Output level: 1.0 Vp-p (75 Ω)
 - Output connector: Pin jack (1 system)
- Component video output (1080i/720p/480p/480i):
 - Y output level: 1.0 Vp-p (75 Ω)
 - P_B output level: 0.7 Vp-p (75 Ω)
 - P_R output level: 0.7 Vp-p (75 Ω)
 - Output connector: Pin jack (Y: green, P_B: blue, P_R: red) (1 system)
- HDMI AV output:
 - Output format: 480p (525p)/576p (625p)/720p (750p)/1080i (1125i)/1080p(1125p)
 - Output connector: Type A (19 pin)
 - HDMI™ (V.1.3a with Deep Colour, x.v.Colour™, High Bit rate Audio)
 - This unit supports "HDAVI Control 4" function.

NETWORK SECTION

- Ethernet 10BASE-T/100BASE-TX (1 system)

GENERAL

- Power supply AC 220 to 240 V, 50 Hz
 - iPod Connector DC OUT 5 V 500 mA MAX
 - Power consumption 120 W
 - Power consumption in standby mode approx. 0.3 W
 - Dimensions (W×H×D) 430 mm×63 mm×327 mm
 - Mass Approx. 3.7 kg
- (Dimensions and Mass do not include the speakers.)
- Operating temperature range 0 °C to +40 °C
 - Operating humidity range 35 % to 80 % RH (no condensation)



Specifications are subject to change without notice.

NOTE

CAUTION!
THIS PRODUCT UTILIZES A LASER.
USE OF CONTROLS OR ADJUSTMENTS OR PERFORMANCE OF PROCEDURES OTHER THAN THOSE SPECIFIED HEREIN MAY RESULT IN HAZARDOUS RADIATION EXPOSURE.
DO NOT OPEN COVERS AND DO NOT REPAIR YOURSELF. REFER SERVICING TO QUALIFIED PERSONNEL.

CAUTION!
DO NOT INSTALL OR PLACE THIS UNIT IN A BOOKCASE, BUILT-IN CABINET OR IN ANOTHER CONFINED SPACE. ENSURE THE UNIT IS WELL VENTILATED. TO PREVENT RISK OF ELECTRIC SHOCK OR FIRE HAZARD DUE TO OVERHEATING, ENSURE THAT CURTAINS AND ANY OTHER MATERIALS DO NOT OBSTRUCT THE VENTILATION VENTS.
DO NOT OBSTRUCT THE UNIT'S VENTILATION OPENINGS WITH NEWSPAPERS, TABLECLOTHS, CURTAINS, AND SIMILAR ITEMS.
DO NOT PLACE SOURCES OF NAKED FLAMES, SUCH AS LIGHTED CANDLES, ON THE UNIT.
DISPOSE OF BATTERIES IN AN ENVIRONMENTALLY FRIENDLY MANNER.

WARNING:
TO REDUCE THE RISK OF FIRE, ELECTRIC SHOCK OR PRODUCT DAMAGE,
DO NOT EXPOSE THIS APPARATUS TO RAIN, MOISTURE, DRIPPING OR SPLASHING AND THAT NO OBJECTS FILLED WITH LIQUIDS, SUCH AS VASES, SHALL BE PLACED ON THE APPARATUS.
USE ONLY THE RECOMMENDED ACCESSORIES.
DO NOT REMOVE THE COVER (OR BACK); THERE ARE NO USER SERVICEABLE PARTS INSIDE. REFER SERVICING TO QUALIFIED SERVICE PERSONNEL.

THIS UNIT IS INTENDED FOR USE IN MODERATE CLIMATES.

This product may receive radio interference caused by mobile telephones during use. If such interference is apparent, please increase separation between the product and the mobile telephone.

The socket outlet shall be installed near the equipment and easily accessible.
 The mains plug of the power supply cord shall remain readily operable.
 To completely disconnect this apparatus from the AC Mains, disconnect the power supply cord plug from AC receptacle.



(Side of product)

DANGER - VISIBLE AND INVISIBLE LASER RADIATION WHEN OPEN. AVOID DIRECT EXPOSURE TO BEAM. <small>FDA 21 CFR/Class IIb</small>	
CAUTION - CLASS 3B VISIBLE AND INVISIBLE LASER RADIATION WHEN OPEN. AVOID EXPOSURE TO THE BEAM. <small>IEC60825-1 →A2/Class 3B</small>	
ATTENTION - RAYONNEMENT LASER VISIBLE ET INVISIBLE, CLASSE 3B. EN CAS D'OUVERTURE, EVITER L'UNE EXPOSITION AU STRAHL.	
FORSIGTIG - SYNLIG OG USYNLIG LASERSTRÅLING KLASSE 3B, NÅR LÅGET ER ÅBENT. UNDGÅ AT BLIVE UDSAT FOR STRÅLEN.	
VARO - AVATTAESSA OLET ALTTIINA LUOKAN 3B NÄKYVÄÄ JA NÄKYMÄTÖNTÄ LASERSÄTEILYÄ. VARO ALTISTUMISTA SÄTEELLE.	
WARNING - KLASS 3B SYNLIG OCH OSYNLIG LASERSTRÅLING NÄR DENNA DEL ÄR ÖPPNAD. UNDVIK EXPOSERING FÖR STRÅLEN.	
VORSICHT - SICHTBARE UND UNSICHTBARE LASERSTRÄHLUNG KLASSE 3B. WENN ABDECKUNG GEÖFFNET, NICHT DEM STRAHL AUSSETZEN.	
注意 - 打开时有可见及不可见激光辐射。避免光束照射。	
注意 - ここを開くと可視及び不可視レーザー光が出ます。ビームを見たり、触れたりしないでください。VOL1J70	

(Inside of product)

Information for Users on Collection and Disposal of Old Equipment and used Batteries



These symbols on the products, packaging, and/or accompanying documents mean that used electrical and electronic products and batteries should not be mixed with general household waste.

For proper treatment, recovery and recycling of old products and used batteries, please take them to applicable collection

points, in accordance with your national legislation and the Directives 2002/96/EC and 2006/66/EC.

By disposing of these products and batteries correctly, you will help to save valuable resources and prevent any potential negative effects on human health and the environment which could otherwise arise from inappropriate waste handling.

For more information about collection and recycling of old products and batteries, please contact your local municipality, your waste disposal service or the point of sale where you purchased the items.

Penalties may be applicable for incorrect disposal of this waste, in accordance with national legislation.



For business users in the European Union

If you wish to discard electrical and electronic equipment, please contact your dealer or supplier for further information.

[Information on Disposal in other Countries outside the European Union]

These symbols are only valid in the European Union. If you wish to discard these items, please contact your local authorities or dealer and ask for the correct method of disposal.



Note for the battery symbol (bottom two symbol examples):

This symbol might be used in combination with a chemical symbol. In this case it complies with the requirement set by the Directive for the chemical involved.

Index

- A**
 - AC mains lead connection 13
 - AVCHD 55
 - Angle 35
 - Audio
 - Attribute 35
 - Changing audio during play . . . 19
 - Channel 35
 - Language 35, 37
- B**
 - BD-J 55
 - BD-Live 21, 55
 - BD-Video Ratings 37
 - BONUSVIEW 21, 55
- C**
 - Chapter 19
 - Cleaning
 - Disc 3
 - Lens 3
 - Main unit. 3
 - Connection
 - Antenna 12
 - AUX 10, 11
 - Digital transmitter 42
 - DVD recorder 12
 - HDMI 11
 - iPod 30
 - OPTICAL IN 10, 11, 12
 - Set Top Box 12
 - Speaker 9
 - TV 10, 11
 - USB 18, 23
 - Video cassette recorder 12
 - Wireless system 42
- D**
 - DNS Server 33, 55
 - DTS 38, 55
 - DTS-HD 38, 55
 - DVD-Video Ratings 37
 - Deep Colour 55
 - Default Settings 40
 - Dialog Enhancer 36
 - Direct Navigator 18
 - Direct Play 19
 - Discs that cannot be played 45
 - DivX 22, 46, 55
 - Dolby Digital 38, 55
 - Dolby Digital Plus 38, 55
 - Dolby Pro Logic II 17, 55
 - Dolby TrueHD 38, 55
- F**
 - Finalize 44
 - Firmware 32
 - Formatting SD cards 21
 - Frame-by-frame 19
- H**
 - HDMI 11, 55
 - High Clarity Sound 36, 38
- I**
 - iPod 30
 - IP address 33, 55
- J**
 - JPEG 23, 46, 56
- L**
 - LAN 13, 56
 - LPCM 56
 - Language
 - Audio 35, 37
 - Code list 54
 - Menu. 37
 - On screen 38
 - Soundtrack 35, 37
 - Subtitle 35, 37
 - Local storage 56
- M**
 - MPEG2 56
 - MP3 25, 46, 56
 - Maintenance 3
 - Menu
 - On-screen 35
 - Pop-up 18
 - Setup 37
 - Mute the sound 18
- O**
 - On-screen
 - Language 38
 - Menu. 35
 - Status messages 20
- P**
 - PCM Down Conversion 38
 - Playback Information Window 36
 - Playlists 15
 - Picture-in-picture 21
 - Pop-up menu 18
 - Product disposal 3
 - Progressive 36, 56
 - Properties
 - Chapter 19
 - Still picture 24
 - Proxy Server 34
 - P4HD 56
- R**
 - Radio 12, 26
 - Re-master 36
 - Remote control
 - Batteries 5
 - Remote control code 51
 - Repeat Play 36
 - Resume play function 19
- S**
 - SD card 18
 - Search 19
 - Setup menu 37
 - Skip 19
 - Sleep timer 20
 - Slideshow 24
 - Slow-motion 19
 - Soundtrack 35
 - Status messages 20
 - Still pictures 23
 - Subtitle 35
 - Surround sound effects 17
- T**
 - TV System 39
- U**
 - USB 18
 - Unit and media care 3
- V**
 - VIERA CAST™ 32
 - VIERA Link “HDAVI Control™” 28
- W**
 - Whisper-mode Surround 17
- x.v. Colour™** 56
- 24p 36, 39, 56

