

2017-2018

Rural Lifestyle Guide

PRICES EFFECTIVE FROM 1st SEPTEMBER 2017



silvan.com.au

Silvan
SELECTA™

Silvan

NEW PRODUCTS

**70 LITRE
RAKPAK QUAD
BIKE SPRAYER KIT**



RP70N-S10B P: 15

**12VOLT 200 LITRE
RECHARGEABLE
TROLLEY SPRAYER**



TK200-S3GG P: 21

**400L E - WIND 12 VOLT
REMOTE CONTROL
HOSEREEL**



L04H4-38K180 P: 27

**300L LIGHTFOOT
SPRAYER ENGINE
DRIVE PUMP**



LT30-34-2 P: 31

**ECO HOSE REEL
INCLUDES ATOMIZER+
SPRAY GUN**



180G03010C P: 39

**E-WIND 12 VOLT
REMOTE HOSEREEL**



180K10012T P: 42

TOMMY GUN



410-54 P: 51

**CONVERTIBLE BRASS
BOOMLESS NOZZLE**



M99-65 P: 92

**800 LITRE HONDA
DAVEY FIREFIGHTING
UNIT**



SQF800D-3 P: 111

NEW PRODUCTS

SILVAN 20 LITRE FIRE FIGHTER KNAPSACK



12V 400 LITRE DIESEL CUBE TRANSFER UNIT



SOLAR MOTION LIGHT WITH REMOTE

SOLAR-5 P: 181



LED SOLAR OUTDOOR LIGHT

SOLAR-2 P: 181



3 PACK MAGNETIC RECHARGEABLE WARNING LIGHTS

WL003 P: 183

WIDE ANGLE MOTION ACTIVATED SECURITY CAMERA WITH 3G CAPABILITY



SECURE100-3G P: 187

PUSH ALONG SWEEPER



S920 P: 194

MULTI-LAYOUT ANIMAL ENCLOSURE



TC8009-4 P: 201

200 LITRE STEEL MESH CART



BBGC1010 P: 219

Contents



12V & MOTORISED SPRAYERS

Redline Spotpak Sprayers & Accessories	9
Spotpak Sprayers	12
Quad Bike & Rangkap Sprayers	14
Trukpak Sprayers	16
Squatpak Sprayers	22
Skid Sprayer With Reel Tuff Remote Reel	24
Skid Sprayer With E-Wind Remote Reel	27
Rechargeable, Trolley & Lightfoot Sprayers	28
Traylink	32



BOOMS & HOSEREELS

Boomless Nozzles Kits & Booms	34
Wick Wipers	38
Hose Reels	39
Accessories Fitment Chart	43



GUIDANCE, MONITORS & FOAM MARKERS

GPS Guidance, Monitors & Meters	44
Foam Markers & Accessories	47



SPRAY GUNS, NOZZLES & ACCESSORIES

Spray Guns	49
Nozzles & Accessories	59
Spray Shield & Couplings	60



HAND & KNAPSACK SPRAYERS

Chapin Hand Sprayers & Trolley Pressure Sprayer	63
Knapsack Sprayers	64
Selecta Blowamist	66



SAFETY EQUIPMENT & CHEMICAL TRANSFER

Eye & Ear Protection	68
Dust Masks, Respirators & Spray Helmets	68
Gloves and Jugs	70
Chemical Transfer	71



NOZZLES & ACCESSORIES

Nozzle Selection Guide	72
Nozzles & Caps	79
Nozzle Bodies & Adapters	97



FIRE FIGHTERS

Fire Fighting & Water Transfer Pumps	105
Fire Fighting Units	107
Trailed & Skid Fire Fighting Units	112
Fire Fighting Accessories	114
Fire Fighting Knapsack	116



PUMPS, TANKS, CONTROLLERS, VALVES & HOSES

Pumps, Controllers, Valves & Service Parts	117
Pumps 12V	124
Solenoids & Regulators	132
Tanks	136
Hoses	140



PLUMBING, FILTRATION & TANK ACCESSORIES

Filtration	142
Tank Fittings and Gauges	149
Hose Fittings	152



DIESEL TANKS & ACCESSORIES

Diesel Transfer Units	158
Diesel Pumps & Kits	164
Diesel Hose Reels, Filters, Meters & Guns	169
Diesel Fitment Chart	173



SELECTA BLUE (ADBLUE®) TANKS & ACCESSORIES

Selecta Blue Transfer Units & Kits	174
Selecta Blue Pumps, Kits & Accessories	177



LIGHTING

LED Worklights & Light Bars	179
Solar Area Light and 12V Beacons	181
Solar Chargers	184



ASSET PROTECTION & MAINTENANCE

Motion Activated Alert, Camera & Accessories	185
Sentinel CCTV	190
Farmeyes Remote Observation	192



WORKSHOP & MAINTENANCE

Floor Sweeper and Tyre Inflator	194
Torches	195
Jump Start	197
Boot Scraper, Sharpeners and Lubrication	198
Workshop Trolleys	199
Firewood Trolley And Rack	200
Animal Enclosures	201
Assortment Kits	202
Air Conditioners	204
Ramps	206
Water Roller	208
Safety Warning Signs	209



SPREADERS AND CARRYALLS

Spreaders	211
Carryalls	215



HARDWARE

Wheelbarrows & Spare Parts	216
Trolleys	219
Cyclone Products	221

Silvan

Motorised & 12V Sprayers



Silvan

Silvan

12 Volt Sprayers

REDLINE 25L, 55L & 100L



Ideal for weed control, spot and fence line spraying. Fits neatly onto the back of most Quad Bike, UTV's and utility style vehicles. Includes spray shield
Polytuff tank with 650ml measuring jug, chemical spill barrier and drain plug for easy cleaning
Wrap around hose with clips for easy Spraygun storage
Optional trailers and boomless nozzle kit available

UTEPAK/TRUKPAK 100L - 200L



Professional Series ideal for spot and boom spraying
Non-spill lid, in-built carry handles, chemical spill barrier
Tank lid basket strainer and brass inserts in bottom of tank for permanent fixing
Variety of pump options

SMOOTHFLO SPOTPAKS 50L, 100L & 200L



All-purpose 12V sprayer ideal for spot spraying on-farm
Non-spill lid, inbuilt carry handles
Polytuff tank with and drain plug for easy cleaning
Pump is recessed within tank for protection
Clips for neat and easy Spraygun storage

TRAYLINK 200L & 300L



Suitable for mounting to compact tractors and utility/trailer trays
Aquatec high capacity pump 20L/min
Robust multi-purpose frame with CAT 1 pins
Hypro boomless nozzle sprays up to 10 metre width
Control valve, pressure gauge, spotjet Spraygun & hose

QUAD BIKE/RAKPAK 50 - 70L



All-purpose 12V sprayer ideal for spot spraying on quad bikes
Non-spill lid, chemical spill barrier
Pump is recessed within tank for protection
Moulded hose storage rack (some models)
Variety of pump options

RECHARGEABLE 25L



Self powered sprayers for home, garden, professional or farm use
Easy to push or tow with Ezy Glide wheels
With rechargeable battery and 240V recharger

SQUAT & SKID SPRAYERS 300 - 600L



Professional range for contractor/large operator
Rugged tank with internal baffle & non spill lid
12V Pump and Motorised Comet Diaphragm pump models

LIGHTFOOT TRAILED 300L



Ideal for towing behind compact tractors and quad bikes
Robust chassis with tow hitch
High Capacity 12V pump
Optional booms and hoses

*Warning: Refer to vehicle or tractor manufacturer's instructions for appropriate load and towing limits and fitting positions. Never fill the spray tank capacity to exceed the vehicle or tractor manufacturer's specified safe load carrying capacities.
Note: 1L of water = 1 kg.*

Redline Spotpak Sprayers

Delivers all the features to suit your spot spraying requirements at a great price!

RETAINING RING TO PREVENT ACCIDENTAL LOSS OF LID

6M OF DELIVERY HOSE

BUILT IN CARRY HANDLES

CHEMICAL MEASURING JUG STORED BENEATH THE LID

3M BATTERY CABLE WITH ALLIGATOR CLIPS



1" DRAIN PLUG FOR EASY EMPTYING

TANK CLIPS FOR NEAT SPRAY GUN STORAGE

BOTTOM TANK MOUNT INSERTS (4X M6) FOR STRAPLESS MOUNTING

INCLUDES CONVENIENT SPRAY SHIELD IN 55 & 100LTR MODELS

TIE DOWN POINTS FOR STRAPPED MOUNTING

SPRAY GUN WITH 550MM STAINLESS STEEL LANCE AND ADJUSTABLE NOZZLE

UV STABILISED POLYTUFF TANK



12 Volt Sprayers



25L REDLINE SPOTPAK SPRAYERS

Rechargeable and 12V Spotpak options available. Fits neatly onto ride-on mower trailers, quad bike racks and ideal for weed control, spot & fenceline spraying.

- UV stabilised polyethylene tank with 1" drain plug for easy cleaning and emptying
- 6m of delivery hose
- Spray gun with 550mm stainless steel lance and adjustable nozzle, clips easily to tank
- Lid retaining ring to prevent accidental loss
- Mounted pump On/Off switch and fuse
- Bottom tank mount inserts (4x M6) for strapless mounting to trailer or skid
- 2.6L/min open flow, 3.3 Bar/50psi pump (available in 12V and rechargeable versions)
- **SP25-R1**: 3m of battery cable with alligator clips
- **SP25-B**: Rechargeable model
Supplied with battery and 240 volt wall charger
Approx run time 4 tank fulls

SPRING RETRACTABLE HOSE REEL

Ideal for 12V spot spraying and linkage sprayers.

- Can also be mounted on workshop wall
- 1/4" BSPM outlet connection
- 10m of 8mm ID hose
- 16 Bar/240psi max pressure

SP25-R1



SP25-B



SUITABLE FOR 25L & 55L REDLINE SPRAYERS

SWIVELLING STEEL MOUNTING BRACKET



180L01008A

CODE	DESCRIPTION	LENGTH	WIDTH	HEIGHT	WT	LIST EX	LIST INC	CAT
SP25-R1	25L Redline 12V Sprayer	580mm	330mm	280mm	4.4 kg	\$190.00	\$209.00	A
SP25-B	25L Redline Rechargeable SLA 12V 3.2Ahr Battery	580mm	330mm	280mm	5.5 kg	\$205.45	\$226.00	A
180L01008A	Spring Retractable Hose Reel	360mm	140mm	290mm	4.1 kg	\$136.36	\$150.00	A

Warning: Refer to vehicle or tractor manufacturer's instructions for appropriate load & towing limits & fitting positions. Never fill the spray tank capacity to exceed the vehicle or tractor manufacturer's specified safe load carrying capacities. Note: 1L of water = 1 kg.

12 Volt Sprayers



SP55-R1

The Redline range of 12V sprayers are the most feature packed economical sprayers in Australia. Ideal for weed control, spot and fence line spraying, they fit neatly onto the back of most quad bikes, UTV's and utility style vehicles.

55L & 100L REDLINE SPOTPAK SPRAYERS

- UV stabilised polyethylene tank with 1" drain plug for easy cleaning and emptying
- **55L Model:** 2.6L/min open flow, 3.3 Bar/50psi max pressure
- **100L Model:** 5.3L/min open flow, 4 Bar/60psi max pressure
- Spray gun with 550mm stainless steel lance and adjustable nozzle, clips easily to tank
- 6m of delivery hose
- 3m of battery cable with alligator clips
- Lid retaining ring to prevent accidental loss
- Mounted pump On/Off switch and fuse
- Bottom tank mount inserts (4x M6) for strapless mounting to trailer or skid
- Chemical measuring jug (650mm)



Convenient heavy duty filter standard



SP55-R1



SP100-R2

SPRING RETRACTABLE HOSE REEL 15M

Suitable for air, water or agricultural chemicals

- See page xx for full details



SUITABLE FOR 100L REDLINE SPRAYERS



Now includes convenient spray shield

180J1510A

CODE	DESCRIPTION	LENGTH	WIDTH	HEIGHT	WT	LIST EX	LIST INC	CAT
SP55-R1	55L Redline 12V Sprayer	715mm	425mm	360mm	5.4 kg	\$213.64	\$235.00	A
SP100-R2	100L Redline 12V Sprayer	885mm	470mm	435mm	9 kg	\$353.64	\$389.00	A
180J1510A	Spring Retractable Hose Reel 15m	400mm	160mm	450mm	7 kg	\$171.82	\$189.00	A

Warning: Refer to vehicle or tractor manufacturer's instructions for appropriate load & towing limits & fitting positions.

12 Volt Sprayers



SP100-R2 WITH OPTIONAL TR100 & TR100-10

REDLINE TRAILER KITS

Converts a Redline into a trailed sprayer for spraying larger areas with ride-on mowers.

- Powder coated Steel frame with adjustable double tongue hitch
- Large pneumatic wheels for smoother ride and better manoeuvrability
- 55L Model with 16" x 4.8" wheels
- 100L Model with 16" x 6.5" wheels

REDLINE BOOMLESS NOZZLE KITS

Adapts a trailed Redline into a boom sprayer with the kit matched to the pump. An Included swivel nozzle holder allows coverage to be adjusted.

- Easy assembly - just bolts onto trailer
- 55L Model with 2m spray width
- 100L Model with 3m spray width

SP55-R1 WITH OPTIONAL TR55 (TRAILER) & TR55-10 (BOOMLESS NOZZLE KIT)



SP100-R2 WITH OPTIONAL TR100 (TRAILER)



Wide area spray width



2 Metre spray width (55L)



3 Metre spray width (100L)

CODE	DESCRIPTION	ASSEMBLY	LIST EX	LIST INC	CAT
TR55	Trailer Kit for 55L Redline	DIY	\$117.27	\$129.00	B
TR55-10	Boomless Nozzle Kit for 55L Redline	DIY	\$119.09	\$131.00	B
TR100	Trailer Kit for 100L Redline	DIY	\$162.73	\$179.00	B
TR100-10	Boomless Nozzle Kit for 100L Redline	DIY	\$124.55	\$137.00	B

Warning: Refer to vehicle or tractor manufacturer's instructions for appropriate load & towing limits & fitting positions. Prices do not include sprayer.

Smoothflo Spotpaks

*Delivers constant flow without pulsation
for professional spraying results*



Scan here to see the Smoothflo in action!

Constant Flow Technology
NO PULSATION!

12 Volt Sprayers



Scan here to see the Smoothflo in action!

Constant Flow Technology
NO PULSATION!

SP100-S7

12V SMOOTHFLO SPOTPAK SPRAYERS 50, 100 & 200L

SP100-S7

Ideal for weed control, spot & fence line spraying applications, the Smoothflo series deliver constant flow, no pulsation and the highest pressure for distance spraying. Suitable for use on quad bikes, side by sides utes, trays & trailers, with UV stabilised Polytuff tanks to ensure long life.

- 7L/min (open flow) 8 Bar/120psi max pressure
- Pump is recessed within tank for protection
- Spotjet spray gun with 600mm stainless steel lance & adjustable nozzle with tank clips for neat and easy spray gun storage
- 6 metres of 8mm delivery hose
- Drain plug 3/4" for easy clean and empty
- Non-spill lid, in-built carry handles
- 3 metre battery cable with alligator clips
- Ideal for use with up to 30m 10mm hose



DRAWING
10862

SPRING RETRACTABLE HOSE REEL 15M

Suitable for air, water or agricultural chemicals

- See page 40 for full details



180J1510A



CODE	DESCRIPTION	OPEN FLOW	LENGTH	WIDTH	HEIGHT	WT	LIST EX	LIST INC	CAT
SP50-S7	50L Smoothflo SpotPak	7L/min	700mm	400mm	300mm	6 kg	\$471.82	\$519.00	A
SP100-S7	100L Smoothflo SpotPak	7L/min	800mm	475mm	395mm	10 kg	\$562.73	\$619.00	A
SP200-S7	200L Smoothflo SpotPak	7L/min	1000mm	540mm	550mm	14 kg	\$662.73	\$729.00	A
180J1510A	Spring Retractable Hose Reel 15m		400mm	160mm	450mm	7 kg	\$171.82	\$189.00	A
M99-65	Boomless Nozzle Kit with Single or Double Sided Swath						\$135.45	\$149.00	B

Warning: Refer to vehicle or tractor manufacturer's instructions for appropriate load & towing limits & fitting positions. Never fill the spray tank capacity to exceed the vehicle or tractor manufacturer's specified safe load carrying capacities. Note: 1L of water = 1 kg.

12 Volt Sprayers



RP50-P1

Silvan Quad Bike and Rakpak sprayers are designed to fit neatly on quad bikes and meet the strict weight requirement of these vehicles. The Wrap around design allows for a lower centre of gravity, essential for improved quad bike safety.

12 VOLT 50 & 70 LITRE QUADBIKE SPRAYERS

- UV Stabilized Polytuff tanks
- Selecta 5.3L/Min open flow pump, 4 Bar/60psi max pressure
- Spotjet spraygun with 500mm stainless steel lance and adjustable nozzle
- Chemical resistant Viton valves & TPU diaphragms
- 6m of 8mm delivery hose
- 3m battery cable with alligator clips
- Ratchet straps to secure to QUAD (pair included)
- Anti spill barrier around Lid to protect rider

Additional features with the 70L model:

- BAFFLED poly tank to reduce surge when travelling
- Gun holder to secure spray gun when travelling



CODE	DESCRIPTION	OPEN FLOW	LENGTH	WIDTH	HEIGHT	WT	LIST EX	LIST INC	CAT
RP50-P1	50L Quad Bike	5.3 L/min	775mm	850mm	250mm	10 kg	\$417.27	\$459.00	A
RP70-P1	70L Quad Bike	5.3L/min	800mm	850mm	390mm	12 kg	\$499.09	\$549.00	A
M99-65	Boomless Nozzle Kit with Single or Double Sided Swath						\$135.45	\$149.00	B
RP1-24-3	Pressure Regulator Kit						\$230.91	\$254.00	B

Warning: Refer to vehicle or tractor manufacturer's instructions for appropriate load & towing limits & fitting positions.

12 Volt Sprayers



RP70N-S3

The Silvan Rakpak Plus sprayers incorporate premium features for added convenience at the highest quality, with a choice of pump to suit your spot or boom spraying needs. The wrap-around design of Rakpak Sprayers allows for a lower centre of gravity essential for improved quad bike safety.

70 LITRE RAKPAK PLUS

- UV stabilised polytuff tank 70L capacity with **internal baffle**
- Pumps with Viton valves & Santoprene diaphragm
- 6m of 8mm delivery hose
- Spotjet spray gun with 500mm stainless steel lance and adjustable nozzle
- Gun holder to secure spray gun when travelling
- Anti-spill barrier around lid to protect rider
- 3 metre battery cable with alligator clips
- Ratchet straps to secure to Quad (pair included)
- Provision to fit drain tap

SPOT SPRAY PUMPS:

- **RP70N-S7** features a Aquatec Smoothflo 7.0L/min (open flow) pump with constant flow technology for no pulsation spraying 8 Bar/120psi max pressure

BOOM SPRAY PUMPS:

The higher flow is ideal for boom spraying. A pressure regulator is recommended for low flow spot and boom spraying

- **RP70N-S10** incorporates a Aquatec 14.0 L/min open flow pump 4 Bar/60 psi



RP70N-S7

DRAWING
0860



RP70N-S10B

CODE	DESCRIPTION	OPEN FLOW	LENGTH	WIDTH	HEIGHT	WT	LIST EX	LIST INC	CAT
RP70N-S7	70L RakPak Smoothflo Plus	7 L/min	800mm	850mm	390mm	12 kg	\$708.18	\$779.00	A
RP70N-S10	70L RakPak H/Capacity	14L/min	800mm	850mm	390mm	12 kg	\$799.09	\$879.00	A
RP70N-S10B	70L RakPak H/Capacity/ With M99-75 Kit	14L/min	800mm	850mm	390mm	12 kg	\$862.73	\$949.00	A
M99-75	Twin Boomless Nozzle (suit S3)						\$171.82	\$189.00	B
M99-65	Boomless Nozzle Kit with Single or Double Sided Swath (suit S7)						\$135.45	\$149.00	B

Warning: Refer to vehicle or tractor manufacturer's instructions for appropriate load & towing limits & fitting positions.

Truckpak Sprayers

Simple rugged design with essential features for professional use.

HEAVY DUTY
INSERTS FOR MOUNTING
HOSE REELS

LARGE FILLER
LID WITH BASKET
STRAINER

PUMP OPTIONS
FOR HIGH PRESSURE,
HIGH FLOW AND
GENERAL SPOT
SPRAYING

TALL ANTI-SPILL
LIP

Constant Flow Technology
NO PULSATION!

DRAIN BUNG

TANK BOTTOM INSERTS
FOR SECURE MOUNTING
TO TRAY OR DECK

RANGE OF PROFESSIONAL
SPRAY GUNS
(TK200-S9-2 SHOWN)

Silvan

12 Volt Sprayers



UP100-S7-2

100L UTEPAK TRUKPAK SPRAYER

Professional self contained sprayers favoured for their flexible range of options and industrial design. Fit to Utility, carryall or UTV's for a range of applications including pest control, road side spraying or on-farm.

See charts for individual specifications.

TANK 100L:

- UV stabilised polytuff tank brass inserts at base for easy mounting
- Large Drain outlet for easy empty and clean
- Fitted In-line suction filter with viewing bowl
- 100L Dimensions (mm): L 660, W 580, H490

12V PUMPS:

- Smoothflo, Aquatec pump 7L/min (open flow) or max 8 Bar /120psi for pulsation free spraying

HOSE REELS:

Supplied as kit with some models
30m ECO: (adds 395mm to height)

- 30m of 10mm Ag Hose on hub with locking pin
- 15m Spring Retractable: (adds 445mm to height)
- Swiveling body with 15m of 3/8" Hose

UP100-S7-2
Shown with 15m
Retractable Reel



M99-65 ;
See page 34 for full details.

CODE	CAPACITY	PUMP	FLOW	HOSE REEL	SPRAY GUN	LIST EX	LIST INC	CAT
UP100-S7-2	100L	Smoothflo	7L/min 120 psi	15m Retractable	SpotJet Gun	\$935.45	\$1,029.00	A

Warning: Refer to vehicle or tractor manufacturer's instructions for appropriate load & towing limits & fitting positions.

12 Volt Sprayers



200L TRUKPAK SPRAYER WITH ECONOMY REEL

Spray with the increased flexibility of a 30m hose reel for pest control, roadside or on-farm use.

- Aquatec 7L/min open flow, 8 Bar/120psi max pressure
- 30m of 10mm I.D. Ag hose and professional PA spray gun

SCREW DOWN LID WITH STRAINER FILL BASKET BENEATH

TK200-S7-1

120PSI
MAX
PUMP



200L TRUKPAK SPRAYER WITH RETRACTABLE REEL

Comes with a 15m hose retractable reel for pest control, roadside or on-farm use.

- Aquatec 7L/min open flow, 8 Bar/120psi max pressure



8MM BRASS MOUNTING INSERTS

270° SWIVEL

TK200-S7-2

120PSI
MAX
PRESSURE



CODE	CAPACITY	PUMP	FLOW	HOSE REEL	SPRAY GUN	LIST EX	LIST INC	CAT
TK200-S7-1	200L	Smoothflo	7L/min 120 psi	30m Eco	PA Gun	\$1,044.55	\$1,149.00	A
TK200-S7-2	200L	Smoothflo	7L/min 120 psi	15m Retractable	PA Gun	\$1,044.55	\$1,149.00	A

Warning: Refer to vehicle or tractor manufacturer's instructions for appropriate load & towing limits & fitting positions.



12 Volt Sprayers



TK200-S9-1

200L TRUKPAK SPRAYER

Professional self contained sprayers favoured for their flexible range of options and industrial design. Fit to Utility, carryall or UTV's for a range of applications including pest control, road side spraying or on-farm.

See charts for individual specifications.

TANK 200L:

- UV stabilised polytuff tank brass inserts at base for easy mounting
- Large Drain outlet for easy empty and clean
- Fitted In-line suction filter with viewing bowl
- 200L Dimensions (mm): L 1030, W 580, H535

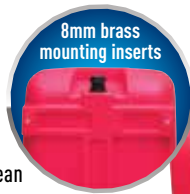

12V PUMPS:

- Smoothflo, Aquatec pump 5L/min (open flow) or max 13 Bar/200psi for pulsation free spraying with greater pressure for spraying longer distances and finer atomising

HOSE REELS: Supplied as kit with some models 30m ECO: (adds 395mm to height)

- 30m of 10mm Ag Hose on hub with locking pin

15m Spring Retractable: (adds 445mm to height)

- Swiveling body with 15m of 3/8" Hose



TK200-S9-2



200psi pump for distance spraying up to 11m

CODE	CAPACITY	PUMP	FLOW	HOSE REEL	SPRAY GUN	LIST EX	LIST INC	CAT
TK200-S9-1	200L	Smoothflo	5L/min 200 psi	30m Eco	JetPro	\$1,226.36	\$1,349.00	A
TK200-S9-2	200L	Smoothflo	5L/min 200 psi	15m Retractable	JetPro	\$1,226.36	\$1,349.00	A

Warning: Refer to vehicle or tractor manufacturer's instructions for appropriate load & towing limits & fitting positions.



12 Volt Sprayers



Scan here to see the 200L Trukpak in action!

OPTIONAL BOOMLESS NOZZLE KIT - S3B

Boomless nozzle kit eliminates the need for a spray boom.

- Up to 3.7m swath with pumps 5-10L/min and single nozzle
- Up to 7.4m swath with pumps 10-20L/min and two nozzles

TK200-S3 WITH S3B KIT

200L TRUKPAK SPRAYERS

Professional self contained sprayers favoured for their flexible range of options and industrial design to fit to Utility, carryall or UTV's.

See charts for individual specifications.

TANK 200L:

- UV stabilised polytuff tank brass inserts at base for easy mounting
- Large Drain outlet for easy empty and clean
- Fitted In-line suction filter with viewing bowl
- 200L Dimensions (mm): L 1030, W 580, H535

BOOM SPRAY PUMPS:

- 2088 Model Shurflo pump with 11.3L/min (open flow) or max 3 Bar /45psi suitable boom spraying
- DDP-555 Model Aquatec pump with 14.0L/min (open flow) or max 413kpa /60psi suitable boom spraying
- Spray gun included for optional spot spraying

NOTE: Regulators recommended for spot spraying

OPTIONAL EXTRAS:

Pressure Regulator Kit - RP1-24-4

- Fits to pump to regulate pressure and bypass flow back to tank for agitation
- Ideal for regulating 11.3L pumps for lower flow applications



RP1-24-4:
Regulator to suit 11.3 model



TK200-S3



TK200-S10

CODE	CAPACITY	PUMP	FLOW	HOSE REEL	SPRAY GUN	LIST EX	LIST INC	CAT
TK200-S3	200L	2088 Model	11.3L/min 45 psi		PA Gun	\$1,035.45	\$1,139.00	A
TK200-S3B	200L	2088 Model	11.3L/min 45 psi	With S3B kit	PA Gun	\$1,263.64	\$1,390.00	A
TK200-S10	200L	Aquatec DDP-555	14.0L/min, 60 psi		PA Gun	\$1,090.91	\$1,199.00	A
TK200-S10B	200L	Aquatec DDP-555	14.0L/min, 60 psi	With S3B Kit	PA Gun	\$1,090.91	\$1,199.00	A
S3B		Boomless Nozzle Kit				\$348.00	\$383.00	B
RP1-24-4		Pressure Reg & Gauge Kit For Paks				\$161.82	\$178.00	B

Warning: Refer to vehicle or tractor manufacturer's instructions for appropriate load & towing limits & fitting positions.



12 Volt Sprayers



TK200-S7NU

12 VOLT 200 LITRE RECHARGABLE EQUINE/WEED SPRAYERS

STANDARDS FEATURES INCLUDE:

- 240 Volt to 12 Volt AC charger and battery
- Easy access ON/OFF power switch and charging socket
- Heavy duty trolley with pneumatic tyres
- Easy to pull by handle or tow hitch

Equine sprayer is designed for cooling horses after training/racing, cattle and for wash down applications.

- 14L/Min open flow pump, 4 Bar/60psi max pressure
- 6m of 8mm delivery hose and shower head rose spray gun

Weed sprayer designed for hot houses, nurseries, gardens and weed spraying applications.

- Smoothflo 7L/Min open flow pump, 8 Bar/120psi max pressure
- 6m of 8mm delivery hose and PA spray gun



CODE	CAPACITY	SPRAYER	WIDTH	LENGTH	HEIGHT	WT	SPRAY GUN	LIST EX	LIST INC	CAT
TK200-S10GG	200L	Equine	600mm	1135mm	920mm	52 kg	PA Gun	\$1,299.09	\$1,429.00	A
TK200-S7NU	200L	Weed	600mm	1135mm	920mm	52 kg	PA Gun	\$1,299.09	\$1,429.00	A

12 Volt Sprayers



SQ300-S7-2

300L SquatPak spraying tanks are available with 12V pumps and hose reels to provide a range of outputs to support general spot spraying. Their lower height and internal baffle make them ideal for use with UTV's.

300L SQUATPAK

- UV stabilised polytuff tank with Large baffle to reduce surge
- Screw down lid with strainer fill basket beneath
- Large Drain outlet for easy empty and clean
- Deep Tie-down locating channels for strap mounting and tank strength
- Tanks feature durable accessory mounting points with large M10 inserts
- One spare tank corner for additional accessories

SQ300-S7-1:

- Aquatec Smoothflo pump 12V DC
- 7L/min (open flow) for no pulsation spraying max 8 Bar/120psi
- Eco Hose Reel with 30m of 10mm hose
- Atomiser + Spray gun with lever adjustable spray pattern from pencil stream to cone mist

SQ300-S7-2:

- Aquatec Smoothflo pump 12V DC
- 7L/min (open flow) for no pulsation spraying max 8 Bar/120psi
- Spring Retractable Hose Reel with 15m of 3/8 hose
- Atomiser + Spray gun with lever adjustable spray pattern from pencil stream to cone mist

SQ300-S7-1



SQ300-S7-2



CODE	DESCRIPTION	FLOW	LENGTH	WIDTH	HEIGHT	LIST EX	LIST INC	CAT
SQ300-S7-1	300L Smoothflo -30m 10mm Hose	7 L/min	1060mm	1010mm	890mm	\$1,308.18	\$1,439.00	A
SQ300-S7-2	300L Smoothflo -15m 3/8 mm Hose	7 L/min	1050mm	1010mm	940mm	\$1,308.18	\$1,439.00	A

Warning: Refer to vehicle or tractor manufacturer's instructions for appropriate load & towing limits & fitting positions.

12 Volt Sprayers

Constant Flow Technology
NO PULSATION



L04H4-42

SquatPak spraying tanks are available with 12V or motorised pumps and hose reels to provide a range of outputs to support general spot spraying, high volume spraying and high pressure spraying needs. They can be used with a range of accessory equipment to support most spraying needs.

400L SQUATPAK

- UV stabilised polytuff tank with Large baffle to reduce surge
- Large Drain outlet for easy empty and clean
- Fitted with Hose Reel with 30m of 10mm Ag hose
- Deep Tie-down locating channels for strap mounting and tank strength
- Tanks feature durable accessory mounting points with large M10 inserts
- One spare tank corner for additional accessories

12V Pump options:

- Model SQ400-S7-1 with Aquatec Smoothflo pump 7L/min (open flow) for no pulsation spraying 8 Bar /120psi
- Model SQ400-S8-1 with Aquatec High Capacity 20L/min(open flow) or 4 Bar/60psi
- Pressure regulator fitted
- PA series spray gun with 500mm stainless steel extension lance, flat fan nozzle and hollow cone supplied

Motorised option (L04H4-42):

- World class manufacturer Comet APS41 pump, 38L/min (open flow) or 40 Bar (580psi)max
- Honda 5.5HP GX160 engine
- JetPro spraygun for close and distance spraying

SQ400-S7-1

DRAWING
0595



L04H4-42

CODE	DESCRIPTION	FLOW	LENGTH	WIDTH	HEIGHT	LIST EX	LIST INC	CAT
SQ400-S7-1	400L Smoothflo - 30m 10m Hose	7 L/min	1060mm	900mm	1010mm	\$1,362.73	\$1,499.00	9
SQ400-S8-1	400L Hi Capacity - 30m 10m Hose	20 L/min	1060mm	900mm	1010mm	\$1,571.82	\$1,729.00	9
L04H4-42	400L Motorised - 20m 10m HP Hose	38 L/min	1060mm	900mm	1010mm	\$4,527.27	\$4,980.00	9

Warning: Refer to vehicle or tractor manufacturer's instructions for appropriate load & towing limits & fitting positions.



12 Volt Sprayers



L03H4-38R147

300 LITRE SKID SPRAYER WITH REEL TUFF REMOTE REEL

- Australian made REEL TUFF Remote hose reel Galvanised steel construction for enhanced durability, direct drive gearbox, long range interference-free remote control, Hub position lock with spring loaded mechanism
- 300 & 400L Polytuff tank with sump (400L baffled)
- Turbo 400 spray gun and liquid shutoff snap coupling for easy removal, storage or change
- Steel skid frame, hot dipped galvanised skid for extra durability and superior corrosion resistance
- Engine driven Comet BP60/20 Diaphragm pump (58L/min open flow or max 2000kpa) with regulator and spare outlets
- Honda GX160 5.5HP engine & direct drive reduction gearbox
- 100m of 1/2" O.D hose with kink resistant nylon tubing
- Keeps hose tight in transport



L03H4-38R147

CODE	DESCRIPTION	FLOW	LENGTH	WIDTH	HEIGHT	WEIGHT	LIST EX	LIST INC	CAT
L03H4-38R147*	300L Single Reel	58L/min (20 Bar)	1020mm	1340mm	970mm	182 kg	\$7,999.00	\$8,800.00	9

Warning: Refer to vehicle or tractor manufacturer's instructions for appropriate load & towing limits & fitting positions.

* Special Dealer Discount applies to these items

12 Volt Sprayers



L06H4-38R147

400 LITRE SKID SPRAYER WITH REEL TUFF REMOTE REEL

- 400L baffled tank with sump, fitted to galvanised skid
- Honda engine and Comet 60/20 pump (58L/min open flow, 20 Bar 290psi max pressure)
- 100m Smoothline hose and Turbo 400 spray gun

Additional model options:

- Twin Reels: Add a second hose reel allows two operators to spray independently at the same (400L only)
- Substitute an alternate engine drive pump to suit your spraying requirements (Price on application)

L04H4-38R147



L04H4-38R147T



LONG RANGE REMOTE SYSTEM



CODE	DESCRIPTION	FLOW	LENGTH	WIDTH	HEIGHT	WEIGHT	LIST EX	LIST INC	CAT
L04H4-38R147*	400L Single Reel	58L/min (20 Bar)	1850mm	1200mm	750mm	215 kg	\$8,180.91	\$8,999.00	9
L04H4-38R147T*	400L Twin Reel	58L/min (20 Bar)	1850mm	1200mm	750mm	265 kg	\$11,972.73	\$13,170.00	9

Warning: Refer to vehicle or tractor manufacturer's instructions for appropriate load & towing limits & fitting positions.

* Special Dealer Discount applies to these items



12 Volt Sprayers



L06H4-38R147

600 LITRE SKID SPRAYER WITH REEL TUFF REMOTE REEL

- Australian made REEL TUFF Remote hose reel Galvanised steel construction for enhanced durability, direct drive gearbox, long range interference-free remote control, Hub position lock with spring loaded mechanism
- 600L Polytuff barrel tank with internal sump
- Engine driven Comet BP60/20 Diaphragm pump (58L/min open flow or max 2000kpa) with regulator and spare outlets
- Honda GX160 5.5HP engine & direct drive reduction gearbox
- Steel skid frame, hot dipped galvanised skid for extra durability and superior corrosion resistance
- Keeps hose tight in transport
- 100m of 1/2" O.D hose with kink resistant nylon tubing.
- Turbo 400 spray gun and liquid shutoff snap coupling for easy removal, storage or change
- Weight on Bare reel 50kg

Additional model options:

- Twin Reels: Add a second Hose reel allows two operators to spray independently at the same (Price on application)
- Substitute an alternate engine drive pump to suit your spraying requirements (Price on application)



LONG RANGE
REMOTE SYSTEM



CODE	DESCRIPTION	FLOW	LENGTH	WIDTH	HEIGHT	LIST EX	LIST INC	CAT
L06H4-38R147*	600L Single Reel	58L/min (20 Bar)	1850mm	1200mm	900mm	\$8,363.64	\$9,200.00	9
L06H4-38R147T*	600L Twin Reel	58L/min (20 Bar)	1850mm	1200mm	900mm	\$12,154.55	\$13,370.00	9
147R10012T*	Reel with 100m Hose and Gun		750mm	500mm	700mm	\$3,790.91	\$4,170.00	9

Warning: Refer to vehicle or tractor manufacturer's instructions for appropriate load & towing limits & fitting positions.

* Special Dealer Discount applies to these items

12 Volt Sprayers



L04H4-38K180

SILVAN E-WIND 400 LITRE SKID SPRAYER

- 100 Metre Smoothline hose & Atomiser gun- snap coupling
- E-Wind 12 Volt high torque hosereel
- BP6020- Honda direct drive engine
- Fully galvanised chassis
- Heavy duty controller

SILVAN E-WIND 12 VOLT REMOTE HOSEREEL

- Heavy duty steel construction with powder coated finish
- 12 Volt High Torque Electric Motor direct coupled to Gearbox. Max 25amp under load
- Reel hub freely unwinds and uses electric clutch to engage rewind
- Ariel is positioned inside the control box
- Heavy duty controller
- 100m Smoothline Hose and Atomiser + Spray Gun

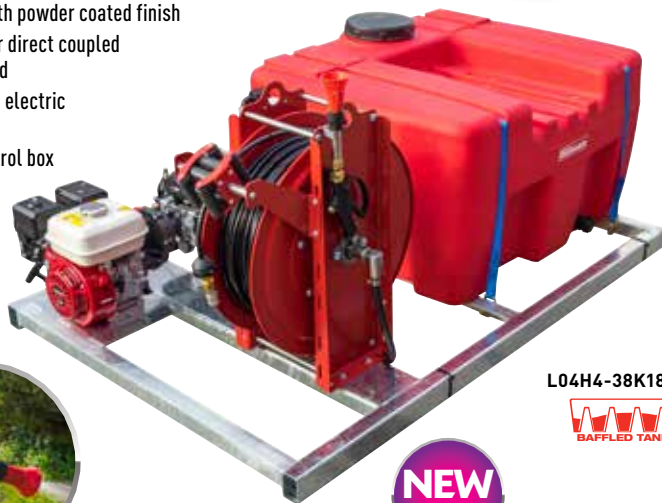

L04H4-38K180



180K10012T

CODE	DESCRIPTION	FLOW	LENGTH	WIDTH	HEIGHT	WT	LIST EX	LIST INC	CAT
L04H4-38K180*	400L Single Reel	58L/min	1850mm	1200mm	750mm	215 kg	\$7,635.45	\$8,399.00	9
180K10012T	Reel with 100m Hose and Gun		590mm	400mm	735mm	49 kg	\$3,271.82	\$3,599.00	9

Warning: Refer to vehicle or tractor manufacturer's instructions for appropriate load & towing limits & fitting positions.

* Special Dealer Discount applies to these items



12 Volt Sprayers



Now includes convenient spray shield

25L RECHARGEABLE REDLINE TROLLEY SPRAYER

SP25-TR2

All the convenience of a powered sprayer built upon a trolley for easy portability offers hours of use without being plugged into an external power source.

- 12V pump 2.5L/min open flow, 50psi
- Rechargeable battery and 240V wall charger
- Up to 1.5 hours operation from one full charge (or approx 3 tank fulls)
- 6m delivery hose with storage hanging hook
- Spray gun with 550mm stainless steel lance and adjustable nozzle
- Easy reach/trail trolley frame with soft hand grip and spray gun holder
- Large 265mm Ezy Glide wheels
- Screw down lid with retaining lid to prevent accidental loss
- Includes chemical measuring jug stored safely beneath the lid
- 1" drain plug for easy cleaning and emptying



Adjustable conical spray pattern



Pencil stream sprays up to 8m



Includes a chemical measuring jug stored safely beneath the lid



CODE	DESCRIPTION	LENGTH	WIDTH	HEIGHT	LIST EX	LIST INC	CAT
SP25-TR2	25L Rechargeable Redline Trolley Sprayer	900mm	440mm	800mm	\$271.82	\$299.00	A
BAT5	Replacement Battery 12V 3.2Ah suit SP25-TR2 & SP25-B				\$35.75	\$39.33	B
382-068B	Replacement Battery Charger				\$46.83	\$51.51	B

Warning: Refer to vehicle or tractor manufacturer's instructions for appropriate load & towing limits & fitting positions.

12 Volt Sprayers

25L RECHARGEABLE TROLLEYPAK SPRAYERS

These larger TrolleyPaks offer larger pumps to support a wider range of spraying needs.

- Large Ezy glide wheels & adjustable handle
- 17 Amp/hr sealED lead acid battery and 8 hour charger
- Screw down lid with anti-spill breather
- 6m of 8mm delivery hose and stainless steel in-line filter

Model TR25-S7 Features

- Smoothflo 7L/min (open flow) pump with constant flow technology for no pulsation spraying 690kpa/120psi max
- Spotjet spray gun with 500mm stainless steel lance and adjustable nozzle supplied

Model TR25-P Features

- Shurflo 6.8L/min open flow pump, 414kpa/60psi max
- Pressure regulator and gauge
- **NOTE:** Spray gun not supplied. (See page 50-60 for Spray guns)



TR25-S7

DRAWING
0934

300L 12V LIGHTFOOT

Designed to be towed behind ATV bikes or other vehicles with a 50mm tow ball hitch.

- Suits mounting of numerous spray equipment & accessories
- Single axle with 22 x 11 x 8 Mud Puppy tyres
- Wiring loom with remote mountable on/off switch

PUMP OPTIONS:

- Model **LT30-S5** with 12V Shurflo 13.6 L/min (open flow) fin cooled pump, 310 kPa/45 psi max pressure
- Model **LT30-S8** with 12V high capacity Aquatec 20L/min (open flow) pump, 414 kPa/60psi max pressure with regulator
- Optional hose, reels, spray guns, booms & pressure regulators



LT30-S5

DRAWING
0723

CODE	DESCRIPTION	LENGTH	WIDTH	HEIGHT	WT	LIST EX	LIST INC	CAT
TR25-S7	25L Smoothflo TrolleyPak	440mm	470mm	1070mm	21 kg	\$1,362.73	\$1,499.00	A
TR25-P	25L TrolleyPak w/ Pressure Regulator	440mm	470mm	1070mm	21 kg	\$1,453.64	\$1,599.00	A
LT30-S5	300L Lightfoot 13.6L/min Pump	1580mm	1160mm	870mm	72 kg	\$2,271.82	\$2,499.00	9
LT30-S8	300L Lightfoot 20L/min Pump & Regulator	1580mm	1160mm	870mm	72 kg	\$2,318.18	\$2,550.00	9
OPTIONS								
BAT3	Replacement 12V Battery (Suit TR25-P & TR25-S7)					\$129.09	\$142.00	B
180G03010B*	Eco Hose Reel With 30m of 9.5mm I.D. Hose for LT30-S5					\$235.45	\$259.00	A

Warning: Refer to vehicle or tractor manufacturer's instructions for appropriate load & towing limits & fitting positions.

* Accessory hose reel supplied unfitted to unit, 4 x 10mm x 16mm bolts required to mount 300L unit.

12 Volt Sprayers



LT30-S8-2

300L MOTORISED LIGHTFOOT SPRAYERS

These complete trailed ATV sprayers come pre-equipped ready for spot and boom spraying to suit a variety of applications.

LT30-S8-1:

300L standard boomless ideal for coarse droplet herbicide and fertiliser application.

- Mud Puppy tyres for extra stability
- Aquatec 20L/min max 60psi pressure with inline filter and regulator
- 7.4 max coverage with **twin boomless nozzles** (or 3.7m with single nozzle), coarse droplet ideal for herbicide or fertiliser, fenceline or firebreak application
- Spotjet spraygun with 6m of 8mm I.D hose

LT30-S8-2:

300L professional with boom for more precise application.

- Aquatec 20L/min, max 60psi pressure with inline filter and regulator
- 4m max coverage with galvanised cross fold boom with spring loaded break back and non drip nozzle bodies
- Air induction nozzles for low drift spraying applications
- Adjustable Atomiser spraygun with ECO hose reel featuring 30m of 10mm hose with lockable hub

LT30-S8-1

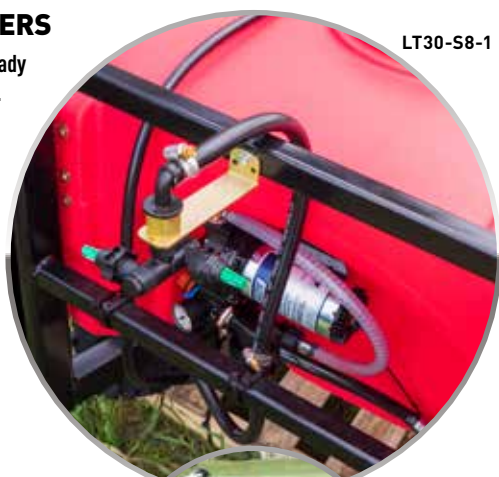

LT30-S8-2

CODE	DESCRIPTION	LIST EX	LIST INC	CAT
LT30-S8-1	300L Trailed with Twin Boomless Nozzle	\$3,090.00	\$3,399.00	9
LT30-S8-2	300L Trailed with Reel and 4M Folding Boom	\$3,544.55	\$3,899.00	9

12 Volt Sprayers



LT30-34-2

300L MOTORISED LIGHTFOOT SPRAYERS

These complete trailed ATV sprayers come utilise engine driven Comet pumps for high performance spot and boom spray applications.

300L LIGHTFOOT

- Large Mud Puppy tyres for extra stability
- 50mm tow ball hitch and fold stand
- Vertical boom channel for fitment of accessories
- In-Line filtration
- Engine driven Comet MC20/20 18L/Min 20Bar/290psi
- Honda GX120 engine

LT30-34:

- Ready for fitment of accessories

LT30-34-2:

- 4m Cross fold boom with air induction nozzles for drift reduction
- Easy boom On/Off with electric solenoid (max operation to 150psi) for operation from vehicle
- Retractable 15m hosereel with Atomiser+ spray gun



LT30-34

CODE	DESCRIPTION	LIST EX	LIST INC	CAT
LT30-34	300L Lightfoot MC20/20 Pump, Accessory Ready	\$4,027.27	\$4,430.00	9
LT30-34-2	300L Lightfoot MC20/20, 4m Boom, 15m Hosereel	\$5,135.45	\$5,649.00	9

12 Volt Sprayers



K02A

The Traylink sprayers eliminate the need for a PTO connection for small to medium boom spraying. The frames can be fitted to CAT 1 linkages, utilities, RTV's and trailers by only requiring a 12V connection for the high capacity pump. A boomless nozzle and spot spray gun are included.

12V TRAYLINK SPRAYER

- UV stabilised polytuff tank with sump
- Steel TPL frame (CAT 1)
- **200L unit:** powder coated frame
- **300L unit:** galvanised frame
- Aquatec High capacity 12V pump 20 L/min (open flow) or 4 Bar/60psi max w/ Viton valves & Santoprene diaphragms
- Graduated regulator w/pressure gauge for control and agitation
- Two manual section valves for spot and boom spraying
- Spotjet spray gun with adjustable nozzle
- 6m of 12mm I.D. hose
- Hypro boomless nozzle can be attached at rear when unit is attached to a tractor. If used crossways on the back of a ute, mule or carryall the unit can be easily moved to an end
- Boomless swath width of 7.4m (or 3.7 m when one-sided spraying) ideal for applying herbicide, fence line spraying or generating fire breaks
- Pump reorder code: DDP-550



K02A

DRAWING
10749



K03A

DRAWING
10063

CODE	DESCRIPTION	FLOW	LENGTH	WIDTH	HEIGHT	WT	LIST EX	LIST INC	CAT
K02A	200L Traylink Sprayer	20 L/min	1040mm	460mm	745mm	55 kg	\$1,536.36	\$1,690.00	9
K03A	300L Traylink Sprayer	20 L/min	1070mm	830mm	1060mm	72 kg	\$2,172.73	\$2,390.00	9

Warning: Refer to vehicle or tractor manufacturer's instructions for appropriate load & towing limits & fitting positions.

Booms and Hose Reels



Silvan

**GENUINE
ACCESSORIES**

Silvan

Booms & Hose Reels



Nozzle Storage:
Both nozzles are kept conveniently attached to the kit with the unused nozzle stacked on top.



M99-65

BRASS BOOMLESS NOZZLES KIT WITH SINGLE OR DOUBLE SIDED SWATH

These compact kits offer broadcast spraying, ideal for applications around obstacles that could damage a traditional boom such as fences, guardrails and power poles.

- Attaches to an ATV rack, UTV or side by side or side framework with supplied clamp
- Supplied with 600mm of 12mm I.D hose with Inline tap to turn isolate flow or turn on or off
- Supplied with both single and twin sided nozzles
- Compatible with a broad range of Silvan spray equipment

M99-65 (size 02)

- Pump flow suitable is 7L/Min (DDP-552A - Smoothflo)
- Spray Swath single from 3.4m or Double 7.6m

M99-66 (size 05)

- Pump flow suitable is 11 -14L/Min 381-125, 361-2088 or DDP-555
- Spray Swath single from 3.8m or Double 7.6m

SINGLE NOZZLE (90 DEGREES)					
PSI	L/min	Swath (m)	Litres per hectare (L/Ha)		
			3 km/hr	6 km/hr	9 km/hr
30	1.61	3.4	96	48	32
40	1.89	3.5	108	54	36
50	2.08	3.7	114	57	38
60	2.27	3.8	119	60	40

SINGLE NOZZLE (90 DEGREES)					
PSI	L/min	Swath (m)	Litres per hectare (L/Ha)		
			3 km/hr	6 km/hr	9 km/hr
30	3.22	3.4	96	48	32
40	1.89	3.5	108	54	36
50	2.08	3.7	114	57	38
60	2.27	3.8	119	60	40

DOUBLE NOZZLE (180 DEGREES)					
PSI	L/min	Swath (m)	Litres per hectare (L/Ha)		
			3 km/hr	6 km/hr	9 km/hr
30	3.22	6.7	96	48	32
40	3.79	7.0	108	54	36
50	4.16	7.3	114	57	38
60	4.54	7.6	119	60	40

DOUBLE NOZZLE (180 DEGREES)					
PSI	L/min	Swath (m)	Litres per hectare (L/Ha)		
			3 km/hr	6 km/hr	9 km/hr
30	6.44	16.8	96	48	32
40	7.57	14.0	108	54	36
50	8.33	14.6	114	57	38
60	9.08	15.2	119	60	40

CODE	DESCRIPTION	PRESSURE	L/MIN (UP TO)	SWATH WIDTH	LIST EX	LIST INC	CAT
M99-65	Boomless Nozzle Kit with Double Sided Swath	14 Bar/30 psi	18.2	10.4	\$135.45	\$149.00	B
M99-66	Boomless Nozzle (05)				\$144.54	\$159.00	B

Booms & Hose Reels

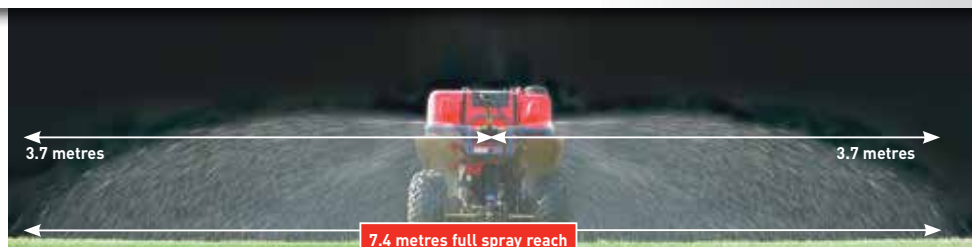

ATV BOOMLESS NOZZLE KIT

Ideal for applications where a conventional boom cannot be used due to obstacles, such as power poles, guardrails, fences, trees, etc.

- Attaches to ATV rack and runs off your 12V pump/RakPak
- Fitted with 30cm of hose with clamp to attach to Quad Bike carry frame
- Durable nozzle produce large droplet size for herbicide or fertiliser application
- **M99-74**: Single sided output suits pumps 5 - 10L/min (60psi)
- **M99-75**: Double sided output suits pump 10 - 20L/min (60psi)
- Nozzle reorder code: For green Hypro boomless nozzle



M99-74 (1 jet)

3.7m full spray reach



M99-75 (2 jet)

7.4m full spray reach

CODE	DESCRIPTION	PRESSURE	L/MIN (UP TO)	SWATH WIDTH	NOZZLE COLOUR	LIST EX	LIST INC	CAT
M99-74	Boomless Nozzle Kit 1 Jet	2 Bar/30 psi	3.2	3.7		\$162.73	\$179.00	B
M99-75	Boomless Nozzle Kit 2 Jet	2 Bar/30 psi	7.6	7.4		\$180.91	\$199.00	B

For application rates per nozzle see page xx



TPL BOOMLESS NOZZLE

Specifically designed for a 3 point linkage unit running between 30 and 60 psi spraying pressure. It can spray up to 9.6 metres wide and is available with an optional mounting bracket that fits between the upright bars on Silvan linkage equipment.

- Sprays 4.8 metres one side or 9.6 metres both sides together
- Can spray one or both sides with blanking cap included
- Fitted with 2.5 metres of Ag hose
- Nozzle reorder code: For blue FC-XT020 Hypro boomless nozzle



DRAWING
10843

M99-76

CODE	DESCRIPTION	PRESSURE	L/MIN (UP TO)	SWATH WIDTH	NOZZLE COLOUR	LIST EX	LIST INC	CAT
M99-76	Boomless Nozzle Kit 2 Jet	14 Bar/30 psi	18.2	10.4		\$271.82	\$299.00	B
K99-10	Mounting Bracket (Suit Super Series TPL)							

1M, 2M & 3M PAK BOOM

L99-09 (1M LENGTH, 2M SPRAY)

DRAWING
10012
10100
10013

Stainless steel construction. 1, 2 & 3 metre width, non-drip nozzle assemblies.

- Supplied with connecting hose, on/off tap and mounting clamps
- LC-15 Anvil deflector nozzles @ 2 bar .97L/min
- Includes breakaway clips (pictured) boom unclips if an obstruction is hit

L99-08 (3M SPRAY)
(2M LENGTH, 3M SPRAY)

DRAWING
0863

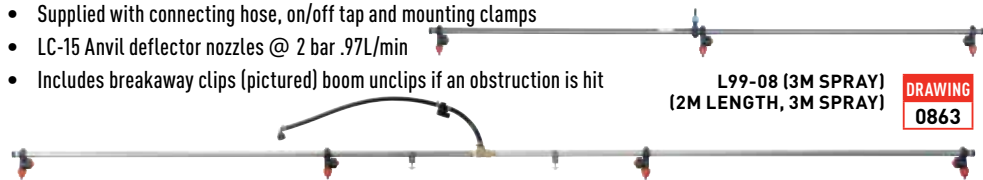

3M & 4M CROSS FOLD BOOM

RP1-10 (3M LENGTH, 4M SPRAY)

DRAWING
0863

- Break back device protects boom if an obstruction is hit
- Designed for rear carry-all on most ATVs
- Adjustable height and quick fold mechanism
- Non-drip nozzle assemblies
- Mounting brackets supplied
- Stainless steel spraylines
- Air induction nozzles

3M CROSS FOLD BOOM
RP1-25 (PICTURED)



FENCELINE KIT (TWIN PACK)

- Ideal for fenceline work. Mounts on the end of boom (minimum boom height 500mm)
- 1/2" BSP Male connection with nozzle swivel and on/off tap
- Off-centre jet
- Ideal to use with L99, RPI Boom to increase spray width

DRAWING
10780

M99-72

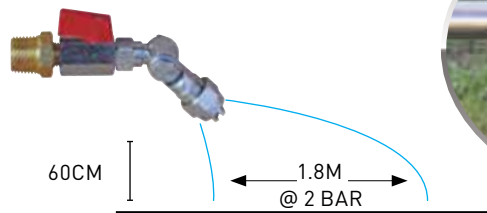

CODE	NOZZLE QTY	BOOM WIDTH	SPRAY WIDTH	NOZZLE SPACING	BREAK BACK	MIN BOOM HEIGHT	FOLDING POSITION	WT	LIST EX	LIST INC	CAT
L99-09	2	1.05m	2m	1m	No	1000mm	None	2 kg	\$207.27	\$228.00	A
L99-08	3	2.05m	3m	1m	No	1000mm	None	2.5 kg	\$256.36	\$282.00	A
RP1-10	4	3m	4m	1m	No	1000mm	None	3 kg	\$367.27	\$404.00	A
RP1-25	6	2.6m	3m	0.5m	Yes	500mm	Cross	8.1 kg	\$787.27	\$866.00	A
RP1-26	8	3.6m	4m	0.5m	Yes	500mm	Cross	9.6 kg	\$900.91	\$991.00	A
CODE	DESCRIPTION		ADJUSTMENT				LIST EX	LIST INC	CAT		
M99-72	Fenceline Kit (Twin Pack)						\$139.09	\$153.00	B		

Booms & Hose Reels



6M & 8M FIELD BOOMS

Medium-duty corrosion resistant hot dip galvanised frame in 6 or 8m spraying width. Features break back device that protects boom if an obstruction is hit.

- Fully folding arms with stainless steel spraylines & non-drip nozzle assembly
- Ideal for linkage or trailer type sprayers.
- Nozzles fully shielded from damage and supplied with Air induction nozzles



032-044-6



CODE	NOZ QTY	BOOM WIDTH	SPRAY WIDTH	NOZZLE SPACING	BREAK BACK	MIN BOOM HEIGHT	FOLDING POSITION	WT	LIST EX	LIST INC	CAT
032-044-6	12	5.8m	6m	0.5m	Yes	500mm	Horizontal	39 kg	\$1,300.00	\$1,430.00	A
032-044-8	16	7.5m	8m	0.5m	Yes	500mm	Horizontal	47 kg	\$1,700.00	\$1,870.00	A

DOUBLE SIDED UNDER VINE SHIELDED BOOM

An adjustable shielded boom for spraying along fences, under tree lines and vine rows.

- Boom with telescopic boom width adjustment from 3 to 3.8 metres total width
- Spring loaded breakaways to protect the boom if an obstacle is struck
- Durable boom shields to minimise spray drift and avoid snagging

G8292045



CODE	DESCRIPTION	ADJUSTMENT	LIST EX	LIST INC	CAT
G8292045	Double Side Strip Boom	3.0 - 3.8 metres	\$699.09	\$769.00	A

Booms & Hose Reels



Wick Applicators are great for precision or drift free direct contact application, eliminating mist spray around valued plants or obstacles. Available as hand held Wick Stick for direct manual application or as a Boom Wick for vehicle attachment ideal for larger areas.

GARDEN WICK STICK

One wipe does it all! The successful wick wiping method has also been adapted to general garden use in an easy to handle, rake-size applicator. Its simple design allows liquid to flow from a long re-fillable PVC handle into a Pistachio wick head that in turn applies a lethal dose to weeds.

489

DRAWING
0694

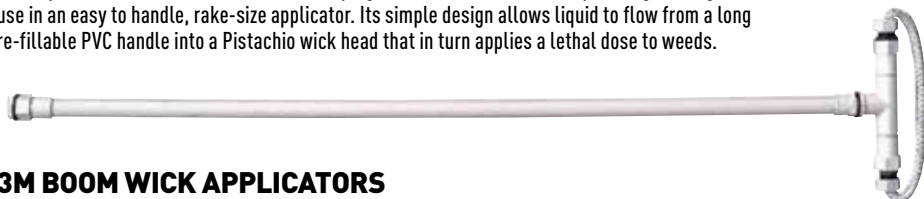

3M BOOM WICK APPLICATORS

The boom wick applicator Ideal for killing weeds over crops or pasture when installed at a certain height features a tough chemical resistant PVC boom with a horizontally mounted double row of pistachio wicks that are at right angles to the tractor. The boom itself acts as a herbicide reservoir and can be simply filled by unscrewing its end cap. Supplied with bracing plate and brackets.

48930BP

DRAWING
0287



PRESSURE REGULATOR KITS



RP1-24-3

Suitable for mounting to the tanks of 12V spray units

DRAWING
0632



RP1-24-4

Suitable for mounting direct to base of stand-alone Shurflo and Selecta 12V pumps

DRAWING
10721

CODE	BOOM CAPACITY	WICKS	LENGTH	WIDTH	HEIGHT	WT	LIST EX	LIST INC	CAT
489	0.6L	1	1260mm	280mm	-	0.42 kg	\$180.91	\$199.00	B
48930BP	16L	22	3000mm	80mm	80mm	14 kg	\$1,699.09	\$1,869.00	A
RP1-24-3	Pressure Regulator Kit						\$230.91	\$254.00	B
RP1-24-4	Pressure Regulator Kit						\$161.82	\$178.00	B

Booms & Hose Reels

BARE HOSE REELS

- Powder coated steel
- Made in Italy
- 181 to suit up to: 30m of 10mm hose or 20m of 12.5mm hose
- 190 to suit up to 100m of 12.5mm hose
- Supplied unassembled

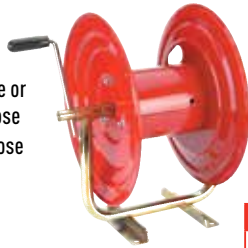

181

DRAWING
10555



190

DRAWING
10665

ECONOMY HOSE REELS

- Powder coated
- Steel plate construction with rewind handle
- Brass swivel and fittings are standard
- Common foot print suits 300L Lightfoot and 400L/800L SquatPak tanks

180E03010C:

- 30m of 10mm AG hose
- PA Spray gun



180E02012CT

180E02012CT:

- 20m of 12.5mm AG hose
- JetPro 49 Spray gun



180E03010C

ECO HOSE REEL

- Powder coated steel
- 30m of 10mm Ag hose
- 2.5m of 10mm ID hose for inlet
- 1/4" BSP brass outlet on hose
- Lockable hub with locking pin
- Common foot print suits 300L Lightfoot and 400L/800L SquatPak tanks



180G03010B

ECO HOSE REEL INCLUDES ATOMIZER+ SPRAY GUN

- Powder coated steel
- 2.5m of 10mm ID hose for inlet
- Lockable hub with locking pin
- 1/4" BSP brass outlet on hose



180G03010C

CODE	LENGTH	WIDTH	HEIGHT	WT	SPRAY GUN	HOSE LENGTH /I.D.	MAX PRESS	LIST EX	LIST INC	CAT
181	450mm	350mm	370mm	4 kg	-	-	20Bar/290 psi	\$303.64	\$334.00	A
190	500mm	500mm	500mm	9 kg	-	-	17Bar/250 psi	\$302.73	\$333.00	A
180E02012CT	450mm	350mm	370mm	12 kg	JetPro	20m/12.5mm	20Bar/290 psi	\$530.00	\$583.00	A
180E03010C	450mm	350mm	370mm	12 kg	Atomiser	30m/10mm	20Bar/290 psi	\$471.82	\$519.00	A
180G03010B	330mm	375mm	390mm	10 kg	-	30m/10mm	20Bar/290 psi	\$217.27	\$239.00	A

10M SPRING RETRACTABLE HOSE REEL

A versatile compact hose reel ideal for air, water and spraying applications.

- 10m of 8mm delivery hose & hose stop
- 1m inlet hose
- Max pressure 16 Bar/240psi
- 1/4" BSP M inlet/outlet connectors
- Swivelling steel mounting bracket
- Spring rewind with multi position latching
- Suitable for air, water or agricultural chemicals
- **Ideal to use with 25L & 55L Redline sprayers**



Scan here to see the 15m Spring Retractable Hose Reel in action!

15M SPRING RETRACTABLE HOSE REEL

Suitable for air, water or agricultural chemicals.

- Ideal for Linkage Sprayers
- Can also be mounted on workshop wall
- 1/4" BSP M outlet connection
- 15m of 10mm ID hose
- 1.5m inlet hose
- Max pressure 20 Bar
- **Ideal to use with 100L Redline sprayer and Smoothflo sprayers**



AIR / **WATER** / **CHEMICAL**



AIR / **WATER** / **CHEMICAL**



CODE	LENGTH	WIDTH	HEIGHT	WT	SPRAY GUN	HOSE LENGTH/I.D.	MAX PRESS.	LIST EX	LIST GST)	CAT
180L01008A	360mm	140mm	290mm	4.1 kg	-	10m/8mm	16 Bar/240 psi	\$136.36	\$150.00	A
180J1510A	400mm	160mm	450mm	7 kg	-	15m/10mm	20 Bar/290 psi	\$171.82	\$189.00	A



147R10012T

FREQUENCY HOPPING IMPROVES RELIABILITY TO WORK AROUND INTERFERENCE

NEATLY CONTAINED DIRECT DRIVE GEARBOX IS MAINTENANCE FREE

SELF RATCHETING PINLOCK KEEPS HOSE TAUGHT AND SECURE IN TRANSIT

HEAVY GAUGE HOT DIPPED GALVANISED STEEL FOR LONGER WORKING LIFE

FITTED WITH SNAP-LOCK FOR NEAT GUN STORAGE OR CHANGE



LONG RANGE REMOTE SYSTEM



RATCHETING PIN LOCK ELIMINATES ACCIDENTAL UNSPOOLING



OPTIONAL BRACKET FOR TPL MOUNTING

REEL TUFF 12V HEAVY DUTY REMOTE REEL

The professional tool for convenience, ideal for contract spraying or farm. This reel can be used for road side spraying, through undulating scrub, poultry sheds or glass houses.

- Heavy-Duty High torque Direct Drive Gear box
- Galvanised steel construction for corrosion & scratch resistance
- Long range remote system with automatic frequency hopping technology for interference-free use, 915mhz
- 100m of 1/2" Nylon tubing
- Turbo 400 spray gun with Snap-Lock connectors for neat storage
- Ratcheting pin lock for transport, keeps hose on the spool
- No belts, chains or sprockets to maintain

CODE	DESCRIPTION	LENGTH	WIDTH	HEIGHT	WT	MAX PRESS	LIST EX	LIST INC	CAT
147R10012T	Reel Tuff 12V Remote Reel	750mm	500mm	850mm	50 kg	40 Bar/580 psi	\$3,790.91	\$4,170.00	9



SILVAN E-WIND 12 VOLT REMOTE HOSEREEL

- Heavy Duty steel construction with powder coated finish
- 12 Volt High Torque Electric Motor direct coupled to Gearbox. Max 25amp under load
- Reel hub freely unwinds and uses electric clutch to engage rewind
- Aerial is positioned inside the control box
- Heavy Duty controller
- 100m Smoothline hose and Atomiser + Spray Gun

**NEW
RELEASE**



180K10012T

CODE	DESCRIPTION	LENGTH	WIDTH	HEIGHT	WT	LIST EX	LIST INC	CAT
180K10012T	Remote Reel with 100m Hose and Gun	590mm	400mm	735mm	49 kg	\$3,271.82	\$3,599.00	9

Warning: Refer to vehicle or tractor manufacturer's instructions for appropriate load & towing limits & fitting positions.
* Special Dealer Discount applies to these items

Accessory Fitment Chart

PRODUCT	PRESS REG	SPRAY BOOMS & PAK BOOMS			CROSS FOLD BOOMS			BOOMLESS NOZZLES						
		2M	3M	4M	3M	4M	SINGLE	TWIN	BRASS (02)	BRASS (05)	REDLINE 55L	REDLINE 100L		
		L99-09	L99-08	RP1-10	RP1-25	RP1-26	M99-74	M99-75	M99-65	M99-66	TR55-10	TR100-10		
REDLINE SPOTPAK - 25L TO 100L														
SP25-B/SP25-R1 (25L)	✓	✓	✗	✗	✗	✗	✗	✗	✗	✗	✗	✗	✓*	✗
SP55-R1 (55L)	✓	✓	✗	✗	✗	✗	✗	✗	✗	✗	✗	✗	✓*	✗
SP100-R2 (100L)	✓*	✓	✓	✓	✗	✗	✗	✗	✗	✗	✗	✗	✗	✓*
SPOTPAK - 50L TO 200L														
SP50-S7 (50L)	✓	✓	✓	✓	✓	✗	✓*	✗	✓*	✗	✗	✗	✗	✗
SP100-S7(100L)	✓	✓	✓	✓	✓	✗	✓*	✗	✓*	✗	✗	✗	✗	✗
SP200-S7 (200L)	✓	✓	✓	✓	✓	✗	✓*	✗	✓*	✗	✗	✗	✗	✗
QUADPAK - 50L & 70L														
RP50-P1 (50L)	✓*	✓	✓	✓	✗	✗	✓*	✗	✓*	✗	✗	✗	✗	✗
RP70-P1 (70L)	✓*	✓	✓	✓	✗	✗	✓*	✗	✓*	✗	✗	✗	✗	✗
RAKPAK - 70L														
RP70N-S7 (70L)	✓	✓	✓	✓	✓	✗	✓	✗	✓	✗	✗	✗	✗	✗
RP70N-S3 (70L)	✓	✓	✓	✓	✓	✗	✓*	✓*	✓	✗	✗	✗	✗	✗
RP70N-S10 (70L)	✓	✓	✓	✓	✓	✗	✓*	✓*	✓	✗	✗	✗	✗	✗
UTEPAK - 100L														
UP100-S7-2 (100L)	✓	✓	✓	✓	✓	✗	✓*	✗	✓*	✗	✗	✗	✗	✗
TRUKPAK-200L														
TK200-S7-1 & -2 (200L)	✓	✓	✓	✓	✓	✗	✓	✗	✓	✗	✗	✗	✗	✗
TK200-S9 - 1 & -2 (200L)	✗	✗	✗	✗	✗	✗	✗	✗	✗	✗	✗	✗	✗	✗
TK200-S3 (200L)	✓	✓	✓	✓	✓*	✓*	✓*	✓*	✓*	✓	✓	✓	✗	✗
TK200-S10 (200L)	✓	✓	✓	✓	✓*	✓*	✓*	✓*	✓*	✓	✓	✓	✗	✗
LIGHTFOOT - 300L TRAILED														
LT30-S5 (300L)	✗	✓	✓	✓	✓	✓	✓	✓*	✓*	✓*	✓*	✓*	✓*	✗
LT30-S8 (300L)	Fitted	✓	✓	✓	✓	✓	✓	✓*	✓*	✓*	✓*	✓*	✓*	✗
LT30-S8-1 & 2 (300L)	Fitted	✓	✓	✓	✓	✓	✓	✓*	✓*	✓*	✓*	✗	✗	✗
LT30-34 & LT30-34-2 (300L)	Fitted	✓	✓	✓	✓	✓	✓	✓*	✓*	✓*	✗	✗	✗	✗
SQUATPAK - 300L & 400L														
SQ300-S7-1 & S2	✓	✓	✓	✓	✓	✗	✓	✗	✓	✗	✗	✗	✗	✗
SQ-400-S7-1 (400L)	Fitted	✓	✓	✓	✓	✓	✓*	✗	✓*	✗	✗	✗	✗	✗
SQ400-S8-1 (400L)	Fitted	✓	✓	✓	✓	✓	✓*	✓*	✓*	✓*	✓*	✗	✗	✗
L04H4-42 (400L)	Fitted	✓	✓	✓	✓	✓	✓*	✓*	✓*	✓	✓	✗	✗	✗
TRAYLINK 200L & 300L														
K02A (200L)	Fitted	✓	✓	✓	✗	✗	Fitted	Fitted	✓*	✗	✗	✗	✗	✗
K03A (300L)	Fitted	✓	✓	✓	✓	✓	Fitted	Fitted	✓*	✗	✗	✗	✗	✗
TROLLEY SPRAYERS - 25L														
SP25-TR2 (25L)	✗	✓	✗	✗	✗	✗	✗	✗	✗	✗	✗	✓	✗	✗
TR25-P (25L)	Fitted	✓	✗	✗	✗	✗	✗	✗	✗	✗	✗	✗	✗	✗
TR25-S7 (25L)	✗	✗	✗	✗	✗	✗	✗	✗	✗	✗	✗	✗	✗	✗
12V PUMPS														
DDP-552A	✓	✓	✓	✓	✓	✓	✓	✗	✓	✗	✗	✗	✗	✗
DDP-550,DDP-551	✓	✓	✓	✓	✓	✓	✓	✓	✓	✓	✓	✗	✗	✗
DDP-554	✗	✗	✗	✗	✗	✗	✗	✗	✗	✗	✗	✗	✗	✗
DDP-555	✓	✓	✓	✓	✓	✓	✓	✓	✓	✓	✓	✓	✗	✗
381-35	✗	✓	✗	✗	✗	✗	✗	✗	✗	✗	✗	✗	✓*	✗
381-38	✗	✓	✗	✗	✗	✗	✗	✗	✗	✗	✗	✓*	✗	✗
381-2000	✓	✓	✓	✓	✓	✗	✓	✗	✓	✓	✓	✗	✗	✓*
381-125	✓	✓	✓	✓	✓	✓	✓	✓	✓	✓	✓	✗	✗	✗
361-SLV10-AA40	✗	✓	✗	✗	✗	✗	✗	✗	✗	✗	✗	✓*	✗	✗
361-8000	✓	✓	✓	✓	✓	✗	✓	✗	✓	✗	✗	✗	✗	✗
361-2088	✓	✓	✓	✓	✓	✓	✓	✓	✓	✓	✓	✗	✗	✗

KEY: ✓ Available option
✗ Not recommended

Fitted: Already fitted to unit
✓* Unit requires extra 186-12C hose (sold separately) in order to mount the nozzle kit in a suitable location on the vehicle

PLEASE NOTE: If fitting on a unit with a pressure regulator (RPI-24-3), an adapter (G8001151) will be required (sold separately).

WARNING: Refer to vehicle or tractor manufacturer's instructions for appropriate load and towing limits and fitting positions. Never fill the spray tank capacity to exceed the vehicle or tractor manufacturer's specified safe load carrying capacities.
NOTE: 1L of water = 1kg

Guidance, Monitors & Foam Markers





GPS GUIDANCE SYSTEMS

The Matrix use's GPS technology to help guide tractors and machinery when boom spraying to minimise spray overlap/undertlap to ensure optimal application. This modern advancement is ideal for use with a Boom Spray, Fertiliser Spreaders or even when raking hay to keep you on track and in a straight line replacing and enhancing the function of a foam marker.

MATRIX 430

- Versatile GNSS guidance in a compact, portable package
- High-contrast, full colour, 4.3 in / 110mm graphic touchscreen display provides superior visibility in bright light conditions
- Guidance modes include: Straight AB, Curved AB, Circle Pivot and Last Pass
- Applied alert provides operator with audible alarm when entering into previously applied areas
- Area counter measures and displays applied area throughout application
- Elapsed time counter measures amount of time spent on current job



GD430-GLO-P-L

MATRIX GUIDANCE FUNCTIONS

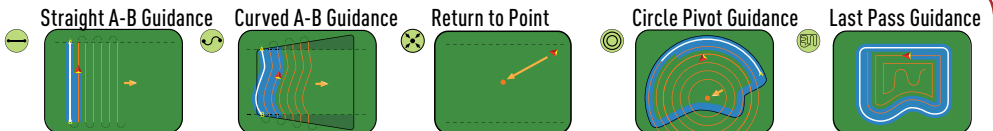

CODE	DESCRIPTION	LIST EX	LIST INC	CAT
GD430-GLO-P-L	Matrix 430	\$2,271.82	\$2,499.00	A



Visio is the innovative multi-function display featuring compact dimensions and accuracy at an affordable price. The desired function can be selected via software. It can be connected to several sensors, to view a wide range of data from agricultural spraying applications.

Overall dimensions: 125mm (W) x 80mm (H) x 65mm (D) Screen size: 65mm backlit LCD display.

VISIO HECTARE METER

Simultaneous display of treated area and ground speed using an inductive speed sensor.

1. Visio display unit
2. Cable kit for single sensor
3. Inductive speed sensor

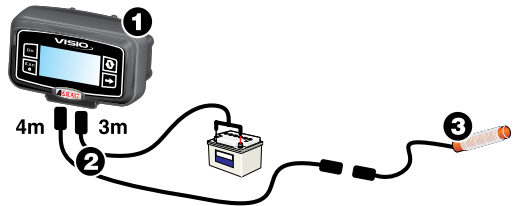

VISHA

VISIO RATE MONITOR

Display of ground speed, area, flow rate, application rate and volume using a 10-200 L/min (40 Bar) flow sensor.

1. Visio display unit
2. Cable kit for double sensor
3. Inductive speed detector
4. 10-200 L/min (40 Bar) 'WOLF' flowmeter

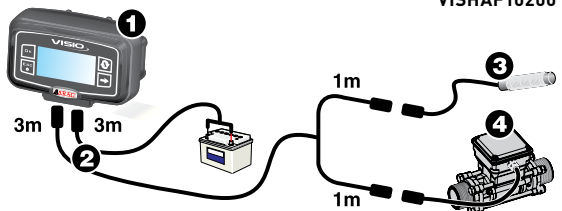

VISHAF10200

CODE	DESCRIPTION	LIST EX	LIST INC	CAT
VISHA	VISIO Hectare Meter	\$590.00	\$649.00	A
VISHAF10200	VISIO Rate Monitor	\$1,160.00	\$1,276.00	A

Note: Fitment and plumbing required when fitting to existing sprayers.

FOAM MARKERS

Designed for the spray operator that can have a visual reference of the areas sprayed with a boom, eliminating expensive under or over lapping of chemicals.

- UV stabilised poly tanks
- 12 volt fully sealed, dust free diaphragm compressor with breather
- In cab remote mounted control box with wiring loom
- Valve for foam output adjustment
- 1L foam marker concentrate supplied with each unit

14L MODEL - 042M

- 10m reinforced delivery hose and single foam dropper

16L MODEL - 042D-16S

- 16m delivery hose and double foam droppers
- In cab remote with On/Off & Left/Right control

57L MODEL - 042D-57

- 36m delivery hose and Double foam droppers
- In cab remote with On/Off & Left/Right control

042M

DRAWING
0725



042D-16S



042D-57
SHOWN WITH 600L
LINKAGE SPRAYER

CODE	DESCRIPTION	LENGTH	WIDTH	HEIGHT	WT	LIST EX	LIST INC	CAT
042M	14L Foam Marker	570mm	195mm	340mm	12 kg	\$743.64	\$818.00	A
042D-16S	16L Foam Marker	570mm	210mm	460mm	14.5 kg	\$950.00	\$1,045.00	A
042D-57	57L Paddock Foam Marker	850mm	300mm	570mm	21 kg	\$1,450.00	\$1,595.00	A

ALL CLEAR TANK CLEANER

Remove pesticide deposits and other debris, including oily substance from tanks, hoses, booms, transfer and mixing systems, filters, screens and nozzles

- 1L of All Clear makes up to 400L of cleaning solution



071-1LAC

5L FOAM CONCENTRATE

Makes 500L of high density foam Provides excellent visibility and long life on the ground.



071-4D

12V COMPRESSOR

As used on Selecta foam markers. Ideal for high volume, low pressure foam making application.

- 1/8" BSP outlet
- 37L/min@32kPa/4.6psi
- 60W

042C-6

DRAWING
5003



12V HEAVY DUTY COMPRESSOR

As used on Silvan foam markers. Ideal for high volume, low pressure foam making application.

- 1/4" BSP outlet
- 38L/min@32kPa/4.6psi
- 96W



042D-45201

DRAWING
10138

CODE	DESCRIPTION	LENGTH	WIDTH	HEIGHT	LIST EX	LIST INC	CAT
071-1LAC	1L All Clear Tank Cleaner				\$60.00	\$66.00	B
071-4D	5L Foam Concentrate				\$85.45	\$94.00	B
042C-6	Compressor 37L/min 12V	200mm	110mm	140mm	\$252.73	\$278.00	B
042D-45201	Compressor 38L/min 12V Heavy Duty	200mm	140mm	170mm	\$365.45	\$402.00	A

Spray Guns



EN 300
3111
CE

Silvan

**GENUINE
ACCESSORIES**

Silvan



DESIGNED BY SILVAN

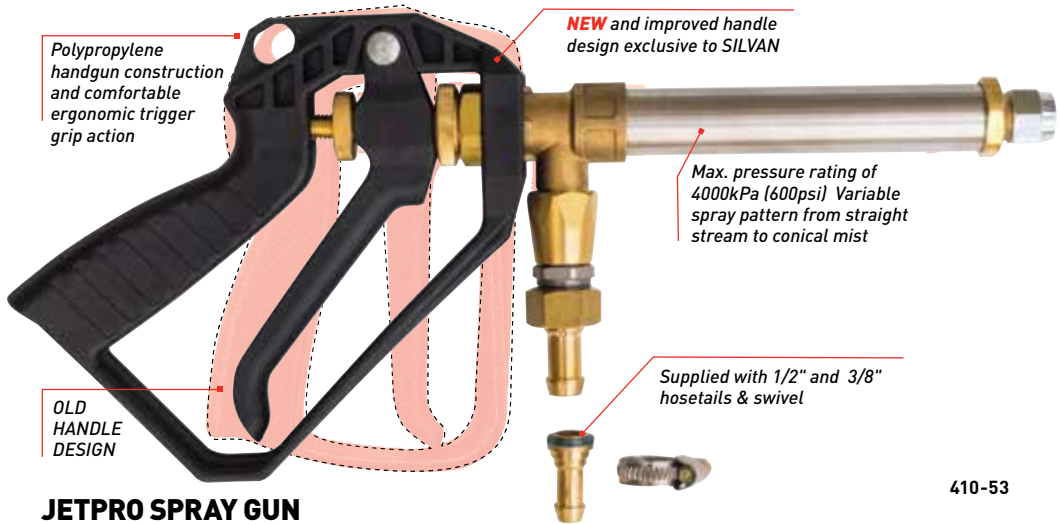

410-53

JETPRO SPRAY GUN

Ergonomic design for comfortable hold and to reduce fatigue

- Strong corrosion resistant lance with non-drip shut off at nozzle
- Max pressure 40bar (600psi) to support atomising spray for greater coverage
- Supplied with hose swivel, 1/2" and 3/8" hosetails
- Professional spray gun, that has the ability to deliver a straight stream to a cone spray pattern by easily adjusting the trigger. The spray gun has a locking device that allows the operator to set a desired spray pattern for easier constant spraying requirements



CODE	DESCRIPTION	HOSE SIZES I.D.	LENGTH	WT	MAX PRESSURE	LIST EX	LIST INC	CAT
410-53	JetPro Spray Gun	3/8" 1/2"	380mm	.755 kg	40 Bar/600 psi	\$122.73	\$135.00	B



**NEW
RELEASE**

TOMMY GUN

Designed for applications where volume and ranged spraying are required up to 25 meters. Uses include tree spraying, watering, fire fighting, wash down, cleaning chicken sheds.

- Front hand piece ergonomically adjusts spray pattern from distance to wide spray
- On/Off Trigger lock for easy no strain spraying
- Tough tungsten nozzle
- 1/2" BSP thread
- Supplied with 2 nozzles, 1.5 and 2.5mm



410-54

CODE	DESCRIPTION	HOSE SIZES I.D.	MAX PRESSURE	LENGTH	WT	LIST EX	LIST INC	CAT
410-54	Tommy Gun	12.5mm	50 Bar/725 psi	570mm	1.7 kg	\$90.00	\$99.00	B

HIGH PRESSURE HAND GUN

Utilise the power of your spray pump to operate this high powered pressure washer.

- Circular pulse nozzle enhances pressure for deep cleaning
- Requires 30 + Bar to operate
- Ideal for cleaning Tractor, Implements and sprayers after use and general cleaning
- Portable use as this cleaning gun can be used anywhere within the range of your high pressure sprayer and doesn't require a 240V Connection



**NEW
RELEASE**

CODE	DESCRIPTION	HOSE SIZES I.D.	MAX PRESSURE	LENGTH	WT	LIST EX	LIST INC	CAT
410-55	High Pressure Hand Gun	12.5mm	50 Bar/725 psi	1170mm	1.4 kg	\$144.53	\$159.00	B

DRAWING
10806



TRIGGER SPRAY GUN

This Lightweight durable spraygun is a replacement gun on our Redline 25L & 55L Sprayer. Suitable for many hand sprayers, knapsack sprayers and 12 volt sprayers.

401-213-05
10MM HOSETAIL & O'RING
(OPTIONAL)

- Adjustable nozzle that produce a straight stream or a conical spray pattern
- The poly hand piece has a lock on/off feature
- Fitted with chemical resistant O'Rings
- Stainless steel lance
- 6mm hosetail supplied



CODE	DESCRIPTION	HOSE SIZES I.D.	MAX PRESSURE	LENGTH	WT	LIST EX	LIST INC	CAT
382-052	Redline Spray Gun	8/10mm	6.6 Bar/100 psi	770mm	0.420 kg	\$20.00	\$22.00	B
401-213-05	10mm Hosetail and O'Ring					\$1.36	\$1.50	B

Spray Guns



ATOMISER+ SPRAY GUN

A Heavy Duty spray gun designed for professional and general spraying with an ergonomic handle to maintain comfort of use. An adjustable spray lever changes spray from straight stream to conical mist.

- Heavy duty polypropylene construction with steel/brass barrel
- Airvac nozzle shroud atomiser ensures a very fine mist for excellent leaf coverage and reduction of droplet leakage
- 1/2" Bsp Male with hose tails to suit 10 & 12.5mm ID hose



CODE	DESCRIPTION	HOSE SIZES I.D.	LENGTH	MAX PRESSURE	WT	LIST EX	LIST INC	CAT
410-52	Atomiser+ Spray Gun	10/12.5mm	400mm	40 Bar/580 psi	0.70 kg	\$92.73	\$102.00	B



VARIJET SPRAY GUN MKII

Lightweight, corrosion resistant ergonomical design, sprays from straight stream to conical mist.

- Spray pattern changes by rotating gun barrel
- On/off trigger grip action with lock off position
- Designed to reduce fatigue while spraying
- 1/2" BSP M inlet with hose tail to fit 10/12.5mm hose
- Hose swivel Included



410-43

DRAWING
10533

TRIAM SPRAY GUN

Ideal for high pressure applications with a trigger adjustable spray pattern for straight stream for distance or wide cone for atomising with non-drip shut-off at nozzle. Has a sturdy stainless steel/brass barrel and a polypropylene handgun construction to help reduce fatigue. Supplied with hose swivel, cone and fan nozzle.

- 1/2" BSP M inlet supplied with 3/8" and 1/2" hosetails

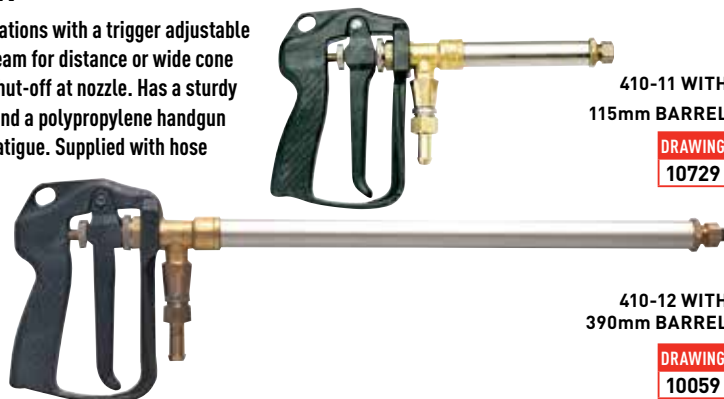

410-11 WITH
115mm BARREL

DRAWING
10729

410-12 WITH
390mm BARREL

DRAWING
10059

CODE	DESCRIPTION	HOSE SIZES I.D.	LENGTH	WT	MAX PRESSURE	LIST EX	LIST INC	CAT
410-43	Varijet Spray Gun With Adjustable Spray Pattern	10/12.5mm	293mm	0.500 kg	40 Bar/600 psi	\$193.64	\$213.00	B
410-11	Triam 44 Spray Gun	10/12.5mm	305mm	0.650 kg	40 Bar/600 psi	\$171.82	\$189.00	B
410-12	Maxi Triam Spray Gun	10/12.5mm	620mm	1.020 kg	40 Bar/600 psi	\$251.82	\$277.00	B
SERVICE KIT CODE	401-45BR Service Kit to Suit 44 Triam Spray Guns					\$28.18	\$31.00	B

Spray Guns



M30 JET TRIGGER SPRAY GUNS

Features a very strong and sturdy handgun body with on/off trigger and locking device. Extremely lightweight and comfortable. Supplied with extension lance and brass adjustable nozzle.

- 1/2" BSP M inlet supplied with 3/8" and 1/2" hosetails

411-25

DRAWING
10278



411-26

DRAWING
10264



CODE	DESCRIPTION	HOSE SIZES I.D.	LENGTH	WT	MAX. PRESSURE	LIST EX	LIST INC	CAT
411-26	M30 Spray Gun - Long	10/12.5mm	710mm	0.330 kg	20 Bar/290 psi	\$75.45	\$83.00	B
411-25	M30 Spray Gun - Short	10/12.5mm	370mm	0.300 kg	20 Bar/290 psi	\$73.64	\$81.00	B
401-30-302-25	Service Kit to Suit M30 Spray Gun Only					\$19.09	\$21.00	B
479-1928	Spare Nozzle					\$8.82	\$9.70	B

KWAZAR TELESCOPIC SPRAY LANCE

Supplied standard with fully adjustable nozzle.
Extends from 600mm to 1000mm.



410-26

CODE	DESCRIPTION	HOSE SIZE	WT	MAX. PRESSURE	LIST EX	LIST INC	CAT
410-26	Kwazar Telescopic Spray Lance	8mm	0.2 kg	6.6 Bar/100 psi	\$53.64	\$59.00	B
C1210-043	'O' ring				\$1.18	\$1.30	B
401-WN040	45 Degree Elbow And Nozzle Cap				\$10.91	\$12.00	B
401-213-05	Hose Tail				\$1.36	\$1.50	B
5500-PPB-X18	Replacement Nozzle				\$26.36	\$29.00	B



410-34

DRAWING
10472

PA SPRAY GUN

Selecta spray guns are designed to help reduce fatigue whilst hand spraying. Popular with farmers, orchardists and contractors they are manufactured in a range of materials from stainless steel, brass and polypropylene.

- On/off trigger grip action with lock off position
- Fibreglass reinforced body
- 1/4" BSP F inlet supplied with 3/8" and 1/2" hosetails



410-30

DRAWING
10473



410-38

DRAWING
10474

CODE	DESCRIPTION	HOSE I.D.	LENGTH	WT	MAX. PRESSURE	LIST EX	LIST INC	CAT
410-34	500mm S/S Lance, Cone & Fan Nozzle	10mm/12.5	700mm	0.42 kg	20 Bar/290 psi	\$126.36	\$139.00	B
410-30	200mm Poly Lance & Adj. Brass Nozzle	10mm/12.5	430mm	0.32 kg	20 Bar/290 psi	\$126.34	\$136.00	B
410-38	Spray Gun With Adjustable Brass Nozzle	10mm/12.5	230mm	0.35 kg	20 Bar/290 psi	\$61.82	\$160.00	B
PARTS CODE	410-36	Replacement Stainless Steel Lance To Suit 410-34 PA Spray Gun				\$61.82	\$68.00	B
	5500-PPB-X12	Optional Adjustable Poly Nozzle To Suit 410-34				\$26.36	\$29.00	B
	410-32	Replacement Poly Lance To Suit 410-30 PA Spray Gun				\$34.55	\$38.00	B
SERVICE KIT	410-30000224	Service Kit To Suit PA Series Spray Guns (No Spring Included)				\$25.45	\$28.00	B

Spray Guns

GUNJET 30 SPRAY GUN

The Gunjet 30 spray gun is ideal for all types of spraying. Both spray guns are durable and designed for excellent corrosion resistance. The AAB30L-1/4 body and trigger are moulded from tough nylon and the AAB30L-PP from polypropylene.

TO ORDER: SPECIFY LANCE EXTENSION SIZE (INCHES) – SEE EXAMPLES BELOW.

** Hosetails not supplied (see below)*

AA31



DRAWING
0600

AAB30L-PP



AAB30L-1/4 pictured with **7715-12** Straight lance (each sold separately)

AAB30L-1/4

DRAWING
0599

CODE	INLET CONNECTION	LENGTH	WT	MAX. PRESSURE	MAX. FLOW	LIST EX	LIST INC	CAT
AAB30L-1/4	1/4" BSPT (F)	160mm	0.436 kg	16 Bar/250 psi	19 L/min	\$117.27	\$129.00	B
AAB30L-PP	1/4" BSPT (F)	160mm	0.370 kg	10 Bar/150 psi	19 L/min	\$122.73	\$135.00	B
AA31	500psi (35 bar)					\$173.64	\$191.00	B
474-191T	Brass Hosetail 1/4" Male x 3/8" Barb					\$4.64	\$5.10	B
474-200T	Brass Hosetail 1/4" Male x 1/2" Barb					\$4.73	\$5.20	B
AB30L-KIT	Service Kit To Suit Gunjet 30 (AAB30L - 1/4)					\$30.00	\$33.00	B
PK-AB30L-PP-KIT	Service Kit To Suit Gunjet 30 (AAB30L - PP)					\$41.82	\$46.00	B

STRAIGHT LANCE



7715-** (sizes available: 8, 12, 18, 24, 30, 36 and 48 inch)

*** To order: 7715-8 (8 inch)**

CURVED LANCE



6671-** (sizes available: 8, 18, 24, 30, 36 & 48 inch)

*** To order: 6671-8 (8 inch)**



AA31 pictured with **6671-24** curved lance (each sold separately)

CODE	DESCRIPTION	LIST EX	LIST INC	CAT
6671-**	8 - 48 Curved Extension With Fixed Body	\$36.36	*from \$40.00	B
7715-**	8 - 48 Straight Extension	*from \$30.91	*from \$34.00	B

GUNJET 43 SPRAY GUN

AAB43HA-8

A heavy duty robust spray gun ideal for professional contractors and for spraying blackberries and Patterson's Curse. Stem extends through extension to valve seat located directly behind orifice disc for drip-free shutoff and instant operating response. Convenient trigger-lock for continuous spraying.

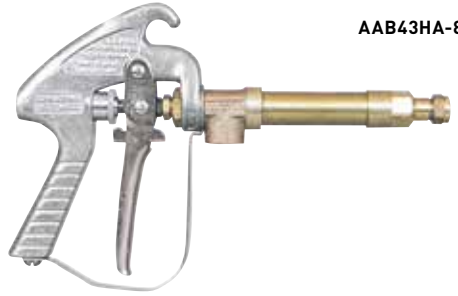

CODE	INLET CONNECTION	LENGTH	WT	MAX. PRESSURE	MATERIAL	LIST EX	LIST INC	CAT
AAB43HA-8	1/2" BSPT (F)	330mm	1.30 kg	53 Bar/797 psi	Brass	\$317.27	\$349.00	B
AAB43LA-AL8	1/2" BSPT (F)	330mm	1.00 kg	3.5 Bar/203 psi	Aluminium	\$286.36	\$315.00	B
474-209	Hosetail 1/2 "Male x 3/8 " Barb				Brass	\$11.82	\$13.00	B
474-207	Hosetail 1/2 "Male x 1/2 " Barb				Brass	\$9.09	\$10.00	B
PK-AB43-KIT	Service Kit To Suit Gunjet 43 (Brass)					\$89.09	\$98.00	B
PK-AB43-AL-KIT	Service Kit To Suit Gunjet 43 (Aluminium)					\$89.09	\$98.00	B

TURBO 400 SPRAY GUN

Constructed from high impact chemical resistant plastic with stainless steel and brass components. Features include spring loaded adjustable spray lever with variable spray control from misting to spot spraying and a trigger locking device. The Airvac nozzle shroud atomiser ensures a very fine mist with excellent leaf coverage and reduction of droplet leakage when operating from 1500kPa upwards.

- Minimum operating pressure for misting is 150 psi
- 1/2" BSP M inlet and hose swivel.
- Supplied with 3/8" and 1/2" hosetails



411-22
With polypropylene hand piece

DRAWING
10706

NOZZLE OPTIONS	SIZE	NOZZLE OPTIONS	SIZE
MA7-10	1.0	MA7-23	2.3
MA7-12	1.2	MA7-25	2.5
MA7-15	1.5	MA7-30	3.0
MA7-18	1.8	MA7-35	3.5
MA7-20	2.0	MA7-40	4.0



401-26BRQS
Aluminium hand piece with trigger guard

DRAWING
107156

CODE	DESCRIPTION	HOSE I.D.	LENGTH	WT	MAX. PRESSURE	LIST EX	LIST INC	CAT
411-22	Turbo 400	10/12.5mm	440mm	0.700 kg	50 Bar/725 psi	\$190.00	\$209.00	B
401-26BRQS	Turbo 400	10/12.5mm	440mm	0.700 kg	50 Bar/725 psi	\$167.27	\$184.00	B
401-26BR-001	Service Kit To Suit Turbo 400 Spray Gun					\$74.55	\$82.01	B

Spray Guns



ADJUSTABLE NOZZLES

5500-X**: Brass nozzle provides half turn for wide angle, finely atomised cone spray to a straight stream distance spraying.

(SIZES AVAILABLE: -X1;-X2; -X3; -X4; -X5; -X6; -X8; -X10; -X12; -X14)

*To order: 5500-X1 for -X1 size



5500-X**

5500-PPB-X**: Poly version provides excellent chemical resistance and is lightweight, making it well suited for hand held and backPack type sprayers.

(SIZES AVAILABLE: -X3; -X5; -X6; -X8; -X12; -X18)

*To order: 5500-PPB-X3 for -X3 size



5500-PPB-X**

ADJUSTABLE NOZZLES

Single adjustable brass nozzle suit Triam and low pressure guns.



417-80

CODE	MATERIAL	LENGTH	WT	MAX. PRESSURE	LIST EX	LIST INC	CAT
5500-X**	Brass	42mm	46gm	10 Bar/145 psi	\$43.64	\$48.00	B
5500-PPB-X**	Poly	47mm	8gm	10 Bar/145 psi	\$26.36	\$29.00	B
417-80	Brass	65mm	90gm	13 Bar/200 psi	\$38.18	\$42.00	B

SPRAY HOSE SWIVEL

Eliminates twisted hose. Brass with Viton 'O' ring.

- Thread size 1/2" BSPT male/female



418-94

CODE	DESCRIPTION	MAX. TEMP	LENGTH	WT	MAX. PRESSURE	LIST EX	LIST INC	CAT
418-94	Spray Hose Swivel	93 °C (200 °)	40mm	80gm	50 Bar/725 psi	\$34.55	\$38.00	B

Spray Guns



382-076

SPRAY SHIELDS

Helps reduce excess spray drift. Complete with swivel adjustment.

Supplied with adapters to adapt to the Spotjet and PA spray guns, which are fitted to popular sprayers.

Also; Jet Trigger, Gunjet 30 (with or without extension) and Gunjet 43.

Includes Non-drip check valve, 80 deg (-02) flat fan nozzle and swivel elbow connection to the spraygun.

See earlier pages for spray guns.



417-86A

DRAWING
10920

**FITS TO
SMOOTHFLO
SPOTPAKS**

CODE	INLET CONNECTION	LENGTH	WEIGHT	MAX PRESSURE	LIST EX	LIST INC	CAT
382-076	Redline Spray Shield	220mm	64 g	4 Bar/60 psi	\$9.90	\$10.89	B
417-86A	Various	295mm	0.700kg	9.3 Bar /140 psi	\$57.27	\$63.00	B

SNAP COUPLING BRASS

Provides instant liquid cut off when pistol is detached from spray hose.

1/2" BSP male. Max pressure 3000 kPa/435 psi.



406-02-PK

SNAP COUPLING POLY

Provides instant liquid cut off when pistol is detached from spray hose.

- 1/2" BSP male with locking device
- Maximum pressure 1450 kPa/210 psi.



406-03-PK

CODE	INLET CONNECTION	LENGTH	WEIGHT	MAX PRESSURE	LIST EX	LIST INC	CAT
406-02-PK	1/2" BSPT (M)	75mm	155gm	30 Bar/435 psi	\$102.73	\$113.00	B
406-03-PK	1/2" BSPT (M)	75mm	40gm	14 Bar/210 psi	\$84.55	\$93.00	B

Silvan

Hand, Backpack & Trolley Sprayers



Silvan

Silvan Sprayers

Feature packed professional & household ranges for efficient & easy spraying

KNOW YOUR APPLICATIONS



HERBICIDES



PESTICIDES



FERTILISERS



DEGREASER



CONCRETE SEALING

CONVENIENT LANCE HOLDER

PADDED LARGE LOOP HANDLE FOR COMFORT

HANDLE HEIGHT ADJUSTMENT

ROBUST WHEELS FOR EASY CARTING

3 BAR MAX PRESSURE WITH RELEASE VALVE

SUPERIOR NON-SPILL LID

CORROSION RESISTANT SPRAY LANCE WITH SOFT HAND GRIP

TRIGGER LOCK FOR CONTINUOUS SPRAYING

EASY OPERATING SPRAY HANDLE FOR LEFT OR RIGHT HANDED USE



VITON EQUIPPED

3 DIFFERENT NOZZLES SUPPLIED: ADJUSTABLE BRASS, ADJUSTABLE PLASTIC & FLAT FAN PLASTIC



4L & 8L CHAPIN SURESPRAY PORTABLE SPRAYERS

Suitable for applying herbicide, pesticide, fertiliser and degreaser.

- Strong polyethylene tank with funnel top opening
- Spray gun includes a brass & plastic adjustable nozzle
- Includes clip-on spray shield and anti-clog filter
- Includes a 125mL (1/2 cup) measuring cup for chemicals which latches to spray tank for storage



LEADING
USA BRAND
Since 1884

DRAWING
10691
10728

CP-27010 (4L)
CP-27020 (8L)



12L HEAVY DUTY TROLLEY PRESSURE SPRAYER

Viton equipped professional quality pressure sprayer for accurate application of herbicide, pesticide, fertiliser, degreaser & cleaning products.

- Trolley wheels and adjustable large loop handle with comfort grip
- Easy-to-use spray handle with 500mm aluminium lance and adjustable nozzle
- Easy operating spray handle with continuous spray feature



TR12-2



CODE	DESCRIPTION	LENGTH	WIDTH	HEIGHT	WT	LIST EX	LIST INC	CAT
SERVICE KIT CODE	479-1000 Service Kit To Suit Volpi Hand Sprayer					\$45.45	\$50.00	B
CP-27010	4L Chapin Surespray Portable	187mm	187mm	380mm	1.1 kg	\$57.27	\$63.00	A
CP-27020	8L Chapin Surespray Portable	210mm	210mm	480mm	1.6 kg	\$66.36	\$73.00	A
TR12-2	12L Heavy Duty Trolley Pressure Sprayer	180mm	180mm	600mm	2 kg	\$79.09	\$87.00	A

15L BACKPACK SPRAYER

KN15D-1

Silvan sprayers are professional quality pressure sprayers. Designed for accurate application of chemicals using adjustable nozzles for spraying from a fine mist to a coarse pencil stream.

- Fitted with quality Viton diaphragm
- Flat fan and adjustable nozzle
- 500mm spray gun with stainless steel lance
- Lockable spray lance trigger
- Anti spill screw lid and strainer with handle storage
- Adjustable padded straps
- Left or right side pump handle

Must be purchased in a 5 pack



RRP
\$79.00
EACH



Adjustable Padded Straps & Handle Storage



Adjustable Nozzle Included (Fine Mist to Coarse Pencil Stream)



15L CHAPIN BACKPACK SPRAYER

Ideal for weed control, pest control and fertilisers.

- Viton equipped
- Easy operating spray handle for left or right handed use
- 740mm corrosion resistant spray lance with soft hand grip and trigger lock for continuous spraying
- Supplied with 3 different nozzles: adjustable brass, adjustable plastic and flat fan plastic
- Three stage filtration maintains long working life
- Padded straps and waist belt reduces shoulder strain
- Ergonomically contoured tank for added comfort
- Large Viton piston pump builds pressure fast

LIQUID
CHEMICALS

CP-61800

DRAWING
10714
10051



VITON[®]
SEALS & GASKETS
EQUIPPED



CODE	DESCRIPTION	LENGTH	WIDTH	HEIGHT	WT	LIST EX	LIST INC	CAT
KN15D-1-5	Pack of 5 x KN15D-1 Dealer Reorder Code	210mm	350mm	570mm	4 kg	\$359.10	\$395.01	A
CP-61800	15L Chapin Bkpk Sprayer (Piston Pump)	230mm	388mm	580mm	4 kg	\$170.91	\$188.00	A

Hand & Backpack Sprayers



Stainless Steel wand



Easy to use gun



JetClean self-cleaning pump



HEAVY DUTY CHAPIN KNAPSACK

Best in class, ease and innovation combined, the Chapin Self-Cleaning Backpack sprayer is loaded with features for the DIY Homeowner yet rugged enough for the Professional.

- Commercial quality sprayer with Jet Clean self-cleaning filter to reduce nozzle blockage
- Stainless steel wand with cushion grip and 3 nozzles - fan, cone and adjustable brass
- Swing-away handle for right or left hand use, folds up for storage. Padded shoulder straps and back pad
- Viton seals
- Fold-up handle



Pencil stream spray pattern



Conical spray pattern



CP-63900

VITON[®]
SEALS & GASKETS
EQUIPPED

CODE	DESCRIPTION	LENGTH	WIDTH	HEIGHT	WT	LIST EX	LIST INC	CAT
CP-63900	15L Chapin Bkpk Sprayer (Piston Pump)	230mm	388mm	580mm	4 kg	\$199.09	\$219.00	A

16L RECHARGEABLE BACKPACK SPRAYER

Ideal for weed control, pest control & fertilisers around the farm, park, garden & nursery.

- UV stabilised polytuff tank
- Rechargeable 7.4V Li-Ion battery with charger
- Heavily padded shoulder straps, adjustable
- 1.5L/min open flow (275kpa/40psi max.)
- Santo diaphragm
- Replacement pump code 382-072 6V pump
- Using adjustable nozzle: Up to 6m throw



WP16-6

DRAWING
10821



Scan here to see the 16L Rechargeable Backpack Sprayer in action!

**POWERED
SPRAYER**
NO PUMPING
REQUIRED!

14L SILVAN BLOWAMIST

A necessity for any nursery, greenhouse or small orchard. Fan forced spray mist generates coverage deep into foliage.

- Compact 2 stroke 43cc engine
- 14L chemical tank with anti spill lid
- Chemical throw up to 15 metres
- Variable flow adjuster
- Padded shoulder support



NBB-3W650

DRAWING
10822



Scan here to see the 14L Selecta Blowmist in action!

CODE	DESCRIPTION	LENGTH	WIDTH	HEIGHT	WT	LIST EX	LIST INC	CAT
WP16-6	16L 6V WeedPak Knapsack	260mm	345mm	550mm	6.5 kg	\$177.27	\$195.00	A
382-072	Replacement Pump for WP16-6					\$76.36	\$84.00	B
NBB-3W650	14L Silvan Blowmist	380mm	510mm	640mm	10 kg	\$453.64	\$499.00	A

Silvan

Safety Equipment & Chemical Transfer



Silvan

SAFETY GOGGLES

- Wide Viewing area & can be worn with most prescription glasses
- Soft frame for comfort
- Stops 99.99% of UV light

SCP2065



EAR MUFFS

- 18db reduction rating
- Adjustable fit

SCP5015



HALF MASK RESPIRATOR KIT

- Soft Silicone face seal
- Downward outflow prevent eyewear fogging
- Supplied with P2 Particulate filter.
- Optional A1 Filter for organic vapors (meet AS/NZS 1715-16).
- A1 & P2 Filters can be combined for A1P2 protection



SCP1085

PROFESSIONAL FACE SHIELD

- Ratchet adjustable headband
- 200mm x 394mm visor

SCP6015



DISPOSABLE COVERALLS

- One size fits all
- Zipper front
- Long sleeves
- Attached hood
- Elastic cuff & ankle

SCP8010



SUNDSTROM RESPIRATOR KIT

Top quality breathing apparatus comes complete with a gas filter suitable to most farm spraying operations and a pack of five pre-filters, all in a convenient carry and storage case.

JA-2101031



CODE	DESCRIPTION	LIST EX	LIST INC	CAT
SCP2065	Safety Goggles (Meets AS/NZS 1337)	\$20.00	\$22.00	B
SCP6015	Face Shield	\$30.91	\$34.00	B
SCP5015	Ear Muffs	\$11.82	\$13.00	B
SCP8010	Disposable Coveralls	\$5.09	\$5.60	B
SCP1085	Half Mask Respirator Kit with P2 Filters (Meets AS/NZS 1715-16)	\$65.45	\$72.00	B
SCP1065	P2 Filter Cartridge PK of 2 for Mask SCP1065 (not pictured)	\$18.18	\$20.00	B
SCP1075	A1 Filter Cartridge PK of 2 for Mask SCP1085 (not pictured)	\$40.91	\$45.00	B
JA-2101031	Sundstrom Respirator Kit	\$243.64	\$268.00	B
JA-2101029	Replacement Gas Filter For Sundstrom Respirator Kit	\$72.73	\$80.00	B

SAFETY SPRAY HELMETS

These helmets supply fan forced and filtered air (up to 120l/m) to the user in place of a face fitted respirator allowing easy breathing and communication.

K80S-T5 ASSEMBLY

Powered by a 6V battery ideal for full independence from a vehicle power source.

The battery pack and motor/fan pack are carried separately on a belt (supplied) to permit freedom of movement for up to 6 hours.

The battery pack is recharged from 240 Volt mains via a supplied recharging unit supplied.



K80S-T5

DRAWING
0335

K80S-T9R ASSEMBLY

Powered by Vehicle 12V system and battery for vehicle mounted or independent use with a backup NiCd rechargeable battery for up to 4 hours of use.

This permits the wearer to safely leave the tractor or vehicle seat to make machine adjustments, check spray performance, add chemicals to the tank, etc.

Uses vehicle dashboard plug to power and charge.



K80S-T9R

DRAWING
10791

KASCO A1P3 FILTER

The A1P3 filter is particularly formulated to suit insecticides, fungicides, weed killers, organic vapours and dust, fumes and mist. The unique filtering system uses filter paper as a particulate filter medium and activated carbon as the vapour filter medium. A plastic cap seals the filter when not in use, adding durability.



178-0601-19

CODE	DESCRIPTION	LIST EX	LIST INC	CAT
K80S-T5	Kasco 6V Independent Use Filter Helmet	\$1,754.55	\$1,930.00	A
K80S-T9R	Kasco 12V Vehicle And Independent Use Filter Helmet	\$1,627.27	\$1,790.00	A
178-0601-19	Kasco A1P3 Single Filter	\$126.36	\$139.00	B

RODEO GLOVES

- Hard wearing
- Soft leather
- Retains natural feel



SCP4030

CHEMICAL GLOVES

- Long 450mm length
- Resistant to oil, grease and chemicals



SCP4000

MEASURING JUG

Measure chemicals accurately and pour them safely with these quality measuring jugs.

- Available in 1, 3 and 5L



JA-2102032
1L JUG

JA-2102033
3L JUG

JA-2102034
5L JUG

NITRILE GENERAL PURPOSE GLOVES

- Tough and durable with excellent chemical and oil resistance
- Made from 100% Nitrile rubber with textured non-slip grip
- Available in Large & X-Large



JA-2101010

NITRILE GAUNTLETS

Chemically toughened for protection against most agricultural chemicals. Available in sizes 10 and 11.



JA-2101040

15 & 25L CHEMICAL BUCKET

A heavy duty chemical bucket with graduated handgrip, made from quality U.V. stabilised polyethylene. Will stand the test of time.



CJ15
15 LITRE

CJ25
25 LITRE

CODE	DESCRIPTION	LIST EX	LIST INC	CAT
SCP4030	Rodeo Gloves (Meets AS/NZS 2161)	\$12.73	\$14.00	B
JA-2101010	Nitrile Gloves (box of 100) - Large Size	\$34.55	\$38.00	B
JA-2101011	Nitrile Gloves (box of 100) - X Large Size	\$34.55	\$38.01	B
SCP4000	Chemical Gloves (Meets AS/NZS 2161)	\$10.00	\$11.00	B
JA-2101040	Nitrile Gauntlets, Pair - Size 10	\$28.18	\$31.00	B
JA-2101045	Nitrile Gauntlets, Pair - Size 11	\$29.09	\$32.00	B
JA-2102032	1L Measuring Jug	\$11.82	\$13.00	B
JA-2102033	3L Measuring Jug	\$18.18	\$20.00	B
JA-2102034	5L Measuring Jug	\$23.64	\$26.00	B
CJ15	15L Chemical Measuring Bucket	\$46.36	\$51.00	B
CJ25	25L Chemical Measuring Bucket	\$65.45	\$72.00	B

FREE STANDING SILMIX

- Uses external water supply to activate venturi inductor at the base of the unit to transfer chemicals from hopper to sprayer tank. The same water supply operates the wash bar and drum rinse nozzle in the hopper. Transfer system requires minimum 2 Bar water pressure to operate
- 30L polyethylene tank with 455mm hinged lid
- 3 on/off taps to control
- Powder washer bar inside hopper
- Drum rinse nozzle
- Chemical transfer venturi. Also has valve at base of unit to isolate the tank from the induction venturi



042J-06ST

AG RUNNER CHEMICAL TRANSFER PUMP

The Shurflo Ag Runner allows you to pump and measure chemical from the chemical container directly into the sprayer tank without the need for manually measuring or any other handling of the chemicals.

- Max Output: 40 L/min open flow, variable depending on viscosity
- Viton equipped pump
- Max. Pressure: 15psi
- 12V operation with 6m lead & alligator clips
- 1" x 3.6m suction / 1" x 3.6m delivery hoses
- Electrical meter



361-SF1105-PTS

DRAWING
10726

SELECTA BLUE HAND PUMP

- Piston lever pump
- Viton equipped for broad chemical compatibility
- 15 L/min capacity
- Includes drum adaptors for Mauer and Greif type drums
- 3 metre delivery kit
- Extendable Dip tube included



Piston hand pump with delivery kit, dip tube and drum adaptors.

F00332100

CODE	DESCRIPTION	LIST EX	LIST INC	CAT
042J-06ST	Free Standing Silmix	\$1,900.00	\$2,090.00	A
361-SF1105-PTS	Ag Runner Chemical Transfer Pump Kit	\$1,936.36	\$2,130.00	A
F00332100	Piston Pump Kit	\$175.45	\$193.00	A

Nozzles & Accessories



Silvan

**GENUINE
ACCESSORIES**

Nozzle selection and maintenance are two of the most important aspects of accurate and efficient spray application. Selecta offers the largest range of nozzles from leading brands to suit your needs.



KEY	
DROPLET SIZE	
COLOUR REFERENCE	
VERY FINE	VF
FINE	F
MEDIUM	M
COARSE	C
VERY COARSE	VC
EXTRA COARSE	XC
ULTRA COARSE	UC

Droplet size classifications are based on BCPC specifications and in accordance with ASAE Standard S-572 at the date of printing. Classifications subject to change.

NOZZLE DROPLET SIZE

When selecting a suitable nozzle the droplet size is critical to ensure chemical is applied to target instead of being miss-applied as drift. Finer droplet sizes ensure improved coverage however they are also more prone to drift and conversely larger droplets are less prone to drift.

Droplet sizes are defined by ISO standards ranging from Very Fine to Ultra course.

Droplet size follow two trends:

- As pressure increases droplet sizes decreases
- Larger size nozzles provide larger droplets and increased flow

Icon	XR TeeJet and XRC TeeJet						
	BAR						
	1	1.5	2	2.5	3	3.5	4
XR8001	M	F	F	F	F	F	F
XR80015	M	M	F	F	F	F	F
XR8002	M	M	M	M	F	F	F
XR8003	M	M	M	M	M	M	M
XR8004	C	M	M	M	M	M	M
XR8005	C	C	C	M	M	M	M
XR8006	C	C	C	C	C	C	C
XR8008	VC	VC	C	C	C	C	C

Small Nozzle

Large Nozzle

HOW TO READ AND IDENTIFY A NOZZLE

Each nozzle has a code embossed on its surface allowing the following information to be identified.

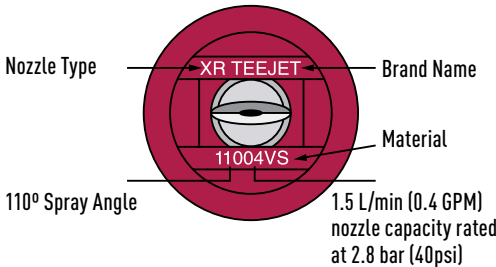

NOZZLE CODE EXPLANATION

Example of XR Nozzle 110° spray angle, 04 size made Stainless steel (VS).

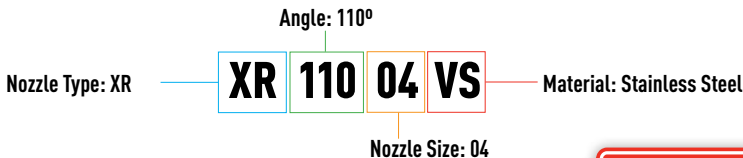

NOZZLE MATERIAL

A variety of materials are available which differ by resistance to wear summarised below.

Strongest: VK (Ceramic), VS, SS (Stainless Steel)

Moderate: VP (Polymer)

Soft: VB (Brass)

Icon	XR TeeJet and XRC TeeJet						
	BAR						
	1	1.5	2	2.5	3	3.5	4
XR11001	F	F	F	F	F	VF	VF
XR110015	F	F	F	F	F	F	F
XR11002	M	F	F	F	F	F	F
XR110025	M	M	F	F	F	F	F
XR11003	M	M	F	F	F	F	F
XR11004	M	M	M	M	M	F	F
XR11005	C	M	M	M	M	M	M
XR11006	C	C	M	M	M	M	M
XR11008	C	C	C	C	M	M	M

Nozzles and Accessories

TYPICAL APPLICATION RATES FOR NOZZLES SPACED 50CM APART

MESH SIZE	CODE	LIQ PRES BAR	CAP. L/MIN	APPLICATION RATE: LITRES PER HECTARE AT KM/H													
				4 KM/H	5 KM/H	6 KM/H	7 KM/H	8 KM/H	10 KM/H	12 KM/H	16 KM/H	18 KM/H	20 KM/H	25 KM/H	30 KM/H	35 KM/H	
100 Mesh*	01	1.0	0.23	69.0	55.2	46.0	39.4	34.5	27.6	23.0	17.3	15.3	13.8	11.0	9.2	7.9	
		1.5	0.28	84.0	67.2	56.0	48.0	42.0	33.6	28.0	21.0	18.7	16.8	13.4	11.2	9.6	
		2.0	0.32	96.0	76.8	64.0	54.9	48.0	38.4	32.0	24.0	21.3	19.2	15.4	12.8	11.0	
		2.5	0.36	108	86.4	72.0	61.7	54.0	43.2	36.0	27.0	24.0	21.6	17.3	14.4	12.3	
		3.0	0.39	117	93.6	78.0	66.9	58.5	46.8	39.0	29.3	26.0	23.4	18.7	15.6	13.4	
		3.5	0.42	126	101	84.0	72.0	63.0	50.4	42.0	31.5	28.0	25.2	20.2	16.8	14.4	
		4.0	0.45	135	108	90.0	77.1	67.5	54.0	45.0	33.8	30.0	27.0	21.6	18.0	15.4	
		5.0	0.50	150	120	100	85.7	75.0	60.0	50.0	37.5	33.3	30.0	24.0	20.0	17.1	
6.0	0.55	165	132	110	94.3	82.5	66.0	55.0	41.3	36.7	33.0	26.4	22.0	18.9			
100 Mesh*	015	1.0	0.34	102	81.6	68.0	58.3	51.0	40.8	34.0	25.5	22.7	20.4	16.3	13.6	11.7	
		1.5	0.42	126	101	84.0	72.0	63.0	50.4	42.0	31.5	28.0	25.2	20.2	16.8	14.4	
		2.0	0.48	144	115	96.0	82.3	72.0	57.6	48.0	36.0	32.0	28.8	23.0	19.2	16.5	
		2.5	0.54	162	130	108	92.6	81.0	64.8	54.0	40.5	36.0	32.4	25.9	21.6	18.5	
		3.0	0.59	177	142	118	101	88.5	70.8	59.0	44.3	39.3	35.4	28.3	23.6	20.2	
		3.5	0.64	192	154	128	110	96.0	76.8	64.0	48.0	42.7	38.4	30.7	25.6	21.9	
		4.0	0.68	204	163	136	117	102	81.6	68.0	51.0	45.3	40.8	32.6	27.2	23.3	
		4.5	0.72	216	173	144	123	108	86.4	72.0	54.0	48.0	43.2	34.6	28.8	24.7	
		5.0	0.76	228	182	152	130	114	91.2	76.0	57.0	50.7	45.6	36.5	30.4	26.1	
		5.5	0.80	240	192	160	137	120	96.0	80.0	60.0	53.3	48.0	38.4	32.0	27.4	
		6.0	0.83	249	199	166	142	125	100	83.0	62.3	55.3	49.8	39.8	33.2	28.5	
		6.5	0.87	261	209	174	149	131	104	87.0	65.3	58.0	52.2	41.8	34.8	29.8	
7.0	0.90	270	216	180	154	135	108	90.0	67.5	60.0	54.0	43.2	36.0	30.9			
8.0	0.96	288	230	192	165	144	115	96.0	72.0	64.0	57.6	46.1	38.4	32.9			
50 Mesh*	02	1.0	0.46	138	110	92.0	78.9	69.0	55.2	46.0	34.5	30.7	27.6	22.1	18.4	15.8	
		1.5	0.56	168	134	112	96.0	84.0	67.2	56.0	42.0	37.3	33.6	26.9	22.4	19.2	
		2.0	0.65	195	156	130	111	97.5	78.0	65.0	48.8	43.3	39.0	31.2	26.0	22.3	
		2.5	0.72	216	173	144	123	108	86.4	72.0	54.0	48.0	43.2	34.6	28.8	24.7	
		3.0	0.79	237	190	158	135	119	94.8	79.0	59.3	52.7	47.4	37.9	31.6	27.1	
		3.5	0.85	255	204	170	146	128	102	85.0	63.8	56.7	51.0	40.8	34.0	29.1	
		4.0	0.91	273	218	182	156	137	109	91.0	68.3	60.7	54.6	43.7	36.4	31.2	
		4.5	0.97	291	233	194	166	146	116	97.0	72.8	64.7	58.2	46.6	38.8	33.3	
		5.0	1.02	306	245	204	175	153	122	102	76.5	68.0	61.2	49.0	40.8	35.0	
		5.5	1.07	321	257	214	183	161	128	107	80.3	71.3	64.2	51.4	42.8	36.7	
		6.0	1.12	336	269	224	192	168	134	112	84.0	74.7	67.2	53.8	44.8	38.4	
		6.5	1.16	348	278	232	199	174	139	116	87.0	77.3	69.6	55.7	46.4	39.8	
7.0	1.21	363	290	242	207	182	145	121	90.8	80.7	72.6	58.1	48.4	41.5			
8.0	1.29	387	310	258	221	194	155	129	96.8	86.0	77.4	61.9	51.6	44.2			
50 Mesh*	025	3.0	0.99	297	238	198	170	149	119	99.0	74.3	66.0	59.4	47.5	39.6	33.9	
		3.5	1.07	321	257	214	183	161	128	107	80.3	71.3	64.2	51.4	42.8	36.7	
		4.0	1.14	342	274	228	195	171	137	114	85.5	76.0	68.4	54.7	45.6	39.1	
		4.5	1.21	363	290	242	207	182	145	121	90.8	80.7	72.6	58.1	48.4	41.5	
		5.0	1.28	384	307	256	219	192	154	128	96.0	85.3	76.8	61.4	51.2	43.9	
		5.5	1.34	402	322	268	230	201	161	134	101	89.3	80.4	64.3	53.6	45.9	
		6.0	1.40	420	336	280	240	210	168	140	105	93.3	84.0	67.2	56.0	48.0	
		6.5	1.46	438	350	292	250	219	175	146	110	97.3	87.6	70.1	58.4	50.1	
7.0	1.51	453	362	302	259	227	181	151	113	101	90.6	72.5	60.4	51.8			
8.0	1.62	486	389	324	278	243	194	162	122	108	97.2	77.8	64.8	55.5			
50 Mesh*	03	1.0	0.68	204	163	136	117	102	81.6	68.0	51.0	45.3	40.8	32.6	27.2	23.3	
		1.5	0.83	249	199	166	142	125	100	83.0	62.3	55.3	49.8	39.8	33.2	28.5	
		2.0	0.96	288	230	192	165	144	115	96.0	72.0	64.0	57.6	46.1	38.4	32.9	
		2.5	1.08	324	259	216	185	162	130	108	81.0	72.0	64.8	51.8	43.2	37.0	
		3.0	1.18	354	283	236	202	177	142	118	88.5	78.7	70.8	56.6	47.2	40.5	
		3.5	1.27	381	305	254	218	191	152	127	95.3	84.7	76.2	61.0	50.8	43.5	
		4.0	1.36	408	326	272	233	204	163	136	102	90.7	81.6	65.3	54.4	46.6	
		4.5	1.45	435	348	290	249	218	174	145	109	96.7	87.0	69.6	58.0	49.7	
		5.0	1.52	456	365	304	261	228	182	152	114	101	91.2	73.0	60.8	52.1	
		5.5	1.60	480	384	320	274	240	192	160	120	107	96.0	76.8	64.0	54.9	
		6.0	1.67	501	401	334	286	251	200	167	125	111	100	80.2	66.8	57.3	
		6.5	1.74	522	418	348	298	261	209	174	131	116	104	83.5	69.6	59.7	
7.0	1.80	540	432	360	309	270	216	180	135	120	108	86.4	72.0	61.7			
8.0	1.93	579	463	386	331	290	232	193	145	129	116	92.6	77.2	66.2			

* Recommended nozzle filter mesh size.

Nozzles and Accessories

TYPICAL APPLICATION RATES FOR NOZZLES SPACED 50CM APART

MESH SIZE	CODE	LIQ PRES BAR	CAP. L/MIN	APPLICATION RATE: LITRES PER HECTARE AT KM/H													
				4 KM/H	5 KM/H	6 KM/H	7 KM/H	8 KM/H	10 KM/H	12 KM/H	16 KM/H	18 KM/H	20 KM/H	25 KM/H	30 KM/H	35 KM/H	
50 Mesh*	04	1.0	0.91	273	218	182	156	137	109	91	68.3	60.7	54.6	43.7	36.4	31.2	
		1.5	1.12	336	269	224	192	168	134	112	84.0	74.7	67.2	53.8	44.8	38.4	
		2.0	1.29	387	310	258	221	194	155	129	96.8	86.0	77.4	61.9	51.6	44.2	
		2.5	1.44	432	346	288	247	216	173	144	108	96.0	86.4	69.1	57.6	49.4	
		3.0	1.58	474	379	316	271	237	190	158	119	105	94.8	75.8	63.2	54.2	
		3.5	1.71	513	410	342	293	257	205	171	128	114	103	82.1	68.4	58.6	
		4.0	1.82	546	437	364	312	273	218	182	137	121	109	87.4	72.8	62.4	
		4.5	1.94	582	466	388	333	291	233	194	146	129	115	93.1	77.6	66.5	
		5.0	2.04	612	490	408	350	306	245	204	153	136	122	97.9	81.6	69.9	
		5.5	2.14	642	514	428	367	321	257	214	161	143	128	103	85.6	73.4	
		6.0	2.23	669	535	446	382	335	268	223	167	149	134	107	89.2	76.5	
		6.5	2.33	699	559	466	399	350	280	233	175	155	140	112	93.2	79.9	
7.0	2.41	725	578	482	413	362	289	241	181	161	145	116	96.4	82.6			
8.0	2.58	774	619	516	442	387	310	258	194	172	155	124	103	88.5			
50 Mesh*	05	1.00	1.14	342	274	228	195	171	137	114	85.5	76.0	68.4	54.7	45.6	39.1	
		1.5	1.39	417	334	278	238	209	167	139	104	92.7	83.4	66.7	55.6	47.7	
		2.0	1.61	483	386	322	276	242	193	161	121	107	96.6	77.3	64.4	55.2	
		2.5	1.80	540	432	360	309	270	216	180	135	120	108	86.4	72.0	61.7	
		3.0	1.97	591	473	394	338	296	236	197	148	131	118	94.6	78.38	67.5	
		3.5	2.13	639	511	426	365	320	256	213	160	142	128	102	85.2	73.0	
		4.0	2.27	681	545	454	389	341	272	227	170	151	136	109	90.8	77.8	
		4.5	2.41	723	578	482	413	362	289	241	181	161	145	116	96.4	82.6	
		5.0	2.54	762	610	508	435	381	305	254	191	169	152	122	102	87.1	
		5.5	2.67	801	641	534	458	401	320	267	200	178	160	128	107	91.5	
		6.0	2.79	837	670	558	478	416	335	279	209	186	167	134	112	95.7	
		6.6	2.90	870	696	580	497	435	348	290	218	193	174	139	116	99.4	
7.0	3.01	903	722	602	516	452	361	301	226	201	181	144	120	103			
8.0	3.22	966	773	644	552	483	386	322	242	215	193	155	129	110			
50 Mesh*	06	1.0	1.37	411	329	274	235	206	164	137	103	91.3	82.2	65.8	54.8	47.0	
		1.5	1.68	504	403	336	288	252	202	168	126	112	101	80.6	67.2	57.6	
		2.0	1.94	582	466	388	333	291	233	194	146	129	116	93.1	77.6	66.5	
		2.5	2.16	648	518	432	370	324	259	216	162	144	130	104	86.4	74.1	
		3.0	2.37	711	569	474	406	356	284	237	178	158	142	114	94.8	81.3	
		3.5	2.56	768	614	512	439	384	307	256	192	171	154	123	102	87.8	
50 Mesh*	08	4.0	2.74	822	658	548	470	411	329	274	206	183	164	132	110	93.9	
		1.0	1.82	546	437	364	312	273	218	182	137	121	109	87.4	72.8	62.4	
		1.5	2.23	669	535	446	382	335	268	223	167	149	134	107	89.2	76.5	
		2.0	2.58	774	619	516	442	387	310	258	194	172	155	124	103	88.5	
		2.5	2.88	864	691	576	494	432	346	288	216	192	173	138	115	98.7	
		3.0	3.16	948	758	632	542	474	379	316	237	211	190	152	126	108	
50 Mesh*	10	3.5	3.41	1023	818	682	585	512	409	341	256	227	205	164	136	117	
		4.0	3.65	1095	876	730	626	548	438	365	274	243	219	175	146	125	
		1.0	2.28	684	547	456	391	342	274	228	171	152	137	109	91.2	78.2	
		1.5	2.79	837	670	558	478	419	335	279	209	186	167	134	112	95.7	
		2.0	3.23	969	775	646	554	485	388	323	242	215	194	155	129	111	
50 Mesh*	15	3.0	3.95	1185	948	790	677	593	474	395	296	263	237	190	158	135	
		4.0	4.56	1368	1094	912	782	684	547	456	342	304	274	219	182	156	
		1.0	3.42	1026	821	684	586	513	410	342	257	228	205	164	137	117	
		1.5	4.19	1257	1006	838	718	629	503	419	314	279	251	201	168	144	
50 Mesh*		2.0	4.83	1449	1159	966	828	725	580	483	362	322	290	232	193	166	
		3.0	5.92	1776	1421	1184	1015	888	710	592	444	395	355	284	237	203	
		4.0	6.84	2052	1642	1368	1173	1026	821	684	513	456	410	328	274	235	

* Recommended nozzle filter mesh size.

NOZZLE APPLICATION RATES

The previous two pages display the ISO std application rates which apply to most nozzles.

Nozzles are colour coded according to L/min output size at 2.8 bar.

For example: All Yellow 02 nozzles at 2.8 bar (40psi) have a flow rate of 0.2 US Gallons (0.75L/min).

Note: Each nozzle type has a different droplet size profile.

SELECTING THE RIGHT SIZE NOZZLE

Application rates can be adjusted by pressure, vehicle speed and nozzle size.

Pressure can change droplet size and increase nozzles wear. Vehicle speed is an inaccurate method of adjusting output; higher speeds leads to increased bumps and vibration which is hard on equipment that can lead to critical failures. High speeds can also cause boom yaw, effectively changing boom height, leading to uneven spray application.

Nozzle size is the ideal and easiest way to select a suitable nozzle as you can change the output rate without significant changes to the machinery.

TO SELECT A NOZZLE

	XR TeeJet and XRC TeeJet							Droplet Size
	BAR							
	1	1.5	2	2.5	3	3.5	4	
XR8001	M	F	F	F	F	F	F	Medium
XR80015	M	M	F	F	F	F	F	
XR8002	M	M	M	M	F	F	F	
XR8003	M	M	M	M	M	M	M	
XR8004	C	M	M	M	M	M	M	
XR8005	C	C	C	M	M	M	M	
XR8006	C	C	C	C	C	C	C	
XR8008	VC	VC	C	C	C	C	C	

1. You need to know your preferred safe vehicle speed.
2. Define your required droplet size & application rate eg. Medium droplet at 70L/h

Check the Droplet chart and you can see that a yellow 02 nozzle will provide a medium droplet at 2 and 2.5 bar.

3. Confirm against the Application Rates table the nozzle can put out the required 70 L/ha at 2 or 2.5 bar.

In the example above, a yellow 02 nozzle will be suited for use at 2.5.

WHAT DROPLET SIZE DO I REQUIRE?

The manufacturer of your chemical recommends suitable droplet sizes on the Chemical label ranging from Very Fine to Ultra Course. Alternatively refer to your agronomist.

Nozzles that produce fine droplets are recommended for post-emergence applications, which require excellent coverage on the intended target area. The most common nozzles used in agriculture are those that produce medium sized droplets. Nozzles producing medium and coarse-sized droplets can be used for contact and systemic herbicides, pre emergence surface-applied herbicides, insecticides and fungicides.

Remember, as droplet size is reduced the drift potential is increased. Where possible, choose nozzles with a slightly coarser droplet size to reduce the risk potential. Review the nozzle Droplet size charts for the appropriate nozzles capable of the required droplet size.

UNIVERSAL APPLICATION RATE CHART FOR 50 CM TIP SPACING

TIP CAPACITY	LIQUID PRESSURE IN BAR	CAPACITY 1 NOZZLE IN L/MIN	L/HA – 50CM NOZZLE SPACING					Speed	
			4 KM/H	6 KM/H	8 KM/H	10 KM/H	12 KM/H		
01	1.0	0.23	69.0	46.0	34.5	27.6	23.0	Rate	
	1.5	0.28	84.0	56.0	42.0	33.6	28.0		
	2.0	0.32	96.0	64.0	48.0	38.4	32.0		
	3.0	0.39	117	78.0	58.5	46.8	39.0		
	4.0	0.45	135	90.0	67.5	54.0	45.0		
	5.0	0.50	150	100	75.0	60.0	50.0		
	6.0	0.55	165	110	82.5	66.0	55.0		
	7.0	0.60	180	120	90.0	72.0	60.0		
015	1.0	0.34	102	68.0	51.0	40.8	34.0		
	1.5	0.42	126	84.0	63.0	50.4	42.0		
	2.0	0.48	144	96.0	72.0	57.6	48.0		
	3.0	0.59	177	118	88.5	70.8	59.0		
	4.0	0.68	204	136	102	81.6	68.0		
	5.0	0.76	228	152	114	91.2	76.0		
	6.0	0.83	249	166	125	99.6	83.0		
7.0	0.90	270	180	135	108	90.0			
02	1.0	0.46	138	92.0	69.0	55.2	46.0		
	1.5	0.56	168	112	84.0	67.2	56.0		
	2.0	0.65	195	130	97.5	78.0	65.0		
	3.0	0.79	237	158	119	94.8	79.0		
	4.0	0.91	273	182	137	109	91.0		
	5.0	1.02	306	204	153	122	102		
	6.0	1.12	336	224	168	134	112		
	7.0	1.21	363	242	182	145	121		

NOTE: Always double check your application rates. Tabulations are based on spraying water at 70°F (21°C).

WHEN IS IT RIGHT TO SPRAY?

The weather has major impact on spraying conditions.



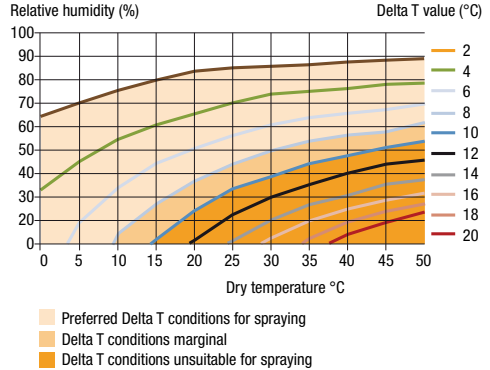

The effects of Wind on spraying can be very clear and easy to see but temperature and humidity also have critical effects that can be measured by a Delta T.

Delta T is a relative measure of Humidity vs Temperature summarised in the table (right) that indicates suitability of spray conditions. Preferably spraying should occur when Delta T is between 2 and 8; a higher Delta T has an increased chance for drift caused by evaporation when water based spraying.



WIND SPEED AND SPRAYING

Wind speeds are critical when spraying. If conditions are too windy, chemicals may not be applied correctly to the target crop leading to poor results, increased drift and possible off target damage. The table below offers a simple method of assessing wind speeds, otherwise can be more accurately measured using a Wind Meter.

Approx. Airspeed at Boom Height	Description	Visible Signs	Spraying
Less than 2 km/h	Calm	 Smoke rises vertically	Spraying inadvisable
2-3.3 km/h	Light air	 Direction shown by smoke drift	Avoid spraying
3.2-6.5 km/h	Light breeze	 Leaves rustle, wind felt on face	Ideal spraying
6.5-9.6 km/h	Gentle breeze	 Leaves & twigs in constant motion	Use low drift nozzles (medium droplets)
9.6-14.5 km/h	Moderate	 Small branches moved raises dust or loose paper	Use air induction nozzles (coarse droplets)

BOOM SPRAY CALIBRATION INFORMATION

Equipment information

Date	Tractor	RPM
Gear	Spray plant	Pressure
Size, number & spacing of nozzles		

CALCULATE SPEED IN KILOMETRES PER HOUR

$$\frac{3.6 \text{ metres} = \text{km/h } 3.6 \times \boxed{} \text{ metres} = \text{km/h}}{\text{Seconds} \quad \boxed{} \text{ seconds}}$$

$$\frac{600 \times \text{litres per minute}}{\text{Boom width (m) x speed (km/h)}} = \text{Litres per hectare}$$

$$\frac{600 \times \text{L}}{\text{m x km/h}} \times \frac{\boxed{}}{\boxed{}} = \boxed{} = \text{Litres per hectare}$$

CALCULATE CHEMICAL TO ADD TO TANK

$$\frac{\text{Tank capacity (L) X chemical rate (L/ha)}}{\text{Output (L/ha)}} = \text{Chemical required per tank}$$

$$\frac{(\text{L}) \boxed{} \times \boxed{} (\text{L/ha})}{\text{Output } \boxed{} (\text{L/ha})} = \boxed{} (\text{L})$$

Amount of chemical to add per tank

FACTORS AFFECTING CALIBRATION OF BOOM SPRAYS

1. Application rate in Litres per hectare.
2. Travel Speed of Tractor.

The tractor travel speed is the most important variable in sprayer performance. A 10% change in tractor speed gives a 10% change in application rate. This can lead to over or under application of chemicals. Determine the speed by measuring 100 metres then time in seconds how long it takes to cover the 100 metres.

If spraying in hilly terrain time distance both up hill and down hill and average the results.

THE FORMULA FOR SPEED IS:

$$\text{km/h} = \frac{360}{\text{Time in seconds for 100 metres}}$$

3. Nozzle Spacing on boom

(Std nozzle spacing is 50 cm).

4. Calculate required output per nozzle:

$$\frac{\text{L/min/ nozzle}}{\text{nozzle}} = \frac{\text{L/ha x km/h x nozzle spacing (cm)}}{60,000}$$

$$\text{e.g. } \frac{100 \times 10 \times 50}{60,000} = 0.83 \text{ L/min/ nozzle}$$

Where application rate is: 100 L/Ha, speed is 10 km/h and nozzle spacing is 50 cm.

Use the nozzle output charts to select the correct nozzle tip for your application.

5. Check the calibration procedure

Use a measuring jug and stopwatch to check the output of several nozzles across the boom at the recommended pressure. If the outputs vary slightly from the chart then adjust the pressure in the system to achieve the correct volume. If nozzle flow rates are greater than 5% above or below the manufacturer's charts then the whole sprayer system needs to be checked for leaks, blockages etc, cleaned out and the calibration process repeated until accuracy is attained. The nozzle charts also allow application rates to be determined if the tractor speed, the nozzle and the spraying pressure are known.

Nozzles and Accessories

Geoline, manufacturers of world class agricultural spraying accessories and components have released a range of ISO standard spray nozzles exclusive to Silvan.

Ideal for many applications where spray coverage and drift management is important, the Geoline nozzles offer excellent results.

RS FLAT FAN POLY NOZZLE

- Air-induction flat-spray tip
- Spray angle: 110°
- Spray height = 50 cm
- Pressure recommended ranges from 1.5 to 4 bar
- Low Drift at low pressure. Increased coverage and drift potential at higher pressure



GEOline
AGRICULTURAL SPRAY PRODUCTS

**RRP
\$2.³³
EACH**

	FLAT FAN POLY NOZZLE RS SERIES					
	BAR					
	1.5	2	2.5	3	3.5	4
RS110015	F	F	F	F	F	F
RS11002	F	F	F	F	F	F
RS11003	M	F	F	F	F	F
RS11004	M	M	M	F	F	F



CODE	ANGLE	NOZZLE PACKETS	SIZES AVAILABLE	LIST EX	LIST INC	CAT
RS110***	110°	RS-FlatFan-Poly 24Pk	015,02,03,04	\$55.45	\$61.00	B

*** DENOTES SIZE REQUIRED. TO ORDER ADD THE SIZE IN PLACE OF ***

Note: Automatic spray alignment order cap G8253000 and gasket 402200-040

Silvan

TP FLAT FAN STANDARD

- Single piece nozzle with even coverage
- Pressure Range: 2-4 Bar
- Poly material available

TeeJet

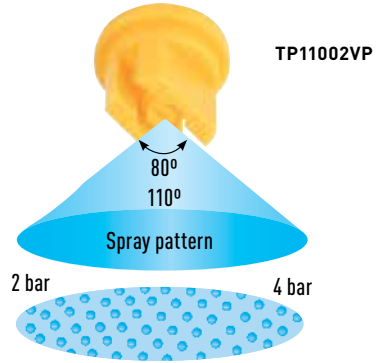

XR EXTENDED RANGE

- Single piece nozzle with even coverage
- Pressure Range: 1-4 Bar
- Poly and Ceramic material available
- Low drift at low pressure. Increased coverage and drift potential at higher pressure

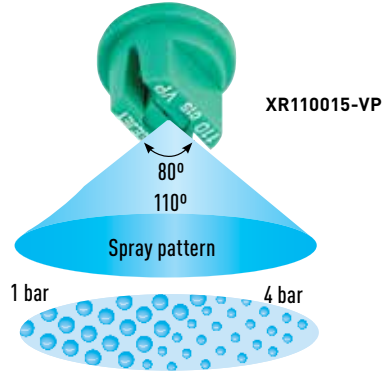

XRC EXTENDED RANGE

- Same droplet size as XR Nozzle with added convenience of a moulded Quick TeeJet cap for easy fitment and automatic alignment
- Single piece nozzle with even coverage
- Pressure Range: 1-4 Bar
- Poly material
- Low drift at low pressure. Increased coverage and drift potential at higher pressure

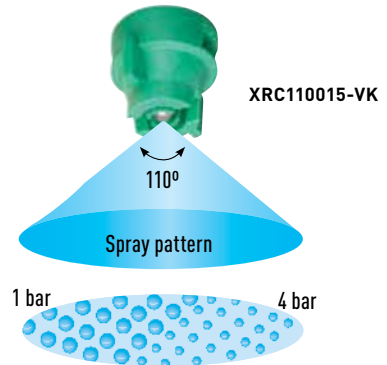

REFER TO PAGES 94-95 FOR AUTOMATIC ALIGNMENT CAP & GASKET

ISO DROPLET SIZE INFORMATION

	TP TeeJet				
	BAR				
	2	2.5	3	3.5	4
TP8001	F	F	F	F	F
TP80015	F	F	F	F	F
TP8002	M	M	F	F	F
TP8003	M	M	M	M	M
TP8004	M	M	M	M	M
TP8005	C	M	M	M	M
TP8006	C	C	C	C	C
TP8008	C	C	C	C	C
TP11001	F	F	F	VF	VF
TP110015	F	F	F	F	F
TP11002	F	F	F	F	F
TP11003	F	F	F	F	F
TP11004	M	M	M	F	F
TP11005	M	M	M	M	M
TP11006	M	M	M	M	M
TP11008	C	C	M	M	M

	XR TeeJet and XRC TeeJet						
	BAR						
	1	1.5	2	2.5	3	3.5	4
XR8001	M	F	F	F	F	F	F
XR80015	M	M	F	F	F	F	F
XR8002	M	M	M	M	F	F	F
XR8003	M	M	M	M	M	M	M
XR8004	C	M	M	M	M	M	M
XR8005	C	C	C	M	M	M	M
XR8006	C	C	C	C	C	C	C
XR8008	VC	VC	C	C	C	C	C
XR11001	F	F	F	F	F	VF	VF
XR110015	F	F	F	F	F	F	F
XR11002	M	F	F	F	F	F	F
XR110025	M	M	F	F	F	F	F
XR11003	M	M	F	F	F	F	F
XR11004	M	M	M	M	M	F	F
XR11005	C	M	M	M	M	M	M
XR11006	C	C	M	M	M	M	M
XR11008	C	C	C	C	M	M	M

For ISO application rates see pages 68-69.

XR produce same droplet as XR.

CODE	ANGLE	DESCRIPTION	SIZES AVAILABLE	LIST EX	LIST INC	CAT
TP110***-VP	110°	TP - Flat Fan - Poly	015,02,03,04,05,06,08	\$2.55	\$2.80	B
TP80***-VP	80°	TP - Flat Fan - Poly	015,02,03,04,05,06,08	\$2.55	\$2.80	B
XR110***-VP	110°	XR - Flat Fan - Poly	015,02,03,04,05,06,08	\$6.00	\$6.60	B
XR110***-VK	110°	XR - Flat Fan - Ceramic	02,025,03,04,05,06,08	\$10.00	\$11.00	B
XR80***-VK	80°	XR - Flat Fan - Ceramic	03,04,05,06,08	\$10.00	\$11.00	B
XRC110***-VK	110°	XRC - Flat Fan - Ceramic with Moulded Cap	025,03,04,05,06,08	\$10.91	\$12.00	B
10 PACK NOZZLES:						
PKT-TP110***-VP	110°	VisiFlo - Flat Fan - Poly 10 Pk	015,02,03,04,05,06,08	\$26.36	\$29.00	B
PKT-XR110***-VP	110°	XR - Flat Fan - Poly 10 Pk	015,02,03,04,05,06,08	\$63.64	\$70.00	B
*** DENOTES SIZE REQUIRED. TO ORDER ADD THE SIZE IN PLACE OF ***. EG TP11004VP						

DRIFT GUARD SPRAY TIPS

- Pre-orifice design produces larger droplets and reduces the small drift prone droplets, minimising off-target spray contamination
- Tapered edge flat spray pattern provides uniform coverage when adjacent nozzle patterns are overlapped in broadcast spraying
- The colour-coded pre-orifice is removable for any necessary cleaning operations
- Poly & Stainless steel material available

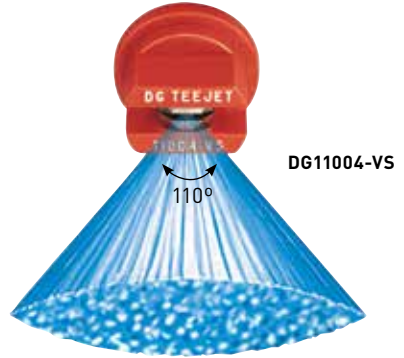

TURBO TEEJET FLAT SPRAY TIPS

- Tapered edge wide angle pattern for uniform coverage in broadcast spraying
- Large, rounded internal passage to minimise clogging
- Larger droplets for less drift 15-90 psi (1-6 bar)
- Poly material

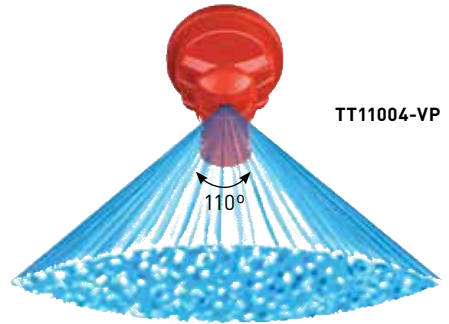

TeeJet

TURBO TWINJET SPRAY TIPS

- All the features of the TT Turbo TeeJet, but with a double outlet nozzle that helps reduce spray drift
- Excellent canopy coverage and penetration while delivering excellent drift resistance
- Spraying pressure 20-90 psi (1.5-6 bar), ideal for use with automatic sprayrate controllers
- Best suited to applications where superior leaf coverage and canopy penetration is important
- Poly material

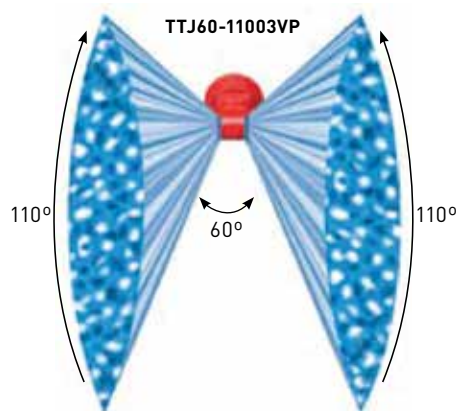

REFER TO PAGES 94-95 FOR AUTOMATIC ALIGNMENT CAP & GASKET

ISO DROPLET SIZE INFORMATION

	DG TeeJet				
	BAR				
	2	2.5	3	3.5	4
DG110015	M	F	F	F	F
DG11002	M	M	M	M	M
DG11003	C	M	M	M	M
DG11004	C	C	M	M	M
DG11005	C	C	C	M	M

	Turbo TeeJet										
	BAR										
	1	1.5	2	2.5	3	3.5	4	4.5	5	5.5	6
TT11001	C	M	M	M	F	F	F	F	F	F	F
TT110015	C	C	M	M	M	M	M	F	F	F	F
TT11002	C	C	C	M	M	M	M	M	M	M	F
TT110025	VC	C	C	M	M	M	M	M	M	M	M
TT11003	VC	C	C	C	C	M	M	M	M	M	M
TT11004	XC	VC	C	C	C	C	C	C	M	M	M
TT11005	XC	VC	VC	VC	C	C	C	C	C	M	M
TT11006	XC	VC	VC	VC	C	C	C	C	C	C	M
TT11008	XC	XC	VC	VC	C	C	C	C	C	C	M

	Turbo Twinjet (TTJ60)										
	BAR										
	1.5	2	2.5	3	3.5	4	4.5	5	5.5	6	
TTJ60-11002	C	C	C	C	M	M	M	M	M	M	
TTJ60-110025	VC	C	C	C	C	C	C	M	M	M	
TTJ60-11003	VC	C	C	C	C	C	C	C	M	M	
TTJ60-11004	VC	C	C	C	C	C	C	C	C	M	
TTJ60-11005	VC	C	C	C	C	C	C	C	C	C	
TTJ60-11006	XC	VC	C	C	C	C	C	C	C	C	

CODE	ANGLE	DESCRIPTION	SIZES AVAILABLE	LIST EX	LIST INC	CAT
DG110***-VP	110°	Polymer - Drift Guard Even Flat Fan	015,02,03,04,05	\$11.82	\$13.00	B
DG110***-VS	110°	Stainless Steel - Drift Guard Even Flat Fan	015,02,03,04,05	\$22.73	\$25.00	B
TT110***-VP	110°	Poly - Turbo Wide Angle Flat Fan	01,015,02,025,03,04,05,06,08	\$10.91	\$12.00	B
TTJ60-110***VP		Poly - Turbo Twinjet Wide Angle Flat Fan	02,025,03,04,05,06	\$15.45	\$17.00	B

*** DENOTES SIZE REQUIRED. TO ORDER ADD THE SIZE IN PLACE OF ***

AIXR AIR INDUCTION SPRAY TIPS

- Pressure range 15-90 psi (1-6 bar)
- Made of a two-piece polymer construction. Excellent chemical resistance, including acids, as well as exceptional wear life
- A lower pressure air induced nozzle offers better drift management and suitable for the broadacre market
- Compact size to prevent tip damage and removable pre-orifice
- Depending on the chemical, produces large air-filled drops through a Venturi air aspirator

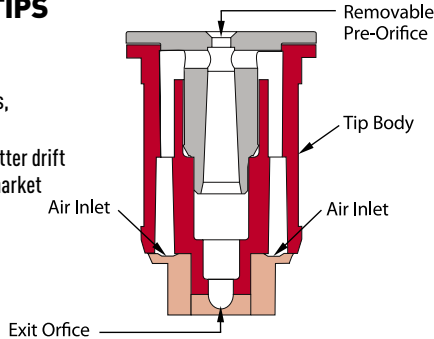

AIXR110__-VP Spray Tip
(Cross Section View)

AIXR11002-VP

110°

IDK AIR INJECTED NOZZLE

- Air-aspirating flat-spray tip
- Pressure Range:
 - Spray angle 120° all Poly nozzle
 - IDK-01 to 03, 20-90 psi (1.5 - 6 bar)
 - IDK-04, 15-90 psi (1 - 6 bar)
- More suitable for lower pressures
- Hard-wearing and non-clogging thanks to lateral air-aspirating channels of ample size

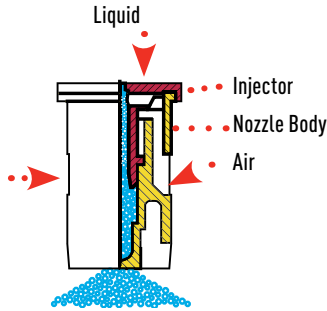

IDK12004P



120°



TURBO TEEJET INDUCTION FLAT SPRAY TIPS

- Compact size to prevent tip damage and removable pre-orifice for easy cleaning
- Large droplets are produced through a venturi air aspirator resulting in less drift
- Wide operating pressure 15-105 psi (1-7bar) producing extra coarse droplets
- Ideal for use with automatic rate controllers
- Poly material

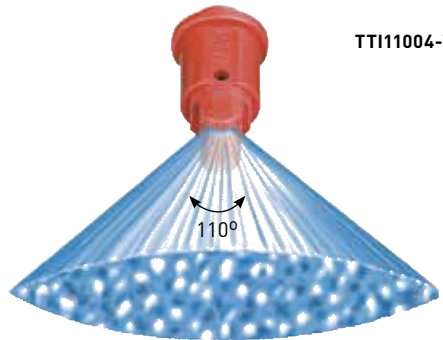



TT111004-VP

110°

REFER TO PAGES 94-95 FOR AUTOMATIC ALIGNMENT CAP & GASKET

ISO DROPLET SIZE INFORMATION

	AIXR TeeJet										
	BAR										
	1	1.5	2	2.5	3	3.5	4	4.5	5	5.5	6
AIXR110015	XC	VC	VC	C	C	C	C	M	M	M	M
AIXR11002	XC	XC	VC	VC	C	C	C	C	C	M	M
AIXR110025	XC	XC	XC	VC	VC	C	C	C	C	C	C
AIXR11003	XC	XC	XC	VC	VC	C	C	C	C	C	C
AIXR11004	UC	XC	XC	XC	VC	VC	VC	C	C	C	C
AIXR11005	UC	XC	XC	XC	XC	VC	VC	VC	C	C	C
AIXR11006	UC	XC	XC	XC	XC	VC	VC	VC	C	C	C

	IDK Lechler						
	BAR						
	1.5	2	2.5	3	4	5	6
IDK12001	C	C	C	M	M	M	F
IDK120015	C	C	C	C	M	M	F
IDK12002	C	C	C	C	M	M	F
IDK120025	VC	VC	C	C	C	M	M
IDK12003	VC	VC	VC	C	C	M	M
IDK12004	VC	VC	VC	VC	C	C	M

	Turbo TeeJet Induction (TTI)											
	BAR											
	1	1.5	2	2.5	3	3.5	4	4.5	5	5.5	6	7
TTI110015	UC	UC	UC	UC	UC	UC	XC	XC	XC	XC	XC	XC
TTI11002	UC	UC	UC	UC	UC	UC	UC	UC	XC	XC	XC	XC
TTI110025	UC	UC	UC	UC	UC	UC	UC	UC	XC	XC	XC	XC
TTI11003	UC	UC	UC	UC	UC	UC	UC	UC	XC	XC	XC	XC
TTI11004	UC	UC	UC	UC	UC	UC	UC	UC	XC	XC	XC	XC
TTI11005	UC	UC	UC	UC	UC	UC	UC	UC	XC	XC	XC	XC
TTI11006	UC	UC	UC	UC	UC	UC	UC	UC	XC	XC	XC	XC

CODE	ANG	DESCRIPTION	SIZES AVAILABLE	LIST EX	LIST INC	CAT
AIXR110***-VP	110°	Poly - Air Induction Spray Tip	015,02,025,03,04,05,06	\$13.64	\$15.00	B
IDK120***P	120°	Poly - Air Injected Spray Tip	01,015,02,025,03,04	\$12.73	\$14.00	B
IDK120***C	120°	Ceramic - Air Injected Spray Tip	015,02,025,03,04	\$25.45	\$28.00	B
TTI110***-VP	110°	Poly - Turbo Induction Spray Tip	015,02,025,03,04,05,06	\$22.00	\$24.20	B
10 PACK NOZZLES:						
PKT-AIXR110***-VP	110°	10 Pk Poly - Turbo Wide Angle Flat Spray Tip	015,02,03,04	\$130.00	\$143.00	B

*** DENOTES SIZE REQUIRED. TO ORDER ADD THE SIZE IN PLACE OF ***

AI AIR INDUCTION SPRAY TIPS

- Stainless steel insert produces tapered edge flat spray 110° pattern for uniform coverage in broadcast spraying
- Polymer insert holder and pre-orifice with VisiFlo colour-coding
- Larger droplets for less drift
- Depending on the chemical, produces large air-filled drops through the use of a venturi air aspirator
- Pressure ranges from 2 – 8 bar



AI11004-VS

AIC AIR INDUCTION SPRAY TIPS

- Same droplet size as AI nozzles with added convenience of a moulded nozzle cap
- Available in stainless steel and ceramic inserts, produces tapered edge flat spray pattern for uniform coverage in broadcast spraying
- Polymer insert holder and pre-orifice with VisiFlo colour-coding
- Larger droplets for less drift
- Depending on the chemical, produces large air-filled drops through the use of a Venturi air aspirator
- AI TeeJet nozzle molded into Quick TeeJet cap provides automatic spray alignment
- Includes tightly fitting washer that assures a good seal

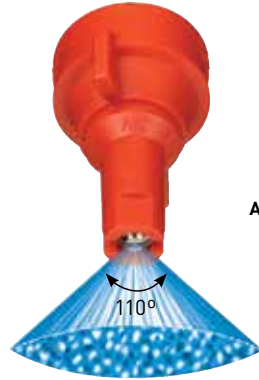

AIC11004-VS

AITTJ60 AIR INDUCTION TURBO TWINJET

- Air induction with dual 110° flat fan patterns
- 60° between leading and trailing spray patterns
- Good coverage with increased canopy penetration and best drift control
- Best suited for postemergence applications
- Excellent drift control with coarse to very coarse droplets
- Available in VisiFlo color coded capacities (02 through 06)
- Pressure ranges from 1.5 – 6 bar (20 – 90 PSI)

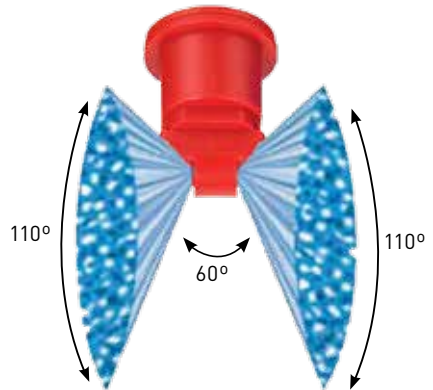

AITTJ60-11004VP

REFER TO PAGES 94-95 FOR AUTOMATIC ALIGNMENT CAP & GASKET

ISO DROPLET SIZE INFORMATION

	AI TeeJet and AIC TeeJet											
	BAR											
	2	2.5	3	3.5	4	4.5	5	5.5	6	6.5	7	8
AI110015	UC	XC	XC	XC	XC	VC	VC	VC	VC	C	C	C
AI11002	UC	XC	XC	XC	XC	VC	VC	VC	VC	C	C	C
AI110025	UC	UC	XC	XC	XC	XC	VC	VC	VC	VC	C	C
AI11003	UC	UC	XC	XC	XC	XC	VC	VC	VC	VC	C	C
AI11004	UC	UC	XC	XC	XC	XC	VC	VC	VC	VC	C	C
AI11005	UC	UC	XC	XC	XC	XC	VC	VC	VC	VC	C	C
AI11006	UC	UC	XC	XC	XC	XC	XC	VC	VC	VC	VC	C
AI11008	UC	UC	UC	XC	XC	XC	XC	VC	VC	VC	VC	C
AI11010*	UC	UC	UC	XC	XC	XC	XC	XC	VC	VC	VC	C

CODE	ANG	DESCRIPTION	SIZES AVAILABLE	LIST EX	LIST INC	CAT
AI110***-VS	110°	Air Induction Flat Spray Tip - Stainless Steel	015,02,03,04,05,06,08	\$30.00	\$33.00	B
AIC110***-VS	110°	Air Induction Spray Tip With Cap & Gasket - S/Steel	015,02,025,04,06,08,10,15	\$30.00	\$33.00	B
AIC110***-VK	110°	Air Induction Spray Tip With Cap & Gasket - Ceramic	025,03,04,05	\$25.45	\$28.00	B
AITTJ60-110**VP	110°	Air Induction Turbo Twinjet - Poly	02,025,03,04,05,06	\$18.18	\$20.00	B

*** DENOTES SIZE REQUIRED. TO ORDER ADD THE SIZE IN PLACE OF ***

FERTILISER NOZZLES

STREAMJET SJ-3 FERTILISER (3 STREAM)

- Removable metering orifice for easy cleaning
- Equally spaced distribution at 20" (50 cm) h
- Use with Quick TeeJet cap 25598-*-NYR
- All acetal construction for excellent chemical resistance
- Recommended operating pressure: 1.5-4 bar (20-60 psi)



SJ3

CODE	DESCRIPTION	SIZES AVAILABLE	LIST EX	LIST INC	CAT
SJ3-***-VP	Poly - 3 Stream Streamjet Fertilizer Nozzles	015,02,03,04,05,06,08,10,15,20	\$22.73	\$25.00	B

*** DENOTES SIZE REQUIRED. TO ORDER ADD THE SIZE IN PLACE OF ***

LURMARK DEFLECTIP 80°-145°

LC-15

The Lurmark Deflectip produces a wide angled even spray (from 80 to 145 degrees depending on pump pressure) making it ideal for banding pre and post emergent herbicides.

- Large orifice produces coarser droplets which are less prone to drift and blocking
- Fits in most nozzle caps
- Precision moulded in tough and durable polyacetal, with a spray angle tolerance of +/- 5%



CODE	ANGLE	DESCRIPTION	SIZES AVAILABLE	LIST EX	LIST INC	CAT
LC-**	80° -145°	Poly - Lurmark Deflectip Spray Nozzle	15,20	\$7.36	\$8.10	B

PART NUMBER (REC FILTER MESH)	SPRAY ANGLE	SPRAY WIDTH* (50CM HEIGHT)	PRESS. BAR	FLOW L/MIN	SINGLE NOZZLE APPLICATION RATES L/HA AT KM/H				
					2KPH	3KPH	4KPH	5KPH	
BLUE	LC-15 (100#)	105°	1.30m	1.0	0.68	157	105	79	63
				2.0	0.97	223	148	111	89
				3.0	1.18	273	182	136	109
RED	LC-20 (50#)	105°	1.30m	1.0	0.91	210	140	105	84
				2.0	1.29	298	198	149	119
				3.0	1.58	365	243	182	146

Note: Spray angle and widths given are at 3 Bar.

BRASS OFF-CENTRE – SMALL CAPACITY

G8259139

These spray tips are commonly installed in double and single swivel nozzle bodies. A wide spray swath is easily obtained from the bodies' easily adjustable angular position.

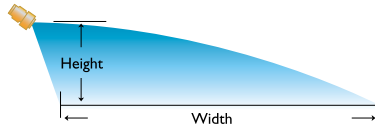

CODE	BAR	L/MIN	H = 45CM L/HA					H = 60CM L/HA				
			W (CM)	4 KM/H	6 KM	8 KM	10 KM	W(CM)	4 KM/H	6 KM	8 KM	10 KM
G8259139 OC-02	2.0	0.65	172	56.7	37.8	28.3	22.7	190	51.3	34.2	25.7	20.5
	3.0	0.79	177	66.9	44.6	33.5	26.8	195	60.8	40.5	30.4	24.3
	4.0	0.91	182	75.0	50.0	37.5	30.0	198	68.9	46.0	34.5	27.6
G8259140 OC-03	2.0	0.96	195	73.8	49.2	36.9	29.5	203	70.9	47.3	35.5	28.4
	3.0	1.18	203	87.2	58.1	43.6	34.9	210	84.3	56.2	42.1	33.7
	4.0	1.36	208	98.1	65.4	49.0	39.2	215	94.9	63.3	47.4	38.0
G8259141 OC-04	2.0	1.29	231	83.8	55.8	41.9	33.5	236	82.0	54.7	41.0	32.8
	3.0	1.58	236	100	66.9	50.2	40.2	238	99.6	66.4	49.8	39.8
	4.0	1.82	238	115	76.5	57.4	45.9	241	113	75.5	56.6	45.3
G8259142 OC-06	2.0	1.94	251	116	77.3	58.0	46.4	274	106	70.8	53.1	42.5
	3.0	2.37	256	139	92.6	69.4	55.5	279	127	84.9	63.7	51.0
	4.0	2.74	259	159	106	79.3	63.5	281	146	97.5	73.1	58.5

CODE	DESCRIPTION	SIZES AVAILABLE	LIST EX	LIST INC	CAT
G8259***	Brass - Geoline Off Centre Nozzle	02,03,04,06,08,16	\$19.09	\$21.00	B
OC-**	Brass - TeeJet Off Centre Nozzle	01,02,03,04,06,08,12,16	\$26.36	\$29.00	B

*** DENOTES SIZE REQUIRED. TO ORDER ADD THE SIZE IN PLACE OF ***

Nozzles and Accessories



HYPRO BOOMLESS NOZZLES

Eliminate the need for a spraying boom with the durable boomless nozzle that provides efficient spray.

- Ideal for applications where a conventional boom cannot be used due to obstacles, such as power poles, fences, trees, etc.
- Common uses include orchard, vineyard, forestry, pasture, turf and golf course spraying, as well as maintaining fence lines
- Designed for herbicide or fertiliser application
- Coarse droplet size, excellent low drift option while extending spray reach
- Maintains a consistent and adjustable spray swath over a pressure range of 30-60 PSI
- Includes quick connect cap and gasket for easy handling
- Excellent durability and low maintenance
- Also available as a spray kit (see page 35)

PICTURED
M99-75 WITH TWO
FC-XT010 NOZZLES

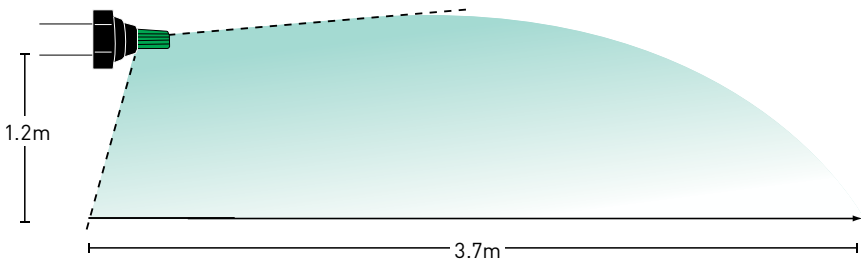

CODE	PRESSURE	L/MIN	SWATH WIDTH	L/HA				LIST EX	LIST INC	CAT
				6 KM/H	8 KM/H	12 KM/H	16 KM/H			
FC-XT010	2 Bar/30psi	3.2	3.7	83	62	41	31	\$80.00	\$88.00	B
FC-XT020	2 Bar/30psi	6.4	4.8	134	101	67	50	\$80.00	\$88.00	B
FC-XT024	2 Bar/30psi	7.7	4.9	158	118	79	59	\$80.00	\$88.00	B

HOLLOW CONE NOZZLES (HCC)

The ceramic hollow cone nozzles are designed for creating small droplets ideal for foliar of insecticides and fungicides and are constructed with a moulded outer over a ceramic insert that is mated to a turbulence chamber and counter-swirling device easily separated for cleaning. The ceramic nozzle allows for long lasting life and the vortexing action in the nozzle provides a 80° spray angle between 3-5 bar, but works well at both high and low operation pressures. The ceramic hollow cone nozzles are the offered alternative to the Albuz ATR Hollow cone nozzles.



HCC

	HCC Spray-Jet						
	BAR						
	3	4	5	6	8	10	15
HCC005	VF	VF	VF	VF	VF	VF	VF
HCC0075	F	VF	VF	VF	VF	VF	VF
HCC01	F	VF	VF	VF	VF	VF	VF
HCC015	F	F	VF	VF	VF	VF	VF
HCC02	F	F	F	VF	VF	VF	VF
HCC025	F	F	F	VF	VF	VF	VF
HCC03	F	F	F	VF	VF	VF	VF
HCC035	F	F	F	VF	VF	VF	VF
HCC04	F	F	F	F	F	VF	VF
HCC05	F	F	F	F	F	F	VF

HOLLOW CONE NOZZLES (TX)

VisiFlo colour-coded version consists of ceramic orifice in polypropylene body. Maximum operating pressure 20 bar. Spray angle is 80° at 7 bar. Finely atomised spray pattern provides thorough coverage.

Excellent: Post – Emergence Contact herbicides, fungicides and insecticides ensures finely atomised spray droplets reach target areas.

Good: With defoliant & foliar fertilisers at 3 bar pressure and above.



TX

CODE	ANG	DESCRIPTION	SIZES AVAILABLE	LIST EX	LIST INC	CAT
HCC***	80°	Ceramic-Hollow Cone Nozzle	005,0075,01,015,02,025,03,035,04,05	\$11.82	\$13.00	B
TX-VK**	80°	Ceramic-Conejet Hollow Cone Nozzle	3,4,6,8,10,12,18,26	\$15.45	\$17.00	B

*** DENOTES SIZE REQUIRED. TO ORDER ADD THE SIZE IN PLACE OF ***

HCC NOZZLES APPLICATION RATES

	BAR	L/MIN		BAR	L/MIN
HCC005	3	0.19	HCC025	3	1
	4	0.22		4	1.15
	6	0.27		6	1.41
	8	0.31		8	1.63
	10	0.35		10	1.83
	12	0.38		12	2
	15	0.42		15	2.24
HCC0075	20	0.49	20	2.58	
	3	0.3	HCC03	3	1.2
	4	0.35		4	1.39
	6	0.42		6	1.7
	8	0.49		8	1.96
	10	0.55		10	2.19
	12	0.6		12	2.4
15	0.67	15		2.68	
HCC01	20	0.77	20	3.10	
	3	0.4	HCC035	3	1.4
	4	0.46		4	1.62
	6	0.57		6	1.98
	8	0.65		8	2.29
	10	0.73		10	2.56
	12	0.8		12	2.8
15	0.89	15		3.13	
HCC015	20	1.03	20	3.61	
	3	0.6	HCC04	3	1.6
	4	0.69		4	1.85
	6	0.85		6	2.26
	8	0.98		8	2.61
	10	1.1		10	2.92
	12	1.2		12	3.2
15	1.34	15		3.58	
HCC02	20	1.55	20	4.13	
	3	0.8	HCC05	3	2
	4	0.92		4	2.31
	6	1.13		6	2.83
	8	1.31		8	3.27
	10	1.46		10	3.64
	12	1.6		12	4
15	1.79	15		4.47	
20	2.07	20	5.16		

TX NOZZLES APPLICATION RATES

	BAR	L/MIN
"TX-VK3 (100 MESH)"	5	0.25
	7	0.28
	10	0.33
	15	0.39
	20	0.45
"TX-VK4 (50 MESH)"	5	0.33
	7	0.39
	10	0.45
"TX-VK6 (50 MESH)"	15	0.55
	20	0.62
	5	0.5
"TX-VK8 (50 MESH)"	7	0.58
	10	0.68
	15	0.82
	20	0.93
"TX-VK10 (50 MESH)"	5	0.67
	7	0.79
	10	0.93
	15	1.1
"TX-VK12 (50 MESH)"	20	1.3
	5	0.84
	7	0.98
	10	1.2
"TX-VK18 (50 MESH)"	15	1.4
	20	1.6
	5	1
	7	1.2
"TX-VK26 (50 MESH)"	10	1.4
	15	1.7
	20	2
	5	1.5
"TX-VK3 (100 MESH)"	7	1.8
	10	2.2
	15	2.6
	20	3
"TX-VK4 (50 MESH)"	5	2.2
	7	2.6
	10	3.1
	15	3.8
"TX-VK6 (50 MESH)"	20	4.4

Nozzles and Accessories



*M99-65: Kit pic shown for display only. See page 34 for full details.

M99-65

BRASS BOOMLESS NOZZLES KIT WITH SINGLE OR DOUBLE SIDED SWATH

These compact kits offer broadcast spraying, ideal for applications around obstacles that could damage a traditional boom such as fences, guardrails and power poles.

- Attaches to an ATV rack, UTV or side by side or side framework with supplied clamp
- Supplied with 600mm of 12mm I.D hose with Inline tap to turn isolate flow or turn on or off
- Supplied with both single and twin sided nozzles
- Compatible with a broad range of Silvan spray equipment



6560-01

M99-65 (size 02)

- Pump flow suitable is 7L/Min (DDP-552A - Smoothflo)
- Spray Swath single from 3.4m or Double 7.6m

M99-66 (size 05)

- Pump flow suitable is 11 -14L/Min 381-125, 361-2088 or DDP-555
- Spray Swath single from 3.8m or Double 7.6m

SINGLE NOZZLE (90 DEGREES)					
PSI	L/min	Swath (m)	Litres per hectare (L/Ha)		
			3 km/hr	6 km/hr	9 km/hr
30	1.61	3.4	96	48	32
40	1.89	3.5	108	54	36
50	2.08	3.7	114	57	38
60	2.27	3.8	119	60	40

SINGLE NOZZLE (90 DEGREES)					
PSI	L/min	Swath (m)	Litres per hectare (L/Ha)		
			3 km/hr	6 km/hr	9 km/hr
30	3.22	3.4	96	48	32
40	1.89	3.5	108	54	36
50	2.08	3.7	114	57	38
60	2.27	3.8	119	60	40

DOUBLE NOZZLE (180 DEGREES)					
PSI	L/min	Swath (m)	Litres per hectare (L/Ha)		
			3 km/hr	6 km/hr	9 km/hr
30	3.22	6.7	96	48	32
40	3.79	7.0	108	54	36
50	4.16	7.3	114	57	38
60	4.54	7.6	119	60	40

DOUBLE NOZZLE (180 DEGREES)					
PSI	L/min	Swath (m)	Litres per hectare (L/Ha)		
			3 km/hr	6 km/hr	9 km/hr
30	6.44	16.8	96	48	32
40	7.57	14.0	108	54	36
50	8.33	14.6	114	57	38
60	9.08	15.2	119	60	40

CODE	DESCRIPTION	PRESSURE	L/MIN (UP TO)	SWATH WIDTH	LIST EX	LIST INC	CAT
M99-65	Boomless Nozzle Kit with Double Sided Swath	14 Bar/30 psi	18.2	10.4	\$135.45	\$149.00	B
M99-66	Boomless Nozzle (05)				\$144.54	\$159.00	B



XP BOOMJET BOOMLESS FLAT SPRAY

Type 5880 Boomjet Nozzle is used for spraying areas not easily accessed with a boom sprayer. It combines two off-centre tips and three VeeJet nozzles to produce an overall wide swath flat spray. The nozzle assembly provides good distribution considering the wide pattern coverage obtained: however the uniformity is not as good as with a properly operated boom sprayer. Uniformity can be optimised by double overlapping spray swaths on successive sprayer passes. Remember this also doubles the application volume.

Supplied with one additional 1/4" NPT pipe plug and one blank tip for setting BoomJet to one side only. Also has a 1/4" NPT pressure gauge port.

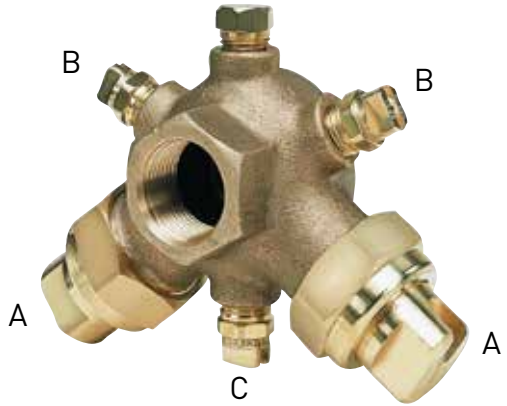

5880-3/4-2TOC06;
5880-3/4-2TOC10;
5880-3/4-2TOC20;
5880-3/4-2TOC40

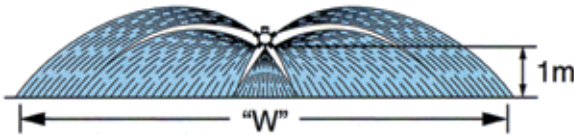

W = Maximum effective coverage
with nozzle mounted at 1m height

CODE	NOZZLE A	NOZZLE B	NOZZLE C	BAR	L/MIN	I/HA					LIST EX	LIST INC	CAT	
						WIDTH	6 KM/H	8 KM/H	12 KM/H	16 KM/H				24 KM/H
5880-3/4-2TOC06	6733-0C06	H1/4VW-1506	H1/4VVL-9502 with 50 mesh strainer	1.5	7.26	10.2M	71.2	53.4	35.6	26.7	17.8	\$508.18	\$559.00	B
				2.0	8.38	10.3M	81.4	61.0	40.7	30.5	20.3			
				2.5	9.37	10.5M	89.2	66.9	44.6	33.5	22.3			
5880-3/4-2TOC10	OC-10	H1/4U-0508HE	H1/4VVL-11004 with 50 mesh strainer	1.5	11.16	12.0M	93.0	69.8	46.5	34.9	23.3	\$508.18	\$559.00	B
				2.0	12.89	12.1M	107.0	79.9	53.3	39.9	26.3			
				2.5	14.41	12.3M	117.0	87.9	58.6	43.9	29.3			
5880-3/4-2TOC20	OC-20	H1/4U-0520HE	H1/4VVL-9506 with 50 mesh strainer	1.5	24.00	14.3M	168.0	126.0	83.9	62.9	42.0	\$508.18	\$559.00	B
				2.0	27.72	15.2M	182.0	137.0	91.2	68.4	45.6			
				2.5	30.99	15.8M	196.0	147.0	98.1	73.6	49.0			
5880-3/4-2TOC40	OC-40	H1/4U-0540HE	H1/4U-9510	1.5	47.44	17.1M	277.0	208.0	139.0	104.0	69.4	\$508.18	\$559.00	B
				2.0	54.78	18.2M	300.01	226.0	150.0	113.0	75.2			
				2.5	61.25	19.2M	319.0	239.0	160.0	120.0	79.8			

Nozzles and Accessories

FOR USE WITH SPRAY TIPS) REFERENCE GUIDE ONLY)

COLOUR CAPS

TeeJet Flat Spray Tips (Smaller Capacities)

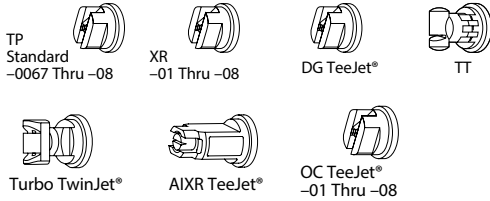

TeeJet Flat Spray Tips (Larger Capacities)

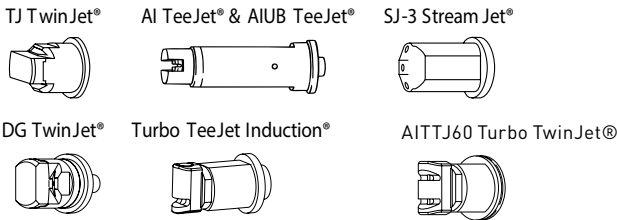
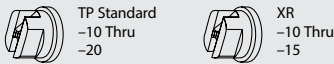

Turbo Flood Jet®
VisiFlo® Spray Tip

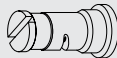

TK-VS Flood Jet®
VisiFlo Spray Tip

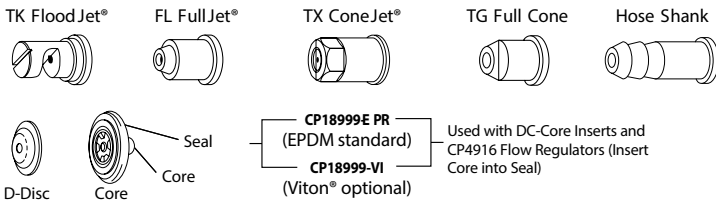
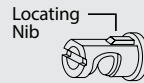

Ceramic Disc-Core



Provides shut-off at nozzle for quick spacing change or change in spray swath



CP19438-EPR (EPDM standard) Gasket only

CP19438-VI (Viton optional) Gasket only



Nozzles and Accessories

TeeJet®

TEEJET CAP CODE	LIST EX	LIST INC	CAT	TEEJET GASKET & CAP KIT CODE	LIST EX	LIST INC	CAT
CP25611-3-NY	\$1.64	\$1.80	B	25612-3-NYR	\$2.27	\$2.50	B
CP25611-4-NY				25612-4-NYR			
CP25611-5-NY				25612-5-NYR			
CP25611-6-NY				25612-6-NYR			
CP25611-7-NY				25612-7-NYR			
CP25611-8-NY							
CP25609-4-NY	\$1.82	\$2.00	B	25610-1-NYR	\$2.91	\$3.20	B
CP25609-6-NY							
CP25597-3-NY	\$1.82	\$2.00	B	25598-3-NYR	\$2.91	\$3.20	B
CP25597-4-NY				25598-4-NYR			
CP25597-5-NY				25598-5-NYR			
CP25597-6-NY				25598-6-NYR			
CP25597-7-NY				25598-1-NYR			
CP25599-3-NY	\$1.82	\$2.00	B	25600-6-NYR	\$2.91	\$3.20	B
CP25599-6-NY							
CP25607-3-NY	\$1.82	\$2.00	B	25608-1-NYR	\$2.91	\$3.20	B
CP25607-4-NY				25608-3-NYR			
CP25607-5-NY				25608-4-NYR			
CP25607-6-NY							
CP26277-1-NY	\$4.00	\$4.40	B	26278-1-NYR	\$4.91	\$5.40	B
N/A	N/A	N/A	B	19843-NYR	\$5.09	\$5.60	B
	\$2.27	\$2.50	B				
	\$7.55	\$8.31	B				

CP19438-EPR (EPDM standard)

CP19438-VI (Viton optional)



Quick TeeJet Cap & Std Seat Gasket Kit

TEEJET NOZZLE CAPS









The Quick TeeJet® caps are designed with grooves that fit locating lugs on the nozzle body. Caps are made of nylon and are available for use with all TeeJet spray tips. Maximum operating pressure of 20 bar/290 psi.

*Specify colour code (see chart), e.g.: CP25611-3-NY will supply red cap.

Silvan

Nozzles and Accessories

Silvan self-aligning nozzle caps are designed to fit all popular brands of spray tips including fan, cone, anvil and other specialised nozzles. Cap sealing gaskets are manufactured from chemical resistant EPDM material. Maximum operating pressure 30 Bar (435 PSI).

FOR USE WITH SPRAY TIPS (REFERENCE GUIDE ONLY)	COLOUR CAPS	CAP CODE	LIST EX	LIST INC	CAT	GASKET ONLY CODE	LIST EX	LIST INC	CAT
 TeeJet® Flat Spray Tips Lurmark Flat Fan Tips Albus Flat Fan Tips (Fits Sizes 01 To 08) Lechler Idk		G8253000	\$2.18	\$2.40	B	402200-040	\$2.27	\$2.50	B
 Albus Avi-0c; Albus Avi; Albus Ape-Exa; Albus Esi		G8253004	\$4.27	\$4.70	B	402200-040	\$4.36	\$4.80	B
 Albus Apm;Tk Floodjet Tg Full Cone; Fl Full Jet		G8253012	\$4.27	\$4.70	B	402200-040	\$4.36	\$4.80	B
 Albus Apt-Atr-Ampt, Hcc hollow cones		G8253020	\$4.27	\$4.70	B	402200-040	\$4.36	\$4.80	B
PROVIDES BLANKING SHUT-OFF OF NOZZLE		G8253040 gasket not inc.	\$4.10	\$3.13	B	402200-040	\$2.18	\$2.40	B

UNI CAP

- Universal nozzle cap suitable for use with the majority of nozzles used in agriculture today
- Lower stock costs and easier managing
- Supplied with gasket

Suitable for the following nozzles:















- ARAG® Kematal
- Lurmark® Flat Fan Tips

- Lechler Series 652, IDK, Air Mix,
- Lechler series ID, LU
- TeeJet® Flat Fan Tips Std.-
- TeeJet® FL Fulljet,
- TeeJet® TG Fullcone



CODE	DESCRIPTION	COLOUR	QUANTITY	LIST EX	LIST INC	CAT
40299003	Uni Cap	Red	1 PACK	\$4.09	\$4.50	B

CAPS FOR HARDI NOZZLE BODIES

QUICK TEEJET CAPS	CAP ONLY	LIST EX	LIST INC	CAT	FOR USE WITH FLAT SPRAY TIPS 150PSI (10 BAR) MAXIMUM PRESSURE
	CP21399-6-CE	\$3.73	\$4.10	B	 TJ TwinJet®  AI TeeJet® & AIUB TeeJet®  SJ-3 StreamJet®  DG TwinJet®  Turbo TeeJet® Induction
	CP23307-4-CE	\$3.73	\$4.10	B	 TP Standard -0067 Thru -08  XR -01 Thru -08  DG TeeJet®  TT
	CP23307-6-CE	\$3.73	\$4.10	B	 Turbo TwinJet®  AIXR TeeJet®  OC TeeJet® -01 Thru -08

Gasket code CP23308-EPR \$2.20 CAT B], use 4067 series cup strainers with TTI nozzles

Nozzles and Accessories

Silvan nozzle holders are the easiest and fastest means of mounting spray nozzles to booms. Simply drill an appropriate size hole and clamp nozzle holder in place. The range available includes non-drip valves, swivel nozzle holders, low pressure and high pressure holders and wet and dry boom nozzle holders.

All are UV light resistant, house most standard size nozzle tips and feature self aligning quick fit caps for ease of nozzle cleaning. Applications include boom spraying, poultry shed lines, car washes, livestock races and production line cooling. All nozzle holders are supplied less tip. Merchandise packs of 4 where stated.

WET BOOM NOZZLE HOLDERS

Designed for clamping around 1/2" spray tubes. Feature a self-aligning nozzle cap and a mounting recess in the top clamp for attachment to flat surfaces. Polypropylene construction. Includes nozzle cap, gasket and screw.



DRAWING
0114
AR-100

CODE	INLET SIZE	TUBE SIZE	MAX PRESSURE	LIST EX	LIST INC	CAT
AR-100 (4 pack)	7mm	1/2"	9.6 Bar/145 psi	\$52.73	\$58.00	B

NON-DRIP NOZZLE HOLDERS

Single clamping screw on the 1/2" model. Non-drip shut-off valve. Opens above 0.5 Bar. Includes nozzle body & cap, gasket & screw.

- 1/2" model maximum pressure of 30 Bar
- 3/4" model maximum pressure of 20 Bar



AR-200



AR-210

DRAWING
10314

CODE	INLET SIZE	TUBE SIZE	MAX PRESSURE	LIST EX	LIST INC	CAT
AR-200 (4 pack)	7mm	1/2"	30 Bar/435 psi	\$69.09	\$76.00	B
AR-210 (4 pack)	10mm	3/4"	20 Bar/290 psi	\$70.00	\$77.00	B

TEEJET NOZZLE HOLDERS

Features ChemSaver drip-free shut-off.
Requires 10 PSI (0.7 bar) at the nozzle to open check valve.

Note: Excludes nozzle cap and gasket.



CODE	INLET SIZE	TUBE SIZE	MAX PRESSURE	LIST EX	LIST INC	CAT
QJ17560A-1/2x7-NYB	7mm	1/2"	20 Bar/300 psi	\$8.00	\$8.80	B
QJ17560A-1/2-NYB	9.5mm	1/2"	20 Bar/300 psi	\$8.00	\$8.80	B
QJ17560A-3/4-NYB	9.5mm	3/4"	20 Bar/300 psi	\$8.00	\$8.80	B
QJ17560A-1-NYB	9.5mm	1"	20 Bar/300 psi	\$9.09	\$10.00	B

TEEJET MULTIPLE NOZZLE HOLDERS

This 3 position nozzle holder features a positive shut-off between each position and includes ChemSaver® diaphragm check valve for drip-free shut-off.

Note: Excludes nozzle cap and gasket.



CODE	INLET SIZE	TUBE SIZE	MAX PRESSURE	LIST EX	LIST INC	CAT
QJ363C-1/2-NYB	9.5mm	1/2"	20 Bar/300 psi	\$36.36	\$40.00	B
QJ363C-3/4-NYB	9.5mm	3/4"	20 Bar/300 psi	\$36.36	\$40.00	B
QJ363C-1-NYB	9.5mm	1"	20 Bar/300 psi	\$36.36	\$40.00	B

Nozzles and Accessories

Dry boom nozzle holders are designed for mounting directly to boom frame for variable nozzle spacings when used with hose and clamps. Fits round or square tubing or pipe and is connected by hose and clamps. Polypropylene construction with max pressure of 2000kPa (290psi).



G8235021



G8235027

8235 SERIES

Self aligning nozzle cap. Available in single or double hose-tails. Non-drip shut-off valve standard (open 0.5 Bar).

CODE	NOZZLE HOLDER TYPE	INLET HOSE TAIL SIZE I.D.	MAX PRESSURE	LIST EX	LIST INC	CAT
G8235021	SINGLE	1/2"	20 Bar/290 psi	\$23.64	\$26.00	B
G8235027	DOUBLE	1/2"	20 Bar/290 psi	\$20.00	\$22.00	B

193 SERIES

- Drip free shut-off with ChemSaver®
- Opening pressure - 10 psi (0.7 bar)
- Available in single or double hose shanks
- Hose barb sizes for 3/8", 1/2" or 3/4" I.D. hose
- Use with Vari Spacing clamps (Refer Page 100)



19349

A



19350

B

CODE	REF	NOZZLE HOLDER TYPE	INLET HOSE TAIL SIZE I.D.	MAX PRESSURE	LIST EX	LIST INC	CAT
19349-211-406-NYB	A	SINGLE	3/8"	8 Bar/125 psi	\$20.91	\$23.00	B
19349-211-540-NYB	A	SINGLE	1/2"	8 Bar/125 psi	\$20.91	\$23.00	B
19349-211-785-NYB	A	SINGLE	3/4"	8 Bar/125 psi	\$20.91	\$23.00	B
19350-212-406-NYB	B	DOUBLE	3/8"	8 Bar/125 psi	\$20.91	\$23.00	B
19350-212-540-NYB	B	DOUBLE	1/2"	8 Bar/125 psi	\$20.91	\$23.00	B
19350-212-785-NYB	B	DOUBLE	3/4"	8 Bar/125 psi	\$20.91	\$23.00	B

QJ39685 SERIES

- TeeJet ChemSaver® drip-free shut-off
- Made of corrosion-resistant materials



1



2



3

CODE	REF	NOZZLE HOLDER TYPE	INLET HOSE TAIL SIZE I.D.	MAX PRESSURE	LIST EX	LIST INC	CAT
QJ39685-1L-500-NYB	1	SINGLE LEFT	1/2"	20 Bar/290 psi	\$12.73	\$14.00	B
QJ39685-1R-500-NYB	2	SINGLE RIGHT	1/2"	20 Bar/290 psi	\$12.73	\$14.00	B
QJ39685-2-500-NYB	3	DOUBLE	1/2"	20 Bar/290 psi	\$12.73	\$14.00	B

Nozzles and Accessories

G8235 SERIES

- Geoline compact non-drip elbow
- Made of corrosion-resistant materials



CODE	REF	NOZZLE HOLDER TYPE	INLET HOSE TAIL SIZE I.D.	MAX PRESSURE	LIST EX	LIST INC	CAT
G8235035	4	SINGLE LEFT	1/2"	20 Bar/290 psi	\$16.36	\$18.00	B
G8235031	5	SINGLE RIGHT	1/2"	20 Bar/290 psi	\$16.36	\$18.00	B
G8235033	6	DOUBLE	1/2"	20 Bar/290 psi	\$16.36	\$18.00	B
CP21953-EPR	Replacement Standard Diaphragm				\$2.00	\$2.20	B
CP21953-VI	Replacement Viton				\$5.55	\$6.11	B

NOZZLE ADAPTORS

- Features ChemSaver® non-drip shutoff
- Requires 10 PSI (0.7 bar) at the nozzle to open check valve
- QJ8360-NYB allows use of Quick TeeJet system from 1/4" NPT female connections
- QJT8360-NYB permits use of Quick TeeJet system with standard 11/16" TeeJet thread



QJ8360-NYB

QJT8360-NYB

CODE	THREAD SIZE	ANTI DRIP VALVE	MAX PRESSURE	LIST EX	LIST INC	CAT
QJ8360-NYB	1/4" NPT (M)	YES	20 Bar/290 psi	\$15.45	\$17.00	B
QJT8360-NYB	11/16" TeeJet THREAD (F)	YES	20 Bar/290 psi	\$15.45	\$17.00	B

VARI SPACING CLAMPS

These clamps are for use on all dry boom nozzle bodies. Simply order the round or square clamps for the required O.D. tubing.

Example: QJ111-1/2 (Round 1/2" tubing).

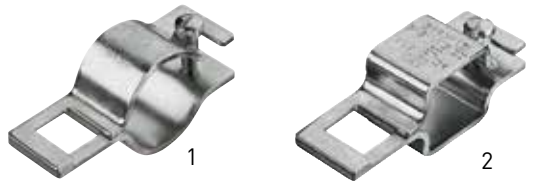

QJ111-1/2

QJ111SQ-3/4

CODE	REF	TO FIT	LIST EX	LIST INC	CAT
QJ111-1/2	1	1/2" Pipe (13/16" & 7/8" O.D. Tubing)	\$6.00	\$6.60	B
QJ111-3/4	1	3/4" Pipe (1" & 11/16" O.D. Tubing)	\$6.00	\$6.60	B
QJ111-1	1	1" Pipe (11/8", 11/4" & 13/8" O.D. Tubing)	\$6.00	\$6.60	B
QJ111-1-1/4	1	1-1/4" Pipe (19/16" & 111/16" O.D. Tubing)	\$6.00	\$6.60	B
QJ111SQ-3/4	2	3/4" Square Tubing	\$6.00	\$6.60	B
QJ111SQ-1	2	1" Square Tubing	\$6.00	\$6.60	B
QJ111SQ-1-1/4	2	1-1/4" Square Tubing	\$6.00	\$6.60	B
QJ111SQ-1-1/2	2	1-1/2" Square Tubing	\$6.00	\$6.60	B

POLY - SWIVEL NOZZLE HOLDERS

Features an adjustable spray angle with lock nut to hold body in place. Self-aligning nozzle cap. Ideal for use in row crop application or fenceline spraying.

Uses bayonet caps, see page 96



68247014

BRASS - SWIVEL NOZZLE HOLDERS

Plated brass adjustable angle swivel bodies.

Threaded nozzle caps for high pressure application and row crop spraying. Single or twin outlets.

68247004



68247008



DRAWING
10889

CODE	NOZZLE HOLDER TYPE	INLET SIZE (BSP)	MAX PRESSURE	L (MM)	LIST EX	LIST INC	CAT
68247014	Double Poly	1/4" F	9.6 Bar/145 psi	70	\$22.73	\$25.00	B
68247004	Single Brass	1/4" F	20 Bar/300 psi	70	\$31.82	\$35.00	B
68247008	Double Brass	1/4" F	20 Bar/300 psi	70	\$41.82	\$46.00	B



TEEJET NOZZLE CAPS

Secure interchangeable TeeJet tips to the various nozzle bodies.



CP1325



CP8027-NYB

CODE	MATERIAL	LIST EX	LIST INC	CAT
CP1325	Brass	\$3.18	\$3.50	B
CP8027-NYB	Nylon	\$1.82	\$2.00	B

TEEJET SWIVEL NOZZLE HOLDERS

TeeJet swivel nozzle bodies are primarily for use with tips employed in row crop spraying. A locknut holds swivel bodies firmly in position at a selected spray projection angle so they are not affected by jarring and vibration. For use at pressures up to 125 PSI (8.6 bar). These are also available in the QJ8600 swivel Quick TeeJet nozzle body assemblies which provide the same spray tip adjustability of a standard TeeJet threaded swivel plus the quick change and self-aligning features of the Quick TeeJet System.

QJ8600-1/4-NYB



5000-1/4T



QJ8600-2-1/4-NYB



4202-2-1/4T



6240-1/4TT



8600-1/4T-NYB



8600-2-1/4T-NYB



CODE	INLET SIZE BSP)	MATERIAL	SWIVEL ARC RANGE	MAX PRESSURE	LIST EX	LIST INC	CAT
QJ8600-1/4-NYB	1/4" NPT (F)	Nylon	280°	8 Bar/125 psi	\$16.36	\$18.00	B
QJ8600-2-1/4-NYB	1/4" NPT (F)	Nylon	280°	8 Bar/125 psi	\$19.09	\$21.00	B
5000-1/4T	1/4" NPT (F)	Brass	280°	8 Bar/125 psi	\$48.18	\$53.00	B
4202-2-1/4T	1/4" NPT (F)	Brass	280°	8 Bar/125 psi	\$57.27	\$63.00	B
6240-1/4TT	1/4" NPT (M)	Brass	280°	8 Bar/125 psi	\$50.91	\$56.00	B
8600-1/4T-NYB	1/4" NPT (F)	Nylon	280°	8 Bar/125 psi	\$18.18	\$20.00	B
8600-2-1/4T-NYB	1/4" NPT (F)	Nylon	280°	8 Bar/125 psi	\$18.18	\$20.00	B

HIGH PRESSURE WET BOOM NOZZLE HOLDERS

High pressure nozzle holders are ideal for orchard, vineyard, market garden and poultry shed applications. They can be retro-fitted to existing equipment or for specialised manufacturing uses, eg. special spray booms. Brass construction with BSP connections.

- Suits 1/2" tube with 7mm outlet hole
- Inlet 1/4" female



004215

CODE	INLET SIZE	TUBE SIZE	OUTLET SIZE (BSP)	MAX PRESSURE	LIST EX	LIST INC	CAT
004215	7mm	1/2"	1/4" Female	50 Bar/725 psi	\$10.91	\$12.00	B

HIGH PRESSURE NOZZLE HOLDERS

NON DRIP BRA SERIES

Brass flip over nozzle fitted with anti-drip valve with viton diaphragm. Anti-drip valve opens at 1 Bar pressure. 1/4" BSP thread, all brass construction, ceramic tips, stainless steel swirl plates, 90° shut off.



DRAWING
10849

MA3-66

68 SERIES

Double sided version of Single Series.



DRAWING
10226

MA3-68

VINE SERIES

Features adjustable spray pattern simply by twisting rear adjusting nut. Supplied with 1/4" BSP swivel which allows the nozzle to be locked in almost any spray angle/position. Brass construction with ceramic nozzle tip.



DRAWING
0642

P50

SINGLE SERIES

Flip over nozzle fitted with 1/4" BSP thread, all brass construction, ceramic tip, stainless steel swirl plate, 90° shut off.



DRAWING
10221

G8264000A

MA7 SERIES

Ideal for use in high volume pressure applications in heavy foliage. Features adjustable spray pattern, tungsten carbide nozzle supplied standard with 1.5mm jet and brass construction. Supplied with 1/4" BSP swivel.



G8275016

MA3 SERIES

Double brass nozzle holder designed to increase number of nozzles thus reducing the droplet size and increasing the coverage. Fits directly to most brass nozzle holders (1), (2) and (3) to replace existing nozzle & cap i.e. 1 jet nozzle holder becomes 2 jet.



MA3-78

CODE	INLET SIZE	NOZZLE SIZE	ANTI DRIP VALVE	MAX PRESSURE	LENGTH	WIDTH	HEIGHT	LIST EX	LIST INC	CAT
G8264000A	1/4" Male	1.2	NO	50 Bar/725 psi	50mm	30mm	60mm	\$42.73	\$47.00	B
MA3-68	1/4" Male	1.2/1.5	NO	50 Bar/725 psi	70mm	30mm	60mm	\$48.18	\$53.00	B
MA3-66	1/4" Male	1.2/1.5	YES	50 Bar/725 psi	80mm	30mm	40mm	\$70.91	\$78.00	B
P50	1/4" Male	1.2	NO	50 Bar/725 psi	100mm	25mm	70mm	\$54.55	\$60.00	B
G8275016	1/4" Male	1.5	NO	50 Bar/725 psi	130mm	30mm	30mm	\$88.18	\$97.00	B
MA3-78	3/4" Female	-	-	50 Bar/725 psi	30mm	125mm	50mm	\$54.55	\$60.00	B

Silvan

Fire Fighters



Silvan



The Silvan Selecta Power Water Transfer pumps handle high volume water pumping and are ideal when portability is needed or electrical power supply is scarce.

LBA-115

DRAWING
10820

FOUR STROKE COMPACT WATER PUMP

Centrifugal water pump with handy carry handle for fire control, watering and washing.

- 115 L/min open flow, 40 psi max. pressure
- 3 metres suction Lift
- Outlet and inlet connections 1" BSP (25mm)
- 4 Stroke, 33 cc capacity with recoil start
- 0.6L fuel tank capacity
- Petrol powered – no mixing



SILVAN SELECTA POWER FIRE FIGHTING PUMP

For fire fighting and watering and features a carry/ mounting frame for mobility and added protection.

- 4 stroke over head cam engine with oil alert
- Max. 250 L/min open flow, Max. 100psi pressure
- Direct coupled centrifugal, twin impeller fire fighting pump
- Maximum suction lift 3.5 metres
- 1 x 1 1/2" inlet, 2 x 1" outlet, 1 x 1 1/2" outlet
- Weight 8kg
- Optional hose kit (Code: LBA-100A) consisting of 20m fire fighting hose, nozzle, 6m suction hose and foot filter



LBA-100

DRAWING
5070

CODE	POWER	MAX PRESSURE	MAX OUTPUT	LENGTH	WIDTH	HEIGHT	WT	LIST EX	LIST INC	CAT
LBA-115	1.21HP	3 Bar/40 psi	115 L/min	420mm	300mm	360mm	8 kg	\$362.73	\$399.00	A
LBA-100	6.5HP	7 Bar/100 psi	250L/min	500mm	370mm	400mm	31 kg	\$626.36	\$689.00	A
OPTION CODE	DESCRIPTION	SUCTION HOSE	DELIVERY HOSE	LIST EX	LIST INC	CAT				
LBA-100A	Water Transfer Hose Kit	6m x 40mm ID with foot filter	20 m x 19mm ID with Adjustable Nozzle	\$256.36	\$282.00	A				
328-254-28	Seal Kit – Mechanical (To suit LBA-100)			\$37.27	\$41.00	B				

Silvan Fire Fighting Units 400L, 600L & 800L

Ideal for fire fighting, water transfer and washdown.



AVAILABLE WITH 20M HOSE
COIL OR 30M HOSE REEL

400 & 800L UV
STABILISED TANKS

ALL MODELS WITH
STRAINER BASKET TO
REMOVE COARSE DEBRIS



5.5 HP HONDA GX160
ENGINE WITH DAVEY FIRE
FIGHTING PUMP

SINGLE IMPELLER MAX
PRESSURE 80PSI (425L/MIN
OPEN FLOW)



6.5 HP SELECTA
POWER FIRE FIGHTING
PUMP AVAILABLE

TWIN IMPELLER MAX
PRESSURE 100PSI (250L/MIN
OPEN FLOW)



UNIQUE BAFFLE
DESIGN REDUCES SURGE
WHEN TRAVELING

400L, 600L & 800L UV
STABILISED TANKS

3/4" FIRE FIGHTING HOSE
AND POLY FIRE NOZZLE



SQF400D-1

Silvan Fire fighting units are made of high quality components sourced from world class manufacturers. Ideal for water transfer and washdown of machinery, they fit neatly across the back of a one tonne tray and between the wheel arches of popular utilities.

All units are fully assembled and tested ready for use.

400L SILVAN SELECTA POWER UNIT - SQF400S

- 20mtr 3/4" I.D. hose and poly adjustable fire fighter nozzle
- 4 Stroke 6.5HP Selecta Power Engine, twin Alloy Impellor
- Inlet 1 x 1.5", Outlet 1 x 1.5" & 2 x 1"
- 100psi max pressure or 250L/Min open flow
- Maximum head 70 (metres)
- Fuel capacity 3.6 Litre (Unleaded), 2 hours approx run time



SQF400S



DRAWING 10092

400L SILVAN HONDA DAVEY UNIT - SQF400D

- 20mtr 3/4" I.D. hose and poly adjustable fire fighter nozzle
- 4 Stroke 5.5HP GX160 Honda Engine, direct coupled Impellor
- Inlet 1 x 1.5", Outlet 1 x 1.5" & 2 x 1"
- 80psi max pressure or 425L/Min open flow
- Maximum head 56 (metres)
- Fuel capacity 3.6 Litre (Unleaded), 2 hours approx run time



SQF400D-1



DRAWING 10092

400L SILVAN HONDA DAVEY UNIT - SQF400D-1

- Hosereel, fitted with 30mtr 3/4" I.D. hose and poly adjustable fire fighting nozzle



CODE	TANK	OPEN FLOW	MAX PRESSURE	LENGTH	WIDTH	HEIGHT	WT	LIST EX	LIST INC	CAT
SQF400S	400L	250 L/Min	6 Bar/100 psi	935mm	1080mm	650mm	65 kg	\$1,944.55	\$2,139.00	9
SQF400D	400L	425 L/Min	5 Bar/80 psi	935mm	1080mm	650mm	65 kg	\$2,671.82	\$2,939.00	9
*SQF400D-1	400L	425 L/Min	5 Bar/80 psi	935mm	1080mm	980mm	77 kg	\$3,009.09	\$3,310.00	9

Warning: Refer to vehicle or tractor manufacturer's instructions for appropriate load & towing limits & fitting positions.



SQF600S-1

Silvan Fire fighting units are made of high quality components sourced from world class manufacturers. Ideal for water transfer and wash down of machinery, they fit neatly across the back of a one tonne tray and between the wheel arches of popular utilities.

All units are fully assembled and tested ready for use.

600L SILVAN SELECTA POWER FIRE FIGHTING UNITS - SQF600S

- UV stabilised Polytuff tank that meets the harsh Australian conditions
- Internal Baffle to reduce surge when travelling
- Tie down points moulded into the top of the tank
- Screw down lid with breather and strainer basket
- 4 Stroke 6.5HP Selecta Power Engine, twin Alloy Impellor
- 100psi max pressure or 250L/Min open flow
- Inlet 1 x 1.5", Outlet 1 x 1.5" & 2 x 1"
- Maximum head 70 (metres)
- Fuel capacity 3.6 Litre (Unleaded)
- 2 hours approx run time



SQF600S

UNIQUE TWIN
BAFFLED TANK

600L SILVAN SELECTA POWER UNIT - SQF600S-1

- Hosereel, fitted with 30mtr 3/4" I.D. hose and poly adjustable fire fighter nozzle



CODE	DESCRIPTION	LENGTH	WIDTH	HEIGHT	WT	LIST EX	LIST INC	CAT
SQF600S	600L Selecta Power Fire Fighting Unit	1830mm	940mm	840mm	67 kg	\$2,180.91	\$2,399.00	9
SQF600S-1	600L Selecta Power c/w 30mtr Hosereel	1830mm	940mm	840mm	82 kg	\$2,599.09	\$2,859.00	9

Warning: Refer to vehicle or tractor manufacturer's instructions for appropriate load & towing limits & fitting positions.

Fire Fighters



Silvan Fire fighting units are made of high quality components sourced from world class manufacturers. Ideal for water transfer and wash down of machinery, they fit neatly across the back of a one tonne tray and between the wheel arches of popular utilities.

All units are fully assembled and tested ready for use.

SQF600D

UNIQUE TWIN



600L SILVAN HONDA DAVEY FIRE FIGHTING UNITS

- UV stabilised Polytuff tank that meets the harsh Australian conditions
- Internal Baffle to reduce surge when travelling
- Tie down points moulded into the top of the tank
- Screw down lid with breather and strainer basket
- 4 Stroke 5.5HP GX160 Honda Engine, direct coupled Impellor
- Inlet 1 x 1.5", Outlet 1 x 1.5" & 2 x 1"
- 80psi max pressure or 425L/Min open flow
- Maximum head 56 (metres)
- Fuel capacity 3.6 Litre (Unleaded)
- 2 hours approx run time



600L SILVAN HONDA DAVEY UNIT - SQF600D

- 20mtr 3/4" I.D. hose and poly adjustable fire fighter nozzle

600L SILVAN HONDA DAVEY UNIT - SQF600D-1

- Hosereel, fitted with 30mtr 3/4" I.D. hose and poly adjustable fire fighter nozzle

SQF600D-1

UNIQUE TWIN



CODE	DESCRIPTION	LENGTH	WIDTH	HEIGHT	WT	LIST EX	LIST INC	CAT
SQF600D	600L Honda Davey Fire Fighting Unit	1830mm	940mm	840mm	67 kg	\$2,817.27	\$3,099.00	9
SQF600D-1	600L Honda Davey Unit C/W 30mtr Hosereel	1830mm	940mm	840mm	82 kg	\$3,271.82	\$3,599.00	9

Warning: Refer to vehicle or tractor manufacturer's instructions for appropriate load & towing limits & fitting positions.



800L SELECTA POWER UNIT - SQF800S-1

SQF800S-1

- Heavy duty hose reel, fitted with 30mtr 3/4" I.D. hose and poly adjustable fire fighting nozzle.
- 4 Stroke 6.5HP Selecta Power Engine, twin Alloy Impellor
- Inlet 1 x 1.5", Outlet 1 x 1.5" & 2 x 1"
- 100psi max pressure or 250L/Min open flow
- Maximum head 70 (metres)



800L HONDA DAVEY UNIT - SQF800D

SQF800D

- 20mtr 3/4" I.D. hose and poly adjustable fire fighter nozzle
- 4 Stroke 5.5HP GX160 Honda Engine, direct coupled Impellor
- Inlet 1 x 1.5", Outlet 1 x 1.5" & 2 x 1"
- 80psi max pressure or 425L/Min open flow
- Maximum head 56 (metres)



CODE	TANK	OPEN FLOW	MAX PRESSURE	LENGTH	WIDTH	HEIGHT	WT	LIST EX	LIST INC	CAT
SQF800S-1*	800L	250 L/Min	6 Bar/100 psi	1800mm	940mm	1090mm	95 kg	\$2,962.73	\$3,259.00	9
SQF800D	800L	500 L/Min	5 Bar/80 psi	1800mm	940mm	760mm	77 kg	\$3,126.36	\$3,439.00	9

Warning: Refer to vehicle or tractor manufacturer's instructions for appropriate load & towing limits & fitting positions.





SQF800D-1

800L SILVAN FIRE FIGHTING UNITS

- UV stabilised Polytuff tank that meets the harsh Australian conditions
- TWIN Internal Baffle to reduce surge when travelling
- Tie down points moulded into the top of the tank
- Fuel capacity 3.6 Litre (Unleaded), 2 hours approx run time
- Screw down lid with breather and strainer basket
- Engines are fitted with Oil Alert

SQF800D-3



800L HONDA TWIN STAGE UNIT - SQF800D-3



- Heavy duty hosereel, fitted with 30m 3/4" I.D. hose and poly adjustable fire fighting nozzle

CODE	TANK	OPEN FLOW	MAX PRESSURE	LENGTH	WIDTH	HEIGHT	WT	LIST EX	LIST INC	CAT
SQF800D-1	800L	500 L/Min	5 Bar/80 psi	1800mm	940mm	1090mm	95 kg	\$3,426.36	\$3,769.00	9
SQF800D-3	800L	400 L/Min	10 Bar/150 psi	1800mm	940mm	1090mm	97 kg	\$3,608.18	\$3,969.00	9

Warning: Refer to vehicle or tractor manufacturer's instructions for appropriate load & towing limits & fitting positions.



UV stabilised Polytuff tank that meets the harsh Australian conditions



1100L SILVAN FIRE FIGHTING UNITS

- Tie down points moulded into the top of the tank
- Screw down lid with breather and 455mm strainer basket
- Galvanised fork lift – able skid base
- Heavy duty hosereel, fitted with 30m x 3/4" I.D. hose and poly adjustable nozzle
- Fuel capacity 3.6 Litre (Unleaded), 2 hours approx run time
- Engines fitted with low oil alert



SLF1000D-1

1100L HONDA DAVEY UNIT - SLF1000D-1

- 4 Stroke 5.5HP GX160 Honda Engine, direct coupled Impellor
- Inlet 1 x 1.5", Outlet 1 x 1.5" & 2 x 1"
- 80psi max pressure or 425L/Min open flow
- Maximum head 56 (metres)



2200L HONDA DAVEY SLED UNIT - SLF2200D-1

- Honda 4 Stroke 5.5HP GX160 engine, direct coupled to Davey Pump
- Max 425L/min open flow or max 80psi pressure
- Heavy duty hosereel, 30m x 3/4" hose and adjustable nozzle



SLF2200D-1

CODE	DESCRIPTION	LENGTH	WIDTH	HEIGHT	WT	LIST EX	LIST INC	CAT
SLF1000D-1	1100L Honda Davey Unit c/w 30m Hosereel	1970mm	1160mm	1050mm	200 kg	\$3,699.09	\$4,069.00	9
SLF2200D-1	2200L Honda Davey Unit c/w 30m Hosereel	2300mm	1350mm	1400mm	322 kg	\$5,509.09	\$6,060.00	9

Warning: Refer to vehicle or tractor manufacturer's instructions for appropriate load & towing limits & fitting positions.



800L ON-FARM FIRE FIGHTING UNIT

STF800S-1*

6.5 HP Selecta Power Engine with low oil protection.

- Max. 250 L/min open flow or max. 100psi pressure
- Galvanised trailer with mudguards
- 50mm tow hitch and Jockey wheel
- Polytuff tank with unique Double baffle design reduces surge when travelling
- Screw down lid with breather and strainer basket for leaves and other debris
- Hose Reel fitted with 30m 3/4" fire fighting hose & poly fire nozzle



1100L ON-ROAD TRAILED FIRE FIGHTING UNIT

ROAD-REGISTRABLE

5.5 HP Honda/Davey with low oil protection.

- Max. 425 L/min open flow or max. 80psi pressure
- Heavy Duty Hosereel, 30m x 3/4" hose and adjustable fire nozzle
- Quick fill kit uses pump & large 6m hose for rapid tank fill, pump max. suction lift 6 meters
- Road-Registrable Galvanised trailer with mudguards
- 50mm tow hitch and Jockey wheel
- Screw down lid with breather and strainer basket for leaves and other debris
- ADR approved LED Tail lights & brake system



STF1000D-1-BLV*

CODE	DESCRIPTION	LENGTH	WIDTH	HEIGHT	WT	LIST EX	LIST INC	CAT
STF800S-1*	On-Farm 800L Fire Fighter	3000mm	1400mm	1500mm	280 kg	\$5,199.09	\$5,719.00	9
STF1000D-1-BLV*	On-Road 1100L Fire Fighter	3500mm	2000mm	1500mm	440 kg	\$9,636.36	\$10,600.00	9

* Important: Additional freight charges may apply. For further information contact customer service.

Warning: Refer to vehicle or tractor manufacturer's instructions for appropriate load & towing limits & fitting positions.



FIRE FIGHTING HOSE REEL

- Powder coated metal construction
- Fitted with 30 metres of 3/4" delivery hose
- Adjustable poly nozzle
- Supplied with mounting brackets to suit SquatPak tanks - 400,600 & 800 Litre

180F03019E

WATER & DIESEL HEAVY DUTY HOSE REEL

This versatile hose reel is a great addition to fire fighters or diesel units where extra hose is required.

- Inlet 3/4" BSP/outlet tapered hose tail
- 30m of 3/4" I.D. hose
- Manual rewind reel with hose guide rollers and stopper

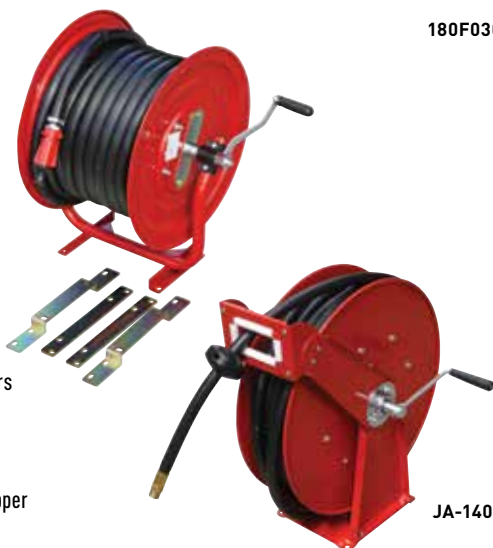

JA-1402020

QUICK FILL SUCTION KIT

When fitted to a fire fighting pump, this quick fill option allows alternative water sources such as dams and tanks to be utilised.

- 3-way valve and 6 metres of quality 38mm I.D. suction hose with foot filter
- Honda Davey pump max. lift 6m
- Selecta Power pump max. lift 3.5m

Note: Pump suction lift ability may vary.

SQF-DAMKIT

DRAWING
10101



CODE	HOSE I.D.	HOSE LENGTH	MAX PRESSURE	LIST EX	LIST INC	CAT
180F03019E	19mm	30 metres	9 Bar/131 psi	\$685.45	\$754.00	A
JA-1402020	19mm	30 metres	17 Bar/247 psi	\$617.27	\$679.00	A
SQF-DAMKIT	38mm	6 metres		\$362.73	\$399.00	A

Fire Fighters



SQF400B



SQF600B



400L, 600L & 800 LITRE BARE DIY FIRE FIGHTING TANKS

The Selecta Fire Fighting SquatPak tanks are fitted with a base plate and are Baffled to reduce surge when travelling. Suction fittings are provided to mount various pump & hose combinations.



SQF800B



FIRE FIGHTING NOZZLE - 422-502

- High density plastic outer and inner body
- Adjustable spray from straight to conical pattern
- 3/4" BSP female thread



422-502



410-40

FIRE FIGHTING PISTOL - 410-40

- Brass body covered by a shockproof plastic housings and fitted with 3 shockproof rings
- Ideal for firefighting or wash down
- Maximum pressure 24 BAR, maximum output 60 L/min
- Pull trigger to vary flow from cone to straight stream
- Threads 1/2" standard female BSP

631849

RAKHO - FIRE FIGHTING

- An essential implement for country fire fighters and farmers
- Designed for raking combustible debris, chopping fire breaks and scraping back bark from trees



CODE	DESCRIPTION	LIST EX	LIST INC	CAT		
SQF400B	400L Tank, Base Plate & Suction Hose	\$963.64	\$1,060.00	A		
SQF600B	600L Tank, Base Plate & Suction Hose	\$1,081.82	\$1,190.00	A		
SQF800B	800L Tank, Base Plate & Suction Hose	\$1,536.36	\$1,690.00	A		
CODE	DESCRIPTION	MAX PRESSURE	THREAD SIZE	LIST EX	LIST INC	CAT
422-502	Fire Fighting Nozzle	92 Bar/200 psi	3/4" female (BSP)	\$60.00	\$66.00	B
G8001203	3/4" Hosetail (Poly) O.D.	92 Bar/200 psi	3/4" male	\$6.45	\$7.10	B
G8001205	1" Hosetail (Poly) O.D.	92 Bar/200 psi	3/4" male	\$6.55	\$7.20	B
410-40	Fire Fighting Pistol	160 Bar/348 psi	1/2" female	\$193.64	\$213.00	B
631849	Rakho 275 x 225mm Blade/ Long Timber Handle			\$100.91	\$111.00	B



FIRE FIGHTER KNAPSACK 20 LITRE

Ideal for ember suppression, spot fires and burn-off management.

- Robust double-action hand pump, meets the requirements of AS1687
- Adjustable nozzle supports targeted distance spraying and closer broader ember suppression
- Left or right handed operation
- Gun holder for storage
- Suction filter

Note: For use with water only. Not suitable for chemical application.



KN20F-1

CODE	DESCRIPTION	LENGTH	WIDTH	HEIGHT	WT	LIST EX	LIST INC	CAT
KN20F-1	20L Knapsack Fire Fighter	160mm	350mm	520mm	3.5 kg	\$144.55	\$159.00	A

Pumps, Valves Controllers, Tanks & Hoses



Silvan

**GENUINE
ACCESSORIES**

Silvan

Silvan Diaphragm Pumps

Tough, reliable and no risk of damage if run dry!

VISUAL OIL LEVEL
SITE GLASS

AIR PRESSURE
CHAMBER

MANIFOLD PARTS IN
CONTACT WITH LIQUID
ARE MADE IN PLASTIC
MATERIAL

STRONG ALUMINIUM
CRANKCASE

CHEMICAL RESISTANT OIL
BACKED DIAPHRAGMS

METAL 1 $\frac{3}{8}$ " SHAFT
SUIT PTO, ENGINES AND
HYDRAULIC MOTORS

METAL MOUNTING FEET

BP SERIES

All Silvan diaphragm pumps are built for 540 RPM operation, are Self-priming and designed so no special tools are required for service. Tough and reliable they will run dry without risk of damage. All pumps are supplied with appropriate hose connections, mounting base plates and 1 3/8" six splined shaft. Some models are available with keyed shaft.

†All pumps are supplied, ready to use with 40/20 motor oil in the Crankcase.

BP20/15

Diaphragms: 2

Output @ 540 RPM: 19 L/min

HP required at max. pressure: 0.83

L x W x H (mm): 224 x 260 x 174

Weight (kg): 7.3

CONTROL VALVE TO SUIT

Attached (2 outlet)

Code: **C1204-528**



CBP02015

DRAWING
10573

BP60/20

Diaphragms: 2

Output @ 540 RPM: 58 L/min

HP required at max. pressure: 3.3

L x W x H (mm): 258 x 276 x 280

Weight (kg): 10.0

CONTROL VALVE TO SUIT

Attached (2 outlet)

Code: **C1204-528**

Remote mount (3 outlet)

Code: **C1204-034R**

Remote mount (4 outlet)

Code: **C1204-332**



CBP06020

DRAWING
10576

BP75/15

Diaphragms: 3

Output @ 540 RPM: 67 L/min

Max pressures 20 Bar/290psi

HP required at max. pressure: 3.5HP

L x W x H (mm): 271 x 276 x 278

Weight (kg): 12.3

CONTROL VALVE TO SUIT

Attached (2 outlet)

Code: **C1204-528**

Remote mount (3 outlet)

Code: **C1204-034R**

Remote mount (4 outlet)

Code: **C1204-332**



CBP07015

DRAWING
10580

CODE	PUMP	MAX PRESSURE	LIST EX	LIST INC	CAT
CBP02015	BP20/15	15 Bar/218 psi	\$908.18	\$999.00	A
CBP06020	BP60/20	20 Bar/290 psi	\$918.18	\$1,010.00	A
CBP07015	BP75/20	20 Bar/290 psi	\$1,362.73	\$1,499.00	A

BP110/20

Diaphragms: 3

Output @ 540 RPM: 110 L/min

Max pressures 20 Bar/290psi

HP required at max. pressure: 6.5HP

L x W x H (mm): 275 x 283 x 242

Weight (kg): 12.3

CONTROL VALVE TO SUIT

Attached (3 outlet)

Code: **C1204-034R**

Remote mount (4 outlet)

Code: **C1204-332**



CBP11020

DRAWING
10580

BP125/20

Diaphragms: 3

Output @ 540 RPM: 121 L/min

HP required at max. pressure: 6.8HP

L x W x H (mm): 293 x 317 x 265

Weight (kg): 12.3

CONTROL VALVE TO SUIT

Attached (3 outlet)

Code: **C1204-191**

Remote mount (4 outlet)

Code: **C1204-332**



CBP12520

DRAWING
10580

CODE	PUMP	MAX PRESSURE	LIST EX	LIST INC	CAT
CBP11020	BP110/20	20 Bar/290 psi	\$1,018.18	\$1,120.00	A
CBP12520	BP125/20	20 Bar/290 psi	\$1,399.09	\$1,539.00	A

FERRONI NYLON ROLLER PUMP

These compact self-priming pumps can be quickly fitted direct to the PTO of any 540 RPM tractor to meet your spraying or transfer needs.

- Max pressure 25 bar or 180L/min
- Absorbed power 5.5HP @ 600 RPM
- Brass pressure Regulator
- Cast iron* housing
- Rotor with nylon† rollers
- PTO Drive rotates in a clockwise direction only
- Includes hose connectors and chain for rigid fastening to the tractor



ML125

DRAWING
0112

† Nylon not suitable for abrasive products i.e. wettable powders.

*Cast iron not suitable with corrosive chemicals.

WARNING: Do not operate pumps without appropriate safety guards fitted.

CODE	OPEN FLOW	INLET	OUTLET	LENGTH	WIDTH	HEIGHT	WT	LIST EX	LIST INC	CAT
ML125	180 L/min	30mm	19mm	220mm	190mm	250mm	11 kg	\$574.55	\$632.00	A
357-0501	Service Kit To Suit Nylon Roller Pumps							\$98.18	\$108.00	B

Pumps, Controllers, Valves, Tanks and Hoses

Silvan control valves regulate spray pressure, direct the flow of spray liquid from the pump to the spray nozzles and bypass excess liquid back to the tank, in most cases through an agitator.

All feature adjustable pressure regulator, glycerine filled gauge, hose connections, mounting kits where applicable, on/off directional valves and bypass lock position.

3 OUTLET ON/OFF CONTROL VALVE

3 outlet control, pressure regulator, bypass valve, gauge. Features quick action on/off ball valves



C1204-191

DRAWING
10624

2 OUTLET ON/OFF CONTROL VALVE

2 outlet control, pressure regulator, bypass valve, gauge



C1204-528

DRAWING
10112

3 OUTLET

3 outlet control, pressure regulator, bypass valve, gauge. Manufactured from Rilsan Plastic. Controls include remote mount kit (C5004-05)



C1204-034R

DRAWING
10117

4 OUTLET

One lever 4 outlet control shuts all boom sections off by simply flicking main lever to one side, standard with dual stage gauge. Supplied with remote bracket kit (C5004-05)



C1204-332

DRAWING
10171

CODE (ATTACHED)	CONTROL VALVE	PUMP APP	HOSE INLET	SIZE OUTLET	BYPASS HOSE	MAX. PRESS.	MAX. FLOW	LIST EX	LIST INC	CAT
C1204-528	2 Outlet	BP20/15	19mm	13mm	13mm	14 Bar/218 psi	40L/min	\$184.55	\$203.00	B
C1204-457	2 Outlet	APS41	19mm	10mm	13mm	40 Bar/580 psi	40L/min	\$196.36	\$216.00	B
C1204-191	3 Outlet	BP60/20, BP125/20	19mm	10mm	23mm	20 Bar/290 psi	100L/min	\$362.73	\$399.00	B
CODE (REMOTE)	CONTROL VALVE	PUMP APP	HOSE INLET	SIZE OUTLET	BYPASS HOSE	MAX. PRESS.	MAX. FLOW	LIST EX	LIST INC	CAT
C1204-034R	3 Outlet	BP60/20	19mm	13mm	23mm	20 Bar/290 psi	60L/min	\$434.55	\$478.00	B
C1204-332	4 Outlet	BP60/20, BP125/20	19mm	13mm	23mm	20 Bar/290 psi	150L/min	\$700.00	\$770.00	B
SERVICE KITS										
C5004-05	Remote Control Mounting Kit							\$51.82	\$57.00	B
CSN5	Service Kit to Suit 2 Outlet Control Valve (C1204-528)							\$65.45	\$72.00	B
CSN2	Service Kit to Suit 3 Outlet Control Valve (C1204-191, C1204-195)							\$90.91	\$100.00	B
CSN3	Service Kit to Suit 3 Outlet Control Valve (C1204-034R)							\$60.91	\$67.00	B
CSN1	Service Kit to Suit 4 Outlet Control Valve (C1204-332)							\$119.09	\$131.00	B

Silvan motorised pumping units provide a go-anywhere pressure pumping unit in a wide range of sizes and capacities. Each unit consists of a matched engine and pump, control valve, base plate, hose connections and in most cases pressure gauge as standard equipment.

MC20/20 MOTORISED UNIT

- Pressure accumulator with pressure gauge
- Honda engine GX120
- Oil backed diaphragm pump
- Direct coupled to motor
- Adjustable pressure regulator
- Inlet size: 19mm; Outlet size: 10mm
- 1 metre maximum suction lift



LBA-34C

DRAWING
10112

BP60/20 MOTORISED UNIT

- Pressure accumulator with pressure gauge
- Honda engine GX160
- Oil backed diaphragm pump
- Direct coupled to motor
- Adjustable pressure regulator
- 1 metre maximum suction lift
- Inlet size: 25mm; Outlet size: 12mm



LBA-38C

DRAWING
10672

APS41 MOTORISED UNIT

- Pressure accumulator with pressure gauge
- Honda engine GX160
- Oil backed diaphragm pump
- Direct coupled to motor
- Adjustable pressure regulator
- 1 metre maximum suction lift
- Inlet size: 25mm; Outlet size: 12mm
- Replacement pump code: **CAPS41**



LBA-42C

DRAWING
10677

CODE	MAX PRESSURE	MAXIMUM OUTPUT	OUTLETS	LENGTH	WIDTH	HEIGHT	WT	LIST EX	LIST INC	CAT
LBA-34C	20 Bar/290 psi	18.5 L/min	1	540mm	340mm	360mm	12 kg	\$2,172.73	\$2,390.00	A
LBA-38C	20 Bar/290 psi	58 L/min	3	720mm	425mm	470mm	24 kg	\$2,926.36	\$3,219.00	A
LBA-42C	40 Bar/580 psi	38 L/min	2	550mm	430mm	410mm	29 kg	\$2,872.73	\$3,160.00	A

PUMP SERVICE KITS

Our service kits have everything you need to service your pump or control valve in one convenient package, making regular maintenance or running repairs much more simple. Silvan all-in-one service kits are the most economical way to purchase the individual parts required. They will also prove invaluable for those emergency on the spot repairs.



CODE	TO SUIT PUMP	MATERIAL	SHAFT	LIST EX	LIST INC	CAT
CSK2015	BP20/15	NBR	SPLINED	\$120.91	\$133.00	B
C5026-245	APS41	NBR	SPLINED	\$162.73	\$179.00	B
C5026-215	P38 / P48	NBR	SPLINED	\$175.45	\$193.00	B
CSK6020S	BP60/20	NBR	SPLINED	\$147.27	\$162.00	B
CSK6020K	BP60/20	NBR	KEYED	\$152.73	\$168.00	B
C5026-197	BP60/20 (D)	DESMOPAN	SPLINED	\$175.45	\$193.00	B
C5026-198	BP60/20 (V)	VITON	SPLINED	\$380.00	\$418.00	B
C5026-314	BP75/20	NBR	SPLINED	\$130.00	\$143.00	B
C5026-374**	BP110/20	NBR	SPLINED	\$230.30	\$253.33	B
CSK10520S	BP105/20, BP125/20S	NBR	SPLINED	\$172.73	\$190.00	B
C5026-199	BP105/20, BP125/20K	NBR	KEYED	\$172.73	\$190.00	B
C5026-375**	BP135/20	NBR	SPLINED	\$275.90	\$303.49	B
C5026-205	BP151/20	NBR	SPLINED/30mm KEYED	\$138.18	\$152.00	B
CSKAPS71	APS71	NBR	SPLINED	\$200.00	\$220.00	B
C5026-228	APS96	NBR	SPLINED	\$258.18	\$284.00	B
CSKAPS121	APS121	NBR	SPLINED	\$258.18	\$284.00	B
C5026-222	APS145	NBR	SPLINED	\$274.55	\$302.01	B
C5026-224	APS166 APS141	NBR	SPLINED	\$311.82	\$343.00	B
C5026-346*	IDS960	NBR	SPLINED	\$94.55	\$104.10	B
C5026-278*	IDS140	NBR	SPLINED	\$108.30	\$119.13	B
C5026-279*	IDS1701, IDS2001	NBR	SPLINED	\$280.00	\$308.00	B
C5026-208	IDS2200/2600	NBR	SPLINED	\$424.55	\$467.01	B
C5026-207	MC19/20** 20/20	NBR	KEYED	\$57.27	\$63.00	B
CSKMP40	CMP40	NBR	SPLINED	\$280.00	\$308.00	B

D = Desmopan diaphragms (long lasting); S = Splined model pump; K = Keyed model pump;
V = Viton diaphragms (longest lasting); NBR = Nitrile / Buna rubber

*Service kits include valve assemblies, accumulator diaphragm, piston diaphragms only.

**Service kits include valve assemblies, piston diaphragm, viewer gasket, manifold O'rings and outlet tail only.

Silvan 12V Diaphragm Pumps

Tough and reliable they will run dry without risk of damage.



**CORROSION
RESISTANT COATING**

**TWIN BEARING
DRIVELINE FOR SUPERIOR
LONGEVITY**

EASY 12V POWERED

COMMON BASEPLATE

**EXTRA THICK HOUSING
FOR HIGHER PRESSURES**

**ON DEMAND SWITCH
STOPS PUMP WHEN
FLOW STOPS**

**VITON VALVES FOR BROAD
CHEMICAL RESISTANCE**

Selected Smoothflo products with:

Constant Flow Technology
NO PULSATION!

Smoothflo is an anti-pulsation system that maintains stronger flow at higher pressures with no pulsation



DDP-554

Aquatec pumps are made of the highest quality and are exclusive to Silvan. Aquatec are a leading American manufacturer of pumps which are of proven durability with minimal maintenance. Constant Flow Technology provides consistent spraying without pulsation.

AQUATEC SMOOTHFLO 12V PUMP

- Smooth flow and even pressure
- 7 L/min or 120 psi max.
- Pump adapts to changes in output volume to maintain higher flows under increasing pressure
- Fitted with on/off demand pressure sensing switch

RETROFITS TO MOST BRANDS OF SPRAYERS



DDP-552A
(9 AMPS)

DRAWING
10783



Scan here to see the Smoothflo in action!

AQUATEC HIGH CAPACITY 12V PUMP

Used where higher volume is required such as boomless nozzle spraying and larger boom spraying.

- 20 L/min open flow
- Supplied with 5D connections: 2 x 1/2" and 2 x 3/4"
- Rated for continuous duty for pressures up to 40 psi, above 40 psi it has an intermittent duty rating
- Fitted with ON/OFF demand pressure sensing switch



DDP-550
(18 AMPS MAX.)

DRAWING
10723

CODE	OPEN FLOW	MAX PRESSURE	VALVES MAT.	DIAPHRAGM MATERIAL	DUTY RATING	PORT SIZE/TYPE	LIST EX	LIST INC	CAT
DDP-552A	7 L/min	8 Bar/120 psi	Viton	Santo	-	3/8" BSP Female	\$199.09	\$219.00	A
DDP-550	20 L/min	4 Bar/60 psi	Viton	Santo	Continuous to 40 psi	5D Quick Connection	\$375.45	\$413.00	A



DDP-555

AQUATEC HIGH CAPACITY 12V PUMP

- 26.5 L/Min capacity (open flow)
- Viton valves and a Santoprene diaphragm
- Supplied with 5D connections: 2 x 1/2" and 2 x 3/4"



DDP-551
(22.4 AMPS MAX.)

DRAWING
10093

AQUATEC HIGH PRESSURE 12V PUMP

- Smooth flow and even pressure
- 5 L/Min capacity (open flow)
- Viton valves and a Santoprene diaphragm



DDP-554
(16 AMPS)



AQUATEC MEDIUM CAPACITY 12V PUMP

- Mid Capacity pump is suitable for small and medium booms, high volume spot spraying and transfer applications.
- 14.0L/min or 4 Bar/60psi max
- Supplied with 5D connections: 2x12mm tails and 2 x 1/2" BSP
- Fitted with ON/OFF demand pressure sensing switch



DDP-555
(11 AMPS)



CODE	OPEN FLOW	MAX PRESSURE	VALVES MAT.	DIAPHRAGM MATERIAL	DUTY RATING	PORT SIZE/TYPE	LIST EX	LIST INC	CAT
DDP-551	26.5 L/min	4 Bar/60 psi	EPDM	Santo	Continuous to 10 psi	5D Quick Connection	\$614.55	\$676.00	A
DDP-554	5 L/min	13 Bar/200 psi	EPDM	Santo	-	3/8" BSP Female	\$326.36	\$359.00	A
DDP-555	14.0L/min	4 Bar/60 psi	Viton	Santo	Continuous to 40 psi		\$244.55	\$269.00	A

Selecta 12V Pak Pumps are high quality positive displacement diaphragm pumps that can run dry without damage. All pumps feature an on/off demand pressure switch with standard BSP thread connections or hose barbs.

12V SILVAN PAK PUMPS

Ideal for spot spraying applications where a single nozzle is used.

- 2.6 L/min open flow
- 381-35 with male threaded connectors to suit Redline 25L and 55L spray tanks
- 381-38 with 8mm barb inlet/outlet



381-35
(1.6 AMPS)



381-38
(1.7 AMPS)

12V SILVAN PAK PUMP (381-2000)

The 381-2000 is the ideal mid-range pump for spot spraying applications or small boom spraying.

- 5.3 L/min open flow
- 7.3 Amps



381-2000
(7.3 AMPS)

DRAWING
10711

12V SILVAN PAK PUMP (381-125)

This larger flow rate pump is ideal for boom spraying or fluid transfer applications.

- 12.5 L/min open flow
- Supplied with filter as pictured
- 7.0 Amps



381-125*
(7.0 AMPS)

DRAWING
10292

CODE	MAX PRESSURE	VALVES MAT.	DIAPHRAGM MATERIAL	PRESS. SWITCH	DUTY RATING	PORT SIZE/TYPE	LIST EX	LIST INC	CAT
381-35	3.5 Bar/50 psi	Viton	TPU	Yes	Intermittent	Threaded Male	\$71.81	\$79.00	A
381-38	4 Bar/60 psi	Viton	TPU	Yes	Intermittent	8mm tail	\$102.73	\$113.00	A
381-2000	4 Bar/60 psi	Viton	Santo	Yes	Continuous	3/8" BSP F	\$162.73	\$179.00	A
381-125*	3 Bar/50 psi	Viton	TPU	Yes	Intermittent	12.5mm tail	\$165.45	\$182.00	A
381-125-05	Replacement quick connect filter to suit 381-125 Pak Pump (shown attached)						\$11.82	\$13.00	B

* Supplied standard with filter (as pictured)

SLV SERIES 12V DC PUMP

- 3.8 L/min open flow



361-SLV10-AA40;
(1.9 AMPS)

8000 SERIES 12V DC PUMP

There are two 8000 series Shurflo pumps available, ranging from 4.5L/min to 6.8L/min open flow and to max. pressure 4 Bar/60psi. A versatile pump ideal for agricultural and industrial applications. Full Viton equipped pump available (361-8000-342-136).



361-8000;
(7.3 AMPS)

2088 SERIES 12V DC PUMP

The 2088 series diaphragm pump is an ideal choice for higher flow applications such as boom spraying and fluid transfer.



361-2088;
(8.0 AMPS)

FIN COOLED 12V DC PUMP

Ideal for larger duty cycle application, aluminium heat sink crankcase design dissipates heat build up from electric motor. Capacity 13.6L/min open flow, max. pressure 3 Bar/45psi. On/off demand pressure switch, 1/2" Male ports, Viton valves, Santoprene diaphragm.



361-2088-313-145;
(10.1 AMPS)

24V DC PUMP

Available in 11.3L/min, 3 Bar/45psi open flow with on/off demand pressure switch. Compact size 1/2" BSP male ports. Suited to machines fitted with 24V DC system eg. bulldozers, trucks and road sweepers.



361-2088-474-144;
(2.5 AMPS @ 24V DC)

CODE	OPEN FLOW	MAX PRESSURE	VALVES MAT	DIAPH MAT	DUTY RATING	PORT SIZES	LIST EX	LIST INC	CAT
361-SLV10-AA40	3.8 L/min	2.6 Bar/40 psi	Viton	Santo	Intermittent	3/8" Hose Barbs	\$157.27	\$173.00	A
361-8000	6.8 L/min	4 Bar/60 psi	Viton	Santo	Continuous	1/2" BSP Male	\$208.18	\$229.00	A
361-8000-342-136	4.5 L/min	4 Bar/60 psi	Viton	Viton	Continuous	1/2" BSP Male	\$513.64	\$565.00	A
361-2088	11.3 L/min	3 Bar/45 psi	Viton	Santo	Intermittent	1/2" BSP Male	\$290.00	\$319.00	A
361-2088-313-145	13.6 L/min	3 Bar/45 psi	Viton	Santo	Continuous	1/2" BSP Male	\$551.82	\$607.00	A
361-2088-474-144	11.3 L/min	3 Bar/45 psi	Santo	Santo	Intermittent	1/2" BSP Male	\$470.00	\$517.00	A

12V DIAPHRAGM PUMP SPARE PARTS

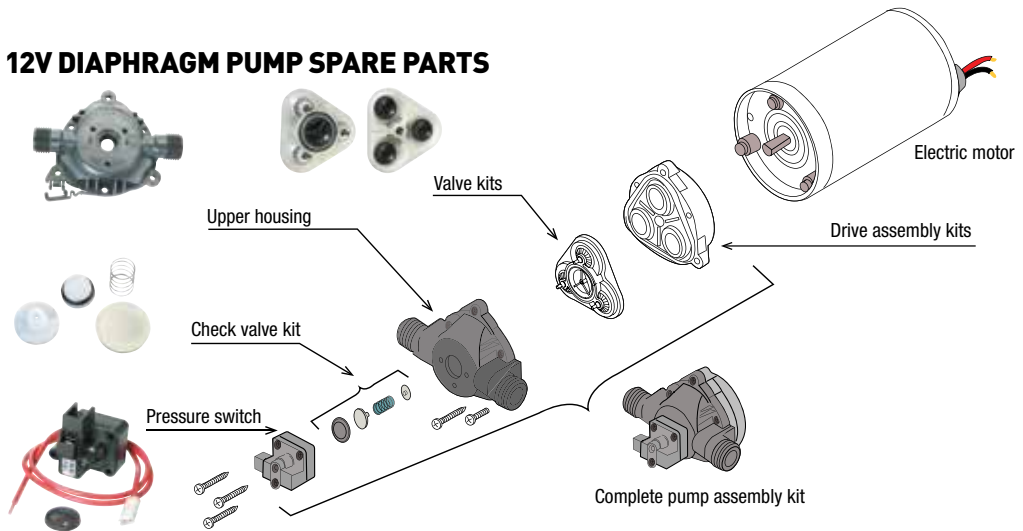

PRESSURE SWITCHES

CODE	SUITS PUMPS	MAX PRESSURE	LIST EX	LIST INC	CAT
361-94-375-05	8000 Series With Viton Dphm	60 psi	\$114.55	\$126.00	B
361-94-375-06	8000 Series With Santo Dphm*	60 psi	\$93.64	\$103.00	B
361-94-375-18	8002 Series With Santo Dphm	100 psi	\$106.36	\$117.00	B
361-94-229-03	8090 Series With Viton Dphm	60 psi	\$121.82	\$134.00	B
361-94-229-05	8090 Series With Viton Dphm	100 psi	\$145.45	\$160.00	B
361-94-230-35	2088 Series With Santo Dphm*	45 psi	\$95.45	\$105.00	B
361-94-230-36	2088 Series With Viton Dphm	45 psi	\$125.45	\$138.00	B
361-94-230-55	2088 Series Fin Cooled	45 psi	\$169.09	\$186.00	B
381-2000-03	381-2000 (Excludes Check Valve Kit)	60 psi	\$11.82	\$13.00	B
381-125-04	381-125	35 psi	\$24.55	\$27.00	B
5503-PSW	DDP-550	60 psi	\$50.00	\$55.00	B
5504-PSW	DDP-551	60 psi	\$50.00	\$55.00	B
5880-PSW	DDP-552A	120 psi	\$46.36	\$51.00	B

UPPER HOUSINGS

CODE	SUITS	LIST EX	LIST INC	CAT
361-94-378-00	8000 Series Pumps With 1/2" Male Ports	\$75.45	\$83.00	B
361-94-231-30	2088 Series Pumps With 1/2" Male Ports	\$58.18	\$64.00	B
361-94-231-05	2088 Series Pumps With 1/2" Male Ports And Viton Pressure Switch	\$210.00	\$231.00	B
5503-UHA	DDP-550 With 5D Quick Connectors (Inc Pressure Switch)	\$120.00	\$132.00	B
5504-UHA	DDP-551 With 5D Quick Connectors (Inc Pressure Switch)	\$120.00	\$132.00	B
5880-UHA	DDP-552A Series Pump With 3/8" Female BSP Ports	\$65.45	\$72.00	B

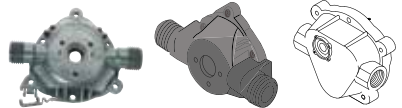

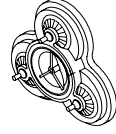

VALVE KITS

CODE	SUITS	LIST EX	LIST INC	CAT
361-94-390-05	8000 Series Pumps Viton Valve Kit (Blk)	\$173.64	\$191.00	B
361-94-232-05	2088 Series Pumps Viton Valve Kit	\$210.91	\$232.00	B
361-94-232-00	2088 Series Pumps Santo Valve Kit For 24V Model	\$73.64	\$81.00	B
5503-VHA	DDP-550 Viton Valve Kit	\$98.18	\$108.00	B
5504-VHA	DDP-551 EPDM Valve Kit	\$98.18	\$108.00	B
5880-VHA	DDP-552 Viton Valve Kit	\$57.27	\$63.00	B

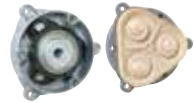

DRIVE ASSEMBLY KITS

CODE	SUITS	LIST EX	LIST INC	CAT
361-94-385-32	8000 Series Pumps With Santo Diaphragm 361-8000 (Pumps Made After March 1999)	\$196.36	\$216.00	B
361-94-238-04	2088 Series Pumps With Santo Diaphragm	\$133.64	\$147.00	B
361-94-238-03	2088 DHP with Santo Diaphragm	\$159.09	\$175.00	B
5503-LHA	DDP-550 with Santo Diaphragm	\$137.27	\$151.00	B
5504-LHA	DDP-551 with Santo Diaphragm	\$137.27	\$151.00	B
5880-LHA	DDP-552 with Santo Diaphragm	\$77.27	\$85.00	B



CHECK VALVE KIT

CODE	SUITS	LIST EX	LIST INC	CAT
361-94-374-16	8000 Series Pumps with EPDM Valve Kits	\$59.09	\$65.00	B
361-94-374-05	8000 Series Pumps with Viton Valve Kits	\$63.64	\$70.00	B
361-94-237-00	2088 Series Pumps with Santo Valve Kits	\$70.00	\$77.00	B
361-94-237-05	2088 Series Pumps with Viton Valve Kits	\$76.36	\$84.00	B

DIAPHRAGM KITS (BARE DIAPHRAGM TO SUIT CERTAIN MODELS)

CODE	SUITS	LIST EX	LIST INC	CAT
361-94-395-05	361-800-342-136 Viton-Viton Pump	\$209.09	\$230.00	B
361-94-395-06	361-8000	\$71.82	\$79.00	B
361-94-238-04	2088 Series Pumps with Santo Diaphragm	\$137.27	\$151.00	B
361-94-238-03	Obsolete DHP Model With Santo Diaphragm	\$163.64	\$180.00	B

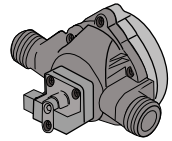

COMPLETE PUMP HEAD ASSEMBLY KITS

CODE	SUITS	LIST EX	LIST INC	CAT
381-2000-02	Suit 381-2000 Pak Pump	\$36.36	\$40.00	B

PUMP FITTINGS



CODE	REF	DESCRIPTION	LIST EX	LIST INC	CAT
361-8-071-00-PK	A	Hosetail 1/2" Female x 3/8" Barb (2 Pack)	\$14.09	\$15.50	B
361-8-070-01-PK	A	Hosetail 1/2" Female x 1/2" Barb (2 Pack)	\$14.09	\$15.50	B
361-8-034-PK	B	Elbow 1/2" Female Swivel x 1/2" Barb (2 Pack)	\$14.09	\$15.50	B
361-8-060-PK	B	Elbow 1/2" Female Swivel x 3/8" Barb (2 Pack)	\$14.09	\$15.50	B
361-8-145-01 †	C	Nipple 3/8" Male NPT x 1/2" NPT	\$4.27	\$4.70	B
320-60806	D	Elbow 3/8" Male BSP x 8mm Barb	\$3.73	\$4.10	B
361-255-613-PK	E	Inlet Filter 1/2" BSP, 50 Mesh, Viton o-ring	\$14.09	\$15.50	B

AQUATEC PUMP 5D FITTINGS



CODE	REF	DESCRIPTION	LIST EX	LIST INC	CAT
QBE-554	A	5D Elbow 1/2" Tail	\$13.64	\$15.00	A
QBE-555	A	5D Elbow 5/8" Tail	\$13.64	\$15.00	A
QBE-556	A	5D Elbow 3/4" Tail	\$13.64	\$15.00	A
QBS-554	B	5D Straight 1/2" Tail	\$13.64	\$15.00	A
QBS-555	B	5D Straight 5/8" Tail	\$4.27	\$4.70	A
QBS-556	B	5D Straight 3/4" Tail	\$3.73	\$4.10	A
9620522	C	5D Pressure Regulator	\$40.00	\$44.00	A

SPRAYER CONTROL BOXES AND VALVES

2 SECTION AND PRESSURE

- Control box
- 2 on/off section and master on/off
- Pressure adjustment
- No gauge
- Suitable for motor valves not solenoids
- Supplied with Power Loom and Tractor Loom



DRAWING
10186

G8406006

CODE	DESCRIPTION	LIST EX	LIST INC	CAT
G8406006	Control Box With Tractor Loom	\$289.09	\$318.00	B
GC00900008	3m Sprayer Loom	\$120.91	\$133.00	B
GC00900009	5m Sprayer Loom	\$146.36	\$161.00	B

3 SECTION ELECTRIC SOLENOID KIT – MEDIUM PRESSURE

M99-14

Suitable for most brands of 12 volt sprayers, motorised skid sprayers and linkage units with booms. Silvan medium pressure control kits are an effective way of controlling individual sections of your spray boom from the cab of a vehicle.

- Supplied with a multi section control box, mounting bracket and 5 metre electric wiring loom
- Master on/off switch to shut the entire boom off or switch individual sections off
- 3 x Goyen Solenoids, maximum operating pressure 10 bar/ 150psi
- Maximum open flow 65L/min per solenoid
- Extra components may be needed. Pressure regulator and hoses not included



CODE	DESCRIPTION	LIST EX	LIST INC	CAT
M99-14	3 Section Electric Solenoid Kit	\$630.00	\$693.00	A



HIGH PRESSURE ELECTRIC SOLENOID SYSTEM – CONTROLS UP TO FOUR SOLENOIDS

Simply order the control box, wiring harness and up to 4 high pressure solenoids to develop your own cab controlled independent spray boom system.

CONTROL BOX:

- With a 4 section switches, mounting bracket and 5 metre electric wiring loom
- Master on/off switch to shut the entire boom or switch individual sections on/off

Note: Can connect up to 4 solenoids sold separately.



G8406076

CODE	DESCRIPTION	LIST EX	LIST INC	CAT
G8406076	4 Section Control Box And Mounting Bracket	\$207.27	\$228.00	B

HIGH PRESSURE 12V SOLENOIDS:

- Geoline high pressure Brass Solenoid 1/2" F BSP ports
- Maximum open flow 80L/Min. per Solenoid
- Maximum pressure 40Bar/580psi

*Extra components may be needed.
Pressure regulator and hoses not included.*



GC00902021

G8388012

CODE	DESCRIPTION	LIST EX	LIST INC	CAT
GC00902021	4 Section Wiring Harness	\$188.18	\$207.00	B
G8388012	High Pressure Brass 40 Bar Solenoid	\$232.73	\$256.00	B

GOYEN ELECTRIC SOLENOID VALVE

Comprises a nylon body with either 1/2" x 1/2" barb, or 1/2" barb x 3/4" BSP thread, and is a servo-assisted solenoid.

- Ideal for fitting to single spray bars and features Viton diaphragms
- Requires 12V power and has pressure loss of 5psi across valve
- Max pressure 1000/145 kPa/psi

GOYEN SOLENOID
REPAIR KIT
042-1-047K



042-1-ST2-HR

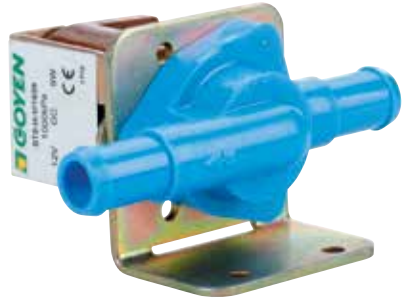

042-1-ST-HV



042-1-ST2-6R



042-1-ST2-6

CODE	FLOW	SIZE BSP	LENGTH	WIDTH	HEIGHT	WT	LIST EX	LIST INC	CAT
042-1-ST2-HR	65 L/min	1/2" X 1/2" Barbs	90mm	70mm	50mm	200 g	\$107.27	\$118.00	B
042-1-ST2-6R	65 L/min	1/2" Barb X 3/4" BSP	90mm	70mm	50mm	200 g	\$107.27	\$118.00	B
042-1-ST-HV	65 L/min	1/2" X 1/2" Barbs	90mm	70mm	50mm	200 g	\$107.27	\$118.00	B
042-1-ST2-6	65 L/min	1/2" Barb X 3/4" BSP	90mm	70mm	50mm	200 g	\$107.27	\$118.00	B
042-1-047K	Goyen Solenoid Repair Kit						\$96.36	\$106.00	B

8460 SERIES HIGH FLOW REGULATOR

- Made from nylon and aluminium,
- Gauge port 1/4"
- Excellent chemical resistance
- Chatter free, responsive pressure control
- Available with 3/4" connections
- Sturdy high flow regulator



23120 SERIES REGULATOR

- Nylon body
- Stainless steel spring
- Gauge port 1/4"
- Excellent chemical resistance
- Positive lock nut to hold adjuster at your desired setting
- Available with 1/2" or 3/4" connections



CODE	DESCRIPTION	MAX FLOW	MAX PRESSURE	LIST EX	LIST INC	CAT
8460-3/4	Pressure Regulator, 3/4"	265L/min	20 Bar/290 psi	\$153.64	\$169.00	B
23120-1/2-PP	Pressure Regulator, 1/2"	35L/min	7 Bar/102 psi	\$79.09	\$87.00	B
23120-3/4-PP	Pressure Regulator, 3/4"	55L/min	7 Bar/102 psi	\$79.09	\$87.00	B

FOAM MARKER/SPRAYER SOLENOID VALVE

Offers the advantages of low energy requirements, instant response and the ability to remain in an energised (open) state indefinitely without overheating or failing.

- Suits 12-volt and 24-volt. 3/4" threaded inlet and outlet



JA-1502003

CODE	DESCRIPTION	MAX PRESSURE	FLOW	LIST EX	LIST INC	CAT
JA-1502003	Solenoid Ideal For Foam Markers	8 Bar/116 psi	37L/min	\$38.18	\$42.00	B
JA-1502030	Replacement Viton Diaphragm			\$62.73	\$69.00	B
JA-1502031	Solenoid Viton	116 psi	37L/min	\$129.09	\$142.00	B

DIRECTOVALVE CONTROL VALVES

- Direct acting, large internal flow chamber without pilot hole reduces chance of clogging
- Corrosive resistant Stainless steel wetted parts
- Operation on 12V DC system
- Encapsulated solenoid coil can be changed without removing valve from system
- EPDM diaphragms and seat washer, Viton optional
- Continuous flow through bypass connection, with flow to spray line controlled by valve "on-off" action

AA144A-1



DIRECTOVALVE CONTROL VALVE

- 37.9 L/min flow with 0.35 bar pressure drop
- Can join with other 144A Directo Valve control valves
- 2.5 Amp current draw
- Polypropylene body for chemical resistance
- Fabric reinforced diaphragms

CODE	INLET SIZE	OUTLET SIZE	FLOW RATE	MAX PRESSURE	CURR. DRAW	LIST EX	LIST INC	CAT
AA144A-1	3/4"	1/2"	37.9 L/min	7 Bar/102 psi	2.5 Amp	\$360.91	\$397.00	B
AA144A-1-VI*	3/4"	1/2"	37.9 L/min	7 Bar/102 psi	2.5 Amp	\$415.45	\$457.00	B
PK-AB144A-1-KIT				Standard Service Kit to Suit Directo Valve Control Valve		\$62.73	\$69.00	B
PK-AB144A-1-VI-KIT				Viton Service Kit to Suit Directo Valve Control Valve		\$74.55	\$82.01	B

* Viton option

50, 100 & 200 LITRE SPOTPAK



430-50S
430-100S
430-200S

100 LITRE UTEPAK



430-0100AW
1 1/4" THREADED
OUTLET

*Ideal for pest control
Translucent tank*

200 LITRE TRUKPAK



430-0200AW
1 1/4"
THREADED
OUTLET

*Ideal for
pest control
Translucent tank*

70 LITRE RAKPAK PLUS



430-70N



100 LITRE UTEPAK



430-0100A
1 1/4" THREADED
OUTLET

200 LITRE TRUKPAK



430-0200A
1 1/4"
THREADED
OUTLET

300L BARREL TANK



430-300R

600 LITRE BARREL TANK



430-0600R
1 1/4"
THREADED
OUTLET

CODE	MOUNTING	LID DIAM	LENGTH	WIDTH	HEIGHT	WT	LIST EX	LIST INC	CAT
430-20S	20L SpotPak	110mm	550mm	280mm	250mm	3 kg	\$126.36	\$139.00	A
430-50S	50L SpotPak	175mm	700mm	420mm	300mm	5 kg	\$196.36	\$216.00	A
430-100S	100L SpotPak	175mm	800mm	475mm	395mm	9 kg	\$321.82	\$354.00	A
430-200S	200L SpotPak	175mm	1015mm	550mm	520mm	14 kg	\$428.18	\$471.00	A
430-70N**†	70L Bare RakPak Plus	175mm	800mm	850mm	290mm	7.5 kg	\$349.09	\$384.00	A
430-0100A*	100L UtePak	255mm	660mm	580mm	490mm	8 kg	\$410.00	\$451.00	A
430-0100AW*	100L UtePak White	255mm	660mm	580mm	490mm	8 kg	\$410.00	\$451.00	A
430-0200A*	200L TrukPak	255mm	1030mm	580mm	535mm	13 kg	\$463.64	\$510.00	A
430-0200AW*	200L TrukPak White	255mm	1030mm	580mm	535mm	13 kg	\$463.64	\$510.00	A
430-300R	300L Barrel Tank	255mm	945mm	600mm	820mm	16 kg	\$535.45	\$589.00	A
430-0600R	600L Barrel Tank	255mm	1300mm	800mm	850mm	32 kg	\$691.82	\$761.00	A

* Supplied with 8mm brass insert mountings in base. ** Supplied with tank straps. † Baffled tank

300 LITRE SQUATPAK



430-0300E



400 LITRE SQUATPAK



430-0400E



600 LITRE SQUATPAK



430-0600E

800 LITRE SQUATPAK



430-0800E

1100 LITRE FREESTANDING



430-1000U

2200 LITRE FREESTANDING



430-2200

OPTIONAL ACCESSORIES (TO SUIT 1100 L)



Long skid with space for pump & or reel (430-114)
Frame supplied with mounting pins.

CODE	MOUNTING	LID DIAM	LENGTH	WIDTH	HEIGHT	WT	LIST EX	LIST INC	CAT
430-0300E†	300L SquatPak	240mm	1060mm	900mm	530mm	23 kg	\$737.21	\$811.00	A
430-0400E†	400L SquatPak	240mm	1060mm	900mm	650mm	27 kg	\$791.82	\$871.00	A
430-0600E†	600L SquatPak	240mm	1830mm	940mm	570mm	43 kg	\$1,081.82	\$1,190.00	A
430-0800E†	800L SquatPak	240mm	1800mm	940mm	760mm	46 kg	\$1,245.45	\$1,370.00	A
430-1000U	1100L Freestanding Tank	455mm	1500mm	1180mm	900mm	45 kg	\$1,372.73	\$1,510.00	A
430-114	Long Skid to Suit 1100L	240mm	1860mm	1160mm	140mm	50 kg	\$880.91	\$969.00	A
430-2200	2200L Tank	455mm	1900mm	1380mm	1150mm	81 kg	\$2,372.73	\$2,610.00	A
033-999-KIT	Tank Bolt Down Mounting Brackets To Suit 1100L & 2200L Tanks						\$170.00	\$187.00	B

† Baffled tank

Selecta Polytuff Diesel Tanks are constructed for the toughest Australian conditions. Manufactured with a unique diesel-grade polyethylene that is UV stabilised and impact resistant. Each tank is a product of careful testing and manufacture to ensure a strong, durable and maintenance-free tank. A wide range of a freestanding Polytuff Diesel Tanks are available from 100L to 2200L.

200 LITRE LOW PROFILE DIESEL TANK

430-200H



400 LITRE DIESEL TANK



430-0400F



CODE	MOUNTING	LID DIAM	L	W	H	WT	LIST EX	LIST INC	CAT
430-200H***	200L Low Profile DieselPro/Power	100mm	1100mm	640mm	550mm	13 kg	\$561.82	\$618.00	A
430-0400F	400L DieselPak/Power	122mm	1060mm	900mm	650mm	32 kg	\$879.09	\$962.00	A

† Supplied with 8mm brass insert mountings in base. ** Supplied with lockable filling cap.

1100 LITRE DIESEL TANK



430-1000V

OPTIONAL ACCESSORIES



Selecta DieselPower 12V Pump Kit (PF48)



12/24V Panther Diesel Pump Kit (PF341090)



Puisi 10m Retractable Diesel Hose Reel (F00750030)



12V HI-FLOW Diesel Pump Kit (PF363260)

2200 LITRE DIESEL TANK



430-2200V



Long skid to suit 1100L with space for pump reel. Includes bolt down kit (430-114)

OPTIONAL ACCESSORIES



Tank bolt down Galvanised mounting brackets to suit 1100L tank (033-999-kit)

* Kit of 4 mounting brackets without skid to suit 1100L (enquire using code 033-999-KIT).

CODE	CAPACITY	LID DIAM	L	W	H	WT	LIST EX	LIST INC	CAT
430-1000V	1100L Diesel Tank	122mm	1500mm	1180mm	900mm	45 kg	\$1,600.00	\$1,760.00	A
430-114	Long Skid Suit 1100L Tank (Area For Mounting A Pump And/Or Hose Reel)		1860mm	1160mm	140mm	50 kg	\$880.91	\$969.00	A
430-2200V	2200L Diesel Tank	122mm	1900mm	1380mm	1150mm	81 kg	\$2,445.45	\$2,690.00	A
033-999-KIT	Tank Bolt Down Mounting Brackets To Suit 1100L & 2200L Tanks						\$170.00	\$187.00	B

Silvan hoses are manufactured from the highest quality materials and have been rigorously tested to ensure reliable performance and durability. Ideal for most agricultural applications. The Silvan range includes delivery hose, suction hose, bypass hose. Available in sizes from 8mm I.D to 50mm I.D with pressures ranging up to 4000KPa (560psi). A wide range of hose connectors, hose clamps and fittings to suit are readily available off the shelf. All hose dimensions are inside diameter. (I.D.).



12MM
186-12B-100

SMOOTHLINE DELIVERY TUBING

Lightweight rigid tubing hose for use in inaccessible terrain where risk of snagging hose is high. Maximum working pressure 1724 kPa (250psi). Requires special hose connectors.

CODE	HOSE I.D.	LIST EX	LIST INC	CAT
186-12B-100	1/2" O.D.	\$792.73	\$872.00	B
100 Metre Coil Length Only				

BYPASS HOSE

Low pressure flexible PVC hose ideally suited for the use on Bypass return lines of pumps. Maximum pressure 1379 kPa (200psi). (Available per metre).

CODE	HOSE I.D.	LIST EX	LIST INC	CAT
186-25E	25mm	\$32.73	\$36.00	B



25MM
186-25E

DIESEL DELIVERY HOSE

Quality delivery hose for all diesel applications (Available per metre).

CODE	HOSE I.D.	LIST EX	LIST INC	CAT
PF0225-33	19mm	\$15.45	\$17.00	B
186-25D	25mm	\$45.45	\$50.00	B



25MM
186-25D

SUCTION HOSE

Ideal for fitting on the inlet suction side of pumps. Wire reinforced construction helps guard against the hose collapsing. (Available per metre).

HOSE I.D.	12MM	19MM	25MM	32MM	38MM	50MM
CODE	186-12F	186-19F	186-25A	186-32A	186-38S	186-50S
LIST EX	\$13.64	\$10.91	\$16.36	\$26.36	\$26.36	\$35.45
LIST INC	\$15.00	\$12.00	\$18.00	\$29.00	\$29.00	\$39.00
CAT	B	B	B	B	B	B



25MM
186-25A

SILVAN AG DELIVERY HOSE

Flexible PVC reinforced spray hose. Maximum working pressure 690 kPa (100psi) for 186-8D and 2067 kPa (300psi) for all others.

20 METRE COIL LENGTHS

HOSE I.D.	8MM	10MM	12MM
CODE	186-8D-20	186-10D-20	186-12C-20
LIST EX	\$63.64	\$65.45	\$87.27
LIST INC	\$70.00	\$72.00	\$96.00
CAT	B	B	B

100 METRE COIL LENGTHS

HOSE I.D.	10MM	12MM
CODE	186-10D-100	186-12C-100
LIST EX	\$319.09	\$378.18
LIST INC	\$351.00	\$416.00
CAT	B	B

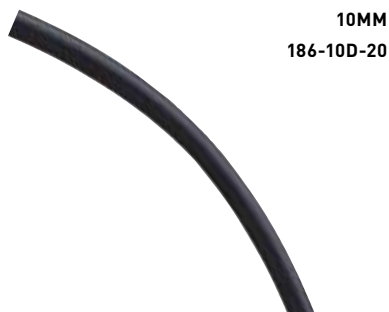

10MM
186-10D-20

FIRE FIGHTING HOSE

Designed to suit stationary or mobile reels on fire control units. Also popular in agricultural applications, manufactured to AS 1221. Lightweight PVC, resistant to U.V. light and the material has self extinguishing properties. Maximum pressure 900 kPa (131psi).

CODE	HOSE I.D.	LIST EX	LIST INC	CAT
186-19E-30	19mm	\$146.36	\$161.00	B

Available In 30 Metre Coil Lengths Only



19MM
186-19E-30

PROFESSIONAL DELIVERY HOSE

Flexible PVC reinforced spray hose ideally suited for high pressure applications. Maximum working pressure 4000kPa (568 psi).

CODE	HOSE I.D.	LIST EX	LIST INC	CAT
186-10M	10mm	\$9.09	\$10.00	B
186-12M	12mm	\$11.82	\$13.00	B
186-19M	19mm	\$20.00	\$22.00	B
186-25M	25mm	\$35.45	\$39.00	B

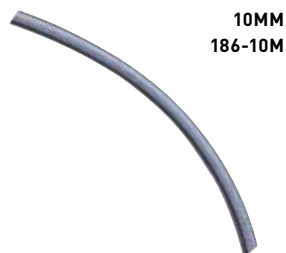

10MM
186-10M



Plumbing, Filtration, & Tank Accessories

Silvan

**GENUINE
ACCESSORIES**



FILTRATION

Efficient filtration is an important component of every sprayer and prevents blocked nozzles, reduce or inhibit pump wear and reduce down time and expense due to repairs. Selecta offers a choice of foot, suction, pressure line, nozzle and high volume irrigation filters to suit most applications.

GRADUATED OR PROGRESSIVE FILTRATION?

Filtration is ideally applied in stages, starting with a coarse mesh progressing to finer mesh sizes as liquid moves towards the spray tip. Filter mesh is described in terms of the number of wires per linear inch, which relates to the size of the apertures through which liquid passes. The larger the mesh number the smaller the aperture and the finer the filtration.

NOTE: images below are for illustrative purposes only.

COARSE FILTRATION

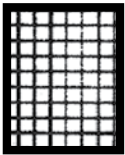

20 Mesh/inch
0.6mm Aperture

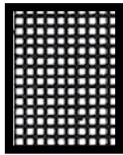

30 Mesh/inch
0.4mm Aperture

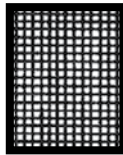

50 Mesh/inch
0.3mm Aperture

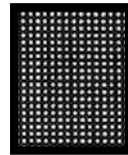

80 Mesh/inch
0.18mm Aperture

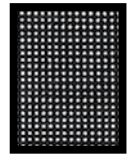

100 Mesh/inch
0.14mm Aperture

STAGES OF FILTRATION

STAGE A – INTO THE TANK

COARSE FILTRATION: Liquid passing into the tank is filtered by the foot filter or the lid basket strainer.

STAGE B – FROM TANK TO PUMP

COARSE/MEDIUM FILTRATION: Suction filters provide protection for the pump and screen out larger particles.

STAGE C – FROM PUMP TO SPRAYLINES

MEDIUM/FINE FILTRATION: Pressure line filters are used to remove finer particles before nozzle holders.

- Large pressure line/flushing filter is ideally fitted between pump and pressure regulator.
- Small pressure line filters are usually fitted in each boom section spray line.

STAGE D – SPRAY TIP FILTERS

FINE FILTRATION: Last stage of filtration before the spray tip, usually 50 mesh or finer.



A

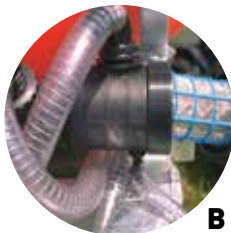

B



C



D

STAGE B SUCTION LINE FILTERS

Suction line filters provide filtration to remove larger particles of grit and are ideally mounted between the tank and pump. Featuring 8mm threaded brass inserts and mounting bolts for easy adaptation to frames and chassis etc. Screw off bowl for easy cleaning.

SAR2/V and SAR3/V models feature auto shut-off action valve which closes off the supply line while removing element for cleaning.

Supplied with mesh elements and replacement elements are available.



DRAWING
10650

LSA-310058



DRAWING
10115

LSA-312158



DRAWING
10795

LSA-314163



DRAWING
10810

LSA-316063



DRAWING
10111

LSA-314463



DRAWING
10811

LSA-316573

CODE	FILTER TYPE	MESH SIZE	FLOW L/MIN	PORT SIZE BSP	MOUNT INSERTS	WIDTH	HEIGHT	LIST EX	LIST INC	CAT
LSA-310058	SAR0	32	UP TO 60	1 1/4"	2	107mm	163mm	\$48.18	\$53.00	B
LSA-312158	SAR1	32	UP TO 100	1 1/4"	2	107mm	213mm	\$62.73	\$69.00	B
LSA-314163	SAR2	50	UP TO 160	1 1/2"	3	122mm	233mm	\$109.09	\$120.00	B
LSA-316063	SAR3	50	UP TO 180	1 1/2"	3	170mm	292mm	\$140.00	\$154.00	B
LSA-316173	SAR3	50	UP TO 220	2"	3	170mm	292mm	\$140.00	\$154.00	B
LSA-314463*	SAR2/V	50	UP TO 150	1 1/2"	3	140mm	260mm	\$134.55	\$148.00	B
LSA-314563*	SAR2/V	50	UP TO 150	1 1/2"	3	122mm	278mm	\$140.00	\$154.00	B
LSA-316573*	SAR3/V	50	UP TO 220	2"	3	170mm	329mm	\$166.36	\$183.00	B

*Include a shut off valve

MESH ELEMENTS – SUCTION LINE FILTERS

Efficient filtration is an important component of every sprayer. Effective filtration through the use of the correct suction filter/element will screen out any larger particles and provide protection for the pump.



GC00100021



GC00100012



GC00100008

"O" RINGS NOT INCLUDED

CODE	FILTER TYPE	MESH SIZE	NEW COLOUR	OLD COLOUR	WIDTH	HEIGHT	LIST EX	LIST INC	CAT
GC00100021	SAR1	50	BLUE	BLUE	70	150	\$38.18	\$42.00	B
GC00100012	SAR2/SAR2/V	50	BLUE	BLUE	80	165	\$53.64	\$59.00	B
GC00100008	SAR3/SAR3/V	32	RED	WHITE	107	200	\$65.45	\$72.00	B
GC00100009	SAR3/SAR3/V	50	BLUE	BLUE	107	200	\$65.45	\$72.00	B

HIGH VOLUME FILTER

Ideal for liquid storage tanks, irrigation or fertiliser systems. Filtering capacity up to 800 litres per minute. Built in flow deflector helps prevent cartridge clogging in the outlet area with sediment depositing at the base of the filter bowl allowing for easy cleaning through the drain plug. Features 1/4" BSP gauge ports on the inlet and outlet side. Maximum pressure 7.8 Bar (114 psi).



3352195

DRAWING
10743

CODE	FILTER TYPE	MESH SIZE	FLOW L/MIN	PORT SIZE BSP	WIDTH	HEIGHT	WT	LIST EX	LIST INC	CAT
3352195	335	120 S/Steel	Up to 800	3" Male	415mm	358mm	2.9 g	\$352.73	\$388.00	B

TeeJet

AAB122ML

STAGE B & C FILTRATION

IN-LINE TEEJET SUCTION PRESSURE FILTER 122 SERIES

Mountable design, 1/2" or 3/4" female BSPT nylon construction with stainless steel screen. Ideal for spot sprayers or small booms. Maximum pressure 10 BAR. This filter assembly is fully mountable with female brass threads moulded into its housing.



80#



100#

CODE	DESCRIPTION	MESH SIZE	MESH COLOUR	FLOW L/MIN	THREAD	LIST EX	LIST INC	CAT
AAB122ML-1/2-PP-50	Filter Assembly	50	BLUE	45	1/2"	\$37.27	\$41.00	B
AAB122ML-3/4-PP-50	Filter Assembly	50	BLUE	60	3/4"	\$37.27	\$41.00	B
AAB122ML-1/2-PP-80	Filter Assembly	80	YELLOW	45	1/2"	\$37.27	\$41.00	B
AAB122ML-3/4-PP-80	Filter Assembly	80	YELLOW	60	3/4"	\$37.27	\$41.00	B
AAB122ML-1/2-PP-100	Filter Assembly	100	GREEN	45	1/2"	\$37.27	\$41.00	B
AAB122ML-3/4-PP-100	Filter Assembly	100	GREEN	60	3/4"	\$37.27	\$41.00	B
CP45102-3-SSPP	Screen	50	BLUE	-	-	\$20.91	\$23.00	B
CP45102-4-SSPP	Screen	80	YELLOW	-	-	\$20.91	\$23.00	B
CP45102-5-SSPP	Screen	100	GREEN	-	-	\$20.91	\$23.00	B
CP23173-VI	Housing O-ring (viton)	-	-	-	-	\$27.27	\$30.00	B



IN-LINE TEEJET SUCTION PRESSURE FILTER 126ML SERIES

14 BAR/203psi pressure rating at 38°C 1 1/2"
BSPT female inlet/outlets, polypropylene construction,
high strength 1" bypass line on bowl.

Available with 30, 50, 80 or 100 stainless steel mesh.



AAB126ML-6-***



50# 80# 100# 120#

CODE	DESCRIPTION	MESH SIZE	MESH COLOUR	FLOW L/MIN	THREAD	LIST EX	LIST INC	CAT
AAB126ML-6-30	Filter Assembly	30	RED	291	1 1/2"	\$142.73	\$157.00	B
AAB126ML-6-50	Filter Assembly	50	BLUE	291	1 1/2"	\$142.73	\$157.00	B
AAB126ML-6-80	Filter Assembly	80	YELLOW	291	1 1/2"	\$142.73	\$157.00	B
AAB126ML-6-100	Filter Assembly	100	GREEN	291	1 1/2"	\$142.73	\$157.00	B
CP15941-1-SSPP	Filter Cartridge	16	BROWN RED	-	-	\$45.45	\$50.00	B
CP15941-2-SSPP	Filter Cartridge	30	RED	-	-	\$45.45	\$50.00	B
CP15941-3-SSPP	Filter Cartridge	50	BLUE	-	-	\$45.45	\$50.00	B
CP15941-4-SSPP	Filter Cartridge	80	YELLOW	-	-	\$45.45	\$50.00	B
CP15941-5-SSPP	Filter Cartridge	100	GREEN	-	-	\$45.45	\$50.00	B
CP15941-6-SSPP	Filter Cartridge	120	BROWN	-	-	\$45.45	\$50.00	B
CP48656-EPDM	Housing O-ring (EPDM)	-	-	-	-	\$12.73	\$14.00	B

IN-LINE TEEJET SUCTION PRESSURE FILTER 126ML SERIES

- 3/4" BSPT nylon construction, 87 L/min max flow
- Maximum pressure ratings 10 BAR/145psi
- Available with 16, 30, 50, 80 or 100 stainless steel mesh filters.



AAB126ML-3



50# 80# 100#

CODE	DESCRIPTION	MESH SIZE	MESH COLOUR	FLOW L/MIN	THREAD	LIST EX	LIST INC	CAT
AAB126ML-3	Housing Only	-	-	87	3/4"	\$40.91	\$45.00	B
CP16903-1-SSPP	Screen	16	BROWN RED	-	-	\$31.82	\$35.00	B
CP16903-3-SSPP	Screen	30	RED	-	-	\$31.82	\$35.00	B
CP16903-4-SSPP	Screen	50	BLUE	-	-	\$31.82	\$35.00	B
CP16903-5-SSPP	Screen	80	YELLOW	-	-	\$31.82	\$35.00	B
CP16903-6-SSPP	Screen	100	GREEN	-	-	\$31.82	\$35.00	B
CP50494-EPR	Housing O-ring (EPDM)	-	-	-	-	\$7.55	\$8.31	B



STAGE C FILTRATION PRESSURE LINE STRAINERS

Pressure line strainers are ideal for placing in hose lines between pump and spray lines for finer filtration. They remove fine particles preventing spray tip blockage or excessive wear. Polypropylene or brass construction, mesh element standard, twist-off bowl for easy cleaning. Some models feature a clean flushing tap. Pressures range from 1000 kPa (145 psi) to 5000 kPa (725 psi) maximum, flow from 70 to 150 L/min.



BRA-M147

DRAWING
10758



G8135002

DRAWING
10796



PLF-324024A

DRAWING
10201

CODE	MAX PRESS KPA/PSI	FLOW L/MIN	PORT SIZE BSP	MOUNT. INSERTS	WIDTH	HEIGHT	MAT	LIST EX	LIST INC	CAT
BRA-M147	5000/725	70L Max	1/2" F	-	90mm	155mm	BRASS	\$124.55	\$137.01	B
G8135002	5000/725	150L Max	3/4" F	2	100mm	240mm	POLY	\$160.91	\$177.00	B
PLF-324024A	1000/145	100L Max	1/2" F	2	97mm	134mm	POLY	\$65.45	\$72.00	B
PLF-324034A	1000/145	100L Max	3/4" F	2	97mm	134mm	POLY	\$65.45	\$72.00	B

MESH ELEMENTS – PRESSURE LINE STRAINERS

"O" RINGS NOT INCLUDED



REF: 2



REF: 3



REF: 4



REF: 5

CODE	REF	FILTER TYPE	MESH SIZE	NEW COLOUR	OLD COLOUR	WIDTH	HEIGHT	LIST EX	LIST INC	CAT
GC00100001	2	324	50	BLUE	BLUE	40mm	90mm	\$30.91	\$34.00	B
GC00100003	2	324	100	GREEN	RED	40mm	90mm	\$30.91	\$34.00	B
GC00100033	3	326	50	BLUE	BLUE	58mm	210mm	\$57.27	\$63.00	B
GC00100035	3	326	100	GREEN	RED	58mm	210mm	\$57.27	\$63.00	B
GC00100005	4	3244	50	BLUE	BLUE	38mm	125mm	\$30.91	\$34.00	B
GC00100007	4	3244	100	GREEN	RED	38mm	125mm	\$30.91	\$34.00	B
GC00100015	5	G8135	50	BLUE	BLUE	50mm	150mm	\$37.27	\$41.00	B
GC00100016	5	G8135	80	YELLOW	GREY	50mm	150mm	\$37.27	\$41.00	B



STAGE D FILTRATION

Nozzle or tip filters provide the final stage of filtration before the liquid is sprayed. They are available as standard or small cup type filters and fit most nozzle holders. Also available in anti-drip versions.

CUP STRAINERS

- Stainless steel construction
- Choice of 50 and 100 mesh screens



10 PACK

4067 SERIES

CODE	MESH SIZE	MESH SCREEN MATERIAL	TYPE	STRAINER BODY & CAP MATERIAL	LIST EX	LIST INC	CAT
PKT-4067-SS-50	50	Stainless Steel	CUP	Stainless Steel	\$36.36	\$40.00	B
PKT-4067-SS-100	100	Stainless Steel	CUP	Stainless Steel	\$36.36	\$40.00	B

POLY TIP STRAINERS

Tip strainers protect the spray tip orifice from clogging and damage. Stainless steel screens available in 50 and 100 mesh individually

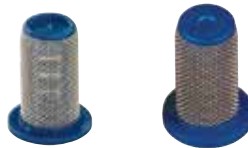

10 PACK

8079 SERIES

CODE	MESH SIZE	MESH SCREEN MATERIAL	TYPE	STRAINER BODY & CAP MATERIAL	LIST EX	LIST INC	CAT
PKT-8079-PP-50	50	Stainless Steel	Standard	Polypropylene	\$29.09	\$32.00	B
PKT-8079-PP-100	100	Stainless Steel	Standard	Polypropylene	\$29.09	\$32.00	B

TIP STRAINER WITH CHECK VALVE

Ideal for knapsacks and 12V sprayers by eliminating any excess drips. Fits all Silvan nozzle bodies.

- Ball check opens at 5psi (0.34 bar)
- Recommended for flow rates up to 3 L/min
- Available in 50 and 100 mesh screens

Note: Use of these ball check valves results in a pressure drop of 5psi (0.34 bar).



4193A SERIES

NOTE: CUT-AWAY PICTURE SHOWN FOR ILLUSTRATIVE PURPOSES ONLY

CODE	MESH SIZE	MESH SCREEN MATERIAL	TYPE	STRAINER BODY & CAP MATERIAL	LIST EX	LIST INC	CAT
4193A-10-50SS	50	Stainless Steel	Standard With Check Valve	Brass	\$10.91	\$12.00	B
4193A-PP-10-100SS	100	Stainless Steel	Standard With Check Valve	Polypropylene	\$8.18	\$9.00	B
4193A-PP-10-50SS	50	Stainless Steel	Standard With Check Valve	Polypropylene	\$8.18	\$9.00	B



BREATHER VALVES

1. Single breather valve with locking nut.
2. Single Labyrinth valve to suit Arag lids
3. Double one way spring valve to suit Geoline lids



CODE	REF	TYPE	DIAMETER		HEIGHT	LIST EX	LIST INC	CAT
			INSIDE	OUTSIDE				
G8208000	1	Single	35mm	55mm	80mm	\$16.36	\$18.00	B
3522000	2	Single	110mm	140mm	80mm	\$27.27	\$30.00	B
G8140002	3	Dual	120mm	140mm	75mm	\$31.82	\$35.00	B

STAGE A TANK LIDS

Silvan "Smooth-Line" lid assemblies are used extensively through out Australia. A wide range of sizes is available to suit many applications, eg. filling points, inspection hatches and man-holes used in agricultural water and chemical tanks.

Manufactured from high quality chemical resistant UV stabilised polypropylene for durability. Two start threads are convenient and larger screw type lids feature twist on/off centre cap, incorporating a double breather valve (single on smaller lids) for fast tank filling and quick emptying.

A. Male thread with breather

B. Male thread with breather

C. Female thread with breather

D. Female thread no breather



G8146002



G8158002



G8178001



354130

CODE	SIZE	DIAMETER		HEIGHT	LIST EX	LIST INC	CAT
		INSIDE	OUTSIDE				
A G8146002	255mm	210mm	250mm	31mm	\$36.36	\$40.00	B
B G8152002	355mm	313mm	355mm	29mm	\$45.45	\$50.00	B
B G8158002	455mm	408mm	450mm	23mm	\$54.55	\$60.00	B
C G8178001	170mm	150mm	170mm	56mm	\$21.82	\$24.00	B
D 354130	122mm	106mm	122mm	32mm	\$18.18	\$20.00	B

LID RINGS

Two start threads for secure, positive fastening and sealing. Suits male threaded lids.

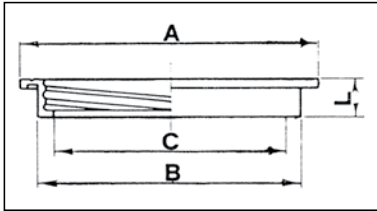

CODE	SIZE		DIAMETER		HEIGHT	LIST EX	LIST INC	CAT
	A	B	C					
G8148000	255mm	218mm	192mm		38mm	\$18.18	\$20.00	B
G8154000	355mm	320mm	290mm		38mm	\$21.82	\$24.00	B
G8160000	455mm	415mm	382mm		35mm	\$24.55	\$27.00	B

HINGE TYPE G8170015

Twin threaded lid with sealing gasket, breather valve and threaded ring



G8170015

CODE	SIZE	DIAMETER		HEIGHT	LIST EX	LIST INC	CAT
		INSIDE	OUTSIDE				
G8170015	455mm	415mm	457mm	22.5mm	\$97.27	\$107.00	B

LID STRAINERS

For prevention of large particles or debris entering tank



CODE	SIZE	MESH SIZE	DIAMETER		HEIGHT	LIST EX	LIST INC	CAT
			INSIDE	OUTSIDE				
G8147002	255mm	20mm	188mm	200mm	240mm	\$43.64	\$48.00	B
G8153001	355mm	20mm	286mm	300mm	254mm	\$57.27	\$63.00	B
G8159000	455mm	20mm	378mm	398mm	160mm	\$60.00	\$66.00	B

VALVES

Selecta offer a wide range of valves manufactured to high specifications with excellent resistance to agricultural chemicals with minimum flow restriction or pressure loss.

They feature BSP connections and quick turn on/off and are ideal for controlling boom lines, change of liquid directional flow, stop cocks or tank outlets.

BUTTERFLY VALVE – HIGH PRESSURE

Teflon seals, durable chrome coating, 90° on/off with female BSP connections



472-28B

IN LINE TAP

Designed for low pressure applications



320-TAP1

CODE	SIZE FEM BSPT	MAX PRESSURE	LENGTH	WIDTH	HEIGHT	LIST EX	LIST INC	CAT
472-22B	1/4"	50 Bar/725 psi	52mm	25mm	55mm	\$28.18	\$31.00	B
472-28B	1/2"	50 Bar/725 psi	52mm	32mm	60mm	\$30.00	\$33.00	B
CODE	SUIT I.D. HOSETAIL	MAXPRESSURE	LENGTH	WIDTH	HEIGHT	LIST EX	LIST INC	CAT
320-TAP1	1/2"	7 Bar/100 psi	74mm	28mm	49mm	\$8.64	\$9.50	B
320-TAP2	3/8"	7 Bar/100 psi	82mm	27mm	39mm	\$17.27	\$19.00	B

PRESSURE GAUGE

Ideal where exact measurements. Both standard and dual pressure gauges for high and low pressure readings. Feature a nominal size 63mm gauge, clear lens, glycerine filled, 1/4" BSP male thread in either bottom or back entry models.



1 BAR = 14.5 PSI

CODE	ENTRY TYPE	PRESSURE LIMITS	OPTIMUM OPERATING PRESSURE	LIST EX	LIST INC	CAT
C99-247*	Back	0-60 Bar	60 Bar	\$230.91	\$254.00	B
C99-248-PK†	Bottom	0/5/25 Bar	1-5 Bar	\$60.00	\$66.00	B
C99-249-PK†	Back	0/5/25 Bar	1-5 Bar	\$69.09	\$76.00	B
C99-205/30B	Bottom	0-60 Bar	30 Bar	\$48.18	\$53.00	B
C99-204	Back	0-60 Bar	30 Bar	\$48.18	\$53.00	B
G8302058	Bottom	0-80 Bar	40 Bar	\$45.45	\$50.00	B
C99-210/50B	Bottom	0-100 Bar	50 Bar	\$48.18	\$53.00	B

* 100mm face gauge model with 1/2 BSP connection † Dual Stage gauge model PK = Packaged

TANK KIT SIGHT GAUGE

Ideal for fitting to all types of tanks including poly, fibreglass or steel. Supplied in kit form and includes fittings which insert into tank wall, fluorescent sight ball and EPDM transparent PVC hose which makes gauging tank contents easy.

CODE	L SIZE (MM)	HOLE SIZE (MM) I.D.	LIST EX	LIST INC	CAT
BRA-1688041	1130	19	\$71.82	\$79.00	B

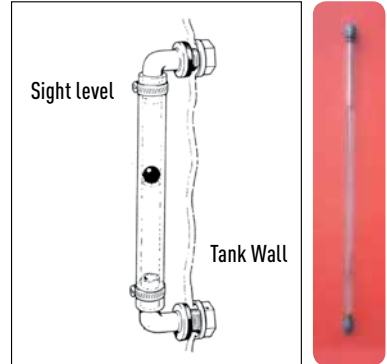

BRASS CONNECTORS & FITTINGS

Non-corrosive and chemical resistant, these brass fittings can be utilised in many applications where durability under high pressure and stress is essential.

BRASS HOSE CONNECTORS

Manufactured from high quality brass and can be used in conjunction with any BSP fittings



HOSE TAIL



CODE (2 PACK)	NO.	HOSE SIZE	LIST EX	LIST INC	CAT	CODE	THREAD SIZE BSP	TAIL SIZE	LIST EX	LIST INC	CAT	
NUT & TAIL	G8304004-PK	1	10	\$13.64	\$15.00	B	474-191	1/4" Male	3/8"	\$6.00	\$6.60	B
	G8304005-PK	1	12.5	\$13.64	\$15.00	B	474-200	1/4" Male	1/2"	\$6.09	\$6.70	B
NUT & ELBOW	G8304008	2	12.5	\$11.82	\$13.00	B	474-207	1/2" Male	1/2"	\$9.09	\$10.00	B
						474-209	1/2" Male	3/8"	\$11.82	\$13.00	B	

HOSE SNAP COUPLINGS

Ideal for quick disconnection of spray guns from hose reels featuring liquid shut-off. Manufactured from corrosion resistant materials.

- POLY - Maximum pressure 1450kPa (210psi)
- BRASS - Maximum pressure 3000kPa (435psi)



CODE	REF	COUPLING TYPE	MAT	CONNECT. SIZE	LIST EX	LIST INC	CAT
406-03-PK	1, 2	Complete Set	Poly	1/2" BSPT (M)	\$86.36	\$95.00	B
406-02-PK	3, 4	Complete Set	Brass	1/2" BSPT (M)	\$104.55	\$115.00	B
406-031	1	Male	Poly	1/2" BSPT (M)	\$14.55	\$16.00	B
406-032	2	Female	Poly	1/2" BSPT (M)	\$70.91	\$78.00	B
406-02M	3	Male	Brass	1/2" BSPT (M)	\$20.91	\$23.00	B
406-02F	4	Female	Brass	1/2" BSPT (M)	\$86.36	\$95.00	B

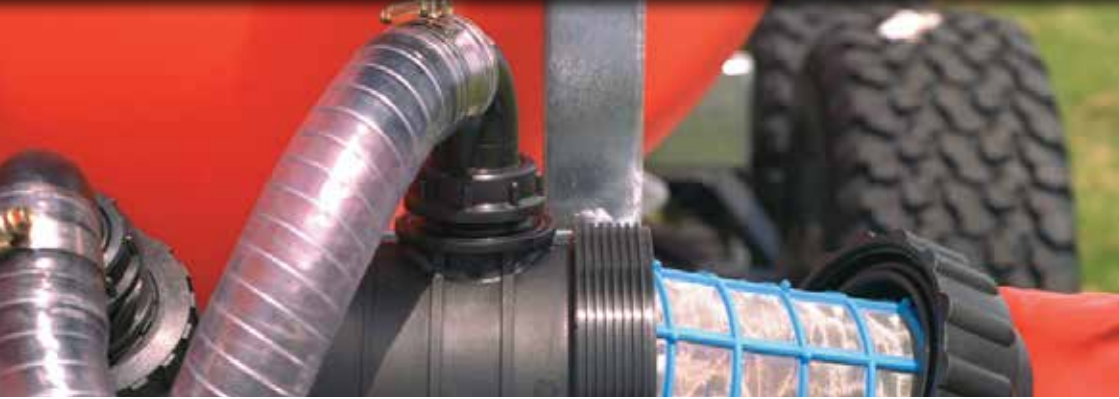

Maintaining a leak free and smooth liquid flow by using quality components and fittings is essential for maximum performance from all installations. Selecta's range of fittings are manufactured from high quality polypropylene and are compatible with fungicides, herbicides, chemical fertilisers etc, and will withstand temperatures of up to 100°C.

Standard BSP male and female threads can be used in conjunction with each other to construct assorted types and sizes of inlets, outlets, suction fittings and hose unions or they can be used with standard brass, galvanised and other fittings.

HOSETAIL MALE THREAD



CODE	THREAD (BSP)	SUIT ID HOSE	LIST EX	LIST INC	CAT
G8001151	1/2"	13mm	\$5.82	\$6.40	B
G8001153	1/2"	19mm	\$6.00	\$6.60	B
G8001201	3/4"	13mm	\$6.36	\$7.00	B
G8001203	3/4"	19mm	\$6.64	\$7.30	B
G8001205	3/4"	25mm	\$6.73	\$7.40	B
G8001251	1"	19mm	\$7.00	\$7.70	B
G8001252	1"	25mm	\$7.09	\$7.80	B

HOSETAIL ELBOW 90° MALE THREAD



CODE	THREAD (BSP)	SUIT ID HOSE	LIST EX	LIST INC	CAT
G8011101	3/8"	13mm	\$7.09	\$7.80	B
G8011151	1/2"	13mm	\$7.27	\$8.00	B
G8011152	1/2"	15mm	\$7.45	\$8.20	B
G8011153	1/2"	20mm	\$7.82	\$8.60	B
1132320	3/4"	19mm	\$7.55	\$8.31	B
G8011203	3/4"	25mm	\$7.82	\$8.60	B
G8011252	1"	30mm	\$10.91	\$12.00	B

HOSETAIL ELBOW 90° FEMALE THREAD



CODE	THREAD (BSP)	SUIT I.D. HOSE	LIST EX	LIST INC	CAT
G8010201	3/4"	19mm	\$7.18	\$7.90	B
G8010203	3/4"	25mm	\$7.45	\$8.20	B

SINGLE PIECE 90° ELBOW WITH BACK NUT



CODE	THREAD (BSP)	SUIT ID HOSE	LIST EX	LIST INC	CAT
G8039151	1/2"	15mm	\$11.82	\$13.00	B
G8039201	3/4"	19mm	\$12.73	\$14.00	B
G8039251	1"	25mm	\$13.64	\$15.00	B

REDUCING NIPPLE MALE/MALE



CODE	THREAD SIZE (BSP)	THREAD (BSP)	LIST EX	LIST INC	CAT
2402020	1/4"	1/2"	\$6.36	\$7.00	B
G8058151	1/2"	3/4"	\$6.73	\$7.40	B
G8058201	3/4"	1"	\$7.27	\$8.00	B

REDUCING NIPPLE MALE/FEMALE



CODE	THREAD M (BSP)	THREAD F (BSP)	LIST EX	LIST INC	CAT
G8059203	3/4"	1"	\$9.09	\$10.00	B
G8059204	3/4"	1 1/4"	\$9.09	\$10.00	B
G8059401	2"	1 1/2"	\$10.91	\$12.00	B



HOSE CLAMPS

Feature continuous rolled thread with hex head for screwdriver or spanner tightening.

TO FIT HOSE I.D. SIZE				
HOSE CLAMP	8MM	10MM	12MM	20MM
CODE	187-MH04	187-MH05	187-HS06	187-HS12
LIST EX	\$1.73	\$1.73	\$3.00	\$2.91
LIST INC	\$1.90	\$1.90	\$3.30	\$3.20
CAT	B	B	B	B

TEE PIECE FEMALE



CODE	THREAD (BSP)	LIST EX	LIST INC	CAT
G8026151	1/2"	\$10.00	\$11.00	B
G8026201	3/4"	\$10.00	\$11.00	B

MALE PLUG



CODE	THREAD (BSP)	OVERALL LENGTH	LIST EX	LIST INC	CAT
G8046151	1/2"	15mm	\$4.73	\$5.20	B
G8046201	3/4"	17mm	\$4.82	\$5.30	B

BARBED TEE PIECES



CODE	SUIT I.D. HOSETAIL	LIST EX	LIST INC	CAT
320-T38	3/8"	\$5.27	\$5.80	B
320-T12	1/2"	\$5.09	\$5.60	B
320-T34	3/4"	\$5.18	\$5.70	B

TANK OUTLET



CODE	THREAD SIZE (BSP)	OVERALL LENGTH	LIST EX	LIST INC	CAT
G8050151	1/2"	43mm	\$7.09	\$7.80	B
G8050201	3/4"	43mm	\$7.18	\$7.90	B
G8050251	1"	50mm	\$7.27	\$8.00	B
G8050302	1 1/4"	48mm	\$7.36	\$8.10	B
G8050351	1 1/2"	48mm	\$7.82	\$8.60	B

BLANKING CAPS FEMALE THREAD



CODE	THREAD (BSP)	THREAD LENGTH	LIST EX	LIST INC	CAT
G8044151	1/2"	15mm	\$4.45	\$4.90	B
2102030	3/4"	13mm	\$4.27	\$4.70	B
G8044251	1"	21mm	\$4.55	\$5.00	B
G8044301	1 1/4"	18mm	\$4.82	\$5.30	B
G8044351	1 1/2"	19mm	\$5.09	\$5.60	B

BACK NUT FEMALE



CODE	THREAD (BSP)	THREAD LENGTH	LIST EX	LIST INC	CAT
G8042151	1/2"	13mm	\$3.91	\$4.30	B
G8042201	3/4"	13mm	\$4.27	\$4.70	B
G8042251	1"	13mm	\$4.73	\$5.20	B
G8042301	1 1/4"	15mm	\$7.55	\$8.31	B
G8042351	1 1/2"	15mm	\$11.82	\$13.00	B
G8042401	2"	17mm	\$13.64	\$15.00	B

Plumbing, Filtration & Tank Accessories

NIPPLES



CODE	SIZE (BSP)	OVERALL LENGTH	LIST EX	LIST INC	CAT
G8056151	1/2"	54mm	\$3.73	\$4.10	B
G8056152	1/2"	75mm	\$7.18	\$7.90	B
G8056201	3/4"	60mm	\$7.64	\$8.40	B
G8056251	1"	64mm	\$9.09	\$10.00	B
G8056252	1"	70mm	\$9.09	\$10.00	B
G8056301	1 1/4"	68mm	\$15.45	\$17.00	B
G8056351	1 1/2"	68mm	\$16.36	\$18.00	B

FLAT GASKET



CODE	I.D.	O.D.	LIST EX	LIST INC	CAT
G600002004	3/8"	3/4"	\$4.09	\$4.50	B
G600002012	1"	1 1/2"	\$2.00	\$2.20	B
G600002010	3/4"	1 1/4"	\$3.64	\$4.00	B
G600002006		1"	\$3.27	\$3.60	B
G600002014	1 1/4"	2"	\$5.09	\$5.60	B
G600002016	1 1/2"		\$6.09	\$6.70	B
G600002018	2"		\$7.18	\$7.90	B
G600001014		1/2"	\$0.82	\$0.90	B

O-RING



O-RING CODE	O.D.	LIST EX	LIST INC	CAT
G600001002	1/2"	\$1.27	\$1.40	B
G600001012	3/4"	\$1.09	\$1.20	B
G600001018	1"	\$2.36	\$2.60	B
G600001022	1 1/4"	\$3.18	\$3.50	B
C1210-173	1 1/2"	\$3.18	\$3.50	B
G10071V	2"	\$4.36	\$4.80	B

ELBOWS



CODE	THREAD SIZE (BSP)	THREAD SIZE (BSP)	LIST EX	LIST INC	CAT
G8021151	1/2" M	1/2" F	\$5.00	\$5.50	B
G8019201	3/4" F	3/4" F	\$11.82	\$13.00	B

ELBOWS



CODE	SIZE	SUIT I.D. HOSE	LIST EX	LIST INC	CAT
116210	1/2"	10mm	\$6.18	\$6.80	B
G8012200	3/4"	13mm	\$6.73	\$7.40	B
G8012203	3/4"	19mm	\$7.27	\$8.00	B
G8012251	1"	19mm	\$9.00	\$9.90	B
G8012252	1"	25mm	\$9.09	\$10.00	B
G8012301	1 1/4"	25mm	\$10.00	\$11.00	B
G8012350	1 1/2"	25mm	\$10.00	\$11.00	B
G8012353	1 1/2"	35mm	\$10.00	\$11.00	B
G8012355	1 1/2"	40mm	\$10.00	\$11.00	B
G8012400	2"	40mm	\$11.82	\$13.00	B

HOSETAILED



CODE	SIZE	SUIT I.D. HOSE	LIST EX	LIST INC	CAT
G8002151	1/2"	13mm	\$5.36	\$5.90	B
G8002200	3/4"	13mm	\$5.45	\$6.00	B
G8002202	3/4"	19mm	\$5.55	\$6.10	B
G8002250	1"	13mm	\$5.64	\$6.20	B
G8002252	1"	19mm	\$5.73	\$6.30	B
G8002254	1"	25mm	\$5.82	\$6.40	B
G8002301	1 1/4"	25mm	\$11.82	\$13.00	B
G8002302	1 1/4"	30mm	\$11.82	\$13.00	B
G8002353	1 1/2"	35mm	\$12.73	\$14.00	B
G8002350	1 1/2"	25mm	\$12.73	\$14.00	B
G8002355	1 1/2"	40mm	\$13.64	\$15.00	B
G8002402	2"	50mm	\$14.55	\$16.01	B

FLY NUT



CODE	THREAD SIZE (BSP) (F)	LIST EX	LIST INC	CAT
G8040151	1/2" Suit 10mm tails	\$4.18	\$4.60	B
G8040152	1/2" Suit 13mm tails	\$5.36	\$5.90	B
G8040202	3/4"	\$5.45	\$6.00	B
G8040251	1"	\$5.55	\$6.10	B
G8040301	1 1/4"	\$5.36	\$5.90	B
G8040351	1 1/2"	\$5.55	\$6.11	B
G8040401	2"	\$5.55	\$6.11	B

Diesel Tanks & Accessories



Diesel Tanks and Accessories

DieselPro



DieselPro 200L – 600L

Premium Diesel transfer units

Baffled tank: 400 and 600L

Lockable filling lid and Pump cover

Puisi Italy 12V pump

Auto shut-off nozzle with 5 metres of hose

Anti-static earthing strap

DieselPak



Diesel Cube 400L

Efficient sized workstation

Baffled tank

Selecta 12V Diesel Power pump

Tank fill gauge

Lockable filling lid and Pump cover

Auto shut-off nozzle with 4 metres of hose

DieselPower



DieselPower 100L – 400L

Low profile & SquatPak designs available

Baffled tank: 300 and 400L models

Selecta 12V Diesel Power pump

Auto shut-off nozzle with 4 metres of hose

100, 200 & 400L Models feature lockable filling lid and pump cover for added security

DieselPak



DieselPak 1100L – 2200L

Bulk volume units

PIUSI Italy 12V pump options

Auto shut-off nozzle with 4 metres of hose

Hose hanging hook

Tie-down locating channels for straps

Tank have moulded feet for 4 point bolt-down

Optional steel skid available (1100L only)

DieselPak



DieselPak 400L - 800L

SquatPak tank design feature large baffle and accessory mounting points

PIUSI Italy 12V pump

Auto shut-off nozzle with 5 metres of hose

WARNING: Refer to vehicle or tractor manufacturer's instructions for appropriate load and towing limits and fitting positions. Never fill the tank capacity to exceed the vehicle or tractor manufacturer's specified safe load carrying capacities. Note: 1L of water = 1kg

DIESELPRO TRANSFER UNITS

Safe & reliable diesel transfer solutions for refueling on the go!

STRONG LOCKABLE LID & SHIELDED TANK BREATHER TO PREVENT THEFT

AUTO SHUT OFF NOZZLE WITH HOSE SWIVEL

45 L/MIN PIUSI 12V DIESEL PUMP

IMPACT RESISTANT UV STABILISED DIESEL GRADE POLYTUFF TANKS

LOCKABLE FILLING CAP

5M 3/4" DELIVERY HOSE & AUTO SHUT OFF TRIGGER

**NEW
RELEASE**



SQDS400-7

100L DIESEL ECO UNIT

SQDN100-P1

The Diesel ECO brings a simple approach to transfer solutions while including some premium features.

- 12V Poly Diesel Power pump
- 40L/min open flow
- Manual Shut-off nozzle
- 100L Low profile tank with lockable filler cap
- 4m of 3/4" delivery hose



**NEW
RELEASE**

200L 12 VOLT DIESEL ECO UNIT

TKD200-7

- UV Stabilized polytuff tank
- 40L/Min open flow self priming pump
- 4m of 3/4" delivery hose with swivel and manual nozzle
- 3m Long power cord with alligator clips



SQDS400-7

400L DIESEL CUBE

Incorporates premium features in a simple square workstation.

- 12V Diesel Power pump
- 40L/min open flow
- Auto shut-off nozzle
- Internal baffle and no spill breather
- Lockable filler cap and pump cover
- Tank fill gauge
- 4m of 3/4" delivery hose neatly wraps under the cover



**NEW
RELEASE**

FORKLIFT
BOOTS

CODE	DESCRIPTION	LENGTH	WIDTH	HEIGHT	WT	LIST EX	LIST INC	CAT
SQDN100-P1	100L Diesel Eco Unit	800mm	620mm	440mm	18 kg	\$499.09	\$549.00	A
TKD200-7	200L Diesel Eco Unit	1030mm	580mm	535mm	21 kg	\$635.45	\$699.00	A
SQDS400-7	400L Diesel Cube	1100mm	960mm	660mm	46 kg	\$1,253.64	\$1,379.00	A

Warning: Refer to vehicle or tractor manufacturer's instructions for appropriate load & towing limits & fitting positions.

* Note customer fitment.

DieselPro range tanks are manufactured with a diesel grade polyethylene that is UV stabilised and impact resistant. Our heavy duty reliable 12V pumps are from Italy, made by PIUSI, a world class pump manufacturer. Also features a lockable filling cap and a lockable pump cover to protect your diesel.

200L, 400L & 600L DIESELPRO

- Low Profile design for clear rear view on a utility vehicle
- 12V PIUSI Self-priming pump
- 45L/Min open flow
- High quality auto shut off nozzle
- 5m of 3/4" delivery hose with swivel and crimped fittings
- Strong double walled lockable pump cover (padlock incl.) protects the pump and tank breather from unwanted access
- Lockable filling cap with 2 keys
- 4m wiring harness with alligator clips
- Suction foot screen filter on internal suction line
- 30 min duty cycle, 30 min on/off
- Baffled tank (400 and 600L)
- Anti static earth strap
- Tank Bottom 8mm Brass inserts for bolt down mounting to a tray, skid or platform - 600L only

400L DIESELPRO FEATURES:

- IBC approved container for diesel fuel
- Worksafe Victoria approval number 30315

SQDN200L-Z1

DRAWING
10080



SQDN400L-Z1

DRAWING
10081



SQDN600L-X1

DRAWING
10082



OPTIONAL
ACCESSORY



Digital Litre
Counter
(PF26-X3)*

PIUSI

12V ITALIAN MADE
QUALITY PIUSI PUMP



FEATURED ON:

400L & 600L

CODE	DESCRIPTION	LENGTH	WIDTH	HEIGHT	WT	LIST EX	LIST INC	CAT
SQDN200L-Z1	200L DieselPro	1100mm	640mm	610mm	27 kg	\$1,090.00	\$1,199.00	A
SQDN400L-Z1	400L DieselPro	1700mm	820mm	590mm	41 kg	\$1,217.27	\$1,339.00	A
SQDN600L-X1	600L DieselPro	1664mm	840mm	810mm	50 kg	\$1,544.55	\$1,699.00	A
06792504	Lockable Filler Cap Suit DieselPro 200L and 400L					\$68.18	\$75.00	B
G8178013	Lockable Filler Cap Suit DieselPro 600L					\$81.82	\$90.00	B
PF26-X3*	Optional Electronic Selecta Diesel Meter Kit - Gun Fitment					\$290.91	\$320.00	A

Warning: Refer to vehicle or tractor manufacturer's instructions for appropriate load & towing limits & fitting positions.

* Note customer fitment.

Diesel Tanks and Accessories

The Selecta 12V DieselPower transfer units are available from 100L to 400L capacity. Tanks are made from a diesel grade polyethylene that are impact resistant and UV stabilised. Proven and reliable Selecta DieselPower pumps are the heart of this rugged product.

100L, 200L, 300L & 400L DIESELPOWER

- 12V DieselPower Self-priming pump
- 40 L/Min open flow
- High quality auto shut-off nozzle
- Strong double walled lockable pump cover (padlock incl.) protects the pump and tank breather from unwanted access (100, 200 and 400L)
- Lockable filling cap with 2 keys (100, 200 and 400L)
- Suction foot screen filter on internal suction line
- 4m of 3/4" delivery hose with swivel and crimped fittings
- 4m wiring harness with alligator clips
- 30 min duty cycle, 30 min on/off
- Baffled tank (300 and 400L)
- Low profile design (100, 200 & 400L)
- SquatPak design (300L)



OPTIONAL ACCESSORY

Digital Litre Counter (PF26-X3)*



FEATURED ON:
300L & 400L

CODE	DESCRIPTION	LENGTH	WIDTH	HEIGHT	WT	LIST EX	LIST INC	CAT
SQDN100-1	100L DieselPower	800mm	620mm	440mm	18 kg	\$771.82	\$849.00	A
SQDN200-7	200L DieselPower	1100mm	640mm	550mm	24 kg	\$908.18	\$999.00	A
SQD300-7	300L DieselPower	1060mm	900mm	530mm	30 kg	\$1,017.27	\$1,119.00	A
SQDN400-7	400L DieselPower	1700mm	820mm	590mm	41 kg	\$1,117.27	\$1,229.00	A
06792504	Lockable FillerCap Suit DieselPower 100L, 200L and 400L					\$68.18	\$75.00	B
354130B	FillerCap with Breather Suit DieselPower 300L					\$45.45	\$50.00	B
PF26-X3*	Optional Electronic Selecta Diesel Meter Kit – Gun Fitment					\$290.91	\$320.00	A

Warning: Refer to vehicle or tractor manufacturer's instructions for appropriate load & towing limits & fitting positions.

* Note customer fitment.

Diesel Tanks and Accessories

The rugged Selecta 12V DieselPak transfer units feature SquatPak design tanks are available from 400L to 800L capacity. They feature large internal baffles, heavy duty accessory mounting points and are manufactured with a

diesel grade polyethylene that is UV stabilised and impact resistant. The premium 12V pumps are made by PIUSI, a world class Italian pump manufacturer.

400L/800L DIESELPAK

- 12V PIUSI Self-priming pump
- 45 L/Min open flow
- 5m 3/4" delivery hose with auto shut-off nozzle
- 4m wiring harness with alligator clips
- Suction foot screen filter on internal suction line
- 30 min duty cycle, 30 min on/off
- Large Internal baffle (**800L with large twin Baffle**)
- SquatPak style accessory mounting points. Two tank corners with large M10 Inserts for mounting hose reels
- Deep Tie-down locating channels for straps mounting and tank strength
- Optional 10m retractable reel kit available (PF16)



12V ITALIAN MADE
QUALITY PIUSI PUMP



SQD400-X1

DRAWING
10086



SQD800-X1

DRAWING
10087

OPTIONAL
ACCESSORY



Digital Litre
Counter
(PF26-X3)*

UNIQUE TWIN



CODE	DESCRIPTION	LENGTH	WIDTH	HEIGHT	WT	LIST EX	LIST INC	CAT
SQD400-X1	400L Tank with BP3000 12V Pump	1060mm	900mm	650mm	42 kg	\$1,327.27	\$1,460.00	A
SQD800-X1	800L Tank with BP3000 12V Pump	1800mm	940mm	760mm	68 kg	\$1,817.27	\$1,999.00	A
PF26-X3*	Optional Digital Litre Counter Kit – Gun Fitment					\$290.91	\$320.00	A
354130B	Filler cap Suit DieselPak 400L and 800L					\$45.45	\$50.00	B

Warning: Refer to vehicle or tractor manufacturer's instructions for appropriate load & towing limits & fitting positions.

* Note customer fitment.

Diesel Tanks and Accessories

The rugged Selecta 12V DieselPak transfer units using our own Freestanding design tanks are available from 1100L to 2200L capacity. All DieselPak transfer units are manufactured with a diesel grade polyethylene that

is UV stabilised and impact resistant. The reliable 12V pumps are made by PIUSI, a world class Italian pump manufacturer.

DRAWING
10088

1100L/2200L DIESELPAK



- 12V PIUSI Self-priming pump
- 4m wiring harness with alligator clips
- Suction foot screen filter on internal suction line
- 30 min duty cycle, 30 min on/off
- Integrated four point foot mounting for Bolt Down Pin lock allowing fixture to a tray or skid
- Optional Skid Frame for 1100L models

1100L DIESELPAK FEATURES

- 45 L/Min open flow pump
- 5m 3/4" delivery hose with auto shut-off nozzle

2200L DIESELPAK FEATURES

- 85 L/Min open flow pump
- 4m 1" delivery hose with shut-off nozzle



SQD1000-X1



SQD2200-5
PICTURED WITH OPTIONAL
DIGITAL LITRE COUNTER

OPTIONAL ACCESSORIES



Digital Litre Counter
kit (PF26-X3)*



Hose Reels (pg 160)



Long Skid Frame for
1100L Tank (430-114)

CODE	DESCRIPTION	LENGTH	WIDTH	HEIGHT	WT	LIST EX	LIST INC	CAT
SQD1000-X1	1100L Tank With BP3000 12V Pump	1500mm	1180mm	1000mm	56 kg	\$2,026.36	\$2,229.00	9
SQD2200-5	2,200L 12V Hi-Flow PIUSI Diesel Pump	1900mm	1380mm	1150mm	103 kg	\$3,418.18	\$3,760.00	9
PF26-X3*	Optional Digital Litre Counter Kit - Gun Fitment					\$290.91	\$320.00	9
430-114*	Long Frame	1860mm	11160mm	140mm		\$850.91	\$936.00	9
354130B	Fillercap Suit DieselPak 1100L and 2200L					\$45.45	\$50.00	B

Warning: Refer to vehicle or tractor manufacturer's instructions for appropriate load & towing limits & fitting positions.

* Note customer fitment.



12V DIESELPOWER PUMP

- 40 L/min open flow, 22 Amp max
- 3/4" female BSP inlet/outlet
- 4m battery cable with alligator clips
- Self priming with internal 3 minute pressure bypass
- Max. head 10 metres



382-009



DRAWING
10823

12V BP3000 DIESEL PUMP

- 45 L/min open flow, 22 Amp max
- Comes with 2x 19mm hose tails
- 4m battery cable with alligator clips
- Self priming with internal 3 minute pressure bypass
- Max. head 10 metres
- 30 minute duty cycle
- Made in Italy by PIUSI



F0022325A



PIUSI

DRAWING
10713

12V INLINE BP3000 DIESEL PUMP

- 45 L/min open flow, 22 Amp max
- 3/4" female BSP inlet/outlet
- 4m battery cable with alligator clips
- Self priming with internal 3 minute pressure bypass
- Max. head 10 metres
- 30 minute duty cycle
- Made in Italy by PIUSI



382-059



PIUSI

CODE	DESCRIPTION	OPEN FLOW	LIST EX	LIST INC	CAT
382-009	12V DieselPower Pump	40L/min	\$199.09	\$219.00	A
F0022325A	12V BP3000 Diesel Pump	45L/min	\$426.36	\$469.00	A
382-059	12V inline BP3000 Diesel Pump	45L/min	\$453.64	\$499.00	A

12/24V PANTHER DIESEL PUMP

- 12 volt: 35 L/min open flow, 16 Amp max
- 24 volt: 75 L/min open flow, 25 Amp max
- Self priming w/ internal 3 minute pressure bypass
- 4m battery cable with alligator clips
- Self-priming vane pump
- Internal screen filter
- 1" BSP female ports
- Made in Italy by PIUSI



F00341160



PIUSI

DRAWING
10416

12V HI-FLOW DIESEL PUMP

- 85 L/min open flow, 35 Amp
- 1" BSP female ports
- 4m battery cable with alligator clips
- Self-priming vane pump
- Made in Italy by PIUSI



F0036302A



DRAWING
10417

PIUSI

240V (AC) DIESEL TRANSFER PUMP

- 56 L/min open flow, 3 Amp max
- 1" BSP female ports
- 2m power lead
- Self-priming vane pump
- Internal screen filter
- Max. suction (Head) 10 meters
- Made in Italy by PIUSI



F0073022A



PIUSI

CODE	DESCRIPTION	OPEN FLOW	LIST EX	LIST INC	CAT
F00341160	12/24V Panther Diesel Pump	35/75L/min	\$607.27	\$668.00	A
F0036302A	12V Hi-Flow Diesel Pump	85L/min	\$762.73	\$839.00	A
F0073022A	240V AC Diesel Pump	56L/min	\$471.82	\$519.00	A

12/24V PANTHER DIESEL PUMP KIT

- 12V: 35 L/min open flow, 16 Amp max
- 24V: 75 L/min open flow, 25 Amp max
- Suction foot screen filter with hosedetails & clamps
- Automatic shut-off nozzle with hose swivel
- 4m of 3/4" I.D. diesel delivery hose
- 4m battery cable with alligator clips
- Made in Italy by PIUSI



PF341090



PIUSI

DRAWING
10416

12V HI-FLOW DIESEL PUMP KIT

- 85 L/min open flow, 35 Amp max
- Automatic shut-off nozzle with hose swivel
- Suction foot screen filter with hosedetails & clamps
- 4m battery cable with alligator clips
- 4m of 1" I.D. diesel delivery hose
- Made in Italy by PIUSI



PF363260

PIUSI



DRAWING
10417

CODE	DESCRIPTION	OPEN FLOW	LIST EX	LIST INC	CAT
PF341090	12/24V Panther Diesel Pump Kit	35L/min (12V) 75L/min (24V)	\$869.00	\$949.00	A
PF363260	12V Hi-Flow Diesel Pump Kit	85L/min	\$999.09	\$1,099.00	A

12V DIESELPUMP PUMP KIT

PF48

- 45L/min open flow
- 1" BSP female ports
- 4m of 19mm I.D. hose
- Auto shut-off gun & swivel
- 4m battery cable



12V BP3000 DIESEL PUMP KIT WITH AUTOMATIC GUN

F0022511C

- 45 L/min open flow, 22 Amp max
- Suction foot screen filter w/ hosetails & clamps
- Automatic shut-off nozzle with hose swivel
- 4m battery cable with alligator clips
- 4m of 3/4" I.D. delivery hose
- Made in Italy by PIUSI

PIUSI



CODE	DESCRIPTION	OPEN FLOW	LIST EX	LIST INC	CAT
PF48	12V DieselPower Pump Kit	45L/min	\$353.64	\$389.00	A
F0022511C	12V BP3000 Diesel Pump Kit W/ Auto Gun	45L/min	\$623.64	\$686.00	A



12V SUBMERSIBLE DIESEL AND WATER TRANSFER PUMP

- 18 L/min open flow, 15 PSI max pressure
- 50mm diameter
- 12 volt DC
- Durable ABS plastic with stainless steel motor shell
- 2.8 metre cable with alligator clips
- Integral inlet strainer
- 2m delivery hose



PF49

12V SUBMERSIBLE DIESEL AND WATER TRANSFER PUMP

- 50mm pump diameter
- 2.8 metre cable with alligator clips
- 12 volt DC powered
- Durable ABS plastic with stainless steel motor shell
- Integral inlet strainer
- 4m delivery hose



MAX. CONTINUAL
USE - 60 MINS



PF51

CODE	DESCRIPTION	OPEN FLOW	LIST EX	LIST INC	CAT
PF49	12V Submersible Diesel & Water Transfer Pump	18L/min	\$62.73	\$69.00	B
PF51	12V Submersible Diesel & Water Transfer Pump Kit	18L/min	\$173.64	\$191.00	B

WATER & DIESEL HEAVY DUTY HOSE REEL

JA-1402020

Capable of handling water or diesel, this versatile hose reel is a great addition to diesel units or fire fighters where extra hose is required.

- Inlet 3/4" BSP/outlet tapered hose tail
- Maximum pressure 1700 Kpa / 247 PSI
- 30m of 3/4" I.D. hose
- Manual rewind reel with hose guide rollers and stopper
- Height: 680mm, Length: 660, Width: 490mm
- Weight: 44.5kg



PIUSI 10M RETRACTABLE DIESEL HOSE REEL

Heavy duty spring rewind reel with simple hose guide.

- Supplied with 10 metres of 1" delivery hose
- Adjustable arms for easy positioning as required
- Reduced pressure loss through the hydraulic system
- Latch mechanism prevents accidental contact with hands
- Complete with Inlet hose swivel
- 1" BSP Inlet and Outlet
- Made in Italy by PIUSI
- Height: 530mm, Length: 550, Width: 250mm
- Weight: 20kg

F00750030



DIESEL WATER FILTER

An Easy to install and maintain filter for protecting your equipment. The filter catches water and additional material that contaminates a diesel tank and prevents these materials from passing on to the next tank of your vehicle or machine. Each filter includes the housing bowl and element.

- Inline Diesel moisture filter
- 1" BSP Female ports
- Clear filter bowl with drain tap

PF21



HOSETAILS TO SUIT:

- PF0225-39 (3/4" Tail) ; PF0225-65 (1" Tail)

CODE	DESCRIPTION	HOSE	LIST EX	LIST INC	CAT
JA-1402020	30M Water & Diesel Heavy Duty Hose Reel	30m of 3/4" ID	\$617.27	\$679.00	A
F00750030	PIUSI 10 Metre Retractable Hose Reel	10m of 1" ID	\$850.91	\$936.00	A
PF21	Diesel Water Filter (Includes One Element)		\$120.91	\$133.00	B
PF21-1	Filter Element Suit PF21		\$25.45	\$28.00	B
PF0225-39	Hosetail (to suit PF21) 3/4" Tail (O.D) x 1" BSP Male Thread		\$23.64	\$26.00	B
PF0225-65	Hosetail (to suit PF21) 1" Tail (O.D) x 1" BSP Male Thread		\$21.82	\$24.00	B

SELECTA 4 DIGIT MECHANICAL DIESEL METER

PF12

- Flow rate 20-120 L/min
- Batch readout (maximum): 999L
- Total readout (max.): 9999999L
- 1" BSP Female ports
- Accurate to +/- 1% (after calibration)
- Subtotal can be set to zero, total readouts cannot



PIUSI 4 DIGIT MECHANICAL DIESEL METER K44

PF14



An easy to install Diesel meter which provides large volume batch readouts for high resolution fuel monitoring on an easy to read mechanical display.

- Meter face can be rotated in four different orientations
- Flow rate: 20-120 L/min
- Batch readout (max.): 999L
- Total readout (max.): 9999999L
- 1" BSP Female ports
- Accuracy: ±1% (after calibration)
- Suitable for gravity feed (tank must be 1.5m above meter)
- Subtotal can be set to zero



CODE	DESCRIPTION	LIST EX	LIST INC	CAT
PF12	Selecta 4 Digit Mechanical Diesel Meter	\$220.00	\$242.00	A
PF14	PIUSI 4 Digit Mechanical Diesel Meter K44	\$217.27	\$239.00	A

PIUSI K24 DIGITAL DIESEL METER

PF11

Can be fitted to your diesel or oil pumping product, or directly to the dispensing nozzle. There are three configurations to match your diesel transfer setup.

- Easy to mount inline fuel meter
- Able to be calibrated and provides information as to the individual litre count or the totality of litres counted
- Flow rate of 10 - 120L/min
- Compact and sturdy design H:55mm x W:75mm x D:100mm
- Max. pressure 10 bar of 145 PSI
- Accurate to +/- 1%
- 1" BSP male inlet and male outlet



SELECTA DIGITAL DIESEL METER KIT

The easiest way to fit an inline fuel meter to a wide variety of diesel equipment.

- This kit is supplied with additional fittings to allow the 1" BSP meter to be fitted to 3/4" BSP, or adapt a 1" Hose to a 3/4" nozzle and meter



PF26-X3

PIUSI

CODE	DESCRIPTION	LIST EX	LIST INC	CAT
PF11	PIUSI K24 Digital Diesel Meter	\$277.27	\$305.00	A
PF26-X3	Selecta Digital Diesel Litre Counter Kit	\$290.91	\$320.00	A

PIUSI MANUAL SHUT-OFF GUN

- Aluminium
- Capacity up to 120 L/min
- 1" BSP female inlet

PF0225-02



AUTO SHUT-OFF GUN

This gun is featured on most Selecta diesel units.

- Capacity to 58 L/min
- Requires 50 kPa (7.5 psi) to open
- 3/4" BSP female inlet
- Not suitable for gravity fed applications
- Optional swivels to suit (see below)

SELECTA DIESEL TRANSFER GUN

- High quality auto shut-off dispensing nozzle
- 120 L/min max capacity
- 29mm dispensing spout
- Trigger lock
- 1" BSP female port
- Weight 1.8 kg
- Not suitable for gravity fed applications
- Optional swivel to suit (PF01-SW3)

PF01



PF17



PIUSI AUTO SHUT-OFF GUN

- Capacity to 120 L/min
- Requires 30 kPa (4.4 psi) to open
- 1" BSP female swivel inlet
- Not suitable for gravity fed applications

PF13



DIESEL SWIVEL ADAPTOR

- BSPT thread Male/Female adaptor
- Made from stainless steel/aluminium



CODE	DESCRIPTION	LIST EX	LIST INC	CAT
PF0225-02	Manual Shut-Off Gun	\$50.00	\$55.00	B
PF01	Auto Shut-Off Gun	\$126.36	\$139.00	B
PF17	Automatic Shut-Off Gun	\$162.73	\$179.00	B
PF13	Auto Shut-Off Gun	\$198.18	\$218.00	B
CODE	DESCRIPTION	LIST EX	LIST INC	CAT
PF01-SW	3/4" Male to 3/4" Female Swivel	\$25.45	\$28.00	B
PF01-SW2	3/4" Male to 1" Female Swivel	\$28.18	\$31.00	B
PF01-SW3	1" Male to 1" Female Swivel	\$47.27	\$52.00	B

ACCESSORIES FOR FITMENT TO SELECTA DIESEL TRANSFER UNITS

CAPACITY	DIESEL CUBE	DIESEL POWER	DIESEL PRO	DIESEL PAK	
100L		SQDN100-1			
200L		SQDN200-7	SQDN200L-Z1		
300L		SQD300-7			
400L	SQDS400-7	SQDN400-7	SQDN400L-Z1	SQD400-X1	
600L			SQDN600L-X1		
800L				SQD800-X1	
1100L					SQD1000-X1
2200L					SQD2200-5
DIGITAL METERS					
PF11 (Meter 1" only)	✓*	✓*	✓*	✓*	✓*
PF26 (Meter 1" only)	✓*	✓*	✓*	✓*	✓*
PF26-X3 Universal Kit	✓	✓	✓	✓	✓
NOZZLE/ DISPENSING GUN					
PF0225-02 1" (Manual)	✓*	✓*	✓*	✓*	✓*
PF01 3/4" (Auto)	✓	✓	✓	✓	✓
PF17 1" (Auto)	✓*	✓*	✓*	✓*	✓*

ACCESSORIES FOR GENERAL FITMENT TO TANKS AND PUMP KITS

METERS		
PF12 Selecta 4 Digit Meter		Suits 20-120L/min Operation
PF14 PIUSI 4 Digit Meter		Suits 20-120L/min Operation and gravity feed*
WATER FILTER		
PF21 Water Filter		Suits 1" BSP Connections
PF21-1		Replacement Element
HOSE REELS SUITABLE FOR AFFIXING TO SKID, TRAILER OR DECK		
F00750030 PIUSI Retractable Hose Reel with 10m of 1" Hose		
JA-1402020 Manual Hose Reel with 30m of 3/4" Hose		
ADAPTORS AND HOSE SWIVELS		
PF01-SW Swivel 3/4" BSP M to F		
PF01-SW2 Swivel 1" BSP M to F		
PF01-SW3 Swivel Adaptor 1" F to 3/4" M BSP		
474-103 Reducing Bush 1" M to 3/4" F BSP		

KEY: ✓ Available option

✗ Not recommended

✓* Requires additional fittings

Selecta Blue

Selecta Blue products are designed to meet the requirements for storage and transfer of Diesel exhaust fluid (DEF)/AUS32 urea solution, commonly referred to by the trade names of Adblue®, NoNox® and Air1®.



12 VOLT 200 LITRE SELECTA BLUE TRANSFER UNIT

- Designed for the storage and transfer of AUS32 Solution
- UV Stabilized polytuff tank
- 35L/Min open flow self priming pump
- 4m of 3/4" delivery hose with manual nozzle
- 3m Long power cord with alligator clips



TKA200-7



CODE	DESCRIPTION	LIST EX	LIST INC	CAT
TKA200-7	12 Volt 200 Litre Selecta Blue transfer unit	\$635.45	\$699.00	B

SELECTA BLUE HAND PUMP

- Piston lever pump
- 15 L/min capacity
- Includes drum adaptors for Mauser and Greif type drums
- 3 metre delivery kit
- Extendable Dip tube included

Piston hand pump w/ delivery kit, dip tube and drum adaptors.



F00332100

CODE	DESCRIPTION	FLOW	WT	LIST EX	LIST INC	CAT
F00332100	Piston Pump Kit/ 357 x 357 x 275	15L/min	3.4 kg	\$180.91	\$199.00	A

† AdBlue® is a registered trademark of the VDA *Optional extra hose ls available, customer fitment.

200L 12V SELECTA BLUE TRANSFER UNIT

A convenient 200L transfer unit used to transfer AUS32 solution.

- UV stabilised polyethylene polytuff tank
- 12V self-priming 35L/m diaphragm pump
- Manual shut off gun with trigger lock
- 4m delivery hose
- Suction foot screen filter on internal suction line
- 30 min duty cycle, 30 min on/off



TKA200-1



IBC BASIC SELECTA BLUE KIT

This self priming 240V pump kit attaches directly to the framework of an IBC container.

- Flow rate 35L/min open flow
- Manual nozzle with 6 meters of delivery hose
- Suction hose 1.1m with with CDS quick suction connector
- Sturdy Stainless Steel Frame with nozzle holder
- Hose tail and clamps provided

Note: CDS Suction Tube Not included.



F00201B20



240 VOLT

CODE	DESCRIPTION	FLOW	WT	LIST EX	LIST INC	CAT
TKA200-1	200L 12V Selecta Blue Transfer Unit	35L/min	21 kg	\$1,362.73	\$1,499.00	A
F00201B20	IBC Basic Selecta Blue Kit	35L/min	16 kg	\$1,381.82	\$1,520.00	A

† AdBlue® is a registered trademark of the VDA *Optional extra hose ls available, customer fitment.

SELECTA BLUE 12V PUMP

- DC Pump Flow rate 35L/min
- Convenient carry handle
- Self-priming
- Max working pressure 1.5 bar
- Duty cycle 30 min
- 2m power cord with alligator clips
- 19mm hose tails



12V: F00204000



MANUAL NOZZLE

- Flow rate up to 80 L/min
- Spout ext. Ø 3/4"
- Hose tail 3/4"



F14761000

K24 METER

- Display can rotate to four positions
- 1" BSP M/M with 1" Socket for M/F or M/M installation
- Working Flow rate 6-100L/min
- Accuracy to +/- 1%
- Adjustable calibration
- Resolution to 0.1L
- Batch total to 99999L
- Complete total to 999999L
- View flow rate L/min
- Suitable for urea, water, windscreen washing liquid, basic Ag chemicals



F00407090

CDS/SEC SUCTION TUBE



F15606000

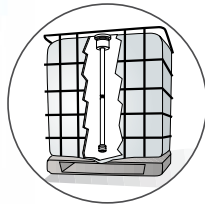

CODE	DESCRIPTION	FLOW	WT	PACKAGING (MM)	LIST EX	LIST INC	CAT
F00204000	Pump 12V DC Selecta Blue	35L/min	3.6 kg	350 x 180 x 280	\$560.00	\$616.00	A
F14761000	Manual Nozzle	80L/min	0.2 kg		\$113.64	\$125.00	B
F00407090	K24 Meter (1 socket)		0.4 kg		\$362.73	\$399.00	A

Lighting



Lighting



OPTICAL SPECTRUMS

FLOOD

(FEATURED ON LIGHT-10A,
LIGHT-12B)

SPOT

(FEATURED ON LIGHT-13B)

COMBINATION

(FEATURED ON LIGHT-16C)

15 WATT LED FLOOD LIGHT

- 780+ Lumens Flood beam work light
- 12/24V nominal operation
- Robust die-cast aluminum body
- Adjustable mount
- IP67 Rated water and dust resistance

27 WATT LED FLOOD LIGHT

- 1900+ Lumens Flood beam work light
- 12/24V nominal operation
- Robust die-cast aluminium body
- Adjustable mount
- IP67 Rated water and dust resistance

MAGNETIC BASE

- Compatible with all Selecta LED work lights



LIGHT-10A



LIGHT-12B



LIGHT-MAGNET

CODE	DESCRIPTION	WATTS	LENGTH	WIDTH	HEIGHT	LIST EX	LIST INC	CAT
LIGHT-10A	LED Flood Light - 12/24V	15W	145mm	90mm	45mm	\$57.27	\$63.00	B
LIGHT-12B	LED Flood Light - 12/24V	27W	105mm	60mm	140mm	\$103.64	\$114.00	B
LIGHT-MAGNET	LED Light Magnetic Holder		77mm	77mm	18mm	\$16.36	\$18.00	B

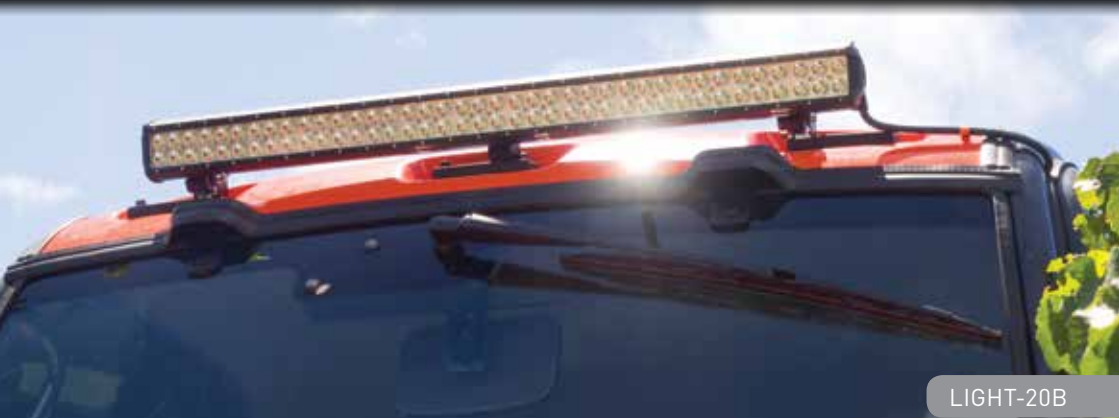

LIGHT-20B

LED LIGHT BARS

Powerful and high quality, ideal for use with a range of equipment.

- 12/24V nominal operation
- Robust die-cast aluminium body
- Polycarbonate lens for added strength
- IP67 rated water and dust resistance
- Adjustable mount

Note: Brightness quoted in Operating Lumens, not Theoretical Lumens for true comparison.

LIGHT-13B



54 WATT LED SPOT LIGHT

- 3780+ Lumens Spot light beam for distant viewing

90 WATT LED COMBO LIGHT WITH SPOT AND FLOOD BEAM

- 6250+ Lumens Combo light incorporates
- Spot light and floods for clear view at distance and good peripheral close up view



LIGHT-16C



LARGE 234W LIGHTBAR WITH SPOT LENS

- 16,200+ Lumens Spotlight beam for distance viewing
- Also includes simple swivel mount

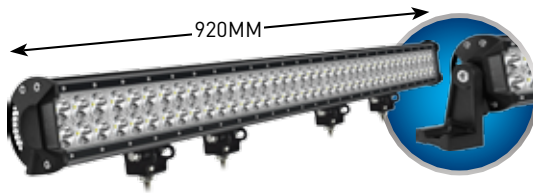

LIGHT-20B



CODE	DESCRIPTION	WATTS	LENGTH	WIDTH	HEIGHT	LIST EX	LIST INC	CAT
LIGHT-13B	LED Spot Light - 12/24V	54W	235mm	70mm	100mm	\$221.82	\$244.00	B
LIGHT-16C	LED Combo Light - 12/24V	90W	370mm	70mm	100mm	\$270.00	\$297.00	B
LIGHT-20B	LED Spot Light - 12/24V	234W	920mm	70mm	100mm	\$362.73	\$399.00	B



LED SOLAR AREA LIGHTING

Using only sun light this self powered system is ideal for illuminating around sheds, front gates, carports and fuel supplies.

- Night lighting for your convenience and deterrent to potential night prowlers
- Up to 7 hours of Night lighting automatically switching on at night
- IP65 water resistant
- Bright 12W LED flood light (Max 1000 Lumens)
- Large 12W solar panel
- Sturdy steel frame with powder coated finish
- Easy installation suitable for post mount or wall mounting

Pole not included, shown for illustrative purposes only.



SOLAR-2

SOLAR MOTION LIGHT WITH REMOTE

Perfect for outdoor or undercover to improve the lighting of carports, pergolas, balconies, workshops and fuel supplies.

- Automatically brightens when movement detected
- 3.5m charge cable to fit light & solar panel separately
- Use remote to power on/off or activate timed 1-2hr 1000Lm work light
- Provides gentle 150Lm ambient light for up to 3 full nights (from 1 full charge)
- Motion sensor activates bright 500Lm work light whenever activity
- IP65 water resistant



SOLAR-5

CODE	DESCRIPTION	WATTS	LENGTH	WIDTH	HEIGHT	LIST EX	LIST INC	CAT
SOLAR-2	LED Shed Light - 12/24V	12W	235mm	70mm	100mm	\$180.91	\$199.00	B
SOLAR-5	Solar Motion Light	5W	235mm	70mm	120mm	\$226.36	\$249.00	B

RRP
\$77.60
EACH

GF40

12V ROTATING BEACONS

Economy beacon available to dealers in multiples of six. Covered magnetic base with suction cup & provision to screw down for temporary or permanent install.



GF40



GF40-6 (Supplied in multiples of 6 only)

EUROPEAN MAGNETIC BASE BEACON

- Soft magnetic base for temporary install
- Cigarette lighter plug



GF25011

EUROPEAN ROD BASE BEACON

For installation to existing vehicle post or prominently positioned to maximize visibility.



GF35011

CODE	DESCRIPTION	FIXING	LIST EX	LIST INC	CAT
GF40-6	12V Magnetic Base Beacon (6 Pack for resellers)	Temp & Perm	\$423.64	\$466.00	B
GF25011	12V Magnetic Base Beacon	Temp	\$126.36	\$139.00	B
GF35011	12V Rod Base Beacon	Perm	\$113.64	\$125.00	B
GF15210	Spare Orange Cover to Suit GF15011, GF35011, GF25011	-	\$20.91	\$23.00	B
GF50310/1	Spare Globe to Suit GF15011, GF35011, GF25011	-	\$21.82	\$24.00	B



Multiple light patterns including fast and slow strobe.

WL003

MAGNETIC RECHARGEABLE WARNING LIGHTS 3 PACK

- 6 hour operation as warning strobe
- Carry case with all 3-at-once charging with 240V and 12V adaptors



WL003

LED ROTATING BEACON

- Magnetic base for fast install
- Multiple flash patterns including rotating and strobe
- No moving parts
- Low profile design
- Cigarette lighter plug, 2.3m cable



GF16

LED MAGNETIC BEACON

- Brilliant array of 3W LED's with premium design reflector provides safe visibility at distance
- ECE R65 and ECE R10 compliant for road use
- 3 Flash patterns: rotating flash, fast strobe and slow strobe
- 12/24V Operation with reverse polarity protection
- Cigarette lighter plug and coiled cable for easy install
- Soft magnetic base with suction cup for extra hold
- Provision for screw mounting



**NEW
RELEASE**

GF60

**IP66
WATER
RESISTANT**

CODE	DESCRIPTION	FIXING	LIST EX	LIST INC	CAT
WL003	Magnetic rechargeable warning Lights 3 Pack	Temp	\$117.27	\$129.00	B
GF16	12V Magnetic Base LED Beacon	Temp	\$105.45	\$116.00	B
GF60	12V Magnetic Base Beacon (6 Pack for resellers)	Temp & Perm	\$423.64	\$466.00	B

Solar Trickle Chargers maintain a battery, boat, irrigation pump, or tractor when not in use and will not damage, flatten or overcharge battery.



3 WATT SOLAR TRICKLE CHARGER

- Power rating 3W with output to 12V battery
- 2m power cable with alligator battery clamp
- Weather resistant plastic frame includes suction cups for window mounting

SOLAR-3W



6 WATT SOLAR TRICKLE CHARGER

- Power rating 6W with output to 12V battery or USB charging (eg. USB Power bank, phone or mp3 player)
- 2m power cable with alligator battery clamp and cigarette lighter plug connectors
- Plastic frame with inbuilt plastic stand

SOLAR-6W



USB Power bank for display purposes only

CODE	DESCRIPTION	LENGTH	WIDTH	DEPTH	WATTS	LIST EX	LIST INC	CAT
SOLAR-3W	Solar Trickle Charger	350mm	126mm	13mm	3W	\$39.09	\$43.00	B
SOLAR-6W	Solar Trickle Charger	268mm	212mm	20mm	6W	\$79.09	\$87.00	B

SELECTA SECURITY CAMERAS

Motion activated cameras to protect your property, day & night! SECURE01 & SECURE120 Models

RECORDS VIDEO AND PHOTOS

SD CARD INCLUDED

MODELS WITH STANDARD OR WIDE ANGLE VIEW

MOTION ACTIVATED WITH PIR SENSOR

OPERATES WITH BATTERIES
NO 240V REQUIRED

INVISIBLE INFRA-RED FLASH FOR NIGHT VISION

OPTIONAL MOUNTING BRACKET

SECURE 120 WIDE ANGLE CAMERA VIEW

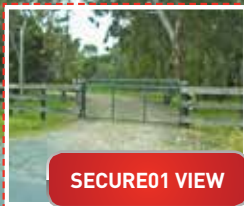

SECURE01 VIEW

NIGHT USE



Asset Protection Security Cameras



V60 MOTION ACTIVATED SECURITY CAMERA - SECURE06

Compact and self contained surveillance device for covertly monitoring indoors & outdoor areas. Ideal for securing of; farm gates & driveways, fuel supplies, sheds, garages, workshops, livestock, fox's & wild dogs, machinery and tools.

- High clarity 12MP Camera
- Records pictures and videos with date stamp
- Day and night use with No-Glow night vision
- Internal Screen for image review and setup
- IP54 for outdoor use
- Includes mounting strap

Additional features:

- 60° lens
- Fast response time down to 0.6 Seconds
- Operates with 4 or 8 AA batteries
- 8GB SD card included can store up to 3400 images
- Note: not suitable for WiFi SD cards

CAMERA MOUNTING BRACKET

- Adjustable wall mounting bracket to suit cameras
- Mounting screws included



SECURE02

CODE	DESCRIPTION	LENGTH	WIDTH	HEIGHT	LIST EX	LIST INC	CAT
SECURE06	Motion Activated Security Camera	90mm	75mm	136mm	\$190.00	\$209.00	B
SECURE02	Security Camera Mounting Bracket				\$8.00	\$8.80	B

Asset Protection Security Cameras



**NEW
RELEASE**

3G MOBILE MOTION ACTIVATED SECURITY CAMERA

- Broad angle lens 100° degree field of view
- Uses the 3G mobile network to send photos via email or mms to phone
- Sends daily reports to phone with number pictures taken, temperature, memory available and %Charge of AA batteries
- Day & Night use with No-Glow night vision up to 15m
- Requires 4 or 8 AA good quality batteries for long stand by time
- Records to SD memory card (not included)
- Accepts 3G micro sim cards. For best result check the availability of the Telestra 3G network in your area before purchasing a sim card
- IP54 Water & dust resistant
- Includes mounting strap with provision for mounting bracket

**Good quality camera batteries are recommended for best results. Battery life effected by user setup, environment and strength of 3G signal when transmitting.*



BATTERY POWERED DAY AND NIGHT FEATURES



SECURE100-3G

CODE	DESCRIPTION	LENGTH	WIDTH	HEIGHT	WT	LIST EX	LIST INC	CAT
SECURE100-3G	3G Motion Activated Security Camera	100mm	80mm	135mm	440 g	\$453.64	\$499.00	B





SECURE SOLAR PANEL AND BATTERY FOR 3G MOTION ACTIVATED CAMERAS

- Large 3000mAh battery and
- 2W panel can charge by sun or use the wall adaptor to fast charge the internal battery
- Include mounting bracket and strap
- Replaces the need for AA batteries
- Can operate the camera day & night
- 10V output suited to Selecta 3G cameras - SECURE01 and SECURE120



**NEW
RELEASE**

SEC-SOLAR2

CODE	DESCRIPTION	LENGTH	WIDTH	HEIGHT	WT	LIST EX	LIST INC	CAT
SEC-SOLAR2	Secure Solar Panel And Battery	140mm	30mm	155mm	340 g	\$108.18	\$119.00	B

Asset Protection Security Cameras



SCAN TO LEARN MORE!



SECURE01

SECURE120

MOTION ACTIVATED SECURITY CAMERAS

These popular cameras operate independently of covertly monitor indoors & outdoor areas. Ideal for securing surveillance of; farm gates & driveways, fuel supplies, sheds, garages, workshops, livestock, fox's & wild dogs, machinery and tools.

- 12MP Camera
- Records pictures and videos with date stamp
- Day and night use with No-Glow night vision
- Internal Screen for image review and setup
- IP54 for outdoor use
- Includes mounting strap

SECURE01

MOTION ACTIVATED SECURITY CAMERA - SECURE01

- Standard angle 52° lens (similar to most mobile phones)
- Response time 1 Second
- Operates with 4 or 8 AA batteries
- 8GB SD card included can store up to 5600 images



SECURE120

WIDE ANGLE SECURITY CAMERA - SECURE120

- Wide angle view 120° lens, ideal for close range targets in and around buildings
- Response time 0.85 Second
- Operates with 6 or 12 AA batteries
- 16GB SD card included can store up to 11300 images



CODE	DESCRIPTION	LIST EX	LIST INC	CAT
SECURE01	Security Camera	\$226.36	\$249.00	B
SECURE120	Wide Angle Security Camera	\$308.18	\$339.00	B

Asset Protection Security Cameras



Can be monitored from your Android or ios phone by utilising the FREE "APP"



***ABLE TO SEND TEXT TO PHONES UPON MOTION DETECTION**

SENTINEL WIRELESS SURVEILLANCE KIT

Complete kit ideal for watching your business, home, workshop or valuables. Review with the included screen or live view* to mobile phone.

- Easy set-up indoor and outdoor CCTV system with 7" Screen and 1x Camera
- Don't miss a thing with Smart motion activated loop recording keeps 6 seconds of footage from before the movement even detected
- 24/7 operation with overwrite recording
- Wireless video up to 150m for monitoring and recording
- Night vision range up to 15m
- Records to SD card (not supplied) by schedule, manual or motion activation
- Each screen and camera supplied with 240V AC power supply

* Live view to mobile requires broadband internet connection. You must connect base station to modem via cable for remote viewing.



CCTV1-01

SENTINEL WIRELESS EXTRA VIDEO CAMERA

Add another video camera to your Sentinel Wireless Surveillance Kit.

- Camera IP55 weather rated for indoor/outdoor use
- Easy to pair with existing Sentinel kit (max 4 camera per kit)



CCTV1-

CODE	DESCRIPTION	LIST EX	LIST INC	CAT
CCTV1-01	Sentinel Wireless Surveillance Kit with 1x Camera	\$420.00	\$462.00	B
CCTV1-02	Sentinel Wireless Surveillance Kit with 2x Cameras	\$544.55	\$599.00	B
CCTV1-CAM	Sentinel Wireless Extra Video Camera (1x Add-on Camera)	\$157.27	\$173.00	B
118-202	5M Power Extension Cable For Camera	\$21.82	\$24.00	B

Asset Protection Security Cameras



ALERT TONE WHEN
MOTION IS DETECTED

DRIVEWAY SENSOR MOTION ALERT & DOORBELL

Mount at front door, gate, workshop or restricted areas, audibly alerting when people or vehicles pass.

- Motion sensor wirelessly transmits up to 100m in open areas
- Detects motion up to 8m
- Doorbell triggers simple "Ding-Dong" chime
- IP44 Weather-resistant plastic housing
- Alert Speaker with adjustable volume to suit surroundings
- Battery Operated: Sensor requires 3 x AAA cell batteries, Receiver requires 3 x C cell batteries*
* batteries not included



WIRELESS DOORBELL TRIGGER
CLASSIC "DING-DONG" CHIME
UP 20M FROM RECEIVER



EASY TO ATTACH WITH
INCLUDED MOUNTING SCREWS



Warning: Doorbell transmitter contains a CR 2032 button cell type battery. These batteries can cause sever harm if ingested. Do not leave or install doorbell within reach of children.

CODE	DESCRIPTION	LIST EX	LIST INC	CAT
SEC-ALERT2	Driveway Sensor Alert	\$44.55	\$49.00	B

* Due to seasonality this item may not be stocked at all times - please check availability.

Asset Protection Security Cameras



Scan here to see Farmeyes Remote Aerial Observation System in action!

FARMEYES REMOTE AERIAL OBSERVATION SYSTEM

ROS-06FPV

Record high quality inspection video and wirelessly transmit direct to the operator. Ideal for review of crop & pasture growth, irrigation progress, livestock & hard-to-access areas.

- Fly direct point-to-point over ground obstacles for fast inspection
- Control unit from up to 1km away
- HD camera with gyroscopic stabilisation for smooth and steady video with remote adjustable camera roll and tilt
- Live view video up to 600m
- Record super clear 1080P videos on the camera for later review
- Strong carbon fibre air frame with 6 rotors for stable flight
- Complete first person view system with everything in the box



TELEMETRY KIT

2 Way radio kit connects to new and existing Farmeyes units allowing a bluetooth connection to an Android device for control by an app. Plan and operate short range missions that can be saved and repeated suitable for checking several water troughs or collecting video for progressive comparison.

- Supplies live data of UAV position, height and speed



ROS-TELEM

*Tablet shown for display only.

CODE	DESCRIPTION	LIST EX	LIST INC	CAT
ROS-06FPV	Farmeyes Remote Aerial Observation System	\$2,572.73	\$2,830.00	A
ROS-TELEM	Telemetry Kit To Suit Farmeyes	\$244.55	\$269.00	A
65-001A	Rotor A (CW Direction) Pack of 2	\$16.36	\$18.00	A
65-001B	Rotor B (CCW Direction) Pack of 2	\$16.36	\$18.00	A
65-B003	Spare Flight Battery	\$159.09	\$175.00	A

* Due to seasonality this item may not be stocked at all times - please check availability. Silvan Australia may make modifications, improvements or changes without notice.

Workshop & Maintenance





TYRE INFLATOR HEAVY DUTY WITH GAUGE

Ideal upgrade for your air compressor or workshop.

- Inflate/Deflate Lever
- Protected Pressure Gauge for tough environments
- Working Range: 0-140psi (0-9.5 Bar)
- Max Air Supply: 200psi (13.5 Bar)
- Inlet 1/4" BSP F
- Anti-Kink Hose Cover



**PROMO
LINE***



PF52

SWEEPER PUSH ALONG 920MM PICK UP

- Industrial Grade Workshop Sweeper
- Dual Sweeper arms bring debris to catcher
- Easy to empty trash catch
- Save valuable time clearing the workshop
- Can be used with left, right or both arms
- Adjustable Belt for each sweeper arm to maximise the brush tension



**NEW
RELEASE**

S920

CODE	DESCRIPTION	LENGTH	WIDTH	HEIGHT	WT	LIST EX	LIST INC	CAT
PF52	Tyre Inflator	800mm	80mm	70mm	925 g	\$45.45	\$49.90	A
S920	Push Along Sweeper	1200mm	1150mm	1100mm	20 kg	\$435.45	\$479.00	A

* Due to seasonality this item may not be stocked at all times - please check availability.



Available
late October
2017

**NEW
RELEASE**



RECHARGEABLE WORKLIGHT WITH HOOD + STAND

- Swivel hook on top
- 2 Modes: High 600lm = 1hr, Low 200lm = 3hr
- Foldable stand for more convenient usage
- Durable housing with rubberized handle
- 3.7V 2800mAh Li-ION batteries included
- Can operate while charging
- AC/DC adaptor and DC12V car charger

Lithium-Ion
BATTERY POWER

WL004



COMPACT WORK LIGHT + MAGNETIC PICKUP TOOL

- Compact design easily packs away into tool boxes and glove compartments
- High intensity 200lm work light from compact size
- Strong magnetic base and hanging loop suiting a range of applications
- Operates with 3 AA size batteries for fast emergency work lighting with a 1+Hr Run time for the work light

WL002



TELESCOPIC
HEAD REVEALS
SMALL LIGHT
WITH MAGNETIC
PICK UP

**NEW
RELEASE**



SURFACE
MOUNT LEDS

CODE	DESCRIPTION	LUMENS	LENGTH	WIDTH	HEIGHT	WT	LIST EX	LIST INC	CAT
WL004	Rechargeable Worklight with Hood	600	100mm	100mm	370mm	572 g	\$53.64	\$59.00	A
WL002	Compact Worklight	200	155mm	85mm	170mm	200 g	\$22.72	\$24.99	B



Available
late October
2017

**NEW
RELEASE**

**IP54
WATER
RESISTANT**

SPOT-6

LONG FOCUS HEADLIGHT LED 250 LUMENS

Allows operators to have a powerful light whilst being hands free which Ideal at night when operating or working on machinery, cutting wood and more.

- 2 mode settings: High 250 Lumens & Low 100 Lumens, operating time from 1 – 3hrs
- Aluminium housing with CREE XPG LED
- Adjusting head light angle with focus adjustment function
- Rear red light in housing for safety

15W PORTABLE RECHARGEABLE WORK LIGHT WITH MAGNETIC BASE

Ideal for general use, car maintenance, camping, off road work or in a workshop. Suitable for 12V & 24V systems.

- 5 bright powerful LEDs
- 1000+ Lumens upto 4 hours running time
- Sturdy adjustable hanging hook
- Large capacity Lithium rechargeable battery
- AC 240v charger and 12v DC car cigarette charger
- Strong magnet attached to the base which can be installed on metal surfaces

**Lithium-Ion
BATTERY POWER**

**THREE
MODES:
HIGH POWER,
LOW POWER
AND SOS**



LIGHT-21



LED 5 WATT RECHARGEABLE SPOTLIGHT

- 280+ Lumens, strong light beam for distant viewing
- Tough Polycarbonate lens
- Lithium rechargeable battery - 2.5 hour use
- With 240V and 12V charger cables
- IP54 Splash and water resistant



SPOT-5W



**POWERFUL
LIGHT BEAM
UP TO
200
METRES**

**CLEAR VISION
AT NIGHT**

CODE	DESCRIPTION	LUMENS	LENGTH	WIDTH	HEIGHT	WT	LIST EX	LIST INC	CAT
SPOT-6	Long Focus Headlight LED 250 Lumens	250				220 g	\$18.17	\$19.99	B
LIGHT-21	15W Portable Rechargeable Work Light With Magnetic Base	1000	110mm	95mm	225mm	725 g	\$88.18	\$97.00	B
SPOT-5W	LED Rechargeable Spotlight	280	155mm	85mm	170mm	405 g	\$41.82	\$46.00	B



Scan here to see the Portable Jumper Starter Leads in action!

JS012

PORTABLE POWERPACK AND JUMPSTART KIT – 600 CRANKING AMPS (PEAK)

- Suitable for Petrol & Diesel engines (up to 3.5L)
- Built in 12,000mAh Li – polymer battery
- 2 x USB plugs to charge phones
- LED charge battery display
- LED worklight with SOS light function
- Recharge jumpstart from car cigarette lighter, USB connection or 240VAC wall adaptor
- Overload, reverse polarity and short-circuit protection
- Will start a 30HP tractor



JS012



PORTABLE POWERPACK AND JUMPSTART KIT – 850 CRANKING AMPS (PEAK)

- Suitable for Petrol & Diesel engines (up to 6L)
- Built in 20,000mAh Li – polymer battery
- 2 x USB plugs and a cable kit to charge popular phones
- LED charge battery display
- LED worklight with SOS light function
- Recharge jumpstart from car cigarette lighter or 240VAC wall adaptor
- Overload, reverse polarity & short-circuit protection
- Will start a 70HP tractor



JS020



CODE	DESCRIPTION	LENGTH	WIDTH	HEIGHT	WT	LIST EX	LIST INC	CAT
JS012	Jumpstart – 600 Cranking Amps	165mm	40mm	70mm	390 g	\$162.72	\$179.00	B
JS020	Jumpstart – 850 Cranking Amps	230mm	35mm	85mm	750 g	\$253.63	\$279.00	B

* Due to seasonality this item may not be stocked at all times - please check availability.

12V OIL CHANGE PUMP KIT

Ideal for quick & easy oil changes on lawn mowers, ATV's, cars, lawn mowers, tractors and small engines.

- Supplied with pump & suction hoses
- 1.5 L/min maximum transfer rate



PF27



OIL JUGS

- Available in 5L
- Flexible pouring spout with sealable cap
- Screw-on lid to prevent spillage and keeps out dust



PF45

KNIFE & SHEARS SHARPENER

Multi-functional blade sharpener.

- Finger guard ensures safe sharpening
- Ergonomic handle design
- Suitable for many kinds of knives



SHARP02

PROMO LINE*

SHARP-N-EASY KNIFE SHARPENER

Two step ceramic knife sharpener.

- Brown ceramic for coarse
- White ceramic for fine
- Rubber moulding for a secure grip while sharpening
- Only available individually through resellers

RRP \$10.80 EACH



SHARP01-24

CODE	DESCRIPTION	LIST EX	LIST INC	CAT
PF27	Oil Change Pump 12V Kit	\$58.18	\$64.00	B
PF45	5L Oil Jug	\$17.27	\$19.00	B
SHARP02	Knife And Shears Sharpener	\$16.36	\$18.00	B
SHARP01-24	Sharp-N-Easy Knife Sharpener (24 Pack for Resellers)	\$235.45	\$259.00	B

* Due to seasonality this item may not be stocked at all times - please check availability.



HEAVY DUTY WORKSHOP TROLLEYS

- 120mm non-marking wheels (2x fixed, 2 x castor)
- Drink holder, storage for box cutter, pens & markers
- 2 Reinforced poly trays
- Flat packed
- Easy assembly

PCART-1

- Size: W 650mm x L 1180mm x H 835mm
- Tray size: W 650mm x L 940mm

PCART-2

- Tray size: W 435mm x L 790mm
- Size: W 435mm x L 1000mm x H 835mm

Trolley contents not included.

Shown for illustrative purpose only.



**200KG
MAX
LOAD**

**150KG
MAX
LOAD**

PCART-1

PCART-2

CODE	DESCRIPTION	LIST EX	LIST INC	CAT
PCART-1	Heavy Duty Workshop Trolley	\$171.81	\$189.00	B
PCART-2	Heavy Duty Workshop Trolley	\$135.45	\$149.00	B

FIREWOOD HAND TROLLEY

Easily move & store firewood around the home

- 500mm (l) x 540mm (w) x 1065mm (h) assembled
- Standard 10" x 3" pneumatic wheels on steel rim
- 150kg load capacity
- Easy assembly

HEAVY DUTY FIREWOOD RACK

Neatly store & protect firewood around the home

- 1170mm (h) x 1270mm (w) x 390mm (d) assembled
- Keeps firewood off the ground & free from moisture and wood rot
- Provides excellent ventilation for seasoning your firewood
- Easy assembly



WOOD3



WOOD5



Includes PVC cover for further protection and a neater appearance

CODE	DESCRIPTION	LIST EX	LIST INC	CAT
WOOD3	Firewood Hand Trolley	\$59.09	\$65.00	SH
WOOD5	Heavy Duty Firewood Rack	\$68.18	\$75.00	SH

* Due to seasonality this item may not be stocked at all times - please check availability.

Robust powder-coated steel with Hammertone finish



Enclosure can be installed in various shapes and sizes (eg: 2400mm x 800mm rectangle and 1600mm x 1600mm square)

ANIMAL ENCLOSURE

Designed for small pets, the fully galvanised steel and chain link mesh construction is sturdy, reliable and some assembly required.

- Small Size (m): 2.3 L x 1.9 W x 1.2 H
- Large Size (m): 3.9 L x 2.2 W x 1.82 H
- Flat pack for easy delivery

FULLY GALVANISED STEEL AND CHAIN LINK MESH



MULTI-PURPOSE PET ENCLOSURE

Easily stored and transported, ideal for a variety of animals including dogs, cats, chickens and more.

- Various shapes and sizes (eg: 2400mm x 800mm rectangle and 1600mm x 1600mm square)
- Robust powder coated steel with Hammertone finish

NEW RELEASE

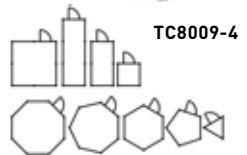

CODE	DESCRIPTION	SIZE	WEIGHT	LIST EX	LIST INC	CAT
TC8009-1	Animal Enclosure (Small)	2.3 L x 1.9 W x 1.2 H	46 kg	\$180.91	\$199.00	A
TC8009-2	Animal Enclosure (Large)	3.9 L x 2.2 W x 1.82 H	72 kg	\$344.55	\$379.00	A
TC8009-4	Multi-Purpose Pet Enclosure	Various sizes	24.5 kg	\$135.45	\$149.00	A

70PC GREASE NIPPLE ASSORTMENT KIT

TC3019-6
(COUNTER PACK OF 6)

- 20pc 1/4" UNF Straight
- 5pc 1/4" UNF 90°
- 5pc 1/8" BSP 45°
- 10pc M6 x 1.0 Straight
- 5pc M10 x 1.0 Straight
- 5pc 1/4" UNF 45°
- 10pc 1/8" BSP Straight
- 5pc 1/8" BSP 90°
- 5pc M8 x 1.0 Straight

INDIVIDUAL BOX
RRP \$29.00



360PC AUTO TERMINALS AND CONNECTORS ASSORTMENT KIT

TC3057-6
(COUNTER PACK OF 6)

- Spades
- Ring Terminals
- Forked Spades
- Bullet Connectors
- Insulated Spades
- Joiners

INDIVIDUAL BOX
RRP \$24.95

**SIMPLY
CRIMP TO
CONNECT**



40PC STAINLESS STEEL HOSECLAMP ASSORTMENT KIT

TC3091-6
(COUNTER PACK OF 6)

- 5pc 8mm
- 10pc 13mm (1/2")
- 3pc 16mm
- 4pc 25mm (1")
- 7ps 10mm (3/8")
- 4pc 15mm
- 3pc 19mm (3/4")
- 4pc 31mm (1 1/4")

**STAINLESS
STEEL**



INDIVIDUAL BOX
RRP \$39.00



CODE	DESCRIPTION	LIST EX	LIST INC	CAT
TC3019-6	70PC Grease Nipple Assortment Kit	\$142.73	\$157.00	B
TC3057-6	360PC Auto Terminals And Connectors Assortment Kit	\$122.73	\$135.00	B
TC3091-6	40PC Stainless Steel Hoseclamp Assortment Kit	\$191.82	\$211.00	B

* Due to seasonality this item may not be stocked at all times - please check availability.



120PC MINI AUTO FUSE ASSORTMENT KIT

TC1038-6
(COUNTER PACK OF 6)

- 20ps 5 Amp Orange
- 20pc 10 Amp Red
- 20pc 15 Amp Blue
- 20pc 20 Amp Yellow
- 20pc 25 Amp Clear
- 20pc 30 Amp Green

**RANGE
OF COMMON
SIZE FUSES**



INDIVIDUAL BOX
RRP \$19.90



382PC ASSORTMENT KIT VITON METRIC O-RINGS

TC3108

Range of O-rings neatly contained in a compact kit.

- Minimize down time with this quick to access kit to quickly get equipment back into operation
- Broad chemical resistance to suite a range of agricultural applications
- Typical applications Herbicides, pesticides fertilizers and diesel transfer
- From 3mm ID to 44mm ID



**VITON
MATERIAL**



CODE	DESCRIPTION	LIST EX	LIST INC	CAT
TC1038-6	120PC Mini Auto Fuse Assortment Kit	\$108.18	\$119.00	B
TC3108	382PC Assortment Kit Viton Metric O-Rings (only sold in single boxes)	\$144.55	\$159.01	B

* Due to seasonality this item may not be stocked at all times - please check availability.



FC400

SELECTA EVAPORATIVE AIR CONDITIONER

Ideal for retail shops, farm sheds, workshops, work garages, patios, outdoor events and marquees.

- The Float valve controls water level when connected to a tap
- Electric level sensor to indicate when water empty
- Heavy duty poly construction
- Quite running 230 volt electric motor
- Fill by bucket or connect via a garden tap
- Portable with 4 swivel wheels, 2 with locking function
- Timer function for auto start and finish
- Air direction function
- Adjustable fan speed 3 positions
- Remote control unit
- Liquid site level indicator
- Easy to empty drain plug
- Water consumption 10 -20L/Hr
- Noise 54,58,63db

**PROMO
LINE***



FC440

70 LITRE MODEL - FC400

- 400W, 230volt Electric motor
- Max Air Flow 9000 m³/hr
- Effective area 30 -50m²

70 LITRE MODEL - FC440

- 440W, 230volt Electric motor
- Max Air Flow 12,000 m³/hr
- Effective area 70 -100m²

CODE	DESCRIPTION	LENGTH	WIDTH	HEIGHT	WT (DRY)	LIST EX	LIST INC	CAT
FC400	70 Litre Evaporative Cooler	860mm	530mm	1400mm	36 kg	\$726.36	\$799.00	A
FC440	70 Litre Evaporative Cooler	925mm	580mm	1440mm	43 kg	\$1,044.55	\$1,149.00	A

* Due to seasonality this item may not be stocked at all times - please check availability.



**PROMO
LINE***



Scan here to see the Selecta Evaporative Air Conditioner in action!

SELECTA EVAPORATIVE AIR CONDITIONER

Ideal for retail shops, farm sheds, workshops, work garages, patios, outdoor events and marquees.

100 LITRE MODEL - FC700

- 700W, 230volt Electric motor
- Max Air Flow 18,000 m³/hr
- Effective area 70 -100m²
- Higher air flow for faster cooling



MARQUEES



SHEDS



STABLES



PATIOS



FC700

CODE	DESCRIPTION	LENGTH	WIDTH	HEIGHT	WT (DRY)	LIST EX	LIST INC	CAT
FC700	100 Litre Evaporative Cooler	600mm	1120mm	1650mm	70 kg	\$1,890.91	\$2,080.00	A

* Due to seasonality this item may not be stocked at all times - please check availability.

SUITABLE FOR
A DISTRIBUTED
WEIGHT CAPACITY OF
625kg
PER PAIR



FOLDING LOADING RAMPS

Compact design made from tough Lightweight aluminium

- Overall length is 2.26m x 280mm wide x 11.9kg (each ramp)
- Curved design increases clearance
- Long lip on end on ramp with ribs for grip
- Folds in half to make handling and storage easier

ATV-18



HEAVY DUTY



CODE	DESCRIPTION	LENGTH	WIDTH	WT (EACH)	LIST EX	LIST INC	CAT
ATV-18	Heavy Duty Ramps (Pair)	2260mm	280mm	11.9 kg	\$317.27	\$349.00	A



ATV-11

QUAD BIKE RAMPS

- 450 kg capacity
- Tough, lightweight and compact design
- Folds in half for easy storage
- Safety strap and lip to avoid slippage

ATV-03

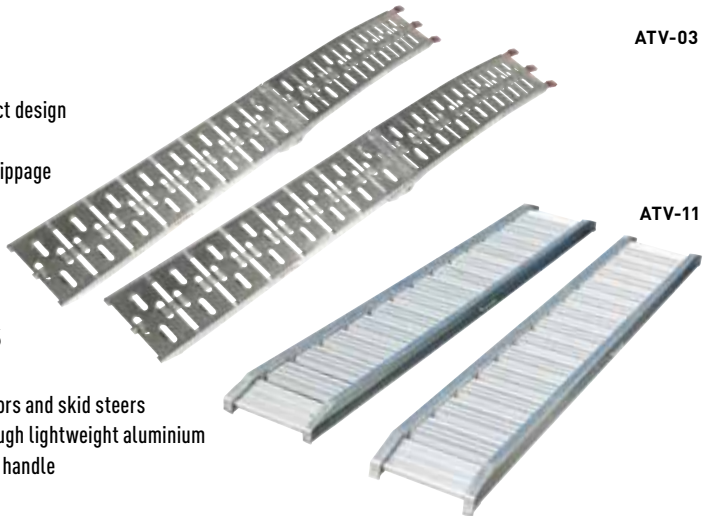

HEAVY DUTY RAMPS

- 1800 kg capacity
- Ideal for mini dingo's, excavators and skid steers
- Compact design made from tough lightweight aluminium
- Single piece design with carry handle

CODE	DESCRIPTION	LENGTH	WIDTH	WT (EACH)	LIST EX	LIST INC	CAT
ATV-03	ATV/Mower Ramps (Pair)	2260mm	280mm	16 kg	\$171.82	\$189.00	A
ATV-11	Heavy Duty Ramps (Pair)	2450mm	370mm	32 kg	\$862.73	\$949.00	A



60L WATER ROLLER

- Maintain a smooth and level lawn with complete ease
- Water filled plastic garden roller 60 Litre
- Light and easy to handle
- U.V. treated barrel
- Galvanised tube handles with steel bearings to ensure a long life
- Easy assembly



RP5

CODE	DESCRIPTION	SIZE	LIST EX	LIST INC	CAT
RP5	60L Water Roller	600mm (width) 370mm (diameter)	\$135.45	\$149.00	B

* Due to seasonality this item may not be stocked at all times - please check availability.

SAFETY SIGNS

New range of hard-to-find safety signs for the rural property.
 Standard: 200mm x 300mm rigid signs and self-adhesive.
 Large: 400mm x 600mm thick rigid signs (2 models available).

- All signs suitable for install with nail or screw
- Printed using UV resistant inks
- PVC material resists yellowing & brittleness
- Compliant to Australian Standards
- Portrait or landscape as displayed



LARGE:AS-SJ0001
 STANDARD:AS-S0001

Large Size Signs 400mm x 600mm

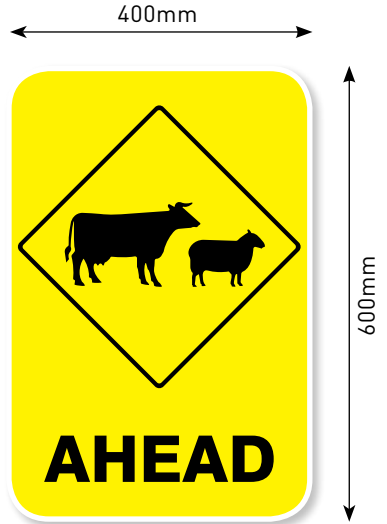

LARGE:AS-AJ0001
 STANDARD:AS-A0001

Standard Size Signs 200mm x 300mm



AS-D0013



AS-D0015



AS-D0009



AS-D0006



AS-D0017

CODE	DESCRIPTION	LIST EX	LIST INC	CAT
AS-****	Rigid Self Adhering Sign 200mm x 300mm (Standard Size)	\$13.64	\$15.00	B
AS-****	Rigid Self Adhering Sign 400mm x 600mm (Large Size)	\$33.64	\$37.00	B

**** Note to order signs use code quoted with image eg AS-P0004 for "KEEP OUT" sign

Standard Size Signs 200mm x 300mm



AS-D0018



AS-D0003



AS-N0001



AS-T0002



AS-T0003



AS-T0004



AS-A0001



AS-P0004



AS-P0005



AS-M0006

1460mm

M-KIT01



320mm

MERCHANDISE STAND FOR SIGNS AND STENCIL PACKS

12-Tier Dealer Merchandise stand only available to resellers.

CODE	DESCRIPTION	LIST EX	LIST INC	CAT
AS-****	Rigid Self Adhering Sign 200mm x 300mm (Standard Size)	\$13.64	\$15.00	B
AS-****	Rigid Self Adhering Sign 200mm x 300mm (Standard Size)	\$13.64	\$15.00	B
**** Note to order signs use code quoted with image eg AS-P0004 for "KEEP OUT" sign				
M-KIT01**	12-Tier Sign & Stencil Dealer Merchandise Stand (supplied empty)**	\$95.45	\$105.00	B

** Contact Customer Service for how to get your merchandising stand and additional information

Spreaders & Carryalls





345L POLY HOPPER 3 POINT LINKAGE SPREADER

PL-500

Multi functional spreader with corrosion resistant poly hopper suited to a variety of product such as granular fertiliser and seed.

- 6 - 18m throw
- Stainless steel metering and spreading discs
- Grease packed single speed gearbox with cast aluminium housing
- P.T.O. drive shaft with approved safety cover
- One manual control lever is calibrated for quantity of application and a second control lever offers three settings for spreading pattern, left, right and full.
- Optional accessories include one or two sided conveyor, agitator and hopper cover



CODE	DESCRIPTION	W (MM)	H (MM)	WT	LIST EX	LIST INC	CAT
PL-500	345L Poly Hopper Spreader	1130	1000	63 kg	\$1,100.00	\$1,210.00	A
OPTIONAL ACCESSORIES					LIST EX	LIST INC	CAT
619012	Agitator				\$50.00	\$55.00	A
902003	Hopper Cover				\$170.00	\$187.00	A
620102	One Sided Conveyor				\$460.00	\$506.00	A
620106	Two Sided Conveyor				\$700.00	\$770.00	A

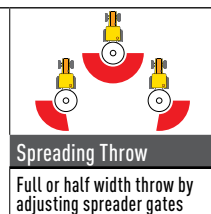
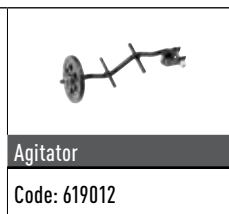

Spreaders and Carryall



SX SERIES LINKAGE SPREADER

- 338L capacity galvanised hopper
- 6 - 12m throw
- Spreading disc with 4 rotor blades able to be set in 5 positions
- CAT1 pins for linkage model

OPTIONAL ACCESSORIES



Side throw conveyor
(PAX26)



Articulated agitator
(PAX20)



DRAWING
0081

SX-500GALHOP

DIRECTIONAL
PRODUCT
SPREAD:
CENTRE, LEFT
OR RIGHT

GREASE
PACKED
GEARBOX

CODE	DESCRIPTION	LENGTH	WIDTH	HEIGHT	WT	LIST EX	LIST INC	CAT
SX-500GALHOP	338L Galvanised Spreader	1180mm	1180mm	1180mm	67 kg	\$950.00	\$1,045.00	A
CODE	OPTIONS TO SUIT SX-SERIES SPREADER					LIST EX	LIST INC	CAT
PAX26	Side Throw Conveyor					\$550.00	\$605.00	A
PAX20	Articulated Agitator					\$70.00	\$77.00	A



SP150

SP150 ECONOMY TRAILED SPREADER

- Quality grease packed gearbox & two piece cast aluminium housing
- Constantly engaged ground drive, one driven wheel, one free wheel
- 6 - 12m throw
- 4 adjustable spreading vanes each with 3 settings
- Simple, single lever rate control
- Mechanical spindle agitation
- Adjustable drawbar – 5 height positions

SP150

DRAWING
0175



TSP TRAILED SPREADER

- The TSP Trailed Spreader is ground driven and designed for spreading fertiliser and fine seed on sporting fields, lawns and pastures. It is ideal for towing behind compact tractors and some ATV motorbikes
- The hopper is made from corrosion resistant UV stabilised polyethelene
- Differential type gearbox ground drive with neutral position
- One manual control lever is calibrated for quantity of application and a second control lever offers three settings for spreading pattern, left, right and full
- 6-18m throw
- Max load capacity 450kgs



TSP-500

CODE	DESCRIPTION	LENGTH	WIDTH	HEIGHT	WT	LIST EX	LIST INC	CAT
SP150*	150L Spreader	1400mm	850mm	1050 mm.	61 kg	\$1,390.00	\$1,529.00	A
TSP-500*	345L Trailed Spreader	2000mm	1300mm	1190mm	119 kg	\$3,300.00	\$3,630.00	A

* Capacity will vary according to the type of fertiliser used. ** Variable according to speed and type of fertiliser.

Spreaders and Carryall



155SF2G

ALL-STEEL GALVANISED CARRYALL

- 4' and 6' size Cat. I TPL linkage
- Steel checker plate deck
- Replaceable bolt-on checker plate floor
- All round farm use for carrying various items such as fertiliser, fencing equipment, firewood, tools, spot sprayers etc.



155SF1G

CODE	DESCRIPTION	DECK	WT	LIST EX	LIST INC	CAT
155SF1G	4 Foot All-Steel Carryall - Galvanised	4' x 3'	62 kg	\$400.00	\$440.00	A
155SF2G	6 Foot All-Steel Carryall - Galvanised	6' x 3'6"	90 kg	\$500.00	\$550.00	A

EZ PUSH SPREADER

A simple adjustment of the gate opening selects the most appropriate setting for the material you're spreading.

- Easy rate adjustment
- Side throw adjustment lever
- Powder coated steel frame
- Even distribution with the wide 3 hole opening
- Supplied unassembled



CP-80080

ENCLOSED GEARS TO PROTECT FROM THE ELEMENTS

CODE	DESCRIPTION	WT	LIST EX	LIST INC	CAT
CP-80080	Chapin EZ Push Spreader	36 kg	\$317.27	\$349.00	A



Hardware

SELECTA BB68 WHEELBARROW

Heavy duty trade quality wheelbarrow.

- UV treated polyethylene tray for strength & durability
- 100L capacity
- Heavy duty hardwood timber handles
- Fully welded solid steel legs and front stays
- Heavy duty 18mm poly base board
- 16" x 4.8" Pneumatic wheel on steel rim with sealed bearings



BB68

SELECTA BB68BF WHEELBARROW

Heavy duty trade quality wheelbarrow.

- U.V. treated polyethylene tray for strength & durability
- 100L capacity
- Heavy duty hardwood timber handles
- Fully welded solid steel legs and front stays
- Heavy duty 18mm poly base board
- Bigfoot 16" x 6.5" Pneumatic wheel on steel rim with sealed bearings



BB68BF

SELECTA SH68BF WHEELBARROW

Heavy duty trade quality wheelbarrow.

- U.V. treated polyethylene tray for strength & durability
- 100L capacity
- Heavy duty galvanised steel handles
- Fully welded solid steel legs and front stays
- Heavy duty 18mm poly base board
- Bigfoot 16" x 6.5" Pneumatic wheel on steel rim with sealed bearings



SH68BF

CODE	TRAY TYPE	HANDLES	WHEELS	LIST EX	LIST INC	CAT
BB68	100L UV Treated Polyethylene	Timber	16" x 4.8"	\$240.91	\$265.00	B
BB68BF	100L UV Treated Polyethylene	Timber	16" x 6.5"	\$259.09	\$285.00	B
SH68BF	100L UV Treated Polyethylene	Galvanised Steel	16" x 6.5"	\$253.64	\$279.00	B

SELECTA 100L STEEL TRAY WHEELBARROW

WB038

- 100L powder coated steel tray with rolled lip for added strength
- Shock board
- Powder coated handles with rubber grips
- Bigfoot 16" x 6.5" Pneumatic wheel on steel rim with sealed bearings
- Strong tubular frame
- Robust bullbar with lifting hook



SELECTA SHRED WHEELBARROW

Heavy duty builder's wheelbarrow.

- Heavy duty, 1.2mm thick, red powder coated steel tray for superior strength and durability
- 100L (6 cu ft) capacity
- Bolt through style tray
- Heavy duty galvanised steel handles
- Fully welded solid steel legs and front stays
- 16" x 4.8" Pneumatic wheel on steel rim with sealed bearings



SHRED

SELECTA SS SERIES WHEELBARROW

100L handyman and gardener's wheelbarrow.

- Heavy duty poly tray
 - Heavy duty plated steel handles
 - Strong tubular steel frame
 - Supplied unassembled
 - Bigfoot 16" x 6.5" pneumatic wheel on poly rim
- † ONLY AVAILABLE TO DEALERS IN MULTIPLES OF 5
- CODE SS100P-5

RRP
\$159.00
EACH



SS100P†

SUPPLIED
UNASSEMBLED

SS100P-5

CODE	TRAY TYPE	HANDLES	WHEEL	LIST EX	LIST INC	CAT
WB038	100L Steel Tray Wheelbarrow	Powder Coated	16" x 4.8"	\$153.64	\$169.00	B
SHRED	Powder Coated Steel	Galvanised Steel	16" x 4.8"	\$204.55	\$225.00	B
SS100P-5	Pack of 5 x SS100P	Galvanised Steel	16" x 6.5"	\$722.73	\$795.00	B

* Dealer reorder code. Only available in multiples of five

LARGE STEEL MESH CART

The ideal cart for many applications.

- Durable 200kg load steel mesh tray
- Standard 13" x 6" Pneumatic wheels on steel rim
- Easy convert powder coated steel handle for push or tow arrangement
- Robust powder coated steel frame
- Easy to remove sides for platform arrangement
- Tray: L 1040mm x W 590mm x H 250mm
- Supplied unassembled



**NEW
RELEASE**



BBGC1010

POLY TRAY CART

- 245L tray capacity
- Tray tilts for easy loading or unloading of contents
- Pneumatic wheels with steel rims
- Powder coated steel frame
- Drawbar and universal hitch pin for ride-on mower attachment
- Easy assembly



TC3080PL



HT2401

HEAVY DUTY HAND TROLLEY

Ergonomic P-shaped handle design for better comfort and single handed control.

- Fully welded powder coated steel frame for maximum strength and longevity
- Solid puncture proof 13" x 4" wheels

**KG
STRONG
300KG
CAPACITY**

CODE	DESCRIPTION	WT	LIST EX	LIST INC	CAT
BBGC1010	Large Steel Mesh Cart	200 kg	\$180.90	\$199.00	B
TC3080PL	Poly Tray Cart		\$226.36	\$249.00	B
HT2401	Heavy Duty Hand Trolley	300 kg	\$86.36	\$95.00	B

SELECTA POLY WHEELBARROW TRAY

BB68TI

Selecta U.V. stabilised high density poly tray to suit BB68 & BB68BF wheelbarrows



CODE	DESCRIPTION	LIST EX	LIST INC	CAT
BB68TI	Injection Moulded 100L Poly - Drilled Tray To Suit Selecta 68 Series	\$111.82	\$123.00	B

SELECTA STEEL WHEELBARROW HANDLE

- Suits all Selecta pre-assembled wheelbarrows
- Size 1530 x 25 x 50mm (60" x 1" x 2")
- Rubber hand grips



BPSH

SELECTA WHEELBARROW WHEELS

- 4 ply pneumatic tyres with tube
- Steel rim with 1" sealed bearings
- BB68W fitted with 4.80-4.00 x 8" tyre
- BBBIGFOOT fitted with 16 x 6.5-8" tyre



BB68W
(16" X 4.8")



BBBIFOOT
(16" X 6.5")

SELECTA WHEELBARROW BEARING

- Replacement sealed bearing to suit 1" axle



BB68WB

CODE	DESCRIPTION	SIZE	LIST EX	LIST INC	CAT
BPSH	Selecta Steel Builder's Barrow Handle - Drilled (Single)		\$30.91	\$34.00	B
BB68W	Complete Std Pneumatic Wheel On Steel Rim To Suit 1" Shaft	16" x 4.8"	\$54.55	\$60.01	B
BBBIFOOT	Complete Bigfoot Pneumatic Wheel On Steel Rim To Suit 1" Shaft	16" x 6.5"	\$67.27	\$74.00	B
MW7TY	Bigfoot Tyre Only	16 x 6.5"-8	\$77.27	\$85.00	B
MW2TY	Standard 2 Ply Tyre Only	4.80-4.00" x 8"	\$59.09	\$65.00	B
MW7TU	Bigfoot Tube Only	16" x 6.5" - 8"	\$33.64	\$37.00	B
MW2TU	Tube Only - Suits All Standard Wheelbarrows	4.80-4.00" x 8"	\$23.64	\$26.00	B
BB68WB	Bearing to suit 1" Axle	1" bore	\$8.45	\$9.30	B



SHIFTING SHOVELS

- General purpose shovel for shifting, loading and spreading heavy to light materials
- Long handle for extra leverage
- Short handle for close work
- Includes models: 641763, 641916, 641985, 642241, 642388



DIGGING AND SHIFTING SHOVELS

- Suitable for digging, shifting and loading compact materials, including dry soil and sand
- Short handle for close work
- Long handle for extra leverage
- Includes models: 640858, 641336



MULTI PURPOSE SHOVEL

- UV stabilised for longer life
- Single piece polypropylene
- Large capacity per load
- Impact proof construction
- High chemical tolerance



FARMER'S FRIEND SHOVEL

- An all purpose shovel suitable for digging, shifting and spreading
- Long handle for extra leverage



CODE	TYPE	HANDLE	LIST EX	LIST INC	CAT
641763	Square Mouth Shovel 225mm x 280mm	Short Timber D	\$70.91	\$78.00	B
641916	Square Mouth Shovel 265mm x 315mm	Short Timber D	\$76.36	\$84.00	B
641985	Square Mouth Shovel 275mm x 330mm	Short Timber D	\$79.09	\$87.00	B
642241	Square Mouth Shovel 225mm x 280mm	Long Timber	\$69.09	\$76.00	B
642388	Square Mouth Shovel 265mm x 315mm	Long Timber	\$73.64	\$81.00	B
640858	Round Mouth Shovel 285mm x 300mm	Short Timber D	\$77.27	\$85.00	B
641336	Round Mouth Shovel 285mm x 300mm	Long Timber	\$73.64	\$81.00	B
639302	Multi Purpose Square Mouth Shovel 350mm x 250mm	One Piece Polypropylene	\$82.73	\$91.00	B
639586	Farmer's Friend Shovel 250mm x 290mm	Long Timber	\$70.00	\$77.00	B

GARDEN & COTTAGE SPADES

- General purpose garden spade suitable for most gardening needs, including digging and turning soils and clay
- Heavy duty garden spade suitable for nurserymen, professionals and enthusiastic gardeners
- Includes models: 642807, 650970, 651045, 651120



642807



651120



651045

PLUMBERS SHOVEL

- 1460mm long handle for extra leverage. Ideal for digging drains, holes and general garden work



639906

DEEP HOLE SHOVEL

- Specialised shovel for digging deep holes, and pits and clearing walls
- Long handle for extra leverage



639685

TRENCHING SHOVEL

- Specially designed for narrow trenching of agricultural drainage, laying water and gas pipes, as well as cables
- Long handle for extra leverage
- Includes model: 640216



640216

4WD CAMPING SHOVEL

- Ideal for off road use camping and light gardening
- 925mm handle length



639227

CODE	TYPE	HANDLE	LIST EX	LIST INC	CAT
642807	General Purpose 200mm x 290mm	Short Timber Poly D	\$53.64	\$59.00	B
651120	Gardenmaster 1050mm	Short Timber D	\$36.36	\$40.00	B
650970	Gardenmaster Heavy Duty 200mm x 290mm	Short Timber D	\$72.73	\$80.00	B
651045	Heavy Duty 200mm x 290mm	Long Timber	\$70.00	\$77.00	B
639906	Plumbers Shovel 180mm x 290mm blade	1460mm Long	\$70.00	\$77.00	B
639685	Deep Hole Shovel 195mm x 275mm	Long Timber	\$64.55	\$71.00	B
640216	Trenching 120mm x 285mm	Long Timber	\$64.55	\$71.00	B
639227	4WD Camping Shovel 210mm x 250mm Blade	925mm Timber	\$66.36	\$73.00	B

GRAIN SCOOP

- Lightweight aluminium shovel
- Ideal for shifting and lifting light materials



639634

POST HOLE SHOVELS

- Ideal for digging and clearing deep, narrow holes and pits, fencing and shallow trench digging
- Long handle for extra leverage

- Square and round mouth post hole shovel suitable for sinking holes into loose soil or sand and for trenching prior to pipe and drain laying



640001



640087



640018



640025



640032



640124

POST HOLE PINCER

- Suitable for digging narrow, deep holes and holes for planting trees, shrubs and flowers



A482110

CODE	TYPE	HANDLE	LIST EX	LIST INC	CAT
639634	Grain Scoop 320mm x 395mm	Short Timber Poly D	\$184.55	\$203.00	B
640087	Round Mouth 205mm x 320mm	Long Timber	\$63.64	\$70.00	B
640001	Square Mouth 195mm x 275mm	Long Timber	\$63.64	\$70.00	B
640025	Gardenmaster Square Mouth 195mm x 275mm	Long Fibreglass	\$90.00	\$99.00	B
640018	Gardenmaster Square Mouth 195mm x 275mm	Long Timber	\$40.00	\$44.00	B
640124	Prosteel Post Hole Shovel 190mm x 270mm	Steel	\$70.00	\$77.00	B
640032	Hardcore Post Hole Shovel 190mm x 270mm	Fibreglass	\$77.27	\$85.00	B
A482110	Post Hole Pincer	All Steel	\$132.73	\$146.00	B

More Cyclone products are available by indent order

EARTH AUGERS

- Ideal for digging post holes for fencing, hanging gates, even for planting trees and shrubs
- Spring loaded tamper for compacting earth within the drum models: 655692 & 655708

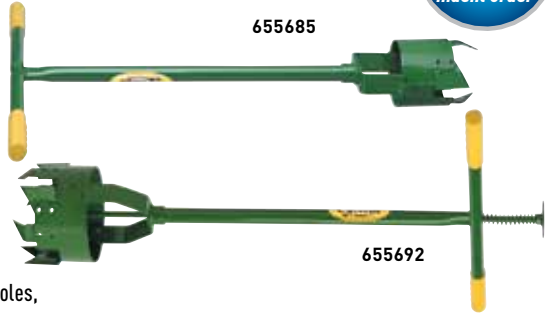

CROW BARS

- Suitable for digging post and in-ground support holes, also holes for planting trees, shrubs and flowers



FENCING BARS - HEXAGONAL & ROUND

- The chisel point is ideal for digging and the upset head is great for ramming or packing soil when setting posts

604461



604225

GARDEN MATTOCKS

- Ideal for breaking up hard-packed soils and removing trees and shrubs
- Great for cutting fibrous weeds and digging around the rootball of plants
- Includes models: 634737, 634475, 634529



634734

CODE	DESCRIPTION	HANDLE	LIST EX	LIST INC	CAT
655685	Auger 850mm L x 100mm Diameter	Steel	\$100.91	\$111.00	B
655692	Auger 985mm L x 150mm Diameter	Steel	\$111.82	\$123.00	B
655708	Auger 985mm L x 200mm Diameter	Steel	\$117.27	\$129.00	B
604447	Crow Bar 1830mm x 25mm 8kg		\$67.27	\$74.00	B
604461	Crow Bar 1830mm x 30mm 11kg		\$86.36	\$95.00	B
604188	Hexagonal Fencing Bar 1650mm x 25mm 7kg		\$69.09	\$76.00	B
604225	Hexagonal Fencing Bar 1830mm x 25mm 8kg		\$73.64	\$81.00	B
634734	350mm x 85mm Chisel And Blade Mattock	Short Timber	\$60.00	\$66.00	B
634475	415mm x 103mm Cutter And Blade Mattock	Short Timber	\$69.09	\$76.00	B
634529	Gardenmaster 400mm x 90mm Cutter & Blade Mattock	Short Timber	\$54.55	\$60.00	B

PELICAN PICK

- Used for picking and scraping loose surfaces and moving loose ground materials
- Ideal for mining



635298

BURR CHIPPING HOE

- Great for heavy duty clearing and cultivating
- Suitable for breaking up soil, clearing and chopping weeds



632051

SWAN NECK HOE

- A popular hoe designed for deeper hoeing and cultivating
- Works soil and destroys weeds with a chopping action



632884

CULTIVATOR

- Suitable for quick, shallow cultivation and aeration of garden beds and around established plants and shrubs
- For use around small seedlings



629150

RAKHO – FIRE FIGHTING

- An essential implement for country fire fighters and farmers
- Designed for raking combustible debris, chopping fire breaks and scraping back bark from trees



631849

MULCH AND BARK FORK

- Heavy duty fork with wide, dished head, designed for moving light material such as mulch and bark
- Short handle for close work



630866

CODE	TYPE	HANDLE	LIST EX	LIST INC	CAT
635298	Pelican Pick 400mm x 180mm	Short Timber	\$89.09	\$98.00	B
632051	135mm x 160mm Blade Chipping Hoe	Long Timber	\$90.00	\$99.00	B
632884	150mm x 120mm Blade Swan Neck Hoe	Long Timber	\$35.45	\$39.00	B
629150	3 Prong Cultivator	Long Timber	\$35.45	\$39.00	B
631849	Rakho 275 x 225mm Blade	Long Timber	\$100.91	\$111.00	B
630866	10 Tyne Mulch & Bark Fork	Short Timber D	\$252.73	\$278.00	B

HAY FORK

- Designed for lifting and spreading hay and light farm fodder

630729

MANURE FORK

- For mucking out stables and moving bulk lightweight produce

630859

GARDEN FORKS

- Used for digging, tilling and breaking up soil ready for further preparation
- Heavy duty fork designed to handle heavy textured soils with a high clay content
- Short handle for close work

630415

630361

GARDEN NAIL RAKES

- A general purpose tool for raking soil, stones and leaves
- Useful for cultivating, scarifying, aerating and making seed furrows

636202

LANDSCAPER'S RAKES

- Designed for levelling and spreading top soils, sand, dressings and fertilisers
- Suitable for levelling garden beds and other soft surfaces, as well as covering new seed after sowing

636516

CODE	TYPE	HANDLE	LIST EX	LIST INC	CAT
630729	3 Tyne Hay Fork	Long Timber	\$122.73	\$135.00	B
630859	4 Tyne Manure Fork	Long Timber	\$132.73	\$146.00	B
630415	General Purpose 4 Tyne Fork	Short Timber D	\$93.64	\$103.00	B
630361	Gardenmaster 4 Tyne Fork	Short Timber D	\$34.55	\$38.00	B
636202	14 Steel Nail Rake	Long Timber	\$45.45	\$50.00	B
636240	16 Steel Nail Rake	Long Timber	\$45.45	\$50.00	B
636318	Gardenmaster 14 Steel Nail Rake	Long Timber	\$28.18	\$31.00	B
636516	14 Steel Tooth Landscaper Rake	Long Timber	\$50.91	\$56.00	B
636554	16 Steel Tooth Landscaper Rake	Long Timber	\$54.55	\$60.00	B

TOP SOIL SPREADER

- Designed for levelling and spreading top soils, sand, dressings and fertilisers
- Level garden beds and other soft surfaces, as well as covering new seed after sowing



633621

LEAF RAKE – STEEL

- For raking leaves, grass & weed clippings
- Great for preparing lawns for top dressing and teasing established lawns



636707

LEAF RAKE – PLASTIC

- A huge plastic rake for raking just about everything
- Turn it around and use the scraper for levelling sand

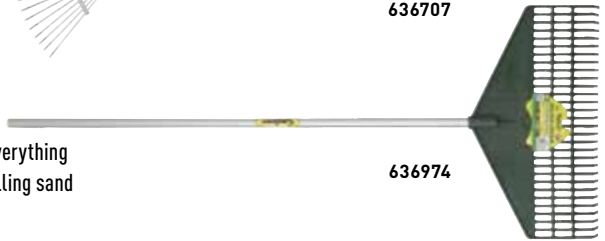

636974

AXE – 2KG POLISHED

- Two popular, general purpose axes for home, farm & camping
- 2kg head provides positive follow through while remaining a manageable weight to control
- Includes models: 603457, 603662



603457

SUPER SPLITTER

- Lightweight design with cutting head and balanced shaft
- Manufactured with 2 angled LED deflecting flanges that drive apart the timber on impact



603600

BLOCKSPLITTER – POLISHED

- These blocksplitters come with a rubber overstrike protector which protects the head from overstrike



603792

CODE	TYPE	HANDLE	LIST EX	LIST INC	CAT
633621	710mm x 250mm Steel Head Top Soil Spreader	Long Timber	\$96.36	\$106.00	B
636707	465mm x 320mm Steel Rake	Long Timber	\$32.73	\$36.00	B
636974	580mm x 320mm Plastic Leaf Rake	Long Aluminium	\$33.64	\$37.00	B
603457	2kg Polished Head Axe	Timber	\$108.18	\$119.00	B
603662	Gardenmaster 2kg Polished Head Axe	Timber	\$60.91	\$67.00	B
603600	Super Splitter Axe 2kg, high carbon steel head	Timber	\$93.64	\$103.00	B
603792	Blocksplitter – Polished	Timber	\$103.64	\$114.00	B
603860	Gardenmaster 2.5kg Polished Head Axe	Timber	\$60.91	\$67.00	B

OVERSTRIKE PROTECTOR

- An overstrike protector protects a blocksplitter handle from the effects of an overstrike



603785

BYPASS PRUNER - TITANIUM BLADE

- Non-stick titanium coated blades provide long lasting sharpness for low friction and even cutting
- Quick Release Unlocking Technology
- Lightweight Cast Aluminium Handles won't dig into your palms



657597

FOLDING PRUNING SAWS

- Ideal for trimming branches and shrubs
- A pocket sized folding blade for light trimming jobs
- Safety blade lock means the blade stays secure both in and out of use



656729

HEDGE SHEARS – STRAIGHT EDGED

- Ideal for shaping and trimming topiary subjects, borders and small hedges



658075

HEDGE SHEARS – WAVY EDGED

- Ideal for trimming thick or slippery stems



658051

TELESCOPIC BYPASS LOPPERS

- Ideal for precision pruning of green plant material or small branches
- Easily extendible, 'Sure- Lock' telescopic handles allows easy reach and excellent cutting leverage



659102

CODE	DUTY	BLADE	LENGTH	LIST EX	LIST INC	CAT
603785	Overstrike Protector	-	-	\$10.00	\$11.00	B
657597	Heavy	Titanium	220mm	\$34.55	\$38.00	B
656729	General	Fine Shark Tooth Blade	345mm	\$41.82	\$46.00	B
658075	Light To Medium	Straight Edged	530mm	\$50.00	\$55.00	B
658051	Heavy Duty	Wavy Edged	620mm	\$72.73	\$80.00	B
658082	Heavy Duty	Wavy Edged	Extend (660-780mm)	\$80.91	\$89.00	B
659102	Super Heavy Duty With Ratchet	-	Extend (680/1030mm)	\$100.91	\$111.00	B

A		Chemical Handling Equipment.....	68-71
Accessories Fitment Chart - Diesel	173	Chemical Jugs & Buckets.....	70
Accessory Fitment Chart - 12V Sprayers	43	Chemical Transfer Pump.....	71
Adblue - Selecta Blue Range.....	174	Clamps - Hose	154
Adjustable Spray Gun Nozzles.....	59	Cleaner - Tank Wash Detergent	48
Ag Runner Pump.....	71	Comet Diaphragm Pumps	118
Air Compressor	48	Compact Water Pump.....	105
Air Conditioning	204	Compressors - Foam Marker	48
All Clear Tank Cleaner.....	48	Connectors, Electrical	202
Animal Enclosure.....	201	Control Boxes.....	132-133
Aquatec 12V Pumps	125-126	Control Valves - Electric	132-134
Assortment Kits	202	Control Valves - Manual.....	121
Atomiser + Spray Gun	53	Controllers Suit Comet Pumps.....	121
ATV Boomless Nozzle	34-35	Couplings - Snap.....	152
ATV Booms	36	Coveralls	68
ATV Ramps	206	Crow Bars	225
Augers	225	Cultivators.....	226
Auto Fuse Kit.....	202	Cup Strainers.....	148
Auto Terminals & Connectors	202	Curved Lance	57
Axes.....	228	Cyclone Tools	221
B		D	
Backpack Sprayers	61-69	Degreaser Sprayers.....	61-68
Ball Valve.....	151	Delivery Hose	141
Bark & Mulch Fork.....	226	Detergent - Tank Cleaner	48
Beacons - Rotating	182	Diaphragm Pumps.....	118
Blocksplitter	228	Diesel Filter	169
Blowamist	66	Diesel Guns.....	172
Boom Wick Applicators.....	38	Diesel Hose Reels.....	169
Boomless nozzles	34	Diesel Meters.....	170
Boomless Nozzles.....	34-35	Diesel Pump Kits	166-167
Booms	37	Diesel Pumps Bare	164-165
Brass Connectors & Fittings	152	Diesel Swivels.....	172
Breather Valves.....	149	Diesel Tanks - All Models	156-163
Breathing Protection.....	68-71	Diesel Tanks Bare	138-139
Burr - Chipping Hoe.....	226	DieselCube.....	159
Bypass Loppers / Pruners.....	229	DieselEcon	159
C		DieselPak.....	162-163
Camera Security	186-191	DieselPower	161
Carryall	215	DieselPro.....	160
CCTV Security.....	190	Disposable Gloves.....	70
Chapin Sprayers.....	61-67	Driveway Sensor	191
Chapin Spreaders	216	Droplet Size Information.....	73

Index

Drum Pump Kit.....	168	Goggles.....	68
Dust Masks - Disposable.....	68	Goyen Solenoids & Repair Kit.....	134
E		GPS Guidance & Monitors.....	44
Eco Hose Reel.....	39	GPS Guidance Systems.....	44
Economy Hose Reel.....	39	Grain Scoop.....	224
Electric Automotive Terminals.....	202	Grease Nipples, Assortment Kit.....	202
Electric Solenoids.....	134-135	Gunjet 30 Spray Gun & Extensions.....	57
Enclosure - Animal.....	201	Gunjet 43 Spray Gun.....	57
Engine Driven Pumps.....	122	Guns - Adblue.....	177
Evaporative Coolers.....	204	Guns - Diesel.....	172
Eye Protection.....	68	Guns - Spraying.....	49-60
F		H	
Face Shield.....	68	Hand Sprayers.....	61-66
Farmeyes Remote Observation System.....	192	Helmets - Kasco.....	69
Fenceline Kit.....	36	High Volume Filter.....	145
Fencing Bars.....	225	J	
Fertiliser Spreaders.....	211	Jetpro Spray Gun.....	50
Field Boom.....	37	K	
Filter - Diesel.....	169	Knapsack Sprayers.....	64
Filter - Elements.....	144-149	L	
Filter - Respirator.....	68-72	Led Lights.....	178
Filter - Suction & or Pressure.....	144	Lid Strainers.....	150
Filtration.....	143	Lids - Tank.....	150
Filtration Information.....	143	Lightfoot - 300 Litre.....	29-31
Fire Fighter Units.....	106	Loading Ramps.....	206
Fire Fighting - Hose Reels.....	114	M	
Fire Fighting - Pistol & Nozzles.....	115	Matrix Guidance System.....	44
Fire Fighting Knapsack.....	116	Mattocks.....	225
Fire Fighting Pumps.....	105	Measuring Jugs.....	70
Fire Fighting Units.....	104	Mesh Elements.....	144-149
Flow Meters - Diesel.....	170	Mister, Motorised.....	66
Flow Meters- Adblue Aus32.....	177	Motion Activated Camera.....	186-190
Foam Marker.....	47	Motorised Pumps.....	122
Foam Marker Accessories.....	48	Multiple Nozzle Holders.....	98
Foam Marker Solenoids.....	135	N	
Forks.....	227	Niagra Chemical Mixer.....	71
Fuse kit.....	202	Nitrile Gloves & Gauntlets.....	70
G		Nozzle Accessories & Caps.....	94
Gardening Tools.....	221-229	Nozzle Boomless.....	89,92,93
Gauges, Pressure.....	151	Nozzle Flow Rate Chart.....	74
Geoline Nozzles.....	79	Nozzle Holders -.....	97-103
Gloves.....	70	Nozzle Holders - Swivel.....	101-102

Nozzle Strainers	148	Pumps - Diesel 12, 12/24, 240V	164-165
Nozzles - AI Air Induction	86	Pumps - Motorised Diaphragm	122
Nozzles - AIC Air Induction	86	Pumps - Oil Change Kit	198
Nozzles - AITTJ60 Turbo Twinjet	86	Pumps - PTO Diaphragm	118
Nozzles - AIXR Air Induction	84	Pumps - Selecta Blue	177
Nozzles - Brass Off Centre OC	88	Pumps - Service Kits & Acc	123
Nozzles - DG Teejet Drift Guard	82	Q	
Nozzles - Fertilizer	87	Quad Bike Ramps	206
Nozzles - Geoline Flat Fan Poly RS	79	Quad Bike Sprayer 50/70 Litre	14
Nozzles - HCC & TX Hollow Cone	90	Quick Fill Suction Kit	114
Nozzles - Hypro Boomless	89	R	
Nozzles - IDK Air Injected	84	Rakes	228
Nozzles - Lurmark LC Deflectip	88	Rakho - Fire Fighting	226
Nozzles - TP Teejet Flat fan	80	Rakpak 12V Sprayer	14-15
Nozzles - TT Twin Turbo	82	Ramps - Quad Bike, Mower, Motorcycle	206
Nozzles - TTI Turbo Teejet Induction	84	Rechargeable Sprayers	9, 21, 28, 29
Nozzles - TTJ60 Turbo Twinjet	82	Redline Sprayers	9, 10, 11
Nozzles - XR Teejet Flat fan Extended	80	Redline Sprayers	9-11, 28
Nozzles - XRC Extended	80	Reels, Hosereels	39-40
Nozzles Holders High Pressure Brass	102	Regulators	135
Nylon Roller Pumps	120	Remote Control Hosereels	41
O		Remote Control Skid Sprayers	24
Oil Change Pump	198	Remote Hose Reel, Spray Unit	24-27, 41-42
Ontrack Foam Concentrate	48	Respirator Filters & Kits	68-73
O-Rings Kit	203	Retractable Hose Reels	39-42
P		Roller Pumps - Nylon	120
Pak Booms	36	Ropewick Applicators	38
Pet Enclosure	201	Rubber Wheels	220
Pistols Fire Fighting	115	S	
Pitarm Hose Reel	39	Safety Clothing	68-70
Poly Fittings	152-155	Safety Signs	209-210
Poly Tanks	136	Saws - Pruning	229
Portable Hand Sprayers	62	Section Valves	132
Power Supply - Jump Starts	197	Security Cameras	186
Pressure Gauges	151	Security Cameras	186-192
Pressure Line Strainers - Filters	147	Selecta Blue Pumps & Accessories	177
Pressure Regulator Kits	38	Selecta Blue Transfer Unit	175
Pressure Relief Valves	135	Selecta Pak Pumps	127
Pruning Hand Tools	229	Selecta Power - Fire Fighting Units	104
Pumps - 12, 24 & 240-Volt Shurflo	128	Selecta Wheelbarrows	217-218
Pumps - 12V Aquatec, Smoothflo	125	Service Kits - Diaphragm Pumps	123
Pumps - Comet	118	Service Kits - Valves	123

Index

Sharp ëNí Easy Knife Sharpener	198	Teejet - Suction Pressure Filters	146
Sharpener, Knife, Shears	198	Teejet Nozzle Application Rate	74
Shears	229	Teejet Nozzle Caps	95
Shield - Spray Guns	60	Teejet Nozzle Holders	98-102
Shielded - Booms	37	Teejet Nozzles	80-87
Shovels	222-224	Telemetry kit	192
Shurflo 12, 24 & 240V Pumps	128	Telescopic Loppers	229
Shurflo, Aquatec, Pakpump Service Parts	129	Telescopic Spray Lance	56
Sight Line Gauge	152	Tip Strainers	148
Signs Safety, Warning, Notice	209-211	Tommy Gun Spray Gun	51
Silmix Chemical mixer	71	Torch Spotlight	196
Siphon Pump	168	TPL Boomless Nozzle	89, 92, 94
Skid Sprayers	23	Trailed Fire Fighters	113
Smoothflo 12V Pump	125-126	Trailed Sprayers	11, 29, 30-31
Smoothflo 12V Sprayers	124-126	Trailed Spreaders	214
Solar Light	181	Tray - Barrow	220
Solar Trickle Chargers	183	Traylink Sprayers	32
Solenoids	134-135	Triam Spray Gun	54
Spades	223	Trickle Charger, Solar	183
Spotlight, LED	195-196	Trolley Sprayer	21, 28-29
Spotpak Smoothflo 12V Sprayers	13	Trukpak	16-21
Spray Booms	37	Turbo 400 Spray Gun	58
Spray Guns	49-61	U	
Spray Shield	60	UAV	192
Spreaders	211	Uni-Cap	96
Squatpak 12V Sprayers	22-23	UTV - Ramps	206
Squatpak Fire Fighting Accessories	114	UTV - Sprayers	16
Squatpak Fire Fighting Units	104	V	
Strainers - Lid	150	Valves - Bypass Regulator	135
Strainers - Nozzle	148	Valves - Solenoid	134-135
Strainers - Pressure / Suction	143-147	Vari Spacing Clamps	100
Submersible Pump	168	Varijet Spray Gun	54
Suction Filters	144	Video Camera, Security	190
Suction Hose	140	W	
Sweeper push along	194	Water Roller	208
Swivels	172	Wet Boom Nozzle Holders	97-98
T		Wheelbarrow Wheels/Tray/Handle/Bearing	220
Tank & Hose Fittings	152-155	Wheelbarrows	217-219
Tank Kit Sight Gauge	152	Wick Stick & Applicator	38
Tanks Bare- Diesel	138-139	Wind Speed Information	77
Tanks Bare- Polytuff, Spray, Water	136-137	Worklight/Torch	195-196
Taps - In Line	151		



DIESEL STAND CODE: 070-DIESELMK2

SELECTA 100, 200 AND 400 LITRE DIESELPRO/DIESELPower STAND

The diesel tank stand is ideal for showcasing 100, 200 and 400 litre diesel units from the DieselPro and DieselPower ranges. It features lockable castor wheels to allow the stand to be moved around the store for higher visibility and it's stronger than ever. Many stores move it outside during the day as a great way to promote the range to passing traffic.

To qualify for a FREE Diesel stand:

A minimum order of 5 units is required, consisting of 1x 100L DieselPower, 2x 200L (of DieselPro or DieselPower units) and 2x 400L (of DieselPro or DieselPower units).



SPOTPAK STAND CODE: 070-PAK

SILVAN 20, 50, 100 AND 200 LITRE SPOTPAK STAND

The Silvan SpotPak stands are an extremely popular 'silent salesman'. Designed to display a 25, 55 and 100 litre Redline sprayers and 50, 100 and 200 litre Smoothflo SpotPak units on a tiered stand, the SpotPak display is ideal for any retail outlet.

To qualify for a FREE SpotPak stand:

A minimum order of 5 SpotPak or 5 Redline units will qualify you for a new SpotPak stand.

Store-In-Store Displays



070-SISP0790



STORE-IN-STORE DISPLAYS

Selecta's Store-in-Store concept has proven to increase sales in store by showcasing fast moving merchandise and spare parts in easily identifiable and neatly arranged displays.

These Store-in-Store displays consist of black gloss shelving in configurations to fit your store layout, with header cards, reorder cards, and matched with Selecta's well packaged products becomes a spraying and accessories store within your store.

TO QUALIFY FOR A FREE STORE-IN-STORE SHELVING DISPLAY:

A minimum stock order (value dependant on display size) is required to be placed in conjunction with the display stand order. For more information on this, contact your account manager or customer service on **1300 745 826**.

Store-In-Store Displays



AVAILABILITY

Products in the Silvan Price List are available through authorised Silvan and Selecta dealers.

TERMS

The Silvan terms and conditions are set out in your individual trading terms and at www.silvan.com.au/terms

PRICES

All prices are suggested list prices in Aus dollars. Prices are subject to change without prior notice. For stocking incentive programmes refer to your individual trading terms, or contact customer services staff on 1300 745 826.

GST

All prices are shown both inclusive of GST and exclusive of GST. All invoices will include GST.

FREIGHT CHARGES

Prices are ex Silvan Distribution Centres in Melbourne, Brisbane, Perth, Sydney & Adelaide (Sydney & Adelaide have limited stock lines). Check with Silvan Customer Service for freight charges into your area. Freight and handling charges will be added to the invoice amount.

TITLE AND RISK

Silvan retains title to all goods until paid for in full in clear funds. Risk in respect of goods passes to you as soon as the goods leave the Silvan Distribution Centre.

PPSA

Silvan may register a security interest over the goods as security for any payment. You will need to provide Silvan with all information, documents and consents as Silvan requires to register and maintain this security interest.

MINIMUM ORDER VALUE

A \$75 Minimum Order Value (Excl. GST) applies to all standard orders. Orders under the required minimum value will attract a \$23 handling charge (Inc. GST). A \$250 Minimum Order Value (Inc. GST) applies to hardware range orders. Urgent/breakdown orders don't have a required Minimum Order Value, and attract a \$23 priority fee (Inc. GST).

WARRANTY

The only warranty provided by Silvan is set out on the forms accompanying the goods (for a copy please contact the Silvan Customer Service Centre). No other warranty or representation is made by Silvan. The terms of Silvan's warranties are subject to the operation of any law including the Australian Consumer Law.

CANCELLATIONS

1. Cancellations made on the day the order was placed:
 - a. If stock isn't dispatched, no handling fee applies
 - b. If stock has been dispatched a restocking fee applies
2. Cancellations made after the day the order was placed, a restocking fee will apply.

RETURNS POLICY

1. Before returning any product to Silvan, a Return Authorisation (RA) Number and approval form must be obtained from Silvan Customer Service. Goods WILL NOT be accepted without an RA number and form.
2. All returns must be requested within 14 days of the invoice date.
3. Goods will only be accepted for credit if they are returned undamaged and in saleable condition.
4. Return freight will be paid by the Customer if the goods are returned at the Customer's volition, unless authorised by the Company in writing prior to return of the goods.
5. Written claims must reference Silvan invoice numbers, and must be dated and state the reason for the claim.
6. A restocking fee will be applied if the goods have been dispatched according to the order.
7. Return of products valued under \$50 (Excl. GST) won't be accepted if dispatched according to the order.

CLAIMS

Pricing & Freight Claims need to be made within 14 days of the invoice date. Any claims after this for pricing discrepancies will not be accepted. Claims for Freight Damage need to be made within 14 days of the invoice date by notifying Silvan Customer Service. Claims received after this will not be accepted.

DISCOUNT CODES

Refer to individual Trading Terms for specific discounts.

Return Authorisation Form

RETURN AUTHORISATION FORM - FOR DEALER USE ONLY

Date:	Customer account code:
Requested by:	Customer name:
Contact name and number:	

Silvan invoice number:	Customer order number:
Silvan invoice date:	Customer claim number:
Claim type:	<input type="checkbox"/> Return <input type="checkbox"/> Pricing/Discount <input type="checkbox"/> Other
Action Required:	<input type="checkbox"/> Credit <input type="checkbox"/> Replace
<i>NOTE: For warranty claims please refer to the Request for Warranty Assessment Form</i>	

Reason for Claim: _____

Part Number Claimed	Number of Units (Q)	Ex-GST Unit Credit (C)	Ex-GST Extended Value (Q) x (C)	Incl-GST Extended Value (Q) x (C) + 10%
Ancillary claim: Freight/Other				
Handling Fee %				
Attach extra pages if required	TOTAL CREDIT REQUESTED		\$	

Internal Use Only:	<u>Approved By:</u>	Reason Code:
<u>Claim Log:</u> Opened by:	Customer Service Mgr:	Date:
Closed by:	Department Mgr:	Date:

Is item to be returned to stock?: Yes No Return Warehouse: Put Location:

Comments: _____

Adjustment Note Comments: _____

Adjustment Note Number: Processed by: Process date:

Is item to be re-charged?: Yes No Account No. Re-Invoice number:

Re-invoice comments: _____

Cause of error: _____

Action to prevent reoccurrence: _____

Completed by: Date:

**FAX: 1800 745 826 OR CONTACT
SELECTA CUSTOMER SERVICE ON: 1300 745 826**

Internal use only: Claim #:



Warranty Claim Form

ALL WARRANTY ENQUIRIES MUST BE REFERRED TO AUTHORISED SILVAN/SELECTA DEALER

Fax or post Form to:
 Selecta Warranty Department
 P.O. Box 4453, Dandenong Sth
 Victoria, 3164, Australia
 Phone: 1300 745 826

Request for Warranty Claim



Aust. Fax: 1800 745 826

E-Mail: support@silvanaust.com

A.B.N. 48-099-851-144

Dealer:

Address:

Phone
OR
Email

Customer:

Address:

Phone
OR
Email

Dealer Claim No:

Silvan Invoice No:
(From purchase of item)

Date of Sale:
(Provide Proof of Purchase)

Date of Failure:

Claim Value: \$
(GST Exclusive)

Customer Invoice No:

Product:

Quantity:

Part/s Required:

<u>Detailed Nature of Fault & Cause:</u>	Labour at \$50.00	Number of Hours:
	Total Cost: \$	
<u>Action taken to rectify problem -Eq. Repaired or Replaced:</u>	Sublet Cost	
	\$ INCLUDE COPY OF SUBLET INVOICE	

Action Requested?	<u>Additional Information</u>
Issue a Credit Note <input type="checkbox"/>	
OR	
FOC Replacement <input type="checkbox"/>	

R.C.T.I. Authorisation: In line with current GST legislation warranty claims must be processed as tax invoices from the Dealer to Silvan.

I hereby authorise Silvan Australia Pty. Ltd. to raise a recipient created tax invoice on my behalf for the assessed value of this claim.

Claimant's Name: _____ **Dated:** _____
(PLEASE PRINT)

Signature: _____

***** Selecta Internal Use Only *****

DATE:	ACTIONED BY:
PTS:	RA:
SUB:	INVOICE/CREDIT:
LAB:	
PWA No:	



Silvan

Supporting Life on the Land

SINCE 1962



Silvan WHEELBARROW SPRAY

VERSATILE... EASY TO USE... HIGH QUALITY SPRAYERS!

AVAILABLE NOW!
ENQUIRIES WELCOME!

THE BEST IN PORTABLE SPRAYERS!

Silvan POW PRO

Call now (03) 800



Silvan Customer Service

We are ready to take your call.

Your phone call to 1300 SILVAN (1300 745 826) will direct you to our highly experienced Silvan Customer Service staff that will assist you with:

- Price and availability
- Product enquiries
- Back order advices
- Order entry
- Credit processing

If your enquiry is of a technical nature, our Customer Service team will transfer you to our National Spare Parts team for parts interpretation and parts sourcing, or our Warranty team for after sales service issues.

Call: **1300 SILVAN (1300 745 826)**

Fax: **1800 SILVAN (1800 745 826)**

e-Commerce



e-Commerce @ Silvan

Silvan's e-Commerce tool is available for immediate registration by clicking on the dealer login on the main page at www.silvan.com.au

This e-Commerce tool allows you to:

- Order online
- Enquire on your order status online
- *open orders, back orders, dispatched orders*
- Follow freight for your goods online
- *direct access to Freight con notes*
- Enquire on your invoices and credit notes online

For more details, phone Customer Service on **1300 SILVAN (1300 745 826)**.





Supporting Life on the Land

All prices are recommended prices and exclude any dealer installation and/or freight charges. Prices may vary between individual Silvan dealers. Recommended prices are effective from 1st September 2017.

The company reserves the right to change recommended prices and specifications without notice. All items in this Price List have been included in good faith on the basis that the goods described were available at the time this book was published. Failure of suppliers to deliver in accordance with samples, descriptions, or at all, or other unintentional causes may result in some lines being unavailable. Space may prevent some dealers from stocking all items. All brand names and product names used in this publication are trade names, registered trade marks, or pending trade marks of their respective owners.

SILVAN AUSTRALIA PTY. LTD.

ABN 48 099 851 144

Head Office: 244-264 Greens Road,
Dandenong South, VIC, Australia 3175

QLD. Office: Warehouse 2, 30 Gow Street,
Moorooka, QLD 4105

W.A. Office: 12 Cressall Road, Balcatta, WA 6021

Freecall: 1300 745 826

Fax: 1800 745 826

Email: info@silvanaust.com

Web: silvan.com.au

COPYRIGHT © SILVAN AUSTRALIA PTY. LTD. 2017



For more information call **1300 745 826** or visit: silvan.com.au

Reference No: 070-SEL-PL-17-18