



NEXT INNOVATION



M12 *Telemetry System*



Spread Spectrum
Technology By **SANWA**

User's Guide

M12 2.4GHZ FH4T RADIO CONTROL SYSTEM USER'S GUIDE

TABLE OF CONTENTS

GENERAL

Introduction.....	Page 2
Packaging.....	Page 2
Service and Support.....	Page 3
Safety.....	Page 3
FCC Compliance Statement.....	Page 3
2.4GHz Frequency Band Precautions.....	Page 4
Transmitter Precautions.....	Page 4
Receiver Precautions.....	Page 4
Servo Connectors.....	Page 4
System Features.....	Page 5
What's Included.....	Page 5
System Specifications.....	Page 5
Transmitter Overview Diagrams.....	Page 6
Receiver Overview Diagram, Connections and Mounting.....	Page 8
Transmitter and Receiver Overview Diagram Descriptions.....	Page 8
Transmitter Warning Alarms and LED Condition Indicators.....	Page 10
Transmitter Battery Options.....	Page 11
Alkaline Battery Installation.....	Page 11
Transmitter Battery Charging Options.....	Page 11
Warnings if Using a Li-Po or Li-Fe Battery Pack.....	Page 11
Steering Wheel and Throttle Trigger Spring Tension Adjustment.....	Page 12
Optional Steering Wheel Spring Installation.....	Page 12
Steering Wheel Travel Adjustment.....	Page 12
Optional Steering Wheel Installation.....	Page 13
Optional Grip Installation.....	Page 13
Throttle Trigger Angle Adjustment.....	Page 13
Wrist Strap Anchor Installation.....	Page 13
Throttle Trigger Position Adjustment.....	Page 14
Optional Steering Wheel Offset Plate Installation.....	Page 14
Optional Steering Wheel Angle Plate Installation.....	Page 15
Driving Position Adjustment.....	Page 16
Programming Keys Overview and Functions.....	Page 17
Display Screens Overview.....	Page 17
Main Menu Structure Overview.....	Page 19
Main Menus Overview.....	Page 20
Telemetry Screen Overview.....	Page 21
Transmitter and Receiver Binding.....	Page 23
System Menu Overview.....	Page 24
Includes System Programming Menu Contents.....	Page 24
Setup Menu Overview.....	Page 61
Includes System Programming Menu Contents.....	Page 61
Racing Menu Overview.....	Page 74
Includes System Programming Menu Contents.....	Page 74
Custom Menu Overview.....	Page 94
Includes System Programming Menu Contents.....	Page 94
Telemetry Connections and Mounting.....	Page 96
Troubleshooting Guide.....	Page 97
Racing Mode Functions by Car Type Table.....	Page 99
Trim Switch Functions Table.....	Page 100
Glossary of Terms.....	Page 101
Index.....	Page 106

 Additional Airtronics 2.4GHz FH2, FH3, FH4 and FH4T surface receivers* can be purchased and paired with the M12 transmitter. Due to differences in the implementation of 2.4GHz technology among different manufacturers, only Airtronics brand 2.4GHz surface receivers are compatible with your radio control system. Telemetry functions are available only when used with Telemetry-capable receivers (available separately). Visit your local Airtronics dealer or our website at <http://www.airtronics.net> for more information.

*Not all Features are Supported by all Types of Receivers. Some Features Limited by Receiver Type

PACKAGING

GENERAL

The packaging of your radio control system has been specially designed for the safe transportation and storage of the system's components. After unpacking your radio control system, do not discard the packaging materials. Save the packaging materials for future use if you ever need to send your radio control system to us for service or to store your radio control system if you don't plan on using it for an extended period of time.

M12 2.4GHZ FH4T RADIO CONTROL SYSTEM USER'S GUIDE

SERVICE AND SUPPORT

GENERAL

If you have any questions or concerns, we're here to help. If you encounter a problem with your radio control system, first check the *Troubleshooting Guide* section on pages 97 ~98. If you require further help, please contact us directly.

In North America Only:

Global Services	Telephone: 1-714-963-0329
18480 Bandilier Circle	Fax: 1-714-964-6236
Fountain Valley, CA 92708	Email: service@airtronics.net

If you made your purchase outside of North America, please contact your regional Airtronics/Sanwa agent for service and support.

SAFETY

GENERAL

This is a high-output, full-range radio control system that should well exceed the range needed for any surface Model. For safety, the user should perform a range test at the area of operation to ensure that the radio control system has complete control of the Model at the farthest reaches of the operational area. Rather than operating the Model, we recommend that the user enlist the help of a fellow modeler to walk the Model to the farthest reaches of the track (or for boats, to walk the shore line well in excess of the operational distance of the boat), then test for proper operation.

- Be certain to read this User's Guide in its entirety.
- 'Safety First' for yourself, others and your equipment.
- Observe all the rules of the field, track or lake where you operate your radio control equipment.
- If at any time during the operation of your Model, should you feel or observe erratic operation or abnormality, end your operation as quickly and safely as possible. DO NOT operate your Model again until you are certain the problem has been corrected. TAKE NO CHANCES.
- Your Model can cause serious damage or injury. Please use caution and courtesy at all times.
- Do not expose the radio control system to water or excessive moisture.
- Waterproof the receiver and servos by placing them in a water-tight radio box when operating R/C Model boats.
- If you have little to no experience operating R/C Models, we recommend you seek the assistance of an experienced modeler or your local hobby shop for guidance.
- The Low Voltage Alert alarm will sound when the transmitter battery voltage drops to the default threshold of 4.6 volts. If this occurs, stop using the transmitter as soon as is safely possible, then replace or recharge the transmitter batteries.

 This radio control system operates on the 2.4GHz frequency band. The 2.4GHz connection is determined by the transmitter and receiver pair. Unlike ordinary crystal-based systems, your Model can be used without frequency control.

FCC COMPLIANCE STATEMENT

GENERAL

This equipment has been tested and found to comply with the limits for a Class B digital device, pursuant to Part 15 of the FCC Rules. These limits are designed to provide reasonable protection against harmful interference in a residential installation. This equipment generates, uses, and can radiate radio frequency energy and, if not installed and used in accordance with the operating instructions, may cause harmful interference to radio communications. However, there is no guarantee that interference will not occur in a particular installation.

If this equipment does cause harmful interference to radio or television reception, which can be determined by turning the equipment OFF and ON, the user is encouraged to try to correct the interference by one or more of the following measures:

- Reorient or relocate the receiving antenna.
- Increase the separation between the equipment and the receiver.
- Connect the equipment into an outlet on a circuit different from that to which the receiver is connected.
- Consult the dealer or an experienced technician for help.

This device complies with Part 15 of the FCC Rules and with RSS-210 of Industry Canada. Operation is subject to the following two conditions:

- 1) This device may not cause harmful interference, and...
- 2) This device must accept any interference received, including interference that may cause undesired operation.

 Changes or modifications made to this equipment not expressly approved by Airtronics may void the FCC authorization to operate this equipment.

RF Exposure Statement:

This transmitter has been tested and meets the FCC RF exposure guidelines when used with the Airtronics accessories supplied or designated for this product, and provided at least 20cm separation between the antenna the user's body is maintained. Use of other accessories may not ensure compliance with FCC RF exposure guidelines.

M12 2.4GHZ FH4T RADIO CONTROL SYSTEM USER'S GUIDE

2.4GHZ FREQUENCY BAND PRECAUTIONS

GENERAL

- The 2.4GHz frequency band may be used by other devices, or other devices in the immediate area may cause interference on the same frequency band. Always before use, conduct a bench test to ensure that the servos operate properly. Also, conduct checks with the transmitter as distant as possible from your Model.
- The response speed of the receiver can be affected if used where multiple 2.4GHz transmitters are being used, therefore, carefully check the area before use. If response seems slow during use, stop your Model immediately and discontinue use.
- If the 2.4GHz frequency band is saturated (too many transmitters turned ON at once), as a safety precaution, the transmitter and receiver may not Bind. This ensures that your radio control system does not get hit by interference. Once the frequencies have been cleared, or the saturation level has dropped, your transmitter and receiver should Bind without any problems.

TRANSMITTER PRECAUTIONS

GENERAL

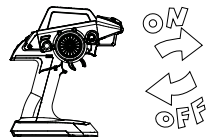

- To prevent possible damage to your servos or a runaway Model, turn the transmitter ON first, then turn the receiver ON. After running your Model, turn the receiver OFF first, then turn the transmitter OFF.

- Before use, double-check that the transmitter and receiver batteries have sufficient power.

- The transmitter antenna is mounted internally and is located in the vertical back portion of the carrying handle. Do NOT cover the carrying handle in any way during use! Doing so can block the RF signal, resulting in loss of control of your Model.



- During use, hold the transmitter so that its orientated as close to vertical as possible at all times. This provides the best RF signal between the transmitter and the receiver. Try not to ever 'follow' your Model with the transmitter, as this can result in a weakened RF signal.



- Do not expose the transmitter or any other components to excessive heat, moisture, fuel, exhaust residue, etc.

- If the outer case becomes dirty, it can be cleaned with a soft dry cloth. If the outer case becomes soiled, it can be cleaned with a damp cloth and liquid detergent.



- Do not use any solvents to clean the outer case. Solvents will damage the finish.

RECEIVER PRECAUTIONS

GENERAL

- The antenna consists of a coaxial cable and a reception wire (the thin tip at the end of the coaxial cable). When you mount the antenna, do not bend the reception wire. Reception performance decreases if the reception wire is bent.



- The antenna is delicate, therefore, handle with care. Do not pull on the antenna with force. Do not cut or extend the antenna.

- The coaxial cable (the thicker portion of the antenna) can be bent into gentle curves, however, do not bend the coaxial cable acutely, or repeatedly bend it, or the antenna core can be damaged.

- The antenna should be installed into a vertical plastic tube per your particular Model's assembly instructions. Keep the receiver antenna as far away from the motor, battery and ESC as possible.

- There is a danger of runaway operation if connectors shake loose during use. Make sure that the receiver, servo(s) and switch connectors are securely fitted.

- The receiver is susceptible to vibration, shock and moisture. Take appropriate measures to protect against vibration and moisture. Failure to take appropriate measures could result in runaway operation or damage to the receiver. We suggest wrapping the receiver in shock-absorbing foam or securing it with double-sided foam tape when installing it into your Model.

- When routing the antenna, avoid contact with any carbon or metal chassis components. Contact between metal or carbon parts can result in electrical noise, which can adversely effect receiver performance and possibly result in runaway operation and result in damage to your Model.

- With electric-powered Models, be sure to fit any brushed motors with a noise suppression capacitor. Without a noise suppression capacitor, excessive electrical noise generation can cause runaway operation and result in damage to your Model.

SERVO CONNECTORS

GENERAL

The receiver uses Airtronics 'Z' connectors, which are electronically compatible with the servos of other radio control system manufacturers. The connectors are rugged, but should be handled with care.



If using another brand of servo, double-check the polarity of the servo connector prior to plugging it into the receiver.



When unplugging the servo connector, don't pull on the servo wire itself. This could result in damage to the servo wire pins in the plastic plug. Always grasp the plastic connector itself.

M12 2.4GHZ FH4T RADIO CONTROL SYSTEM USER'S GUIDE

SYSTEM FEATURES

GENERAL

- 4-Channel 2.4GHz FH4T Digital High-Response Telemetry System with Advanced Programming
- Large LCD Screen Features STATUS screen, ASSIGN screen and TELEMETRY screen*
- High-Power FH4T Technology Provides the Best Reception and Connectivity, Giving Racers Added Assurance
- 4-Cell Dry Battery Holder for Lighter Weight - Also Accepts Optional Ni-Cd/Ni-MH Batteries or 2S Li-Po/Li-Fe Battery Pack
- Includes RX-471 2.4GHz FH4 Super Response Receiver
- 50 Model Memory
- Direct Model Select Up to 3 Models
- Adjustable Steering and Throttle Channel Response Time
- 10 Car Type Templates Including 3 Crawler Setups
- User-Selectable Start-Up Screen
- PC-Link Allows PC-Connectivity Using Mini USB Cable
- Receiver Safety Link
- Large, Easy-to-Reads LCD with Smooth Scrolling
- Telemetry Logging and Servo Monitor
- Five Racing Modes Allow Setup Changes on the Fly While Driving
- Model Select, Naming, Copy, Clear and Sort
- Selectable Modulation Type
- Programmable Push-Button Switches, Trim Switches, Lever and Dial
- Configurable Vibration Alarms and Timers
- User Naming
- Servo Reversing
- Steering, Throttle and Brake Dual Rate
- End Point Adjustment
- Exponential, ARC and Curve Adjustments
- Servo Speed Adjustment
- Anti-Lock Braking
- Throttle Offset
- Throttle Hold
- Lap Timer and Two Interval Timers
- Large, Easy-to-Read Lap Timer Display
- Two Compensation Mixers
- Channel Set Menu
- Normal, SSR and SHR Servo Modes
- Center or Parallel Trim Types
- Programmable Fail Safe
- Receiver Battery Voltage Fail Safe
- Digital Trims
- Servo Sub-Trim
- Variable Rate Adjustment
- Selectable Throttle Bias
- Adjustable Key Volume and Tone
- Programmable Low Voltage Alert and Limit Alarms
- Separate Display Button
- Inactivity and Over Voltage Alarms
- Digital Battery Voltage Monitor
- Adjust for Right-Handed or Left-Handed Use

*Requires Airtronics RX-461, RX-462 or Other Airtronics FH4T Telemetry Receiver, Available Separately

WHAT'S INCLUDED?

GENERAL

In addition to the transmitter, receiver and on/off switch, a number of optional items are included to customize the transmitter to your exact liking. This ensures the best comfort and feel during many hours of use.

- M12 FH4T Digital High-Response Telemetry Transmitter
- RX-471 Super Response Receiver
- On/Off Switch
- Optional Grips (Large and Small)
- Optional Larger Diameter Steering Wheel
- Optional Steering Wheel Angle Plates (Right and Left)
- Optional Steering Wheel Offset Plate
- Optional Steering Wheel Springs (Soft and Hard)
- Optional Throttle Trigger Angle Brackets (Thin and Thick)
- Receiver Dust Boot Covers
- Transmitter Wrist Strap Mount

SYSTEM SPECIFICATIONS

GENERAL

Transmitter:

- Model: M12
- Output Power: 100mW
- Nominal Input Voltage: 4.8v ~ 7.4v
- Operating Voltage Range: 4.0v ~ 9.0v
- Dry Weight: 20.8oz (590g)
- Frequency: 2.4GHz FHSS
- Modulation Type: FH2, FH3, FH3F, FH4T, FH4FT

Receiver:

- Model: RX-471 Super Response
- Nominal Input Voltage: 4.8v ~ 7.4v
- Weight: 0.23oz (6.6gr)
- Dimensions: 1.18 x 0.91 x 0.55in (30.0 x 23.3 x 14.0mm)
- Frequency: 2.4GHz FH3/FH4 Selectable Via Transmitter
- Fail Safe Support: Yes (All Channels)
- Battery Voltage Fail Safe Limit: 3.5 ~ 5.0v (FH3) / 3.5 ~ 7.4v (FH4)

M12 2.4GHZ FH4T RADIO CONTROL SYSTEM USER'S GUIDE

TRANSMITTER OVERVIEW DIAGRAMS

GENERAL

Use the diagrams in this section to familiarize yourself with the layout of your transmitter. Descriptions of these features can be found in the *Transmitter and Receiver Overview Diagram Descriptions* section on pages 8 ~ 9.

! The transmitter antenna is mounted internally and is located in the vertical back portion of the carrying handle. Do NOT cover the carrying handle in any way during use! Doing so can block the RF signal, resulting in loss of control of your Model. During use, hold the transmitter so that its orientated as close to vertical as possible at all times. This provides the best RF signal between the transmitter and the receiver. Try not to ever 'follow' your Model with the transmitter, as this can result in a weakened RF signal.

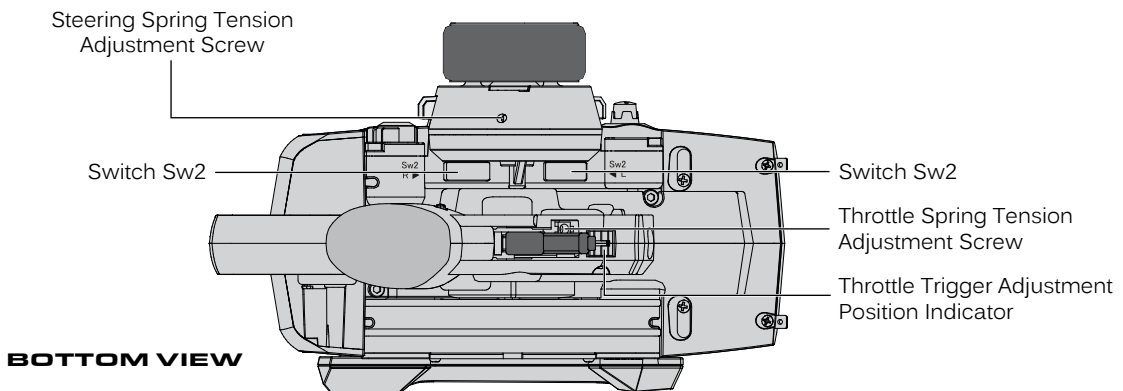
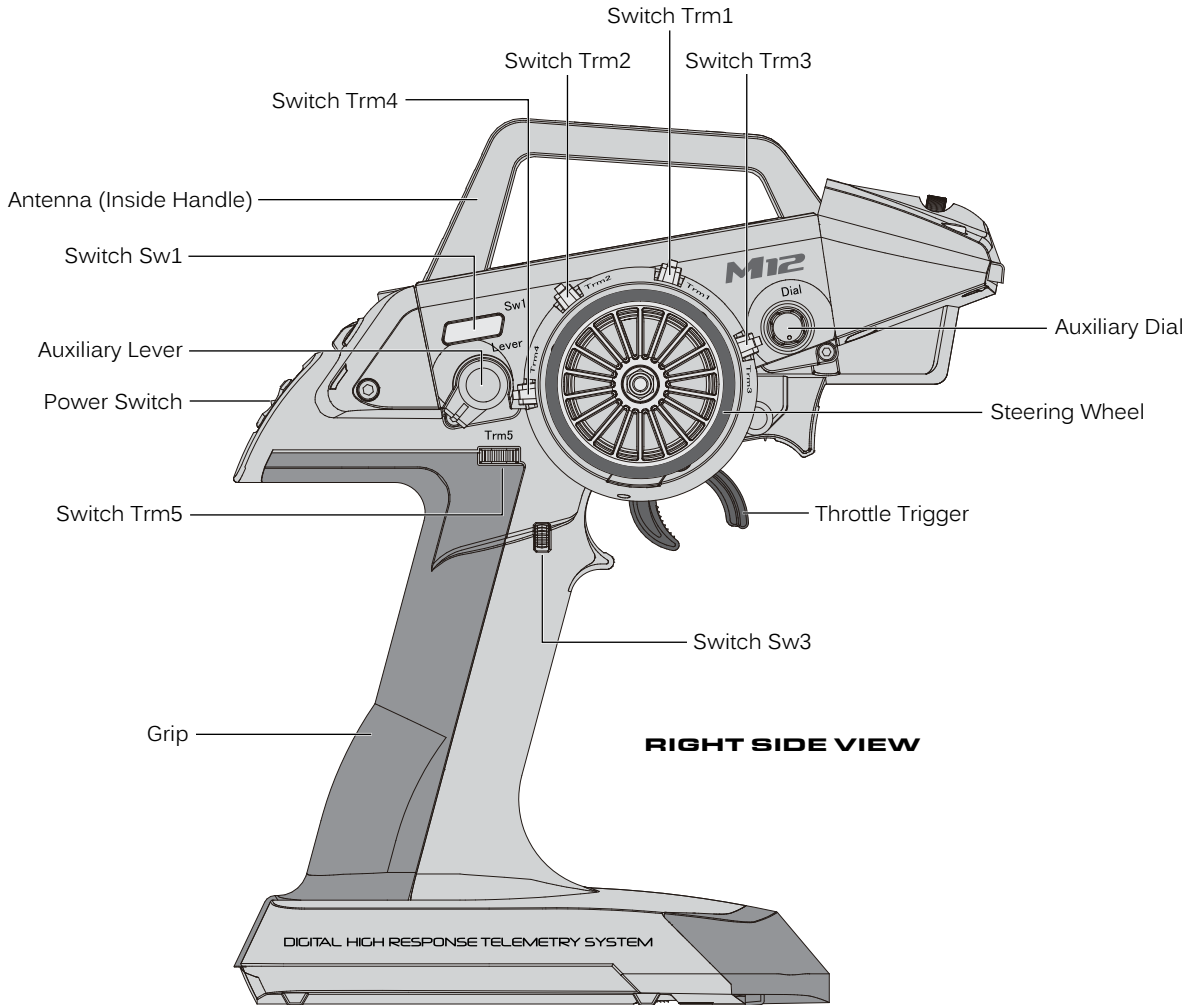

M12 2.4GHZ FH4T RADIO CONTROL SYSTEM USER'S GUIDE

TRANSMITTER OVERVIEW DIAGRAMS

GENERAL

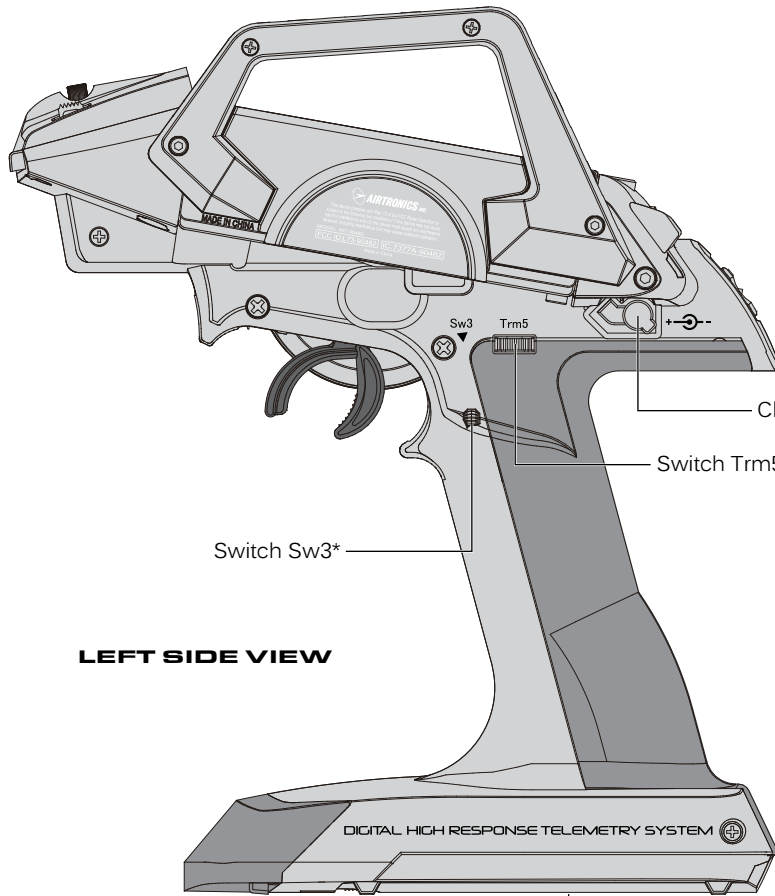

LEFT SIDE VIEW

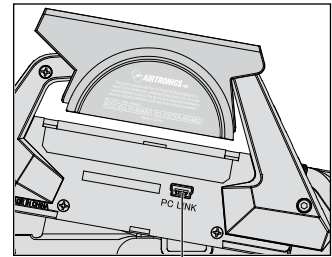

PC-Link Input
(Under Cover)

Charge Jack

Switch Trm5*

Switch Sw3*

Battery Compartment

*For Left-Handed Use

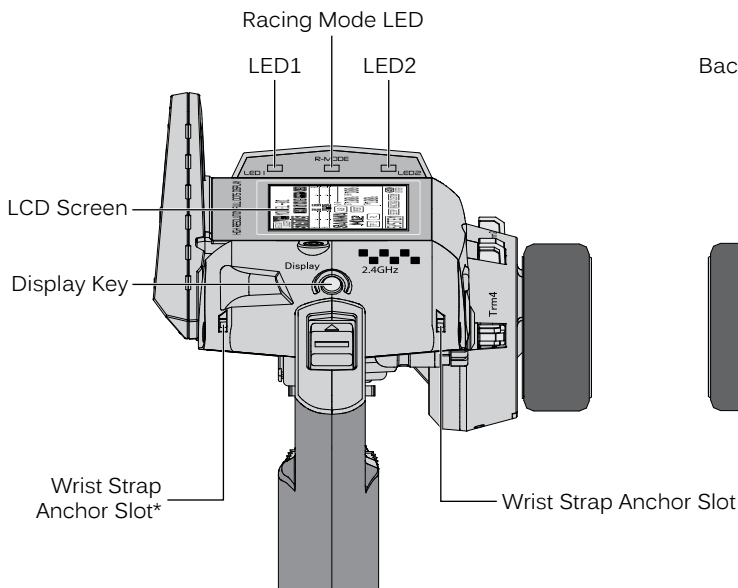

REAR VIEW

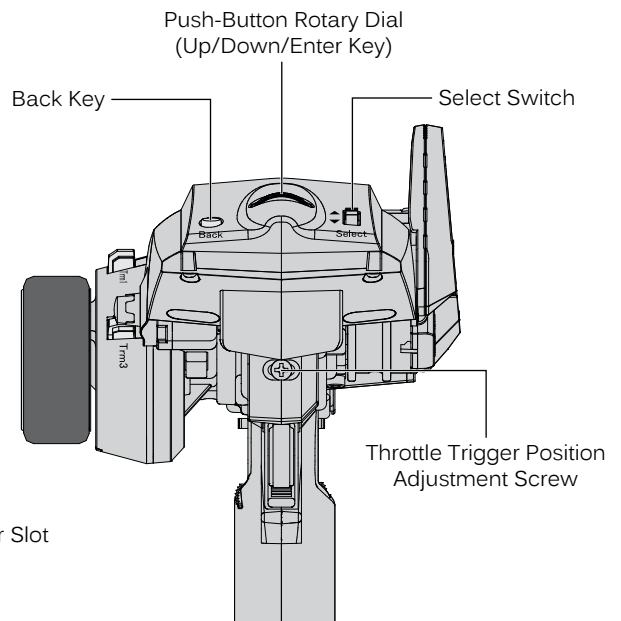

FRONT VIEW

M12 2.4GHZ FH4T RADIO CONTROL SYSTEM USER'S GUIDE

RECEIVER OVERVIEW DIAGRAM, CONNECTIONS AND MOUNTING

GENERAL

Use the diagrams in this section to make receiver connections and to familiarize yourself with the RX-471 4-Channel 2.4GHz FH4 Super Response receiver included with your M12 radio control system. Descriptions of the features can be found in the *Transmitter and Receiver Features Descriptions* section below and on the next page.

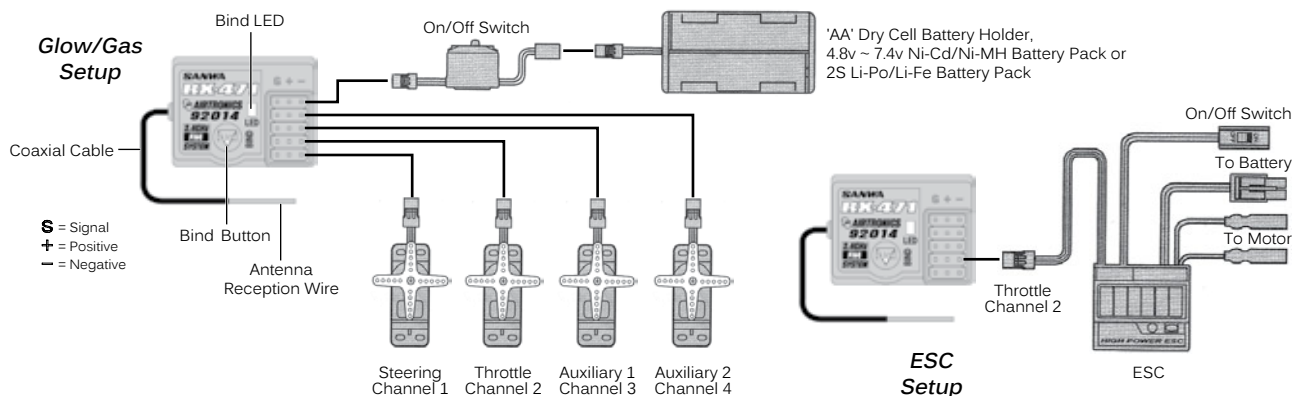

The receiver's Nominal Input Voltage is 4.8 ~ 7.4 volts. A 2 cell Li-Po or Li-Fe battery pack can be used to power the receiver without the use of a voltage regulator. In addition, this allows you to take advantage of the Higher torque and speed provided by using 7.4 volt digital servos.

Use a 2 cell Li-Po or Li-Fe battery pack ONLY if your servos are rated to handle the Higher voltage.

- We suggest Binding the transmitter and receiver and making all receiver connections to check for correct operation prior to mounting the receiver in your Model.
- The receiver should be mounted as far away from any electrical components as possible. When routing the antenna, avoid contact with any carbon or metal chassis components. Contact between metal or carbon parts can result in electrical noise, which can adversely effect receiver performance and possibly result in runaway operation and result in damage to your Model.
- Route the receiver antenna up through a plastic tube so that it is in the vertical position. Do not bend the reception wire. Reception performance decreases if the reception wire is bent. Do not pull on the antenna with force. Do not cut or extend the antenna. The coaxial cable can be bent into gentle curves, however, do not bend the coaxial cable acutely, or repeatedly bend it, or the antenna core can be damaged.
- To protect the receiver from vibration and other damage, we recommend wrapping the receiver in shock absorbing foam or using double-sided foam tape when installing it in your Model.

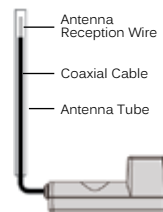

! As a safety precaution, set your Model on a stand so the wheels are off the ground before turning on your radio control system or connecting your motor for the first time.

Bind LED Condition Indicator:

The Bind LED on the receiver can be used to determine receiver condition at a glance. The Bind LED will alert you to various receiver conditions, as shown in the table below.

LED COLOR	LED CONDITION	RECEIVER STATUS
Blue	ON	Receiving RF Signal
Blue	Slow Flash/Fast Flash	Binding Operation
Red & Blue	Flash	Receiver Battery Fail Safe Activates
Red	ON	No RF Signal After Receiver Battery Fail Safe Activates

TRANSMITTER AND RECEIVER OVERVIEW DIAGRAM DESCRIPTIONS

GENERAL

Antenna: Transmits the signal from the transmitter to the receiver in the Model.

Antenna Reception Wire: The portion of the receiver antenna that receives the transmitter signal. The Antenna Reception Wire should never be bent or it could be damaged and limit the range of your Model.

Auxiliary Dial: The Auxiliary Dial can rotate 360° and is programmable to perform a different function depending on what function is Assigned to it. In the default configuration, it controls Auxiliary 1 High and Low servo travel.

Auxiliary Lever: The Auxiliary Lever is programmable and will perform a different function depending on what function is Assigned to it. In the default configuration, it controls Auxiliary 2 High and Low servo travel.

Back Key: Pressing the BACK key returns the Programming Cursor to the previous menu. Press the BACK key repeatedly to return to the STATUS screen.

Battery Compartment: Houses the four 'AA' Alkaline cells that power the transmitter. Alternatively, the transmitter can be powered using four 'AA' Ni-Cd or Ni-MH rechargeable batteries or a 2S Li-Po or Li-Fe battery pack.

Bind Button: Used in the process of Binding the transmitter and receiver.

Bind LED: Displays the current operating status of the receiver.

Charge Jack: Used for onboard charging of optional Ni-Cd or Ni-MH batteries. Do not attempt to charge Alkaline batteries. Only the recommended Airtronics 110v AC charger should be used through the Charge Jack. If using an after-market Peak-Detection charger or other type of fast charger, the batteries should be removed from the transmitter to avoid damage to the transmitter circuitry and/or your batteries. Do not attempt to charge a Li-Po or Li-Fe battery pack through the Charge Jack.

Coaxial Cable: The portion of the receiver antenna that extends the Antenna Reception Wire. The Coaxial Cable can be bent into gentle curves, however, do not bend it acutely, or repeatedly bend it or the antenna core can be damaged.

Display Key: Turns the transmitter's LCD Screen ON without actually turning the transmitter ON. This allows you to check and/or change programming options without actually turning the transmitter ON. To turn only the LCD Screen ON, press and HOLD the DISPLAY key for approximately 3 seconds. To turn the LCD Screen OFF, press the DISPLAY key once.

Grip: The Grip is molded from rubber in an ergonomic shape for increased comfort, control and feel.

LED1: Displays the current RF signal output status of the transmitter. When illuminated, an RF signal is being transmitted. When extinguished, no RF signal is being transmitted. In addition, LED1 is used to indicate various transmitter conditions.

LED2: Displays the current status of the Telemetry connection. When illuminated, no Telemetry connection is present. When extinguished, the Telemetry connection is Active. In addition, LED2 is used to indicate various transmitter conditions.

LCD Screen: The heart of the programming and display features of the transmitter. All programming and transmitter display functions are shown on the LCD Screen. The M12 features a large, backlit LCD Screen with smooth scrolling.

PC-Link Input: When used with an USB cable with a Mini USB connector (available separately), the PC-Link Input allows you to save Telemetry Data Logs and Model Programming Data to your PC. In addition, it also allows you to load saved Model Programming Data from your PC and update the M12's software version.

Power Switch: Turns the transmitter ON and OFF.

Push-Button Rotary Dial: The Push-Button Rotary Dial (also referred to as the UP key, DOWN key and ENTER key) is used along with the BACK key and the SELECT switch to facilitate transmitter programming. It allows you to quickly and easily navigate the various Programming Menus and switch between the STATUS screen, ASSIGN screen and TELEMETRY screen.

Push-Button Switches: The transmitter features three Push-Button Switches in different locations (Sw1, Sw2 and Sw3). Each Push-Button Switch is programmable and will perform a different function depending on what function is Assigned to it. For example, Sw1 can be used to operate a reverse servo in a gas- or glow-powered Model and Sw3 can be used to toggle Anti-Lock Braking ON and OFF. Sw2 is a Rocker Switch that can be pressed from either the Front or the Back.

Racing Mode LED: Displays the currently Active Racing Mode. The color of the LED will vary depending on which of the Five Racing Modes is Active. When extinguished, Racing Mode is Inhibited.

Select Switch: Used along with the Push-Button Rotary Dial and the BACK key to facilitate transmitter programming. Use the SELECT switch to scroll through the STATUS screen's main menus, scroll through the TELEMETRY pages and make selections in many of the Programming Menus.

Steering Spring Tension Adjustment Screw: Used to adjust the spring tension of the Steering Wheel to best suit the feel of the user. Turning the Steering Spring Tension Adjustment Screw clockwise increases Steering Wheel spring tension and turning the Steering Spring Tension Adjustment Screw counter-clockwise decreases Steering Wheel spring tension.

Steering Wheel: Proportionally operates the Model's Right and Left Steering control. The Steering Wheel features a foam grip for increased comfort, control and feel. The Steering Wheel's position, angle and spring tension can all be adjusted.

Throttle Trigger: Controls the speed of the Model, both forward and backward, or the Model's Brake. The Throttle Trigger position, angle and spring tension can all be adjusted.

Throttle Spring Tension Adjustment Screw: Used to adjust the spring tension of the Throttle Trigger to best suit the feel of the user. Turning the Throttle Spring Tension Adjustment Screw clockwise increases Throttle Trigger spring tension and turning the Throttle Spring Tension Adjustment Screw counter-clockwise decreases Throttle Trigger spring tension.

Throttle Trigger Adjustment Position Indicator: Indicates the current position of the Throttle Trigger. As the Throttle Trigger position is adjusted forward or backward, the Throttle Trigger Adjustment Position Indicator will move forward or backward.

Trim Switches: The transmitter features five separate Trim Switches - four positioned around the Steering Wheel (Trm1, Trm2, Trm3 and Trm4) and one positioned below the Auxiliary Lever (Trm5). Each Trim Switch is programmable and will perform a different function depending on what function is Assigned to it. For example, Trm1 and Trm2 can be used to adjust Steering and Throttle Trim and Trm4 and Trm5 can be used to adjust Dual Rate and Steering EPA.

Wrist Strap Anchor Slot: Used to attach the wrist strap anchor to the transmitter.

The M12 is equipped with several different Audible Warning Alarms to warn you of an abnormal transmitter condition. In addition, LED1, LED2 and the R-MODE LED are used to indicate various transmitter conditions at a glance.

Audible Warning Alarms

The audible alarms listed below may also be accompanied by an on-screen warning.

Inactivity (Power ON) Alarm:

The Inactivity Alarm will sound if the transmitter is Left on for a period of 10 minutes without any control input from the user. This alarm alerts you to prevent unwanted draining of the transmitter battery. To clear this alarm, either turn the transmitter OFF or press the BACK key or the ENTER key.

Over Voltage Alarm:

The Over Voltage Alarm will sound if the transmitter battery voltage is greater than 9.6 volts. To clear this alarm, turn the transmitter OFF and replace the transmitter battery with one that when fully charged does not exceed 9.6 volts.

Low Voltage Alert Alarm:

The Low Voltage Alert alarm will sound when the transmitter batteries reach the Low Voltage Alert alarm voltage value programmed in the SYSTEM - BATTERY menu. The alarm will sound each time the transmitter battery voltage decreases by 0.1 volt. To clear this alarm, press the BACK key or the ENTER key.

Low Voltage Limit Alarm:

The Low Voltage Limit alarm will sound when the transmitter batteries reach the Low Voltage Limit alarm voltage value programmed in the SYSTEM - BATTERY menu. This alarm can only be cleared by turning the transmitter OFF and recharging or replacing the transmitter batteries.

LED Condition Indicators

LED1, LED2 and the R-MODE LED are used to indicate various transmitter conditions at a glance. Some of the conditions indicated by the LEDs may also be accompanied by an audible alarm and/or and on-screen warning.

TRANSMITTER STATUS	LED1 CONDITION	LED2 CONDITION	R-MODE LED CONDITION
Display Mode	OFF	-----	-----
RF Output Signal	ON	-----	-----
Throttle Offset Function Active	0.1 Sec. Flash	-----	-----
Telemetry Logger Function Active	0.5 Sec. Flash	-----	-----
RF Binding - Sending Bind Code	0.35 Sec. Flash	-----	-----
PC-Link USB Send/Receive Active	0.05 Sec. Flash	-----	-----
Inactivity Alarm Active	-----	0.1 Sec. Flash	-----
Telemetry Alarm Active	-----	0.1 Sec. Flash	-----
Telemetry Connection Active	-----	OFF	-----
No Telemetry Connection	-----	ON	-----
Low Voltage Alert Alarm Active	-----	0.35 Sec. Flash	-----
Low Voltage Limit Alarm Active	-----	0.05 Sec. Flash	-----
Over Voltage Alarm Active	-----	0.05 Sec. Flash	-----
Transmitter Error	1 Sec. Flash	1 Sec. Flash	OFF
Programming Data/Update Error	-----	1 Sec. Flash	OFF
Unrecoverable Update Error	-----	-----	OFF
Racing Mode 1 Active	-----	-----	Green
Racing Mode 2 Active	-----	-----	Magenta
Racing Mode 3 Active	-----	-----	Cyan
Racing Mode 4 Active	-----	-----	Yellow
Racing Mode 5 Active	-----	-----	White
Racing Mode Function Inhibited	-----	-----	OFF

----- Indicates HOLD Condition. LED May Be ON or OFF Depending on Other Specific Conditions

M12 2.4GHZ FH4T RADIO CONTROL SYSTEM USER'S GUIDE

TRANSMITTER BATTERY OPTIONS

GENERAL

The M12 transmitter's Operating Voltage Range is 4.0 ~ 9.6 volts. This allows you to use several different battery options (not included), depending on your preference.

Alkaline - In the default configuration, the transmitter is designed to be powered using four 'AA' Alkaline batteries. This results in a transmitter that is lightweight and well-balanced for unmatched comfort.

Ni-Cd/Ni-MH - Rechargeable Ni-Cd or Ni-MH batteries of desired capacity can be used in place of the Alkaline batteries. Using rechargeable Ni-Cd or Ni-MH batteries is more convenient and cheaper in the long run. The Higher capacity batteries will also provide longer usage time than most Alkaline batteries.

Li-Po or Li-Fe - A 2 cell Li-Po or Li-Fe battery pack can be used to power the transmitter. These battery packs are popular due to their light weight and high capacity for long usage time between charges.

⚠ Transmitter power output, range and speed are the same, regardless of the battery type used. If using a Li-Po or Li-Fe battery pack, please read the *Warnings if Using a Li-Po or Li-Fe Battery Pack* section below.

ALKALINE BATTERY INSTALLATION

GENERAL

1) Remove the battery cover from the bottom of the transmitter by pushing firmly on the battery cover in the direction of the arrow.

2) Install four fresh 'AA' Alkaline batteries into the battery holder, making sure that the polarity is correct. The direction that each battery should be installed is molded into the bottom of the battery holder (+ Positive and - Negative).

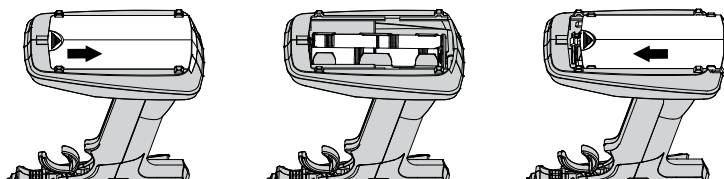

3) Slide the battery cover back onto the transmitter and push it firmly until it 'clicks' closed.

⚠ When installing the batteries, remove the battery holder and double-check that the battery holder is plugged in. If it isn't, plug the connector on the battery holder into the matching connector in the transmitter.

TRANSMITTER BATTERY CHARGING OPTIONS

GENERAL

The M12 transmitter features a Charge Jack that can be used with the Airtronics 95034 Dual Output charger (available separately) to charge the optional Ni-Cd or Ni-MH batteries. This allows you to charge these batteries without removing them from the transmitter. A Charge Jack is located on the Left side of the transmitter. For more information, see the *Transmitter Overview Diagrams* section on page 7.

WARNING: Do NOT attempt to recharge Alkaline batteries. Only Ni-Cd or Ni-MH batteries should be charged through the transmitter's Charge Jack, using only the Airtronics 95034 Dual Output charger or equivalent overnight/slow charger. Do NOT attempt to charge a Li-Po or Li-Fe battery pack through the Charge Jack.

Do NOT use the Charge Jack with a fast charger or a peak-detection charger, or the transmitter could be damaged!

If you use a fast charger or a peak-detection charger to charge the transmitter batteries, the battery holder must be removed from the transmitter first. The circuitry within the transmitter will interfere with the peak-detection charger's normal operation, resulting in over-charging and damaging the batteries and possibly the transmitter itself. In addition, the Higher charge rate common in many fast chargers can damage the transmitter's circuitry.

Damage caused by fast-charging through the transmitter or using an incorrect battery type will not be covered under warranty!

WARNINGS IF USING A LI-PO OR LI-FE BATTERY PACK

GENERAL

- Use ONLY a 2 Cell Li-Po or Li-Fe battery pack of desired capacity.
- Do NOT charge your Li-Po or Li-Fe battery pack through the Charge Jack. The battery pack MUST be removed from the transmitter prior to charging or the transmitter could be damaged. For more information, see the WARNING in the *Transmitter Battery Charging Options* section above.
- Use a charger specifically designed to charge Li-Po or Li-Fe battery packs.
- When changing the connector on your battery pack to match the battery connector in the transmitter, please observe correct polarity. Connecting with reverse polarity will damage the transmitter.
- Observe all safety precautions provided with your Li-Po or Li-Fe battery pack.
- Damage to the transmitter caused by improper use, wrong battery type, incorrect voltage, reverse polarity or charging through the Charge Jack will not be covered under warranty!

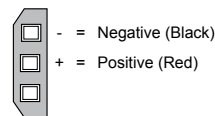

⚠ The transmitter has a Nominal Input Voltage range of 4.8 ~ 7.4 volts. **DO NOT USE A 3 CELL Li-Po or Li-Fe battery pack** or the transmitter will be damaged!

M12 2.4GHZ FH4T RADIO CONTROL SYSTEM USER'S GUIDE

STEERING WHEEL AND THROTTLE TRIGGER SPRING TENSION ADJUSTMENT

GENERAL

The spring tension of the Steering Wheel and Throttle Trigger can be adjusted to best suit the user. Some users may prefer the Throttle Trigger and/or Steering Wheel to feel 'firmer' and some users may prefer them to feel 'softer'. It all depends on your personal preference.

To adjust the Throttle Trigger spring tension, follow the step below:

- 1) To Increase the spring tension of the Throttle Trigger (make firmer), use a 1.5mm hex wrench to turn the Throttle Spring Tension Adjustment Screw (A) clockwise. To Decrease the spring tension of the Throttle Trigger (make softer), turn the Throttle Spring Tension Adjustment Screw counter-clockwise.

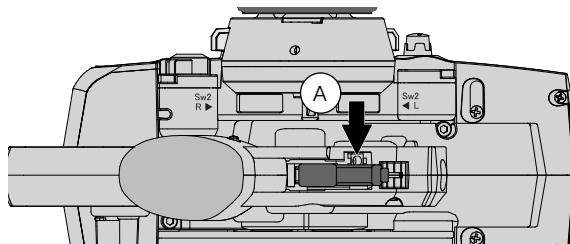

To adjust the Steering Wheel spring tension, follow the step below:

- 1) To Increase the spring tension of the Steering Wheel (make firmer), use a 1.5mm hex wrench to turn the Steering Spring Tension Adjustment Screw (A) clockwise. To Decrease the spring tension of the Steering Wheel (make softer), turn the Steering Spring Tension Adjustment Screw counter-clockwise.

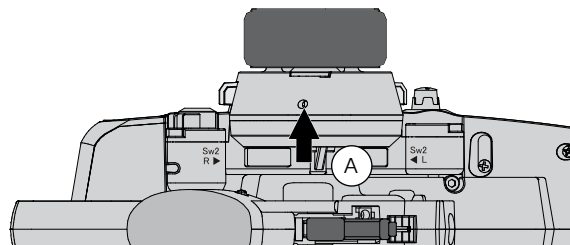

OPTIONAL STEERING WHEEL SPRING INSTALLATION

GENERAL

Two optional Steering Wheel springs (one soft and one hard) are included should adjusting the spring tension as described above not give you the desired feel. Use the hard spring for a firmer feel and soft spring for a softer feel.

To install one of the optional Steering Wheel springs, follow the steps below:

- 1) Use a 7mm nut driver to remove the Steering Wheel retaining nut, then pull the Steering Wheel straight off.
- 2) Use a small philips head screwdriver to remove the spring cover retaining screw (A), then remove the plastic spring cover.
- 3) Using a small pair of needle nose pliers, carefully unhook the top of the spring from the metal peg, then remove the spring.
- 4) Carefully install the desired optional spring, then reinstall the plastic spring cover and the Steering Wheel. Installation is the reverse of removal.

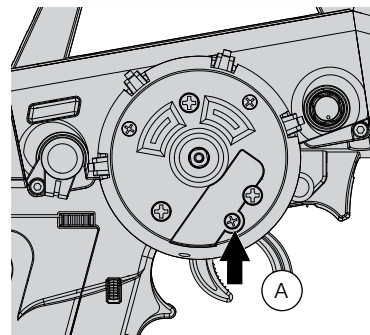

STEERING WHEEL TRAVEL ADJUSTMENT

GENERAL

The maximum Right and Left travel of the Steering Wheel can be adjusted to best suit the feel of the Steering Wheel and your driving style. Some drivers prefer to limit the travel of the Steering Wheel as it makes them feel more 'connected' to their Model.

To adjust the maximum travel of the Steering Wheel, follow the steps below:

- 1) Remove the foam Steering Wheel grip from the Steering Wheel by firmly pulling it straight off.
- 2) To limit the maximum travel of the Steering Wheel, use a 1.5mm hex wrench to turn both grub screws in the Steering Wheel adapter hub clockwise equally the desired amount. To maximize the travel of the Steering Wheel, turn both grub screws in the Steering Wheel adapter hub counter-clockwise equally the desired amount.

⚠ After making Steering Wheel travel adjustments, you must use the Variable Rate Adjustment function to ensure your Steering servo travel limits are equalized. For more information, see the *VR ADJUST Menu* section on pages 44 ~ 46.

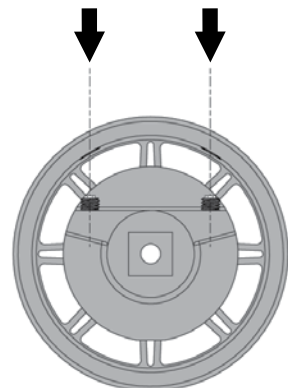

⚠ Limiting the maximum travel of the Steering Wheel will increase the sensitivity of the Steering. We recommend setting Negative Exponential or ARC percentage values to Soften the control feel around Neutral. For more information, see the *CURVE Menu* section on pages 78 ~ 82.

M12 2.4GHZ FH4T RADIO CONTROL SYSTEM USER'S GUIDE

OPTIONAL STEERING WHEEL INSTALLATION

GENERAL

An optional larger diameter Steering Wheel is included to best suit the user. Some user's feel that the larger diameter Steering Wheel makes the Steering operation seem finer.

To install the optional larger diameter Steering Wheel, follow the steps below:

- 1) Use a 7mm nut driver to remove the Steering Wheel retaining nut, then pull the Steering Wheel straight off.
- 2) Remove the foam Steering Wheel grip from the Steering Wheel by firmly pulling it straight off.
- 3) Pull the Steering Wheel adapter hub from the original Steering Wheel then push it into the optional Steering Wheel.
- 4) Slide the foam grip over the new Steering Wheel, then reinstall the Steering Wheel. Installation is the reverse of removal.

OPTIONAL GRIP INSTALLATION

GENERAL

Two optional Steering Wheel grips (one small and one large) are included to best suit the user. Some user's may find that one of these two grips feels more comfortable than the normal size stock grip.

To install one of the optional grips, follow the steps below:

- 1) Remove the original grip from the handle by firmly pulling down on the back of the grip (at the top), then by pulling the grip out along its Front edges.
- 2) To install the new grip, align the molded tabs in the grip with the matching slots in the handle, then firmly push the molded tabs into the slots, working your way around the grip until the edges of the grip are flush with the handle.

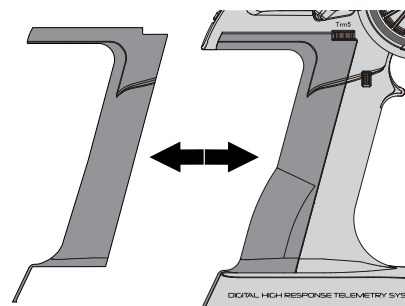

THROTTLE TRIGGER ANGLE ADJUSTMENT

GENERAL

The angle of the Throttle Trigger can be adjusted Right or Left to change the feel of the Throttle Trigger during use. Some users may prefer the Throttle Trigger straight while some users may prefer the Throttle Trigger angled toward the Right or Left. It all depends on your personal preference. Two Throttle Trigger adjustment plates are included to fine-tune the angle.

To adjust the Throttle Trigger angle, follow the steps below:

- 1) Use a philips head screwdriver to remove the Throttle Trigger mounting screw (A) from the Left side of the transmitter.
- 2) Use the tip of a modeling knife to carefully pop the trigger adjustment plate (B) out of the transmitter.

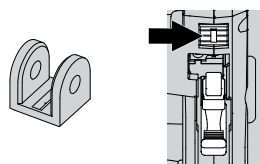
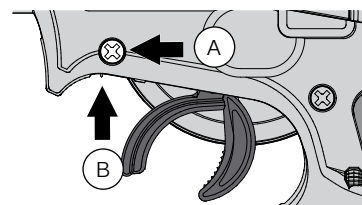

A - Throttle Trigger Centered (Stock)

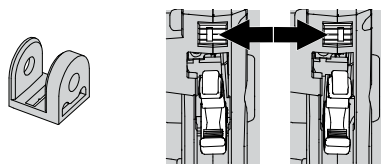

B - Throttle Trigger Angled Slightly. Angle Right or Left Depending on Orientation.

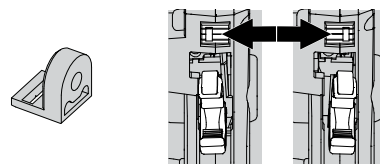

C - Throttle Trigger Angled More. Angle Right or Left Depending on Orientation.

- 3) Carefully press the desired trigger adjustment plate (B) into the transmitter, making sure to orientate it in the direction you want to angle the Throttle Trigger, then reinstall and tighten the Throttle Trigger mounting screw (A).

WRIST STRAP ANCHOR INSTALLATION

GENERAL

A wrist strap anchor is included that can be installed onto the transmitter to facilitate the use of a wrist strap (not included).

To install the wrist strap anchor, follow the steps below:

- 1) Using a 2.5mm hex wrench, remove the wrist strap anchor mounting screw (A) from the Right side of the transmitter.
- 2) Slide the wrist strap anchor into the mounting slot in the back of the transmitter, then reinstall and tighten the wrist strap anchor mounting screw (A).

⚠ When installing the wrist strap anchor, note its orientation. The U-Shaped groove (B) in the base of the wrist strap anchor should be pointing down.

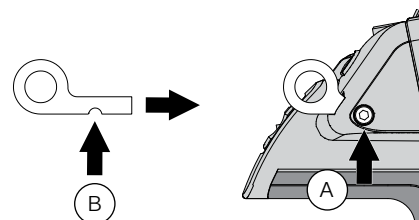

THROTTLE TRIGGER POSITION ADJUSTMENT

GENERAL

The position of the Throttle Trigger can be adjusted forward or backward to change the feel of the Throttle Trigger during use. Some users may prefer the Throttle Trigger positioned farther forward and some users may prefer the Throttle Trigger positioned farther back. It all depends on your personal preference.

To adjust the Throttle Trigger position, follow the steps below:

- 1) Use a philips head screwdriver to loosen the Throttle Trigger mounting screw (A) from the Left side of the transmitter.
- 2) To move the Throttle Trigger backward, use a philips head screwdriver to turn the Throttle Trigger Position Adjustment Screw (B) counter-clockwise. To move the Throttle Trigger forward, turn the Throttle Trigger Position Adjustment Screw (B) clockwise.

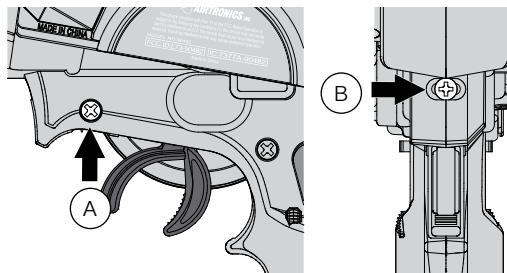

- 3) When satisfied with the adjustment, tighten the Throttle Trigger mounting screw (A).

! As you adjust the Throttle Trigger position, the Throttle Trigger Position Adjustment Indicator (C) will move, indicating the current position of the Throttle Trigger.

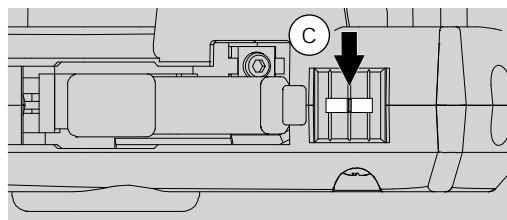

! The total adjustment range is approximately 5mm. Do not attempt to adjust the Throttle Trigger position beyond the limits indicated by the Throttle Trigger Position Adjustment Indicator or damage may result. Moving the Throttle Trigger position does not affect the physical movement of the Throttle Trigger.

OPTIONAL STEERING WHEEL OFFSET PLATE INSTALLATION

GENERAL

An optional Steering Wheel offset plate is included that lowers the position of the Steering Wheel and the Trim Switch assembly. Some users may find the Lower Steering Wheel position more comfortable not only for hand position, but also for the overall balance and feel of the transmitter.

To install the Steering Wheel offset plate, follow the steps below:

- 1) Use a 7mm nut driver to remove the Steering Wheel retaining nut, then pull the Steering Wheel straight off and set it aside.
- 2) Using a philips head screwdriver, remove the three larger philips head screws (A), then carefully pull the Trim Switch assembly off the transmitter and very carefully unplug the two connectors.

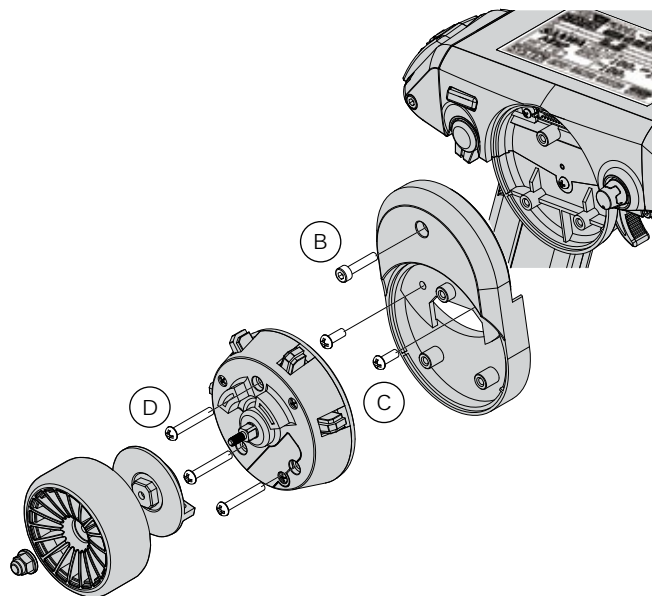
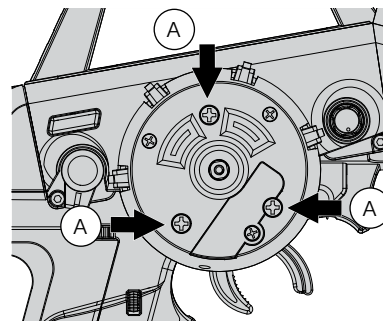

- 3) Feed the connectors from the Trim Switch assembly through the hole in the offset plate, then very carefully plug them into the matching connectors in the transmitter.
- 4) Being careful not to pinch any connectors or wires, align and secure the offset plate to the transmitter using one M3 x 14mm socket-cap screw (B) and two M3 x 8mm philips head screws (C) included. There are small notches in both the Trim Switch assembly and the offset plate that line up with corresponding small tabs in the offset plate and the transmitter to ensure both the Trim Switch assembly and the offset plate are installed in the correct orientation.
- 5) Being careful not to pinch any connectors or wires, align and secure the Trim Switch assembly to the offset plate using the three larger philips head screws (D) you removed previously.
- 6) Reinstall the Steering Wheel. Installation is the reverse of removal.

OPTIONAL STEERING WHEEL ANGLE PLATE INSTALLATION

GENERAL

Two optional Steering Wheel angle plates (one Right and one Left) are included that angles the position of the Steering Wheel and Trim Switch assembly. Some users may find that angling the Steering Wheel to the Right or Left may be more comfortable during use.

⚠ 'R' and 'L' are molded into the angle plates to differentiate them. The 'R' angle plate will angle the Steering Wheel toward the Right and the 'L' angle plate will angle the Steering Wheel toward the Left.

To install the Right or Left Steering Wheel angle plate, follow the steps below:

- 1) Use a 7mm nut driver to remove the Steering Wheel retaining nut, then pull the Steering Wheel straight off and set it aside.
- 2) Using a philips head screwdriver, remove the three larger philips head screws (A), then carefully pull the Trim Switch assembly off the transmitter and very carefully unplug the two connectors.

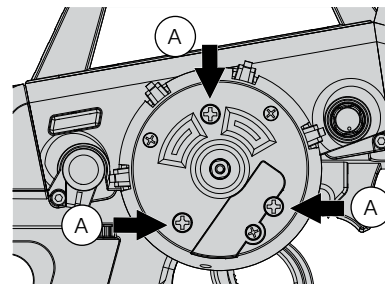

Installation Without Offset Plate:

The installation procedures below outline installing either angle plate WITHOUT the optional offset plate described in the *Steering Wheel Offset Plate Installation* section on the previous page. Complete steps 1 and 2 above before proceeding.

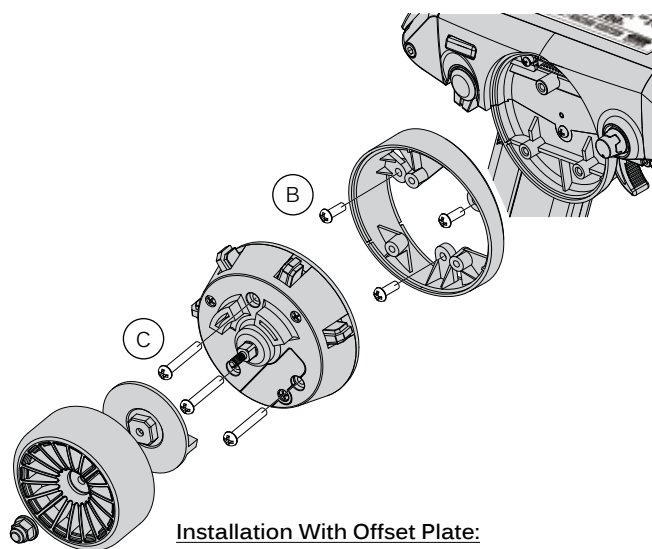

- 3) Choose which angle plate you want to install, then align and secure the angle plate to the transmitter, using the three M3 x 8mm philips head screws (B) included. There are small notches in both the Trim Switch assembly and the angle plate that line up with corresponding small tabs in the transmitter to ensure both the Trim Switch assembly and the angle plate are installed in the correct orientation.
- 4) Very carefully plug the connectors from the Trim Switch assembly into the matching connectors in the transmitter.
- 5) Being careful not to pinch any connectors or wires, align and secure the Trim Switch assembly to the angle plate using the three larger philips head screws (C) you removed previously.
- 6) Reinstall the Steering Wheel. Installation is the reverse of removal.

Installation With Offset Plate:

The installation procedures below outline installing either angle plate along WITH the optional offset plate described in the *Steering Wheel Offset Plate Installation* section on the previous page. Complete steps 1 and 2 above before proceeding.

- 3) Choose which angle plate you want to install, then feed the connectors from the Trim Switch assembly through the angle plate and on through hole in the offset plate. Very carefully plug the connectors into the matching connectors in the transmitter*.
- 4) Being careful not to pinch any connectors or wires, align and secure the offset plate to the transmitter using one M3 x 14mm socket-cap screw (B) and two M3 x 8mm philips head screws (C).
- 5) Align and secure the angle plate to the offset plate, using the three M3 x 8mm philips head screws (D) included.
- 6) Being careful not to pinch any connectors or wires, align and secure the Trim Switch assembly to the offset plate using the three larger philips head screws (E) you removed previously.
- 7) Reinstall the Steering Wheel. Installation is the reverse of removal.

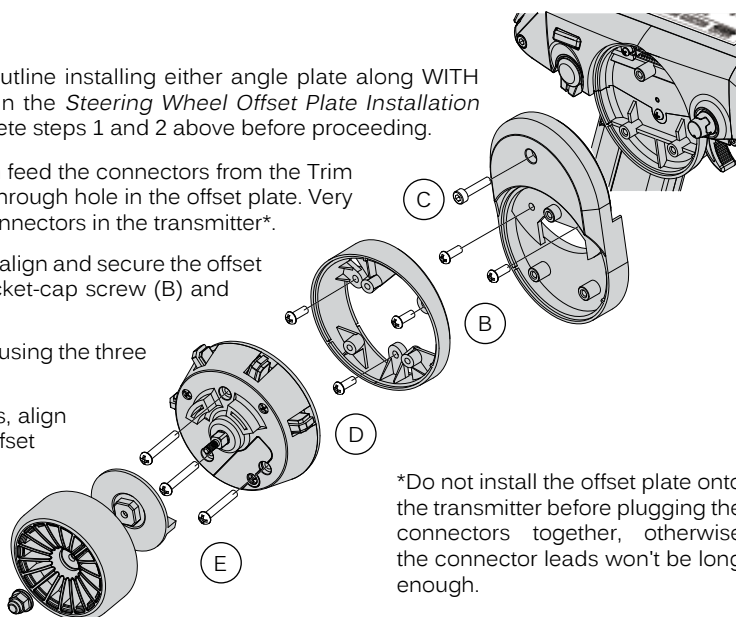

*Do not install the offset plate onto the transmitter before plugging the connectors together, otherwise the connector leads won't be long enough.

⚠ There are small notches on the back side of each of the parts that correspond to matching tabs on the Front side of each of the parts and the transmitter to ensure everything is installed in the correct orientation.

DRIVING POSITION ADJUSTMENT

GENERAL

The position of the Steering Wheel can be switched from the Right side to the Left side to accommodate Left-handed drivers. This makes the M12 much more comfortable for natural Left-handed drivers to use.

To change the driving position for Left-handed use, follow the steps below:

- 1) Using a 2.5mm hex wrench, remove the three socket cap screws (A) that hold the display switch cover in place, then carefully pull the display switch cover off.

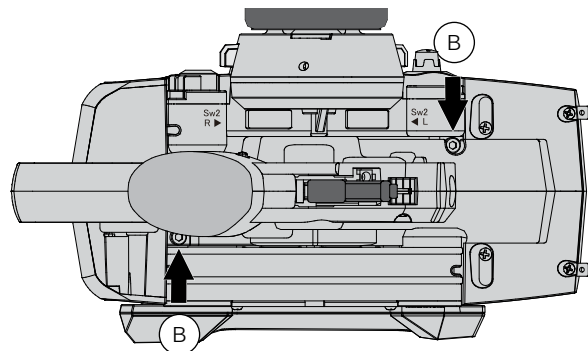
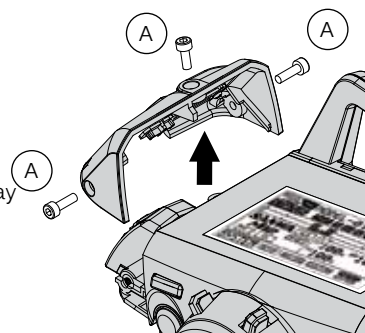

- 2) Using a 2.5mm hex wrench, remove the two socket-cap screws (B) from the bottom the transmitter that hold the main body in place.

- 3) Carefully pull the main body up and off the base (C), being careful not to damage any of the wiring.
- 4) Rotate the main body 180° (D), then push it back down onto the base (E), being careful not to pinch any of the wiring.
- 5) Reinstall the two socket-cap screws you removed previously to secure the main body to the base.
- 6) Reinstall the display switch cover. Installation is the reverse of removal.

! When reinstalling the display switch cover, make sure to install the two machine screws into the sides of the cover and the one self-tapping screw in the top of the cover.

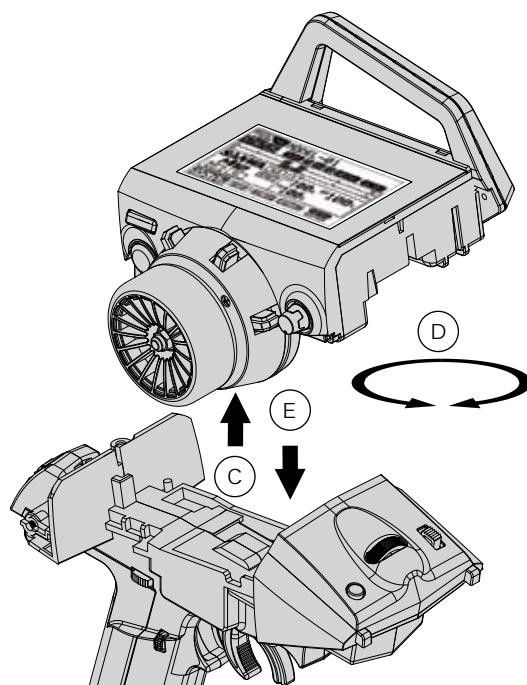

Changing the Direction of the Push-Button Rotary Dial:

When you switch the driving position as described above, the direction the Push-Button Rotary Dial moves the Programming Cursor will be reversed. If desired, the direction the Push-Button Rotary Dial moves the Programming Cursor can be changed.

To change the direction the Push-Button Rotary Dial moves the Programming Cursor, follow the step below:

- 1) Press and HOLD the ENTER key, then turn the transmitter ON. Release the ENTER key AFTER the transmitter finishes initializing and beeps once.

Activating the Left Side Switches:

Two duplicate switches (Sw3 and Trm5) are positioned on the left side of the transmitter for use in the left-handed driving position. In the default configuration, these switches are Inhibited for right-handed use. When you switch the driving position as described above, you will want to Activate these switches for ease of use.

To Activate the Sw3 and Trm5 switches on the Left side of the transmitter, follow the steps below:

- 1) Remove the battery cover from the bottom of the transmitter, then remove the battery holder.
- 2) Flip the switch that's in the base of the transmitter below the battery holder toward the Front of the transmitter. When the switch is toward the Front of the transmitter, the left-hand switches will be Active and when the switch is toward the back of the transmitter, the right-hand switches will be Active.





M12 2.4GHZ FH4T RADIO CONTROL SYSTEM USER'S GUIDE

PROGRAMMING KEYS OVERVIEW AND FUNCTIONS

GENERAL

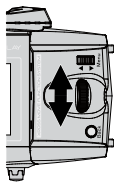
Moving around the various screens and programming the transmitter is accomplished using the ENTER key (Push-Button Rotary Dial), the SELECT switch and the BACK key.

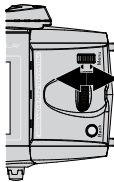
PRO TIP: While navigating Programming Menus and changing Programming Values, keep the following in mind: to choose a menu from the STATUS screen, use the SELECT switch. To open a menu, press the ENTER key. To choose an option to program, scroll UP or DOWN to highlight the desired option, then press the ENTER key. The highlighted option will flash, indicating the Programming Value can be changed. Once you've changed the Programming Value, press the ENTER key again or press the BACK key and the highlighted option will stop flashing, indicating you can scroll UP or DOWN to highlight another programming option. To reset a programming option to its default value, highlight the option and press the HOLD the ENTER key.

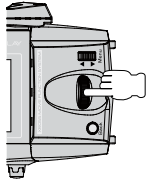
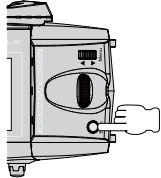
PROGRAMMING KEY	NAME	FUNCTION
	 Push-Button Rotary Dial (Scroll UP/DOWN)	Scrolls between STATUS, ASSIGN and TELEMETRY screens. Scrolls the Programming Cursor RIGHT or UP and LEFT or DOWN. Increases or Decreases Programming Values.
	 SELECT Switch	Used to Select various menus. In addition, the SELECT switch's function will vary depending on the menu chosen and will be indicated in the menu's Message Display Window.
	Push-Button Rotary Dial (Push ENTER)	Opens the Selected menu or programming option. Press and HOLD to reset the Selected programming option to its default value.
	BACK Key	Returns to the previous menu. Repeatedly press to return to the STATUS screen.

DISPLAY SCREENS OVERVIEW

GENERAL

In the default configuration, when you turn the M12 transmitter ON, the transmitter will start-up and display the BOOT screen temporarily, then display the STATUS screen.

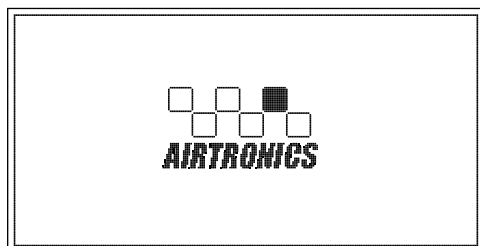

BOOT Screen

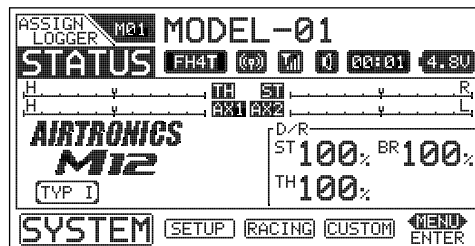

STATUS Screen

BOOT Screen: The BOOT screen is displayed when the transmitter is turned ON. The BOOT screen can be disabled. For more information, see the *BOOT Menu* section on page 56.

STATUS Screen: The STATUS screen is displayed after the BOOT screen and displays important information about the transmitter. It's also a base from which you access other Programming Menus. For more detailed information, see the *STATUS Screen Overview* section on the next page.

DISPLAY SCREENS OVERVIEW

GENERAL

Use the information in this section to familiarize yourself with the layout and different indicators and displays that comprise the STATUS screen. The STATUS screen displays all pertinent information, such as the Model Name, Modulation Type, Timer, Voltage and much more.

The STATUS screen will always be displayed after the BOOT screen unless you change that option in the SYSTEM BOOT menu. For more information, see the *BOOT Menu* section on page 56.

STATUS Screen Overview Diagram:

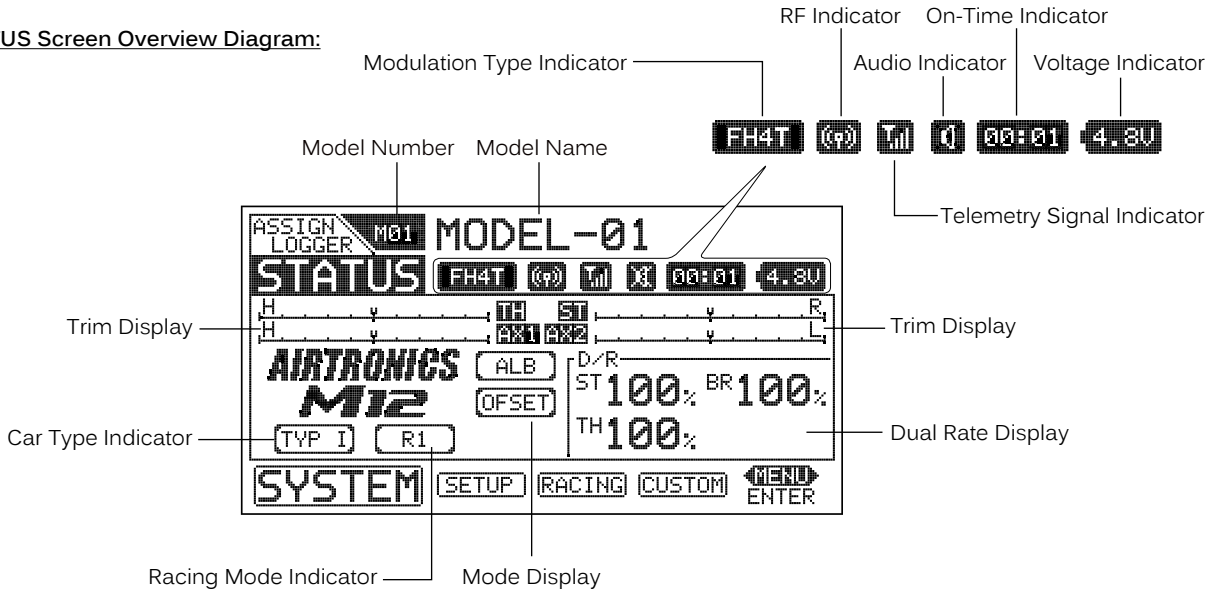

From the STATUS screen, use the Push-Button Rotary Dial to scroll UP or DOWN to display the ASSIGN and TELEMETRY screens. To return to the STATUS screen, either scroll to it or press the BACK key.

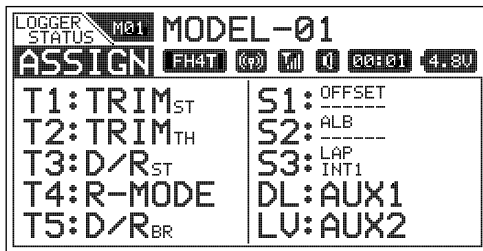

ASSIGN Screen

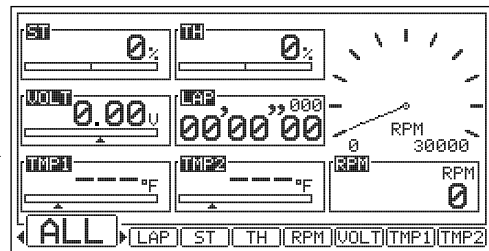

TELEMETRY Screen

ASSIGN Screen: The ASSIGN screen displays the functions that are currently Assigned to the Push-Button Switches, the Trim Switches, the Auxiliary Dial and the Auxiliary Lever, all in one convenient location.

TELEMETRY Screen: The TELEMETRY screen displays Telemetry Data, such as RPM or Speed, Temperature, Receiver Voltage and more. Use the SELECT switch to switch between ALL and LAP, ST, TH, RPM, VOLT, TMP1 and TMP2 pages.

Telemetry integration requires the use of an Airtronics 2.4GHz FH4T Telemetry-capable surface receiver, such as the RX-461 or RX-462. Steering and Throttle Output and Lap Times can still be viewed when used other types of receivers.

STATUS Screen Overview Diagram Descriptions:

Audio Indicator: Indicates whether Audible Key Tones and Transmitter Alarms are Muted or not.

Car Type Indicator: Indicates the current Car Type Selected.

Dual Rate Display: Displays the current Dual Rate percentage value of channels that Dual Rate can be programmed for. Channels displayed will vary based on the currently Selected Car Type.

Mode Display: Displays any special Programming Modes that are Active, such as Throttle Offset or Anti-Lock Braking.

Model Name: Displays the Name of the currently Selected Model.

Model Number: Displays the number of the currently Selected Model.

Modulation Type Indicator: Indicates the current Modulation Type that the transmitter is set to.

DISPLAY SCREENS OVERVIEW

GENERAL

STATUS Screen Overview Diagram Descriptions, Continued...

On-Time Indicator: Displays the current cumulative On-Time of the transmitter in Hours and Minutes.

Racing Mode Indicator: Indicates whether Racing Mode is Active or Inhibited and Which Racing Mode (R1 ~ R5) is Active.

RF Indicator: Indicates whether the transmitter is sending an RF signal or not.

Trim Display: Displays the current position of channel Trim. Trim Indicators (ST, AUX1, etc.) displayed will vary based on the currently Selected Car Type.

Telemetry Signal Indicator: Indicates the current signal strength of the Telemetry connection between the transmitter and receiver.

Voltage Indicator: Indicates the current Voltage of the transmitter batteries.

MAIN MENU STRUCTURE OVERVIEW

GENERAL

The M12 features four main menus that are accessed from the STATUS screen. Each of the four main menus include a number of different Programming Menus. The four main menus consist of the SYSTEM menu, the SETUP menu, the RACING menu and the CUSTOM menu. To access these menus from the STATUS screen, use the SELECT switch to highlight the desired menu, then press ENTER key to open the Selected menu.

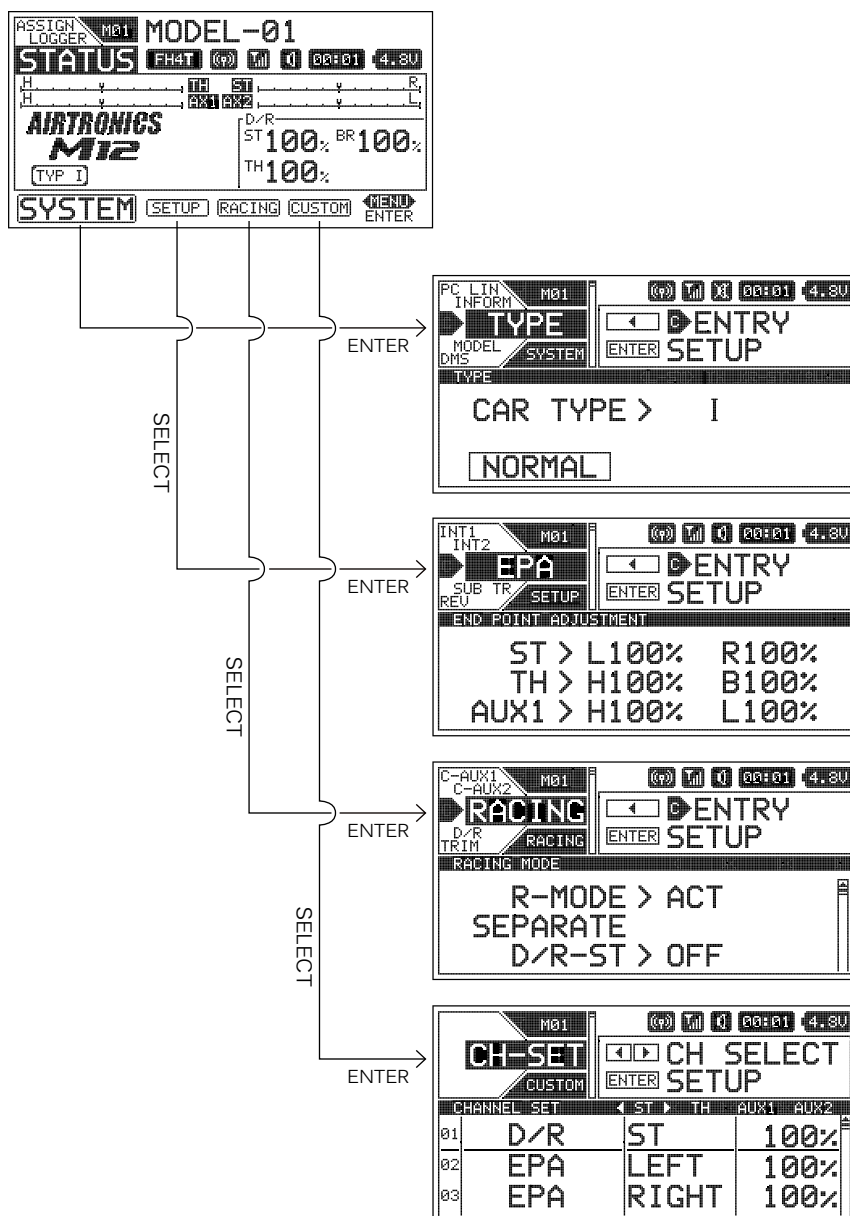

SYSTEM Menu: Pages 24 ~ 61.

Features system-specific Programming Menus, such as Car Type, Key Assign, LCD Contrast, Binding, Auxiliary Type, Trim Type and more.

SETUP Menu: Pages 61 ~ 74.

Features basic Model-specific Programming Menus, such as EPA, Sub-Tim, Servo Reversing, Timers and more.

RACING Menu: Pages 74 ~ 93.

Features more complex Model-specific Programming Menus, such as C-Mixing, Anti-Lock Braking, Servo Speed, Curves and more.

CUSTOM Menu: Pages 94 ~ 95.

Features the Channel Set Programming Menu and any favorite Programming Menus that you add yourself.

The four main menus described in the previous section all share the same basic layout as illustrated below. Use this information to familiarize yourself with the layout and the information presented.

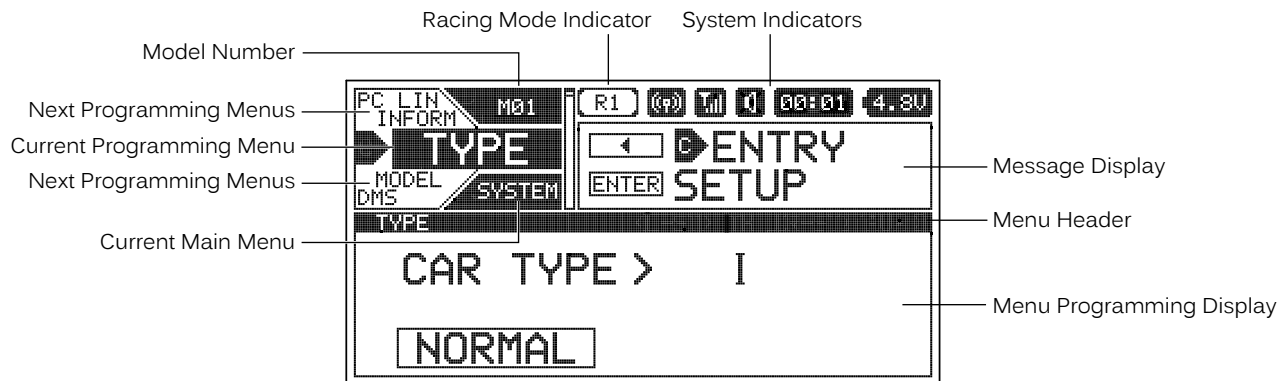

Current Main Menu: Displays the currently Active main menu, either SYSTEM, SETUP, RACING or CUSTOM.

Current Programming Menu: Displays the currently Active Programming Menu.

Menu Header: Displays the name of the currently Active Programming Menu. In some cases, programming options may also be found within the Menu Header.

Menu Programming Display: Displays all programming information pertinent to the currently Active Programming Menu.

Message Display: Displays different Programming Key functions based on the currently Active Programming Menu. For more information, see the illustrations and descriptions below.

Model Number: Displays the number of the currently Selected Model.

Next Programming Menus: Displays the next two Programming Menus within the current main menu.

Racing Mode Indicator: Indicates which Racing Mode (R1 ~ R5) is Active or Inhibited.

System Indicators: Indicates current transmitter status information as described in the *Display Screens Overview* section on pages 17 ~ 19.

The function of the SELECT switch and the ENTER key will vary depending on the specific Programming Menu displayed.

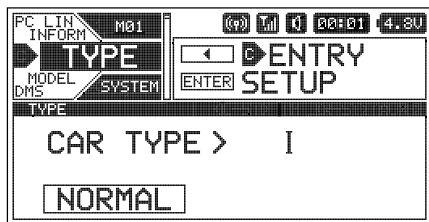

In This Menu Style:

The SELECT switch Saves or Removes the current Programming Menu from the CUSTOM menu.

The ENTER key opens the highlighted Programming Menu. Scroll UP and DOWN to choose different Programming Menus.

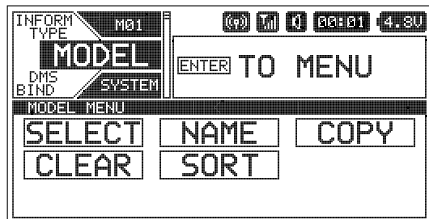

In This Menu Style:

The ENTER key opens a Sub-Menu. Scroll UP and DOWN to choose different Sub-Menus.

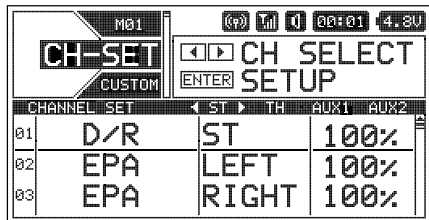

In This Menu Style:

The SELECT switch scrolls RIGHT or LEFT to Select different channels.

Scroll UP and DOWN to choose the desired function Programming Value, then press the ENTER key change the Programming Value.

TELEMETRY SCREEN OVERVIEW

GENERAL

The TELEMETRY screen displays Telemetry Data, such as RPM or Speed, Temperature, Receiver Voltage and more.

For information about making Telemetry option changes that effect how and what Telemetry Data is displayed on the various TELEMETRY pages, see the *LOG SETUP Menu* section on pages 48 ~ 56.

 Telemetry integration requires the use of an Airtronics 2.4GHz FH4T Telemetry-capable surface receiver, such as the RX-461 or RX-462. Steering and Throttle Output and Lap Times can still be viewed when used other types of receivers.

From the STATUS screen, use the Push-Button Rotary Dial to scroll UP or DOWN to display the TELEMETRY screen.

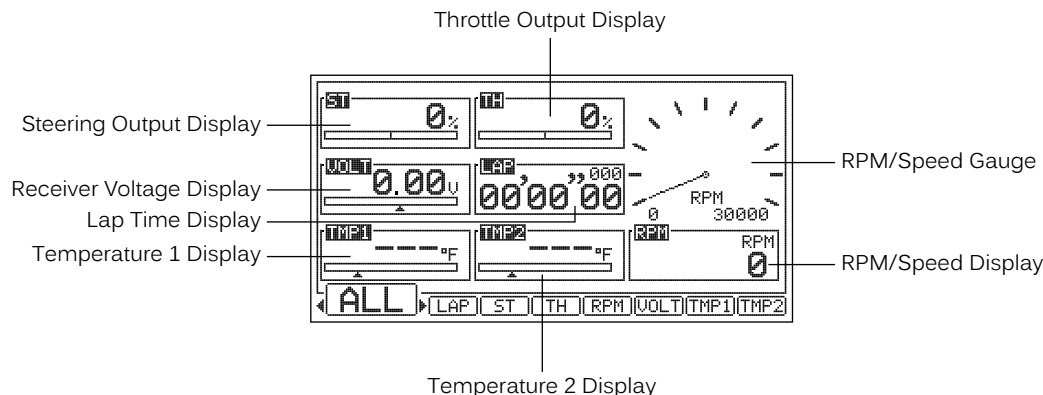

Use the SELECT switch to switch between ALL and LAP, ST, TH, RPM, VOLT, TMP1 and TMP2 pages. These pages display more detailed Telemetry Data and allow you to review Telemetry Data and Save the current Telemetry Data Log to your PC for archiving or viewing at a later time.

 The layout of the information displayed on the ST, TH, RPM, VOLT, TMP1 and TMP2 pages is similar, so only the STEERING page is shown in this section.

 For information about viewing Lap Times, see the *Viewing Lap Times* section on page 73.

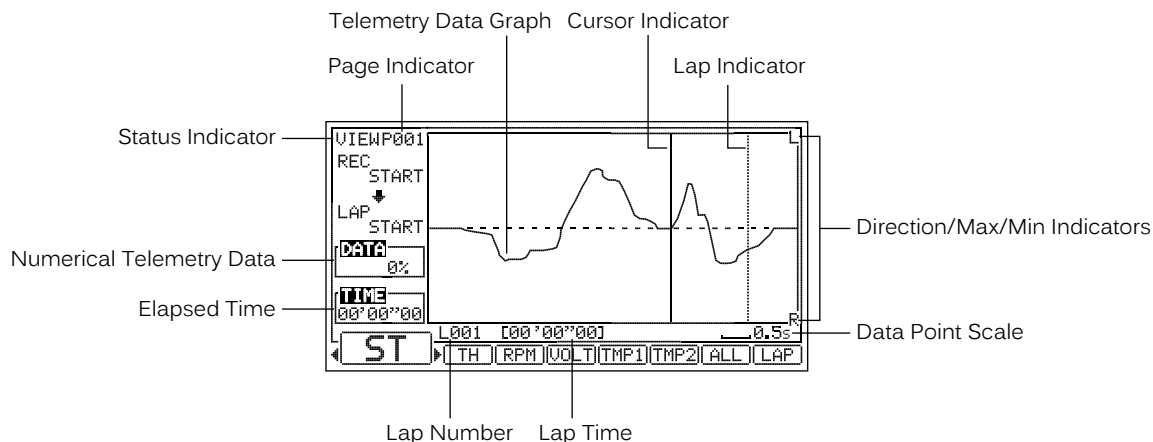

TELEMETRY Screen Overview Diagram Descriptions:

Cursor Indicator: Indicates the current position of the Cursor when reviewing Telemetry Data. The Cursor Indicator will only be displayed when in VIEW Mode.

Data Point Scale: Indicates the time in Seconds between recorded Telemetry Data Points. This value is fixed at 0.5 seconds.

Direction/Max/Min Indicators: Indicates Control Movement Direction or Programmed Maximum and Minimum Telemetry Data values, depending on the current TELEMETRY page being displayed.

Elapsed Time: Displays the current position in Time of the Cursor Indicator within the current Telemetry Data Log.

Lap Indicator: Indicates the position along the Telemetry Data Stream that a Lap Time was counted.

Lap Number: Displays the current Lap Number.

Lap Time: Displays the Lap Time of the currently Selected Lap Number.

Lap Time Display: Displays the current Lap Time in Minutes, Seconds and 1/100th of a Second, and the current Lap Number.

TELEMETRY Screen Overview Diagram Descriptions, Continued....

Numerical Telemetry Data: Displays the Telemetry Data in a numerical format.

Page Indicator: Indicates the current Page within the Telemetry Data Stream that Telemetry Data is currently being displayed on.

Receiver Voltage Display: Displays the current Voltage of the receiver battery. The tick mark indicates the current Voltage relative to the programmed Maximum Voltage value.

RPM/Speed Display: Displays the current RPM or speed in MPH or KM/H.

RPM/Speed Gauge: Displays the current RPM or speed in MPH or KM/H in graphical format. The needle indicates the current RPM or Speed relative to the programmed Maximum RPM or Speed value.

Status Indicator: Indicates the current Status of the Telemetry system. When VIEW is displayed, the Telemetry system is in VIEW mode, allowing you to view and analyze Telemetry Data. When REC is displayed, the Telemetry system is Recording Telemetry Data. When LOG is displayed, the Telemetry system is in Standby.

Steering Output Display: Displays the current position of the Steering channel as a percentage of Steering Wheel travel.

Telemetry Data Graph: Displays the Telemetry Data Stream in a graphical format.

Temperature 1 Display: Displays the current temperature in Fahrenheit or Celsius of the Temperature Sensor plugged into the TEMP1 Sensor Port in the receiver. The tick mark indicates the current temperature relative to the programmed Maximum and Minimum Temperature values.

Temperature 2 Display: Displays the current temperature in Fahrenheit or Celsius of the Temperature Sensor plugged into the TEMP2 Sensor Port in the receiver. The tick mark indicates the current temperature relative to the programmed Maximum and Minimum Temperature values.

Throttle Output Display: Displays the current position of the Throttle channel as a percentage of Throttle Trigger travel.

Reviewing Telemetry Data:

When the Telemetry Data Recorder has Stopped, you are able to view Telemetry Data in more detail. For more information about Starting and Stopping the Telemetry Data Recorder, see the *Telemetry Data Recording* section on page 48.

1) After Stopping the Telemetry Data Recorder, press the SELECT switch to open the desired TELEMETRY page, either ST, TH, RPM, VOLT TMP1 or TMP2.

2) Press the ENTER key. The VIEW menu will open and PAGE will be surrounded by a box.

3) Scroll UP or DOWN to Select the desired VIEW menu option.

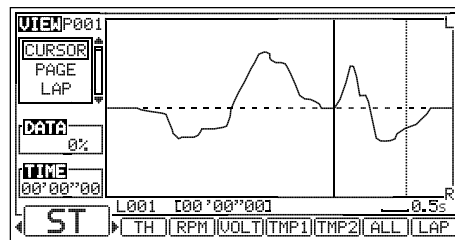

CURSOR - When chosen, scrolls through the Telemetry Data Stream in 0.5 second intervals.

PAGE - When chosen, scrolls through the individual pages of the Telemetry Data Stream.

LAP - When chosen, scrolls through each counted Lap Time along the Telemetry Data Stream.

LAP-LT - When chosen, displays Total, Best and Average Lap Times, in addition to individual Lap Times.

SAVE - When chosen, allows you to Save the Telemetry Data Log to your PC.

4) Press the ENTER key to highlight the desired VIEW menu option, then scroll UP or DOWN to scroll through the Telemetry Data Stream via the VIEW menu option you chose. You can also press the SELECT switch RIGHT or LEFT to view different TELEMETRY pages.

 If you choose the SAVE option to Save the Telemetry Data Log to your PC, see the *PCLINK Menu Saving the Telemetry Data Log* section on page 58 for information on how to do this.

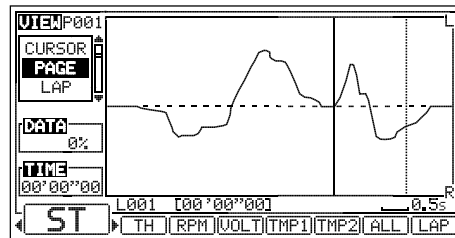

5) To choose a different VIEW menu option, press the BACK key, then repeat steps 3 and 4 to choose and highlight the desired VIEW menu option.

 When viewing the Telemetry Data Stream using the VIEW option menu, keep these things in mind: When a VIEW menu option is surrounded by a box, scroll UP or DOWN to choose a different VIEW menu option. When a VIEW menu option is highlighted, scroll UP or DOWN to scroll through the Telemetry Data Stream. Press the BACK key to cancel the highlighted VIEW menu option and choose another VIEW menu option.

 As you're scrolling through the Telemetry Data Stream, press the ENTER key at any time to Open a detailed list of Telemetry Data Entries. The highlighted Telemetry Data Entry at the top of the list is the one where you pressed the ENTER key.

TRANSMITTER AND RECEIVER BINDING

GENERAL

The Binding function allows you to Bind the transmitter and receiver pair. When new, it is necessary to pair the transmitter and receiver to prevent interference from transmitters operated by other users. This operation is referred to as 'Binding'. Once the Binding procedure is complete, the setting is remembered even when the transmitter and receiver are turned OFF, therefore, this procedure usually only needs to be done once.

 The M12 transmitter features a Safety Link function that is used to program a unique code to each receiver/Model pair, preventing the transmitter from controlling a Model that it's not currently programmed for. The Safety Link function is compatible only with FH4 or FH4T receivers. It's not compatible with FH2 or FH3 receivers.

IMPORTANT: This section details Binding the RX-471 FH4 Super Response receiver with a Safety Link Model number of 1 and with the Servo Operating Mode set to Normal mode. If you are Binding an FH2 or FH3 receiver, or if you prefer to change the Safety Link Number or the Servo Operating Mode, see the *BIND Menu* section on pages 30 ~ 32.

 Before beginning the Binding procedure, connect the switch harness, servos and the receiver battery to your receiver, using the diagram in the *Receiver Overview Diagram, Connections and Mounting* section on page 8. Make sure that both the transmitter and the receiver are turned OFF.

- 1) Turn the transmitter ON. The STATUS screen should be displayed.
- 2) Press the SELECT switch to highlight the SYSTEM menu, then press the ENTER key to open the SYSTEM menu.

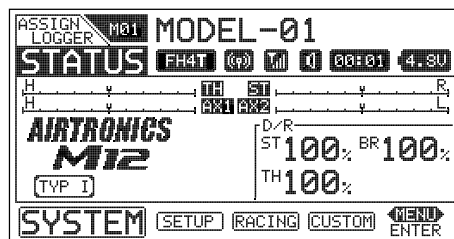

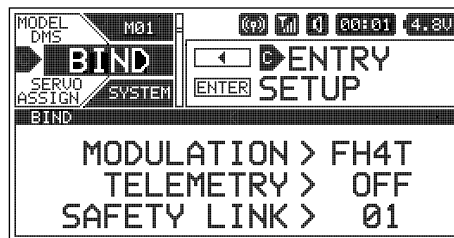

- 3) Scroll UP or DOWN to highlight the BIND menu, then press the ENTER key to open the BIND menu.

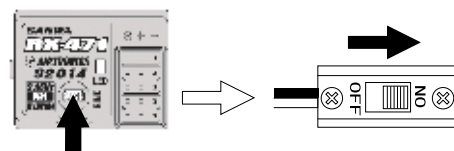

 Double-check that the Modulation is set to FH4T, Telemetry is turned ON, Safety Link is set to 01 and CH1, CH2, CH3 and CH4 are each set to NOR. If you want to change any of these settings, see the *BIND Menu* section on pages 30 ~ 32.

- 4) While holding down the Bind Button on the receiver, turn the receiver ON. The Bind LED on the receiver will flash slowly. Release the Bind Button. The Bind LED on the receiver will continue to flash slowly.



 You must complete step 5 below within 10 seconds or the Bind LED will go out, indicating the receiver has timed out. If this occurs, turn the receiver OFF, then repeat step 4.

- 5) Scroll DOWN to highlight the BIND [ENTER] option, then press the ENTER key. The [ENTER] command and LED1 on the transmitter will begin to flash and the Bind LED on the receiver will flash rapidly, then go out.

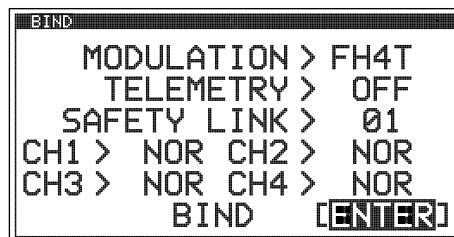
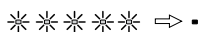

- 6) After the Bind LED on the receiver goes out, press the ENTER key a second time. Both the Bind LED on the receiver and LED1 on transmitter will illuminate solid blue, indicating that the Binding procedure is complete.



- 7) Move the Steering Wheel and Throttle Trigger to verify that the servos are operating normally, then repeatedly press the BACK key to return to the STATUS screen.

 Under some circumstances, the receiver may not operate after turning the transmitter and receiver ON. If this occurs, perform the Binding procedure again.

M12 2.4GHZ FH4T RADIO CONTROL SYSTEM USER'S GUIDE

SYSTEM MENU OVERVIEW

SYSTEM

To access the various SYSTEM Programming Menus, turn the transmitter ON, then press the SELECT switch to highlight the SYSTEM menu. Press the ENTER key to open the SYSTEM menu.

Scroll UP or DOWN to highlight the desired Programming Menu, then press the ENTER key to open that menu.

⚠ Depending on the Car Type chosen, some Function Programming Value Names may differ from those shown in this section.

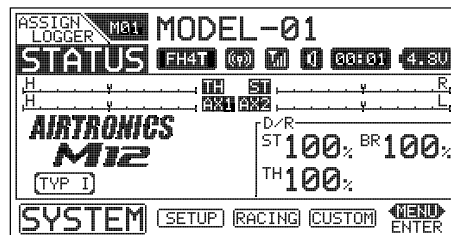

The following Programming Menus are available within the SYSTEM menu:

MENU	MENU DESCRIPTION	PAGE #
TYPE	Choose Car Type Templates From Normal to Crawler	PG. 24
MODEL	Model Select, Model Name, Model Copy, Model Clear and Model Sort	PG. 25
DMS	Direct Model Select - Use to Quickly Select Your Favorite Models	PG. 29
BIND	Bind, Choose Modulation Type, Safety Link Number and Servo Operating Mode	PG. 30
SERVO	Use the Servo Monitor to View Servo Travel Digitally	PG. 32
ASSIGN	Assign Functions to the Switches, Rotary Dial and Auxiliary Lever	PG. 33
BUZZER	Turn Audible Key Tones and Alarms ON and OFF and Control Their Pitch and Volume	PG. 38
VIBRATOR	Turn Vibrating Alerts and Alarms ON and OFF	PG. 39
LCD	Adjust the Contrast, Brightness and Display Mode of the LCD Screen	PG. 40
AUX TYPE	Choose the Operating Mode of the Two Auxiliary Channels	PG. 41
TRIM TYPE	Choose the Desired Servo Trim Type - Either Parallel or Centered	PG. 43
TH TYPE	Choose the Desired Throttle Bias Type	PG. 43
VR ADJUST	Calibrate Steering, Throttle and Auxiliary Lever Controls	PG. 44
BATT	Specify Transmitter Battery Low Voltage Alert and Limit Alarms	PG. 46
LOG SETUP	Program TELEMETRY Screen and Telemetry Recording Options	PG. 48
BOOT MENU	Change Transmitter Start-Up Behavior	PG. 56
USER NAME	Change the Name Displayed Above the M12 Logo on the STATUS Screen	PG. 56
PC-LINK	Save Telemetry Logs, Save and Load Model Programming and Update Firmware	PG. 58
INFORMATION	View Transmitter Firmware Version and On-Time Information	PG. 61

TYPE MENU (CAR TYPE TEMPLATES)

SYSTEM

The Type function allows you to quickly set up the transmitter's Mixing options based on the type of Model you're driving. Common templates for Car or Truck and Crawler Car Types are provided. For example, if your Crawler features separate Front and Rear Steering servos, choosing one of the Crawler Car Types will automatically program the transmitter for Four Wheel Steering.

The TYPE menu will also display what receiver channels to plug the servos into since this will vary depending on the Car Type chosen. This takes the guess-work out of setting up your Model.

WARNING: TYPE menu selections are designed to be used when setting up a new Model and should be done prior to making any programming changes to your Model. When the Type function is used to change the Car Type, all Programming Data (including custom Programming Data) for the current Model will be RESET!

Choosing a Car Type:

- 1) From within the SYSTEM menu, scroll UP or DOWN to highlight the TYPE menu.

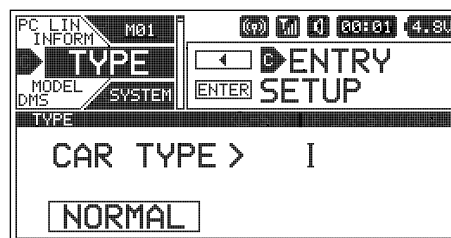

TYPE MENU (CAR TYPE TEMPLATES) SYSTEM

Choosing a Car Type, Continued:

- Press the ENTER key to open the TYPE menu. The cursor will default to CAR TYPE > I.
- Press the ENTER key, then scroll UP or DOWN to Select the desired Car Type as shown in the table below. The TYPE Menu Programming Display shows the Car Type (Normal or Crawler) and which servos should be plugged into what receiver channel slots. For example, CAR TYPE > VII is a Normal Car Type that might be used for a 1:5 scale off-road gas buggy that uses two Steering servos and a separate second Brake servo. In this example, the Left Steering servo should be plugged into channel 3, the Throttle/first Brake servo should be plugged into channel 2 and the second Brake servo should be plugged into channel 4.
- Press the ENTER key. MODEL DATA CLEAR? NO/YES will be displayed.
- Scroll UP or DOWN to highlight YES, then press the ENTER key. EXECUTING will be displayed and the current Model Programming Data will be reset with the Selected Car Type options.

⚠ If you want to go back and change the Car Type or you don't want to create the new Car Type for any reason, choose NO or press the BACK key prior to EXECUTING.

⚠ Your particular Model may not require the use of all four channels, even though each Car Type template may show them. In this case, those channels will simply go unused.

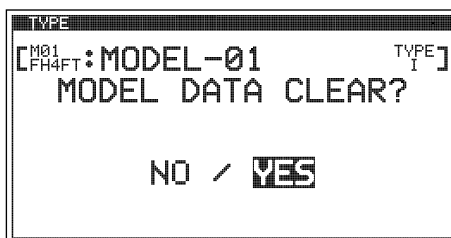
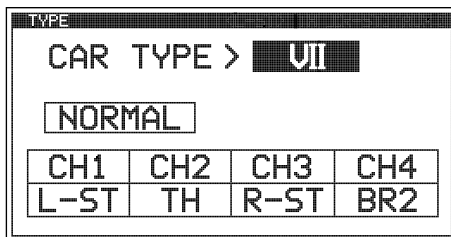
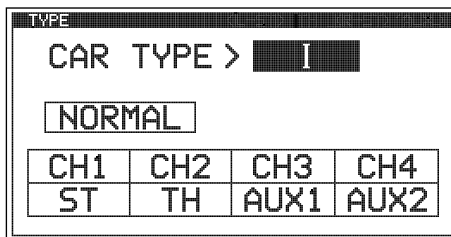

TYPE CH	TYP I	TYP II	TYP III	TYP IV	TYP V	TYP VI	TYP VII	TYP VIII	TYP IX	TYP X
CH 1	ST	ST	ST	ST	L-ST	L-ST	L-ST	F/ST	ST	F/ST
CH 2	TH+BR	TH	TH+BR	TH	TH+BR	TH	TH+BR	TH+BR	F/TH+BR	F/TH+BR
CH 3	AUX1	BR	BR2	BR	R-ST	R-ST	R-ST	R/ST	R/TH+BR	R/ST
CH 4	AUX2	AUX	AUX	BR2	AUX	BR	BR2	AUX	AUX	R/TH+BR

ST=Steering • TH=Throttle • BR=Brake • BR2=Brake 2 • R-ST=Right • L-ST=Left • R/ST or R/TH=Rear • F/ST or F/TH=Front

MODEL MENU (SELECT, NAME, COPY, CLEAR AND SORT) SYSTEM

The MODEL menu allows you to Select different Models, Name your saved Models, Copy Programming Data from one Model to another Model, Clear Programming Data from one or more Models and Sort your saved Models into a Custom list, using the Model Select, Model Name, Model Copy, Model Clear and Model Sort functions. This allows you to use the transmitter with different Models and quickly and easily Select the Programming Data for each of them. Programming Data for up to 50 different Models can be stored in the transmitter's memory.

Model Select

The Model Select function allows you to load the Programming Data for the particular Model you wish to drive. The MODEL SELECT menu displays the currently Selected Model, along with a list of available Models that can be Selected. The current Modulation Type and Car Type of each Model is also displayed. The transmitter can store Programming Data for up to 50 different Models.

Selecting a Model:

- From within the SYSTEM menu, scroll UP or DOWN to highlight the MODEL menu.

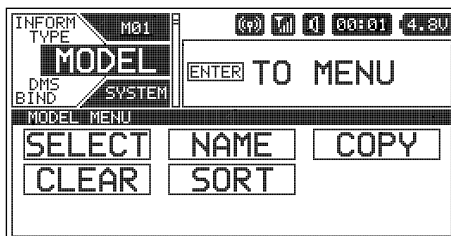

MODEL MENU (SELECT, NAME, COPY, CLEAR AND SORT)

SYSTEM

Selecting a Model, Continued:

2) Press the ENTER key to open the MODEL menu. The SELECT menu will be highlighted and the currently Selected Model will be displayed in brackets at the top of the Model Select List.

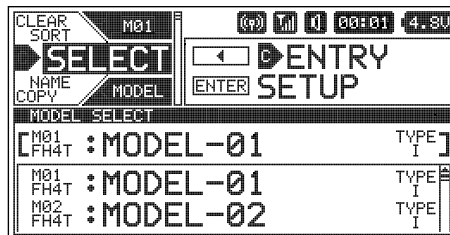

3) Press the ENTER key to open the SELECT menu, then scroll UP or DOWN within the Model Select List to highlight the Model you would like to load Programming Data for.

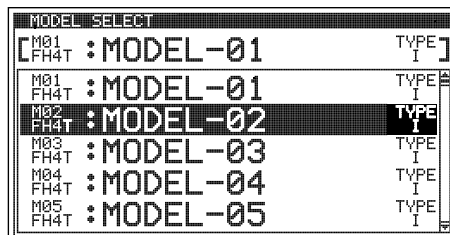

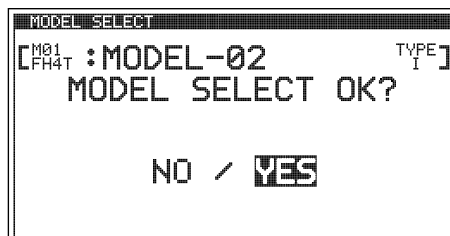

4) Press the ENTER key. MODEL SELECT OK? NO/YES will be displayed. Scroll UP or DOWN to highlight YES, then press the ENTER key.

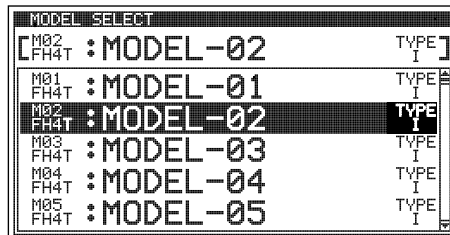

 If you want to go back and change Models or you don't want to Select a different Model for any reason, choose NO or press the BACK key prior to EXECUTING.

5) EXECUTED will be displayed and the Model that you just Selected will be displayed in brackets above the Model Select List.



 When a Model is Selected, the Programming Data for that Model will be loaded immediately.

Model Name

The Model Name function allows you to name each of the 50 individual Models. This makes it easy to keep track of multiple Models. The Model Name can consist of up to 14 letters, numbers or symbols. Choose from capital letters, Lower case letters, numbers and various symbols. A Model must be Selected before a Model Name can be entered or modified. In the default configuration, M01:MODEL-1 is Selected. To enter a Model Name for another Model, that Model must first be Selected using the Model Select function.

Entering a Model Name:

1) From within the SYSTEM menu, scroll UP or DOWN to highlight the MODEL menu.

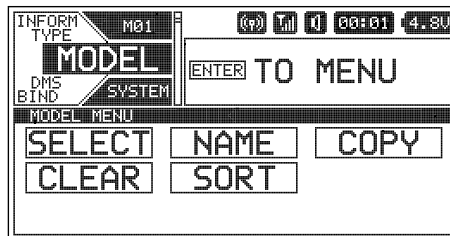

2) Press the ENTER key to open the MODEL menu, then scroll UP or DOWN to highlight the NAME menu.

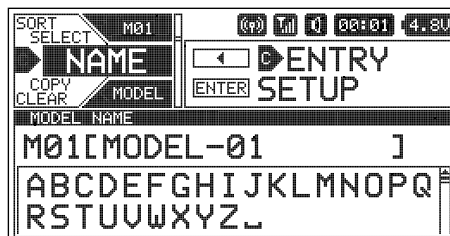

MODEL MENU (SELECT, NAME, COPY, CLEAR AND SORT)

SYSTEM

Entering a Model Name, Continued...

- Press the ENTER key to open the NAME menu. The underscore will be positioned under the first character in the Model Name.
- Press the SELECT switch RIGHT or LEFT or scroll UP or DOWN to move the underscore under the character you want to change, then press the ENTER key.
- Scroll UP or DOWN and press the SELECT switch RIGHT or LEFT to highlight a character in the Character List. Press the ENTER key to Select the highlighted character. That character will be displayed in the Model Name and the underscore will advance to the next space.
- Repeat step 5 to enter the rest of the characters. Up to 14 characters can be entered. If desired, press the BACK key to re-gain control of the underscore, then use the SELECT switch or scroll UP or DOWN to move the underscore RIGHT or LEFT. To add a space (or spaces) in your Model Name, use the  character.

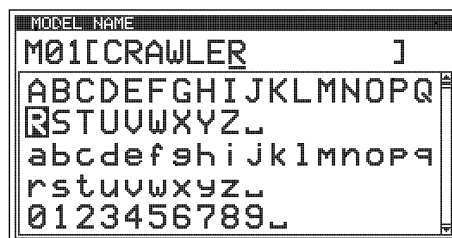
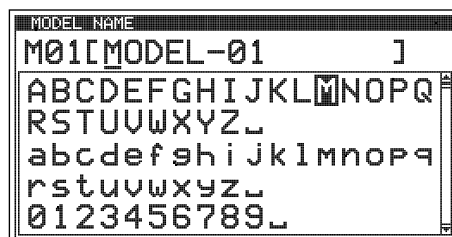



Deleting a Character:

- Press the SELECT switch RIGHT or LEFT or scroll UP or DOWN to move the underscore under the character in your Model Name you want to delete.
- Press the ENTER key, then scroll UP or DOWN and press the SELECT switch RIGHT or LEFT to highlight the  character in the Character List. Press the ENTER key. The character in your Model Name will be deleted and the underscore will advance to the next space.

 If you can't move the underscore, press the BACK key to re-gain control of the underscore.

Deleting a Model Name:

- Press the SELECT switch RIGHT or LEFT or scroll UP or DOWN to move the underscore under the first character in your Model Name.
- Press the ENTER key, then scroll UP or DOWN and press the SELECT switch RIGHT or LEFT to highlight the  character in the Character List. Continuously press the ENTER key to delete each character in your Model Name.

 If you can't move the underscore, press the BACK key to re-gain control of the underscore.

Model Copy

The Model Copy function allows you to copy the Programming Data FROM the currently Selected Model TO another Model. For example, if you have two Models that are similar, you can copy the Programming Data from the first Model to the second Model to use as a base to start fine-tuning the programming for the second Model. Make sure that prior to using the Model Copy function, you first Select and load the desired Model you want to copy Programming Data FROM, using the Model Select function.

Copying Model Programming Data:

- From within the SYSTEM menu, scroll UP or DOWN to highlight the MODEL menu.

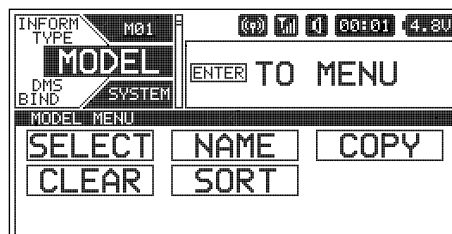

- Press the ENTER key to open the MODEL menu, then scroll UP or DOWN to highlight the COPY menu.

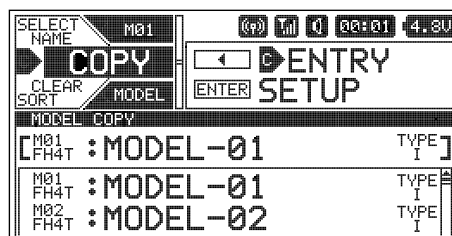

MODEL MENU (SELECT, NAME, COPY, CLEAR AND SORT)

SYSTEM

Copying Model Programming Data, Continued...

- Press the ENTER key to open the COPY menu. The currently Selected Model will be displayed in brackets above the Model Copy List.
- Scroll UP or DOWN within the Model Copy List to highlight the Model you would like to copy the current Model's Programming Data TO.
- Press the ENTER key. MODEL COPY OK? NO/YES will be displayed. Scroll UP or DOWN to highlight YES, then press the ENTER key.

 All Model-specific Programming Data, including the Model Name will be copied to the highlighted Model. If you want to go back and change Models or you don't want to Copy the Programming Data for any reason, choose NO or press the BACK key prior to EXECUTING.

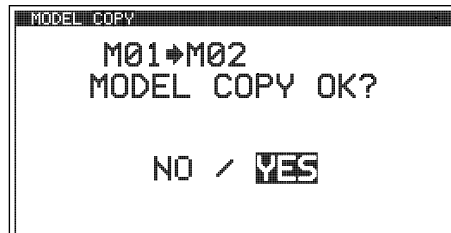
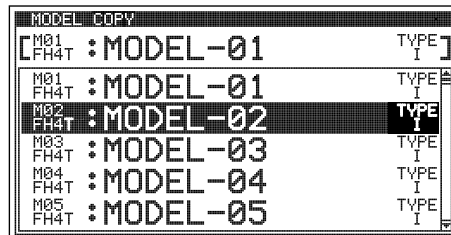

- EXECUTED will be displayed and the Model you just copied Programming Data TO will be highlighted in brackets and the top of the Model Copy List.

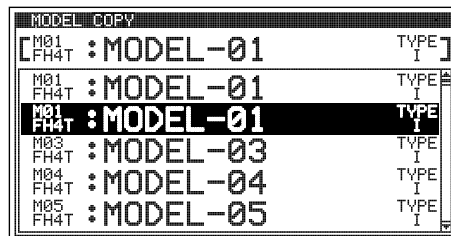

Model Clear

The Model Clear function allows you to reset Model-specific Programming Data for the currently Selected Model back to the Factory Default settings. Make sure that prior to using the Model Clear function, you first Select and load the desired Model you want to clear the Programming Data for, using the Model Select function.

 When the Model Clear function is EXECUTED, all custom Programming Data for the currently Selected Model will be lost and reset to the Factory Default settings!

Clearing Model Programming Data:

- From within the SYSTEM menu, scroll UP or DOWN to highlight the MODEL menu.
- Press the ENTER key to open the MODEL menu, then scroll UP or DOWN to highlight the CLEAR menu. The currently Selected Model will be displayed.

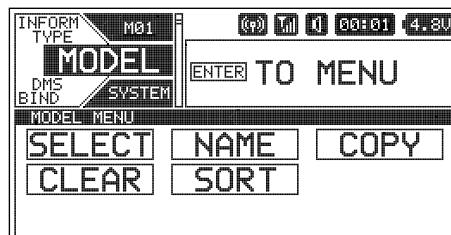

- Press the ENTER key. MODEL CLEAR OK? NO/YES will be displayed. Scroll UP or DOWN to highlight YES, then press the ENTER key. EXECUTED will be displayed and all Programming Data for the currently Selected Model will be reset to the Factory Default settings.

 If you want to go back and change Models or you don't want to Clear the Programming Data for any reason, choose NO or press the BACK key prior to EXECUTING.

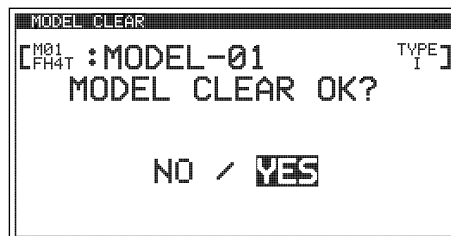
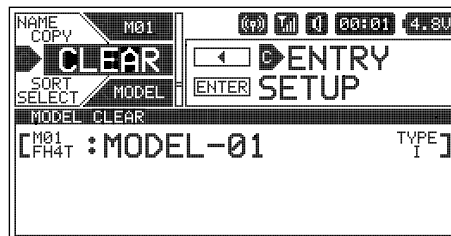

MODEL MENU (SELECT, NAME, COPY, CLEAR AND SORT)

SYSTEM

Model Sort

The Model Sort function allows you to change how your Models are displayed in the Model Select List by allowing you to swap the currently Selected Model with other Models. For example, you might want to Sort your Models so that your most frequently used Models are at the top of the Model Select List, or you might want to Sort your Models by type, such as crawlers, on-road, etc.

Sorting Models:

- 1) From within the SYSTEM menu, scroll UP or DOWN to highlight the MODEL menu.

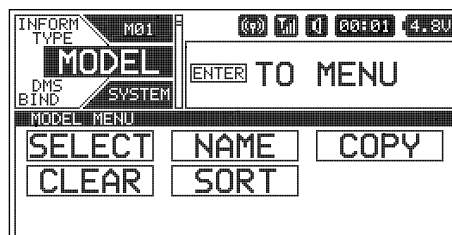

- 2) Press the ENTER key to open the MODEL menu, then scroll UP or DOWN to highlight the SORT menu.

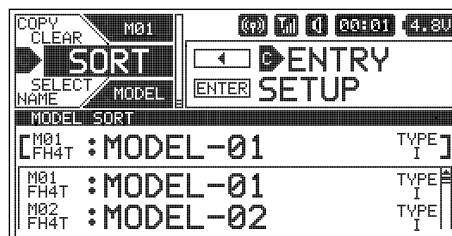

- 3) Press the ENTER key to open the SORT menu. The currently Selected Model will be displayed in brackets above the Model Sort List and the first Model in the Model Sort List will be highlighted.
- 4) Scroll UP or DOWN within the Model Sort List to highlight the Model you would like to swap the currently Selected Model with and move to the top of the Model Sort List. For example, the currently Selected Model is M01. Highlight M02 to swap M01 with M02 and move it to the top of Model Sort List.

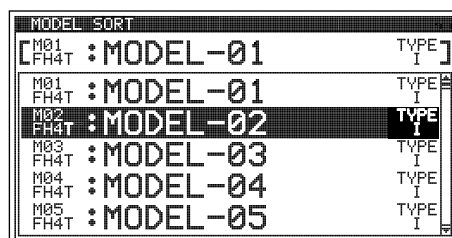

- 5) Press the ENTER key. MODEL SORT OK? NO/YES will be displayed. Scroll UP or DOWN to highlight YES, then press the ENTER key.

 If you want to go back and choose a different Model or you don't want to Sort the Selected Model for any reason, choose NO or press the BACK key prior to EXECUTING.

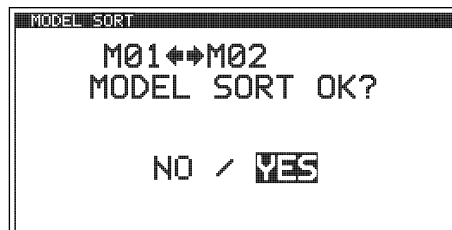

- 6) EXECUTED will be displayed and the Model you highlighted (i.e. M02) will be swapped with the currently Selected Model and moved to the top of the Model Sort List.
- 7) Repeat steps 4 through 6 to continue Sorting Models by swapping with the currently Selected Model. To swap with a different Model, you must Select that desired Model using the Model Select function first. For more information, see the Model Select section on pages 25 ~ 26.

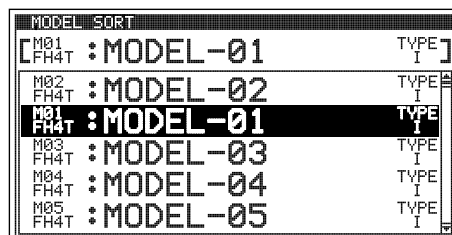

DMS MENU (DIRECT MODEL SELECT)

SYSTEM

The DMS function allows you to choose up to three different Models that can be Selected when turning the transmitter ON. Simply press a key while turning the transmitter ON and the Programming Data for your favorite Model will load automatically.

Using the Direct Model Select Function:

- 1) Turn the transmitter turned OFF.
- 2) Press and HOLD the SELECT switch Right or Left, or press and HOLD the BACK key while turning the transmitter ON. The Model Programming Data associated with either of those key presses will automatically load.

DMS MENU (DIRECT MODEL SELECT)

SYSTEM

Changing Direct Model Select Models:

- 1) From within the SYSTEM menu, scroll UP or DOWN to highlight the DMS menu.
- 2) Press the ENTER key to open the DMS menu, then scroll UP or DOWN to highlight the Model Name adjacent to the DMS number you would like to change.

SELECT switch LEFT controls DMS1, SELECT switch RIGHT controls DMS2 and the BACK key controls DMS3.

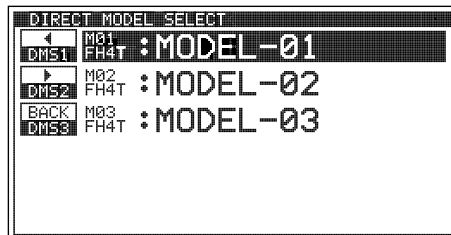
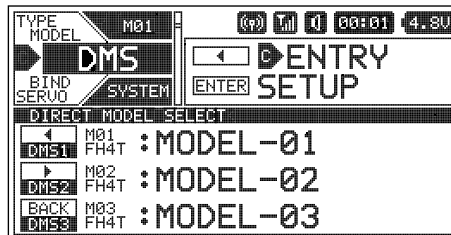

- 3) Press the ENTER key, then scroll UP or DOWN to choose the Model Name you want to be controlled by that particular Direct Model Select switch.
- 4) Repeat step 3 to Assign any other desired Models to the remaining Direct Model Select Switches.

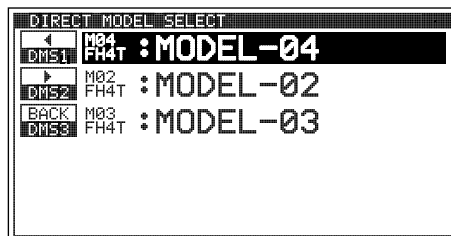

BIND MENU (BINDING, MODULATION TYPE, SAFETY LINK AND SERVO MODE)

SYSTEM

The BIND menu allows you to change the transmitter's Modulation Type, turn the Telemetry function ON and OFF, Assign a Safety Link Number to your Model, change the Servo Operating Mode and Bind the transmitter and receiver pair. All settings are Model-specific, so you can have different settings to suit different Models.

! The Modulation Type and Safety Link Number must be chosen prior to Binding the transmitter and receiver. If these options are changed after Binding, you will need to re-Bind the transmitter and receiver pair.

Make sure the Modulation Type you choose matches the Modulation Type of the receiver you're using!

Changing the Modulation Type:

The Modulation Type function allows you to choose the transmitter Modulation Type. The Modulation Type should be changed to match the receiver you're using. For example, if you use an Airtronics 2.4GHz FH3 surface receiver with your transmitter, you would need to change the Modulation Type to FH3. The Modulation Type should be chosen prior to Binding the transmitter and receiver pair.

- 1) From within the SYSTEM menu, scroll UP or DOWN to highlight the BIND menu.

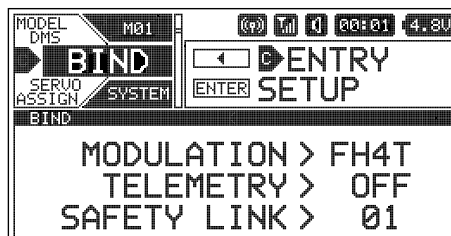

- 2) Press the ENTER key to open the BIND menu. MODULATION > FH4T will be highlighted.
- 3) Press the ENTER key, then scroll UP or DOWN to Select the desired Modulation Type.

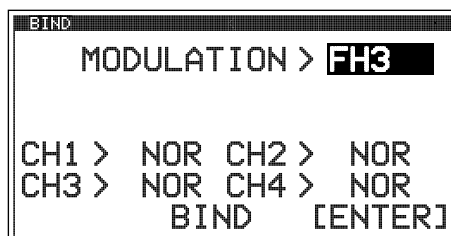

Changing the Modulation Type, Continued...

- 4) Press the ENTER key. SET TO FH3? (or the Modulation Type you Selected) NO/YES will be displayed. Scroll UP or DOWN to highlight YES, then press the ENTER key.

 If you want to go back and change the Modulation Type or if you don't want to change the Modulation Type for any reason, choose NO or press the BACK key.

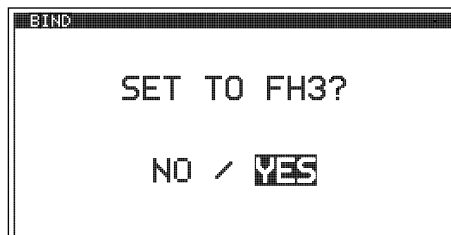

The following Modulation Type options are available:

- FH2** - Select this Modulation Type when using Airtronics 2.4GHz FH2 surface receivers.
- FH3** - Select this Modulation Type when using Airtronics 2.4GHz FH3 surface receivers.
- FH3F** - This Modulation Type is NOT used in North America.
- FH4T (Default)** - Select this Modulation Type when using Airtronics 2.4GHz FH4 or FH4T surface receivers.
- FH4FT** - This Modulation Type is NOT used in North America.

IMPORTANT: Not all BIND menu functions are supported by all Modulation Types. Only supported functions will be displayed once a Modulation Type is chosen. For example, the FH3 Modulation Type does not support Telemetry.

Turning the Telemetry Function ON and OFF:

- 1) From within the BIND menu, scroll down to highlight TELEMETRY > ON.
- 2) Press the ENTER key, then scroll UP or DOWN to choose the desired Telemetry value, either ON or OFF.

TELEMETRY setting range is ON or OFF. The default setting is OFF.

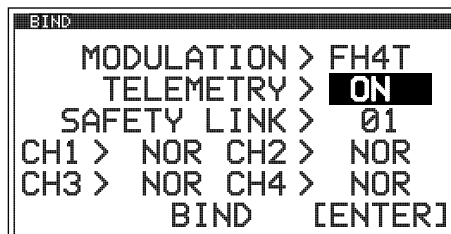

Changing the Safety Link Number:

The Safety Link function is used to program a unique code to each receiver/Model pair, preventing the transmitter from controlling a Model that it's not currently programmed for. This helps prevent a runaway Model should you accidentally choose the wrong Programming Data for the intended Model.

 The Safety Link Number should be chosen prior to Binding the transmitter and receiver pair. To make it easier to keep track of what Safety Link Number goes to what Model, we suggest making the Safety Link Number the same as the Model Number.

- 1) From within the BIND menu, scroll down to highlight SAFETY LINK > 01.
- 2) Press the ENTER key, then scroll UP or DOWN to highlight the desired Safety Link Number.

SAFETY LINK setting range is 01 to 50. The default setting is 01.

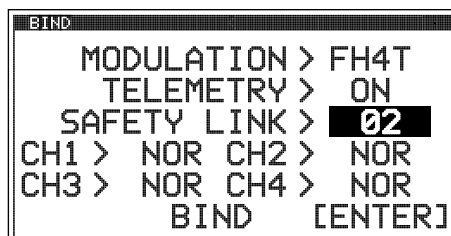

- 3) Press the ENTER key. SET TO LINK No.02? (or the Safety Link Number you Selected) NO/YES will be displayed. Scroll UP or DOWN to highlight YES, then press the ENTER key.

 If you want to go back and change the Safety Link Number or if you don't want to change the Safety Link Number for any reason, choose NO or press the BACK key.

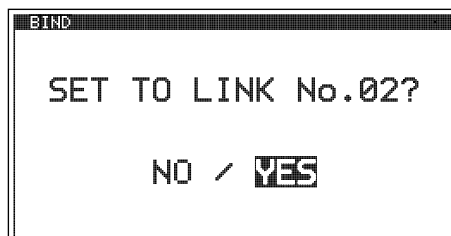

Changing the Servo Operating Mode:

The Servo Operating Mode function is used to optimize the radio control system to suit the type of servos you're using in your Model. For example, using the SHR setting with Digital servos will Increase the servo's response time, even above the manufacturer's stated specification. If you're using Airtronics SRG Digital servos, you can use the SSR setting for the fastest response time. The combination of using Digital servos and using the correct Servo Operating Mode value results in the ultimate feel and response, making you feel more in control of your Model than ever.

BIND MENU (BINDING, MODULATION TYPE, SAFETY LINK AND SERVO MODE)

SYSTEM

Changing the Servo Operating Mode, Continued...

- 1) From within the BIND menu, scroll down to highlight the desired channel you would like to change the Servo Operating Mode for.
- 2) Press the ENTER key, then scroll UP or DOWN to choose the desired Servo Operating Mode value for that channel.
- 3) Press the ENTER key, then repeat steps 1 and 2 to choose the Servo Operating Mode for any desired remaining channels.

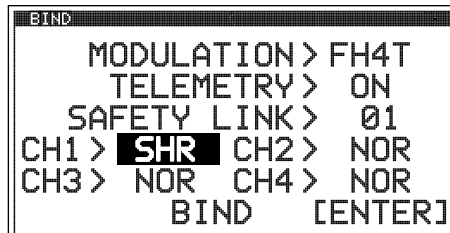
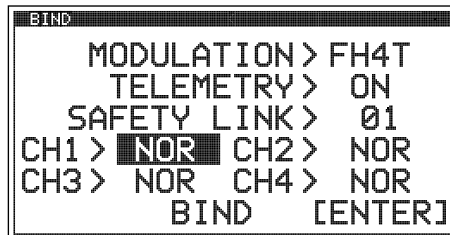

SERVO OPERATING MODE setting range is NOR, SHR and SSR. The default setting is NOR. SSR Operating Mode is not supported when FH3 or FH3F Modulation Type is Selected.

IMPORTANT INFORMATION ABOUT SERVO OPERATING MODE VALUES:

If you're using Analog servos in your Model, DO NOT use SHR or SSR Servo Operating Mode values for those channels. Use the NOR (Normal) Servo Operating Mode with Analog servos. Using SHR or SSR Servo Operating Mode values with Analog servos can result in poor performance or even damage to the servos or the receiver!

Not all ESCs are compatible with SHR or SSR Servo Operating Modes. If your ESC does not operate correctly, change the Servo Operating Mode to NOR (Normal) for that channel (or channels).

SHR and SSR Servo Operating Modes should only be used with Digital servos. While the SHR Servo Operating Mode can be used with any brand of Digital servo, the SSR Servo Operating Mode should ONLY be used with Airtronics SRG Digital servos.

Binding the Transmitter and Receiver:

To Bind the transmitter and receiver, please see the *Transmitter and Receiver Binding* section on page 23. Prior to Binding the transmitter and receiver, make sure to choose the desired Modulation Type and Safety Link Number.

SERVO MENU (SERVO MONITOR)

SYSTEM

The Servo Monitor displays the output levels of the four different channels in bar graph form, allowing you to monitor servo operation in a virtual manner. This is helpful to see servo movement when the controls are moved, and it allows you to visualize what is occurring with servo movements when you apply different Mixing values, exponential, etc. When used in conjunction with the DISPLAY key, the Servo Monitor allows you to see servo movement virtually and make programming changes without the transmitter actually transmitting a signal.

 The channel names displayed will vary based on the Car Type Selected in the TYPE menu. Depending on the current servo reversing settings, the bar graphs may not move the same direction as the transmitter controls. This is normal.

Using the Servo Monitor:

- 1) From within the SYSTEM menu, scroll UP or DOWN to highlight the SERVO menu.
- 2) Press the ENTER key to open and view the full screen Servo Monitor. The hash marks represent the current channel output positions.

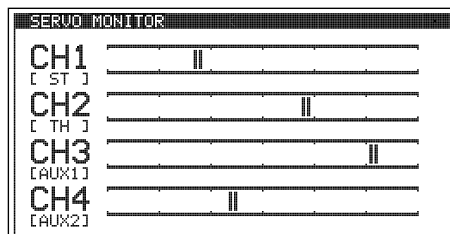
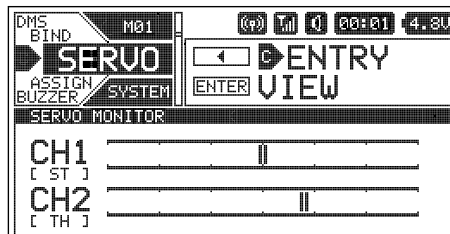

ASSIGN MENU (SWITCH, DIAL AND LEVER FUNCTION ASSIGNMENTS)

SYSTEM

The ASSIGN menu allows you to Assign different functions to each of the three Push-Button Switches, the five Trim Switches, the Auxiliary Dial and the Auxiliary Lever. Each of the three Push-Button Switches can have up to two functions Assigned to it and the ON/OFF behavior can be changed. In addition, the Direction of Travel and the Trim Resolution of the five Trim Switches and the Auxiliary Dial can be changed.

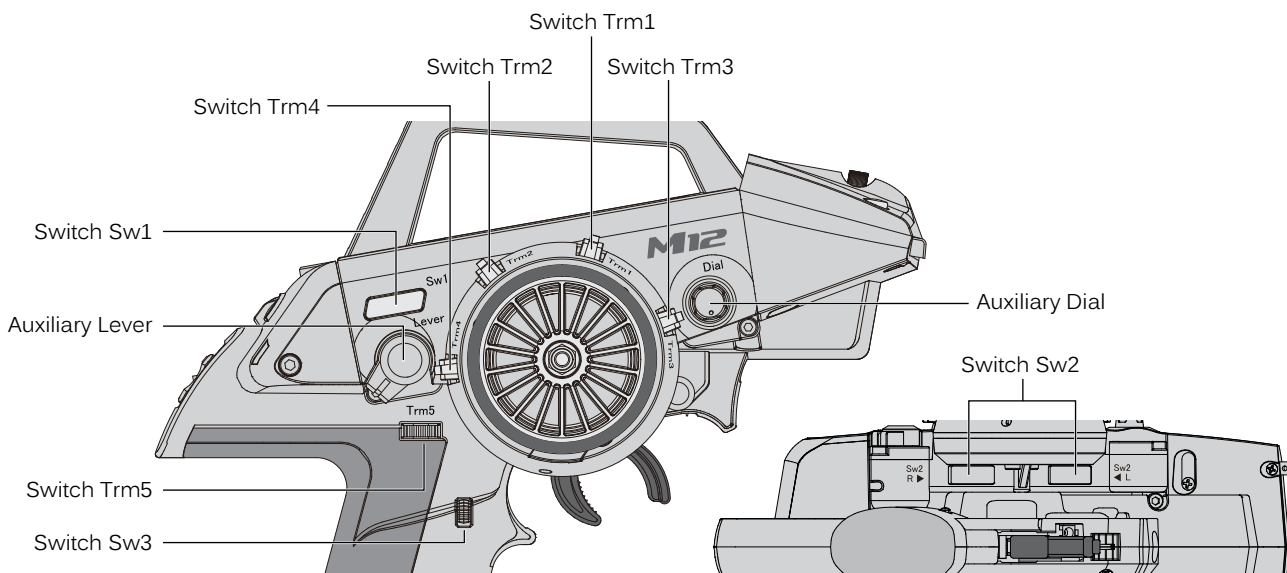

Push-Button Switch Function Assignments

The Switch Assignments function allows you to Assign various functions to the three Push-Button Switches Sw1, Sw2 and Sw3. This allows you to use the Push-Button Switches to turn functions ON and OFF while you're driving. Up to two different functions can be Assigned to each switch and the ON and OFF behavior of each switch can be changed to either PUSH or TOGGLE to suit the programmed function and your specific requirements.

 Push-Button Switch functions vary based on the Car Type Selected in the TYPE menu. For more information, see the table on the next page.

Changing the Push-Button Switch Function Assignments:

1) From within the SYSTEM menu, scroll UP or DOWN to highlight the ASSIGN menu.

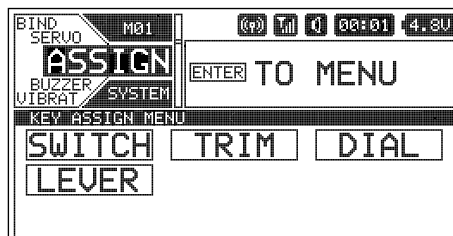

2) Press the ENTER key to open the ASSIGN menu. The SWITCH menu will be highlighted.

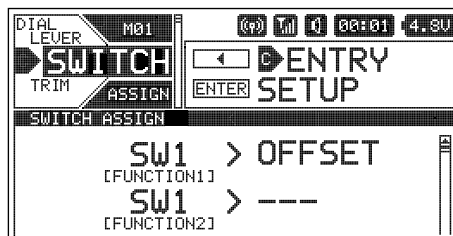

3) Press the ENTER key to open the SWITCH menu. SW1 [FUNCTION 1] > OFFSET will be highlighted.

4) Scroll UP or DOWN to highlight the Switch Number and Function you would like to change. Choose from SW1 [FUNCTION 1 or 2], SW2 [FUNCTION 1 or 2] or SW3 [FUNCTION 1 or 2].

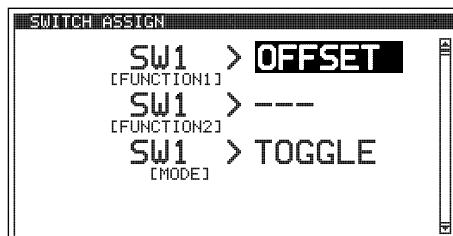

ASSIGN MENU (SWITCH, DIAL AND LEVER FUNCTION ASSIGNMENTS)

SYSTEM

Changing the Push-Button Switch Function Assignments, Continued....

- Press the ENTER key, then scroll UP or DOWN to choose the desired function for the Switch and Function Number you highlighted. A list of functions that can be Assigned to the Push-Button Switches are shown in the table below.
- Press the ENTER key, then repeat steps 4 and 5 to any other desired Push-Button Switch Function Assignments.

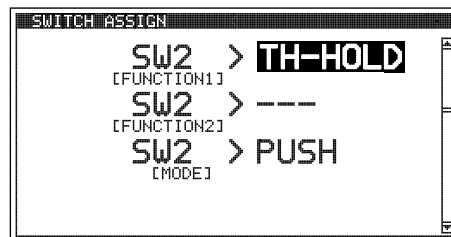

! Although two different functions can be Assigned to the same Push-Button Switch, those functions cannot be controlled independently. AUX may control different functions depending on the Car Type.

TYPE SW	TYP I	TYP II	TYP III	TYP IV	TYP V	TYP VI	TYP VII	TYP VIII	TYP IX	TYP X
	---	---	---	---	---	---	---	---	---	---
Sw2*	ALB	ALB	ALB	ALB	ALB	ALB	ALB	ALB	ALB	ALB
Sw1*	OFFSET	OFFSET	OFFSET	OFFSET	OFFSET	OFFSET	OFFSET	OFFSET	OFFSET	OFFSET
	AUX1	AUX	AUX	LAP	AUX	LAP	LAP	AUX	AUX	LAP
	AUX2	LAP	LAP	INT1	LAP	INT1	INT1	LAP	LAP	INT1
Sw3*	LAP	INT1	INT1	INT2	INT1	INT2	INT2	INT1	INT1	INT2
Sw3*	INT1	INT2	INT2	TH-HOLD	INT2	TH-HOLD	TH-HOLD	INT2	INT2	
	INT2	TH-HOLD	TH-HOLD		TH-HOLD					
	TH-HOLD									

*Indicates default function for Selected Car Type.

Changing the Switch Mode:

The ON and OFF behavior of each Push-Button Switch can be changed to suit the programmed function and your specific requirements. The following Switch Modes are available:

TOGGLE - When Selected, press the Push-Button Switch to turn the function ON and press the Push-Button Switch a second time to turn the function OFF.

PUSH - When Selected, press and HOLD the Push-Button Switch to turn the function ON. Release the Push-Button Switch to turn the function OFF.

- From within the SWITCH menu, scroll UP or DOWN to highlight the Switch Number [MODE] you would like to change. Choose from SW1 [MODE], SW2 [MODE] or SW3 [MODE].

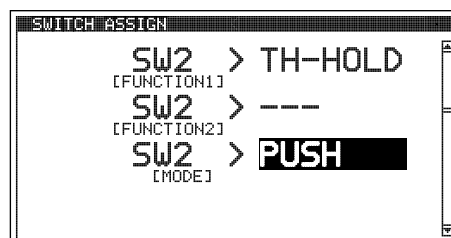

- Press the ENTER key, then scroll UP or DOWN to change the desired Switch Mode value. Choose from either TOGGLE or PUSH.

MODE setting range is PUSH and TOGGLE. The default setting for SW1 is TOGGLE and for SW2 and SW3 is PUSH.

- Repeat step 2 to change any other desired Switch Mode values.

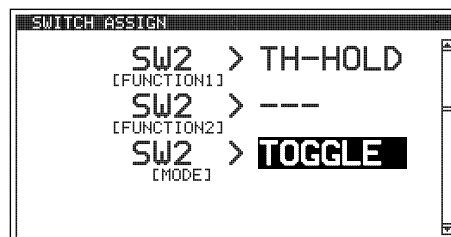

Trim Switch Function Assignments

The Trim Assignments function allows you to Assign a multitude of different functions to the five Trim Switches Trm1, Trm2, Trm3, Trm4 and Trm5. This allows you to use the Trim Switches to control those functions while you're driving. In addition, the Trim Resolution (Step value) and the Direction of Travel (REV) of each Trim Switch can be changed.

! For a complete list of functions that can be Assigned to the Trim Switches, see the Trim Switch Auxiliary Dial and Auxiliary Lever Functions tables on page 100.

ASSIGN MENU (SWITCH, DIAL AND LEVER FUNCTION ASSIGNMENTS)

SYSTEM

Changing the Trim Switch Function Assignments:

- 1) From within the SYSTEM menu, scroll UP or DOWN to highlight the ASSIGN menu.

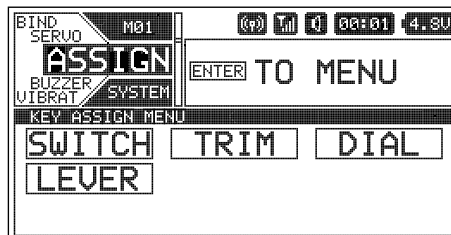

- 2) Press the ENTER key to open the ASSIGN menu, then scroll UP or DOWN to highlight the TRIM menu.

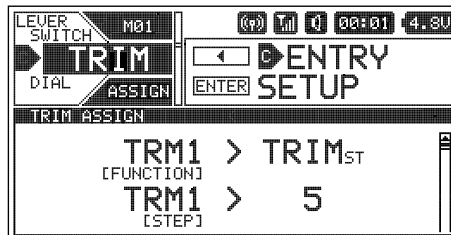

- 3) Press the ENTER key to open the TRIM menu. TRM1 [FUNCTION] > TRIM_{ST} will be highlighted.

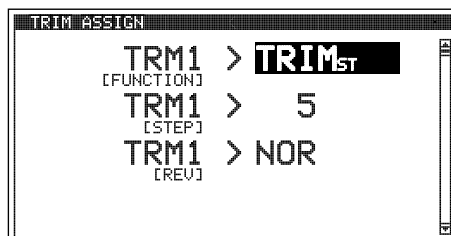

- 4) Scroll UP or DOWN to highlight the Trim Switch Number you would like to change. Choose from TRM1, TRM2, TRM3, TRM4 or TRM5.

- 5) Press the ENTER key, then scroll UP or DOWN to choose the desired function for the Trim Switch Number you highlighted. A complete list of functions that can be Assigned to the Trim Switches are shown in the tables on page 100.

- 6) Press the ENTER key, then repeat steps 4 and 5 to any other desired Trim Switch Function Assignments.

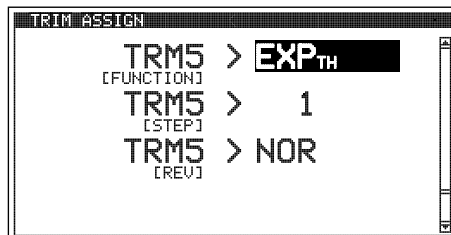

Changing the Trim Switch Step Value:

The Step function allows you to adjust how far a servo travels or a function moves when a Trim Switch is pressed. You can Increase the Trim Resolution by Decreasing the Step value, so that the amount of travel is less when you press the Trim Switches. This makes it possible to fine-tune travel extremely accurately. Alternately, you could Decrease the Trim Resolution by Increasing the Step value, so that the amount of travel is more when you press the Trim Switches. This may not be as accurate, but it allows you to command large amounts of travel or function movement at a time.

- 1) From within the TRIM menu, scroll UP or DOWN to highlight the Trim Switch Number [STEP] you would like to change. Choose from TRM1 [STEP], TRM2 [STEP], TRM3 [STEP], TRM4 [STEP] or TRM5 [STEP].

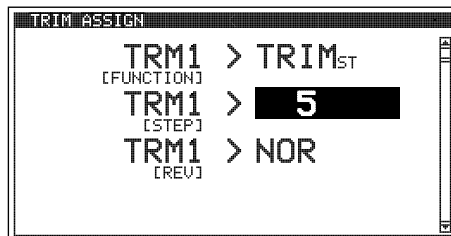

- 2) Press the ENTER key, then scroll UP or DOWN to change the desired Trim Switch Step value.

STEP setting range is 0 to 100. The default setting is 1 or 5 depending on the Trim Switch Number. The Step value is a percentage of travel.

- 3) Repeat step 2 to change any other desired Trim Step values.

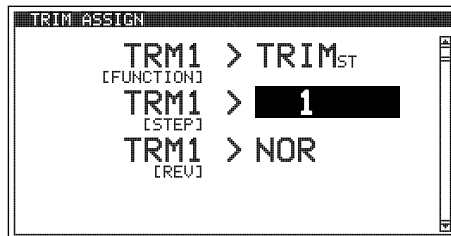

Changing the Trim Switch Direction of Travel:

The direction that the Trim Switches move the servos or function values can be changed from Normal to Reverse. In Normal mode, the Trim Switches will move the servos toward the High Side or Increase function values when the Trim Switches are pushed Forward. In Reverse mode, the Trim Switches will move the servos toward the Low Side or Decrease function values when the Trim Switches are pushed Forward.

- 1) From within the TRIM menu, scroll UP or DOWN to highlight the Trim Switch Number [REV] you would like to change. Choose from TRM1 [REV], TRM2 [REV], TRM3 [REV], TRM4 [REV] or TRM5 [REV].

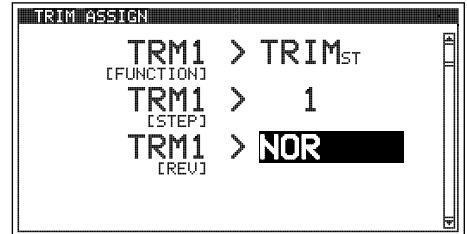

- 2) Press the ENTER key, then scroll UP or DOWN to change the desired Trim Switch Reverse value.

REV setting range is NOR and REV. The default setting is NOR.

- 3) Repeat step 2 to change any other desired Trim Switch Reverse values.

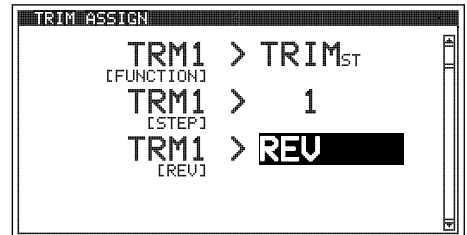

Auxiliary Dial Function Assignments

The Dial Assignments function allows you to Assign a multitude of different functions to the Auxiliary Dial. This allows you to use the Auxiliary Dial to control those functions while you're driving. The Auxiliary Dial can control either of the two Auxiliary channels or it can control a function, such as Steering Dual Rate or Steering Exponential. In addition, the Trim Resolution (Step value) and the Direction of Travel (REV) of the Auxiliary Dial can be changed.

Changing the Auxiliary Dial Function Assignment:

- 1) From within the SYSTEM menu, scroll UP or DOWN to highlight the ASSIGN menu.

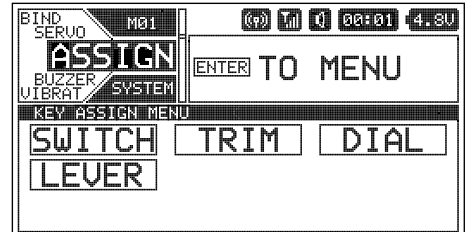

- 2) Press the ENTER key to open the ASSIGN menu, then scroll UP or DOWN to highlight the DIAL menu.

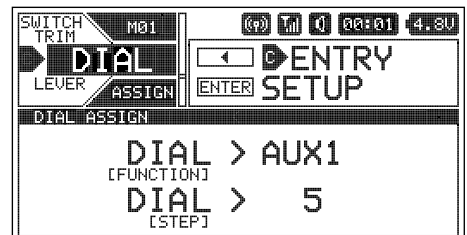

- 3) Press the ENTER key to open the DIAL menu. DIAL [FUNCTION] > AUX1 will be highlighted.

- 4) Press the ENTER key, then scroll UP or DOWN to choose the desired function you want to Assign to the Auxiliary Dial. A complete list of functions that can be Assigned to the Auxiliary Dial is shown in the table on page 100.



Changing the Auxiliary Dial Step Value:

The Step function allows you to adjust how far a servo travels or a function moves when the Auxiliary Dial is turned. You can Increase the Trim Resolution by Decreasing the Step value, so that the amount of travel is less when you turn the Auxiliary Dial. This makes it possible to fine-tune servo travel or function movement extremely accurately. Alternately, you could Decrease the Trim Resolution by Increasing the Step value, so that the amount of travel is more when you turn the Auxiliary Dial. This may not be as accurate, but it allows you to command large amounts of servo travel or function movement at a time.

ASSIGN MENU (SWITCH, DIAL AND LEVER FUNCTION ASSIGNMENTS)

SYSTEM

Changing the Auxiliary Dial Step Value, Continued:

- 1) From within the DIAL menu, scroll UP or DOWN to highlight DIAL [STEP] > 5.
- 2) Press the ENTER key, then scroll UP or DOWN to choose the desired Auxiliary Dial Step value.

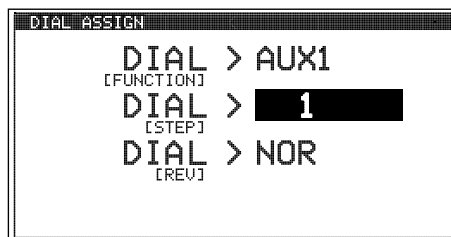

STEP setting range is 1 to 100. The default setting is 5. The Step value is a percentage of travel.

Changing the Auxiliary Dial Direction of Travel:

The direction that the Auxiliary Dial moves the servo or function value can be changed from Normal to Reverse. In Normal mode, the Auxiliary Dial will move the servo toward the High Side or Increase a function value when the Auxiliary Dial is turned clockwise. In Reverse mode, the Auxiliary Dial will move the servo toward the Low Side or Decrease a function value when the Auxiliary Dial is turned counter-clockwise.

- 1) From within the DIAL menu, scroll UP or DOWN to highlight DIAL [REV] > NOR.
- 2) Press the ENTER key, then scroll UP or DOWN to choose the desired Auxiliary Dial Reverse value.

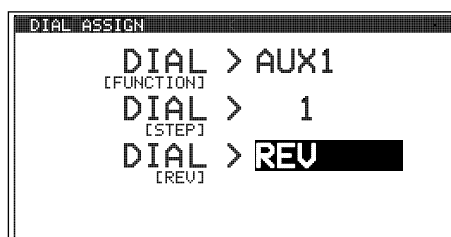

REV setting range is NOR and REV. The default setting is NOR.

Auxiliary Lever Function Assignments

The Lever Assignments function allows you to Assign various functions to the Auxiliary Lever. This allows you to use the Auxiliary Lever to control those functions while you're driving. The Auxiliary Lever can control either of the two Auxiliary channels or it can control a function, such as Steering Dual Rate or Steering Exponential.

Changing the High and Low Tweak values determines the amount of travel and direction.

Changing the Auxiliary Lever Function Assignment:

- 1) From within the SYSTEM menu, scroll UP or DOWN to highlight the ASSIGN menu.

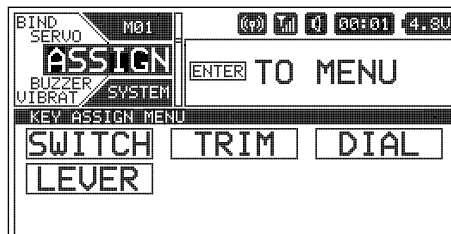

- 2) Press the ENTER key to open the ASSIGN menu, then scroll UP or DOWN to highlight the LEVER menu.

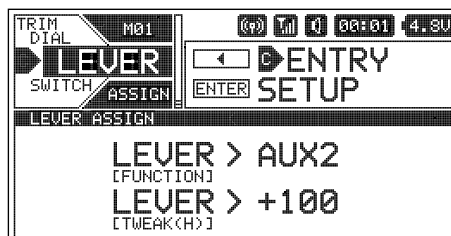

- 3) Press the ENTER key to open the LEVER menu. LEVER [FUNCTION] > AUX2 will be highlighted.
- 4) Press the ENTER key, then scroll UP or DOWN to choose the desired function you want to Assign to the Auxiliary Lever. A complete list of functions that can be Assigned to the Auxiliary Lever are shown in the tables on page 100.

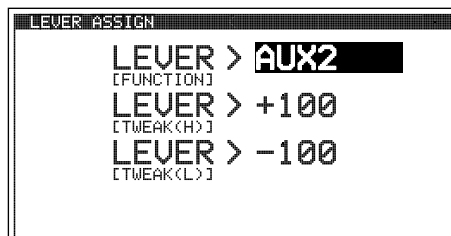

ASSIGN MENU (SWITCH, DIAL AND LEVER FUNCTION ASSIGNMENTS)

SYSTEM

Changing the Auxiliary Lever High and Low Tweak Values:

The High and Low Tweak values both determine how far and in which direction the Auxiliary Lever controls the function Assigned to it when the Auxiliary Lever is moved Up and Down, regardless if the Auxiliary Lever is controlling a servo, such as Auxiliary Channel 2 or a function parameter, such as Steering Trim. For example, if you Assign AUX2 to the Auxiliary Lever and adjust the Tweak values to +50 and -50, the Auxiliary 2 servo will be centered when the Auxiliary Lever is centered and will travel 50% in one direction when the Auxiliary Lever is moved Up and travel 50% in the other direction when the Auxiliary Lever is moved Down. Alternately, if you Assign TRIMst to the Auxiliary Lever and adjust the Tweak values to +50 and -50, the Auxiliary Lever will control Steering Trim from 0% to 50%.

- 1) From within the LEVER menu, scroll UP or DOWN to highlight LEVER [TWEAK (H)] > +100.
- 2) Press the ENTER key, then scroll UP or DOWN to choose the desired High Side Tweak value. Increasing the Tweak value will Increase travel in the High Side direction and Decreasing the Tweak value will Decrease travel in the High Side direction. Using a Negative value will change the direction of travel.

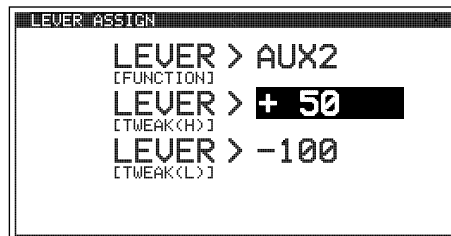

TWEAK (H) setting range is -100 to +100. The default setting is +100.

- 3) Scroll DOWN to highlight LEVER [TWEAK (L)] > -100.
- 4) Press the ENTER key, then scroll UP or DOWN to choose the desired Low Side Tweak value. Decreasing the Tweak value will Increase travel in the Low Side direction and Increasing the Tweak value will Decrease travel in the Low Side direction. Using a Positive value will change the direction of travel.

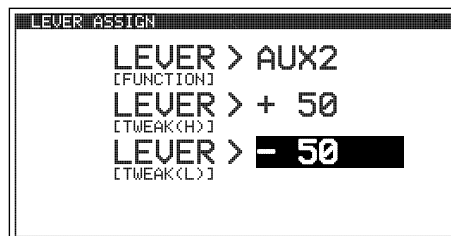

TWEAK (L) setting range is -100 to +100. The default setting is -100.

BUZZER MENU (AUDIBLE KEY TONES AND ALARMS)

SYSTEM

The Buzzer function allows you to change the Tone and Volume of many of the audible sounds that the transmitter makes. This ranges from sounds that are made when you press Trim and Push-Button Switches, scroll UP or DOWN or press the ENTER key, Lap and Interval Timer alarms, Telemetry alarms, transmitter Voltage Limit alarm and more.

The Volume can be Increased or Decreased (or Muted) and the Tones can be changed to suit your preference. In addition, many of the Tones can be set separately for the first half and the second half of a Tone, making it easier to differentiate between the two halves.

The following is a list of the functions that the Tone and Volume can be adjusted for:

FUNCTION	DESCRIPTION
CLICK	Controls Key Press Tones, Such as ENTER, BACK, SELECT and All Push-Button Switches
TRIM	Controls All Trim Switch Key Press Tones
CENTER	Controls the Trim Switch, Auxiliary Dial and Auxiliary Lever Neutral Point Indicator Tones
MULTI	Controls the Push-Button Rotary Dial scroll UP and Scroll DOWN Tones*
TIMER SW	Controls the Lap Timer Start and Stop Tones*
INT1 TIMER	Controls the First Interval Timer Start and Stop Tones
INT2 TIMER	Controls the Second Interval Timer Start and Stop Tones
LAP-PRE	Controls the Lap Timer Pre-Alarm Tone
LAP GOAL	Controls the Lap Timer Goal Alarm Tone
OFFSET	Controls the Offset Function Alarm Tone
TELEMETRY	Controls the Various Telemetry System Alarms*
LIMIT	Controls the Transmitter Limit Voltage Alarm*

*Only TONE1 (first half) changes affected. No affect on TONE2 (second half) changes.

BUZZER MENU (AUDIBLE KEY TONES AND ALARMS)

SYSTEM

Changing the Audible Tones:

- From within the SYSTEM menu, scroll UP or DOWN to highlight the BUZZER menu.
- Press the ENTER key to open the BUZZER menu. CLICK [TONE1] > 1 will be highlighted.
- Scroll UP or DOWN to highlight the Function Tone Number you would like to change.
- Press the ENTER key, then scroll UP or DOWN to choose the desired Tone value for either [TONE1] and/or [TONE2]. Increasing the Tone value will Increase the Tone of the Selected function and Decreasing the Tone value will Decrease the Tone of the Selected function.

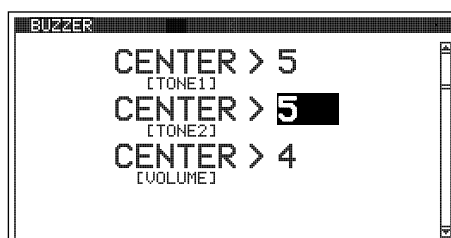
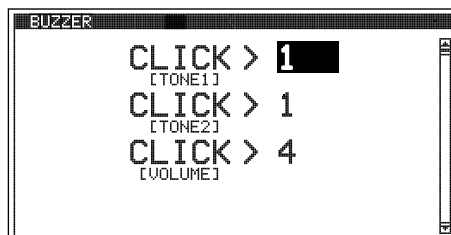
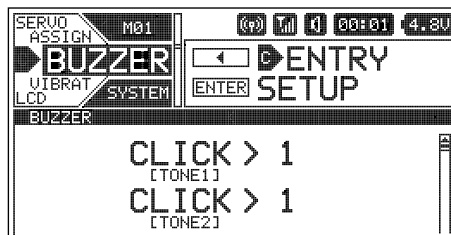

TONE1 and TONE2 setting range is 1 to 7. The default setting is 1. TONE1 changes the first half Tone and TONE2 changes the second half Tone.

- Press the ENTER key, then repeat steps 3 and 4 to change the Audible Tones for any other desired functions.

Changing the Volume:

- From within the BUZZER menu, Scroll UP or DOWN to highlight the Function Volume Number you would like to change.
- Press the ENTER key, then scroll UP or DOWN to choose the desired Volume value. Increasing the Volume value will Increase the Volume of the Selected function and Decreasing the Volume value will Decrease the Volume of the Selected function. Choosing OFF will Mute the Selected function.

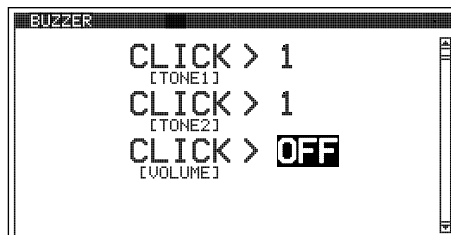
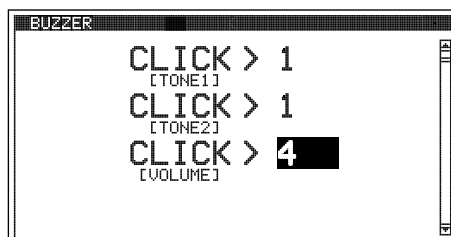

VOLUME setting range is OFF to 5. The default setting is 4.

- Press the ENTER key, then repeat steps 1 and 2 to change the Volume value for any other desired functions.

VIBRATOR MENU (VIBRATION ALERTS AND ALARMS)

SYSTEM

The Vibrator function makes the transmitter vibrate like a cell phone to make you aware of different alerts and alarms that you might encounter during use. For example, you can program the transmitter to vibrate when the an Interval Timer starts or stops or when you reach a Lap Timer Goal Time. You can also program the transmitter to vibrate when the transmitter reaches the programmed Voltage Alert value or when the transmitter is turned ON and more. The Vibrate function is particularly useful if you've Muted any of these related audible alerts and alarms. The Vibrate function can also be used along with these related audible alerts and alarms to provide a level of tactile feedback while you're driving.

VIBRATOR MENU (VIBRATION ALERTS AND ALARMS)

SYSTEM

Turning Vibration Functions ON and OFF:

- From within the SYSTEM menu, scroll UP or DOWN to highlight the VIBRATOR menu.
- Press the ENTER key to open the VIBRATOR menu. POWER > OFF will be highlighted.
- Scroll UP or DOWN to highlight the function you would like to change the Vibration value for.
- Press the ENTER key, then scroll UP or DOWN to choose the desired Vibration value, either ON or OFF.

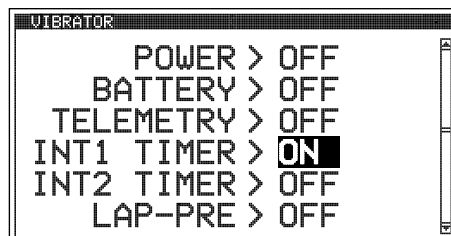
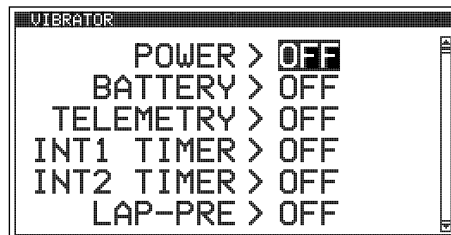
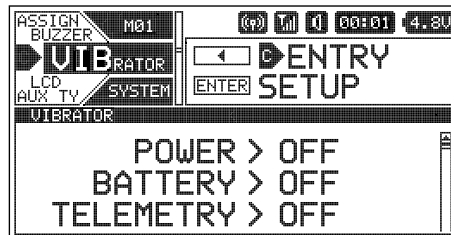

VIBRATOR setting range is OFF to ON. The default setting for all functions is OFF.

- Press the ENTER key, repeat steps 3 and 4 to change the Vibration value for any other desired functions.

The following is a list Vibration Functions that can be turned ON or OFF:

FUNCTION	DESCRIPTION
POWER	Vibrates When the Transmitter is Turned ON
BATTERY	Vibrates to Indicate When the Transmitter Reaches the Programmed Voltage Alert Value
TELEMETRY	Vibrates to Indicate Telemetry System Alarms
INT1 TIMER	Vibrates to Indicate When the First Interval Timer Starts and Stops
INT2 TIMER	Vibrates to Indicate When the Second Interval Timer Starts and Stops
LAP-PRE	Vibrates to Indicate When the Lap Timer Pre-Alarm Time is Reached
LAP GOAL	Vibrates to Indicate When the Lap Timer Goal Time is Reached

LCD MENU (DISPLAY OPTIONS)

SYSTEM

The LCD menu allows you change the contrast of the LCD, the brightness of the LCD Backlight, the Backlight Mode and the Backlight On-Time. Changing the Contrast and Brightness settings can make it easier to view the LCD in different lighting conditions and changing the Backlight Mode and Backlight On-Time affects how the Backlight is turned ON and how long the Backlight stays ON.

IMPORTANT: Increasing the brightness of the LCD Backlight and/or leaving the LCD Backlight ON at all times will increase battery consumption. In addition, Decreasing the Contrast value near the Lower limit can result in the LCD text becoming difficult to read. Be careful not to set the Contrast value too low.

Changing the LCD Contrast:

- From within the SYSTEM menu, scroll UP or DOWN to highlight the LCD menu.

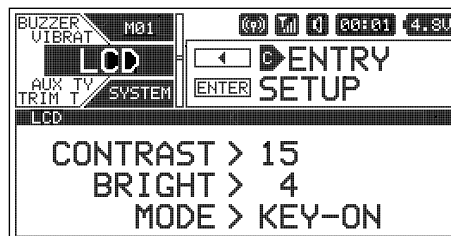

LCD MENU (DISPLAY OPTIONS)

SYSTEM

Changing the LCD Contrast, Continued...

2) Press the ENTER key to open the LCD menu. CONTRAST > 15 will be highlighted.



3) Press the ENTER key, then scroll UP or DOWN to choose the desired Contrast value. Increasing the Contrast value will Increase the contrast of the LCD and Decreasing the Contrast value will Decrease the contrast of the LCD.

CONTRAST setting range is 10 to 20. The default setting is 15.

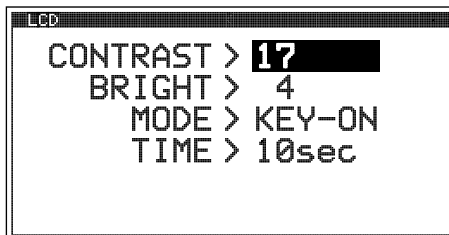

Changing the LCD Backlight Brightness:

- 1) From within the LCD menu, scroll UP or DOWN to highlight BRIGHT > 4.
- 2) Press the ENTER key, then scroll UP or DOWN to choose the desired Brightness value. Increasing the Brightness value increases the brightness of the LCD Backlight and Decreasing the Brightness value decreases the brightness of the LCD Backlight.

BRIGHT setting range is 1 to 5. The default setting is 4.



Changing the LCD Backlight Mode:

- 1) From within the LCD menu, scroll UP or DOWN to highlight MODE > KEY-ON.
- 2) Press the ENTER key, then scroll UP or DOWN to choose the desired LCD Mode value. Choose from OFF, KEY-ON or ALWAYS. When set to OFF, the LCD Backlight will be turned OFF. When set to KEY-ON, the LCD Backlight will turn ON when a key-press is made. When set to ALWAYS, the LCD Backlight will stay ON at all times

MODE setting range is OFF, KEY-ON and ALWAYS. The default setting is KEY-ON.

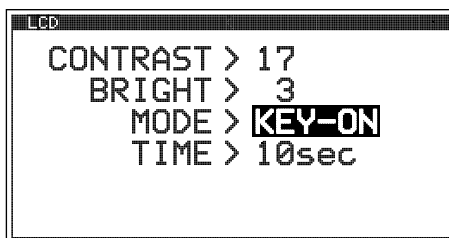

Changing the LCD Backlight On-Time:

- 1) From within the LCD menu, scroll UP or DOWN to highlight TIME > 10sec.
- 2) Press the ENTER key, then scroll UP or DOWN to choose the desired LCD Time value. The Time value (in seconds) determines how long the LCD Backlight will stay ON before turning OFF automatically. This helps save battery power.

TIME setting range is 1 to 30 seconds. The default setting is 10 seconds.

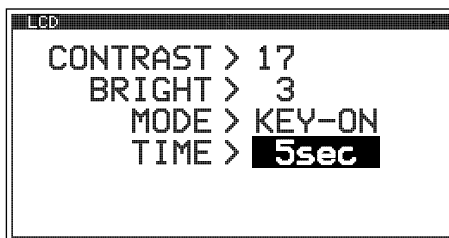

AUX TYPE MENU (AUXILIARY CHANNEL OPERATING MODE)

SYSTEM

The Auxiliary Type function allows you choose the Operating Mode for Auxiliary 1 and Auxiliary 2, making it possible to change the way these two Auxiliary channels function.

 This section details how to change the Operating Mode of the two Auxiliary channels. For details about programming and using each of the Auxiliary functions, see the *POINT AUX 1 Menu* section on pages 64 ~ 65, the *POINT AUX 2 Menu* section on pages 65 ~ 66 or the *CODEAX1 and CODEAX2 Menu* section on page 93.

AUX TYPE MENU (AUXILIARY CHANNEL OPERATING MODE)

SYSTEM

The Operating Mode of Auxiliary 1 and Auxiliary 2 can be changed to suit your specific requirements. The following Operating Modes are available:

NOR - When Selected, the Auxiliary channel(s) operate as Normal proportional linear channels, like the Throttle or Steering channels.

POINT - When Selected, up to six Point positions can be programmed along the entire length of servo travel. You are then able to cycle back and forth through those Point positions. This option is ideal if your Model requires a three or more position switch to operate a feature. This mode is not proportional. It's a 'Stepping' mode.

CODE - This option is for use with future connected products, such as an ESC, whose Programming Parameters can be changed directly via the transmitter. For example, you might be able to change the connected ESC's Driving Modes directly using the Auxiliary Dial to suit different conditions while you're driving.

 Depending on the Car Type Selected in TYPE menu, Auxiliary 2 options may not be available. This is normal.

Changing the Auxiliary Channel Operating Mode:

- 1) From within the SYSTEM menu, scroll UP or DOWN to highlight the AUX TYPE menu.
- 2) Press the ENTER key to open the AUX TYPE menu. AUX1 > NOR will be highlighted.
- 3) Scroll UP or DOWN to choose which Auxiliary Channel you want to change the Operating Mode for, either AUX1 or AUX2.
- 4) Press the ENTER key, then scroll UP or DOWN to choose the desired Auxiliary 1 or Auxiliary 2 Operating Mode.

AUX1 and AUX2 setting range is NOR, POINT and CODE. The default setting for both AUX1 and AUX2 is NOR.

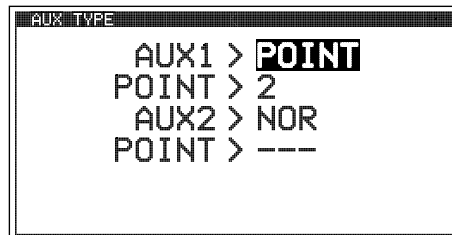
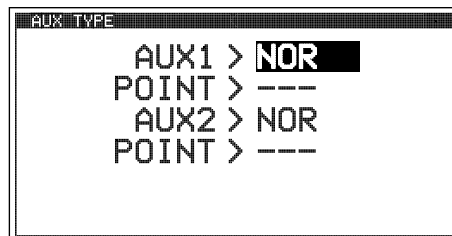
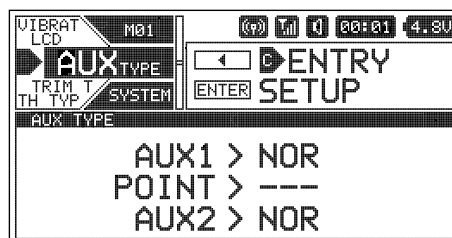

Changing the Number of Points Value:

After changing the Auxiliary 1 or Auxiliary 2 Operating Mode to POINT, you are able to change the number of points you want the servo to travel through. For example, if you want to be able to cycle your servo from 0 to 20 to 40 to 60 degrees and back again, choose POINT > 4.

 When AUX1 and AUX2 values are set to NOR or CODE, POINT options cannot be programmed.

- 1) After choosing the POINT option, scroll UP or DOWN to the desired POINT value, either AUX1 POINT or AUX2 POINT.
- 2) Press the ENTER key, then scroll UP or DOWN to choose the desired number of Point positions to program.

POINT setting range is 2 to 6. The default setting is 2.

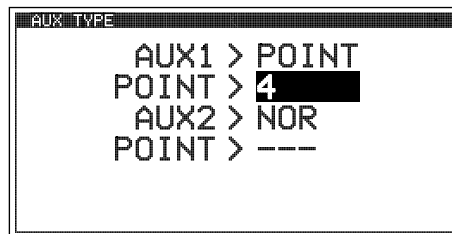

IMPORTANT: When set to POINT, please observe the following: We recommend using either the Auxiliary Dial or one of the Trim Switches to operate the Auxiliary channel. The Auxiliary Lever is not suitable for use in this situation. In addition, the Step value for the Auxiliary Dial and/or Trim Switch should be set to 1, otherwise the transmitter won't cycle properly through the programmed Points.

TRIM TYPE MENU (SERVO TRIM TYPE)

SYSTEM

The Trim Type function allows you choose the way servo Trim and servo End Point Adjustments interact with each other. When you apply Trim to a servo, the Neutral Point of the servo shifts toward the High Side or the Low Side. When you do this, the servo travels less in one direction and more in the other direction because the servo End Points are stationary. In order to balance the servo travel, you would need to manually readjust the servo End Points. Using the Trim Type function allows you to make the servo End Points shift toward the High Side or the Low Side when you apply Trim. This maintains balanced servo travel without the need to manually readjust the servo End Points.

 The Trim Type function does not effect servo Sub-Trim. It only effects servo Trim that's input using the Trim Switches, Auxiliary Dial or Auxiliary Lever. Servo Sub-Trim, which is different, always uses Parallel Trim.

Two Trim Types are available:

CENTER - When Selected, servo End Points are stationary. In order to balance servo travel, you would need to manually readjust the servo End Points, if desired.

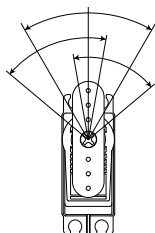

PARALLEL - When Selected, servo End Points shift toward the High Side or the Low Side automatically when you apply Trim. This maintains balanced servo travel without the need to manually readjust the servo End Points.

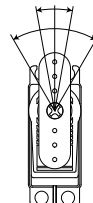

Changing the Trim Type:

- 1) From within the SYSTEM menu, scroll UP or DOWN to highlight the TRIM TYPE menu.
- 2) Press the ENTER key to open the TRIM TYPE menu. ST > CENT will be highlighted.
- 3) Scroll UP or DOWN to highlight the desired channel you would like to change the Trim Type value for. Choose from either ST (Steering), TH (Throttle), AUX1 (Auxiliary 1) or AUX2 (Auxiliary 2).
- 4) Press the ENTER key, then scroll UP or DOWN to choose the desired Trim Type value for that channel.
- 5) Press the ENTER key, then repeat steps 3 and 4 to change the Trim Type value for any other desired channels.

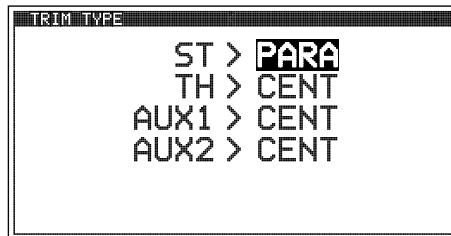
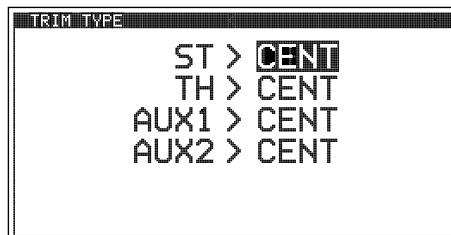
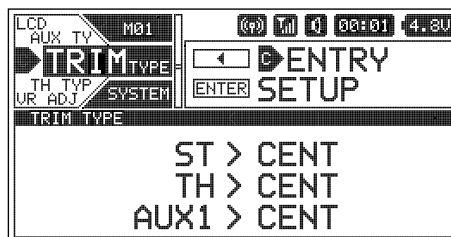

TRIM TYPE setting range is CENT and PARA. The default setting for all channels is CENT.

TH TYPE MENU (THROTTLE BIAS RATIO)

SYSTEM

The Throttle Type function allows you to change the ratio between Throttle High Side servo travel and Throttle Brake Side servo travel. In the default configuration, the Throttle Type is set to F70:B30. This Throttle Type shifts the Throttle Neutral Point toward the Brake Side, resulting in more servo travel toward the High Side and less servo travel toward the Brake Side.

Some users may prefer the ratio between Throttle High Side servo travel and Throttle Brake Side servo travel to be balanced (F50:B50) so that servo travel is equal. The F70:B30 Throttle Type is most common for general use and racing, while the F50:B50 Throttle Type is most common for Rock Crawling.

TH TYPE MENU (THROTTLE BIAS RATIO)

SYSTEM

Two Throttle Types are available:

F70:B30 - When Selected, the Throttle Neutral Point is shifted toward the Brake Side which provides more High Side servo travel and less Brake Side servo travel. This is most common for general use and racing.

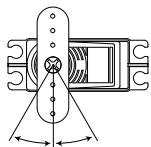
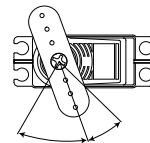

F50:B50 - When Selected, the Throttle Neutral Point is centered, which provides the same amount of High Side and Brake Side servo travel. This is most common for Rock Crawling.

Changing the Throttle Type:

- 1) From within the SYSTEM menu, scroll UP or DOWN to highlight the TH TYPE menu.

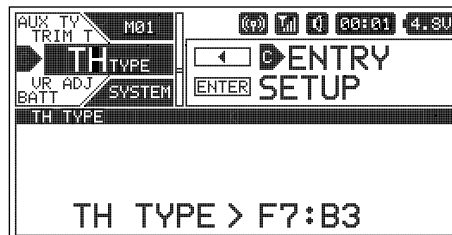

- 2) Press the ENTER key to open the TH TYPE menu. TH TYPE > F7:B3 will be highlighted.

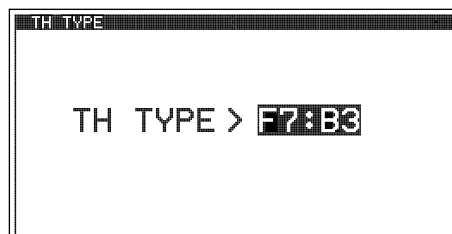



- 3) Press the ENTER key, then scroll UP or DOWN to choose the desired Throttle Type value.

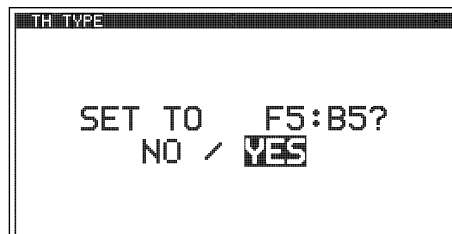

TH TYPE setting range is F7:B3 and F5:B5. The default setting is F7:B3.

- 4) Press the ENTER key. Either Set to F70:B30? NO/YES will be displayed or Set to F50:B50? NO/YES will be displayed. Scroll UP or DOWN to highlight YES, then press the ENTER key.



 If you want to go back and change the Throttle Type or if you don't want to change the Throttle Type for any reason, choose NO or press the BACK key.

VR ADJUST MENU (VARIABLE RATE ADJUSTMENT)

SYSTEM

The Variable Rate Adjustment function allows you to calibrate the operation of the Steering Wheel, Throttle Trigger and Auxiliary Lever End Points and Neutral positions. Over time, it's possible that the End Points and/or Neutral positions of these controls may change slightly or you may purposely limit the travel of the Steering Wheel to suit the best feel of the Steering Wheel and your driving style. Being able to calibrate these controls ensures precise operation at all times and in all conditions.

In addition to being able to store custom Variable Rate Adjustment values, you are also able to reset the Variable Rate Adjustment values back to the Factory Default values.

 We recommend using the Variable Rate Adjustment function as part of a periodic maintenance schedule or after adjusting the Steering Wheel travel as described in the *Steering Wheel Travel Adjustment* section on page 12.

IMPORTANT: After using the Variable Rate Adjustment function, you should double-check the End Point Adjustments of each saved Model. If the End Points have moved, they will need to be readjusted using the End Point Adjustment function.

VR ADJUST MENU (VARIABLE RATE ADJUSTMENT)

SYSTEM

 The steps required to calibrate the operation of the Steering Wheel, Throttle Trigger and Auxiliary Lever are the same. The example shown in this section details calibrating the Steering Wheel.

Two Variable Rate Adjustment Options are available:

FACTORY - When Selected, control End Points and Neutral positions are set to the original Factory Default calibration values. This option should be used if there is a problem with the User calibration values or you want to restore the Factory Default calibration values.

USER - When Selected, the user manually calibrates the control End Points and Neutral positions. This option should be used in most all cases as part of a maintenance schedule or if you've limited or otherwise adjusted the travel of the Steering Wheel.

Calibrating the Steering, Throttle and Auxiliary Lever Controls:

1) From within the SYSTEM menu, scroll UP or DOWN to highlight the VR ADJUST menu.

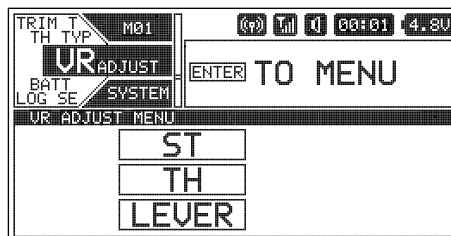

2) Press the ENTER key to open the VR ADJUST menu. The ST (Steering) menu will be highlighted.

 If you want to calibrate a different control, scroll UP or DOWN to highlight the control menu option you would like to calibrate, either TH (Throttle) or LEVER (Auxiliary Lever).

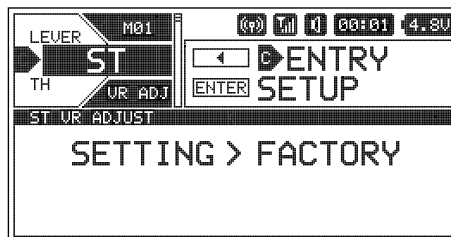

3) Press the ENTER key to open the ST VR ADJUST menu (or the TH VR ADJUST menu or the LEVER VR ADJUST menu, depending on your selection in step 2). SETTING > FACTORY will be highlighted.



4) Press the ENTER key, then scroll UP to highlight SETTING > USER. Calibration value information specific to the control you're calibrating will be displayed. If you're calibrating the Steering Wheel, NEUT >, LEFT and RIGHT values will be displayed. If you're calibrating the Throttle Trigger, NEUT >, HIGH and BRAKE values will be displayed and if you're calibrating the Auxiliary Lever, NEUT >, HIGH and LOW values will be displayed.

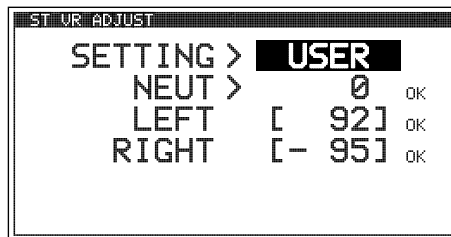

IMPORTANT: When completing the steps below, do not complete the steps out of order or the calibration process may not work correctly.

5) To calibrate the control's Neutral Point, scroll DOWN to highlight NEUT > 0. Depending on the current state of calibration, a value other than 0 may be displayed.

6) With the Steering Wheel (or Throttle Trigger or Auxiliary Lever) centered, press the ENTER key. NEUT > 0 OK will be displayed.

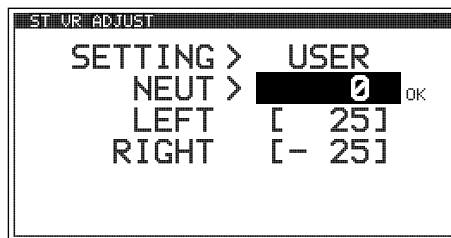

VR ADJUST MENU (VARIABLE RATE ADJUSTMENT)

SYSTEM

Calibrating the Steering, Throttle and Auxiliary Lever Controls, Continued....

- Slowly move the Steering Wheel(or Throttle Trigger or Auxiliary Lever) all the way in one direction. Allow the control to return to Neutral, then slowly move the Steering Wheel, Throttle Trigger or Auxiliary Lever all the way in the opposite direction. A series of values and ADJUST OK? NO/YES will be displayed.

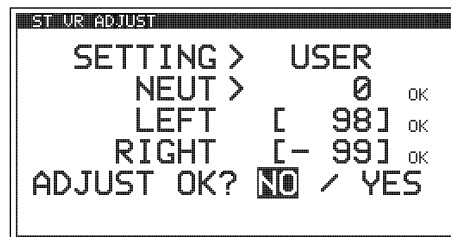

- Scroll UP or DOWN to highlight YES, then press the ENTER key. After the calibration process completes, NEUT > 0 will be highlighted.

 If you want to go back and repeat the calibration process or if you don't want to finish the calibration process for any reason, choose NO or press the BACK key.

- Press the BACK key to return to the VR ADJUST menu and repeat steps 2 through 7 to calibrate the remaining controls.

Resetting the Steering, Throttle and Auxiliary Lever Calibration Values:

The calibration values can be reset to the Factory Default values quickly and easily should you require it.

- From within the VR ADJUST menu, scroll UP or DOWN to highlight the control menu option you would like to reset the calibration values for, either ST (Steering), TH (Throttle) or LEVER (Auxiliary Lever).

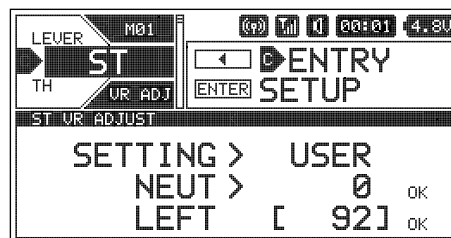

- Press the ENTER key. SETTING > USER will be highlighted.

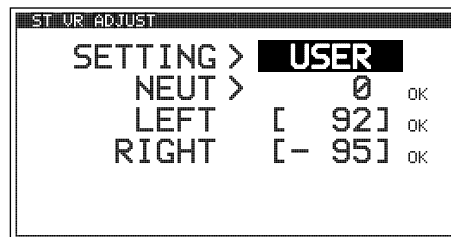

- Press the ENTER key, then scroll DOWN to choose the SETTING > FACTORY option.
- Press the ENTER key. The calibration values for that control will be reset to the Factory Default values.
- Press the BACK key to return to the VR ADJUST menu and repeat steps 1 through 5 to reset the desired remaining controls.

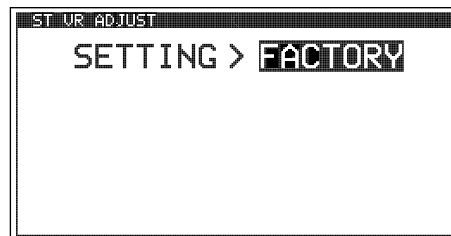

BATT MENU (LOW VOLTAGE ALERT AND LIMIT ALARMS)

SYSTEM

The BATT menu allows to specify the voltage at which the Low Voltage Alert and Low Voltage Limit alarms will sound. This allows you to choose custom Low Voltage values to match the type of transmitter battery you're using. For example, if you're using a 2S Li-Po battery pack, you can set the Low Voltage Alert alarm and the Low Voltage Limit alarm voltage values to suit.

The tables below show the different Low Voltage Alert and Low Voltage Limit values we recommend using:

BATTERY TYPE	ALERT VALUE	LIMIT VALUE
4 Cell Alkaline	4.6 Volts	4.4 Volts
6 Cell Ni-CD/Ni-MH	7.0 Volts	6.6 Volts

BATTERY TYPE	ALERT VALUE	LIMIT VALUE
2S Li-Po	7.2 Volts	6.8 Volts
2S Li-Fe/A123	6.3 Volts	5.8 Volts

 To ensure the safety of your transmitter battery, we suggest using the Low Voltage Alert and Low Voltage Limit values shown in the tables above. We don't suggest using values Lower than recommended.

BATT MENU (LOW VOLTAGE ALERT AND LIMIT ALARMS)

SYSTEM

Changing the Low Voltage Alert Alarm Value:

The Low Voltage Alert alarm will sound to indicate the transmitter batteries are getting low and should be replaced or recharged. We suggest stopping use as soon as safely possible and replacing or recharging the transmitter batteries. The Low Voltage Alert alarm will sound for approximately 5 seconds each time the transmitter battery voltage decreases by 0.1 volt. To clear this alarm before it turns off automatically, press the BACK key or the ENTER key.

- 1) From within the SYSTEM menu, scroll UP or DOWN to highlight the BATT menu.

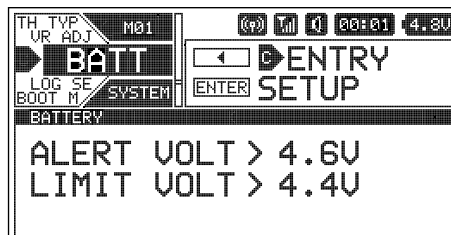

- 2) Press the ENTER key to open the BATT menu. ALERT VOLT > 4.6V will be highlighted and the current transmitter battery voltage will be displayed.

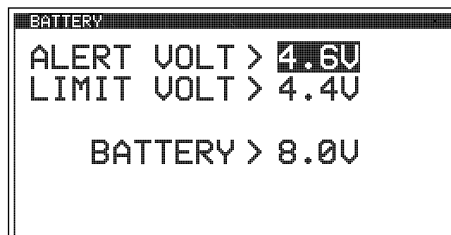

- 3) Press the ENTER key, then scroll UP or DOWN to choose the desired Low Voltage Alert alarm voltage value. We suggest using the value listed in the table on the previous page that matches the type of transmitter battery you're using.

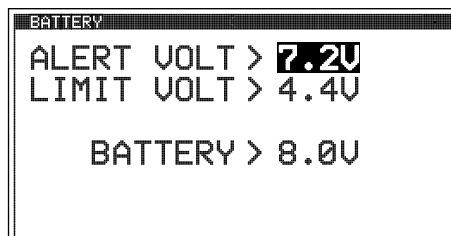

ALERT VOLT setting range is 4.4V to 9.0V. The default setting is 4.6V.

 The Low Voltage Alert alarm voltage value cannot be set Lower than the Low Voltage Limit alarm voltage value.

Changing the Low Voltage Limit Alarm Value:

The Low Voltage Limit alarm will sound to indicate the transmitter batteries are dangerously low and should be replaced or recharged Right away. The Low Voltage Limit alarm cannot be cancelled. When the Low Voltage Limit alarm sounds, you should stop use as soon as it's safe, then replace or recharge the transmitter batteries.

- 1) From within the BATT menu, scroll UP or DOWN to highlight LIMIT VOLT > 4.4V.

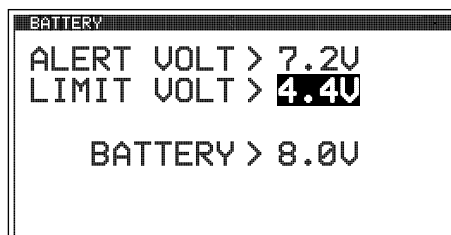

- 2) Press the ENTER key, then scroll UP or DOWN to choose the desired Low Voltage Limit alarm value. We suggest using the value listed in the table on the previous page that matches the type of transmitter battery you're using.

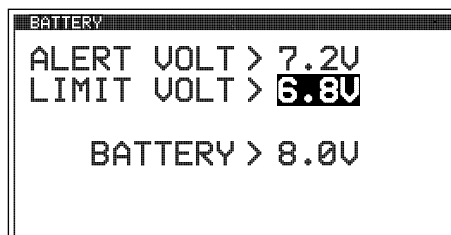

LIMIT VOLT setting range is 4.0v to 9.0v. The default setting is 4.4V.

 The Low Voltage Limit alarm voltage value cannot be set Higher than the Low Voltage Alert alarm voltage value.

WARNING: Continuing to use the transmitter after the Low Voltage Limit alarm sounds can result in loss of control of your Model. When the Low Voltage Limit alarm sounds, stop use as soon as is safe, then replace or recharge the transmitter batteries.

LOG SETUP MENU (TELEMETRY DISPLAY AND RECORDING OPTIONS)

SYSTEM

The LOG SETUP menu allows you to turn Telemetry Recording ON and OFF and configure how Telemetry Data is displayed on the TELEMETRY screen. For example, you are able to change the Telemetry Temperature reading from Fahrenheit to Celsius, change the values at which the different Telemetry Sensor alarms sound, change how Speed and RPM are displayed and much more.

In addition, when only the DISPLAY is turned ON using the DISPLAY key, the M12 can be placed in Receiver Mode, allowing it to Bind with another Airtronics FH3 or FH4T transmitter and read Telemetry Data from it. For example, if using an FH4T transmitter like the MT-4, MT-4 Telemetry Data can be viewed on the M12 TELEMETRY screen, or, if using an FH3 transmitter like the MX-3X or M11X that doesn't support Telemetry, Steering and Throttle Output Data can still be viewed on the M12 TELEMETRY screen. This capability allows the M12 to be used as a separate Telemetry Viewer and Recorder, much like the Airtronics TLS-01 Telemetry Logger.

 For information about saving Telemetry Data to a PC, see the *PCLINK Menu* section on page 58. For information about using the TELEMETRY screen and viewing Telemetry Data, see the *TELEMETRY Screen Overview* section on pages 21 ~ 22.

IMPORTANT: Full Telemetry integration requires the use of an Airtronics RX-461, RX-462 or other Airtronics FH4T Telemetry receiver (available separately), although Throttle and Steering Output Data can still be viewed on the TELEMETRY screen and recorded if using an FH2, FH3 or FH4 receiver.

 For information about using an optional Telemetry receiver with your M12 transmitter, plugging the Telemetry Sensors into your receiver and installing them into your Model, see the *Telemetry Connections and Mounting* section on pages 96 ~ 97.

Telemetry Data Recording

The Telemetry Data Recording function records Telemetry Data when the Lap Timer is Started. When the Lap Timer is Stopped, Telemetry Recording is also Stopped. One Telemetry Data Log is kept in memory at a time and will be available for viewing even after the transmitter is turned OFF. When the Lap Timer is Started again, the current Telemetry Data Log will be erased and a new one Started. If you want to Save the current Telemetry Data Log, use the Save Log option in the PCLINK menu.

Turning Telemetry Data Recording ON and OFF:

- 1) From within the SYSTEM menu, scroll UP or DOWN to highlight the LOG SETUP menu.
- 2) Press the ENTER key to open the LOG SETUP menu, then scroll UP or DOWN to highlight the REC menu.
- 3) Press the ENTER key to open the REC menu. REC > ON will be highlighted.
- 4) Scroll UP or DOWN to choose the desired Record value, either ON or OFF. When ON is chosen, Telemetry Data will be Recorded. When OFF is chosen, Telemetry Data will not be Recorded.

REC setting range is ON or OFF. The default setting is ON.

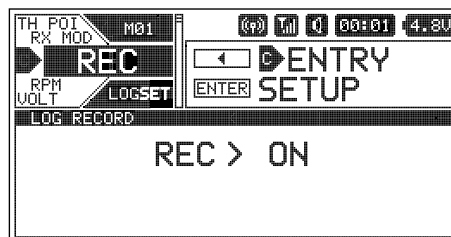
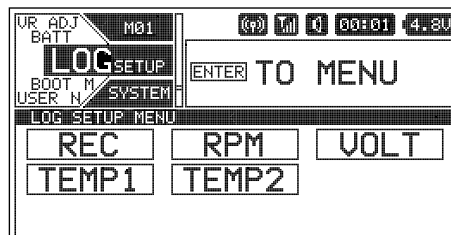

RPM and Speed Telemetry Data Display Options

The RPM menu allows you to change the way RPM and Speed information is displayed on the TELEMETRY screen ALL and RPM pages. For example, you can choose to display RPMs, MPH or KM/H. The RPM Gauge and the RPM Digital Display names will even change from RPM to MPH or KM/H depending on the RPM Unit value chosen. On top of that, you can choose the Maximum Telemetry Data values that are displayed and the RPM sensor can be calibrated to ensure the most accurate RPM or speed in MPH or KM/H is displayed for your specific Model.

LOG SETUP MENU (TELEMETRY DISPLAY AND RECORDING OPTIONS) SYSTEM

Changing the RPM Unit Value:

1) From within the SYSTEM menu, scroll UP or DOWN to highlight the LOG SETUP menu.

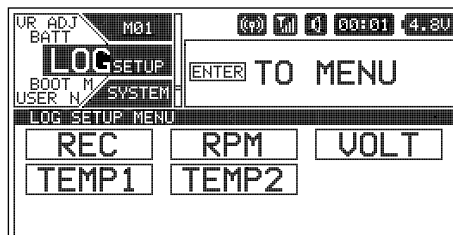

2) Press the ENTER key to open the LOG SETUP menu, then scroll UP or DOWN to highlight the RPM menu.

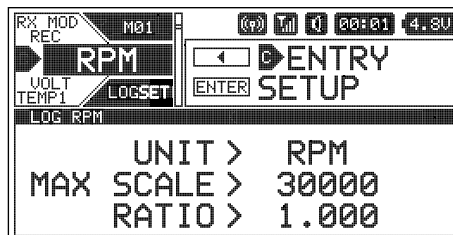

3) Press the ENTER key to open the RPM menu. UNIT > RPM will be highlighted.

4) Press the ENTER Key, then scroll UP or DOWN to change the RPM Unit to the desired value. When RPM is chosen, the RPM of whatever the RPM Sensor is attached to will be displayed. When MPH or KM/H is chosen, the speed of your Model will be displayed in either MPH or KM/H, respectively.

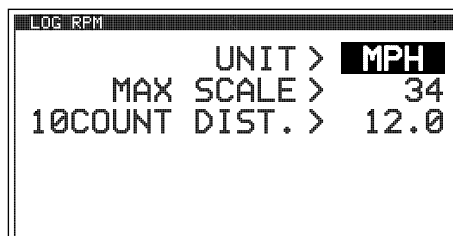

UNIT setting range is RPM, MPH and KM/H. The default setting is RPM.

 When you choose UNIT > MPH or UNIT > KM/H the RATIO > value will be replaced with a 10COUNT DIST. > value.

Changing the Maximum Scale Value:

1) From within the RPM menu, scroll UP or DOWN to highlight the MAX SCALE > value. This value will vary depending on the UNIT > value chosen previously.

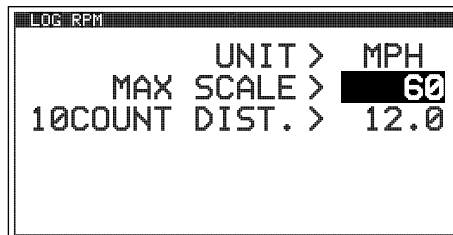

2) Press the ENTER key, then scroll UP or DOWN to change the Maximum Scale value. This value determines the maximum RPM, MPH or KM/H value that will be displayed on the TELEMETRY screen ALL and RPM pages.

MAX SCALE setting range is 500 to 127500 RPM, 1 to 999 MPH and 1 to 999 KM/H. The default setting is 30000 RPM, 34 MPH and 54 KM/H.
The Maximum Scale MPH and KM/H setting range will vary based on the 10Count Distance value programmed when you calibrate the RPM Sensor. For more information, see the *Calibrating the RPM Sensor - Changing the 10Count Distance Value* section on page 50.

Calibrating the RPM Sensor - Changing the Ratio Value:

The Ratio value can be changed if you've Selected UNIT > RPM. By changing the Ratio value you are able to read actual motor or engine RPM even though the RPM sensor may be mounted to your Model's spur gear and not to the motor's pinion gear or the engine's flywheel.

1) From within the RPM menu and with UNIT > RPM Selected, scroll UP or DOWN to highlight RATIO > 1.000.

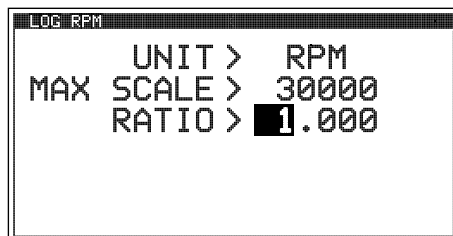

Calibrating the RPM Sensor - Changing the Ratio Value, Continued...

The Ratio value is the gear ratio between the two gears that the RPM sensor is mounted to. For example, if the RPM sensor is mounted to your spur gear, the Ratio value will be the gear ratio of your spur gear and pinion gear.

IMPORTANT: To calculate the gear ratio, divide the number of teeth in the spur gear by the number of teeth in the pinion gear. For example, if your spur gear is 60T and your pinion gear is 14T, the gear ratio is $60 / 14 = 4.28$.

- 2) Press the ENTER key, then scroll UP or DOWN to choose the desired first Ratio value. If using the example above, choose 4.

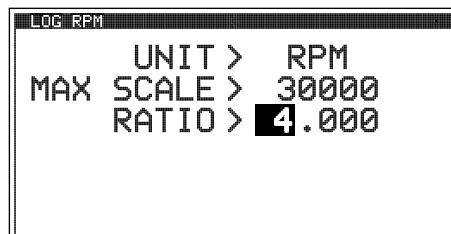

- 3) Press the ENTER key, then scroll DOWN to highlight the second Ratio value. Press the ENTER key, then scroll UP or DOWN to choose the desired second Ratio value. If using the example above, choose 28.

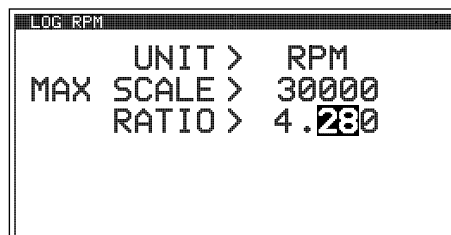

- 4) If necessary, press the ENTER key, then scroll DOWN to highlight the third ratio value. Press the ENTER key, then scroll UP or DOWN to choose the desired third Ratio value.

RATIO setting range is 1.000 to 64.999. The default setting is 1.000.

! If the RPM sensor is mounted to your engine's flywheel or your motor's pinion gear to read the RPM directly, the Ratio value should be set to 1.000.

Calibrating the RPM Sensor - Changing the 10Count Distance Value:

The 10Count Distance value can be changed if you've Selected UNIT > MPH or UNIT > KM/H. By changing the 10Count Distance value you are able to calibrate the RPM sensor to read your specific Model's actual speed, in either MPH or KM/H.

! Prior to calibrating the RPM sensor, you must connect the RPM sensor to your receiver and correctly install the RPM sensor into your Model. For more information, see the *Telemetry Connections and Mounting* section on pages 96 ~ 97.

- 1) With your transmitter and receiver turned ON, and with an Active Telemetry connection, place your Model on the ground.
- 2) Measuring in inches (or centimeters if using KM/H) from where you set your Model on the ground, slowly push your Model and measure the distance covered to complete 10 full revolutions of the RPM sensor (the Bind LED on your receiver will flash 10 times, indicating 10 full revolutions).

- 3) From within the RPM menu and with UNIT > MPH or UNIT > KM/H Selected, scroll UP or DOWN to highlight 10COUNT DIST > 12.0 or 10COUNT DIST > 30, depending on the UNIT > value Selected previously.

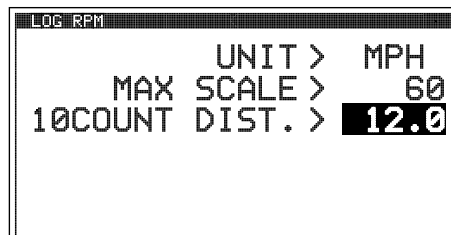

- 4) Press the ENTER key, then scroll UP or DOWN to change the 10Count Distance value to match the measurement obtained in step 2 above. For example, if your Model traveled 2 feet (61cm) to complete 10 full revolutions, enter 24.0 (for MPH) or 61 (for KM/H).

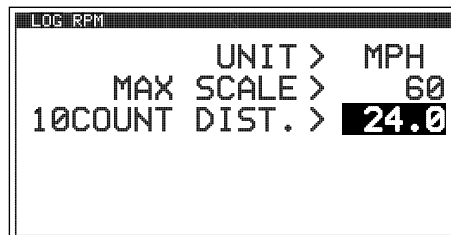

10COUNT DIST setting range is 0.5 to 118.0 for MPH and 1 to 300 for KM/H. The default setting is 12.0 for MPH and 30 for KH/H.

IMPORTANT: Changing the 10Count Distance value will change the Maximum Scale value. After calibration, you should reset the Maximum Scale value back to the value you chose previously.

Receiver Battery Low Voltage Telemetry Data Display and Alert Alarm Options

The VOLT menu allows you to change the way receiver battery Voltage information is displayed on the TELEMETRY screen ALL and VOLT pages and when the receiver battery Low Voltage Alert alarm sounds. For example, the Maximum Voltage value can be adjusted to calibrate the VOLT Indicator on the TELEMETRY screen ALL page. In addition, you can adjust the Voltage value that the receiver battery Low Voltage Alert alarm will sound at to match the type of receiver battery you're using.

Changing the Maximum Voltage Value:

- 1) From within the SYSTEM menu, scroll UP or DOWN to highlight the LOG SETUP menu.
- 2) Press the ENTER key to open the LOG SETUP menu, then scroll UP or DOWN to highlight the VOLT menu.
- 3) Press the ENTER key to open the VOLT menu. MAX VOLT > 9.0V will be highlighted.
- 4) Press the ENTER key, then scroll UP or DOWN to choose the desired Maximum Voltage value. This value determines the Maximum Voltage that will be displayed on the TELEMETRY screen VOLT page and also calibrates the VOLT Indicator on the TELEMETRY screen ALL page. We suggest using a value that matches as closely as possible the peaked voltage value of your receiver battery after it's pulled off your charger.

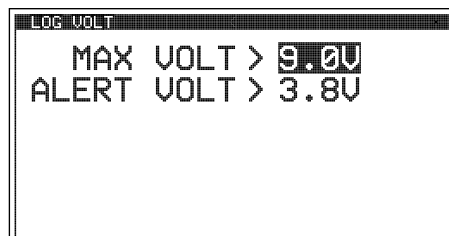
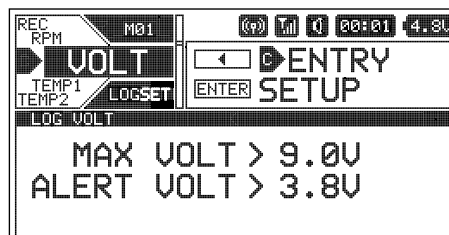
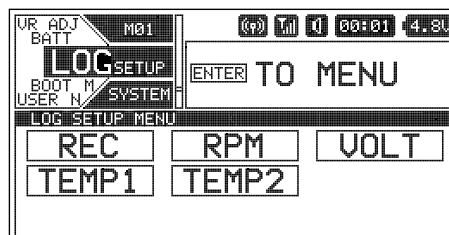

MAX VOLT setting range is 3.0V to 9.0V. The default setting is 9.0V.

! The Maximum Voltage value cannot be set Lower than the Alert Voltage value. If necessary, you may need to Lower the Alert Voltage value prior to lowering the Maximum Voltage value.

Changing the Alert Voltage Value:

The Alert Voltage value determines the voltage at which the receiver battery Low Voltage Alert alarm will sound. For example, you can set the Alert Voltage value to alert you to when your Model's receiver battery is getting low and needs to be recharged. When the Alert Voltage value is reached, the Voltage Alert alarm will sound and LED2 will flash. The Low Voltage Alert alarm will sound for approximately 5 seconds, however, LED2 will continue to flash until you recharge the receiver battery. The audible portion of the Low Voltage Alert alarm can be cleared by pressing the BACK or ENTER keys.

- 1) From within the VOLT menu, scroll UP or DOWN to highlight ALERT VOLT > 3.8V.
- 2) Press the ENTER key, then scroll UP or DOWN to change the Alert Voltage value. The Alert Voltage value is the voltage that the receiver battery Low Voltage Alert alarm will sound at.



ALERT VOLT setting range is 3.0V to 9.0V. The default setting is 3.8V.

IMPORTANT: Refer to the manufacturer of your Model's receiver battery to determine the safest Alert Voltage value to use. In general, the Alert Voltage value should be high enough to alert you when it's time to recharge your receiver battery, but not so low that the receiver can no longer control your Model or operate your servos optimally.

! The Alert Voltage value cannot be set Higher than the Maximum Voltage value. If necessary, you may need to raise the Maximum Voltage value prior to raising the Alert Voltage value.

Temperature 1 and Temperature 2 Telemetry Data Display and Alert Alarm Options

The TEMP1 and TEMP2 menus allow you to change the way Temperature information is displayed on the TELEMETRY screen ALL and TEMP1 and/or TEMP2 pages, and when the Temperature Alert alarm sounds. For example, you can choose to display Temperature values in either degrees Fahrenheit or degrees Celsius. In addition, the Maximum and Minimum Temperature values can be adjusted to calibrate the TEMP1 and/or TEMP2 Indicator(s) on the TELEMETRY screen ALL page. You can also adjust the Temperature value at which the Temperature Alert alarm will sound to suit the component the Temperature sensor is attached to.

 This section covers both the TEMP1 and TEMP2 menus, since programming each of them is exactly the same. Choose either the TEMP1 or the TEMP2 menu depending on which of the two Temperature Sensor Ports you want to make changes to.

Changing the Temperature Unit Value:

- 1) From within the SYSTEM menu, scroll UP or DOWN to highlight the LOG SETUP menu.
- 2) Press the ENTER key to open the LOG SETUP menu, then scroll UP or DOWN to highlight either the TEMP1 or the TEMP2 menu depending on which of the two Temperature Sensor Ports you want to make changes to.
- 3) Press the ENTER key to open the TEMP1 or TEMP2 menu. UNIT > °F will be highlighted.
- 4) Press the ENTER key, then scroll UP or DOWN to choose the desired Temperature Unit value, either Fahrenheit or Celsius.

UNIT setting range is °F and °C. The default setting is °F.

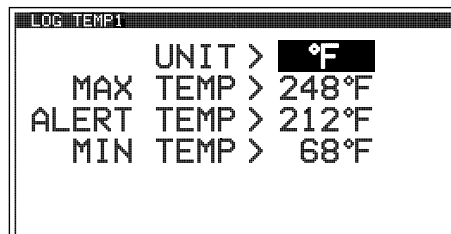
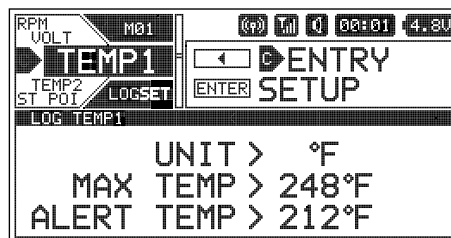
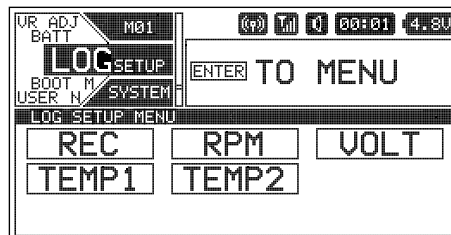



Changing the Maximum Temperature Value:

The Maximum Temperature value determines the Maximum Temperature that will be displayed on the TELEMETRY screen TEMP1 or TEMP2 page and also calibrates the TEMP1 or TEMP2 Indicator on the TELEMETRY screen ALL page.

- 1) From within the TEMP1 or TEMP2 menu, scroll UP or DOWN to highlight MAX TEMP > 248°F (or 120°C).
- 2) Press the ENTER key, then scroll UP or DOWN to choose the desired Maximum Temperature value.

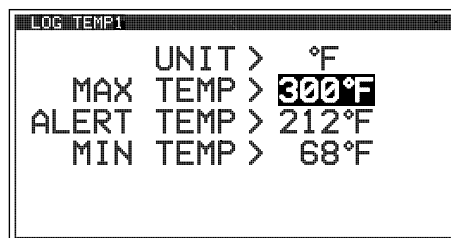
MAX TEMP setting range is 68°F to 302°F (0°C to 150°C). The default setting is 248°F (120°C).



 The Maximum Temperature value cannot be set Lower than the Alert Temperature value or the Minimum Temperature value. If necessary, you may need to Lower the Alert Temperature value prior to lowering the Maximum Temperature value.

Changing the Alert Temperature Value:

The Alert Temperature value determines the temperature at which the Temperature Alert alarm will sound. For example, you can set an Alert Temperature value for your nitro engine that will alert you when your engine's cylinder head temperature is getting too hot. When the Alert Temperature value is reached, the Temperature Alert alarm will sound and LED2 will flash. The Temperature Alert alarm will sound for approximately 5 seconds, however, LED2 will continue to flash until the temperature drops below the Alert Temperature value. The audible portion of the Temperature Alert alarm can be cleared by pressing the BACK or ENTER keys.

LOG SETUP MENU (TELEMETRY DISPLAY AND LOGGING OPTIONS) SYSTEM

Changing the Alert Temperature Value, Continued...

- 1) From within the TEMP1 or TEMP2 menu, scroll UP or DOWN to highlight ALERT TEMP 212°F (or 100°C).
- 2) Press the ENTER key, then scroll UP or DOWN to choose the desired Alert Temperature value.

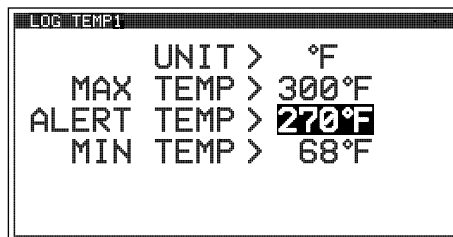

ALERT TEMP setting range is 68°F to 302°F (0°C to 150°C). The default setting is 212°F (100°C).

! The Alert Temperature value cannot be set Higher than the Maximum Temperature value or Lower than the Minimum Temperature value. If necessary, you may need to Lower the Minimum Temperature value prior to lowering the Alert Temperature value.

Changing the Minimum Temperature Value:

The Minimum Temperature value determines the Minimum Temperature that will be displayed on the TELEMETRY screen TEMP1 or TEMP2 page and also calibrates the TEMP1 or TEMP2 Indicator on the TELEMETRY screen ALL page.

- 1) From within the TEMP1 or TEMP2 menu, scroll UP or DOWN to highlight MIN TEMP > 68°F (or 20°C).
- 2) Press the ENTER key, then scroll UP or DOWN to choose the desired Minimum Temperature value.

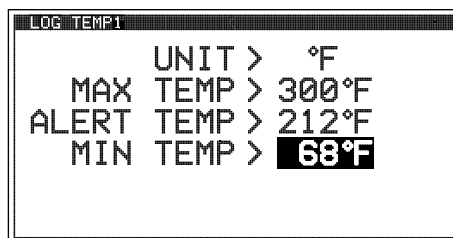

MIN TEMP setting range is 32°F to 302°F (0°C to 150°C). The default setting is 68°F (20°C).

! The Minimum Temperature value cannot be set Higher than the Alert Temperature value or the Maximum Temperature value. If necessary, you may need to Increase these values prior to Increasing the Minimum Temperature value.

LOG SETUP MENU (DISPLAY ONLY TELEMETRY OPTIONS) SYSTEM

As described previously, when only the DISPLAY is turned ON using the DISPLAY key, the M12 can be placed in Receiver Mode, allowing it to Bind with another Airtronics FH3 or FH4T transmitter and read Telemetry Data from it. For example, if using an FH4T transmitter like the MT-4, MT-4 Telemetry Data can be viewed on the M12 TELEMETRY screen, or, if using an FH3 transmitter like the MX-3X or M11X that doesn't support Telemetry, Steering and Throttle Output Data can still be viewed on the M12 TELEMETRY screen. This capability allows the M12 to be used as a separate Telemetry Viewer and Recorder, much like the Airtronics TLS-01 Telemetry Logger. To use this feature, first Bind your other transmitter to its receiver, then place the M12 in Receiver Mode and Bind it to your other transmitter. With your other transmitter turned ON and operating your Model, you can use the M12 in DISPLAY mode to view Telemetry data from the other transmitter.

This section details placing the M12 in Receiver Mode and making Steering and Throttle Point adjustments so that your paired transmitter's Steering and Throttle Output Data is displayed correctly on the M12's TELEMETRY screen.

! The menus shown in this section are only available when using the M12 in DISPLAY mode. They are not available if the M12 is turned ON using the Power Switch.

Receiver Mode

Using the RXMODE menu, you are able to place the M12 transmitter in Receiver Mode, which allows you to Bind the M12 transmitter with another Airtronics FH3 or FH4T transmitter and read Telemetry Data from it.

Enabling Receiver Mode:

- 1) With the transmitter turned OFF, press and HOLD the DISPLAY key to turn only the Display ON.
- 2) From within the SYSTEM menu, scroll UP or DOWN to highlight the LOG SETUP menu.

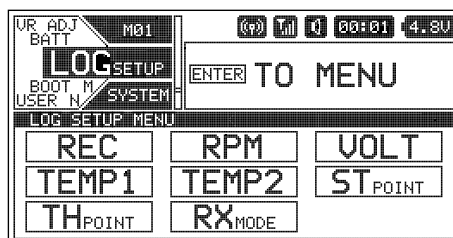

LOG SETUP MENU (DISPLAY ONLY TELEMETRY OPTIONS)

SYSTEM

Enabling Receiver Mode, Continued....

- 3) Press the ENTER key to open the LOG SETUP menu, then scroll UP or DOWN to highlight the RXMODE menu.

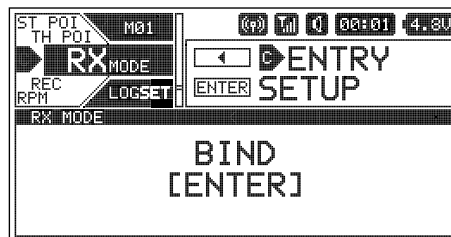

- 4) Press the ENTER key to open the BIND menu. The Bind screen will be displayed and [ENTER] will be highlighted.



- 5) Turn your other transmitter ON, then navigate to that transmitter's BIND menu and highlight the [ENTER] option. For more information, refer to your transmitter's User's Guide.

- 6) Press the ENTER key on the M12 transmitter to begin the Binding process. SEARCH will flash slowly.



- 7) Press the ENTER key on your other transmitter. RECEIVE will flash fast on the M12 transmitter.

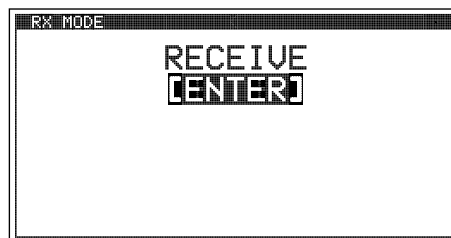

- 8) Press the BACK key, first on the M12 transmitter, then on your other transmitter, to complete the Binding process. The Bind LED on your other transmitter should illuminate solid and both LED1 and LED2 on the M12 transmitter should be extinguished.
- 9) Press the BACK key to return to the STATUS screen, then scroll UP or DOWN to open the TELEMETRY screen. You should now be able to view the other transmitter's Steering and Throttle Output Data on the M12 TELEMETRY screen. In addition, if your other transmitter supports Telemetry, you should be able to view that transmitter's Telemetry Data on the M12 TELEMETRY screen.

Steering and Throttle Output Data Display Adjustments

The Steering Point and Throttle Point functions allow you to calibrate the M12 transmitter's TELEMETRY screen ALL page Steering and Throttle Output Data Displays, so the Output Data displayed matches your paired transmitter's Steering Wheel and Throttle Trigger movement.

 If you don't use the Steering Point and Throttle Point functions to calibrate the Steering and Throttle Output Data Displays, incorrect data will be displayed. These steps should be performed after placing the M12 in Receiver Mode and Binding it to your other transmitter.

Calibrating the Steering Output Data Display:

- 1) With the transmitter turned OFF, press and HOLD the DISPLAY key to turn only the Display ON.
- 2) From within the SYSTEM menu, scroll UP or DOWN to highlight the LOG SETUP menu.

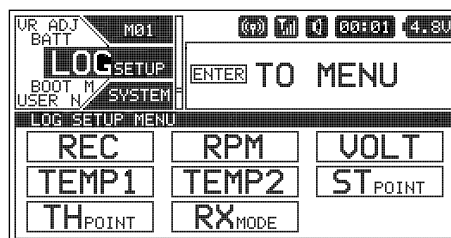

LOG SETUP MENU (DISPLAY ONLY TELEMETRY OPTIONS)

SYSTEM

Calibrating the Steering Output Data Display, Continued....

- 3) Press the ENTER key to open the LOG SETUP menu, then scroll UP or DOWN to highlight the STPOINT menu.

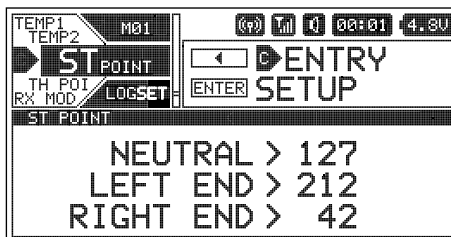

- 4) Press the ENTER key. The ST POINT menu will be displayed and NEUTRAL POINT > 127 will be highlighted.

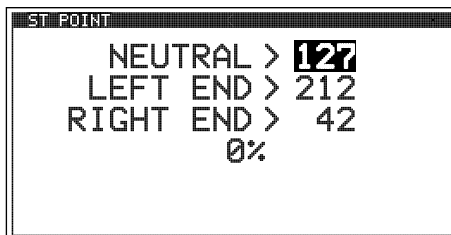

- 5) With your other transmitter turned ON and paired with the M12 transmitter, do the following:
 - A) Center the other transmitter's Steering Wheel, then press the ENTER key on the M12 transmitter.
 - B) Scroll DOWN to highlight LEFT END > 212. Rotate and HOLD the other transmitter's Steering Wheel all the way to the LEFT, then press the ENTER key on the M12 transmitter.

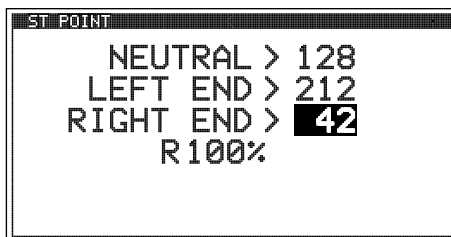

- C) Scroll DOWN to highlight RIGHT END > 42. Rotate and HOLD the other transmitter's Steering Wheel all the way to the RIGHT, then press the ENTER key on the M12 transmitter.

 The values displayed in the ST POINT fields don't represent actual Steering Wheel movement and may vary. Steering Wheel movement is displayed as a percentage below the ST POINT fields.

Calibrating the Throttle Output Data Display:

- 1) Without turning the transmitter ON, press and HOLD the DISPLAY key to turn only the Display ON.
- 2) From within the SYSTEM menu, scroll UP or DOWN to highlight the LOG SETUP menu.

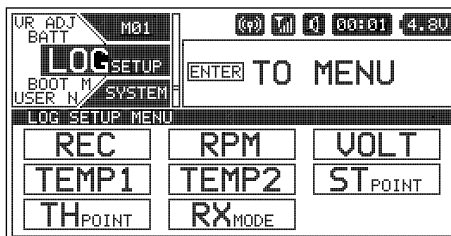

- 3) Press the ENTER key to open the LOG SETUP menu, then scroll UP or DOWN to highlight the THPOINT menu.

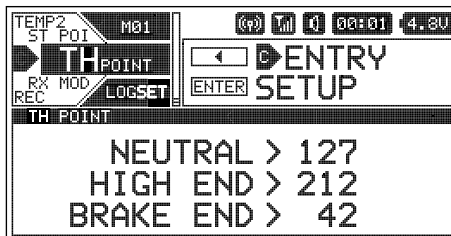

- 4) Press the ENTER key. The TH POINT menu will be displayed and NEUTRAL POINT > 127 will be highlighted.

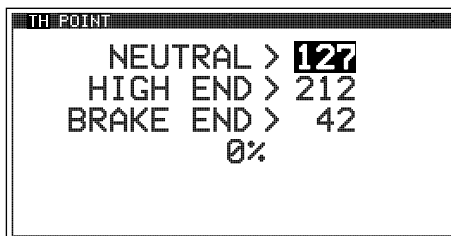



LOG SETUP MENU (DISPLAY ONLY TELEMETRY OPTIONS)

SYSTEM

Calibrating the Throttle Output Data Display, Continued...

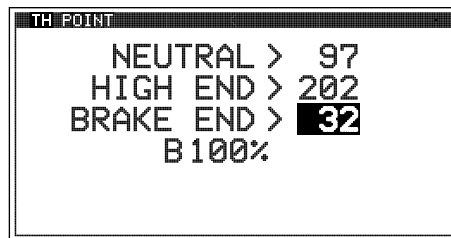
- 5) With your other transmitter turned ON and paired with the M12 transmitter, do the following:
 - A) Center the other transmitter's Throttle Trigger, then press the ENTER key on the M12 transmitter.
 - B) Scroll DOWN to highlight HIGH END > 212. Pull and HOLD the other transmitter's Throttle Trigger all the way BACK, then press the ENTER key on the M12 transmitter.
 - C) Scroll DOWN to highlight BRAKE END > 42. Push and HOLD the other transmitter's Throttle Trigger all the way FORWARD, then press the ENTER key on the M12 transmitter.



 The values displayed in the TH POINT fields don't represent actual Throttle Trigger movement and may vary. Throttle Trigger movement is displayed as a percentage below the TH POINT fields.

BOOT MENU (START-UP OPTIONS)

SYSTEM

The Boot menu allows you to change the default start-up behavior of the transmitter when it's turned ON. For example, when you turn the transmitter ON you can have it temporarily display the Logo (DEMO) before defaulting to the STATUS screen, you can have it Resume from the last Programming Menu you were in when the transmitter was turned OFF (RESUME) or you could have the transmitter default to the STATUS screen (TOP).

Changing the Boot Menu Options:

- 1) From within the SYSTEM menu, scroll UP or DOWN to highlight the BOOT menu.
- 2) Press the ENTER key to open the BOOT menu. MENU > DEMO will be highlighted.
- 3) Press the ENTER key, then scroll UP or DOWN to choose the desired Boot Menu value. When DEMO is Selected, the Logo will be displayed during the start-up process, then default to the STATUS screen. When RESUME is Selected, the transmitter will display the last Programming Menu you were in when the transmitter was turned OFF. When TOP is Selected, the transmitter will default to the STATUS screen when turned ON.

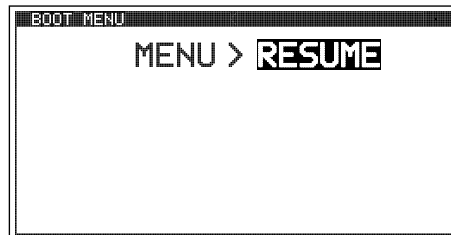
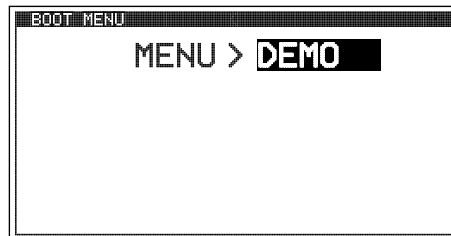
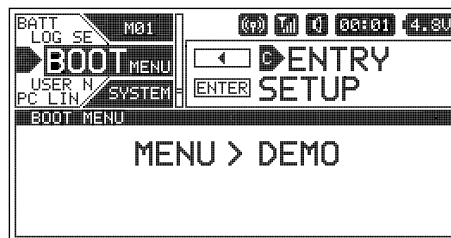

MENU setting range is DEMO, RESUME and TOP. The default setting is DEMO.

USER NAME MENU (TRANSMITTER USER NAMING)

SYSTEM

The User Name function allows you to enter a User Name that is displayed on the STATUS screen, just above the M12 logo. This allows you to actually Name or otherwise personalize your transmitter. The User Name can consist of up to 14 letters, numbers or symbols. Choose from capital letters, Lower case letters, numbers and various symbols.

 If the User Name is Left blank, the Airtronics logo will be displayed in its place.

USER NAME MENU (TRANSMITTER USER NAMING)

SYSTEM

Entering a User Name:

- 1) From within the SYSTEM menu, scroll UP or DOWN to highlight the USER NAME menu.
- 2) Press the ENTER key to open the USER NAME menu. The underscore will be positioned under the first space in the User Name. Press the ENTER key a second time
- 3) Scroll UP or DOWN and press the SELECT switch RIGHT or LEFT to highlight a character in the Character List. Press the ENTER key to Select the highlighted character. That character will be displayed in the User Name and the underscore will advance to the next space.
- 4) Repeat step 3 to enter the rest of the characters. Up to 14 characters can be entered. If desired, press the BACK key to re-gain control of the underscore, then use the SELECT switch or scroll UP or DOWN to move the underscore RIGHT or LEFT. To add a space (or spaces) in your Model Name, use the  character.

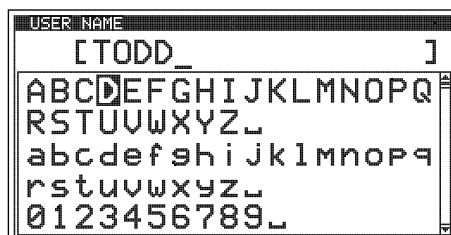
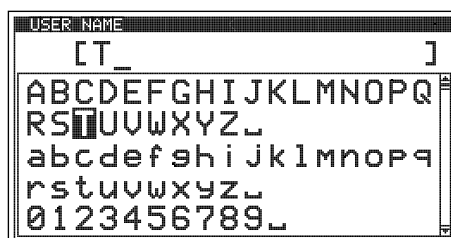
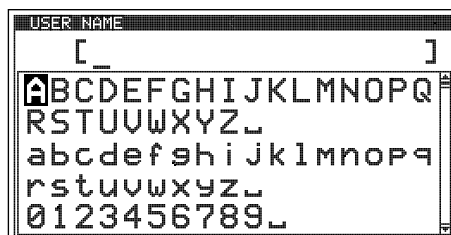
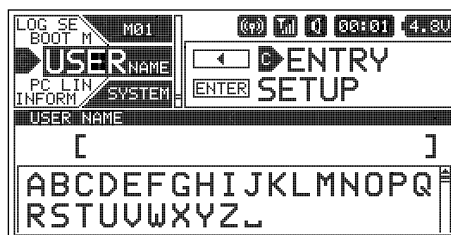

- 5) When you return to the STATUS screen, your User Name will be displayed above the M12 Logo on the Left side of the screen.

 If the User Name is Left blank, the Airtronics logo will be displayed in its place.

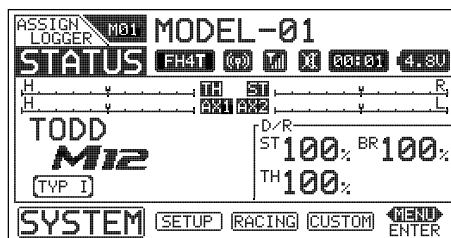

Deleting a Character:

- 1) Press the SELECT switch RIGHT or LEFT or scroll UP or DOWN to move the underscore under the character in your User Name you want to delete.
- 2) Press the ENTER key, then scroll UP or DOWN and press the SELECT switch RIGHT or LEFT to highlight the  character in the Character List. Press the ENTER key. The character in your User Name will be deleted and the underscore will advance to the next space.

Deleting the User Name:

- 1) Press the SELECT switch RIGHT or LEFT or scroll UP or DOWN to move the underscore under the first character in your User Name.
- 2) Press the ENTER key, then scroll UP or DOWN and press the SELECT switch RIGHT or LEFT to highlight the  character in the Character List. Continuously press the ENTER key to delete each character in your User Name.

 If you can't move the underscore, press the BACK key to re-gain control of the underscore.

PC LINK MENU (SAVE TRANSMITTER DATA AND UPDATE FIRMWARE)

SYSTEM

The PCLINK menu allows you to Save the current Telemetry Data Log to your PC for viewing at a later date. Once a Telemetry Data Log is Saved to your PC, the data can be read using a spreadsheet program, such as Microsoft Excel. In addition, the PCLINK menu allows you to Save Model Programming Data to your PC, Load saved Model Programming Data from your PC, and use your PC to update the M12 transmitter's Firmware.

 To use these functions, a Mini USB cable and PC-Link Manager software will be required. Visit <http://www.airtronics.net> to download the PC-Link Manager software and check for Firmware updates. A Mini USB cable should be available from any retail store that sells PC accessories.

IMPORTANT: Before proceeding, make sure that the transmitter is turned ON and connected to your PC, and that the PC-Link Manager software is installed on your PC and running. For more information, refer to the User's Guide included with the PC-Link Manager software.

Saving the Telemetry Data Log

The Save Log function allows you to Save the current Telemetry Data Log for viewing or archiving on your PC. The Telemetry Data Recording function records Telemetry Data when the Lap Timer is Started. When the Lap Timer is Stopped, Telemetry Recording is also Stopped. One Telemetry Data Log is kept in memory at a time and will be available for viewing even after the transmitter is turned OFF. When the Lap Timer is Started again, the current Telemetry Data Log will be erased and a new one Started. If you want to Save the current Telemetry Data Log, follow the steps in this section.

Saving the Telemetry Data Log:

- 1) From within the SYSTEM menu, scroll UP or DOWN to highlight the PCLINK menu.

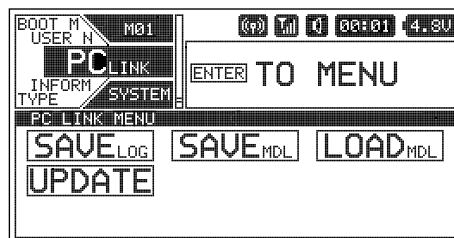

- 2) Press the ENTER key to open the PCLINK menu, then scroll UP or DOWN to highlight the SAVELOG menu.

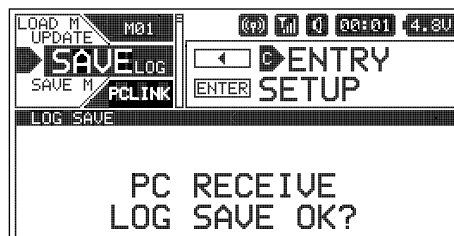

- 3) Click the LOG SAVE TX > PC button on the PC-Link Manager software.
- 4) Navigate to the folder you would like to save the Telemetry Data Log to, then type a name for the file and click the Save button. Do not click the Start button on the PC-Link Manager software yet.

- 5) Press the ENTER key. PC RECEIVE LOG SAVE OK? NO/YES will be displayed.
- 6) Scroll UP or DOWN to highlight YES, then press the ENTER key. PC START will be displayed.

 If you want to go back or if you don't want to Save the Telemetry Data Log for any reason, choose NO or press the BACK key.

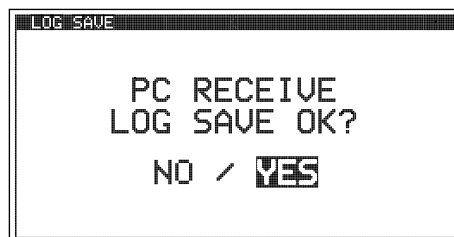

- 7) Click the Start button on the PC-Link Manager software and allow the Data Transfer to complete. Once completed, EXECUTED will be displayed on the M12 and The Operation Was Completed will be displayed on your PC.

Saving Model Programming Data

The Model Save function allows you to Save the currently Selected Model's Programming Data to your PC, either for archiving or for sharing with other M12 users. For example, you can Save your current Model's Programming Data to your PC, then share the file with a friend or fellow driver. They can then upload that Programming Data to their M12 transmitter using the Model Load function.

 Only the currently Selected Model's Programming Data will be Saved. To Save the Programming Data for a different Model, you must Select that Model first, using Model Select function. For more information, see the *Model Select* section on pages 25 ~ 26.

PC LINK MENU (SAVE TRANSMITTER DATA AND UPDATE FIRMWARE) SYSTEM

Saving Model Programming Data:

- 1) From within the SYSTEM menu, scroll UP or DOWN to highlight the PCLINK menu.

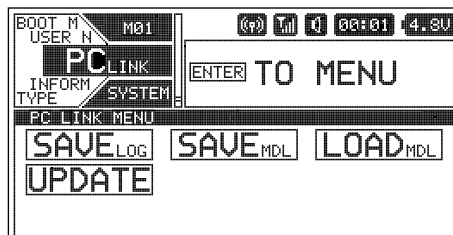

- 2) Press the ENTER key to open the PCLINK menu, then scroll UP or DOWN to highlight the SAVEMDL menu.

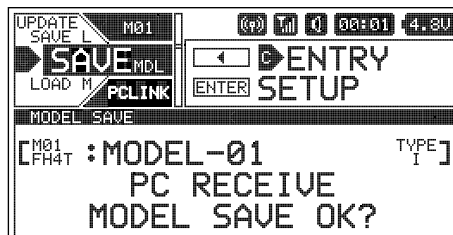

- 3) Click the MODEL SAVE TX > PC button on the PC-Link Manager software.
- 4) Navigate to the folder you would like to save the Model Programming Data to, then type a name for the file and click the Save button. Do not click the Start button on the PC-Link Manager software yet.

- 5) Press the ENTER key. PC RECEIVE MODEL SAVE OK? NO/YES will be displayed.
- 6) Scroll UP or DOWN to highlight YES, then press the ENTER key. PC START will be displayed.

 If you want to go back or if you don't want to Save the Model Programming Data for any reason, choose NO or press the BACK key.

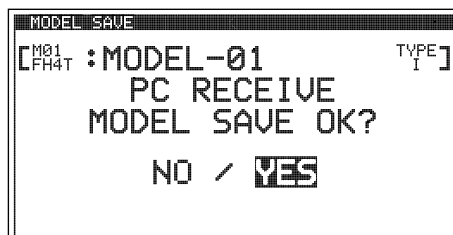

- 7) Click the Start button on the PC-Link Manager software and allow the Data Transfer to complete. Once completed, EXECUTED will be displayed on the M12 and The Operation Was Completed will be displayed on your PC.

Loading Model Programming Data

The Model Load function allows you to Load Model Programming Data from your PC onto your transmitter. For example, if you've archived a Model's Programming Data onto your PC, you can restore it onto the transmitter or you can Load a Model's Programming Data that a friend or fellow driver has provided to you.

WARNING: When you Load Model Programming Data from your PC, that Model Programming Data will overwrite the Programming Data of the currently Selected Model. Please make sure you first load a Model that you don't want to overwrite!

Loading Model Programming Data:

- 1) From within the SYSTEM menu, scroll UP or DOWN to highlight the PCLINK menu.

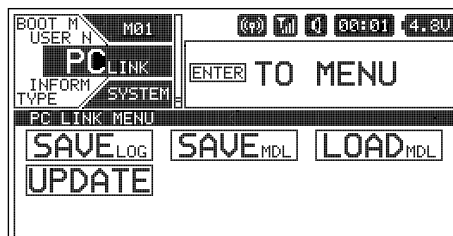

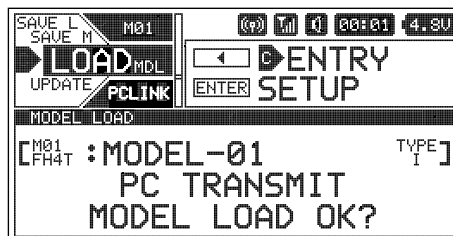

- 2) Press the ENTER key to open the PCLINK menu, then scroll UP or DOWN to highlight the LOADMDL menu.

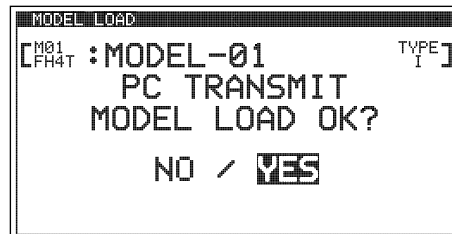

Loading Model Programming Data, Continued...

- 3) Click the MODEL LOAD PC > TX button on the PC-Link Manager software.
- 4) Navigate to the folder where your Saved Model File is, then Select the file and click the Open button. Do not click the Start button on the PC-Link Manager software yet.
- 5) Press the ENTER key. PC TRANSMIT MODEL LOAD OK? NO/YES will be displayed.
- 6) Scroll UP or DOWN to highlight YES, then press the ENTER key. PC START will be displayed.



 If you want to go back or if you don't want to Load the Model Programming Data for any reason, choose NO or press the BACK key.

- 7) Click the Start button on the PC-Link Manager software and allow the Data Transfer to complete. Once completed, EXECUTED will be displayed on the M12 and The Operation Was Completed will be displayed on your PC.

Updating Transmitter Firmware Version

The Update function allows you to Update the transmitter's Firmware to the latest version available. This allows you to keep your transmitter up to date with any future programming feature upgrades or additions. The Firmware version that your transmitter is currently running is shown in the INFORMATION menu. For more information, see the *INFORMATION Menu* section on page 61.

 Before proceeding, download and save the latest Firmware version to a convenient location on your PC. Updates (when available) can be downloaded from our website at <http://www.airtronics.net>.

WARNING: The Update process will take approximately 5 to 10 minutes. Make sure that before starting the Update process that the transmitter's battery voltage is sufficient to complete the Update process. Once started, DO NOT STOP the Update process and DO NOT unplug the transmitter from your PC!

Updating the Transmitter Firmware Version:

- 1) From within the SYSTEM menu, scroll UP or DOWN to highlight the PCLINK menu.

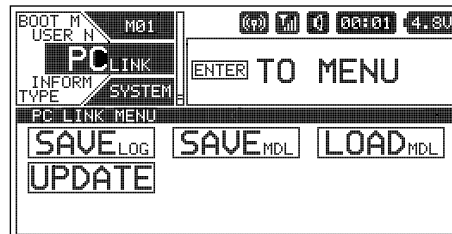

- 2) Press the ENTER key to open the PCLINK menu, then scroll UP or DOWN to highlight the UPDATE menu.

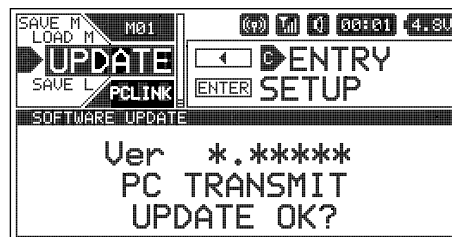

- 3) Click the SOFTWARE UPDATE button on the PC-Link Manager software.
- 4) Navigate to the folder where you Saved the new Firmware version, then Select the file and click the Open button. Do not click the Start button on the PC-Link Manager software yet.

- 5) Press the ENTER key. PC TRANSMIT UPDATE OK? NO/YES will be displayed.
- 6) Scroll UP or DOWN to highlight YES, then press the ENTER key. PC START will be displayed.

 If you want to go back or if you don't want to Update the Firmware version for any reason, choose NO or press the BACK key.

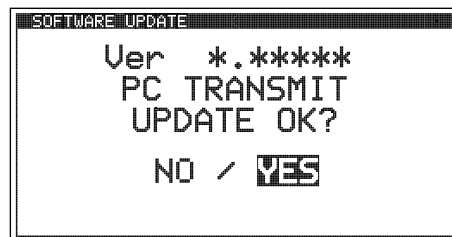

- 7) Click the Start button on the PC-Link Manager software and allow the Update process to complete. Once completed, The Operation Was Completed will be displayed on your PC and transmitter will Reset. Turn the transmitter OFF, unplug the Mini USB cable from the transmitter, then turn the transmitter back ON to finalize the Update process.

M12 2.4GHZ FH4T RADIO CONTROL SYSTEM USER'S GUIDE

INFORMATION MENU (FIRMWARE VERSION AND ON-TIME)

SYSTEM

The INFORMATION menu allows you to view the transmitter's current Firmware version, in addition to the transmitter's cumulative On-Time in Hours and Minutes.

Resetting the On-Time:

- 1) From within the SYSTEM menu, scroll UP or DOWN to highlight the INFORMATION menu.
- 2) Press the ENTER key to open the INFORMATION menu. ON TIME > 00:00 (or the actual Cumulative On-Time) will be highlighted and the current Firmware version will be displayed.
- 3) Press and HOLD the ENTER key to Reset the ON TIME to 00:00. Cumulative On-Time will continue to accrue whether the transmitter is turned ON or if only the Display is turned ON using the DISPLAY key. If Reset to 00:00 after changing or recharging the transmitter batteries, it can be used to determine battery discharge time.

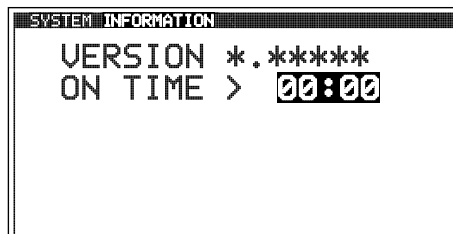
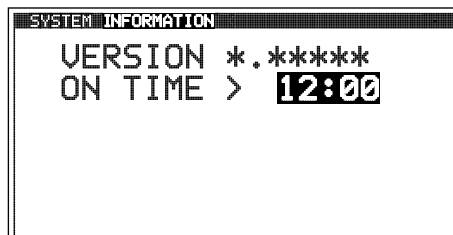
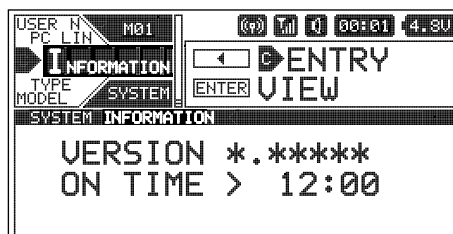

SETUP MENU OVERVIEW

SETUP

To access the various SETUP Programming Menus, turn the transmitter ON, then press the SELECT switch to highlight the SETUP menu. Press the ENTER key to open the SETUP menu.

Scroll UP or DOWN to highlight the desired Programming Menu, then press the ENTER key to open that menu.

⚠ Depending on the Car Type chosen, some Function Programming Value Names may differ from those shown in this section.

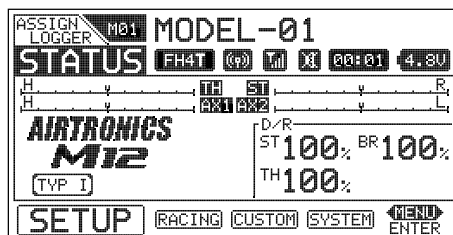

The following Programming Menus are available within the SETUP menu:

MENU	MENU DESCRIPTION	PAGE #
EPA	Adjust Channel End Points to Balance Servo Travel	PG. 62
SUB TRIM	Adjust Servo Centering to Center the Servo Horns	PG. 63
REV	Change the Direction of Servo Travel	PG. 64
POINT AX1	Adjust Auxiliary 1 Point Values to Change the Servo Stepping Behavior	PG. 64
POINT AX2	Adjust Auxiliary 2 Point Values to Change the Servo Stepping Behavior	PG. 65
MOA MIX	Adjust and Change Dual Motor Mixing options (Crawler Car Types Only)	PG. 66
4WS MIX	Adjust and Change Four Wheel Steering Mixing Options (Crawler Car Types Only)	PG. 67
FEELING	Adjust Steering and Throttle Channel Latency Values	PG. 69
F/S	Program Fail Safe Settings	PG. 69
B-F/S	Program Receiver Battery Fail Safe Settings to Ensure Optimum Servo Performance	PG. 70
LAP TIMER	Program the Lap Timer Goal Time, Pre-Alarm and Lap Timer Start Options	PG. 71
INT1	Program Interval Timer 1 and Change its Start Options	PG. 73
INT2	Program Interval Timer 2 and Change its Start Options	PG. 73

EPA MENU (CHANNEL END POINT ADJUSTMENTS)

SETUP

The End Point Adjustment function allows you to adjust servo travel in each direction. This makes it possible to balance servo travel in both directions and set the maximum desired amount of servo travel. For example, on a gas-powered Model, if you pull the Throttle Trigger and the carburetor does not open completely, you can Increase the Throttle High End Point Adjustment so that the carburetor opens completely. Another example is with Steering. If your Model turns sharper to the Right than to the Left, you can Increase the Steering Left End Point Adjustment to balance the Steering.

The End Point Adjustment function can be adjusted for the Steering channel (Right and Left), the Throttle channel (High and Brake), the Auxiliary 1 channel (High and Low) and the Auxiliary 2 channel (High and Low).

 Before making End Point Adjustments, the servo horn needs to be centered. Install the servo horn onto the servo, making sure it's as close to being centered as possible, then use the Servo Sub-Trim function to center the servo arm exactly. For more information, see the *SUB TRIM Menu* section on page 63.

 End Point Adjustment percentage values should not be increased to the point where your linkages and servos Bind when moved all the way to the Right or Left. Binding will cause the servos to 'buzz', resulting in a quicker loss of receiver battery power and eventual damage to the servos or to your Model.

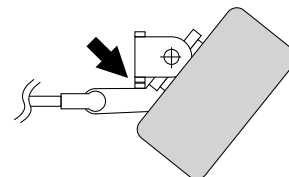

Changing the Channel End Point Adjustment Percentage Values:

1) From within the SETUP menu, scroll UP or DOWN to highlight the EPA menu.

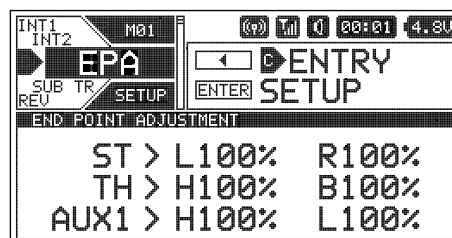

2) Press the ENTER key to open the EPA menu. The cursor will default to either ST > L100% or ST > R100%.

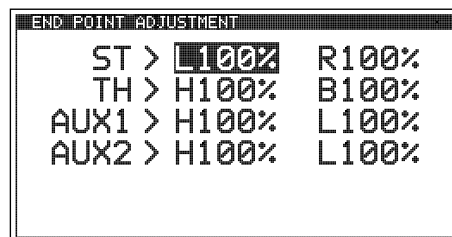

3) Scroll UP or DOWN to highlight the desired End Point Adjustment percentage value you would like to change.

4) Press the ENTER key, then scroll UP or DOWN to Increase or Decrease the End Point Adjustment percentage value. Increasing the percentage value will Increase servo travel in that direction and Decreasing the percentage value will Decrease servo travel in the that direction.

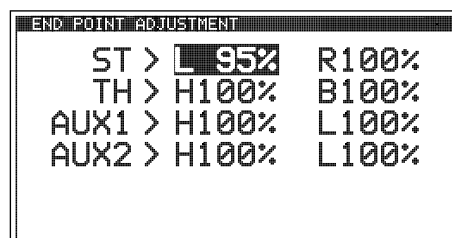

5) Press the ENTER key, then repeat steps 3 and 4 to change any other desired End Point Adjustment percentage values.

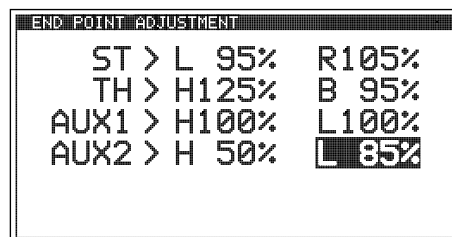

ST L and R setting range is 0% to 150%, TH H and B setting range is 0% to 150%, AUX1 H and L setting range is 0% to 150% and AUX2 H and L setting range is 0% to 150%. The default setting for all channels is 100%.

 If you're using an Electronic Speed Control, the Throttle High and the Throttle Brake End Point Adjustment percentage values are both generally set to 100%, although the Throttle High direction may need to be increased to achieve full power. In some cases, Throttle and Brake End Point Adjustments can also be set directly via the Electronic Speed Control.

SUB TRIM MENU (SERVO CENTERING)

SETUP

The Sub-Trim function allows you to correct the Neutral Trim setting for the Steering, Throttle, Auxiliary 1 and Auxiliary 2 channels, making it possible to center the Trim Switches while ensuring the servo horns remain centered.

It's not unusual that when you center a servo and install the servo horn, the servo horn is not exactly centered. The Sub-Trim function allows you to center the servo horn exactly, without altering the servo End Point travel. This is especially useful when using a Mix, such as Four Wheel Steering Mixing. For example, you can use the Sub-Trim function to adjust the Neutral Trim setting of your Front and Rear Steering servos independently to ensure your Model tracks straight.

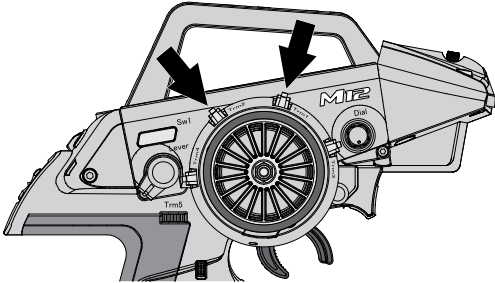

Before changing the Sub-Trim values you should set the Steering and Throttle Trim to 0% using the Trm1 and Trm2 Trim Switches.

Changing the Servo Sub-Trim Values:

- 1) Install the servo horn (or servo saver for the Steering servo) onto your servo, making sure that the servo horn (or servo saver) is as close to being centered as possible. In some cases, you can get the servo horn closer to being centered by rotating the servo horn 180° and reinstalling it.

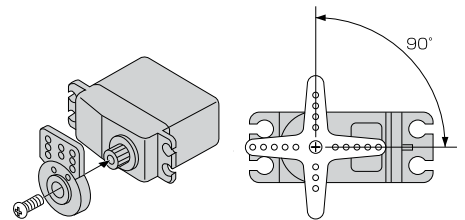

- 2) From within the SETUP menu, scroll UP or DOWN to highlight the SUB TRIM menu.

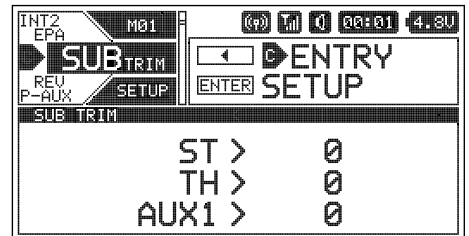

- 3) Press the ENTER key to open the SUB TRIM menu. The cursor will default to ST > 0.

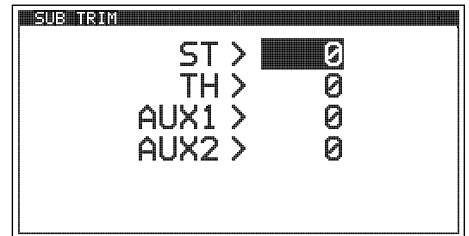

- 4) Scroll UP or DOWN to highlight the desired Sub-Trim value you would like to change.

- 5) Press the ENTER key, then scroll UP or DOWN to Increase or Decrease the Sub-Trim value only enough to center the servo horn.

- 6) Press the ENTER key, then repeat steps 4 and 5 to change any other desired Sub-Trim values.

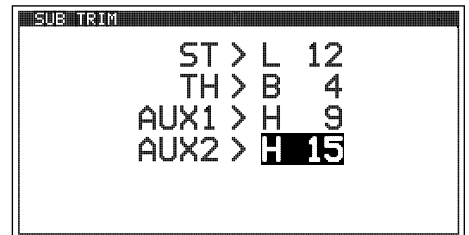

ST setting range is R150 to L150, TH setting range is H150 to B150, AUX1 setting range is H150 to L150 and AUX2 setting range is H150 to L150. The default setting for all channels is 0.

IMPORTANT: Changing the Sub-Trim values will alter the servo's End Points. After changing the Sub-Trim values, use the End Point Adjustment function to Reset the servo End Point Adjustment Percentage Values. For more information, see the *Changing the Channel End Point Adjustment Percentage Values* section on the previous page.

REV MENU (SERVO REVERSING)

SETUP

The Servo Reversing function allows you to electronically switch the direction of servo travel. For example, if you rotate the Steering Wheel to the Right, and the Steering servo moves to the Left, you can use the Servo Reversing function to make the Steering servo move to the Left. The Servo Reversing function is available for all four channels.

 When you change the direction of servo travel, the servo horn may no longer be centered. If this occurs, use the Servo Sub-Trim function to center the servo horn. For more information, see the Changing the *Servo Sub-Trim Values* section on the previous page.

Changing the Servo Reversing Values:

- 1) From within the SETUP menu, scroll UP or DOWN to highlight the REV menu.
- 2) Press the ENTER key to open the REV menu. The cursor will default to ST > NOR.
- 3) Scroll UP or DOWN to highlight the desired Servo Reversing value you would like to change.
- 4) Press the ENTER key, then scroll UP or DOWN to change the Servo Reversing value. Choose from either NOR (Normal) or REV (Reverse).
- 5) Press the ENTER key, then repeat steps 3 and 4 to change any other desired Servo Reversing values.

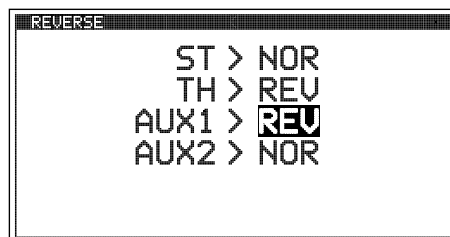
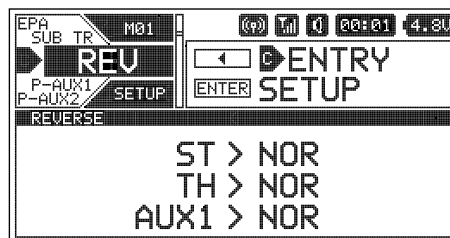

ST, TH, AUX1 and AUX2 setting range is NOR and REV. The default setting for all channels is NOR.

POINT AUX1 MENU (AUXILIARY 1 POINT VALUES)

SETUP

The Point Auxiliary function allows you to program the Auxiliary 1 servo to move up to 6 different Points along its travel, then cycle through those Points using one of the Trim Switches or the Rotary Dial. For example, if your Model requires a separate 3-position or more switch to operate a feature, the Point Auxiliary function can be customized to control this. This section details how to change the actual Point values. For example, if you have 4 Points programmed, you can change the Point values to cycle your servo from 0 to 20 to 40 to 60 degrees and back again.

Use one of the five Trim Switches or the Auxiliary Dial to cycle through the Point Positions while you're driving. The Auxiliary Lever is not suitable for use in this situation. The Point Auxiliary function can be toggled OFF and ON while you're driving by Assigning AUX1 to one of the three Push-Button Switches.

 Prior to programming the Auxiliary 1 Point values, you must first change the Auxiliary Channel Operating Mode to POINT, then choose the number of Points you want to program. For more information, see the *AUX TYPE Menu* section on pages 41 ~ 42.

 The Step value for the Auxiliary Dial or Trim Switch should be set to 1, otherwise the transmitter won't cycle properly through the programmed Points. For more information, see the *Changing the Trim Switch Step Value* section on page 35 or the *Changing the Auxiliary Dial Step Value* section on pages 36 ~ 37.

Changing the Auxiliary 1 Point Values:

- 1) From within the SETUP menu, scroll UP or DOWN to highlight the POINT AX1 menu.

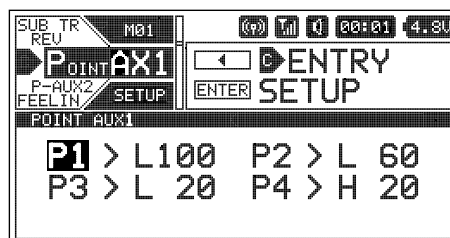

POINT AUX1 MENU (AUXILIARY 1 POINT VALUES)

SETUP

Changing the Auxiliary 1 Point Values, Continued...

- 2) Press the ENTER key to open the POINT AX1 menu. The cursor will default to P1 > L100 and the current Point will be highlighted.

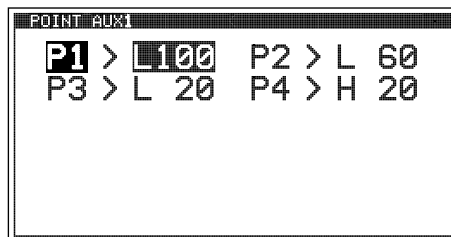

- 3) Scroll UP or DOWN to highlight the desired Point value you would like to change.
- 4) Press the ENTER key, then scroll UP or DOWN to change the Point value. Choosing an H or L value will determine the direction the servo travels.

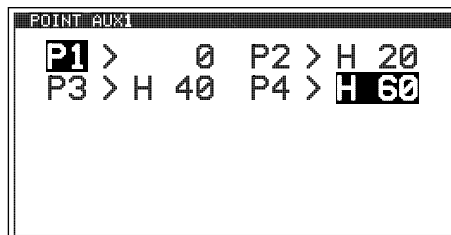

- 5) Press the ENTER key, then repeat steps 3 and 4 to change any other desired Point values.

P1 though P6 setting range is H100 to L100. The default setting for P1 is L100, for P2 is L60, for P3 is L20, for P4 is H20, for P5 is H60 and for P6 is H100. These values are a percentage of Auxiliary 1 servo travel.

- 6) Cycle forward and backward through the Points using the Auxiliary Dial (default) or the Trim Switch you Assigned AUX1 to. You will notice that as you cycle through the Points, the current Point will be highlighted and in addition, the current Point will be displayed in a pop-up window.

POINT AUX2 MENU (AUXILIARY 2 POINT VALUES)

SETUP

The Point Auxiliary function allows you to program the Auxiliary 2 servo to move up to 6 different Points along its travel, then cycle through those Points using one of the Trim Switches or the Rotary Dial. For example, if your Model requires a separate 3-position or more switch to operate a feature, the Point Auxiliary function can be customized to control this. This section details how to change the actual Point values. For example, if you have 4 Points programmed, you can change the Point values to cycle your servo from 0 to 20 to 40 to 60 degrees and back again.

Use one of the five Trim Switches or the Auxiliary Dial to cycle through the Point Positions while you're driving. The Auxiliary Lever is not suitable for use in this situation. The Point Auxiliary function can be toggled OFF and ON while you're driving by Assigning AUX2 to one of the three Push-Button Switches.

 Prior to programming the Point Auxiliary 2 Point values, you must first change the Auxiliary Channel Operating Mode to POINT, then choose the number of Points you want to program. For more information, see the *AUX TYPE Menu* section on pages 41 ~ 42.

 The Step value for the Auxiliary Dial or Trim Switch should be set to 1, otherwise the transmitter won't cycle properly through the programmed Points. For more information, see the *Changing the Trim Switch Step Value* section on page 35 or the *Changing the Auxiliary Dial Step Value* section on pages 36 ~ 37.

Changing the Auxiliary 2 Point Values:

- 1) From within the SETUP menu, scroll UP or DOWN to highlight the POINT AX2 menu.

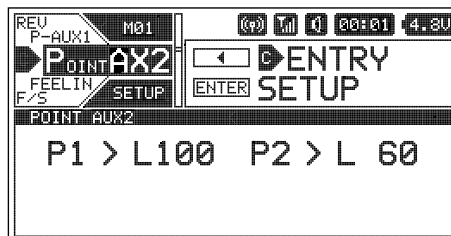

- 2) Press the ENTER key to open the POINT AX2 menu. The cursor will default to P1 > L100 and the current Point will be highlighted.

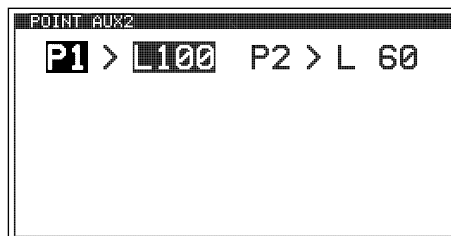

POINT AUX2 MENU (AUXILIARY 2 POINT VALUES)

SETUP

Changing the Auxiliary 2 Point Values, Continued....

- 3) Scroll UP or DOWN to highlight the desired Point value you would like to change.
- 4) Press the ENTER key, then scroll UP or DOWN to change the Point value. Choosing an H or L value will determine the direction the servo travels.
- 5) Press the ENTER key, then repeat steps 3 and 4 to change any other desired Point values.

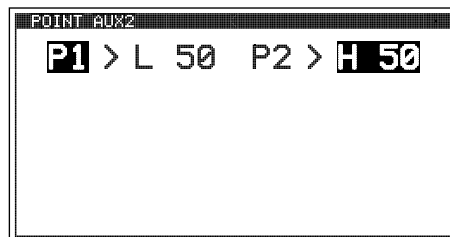

P1 through P6 setting range is H100 to L100. The default setting for P1 is L100, for P2 is L60, for P3 is L20, for P4 is H20, for P5 is H60 and for P6 is H100. These values are a percentage of Auxiliary 2 servo travel.

- 6) Cycle forward and backward through the Points using the Auxiliary Dial or the Trim Switch you Assigned AUX2 to. You will notice that as you cycle through the Points, the current Point will be highlighted and in addition, the current Point will be displayed in a pop-up window.

MOA MIX MENU (MOTOR ON AXLE MIXING)

SETUP

The Motor on Axle Mixing function provides you with two Throttle channels. It is typically used for Rock Crawlers and allows you to control either the Front and Rear motors together or independently, giving you Dig and Burn functions. In addition, you can variably change the power distribution between the Front and Rear motors, allowing you the utmost in functionality.

Use one of the five Trim Switches, the Auxiliary Dial or the Auxiliary Lever to Activate the Dig and Burn functions while you're driving.

 When using the Motor on Axle function, it's important to adjust the F/TH channel and R/TH channel Sub-Trim values so both motors are OFF when the Throttle Trigger is in the Neutral Point. In addition, remember, you are able to adjust many functions, such as Exponential, Servo Speed and much more for each Throttle channel independently to allow for the optimum Motor on Axle Mixing setup.

 The Motor on Axle Mixing function is available only when either Car Type IX or Car Type X is Selected.

Choosing the Motor on Axle Power Distribution Values:

You are able to program Dig and Burn functions by changing the Power Distribution between the two motors. When both Front and Rear values are balanced, Dig and Burn functions are inhibited.

- 1) From within the SETUP menu, scroll UP or DOWN to highlight the MOA MIX menu.

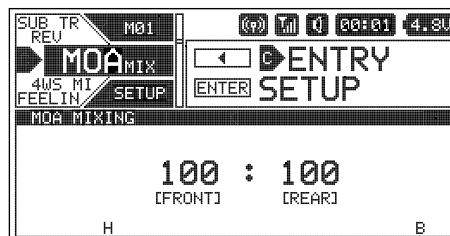

- 2) Press the ENTER key to open the MOA MIX menu. 100 [FRONT] : 100 [REAR] will be highlighted.

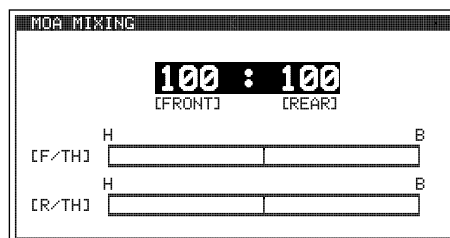

- 3) Press the ENTER key, then scroll UP or DOWN to change the Power Distribution between the Front and Rear motors. Reducing the [REAR] value will reduce the available power to the Rear motor (Dig) and reducing the [FRONT] value will reduce the power to the Front motor (Burn).

 Use the Servo Monitor at the bottom of the MOA MIXING screen to view Throttle channel output.

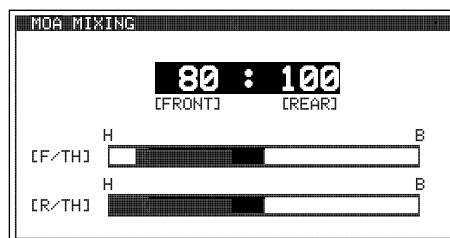

MOA MIX MENU (MOTOR ON AXLE MIXING)

SETUP

Choosing the Motor on Axle Power Distribution Values, Continued...

The following Motor on Axle Mixing options can be programmed by changing the Power Distribution values:

OFF (Balanced) - When set to 100:100 or other balanced value, power will be evenly distributed between the Front and Rear motors.

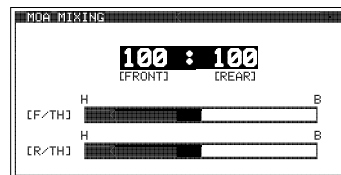
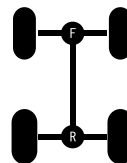

REAR Throttle (BURN) - When set to 0:100, power will only be distributed to the Rear motor. Power can be distributed proportionally between the Front and Rear motors from 0:100 to 99:100.

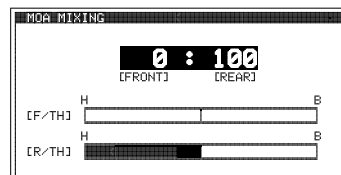
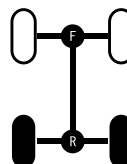

FRONT Throttle (DIG) - When set to 100:0, power will only be distributed to the Front motor. Power can be distributed proportionally between the Front and Rear motors from 100:0 to 100:99.

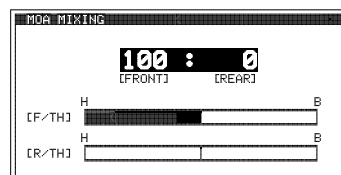
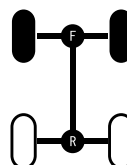

Controlling the Motor on Axle Mixing Function:

- 1) In order to control the Motor on Axle function, the MOA MIX function must be Assigned to either one of the five Trim Switches, the Auxiliary Dial or the Auxiliary Lever. For more information, see the *ASSIGN Menu* section on pages 33 ~ 38.
- 2) Use the Trim Switch, Auxiliary Dial or Auxiliary Lever to adjust the Power Distribution values to achieve the desired results - either OFF, Dig or Burn, as described above. A pop-up window will display the current Power Distribution values.

PRO TIP: In the default configuration, switching between OFF, Dig and Burn will happen gradually as you move the Trim Switch or Auxiliary Dial. This allows you to vary the Power Distribution between the Front and Rear motors. If you prefer to switch between OFF, Dig and Burn as if they were Assigned to an ON/OFF switch, change the Trim Switch or Auxiliary Dial Step value to 100. For more information, see the *ASSIGN Menu* section on pages 33 ~ 38.

Alternately, switching between OFF, Dig and Burn can be controlled using the Auxiliary Lever. This allows you to quickly switch between OFF, Dig and Burn and still have the ability to variably change the Power Distribution between the Front and Rear motors. To set this up, Assign MOA MIX to the Auxiliary Lever, then change the TWEAK (H) value to +100 and the TWEAK (L) value to -100. For more information, see the *ASSIGN Menu* section on pages 33 ~ 38.

4WS MIX MENU (FOUR WHEEL STEERING MIXING)

SETUP

The Four Wheel Steering Mixing function provides you with two Steering channels. It allows you to control either the Front or Rear Steering independently or Mix the Front and Rear Steering to have Parallel Four Wheel Steering (Crab) or Tandem Four Wheel Steering. Use one of the five Trim Switches or the Auxiliary Dial to cycle through the different Four Wheel Steering options while you're driving. The Four Wheel Steering Mixing function can be toggled OFF and ON while you're driving by Assigning 4WS to one of the three Push-Button Switches.

⚠ When using the Four Wheel Steering function, it's important to adjust the F/ST channel and R/ST channel Sub-Trim values to center both Steering servos when the Steering Wheel is centered. This will ensure that your Model tracks straight. In addition, remember, you are able to adjust many functions, such as Exponential, Servo Speed and much more for each Steering channel independently. This allows for the optimum Four Wheel Steering Mixing setup.

⚠ The Four Wheel Steering Mixing function is available only when either Car Type VIII or Car Type X is Selected.

Choosing the Four Wheel Steering Mixing Options:

- 1) From within the SETUP menu, scroll UP or DOWN to highlight the 4WS MIX menu.

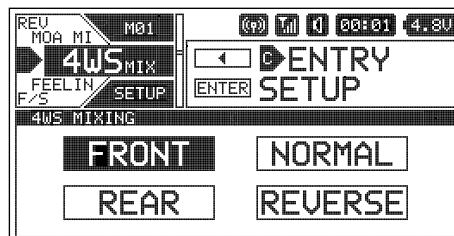

4WS MIX MENU (FOUR WHEEL STEERING MIXING)

SETUP

Choosing the Four Wheel Steering Mixing Options, Continued....

2) Press the ENTER key to open the 4WS MIX menu. The last Four Wheel Steering Mixing option Selected will be highlighted.

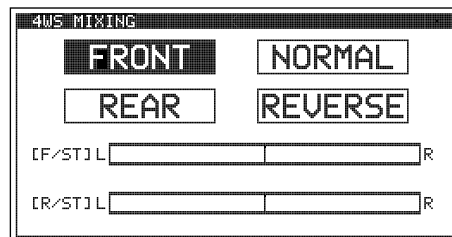

3) Press the ENTER key, then scroll UP or DOWN to highlight the Four Wheel Steering Mixing option you would like to use.

4) Press the ENTER key to Activate that option.

⚠ Use the Servo Monitor at the bottom of the 4WS MIXING screen to view Steering channel output.

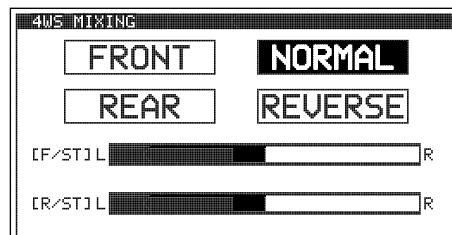

The following Four Wheel Steering Mixing options are available:

FRONT Wheel Steering - When Active, only the Front Steering will operate.

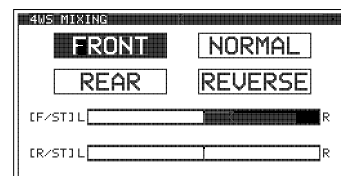
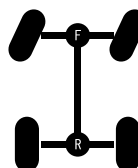

REAR Wheel Steering - When Active, only the Rear Steering will operate.

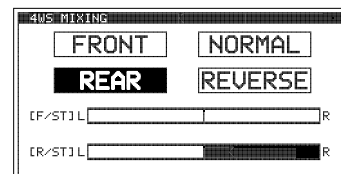
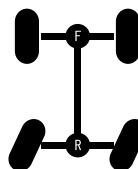

NORMAL (Parallel/Crab) Four Wheel Steering - When Active, both the Front and Rear Steering will operate in Parallel.

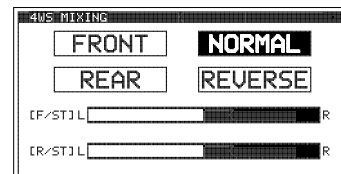
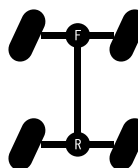

REVERSE (Tandem) Four Wheel Steering - When Active, both the Front and Rear Steering will operate in Tandem.

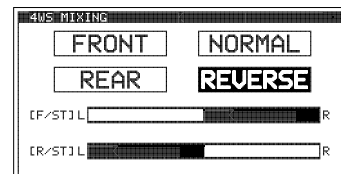
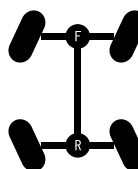

⚠ If the Steering servos do not operate as described above, you can use the Servo Reversing function to change the direction that each servo operates. For more information, see the *REV Menu* section on page 64.

Controlling the Four Wheel Steering Mixing Function:

- 1) In order to control the Four Wheel Steering function, the 4WS MIX function must be Assigned to either one of the five Trim Switches or the Auxiliary Dial. For more information, see the *ASSIGN Menu* section on pages 33 ~ 38.
- 2) Use the Trim Switch or Auxiliary Dial to cycle through the various Four Wheel Steering Mixing options. A pop-up window will display the currently Active option.

⚠ The Step value for the Trim Switch or Auxiliary Dial should be set to 1, otherwise the transmitter won't cycle properly through the Four Wheel Steering Mixing options. For more information, see the *Changing the Trim Switch Step Value* section on page 35 or the *Changing the Auxiliary Dial Step Value* section on pages 36 ~ 37.

FEELING MENU (STEERING AND THROTTLE CHANNEL RESPONSE TIME)

SETUP

The Feeling function allows you to adjust the Response Time of the Steering and Throttle channels to fine-tune the sensitivity of these controls. The M12 transmitter has an extremely fast Response Time (Latency), which results in the driver feeling extremely connected to their Model. This ultra-fast Response Time can be felt by the racer, particularly during on-road racing where the vehicle reacts extremely quickly to control inputs due to the increased traction between the vehicle and the track. After getting used to this fast Response Time, it allows for quicker, smoother control of your Model, which gives you an advantage over other drivers.

Some users may find that the Response Time is in some cases too fast, therefore, we've made it adjustable to suit the driver's driving style, Car Type and track conditions.

The Feeling function works not only with Airtronics FH4T and FH4 receivers, but also with FH3 and FH2 receivers as well.

Changing Steering and Throttle Response Time Values:

- 1) From within the SETUP menu, scroll UP or DOWN to highlight the FEELING menu.

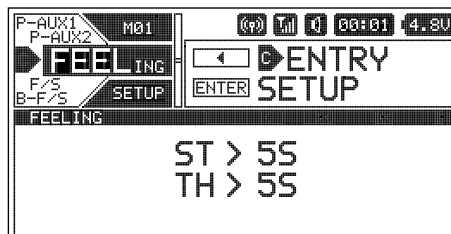

- 2) Press the ENTER key to open the FEELING menu. ST > 5S will be highlighted.

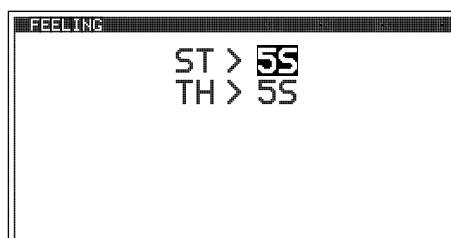

- 3) Scroll UP or DOWN to highlight the desired channel you would like to change the Response Time value for, either ST (Steering) or TH (Throttle).
- 4) Press the ENTER key, then scroll UP or DOWN to choose the desired Response Time value for that channel. When set to 0, Response Time is similar to the Airtronics M11X (approximately 5ms average). Increasing the 'S' value Increases Response Time and Increasing the 'F' value Decreases Response Time.

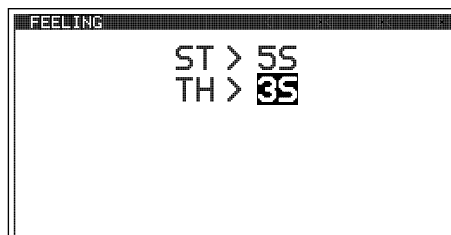

ST and TH setting range is 5S to 1S, 0 and 1F to 5F. The default setting is 5S.

F/S (FAIL SAFE)

SETUP

The Fail Safe function automatically moves the servos to a predetermined position in the event that the signal between the transmitter and the receiver is interrupted, whether due to signal degradation or to low transmitter battery.

Several different options are available. The Fail Safe function can be set to HOLD the servos in the last position they were in when the signal was lost or each of the servos can be set to move to a custom position when the signal is lost. For example, the Throttle servo (or ESC) can be programmed to move toward the Brake Side to engage the Brakes and stop your Model, or, if you're driving a gas- or glow-powered boat, the Fail Safe function could be set to Lower the Throttle servo (or ESC) to idle and turn the rudder slightly Left or Right so that the boat will continue in slow circles.

Fail Safe settings can be programmed for each of the four channels individually. In addition, Fail Safe settings are Model-specific, meaning you can have different Fail Safe settings for each of your Models. The Fail Safe settings will be retained even if the transmitter loses power or if the transmitter and receiver must be paired again.

Three Fail Safe options are available for each channel as described below:

FREE - Fail Safe is Disabled for this channel. Servos can move freely when the signal is lost.

HOLD - When Fail Safe Activates, the servo will be held in the last position it was in when the signal was lost.

% (PERCENTAGE) - When Fail Safe Activates, the servo will travel to the programmed position when the signal is lost.

WARNING: The Fail Safe function will NOT OPERATE if the receiver loses power. For example, if the receiver battery were to die or come unplugged. It will operate only if the transmitter and receiver signal is interrupted or if the transmitter loses power.

F/S (FAIL SAFE)

SETUP

Changing the Fail Safe Settings:

1) From within the SETUP menu, scroll UP or DOWN to highlight the F/S menu.

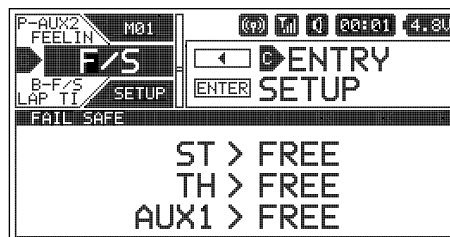

2) Press the ENTER key to open the F/S menu. ST > FREE will be highlighted.

3) Scroll UP or DOWN to highlight the desired channel you would like to change the Fail Safe value for.

4) Press the ENTER key, then scroll UP or DOWN to choose the desired Fail Safe value for that channel. If you choose to program a % value, see step 5 below.

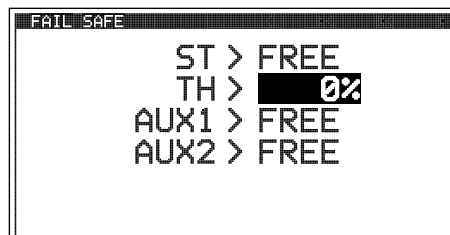

F/S setting range is FREE, HOLD or %. The default setting for all channels is FREE.

5) To program a Fail Safe % value, move the transmitter control (e.g., Throttle Trigger) the desired amount, then press and HOLD the ENTER key until an audible Tone sounds. The direction and percentage the servo will travel will be displayed. For example, to set the Brakes to Engage when the Fail Safe function Activates, push the Throttle Trigger toward the Brake Side the desired amount, HOLD the Throttle Trigger in that position, then press and HOLD the ENTER key.



6) Check to ensure your Fail Safe settings are working properly. Make sure that both the transmitter and receiver are turned ON, then, while someone is holding your Model, turn the transmitter OFF. The servos should react correctly based on the Fail Safe values chosen.

! When using an FH2 receiver with your transmitter, these Fail Safe features are not supported. In this case, the Fail Safe function must be programmed directly through the receiver. For more information, follow the Fail Safe Programming instructions provided with your FH2 receiver.

! If using a Car Type that features two Steering channels or two Throttle channels (like a Rock Crawler) and you're programming a Fail Safe % value, we suggest setting one of the Steering or Throttle channels to FREE and the other Steering or Throttle channels to the desired Fail Safe % value. This will ensure one of the channels won't be fighting the other duplicate channel should the Fail Safe function Activate.

B-F/S (RECEIVER BATTERY VOLTAGE FAIL SAFE)

SETUP

The Receiver Battery Voltage Fail Safe function is designed to alert you when your receiver battery requires recharging. This ensures that the receiver battery's voltage doesn't drop so low that your servos aren't provided adequate voltage to operate optimally. When Activated, the servo(s) will move to the predetermined position that you programmed in step 5 in the *Changing the Fail Safe Settings* section to indicate your receiver battery's voltage has dropped below the programmed Voltage value.

When used with an FH4 or FH4T receiver, the Receiver Battery Voltage Fail Safe function can be Activated for all four channels independently. When used with an FH3 receiver, the Receiver Battery Voltage Fail Safe function can be Activated only for the Throttle channel. The Receiver Battery Voltage Fail Safe function cannot be used with FH2 receivers.

WARNING: This function is designed for use with glow- or gas-powered Models that use a separate receiver battery pack. Do NOT use this function with an electric Model that uses the motor battery to power the servos and receiver.

Choosing the Receiver Battery Voltage Value:

1) From within the SETUP menu, scroll UP or DOWN to highlight the B-F/S menu.

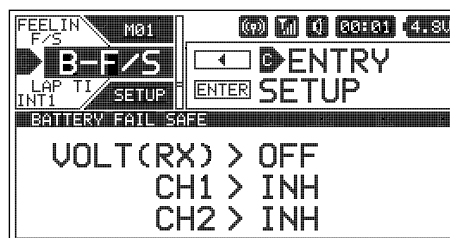

B - F/S (RECEIVER BATTERY VOLTAGE FAIL SAFE)

SETUP

Choosing the Receiver Battery Voltage Value, Continued....

- 2) Press the ENTER key to open the B-F/S menu. VOLT (RX) > OFF will be highlighted.
- 3) Press the ENTER key, then scroll UP or DOWN to choose the desired Receiver Battery Voltage value. Many factors, such as the current draw of your servos and how many servos you're using, etc., will determine the value to use. A good starting point would be 3.7V. If it appears your servos are slow or not producing adequate torque what that Voltage value is reached, Increase the Voltage value.

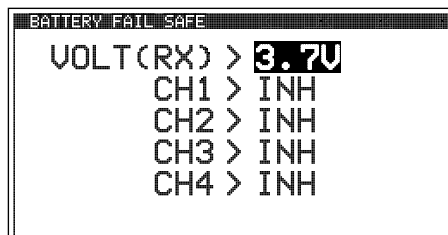

VOLT (RX) setting range for FH4 and FH4T receivers is OFF and 3.5V to 7.4V. VOLT (RX) setting range for FH3 receivers is OFF and 3.5V to 5.0V. The default setting is OFF regardless of the Modulation Type chosen. Use with FH2 receivers is not supported.

Activating the Receiver Battery Voltage Fail Safe Function:

The Receiver Battery Fail Safe function can be Activated for one or more channels, however, in most cases you will want to Activate this function only for the Throttle channel. When Activated, the Throttle servo will move to the predetermined position that you programmed in step 5 in the *Choosing Fail Safe Settings* section to indicate your receiver battery's voltage has dropped below the programmed Voltage value. When this happens, stop using your Model and recharge the receiver battery.

 A % value must be Selected to be able to Activate the Receiver Battery Voltage Fail Safe function. If FREE or HOLD is Selected for any of the channels, you cannot Activate the Receiver Battery Voltage Fail Safe function.

- 1) From within the B-F/S menu, scroll UP or DOWN to highlight desired channel number you want to Activate the Receiver Battery Voltage Fail Safe function for.
- 2) Press the ENTER key, then scroll UP or DOWN to choose the desired Battery Fail Safe value, either ACT or INH.
- 3) Press the ENTER key, then repeat steps 1 and 2 to change any other desired Battery Fail Safe values.

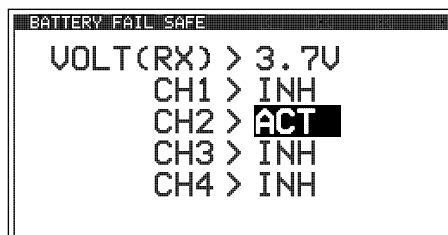

CH1, CH2, CH3 and CH4 setting range is INH and ACT. The default setting for all channels is INH.

LAP TIMER MENU (VIEW LAP TIMES AND CHOOSE LAP TIMER OPTIONS)

SETUP

The Lap Timer function allows you to measure and record Lap Times for up to 250 Laps. The total number of Laps, the Current Lap Time, the Best Lap Time and the Average Lap Time are all displayed. After the Lap Timer is Stopped, the Cumulative Time will be displayed. Lap Times are displayed in the following format: 00:00:00 (Minutes : Seconds : 1/100th of a Second).

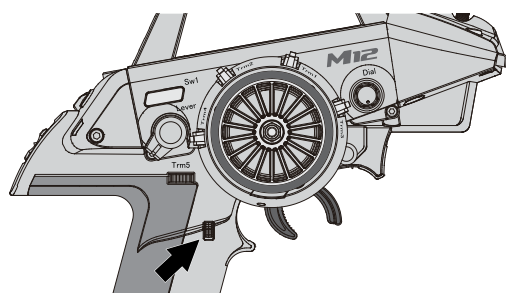

In addition to being able to view Lap Times, a Goal Time function is featured that will sound when you reach your Goal Time. For example, you can set the Goal Time value to the total time you would like to finish your race under. If desired, a Pre-Alarm function can be programmed to Alert you to your upcoming Goal Time.

Lap Times can be viewed within the LAP TIMER menu or on the TELEMETRY screen ALL and LAP pages. In addition, a pop-up window will display when the Lap Timer Starts and Stops, and each time a Lap Time is counted.

In the default configuration, placing the Lap Timer in Standby, Starting and Stopping the Lap Timer, and counting Lap Times, is controlled using the Lap Timer Switch (Push-Button Switch Sw3). In addition, if desired, the Throttle Trigger can be used to Start the Lap Timer after it's been placed in Standby.

LAP TIMER MENU (VIEW LAP TIMES AND CHOOSE LAP TIMER OPTIONS)

SETUP

Setting the Goal Time:

When the Lap Timer is counting Up, a long audible Tone will sound when the Goal Time is reached. For example, if you set the Goal Time value for 5 Minutes, a long audible Tone will sound when the Lap Timer reaches 5 minutes.

 When the Goal Time is reached the Lap Timer will continue counting Up, but you will no longer be able to continue counting Lap Times. The next time you press the Lap Timer Switch, the Lap Timer will Stop.

1) From within the SETUP menu, scroll UP or DOWN to highlight the LAP TIMER menu.

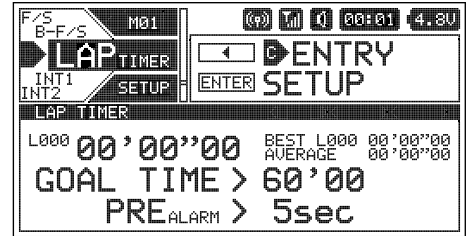

2) Press the ENTER key to open the LAP TIMER menu. GOAL TIME > 60'00 will be highlighted.

3) Press the ENTER key, then scroll UP or DOWN to choose the desired Goal Time value in Minutes : Seconds.

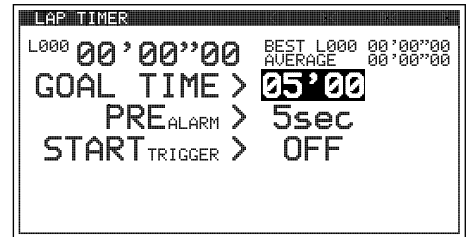

GOAL TIME setting range is 10 Seconds to 60 Minutes (00'10 to 60'00) and is adjustable in 10 second intervals. The default setting is 60 Minutes.

Setting the Pre-Alarm Time:

The Pre-Alarm function is used to alert you that your Goal Time is approaching. You can program the Pre-Alarm to sound once every second the desired number of seconds prior to reaching your Goal Time. For example, if the Pre-Alarm value is set to 5 Seconds, a short audible Tone will sound every second, 5 seconds prior to reaching your Goal Time. If desired, the Pre-Alarm value can be set to OFF to turn the Pre-Alarm OFF.

1) From within the LAP TIMER menu, scroll UP or DOWN to highlight PRE-ALARM > 5sec.

2) Press the ENTER key, then scroll UP or DOWN to choose the desired Pre-Alarm value in Seconds.



PRE-ALARM setting range is OFF and 1 to 20 Seconds. The default setting is 5 Seconds.

Choosing the Optional Throttle Trigger Start:

The Throttle Trigger can be used to Start the Lap Timer after the Lap Timer as been placed in Standby. This is much more convenient than worrying about pressing the Lap Timer Switch again to Start the Lap Timer when you're starting your race.

1) From within the LAP TIMER menu, scroll UP or DOWN to highlight START TRIGGER > OFF.

2) Press the ENTER key, then scroll UP or DOWN to choose the desired Start Trigger value, either ON or OFF.

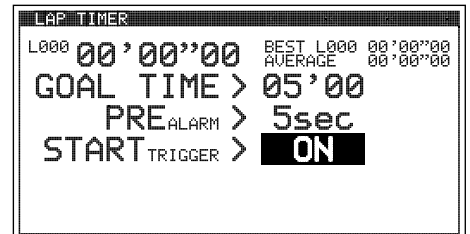

START TRIGGER setting range is OFF and ON. The default setting is OFF.

Starting the Lap Timer and Counting Lap Times:

1) In the default configuration, the Lap Timer Switch (Push-Button Switch Sw3) controls the Lap Timer. Press and HOLD the Lap Timer Switch for 3 seconds. An audible Double-Tone will sound and LAP [STANDBY] will be displayed momentarily in a pop-up window, indicating the Lap Timer is in Standby. To start the Lap Timer, press the Lap Timer Switch a second time or pull the Throttle Trigger if you've Enabled the Start Trigger function. An audible Double-Tone will sound and the Lap Timer will start counting Up.

2) Press the Lap Timer Switch a second time to store the first Lap Time and begin counting a second Lap Time. Each time you press the Lap Timer Switch, an audible Tone sounds, the previous Lap Time is stored, a new Lap Time begins and the current Lap Time is displayed momentarily in a pop-up window.

LAP TIMER MENU (VIEW LAP TIMES AND CHOOSE LAP TIMER OPTIONS)

SETUP

Stopping the Lap Timer:

- 1) To Stop the Lap Timer, press and HOLD the Lap Timer Switch for 3 seconds. An audible Double-Tone will sound and LAP [STOPPED] will be displayed momentarily in a pop-up window, indicating the Lap Timer is stopped.

⚠ The Cumulative Time cannot be manually cleared. It will be automatically cleared when the Lap Timer is put in Standby again.

Viewing Lap Times:

The Cumulative Lap Time, the Best Lap Time and the Average Lap Time, in addition to up to 250 individual Lap Times can be viewed on the TELEMETRY screen LAP page.

- 1) From the STATUS screen, scroll UP or DOWN to open the TELEMETRY screen. Press the SELECT switch Right or Left to open the LAP page.
- 2) Press the ENTER key, then scroll UP or DOWN to view the individual Lap Times.

⚠ Lap Times are stored until you Restart the Lap Timer. When the Lap Timer is Restarted, old Lap Times are Cleared and new Lap Times are Stored.

INT1 AND INT2 MENU (INTERVAL 1 AND INTERVAL 2 TIMERS)

SETUP

The Interval Timer function is used to notify you when a set Interval elapses while you're driving. When the Interval Time is reached, an audible Double-Tone will sound, then the Interval Timer will Reset and begin counting Up again from zero. Interval Times are displayed in the following format: 00:00".00 (Minutes : Seconds : 1/100th of a Second). The Interval Timer can be programmed to work independently or programmed to work along with the Lap Timer function.

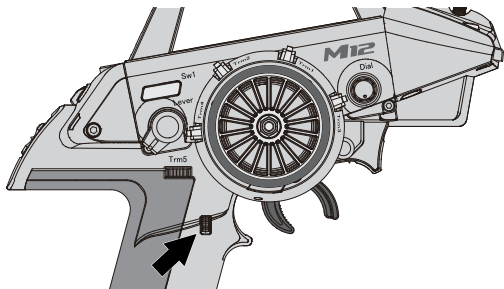

There are two Interval Timers. These Interval Timers can be Started and Stopped independently by Assigning each one to a different Push-Button Switch or they can be Started and Stopped simultaneously by Assigning both of them to the same Push-Button Switch. If desired, different Tones can be Assigned to each Interval Timer to differentiate them and the Throttle Trigger can be programmed to Start the Interval Timer(s).

In the default configuration, Interval Timer 1 is Started and Stopped along with the Lap Timer, using the Lap Timer Switch (Push-Button Switch Sw3).

⚠ This section covers both the INT1 and INT2 menus, since programming each of them is exactly the same. Choose either the INT1 or the INT2 menu depending on which of the two Interval Timers you want to program.

Setting the Interval Timer:

- 1) From within the SETUP menu, scroll UP or DOWN to highlight either the INT1 or the INT2 menu depending on which Interval Timer you want to program. In this section, we show programming Interval Timer 1.
- 2) Press the ENTER key to open the INT1 menu. INTERVAL > 00' will be highlighted.
- 3) Scroll UP or DOWN to highlight the desired Interval Timer value you would like to change, either 00' (Minutes) , 00" (Seconds) or 00 (1/100th Seconds).
- 4) Press the ENTER key, then scroll UP or DOWN to choose the desired Interval Timer value.
- 5) Press the ENTER key again, then repeat steps 3 and 4 to change any other desired Interval Timer values.

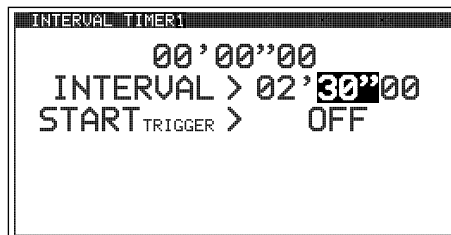
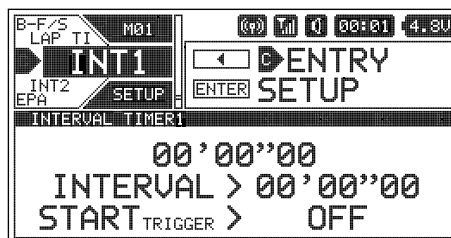

INT1 and INT2 INTERVAL setting range is 00:00:00 to 99:59:90. The default setting for both Interval Timers is 00:00:00 (OFF).

Choosing the Optional Throttle Trigger Start:

The Throttle Trigger can be used to Start the Interval Timer after the Interval Timer as been placed in Standby. This is much more convenient than worrying about pressing the Interval Timer Switch again to Start the Interval Timer when you're starting your race.

INT1 AND INT2 MENU (INTERVAL 1 AND INTERVAL 2 TIMERS)

SETUP

Choosing the Optional Throttle Trigger Start, Continued....

- 1) From within the INT1 menu, scroll UP or DOWN to highlight START_{TRIGGER} > OFF.
- 2) Press the ENTER key, then scroll UP or DOWN to choose the desired Start Trigger value, either ON or OFF.

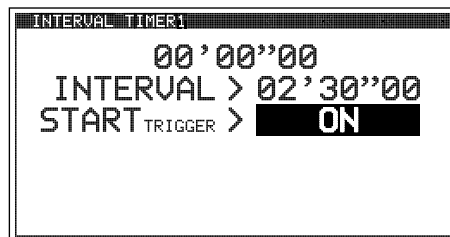

INT1 and INT2 START_{TRIGGER} setting range is OFF and ON. The default setting for both Interval Timers is OFF.

Starting the Interval Timers:

In the default configuration, the Lap Timer Switch (Push-Button Switch Sw3) controls both the Lap Timer and Interval Timer 1. To control Interval Timer 2, it must first be Assigned to a Push-Button Switch. If desired, the Interval Timers can be Started and Stopped independently by Assigning each one to a different Push-Button Switch or they can be Started and Stopped simultaneously by Assigning both of them to the same Push-Button Switch. Regardless of what you decide, follow the step below to control the Interval Timer(s).

- 1) Press and HOLD the Push-Button Switch you've Assigned the Interval Timer(s) to for 3 seconds. An audible Double-Tone will sound and INT1 [STANDBY] or INT2 [STANDBY] will be displayed momentarily in a pop-up window, indicating the Interval Timer is in Standby. To Start the Interval Timer, press the Push-Button Switch a second time or pull the Throttle Trigger if you've Enabled the Start Trigger function. An audible Double-Tone will sound and the Interval Timer will start counting Up. Each time the Interval Time elapses, an audible Double-Tone will sound and the Interval Timer will Reset and start counting Up again from zero. If desired, you can manually Restart the Interval Timer from zero by pressing the Push-Button Switch while the Interval Timer is running.

If the Interval Timer is Assigned to the same Push-Button Switch as the Lap Timer and the Lap Timer is Assigned to Function 1, LAP will flash and Lap Time information will be displayed in a pop-up window, but the Interval Timer will run in the background.

When both Interval Timers are Assigned to the same Push-Button Switch, only the Interval Timer Assigned to Function 1 will be displayed in the pop-up window when the Interval Timers Start and Stop, however, if the Interval Timers are set to different values, each Interval Timer will be displayed in the pop-up window as the Interval Times are reached.

Stopping the Interval Timers:

- 1) To stop the Interval Timer(s), press and HOLD the Push-Button Switch you've Assigned the Interval Timer(s) for 3 seconds. An audible Double-Tone will sound indicating the Interval Timer(s) is stopped.

When Stopped, the Interval Timer will read 00'01"00. This is normal. This value will be cleared when the Interval Timer is placed in Standby again.

RACING MENU OVERVIEW

RACING

To access the various RACING Programming Menus, turn the transmitter ON, then press the SELECT switch to highlight the RACING menu. Press the ENTER key to open the RACING menu.

Scroll UP or DOWN to highlight the desired Programming Menu, then press the ENTER key to open that menu.

Depending on the Car Type chosen, some Function Programming Value Names may differ from those shown in this section.

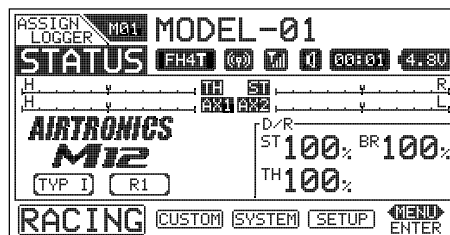

The following Programming Menus are available within the RACING menu:

MENU	MENU DESCRIPTION	PAGE #
R-MODE	Turn Racing Mode ON or OFF and Choose Racing Mode Options	PG. 75
D/R	Adjust Steering, Throttle and Brake Dual Rates	PG. 76
TRIM	Adjust Servo Trim, Including Auxiliary Channel Trim	PG. 77
CURVE	Adjust Channel Exponential, Adjustable Rate Control (ARC) and Curves	PG. 78
SPEED	Adjust Servo Speed in the Forward and the Return to Neutral Directions	PG. 82
ALB	Turn Anti-Lock Braking ON or OFF and Choose Anti-Lock Braking Options	PG. 84

RACING MENU OVERVIEW

RACING

The following Programming Menus are available within the RACING menu:

MENU	MENU DESCRIPTION	PAGE #
OFFSET	Turn Throttle Offset ON or OFF and Choose Throttle Offset Options	PG. 85
BR-MIX	Program Dual Brake Mixing Option (Dual Brake Car Types Only)	PG. 87
TH-HLD	Turn Throttle Hold ON or OFF and Choose Throttle Hold Options	PG. 87
C-MIX1	Program Compensation Mixing 1 Options	PG. 89
C-MIX2	Program Compensation Mixing 2 Options	PG. 89
ACKER	Program Ackerman Angle Options (Left and Right Steering Servo Car Types Only)	PG. 92
R-DLY	Program a Delay When Switching Between Racing Modes	PG. 92
CODE AX1	Program Code Auxiliary 1 Options (For Future Connected Products)	PG. 93
CODE AX2	Program Code Auxiliary 2 Options (For Future Connected Products)	PG. 93

R-MODE MENU (RACING MODE)

RACING

The Racing Mode function provides you with five separate Racing Modes that you can switch between while you're driving. For example, due to changing track conditions or other variables, such as tire wear, different Racing Modes can be Selected at any time to change your Model's setup. A number of functions, such as Dual Rate, Exponential, Curves, Compensation Mixing and more, that might commonly be required to be changed during the course of a race can be programmed with different Programming Values for each Racing Mode. This ensures that your Model can operate with the best-suited setup for ever-changing track conditions throughout an entire race, giving you an advantage over other drivers.

Functions can be programmed the same for all five Racing Modes or functions can be programmed independently, allowing you to have different function Programming Values for each of the five Racing Modes and switch between them while driving.

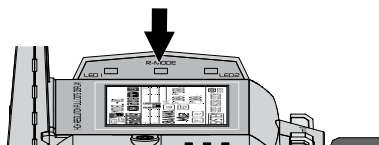
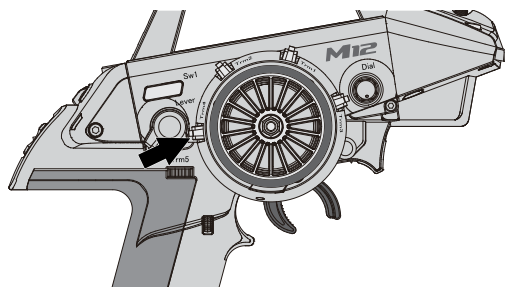

Active R-MODE LED Colors:

MODE	OFF	R1	R2	R3	R4	R5
LED	OFF	GREEN	MAGENTA	CYAN	YELLOW	WHITE

In the default configuration, after Activating the Racing Mode function, you can switch between Racing Modes using the Racing Mode Switch (Trim Switch Trm4). The R-MODE LED will change color to indicate the currently Active Racing Mode. In addition, the currently Active Racing Mode will be displayed on the STATUS screen. When you switch between Racing Modes, the currently Active Racing Mode will be momentarily displayed in a pop-up window.

 Racing Mode functions will vary depending on the current Car Type. For a complete list of Racing Mode functions based on Car Type, see the Racing Mode Functions by Car Type table on page 99.

Turning Racing Mode ON and OFF:

- 1) From within the RACING menu, scroll UP or DOWN to highlight the R-MODE menu.
- 2) Press the ENTER key to open the R-MODE menu. R-MODE > INH will be highlighted.
- 3) Press the ENTER key, then scroll UP or DOWN to choose the desired R-MODE value, either ACT (Active) or INH (Inhibited/OFF).

R-MODE setting range is ACT and INH. The default setting is INH.

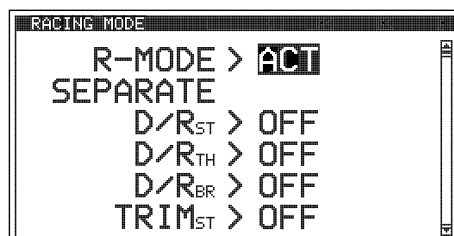
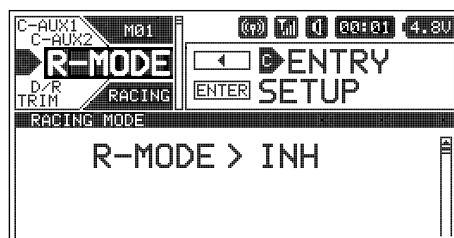

R-MODE MENU (RACING MODE)

RACING

Turning Separate Functions ON and OFF:

When Racing Mode is turned ON (R-MODE > ACT), various functions can be programmed the same for all five Racing Modes or they can be programmed independently, allowing you to have different function Programming Values for each of the five Racing Modes. For example, with D/Rst set to ON, you can choose a Dual Rate Steering percentage value of 100% for Racing Mode 1, a Dual Rate Steering percentage value of 90% for Racing Mode 2 and so on.

- 1) From within the R-MODE menu, scroll UP or DOWN to highlight desired function you would like to turn ON or OFF.
- 2) Press the ENTER key, then scroll UP or DOWN to choose the desired value, either ON or OFF. When set to ON, you will be able to choose different function Programming Values for each Racing Mode. When set to OFF, function Programming Values will be the same for all Racing Modes.

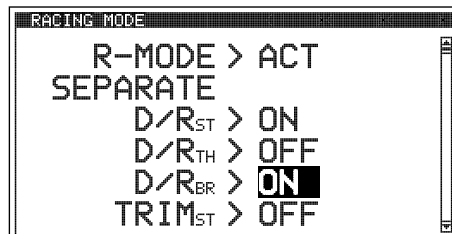

SEPARATE functions setting range is OFF and ON. The default setting for all functions is OFF.

- 3) Press the ENTER key, then repeat steps 1 and 2 to change any other desired values.

Switching Racing Modes to Program Separate Functions:

If you've chosen to program one or more Racing Mode functions separately (as described above), a Racing Mode Icon will be displayed within the specific function Programming Menu to indicate which Racing Mode you're currently programming the function for.

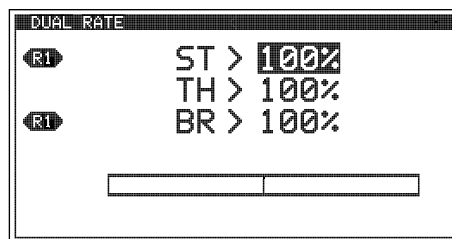

To program different values for each Racing Mode, make sure to switch to the desired Racing Mode first. For example, with SEPARATE D/Rst set to ON, open the D/R menu. An R1, R2, R3, R4 or R5 Racing Mode Icon will be displayed next to the Steering function, depending on which current Racing Mode is Active.

Use the Racing Mode Switch (Trim Switch Trm4) to switch to Racing Mode 1. R1 will be displayed next to the ST > 100% percentage value. Choose the desired Steering Dual Rate percentage value for Racing Mode 1, then press Trim Switch Trm4 to switch to Racing Mode 2. R2 will be displayed next to the ST > 100% percentage value. Choose the desired Steering Dual Rate percentage value for Racing Mode 2. While you're driving, you can now switch to different Dual Rate settings simply by switching Racing Modes.

! The Racing Mode Icon will only be displayed for Programming Menus within the RACING menu and only if the specific function's Separate value is set to ON in the R-MODE menu. If no Racing Mode Icon is displayed, the function Programming Value will be the same regardless of which Racing Mode is currently Active.

D/R MENU (DUAL RATES)

RACING

The Dual Rate function allows you to change the control authority of the Steering, Throttle High Side and Throttle Brake Side by changing the amount of servo travel relative to control input. For example, by Increasing the Steering Dual Rate, you can make the Steering servo travel more which might prevent your Model from pushing during turns. If your Model oversteers during turns, you can reduce the amount of Steering Dual Rate.

IMPORTANT: Prior to programming the Dual Rate function, you should adjust the maximum Left and Right (or High and Low) End Points. For more information, see the EPA Menu section on page 62.

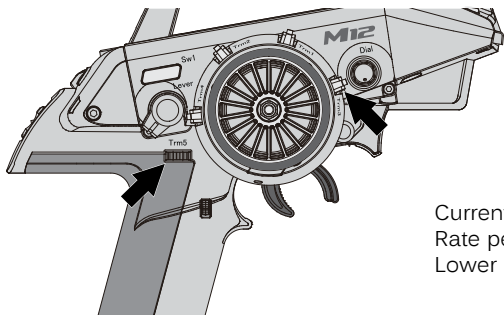

In the default configuration, Trim Switch Trm3 controls Steering Dual Rate and Trim Switch Trm5 controls Brake Dual Rate. Throttle Dual Rate can be changed while you're driving by Assigning the Dual Rate function to another Trim Switch or the Auxiliary Dial. For more information, see the ASSIGN Menu section on pages 33 ~ 38.

Current Steering, Throttle and Brake Dual Rate percentage values are displayed in the Lower Right corner of the STATUS screen.

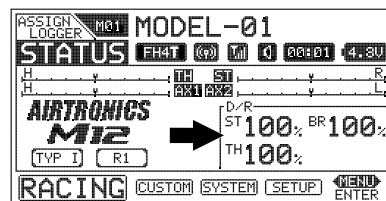

M12 2.4GHZ FH4T RADIO CONTROL SYSTEM USER'S GUIDE

D/R MENU (DUAL RATES)

RACING

Changing the Dual Rate Percentage Values:

1) From within the RACING menu, scroll UP or DOWN to highlight the D/R menu.

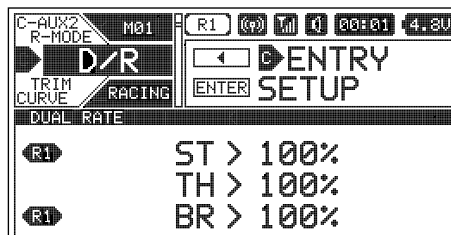

2) Press the ENTER key to open the D/R menu. ST > 100% will be highlighted.

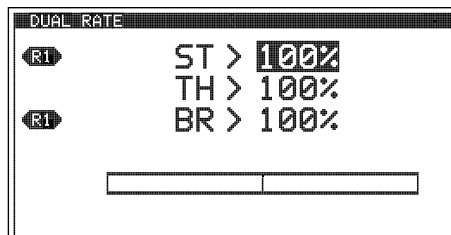

3) Scroll UP or DOWN to highlight the desired Dual Rate percentage value you would like to change.

4) Press the ENTER key, then scroll UP or DOWN to Increase or Decrease the Dual Rate percentage value. Increasing the percentage value will Increase servo travel and Decreasing the percentage value will Decrease servo travel.

5) Press the ENTER key, then repeat steps 3 and 4 to change any other desired Dual Rate percentage values.

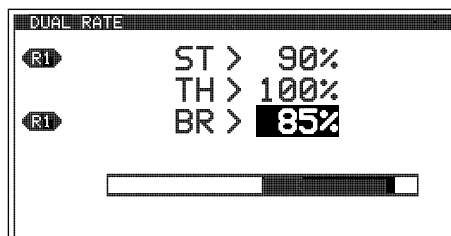

DUAL RATE setting range is 0% to 100%. The default setting for all channels is 100%.

! Dual Rate is a percentage of End Point Adjustment. For example, if you set the Steering Dual Rate percentage value to 100%, the Steering will travel the same amount defined by your End Point Adjustment programming. Alternately, if you set the Steering Dual Rate percentage value to 50%, the Steering will travel half the amount defined by your End Point Adjustment programming.

TRIM MENU (SERVO TRIM)

RACING

The Trim function allows you to view the current Trim value for each of the four channels and, if desired, allows you to change the Trim values using the Push-Button Rotary Dial from within the TRIM menu. For example, if you don't Assign Auxiliary 1 Trim to a Trim Switch, you can still Trim the Auxiliary 1 channel from within the TRIM menu.

The M12 features Digital Trim Memory. Any amount of Trim that you set during use using the Trim Switches or through the TRIM menu is automatically stored in memory for that specific channel and for that specific Model. The Trim values for each Model will automatically be loaded when the transmitter is turned ON.

Each time you move a Trim Switch a short audible Tone is heard. When the Trim value reaches 0 (Centered), a longer audible Tone sounds. This indicates to you that the Trim is centered without the need to look at the transmitter.

! In the default configuration, Trim Switch Trm1 and Trm2 move the Steering and Throttle/Brake Trim in 5% increments. If you want to Increase or Decrease the Trim Resolution, see the *Changing the Trim Switch Step Value* section on page 35.

PRO TIP: The Trim function features two different Trim Type options that you can choose from. Choose from either Center Trim or Parallel Trim. For more information, see the *TRIM TYPE Menu* section on page 43.

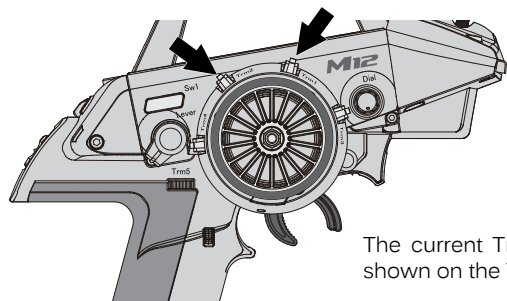

In the default configuration, Trim Switch Trm1 controls Steering Trim and Trim Switch Trm2 controls Throttle/Brake Trim. Auxiliary channel Trim can be changed while you're driving by Assigning the Trim function to another Trim Switch or the Auxiliary Dial. For more information, see the *ASSIGN Menu* section on pages 33 ~ 38.

The current Trim positions for all four channels is shown on the Trim Displays on the STATUS screen.

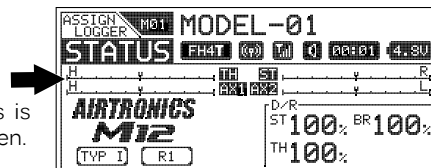

TRIM MENU (SERVO TRIM)

RACING

! Before changing the Trim values, you should first verify that all Trim values are set to 0, then adjust the servo Sub-Trim values to center the servo horns perfectly. For more information, see the *SUB TRIM Menu* section on page 63.

Changing the Trim Values:

- 1) From within the RACING menu, scroll UP or DOWN to highlight the TRIM menu.
- 2) Press the ENTER key to open the TRIM menu. ST > 0 will be highlighted.
- 3) Scroll UP or DOWN to highlight the desired Trim value you would like to change.
- 4) Press the ENTER key, then scroll UP or DOWN to Increase or Decrease the Trim value in the desired direction.
- 5) Press the ENTER key, then repeat steps 3 and 4 to change any other desired Trim values.

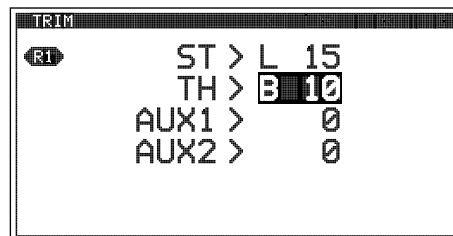
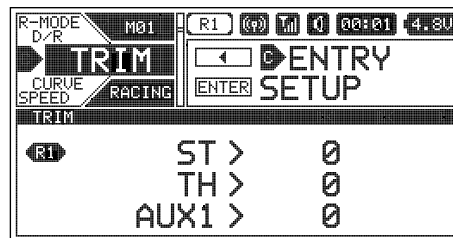

TRIM setting range is 0 to 100 in each direction. The default setting for all channels is 0.

CURVE MENU (EXPONENTIAL, ADJUSTABLE RATE CONTROL AND CURVE)

RACING

The CURVE menu allows you choose what method you would like to use to vary the amount of servo travel in relation to the amount of control movement. Choose from Exponential, Adjustable Rate Control (ARC) and Point Curve functions. Each of these three functions offers something different, and which function you choose to use for each channel will be determined by many factors, including your Car Type, track conditions, driving style and more.

! Exponential, Adjustable Rate Control and Point Curve functions can be programmed for each of the four channels. Programming options will differ within each function depending on the specific channel you're programming. For example, if your Car Type features Front and Rear Steering and Front and Rear Motors (such as Car Type X), only ST and TH channel options will be programmable, however, both Front and Rear channels will be programmed with the same Programming Values.

Exponential Programming

The Exponential function allows you to vary the amount of servo travel in relation to the movement of the Steering Wheel and Throttle Trigger (or in some cases, the Auxiliary Dial and/or the Auxiliary Lever) near the Neutral positions to change the way those functions react to control movement.

Decreasing the Exponential Rate percentage value will Soften the control feel around Neutral and Increasing the Exponential Rate percentage value will Heighten the control feel around Neutral. Using a Lower Negative value allows for smoother control. Using a Higher Positive value may result in more 'twitchy' control response.

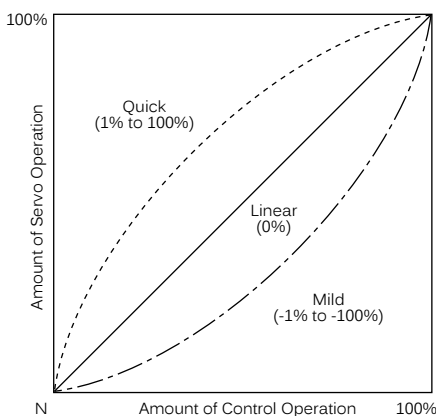

Exponential Rate percentage values can be adjusted from Mild through Linear to Quick to allow you to set the most effective control response for your Model. For example, if your Model over-steers, reduce the Steering Exponential Rate percentage value and if your Model under-steers, Increase the Steering Exponential Rate percentage value.

For another example, reduce the Throttle High Side Exponential Rate percentage value on a slippery track or with a Model that has a Higher-torque motor or engine, and Increase the Throttle High Side Exponential Rate percentage value on a high-grip track or with a Model that has a Lower-torque motor or engine.

For the utmost in precision control, Exponential Rate percentage values can be adjusted separately for the Throttle High Side and the Throttle Brake Side. In addition, the Exponential Tweak Right and Tweak Left function allows you to balance Exponential for Right and Left Steering.

A graph that depicts the control output and Exponential Curve relationship is featured to help visualize the changes you make.

! Exponential Programming Values can be changed while you're driving by Assigning these functions to a Trim Switch, the Auxiliary Dial or the Auxiliary Lever. For more information, see the *ASSIGN Menu* section on pages 33 ~ 38.

CURVE MENU (EXPONENTIAL, ADJUSTABLE RATE CONTROL AND CURVE)

RACING

Choosing the Channel and the Curve Type:

- 1) From within the RACING menu, scroll UP or DOWN to highlight the CURVE menu.
- 2) Press the ENTER key to open the CURVE menu. The < ST > channel will be Selected.
- 3) Press the SELECT switch RIGHT or LEFT to choose the desired channel you would like to program Exponential for.
- 4) From within the CURVE menu, scroll UP or DOWN to highlight the TYPE > value.
- 5) Press the ENTER key and scroll UP or DOWN to choose TYPE > EXP.

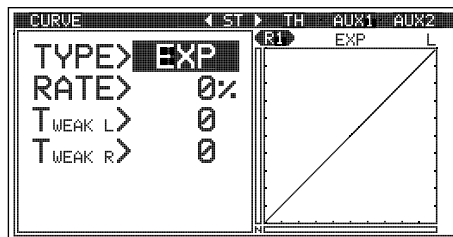
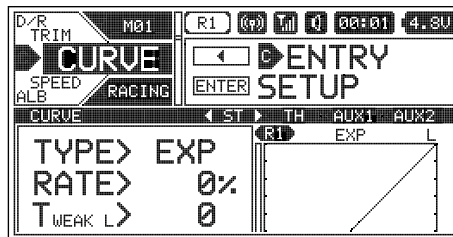

Changing the Rate Percentage Value:

The Rate percentage value determines the amount and type of Exponential, either Quick, Mild or Linear (see diagram on the previous page). When a Positive or Negative Exponential percentage value is programmed, a Curve will be created from a fixed Neutral Point. This Curve will be equal on both sides, except for the Throttle channel. For more information, see the notation below.

- 1) From within the CURVE menu, scroll UP or DOWN to highlight RATE > 0%.
- 2) Press the ENTER key, then scroll UP or DOWN to Increase or Decrease the Rate percentage value. Using a Negative Rate percentage value will Soften the control feel around Neutral and using a Positive Rate percentage value will Heighten the control feel around Neutral.

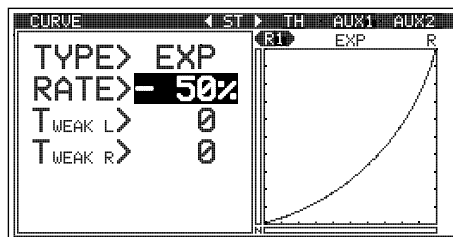

RATE setting range is -100% (Mild) to 100% (Quick). The default setting is 0% (Linear).

! You are able to adjust the Rate percentage value for the Throttle High Side and the Throttle Brake Side separately. In addition, you can even program Exponential for one Side and ARC or Point Curve for the other Side.

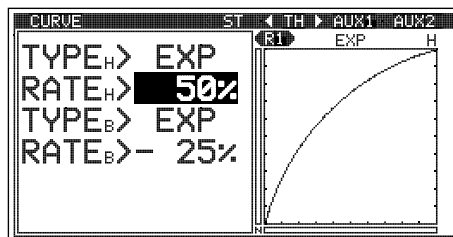

Changing the Steering Tweak Right and Tweak Left Values:

The Tweak function allows you to make small Exponential adjustments to the Right and/or Left sides of the Steering channel Neutral Point to fine-tune the balance between the two sides. Tweak value adjustments are effective whether you program a Negative or a Positive Rate value, or even program a Linear Rate value (0).

- 1) From within the CURVE menu, scroll UP or DOWN to highlight the desired Tweak value, either TWEAK L or TWEAK R.
- 2) Press the ENTER key, then scroll UP or DOWN to Increase or Decrease the Tweak value. Using a Negative Tweak value will Soften the control feel that side of Neutral and using a Positive Rate percentage value will Heighten the control feel around that side of Neutral.
- 3) Press the ENTER key, then repeat steps 1 and 2 to change the other Tweak value, if desired.

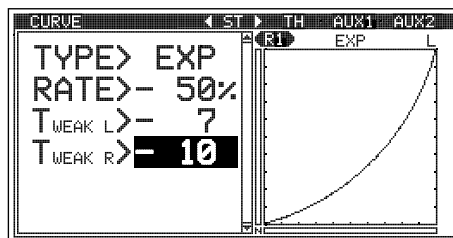

TWEAK L and TWEAK R setting range is -20 (Mild) to 20 (Quick). The default setting for both Tweak values is 0 (Linear).

Adjustable Rate Control Programming

The Adjustable Rate Control (ARC) function allows you to vary the amount of servo travel in relation to the movement of the Steering Wheel and Throttle Trigger (or in some cases, the Auxiliary Dial and/or the Auxiliary Lever) near the Neutral positions to change the way those functions react to control movement.

Decreasing the ARC Rate percentage value will Soften the control feel around Neutral and Increasing the ARC Rate percentage value will Heighten the control feel around Neutral. Using a Lower Negative value allows for smoother control. Using a Higher Positive value may result in more 'twitchy' control response.

The Adjustable Rate Control function works like the Exponential function, except that the Adjustable Rate Control function features the added benefit of being able to move the Neutral Point, whereas the Exponential function Neutral Point is fixed. In addition, the ARC Curve is more Linear than the Exponential Curve.

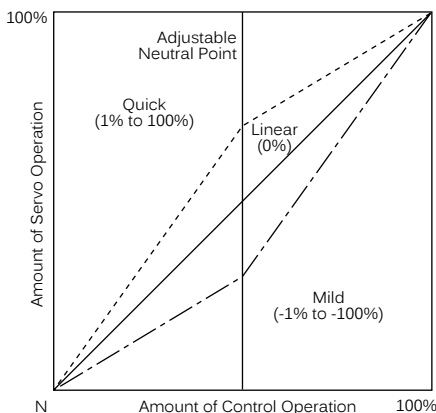

ARC Rate percentage values can be adjusted from Mild through Linear to Quick to allow you to set the most effective control response for your Model. For example, if your Model over-steers, reduce the Steering ARC Rate percentage value and if your Model under-steers, Increase the Steering ARC Rate percentage value.

For another example, reduce the Throttle High Side ARC Rate percentage value on a slippery track or with a Model that has a Higher-torque motor or engine, and Increase the Throttle High Side ARC Rate percentage value on a high-grip track or with a Model that has a Lower-torque motor or engine.

For the utmost in precision control, ARC Point and Rate values can be adjusted separately for the Throttle High Side and the Throttle Brake Side. A graph that depicts the control output and ARC Curve relationship is featured to help visualize the changes you make.

! Adjustable Rate Control Programming Values can be changed while you're driving by Assigning these functions to a Trim Switch, the Auxiliary Dial or the Auxiliary Lever. For more information, see the *ASSIGN Menu* section on pages 33 ~ 38.

Choosing the Channel and the Curve Type:

- 1) From within the RACING menu, scroll UP or DOWN to highlight the CURVE menu.
- 2) Press the ENTER key to open the CURVE menu. The < ST > channel will be Selected.
- 3) Press the SELECT switch RIGHT or LEFT to choose the desired channel you would like to program ARC for.
- 4) From within the CURVE menu, scroll UP or DOWN to highlight the TYPE > value.
- 5) Press the ENTER key and scroll UP or DOWN to choose TYPE > ARC.

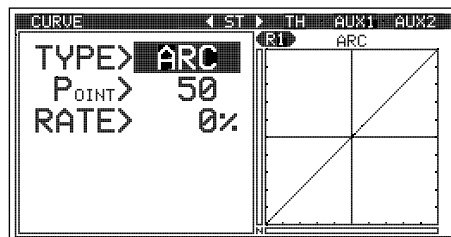
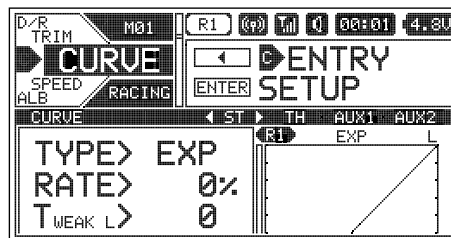

Changing the Point Value:

The Point value determines the Neutral Point where the Rate percentage value begins. For example, you may not want the Neutral Point to be centered between the High and Low End Points. You might want the Neutral Point shifted to the Right or to the Left.

- 1) From within the CURVE menu, scroll UP or DOWN to highlight POINT > 50.
- 2) Press the ENTER key, then scroll UP or DOWN to Increase or Decrease the Point value. Increasing the Point value will shift the Neutral Point to one side of center and Decreasing the Point value will shift the Neutral Point to the opposite side of center.

POINT setting range is 5 to 95. The default setting is 50 (Centered).

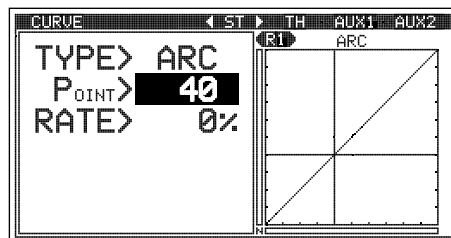

Changing the Rate Percentage Value:

The Rate percentage value determines the amount and type of ARC, either Quick, Mild or Linear (see diagram on the previous page). When a Positive or Negative ARC percentage value is programmed, a Linear Curve will be created from the Neutral Point.

- 1) From within the CURVE menu, scroll UP or DOWN to highlight RATE > 0%.
- 2) Press the ENTER key, then scroll UP or DOWN to Increase or Decrease the Rate percentage value. Using a Negative Rate percentage value will Soften the control feel around the Neutral Point and using a Positive Rate percentage value will Heighten the control feel around the the Neutral Point.

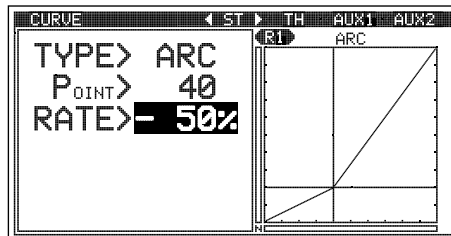

RATE setting range is -100% (Mild) to 100% (Quick). The default setting is 0% (Linear).

! You are able to adjust the Point value and the Rate percentage value for the Throttle High Side and the Throttle Brake Side separately. In addition, you can even program ARC for one Side and Exponential or Point Curve for the other Side.

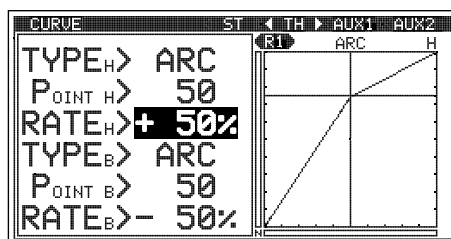

Point Curve Programming

The Point Curve function allows you to vary the amount of servo travel in relation to the movement of the Steering Wheel and Throttle Trigger (or in some cases, the Auxiliary Dial and/or the Auxiliary Lever) at different Points along the entire range of control travel to change the way those functions react to control movement. Nine programmable Points allow you to create your own custom Point Curve to suit any situation.

The Point Curve function works like the Exponential and ARC functions, except that the Point Curve function allows you to program up to 9 different Points along the entire range of control travel to suit whatever setup or situation is required. For example, you can customize the Point Curve to include Mild or Quick Points along the same Curve, or you can create a smooth Point Curve or a more Linear Point Curve.

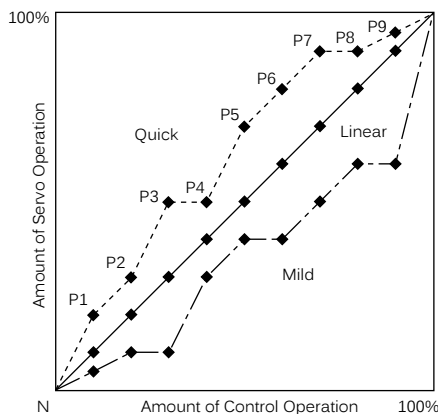

Point Curve percentage values can be adjusted from Mild through Linear to Quick to allow you to set the most effective control response for your Model. For example, if your Model over-steers, reduce the Point Curve percentage values and if your Model under-steers, Increase the Point Curve percentage values.

For another example, reduce the Throttle High Side Point Curve percentage values on a slippery track or with a Model that has a Higher-torque motor or engine, and Increase the Throttle High Side Point Curve percentage values on a high-grip track or with a Model that has a Lower-torque motor or engine.

For the utmost in precision control, Channel Curves can be programmed separately for the Throttle High Side and the Throttle Brake Side. A graph that depicts the control output and Point Curve relationship is featured to help visualize the changes you make.

! Point Curve Programming Values can be changed while you're driving by Assigning these functions to a Trim Switch, the Auxiliary Dial or the Auxiliary Lever. For more information, see the *ASSIGN Menu* section on pages 33 ~ 38.

Choosing the Channel and the Curve Type:

- 1) From within the RACING menu, scroll UP or DOWN to highlight the CURVE menu.

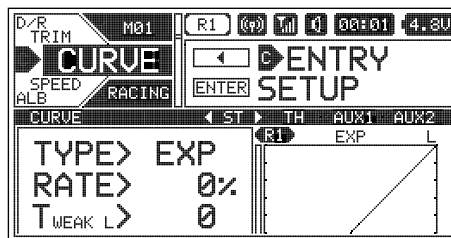

CURVE MENU (EXPONENTIAL, ADJUSTABLE RATE CONTROL AND CURVE)

RACING

Choosing the Channel and the Curve Type, Continued....

- 2) Press the ENTER key to open the CURVE menu. The < ST > channel will be Selected.
- 3) Press the SELECT switch RIGHT or LEFT to choose the desired channel you would like to program Point Curve for.

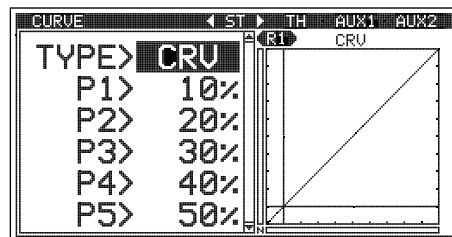

- 4) From within the CURVE menu, scroll UP or DOWN to highlight the TYPE > value, then press the ENTER key and scroll UP or DOWN to choose TYPE > CRV.

Changing the Point Percentage Values:

The Point percentage values determine the type of Point Curve, either Quick, Mild or Linear (see diagram on the previous page). Programming a Point percentage value that is Lower than the default value for that specific Point will Soften the control feel (Mild) and programming a Point percentage value that is Higher than the default value for that specific Point will Heighten the control feel (Quick).

- 1) From within the CURVE menu, scroll UP or DOWN to highlight the desired Point you want to change the Point percentage value for. Choose from P1 through P9.
- 2) Press the ENTER key, then scroll UP or DOWN to Increase or Decrease the Point percentage value. Using a Lower Point percentage value will Soften the control feel and using a Higher Point percentage value will Heighten the control feel.

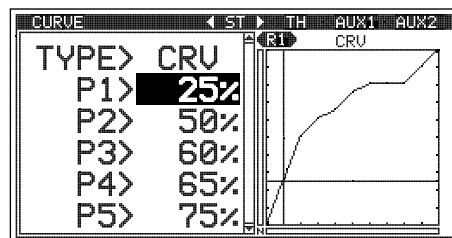

- 3) Press the ENTER key, then repeat steps 1 and 2 to choose the Point percentage value for any other desired Points.

POINT 1 ~ 9 setting range is 0% to 100%. The default setting for P1 is 10%, for P2 is 20%, for P3 is 30%, for P4 is 40%, for P5 is 50%, for P6 is 60%, for P7 is 70%, for P8 is 80% and for P9 is 90%.



You are able to adjust Point percentage values for the Throttle High Side and the Throttle Brake Side separately. In addition, you can even program Point Curve for one Side and Exponential or ARC for the other Side.

SPEED MENU (SERVO SPEED)

RACING

The Servo Speed function allows you to slow the transit speed of the Steering, Throttle, Auxiliary 1 and Auxiliary 2 channels. When driving your Model, proper Steering and Throttle control are vital. For example, lowering the transit speed of the Steering servo can help to limit excessive Steering, which will enable you to achieve smoother cornering. In addition, lowering the transit speed of the Throttle servo High Side can help to ensure smooth Throttle control. This function can be used in conjunction with the Exponential, ARC or Point Curve functions to double the effect.

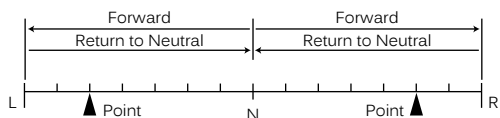

Servo transit speed can be slowed in the Forward and the Return to Neutral directions independently. In addition, you are able to program a Point on either side of servo travel, then define whether the servo transit speed is slowed down either Outside or Inside those two Points.



The Servo Speed function can be programmed for each of the four channels, however, depending on the current Car Type, not all channels may be able to be Selected. For example, if your current Car Type features Front and Rear Steering and Front and Rear Motors (such as Car Type X), only ST and TH channel options will be programmable, however, both Front and Rear channels will be programmed with the same Programming Values.



Servo Speed Programming Values can be changed while you're driving by Assigning these functions to a Trim Switch, the Auxiliary Dial or the Auxiliary Lever. For more information, see the ASSIGN Menu section on pages 33 ~ 38.

Choosing the Channel:

- 1) From within the RACING menu, scroll UP or DOWN to highlight the SPEED menu.

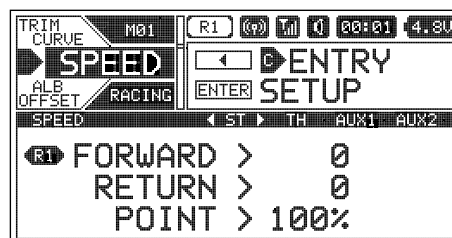

SPEED MENU (SERVO SPEED)

RACING

Choosing the Channel, Continued...

- 2) Press the ENTER key to open the SPEED menu. The < ST > channel will be Selected.
- 3) Press the SELECT switch RIGHT or LEFT to choose the desired channel you would like to program the Servo Speed function for.

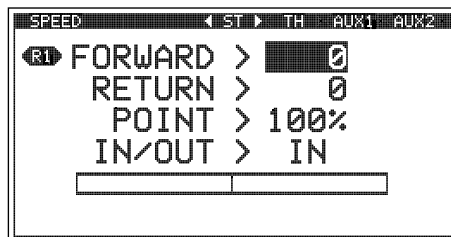

⚠ When the Throttle channel is Selected, you are able to adjust Servo Speed function Programming Values separately for both the Throttle High Side (H) and the Throttle Brake Side (B).

Changing the Servo Speed Forward Value:

- 1) From within the SPEED menu, scroll UP or DOWN to highlight FORWARD > 0.
- 2) Press the ENTER key, then scroll UP or DOWN to choose the desired Servo Speed Forward value. When 0 is Selected, the servo will travel at its normal speed in the Forward direction. When a Negative value is Selected, the servo transit speed will slow down in the Forward direction.

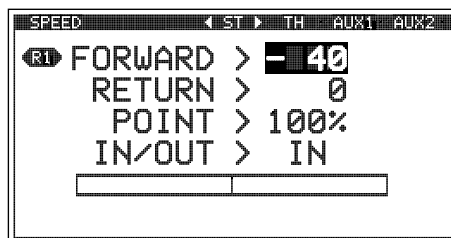

FORWARD setting range is 0 to -100. The default setting is 0 (Normal Speed).

Changing the Servo Speed Return Value:

- 1) From within the SPEED menu, scroll UP or DOWN to highlight RETURN > 0.
- 2) Press the ENTER key, then scroll UP or DOWN to choose the desired Servo Speed Return value. When 0 is Selected, the servo will travel at its normal speed in the Return to Neutral direction. When a Negative value is Selected, the servo transit speed will slow down in the Return to Neutral direction.

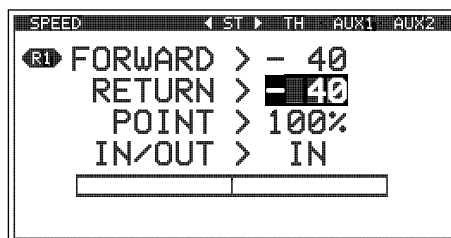

RETURN setting range is 0 to -100. The default setting is 0 (Normal Speed).

Changing the Point Percentage and IN and OUT Values:

The Point percentage value determines where along either side of servo travel that the servo's transit speed will be changed. The IN and OUT values determine whether the change in servo transit speed occurs between the two points (IN) or outside the two Points (OUT). See the diagram on the previous page.

⚠ If a 100% Point percentage value is chosen, the servo's transit speed will be the same along the entire length of travel. IN and OUT values are only discernible if a Point percentage value other than 100% is chosen.

- 1) From within the SPEED menu, scroll UP or DOWN to highlight POINT > 100%.
- 2) Press the ENTER key, then scroll UP or DOWN to choose the desired Point percentage value.

POINT setting range is 5% to 100%. The default setting is 100%.

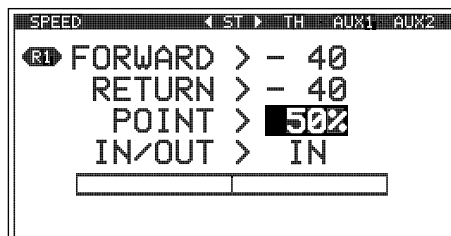

- 3) Press the ENTER key, then scroll DOWN to highlight IN/OUT > IN.
- 4) Press the ENTER key, then scroll UP or DOWN to choose the desired IN/OUT value, either IN or OUT.

IN/OUT setting range is IN or OUT. The default setting is IN.

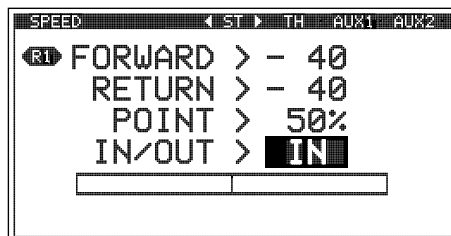

ALB MENU (ANTI-LOCK BRAKING)

RACING

The Anti-Lock Braking function makes it possible to achieve stable Braking even on a slippery surface. With stable Braking, your Model is better able to trace an exact line under Braking. When the Anti-Lock Braking function is turned ON, the Throttle servo will pulse when you apply Brake. Different Anti-Lock Braking options can be programmed, including how quickly the Brake pulsates, the Point at which the Anti-Lock Braking function Starts and more.

The Anti-Lock Braking function is primarily used on gasoline- or glow-powered Models that feature a Throttle servo. It can be used on an electric Model that uses an Electronic Speed Control, however, if your Electronic Speed Control features a reverse function, the Anti-Lock Braking function will not operate properly.

! The Anti-Lock Braking function operates only when the Throttle Trigger is moved from Neutral to the Brake Side. Set the hardest Braking you can obtain from your Model by carefully setting the Anti-Lock Braking function Right before the tires fully lock up but do not slip and lose traction. Be aware that using the Anti-Lock Brake function will never result in your Model losing traction under Braking. It only improves Braking under less than ideal conditions.

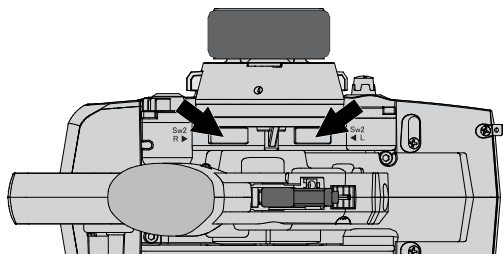
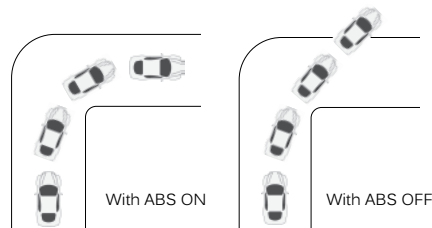

In the default configuration, Push-Button Switch Sw2 controls the Anti-Lock Braking Function. Pressing and HOLDING the switch will turn Anti-Lock Braking ON and releasing the switch will turn Anti-Lock Braking OFF.

! If desired, you can change the behavior of the switch from PUSH (default) to TOGGLE. For more information, see the *Changing the Switch Mode* section on page 34.

! Anti-Lock Braking Programming Values can be changed while you're driving by Assigning these functions to a Trim Switch, the Auxiliary Dial or the Auxiliary Lever. For more information, see the *ASSIGN Menu* section on pages 33 ~ 38.

! The diagram at Right illustrates the relationship between the Point, Lag, Release, Hold and Stroke functions, all of which can be programmed separately to suit your specific Car Type, track conditions and Anti-Lock Braking behavior.

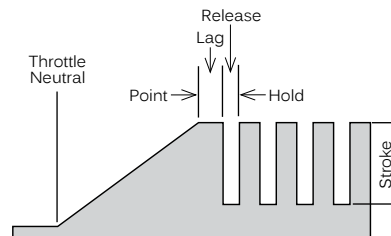

Changing the Stroke Percentage Value:

The Stroke percentage value determines the amount of Brake that's applied automatically when the Anti-Lock Braking function is turned ON.

! A Stroke percentage value of 1% or greater must be programmed for the Anti-Lock Braking function to be turned ON. If a Stroke value of OFF is chosen, the Anti-Lock Braking function cannot be turned ON.

1) From within the RACING menu, scroll UP or DOWN to highlight the ALB menu.

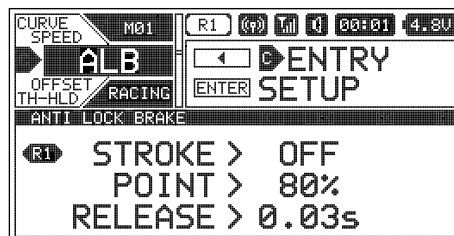

2) Press the ENTER key to open the ALB menu. STROKE > OFF will be highlighted.

3) Press the ENTER key, then scroll UP or DOWN to choose the desired Stroke percentage value. Increasing the Stroke percentage value will Increase Throttle servo travel in the Brake direction and Decreasing the Stroke percentage value will Decrease Throttle servo travel in the Brake direction.

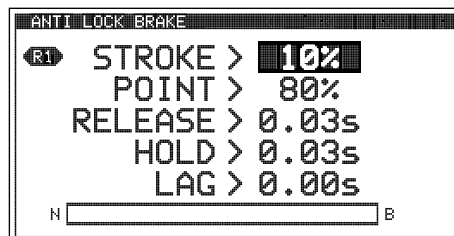

STROKE setting range is OFF to 100%. The default setting is OFF.

ALB MENU (ANTI-LOCK BRAKING)

RACING

Changing the Point Percentage Value:

The Point percentage value determines the position along the length of Brake Side servo travel that the Anti-Lock Braking function Activates at when turned ON. For example, if set to 80%, you will have Normal Braking from the Throttle Neutral Point to 79% of servo travel. At 80% of servo travel and beyond, the Anti-Lock Braking function will Activate when turned ON.

- 1) From within the ALB menu, scroll UP or DOWN to highlight POINT > 80%.
- 2) Press the ENTER key, then scroll UP or DOWN to choose the desired Point percentage value. Increasing the Point percentage value will cause the Anti-Lock Braking function to Activate later and Decreasing the Point percentage value will cause the Anti-Lock Braking function to Activate sooner.

POINT setting range is 5% to 100%. The default setting is 80%.

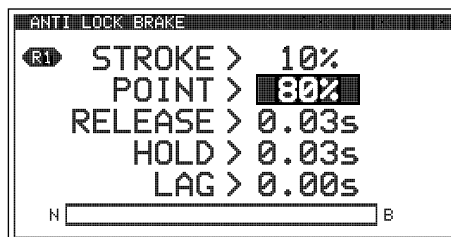

Changing the Release and Hold Values:

The Release and Hold values determine the speed at which the Brake pulsates. By changing the Release and Hold values, you can make the Brake pulsate Faster or Slower. The Release value determines how quickly the Brake moves from the Point setting to the Stroke setting and the Hold value determines how quickly the Brake moves from the Stroke setting back to the Point setting.

! We recommend using equal Release and Hold values, although different values can be used to fine-tune how the Brake pulsates. Using Lower values make the Brake pulsate Faster and using Higher values make the Brake pulsate Slower.

- 1) From within the ALB menu, scroll UP or DOWN to highlight RELEASE > 0.03s.
- 2) Press the ENTER key, then scroll UP or DOWN to choose the desired Release value in Seconds. Increasing the Release value will cause the Brake to move from the Point setting to the Stroke setting Slower and Decreasing the Release value will cause the Brake to move from the Point setting to the Stroke setting Faster.

RELEASE setting range is 0.01s to 1.00s. The default setting is 0.03s.

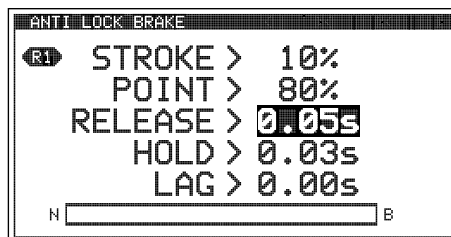

- 3) From within the ALB menu, scroll UP or DOWN to highlight HOLD > 0.03s.
- 4) Press the ENTER key, then scroll UP or DOWN to choose the desired Hold value in Seconds. Increasing the Hold value will cause the Brake to move from the Stroke setting back to the Point setting Slower and Decreasing the Hold value will cause the Brake to move from the Stroke setting back to the Point setting Faster.

HOLD setting range is 0.01s to 1.00s. The default setting is 0.03s.

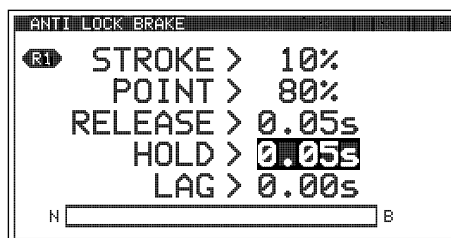

Changing the Lag Value:

The Lag value determines the amount of Delay before the Anti-Lock Braking function Activates after reaching the Point setting.

- 1) From within the ALB menu, scroll UP or DOWN to highlight LAG > 0.00s.
- 2) Press the ENTER key, then scroll UP or DOWN to choose the desired Lag value in Seconds. Increasing the Lag value increases the Delay time to Activate the Anti-Lock Braking function after reaching the Point setting and Decreasing the Lag value decreases the Delay time to Activate the Anti-Lock Braking function after reaching the Point setting.

LAG setting range is 0.00s to 1.00s. The default setting is 0.00s.

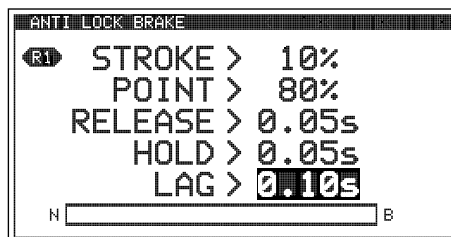

OFFSET MENU (THROTTLE OFFSET)

RACING

The Throttle Offset function allows you to shift the Neutral Point of the Throttle servo to a fixed position, either toward the High Side or the Brake Side, while still allowing you full control of the Throttle. For example, if you're driving a glow- or gas-powered Model, you can use the Throttle Offset function to raise the engine idle for starting or you can program the Throttle Offset function to Increase the engine to a steady idle while you're refueling during a race. If your Model features a separate Brake servo, a Brake Lock function is featured that can be programmed to apply Brake while the Throttle is increased to keep your Model from moving.

! The Throttle Offset function shifts the Neutral Point of the Throttle servo without affecting the High Side or Brake Side End Points. This allows you to have full control over the Throttle even when the Throttle Offset function is turned ON.

OFFSET MENU (THROTTLE OFFSET)

RACING

When the Throttle Offset function is turned ON, [OFFST] ON will be momentarily displayed in a pop-up window, LED1 will flash and an Audible Alarm will sound until the Throttle Offset function is turned OFF.

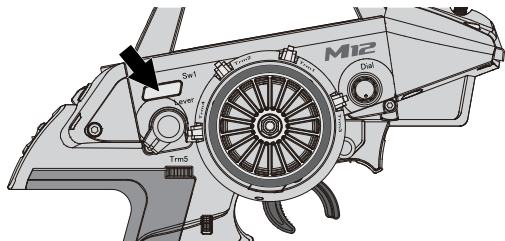

In the default configuration, Push-Button Switch Sw1 turns the Throttle Offset function ON and OFF.

! Throttle Offset Programming Values can be changed while you're driving by Assigning these functions to a Trim Switch, the Auxiliary Dial or the Auxiliary Lever. For more information, see the *ASSIGN Menu* section on pages 33 ~ 38.

Changing the Position Percentage Value:

- 1) From within the RACING menu, scroll UP or DOWN to highlight the OFFSET menu.
- 2) Press the ENTER key to open the OFFSET menu. OFFSET > OFF will be highlighted.
- 3) Scroll UP or DOWN to highlight POSITION > 0%.
- 4) Press the ENTER key, then scroll UP or DOWN to choose the desired High Side (H) or Brake Side (B) Position percentage value. The Position percentage value determines the position the Throttle servo Neutral Point will shift to when the Throttle Offset function is turned ON.

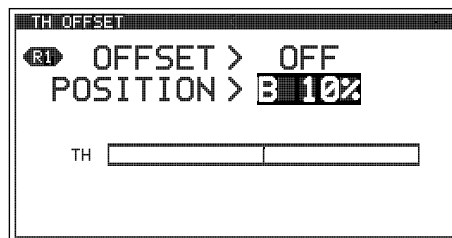
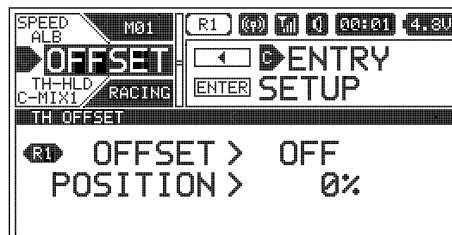

POSITION setting range is H100% to B100%. The default setting is 0%.

Turning the Throttle Offset Function ON and OFF:

- 1) From within the OFFSET menu, scroll UP or DOWN to highlight OFFSET > OFF.
- 2) Press the ENTER key, then scroll UP or DOWN to choose the desired Offset value, either ON or OFF.

OFFSET setting range is ON and OFF. The default setting is OFF.



! Remember, the Throttle Offset function can be turned ON and OFF using Push-Button Switch Sw1 without needing to access the OFFSET menu.

Changing the Brake Lock Percentage Value:

When Car Type II, III, IV, VI or VII is Selected, the Brake Lock function can be programmed to apply Brake to keep your Model from moving while the Throttle Offset Position is increased. If your Car Type features two separate Brake channels, such as Car Type IV, the Brake Lock function percentage value will affect both Brake channels equally.

- 1) From within the OFFSET menu, scroll UP or DOWN to highlight BR-LOCK > OFF.
- 2) Press the ENTER key, then scroll UP or DOWN to choose the desired Brake Lock percentage value. The Brake Lock percentage value determines the position your separate Brake servo (or servos) will shift to when the Throttle Offset function is turned ON.

BR-LOCK setting range is OFF and 0% to 100%. The default setting is OFF.

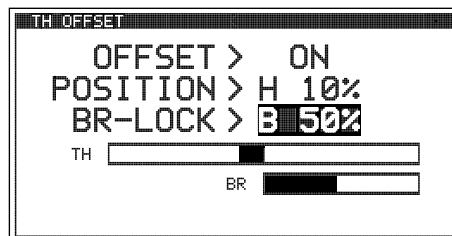

BR-MIX MENU (DUAL BRAKE MIXING)

RACING

The Brake Mixing function allows you change the Brake Bias between the Front and Rear Brakes and is used primarily with 1:5th scale gas-powered Models that use separate Brake servos, although one of the separate Brake servos can be the Brake Side of the Throttle servo, such as when Car Type III is Selected. The Brake Mixing function slows the transit speed of one or both Brake servos, which not only allows to slow down the Braking action, but also allows you to set a Delay between them, which results in you being able to change the Brake Bias.

⚠ Brake Delay Programming Values can be changed while you're driving by Assigning the these functions to a Trim Switch or the Auxiliary Dial. For more information, see the *ASSIGN Menu* section on pages 33 ~ 38.

⚠ The Brake Mixing function is available only when either Car Type III, IV or VII is Selected.

Changing the Brake Delay Percentage Value:

1) From within the RACING menu, scroll UP or DOWN to highlight the BR-MIX menu.

2) Press the ENTER key to open the BR-MIX menu. BR-DELAY > 0% will be highlighted.

3) Scroll UP or DOWN to highlight the Brake Delay percentage value you would like to change, either BR-DELAY or BR2-DELAY.

⚠ Which Brake Delay percentage value affects the Front or Rear Brake servo depends on how your Brake servos are plugged into the receiver and will vary.

4) Press the ENTER key, then scroll UP or DOWN to choose the desired Brake Delay percentage value. Increasing the percentage value will slow the transit speed of that Brake servo.

5) Press the ENTER key, then repeat steps 3 and 4 to change the other Brake Delay percentage value, if desired. The larger the difference between the two Brake Delay percentage values, the greater the Brake Bias.

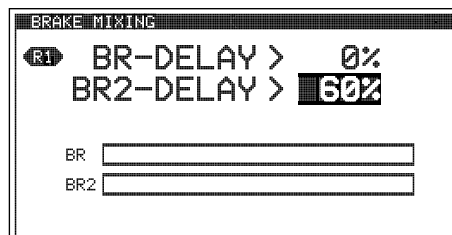
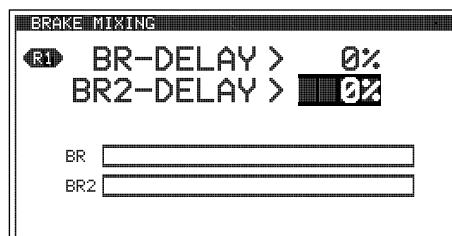
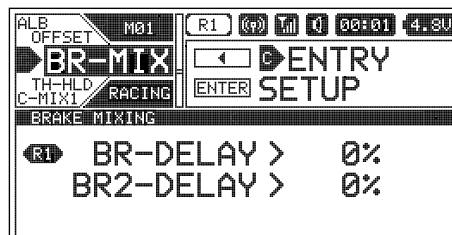

BR-DELAY and BR2-DELAY setting range is 0% to 100%. The default setting for both channels is 0%.

⚠ Setting both Brake Delay percentage values to the same percentage value will result in both Brake servos moving at the same speed. This allows you slow down the Braking action if that is desired. Using different percentage values will result in Brake Bias. You may find that you will need to use a larger percentage value to make a noticeable difference in Brake Bias.

TH-HLD MENU (THROTTLE HOLD)

RACING

The Throttle Hold function moves the Throttle servo to a fixed position, either toward the High Side or the Brake Side, and is used primarily with glow- or gas-powered Models. For example, if you're driving a glow- or gas-powered boat, you can use the Throttle Hold function to stop your engine with only the press of a button. This feature is often referred to as 'Engine Cut'. Alternately, you can use the Throttle Hold function to increase the engine to a steady idle while you're refueling during a race. This feature is often referred to as 'Idle Up'. If your Model features a separate Brake servo, a Brake ON/OFF function is featured that will allow you to lock out the Brake servo (ON) or allow you control of the Brake servo (OFF) while the Throttle Hold function is turned ON.

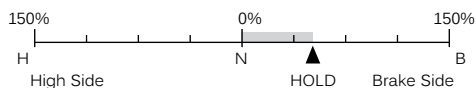

The Throttle Hold function moves the Throttle servo to a fixed position, either toward the High Side or the Brake Side. When the Throttle Hold function is turned ON, you will NOT have control of the Throttle. If your Model has a separate Brake servo and you set the Brake ON/OFF function to OFF, you will still have control over your Model's Brake. To regain Throttle control, you must turn the Throttle Hold function OFF.

WARNING: The Throttle Hold percentage value can be set Higher than your Throttle High Side and Throttle Brake Side End Points. To avoid damage to your Model, we don't suggest programming a Throttle Hold percentage value that exceeds your Throttle High Side or Throttle Brake Side End Points.

TH-HLD MENU (THROTTLE HOLD)

RACING

! So that the Throttle Hold function can be turned ON and OFF while you're driving, it must first be Assigned to a Push-Button Switch. For more information, see the *Push-Button Switch Assignments* section on pages 33 ~ 34. When turned ON and OFF, [TH-HOLD] ACT or [TH-HOLD] INH will be displayed momentarily in a pop-up window.

! The Throttle Hold percentage value can be changed while you're driving by Assigning the Hold function to a Trim Switch or the Auxiliary Dial. For more information, see the *ASSIGN Menu* section on pages 33 ~ 38.

Changing the Hold Percentage Value:

- 1) From within the RACING menu, scroll UP or DOWN to highlight the TH-HLD menu.
- 2) Press the ENTER key to open the TH-HLD menu. HOLD > 0% will be highlighted.
- 3) Press the ENTER key, then scroll UP or DOWN to choose the desired Hold percentage value. The Hold percentage value determines the position the Throttle servo will move to when the Throttle Hold function is turned ON. Choosing a Positive Hold percentage value will move the Throttle servo toward the High Side and choosing a Negative Hold percentage value will move the Throttle Servo toward the Brake Side.

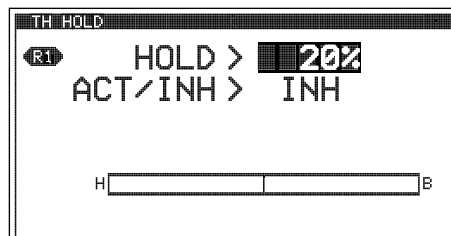
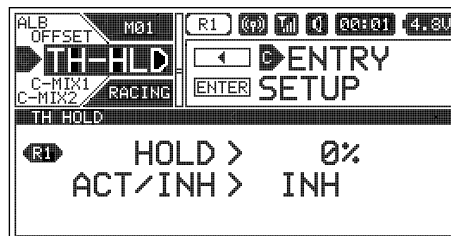

HOLD setting range is 150% to -150%. The default setting is 0%.

! Keep in mind that the Throttle Hold percentage value can be set Higher than your Throttle High Side and Throttle Brake Side End Points. To avoid damage to your Model, we don't suggest programming a Throttle Hold percentage value that exceeds your Throttle High Side or Throttle Brake Side End Points.

Turning the Throttle Hold Function ON and OFF:

- 1) From within the TH-HLD menu, scroll UP or DOWN to highlight ACT/INH > INH.
- 2) Press the ENTER key, then scroll UP or DOWN to choose the desired ACT/INH setting, either ACT (Active ON) or INH (Inhibited OFF).

ACT/INH setting range is ACT and INH. The default setting is INH.

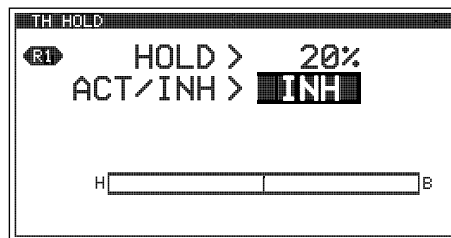

! We suggest Assigning the Throttle Hold function to a Push-Button Switch so that you can turn it ON and OFF without needing to access the TH-HLD menu. See the notation at the top of the page. In addition, ON and OFF behavior will differ based on the ACT/INH setting you choose. We recommend using the INH setting. With this setting, the Throttle Hold function will always be OFF until you turn it ON. If you choose ACT, the Throttle Hold function will always be ON until you turn it OFF.

Changing the Brake Lock-Out Value:

When Car Type II, III, IV, VI or VII is Selected, the Brake Lock-Out function can be programmed, which gives you the option to lock out the Brake servo(s) or retain control of the Brake servo(s). This gives you the option of controlling your separate Brake servo(s) to keep your Model from moving, even when your engine's idle Increases when the Throttle Hold function is turned ON. If your Car Type features two separate Brake channels, such as Car Type IV, the Brake Lock-Out function will affect both Brake channels equally.

- 1) From within the TH-HLD menu, scroll UP or DOWN to highlight BR > ON.
- 2) Press the ENTER key, then scroll UP or DOWN to choose the desired Brake value, either ON or OFF. When set to ON, your separate Brake servo(s) will be locked out along with the Throttle servo when the Throttle Hold function is turned ON. When set to OFF, you will retain control of your separate Brake servo(s) when the Throttle Hold function is turned ON.

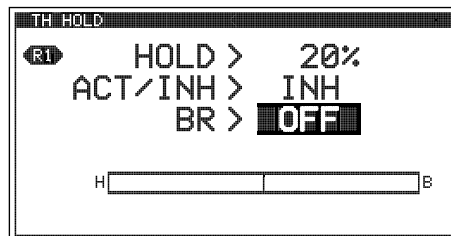

BR setting range is ON and OFF. The default setting is ON.

C-MIX1 AND C-MIX2 MENU (COMPENSATION MIXING 1 AND COMPENSATION MIXING 2) RACING

The Compensation Mixing function is used to create your own custom Mixes that allow you to control any number of desired functions in different combinations. For example, you can use the Compensation Mixing function to deploy an air-Brake when you apply Brake or raise a wing as you Increase Throttle. You could use the Compensation Mixing function to counter-act torque steer by applying a very slight amount of Steering in one direction when you Increase Throttle. The possibilities are nearly endless.

Compensation Mixes are composed of a Master channel and a Slave channel. The Master channel always controls the Slave channel. Any of the four channels can be programmed as a Master or a Slave. The same channel can even be programmed as both a Master and a Slave. Two Rate percentage values can be programmed to determine the direction and amount of travel that the Slave channel servo moves in relation to the Master channel servo. In addition, an Offset function is featured that allows you to shift the Neutral Point of the Slave channel servo to center the Slave channel servo or to shift the Slave channel servo's Neutral Point to change the starting point of your Mix.

Two Compensation Mixers are available, and each can be turned ON separately or both can be turned ON at the same time. A graph is featured to help visualize the Compensation Mixing changes you make.

⚠ Compensation Mixing Programming Values can be changed while you're driving by Assigning these functions to a Trim Switch, the Auxiliary Dial or the Auxiliary Lever. For more information, see the *ASSIGN Menu* section on pages 33 ~ 38.

⚠ This section covers both the Compensation Mixing 1 and Compensation Mixing 2 menus, since programming each of them is exactly the same. Choose either the C-MIX1 or the C-MIX2 menu depending on which of the two Compensation Mixers you want to program.

⚠ The Compensation Mixing Rate 1 and Rate 2 percentage values determine whether the Compensation Mixer(s) are Active (turned ON) or Inhibited (turned OFF). When no Rate percentage values are programmed, the Compensation Mixer(s) will be Inhibited and when a Rate percentage value is programmed, the Compensation Mixer(s) will become Active. To turn the Compensation Mixer(s) ON and OFF while you're driving, you will need to program the Compensation Mixer(s) with a Rate value to one Racing Mode (turned ON), then switch to a Racing Mode without any Compensation Mixer Rate values programmed (turned OFF).

Compensation Mixing 1 Steering to Throttle Mix Example:

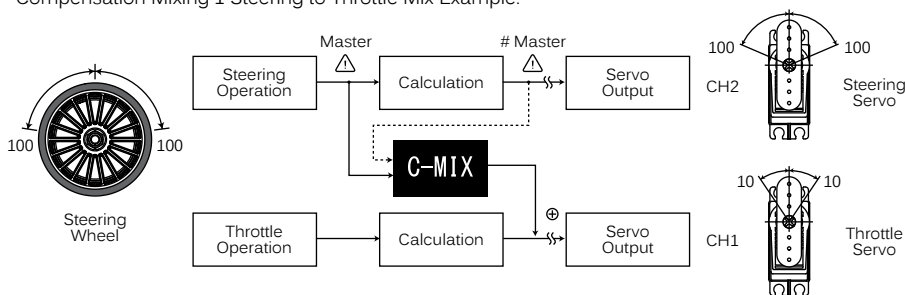

In the example above, Compensation Mixing 1 is programmed as follows: MASTER > ST, SLAVE > TH, RATE1 > 10%, RATE2 > 10% and OFFSET > 0. When you move the Steering Wheel 100% in each direction, the Steering servo will travel 100% in each direction and at the same time, the Throttle servo will travel 10% in each direction.

⚠ Compensation Mixing Rate percentage values are a Ratio of Slave channel servo travel to Master channel servo travel. For example, if both Rate percentage values are set to 10%, the Throttle servo will travel 1:10th the amount as the Steering servo travels in both directions. Compensation Mixes are Linear throughout the entire range of travel. If a Rate value of 0% is chosen, the Slave servo will not move in that direction.

Available channels vary based on the Car Type currently chosen. The table below shows the available channels for each Car Type. See the table on the next page that describes the Channel Output Data of each of these channels. Channels denoted with a Pound sign (#) can be Selected only as Master channels. All other channels can be Selected as Master or Slave channels.

TYPE CH	TYP I	TYP II	TYP III	TYP IV	TYP V	TYP VI	TYP VII	TYP VIII	TYP IX	TYP X
CH 1	ST	ST	ST	ST	ST	ST	ST	ST	ST	ST
	#ST	#ST	#ST	#ST	#L-ST	#L-ST	#L-ST	#F/ST	#ST	#F/ST
CH 2	TH	TH	TH	TH	TH	TH	TH	TH	TH	TH
	#TH	#TH	#TH	#TH	#TH	#TH	#TH	#TH	#F/TH	#F/TH
CH 3	AUX1	BR	BR2	BR	----	----	----	----	----	----
	#AUX1	#BR	#BR2	#BR	#R-ST	#R-ST	#R-ST	#R/ST	#R/TH	#R/ST
CH 4	AUX2	AUX	AUX	BR2	AUX	BR	BR2	AUX	AUX	----
	#AUX2	#AUX	#AUX	#BR2	#AUX	#BR	#BR2	#AUX	#AUX	#R/TH

ST=Steering • TH=Throttle • BR=Brake • BR2=Brake 2 • R-ST=Right • L-ST=Left • R/ST or R/TH=Rear • F/ST or F/TH=Front

The table below shows the Channel Output Data of each Master channel. This is the Data that will be duplicated on the Slave channel when Compensation Mixing is turned ON. Master channels denoted with a Pound sign (#) indicate that not only is the Raw Output Data duplicated on the Slave channel, but the other functions described are also duplicated on the Slave channel. For example, if MASTER > #ST is Selected, any Master channel Steering Trim, End Point Adjustments, Dual Rate, Curve and Speed values, plus the Raw Output Data will be duplicated on the Slave channel. Alternately, if you Select MASTER > ST, only Curve and Speed values, plus the Raw Output Data will be duplicated on the Slave channel.

CH.	CH. NAME	CH. OUTPUT DATA
ST	Steering	Raw Output Data, Plus CURVE and SPEED
#ST	# Steering	Raw Output Data, Plus TRIM, EPA, D/R, CURVE and SPEED
#L-ST	# Left Steering	Raw Output Data, Plus TRIM, EPA, D/R, CURVE and SPEED
#F/ST	# Front Steering	Raw Output Data, Plus TRIM, EPA, D/R, CURVE and SPEED
TH	Throttle	Raw Output Data, Plus CURVE, SPEED and BR-MIX
#TH	# Throttle	Raw Output Data, Plus TRIM, EPA, D/R, CURVE, SPEED, ALB, OFFSET, BR-MIX and TH-HOLD
#F/TH	# Front Throttle	Raw Output Data, Plus TRIM, EPA, D/R, CURVE, SPEED, ALB, OFFSET, BR-MIX and TH-HOLD
AUX1	Auxiliary 1	Raw Output Data, Plus CURVE and SPEED (Referred to as AUX in some Car Types)
BR	Brake	Raw Output Data, Plus CURVE, SPEED and BR-MIX
BR2	Brake 2	Raw Output Data, Plus CURVE, SPEED and BR-MIX
#AUX1	# Auxiliary 1	Raw Output Data, Plus TRIM, EPA, D/R, CURVE and SPEED
#BR	# Brake	Raw Output Data, Plus TRIM, EPA, D/R, CURVE, SPEED, ALB, OFFSET, BR-MIX and TH-HOLD
#BR2	# Brake 2	Raw Output Data, Plus TRIM, EPA, D/R, CURVE, SPEED, ALB, OFFSET, BR-MIX and TH-HOLD
#R-ST	# Right Steering	Raw Output Data, Plus TRIM, EPA, D/R, CURVE and SPEED
#R/ST	# Rear Steering	Raw Output Data, Plus TRIM, EPA, D/R, CURVE and SPEED
#R/TH	# Rear Throttle	Raw Output Data, Plus TRIM, EPA, D/R, CURVE, SPEED, ALB, OFFSET, BR-MIX and TH-HOLD
AUX2	Auxiliary 2	Raw Output Data, Plus CURVE and SPEED
#AUX2	# Auxiliary 2	Raw Output Data, Plus TRIM, EPA, D/R, CURVE and SPEED

Changing the Master Channel:

- From within the RACING menu, scroll UP or DOWN to highlight either the C-MIX1 or the C-MIX2 menu depending on which Compensation Mixer you want to program. In this section, we show programming Compensation Mixer 1.

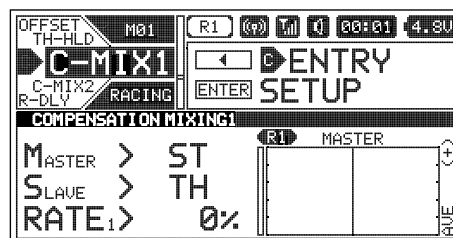

- Press the ENTER key to open the C-MIX1 menu. MASTER > ST will be highlighted.
- Press the ENTER key, then scroll UP or DOWN to choose the desired Master channel.

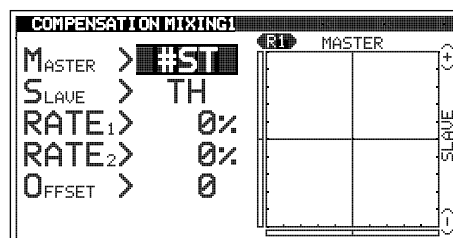

Changing the Slave Channel:

- From within the C-MIX1 menu, scroll UP or DOWN to highlight SLAVE > TH.
- Press the ENTER key, then scroll UP or DOWN to choose the desired Slave channel.

 Channels denoted with a Pound (#) sign cannot be chosen as Slaved channels.

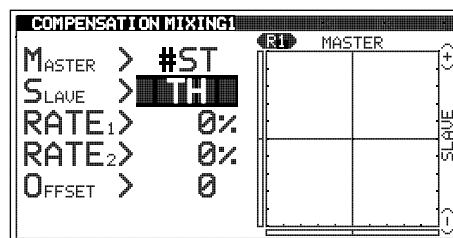

Changing the Rate 1 and Rate 2 Percentage Values:

The Rate percentage values determine the amount and direction of Slave channel servo travel. Use a Positive or Negative percentage value to change the amount and direction of Slave channel servo travel. The Right side of the graph indicates Rate 1 percentage values and the Left side of the graph indicates Rate 2 percentage values.

- 1) From within the C-MIX1 menu, scroll UP or DOWN to highlight either RATE1 > 0% or RATE2 > 0%.
- 2) Press the ENTER key, then scroll UP or DOWN to choose the desired Rate 1 or Rate 2 percentage value.

RATE1 and RATE2 setting range is -150% to 150% . The default setting for both Rate percentage values is 0%.

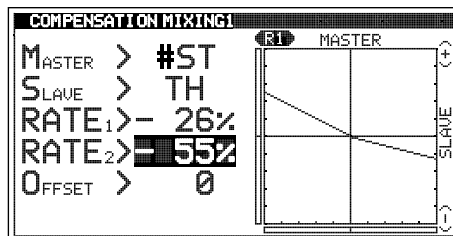

WARNING: The Rate percentage values can be set Higher than your Slave channel servo End Points (up to 150% in either direction). To avoid damage to your Model, we don't suggest programming Rate percentage values that exceed your Slave channel servo End Points.

! When the Master and Slave are set to the same channel, Mixing takes place within the channel itself. This causes servo travel to Increase for Positive Rate percentage values and servo travel to Decrease for Negative Rate percentage values.

Changing the Channel Offset Value:

The Offset function allows you to shift the Neutral Point of the Slave channel servo to compensate for any Master channel servo Trim or to change the starting point of your Mix.

- 1) With the Master channel control centered, check the Master Travel Indicator at the bottom of the graph to see if any Master channel Trim is displayed.

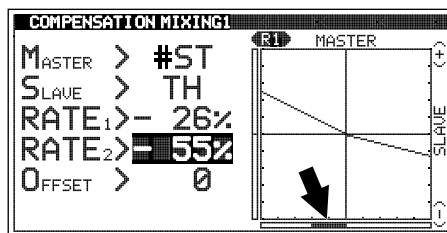

- 2) From within the C-MIX1 menu, scroll UP or DOWN to highlight OFFSET > 0.
- 3) Press the ENTER key, then scroll UP or DOWN to choose the desired Slave channel Offset value. Increase or Decrease the Offset value to move the vertical axis in the desired direction.

OFFSET setting range is -150 to 150 . The default setting is 0%.

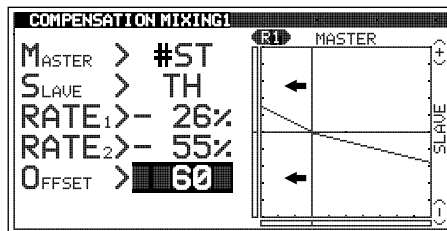

! Adjust the Offset value to move the vertical axis and erase the Trim deviation from the Master Travel Indicator. If there is no Trim deviation displayed, you can simply position the starting point of your Mix by choosing the desired Offset value.

When the Auxiliary Dial is programmed to control Auxiliary 1 or Auxiliary 2 and you choose AUX1 or AUX 2 (or #AUX1 or #AUX2) to be the Master channel, by setting the Offset value to 100 or -100, the Auxiliary Dial can control the full range of Mixing travel in one direction, instead of half the Mixing travel in one direction and half the Mixing travel in the other direction. This is useful if you want the full range of Mixing travel in only one direction.

! Setting the Offset value to a value greater than -100 or 100 will shift the Neutral Point of the Slave channel servo beyond the operation range of the Auxiliary Dial and is not recommended.

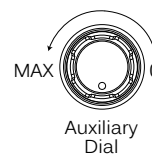

Following the example in the diagram at Right, set the Rate 1 percentage value to 0% and the Rate 2 percentage value to -50%, then set the Offset value to -100. The full range of Mixing travel can now be adjusted in one direction when turning the Auxiliary Dial counter-clockwise.

! This same technique can also be used if you're using the Auxiliary Lever to control either Auxiliary 1 or Auxiliary 2.

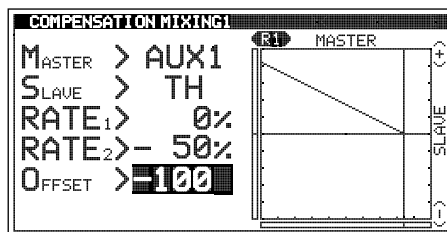

ACKER MENU (ACKERMAN ANGLE ADJUSTMENT)

RACING

The Ackerman function allows you to change the Steering angle of the Front tires independently to prevent the tires from slipping during turns. Being able to change the Ackerman Angle can help improve your Model's high-speed cornering and improve tire wear. In general, your Model will corner better if the inner tire turns in at a sharper angle than the outer tire. The Ackerman function allows you reduce the turn-in angle of the outer tire, which increases the turn-in angle of the inner tire relative to it.

! Ackerman Programming Values can be changed while you're driving by Assigning these functions to a Trim Switch, the Auxiliary Dial or the Auxiliary Lever. For more information, see the *ASSIGN Menu* section on pages 33 ~ 38.

! The Ackerman function is available only when either Car Type V, VI or VII is Selected.

Changing the Ackerman Angle Percentage Values:

- 1) From within the RACING menu, scroll UP or DOWN to highlight the ACKER menu.
- 2) Press the ENTER key to open the ACKER menu. LEFT-ST L > 100% will be highlighted.
- 3) Scroll UP or DOWN to highlight the Ackerman Angle percentage value you would like change. Choose from either LEFT-ST (Left Steering) Left or Right, or RIGHT-ST (Right Steering) Left or Right.
- 4) Press the ENTER key, then scroll UP or DOWN to choose the desired Ackerman Angle percentage value. Reducing the Ackerman Angle percentage value will reduce the amount of control throw in that the direction for that specific servo.
- 5) Press the ENTER key, then repeat steps 3 and 4 to change any other desired Ackerman Angle percentage values.

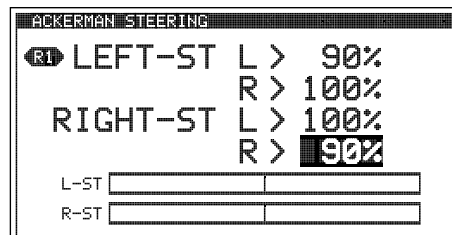
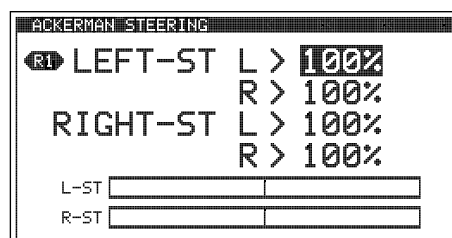
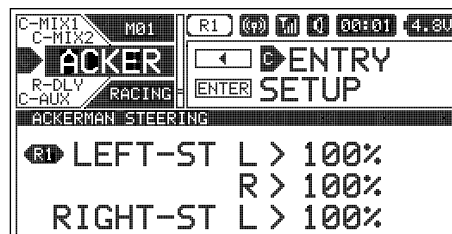

LEFT-ST L and R and RIGHT-ST L and R setting range is 0% to 100%. The default setting for both channels is 100%.

! In general, you want the inner tire to turn in more than the outer tire when turning both Right and Left (unless you're running on an oval track). In order to achieve this, you will need to reduce the control throw of the outer tire in both the Right and Left directions by reducing those Ackerman Angle percentage values. The percentage values you will need to change will vary depending on several factors, so you'll need to experiment to find the ones you need to reduce to achieve the desired results.

R-DLY MENU (RACING MODE DELAY)

RACING

The Racing Mode Delay function allows you to program a Delay for each of the four channels to help prevent drastic changes in channel function settings when switching between Racing Modes. For example, you might have one Dual Rate setting for Racing Mode 1 and a different Dual Rate setting for Racing Mode 2. The Racing Mode Delay function allows you to program a Delay in the Steering channel so that the transition to the different Dual Rates when you switch back and forth between Racing Modes is smooth and less noticeable.

! Racing Mode Delay Programming Values can be changed while you're driving by Assigning these functions to a Trim Switch, the Auxiliary Dial or the Auxiliary Lever. For more information, see the *ASSIGN Menu* section on pages 33 ~ 38.

Changing the Racing Mode Delay Percentage Values:

- 1) From within the RACING menu, scroll UP or DOWN to highlight the R-DLY menu.

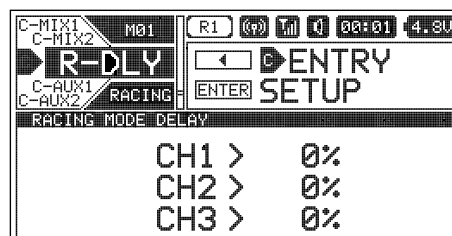

R-DLY MENU (RACING MODE DELAY)

RACING

Changing the Racing Mode Delay Percentage Values, Continued....

2) Press the ENTER key to open the R-DLY menu. CH1 > 0% will be highlighted.

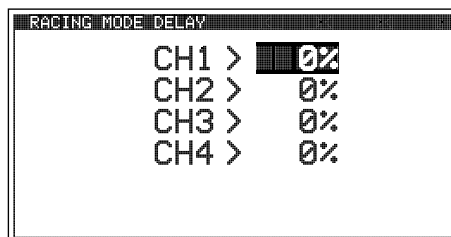

3) Scroll UP or DOWN to highlight the desired channel you want to change the Racing Mode Delay percentage value for.

4) Press the ENTER key, then scroll UP or DOWN to choose the desired Racing Mode Delay Percentage value. Increasing the Racing Mode Delay Percentage value will increase the Delay when switching between Racing Modes.

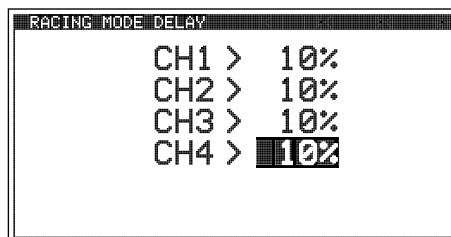

5) Press the ENTER key, then repeat steps 3 and 4 to change any other desired Racing Mode Delay percentage values.

CH1, CH2, CH3 and CH4 setting range is 0% to 100%. The default setting for all channels is 0%.

! The Racing Mode Delay function changes the speed of the servos as they move to their new positions when you switch between Racing Modes. The Higher the Racing Mode Delay percentage value, the Slower the servos will transition to their new positions when you switch Racing Modes, but the smoother the transition will be. You will need to experiment with different percentage values to find a happy medium of smooth, yet quick transition. When the Racing Mode Delay Percentage value is set to 0%, there will be no Delay and the transition between Racing Modes will be immediate.

CODEAX1 AND CODEAX2 MENU (CODE AUXILIARY 1 AND CODE AUXILIARY 2)

SETUP

The Code Auxiliary function is used with future connected products, such as an ESC, whose Programming Parameters can be changed directly via the transmitter. For example, you might be able to change the connected ESC's Driving Modes directly using the Auxiliary Dial to suit different conditions while you're driving.

! Code Auxiliary Programming Values can be changed while you're driving by Assigning these functions to a Trim Switch, the Auxiliary Dial or the Auxiliary Lever. For more information, see the *ASSIGN Menu* section on pages 33 ~ 38.

! This section covers both the Code Auxiliary 1 and Code Auxiliary 2 menus, since programming each of them is exactly the same. Choose either the CODEAX1 or the CODEAX2 menu depending on which of the two Code Auxiliary functions you want to program.

Changing the Code Auxiliary Values:

1) From within the RACING menu, scroll UP or DOWN to highlight either the CODEAX1 or the CODEAX2 menu depending on which Code Auxiliary function you want to program. In this section, we show programming Code Auxiliary 1.

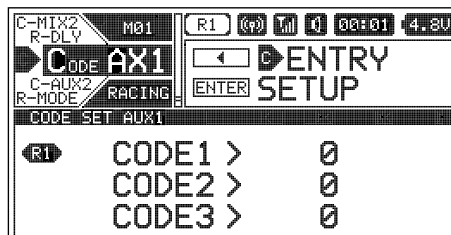

2) Press the ENTER key to open the CODEAX1 menu. CODE1 > 0 will be highlighted.

3) Scroll UP or DOWN to highlight the desired Code Auxiliary value you would like to change.

4) Press the ENTER key, then scroll UP or DOWN to choose the desired Code Auxiliary value.

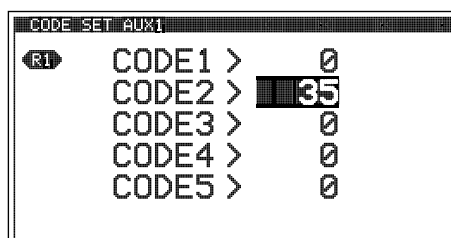

5) Press the ENTER key again, then repeat steps 3 and 4 to change any other desired Code Auxiliary values.

CODE1, CODE2, CODE3, CODE4 and CODE5 setting range is -100 to 100. The default setting for all Code Auxiliary functions is 0 (OFF).

CUSTOM MENU OVERVIEW

CUSTOM

To access the CUSTOM menu, turn the transmitter ON, then press the SELECT switch to highlight the CUSTOM menu.

Press the ENTER key to open the CUSTOM menu. The CUSTOM menu features the CH-SET menu and any other favorite Programming Menus you've added.

Scroll UP or DOWN to highlight the desired Programming Menu, then press the ENTER key to open that menu.

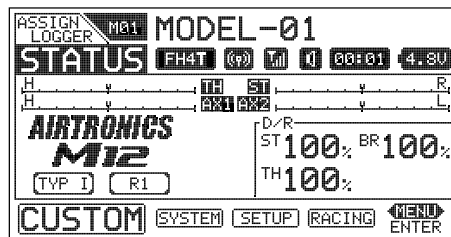

The following Programming Menus are available within the CUSTOM menu:

MENU	MENU DESCRIPTION	PAGE #
CH-SET	Adjust Programming Values for Common Functions in One Convenient Location	PG. 94

CH-SET MENU (CHANNEL SET MENU)

CUSTOM

The CH-SET menu allows you to make a number of common function Programming Value changes to all four channels without the need to enter each of those function's Programming Menus separately. For example, you can make all of your desired Programming Value choices for functions such as End Point Adjustment, Exponential, Curves, Servo Speed, Fail Safe settings and more for each channel, all from within the same menu.

If Racing Mode is turned ON and if you've chosen to program one or more Racing Mode functions separately, a Racing Mode Icon will be displayed next to the function Programming Value to indicate which Racing Mode you're currently programming the function for. For more information, see the *R-MODE Menu* section on pages 75 ~ 76.

This section details how to use the CH-SET menu. For information about programming each of the Programming Menus within the CH-SET menu, refer to the specific Programming Menu sections detailed previously.

Choosing the Channel:

- From within the CUSTOM menu, scroll UP or DOWN to highlight the CH-SET menu.

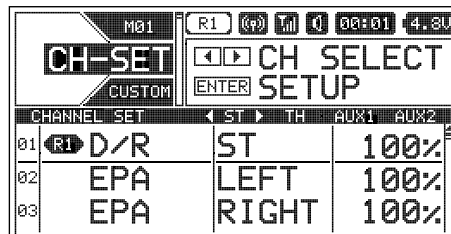

- Press the ENTER key open the CH-SET menu. The < ST > channel will be Selected.

- Press the SELECT switch RIGHT or LEFT to choose the desired channel you would like to change function Programming Values for.

Channels and function Programming Values will vary depending on the current Car Type.

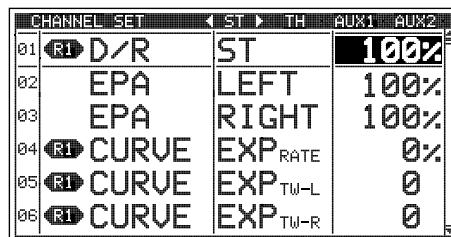

Changing Function Programming Values:

- After selecting the desired channel, scroll UP or DOWN to highlight the function Programming Value you would like to change.
- Press the ENTER key, then scroll UP or DOWN to choose the Selected function Programming Value.
- Press the ENTER key, then repeat steps 1 and 2 to change any other desired function Programming Values.

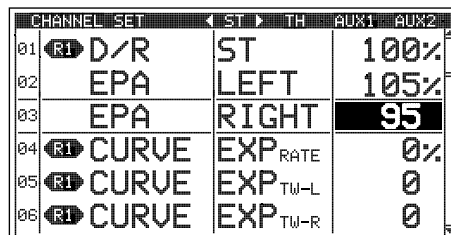

Certain function Programming Values may not be displayed in the CH-SET menu because they haven't been Selected in the specific function's Programming Menu. For example, the CURVE EXP function Programming Value may be displayed in the CH-SET menu, but if you want to change the CURVE ARC function through the CH-SET menu, you will need to first choose the ARC function in the CURVE menu first. The CURVE ARC function Programming Value will then be able to be changed through the CH-SET menu.

Function Programming Values changed from within the CH-SET menu are duplicated in the specific function's Programming Menu and vice-versa.

ADDING AND REMOVING FAVORITE MENUS

CUSTOM

Many Programming Menus can be Added to the CUSTOM menu quickly and easily. This allows you to store and then access your most-used Programming Menus all in one place within the CUSTOM menu.

⚠ Not all Programming Menus can be added to the CUSTOM menu. If a Programming Menu can be added to the CUSTOM menu, 'C' ENTRY will be displayed in the Message Display Window when you highlight the Programming Menu.

Adding Programming Menus to the CUSTOM Menu:

- 1) Highlight the Programming Menu you would like to add to the CUSTOM menu. 'C' ENTRY will be displayed in the Message Display Window.

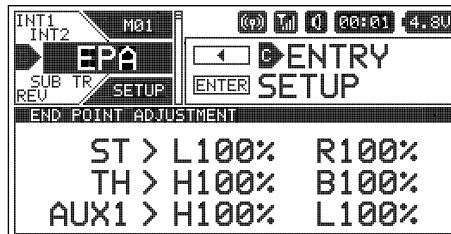

- 2) Press the SELECT switch in the direction of the arrow (LEFT). A 'C' will be displayed in the Pointer next to the Menu Name, indicating the Programming Menu is now added to the CUSTOM menu and CANCEL will now be displayed in the Message Display Window.

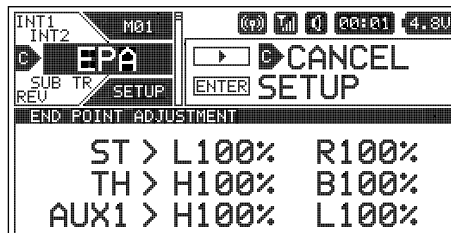

Removing Programming Menus From the CUSTOM Menu:

- 1) Highlight the Programming Menu you would like to remove from the CUSTOM menu. 'C' CANCEL will be displayed in the Message Display Window and a 'C' will be displayed in the Pointer next to the Menu Name, indicating the Programming Menu is part of the CUSTOM menu.

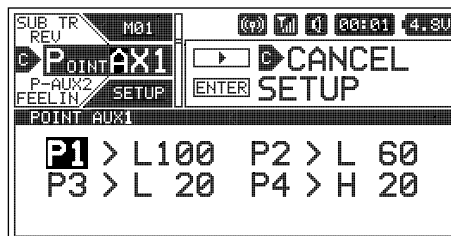

- 2) Press the SELECT switch in the direction of the arrow (RIGHT). The 'C' will be removed from the Pointer next to the Menu Name, indicating the Programming Menu has now been removed from the CUSTOM menu and ENTRY will be displayed in the Message Display Window.

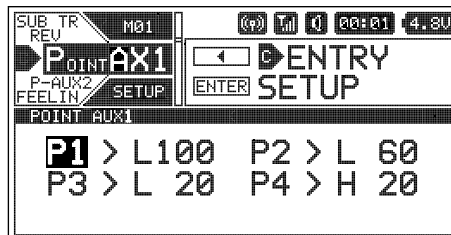

THIS SPACE INTENTIONALLY LEFT BLANK

When used with an Airtronics 2.4GHz FH4T Telemetry-capable surface receiver, such as the RX-461 or RX-462, and up to two Temperature Sensors and an RPM Sensor (all available separately), Telemetry Data, such as RPM or Speed, Temperature, and Receiver Voltage can be viewed on the M12 transmitter's TELEMETRY screen.

This section details connecting the RPM and Temperature Sensors to the RX-461 and/or RX-462 receiver and how to mount those Sensors into your Model. For more information about the specifics of either receiver, refer to the User's Guide included with your receiver.

 For more information about viewing Telemetry Data on the TELEMETRY screen, see the *TELEMETRY Screen Overview* section on pages 22 ~ 23. For more information about choosing Telemetry options, see the *LOG SETUP Menu* section on pages 48 ~ 56.

Overview:

The RX-461 and RX-462 receivers each feature two Temperature Sensor Inputs and one RPM Sensor Input, in addition to the Voltage Sensor built into the receiver. Temperature and RPM Sensors can be installed into your Model to give you Temperature and RPM or Speed feedback in real-time displayed on the transmitter's TELEMETRY screen.

 The range of the Telemetry System is approximately 260 feet (80 meters), although the range can vary based on many environmental factors. Use the Telemetry Signal Indicator to determine the quality of the Telemetry Signal.

Plugging the Telemetry Sensors into the Receiver:

- 1) Carefully pry up and remove the plastic cover from over the Telemetry Sensor Input Ports on the receiver.
- 2) Plug the Telemetry Sensor(s) into their respective Input Ports in the receiver. The Temperature Sensor can be plugged into either the TEMP 1 or the TEMP 2 Input Port and the RPM Sensor is plugged into the RPM Input Port. The Sensor Plugs are indexed so they can be plugged in only one way.

 Make sure to push the Sensor Plugs firmly in place to ensure a good connection. When routing Sensor Wires inside your Model, be careful that they cannot come into contact with any moving parts. The Sensor Wires should be securely mounted and protected against damage. In addition, install the dust covers included with your receiver to prevent dirt and debris from getting into any unused Input Ports.

Mounting the RPM Sensor:

The RPM Sensor uses infrared technology to record RPM data from a rotating part, such as a flywheel or a spur gear. One Black and one White reflective decal is included that is attached to the rotating part so the Sensor Pickup can 'see' it.

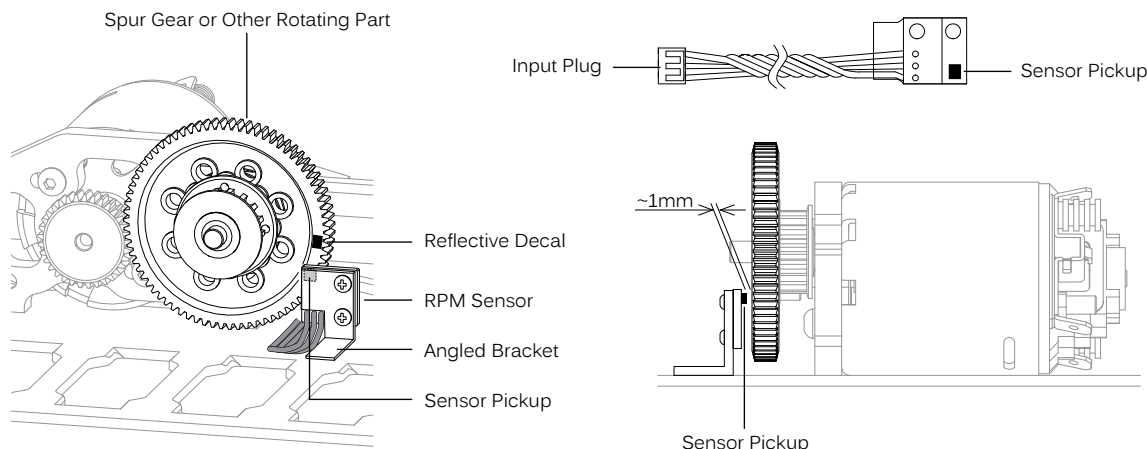

- 1) Mount the RPM Sensor to an aluminum or ABS angled bracket, then mount the bracket to your Model, making sure that it's held securely in place. **For optimal operation, the Sensor Pickup should be positioned approximately 1mm away from the rotating part (flywheel, spur gear, pinion gear etc.)**
- 2) Cut one of the two reflective decals included with the RPM Sensor into an ~2mm diameter and apply it to the rotating part, so that as the part rotates, the reflective decal passes in Front of the Sensor Pickup. If the rotating part is metallic-colored (silver, aluminum, chrome, etc.), use the Black reflective decal and if the rotating part is dark-colored (black, blue or another dark color), use the White reflective decal.

 When installed, it's important that the Sensor Pickup face the rotating part and that the Black or White reflective decal is positioned so that it passes in Front of the Sensor Pickup. It's also important that the reflective decal contrasts with the rotating part it's applied to and that the Sensor Pickup is mounted approximately 1mm away from the rotating part.

 After installing the RPM Sensor and connecting it to your receiver, the RPM Sensor must be calibrated. For more information, see the *RPM and Speed Telemetry Data Display Options* section on pages 48 ~ 50.

TELEMETRY CONNECTIONS AND MOUNTING

REFERENCE

Mounting the Temperature Sensor:

- Secure the Sensor End directly against the part of your engine, motor, battery or other object you want to monitor temperature readings from, using either a nylon cable tie or high-temperature clear tape. For example, to monitor the cylinder head temperature of your glow-powered Model, the best place to secure the Sensor End is where the bottom of the cylinder head meets the top of the engine case. The Sensor End can be held in place using a nylon cable tie wrapped around your engine. To monitor the temperature of your battery pack or electric motor, high-temperature clear tape can be used to secure the Sensor End to the exact spot you want to monitor.

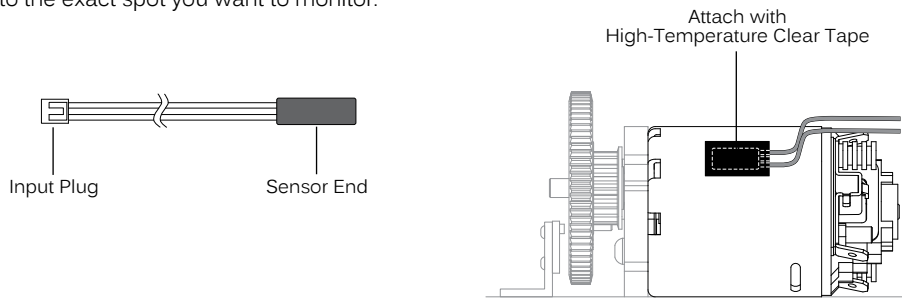

TROUBLESHOOTING GUIDE

REFERENCE

This troubleshooting guide can help you diagnose and solve some of the more common problems that you may encounter with your radio control system.

If you cannot solve the problem using this troubleshooting guide, please contact Airtronics Customer Service using the information in the *Service and Support* section on page 3.

PROBLEM	CAUSE	SOLUTION
Transmitter does not turn ON	Transmitter batteries installed incorrectly	Reinstall batteries, observing correct polarity
	Battery tray not plugged in	Plug in battery tray
	Transmitter batteries are dead	Replace or recharge transmitter batteries
	Damage caused by using incorrect charger or reverse polarity	Contact Airtronics Customer Service
Transmitter will not bind to receiver	Modulation Type incorrect	Change Modulation Type to match receiver
	Too much time elapsed after pressing receiver Bind Button	Quickly press ENTER key in BIND menu after releasing receiver Bind Button
	Attempting to Bind incompatible receiver	Use only Airtronics 2.4GHz FH2, FH3, FH4 or FH4T surface receivers
	Using Electronic Speed control (ESC)	Disconnect ESC and use dry cell battery for Binding procedure, then reconnect ESC after Binding
	Receiver batteries are dead	Replace or recharge receiver batteries
	Using incorrect Binding procedure	Follow Binding procedure carefully
Receiver won't power ON	Receiver batteries are dead	Replace or recharge receiver batteries
	Receiver batteries not installed correctly	Reinstall receiver batteries, observing correct polarity
	Loose switch connection	Double-check all connections including switch
Audible alarm beeps continuously	Low transmitter battery voltage	Replace or recharge transmitter batteries
	Transmitter left ON 10 minutes or more without control input	Move Steering Wheel or Throttle Trigger, or press any key to clear alarm and continue operation
	Transmitter battery voltage too high	Use transmitter battery whose voltage is 9.6 volts or less when fully charged
One or more LEDs flashing	Indicates transmitter status	For more information, see LED Condition Indicators table on page 10.
No key-press, Trim, alarm or alert sounds	Audible tones are Muted	Increase Tone volume in BUZZER menu
Servo movement is slow	Low receiver battery voltage	Replace or recharge receiver batteries
	Control linkages binding	Adjust control linkages to operate smoothly
	Using a negative Servo Speed value	Increase Servo Speed value
Servo does not move when using Trim Switch	Trim is outside of operational range	Center Trim Switches to '0', center the servo horn and control linkages

M12 2.4GHZ FH4T RADIO CONTROL SYSTEM USER'S GUIDE

PROBLEM	CAUSE	SOLUTION
Inadequate transmitting range	Low transmitter battery voltage	Replace or recharge transmitter battery
	Low receiver battery voltage	Replace or recharge receiver batteries
	Receiver antenna not mounted correctly	Mount receiver antenna as recommended
Servo(s) move the wrong direction	Incorrect Servo Reversing setting	Change Servo Reversing setting
Servo Horn(s) not centered	Servo horn not installed correctly	Turn servo horn 180° and reinstall
	Servo Sub-Trim out of adjustment	Adjust Servo Sub-Trim to center servo horn
Control linkage(s) bind	To much servo travel	Decrease servo travel using EPA function
Servo moves too much or not enough when Trim Switch is pressed	Trim Step resolution requires adjustment	Adjust Trim Step resolution
Throttle servo moves to programmed position without input	Receiver battery voltage has reached programmed Receiver Battery Voltage Fail Safe voltage value	Replace or recharge the receiver batteries
Can't program Receiver Battery Voltage Fail Safe	Throttle channel Fail Safe value set to FREE or HOLD	Set Throttle channel Fail Safe to a percentage value
	Using FH2 Receiver	This function is not supported with FH2 receivers
LCD is difficult to read	Transmitter left in direct sunlight too long	Place transmitter in shade
	Contrast setting too high or too low	Readjust contrast setting
Throttle servo pulsates	ABS function is turned ON	This is normal under Braking with ABS function ON
Model veers right or left without control input	Steering out of trim	Use Steering Trim Switch to adjust Steering Trim so model drives straight
Model accelerates without control input	Throttle out of trim	Use Throttle Trim Switch to adjust Throttle Neutral Point
	Throttle Offset function turned ON	Turn Throttle Offset function OFF
	Throttle Hold function turned ON	Turn Throttle Hold function OFF
Model does not react to Throttle	Throttle Hold function turned ON	Turn Throttle Hold function OFF
No Telemetry connection	Telemetry system turned OFF	Turn Telemetry system ON
	Using FH2, FH3 or FH4 receiver	Use FH4T Telemetry receiver
	Out of Telemetry receiving range	Shorten distance between transmitter and receiver
Can't change Racing Modes	Racing Mode Inhibited (turned OFF)	Activate (turn ON) Racing Mode
Can't program RACING menu functions separately for each Racing Mode	SEPARATE value for functions in R-MODE menu set to OFF	Change SEPARATE value in R-MODE menu ON for desired functions
	Not choosing desired Racing Mode first	Choose desired Racing Mode to program function for, then program function
Model seems extremely sensitive to control input	Dual Rate value(s) set too high	Decrease Dual Rate value(s)
	Feeling value set too high	Decrease Feeling value
Transmitter does not control model	Safety Link Number doesn't match Selected Model	Choose correct Model that matches receiver or Bind Model again with correct Safety Link Number
	No RF Signal from transmitter	Transmitter is not turned ON. Only LCD is turned ON using DISPLAY key
	Transmitter in Receiver Mode	Turn DISPLAY OFF, then turn transmitter ON
Servo(s) and/or ESC don't operate at all or operate erratically	Using incorrect Servo Mode setting	Use correct Servo Mode setting based on the type of servos you're using in your Model. Use NOR mode for Throttle channel if using ESC
Direction of travel shown on Servo Monitor is different from control input travel	This is normal	Direction of travel displayed will vary depending on Servo Reversing settings
There is no LCD Backlight	LCD Backlight is turned OFF	Set LCD MODE to Key-On or Always
LCD Backlight keeps turning OFF	LCD MODE is set to Key-On	This is normal to save battery power. Increase TIME value or set LCD MODE to Always
Can't control underscore when changing Model Name or User Name	Cursor is Active in Character Select screen	Press BACK key to re-gain control of underscore
Telemetry Data doesn't record when Lap Timer is Started	Telemetry Data Recording function turned OFF	Turn Telemetry Data Recording function ON
Can't clear Lap Timer	This is normal	Lap Timer will clear when you Start the Lap Timer again
Steering Wheel and/or Throttle Trigger won't center	Spring tension set too loose	Tighten spring tension

M12 2.4GHZ FH4T RADIO CONTROL SYSTEM USER'S GUIDE

RACING MODE FUNCTIONS BY CAR TYPE

REFERENCE

The table below shows the available Racing Mode functions by Car Type and channel.

FUNCTION		TYPE	TYP I	TYP II	TYP III	TYP IV	TYP V	TYP VI	TYP VII	TYP VIII	TYP IX	TYP X
D/R	CH1	ST	ST	ST	ST	ST	ST	ST	ST	ST	ST	ST
	CH2	TH/BR	TH	TH/BR	TH	TH/BR	TH	TH/BR	TH/BR	TH/BR	TH/BR	TH/BR
	CH3	----	BR	BR2	BR	ST	ST	ST	ST	ST	----	ST
	CH4	----	----	----	BR2	----	BR	BR2	----	----	----	----
TRIM	CH1	ST	ST	ST	ST	ST	ST	ST	ST	ST	ST	ST
	CH2	TH	TH	TH	TH	TH	TH	TH	TH	TH	F/TH	F/TH
	CH3	AUX1	BR	BR2	BR	ST	ST	ST	ST	ST	R/TH	ST
	CH4	AUX2	AUX	AUX	BR2	AUX	BR	BR2	AUX	AUX	AUX	R/TH
CURVE	CH1	ST	ST	ST	ST	ST	ST	ST	ST	ST	ST	ST
	CH2	TH/BR	TH	TH/BR	TH	TH/BR	TH	TH/BR	TH/BR	TH/BR	TH/BR	TH/BR
	CH3	AUX1	BR	BR2	BR	ST	ST	ST	ST	ST	TH/BR	ST
	CH4	AUX2	AUX	AUX	BR2	AUX	BR	BR2	AUX	AUX	AUX	TH/BR
SPEED	CH1	ST	ST	ST	ST	ST	ST	ST	ST	ST	ST	ST
	CH2	TH/BR	TH	TH/BR	TH	TH/BR	TH	TH/BR	TH/BR	TH/BR	TH/BR	TH/BR
	CH3	AUX1	BR	BR2	BR	ST	ST	ST	ST	ST	TH/BR	ST
	CH4	AUX1	AUX	AUX	BR2	AUX	BR	BR2	AUX	AUX	AUX	TH/BR
ALB	CH1	----	----	----	----	----	----	----	----	----	----	----
	CH2	BR	----	BR	----	BR	----	BR	BR	BR	BR	BR
	CH3	----	BR	BR	BR	----	----	----	----	----	BR	----
	CH4	----	----	----	BR	----	BR	BR	----	----	----	BR
OFFSET	CH1	----	----	----	----	----	----	----	----	----	----	----
	CH2	TH	TH	TH	TH	TH	TH	TH	TH	TH	TH	TH
	CH3	----	----	----	----	----	----	----	----	----	----	----
	CH4	----	----	----	----	----	----	----	----	----	----	----
OFFSET (BR-LOCK)	CH1	----	----	----	----	----	----	----	----	----	----	----
	CH2	----	----	----	----	----	----	----	----	----	----	----
	CH3	----	BR	BR	BR	----	----	----	----	----	----	----
	CH4	----	----	----	BR2	----	BR	BR2	----	----	----	----
BR-MIX	CH1	----	----	----	----	----	----	----	----	----	----	----
	CH2	----	----	BR	----	----	----	BR	----	----	----	----
	CH3	----	----	BR2	BR	----	----	----	----	----	----	----
	CH4	----	----	----	BR2	----	----	BR2	----	----	----	----
TH-HOLD	CH1	----	----	----	----	----	----	----	----	----	----	----
	CH2	HOLD	HOLD	HOLD	HOLD	HOLD	HOLD	HOLD	HOLD	----	----	----
	CH3	----	HOLD(B)	HOLD(B)	HOLD(B)	----	----	----	----	----	----	----
	CH4	----	----	----	HOLD(B)	----	HOLD(B)	HOLD(B)	----	----	----	----
ACKERMAN	CH1	----	----	----	----	LEFT ST	LEFT ST	LEFT ST	----	----	----	----
	CH2	----	----	----	----	----	----	----	----	----	----	----
	CH3	----	----	----	----	RIGHT ST	RIGHT ST	RIGHT ST	----	----	----	----
	CH4	----	----	----	----	----	----	----	----	----	----	----
C-MIX MASTER	CH1	ST	ST	ST	ST	ST	ST	ST	ST	ST	ST	ST
		#ST	#ST	#ST	#ST	#L-ST	#L-ST	#L-ST	#F/ST	#ST	#F/ST	
	CH2	TH	TH	TH	TH	TH	TH	TH	TH	TH	TH	TH
		#TH	#TH	#TH	#TH	#TH	#TH	#TH	#TH	#TH	#F/TH	#F/TH
	CH3	AUX1	BR	BR2	BR	----	----	----	----	----	----	----
		#AUX1	#BR	#BR2	#BR	#R-ST	#R-ST	#R-ST	#R/ST	#R/TH	#R/ST	
CH4	AUX2	AUX	AUX	BR2	AUX	BR	BR2	AUX	AUX	AUX	----	
	#AUX2	#AUX	#AUX	#BR2	#AUX	#BR	#BR2	#AUX	#AUX	#R/TH		
C-MIX SLAVE	CH1	ST	ST	ST	ST	L-ST	L-ST	L-ST	F/ST	ST	F/ST	
	CH2	TH	TH	TH	TH	TH	TH	TH	TH	F/TH	F/TH	
	CH3	AUX1	BR	BR2	BR	R-ST	R-ST	R-ST	R/ST	R/TH	R/ST	
	CH4	AUX2	AUX	AUX	BR2	AUX	BR	BR2	AUX	AUX	R/TH	

M12 2.4GHZ FH4T RADIO CONTROL SYSTEM USER'S GUIDE

TRIM SWITCH, AUXILIARY DIAL AND AUXILIARY LEVER FUNCTIONS

REFERENCE

The tables below shows the functions that can be Assigned to one of the five Trim Switches, the Auxiliary Dial or the Auxiliary Lever. Functions with an (*) Asterisk cannot be Assigned to the Auxiliary Lever. **Not all functions listed below can be Assigned to all Car Types. Functions will vary by Car Type.**

FUNCTION	DESCRIPTION
D/R ST	Dual Rate Steering
D/R TH	Dual Rate Throttle
D/R BR	Dual Rate Brake
D/R BR2	Dual Rate Brake 2
TRIM ST	Trim Steering
TRIM TH	Trim Throttle
TRIM BR	Trim Brake
TRIM BR2	Trim Brake 2
TRIM F/TH	Trim Front Throttle
TRIM R/TH	Trim Rear Throttle
TRIM AUX	Trim Auxiliary
TRIM AUX1	Trim Auxiliary 1
TRIM AUX2	Trim Auxiliary 2
EXP ST	Exponential Steering
EXPT ST-TW-L	Exponential Steering - Tweak - Left
EXP ST-TW-R	Exponential Steering - Tweak - Right
EXP TH	Exponential Throttle
EXP BR	Exponential Brake
EXP BR2	Exponential Brake 2
EXP AUX	Exponential Auxiliary
EXP AUX1	Exponential Auxiliary 1
EXP AUX2	Exponential Auxiliary 2
ARC ST-PNT	ARC Steering - Point
ARC ST-RATE	ARC Steering Rate
ARC TH-PNT	ARC Throttle - Point
ARC TH-RATE	ARC Throttle - Rate
ARC BR-PNT	ARC Brake - Point
ARC BR-RATE	ARC Brake - Rate
ARC BR2-PNT	ARC Brake 2 - Point
ARC BR2-RATE	ARC Brake 2 - Rate
ARC AUX-PNT	ARC Auxiliary - Point
ARC AUX-RATE	ARC Auxiliary - Rate
ARC AX1-PNT	ARC Auxiliary 1 - Point
ARC AX1-RATE	ARC Auxiliary 1 - Rate
ARC AX2-PNT	ARC Auxiliary 2 - Point
ARC AX2-RATE	ARC Auxiliary 2 - Rate
CRV ST-P1~P9	Curve Steering - Point 1 ~ Point 9
CRV TH-P1~P9	Curve Throttle - Point 1 ~ Point 9
CRV BR-P1~P9	Curve Brake - Point 1 ~ Point 9
CRV BR2-P1~P9	Curve Brake 2 - Point 1 ~ Point 9
CRV AUX-P1~P9	Curve Auxiliary - Point 1 ~ Point 9
CRV AX1-P1~P9	Curve Auxiliary 1 - Point 1 ~ Point 9
CRV AX2-P1~P9	Curve Auxiliary 2 - Point 1 ~ Point 9
SPD ST-FWD	Speed Steering - Forward
SPD ST-RET	Speed Steering - Return to Neutral
SPD ST-PNT	Speed Steering - Point
SPD TH-FWD	Speed Throttle - Forward
SPD TH-RET	Speed Throttle - Return to Neutral
SPD TH-PNT	Speed Throttle - Point
SPD BR-FWD	Speed Brake - Forward
SPD BR-RET	Speed Brake - Return to Neutral
SPD BR-PNT	Speed Brake - Point
SPD BR2-FWD	Speed Brake 2 - Forward
SPD BR2-RET	Speed Brake 2 - Return to Neutral
SPD BR2-PNT	Speed Brake 2 - Point
SPD AUX-FWD	Speed Auxiliary - Forward

FUNCTION	DESCRIPTION
SPD AUX-RET	Speed Auxiliary - Return to Neutral
SPD AUX-PNT	Speed Auxiliary - Point
SPD AX1-FWD	Speed Auxiliary 1 - Forward
SPD AX1-RET	Speed Auxiliary 1 - Return to Neutral
SPD AX1-PNT	Speed Auxiliary 1 - Point
SPD AX2-FWD	Speed Auxiliary 2 - Forward
SPD AX2-RET	Speed Auxiliary 2 - Return to Neutral
SPD AX2-PNT	Speed Auxiliary 2 - Point
ALB STROKE	Anti-Lock Braking Stroke
ALB POINT	Anti-Lock Braking Point
ALB RELEASE	Anti-Lock Braking Release
ALB HOLD	Anti-Lock Braking Hold
ALB LAG	Anti-Lock Braking Lag
OFFST POS	Throttle Offset Position
OFFST LOCK	Throttle Offset Brake Lock
B-MX BR-DLY	Brake Mixing Brake Delay
B-MX BR2-DLY	Brake Mixing Brake 2 Delay
TH-HLD	Throttle Hold
C-M1 RATE1	Compensation Mixing 1 Rate 1
C-M1 RATE2	Compensation Mixing 1 Rate 2
C-M1 OFFST	Compensation Mixing 1 Offset
C-M2 RATE1	Compensation Mixing 2 Rate 1
C-M2 RATE2	Compensation Mixing 2 Rate 2
C-M2 OFFST	Compensation Mixing 2 Offset
ACKER LS-L	Ackerman Left Steering - Left
ACKER LS-R	Ackerman Left Steering - Right
ACKER RS-L	Ackerman Right Steering - Left
ACKER RS-R	Ackerman Right Steering - Right
R-DLY CH1	Racing Mode Delay Channel 1
R-DLY CH2	Racing Mode Delay Channel 2
R-DLY CH3	Racing Mode Delay Channel 3
R-DLY CH4	Racing Mode Delay Channel 4
AUX	Auxiliary
AUX1	Auxiliary 1
AUX2	Auxiliary 2
AXCODE01	Auxiliary Code 01
AXCODE02	Auxiliary Code 02
AXCODE03	Auxiliary Code 03
AXCODE04	Auxiliary Code 04
AXCODE05	Auxiliary Code 05
AX1CODE01	Auxiliary 1 Code 01
AX1CODE02	Auxiliary 1 Code 02
AX1CODE03	Auxiliary 1 Code 03
AX1CODE04	Auxiliary 1 Code 04
AX1CODE05	Auxiliary 1 Code 05
AX2CODE01	Auxiliary 2 Code 01
AX2CODE02	Auxiliary 2 Code 02
AX2CODE03	Auxiliary 2 Code 03
AX2CODE04	Auxiliary 2 Code 04
AX2CODE05	Auxiliary 2 Code 05
R-MODE	Racing Mode*
4WS MIX	Four Wheel Steering Mixing*
MOA MIX	Motor on Axle Mixing (Dig and Burn)*
◀▶	Select Right / Select Left*
INC/DEC	Increase / Decrease*

Ackerman Angle: An engineered value that allows the inner tire to turn at a sharper angle than the outer tire to prevent the tires from slipping during turns.

Activate: To turn ON a particular function.

Antenna: Transmits the signal from the transmitter to the receiver in the Model.

Antenna Reception Wire: The portion of the receiver antenna that receives the transmitter signal. The Antenna Reception Wire should never be bent or it could be damaged and limit the range of your Model.

Anti-Lock Braking: Makes it possible to achieve stable Braking even on slippery surfaces. With stable Braking, your Model is better able to trace an exact line under Braking.

Adjustable Rate Control: Allows you to vary the amount of servo travel in relation to the movement of the Steering Wheel, the Throttle Trigger, the Auxiliary Dial or the Auxiliary Lever near the Neutral positions to change the way those functions react to control movement. The ARC function works like the Exponential function, except that the ARC function features the added benefit of being able to move the Neutral Point, whereas the Exponential function Neutral Point is fixed. In addition, the ARC Curve is more Linear than the Exponential Curve.

Assign Screen: The ASSIGN screen displays the functions that are currently Assigned to the Push-Button Switches, the Trim Switches, the Auxiliary Dial and the Auxiliary Lever, all in one convenient location.

Audio Indicator: Indicates on the LCD screen whether Audible Key Tones and Transmitter Alarms are Muted or not.

Audible Key Tone: An audible Tone that is emitted from the transmitter each time the Push-Button Rotary Dial, the Trim Switches, the Push-Button Switches, the Auxiliary Dial or the Auxiliary Lever is used.

Auxiliary Dial: The Auxiliary Dial can rotate 360° and is programmable to perform a different function depending on what function is Assigned to it. In the default configuration, it controls Auxiliary 1 High and Low servo travel.

Auxiliary Lever: The Auxiliary Lever is programmable and will perform a different function depending on what function is Assigned to it. In the default configuration, it controls Auxiliary 2 High and Low servo travel.

Back Key: Returns to the previous menu. Repeatedly press to return to the STATUS screen.

Battery Compartment: Houses the four 'AA' Alkaline cells that power the transmitter. Alternatively, the transmitter can be powered using four 'AA' Ni-Cd or Ni-MH rechargeable batteries or a 2S Li-Po or Li-Fe battery pack.

Binding: The act of pairing the transmitter and receiver to prevent interference from transmitters operated by other users.

Bind Button: Used in the process of Binding the transmitter and receiver.

Bind LED: Displays the current operating status of the receiver.

Boot Screen: Displays the brand logo while the transmitter starts up after being turned ON.

Brake Bias: The ability to vary the rate of Braking between two Brake servos. For example, programming the Front Brake to Engage sooner than the Rear Brake can affect the handling characteristic of your Model.

Brake Mixing: Allows you change the Brake Bias between the Front and Rear Brakes when two separate Brake servos are used.

Brake Side: Refers to the Throttle Trigger stroke that Engages the Brakes on your Model (pushing the Throttle Trigger).

Burn: Used mostly in Rock Crawling and in conjunction with the Motor on Axle function, power to the Front motor is reduced or turned OFF while keeping full control of the Rear motor.

Car Type Indicator: Indicates on the STATUS screen the current Car Type Selected.

Car Type Templates: Allows you to quickly set up the transmitter's Mixing options based on the type of Model you're driving. Common templates for Car or Truck and Crawler Car Types are provided.

Center Trim Type: A Trim technology that allows the servo End Points to remain stationary when you apply Trim. This can result in unbalanced servo travel. In order to balance servo travel, servo End Points need to be manually readjusted.

Channel Set: Allows you to make Programming Value changes to each of the four channels without the need to enter each Programming Menu separately.

Charge Jack: Used for onboard charging of optional Ni-Cd or Ni-MH batteries. Only the recommended Airtronics 110v AC charger should be used through the Charge Jack. If using an after-market Peak-Detection charger or other type of fast charger, the batteries should be removed from the transmitter to avoid damage to the transmitter circuitry and/or your batteries.

Coaxial Cable: The portion of the receiver antenna that extends the Antenna Reception Wire. The Coaxial Cable can be bent into gentle curves, however, do not bend it acutely, or repeatedly bend it or the antenna core can be damaged.

Code Auxiliary: A function designed for use with future connected products, such as an ESC, whose Programming Parameters can be changed directly via the transmitter.

Compensation Mixing: Used to create your own custom Mixes that allow you to control any number of desired functions in different combinations.

Crab Steering: Used with Four Wheel Steering, both Front and Rear wheels pivot right and left together. Also referred to as Parallel Steering.

Cursor Indicator: Indicates on the TELEMETRY screen the current position of the Cursor when reviewing Telemetry Data.

Data Point Scale: Indicates on the TELEMETRY screen the time in Seconds between recorded Telemetry Data Points.

Dig: Used mostly in Rock Crawling and in conjunction with the Motor on Axle function, power to the Rear motor is reduced or turned OFF while keeping full control of the Front motor.

Digital Trim Memory: Allows the transmitter to store Trim values in its memory. Any amount of Trim that you set during use using the Trim Switches is automatically stored in memory for that specific channel and for that specific Model. The Trim values for each Model will automatically be loaded when the transmitter is turned ON.

Direct Model Select: Allows you to choose up to three different Models that can be Selected when turning the transmitter ON. Simply press a key while turning the transmitter ON and the Programming Data for your favorite Model will load automatically.

Direction/Max/Min Indicators: Indicates on the TELEMETRY pages Control Movement Direction or Programmed Maximum and Minimum Telemetry Data values, depending on the current TELEMETRY page being displayed.

Display Key: Turns the transmitter's LCD Screen ON without actually turning the transmitter ON. This allows you to check and/or change programming options without actually turning the transmitter ON.

Dual Rate: Allows you to change the control authority of the Steering, Throttle High Side and Throttle Brake Side by changing the amount of servo travel relative to control input.

Dual Rate Display: Displays the current Dual Rate percentage value of channels that Dual Rate can be programmed for. Channels displayed will vary based on the currently Selected Car Type.

Elapsed Time: Displays on the TELEMETRY screen the current position in Time of the Cursor Indicator within the current Telemetry Data Log.

End Point Adjustment: Used to adjust the desired amount of servo travel in both directions independently. This makes it possible to balance servo travel in both directions.

Enter Key: Opens the Selected menu or programming option. Press and HOLD to reset the Selected programming option to its default value.

Exponential: Allows you to vary the amount of servo travel in relation to the movement of the Steering Wheel and Throttle Trigger (or in some cases, the Auxiliary Dial and/or the Auxiliary Lever) near the Neutral positions to change the way those functions react to control movement.

Fail Safe: Automatically moves the servos to a predetermined position in the event that the signal between the transmitter and the receiver is interrupted, whether due to signal degradation or low transmitter battery.

Feeling: Allows you to adjust the Response Time of the Steering and Throttle channels to fine-tune the sensitivity of these controls. Some users may find that the Response Time is in some cases too fast, therefore, it's adjustable to suit the driver's driving style, Car Type and track conditions.

FH2 Modulation: Frequency Hopping 2nd generation FHSS technology. FH2 Modulation is used in legacy Airtronics 2.4GHz FHSS-2 transmitters and receivers, such as the Airtronics M11, M11 FHSS-2, and MX-3FG radio control systems.

FH3 Modulation: Frequency Hopping 3rd generation FHSS technology. FH3 Modulation is used in newer-generation Airtronics radio control systems, such as the M11X and MX-3X.

FH4/FH4T Modulation: Frequency Hopping 4th generation FHSS technology. FH4 Modulation is the latest Airtronics 2.4GHz frequency modulation. FH4T frequency modulation is the same, in addition to supporting Telemetry.

FHSS: Frequency Hopping Spread Spectrum. FHSS is a Modulation Type which transmits data across the entire frequency spectrum by transmitting data on different channels at an extremely fast interval.

Firmware: The transmitter's operating software. You can check the Firmware version in the SYSTEM - INFORMATION menu and even update the Firmware if new Firmware becomes available.

Four Wheel Steering Mixing: Used to control either the Front or Rear steering independently, or Mix the Front and Rear steering so that they can be used together. Front or Rear Independent Steering, Parallel Four Wheel Steering and Tandem Four Wheel Steering options are available.

Goal Time: Used in conjunction with the Lap Timer, the Goal Time is designed to alert you when you reach the maximum desired elapsed time during your race or during practice.

Grip: The Grip is molded from rubber in an ergonomic shape for increased comfort, control and feel.

High Side: Refers to the Throttle Trigger stroke that opens the Throttle and powers your Model (pulling the Throttle Trigger).

Hold Setting: Determines how quickly the Brake moves from the Stroke setting to the Point setting when the Anti-Lock Braking function is turned ON.

Inactivity Alarm: This alarm will sound if the transmitter is Left on for a period of 10 minutes without any control input from the user. This alarm alerts you to prevent unwanted draining of the transmitter battery.

Inhibit: To deactivate or turn OFF a particular function.

Interval Timer: Used separately or in conjunction with the Lap Timer, notifies you when a set Interval elapses while you are driving.

KM/H: Kilometers per Hour.

Lag: Controls the amount of Delay before the Anti-Lock Braking function Activates after reaching the Point setting.

Lap Indicator: Indicates on the TELEMETRY screen the position along the Telemetry Data Stream that a Lap Time was counted.

Lap Timer: Allows you to measure and record Lap Times for up to 250 Laps. The total number of Laps, the Current Lap Time, the Best Lap Time and the Average Lap Time are all displayed. Lap Times are displayed in the following format: 00:00".00 (Minutes : Seconds : 1/100th of a Second).

Latency: The Response Time between the transmitter and receiver. The lower the Latency value, the faster the Response Time and the more connected you feel to your Model.

LCD Screen: The heart of the programming and display features of the transmitter. All programming and transmitter display functions are shown on the LCD Screen. The LCD screen features an adjustable backlight, adjustable contrast and smooth scrolling.

LED1: Displays the current RF signal output status of the transmitter. When illuminated, an RF signal is being transmitted. When extinguished, no RF signal is being transmitted. In addition, LED1 is used to indicate various transmitter conditions.

LED2: Displays the current status of the Telemetry connection. When illuminated, no Telemetry connection is present. When extinguished, the Telemetry connection is Active. In addition, LED2 is used to indicate various transmitter conditions.

Low Voltage Alert Alarm: The Low Voltage Alert alarm will sound when the transmitter batteries reach the Low Voltage Alert alarm voltage value programmed in the SYSTEM - BATTERY menu. The alarm will sound each time the transmitter battery voltage decreases by 0.1 volt. To clear this alarm, press the BACK key or the ENTER key.

Low Voltage Limit Alarm: The Low Voltage Limit alarm will sound when the transmitter batteries reach the Low Voltage Limit alarm voltage value programmed in the SYSTEM - BATT menu. This alarm can only be cleared by turning the transmitter OFF and recharging or replacing the transmitter batteries.

Mode Display: Displays on the STATUS screen any special Programming Modes that are Active, such as Throttle Offset or Anti-Lock Braking.

Model Clear: Allows you to reset Model-specific Programming Data for the currently Selected Model back to the Factory Default settings.

Model Copy: Allows you to copy the Programming Data FROM the currently Selected Model TO another Model.

Model Name: Allows you to name each of the 50 individual Models. This makes it easy to keep track of multiple Models. The Model Name can consist of up to 14 letters, numbers or symbols.

Model Select: Allows you to load the Programming Data for the particular Model you wish to drive. The transmitter can store Programming Data for up to 50 different Models.

Model Sort: Allows you to change how your Models are displayed in the Model Select List by allowing you to swap the currently Selected Model with other Models.

Modulation Type Indicator: Indicates on the LCD screen the current Modulation Type that the transmitter is set to.

Motor on Axle Mixing: Used to control either the Front and Rear motors together or independently, giving you Dig and Burn functions.

MPH: Miles Per Hour.

On-Time Indicator: Displays on the STATUS screen the current cumulative On-Time of the transmitter in Hours and Minutes.

Operating Voltage: The safe voltage that the transmitter or receiver can operate within. Exceeding the minimum operating voltage can result in loss of power to the device(s). Exceeding the maximum operating voltage can result in damage to the device(s).

Output Power: The power (in Milliwatts) that your transmitter transmits a signal.

Over Voltage Alarm: The Over Voltage Alarm will sound if the transmitter battery voltage is greater than 9.6 volts. To clear this alarm, turn the transmitter OFF and replace the transmitter battery with one that when fully charged does not exceed 9.6 volts.

Page Indicator: Indicates on the TELEMETRY screen the current Page within the Telemetry Data Stream that Telemetry Data is currently being displayed on.

Parallel (Crab) Steering: Used with Four Wheel Steering, both Front and Rear wheels pivot right and left together.

Parallel Trim: A Trim technology that shifts the servo End Points toward the High Side or the Low Side automatically when you apply Trim. This maintains balanced servo travel without the need to manually readjust the servo End Points.

PC-Link Input: When used with an USB cable with a Mini USB connector (available separately), the PC-Link Input allows you to save Telemetry Data Logs and Model Programming Data to your PC. In addition, it also allows you to load saved Model Programming Data from your PC and update the transmitter's Firmware.

Point Auxiliary: Allows you to program the Auxiliary 1 or Auxiliary 2 channel servo to move up to 6 different Points along its travel, then cycle through those Points using one of the five Trim Switches or the Auxiliary Dial.

Point Curve: Allows you to vary the amount of servo travel in relation to the movement of the Steering Wheel and Throttle Trigger (or in some cases, the Auxiliary Dial and/or the Auxiliary Lever) at different Points along the entire range of control travel to change the way those functions react to control movement.

Point Setting: Locates the Point within the range of servo travel that you want a function to Start or Stop. This setting can vary depending on the actual function the Point setting is controlling.

Power Switch: Turns the transmitter ON and OFF.

Pre-Alarm: Used in conjunction with the Lap Timer, the Pre-Alarm is designed to alert you when you are nearing your Goal Time.

Push-Button Rotary Dial: Also referred to as the UP key, DOWN key and ENTER key, it is used along with the BACK key and the SELECT switch to facilitate transmitter programming. It allows you to quickly and easily navigate the various Programming Menus and switch between the STATUS screen, ASSIGN screen and TELEMETRY screen.

Push-Button Switches: The transmitter features three Push-Button Switches in different locations (Sw1, Sw2 and Sw3). Each Push-Button Switch is programmable and will perform a different function depending on what function is Assigned to it. Sw2 is a Rocker Switch that can be pressed from either the Front or the Back.

Racing Mode: Provides you with five separate Racing Modes that you can switch between while you're driving.

Racing Mode Indicator: Indicates on the LCD screen which Racing Mode (R1 ~ R5) is Active.

Racing Mode LED: Displays which Racing Mode is currently Active. The color of the LED will vary depending on which of the five Racing Modes is Active. When extinguished, Racing Mode is Inhibited.

Receiver Battery Voltage Fail Safe: Used to set a custom voltage that the Receiver Battery Fail Safe function will Activate at to alert you when your receiver battery needs recharging. This ensures that your servos continued to operate optimally at all times.

Receiver Voltage Display: Displays on the TELEMETRY screen the current Voltage of the receiver battery. The tick mark indicates the current Voltage relative to the programmed Maximum Voltage value.

Release Setting: Determines how quickly the Brake moves from Neutral to the percentage value determined by the Stroke setting when the Anti-Lock Braking function is Active.

RF Indicator: Indicates whether the transmitter is sending an RF (Radio Frequency) signal or not.

RPM: Revolutions Per Minute.

RPM/Speed Gauge: Displays on the TELEMETRY screen the current RPM or speed in MPH or KM/H in graphical format. The needle indicates the current RPM or Speed relative to the programmed Maximum RPM or Speed value.

Safety Link: Allows to program a unique code to each receiver/Model pair, preventing the transmitter from controlling a Model that it's not currently programmed for. This helps prevent a runaway Model should you accidentally choose the wrong Programming Data for the intended Model.

Select Switch: Used along with the Push-Button Rotary Dial and the BACK key to facilitate transmitter programming. Use the SELECT switch to scroll through the STATUS screen's main menus, scroll through the TELEMETRY pages and make selections in many of the Programming Menus.

Servo Monitor: Displays the output levels of the four channels in bar graph form, allowing you to monitor servo operation in a virtual manner.

Servo Reversing: Used to electronically switch the direction of servo travel.

Servo Speed: Used to slow down the transit speed of the servos. Servo transit speed can be slowed in both the Forward and the Return to Neutral directions.

SHR Servo Mode: When used with Digital servos, this will increase the servo's response time, even above the manufacturer's stated specification. Do not use with Analog servos!

SSR Servo Mode: When used with Airtronics SRG Digital servos, this will provide the fastest response time. This results in the ultimate feel and response, making you feel more in control of your Model than ever. Use only with Airtronics SRG Digital servos!

Status Screen: Displays information about the transmitter and is the base from which you access other Programming Menus.

Steering Output Display: Displays on the TELEMETRY screen the current position of the Steering channel as a percentage of Steering Wheel travel.

Steering Spring Tension Adjustment Screw: Used to adjust the spring tension of the Steering Wheel to best suit the feel of the user.

Steering Wheel: Proportionally operates the Model's Right and Left Steering control. The Steering Wheel features a foam grip for increased comfort, control and feel. The Steering Wheel's position, angle and spring tension can all be adjusted.

Step Value: A preset amount that the servo will travel when a Trim Switch is pressed once. The Step value can be adjusted so that the servo either moves more or moves less when a Trim Switch is pressed.

Stroke: Determines the amount of Brake that's applied automatically when the Anti-Lock Braking function Activates.

Sub-Trim: Used to correct the Neutral Trim setting for the servos, making it possible to center the Trim Switches while ensuring the servo horns remain centered.

Suppression Capacitor: Primarily used on brushed electric motors, a suppression capacitor helps eliminate electrical noise that could interfere with the operation of your radio control system.

System Indicators: Indicates on the LCD screen transmitter status information.

Tandem Steering: Used with Four Wheel Steering, the Front wheels pivot opposite to the Rear wheels.

Telemetry: A connection between the transmitter and receiver that transfers Sensor Data from the receiver to the transmitter that can be viewed in real-time on the TELEMETRY screen.

Telemetry Screen: Displays Telemetry Data, such as RPM or Speed, Temperature, Receiver Voltage and more. Use the SELECT switch to switch between ALL and LAP, ST, TH, RPM, VOLT, TMP1 and TMP2 pages.

Telemetry Signal Indicator: Indicates on the LCD screen the current signal strength of the Telemetry connection between the transmitter and receiver.

Temperature 1 Display: Displays on the TELEMETRY screen the current temperature in Fahrenheit or Celsius of the object that the Temperature Sensor plugged into the TEMP1 Sensor Port in the receiver is connected to. The tick mark indicates the current temperature relative to the programmed Maximum and Minimum Temperature values.

Temperature 2 Display: Displays on the TELEMETRY screen the current temperature in Fahrenheit or Celsius of the object that the Temperature Sensor plugged into the TEMP2 Sensor Port in the receiver is connected to. The tick mark indicates the current temperature relative to the programmed Maximum and Minimum Temperature values.

Temperature Alert Alarm: The Temperature Alert alarm will sound when the Temperature 1 and/or Temperature 2 temperature reaches the programmed Alert Temperature value.

Throttle Bias: Allows you to change the ratio between Throttle High Side servo travel and Throttle Brake Side servo travel.

Throttle Hold: Moves the Throttle servo to a fixed position, either toward the High Side or the Brake Side, and is used primarily with glow- or gas-powered Models.

Throttle Offset: Allows you to shift the Neutral position of the throttle servo, either toward the High Side or the Brake Side.

Throttle Output Display: Displays on the TELEMETRY screen the current position of the Throttle channel as a percentage of Throttle Trigger travel.

Throttle Trigger: Controls the speed of the Model, both forward and backward, or the Model's Brake. The Throttle Trigger position, angle and spring tension can all be adjusted.

Throttle Trigger Adjustment Position Indicator: Indicates the current position of the Throttle Trigger. As the Throttle Trigger position is adjusted forward or backward, the Throttle Trigger Adjustment Position Indicator will move forward or backward.

Throttle Spring Tension Adjustment Screw: Used to adjust the spring tension of the Throttle Trigger to best suit the feel of the user.

Trim Display: Displays the current position of channel Trim. Trim Indicators (ST, AUX1, etc.) displayed will vary based on the currently Selected Car Type.

Trim Step Resolution: Adjusts how far the servos travel when the Trim Switches are pressed. You can increase the resolution, so that the servos travel less when you press the Trim Switches. This makes it possible to fine-tune the settings extremely accurately.

Trim Switches: The transmitter features five separate Trim Switches - four positioned around the Steering Wheel (Trm1, Trm2, Trm3 and Trm4) and one positioned below the Auxiliary Lever (Trm5). Each Trim Switch is programmable and will perform a different function depending on what function is Assigned to it.

Tweak: Used in conjunction with the Steering Exponential function, allows you to make small Exponential adjustments to the Right and/or Left sides of the Steering channel Neutral Point to fine-tune the balance between the two sides. Also used to adjust the travel limits of the Auxiliary Lever.

User Name: Allows you to change the Name displayed above the M12 logo on the STATUS screen.

Variable Rate Adjustment: Allows you to calibrate the operation of the Steering, Throttle and Auxiliary Lever End Points and Neutral positions to ensure long term precise control operation.

Vibrator: Makes the transmitter vibrate like a cell phone to make you aware of different alerts and alarms that you might encounter during use. This is particularly useful if you've Muted any of these related audible alerts and alarms or to provide a level of tactile feedback while you're driving.

Voltage Indicator: Indicates on the LCD screen the current Voltage of the transmitter batteries.

Wrist Strap Anchor Slot: Used to attach the wrist strap anchor to the transmitter.

Z-Connector: The type of servo and battery connector used by Airtronics. The Z-Connector is a universal connector which is electronically compatible with the airborne components of other radio control system manufacturers.

Symbols

2.4GHz Frequency Band Precautions 4

A

Ackerman Angle, Changing the Ackerman Angle Percentage Values 92

Ackerman Angle, Definition of 101

Ackerman Angle, Overview 92

Activate, Definition of 101

Adjustable Rate Control, Changing the Point Value 80

Adjustable Rate Control, Changing the Rate Percentage Value 81

Adjustable Rate Control, Choosing the Channel and Curve Type 80

Adjustable Rate Control, Definition of 101

Adjustable Rate Control, Overview 80

Alarms. See Inactivity (Power ON) Alarm

See Over Voltage Alarm

See Low Voltage Alert Alarm

See Low Voltage Limit Alarm

Antenna, Definition of 8, 101

Antenna, Diagram of 6

Antenna, Orientation of 6

Antenna Reception Wire, Definition of 8, 101

Antenna Reception Wire, Diagram of 8

Antenna Reception Wire, Orientation of 8

Anti-Lock Braking, Changing the Lag Value 85

Anti-Lock Braking, Changing the Point Percentage Value 85

Anti-Lock Braking, Changing the Release and Hold Values 85

Anti-Lock Braking, Changing the Stroke Percentage Value 84

Anti-Lock Braking, Definition of 101

Anti-Lock Braking, Overview 84

Assign Screen, Definition of 101

Assign Screen, Overview 18

Audible Key Tone. See Audible Tones

Audible Key Tone, Definition of 101

Audible Tones, Changing the Volume 39

Audible Tones, Changing Tones 39

Audible Tones, Tone and Volume Function Table 38

Audio Indicator, Definition of 18, 101

Audio Indicator, Diagram of 18

Auxiliary Dial, Changing the Direction of Travel 37

Auxiliary Dial, Changing the Function 36

Auxiliary Dial, Changing the Step Value 36

Auxiliary Dial, Definition of 8, 101

Auxiliary Dial, Diagram of 6

Auxiliary Dial, Functions Table 100

Auxiliary Dial, Overview 36

Auxiliary Lever, Changing the Function 37

Auxiliary Lever, Changing the Tweak Values 38

Auxiliary Lever, Definition of 8, 101

Auxiliary Lever, Diagram of 6

Auxiliary Lever, Functions Table 100

Auxiliary Lever, Overview 37

Auxiliary Type, Changing the Auxiliary Channel Operating Mode 42

Auxiliary Type, Changing the Number of Points 42

Auxiliary Type, Overview 42

B

Back Key, Definition of 9, 101

Back Key, Diagram of 7

Back Key, Function Overview 17

Battery Compartment, Definition of 9, 101

Battery Compartment, Diagram of 7

Battery - Receiver, Options 8

B

Battery - Receiver, Warning if Using Li-Po or Li-Fe 8
Battery - Transmitter, Charging Options 11
Battery - Transmitter, Installation 11
Battery - Transmitter, Options 11
Battery - Transmitter, Warnings if Using Li-Po or Li-Fe 11
Bind Button, Definition of 9, 101
Bind Button, Diagram of 8
Binding, Changing the Modulation Type 30
Binding, Changing the Safety Link Number 31
Binding, Changing the Servo Operating Mode 31
Binding, Definition of 101
Binding, Overview 30
Binding the Transmitter and Receiver 23
Bind LED, Definition of 9, 101
Bind LED, Diagram of 8
Boot Menu, Changing Boot Menu Options 56
Boot Menu, Overview 56
Boot Screen, Definition of 101
Boot Screen, Overview 17
Brake Bias. *See* Brake Mixing
Brake Bias, Definition of 101
Brake Delay, Adjusting 87
Brake Mixing, Changing the Brake Delay Percentage Value 87
Brake Mixing, Definition of 101
Brake Mixing, Overview 87
Brake Side, Definition of 101
Burn, Adjusting and Controlling 67
Burn, Definition of 101

C

Car Type, Channel Table 25
Car Type, Choosing a Car Type 24
Car Type Indicator, Definition of 18, 101
Car Type Indicator, Diagram of 18
Car Type, Overview 24
Car Type Templates, Definition of 101
Center Trim. *See* Trim Type, Overview
Center Trim Type, Definition of 101
Channel Set, Changing Function Programming Values 94
Channel Set, Choosing the Channel 94
Channel Set, Definition of 101
Channel Set, Overview 94
Charge Jack, Definition of 9, 101
Charge Jack, Diagram of 7
Coaxial Cable, Definition of 9, 101
Coaxial Cable, Diagram of 8
Code Auxiliary, Changing the Code Auxiliary Values 93
Code Auxiliary, Definition of 102
Code Auxiliary, Overview 93
Compensation Mixing, Channels By Car Type Table 89
Compensation Mixing, Choosing the Channel Offset Value 91
Compensation Mixing, Choosing the Master Channel 90
Compensation Mixing, Choosing the Rate 1 and Rate 2 Percentage Values 91
Compensation Mixing, Choosing the Slave Channel 90
Compensation Mixing, Definition of 102
Compensation Mixing, Master Channel Output Data Table 90
Compensation Mixing, Overview 89
Crab Steering, Definition of 102. *See also* Parallel Steering
Current Main Menu, Definition of 20
Current Main Menu, Diagram of 20
Current Programming Menu, Definition of 20

C

- Current Programming Menu, Diagram of 20
- Cursor Indicator, Definition of 21, 102
- Cursor Indicator, Diagram of 21
- Curve. See Point Curve
 - See also Exponential
 - See also Adjustable Rate Control
- Custom Menu, Adding Favorite Programming Menus 95
- Custom Menu Overview 94
- Custom Menu, Removing Favorite Programming Menus 95

D

- Data Point Scale, Definition of 21, 102
- Data Point Scale, Diagram of 21
- Dig, Adjusting and Controlling 67
- Dig, Definition of 102
- Digital Trim Memory, Definition of 102
- Direction Indicators, Definition of 21, 102
- Direction Indicators, Diagram of 21
- Direct Model Select, Changing Direct Model Select Models 30
- Direct Model Select, Definition of 102
- Direct Model Select, Overview 29
- Direct Model Select, Using the Direct Model Select Function 29
- Display Key, Definition of 9, 102
- Display Key, Diagram of 7
- Display Screens, Overview 17
- DMS. See Direct Model Select
- Driving Position, Changing 16
- Dual Rate, Changing the Dual Rate Percentage Values 77
- Dual Rate, Definition of 102
- Dual Rate Display, Definition of 18, 102
- Dual Rate Display, Diagram of 18
- Dual Rate, Overview 76

E

- Elapsed Time, Definition of 21, 102
- Elapsed Time, Diagram of 21
- End Point Adjustment, Changing the Channel End Point Adjustment Percentage Values 62
- End Point Adjustment, Definition of 102
- End Point Adjustment, Overview 62
- Enter Key, Definition of 102
- Enter Key, Using Within Menus 20
- Exponential, Adjusting Steering Tweak 79
- Exponential, Changing the Rate Percentage Value 79
- Exponential, Choosing the Channel and Curve Type 79
- Exponential, Definition of 102
- Exponential, Overview 78

F

- Fail Safe, Choosing Fail Safe Settings 70
- Fail Safe, Definition of 102
- Fail Safe, Overview 69
- FCC Compliance Statement 3
- Feeling, Changing Steering and Throttle Response Time Values 69
- Feeling, Definition of 102
- Feeling, Overview 69
- FH2 Modulation, Definition of 102
- FH3 Modulation, Definition of 102
- FH4/FH4T Modulation, Definition of 102
- FHSS, Definition of 102
- Firmware, Definition of 102
- Firmware, Viewing Current Firmware Version 61

F

- Four Wheel Steering, Controlling 68
- Four Wheel Steering Mixing, Choosing Options 67
- Four Wheel Steering Mixing, Definition of 102
- Four Wheel Steering Mixing, Overview 67

G

- Goal Time, Definition of 102
- Goal Time, Setting the Goal Time 72
- Grip, Changing 13
- Grip, Definition of 9, 102
- Grip, Diagram of 6

H

- High Side, Definition of 102
- Hold Setting, Definition of 102

I

- Inactivity (Power ON) Alarm, Definition of 103
- Inactivity (Power ON) Alarm, Overview 10
- Inhibit, Definition of 103
- Interval Timer, Choosing the Optional Throttle Trigger Start 73
- Interval Timer, Definition of 103
- Interval Timer, Overview 73
- Interval Timer, Setting the Interval Timer 73
- Interval Timer, Starting the Interval Timer 74
- Interval Timer, Stopping the Interval Timer 74

K

- KM/H, Definition of 103

L

- Lag, Definition of 103
- Lap Indicator, Definition of 21, 103
- Lap Indicator, Diagram of 21
- Lap Number, Diagram of 21
- Lap Time, Diagram of 21
- Lap Time Display, Diagram of 21
- Lap Timer, Choosing the Optional Throttle Trigger Start 72
- Lap Timer, Definition of 103
- Lap Timer, Overview 71
- Lap Timer, Setting the Goal Time 72
- Lap Timer, Setting the Pre-Alarm Time 72
- Lap Timer, Starting the Lap Timer and Counting Lap Times 72
- Lap Timer, Stopping the Lap Timer 73
- Lap Timer, Viewing Lap Times 73
- Latency, Adjusting Steering and Throttle. *See* Feeling
- Latency, Definition of 103
- LCD Screen, Changing the Backlight Brightness 41
- LCD Screen, Changing the Backlight Mode 41
- LCD Screen, Changing the Backlight On-Time 41
- LCD Screen, Changing the Contrast 40
- LCD Screen, Definition of 9, 103
- LED1. *See also* LED Condition Indicators
- LED1, Definition of 9, 103
- LED1, Diagram of 7
- LED2. *See also* LED Condition Indicators
- LED2, Definition of 9, 103
- LED2, Diagram of 7
- LED Condition Indicators 10
- Li-Po and Li-Fe Battery Warnings 11
- Log Setup, Overview 48

L

Low Voltage Alert Alarm, Alert Value Tables 46
Low Voltage Alert Alarm, Changing the Low Voltage Alert Alarm Value 47
Low Voltage Alert Alarm, Definition of 103
Low Voltage Alert Alarm, Overview 10
Low Voltage Limit Alarm, Changing the Low Voltage Limit Alarm Value 47
Low Voltage Limit Alarm, Definition of 103
Low Voltage Limit Alarm, Limit Voltage Value Tables 46
Low Voltage Limit Alarm, Overview 10

M

Main Menus, Overview 20
Main Menus Structure, Overview 19
Menu Header, Definition of 20
Menu Header, Diagram of 20
Menu Programming Display, Definition of 20
Menu Programming Display, Diagram of 20
Message Display, Definition of 20
Message Display, Diagram of 20
Mode Display, Definition of 18, 103
Mode Display, Diagram of 18
Model Clear, Clearing Model Programming Data 28
Model Clear, Definition of 103
Model Clear, Overview 28
Model Copy, Copying Model Programming Data 27
Model Copy, Definition of 103
Model Copy, Overview 27
Model Name, Definition of 18, 103
Model Name, Deleting a Character 27
Model Name, Deleting a Model Name 27
Model Name, Diagram of 18
Model Name, Entering a Model Name 26
Model Name, Overview 26
Model Number, Definition of 18
Model Number, Diagram of 18
Model Programming Data, Loading 59
Model Programming Data, Saving 59
Model Select, Definition of 103
Model Select, Overview 25
Model Select, Selecting a Model 25
Model Sort, Definition of 103
Model Sort, Overview 29
Model Sort, Sorting Models 29
Model Type. *See* Car Type
Modulation Type, Changing 30
Modulation Type, Definition of 103
Modulation Type Indicator, Definition of 18
Modulation Type Indicator, Diagram of 18
Modulation Type, Overview 30
Motor on Axle Mixing, Changing the Motor on Axle Power Distribution Values 66
Motor on Axle Mixing, Definition of 103
Motor on Axle Mixing, Overview 66
MPH, Definition of 103

N

Next Programming Menus, Definition of 20
Next Programming Menus, Diagram of 20
Nominal Input Voltage, Receiver Specification 5
Nominal Input Voltage, Transmitter Specification 5

O

Offset. *See* Throttle Offset

O

ON/OFF Switch. See Power Switch
On-Time Indicator, Definition of 19, 103
On-Time Indicator, Diagram of 18
On-Time, Resetting the On-Time 61
Operating Voltage, Definition of 103
Operating Voltage Range, Transmitter Specification 5
Output Power, Definition of 103
Output Power, Transmitter Specification 5
Over Voltage Alarm, Definition of 103
Over Voltage Alarm, Overview 10

P

Packaging 2
Page Indicator, Definition of 22, 103
Page Indicator, Diagram of 21
Pairing. See Binding the Transmitter and Receiver
Parallel Steering, Definition of 103
Parallel Trim. See Trim Type
Parallel Trim, Definition of 103
PC-Link Input, Definition of 9, 103
PC-Link Input, Diagram of 7
PC-Link, Loading Model Programming Data 59
PC-Link, Overview 58
PC-Link, Saving Model Programming Data 58
PC-Link - Saving the Telemetry Data Log 58
PC-Link, Updating Transmitter Firmware Version 60
Point Auxiliary 1, Changing the Auxiliary 1 Point Values 64
Point Auxiliary 1, Overview 64
Point Auxiliary 2, Changing the Auxiliary 2 Point Values 65
Point Auxiliary 2, Overview 65
Point Auxiliary, Definition of 104
Point Curve, Changing the Point Percentage Values 82
Point Curve, Choosing the Channel and Curve Type 81
Point Curve, Definition of 104
Point Curve, Overview 81
Point Setting, Definition of 104
Power ON Alarm. See Inactivity (Power ON) Alarm
Power Switch, Definition of 9, 104
Power Switch, Diagram of 6
Pre-Alarm, Definition of 104
Pre-Alarm, Setting the Pre-Alarm 72
Programming Keys, Overview 17
Push-Button Rotary Dial, Changing the Scrolling Direction 16
Push-Button Rotary Dial, Definition of 9, 104
Push-Button Rotary Dial, Diagram of 7
Push-Button Rotary Dial, Function Overview 17
Push-Button Switches, Changing the Function 33
Push-Button Switches, Changing the Switch Mode 34
Push-Button Switches, Definition of 9, 104
Push-Button Switches, Diagram of 6, 7
Push-Button Switches, Function Table 34
Push-Button Switches, Overview 33

R

Racing Menu, Overview 74
Racing Mode, Active Racing Mode LED Color Table 75
Racing Mode, Definition of 104
Racing Mode Delay, Changing the Racing Mode Delay Percentage Values 92
Racing Mode Delay, Overview 92
Racing Mode, Functions by Car Type Table 99
Racing Mode Indicator, Definition of 19, 104

R

- Racing Mode Indicator, Diagram of 18
- Racing Mode LED. *See* Racing Mode, Active Racing Mode LED Color Table
See also LED Condition Indicators
- Racing Mode LED, Definition of 9, 104
- Racing Mode LED, Diagram of 7
- Racing Mode, Overview 75
- Racing Mode, Switching 76
- Racing Mode, Turning Racing Mode ON and OFF 75
- Racing Mode, Turning Separate Functions ON and OFF 76
- Receiver Battery Voltage Fail Safe, Activating 71
- Receiver Battery Voltage Fail Safe, Choosing the Receiver Battery Voltage Value 70
- Receiver Battery Voltage Fail Safe, Definition of 104
- Receiver, Battery Voltage Fail Safe Limit Specification 5
- Receiver Battery Voltage Fail Safe, Overview 70
- Receiver, Connections and Mounting 8
- Receiver, Dimensions Specification 5
- Receiver, Nominal Input Voltage Specification 5
- Receiver, Overview 8
- Receiver Precautions 4
- Receiver Voltage Display, Definition of 22, 104
- Receiver Voltage Display, Diagram of 21
- Receiver, Weight Specification 5
- Release Setting, Definition of 104
- RF Exposure Statement 3
- RF Indicator, Definition of 19, 104
- RF Indicator, Diagram of 18
- RPM, Definition of 104
- RPM Display, Definition of 22
- RPM Display, Diagram of 21
- RPM Gauge, Diagram of 21
- RPM Sensor, Changing the 10Count Distance Value 50
- RPM Sensor, Changing the Ratio Value 49

S

- Safety 3
- Safety Link, Changing the Safety Link Number 31
- Safety Link, Definition of 104
- Safety Link, Overview 31
- Select Switch, Definition of 9, 104
- Select Switch, Diagram of 7
- Select Switch, Function Overview 17
- Select Switch, Using Within Menus 20
- Service and Support 3
- Servo Connectors 4
- Servo Monitor, Definition of 104
- Servo Monitor, Overview 32
- Servo Monitor, Using the Servo Monitor 32
- Servo Operating Mode, Changing 31
- Servo Operating Mode, Important Information 32
- Servo Operating Mode, Overview 31
- Servo Reversing, Changing the Servo Reversing Values 64
- Servo Reversing, Definition of 104
- Servo Reversing, Overview 64
- Servo Speed, Changing the Point Percentage and IN and OUT Values 83
- Servo Speed, Changing the Servo Speed Forward Value 83
- Servo Speed, Changing the Servo Speed Return Value 83
- Servo Speed, Choosing the Channel 82
- Servo Speed, Definition of 104
- Servo Speed, Overview 82
- Servo Sub-Trim. *See* Sub-Trim
- Servo Trim. *See* Trim

S

Setup Menu, Overview 61
 SHR Servo Mode. See Servo Operating Mode
 SHR Servo Mode, Definition of 104
 Speed Display, Diagram of 21
 Speed Gauge, Diagram of 21
 SSR Servo Mode. See Servo Operating Mode
 SSR Servo Mode, Definition of 104
 Status Indicator, Definition of 22
 Status Indicator, Diagram of 21
 Status Screen, Definition of 104
 Status Screen, Overview 18
 Steering Output Display, Definition of 22, 104
 Steering Output Display, Diagram of 21
 Steering Spring Tension Adjustment Screw, Definition of 9, 104
 Steering Spring Tension Adjustment Screw, Diagram of 6
 Steering Tweak, Adjusting 79
 Steering Wheel Angle Plate, Installing 15
 Steering Wheel, Changing 13
 Steering Wheel, Definition of 9, 104
 Steering Wheel, Diagram of 6
 Steering Wheel Offset Plate, Installing 14
 Steering Wheel Spring, Changing 12
 Steering Wheel Spring Tension, Changing 12
 Steering Wheel Travel, Changing 12
 Step Value, Definition of 104
 Stroke, Definition of 105
 Sub-Trim, Changing the Servo Sub-Trim Values 63
 Sub-Trim, Definition of 105
 Sub-Trim, Overview 63
 Suppression Capacitor, Definition of 105
 System Features 5
 System Indicators, Definition of 20, 105
 System Indicators, Diagram of 20
 System Menu, Overview 24
 System Specifications 5

T

Tandem Steering, Definition of 105
 Telemetry, Calibrating the RPM Sensor 10Count Distance Value 50
 Telemetry, Calibrating the RPM Sensor Ratio Value 49
 Telemetry, Changing the Alert Temperature Value 52
 Telemetry, Changing the Alert Voltage Value 51
 Telemetry, Changing the Maximum Scale Value 49
 Telemetry, Changing the Maximum Temperature Value 52
 Telemetry, Changing the Maximum Voltage Value 51
 Telemetry, Changing the Minimum Temperature Value 53
 Telemetry, Changing the RPM Unit Value 49
 Telemetry, Changing the Temperature Unit Value 52
 Telemetry Connections and Mounting, Overview 96
 Telemetry Data Graph, Definition of 22
 Telemetry Data Graph, Diagram of 21
 Telemetry Data Log, Saving 58
 Telemetry Data Recording, Overview 48
 Telemetry Data Recording, Turning ON and OFF 48
 Telemetry Data, Reviewing 22
 Telemetry, Definition of 105
 Telemetry, Mounting the RPM Sensor 96
 Telemetry, Mounting the Temperature Sensor 97
 Telemetry, Plugging the Telemetry Sensors into the Optional Receiver 96
 Telemetry - Receiver Mode, Calibrating the Steering Output Data Display 54
 Telemetry - Receiver Mode, Calibrating the Throttle Output Data Display 55

T

- Telemetry - Receiver Mode, Enabling Receiver Mode 53
- Telemetry - Receiver Mode, Overview 53
- Telemetry Screen, Definition of 105
- Telemetry Screen, Overview 21
- Telemetry Signal Indicator, Definition of 105
- Telemetry, Turning ON and OFF 31
- Temperature 1 Display, Definition of 22, 105
- Temperature 1 Display, Diagram of 21
- Temperature 2 Display, Definition of 22, 105
- Temperature 2 Display, Diagram of 21
- Temperature Alert Alarm, Definition of 105
- Throttle Bias, Definition of 105
- Throttle Hold, Changing the Hold Percentage Value 88
- Throttle Hold, Choosing the Brake Lock-Out Value 88
- Throttle Hold, Definition of 105
- Throttle Hold, Overview 87
- Throttle Hold, Turning ON and OFF 88
- Throttle Offset, Changing the Brake Lock Percentage Value 86
- Throttle Offset, Changing the Position Percentage Value 86
- Throttle Offset, Definition of 105
- Throttle Offset, Overview 85
- Throttle Offset, Turning ON and OFF 86
- Throttle Output Display, Definition of 22, 105
- Throttle Output Display, Diagram of 21
- Throttle Spring Tension Adjustment Screw, Definition of 105
- Throttle Spring Tension Adjustment Screw, Diagram of 6
- Throttle Trigger Adjustment Position Indicator, Definition of 105
- Throttle Trigger Adjustment Position Indicator, Diagram of 6
- Throttle Trigger Angle, Changing 13
- Throttle Trigger, Definition of 9, 105
- Throttle Trigger, Diagram of 6
- Throttle Trigger Position Adjustment Screw, Diagram of 7
- Throttle Trigger Position, Changing 14
- Throttle Trigger Spring Tension, Changing 12
- Throttle Trigger, Using to Start the Interval Timer 73
- Throttle Trigger, Using to Start the Lap Timer 72
- Throttle Type, Changing the Throttle Type 44
- Throttle Type, Overview 44
- Transmitter and Receiver Binding. *See* Binding the Transmitter and Receiver
- Transmitter Battery Charging Options 11
- Transmitter Battery Installation 11
- Transmitter Battery Options 11
- Transmitter, Dry Weight Specification 5
- Transmitter Firmware Version, Updating 60
- Transmitter, Nominal Input Voltage Specification 5
- Transmitter, Operating Voltage Range Specification 5
- Transmitter, Output Power Specification 5
- Transmitter, Overview 6
- Transmitter Precautions 4
- Trim, Adjusting Trim Values 78
- Trim Display, Definition of 19, 105
- Trim Display, Diagram of 18
- Trim, Overview 77
- Trim Step Resolution, Definition of 105
- Trim Switches, Changing the Direction of Travel 36
- Trim Switches, Changing the Function 35
- Trim Switches, Changing the Step Value 35
- Trim Switches, Definition of 9, 105
- Trim Switches, Diagram of 6, 7
- Trim Switches, Functions Table 100
- Trim Switches, Overview 34

T

Trim Type, Changing the Trim Type 43
Trim Type, Overview 43
Troubleshooting Guide 97
Tweak, Definition of 105

U

User Name, Definition of 105
User Name, Deleting a Character 57
User Name, Deleting the User Name 57
User Name, Entering a User Name 57
User Name, Overview 56

V

Variable Rate Adjustment, Calibrating the Steering Throttle and Auxiliary Lever Controls 45
Variable Rate Adjustment, Definition of 105
Variable Rate Adjustment, Overview 44
Variable Rate Adjustment, Resetting the Steering, Throttle and Auxiliary Lever Calibration Values 46
Vibrator, Definition of 105
Vibrator, Overview 39
Vibrator, Turning Vibration Functions ON and OFF 40
Vibrator, Vibration Functions Table 40
Voltage Indicator, Definition of 19, 105
Voltage Indicator, Diagram of 18
VR Adjust. See Variable Rate Adjustment

W

Weight, Receiver Specification 5
Wrist Strap Anchor, Installing 13
Wrist Strap Anchor Slot, Definition of 9, 105
Wrist Strap Anchor Slot, Diagram of 7

Z

Z-Connector, Definition of 105
Z-Connector, Diagram of 4

THIS SPACE INTENTIONALLY LEFT BLANK



Airtronics is Imported Exclusively in North America by:

Global Hobby Distributors
18480 Bandilier Circle
Fountain Valley, CA 92708

Telephone: (714) 963-0329
Fax: (714) 964-6236

Email: service@airtronics.net
<http://globalservices.globalhobby.com>
<http://www.airtronics.net>

Features and Specifications are Subject to Change Without Notice.

All contents © 2012 Airtronics, Inc.

All Rights Reserved. Revision 1 07.30.2012

670A14432A