

NEXT GENERATION



# MT-4

**Telemetry System**  
OPERATING MANUAL



  
**2.4 GHz** FHSS-4T

Spread Spectrum  
Technology By **SANWA**

# TABLE OF CONTENTS

Introduction.....	Page 3
Safety .....	Page 3
FCC Compliance Statement.....	Page 3
Usage Precautions.....	Page 4
2.4GHz Frequency Band Precautions.....	Page 4
Transmitter Precautions.....	Page 4
Receiver Precautions .....	Page 4
Features and Specifications .....	Page 5
System Features .....	Page 5
System Specifications .....	Page 5
Servo Recommendations .....	Page 5
Features Familiarization.....	Page 6
Transmitter Features Diagrams.....	Page 6
Receiver Features Diagram.....	Page 8
Transmitter and Receiver Features Descriptions.....	Page 8
Servo Connectors.....	Page 9
Transmitter Safety Alarms and LED Condition Indicators.....	Page 9
System Connections.....	Page 11
Transmitter Battery Options.....	Page 11
Alkaline Battery Installation .....	Page 11
Transmitter Battery Charging Options .....	Page 11
Warnings if Using Li-Po or Li-Fe/A123 Transmitter Batteries.....	Page 11
Receiver Connections and Mounting.....	Page 12
Telemetry Connections and Mounting.....	Page 13
Adjustments and Options .....	Page 14
Throttle Trigger Position Adjustment.....	Page 14
Throttle Trigger Angle Adjustment .....	Page 14
Grip.....	Page 14
Throttle Trigger and Steering Wheel Spring Tension Adjustment.....	Page 15
Steering Wheel Travel Adjustment .....	Page 15
Wrist Strap Anchor.....	Page 15
LCD and Programming Keys.....	Page 16
Top Screen and Telemetry Screen Overview .....	Page 16
Programming Keys Overview and Functions .....	Page 17
Transmitter and Receiver Binding .....	Page 18
Programming Menus .....	Page 19
Overview (Includes Complete Programming Menu List) .....	Page 19
System Menus.....	Page 51
Overview (Includes Complete System Menu List).....	Page 51
Reference.....	Page 73
Troubleshooting Guide.....	Page 73
Glossary of Terms.....	Page 74
Index.....	Page 79
Notes .....	Page 87

## PACKAGING

The packaging of your Airtronics MT-4 2.4GHz FHSS-4T radio control system has been specially designed for the safe transportation and storage of the radio control system's components. **After unpacking your radio control system, do not discard the packaging materials.** Save the packaging materials for future use if you ever need to send your radio control system to us for service or to store your radio control system if you don't plan on using it for an extended period of time.

# INTRODUCTION

We appreciate your purchase of the new Airtronics *MT-4 2.4GHz FHSS-4T* radio control system. This Operating Manual is intended to acquaint you with the many unique features of your state of the art Telemetry-capable radio control system. Please read this operating manual carefully prior to use so that you may obtain maximum success and enjoyment from the operation of your new radio control system.

The *MT-4 2.4GHz FHSS-4T* radio control system has been designed for the utmost in comfort and precise control of all types of model cars and boats. We wish you the best of success and fun with your new purchase!

 Additional 2.4GHz receivers can be purchased and paired with the MT-4 transmitter through the Binding operation. Due to differences in the implementation of 2.4GHz technology among different manufacturers, only Airtronics brand 2.4GHz FHSS-2, FHSS-3 and FHSS-4T surface receivers are compatible with your radio control system. **Telemetry functions are available only when used with Telemetry-capable receivers.** Please see your Airtronics dealer or [www.airtronics.net](http://www.airtronics.net) for more information.

## SAFETY

 This is a high-output full-range radio control system that should well exceed the range needed for any surface model. For safety, the user should perform a range test at the area of operation to ensure that the radio control system has complete control of the model at the farthest reaches of the operational area. Rather than operating the model, we recommend that the user enlist the help of a fellow modeler to walk the model to the farthest reaches of the track (or for boats, to walk the shore line well in excess of the operational distance of the boat), then test for proper operation.

- Be certain to read this Operating Manual in its entirety.
- 'Safety First' for yourself, for others, and for your equipment.
- Observe all the rules of the field, track, or lake where you operate your radio control equipment.
- If at any time during the operation of your model, should you feel or observe erratic operation or abnormality, end your operation as quickly and safely as possible. DO NOT operate your model again until you are certain the problem has been corrected. TAKE NO CHANCES.
- Your model can cause serious damage or injury, so please use caution and courtesy at all times.
- Do not expose the radio control system to water or excessive moisture.
- Waterproof the receiver and servos by placing them in a water-tight radio box when operating R/C model boats.
- If you have little to no experience operating R/C models, we strongly recommend you seek the assistance of experienced modelers or your local hobby shop for guidance.
- The Low Voltage Alarm will sound when the transmitter battery voltage drops to the minimum threshold. If this occurs, stop using the transmitter as soon as possible, then replace or recharge the transmitter battery.

 This radio control system operates on the 2.4GHz frequency band. The 2.4GHz connection is determined by the transmitter and receiver pair. Unlike ordinary crystal-based systems, your model can be used without frequency control.

## FCC COMPLIANCE STATEMENT

This equipment has been tested and found to comply with the limits for a Class B digital device, pursuant to Part 15 of the FCC Rules. These limits are designed to provide reasonable protection against harmful interference in a residential installation. This equipment generates, uses, and can radiate radio frequency energy and, if not installed and used in accordance with the operating instructions, may cause harmful interference to radio communications. However, there is no guarantee that interference will not occur in a particular installation.

If this equipment does cause harmful interference to radio or television reception, which can be determined by turning the equipment off and on, the user is encouraged to try to correct the interference by one or more of the following measures:

- Reorient or relocate the receiving antenna.
- Increase the separation between the equipment and the receiver.
- Connect the equipment into an outlet on a circuit different from that to which the receiver is connected.
- Consult the dealer or an experienced technician for help.

This device complies with Part 15 of the FCC Rules and with RSS-210 of Industry Canada. Operation is subject to the following two conditions:

- 1) This device may not cause harmful interference, and....
- 2) This device must accept any interference received, including interference that may cause undesired operation.

**WARNING:** Changes or modifications made to this equipment not expressly approved by Airtronics may void the FCC authorization to operate this equipment.

### RF Exposure Statement

This transmitter has been tested and meets the FCC RF exposure guidelines when used with the Airtronics accessories supplied or designated for this product, and provided at least 20cm separation between the antenna the user's body is maintained. Use of other accessories may not ensure compliance with FCC RF exposure guidelines.

# USAGE PRECAUTIONS

 In addition to the Safety and FCC Compliance sections on the previous page, please observe the following precautions regarding the 2.4GHz frequency band and using your new Airtronics *MT-4 2.4GHz FHSS-4T* radio control system. In addition, pay careful attention to the information in the *Receiver Precautions* section regarding installing the receiver into your model.

## 2.4GHZ FREQUENCY BAND PRECAUTIONS

- The 2.4GHz frequency band may be used by other devices, or other devices in the immediate area may cause interference on the same frequency band. Always before use, conduct a bench test to ensure that the servos operate properly. Also, conduct checks with the transmitter as distant as possible from your model.
- The response speed of the receiver can be affected if used where multiple 2.4GHz radio controllers are being used, therefore, carefully check the area before use. Also, if response seems slow during use, stop your model immediately and discontinue use.
- If the 2.4GHz frequency band is saturated (too many radio controllers on at once), as a safety precaution, the radio control system may not Bind. This ensures that your radio control system does not get hit by interference. Once the frequencies have been cleared, or the saturation level has dropped, your radio control system should be able to Bind without any problems.

## TRANSMITTER PRECAUTIONS



- Turn the transmitter 'ON' first and then turn the receiver 'ON'. After using your model, turn the receiver 'OFF' first, then turn the transmitter 'OFF'. It can be dangerous if you activate the components in reverse order as the servos may start up inadvertently.
- Before use, double-check that the transmitter and receiver batteries have sufficient power.



- The *MT-4 2.4GHz FHSS-4T* transmitter features an internal antenna installed inside the vertical back portion of the carrying handle. Do NOT grab the carrying handle during use! Doing so can block the RF signal, resulting in the loss of control of your model.
- During use, hold the transmitter so that the antenna is orientated as close to vertical as possible at all times. This provides the best RF signal between the transmitter and the receiver. You should never point the antenna directly at your model, nor should you ever 'follow' your model with the antenna, as this results in a weakened RF signal. For more information, see the *Transmitter Features Diagrams* section on page 6.
- Do not expose the transmitter or any other components to excessive heat, moisture, fuel, exhaust residue, etc.
- If the outer case becomes dirty, it can be cleaned with a soft dry cloth. If the outer case becomes soiled, it can be cleaned with a damp cloth and liquid detergent. Do not use any solvents to clean the outer case. Solvents will damage the finish.



## RECEIVER PRECAUTIONS

- The receiver antenna consists of a coaxial cable and a reception wire (the thin tip at the end of the coaxial cable). When you mount the receiver antenna, do not bend the reception wire. Reception performance decreases if the reception wire is bent.



- The antenna wire is delicate, therefore, handle with care. Do not pull on the antenna wire with force. Do not cut or extend the antenna wire.
- The coaxial cable (the thicker portion of the antenna) can be bent into gentle curves, however, do not bend the coaxial cable acutely, or repeatedly bend it, or the antenna core can be damaged.

- The antenna wire should be installed into a vertical plastic tube per your particular model's assembly instructions. Keep the receiver antenna as far away from the motor, battery, and ESC as possible.
- There is a danger of runaway operation if connectors shake loose during use. Make sure that the receiver, servo(s), and switch connectors are securely fitted.
- The receiver is susceptible to vibration, shock, and moisture. Take appropriate measures to protect against vibration and moisture. Failure to take appropriate measures could result in runaway operation or damage to the receiver. We suggest wrapping the receiver in shock-absorbing foam or securing it with double-sided foam tape when installing it into your model.
- When installing the receiver and routing the receiver antenna, avoid contact with any carbon or metal chassis components. Contact between metal parts mounted on a model can result in electrical noise, which can adversely affect receiver performance and possibly result in runaway operation or damage to your model.
- With electric-powered models, be sure to fit any brushed motors with a noise suppression capacitor. Without a noise suppression capacitor, excessive electrical noise generation can cause runaway operation and/or result in damage to your model.
- Use rubber vibration absorbers with servos. Direct transmission of engine vibration to servos can cause servo failure and possibly result in runaway operation with damage to your model.

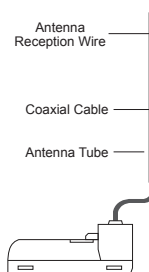

# FEATURES AND SPECIFICATIONS

## SYSTEM FEATURES

- 4-Channel 2.4GHz FHSS-4T Digital High-Response Computer Radio with Advanced Programming
- Telemetry System Features Updated Temperature, RPM/Speed and Voltage Displays in Real-Time on the Telemetry Screen
- High-Power FHSS-4T Technology Provides the Best Reception and Connectivity, Giving Racers Added Assurance
- 4-Cell Battery Holder for Lighter Weight - Also Accepts Optional Ni-Cd/MH Batteries or 2S Li-Po or 2S Li-Fe/A123 Battery Packs
- 18 Model Memory
- Telemetry Logging
- Channel Set Menu
- Servo Reversing
- Steering, Throttle and Brake Dual Rate
- End Point Adjustment
- Exponential and ARC Adjustment
- Servo Speed Adjustment
- Anti-Lock Braking
- Throttle Offset
- Lap and Interval Timers
- Total, Best and Individual Lap Display
- Four Wheel Steering Mixing
- Dual Throttle Mixing w/Dig & Burn
- Normal, SSR and SHR Servo Modes
- Center or Parallel Trim Types
- Step Auxiliary
- Point Auxiliary
- Auxiliary Mixing
- Programmable Fail Safe
- Receiver Battery Voltage Fail Safe
- Digital Trims
- Servo Sub-Trim
- Adjustable Throttle Trigger
- Programmable Switches, Lever and Dial
- Adjustable Steering Wheel
- Adjustable Grip
- Variable Rate Adjustment
- Model Naming
- Model Select
- Model Select Shortcut (Direct Model)
- Model Clear
- Selectable Modulation Type
- Multi-Function LCD Contrast
- Adjustable Key Volume and Tone
- Programmable Low Voltage Alarm
- Inactivity and Over Voltage Alarms
- Digital Battery Voltage Monitor

## SYSTEM SPECIFICATIONS

### Transmitter

Model: MT-4 Telemetry System

Output Power: 100mW

Nominal Input Voltage: 4.8v ~ 7.4v

Operating Voltage Range: 4.0v ~ 9.6v

Dry Weight: 13.68oz (388gr)

Frequency: 2.4GHz FHSS-4T

### Receiver

Model: 92010 (RX-461) Telemetry

Frequency: 2.4GHz FHSS-4T

Nominal Input Voltage: 4.8v ~ 7.4v

Weight: 0.34oz (9.6gr)

Dimensions: 1.43 x 1.04 x 0.64in (36.2 x 26.5 x 16.3mm)

Fail Safe Limit: 3.5v ~ 7.4v (FH4T) / 3.5v ~ 5.0v (FH2/FH3)

## SERVO RECOMMENDATIONS

We recommend using Airtronics brand servos with your *MT-4 2.4GHz FHSS-4T* radio control system. These are a few of our more popular servos. See your local Airtronics dealer or [www.airtronics.net](http://www.airtronics.net) for pricing, availability and more selection.

 Both analog and digital servos will work with your *MT-4 2.4GHz FHSS-4T* radio control system. To get the most out of your experience, we recommend the use of digital servos in SHR or SSR mode. For more information about using different types of servos and the different Servo Mode Types, see the *Changing the Mode Setting* section on page 55.

### 94722 (SDX-1322) Digital Standard Ball Bearing Servo

Torque: 50oz/in (3.6kg/cm @ 4.8v)  
61oz/in (4.4kg/cm @ 6.0v)

Speed: 0.17 sec/60° @ 4.8v  
0.14 sec/60° @ 6.0v

Dimensions: 1.54 x 0.79 x 1.42in  
(39.1 x 20.0 x 36.0mm)

Weight: 1.55oz (43.9gr)

### 94775M (SDX-772) Digital High-Power Metal Gear Dual Ball Bearing Servo

Torque: 124oz/in (8.9kg/cm @ 4.8v)  
151oz/in (10.9kg/cm @ 6.0v)

Speed: 0.17 sec/60° @ 4.8v  
0.13 sec/60° @ 6.0v

Dimensions: 1.54 x 0.78 x 1.50in  
(39.0 x 20.0 x 37.4mm)

Weight: 1.93oz (56gr)

### 94746M (SDX-801) Digital Metal Gear Low-Profile Dual Ball Bearing Servo

Torque: 80oz/in (5.8kg/cm @ 4.8v)  
89oz/in (6.4kg/cm @ 6.0v)

Speed: 0.10 sec/60° @ 4.8v  
0.08 sec/60° @ 6.0v

Dimensions: 1.59 x 0.83 x 1.04in  
(40.4 x 21.1 x 26.4mm)

Weight: 1.77oz (50gr)

### 94780M (SDX-901) Digital High-Power Metal Gear Dual Ball Bearing Servo

Torque: 361oz/in (26.0kg/cm @ 4.8v)  
423oz/in (30.5kg/cm @ 6.0v)

Speed: 0.19 sec/60° @ 4.8v  
0.15 sec/60° @ 6.0v

Dimensions: 1.60 x 0.83 x 1.50in  
(40.6 x 21.1 x 38.1mm)

Weight: 2.33oz (66gr)

# FEATURES FAMILIARIZATION

## TRANSMITTER FEATURES DIAGRAMS

Use the diagrams in this section to familiarize yourself with the basic features of your *MT-4 2.4GHz FHSS-4T* transmitter. Descriptions of these features can be found in the *Transmitter and Receiver Features Descriptions* section on pages 8 and 9.

 The transmitter antenna is mounted internally and is located in the vertical back portion of the carrying handle. When you're driving your model, hold the transmitter so that the antenna is orientated as close to vertical as possible at all times. This provides the best RF signal between the transmitter and the receiver. You should never point the antenna directly at your model, nor should you ever 'follow' your model with the antenna. Doing so can result in a weakened RF signal.

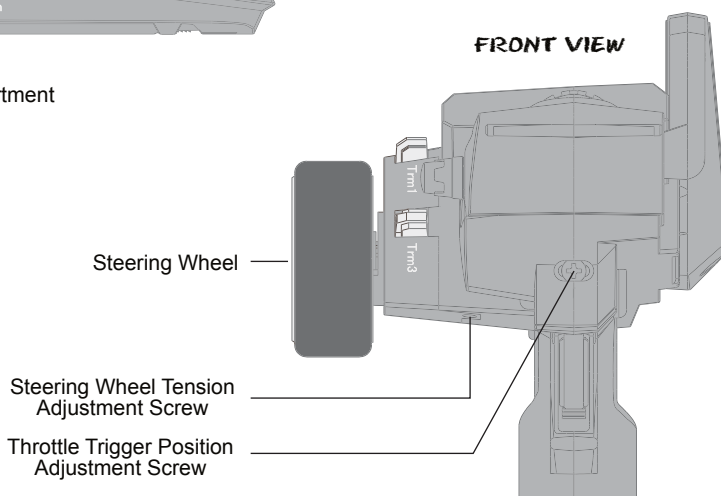
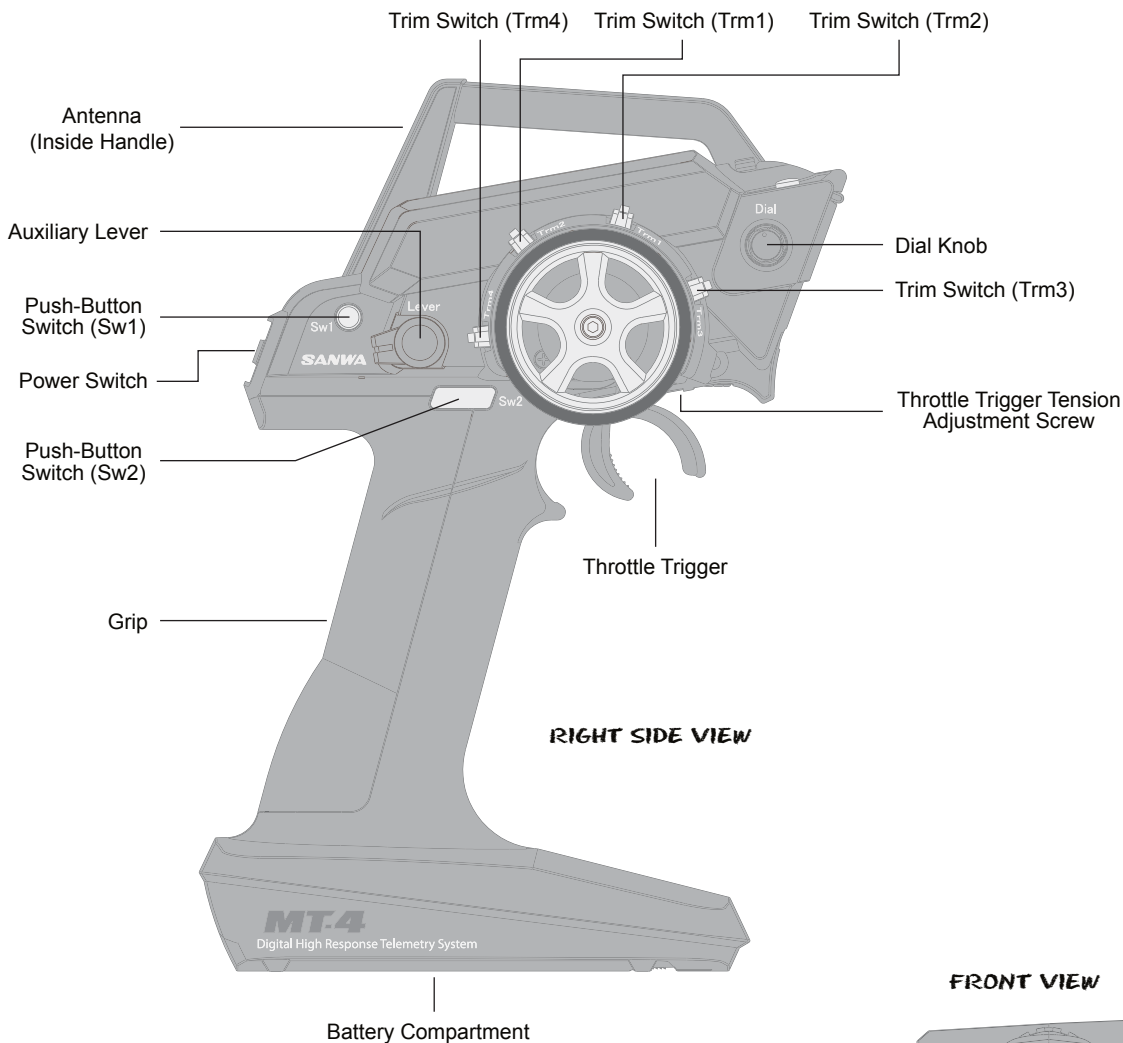

# FEATURES FAMILIARIZATION

## TRANSMITTER FEATURES DIAGRAMS, CONTINUED...

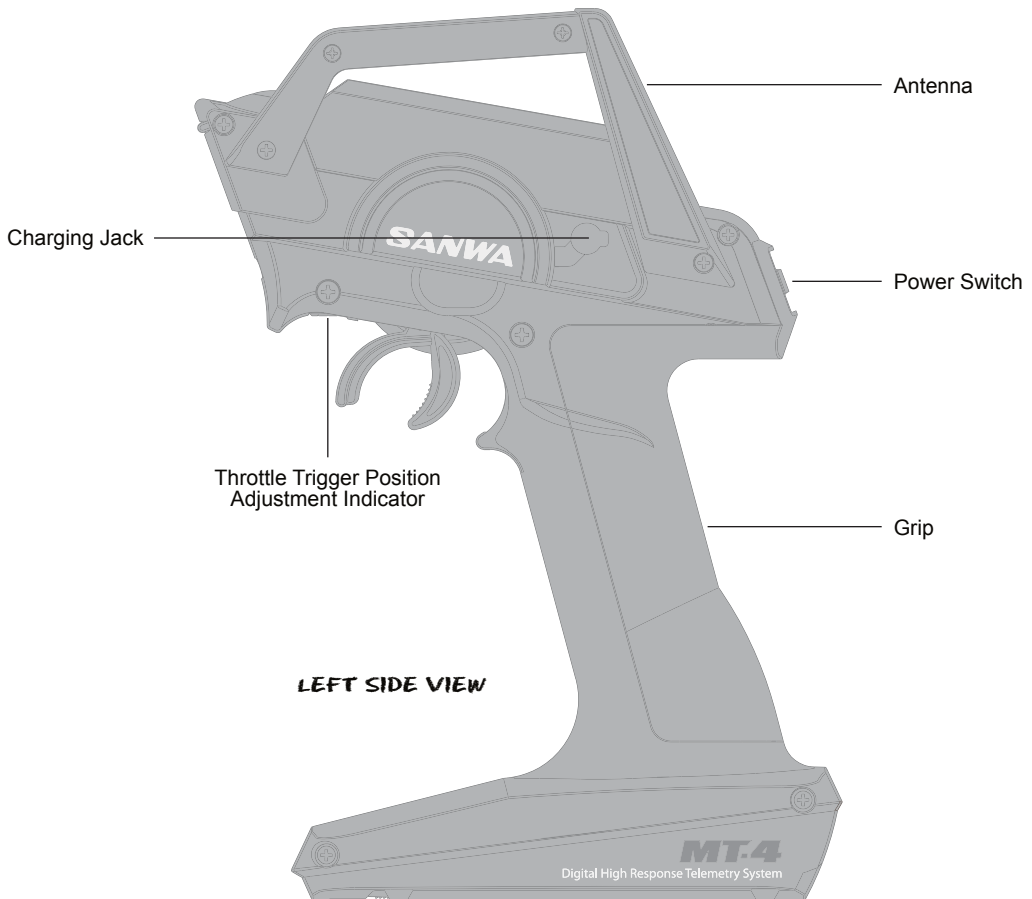
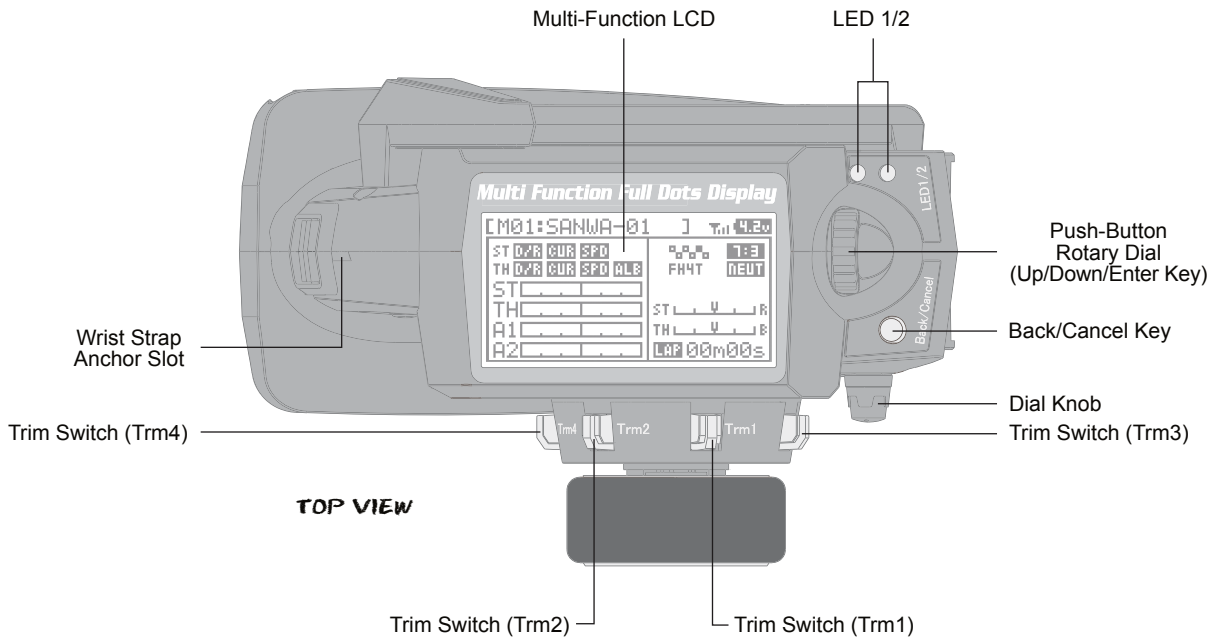

# FEATURES FAMILIARIZATION

## RECEIVER FEATURES DIAGRAM

Use the diagram below to familiarize yourself with the 92010 (RX-461) 4-Channel 2.4GHz FHSS-4T Telemetry receiver included with your *MT-4 2.4GHz FHSS-4T* radio control system. Descriptions of these features can be found in the *Transmitter and Receiver Features Descriptions* section below.

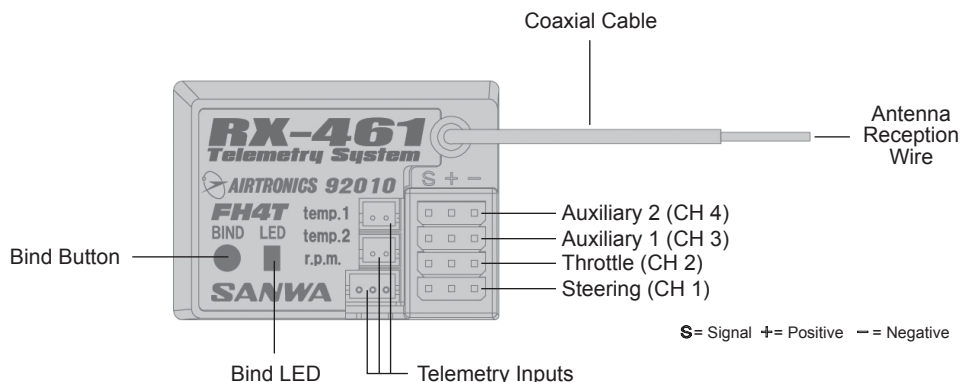

⚠ The receiver battery can be plugged into any channel slot to power the receiver. To utilize all channels and a separate receiver battery, a Y-Harness (not included) must be used. For more information, see the *Receiver Mounting and Connections* section on page 12.

⚠ For information about connecting the Telemetry Sensors, see the *Telemetry Connections and Mounting* section on page 13.

## TRANSMITTER AND RECEIVER FEATURES DESCRIPTIONS

**Antenna:** Transmits the signal from the transmitter to the receiver in the model. Never touch the Antenna during use. Doing so may result in a weakened RF signal or complete loss of control of your model.

**Antenna Reception Wire:** The portion of the receiver antenna that receives the transmitter signal. The Antenna Reception Wire should never be bent or it could be damaged and limit the range of your model.

**Auxiliary Lever:** The Auxiliary Lever is programmable and will perform a different function depending on what function is assigned to it. For example, it can be used to control Auxiliary 1 Channel 3 or to control the Servo Speed function.

**Back/Cancel Key:** Pressing the Back/Cancel Key returns the Programming Cursor to the previous menu. Press and HOLD the Back/Cancel Key to return to the Top Screen.

**Battery Compartment:** Houses the four 'AA' Alkaline cells that power the transmitter. Alternatively, the transmitter can be powered using four 'AA' Ni-Cd or Ni-MH rechargeable batteries or a 2S Li-Po or 2S Li-Fe/A123 battery pack.

**Bind Button:** Used in the process of Binding the transmitter and receiver.

**Bind LED:** Displays the current status of the receiver.

**Charging Jack:** Used for onboard charging of optional Ni-Cd or Ni-MH batteries. Do not attempt to charge Alkaline batteries. Only the recommended Airtronics 110v AC charger should be used through the Charging Jack. If using an after-market Peak-Detection charger or other type of fast charger, the batteries should be removed from the transmitter to avoid damage to the transmitter circuitry and/or your batteries. Do not attempt to charge a Li-Po or Li-Fe/A123 battery pack through the Charging Jack.

**Coaxial Cable:** The portion of the receiver antenna that extends the Antenna Reception Wire. The Coaxial Cable can be bent into gentle curves, however, do not bend it acutely, or repeatedly bend it, or the antenna core can be damaged. The Coaxial Cable should be installed into a nylon tube (antenna tube) and positioned vertically in your model for the best reception.

**Dial Knob:** The Dial Knob can rotate 360° and is programmable to perform a different function depending on what function is assigned to it. For example, it can be used to increase and decrease programming values, control a Trim function or control an Auxiliary Channel.

**Grip:** The Grip is molded from rubber in an ergonomic shape for increased comfort, control and feel. An optional Grip is included that is molded in a different shape that some users may find feels more comfortable.

**LED 1/2:** Displays the current signal output status of the transmitter (LED 1 - Blue) and the Telemetry connection (LED 2 - Red). In addition, one or both LEDs are used to indicate various transmitter conditions. For example, when a Throttle Offset percentage value is programmed, the blue LED will flash.

**Multi-Function LCD:** The heart of the programming and display features of the transmitter. All programming and transmitter display functions are shown on the Multi-Function LCD.



# FEATURES FAMILIARIZATION

## TRANSMITTER AND RECEIVER FEATURES DESCRIPTIONS, CONTINUED....

**Power Switch:** Turns the transmitter 'ON' and 'OFF'.

**Push-Button Rotary Dial:** The Push-Button Rotary Dial (also referred to as the Up Key, Down Key, or Enter key) is used along with the Back/Cancel Key to facilitate transmitter programming. It allows you to quickly and easily navigate the various Programming Menus and switch between the Top Screen and the Telemetry Screen.

**Push-Button Switch:** The transmitter features two separate Push-Button Switches in different locations (Sw1 and Sw2). Each Push-Button Switch is programmable and will perform a different function depending on what function is assigned to it. For example, Sw1 can be used to operate a reverse servo in a gas- or glow-powered model and Sw2 can be used to toggle Anti-Lock Braking 'ON' and 'OFF'.

**Steering Wheel:** Proportionally operates the model's right and left steering control. The Steering Wheel features a foam grip for increased comfort, control and feel. In addition, the Steering Wheel spring tension and travel limits can be adjusted.

**Steering Wheel Tension Adjustment Screw:** Used to adjust the spring tension of the steering wheel to best suit the feel of the user. Turning the Steering Wheel Tension Adjustment Screw clockwise increases steering wheel tension and turning the Steering Wheel Tension Adjustment Screw counter-clockwise decreases steering wheel tension.

**Telemetry Inputs:** Located under a removable protective cover, the Telemetry Inputs are where you plug the Temperature and RPM Sensors into. Two separate temperature inputs and one RPM input are available.

**Throttle Trigger:** Controls the speed of the model, both forward and backward, or the model's brake. The Throttle Trigger position, angle and spring tension can all be adjusted.

**Throttle Trigger Position Adjustment Indicator:** Indicates the current position of the Throttle Trigger. As the throttle trigger position is adjusted forward or backward, the Throttle Trigger Position Adjustment Indicator will move forward or backward.

**Throttle Trigger Tension Adjustment Screw:** Used to adjust the spring tension of the throttle trigger to best suit the feel of the user. Turning the Throttle Trigger Tension Adjustment Screw clockwise increases throttle trigger tension and turning the Throttle Trigger Tension Adjustment Screw counter-clockwise decreases throttle trigger tension.

**Throttle Trigger Position Adjustment Screw:** Used to adjust the position of the Throttle Trigger either forward or backward.

**Trim Switch:** The transmitter features four separate Trim Switches positioned around the steering wheel (Trm1, Trm2, Trm3 and Trm4). Each Trim Switch is programmable and will perform a different function depending on what function is assigned to it. For example, Trm1 and Trm2 can be used to adjust steering and throttle Trim and Trm4 and Trm5 can be used to adjust Dual Rate and steering EPA.

**Wrist Strap Anchor Slot:** Used to attach the wrist strap anchor to the transmitter.

## SERVO CONNECTORS

The 92010 (RX-461) 4-Channel 2.4GHz FHSS-4T Telemetry receiver included with your *MT-4 2.4GHz FHSS-4T* radio control system uses Airtronics 'Z' connectors which are electronically compatible with the servos of other radio control system manufacturers. The connectors are rugged, but should be handled with care.



If using another brand of servo, double-check the polarity of the servo connector prior to plugging it into the receiver.



When unplugging the servo connector, it's best not to pull on the servo wire itself. This could result in damage to the servo wire pins in the plastic plug. Always grasp the plastic connector itself.

## TRANSMITTER SAFETY ALARMS AND LED CONDITION INDICATORS

The *MT-4 2.4GHz FHSS-4T* transmitter is equipped with several different safety alarms to warn you of an abnormal transmitter condition. In addition, LED 1 and LED 2 can also be used to indicate various transmitter conditions.

### Over Voltage Alarm

The Over Voltage Alarm will sound if the transmitter battery voltage is greater than 9.6 volts. To clear this alarm, turn the transmitter 'OFF' and replace the transmitter battery with one that when fully charged does not exceed 9.6 volts.

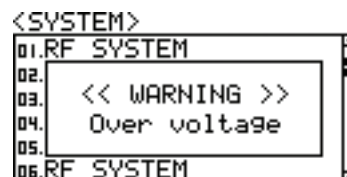

The *MT-4 2.4GHz FHSS-4T* transmitter's Operating Voltage Range is 4.0 ~ 9.6 volts. DO NOT use a transmitter battery with a voltage greater than 9.6 volts or the transmitter can be damaged!

# FEATURES FAMILIARIZATION

## TRANSMITTER SAFETY ALARMS AND LED CONDITION INDICATORS, CONTINUED....

### Inactivity (Power ON) Alarm

The Inactivity Alarm will sound if the transmitter is left on for a period of 10 minutes without any control input from the user. This alarm alerts you to prevent unwanted draining of the transmitter battery. To clear this alarm, either turn the transmitter 'OFF' or press the Back/Cancel key or the Push-Button Rotary Dial.

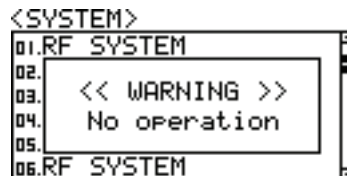

### Low Voltage Alert Alarm

The Low Voltage Alert alarm will sound when the transmitter batteries reach the Alert Voltage value programmed in the SYSTEM - ALARM menu. The alarm will sound each time the transmitter battery voltage decreases by 0.1 volt. To clear this alarm, press the Back/Cancel key or the Push-Button Rotary Dial. For more information, see the *Voltage Alarm* section on pages 64 and 65.

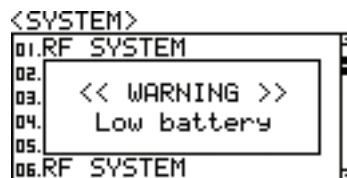

### Low Voltage Limit Alarm

The Low Voltage Limit alarm will sound when the transmitter batteries reach the Limit Voltage value programmed in the SYSTEM - ALARM menu. This alarm can only be cleared by turning the transmitter 'OFF' and recharging or replacing the transmitter batteries. For more information, see the *Voltage Alarm* section on pages 64 and 65.

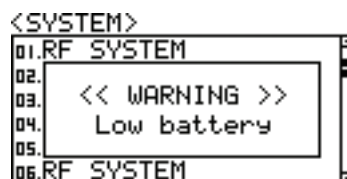

### Temperature Alert Alarm

The Temperature Alert alarm will sound when the TEMP1 and/or TEMP2 temperature reaches the Alert Temperature value programmed in the SYSTEM - TELEMETRY menu. To clear this alarm, press the Back/Cancel key or the Push-Button Rotary Dial. For more information, see the *Changing the Alert Temperature Value* section on page 67.

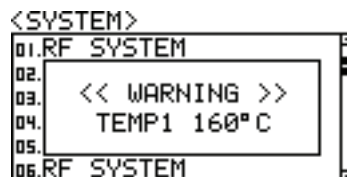

### Voltage Alert Alarm

The Voltage Alert alarm will sound when the receiver battery in your model reaches the Alert Voltage value you've programmed in the SYSTEM - TELEMETRY menu. To clear this alarm, press the Back/Cancel key or the Push-Button Rotary Dial. For more information, see the *Changing the Alert Voltage Value* section on pages 68 and 69.

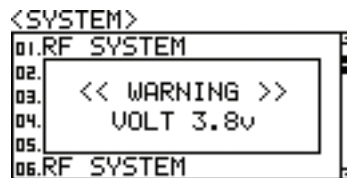

### LED Condition Indicators

LED 1 (Blue) and LED 2 (Red) can be used to determine various transmitter conditions at a glance. The LEDs will alert you to various warnings and other transmitter conditions, as shown in the table below.

LED COLOR	LED CONDITION	LED CONDITION DESCRIPTION
Blue	ON	RF Output Signal OK
Blue	Flash	Throttle Offset Value ON with Positive or Negative Value Programmed
Blue	Slow Flash	Telemetry Logger Function Operating
Blue	Fast Flash	Anti-Lock Braking Function Operating
Red	ON	No Transmitter/Receiver Telemetry Connection
Red	Flash	Telemetry Alarm Started
Red	Flash	Low Voltage Alert Alarm Started
Blue and Red	Flash Alternately	Bind Command Transmitted
Blue and Red	Flash	Inactivity (Power ON) Alarm Started
Blue and Red	Fast Flash Alternately	Low Voltage Limit Alarm Started
Blue and Red	Fast Flash Alternately	Over Voltage Alarm Started

# SYSTEM CONNECTIONS

## TRANSMITTER BATTERY OPTIONS

The MT-4 2.4GHz FHSS-4T transmitter's Operating Voltage Range is 4.0 ~ 9.6 volts. This allows you to use several different battery options (not included), depending on your preference.

**Alkaline** - In the default configuration, the transmitter is designed to be powered using four 'AA' Alkaline batteries. This results in a transmitter that is lightweight and well-balanced for unmatched comfort.

**Ni-Cd/Ni-MH** - Rechargeable Ni-Cd or Ni-MH batteries of desired capacity can be used in place of the Alkaline batteries. Using rechargeable Ni-Cd or Ni-MH batteries is more convenient and cheaper in the long run. The higher capacity batteries will also provide longer usage time than most Alkaline batteries.

**Li-Po or Li-Fe/A123** - A 2 cell Li-Po battery pack or a 2 cell Li-Fe/A123 battery pack can be used to power the transmitter. These battery packs are popular due to their light weight and high capacity for long usage time between charges.

 Transmitter power output, range, and speed are the same, regardless of the battery voltage and type used. If using a Li-Po or Li-Fe/A123 battery pack, please observe the warnings in the *Warnings if Using Li-Po or Li-Fe/A123 Batteries* section below.

## ALKALINE BATTERY INSTALLATION

- 1) Remove the battery cover from the bottom of the transmitter by pushing firmly on the battery cover in the direction of the arrow.
- 2) Install four fresh 'AA' Alkaline batteries into the battery holder, making sure that the polarity is correct. The direction that each battery should be installed is molded into the bottom of the battery holder (+ Positive and - Negative).
- 3) Slide the battery cover back onto the transmitter and push it firmly until it 'clicks' closed.

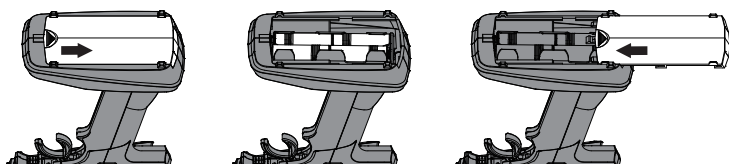

## TRANSMITTER BATTERY CHARGING OPTIONS

The MT-4 2.4GHz FHSS-4T transmitter features a Charging Jack that can be used with the Airtronics 95034 Dual Output charger (available separately) to charge the optional Ni-Cd or Ni-MH batteries. This allows you to charge these batteries without removing them from the transmitter.

**WARNING:** Do NOT attempt to recharge Alkaline batteries. Only Ni-Cd or Ni-MH batteries should be charged through the transmitter's Charging Jack, using only the Airtronics 95034 Dual Output charger or equivalent. DO NOT attempt to charge Li-Po or Li-Fe/A123 batteries through the Charging Jack. Do Not use the Charging Jack with a fast charger or a peak-detection charger, or the transmitter could be damaged.

If you use a fast charger or a peak-detection charger to charge the transmitter batteries, the battery holder must be removed from the transmitter first. The circuitry within the transmitter will interfere with the peak-detection charger's normal operation, resulting in over-charging and damaging the battery and possibly the transmitter itself. In addition, the higher charge rate common in many fast chargers can damage the transmitter's circuitry. Damage caused by fast-charging through the transmitter or using an incorrect battery type will not be covered under warranty.

## WARNINGS IF USING LI-PO OR LI-FE/A123 BATTERIES

- Use **ONLY** a 2 Cell Li-Po or Li-Fe/A123 battery pack of desired capacity.

 Both the transmitter and receiver have a Nominal Input Voltage of 4.8 ~ 7.4 volts. **DO NOT USE A 3 CELL LI-PO OR LI-FE/A123 BATTERY PACK** or the transmitter and/or receiver will be damaged.

- Do NOT charge your Li-Po or Li-Fe/A123 battery pack through the transmitter Charging Jack. The battery pack **MUST** be removed from the transmitter for charging or the transmitter could be damaged.
- Use a charger specifically designed to charge Li-Po or Li-Fe/A123 batteries.
- When changing the connector on your battery pack to match the battery power plug in the base of the transmitter or on the receiver's on/off switch, please observe correct polarity. Connecting with reverse polarity will damage the transmitter and/or receiver.
- Observe all safety precautions provided with your Li-Po or Li-Fe/A123 battery pack.
- Damage to the transmitter and/or receiver caused by improper use, wrong battery type, incorrect voltage or reverse polarity will not be covered under warranty.

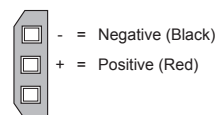

# SYSTEM CONNECTIONS

## RECEIVER CONNECTIONS AND MOUNTING

Use the diagram below to make the connections to the 92010 (RX-461) 4-Channel 2.4GHz FHSS-4T Telemetry receiver included with your *MT-4 2.4GHz FHSS-4T* radio control system.

⚠ The 92010 (RX-461) receiver's Nominal Input Voltage is 4.8 ~ 7.4 volts. A 2 cell Li-Po or 2 cell Li-Fe/A123 battery pack can be used to power the receiver without the use of a voltage regulator. In addition, this allows you to take advantage of the higher torque and speed provided by using 7.4 volt digital servos. **Only use a 2 cell Li-Po or 2 cell Li-Fe/A123 battery pack if your servos are rated to handle the higher voltage.**

⚠ If you're using an Electronic Speed Control with BEC circuitry, verify that it reduces the voltage to between 4.8 and 7.4 volts before making your connections and turning your radio control system 'ON'.

- We suggest Binding the transmitter and receiver and making all receiver connections to check for correct operation prior to mounting the receiver in your model.
- The receiver should be mounted as far away from any electrical components as possible.
- Route the receiver antenna up through a plastic tube so that it is in the vertical position.
- To protect the receiver from vibration and other damage, we recommend wrapping the receiver in shock absorbing foam or using double-sided foam tape when installing it in your model.

**IMPORTANT:** The receiver battery can be plugged into any channel slot to power the receiver. To utilize all channels and a separate receiver battery, a Y-Harness (not included) must be used. Not all items shown in the illustration below are included with your radio control system.

⚠ As a safety precaution, set your model on a stand so the wheels are off the ground before turning on your radio control system or connecting your motor for the first time.

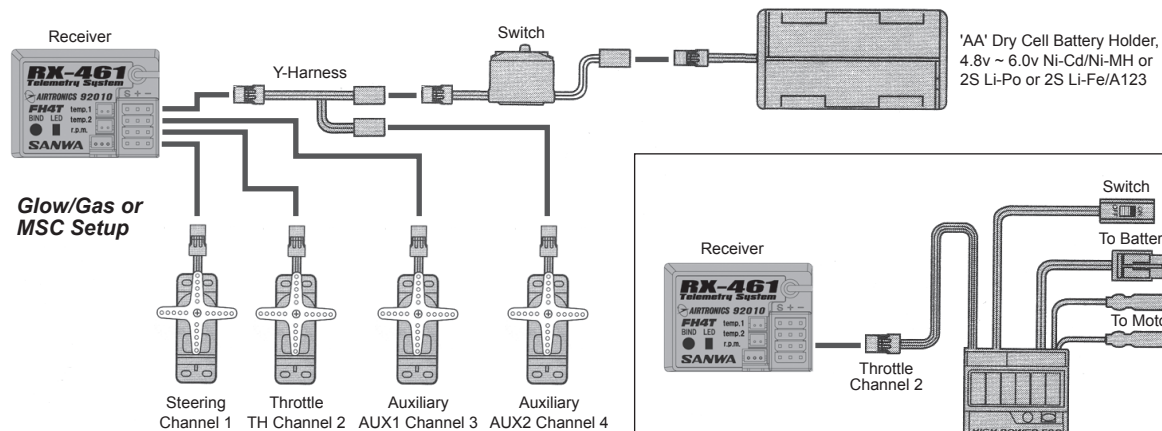

**Glow/Gas or MSC Setup**

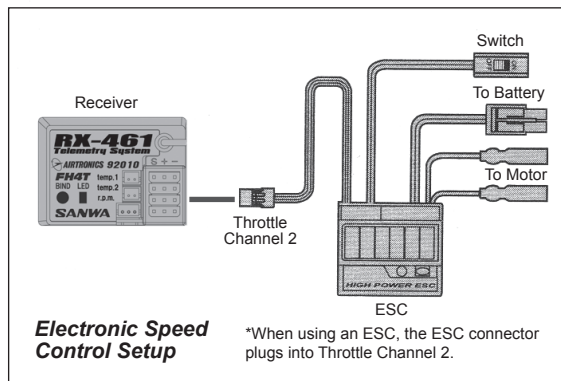

**Electronic Speed Control Setup**

\*When using an ESC, the ESC connector plugs into Throttle Channel 2.

⚠ Do NOT use servos rated for 4.8 or 6.0 volts with a 2S Li-Po or Li-Fe/A123 receiver battery pack or damage to the servos could result.

### Bind LED Condition Indicator

The Bind LED on the receiver can be used to determine receiver condition at a glance. The Bind LED will alert you to various receiver conditions, as shown in the table below.

LED COLOR	LED CONDITION	LED CONDITION DESCRIPTION
Blue	ON	Receiving RF Signal
Blue	Slow Flash	Binding Operation
Blue	Flash	Receiving Signal Command
Green	ON	Telemetry RPM Sensor Connected and Receiving Input

⚠ For information about connecting and mounting the Telemetry Sensors, see the Telemetry Connections and Mounting section on the next page.

# SYSTEM CONNECTIONS

## TELEMETRY CONNECTIONS AND MOUNTING

### Telemetry Sensor Overview

The MT-4 2.4GHz FHSS-4T radio control system includes one Temperature Sensor and one RPM Sensor, in addition to the Voltage Sensor built into the receiver. These sensors can be installed in your model to give you Temperature and RPM or Speed feedback in real-time displayed on the transmitter's Telemetry Screen.

! The receiver supports the use of two different Temperature Sensors at the same time. If desired, an extra Temperature Sensor can be purchased separately. For more information, see your local Airtronics retailer or visit our website at [www.airtronics.net](http://www.airtronics.net). Telemetry is NOT supported when using FHSS-2 or FHSS-3 receivers.

! The range of the Telemetry System is approximately 260 feet (80 meters), although the range can vary based on many environmental factors. Use the Telemetry Signal Indicator to determine the quality of the signal.

### Plugging the Telemetry Sensors into the Receiver

- 1) Use your fingernail to carefully pry up and remove the plastic dust cover from over the Telemetry Sensor inputs on the receiver.
- 2) Plug the Telemetry Sensor(s) into their respective inputs in the receiver. The Temperature Sensor can be plugged into either the TEMP 1 or the TEMP 2 input and the RPM Sensor is plugged into the RPM input. The sensor plugs are indexed so they can be plugged in only one direction.

! Make sure to push the sensor plugs firmly into their inputs in the receiver to ensure a good connection. When routing sensor wires inside your model, be careful that they cannot come into contact with any moving parts or can be damaged in the event of a crash. The sensor wires should be securely mounted and protected against damage.

### Mounting the Temperature Sensor

The Sensor End should be secured directly against the part of your engine, motor or battery you want to monitor temperature readings from. For example, to monitor the cylinder head temperature of your nitro-powered model, the best place to secure the Sensor End is where the bottom of the cylinder head meets the top of the engine case. The Sensor End can be held in place using a nylon cable tie wrapped around your engine. To monitor the temperature of your battery pack or electric motor, clear tape can be used to secure the Sensor End to the spot you want to monitor.

! Do not try to bend the Sensor End or damage it in any way. The Sensor End should be held in place with a nylon cable tie (tightened only enough to hold the Sensor End securely) or clear tape. In some cases, you may need to use high-temperature tape to ensure strong adhesion at higher temperatures.



### Mounting the RPM Sensor

The RPM Sensor uses infrared technology to record RPM data from a rotating part, such as a flywheel or a spur gear. One Black and one White reflective decal are included that is attached to the rotating part so that the RPM Sensor can 'see' it as it passes in front of the Sensor Pickup.

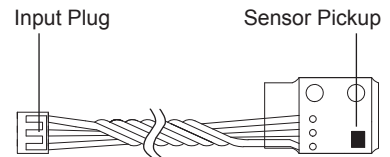

Install the RPM Sensor into your model, making sure that it's held securely in place. **For optimal operation, the Sensor Pickup should be positioned approximately 1mm away from the back of the moving part (flywheel, spur gear, etc.)**

So that the RPM Sensor can work properly, one of the two reflective decals included needs to be applied to the back of the moving part so that when the part rotates, the reflective decal passes in front of the Sensor Pickup. If the flywheel or spur gear is metallic-colored (silver, aluminum, chrome, etc.), apply the BLACK reflective decal. If the flywheel or gear is dark-colored (black, blue or another dark color), apply the WHITE reflective decal.

! When installed, it's important that the Sensor Pickup face the flywheel, spur gear or other moving part. The Black or White reflective decal should be applied to the back side of the flywheel or spur gear and positioned so that the reflective decal passes in front of the Sensor Pickup when the flywheel or spur gear is rotated. It's important that the reflective decal you apply contrasts with the flywheel or spur gear it's applied to and the Sensor Pickup should be approximately 1mm away from the reflective decal.

### RPM Sensor Bind LED

When the Sensor Pickup is receiving input, the Bind LED on the receiver will turn Green. For example, when you rotate the spur gear, the Bind LED will flash Green each time the reflective decal on the spur gear passes in front of the Sensor Pickup. This feedback is used to calibrate the RPM Sensor to display the speed of your model in either MPH or KM/H. For more information, see the *Calibrating the RPM Sensor* section on page 70.

# ADJUSTMENTS AND OPTIONS

## THROTTLE TRIGGER POSITION ADJUSTMENT

The position of the throttle trigger can be adjusted forward or backward to change the feel of the throttle trigger during use. Some users may prefer the throttle trigger positioned farther forward and some users may prefer the throttle trigger positioned farther back. It all depends on your personal preference.

To adjust the throttle trigger position, follow the step below:

- 1) To move the throttle trigger backward, use a # 1 philips head screwdriver to turn the Throttle Trigger Position Adjustment Screw (A) counter-clockwise. To move the throttle trigger forward, turn the Throttle Trigger Position Adjustment Screw clockwise.

⚠ As you adjust the throttle trigger position, the Throttle Trigger Position Adjustment Indicator (B) will move, indicating the current position of the throttle trigger.

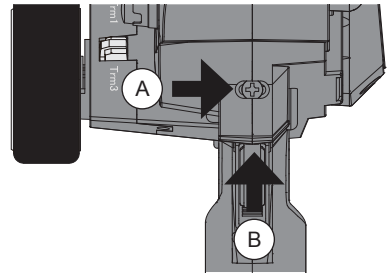

⚠ Moving the throttle trigger position does not affect the physical movement of the throttle trigger. Do not attempt to adjust the throttle trigger position beyond the limits indicated by the Throttle Trigger Position Adjustment Indicator or damage to the transmitter may result.

## THROTTLE TRIGGER ANGLE ADJUSTMENT

The angle of the throttle trigger can be adjusted right or left to change the feel of the throttle trigger during use. Some users may prefer the throttle trigger straight while some users may prefer the throttle trigger angled toward the right or left. It all depends on your personal preference. Throttle trigger adjustment plates are included to fine-tune the angle.

To adjust the throttle trigger angle, follow the steps below:

- 1) Use a # 1 philips head screwdriver to remove the throttle trigger mounting screw (A) from the left side of the transmitter.
- 2) Use the tip of a modeling knife to carefully pop the trigger adjustment plate (B) out of the transmitter.

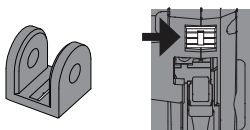
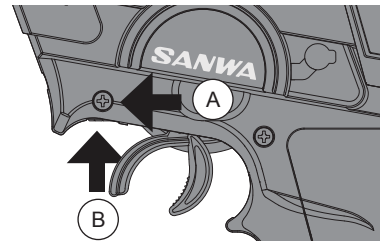

A - Throttle Trigger Centered (Stock)

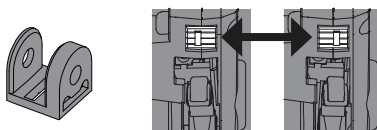

B - Throttle Trigger Angled Slightly.  
Angle Right or Left Depending on Orientation.

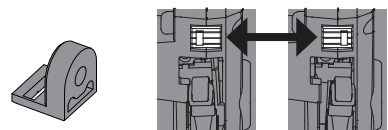

C - Throttle Trigger Angled More.  
Angle Right or Left Depending on Orientation.

- 3) Carefully press the desired trigger adjustment plate into the transmitter, making sure to orientate it in the direction you want to angle the throttle trigger, then reinstall and tighten the throttle trigger mounting screw.

## GRIP

Included is an optional molded rubber grip that is shaped differently from the stock grip that's preinstalled on the transmitter. The optional grip is larger and straight near the bottom, which some users may find more comfortable.

To install the optional grip, follow the steps below:

- 1) Remove the original grip from the handle by firmly pulling down on the back of the grip (at the top), then by pulling the grip out along its front edges.
- 2) To install the new grip, align the molded tabs in the grip with the matching slots in the handle, then firmly push the molded tabs into the slots, working your way around the grip until the edges of the grip are flush with the handle.

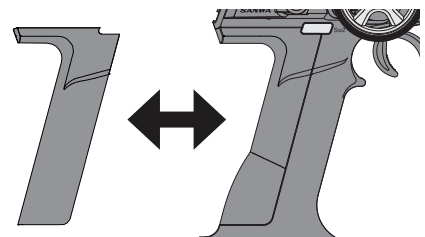

# ADJUSTMENTS AND OPTIONS

## THROTTLE TRIGGER AND STEERING WHEEL SPRING TENSION ADJUSTMENT

The spring tension of the throttle trigger and steering wheel can be adjusted to best suit the user. Some users may prefer the throttle trigger and/or steering wheel to feel 'firmer' and some users may prefer them to feel 'softer'. It all depends on your personal preference.

To adjust the throttle trigger spring tension, follow the step below:

- 1) To increase the spring tension of the throttle trigger (firmer), use a 1.5mm hex wrench to turn the Throttle Trigger Tension Adjustment Screw (A) clockwise. To decrease the spring tension of the throttle trigger (looser), turn the Throttle Trigger Tension Adjustment Screw counter-clockwise.

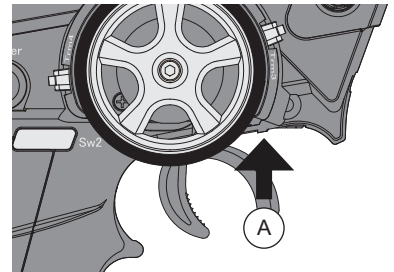

To adjust the steering wheel spring tension, follow the step below:

- 1) To increase the spring tension of the steering wheel (firmer), use a 1.5mm hex wrench to turn the Steering Wheel Tension Adjustment Screw (A) clockwise. To decrease the spring tension of the steering wheel (looser), turn the Steering Wheel Tension Adjustment Screw counter-clockwise.

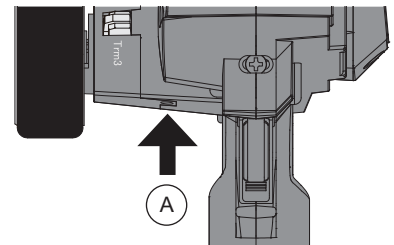

## STEERING WHEEL TRAVEL ADJUSTMENT

The maximum right and left travel of the steering wheel can be adjusted to best suit the feel of the steering wheel and your driving style. Some drivers prefer to limit the travel of the steering wheel as it makes them feel more 'connected' to their model.

To adjust the maximum travel of the steering wheel, follow the steps below:

- 1) Remove the foam steering wheel grip from the steering wheel by firmly pulling it straight off.
- 2) To limit the maximum travel of the steering wheel, use a 1.5mm hex wrench to turn both grub screws (A) clockwise equally the desired amount. To maximize the travel of the steering wheel, turn both grub screws counter-clockwise equally the desired amount.

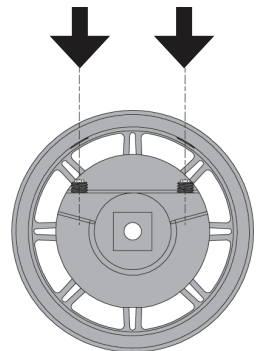

**!** After making steering wheel travel adjustments, you must use the Variable Rate Adjustment function to ensure your steering servo travel limits are equal. For more information, see the *Variable Rate Adjustment* section on page 71.

**!** Limiting the maximum travel of the steering wheel will increase the sensitivity of the steering. We recommend setting negative Exponential to soften the control feel around Neutral. For more information, see the *Exponential and ARC Adjustment* section on pages 23 ~ 25.

## WRIST STRAP ANCHOR

A wrist strap anchor is included that can be installed onto the transmitter to facilitate the use of a wrist strap (not included).

To install the wrist strap anchor, follow the steps below:

- 1) Remove the self-tapping screw (A) from the transmitter, using a # 1 philips head screwdriver.
- 2) Slide the wrist strap anchor into the mounting slot in the back of the transmitter, then reinstall and tighten the self-tapping screw.

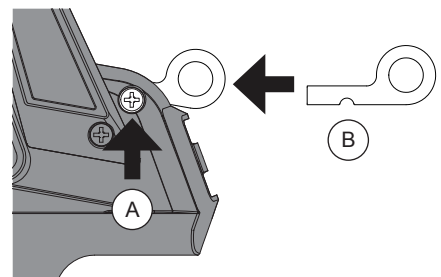

**!** When installing the wrist strap anchor, note its orientation. The U-Shaped groove in the base of the wrist strap anchor should be pointing down.

# LCD AND PROGRAMMING KEYS

The MT-4 2.4GHz FHSS-4T transmitter features a Push-Button Rotary Dial and a Back/Cancel key that are used to facilitate transmitter programming. This section describes the main areas of the different Multi-Function LCD screens, in addition to summarizing the functions of the Push-Button Rotary Dial and the Back/Cancel key.

## TOP SCREEN AND TELEMETRY SCREEN OVERVIEW

Use the diagrams in this section to familiarize yourself with the layout and different indicators and displays that comprise the Top Screen and the Telemetry Screen.

### TOP SCREEN

The Top Screen is displayed when you turn the transmitter 'ON'. The Top Screen displays all pertinent information, such as the Model Name, Modulation Type, Timer, Servo Monitor and much more.

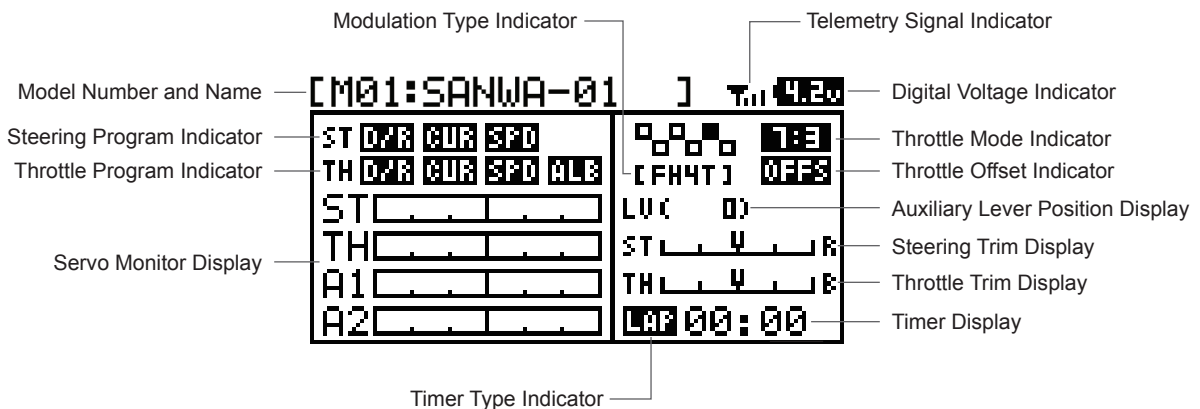

### TELEMETRY SCREEN

The Telemetry Screen displays all pertinent Telemetry information, such as RPM, Temperature and Receiver Voltage. To display the Telemetry Screen, from the Top Screen scroll DOWN using the Push-Button Rotary Dial.

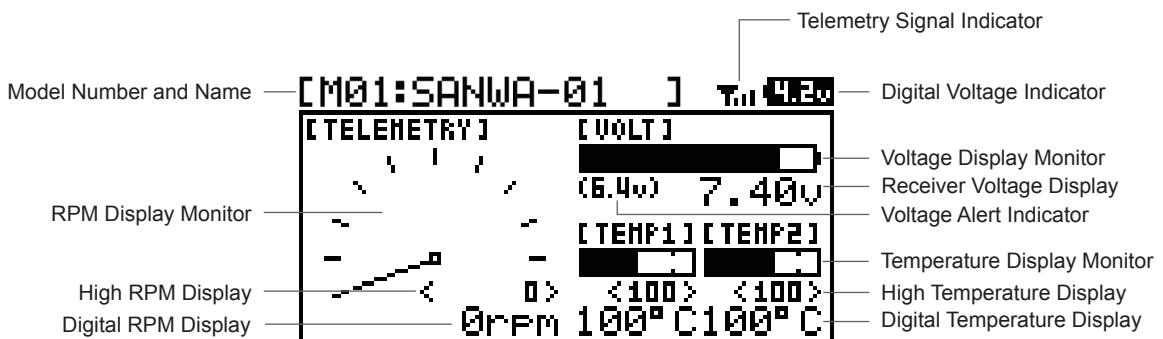

**Auxiliary Lever Position Display:** Displays the current position of the Auxiliary Lever.

**Digital RPM Display:** Displays the current RPM from the RPM Sensor in digital format.

**Digital Temperature Display:** Displays the current temperature from the TEMP1 and TEMP2 Temperature Sensors in digital format.

**Digital Voltage Indicator:** Indicates the current Voltage of the transmitter batteries.

**High RPM Display:** Displays the last highest RPM value. This value can be Reset. For more information, see the *Telemetry Clear Function* section on page 71.

**High Temperature Display:** Displays the last highest Temperature value. These values can be Reset. For more information, see the *Telemetry Clear Function* section on page 71.

**Modulation Type Indicator:** Indicates the current Modulation Type that the transmitter is set to.

**Model Number and Name:** Displays the Model Number and Model Name of the currently selected model.

**Receiver Voltage Display:** Displays the current voltage of the receiver battery.



# LCD AND PROGRAMMING KEYS



## TOP SCREEN AND TELEMETRY SCREEN OVERVIEW, CONTINUED...

- RPM Display Monitor:** Displays the current RPM from the RPM Sensor in graphical format.
- Servo Monitor Display:** Displays the output levels of the four different channels in bar graph form, allowing you to monitor servo operation in a virtual manner.
- Steering Program Indicator:** Indicates up to four different programming options that are currently programmed to the Steering channel. The Steering Program Indicator will only be displayed if a Steering channel programming value is programmed.
- Steering Trim Display:** Displays the current position of the Steering Trim Switch.
- Telemetry Signal Indicator:** Indicates the current signal strength of the Telemetry connection between the transmitter and receiver. The Telemetry Signal Indicator will only be displayed when the receiver is turned 'ON' and there is a Telemetry connection Active.
- Temperature Display Monitor:** Displays the current TEMP1 and TEMP2 temperatures in bar graph format.
- Throttle Mode Indicator:** Indicates the current Throttle Mode type.
- Throttle Offset Indicator:** Indicates that the Throttle Offset function is programmed. The Throttle Offset Indicator will only be displayed if a Throttle Offset percentage value is programmed.
- Throttle Program Indicator:** Indicates up to four different programming options that are currently programmed to the Throttle channel. The Throttle Program Indicator will only be displayed if a Throttle channel programming value is programmed.
- Throttle Trim Display:** Displays the current position of the Throttle Trim Switch.
- Timer Display:** Displays the time of the currently selected Timer.
- Timer Type Indicator:** Indicates the current Timer Type selected, either LAP or INT (Interval).
- Voltage Alert Indicator:** Indicates the currently programmed Voltage value that the receiver Voltage Alert alarm will sound at.
- Voltage Display Monitor:** Displays the current receiver battery voltage in bar graph format.

## PROGRAMMING KEYS OVERVIEW AND FUNCTIONS

Moving around the different Multi-Function LCD screens and programming the transmitter is accomplished using the Push-Button Rotary Dial and the Back/Cancel key.

**PRO TIP:** While navigating Programming Menus and changing programming values, keep the following in mind: to choose an option to program, scroll UP or DOWN to highlight the desired option. Press the ENTER key and the highlighted option will flash, indicating the programming value can be changed. Once you've changed the programming value, press the ENTER key again or press the Back/Cancel key and the highlighted option will stop flashing, indicating you can scroll UP or DOWN to highlight another programming option.

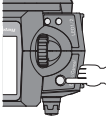
PROGRAMMING KEY	NAME	FUNCTION
	▲ Push-Button Rotary Dial (Scroll UP)	Scrolls the cursor Right or Up. In addition, increases programming values.
	Push-Button Rotary Dial (Scroll DOWN) ▼	Scrolls the cursor Left or Down. In addition, decreases programming values.
	Push-Button Rotary Dial Push (ENTER)	Opens the selected menu or programming option. Press and HOLD to reset the selected programming option to its default value.
	Back/Cancel Key	Returns to the previous menu. Press and HOLD to return to the Top Screen.

# TRANSMITTER AND RECEIVER BINDING

The Binding function allows you to 'Bind' the transmitter and receiver pair. When new, it is necessary to pair the transmitter and receiver to prevent interference from transmitters operated by other users. This operation is referred to as 'Binding'. Once the Binding process is complete, the setting is remembered even when the transmitter and receiver are turned 'OFF'. Therefore, this procedure usually only needs to be done once.

 Under some circumstances, the receiver may not operate after turning the transmitter and receiver 'ON'. If this occurs, perform the Binding process again.

**IMPORTANT:** This section details Binding the 92010 (RX-461) 4-Channel 2.4GHz FHSS-4T Telemetry receiver with Digital or Analog servos set to Normal mode. If you are Binding an FHSS-2 or FHSS-3 receiver to the transmitter, or if you prefer to change the Servo Operating Mode, see the *Binding, Modulation Type and Servo Mode* section on pages 54 and 55.

 Before beginning the Binding process, connect your servos and receiver battery pack to the receiver. For more information, see the *Receiver Connections and Mounting* section on page 12. The transmitter and the receiver should be turned 'OFF'.

## Transmitter and Receiver Binding

- 1) Turn the transmitter 'ON'. The Top Screen will be displayed. Press the ENTER key (Push-Button Rotary Dial) to open the Programming Menu list, then scroll UP or DOWN to highlight the SYSTEM menu. Press the ENTER key to open the SYSTEM menu, then scroll DOWN to highlight the BIND menu. Press the ENTER key to open the BIND menu.

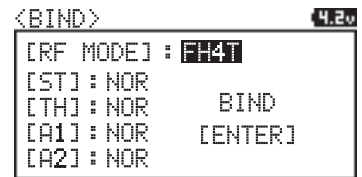

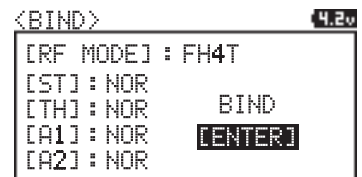

 Verify that [RF MODE]: FH4T is displayed. If it isn't, change the Modulation Type to FH4T. For more information, see the *Changing the Modulation Type* section on page 54.

- 2) Scroll UP or DOWN to highlight the [ENTER] command.

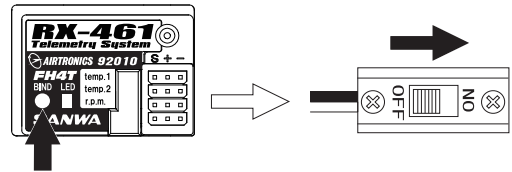

- 3) While holding down the Bind Button on the receiver, turn the receiver 'ON'. The Bind LED on the receiver will flash slowly. After approximately 2 seconds, release the Bind Button. The Bind LED on the receiver will continue to flash slowly.



 Use the tip of a non-conductive instrument to press the Bind Button on the receiver. Do NOT use a sharp object!

- 4) Press the ENTER key. The [ENTER] command will begin to flash and the Bind LED on the receiver will flash rapidly, then go out.

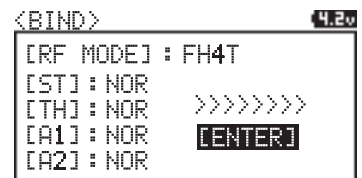

- 5) After the Bind LED on the receiver goes out, press the ENTER key a second time. The Bind LED on the receiver will illuminate solid blue and LED 2 on the transmitter will go out, indicating that the Binding procedure is complete and a Telemetry connection has been made.



- 6) Move the steering wheel and throttle trigger to verify that the servos are operating normally, then press and HOLD the Back/Cancel key to return to the Top Screen.

 When the Binding procedure is successful, the Bind LED on the receiver and LED 1 on the transmitter will illuminate solid blue. If the Bind LED on the receiver is flashing rapidly or is not illuminated at all, the transmitter and receiver are not paired. In this case, turn both the transmitter and receiver 'OFF', then repeat the Binding procedure again.

# PROGRAMMING MENUS

## OVERVIEW

To access the various Programming Menus, turn the transmitter 'ON', then press the ENTER key (Push-Button Rotary Dial). A list of Programming Menus will be displayed along the right side of the screen and the last Programming Menu when the transmitter was turned 'OFF' will be highlighted. The currently highlighted Programming Menu will be displayed in the background.

The following Programming Menus are available by scrolling UP or DOWN using the Push-Button Rotary Dial:

PROGRAMMING MENUS

MENU	MENU NAME	MENU DESCRIPTION	PAGE #
01.CH-SET	Channel Set	Change Common Programming Options in One Convenient Location	PG. 19
02.D/R	Dual Rate	Adjust Channel Dual Rates	PG. 20
03.EPA	End Point Adjustment	Adjust Channel End Points	PG. 22
04.CURVE	Curve	Adjust Channel Exponential or Adjustable Rate Control (ARC)	PG. 23
05.SPEED	Servo Speed	Slow Down Servo Speed in the Forward and Return to Neutral Directions	PG. 25
06.ALB	Anti-Lock Braking	Program the Anti-Lock Braking Function	PG. 27
07.OFFSET	Throttle Offset	Program the Throttle Offset Position	PG. 28
08.AUX1	Auxiliary 1	Choose and Adjust Auxiliary 1 Channel 3 Functions and Programming	PG. 29
09.AUX2	Auxiliary 2	Choose and Adjust Auxiliary 2 Channel 4 Functions and Programming	PG. 36
10.TRIM	Servo Trim	Adjust Servo Trim and Servo Sub-Trim	PG. 42
11.REV	Servo Reversing	Change the Direction that the Servos Travel	PG. 44
12.TIMER	Lap and Interval Timers	Program the Lap Timer and the Interval Timer	PG. 44
13.LAP	Lap Times	Displays Current, Past and Best Lap Times	PG. 47
14.F/S	Fail Safe	Program Fail Safe Settings	PG. 48
15.LOGGER	Telemetry Logging	View Logs of Temperature, Voltage and RPM Telemetry Data	PG. 49
16.SYSTEM	System Menu	Access the System Menu	PG. 51

## 01.CH-SET (CHANNEL SET)

The Channel Set function allows you to make programming changes to each of the four channels without the need to enter each Programming Menu separately. Essentially, the Channel Set function encompasses the most common programming options in one convenient location. For example, you can make all of your desired programming changes, such as End Point Adjustment, Exponential, Servo Speed, Fail Safe settings, etc., for each channel, all from within the same menu.

 This section details how to use the Channel Set function. For information about programming each of the Programming Menus within the CH-SET menu, refer to the specific Programming Menu sections on the pages shown in the table above.

- From the Top Screen, press the ENTER key to open the Programming Menu list.
- Scroll UP or DOWN to highlight the CH-SET menu, then press the ENTER key. The CH-SET menu will be displayed and the cursor will default to [ST].
- Scroll DOWN to move the cursor to the channel you would like to make programming value changes to. Choose from <CH-SET> [ST] (Steering), <CH-SET> [TH] (Throttle), <CH-SET> [A1] (Auxiliary 1) or <CH-SET> [A2] (Auxiliary 2).

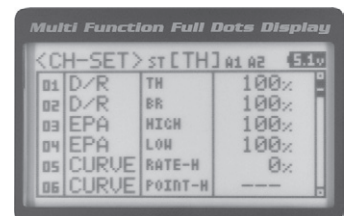
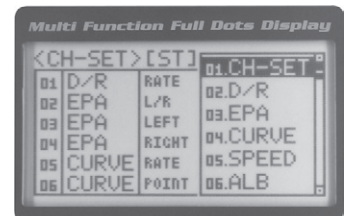

# PROGRAMMING MENUS

## 01.CH-SET (CHANNEL SET), CONTINUED....

- 4) Press the ENTER key to highlight the programming value in the upper right corner.
- 5) Scroll UP or DOWN to highlight the programming value you would like to change, then press the ENTER key to select it. The highlighted programming value will flash indicating you can change the programming value. Scroll UP or DOWN to change the programming value

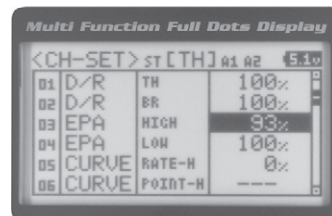

- 6) After changing the desired programming value, press the ENTER key or the Back/Cancel key and the highlighted option will stop flashing, indicating you can scroll UP or DOWN to highlight another programming option. To change to another channel, press the Back/Cancel key, then scroll UP or DOWN to select the desired channel. Repeat steps 4 and 5 above to change the desired programming values for that channel.
- 7) When complete, press and HOLD the Back/Cancel key to return to the Top Screen.

The following Programming Menus are available from within the Channel Set menu:

[ST] STEERING	[TH] THROTTLE	[A1] AUXILIARY 1	[A1] AUXILIARY 2
01.D/R - RATE	01.D/R - TH	01.EPA - HIGH	01.EPA - HIGH
02.EPA - L/R	02.D/R - BR	02.EPA - LOW	02.EPA - LOW
03.EPA - LEFT	03.EPA - HIGH	03.CURVE - RATE	03.CURVE - RATE
04.EPA - RIGHT	04.EPA - LOW	04.CURVE - POINT	04.CURVE - POINT
05.CURVE - RATE	05.CURVE - RATE-H	05.CURVE	05.CURVE
06.CURVE - POINT	06.CURVE - POINT-H	06.CURVE	06.CURVE
07.SPEED - FORWARD	07.CURVE - RATE-B	07.SPEED - FORWARD	07.SPEED - FORWARD
08.SPEED - RETURN	08.CURVE - RATE-H	08.SPEED - RETURN	08.SPEED - RETURN
09.TRIM	09.SPEED - FORWARD	09.TRIM	09.TRIM
10.SUB-T	10.SPEED - RETURN	10.SUB-T	10.SUB-T
11.REV - NOR/REV	11.ALB - POINT	11.REV - NOR/REV	11.REV - NOR/REV
12.F/S	12.ALB - STROKE	12.F/S	12.F/S
	13.ALB - LAG		
	14.ALB - RELEASE		
	15.ALB - HOLD		
	16.TRIM		
	17.SUB-T		
	18.REV - NOR/REV		
	19.F/S		

## 02.D/R (DUAL RATE)

The Dual Rate function allows you to change the control authority of the Steering, Throttle High Side and Throttle Brake Side by changing the amount of servo travel relative to control input. For example, by increasing the Steering Dual Rate, you can make the steering servo travel more which might prevent your model from pushing during turns. If your model oversteers during turns, you can reduce the amount of Steering Dual Rate.

**IMPORTANT:** Prior to programming the Dual Rate function, you should adjust the maximum Left and Right (or High and Low) End Points, using the End Point Adjustment function. For more information, see the *End Point Adjustment* section on pages 22 and 23.

 Dual Rate is a percentage of End Point Adjustment. For example, if you set the Steering Dual Rate percentage value to 100%, the steering will travel the same amount as defined by your End Point Adjustment programming. If you set the Steering Dual Rate percentage value to 50%, the steering will travel half that amount.

# PROGRAMMING MENUS

## 02.D/R (DUAL RATE), CONTINUED...

**PRO TIP:** Use the Servo Monitor at the bottom of the Dual Rate menu to see your programming changes in virtual real time.

### Adjusting the Steering Dual Rate Percentage Value

- 1) From the Top Screen, press the ENTER key to open the Programming Menu list.
- 2) Scroll UP or DOWN to highlight the D/R menu, then press the ENTER key. The D/R menu will be displayed and [ST] : RATE 100% will be highlighted.

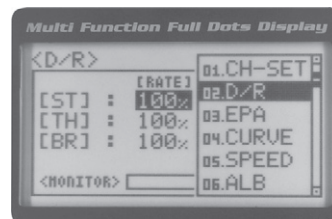

- 3) Press the ENTER key, then scroll UP or DOWN to increase or decrease the Steering Dual Rate percentage value. When the Steering Dual Rate percentage value is decreased, steering servo travel is decreased. When the Steering Dual Rate percentage value is increased, steering servo travel is increased.

D/R ST RATE setting range is 0% to 100%. The default setting is 100%.

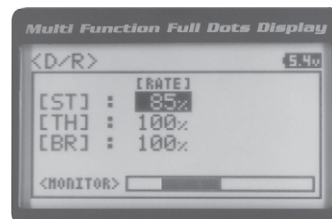

### Adjusting the Throttle Dual Rate Percentage Value

- 1) From within the D/R menu, scroll UP or DOWN to highlight [TH] : RATE 100%.
- 2) Press the ENTER key, then scroll UP or DOWN to increase or decrease the Throttle Dual Rate percentage value. When the Throttle Dual Rate percentage value is decreased, Throttle High side servo travel is decreased. When the Throttle Dual Rate percentage value is increased, Throttle High side servo travel is increased.

D/R TH RATE setting range is 0% to 100%. The default setting is 100%.

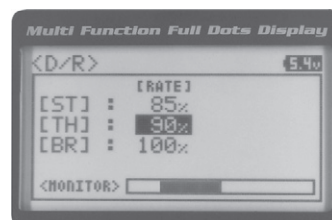

### Adjusting the Brake Dual Rate Percentage Value

- 1) From within the D/R menu, scroll UP or DOWN to highlight [BR] : RATE 100%.
- 2) Press the ENTER key, then scroll UP or DOWN to increase or decrease the Brake Dual Rate percentage value. When the Brake Dual Rate percentage value is decreased, Throttle Brake side servo travel is decreased. When the Brake Dual Rate percentage value is increased, Throttle Brake side servo travel is increased.

D/R BR RATE setting range is 0% to 100%. The default setting is 100%.

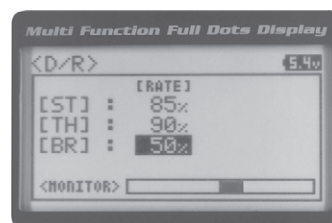

### Controlling the Dual Rate Function

- 1) By assigning the Steering, Throttle and Brake Dual Rate programming functions to one or more of the Trim Switches, Auxiliary Lever or Dial Knob, these functions can be adjusted while driving without accessing the Programming Menu. In addition, these functions can be toggled 'OFF' and 'ON' by assigning them to one or more Push-Button Switches. For more information, see the *Key Assignments* section on pages 56 ~ 61.

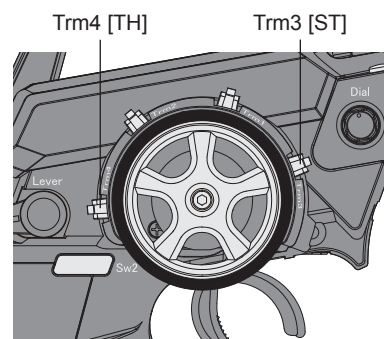

In the default configuration, the Steering and Throttle Dual Rate programming functions are adjusted using Trim Switch Trm3 and Trim Switch Trm4, respectively.

# PROGRAMMING MENUS

## 03.EPA (END POINT ADJUSTMENT)

The End Point Adjustment function allows you to adjust servo travel in each direction. This makes it possible to balance servo travel in both directions and set the maximum desired amount of servo travel. For example, on a gas-powered model, if you pull the throttle trigger and the carburetor does not open completely, you can increase the Throttle High End Point Adjustment so that the carburetor opens completely. Another example is with steering. If your model turns sharper to the right than to the left, you can increase the Steering Left End Point Adjustment to balance the steering. The End Point Adjustment function can be adjusted for the Steering channel (Right and Left), the Throttle channel (Throttle High Side and Throttle Brake Side), Auxiliary 1 Channel 3 (High and Low) and Auxiliary 2 Channel 4 (High and Low).

**WARNING** End Point Adjustment percentage values should not be increased to the point where your linkages and servos bind when moved all the way to the right or left. Binding will cause the servos to 'buzz', resulting in a quicker loss of battery power and eventual damage to the servos.

**PRO TIP:** Use the Servo Monitor at the bottom of the End Point Adjustment menu to see your programming changes in virtual real time.

⚠ Before making End Point Adjustments, the servo horn needs to be centered. Install the servo horn onto the servo, making sure it's as close to being centered as possible, then use the Servo Sub-Trim function to center the servo arm exactly. For more information, see the *Adjusting the Servo Sub-Trim Values* section on page 42.

### Adjusting the Steering End Point Adjustment Percentage Values

Your model's turning radius can differ from left to right because of variations in linkage, suspension balance, tire diameter, or weight distribution. In such cases, Left Steering servo travel and Right Steering servo travel are adjustable using the End Point Adjustment function.

- 1) From the Top Screen, press the ENTER key to open the Programming Menu list.
- 2) Scroll UP or DOWN to highlight the EPA menu, then press the ENTER key. The EPA menu will be displayed and [ST] : EPA L100% will be highlighted.

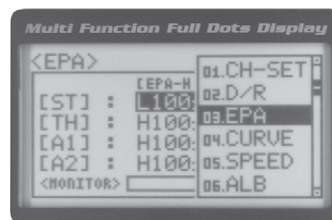

- 3) Press the ENTER key, then scroll UP or DOWN to increase or decrease the Steering Left End Point Adjustment percentage value. Increasing the percentage value will increase steering servo travel in that direction and decreasing the percentage value will decrease steering servo travel in the that direction.

EPA ST L setting range is 0% to 150%. The default setting is 100%.

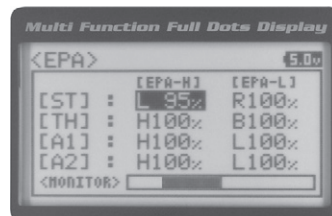
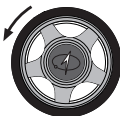

- 4) From within the EPA menu, scroll DOWN to highlight [ST] : EPA R100%. Press the ENTER key, then scroll UP or DOWN to increase or decrease the Steering Right End Point Adjustment percentage value. Increasing the percentage value will increase steering servo travel in that direction and decreasing the percentage value will decrease steering servo travel in the direction.

EPA ST R setting range is 0% to 150%. The default setting is 100%.

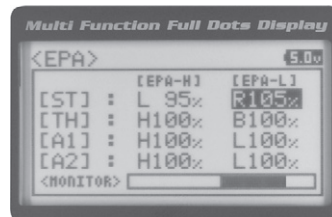

⚠ Steering EPA L/R can be adjusted from within the Channel Set menu. This option changes both Left and Right Steering End Point Adjustment percentage values equally at the same time, which is similar to adjusting Steering Dual Rate.

### Adjusting the Throttle End Point Adjustment Percentage Values

Your model's carburetor may not open completely, or it may open too much and cause the throttle servo to bind. If you're using an Electronic Speed Control, the Electronic Speed Control may not command full power, or the brake may not engage adequately. In such cases, Throttle High servo travel and Throttle Brake servo travel are adjustable using the End Point Adjustment function.

# PROGRAMMING MENUS

## Adjusting the Throttle End Point Adjustment Percentage Values, Continued....

- 1) From within the EPA menu, scroll UP or DOWN to highlight [TH] : EPA H 100%.
- 2) Press the ENTER key, then scroll UP or DOWN to increase or decrease the Throttle High End Point Adjustment percentage value. Increasing the percentage value will increase Throttle High servo travel in that direction and decreasing the percentage value will decrease Throttle High servo travel in that direction.

EPA TH H setting range is 0% to 150%. The default setting is 100%.

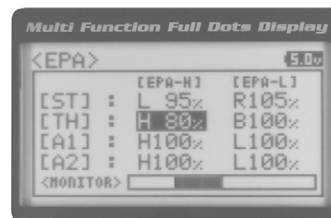

- 3) From within the EPA menu, scroll DOWN to [TH] : EPA B100%. Press the ENTER key, then scroll UP or DOWN to increase or decrease the Throttle Brake End Point Adjustment percentage value. Increasing the percentage value will increase Throttle Brake servo travel in that direction and decreasing the percentage value will decrease Throttle Brake servo travel in that direction.

EPA TH B setting range is 0% to 150%. The default setting is 100%.

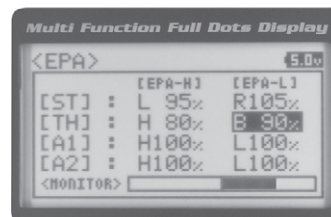

**!** If you're using an Electronic Speed Control, the Throttle High and the Throttle Brake End Point Adjustment percentage values are both generally set to 100%, although the Throttle High direction may need to be increased to achieve full power. In some cases the End Point Adjustments can also be set directly via the Electronic Speed Control.

## Adjusting the Auxiliary 1 Channel 3 and Auxiliary 2 Channel 4 End Point Adjustment Percentage Values

Auxiliary 1 Channel 3 and Auxiliary 2 Channel 4 can be used for a number of different uses. One of the more common uses would be for the reverse function in a glow-powered monster truck. Often, the transmission only requires a small amount of throw, but the servo binds because of too much servo travel. In such a case, Auxiliary High servo travel and Auxiliary Low servo travel are adjustable using the End Point Adjustment function.

- 1) From within the EPA menu, scroll UP or DOWN to highlight [A1] : EPA H 100% or [A2] : EPA H 100%.
- 2) Press the ENTER key, then scroll UP or DOWN to increase or decrease the Auxiliary High End Point Adjustment percentage value. Increasing the percentage value will increase auxiliary servo travel in that direction and decreasing the percentage value will decrease auxiliary servo travel in that direction.

EPAA1 H and EPAA2 H setting range is 0% to 150%. The default setting is 100%.

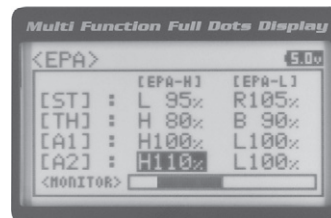

- 3) From within the EPA menu, scroll UP or DOWN to highlight [A1] : EPA L100% or [A2] : EPA L100%. Press the ENTER key, then scroll UP or DOWN to increase or decrease the Auxiliary Low End Point Adjustment percentage value. Increasing the percentage value will increase auxiliary servo travel in that direction and decreasing the percentage value will decrease auxiliary servo travel in that direction.

EPAA1 L and EPAA2 L setting range is 0% to 150%. The default setting is 100%.

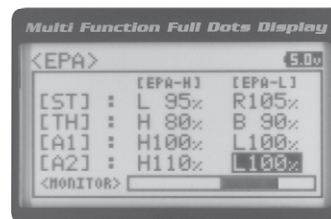

## 04. CURVE (EXPONENTIAL AND ARC ADJUSTMENT)

The Exponential and Adjustable Rate Control (ARC) functions allow you to vary the amount of servo travel in relation to the movement of the steering wheel, throttle trigger and auxiliary lever near the Neutral positions to change the way those functions react to control movement. Decreasing the Exponential or Adjustable Rate Control percentage values will soften the control feel around Neutral and increasing the Exponential or Adjustable Rate Control percentage values will heighten the control feel around Neutral. Using a lower negative value allows for smoother control. Using a higher positive value may result in more 'twitchy' control response. The Exponential and Adjustable Rate Control functions can be adjusted for the Steering channel, the Throttle channel (Throttle High and Throttle Brake), Auxiliary 1 Channel 3 and Auxiliary 2 Channel 4. A graph that depicts the Exponential or Adjustable Rate Control curve is featured to help visualize the changes you make.

# PROGRAMMING MENUS

## 04.CURVE (EXPONENTIAL AND ARC ADJUSTMENT, CONTINUED...)

 The Exponential and Adjustable Rate Control functions work the same, except the Exponential Rate percentage value is programmed from a fixed Neutral Point of 50% and the Adjustable Rate Control Rate percentage value is programmed from a user-adjustable Neutral Point, giving you even greater programming control.

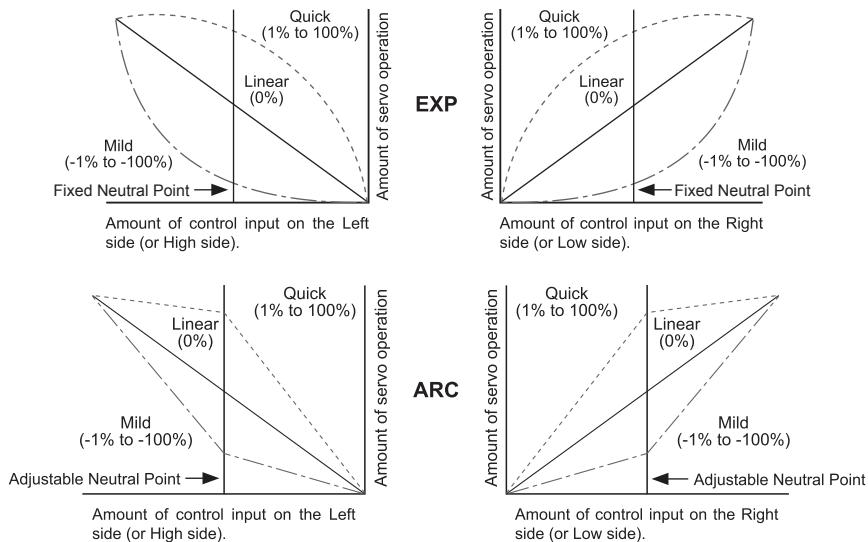

### Choosing the Channel

Exponential or Adjustable Rate Control percentage values can be adjusted from Mild through Linear to Quick to allow you to set the most effective control response for your model. For example, if your model over-steers, reduce the Steering Exponential or Adjustable Rate Control percentage value, and if your model under-steers, increase the Steering Exponential or Adjustable Rate Control percentage value. As another example, reduce the Throttle Exponential or Adjustable Rate Control percentage value on a slippery track or with a model that has a higher-torque motor or engine, and increase the Throttle Exponential or Adjustable Rate Control percentage value on a high-grip track or with a model that has a lower-torque motor or engine.

- 1) From the Top Screen, press the ENTER key to open the Programming Menu list.
- 2) Scroll UP or DOWN to highlight the CURVE menu, then press the ENTER key. The CURVE menu will be displayed and the cursor will default to [ST].

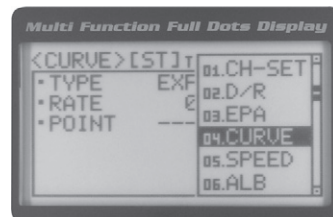

- 3) Scroll DOWN to move the cursor to the channel you would like to make programming value changes to. Choose from <CURVE> [ST] (Steering), <CURVE> [TH] (Throttle), <CURVE> [A1] (Auxiliary 1) or <CURVE> [A2] (Auxiliary 2).

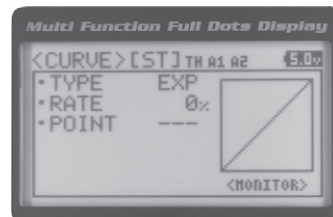

### Choosing the Curve Type

- 1) Press the ENTER key to highlight TYPE EXP. Press the ENTER key a second time, then scroll UP or DOWN to choose the desired Curve Type. If you are programming the Curve function for the Throttle channel, you have the option of adjusting the Curve Type for the Throttle High Side (TYPE-H) and the Throttle Brake Side (TYPE-B) independently.

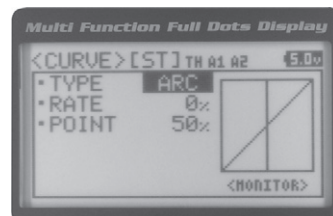

CURVE TYPE setting range is EXP and ARC. The default setting is EXP.



# PROGRAMMING MENUS

## 04. CURVE (EXPONENTIAL AND ARC ADJUSTMENT, CONTINUED...)

### Adjusting the Rate Percentage Value

The Rate percentage value determines the desired amount and type of Exponential or Adjustable Rate Control.

- 1) From within the CURVE menu, scroll DOWN to highlight RATE 0%. Press the ENTER key, then scroll UP or DOWN to increase or decrease the Rate percentage value. Using a negative Rate percentage value will soften the control feel around Neutral and using a positive Rate percentage value will heighten the control feel around Neutral.

CURVE RATE setting range is -100% (Mild) to 100% (Quick). The default setting is 0% (Linear).

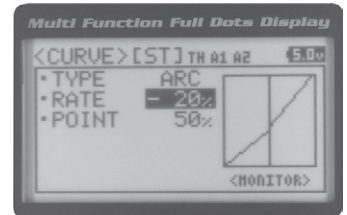

⚠ Changes to the Rate percentage value affects both the channel High side and Low side equally, except for the Throttle channel, which can be adjusted independently.

### Adjusting the Point Percentage Value

The Point percentage value determines the Neutral Point where the Rate percentage value begins. For example, you may not want the Point to be centered between the High and Low End Points. You may want the Point to be offset from the center position.

⚠ The Point percentage value option is available ONLY when the TYPE ARC option is selected.

- 1) From within the CURVE menu, scroll DOWN to highlight POINT 50%. Press the ENTER key, then scroll UP or DOWN to increase or decrease the Point percentage value. Increasing the Point percentage value will shift the Neutral Point to one side of center and decreasing the Point percentage value will shift the Neutral Point to the opposite side of center.

CURVE POINT setting range is 5% to 95%. The default setting is 50% (Centered).

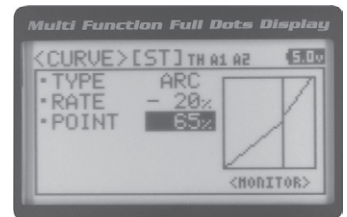

### Controlling the Curve Function

- 1) By assigning the Steering, Throttle High and Throttle Brake Rate and Point programming functions to one or more of the Trim Switches, Auxiliary Lever or Dial Knob, these functions can be adjusted while driving without accessing the Programming Menu. In addition, the Steering Curve and Throttle Curve functions can be Toggled 'OFF' and 'ON' by assigning them to one or more Push-Button Switches. For more information, see the *Key Assignments* section on pages 56 ~ 61.

⚠ Auxiliary 1 and Auxiliary 2 Rate and Point programming functions cannot be assigned.

## 05. SPEED (SERVO SPEED)

The Servo Speed function allows you to slow the transit speed of the Steering, Throttle, Auxiliary 1 and Auxiliary 2 servos. Servo transit speed can be slowed in both the Forward and the Return to Neutral directions independently. When driving your model, proper steering and throttle control are vital. For example, lowering the transit speed of the steering servo can help to limit excessive steering, which will enable you to achieve smoother cornering. In addition, lowering the throttle servo speed can help to ensure smooth throttle control.

**PRO TIP:** Use the Servo Monitor at the bottom of the Speed menu to see your programming changes in virtual real time.

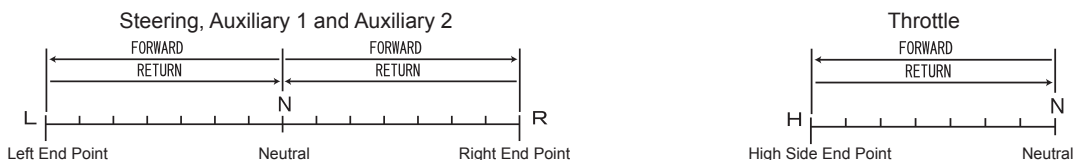

⚠ Throttle Servo Speed affects only the Throttle High Side. The Throttle Brake Side is unaffected.

# PROGRAMMING MENUS

## 05.SPEED (SERVO SPEED). CONTINUED....

### Adjusting the Forward Speed Value

- 1) From the Top Screen, press the ENTER key to open the Programming Menu list.
- 2) Scroll UP or DOWN to highlight the SPEED menu, then press the ENTER key. The SPEED menu will be displayed and [ST] : FORWARD 0 will be highlighted.

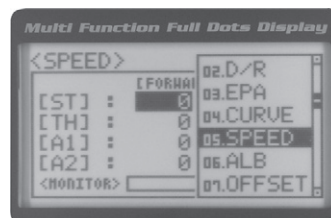

- 3) Scroll UP or DOWN to highlight the desired channel you would like to change the Forward Speed value for. Choose from either [ST] : FORWARD 0 (Steering), [TH] : FORWARD 0 (Throttle), [A1] : FORWARD 0 (Auxiliary 1) or [A2] : FORWARD 0 (Auxiliary 2).

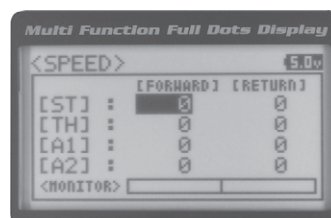

- 4) Press the ENTER key, then scroll DOWN to decrease servo Speed in the Forward direction. Decreasing the Forward Speed value will cause the servo transit time to slow down when it moves from the Neutral position to either End Point.

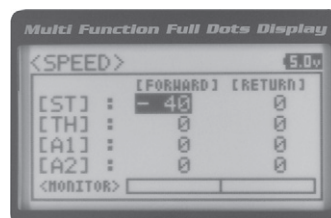

SPEED FORWARD setting range is -100 to 0. The default setting is 0 (Normal Speed).

**IMPORTANT:** Throttle Servo Speed affects only the Throttle High Side. The Throttle Brake Side is unaffected. See Throttle diagram on previous page.

### Adjusting the Return to Neutral Speed Value

- 1) From within the SPEED menu, scroll UP or DOWN to highlight the desired channel you would like to change the Return to Neutral Speed value for. Choose from either [ST] : RETURN 0 (Steering), [TH] : RETURN 0 (Throttle), [A1] : RETURN 0 (Auxiliary 1) or [A2] : RETURN 0 (Auxiliary 2).

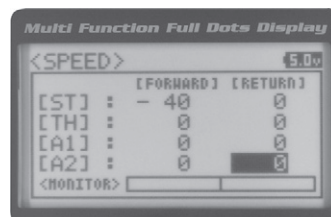

- 2) Press the ENTER key, then scroll DOWN to decrease servo Speed in the Return to Neutral direction. Decreasing the Return to Neutral Speed value will cause the servo transit time to slow down when it moves from either End Point to the Neutral position.

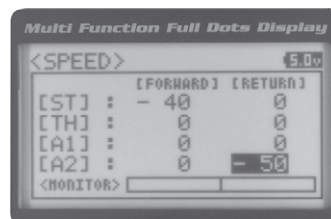

SPEED RETURN setting range is -100 to 0. The default setting is 0 (Normal Speed).

### Controlling the Servo Speed Function

- 1) By assigning the Steering and Throttle Forward and Return to Neutral Speed programming functions to one or more of the Trim Switches, Auxiliary Lever or Dial Knob, these functions can be adjusted while driving without accessing the Programming Menu. In addition, the Steering Speed and Throttle Speed functions can be Toggled 'OFF' and 'ON' by assigning them to one or more Push-Button Switches. For more information, see the *Key Assignments* section on pages 56 ~ 61.

! Auxiliary 1 and Auxiliary 2 Forward and Return to Neutral Speed programming functions cannot be assigned.

# PROGRAMMING MENUS

## 06.ALB (ANTI-LOCK BRAKING)

The Anti-Lock Braking function makes it possible to achieve stable braking even on a slippery surface. With stable braking, your model is better able to trace an exact line under braking. The Anti-Lock Braking function also enables you to set different braking characteristics depending on your particular model. Different Anti-Lock Braking function options can be custom programmed, including the how quickly the brake pulsates, the point at which the Anti-Lock Braking function starts and more.

 When the Anti-Lock Braking function is Active, LED 1 (Blue) will flash rapidly.

**PRO TIP:** Use the Servo Monitor at the bottom of the ALB menu to see your programming changes in virtual real time.

 The Anti-Lock Braking function operates only when the throttle trigger is moved from Neutral to the Brake side. Set the hardest braking you can obtain from your model by carefully setting the Anti-Lock Braking function at the point right before the tires fully lock up but do not slip and lose traction.

### Adjusting the Stroke Percentage Value

The Stroke percentage value determines the amount of Brake that's applied automatically when the Anti-Lock Braking function Activates. When set to 'OFF', the Anti-Lock Braking function will not work. A percentage value of 1% or greater must be programmed for the Anti-Lock Braking function to operate.

- 1) From the Top Screen, press the ENTER key to open the Programming Menu list.
- 2) Scroll UP or DOWN to highlight the ALB menu, then press the ENTER key. The ALB menu will be displayed and STROKE OFF will be highlighted.
- 3) Press the ENTER key, then scroll UP or DOWN to increase or decrease the Stroke percentage value. Increasing the Stroke percentage value will increase throttle servo travel in the Brake direction and decreasing the Stroke percentage value will decrease throttle servo travel in the Brake direction.

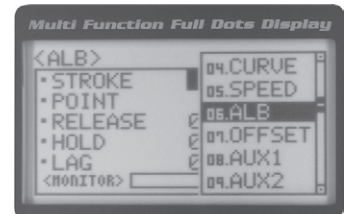

ALB STROKE setting range is OFF to 100%. The default setting is OFF.

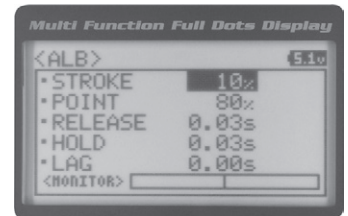

### Adjusting the Point Percentage Value

The Point percentage value determines the position along the servo travel that the Anti-Lock Braking function Activates.

- 1) From within the ALB menu, scroll DOWN to highlight POINT 80%. Press the ENTER key, then scroll UP or DOWN to increase or decrease the Point percentage value. Increasing the Point percentage value will cause the Anti-Lock Braking function to Activate later and decreasing the Point percentage value will cause the Anti-Lock Braking function to Activate sooner.

ALB POINT setting range is 5% to 100%. The default setting is 80%.

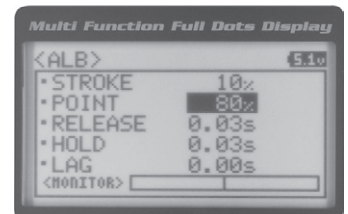

### Adjusting the Release and Hold Values

The Release and Hold values determine the speed at which the brake pulsates. By adjusting the Release and Hold values, you can make the brake pulsate faster or slower. The Release value determines how quickly the Brake moves from Neutral to the percentage value determined by the Stroke setting and the Hold value determines how quickly the Brake moves from the Stroke setting to Neutral.

 We recommend using equal Release and Hold values, although different values can be used to fine-tune how the Brake pulsates. Using lower values make the Brake pulsate faster and using higher values make the Brake pulsate slower.

# PROGRAMMING MENUS

## Adjusting the Release and Hold Values. Continued...

- 1) From within the ALB menu, scroll DOWN to highlight RELEASE 0.03s. Press the ENTER key, then scroll UP or DOWN to increase or decrease the Release value. Increasing the Release value will cause the Brake to move from Neutral to the Stroke setting slower and decreasing the Release value will cause the Brake to move from Neutral to the Stroke setting faster.

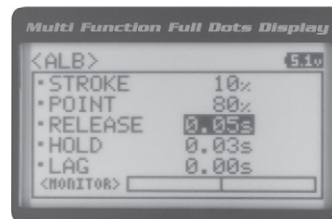

ALB RELEASE setting range is 0.01s to 1.00s. The default setting is 0.03s.

- 2) From within the ALB menu, scroll DOWN to highlight HOLD 0.03s. Press the ENTER key, then scroll UP or DOWN to increase or decrease the Hold value. Increasing the Hold value will cause the Brake to move from the Stroke setting to the Neutral position slower and decreasing the Hold value will cause the Brake to move from the Stroke setting to the Neutral position faster.

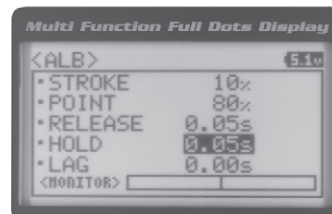

ALB HOLD setting range is 0.01s to 1.00s. The default setting is 0.03s.

## Adjusting the Lag Value

The Lag value determines the amount of delay before the Anti-Lock Braking function Activates after reaching the POINT setting.

- 1) From within the ALB menu, scroll DOWN to highlight LAG 0.00s. Press the ENTER key, then scroll UP and DOWN to increase or decrease the Lag value. Increasing the Lag value increases the delay time to Activate the Anti-Lock Braking function after reaching the Point setting and decreasing the Lag value decreases the delay time to Activate the Anti-Lock Braking function after reaching the Point setting.

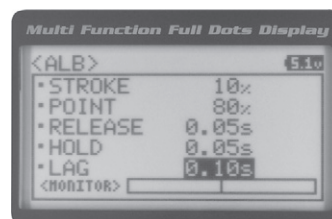

ALB LAG setting range is 0.00s to 1.00s. The default setting is 0.00s.

## Controlling the Anti-Lock Braking Function

- 1) By assigning the Anti-Lock Braking Point, Stroke, Lag, Hold and Release programming functions to one or more of the Trim Switches, Auxiliary Lever or Dial Knob, these functions can be adjusted while driving without accessing the Programming Menu. In addition, the Anti-Lock Braking function can be Toggled 'OFF' and 'ON' by assigning it to one of the Push-Button Switches. For more information, see the *Key Assignments* section on pages 56 ~ 61.

## 07.OFFSET (THROTTLE OFFSET)

The Throttle Offset function allows you to shift the Neutral position of the throttle servo, either toward the High Side or the Brake Side. When used in conjunction with a Push-Button Switch, this function can be used several different ways. For example, if you're driving a glow- or gas-powered model, you can program the Throttle Offset function to shut down your engine with the press of a button. In addition, you can program the Throttle Offset function to increase to a steady idle while you're refueling during a race.

**PRO TIP:** Use the Servo Monitor at the bottom of the OFFSET menu to see your programming changes in virtual real time.

- ! The Throttle Offset function shifts the Neutral position of the throttle servo without affecting the High or Low End Points.

## Turning the Throttle Offset Function 'ON' or 'OFF'

- 1) From the Top Screen, press the ENTER key to open the Programming Menu list.
- 2) Scroll UP or DOWN to highlight the OFFSET menu, then press the ENTER key. The OFFSET menu will be displayed and TH OFFSET OFF will be highlighted.

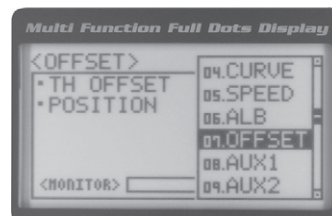

# PROGRAMMING MENUS

## Turning the Throttle Offset Function 'ON' or 'OFF', Continued....

- Press the ENTER key, then scroll UP or DOWN to change the Throttle Offset value to 'ON' or 'OFF'.

OFFSET TH OFFSET setting range is OFF to ON. The default setting is OFF.



**!** Although the Throttle Offset value is set to 'ON', the Throttle Offset function will not operate until a Position percentage value is programmed.

## Adjusting the Throttle Offset Position Percentage Value

- From within the OFFSET menu, scroll DOWN to highlight POSITION 0%. Press the ENTER key, then scroll UP to shift the throttle servo Neutral position the desired amount toward the Throttle High Side or scroll DOWN to shift the throttle servo Neutral position the desired amount toward the Throttle Brake Side.

OFFSET POSITION setting range is H100% to B100%. The default setting is 0%.



**!** When a Position percentage value is programmed and the Throttle Offset function is Active, LED 1 (Blue) will flash rapidly and OFFS will be displayed on the Top Screen.

## Controlling the Throttle Offset Function

- By assigning the Throttle Offset Position programming function to one of the Trim Switches, Auxiliary Lever or Dial Knob, this function can be adjusted while driving without accessing the Programming Menu. In addition, the Throttle Offset function can be Toggled 'OFF' and 'ON' by assigning it to one of the Push-Button Switches. For more information, see the *Key Assignments* section on pages 56 ~ 61.

## 08.AUX1 (AUXILIARY 1 PROGRAMMING)

The Auxiliary 1 Programming function allows you to program the five different Auxiliary Programming functions that are controlled by Auxiliary 1 Channel 3. Use the table below to determine the different functions that are available:

FUNCTION	FUNCTION NAME	FUNCTION DESCRIPTION
S_AUX	Step Auxiliary	Controls Step Values That the Auxiliary Servo Travels
P_AUX	Point Auxiliary	Controls Specific Points That the Auxiliary Servo Travels
4WS	Four Wheel Steering Mixing	Controls Four Wheel Steering Options
MOA	Motor On Axle Dual Throttle Mixing	Controls Dual Throttle Options
A_MIX	Auxiliary Mixing	Controls User-Defined Auxiliary 1 Channel 3 Mixing Options

**IMPORTANT:** Prior to programming an Auxiliary 1 Programming function you must first choose the desired Auxiliary Programming function in the SYSTEM AUX TYPE menu. Only one Auxiliary 1 Programming function can be Active at any given time.

## STEP (STEP AUXILIARY)

The Step Auxiliary function allows you to program the Auxiliary 1 servo to move a defined amount when toggled 'ON' and 'OFF' using a Push-Button Switch. For example, if you assign Auxiliary 1 to a Push-Button Switch, then program the Step Auxiliary percentage value to 50%, the Auxiliary 1 servo will travel from the Neutral position to 50% of travel when the Push-Button Switch is pressed. Press the Push-Button switch a second time and the Auxiliary 1 servo will travel back to the Neutral position. This is useful to control simple ON/OFF functions, such as a reverse servo for a transmission or a mechanical switch to turn lights 'ON' and 'OFF', etc.

**!** The Step Auxiliary Position value can be adjusted while you're driving using one of the four Trim Switches, the Rotary Dial or the Auxiliary Lever. The Step Auxiliary function can be toggled 'OFF' and 'ON' by assigning Auxiliary 1 to one of the two Push-Button Switches. This allows you to control when the Auxiliary 1 servo travels to the programmed Step Auxiliary position.

# PROGRAMMING MENUS

## STEP (STEP AUXILIARY), CONTINUED....

### Choosing the Step Auxiliary Function

- 1) From the Top Screen, press the ENTER key to open the Programming Menu list.
- 2) Scroll UP or DOWN to highlight the SYSTEM menu, then press the ENTER key. Scroll DOWN to highlight the AUX TYPE menu, then press the ENTER key.
- 3) Press the ENTER key, then scroll UP or DOWN to choose the AUX 1: STEP AUX function.

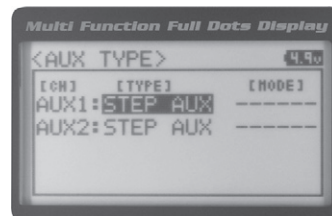

### Adjusting the Step Auxiliary Value

- 1) From the Top Screen, press the ENTER key to open the Programming Menu list.
- 2) Scroll UP or DOWN to highlight the AUX1 menu, then press the ENTER key. The AUX1 STEP menu will be displayed and <AUX1 POSI> 0 will be shown.
- 3) Press the ENTER key, then scroll UP or DOWN to change the Auxiliary 1 Position value. Increasing the value toward the High side (H) or Low side (L) will cause the Auxiliary 1 servo to travel to that specific position when you Activate the Auxiliary 1 Step function.

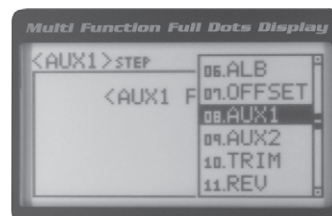

AUX1 STEP AUX1 POSI setting range is H100 to L100. The default setting is 0. This value is a percentage of Auxiliary 1 servo travel.

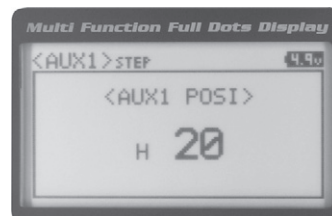

### Controlling the Step Auxiliary Function

- 1) In the default configuration, Auxiliary 1 is controlled by the Rotary Dial which allows the Step Auxiliary function to be adjusted while driving without accessing the Programming Menu. Turn the Rotary Dial clockwise to increase the Position High Side value and turn the Rotary Dial counter-clockwise to increase the Position Low Side value. In addition, Auxiliary 1 can be assigned to one of the four Trim Switches or the Auxiliary Lever. The Step Auxiliary function can be toggled 'OFF' and 'ON' by assigning Auxiliary 1 to one of the two Push-Button Switches. This allows you to control when the Auxiliary 1 servo travels to the programmed Step Auxiliary position. For more information, see the *Key Assignments* section on pages 56 ~ 61.

## POINT (POINT AUXILIARY)

The Point Auxiliary function allows you to program the Auxiliary 1 servo to move up to 6 different Points along its travel, then cycle through those Points using one of the Trim Switches or the Rotary Dial. For example, if your model requires a separate 3-position or more switch to operate a feature, the Point Auxiliary function can be customized to control this.

 Use one of the four Trim Switches or the Rotary Dial to cycle through the Point positions while you're driving. The Point Auxiliary function can be toggled 'OFF' and 'ON' while you're driving by assigning Auxiliary 1 to one of the two Push-Button Switches.

### Choosing the Point Auxiliary Function and the Number of Points

- 1) From the Top Screen, press the ENTER key to open the Programming Menu list.
- 2) Scroll UP or DOWN to highlight the SYSTEM menu, then press the ENTER key. Scroll DOWN to highlight the AUX TYPE menu, then press the ENTER key.
- 3) Press the ENTER key, then scroll UP or DOWN to choose the AUX 1: POINT AUX function.

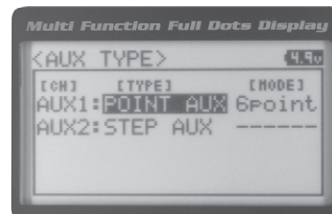

# PROGRAMMING MENUS

## Choosing the Point Auxiliary Function and the Number of Points. Continued....

- 4) From within the AUX TYPE menu, scroll DOWN to highlight [MODE] 6 POINT. Press the ENTER key, then scroll UP or DOWN to choose the desired number of Points you would like to program.

AUX TYPE POINT setting range is 2point to 6point. The default setting is 6point.

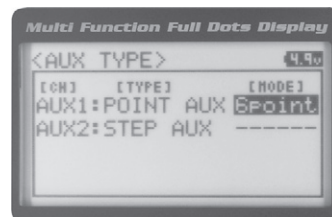

## Adjusting the Point Auxiliary Values

- 1) From the Top Screen, press the ENTER key to open the Programming Menu list.
- 2) Scroll UP or DOWN to highlight the AUX1 menu, then press the ENTER key. The AUX1 POINT menu will be displayed and the last Point selected will be highlighted.
- 3) Scroll UP or DOWN to move the brackets to the Point you would like to change, then press the ENTER key to highlight that Point.
- 4) Press the ENTER key, then scroll UP or DOWN to change the Point value. Increasing the Point value toward the High side (H) or Low side (L) will cause the Auxiliary 1 servo to travel to that specific position when you cycle through the various Points.
- 5) Repeat steps 3 and 4 to change the desired remaining Point values.

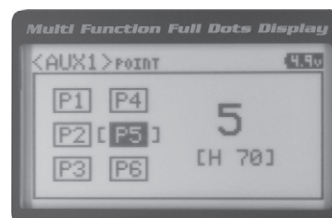
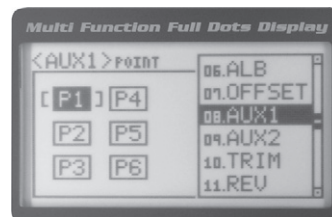

AUX1 POINT setting range is H100 to L100. The default setting for Point 1 is L100, for Point 2 is L60, for Point 3 is L20, for Point 4 is H20, for Point 5 is H60, and for Point 6 is H100. These values are a percentage of Auxiliary 1 servo travel.

## Controlling the Point Auxiliary Function

- 1) In the default configuration, Auxiliary 1 is controlled by the Rotary Dial. Turn the Rotary Dial clockwise to cycle Forward through the programmed Point Auxiliary positions and turn the Rotary Dial counter-clockwise to cycle Backward through the programmed Point Auxiliary positions. The Auxiliary 1 servo will move to the specified Point positions as you cycle through the different Points. In addition, Auxiliary 1 can be assigned to one of the four Trim Switches. The Point Auxiliary function can be toggled 'OFF' and 'ON' by assigning Auxiliary 1 to one of the two Push-Button Switches. For more information, see the *Key Assignments* section on pages 56 ~ 61.

**IMPORTANT:** To operate correctly, the TRIM or DIAL Step value must be set to 1. If set to a value other than 1, Point positions will be skipped as you cycle through them. For more information, see the *Key Assignments* section on pages 56 ~ 61.

## 4WS (FOUR WHEEL STEERING MIXING)

The Four Wheel Steering Mixing function allows you to use Auxiliary 1 Channel 3 as a second steering channel, allowing you to use two separate steering servos for Front and Rear steering. The Four Wheel Steering Mixing function allows you to control either the Front or Rear steering independently, or Mix the Front and Rear steering to have Parallel Four Wheel Steering or Tandem Four Wheel Steering.

## Choosing the Four Wheel Steering Function

- 1) From the Top Screen, press the ENTER key to open the Programming Menu list.
- 2) Scroll UP or DOWN to highlight the SYSTEM menu, then press the ENTER key. Scroll DOWN to highlight the AUX TYPE menu, then press the ENTER key.
- 3) Press the ENTER key, then scroll UP or DOWN to choose the AUX 1: 4WS MIX function.

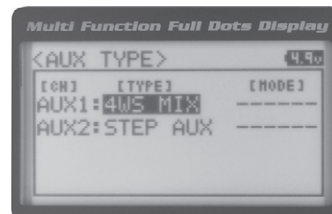

# PROGRAMMING MENUS

## 4WS (FOUR WHEEL STEERING MIXING), CONTINUED...

 Use the Rotary Dial or one of the four Trim Switches to cycle through the different Four Wheel Steering options while you're driving. The Four Wheel Steering Mixing function can be toggled 'OFF' and 'ON' while you're driving by assigning Auxiliary 1 to one of the two Push-Button Switches.

**PRO TIP:** Use the Servo Monitor at the bottom of the AUX 1 4WS menu to see your programming changes in virtual real time.

### Choosing Four Wheel Steering Mixing Options

- 1) From the Top Screen, press the ENTER key to open the Programming Menu list.
- 2) Scroll UP or DOWN to highlight the AUX1 menu, then press the ENTER key. The AUX1 4WS menu will be displayed and the last Steering option selected will be highlighted.
- 3) Scroll UP or DOWN to move the brackets to the Four Wheel Steering option you would like to use, then press the ENTER key to highlight that option. The highlighted option is now Active.

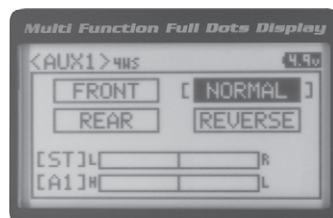
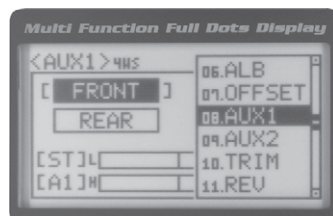

The following Four Wheel Steering Mixing options are available:

**Front Wheel Steering** - When highlighted, only the Front Steering will operate.

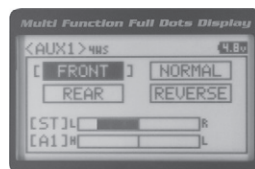
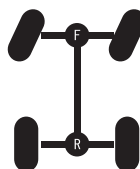

**Rear Wheel Steering** - When highlighted, only the Rear Steering will operate.

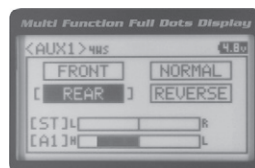
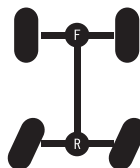

**Parallel (Normal) Four Wheel Steering** - When highlighted, both the Front and Rear Steering will operate in Parallel.

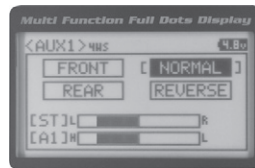
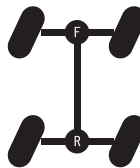

**Tandem (Reverse) Four Wheel Steering** - When highlighted, both the Front and Rear Steering will operate in Tandem.

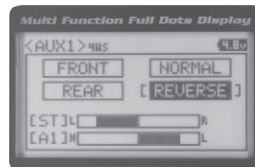
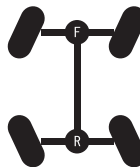

 If the steering servos do not operate as described above, you can use the Servo Reversing function to change the direction that each servo operates. For more information, see the *Servo Reversing* section on page 44.



# PROGRAMMING MENUS

## 4WS (FOUR WHEEL STEERING MIXING), CONTINUED....

### Controlling the Four Wheel Steering Mixing Function

- 1) In the default configuration, Auxiliary 1 is controlled by the Rotary Dial. Turn the Rotary Dial clockwise to cycle Forward through the Four Wheel Steering options (FRONT > REAR > NORMAL > REVERSE) and turn the Rotary Dial counter-clockwise to cycle Backward through the Four Wheel Steering options (REVERSE > NORMAL > REAR > FRONT). In addition, Auxiliary 1 can be assigned to one of the four Trim Switches. The Four Wheel Steering Mixing function can be toggled 'OFF' and 'ON' by assigning Auxiliary 1 to one of the two Push-Button Switches. For more information, see the *Key Assignments* section on pages 56 ~ 61.

**IMPORTANT:** To operate correctly, the DIAL or TRIM Step value must be set to 1. If set to a value other than 1, Four Wheel Steering Mixing options will be skipped as you cycle through them. For more information, see the *Key Assignments* section on pages 56 ~ 61.

⚠ When using Four Wheel Steering, it's important to adjust the Steering Channel 1 and Auxiliary 1 Channel 3 Sub-Trim values to center both servos. This will ensure that your model tracks straight. In addition, remember that you are able to independently adjust the Auxiliary 1 Channel 3 Dual Rate, Exponential, Sub-Trim, Servo Speed settings and more to allow for the optimum Four Wheel Steering Mixing setup.

### MOA (MOTOR ON AXLE MIXING)

The Motor on Axle Mixing function allows you to use Auxiliary 1 Channel 3 as a second throttle channel, allowing you to use two separate throttle servos or ESCs. The Motor on Axle Mixing function is typically used in Rock Crawling and allows you to control either the Front and Rear motors together or independently, giving you Normal (Balanced), Dig and Burn functions. And when coupled with the ability to variably change the power distribution between the Front and Rear motors, allows the utmost in functionality.

⚠ Use the Rotary Dial, one of the four Trim Switches or the Auxiliary Lever to Activate the Dig and Burn functions while you're driving. The Motor on Axle Mixing function can be toggled 'OFF' and 'ON' while you're driving by assigning Auxiliary 1 to one of the two Push-Button Switches.

**PRO TIP:** Use the Servo Monitor at the bottom of the AUX 1 MOA menu to see your programming changes in virtual real time.

### Choosing the Motor on Axle Function

- 1) From the Top Screen, press the ENTER key to open the Programming Menu list.
- 2) Scroll UP or DOWN to highlight the SYSTEM menu, then press the ENTER key. Scroll DOWN to highlight the AUX TYPE menu, then press the ENTER key.
- 3) Press the ENTER key, then scroll UP or DOWN to choose the AUX 1: MOA MIX function.

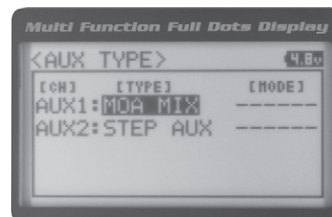

### Changing Motor on Axle Power Distribution Options

You are able to program Normal (Balanced), Dig and Burn functions by changing the Power Distribution between the two motors.

- 1) From the Top Screen, press the ENTER key to open the Programming Menu list.
- 2) Scroll UP or DOWN to highlight the AUX1 menu, then press the ENTER key. The AUX1 MOA menu will be displayed.

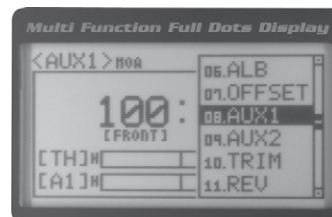

- 3) Press the ENTER key, then scroll UP or DOWN to change the Power Distribution between the Front and Rear motors. Scrolling UP will reduce the available power to the Rear motor (Dig) and scrolling DOWN will reduce the power to the Front motor (Burn).

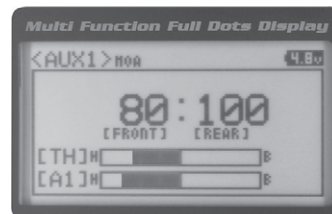

# PROGRAMMING MENUS

## Changing Motor on Axle Power Distribution Options, Continued....

The following Motor on Axle Mixing options are available:

**Normal (Balanced)** - When set to 100:100, power will be evenly distributed between the Front and Rear motors.

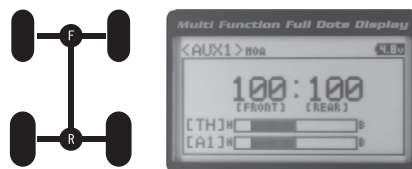

**Front Throttle BURN** - When set to 0:100, power will only be distributed to the Rear motor (Burn). Power can be distributed proportionally between the Front and Rear motors from 0:100 to 99:100.



**Rear Throttle DIG** - When set to 100:0, power will only be distributed to the Front motor (Dig). Power can be distributed proportionally between the Front and Rear motors from 100:0 to 100:99.

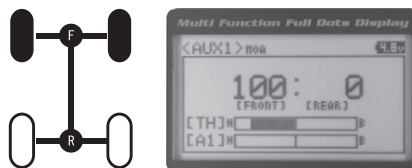

## Controlling the Motor on Axle Mixing Function

- 1) In the default configuration, Auxiliary 1 is controlled by the Rotary Dial. Turn the Rotary Dial clockwise to reduce the available power to the Rear motor (Dig) and turn the Rotary Dial counter-clockwise to reduce the power to the Front motor (Burn). In addition, Auxiliary 1 can be assigned to one of the four Trim Switches or to the Auxiliary Lever. The Motor on Axle Mixing function can be toggled 'OFF' and 'ON' by assigning Auxiliary 1 to one of the two Push-Button Switches. For more information, see the *Key Assignments* section on pages 56 ~ 61.

**IMPORTANT:** In the default configuration, the Rotary Dial Step value is set to 5. This allows you to adjust the Power Distribution in 5 percent increments. If you prefer to control the Dig and Burn functions as if they were assigned to an ON/OFF switch, change the DIAL Step value to 100. Alternately, the Motor on Axle Mixing function can be controlled by the Auxiliary Lever. This allows you to quickly switch between the Dig and Burn functions and still have the ability to variably change the Power Distribution between the Front and Rear motors. To set this up, change the Auxiliary Lever Function to AUX1, then change the TWEAK (H) value to +100 and the TWEAK (L) value to -100. For more information, see the *Key Assignments* section on pages 56 ~ 61.

⚠ When using the Motor on Axle function, it's important to adjust the Throttle Channel 2 and Auxiliary 1 Channel 3 Sub-Trim values so both motors' idle (or 'OFF') settings are equal. This will ensure correct function. In addition, remember that you are able to independently adjust the Auxiliary 1 Channel 3 Dual Rate, Exponential, Sub-Trim, Servo Speed settings and more to allow for the optimum Motor on Axle Mixing setup.

## AUX MIX (AUXILIARY MIXING)

The Auxiliary Mixing function allows you to Mix either Steering Channel 1 or Throttle Channel 2 to Auxiliary 1 Channel 3, while maintaining separate Sub-Trim, End Point Adjustments, Servo Reversing and other channel-specific settings. The Auxiliary Mixing function is used when a custom Mix is necessary. For example, if your monster truck features dual Front steering servos, instead of using a Y-Harness to join the two steering servos together, you can use Steering Mixing to operate both steering servos together and still be able to make adjustments to each servo separately. In addition, if your model features a third-channel brake, you could use Throttle Mixing to control it along with the channel 2 brake.

⚠ The Auxiliary Mixing Rate percentage value can be adjusted while you're driving using one of the four Trim Switches, the Rotary Dial or the Auxiliary Lever. The Auxiliary Mixing function can be toggled 'OFF' and 'ON' while you're driving by assigning Auxiliary 1 to one of the two Push-Button Switches.

**PRO TIP:** Use the Servo Monitor at the bottom of the AUX 1 AUX MIX menu to see your programming changes in virtual real time.

# PROGRAMMING MENUS

## AUX MIX (AUXILIARY MIXING), CONTINUED....

### Choosing the Auxiliary Mixing Function and the Mixing Type

- 1) From the Top Screen, press the ENTER key to open the Programming Menu list.
- 2) Scroll UP or DOWN to highlight the SYSTEM menu, then press the ENTER key. Scroll DOWN to highlight the AUX TYPE menu, then press the ENTER key.
- 3) Press the ENTER key, then scroll UP or DOWN to choose the AUX 1: AUX MIX function.
- 4) From within the AUX TYPE menu, scroll DOWN to highlight [MODE] ST-mix. Press the ENTER key, then scroll UP or DOWN to choose the desired Mixing type you would like to program. Choose from either ST-mix (Steering Mixing) or TH-mix (Throttle Mixing).

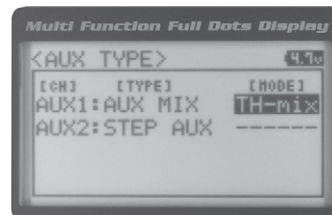
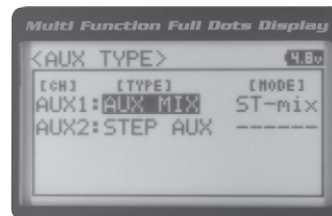

AUX TYPE MIX setting range is ST-mix and TH-mix. The default setting is ST-mix.

### Adjusting the Rate Percentage Value

The Rate percentage value defines how far the Auxiliary 1 servo travels relative to either the Steering servo or the Throttle servo.

 The Master channel (either Steering Channel 1 or Throttle Channel 2) always controls the Slave channel (Auxiliary 1 Channel 3).

- 1) From the Top Screen, press the ENTER key to open the Programming Menu list.
- 2) Scroll UP or DOWN to highlight the AUX1 menu, then press the ENTER key. The AUX1 AUX MIX menu will be displayed.

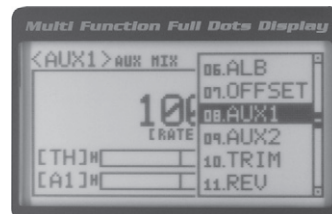

- 3) Press the ENTER key, then scroll UP or DOWN to change the Rate percentage value. Decreasing the Rate percentage value will reduce the amount the Auxiliary 1 servo travels relative to the Steering servo or Throttle servo and increasing the Rate percentage value will increase the amount the Auxiliary 1 servo travels relative to the Steering servo or Throttle servo.

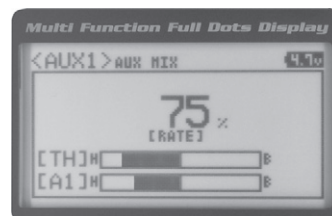

AUX1 AUX MIX RATE setting range is 100% to 0%. The default setting is 100%. This Mix is Linear. For example, if the Rate percentage value is set to 100%, the Auxiliary 1 servo will travel the same amount as the Steering servo. Additionally, if the Rate percentage value is set to 50%, the Auxiliary 1 servo will travel half the amount as the Steering servo.

 In the default configuration, the Auxiliary 1 servo will travel in the same direction as the Steering servo or Throttle servo. To apply the Mix in the opposite direction, change the Servo Reversing value of Auxiliary 1 Channel 3. For more information, see the *Servo Reversing* section on page 44.

### Controlling the Auxiliary Mixing Function

- 1) In the default configuration, Auxiliary 1 is controlled by the Rotary Dial. Turn the Rotary Dial clockwise to increase the Rate percentage value and turn the Rotary Dial counter-clockwise to decrease the Rate percentage value. In addition, the Auxiliary Mixing Rate function can be assigned to one of the four Trim Switches or the Auxiliary Lever. The Auxiliary Mixing function can be toggled 'OFF' and 'ON' by assigning Auxiliary 1 to one of the two Push-Button Switches. For more information, see the *Key Assignments* section on pages 56 ~ 61.

 Remember that you are able to independently adjust the Auxiliary 1 Channel 3 Dual Rate, Exponential, Sub-Trim, Servo Speed settings and more to allow for the optimum Auxiliary Mixing setup.

# PROGRAMMING MENUS

## 09.AUX2 (AUXILIARY 2 PROGRAMMING)

The Auxiliary 2 Programming function allows you to program the five different Auxiliary Programming functions that are controlled by Auxiliary 2 Channel 4. Use the table below to determine the different functions that are available:

FUNCTION	FUNCTION NAME	FUNCTION DESCRIPTION
S_AUX	Step Auxiliary	Controls Step Values That the Auxiliary Servo Travels
P_AUX	Point Auxiliary	Controls Specific Points That the Auxiliary Servo Travels
4WS	Four Wheel Steering Mixing	Controls Four Wheel Steering Options
MOA	Motor On Axle Dual Throttle Mixing	Controls Dual Throttle Options
A_MIX	Auxiliary Mixing	Controls User-Defined Auxiliary 2 Channel 4 Mixing Options

**IMPORTANT:** Prior to programming an Auxiliary 2 Programming function you must first choose the desired Auxiliary Programming function in the SYSTEM AUX TYPE menu. Only one Auxiliary 2 Programming function can be Active at any given time.

### STEP (STEP AUXILIARY)

The Step Auxiliary function allows you to program the Auxiliary 2 servo to move a defined amount when toggled 'ON' and 'OFF' using a Push-Button Switch. For example, if you assign Auxiliary 2 to a Push-Button Switch, then program the Step Auxiliary percentage value to 50%, the Auxiliary 2 servo will travel from the Neutral position to 50% of travel when the Push-Button Switch is pressed. Press the Push-Button switch a second time and the Auxiliary 2 servo will travel back to the Neutral position. This is useful to control simple ON/OFF functions, such as a reverse servo for a transmission or a mechanical switch to turn lights 'ON' and 'OFF', etc.

 The Step Auxiliary Position value can be adjusted while you're driving using one of the four Trim Switches, the Rotary Dial or the Auxiliary Lever. The Step Auxiliary function can be toggled 'OFF' and 'ON' by assigning Auxiliary 2 to one of the two Push-Button Switches. This allows you to control when the Auxiliary 2 servo travels to the programmed Step Auxiliary position.

#### Choosing the Step Auxiliary Function

- 1) From the Top Screen, press the ENTER key to open the Programming Menu list.
- 2) Scroll UP or DOWN to highlight the SYSTEM menu, then press the ENTER key. Scroll DOWN to highlight the AUX TYPE menu, then press the ENTER key.
- 3) Press the ENTER key, then scroll UP or DOWN to choose the AUX 2: STEP AUX function.

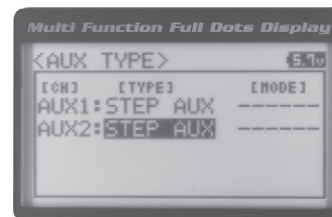

#### Adjusting the Step Auxiliary Value

- 1) From the Top Screen, press the ENTER key to open the Programming Menu list.
- 2) Scroll UP or DOWN to highlight the AUX2 menu, then press the ENTER key. The AUX2 STEP menu will be displayed and <AUX2 POSI> 0 will be shown.
- 3) Press the ENTER key, then scroll UP or DOWN to change the Auxiliary 2 Position value. Increasing the value toward the High side (H) or Low side (L) will cause the Auxiliary 2 servo to travel to that specific position when you Activate the Auxiliary 2 Step function.

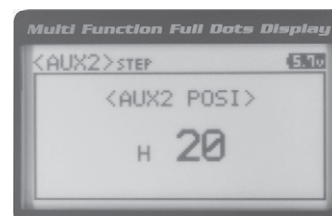
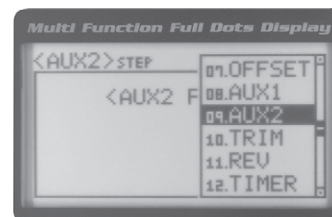

AUX2 STEP AUX2 POSI setting range is H100 to L100. The default setting is 0. This value is a percentage of Auxiliary 2 servo travel.

# PROGRAMMING MENUS

## STEP (STEP AUXILIARY), CONTINUED....

### Controlling the Step Auxiliary Function

- 1) In the default configuration, Auxiliary 2 is controlled by the Rotary Dial which allows the Step Auxiliary function to be adjusted while driving without accessing the Programming Menu. Turn the Rotary Dial clockwise to increase the Position High Side value and turn the Rotary Dial counter-clockwise to increase the Position Low Side value. In addition, Auxiliary 2 can be assigned to one of the four Trim Switches or the Auxiliary Lever. The Step Auxiliary function can be toggled 'OFF' and 'ON' by assigning Auxiliary 2 to one of the two Push-Button Switches. This allows you to control when the Auxiliary 2 servo travels to the programmed Step Auxiliary position. For more information, see the *Key Assignments* section on pages 56 ~ 61.

### POINT (POINT AUXILIARY)

The Point Auxiliary function allows you to program the Auxiliary 2 servo to move up to 6 different Points along its travel, then cycle through those Points using one of the Trim Switches or the Rotary Dial. For example, if your model requires a separate 3-position or more switch to operate a feature, the Point Auxiliary function can be customized to control this.

 Use one of the four Trim Switches or the Rotary Dial to cycle through the Point positions while you're driving. The Point Auxiliary function can be toggled 'OFF' and 'ON' while you're driving by assigning Auxiliary 2 to one of the two Push-Button Switches.

### Choosing the Point Auxiliary Function and the Number of Points

- 1) From the Top Screen, press the ENTER key to open the Programming Menu list.
- 2) Scroll UP or DOWN to highlight the SYSTEM menu, then press the ENTER key. Scroll DOWN to highlight the AUX TYPE menu, then press the ENTER key.
- 3) Press the ENTER key, then scroll UP or DOWN to choose the AUX 2: POINT AUX function.
- 4) From within the AUX TYPE menu, scroll DOWN to highlight [MODE] 6 POINT. Press the ENTER key, then scroll UP or DOWN to choose the desired number of Points you would like to program.

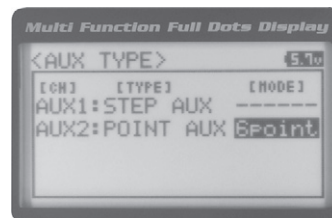
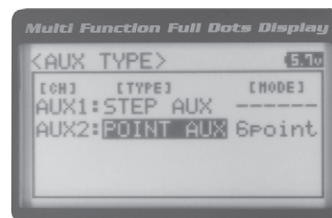

AUX TYPE POINT setting range is 2point to 6point. The default setting is 6point.

### Adjusting the Point Auxiliary Values

- 1) From the Top Screen, press the ENTER key to open the Programming Menu list.
- 2) Scroll UP or DOWN to highlight the AUX1 menu, then press the ENTER key. The AUX2 POINT menu will be displayed and the last Point selected will be highlighted.
- 3) Scroll UP or DOWN to move the brackets to the Point you would like to change, then press the ENTER key to highlight that Point.
- 4) Press the ENTER key, then scroll UP or DOWN to change the Point value. Increasing the Point value toward the High side (H) or Low side (L) will cause the Auxiliary 2 servo to travel to that specific position when you cycle through the various Points.
- 5) Repeat steps 3 and 4 to change the desired remaining Point values.

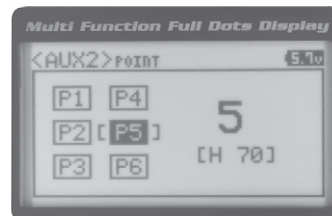
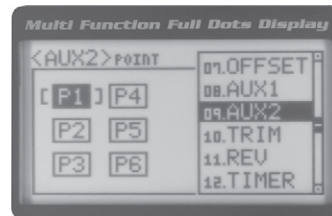

AUX2 POINT setting range is H100 to L100. The default setting for Point 1 is L100, for Point 2 is L60, for Point 3 is L20, for Point 4 is H20, for Point 5 is H60, and for Point 6 is H100. These values are a percentage of Auxiliary 2 servo travel.

# PROGRAMMING MENUS

## POINT (POINT AUXILIARY), CONTINUED....

### Controlling the Point Auxiliary Function

- 1) In the default configuration, Auxiliary 2 is controlled by the Rotary Dial. Turn the Rotary Dial clockwise to cycle Forward through the programmed Point Auxiliary positions and turn the Rotary Dial counter-clockwise to cycle Backward through the programmed Point Auxiliary positions. The Auxiliary 2 servo will move to the specified Point positions as you cycle through the different Points. In addition, Auxiliary 2 can be assigned to one of the four Trim Switches. The Point Auxiliary function can be toggled 'OFF' and 'ON' by assigning Auxiliary 2 to one of the two Push-Button Switches. For more information, see the *Key Assignments* section on pages 56 ~ 61.

**IMPORTANT:** To operate correctly, the TRIM or DIAL Step value must be set to 1. If set to a value other than 1, Point positions will be skipped as you cycle through them. For more information, see the *Key Assignments* section on pages 56 ~ 61.

### 4WS (FOUR WHEEL STEERING MIXING)

The Four Wheel Steering Mixing function allows you to use Auxiliary 2 Channel 4 as a second steering channel, allowing you to use two separate steering servos for Front and Rear steering. The Four Wheel Steering Mixing function allows you to control either the Front or Rear steering independently, or Mix the Front and Rear steering to have Parallel Four Wheel Steering or Tandem Four Wheel Steering.

 Use the Rotary Dial or one of the four Trim Switches to cycle through the different Four Wheel Steering options while you're driving. The Four Wheel Steering Mixing function can be toggled 'OFF' and 'ON' while you're driving by assigning Auxiliary 2 to one of the two Push-Button Switches.

**PRO TIP:** Use the Servo Monitor at the bottom of the AUX 2 4WS menu to see your programming changes in virtual real time.

### Choosing the Four Wheel Steering Function

- 1) From the Top Screen, press the ENTER key to open the Programming Menu list.
- 2) Scroll UP or DOWN to highlight the SYSTEM menu, then press the ENTER key. Scroll DOWN to highlight the AUX TYPE menu, then press the ENTER key.
- 3) Press the ENTER key, then scroll UP or DOWN to choose the AUX 2: 4WS MIX function.

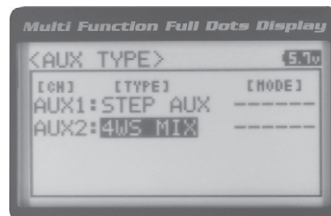

### Choosing Four Wheel Steering Mixing Options

- 1) From the Top Screen, press the ENTER key to open the Programming Menu list.
- 2) Scroll UP or DOWN to highlight the AUX2 menu, then press the ENTER key. The AUX2 4WS menu will be displayed and the last Steering option selected will be highlighted.

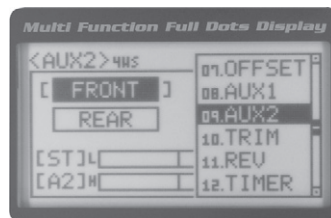

- 3) Scroll UP or DOWN to move the brackets to the Four Wheel Steering option you would like to use, then press the ENTER key to highlight that option. The highlighted option is now Active.

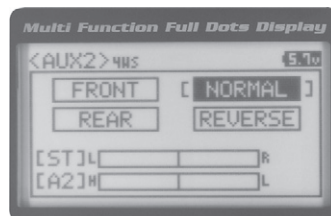

The following Four Wheel Steering Mixing options are available:

**Front Wheel Steering** - When highlight led, only the Front Steering will operate.

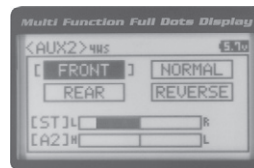
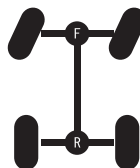

# PROGRAMMING MENUS

## 4WS (FOUR WHEEL STEERING MIXING), CONTINUED....

**Rear Wheel Steering** - When highlighted, only the Rear Steering will operate.

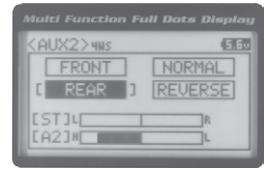

**Parallel (Normal) Four Wheel Steering** - When highlighted, both the Front and Rear Steering will operate in Parallel.

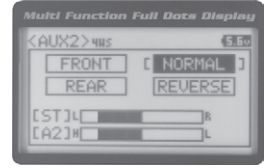

**Tandem (Reverse) Four Wheel Steering** - When highlighted, both the Front and Rear Steering will operate in Tandem.

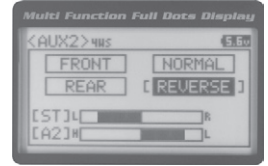

 If the steering servos do not operate as described above, you can use the Servo Reversing function to change the direction that each servo operates. For more information, see the *Servo Reversing* section on page 44.

### Controlling the Four Wheel Steering Mixing Function

- 1) In the default configuration, Auxiliary 2 is controlled by the Rotary Dial. Turn the Rotary Dial clockwise to cycle Forward through the Four Wheel Steering options (FRONT > REAR > NORMAL > REVERSE) and turn the Rotary Dial counter-clockwise to cycle Backward through the Four Wheel Steering options (REVERSE > NORMAL > REAR > FRONT). In addition, Auxiliary 2 can be assigned to one of the four Trim Switches. The Four Wheel Steering Mixing function can be toggled 'OFF' and 'ON' by assigning Auxiliary 2 to one of the two Push-Button Switches. For more information, see the *Key Assignments* section on pages 56 ~ 61.

**IMPORTANT:** To operate correctly, the DIAL or TRIM Step value must be set to 1. If set to a value other than 1, Four Wheel Steering Mixing options will be skipped as you cycle through them. For more information, see the *Key Assignments* section on pages 56 ~ 61.

 When using Four Wheel Steering, it's important to adjust the Steering Channel 1 and Auxiliary 2 Channel 4 Sub-Trim values to center both servos. This will ensure that your model tracks straight. In addition, remember that you are able to independently adjust the Auxiliary 2 Channel 4 Dual Rate, Exponential, Sub-Trim, Servo Speed settings and more to allow for the optimum Four Wheel Steering Mixing setup.

## MOA (MOTOR ON AXLE MIXING)

The Motor on Axle Mixing function allows you to use Auxiliary 2 Channel 4 as a second throttle channel, allowing you to use two separate throttle servos or ESCs. The Motor on Axle Mixing function is typically used in Rock Crawling and allows you to control either the Front and Rear motors together or independently, giving you Normal (Balanced), Dig and Burn functions. And when coupled with the ability to variably change the power distribution between the Front and Rear motors, allows the utmost in functionality.

 Use the Rotary Dial, one of the four Trim Switches or the Auxiliary Lever to Activate the Dig and Burn functions while you're driving. The Motor on Axle Mixing function can be toggled 'OFF' and 'ON' while you're driving by assigning Auxiliary 2 to one of the two Push-Button Switches.

**PRO TIP:** Use the Servo Monitor at the bottom of the AUX 2 MOA menu to see your programming changes in virtual real time.

### Choosing the Motor on Axle Function

- 1) From the Top Screen, press the ENTER key to open the Programming Menu list.
- 2) Scroll UP or DOWN to highlight the SYSTEM menu, then press the ENTER key. Scroll DOWN to highlight the AUX TYPE menu, then press the ENTER key.
- 3) Press the ENTER key, then scroll UP or DOWN to choose the AUX 2: MOA MIX function.

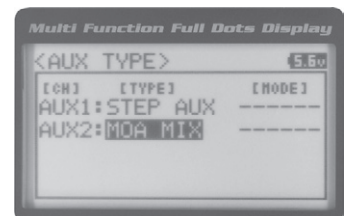

# PROGRAMMING MENUS

## MOA (MOTOR ON AXLE MIXING), CONTINUED....

### Changing Motor on Axle Power Distribution Options

You are able to program Normal (Balanced), Dig and Burn functions by changing the Power Distribution between the two motors.

- 1) From the Top Screen, press the ENTER key to open the Programming Menu list.
- 2) Scroll UP or DOWN to highlight the AUX2 menu, then press the ENTER key. The AUX1 MOA menu will be displayed.

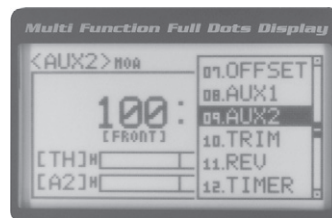

- 3) Press the ENTER key, then scroll UP or DOWN to change the Power Distribution between the Front and Rear motors. Scrolling UP will reduce the available power to the Rear motor (Dig) and scrolling DOWN will reduce the power to the Front motor (Burn).

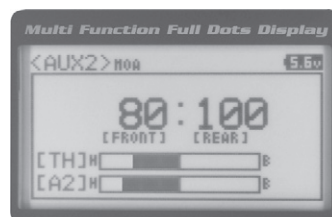

The following Motor on Axle Mixing options are available:

**Normal (Balanced)** - When set to 100:100, power will be evenly distributed between the Front and Rear motors.

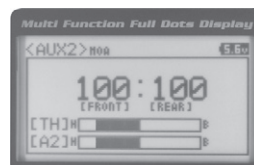
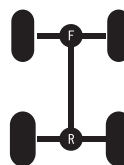

**Front Throttle BURN** - When set to 0:100, power will only be distributed to the Rear motor (Burn). Power can be distributed proportionally between the Front and Rear motors from 0:100 to 99:100.

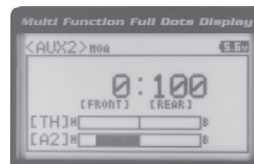
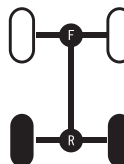

**Rear Throttle DIG** - When set to 100:0, power will only be distributed to the Front motor (Dig). Power can be distributed proportionally between the Front and Rear motors from 100:0 to 100:99.

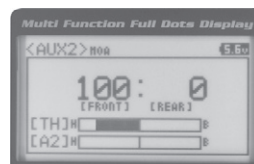
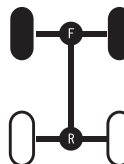

### Controlling the Motor on Axle Mixing Function

- 1) In the default configuration, Auxiliary 2 is controlled by the Rotary Dial. Turn the Rotary Dial clockwise to reduce the available power to the Rear motor (Dig) and turn the Rotary Dial counter-clockwise to reduce the power to the Front motor (Burn). In addition, Auxiliary 2 can be assigned to one of the four Trim Switches or to the Auxiliary Lever. The Motor on Axle Mixing function can be toggled 'OFF' and 'ON' by assigning Auxiliary 2 to one of the two Push-Button Switches. For more information, see the *Key Assignments* section on pages 56 ~ 61.

**IMPORTANT:** In the default configuration, the Rotary Dial Step value is set to 5. This allows you to adjust the Power Distribution in 5 percent increments. If you prefer to control the Dig and Burn functions as if they were assigned to an ON/OFF switch, change the DIAL Step value to 100. Alternately, the Motor on Axle Mixing function can be controlled by the Auxiliary Lever. This allows you to quickly switch between the Dig and Burn functions and still have the ability to variably change the Power Distribution between the Front and Rear motors. To set this up, change the Auxiliary Lever Function to AUX2, then change the TWEAK (H) value to +100 and the TWEAK (L) value to -100. For more information, see the *Key Assignments* section on pages 56 ~ 61.

 When using the Motor on Axle function, it's important to adjust the Throttle Channel 2 and Auxiliary 2 Channel 4 Sub-Trim values so both motors' idle (or 'OFF') settings are equal. This will ensure correct function. In addition, remember that you are able to independently adjust the Auxiliary 2 Channel 4 Dual Rate, Exponential, Sub-Trim, Servo Speed settings and more to allow for the optimum Motor on Axle Mixing setup.



# PROGRAMMING MENUS

## AUX MIX (AUXILIARY MIXING)

The Auxiliary Mixing function allows you to Mix either Steering Channel 1 or Throttle Channel 2 to Auxiliary 2 Channel 4, while maintaining separate Sub-Trim, End Point Adjustments, Servo Reversing and other channel-specific settings. The Auxiliary Mixing function is used when a custom Mix is necessary. For example, if your monster truck features dual Front steering servos, instead of using a Y-Harness to join the two steering servos together, you can use Steering Mixing to operate both steering servos together and still be able to make adjustments to each servo separately. In addition, if your model features a fourth-channel brake, you could use Throttle Mixing to control it along with the channel 2 brake.

 The Auxiliary Mixing Rate percentage value can be adjusted while you're driving using one of the four Trim Switches, the Rotary Dial or the Auxiliary Lever. The Auxiliary Mixing function can be toggled 'OFF' and 'ON' while you're driving by assigning Auxiliary 2 to one of the two Push-Button Switches.

**PRO TIP:** Use the Servo Monitor at the bottom of the AUX 2 AUX MIX menu to see your programming changes in virtual real time.

### Choosing the Auxiliary Mixing Function and the Mixing Type

- 1) From the Top Screen, press the ENTER key to open the Programming Menu list.
- 2) Scroll UP or DOWN to highlight the SYSTEM menu, then press the ENTER key. Scroll DOWN to highlight the AUX TYPE menu, then press the ENTER key.
- 3) Press the ENTER key, then scroll UP or DOWN to choose the AUX 2: AUX MIX function.
- 4) From within the AUX TYPE menu, scroll DOWN to highlight [MODE] ST-mix. Press the ENTER key, then scroll UP or DOWN to choose the desired Mixing type you would like to program. Choose from either ST-mix (Steering Mixing) or TH-mix (Throttle Mixing).

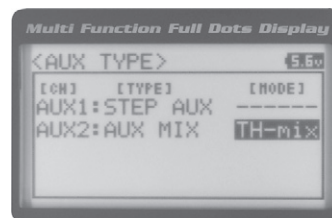
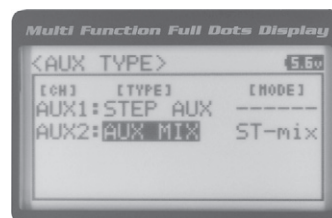

AUX TYPE MIX setting range is ST-mix and TH-mix. The default setting is ST-mix.

### Adjusting the Rate Percentage Value

The Rate percentage value defines how far the Auxiliary 2 servo travels relative to either the Steering servo or the Throttle servo.

 The Master channel (either Steering Channel 1 or Throttle Channel 2) always controls the Slave channel (Auxiliary 2 Channel 4).

- 1) From the Top Screen, press the ENTER key to open the Programming Menu list.
- 2) Scroll UP or DOWN to highlight the AUX2 menu, then press the ENTER key. The AUX2 AUX MIX menu will be displayed.

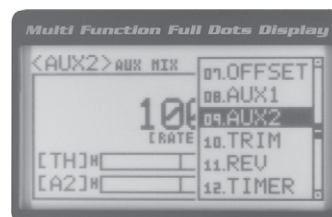

- 3) Press the ENTER key, then scroll UP or DOWN to change the Rate percentage value. Decreasing the Rate percentage value will reduce the amount the Auxiliary 2 servo travels relative to the Steering servo or Throttle servo and increasing the Rate percentage value will increase the amount the Auxiliary 2 servo travels relative to the Steering servo or Throttle servo.

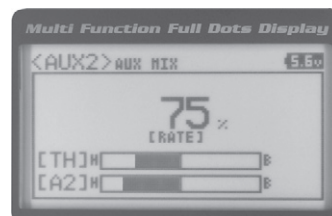

AUX2 AUX MIX RATE setting range is 100% to 0%. The default setting is 100%. This Mix is Linear. For example, if the Rate percentage value is set to 100%, the Auxiliary 2 servo will travel the same amount as the Steering servo. Additionally, if the Rate percentage value is set to 50%, the Auxiliary 2 servo will travel half the amount as the Steering servo.

# PROGRAMMING MENUS

## AUX MIX (AUXILIARY MIXING), CONTINUED....

! In the default configuration, the Auxiliary 2 servo will travel in the same direction as the Steering servo or Throttle servo. To apply the Mix in the opposite direction, change the Servo Reversing value of Auxiliary 2 Channel 4. For more information, see the *Servo Reversing* section on page 44.

### Controlling the Auxiliary Mixing Function

1) In the default configuration, Auxiliary 2 is controlled by the Rotary Dial. Turn the Rotary Dial clockwise to increase the Rate percentage value and turn the Rotary Dial counter-clockwise to decrease the Rate percentage value. In addition, the Auxiliary Mixing Rate function can be assigned to one of the four Trim Switches or the Auxiliary Lever. The Auxiliary Mixing function can be toggled 'OFF' and 'ON' by assigning Auxiliary 1 to one of the two Push-Button Switches. For more information, see the *Key Assignments* section on pages 56 ~ 61.

! Remember that you are able to independently adjust the Auxiliary 2 Channel 4 Dual Rate, Exponential, Sub-Trim, Servo Speed settings and more to allow for the optimum Auxiliary Mixing setup.

## 10. TRIM (TRIM AND SERVO SUB-TRIM)

The Trim function allows you to view the currently programmed Trim value of each of the four channels and, if desired, allows you to change the Trim values using the Push-Button Rotary Dial from within the Trim menu. In addition to the Trim function, the Servo Sub-Trim function allows you to fine-tune the Neutral position of each servo.

### Adjusting the Servo Sub-Trim Values

It's not unusual that when you center a servo and install the servo horn, the servo horn is not perfectly centered as well. The Servo Sub-Trim function allows you to correct the Neutral Trim setting for the Steering, Throttle, Auxiliary 1 and Auxiliary 2 channels, making it possible to center the Trim Switches while ensuring the Steering, Throttle, Auxiliary 1 and Auxiliary 2 servo horns remain centered.

**IMPORTANT:** Before using the Servo Sub-Trim function, you should verify that all four Trim values are set to 0 (Centered). If they are not set to 0, adjust the Trim values to 0 using the Trim function. For more information, see the Adjusting the Trim Values sections on the next page.

1) Install the servo horn (or servo saver for the Steering servo) onto your servo, making sure that the servo horn (or servo saver) is as close to being centered as possible. In some cases, you can get the servo horn closer to being centered by rotating the servo horn 180° and reinstalling it.

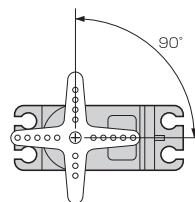

2) From the Top Screen, press the ENTER key to open the Programming Menu list.

3) Scroll UP or DOWN to highlight the TRIM menu, then press the ENTER key. The TRIM menu will be displayed and [ST] : TRIM 0 will be highlighted.

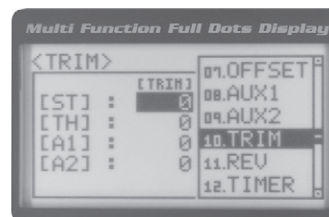

4) Scroll UP or DOWN to highlight the desired channel you would like to change the Sub-Trim value for. Choose from either [ST] : [SUB-T] 0 (Steering), [TH] : [SUB-T] 0 (Throttle), [A1] : [SUB-T] 0 (Auxiliary 1) or [A2] : [SUB-T] 0 (Auxiliary 2).

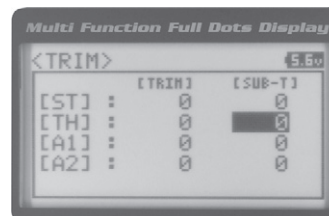

# PROGRAMMING MENUS

## Adjusting the Servo Sub-Trim Values, Continued....

- 1) Press the ENTER key, then scroll UP or DOWN to increase or decrease the Sub-Trim value to center the servo horn.

TRIM SUB-T setting range for the Steering channel is R150 to L150, for the Throttle channel is H150 to B150 and for Auxiliary 1 Channel 3 and Auxiliary 2 Channel 4 is H150 to L150. The default setting for all channels is 0.

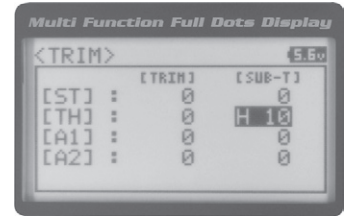

- ⚠ After adjusting the Sub-Trim value, use the End Point Adjustment function to set the desired amount of maximum servo travel in both directions. For more information, see the *End Point Adjustment* section on pages 22 and 23.

## Adjusting the Trim Values

The *MT-4 2.4GHz FHSS-4T* transmitter features Digital Trim Memory. Any amount of Trim that you set during use using the Trim Switches is automatically stored in memory for that specific channel and for that specific model. The Trim values for each model will automatically be loaded when the transmitter is turned 'ON'.

- ⚠ Before adjusting the Trim values, you should first adjust the servo Sub-Trim values to center the servo horns. For more information, see the *Adjusting the Servo Sub-Trim Values* section on the previous page.

- ⚠ The current Steering and Throttle Trim values are displayed on the Trim Indicator on the Top Screen.

- 1) From within the TRIM menu, scroll UP or DOWN to highlight the desired channel you would like to change the Trim value for. Choose from either [ST] : [TRIM] 0 (Steering), [TH] : [TRIM] 0 (Throttle), [A1] : [TRIM] 0 (Auxiliary 1) or [A2] : [TRIM] 0 (Auxiliary 2).

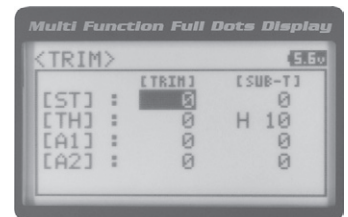

- 2) Press the ENTER key, then scroll UP or DOWN to increase or decrease the Trim value in the desired direction.

TRIM TRIM setting range for the Steering channel is R100 to L100, for the Throttle channel is H100 to B100 and for Auxiliary 1 Channel 3 and Auxiliary 2 Channel 4 is H100 to L100. The default setting for all channels is 0.

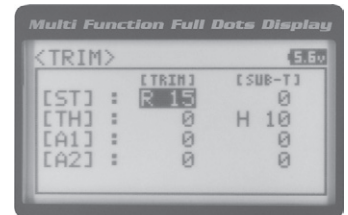

## Controlling the Trim Function

- 1) In the default configuration, Trim Switch Trm1 controls the Steering Right and Left Trim and Trim Switch Trm2 controls the Throttle High and Brake Trim. When you move the Trim Switches, the Trim percentage value changes in 5% increments. When you use the Trim function to change the Trim value, the Trim value changes in 1% increments. Auxiliary 1 Trim and Auxiliary 2 Trim can be assigned to the remaining two Trim Switches, the Rotary Dial or the Auxiliary Lever. For more information, see the *Key Assignments* section on pages 56 ~ 61.

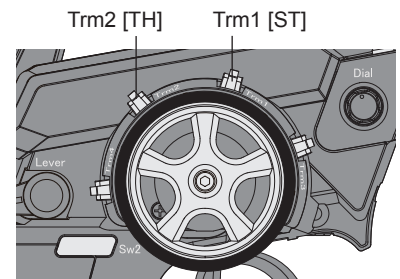

- ⚠ Each time you move a Trim Switch a single audible tone is heard. When the Trim value reaches 0 (Centered), an audible double-tone sounds. This indicates to you that the Trim is centered without the need to look down at the Trim Indicator on the Top Screen while you're driving.

**PRO TIP:** The Trim function features two different Trim Type options that you can choose from. Choose from either Center Trim or Parallel Trim. For more information, see the *Trim Type* section on pages 61 and 62.

# PROGRAMMING MENUS

## 11. REV (SERVO REVERSING)

The Servo Reversing function allows you to electronically switch the direction of servo travel. For example, if you rotate the steering wheel to the right, and the steering servo moves to the left, you can use the Servo Reversing function to make the steering servo move to the right. The Servo Reversing function is available for all four channels.

### Changing the Servo Reversing Values

- 1) From the Top Screen, press the ENTER key to open the Programming Menu list.
- 2) Scroll UP or DOWN to highlight the REV menu, then press the ENTER key. The REV menu will be displayed and [ST] : NOR will be highlighted.

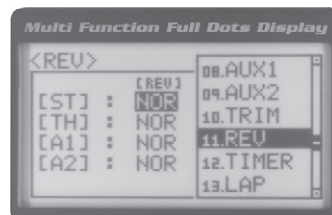

- 3) Scroll UP or DOWN to highlight the desired channel you would like to change the Servo Reversing value for. Choose from either [ST] : NOR (Steering), [TH] : NOR (Throttle), [A1] : NOR (Auxiliary 1) or [A2] : NOR (Auxiliary 2).

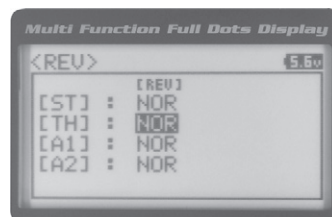

- 4) Press the ENTER key, then scroll UP or DOWN to change the direction of servo travel.

REV setting range is NOR and REV. The default setting for all channels is NOR.

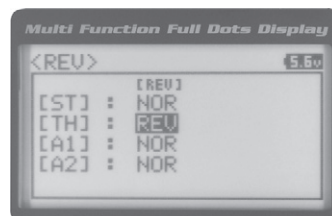

⚠ When you change the direction of servo travel, the servo horn may no longer be centered. If this occurs, use the Servo Sub-Trim function to center the servo horn. For more information, see the *Adjusting the Servo Sub-Trim Values* section on pages 42 and 43.

## 12. TIMER (TRACK TIMERS)

The Track Timers function features three different Timers. Timers are provided for measuring Lap Times, Interval Times, and Countdown Times. **Timers are displayed in the following format: 00:00.00 (Minutes:Seconds.1/100th of a Second).**

### Choosing the Timer Type

- 1) From the Top Screen, press the ENTER key to open the Programming Menu list.
- 2) Scroll UP or DOWN to highlight the TIMER menu, then press the ENTER key. The TIMER menu will be displayed and [TYPE] LAP will be highlighted.

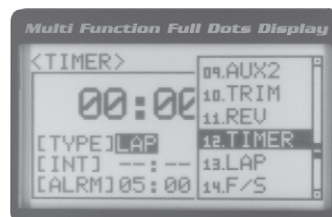

- 3) Press the ENTER key, then scroll UP and DOWN to select the desired Timer Type. Choose from LAP, INT (Interval) and DOWN (Countdown).

⚠ To program the Lap Timer function, see the *Lap Timer* section on the next page. To program the Interval Timer function, see the *Interval Timer* section on page 46. To program the Countdown Timer function, see the *Countdown Timer* section on page 47.

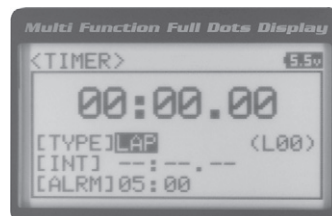

# PROGRAMMING MENUS

## 12. TIMER (TRACK TIMERS), CONTINUED....

### LAP (LAP TIMER)

The Lap Timer function allows you to measure and record times for up to 99 laps. The number of laps completed is displayed in the Timer menu, and when a lap is completed, the lap time is displayed momentarily on the Top Screen. An Alarm (Goal Time) is featured that will sound when you reach your Goal Time and, if desired, the Interval Timer (Target Time) can be programmed within the Lap Timer to alert you of your Target Time separately from your Goal Time.

#### Setting the Interval Timer (Target Time)

- 1) From within the TIMER menu, scroll DOWN to highlight [INT] : --.
- 2) Press the ENTER key, then scroll UP or DOWN to set the desired Interval Timer Minutes value.
- 3) To set the Interval Timer Seconds value, press the ENTER key, then scroll DOWN to highlight --. Press the ENTER key a second time, then scroll UP and DOWN to set the desired Interval Timer Seconds value.
- 4) To set the Interval Timer 1/100th Seconds value, press the ENTER key, then scroll DOWN to highlight --. Press the ENTER key a second time, then scroll UP and DOWN to set the desired Interval Timer 1/100th Seconds value.

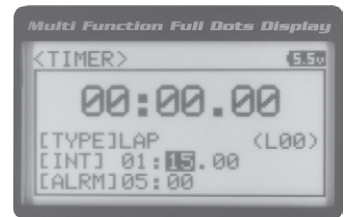
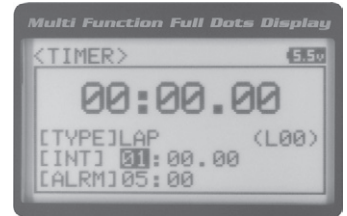

TIMER INT setting range is -- : -- . -- to 99 : 59 : 99. The default setting is -- : -- . -- (OFF). When the Lap Timer is counting up, an audible double-tone will sound each time the Lap Timer reaches the Interval Timer value. For example, if you set the Interval Timer for 30 Seconds, an audible double-tone will sound every 30 seconds.

#### Setting the Alarm (Goal Time)

- 1) From within the TIMER menu, scroll DOWN to highlight [ALRM] 05.
- 2) Press the ENTER key, then scroll UP or DOWN to set the desired Alarm Minutes value.
- 3) To set the Alarm Seconds value, press the ENTER key, then scroll DOWN to highlight 00. Press the ENTER key a second time, then scroll UP and DOWN to set the desired Alarm Seconds value.

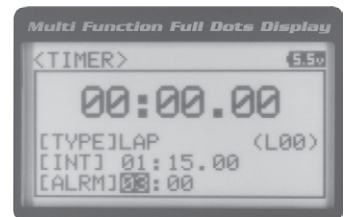

TIMER ALRM setting range is 00:00 to 99:59. The default setting is 5:00 minutes. An audible tone will sound in 1 second intervals 5 seconds before reaching the Goal Time. When the Goal Time is reached, a long audible tone will sound.

#### Starting the Lap Timer

- 1) In the default configuration, Push-Button Switch Sw2 controls the Lap Timer. Press and HOLD the Push-Button Switch for 3 seconds. An audible double-tone will sound and LAP will flash on the Top Screen indicating the Lap Timer is in Stand-by. To start the Lap Timer, press the Push-Button Switch a second time or pull the Throttle Trigger. An audible double-tone will sound and the Lap Timer will start counting up. Pressing the Push-Button Switch a second time will store the first Lap Time, then begin counting a second Lap Time. Each time you press the Push-Button Switch, an audible tone sounds, the previous Lap Time is stored, a new Lap Time begins and the current Lap Time is displayed momentarily on the Top Screen. If desired, the Timer Function can be assigned to Push-Button Switch Sw1. For more information, see the *Key Assignments* section on pages 56 ~ 61.

#### Stopping the Lap Timer

- 1) To stop the Lap Timer, press and HOLD the Push-Button Switch for 3 seconds. An audible double-tone will sound indicating the Lap Timer is stopped and the Cumulative Time will be displayed on the Top Screen and in the TIMER menu.



The Cumulative Time cannot be manually cleared. It will be automatically cleared when the Lap Timer is put in Stand-by again.

# PROGRAMMING MENUS

## 12. TIMER (TRACK TIMERS), CONTINUED....

### INT (INTERVAL TIMER)

The Interval Timer (Target Time) function notifies you when a set interval elapses while you are driving, giving you an idea of how close you are to your Target Time. An Alarm (Goal Time) is featured that will sound when you reach your Goal Time.

#### Setting the Interval Timer (Target Time)

- 1) From within the TIMER menu, scroll DOWN to highlight [INT] : --.
- 2) Press the ENTER key, then scroll UP or DOWN to set the desired Interval Timer Minutes value.
- 3) To set the Interval Timer Seconds value, press the ENTER key, then scroll DOWN to highlight --. Press the ENTER key a second time, then scroll UP and DOWN to set the desired Interval Timer Seconds value.
- 4) To set the Interval Timer 1/100th Seconds value, press the ENTER key, then scroll DOWN to highlight --. Press the ENTER key a second time, then scroll UP and DOWN to set the desired Interval Timer 1/100th Seconds value.

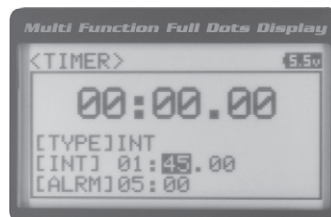
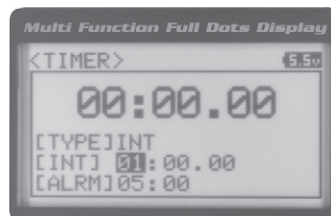

TIMER INT setting range is -- : -- . -- to 99 : 59 : 99. The default setting is -- : -- . -- (OFF). When the Interval Timer is started, an audible double-tone will sound each time the Interval Timer reaches the Interval Timer value. For example, if you set the Interval Timer for 1 Minute, an audible double-tone will sound every Minute.

#### Setting the Alarm (Goal Time)

- 1) From within the TIMER menu, scroll DOWN to highlight [ALRM] 05.
- 2) Press the ENTER key, then scroll UP or DOWN to set the desired Alarm Minutes value.
- 3) To set the Alarm Seconds value, press the ENTER key, then scroll DOWN to highlight 00. Press the ENTER key a second time, then scroll UP and DOWN to set the desired Alarm Seconds value.

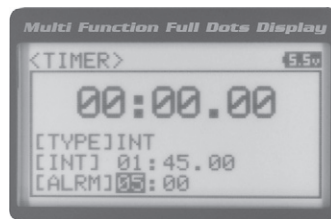

TIMER ALRM setting range is 00:00 to 99:59. The default setting is 5:00 minutes. An audible tone will sound in 1 second intervals 5 seconds before reaching the Goal Time. When the Goal Time is reached, a long audible tone will sound.

#### Starting the Interval Timer

- 1) In the default configuration, Push-Button Switch Sw2 controls the Interval Timer. Press and HOLD the Push-Button Switch for 3 seconds. An audible double-tone will sound and INT will flash on the Top Screen indicating the Interval Timer is in Stand-by. To start the Interval Timer, press the Push-Button Switch a second time or pull the Throttle Trigger. An audible double-tone will sound and the Interval Timer will start counting up. Each time the programmed Interval Time elapses, an audible double-tone will sound and the Interval Timer will restart from zero and the Cumulative Time will be displayed on the Top Screen. You can manually restart the Interval Timer from zero by pressing the Push-Button Switch while the Interval Timer is running. If desired, the Timer Function can be assigned to Push-Button Switch Sw1. For more information, see the *Key Assignments* section on pages 56 ~ 61.

#### Stopping the Interval Timer

- 1) To stop the Interval Timer, press and HOLD the Push-Button Switch for 3 seconds. An audible double-tone will sound indicating the Interval Timer is stopped and the Cumulative Time will be displayed on the Top Screen and in the TIMER menu.

 The Cumulative Time cannot be manually cleared. It will be automatically cleared when the Interval Timer is put in Stand-by again.

# PROGRAMMING MENUS

## 12. TIMER (TRACK TIMERS), CONTINUED....

### DOWN (COUNTDOWN TIMER)

The Countdown Timer function can be used to notify you of your model's running time. For example, you can set the Countdown Timer to alert you when it's time to refuel. When the Countdown Timer expires, a long audible tone will sound and the Count Up Timer function begins automatically. This allows you to check the time elapsed since the Countdown Timer ran out.

#### Setting the Alarm

- 1) From within the TIMER menu, scroll DOWN to highlight [ALRM] 05.
- 2) Press the ENTER key, then scroll UP or DOWN to set the desired Alarm Minutes value.
- 3) To set the Alarm Seconds value, press the ENTER key, then scroll DOWN to highlight 00. Press the ENTER key a second time, then scroll UP and DOWN to set the desired Alarm Seconds value.

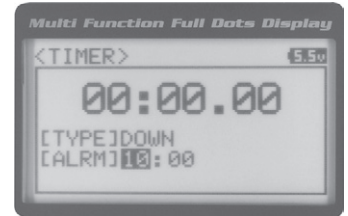

TIMER ALRM setting range is 00:00 to 99:59. The default setting is 5:00 minutes. An audible tone will sound in 1 second intervals 5 seconds before reaching the Countdown Alarm Time. When the Countdown Alarm Time is reached, a long audible tone will sound.

#### Starting the Countdown Timer

- 1) In the default configuration, Push-Button Switch Sw2 controls the Countdown Timer. Press and HOLD the Push-Button Switch for 3 seconds. An audible double-tone will sound and DWN will flash on the Top Screen indicating the Countdown Timer is in Stand-by. To start the Countdown Timer, press the Push-Button Switch a second time or pull the Throttle Trigger. An audible double-tone will sound and the Countdown Timer will start counting down. An audible tone will sound in 1 second intervals 5 seconds before reaching zero. When zero is reached, a long audible tone will sound and the Countdown Timer will begin counting Up. You can manually stop the Countdown Timer at any time by pressing the Push-Button Switch. Press the Push-Button Switch again will start the Countdown Timer from where it was stopped. If desired, the Timer Function can be assigned to Push-Button Switch Sw1. For more information, see the *Key Assignments* section on pages 56 ~ 61.

#### Stopping the Countdown Timer

- 1) To stop the Countdown Timer, press and HOLD the Push-Button Switch for 3 seconds. An audible double-tone will sound indicating the Countdown Timer is stopped and either the remaining Countdown Time or elapsed Count Up Time will be displayed on the Top Screen and in the TIMER menu.

 The remaining Countdown Time or Count Up Time cannot be manually cleared. It will be automatically cleared when the Countdown Timer is put in Stand-by again.

## 13. LAP (LAP TIMES)

The Lap Times menu displays a total of up to 99 laps that are recorded using the Lap Timer function. Each Lap Time is displayed along with the Best Lap Time and the Total (Cumulative) Lap Time.

#### Viewing Lap Times

- 1) From the Top Screen, press the ENTER key to open the Programming Menu list.
- 2) Scroll UP or DOWN to highlight the LAP menu, then press the ENTER key. The LAP menu will be displayed and the last Lap selected will be highlighted.
- 3) Scroll UP and DOWN to view the stored Lap Times. Lap Times are stored from the time you start the Lap Timer to the time you Stop the Lap Timer. The Total (Cumulative) Lap Time and your Best Lap Time are always displayed at the top of the list.

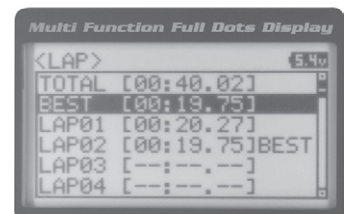
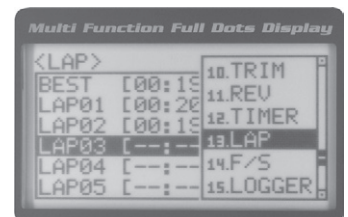

 Lap Times are stored until you restart the Lap Timer function. When the Lap Timer function is restarted, old Lap Times are cleared and new Lap Times are stored.

# PROGRAMMING MENUS

## 14.F/S (FAIL SAFE)

The Fail Safe function automatically moves the servos to a predetermined position in the event that the signal between the transmitter and the receiver is interrupted, whether due to signal degradation or to low transmitter battery. Several different setting options are available. The Fail Safe function can be set to Hold the servos in the last position they were in when the signal was lost, or each of the servos can be set to move to a custom position when the signal is lost. For example, the throttle servo moves to the Brake Side to engage the brakes and stop your model. If you're driving a gas- or glow-powered boat, the Fail Safe function could be set to lower the throttle to idle and turn the rudder slightly left or right so that the boat will continue in slow circles.

In addition, a Receiver Battery Voltage Fail Safe function is available which allows you to set a custom voltage that the Receiver Battery Fail Safe function will Activate at. This is useful if you're using servos with a higher than normal current draw that might run out of power before the receiver does.

**IMPORTANT:** The Fail Safe function will NOT OPERATE if the receiver loses power. It will operate only if the transmitter and receiver signal is interrupted or if the transmitter loses power.

### Setting the Fail Safe

Fail Safe settings can be programmed for each of the four channels individually. In addition, Fail Safe settings are Model-specific, meaning you can have different Fail Safe settings for each Model in memory. The Fail Safe settings will be retained even if the transmitter loses power or if the transmitter and receiver must be paired again. Three Fail Safe options are available for each channel as described below:

**FREE** - Fail Safe is disabled for this channel. Servos can move freely when the signal is lost.

**HOLD** - When Fail Safe Activates, the servo will be held in the last position it was in when the signal was lost.

**% (PERCENTAGE)** - When Fail Safe Activates, the servo will travel to the programmed position when the signal is lost.

**PRO TIP:** Use the Servo Monitor at the bottom of the F/S menu to see your programming changes in virtual real time.

- 1) From the Top Screen, press the ENTER key to open the Programming Menu list.
- 2) Scroll UP or DOWN to highlight the F/S menu, then press the ENTER key. The F/S menu will be displayed and [ST] : FREE will be highlighted.
- 3) Scroll UP or DOWN to highlight the desired channel you would like to change the Fail Safe option for.
- 4) Press the ENTER key, then scroll UP or DOWN to choose the desired Fail Safe option for that channel. If you choose to program a % value, see step 5 below.

F/S setting range is FREE, HOLD, or %. The default setting is FREE.

- 5) To program a Fail Safe percentage value, move the control the amount you want the servo to move to when the Fail Safe function Activates and HOLD it in that position, then press and HOLD the ENTER key until an audible tone sounds. The percentage and direction the servo will travel will be displayed. For example, to set the Throttle Brake to engage when the Fail Safe function Activates, push the throttle trigger toward the Brake side the desired amount, HOLD the throttle trigger in that position, then press and HOLD the ENTER key. The percentage value programmed will be indicated by two hash marks on the Servo Monitor.
- 6) Check to ensure your Fail Safe settings are working properly prior to running your model. For safety, it's preferable to have someone hold your model. To check the Fail Safe settings, make sure that both the transmitter and receiver are turned 'ON', then, while someone is holding your model, turn the transmitter 'OFF'. The servos should react correctly based on the Fail Safe options chosen.

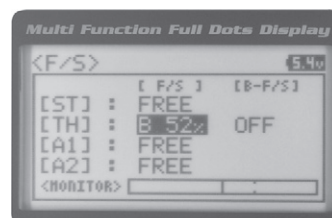
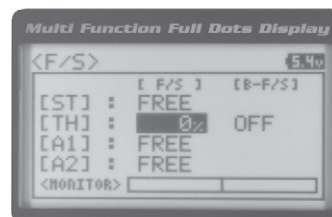
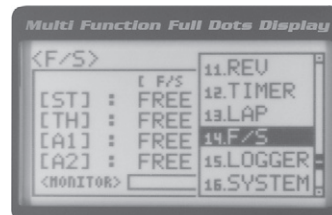



# PROGRAMMING MENUS

## 14. F/S (FAIL SAFE), CONTINUED....

### Setting the Receiver Battery Voltage Fail Safe Function

The Receiver Battery Voltage Fail Safe function allows you to set a custom voltage that the Receiver Battery Voltage Fail Safe function will Activate at. When your receiver battery voltage drops to the programmed voltage, the throttle servo will move to the predetermined position you programmed in step 5 in the *Setting the Fail Safe* section on the previous page. If this occurs, recharge or replace your receiver batteries.

⚠ If FREE or HOLD is chosen for the Throttle channel, you cannot Activate the Receiver Battery Voltage Fail Safe function. A % value must be chosen for the Throttle channel to be able to program and use the Receiver Battery Fail Safe function.

⚠ The Receiver Battery Voltage Fail Safe function works only with FHSS-4T and FHSS-3 receivers. When using an FHSS-2 receiver, these Fail Safe features are not supported. In this case, Fail Safe must be programmed through the receiver. For more information, follow the instructions provided with your FHSS-2 receiver.

- 1) Follow steps 1 through 5 in the *Setting the Fail Safe* section on the previous page to program a Throttle Fail Safe percentage value.
- 2) From within the F/S menu, press the ENTER key, then scroll DOWN to highlight [B-F/S] OFF.

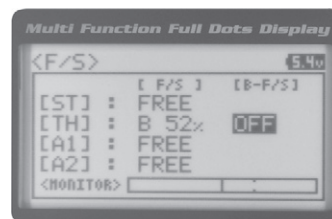

- 3) Press the ENTER key, then scroll UP or DOWN to choose the desired Receiver Battery Fail Safe Voltage value.

F/S B-F/S setting range is 3.5v to 7.4v. The default setting is OFF.

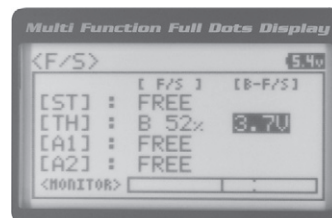

⚠ The receiver will operate down to 2.5 volts, however, the minimum operating voltage of most servos is higher than that. The Receiver Battery Fail Safe Voltage should be set to a value that will allow all of your servos to operate. You will need to check your servo's specifications to determine the minimum voltage required for the compliment of servos you're using.

## 15. LOGGER (TELEMETRY LOG)

The Telemetry Log function allows you to view a log of the Telemetry Data that is sent from the receiver to the transmitter. You are able to view Telemetry Data for both Temperature outputs, the RPM output and the receiver's Voltage. This information can be used to track specific information about your model, such as cylinder head temperature if you're running a nitro-powered model. The interval that Telemetry Data is read and stored can be adjusted so that Telemetry Data can be stored for up to 90 minutes of use. The Telemetry Log can store 120 different data entries at intervals ranging from 00.1 seconds to 45.9 seconds.

### Starting and Stopping the Telemetry Log

The Telemetry Log function must be Started in order for the transmitter to read and store Telemetry Data from the receiver.

- 1) In the default configuration, Push-Button Switch Sw1 controls the Telemetry Log. To start the Telemetry Log, press the Push-Button switch. LED1 (Blue) will flash, indicating the Telemetry Log is storing data. Telemetry Data is stored for all four Telemetry functions, whether the Telemetry Sensors are hooked up or not.
- 2) To stop the Telemetry Log, press the Push-Button Switch a second time. If desired, the Telemetry Log Function can be assigned to Push-Button Switch Sw2. For more information, see the *Key Assignments* section on pages 56 ~ 61.

⚠ Each time the Telemetry Log is started, any old Telemetry Data is automatically erased. In addition, the Telemetry Log will stop automatically once the Telemetry Log is filled. The Telemetry Log can store 120 separate entries. If the Log Interval is set to 00.1 seconds, the Telemetry Log can record for 12 seconds. If the Log Interval is set to 45.1 seconds, the Telemetry Log can record for 90 minutes. To change the Log Interval value, see the *Changing the Telemetry Log Step Value* section on page 71.

⚠ If a Telemetry Sensor is not connected, default Telemetry Data for that input will be shown in the Telemetry Log. Telemetry is NOT supported when using FHSS-2 or FHSS-3 receivers.

# PROGRAMMING MENUS

## 15. LOGGER (TELEMETRY LOG), CONTINUED....

### Viewing Telemetry Data

- 1) From the Top Screen, press the ENTER key to open the Programming Menu list.
- 2) Scroll UP or DOWN to highlight the LOGGER menu, then press the ENTER key. The LOGGER menu will be displayed and TEMP1 DATA will be highlighted.

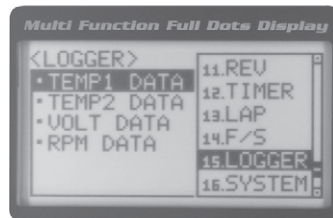

- 3) From within the LOGGER menu, scroll UP or DOWN to highlight the desired Telemetry Data you would like to view. Choose from TEMP1 DATA, TEMP2 DATA, VOLT DATA or RPM DATA.

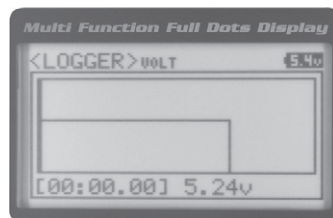

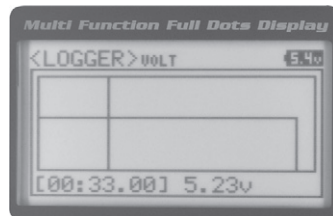

- 4) Press the ENTER key to open the Telemetry Log.

- 5) Telemetry Data can be viewed a couple of different ways. To view the Telemetry Data at a specific point along the graph, scroll UP or DOWN to move the vertical line right or left. The Telemetry Data for each point the vertical line is at is displayed at the bottom of the screen.

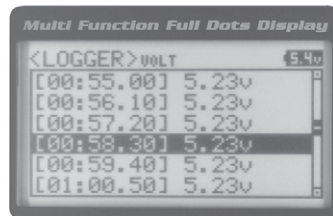

- 6) To view all of the Telemetry Data points, press the ENTER key to open the Telemetry Data List, then scroll DOWN to view all of the recorded Telemetry Data entries.



 The Telemetry Log can be started and stopped while viewing Telemetry Data. To start the Telemetry Log, press and HOLD the ENTER key and to stop the Telemetry Log, press and HOLD the ENTER key a second time.

THIS SPACE INTENTIONALLY LEFT BLANK

# SYSTEM MENUS

## OVERVIEW

To access the various System Menu, turn the transmitter 'ON', then press the ENTER key (Push-Button Rotary Dial) to open the Programming Menu list. Scroll DOWN to SYSTEM, then press the ENTER key a second time to open the System Menu. A list of System Menu will be displayed and the first System Menu will be highlighted.

The following System Menus are available by scrolling UP or DOWN using the Push-Button Rotary Dial:

MENU	MENU NAME	MENU DESCRIPTION	PAGE #
01.MODEL	Model	Model Select, Model Naming, Model Copy and Model Clear	PG. 51
02.BIND	Binding	Bind the Transmitter and Receiver, Select Modulation Type and Servo Mode	PG. 54
03.KEY ASSIGN	Key Assignments	Assign Functions to the Switches Rotary Dial and Auxiliary Lever	PG. 56
04.TRIM TYPE	Servo Trim Type	Change the Servo Trim Type	PG. 61
05.AUX TYPE	Auxiliary Type	Choose the Auxiliary 1 and Auxiliary 2 Programming Functions	PG. 62
06.TH TYPE	Throttle Type	Change the Throttle Servo Travel Proportion	PG. 63
07.BUZZER	Audible Key Tone	Turn Audible Key Tones 'ON' or 'OFF' and Control Their Pitch and Volume	PG. 63
08.BATTERY	Voltage Alarm	Specify the Low Voltage and Limit Alarms for the Transmitter Battery	PG. 64
09.LCD	Contrast	Adjust the Contrast of the Multi-Function LCD Screen	PG. 65
10.TELEMETRY	Telemetry	Program Telemetry Screen and Telemetry Log Options	PG. 66
11.VR ADJUST	Variable Rate Adjustment	Calibrate Steering, Throttle, and Auxiliary Lever Controls	PG. 71

SYSTEM MENUS

SYSTEM MENUS

## 01.MODEL (MODEL SELECT, NAMING, COPY AND CLEAR)

The Model menu allows you to select different models using the Model Select function, name your saved models, using the Model Naming function, and copy Programming Data from one model to another, or clear Programming Data from one or more models using the Model Copy and Model Clear functions. Programming Data for up to 18 different models can be stored in the transmitter's memory. This allows you to use the transmitter with different models and quickly and easily select the Programming Data for each of them. In addition, a Model Select Shortcut function is also featured for quick access to the Model Select (Direct Model) function.

### MODEL SELECT (MODEL SELECT)

The Model Select function allows you to load the Programming Data for the particular model you wish to drive. The Model Select menu displays the currently selected model, along with a list of available models that can be selected. The Modulation Type for each model is also displayed. The transmitter can store Programming Data for up to 18 different models.



When a model is selected and loaded, the Programming Data for that model will be loaded immediately.

#### Selecting a Model

- From within the SYSTEM menu, scroll UP or DOWN to highlight the MODEL menu.
- Press the ENTER key to open the MODEL menu. MODEL SELECT will be highlighted.
- Press the ENTER key. The MODEL SELECT menu will be displayed and the currently selected model in the Model Select List will be highlighted.

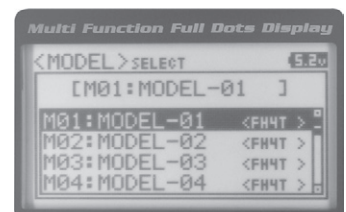
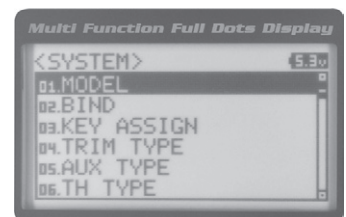

# SYSTEM MENUS

## MODEL SELECT (MODEL SELECT), CONTINUED....

### Selecting a Model. Continued....

- 4) Scroll UP or DOWN to highlight the model you would like to select, then press the ENTER key. Select this model? NO/YES will be displayed. Scroll DOWN to highlight YES, then press the ENTER key. The model that you just selected will be displayed above the Model Select List.

 When a model is selected, the Programming Data for that model will be loaded immediately.

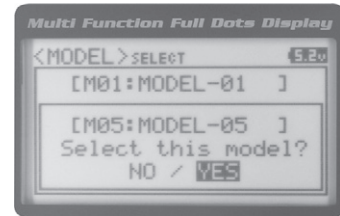

### Model Select Shortcut (Direct Model)

The Model Select Shortcut function allows you to jump directly to the DIRECT MODEL menu when you turn the transmitter 'ON'. This menu works the same as the MODEL SELECT menu and makes it much quicker select your desired model.

- 1) Turn the transmitter 'OFF'.
- 2) Press and HOLD the Back/Cancel key, then turn the transmitter 'ON'. The DIRECT MODEL menu will be displayed. To select a model, follow step 4 in the *Selecting a Model* section above.

## MODEL NAME (MODEL NAMING)

The Model Naming function allows you to name each of the 18 individual models. This makes it easy to keep track of multiple models. The Model Name can consist of up to 10 letters, numbers, or symbols. Choose from capital letters, lower case letters, numbers, and various symbols.

 A model must be selected before a Model Name can be entered or modified. In the default configuration, M01:MODEL-1 is selected. To enter a Model Name for another model, that model must first be selected using the Model Select function or the Model Select Shortcut function. For more information, see the *Model Select* section on pages 51 and 52.

### Entering a Model Name

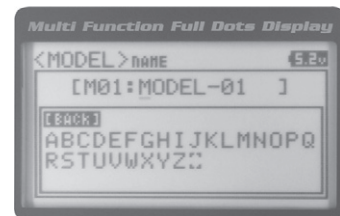

- 1) From within the MODEL menu, scroll DOWN to highlight MODEL NAME.
- 2) Press the ENTER key. The MODEL NAME menu will be displayed, [BACK] will be highlighted and the underscore will be flashing under the first editable character in the Model Name.

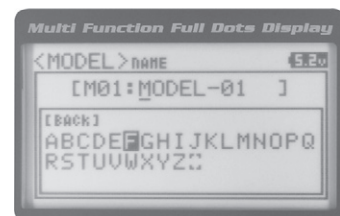

- 3) Scroll UP or DOWN to move the underscore to the character you would like change.
- 4) Press the ENTER key, then scroll UP or DOWN to highlight a character in the Character List. Press the ENTER key a second time to select the highlighted character. That character will be displayed and the underscore will move to the next space in the Model Name.



- 5) Repeat steps 3 and 4 to enter the rest of the characters. Up to ten characters can be entered. Press the Back/Cancel key to re-gain control of the underscore (the underscore will flash indicating you can scroll UP or DOWN to move it Forward or Back).

 To select lower case letters, numbers or symbols, continue to scroll UP or DOWN through the various Character Lists. To add a space in your Model Name, use the  icon.

### Deleting a Character

- 1) Scroll UP or DOWN to move the underscore under the character in your Model Name you want to delete. Press the ENTER key, then scroll UP or DOWN to highlight [BACK] or the  icon in the Character List and press the ENTER key.

 If you can't move the underscore, press the Back/Cancel key to re-gain control of the underscore (the underscore will flash indicating you can scroll UP or DOWN to move it Forward or Back).

# SYSTEM MENUS

## MODEL NAME (MODEL NAMING), CONTINUED....

### Deleting a Model Name

- 1) Scroll DOWN to move the underscore under the last character in your Model Name.
- 2) Press the ENTER key. Scroll UP or DOWN to highlight [BACK], then continuously press the ENTER key to delete each character in your Model Name.

 If you can't move the underscore, press the Back/Cancel key to re-gain control of the underscore (the underscore will flash indicating you can scroll UP or DOWN to move it Forward or Back).

## MODEL COPY (MODEL PROGRAMMING DATA COPY)

The Model Copy function allows you to copy the Programming Data from one model to another model. For example, if you have two models that are similar, you can copy the Programming Data from the first model to the second model to use as a base to start fine-tuning the programming for the second model.

 The Model Copy function allows you to copy Programming Data FROM the currently selected model TO any other model in the Model Copy List. Make sure that prior to using the Model Copy function, you first select and load the desired Model Programming Data you want to copy FROM, using the Model Select function.

### Copying Model Programming Data

- 1) From within the MODEL menu, scroll DOWN to highlight MODEL COPY.
- 2) Press the ENTER key. The MODEL COPY menu will be displayed and the first model in the Model Copy List will be highlighted.

 The currently selected model is displayed above the Model Copy List.

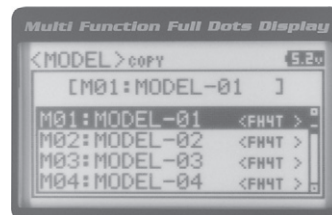

- 3) Scroll UP or DOWN to highlight the model you would like to copy the Programming Data TO.

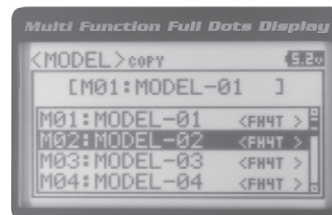

- 4) Press the ENTER key. Copy to this model? NO/YES will be displayed. Scroll DOWN to highlight YES, then press the ENTER key. After ~3 seconds, Executed will flash, indicating the Programming Data has been copied to the highlighted model.

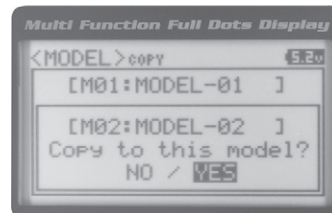

 All model-specific Programming Data, including the Model Name will be copied to the highlighted model. If you want to go back and change models or you don't want to copy the Programming Data for any reason, press the Back/Cancel key.

## MODEL CLEAR (MODEL PROGRAMMING DATA RESET)

The Model Clear function allows you to Reset model-specific Programming Data for any model back to the factory default settings.

**WARNING:** When the Model Clear function is Executed, all custom Programming Data for that model will be lost!

### Clearing Model Programming Data

- 1) Using the Model Select function, select the model you would like to Reset the Programming Data for.

# SYSTEM MENUS

## MODEL CLEAR (MODEL PROGRAMMING DATA RESET), CONTINUED....

2) From within the MODEL menu, scroll DOWN to highlight MODEL CLEAR.

3) Press the ENTER key. Clear this model? NO/YES will be displayed.

! The currently selected model is displayed at the top of the MODEL CLEAR menu.

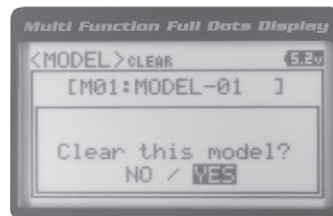

4) Scroll DOWN to highlight YES, then press the ENTER key. After ~3 seconds, Executed will flash, indicating the Programming Data has been Reset to the default values.

! All model-specific Programming Data, including the Model Name and Modulation Type will be Reset to the default values. In addition, if you want to go back and change models or you don't want to Reset the Programming Data for any reason, press the Back/Cancel key.

## 02.BINDING (BINDING, MODULATION TYPE AND SERVO MODE)

The Binding function allows you to 'Bind' the transmitter and receiver pair. When new, it is necessary to pair the transmitter and receiver to prevent interference from transmitters operated by other users. This operation is referred to as 'Binding'. Once the Binding process is complete, the setting is remembered even when the transmitter and receiver are turned 'OFF'. Therefore, this procedure usually only needs to be done once. In addition, the Modulation Type and Servo Mode Setting can also be changed.

### Changing the Modulation Type

The Modulation Type function allows you to choose the transmitter Modulation Type. The Modulation Type can be changed to match the receiver you're using. For example, if you wish to use an Airtronics 2.4GHz FHSS-2 receiver with your transmitter, you would need to change the Modulation Type to FH2 prior to Binding your transmitter and receiver. Modulation Type is model-specific, meaning that you can have one model use FH4T Modulation and another model use FH2 Modulation, etc.

! The Modulation Type must be chosen prior to Binding the transmitter and receiver. Make sure the Modulation Type you choose matches the Modulation Type of the receiver you're using.

1) From within the SYSTEM menu, scroll UP or DOWN to highlight the BIND menu.

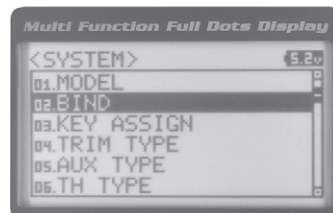

2) Press the ENTER key. The BIND menu will be displayed and [RF MODE] : FH4T will be highlighted.

3) Press the ENTER key, then scroll UP or DOWN to select the desired Modulation Type.

4) Press the ENTER key a second time. Set to (Modulation Type) NO/YES will be displayed. Scroll DOWN to highlight YES, then press the ENTER key.

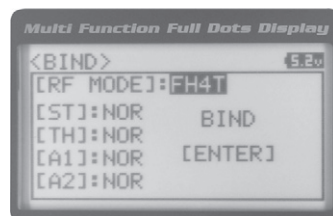

The following Modulation Type options are available:

**FH2** - Select this Modulation Type when using Airtronics 2.4GHz FHSS-2 surface receivers.

**FH3** - Select this Modulation Type when using Airtronics 2.4GHz FHSS-3 receivers.

**FH3F** - This Modulation Type is NOT used in North America. This Modulation Type is typically used in France.

**FH4T** - Select this Modulation Type when using Airtronics 2.4GHz FHSS-4T Telemetry receivers.

**FH4TF** - This Modulation Type is NOT used in North America. This Modulation Type is typically used in France.

## 02. BINDING (BINDING, MODULATION TYPE AND SERVO MODE), CONTINUED...

### Changing the Channel Mode - FH2 Modulation Type Only

If FH2 Modulation is chosen, you can choose to operate the transmitter in either 2-Channel Mode or 4-Channel Mode.

⚠ This option is available ONLY when [RF MODE] FH2 is chosen.

- 1) From within the BIND menu, scroll DOWN to highlight [CH] : 4ch.
- 2) Press the ENTER key, then scroll UP or DOWN to choose the desired Channel Mode. Selecting 2CH will enable 2-channel operation (Steering and Throttle). Selecting 4CH will enable 4-channel operation (Steering, Throttle, Auxiliary 1 and Auxiliary 2).

BIND CH setting range is 2CH and 4CH. The default setting is 4CH.

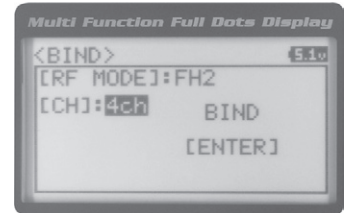

### Changing the Servo Mode Setting

The Servo Mode setting can be changed to suit the type of servos you're using in your model. For example, using the SHR setting with Digital servos will increase the servo's response time, even above the manufacturer's stated specification. If you're using Airtronics SRG Digital servos, you can use the SSR setting for the fastest response time. The combination of using Digital servos and using the correct Servo Mode setting results in the ultimate feel and response, making you feel more in control of your model than ever.

**WARNING:** If you're using Analog servos in your model, DO NOT use SHR or SSR Servo Mode options for that channel. Use the NOR (Normal) Servo Mode with Analog servos. Using SHR or SSR Servo Mode options with Analog servos can result in poor performance or even damage to the servos or the receiver! In addition, not all ESCs are compatible with SHR or SSR Servo Modes. If your ESC does not operate correctly, change the Throttle Channel Servo Mode setting to NOR (Normal).

⚠ SHR and SSR Servo Modes should only be used with Digital servos. While the SHR Servo Mode can be used with any Digital servo, the SSR Servo Mode should ONLY be used with Airtronics SRG Digital servos.

- 1) From within the BIND menu, scroll UP or DOWN to highlight the desired channel you would like to change the Servo Mode option for. Choose from either [ST] : NOR (Steering), [TH] : NOR (Throttle), [A1] : NOR (Auxiliary 1) or [A2] : NOR (Auxiliary 2).

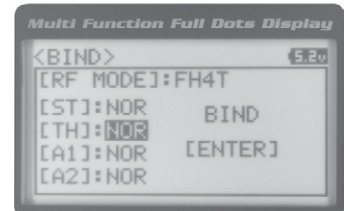

- 2) Press the ENTER key, then scroll UP or DOWN to choose the desired Servo Mode option for that channel.

SERVO MODE setting range is NOR, SHR and SSR. The default setting is NOR.

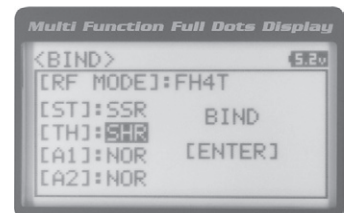

⚠ Servo Mode options are not supported when the FH2 Modulation Type is chosen.

⚠ We recommend that you choose your desired Servo Mode options prior to Binding the transmitter and receiver. Servo Mode option changes will not take effect immediately. If you change the Servo Mode after Binding the transmitter and receiver, you must Bind the transmitter and receiver a second time to initialize the changes.

### Binding the Transmitter and Receiver

To Bind the transmitter and receiver, please see the separate *Transmitter and Receiver Binding* section on page 18.

⚠ Prior to Binding the transmitter and receiver, make sure to choose the desired Modulation Type and Servo Mode options.

# SYSTEM MENUS

## 03. KEY ASSIGN (KEY ASSIGNMENTS)

The Key Assignments function allows you to assign different functions to each of the two Push-Button Switches, the four Trim Switches, the Dial Knob and the Auxiliary Lever. In addition, the ON/OFF behavior of some Push-Button Switch functions can be changed. The Key Assignments function also allows you to change the Direction of Travel and the Trim Resolution of the four Trim Switches and the Rotary Dial. This allows you to fine-tune the movement of the servos when the Trim Switches are pressed and the Rotary Dial is turned.

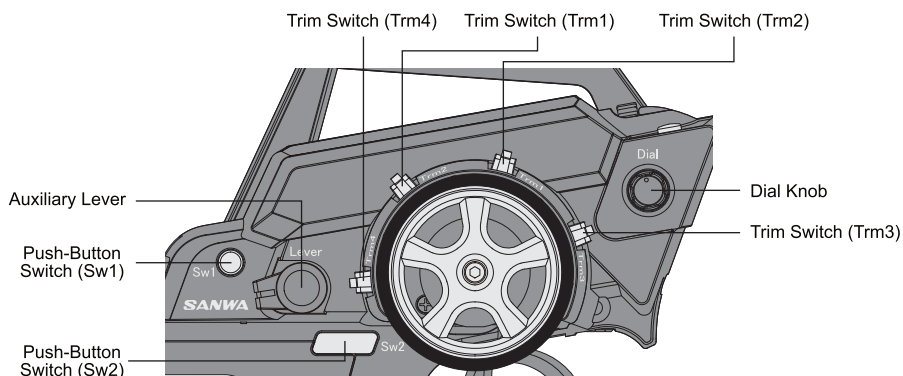

The following functions are programmed in the default configuration:

**Trm1** - Steering Trim

**Trm2** - Throttle Trim

**Trm3** - Steering Dual Rate

**Trm4** - Brake Dual Rate

**Sw1** - Telemetry Logger ON/OFF

**Sw2** - Timer ON/OFF

**Dial Knob** - Auxiliary 1 Channel 3

**Auxiliary Lever** - Auxiliary 2 Channel 4

## SWITCH (PUSH-BUTTON SWITCH KEY ASSIGNMENTS)

The Key Assignments function allows you to assign the ON/OFF control of various functions to Push-Button Switches Sw1 and Sw2. This allows you to use the Push-Button Switches to turn functions 'OFF' and 'ON' during use. One function can be assigned to each Push-Button switch, although both Push-Button Switches can be 'OFF' or 'ON' at the same time. In addition, the ON/OFF behavior of some Push-Button Switch Key functions can be changed.

This table shows the different functions that can be programmed to the two Push-Button Switches.

FUNCTION	MENU	DEFAULT SWITCH	DEFAULT MODE	DEFAULT ON/OFF
Inhibited	OFF		-----	-----
Dual Rate-Steering	D/R-ST		Toggle	ON
Dual Rate-Throttle	D/R-TH		Toggle	ON
Dual Rate-Brake	D/R-BR		Toggle	ON
Curve-Steering	CUR-ST		Toggle	ON
Curve-Steering	CUR-TH		Toggle	ON
Servo Speed-Steering	SPD-ST		Toggle	ON
Servo Speed-Throttle	SPD-TH		Toggle	ON
Anti-Lock Braking	ALB		Toggle	ON
Throttle Offset	OFFSET		Toggle	ON
Auxiliary 1 Channel 3	AUX1		Toggle	ON
Auxiliary 2 Channel 4	AUX2		Toggle	ON
Lap, Interval and Countdown Timers	TIMER	Sw2	-----	OFF
Telemetry Clear	TE-CLR		-----	OFF
Telemetry Logger	LOGGER	Sw1	-----	OFF

**!** When you program a function, that function is 'ON' (Active) by default, unless the function's default ON/OFF value is 'OFF' as noted in the table above. To toggle the function 'OFF' and 'ON' it must be assigned to a Push-Button Switch.



# SYSTEM MENUS

## SWITCH (PUSH-BUTTON SWITCH KEY ASSIGNMENTS), CONTINUED....

### Changing the Push-Button Switch Function

- 1) From within the SYSTEM menu, scroll UP or DOWN to highlight the KEY ASSIGN menu.
- 2) Press the ENTER key to open the KEY ASSIGN menu. SWITCH will be highlighted.
- 3) Press the ENTER key. The SWITCH menu will be displayed and SW1 : LOGGER will be highlighted.
- 4) Scroll UP or DOWN to highlight the function you would like to change for either SW1 or SW2.
- 5) Press the ENTER key, then scroll UP or DOWN to choose the desired function for either SW1 or SW2. A list of functions that can be assigned to the Push-Button Switches is shown in the table on the previous page.

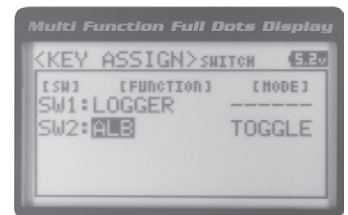
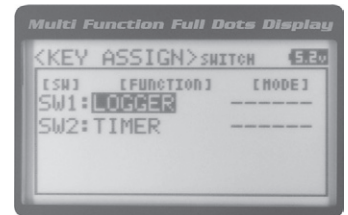
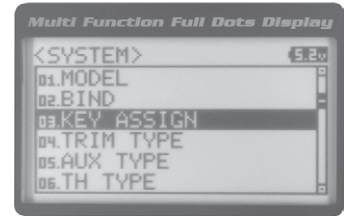

### Changing the Switch Mode

Some functions allow you to change how the Push-Button Switch operates. The following Switch Modes are available:

**TOGGLE** - When selected, press the Push-Button Switch to turn the function 'ON' and press the Push-Button Switch a second time to turn the function 'OFF'. **See note at the bottom of the previous page.**

**PUSH** - When selected, press and HOLD the Push-Button Switch to turn the function 'ON'. When the Push-Button Switch is released, the function will be turned 'OFF'.

- 1) From within the KEY ASSIGN SWITCH menu, scroll DOWN to highlight the MODE you would like to change for either SW1 or SW2.
- 2) Press the ENTER key, then scroll UP or DOWN to choose the desired Switch Mode setting, either TOGGLE or PUSH.

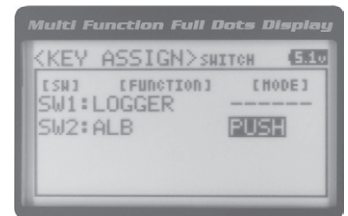

 The Switch Mode cannot be changed for all functions. When [MODE] -----, the Push-Button Switch will act as if it were in Toggle Mode.

## TRIM, DIAL AND LEVER (TRIM, DIAL AND LEVER KEY ASSIGNMENTS)

The Key Assignments function allows you to assign different functions to Trim Switches Trm1, Trm2, Trm3 and Trm4, the Rotary Dial and the Auxiliary Lever. This allows you to use the Trim Switches, Rotary Dial and Auxiliary Lever to control those functions while you're driving. In addition, the Direction of Travel (REV) and the Trim Resolution (Step value) of each Trim Switch and the Rotary Dial can be changed. The High and Low Travel Limits and the Direction of Travel of the Auxiliary Lever can be changed, too.

This table shows the different functions that can be programmed to the Trim Switches, Rotary Dial and Auxiliary Lever.

FUNCTION	MENU	DEFAULT SWITCH	DEFAULT STEP VALUE	DEFAULT REV VALUE
Inhibited	OFF		-----	-----
Trim-Steering	TRIM-ST	Trm1	5	NOR
Trim-Throttle	TRIM-TH	Trm2	5	NOR

# SYSTEM MENUS

## TRIM, DIAL AND LEVER (TRIM, DIAL AND LEVER KEY ASSIGNMENTS) CONTINUED....

This table shows the different functions that can be programmed to the Trim Switches, Rotary Dial and Auxiliary Lever.

FUNCTION	MENU	DEFAULT SWITCH	DEFAULT STEP VALUE	DEFAULT REV VALUE
Trim-Auxiliary 1	TRIM-A1			
Trim-Auxiliary 2	TRIM-A2			
Dual Rate-Steering	D/R-ST	Trm3	1	NOR
Dual Rate-Throttle	D/R-TH			
Dual Rate-Brake	D/R-BR	Trm4	1	NOR
Curve-Rate-Steering	CU-R-ST			
Curve-Point-Steering	CU-P-ST			
Curve-Rate-Throttle	CU-R-TH			
Curve-Point-Throttle	CU-P-TH			
Curve-Rate-Brake	CU-R-BR			
Curve-Point-Brake	CU-P-BR			
Speed-Steering-Forward	SP-ST-F			
Speed-Steering-Return to Neutral	SP-ST-R			
Speed-Throttle-Forward	SP-TH-F			
Speed-Throttle-Return to Neutral	SP-TH-R			
Anti-Lock Braking-Point	ALB-PO			
Anti-Lock Braking-Stroke	ALB-ST			
Anti-Lock Braking-Lag	ALB-LG			
Anti-Lock Braking-Hold	ALB-HL			
Anti-Lock Braking-Release	ALB-RE			
Throttle Offset	OFFSET			
Auxiliary 1 Channel 3	AUX1	Rotary Dial	5	NOR
Auxiliary 2 Channel 4	AUX2	Auxiliary Lever	N/A	N/A
Increase/Decrease Programming Values	INC/DEC		-----	-----

### Changing the Trim Switch Function

- 1) From within the KEY ASSIGN menu, scroll UP or DOWN to highlight TRIM.
- 2) Press the ENTER key. The TRIM menu will be displayed and TRM1 : TRIM-ST will be highlighted.
- 3) Scroll UP or DOWN to highlight the function you would like to change for either TRM1, TRM2, TRM3 or TRM4.
- 4) Press the ENTER key, then scroll UP or DOWN to choose the desired function for Trim Switch Trm1, Trm2, Trm3 or Trm4. A list of functions that can be assigned to the Trim Switches is shown in the table above and on the previous page.

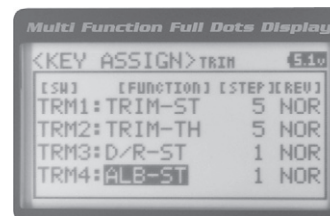
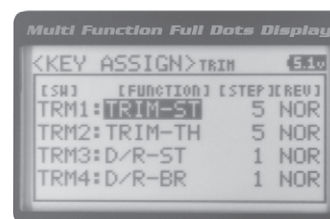

### Changing the Trim Switch Step Value

The Step function allows you to adjust how far the servos travel when the Trim Switches are pressed. You can increase the Trim Resolution by decreasing the Step value, so that the servos travel less when you press the Trim Switches. This makes it possible to fine-tune servo movement extremely accurately. Alternately, you could decrease the Trim Resolution by increasing the Step values, so that the servos travel more when you press the Trim Switches. This setting may not be as accurate, although it allows you to command large amounts of servo travel at a time.

# SYSTEM MENUS

## Changing the Trim Switch Step Value. Continued...

- 1) From within the TRIM menu, scroll UP or DOWN to highlight the Step value you would like to change for either TRM1, TRM2, TRM3 or TRM4.
- 2) Press the ENTER key, then scroll UP or DOWN to choose the desired Step value for Trim Switch Trm1, Trm2, Trm3 or Trm4.

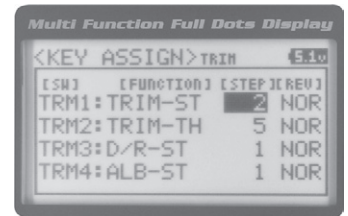

TRIM STEP setting range is 1 to 100. The default setting for TRM1 is 5, for TRM2 is 5, for TRM3 is 1 and for TRM4 is 1. The Step value is a percentage of servo travel.

## Changing the Trim Switch Direction of Travel

The direction that the Trim Switches move the servos can be changed from Normal to Reverse. In Normal mode, the Trim Switches will move the servos toward the High Side when the Trim Switches are pushed Forward. In Reverse mode, the Trim Switches will move the servos toward the Low Side (the opposite direction) when the Trim Switches are pushed Forward.

- 1) From within the TRIM menu, scroll UP or DOWN to highlight the REV value you would like to change for either TRM1, TRM2, TRM3 or TRM4.
- 2) Press the ENTER key, then scroll UP or DOWN to choose the desired REV value for Trim Switch Trm1, Trm2, Trm3 or Trm4.

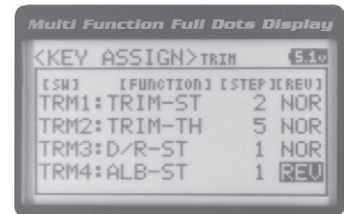

TRIM REV setting range is NOR and REV. The default setting for all Trim Switches is NOR.

## Changing the Rotary Dial Function

- 1) From within the KEY ASSIGN menu, scroll UP or DOWN to highlight DIAL.
- 2) Press the ENTER key. The DIAL menu will be displayed and FUNCTION AUX1 will be highlighted.

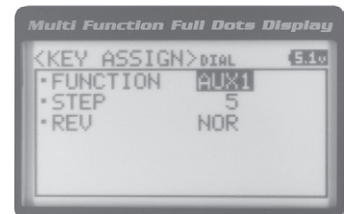

- 3) Press the ENTER key, then scroll UP or DOWN to choose the desired function for the Rotary Dial. A list of functions that can be assigned to the Rotary Dial is shown in the table on pages 57 and 58.

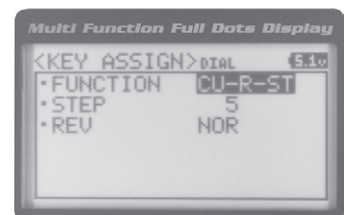

## Changing the Rotary Dial Step Value

The Step function allows you to adjust how far the servo travels when the Rotary Dial is turned. You can increase the Dial Resolution by decreasing the Step value, so that the servo travels less when you turn the Rotary Dial. This makes it possible to fine-tune servo movement extremely accurately. In addition, you could decrease the Dial Resolution by increasing the Step value, so that the servo travels more when you turn the Rotary Dial. This setting may not be as accurate, although it allows you to command large amounts of servo travel at a time.

- 1) From within the DIAL menu, scroll UP or DOWN to highlight STEP 5.
- 2) Press the ENTER key, then scroll UP or DOWN to choose the desired Step value for the Rotary Dial.

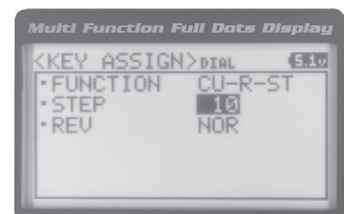

DIAL STEP setting range is 1 to 100. The default setting is 5. The Step value is a percentage of servo travel.

# SYSTEM MENUS

## TRIM, DIAL AND LEVER (TRIM, DIAL AND LEVER KEY ASSIGNMENTS) CONTINUED....

### Changing the Rotary Dial Direction of Travel

The direction that the Rotary Dial moves the servo can be changed from Normal to Reverse. In Normal mode, the Rotary Dial will move the servo toward the High Side when the Rotary Dial is turned clockwise. In Reverse mode, the Rotary Dial will move the servo toward the Low Side (the opposite direction) when the Rotary Dial is turned clockwise.

- 1) From within the DIAL menu, scroll UP or DOWN to highlight REV NOR.
- 2) Press the ENTER key, then scroll UP or DOWN to choose the desired REV value for the Rotary Dial.

DIAL REV setting range is NOR and REV. The default setting is NOR.

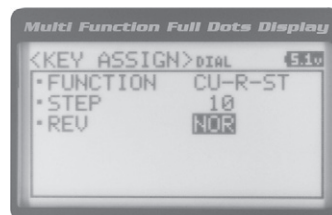

### Changing the Auxiliary Lever Function

In general, the Auxiliary Lever is used to control Auxiliary 1 Channel 3 or Auxiliary 2 Channel 4. Adjusting the High and Low Tweak values determines how far and in which direction the Auxiliary servo travels when the Auxiliary Lever is moved Up and Down. For example, if you assign AUX2 to the Auxiliary Lever and adjust the Tweak values to +50 and -50, the Auxiliary 2 servo will be centered when the Auxiliary Lever is centered and will travel 50% in one direction when the Auxiliary Lever is moved Up and travel 50% in the other direction when the Auxiliary Lever is moved Down. This allows you to use the Auxiliary Lever like a 2- or 3-position switch.

In addition, the Auxiliary Lever can be used to control the same parameter functions as the Trim Switches and the Rotary Dial. For example, if you assign TRIM-ST and adjust the Tweak values to +100 and -100, the Auxiliary Lever will control Steering channel Trim. The direction and amount the Trim moves when you move the Auxiliary Lever Up or Down is dependent on the Positive and Negative Tweak values.

⚠ To control either the Auxiliary 1 or the Auxiliary 2 servos using the Auxiliary Lever, the Auxiliary Type in the AUX TYPE menu must be either STEP AUX or POINT AUX. For more information, see the *Auxiliary Type* section on page 62.

⚠ When you use the Auxiliary Lever to control a function, such as Steering Dual Rate or Exponential, the change in values will not be displayed on the Top Screen like they are when you use the Trim Switches or the Rotary Dial to make the same changes. Instead, the current position of the Auxiliary Lever is displayed on the Top Screen.

Auxiliary Lever Position Display

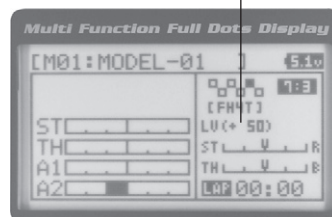

- 1) From within the KEY ASSIGN menu, scroll UP or DOWN to highlight LEVER.
- 2) Press the ENTER key. The LEVER menu will be displayed and FUNCTION AUX2 will be highlighted.

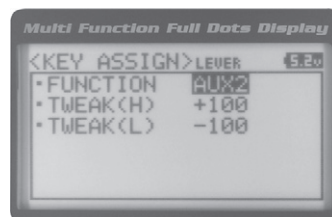

- 3) Press the ENTER key, then scroll UP or DOWN to choose the desired function for the Auxiliary Lever. A list of functions that can be assigned to the Auxiliary Lever is shown in the table on pages 57 and 58.

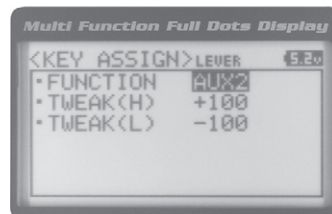

# SYSTEM MENUS

## TRIM, DIAL AND LEVER (TRIM, DIAL AND LEVER KEY ASSIGNMENTS) CONTINUED...

### Changing the High and Low Tweak Values

The High and Low Tweak values determine the direction and amount of Auxiliary 1 or Auxiliary 2 servo travel. In addition the High and Low Tweak values determine the direction and amount of parameter function changes, such as Steering Trim or the Anti-Lock Braking Point percentage value.

- 1) From within the LEVER menu, scroll DOWN to highlight TWEAK(H) +100.
- 2) Press the ENTER key, then scroll UP or DOWN to choose the desired High Side Tweak value. Increasing the Tweak value will increase servo travel in the High Side direction and decreasing the Tweak value will decrease servo travel in the High Side direction. Using a negative value will change the direction of servo travel.

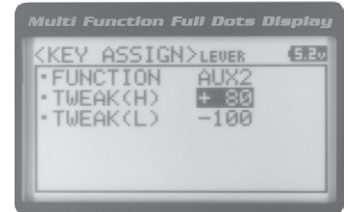

LEVER TWEAK(H) setting range is -100 to +100. The default setting is +100.

- 3) Scroll DOWN to highlight TWEAK(L) -100.
- 4) Press the ENTER key, then scroll UP or DOWN to choose the desired Low Side Tweak value. Decreasing the Tweak value will increase servo travel in the Low Side direction and increasing the Tweak value will decrease servo travel in the Low Side direction. Using a positive value will change the direction of servo travel.

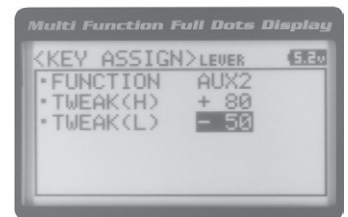

LEVER TWEAK(L) setting range is -100 to +100. The default setting is -100.

### 04.TRIM TYPE (TRIM TYPE)

The Trim Type function allows you choose the way servo Trim and servo End Point Adjustments interact with each other. When you apply Trim to a servo, the Neutral point of the servo shifts toward the High Side or the Low Side. When you do this, the servo travels less in one direction and more in the other direction because the servo End Points are stationary. In order to balance the servo travel, you would need to manually readjust the servo End Points. Using the Trim Type function allows you to make the servo End Points shift toward the High Side or the Low Side when you apply Trim. This maintains balanced servo travel without the need to manually readjust the servo End Points.

Two Trim Types are available:

**CENTER** - When selected, servo End Points are stationary. In order to balance servo travel, you would need to manually readjust the servo End Points.

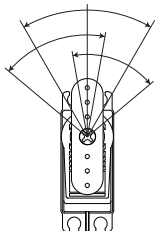
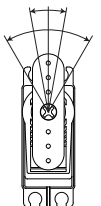

**PARALLEL** - When selected, servo End Points shift toward the High Side or the Low Side automatically when you apply Trim. This maintains balanced servo travel without the need to manually readjust the servo End Points.

### Changing the Trim Type

- 1) From within the SYSTEM menu, scroll UP or DOWN to highlight the TRIM TYPE menu.

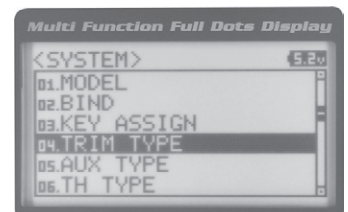

# SYSTEM MENUS

## Changing the Trim Type, Continued....

- 2) Press the ENTER key. The TRIM TYPE menu will be displayed and [ST] CENT will be highlighted.
- 3) Scroll UP or DOWN to highlight the desired channel you would like to change the Trim Type option for. Choose from either [ST] CENT (Steering), [TH] CENT (Throttle), [AUX1] CENT (Auxiliary 1) or [AUX2] CENT (Auxiliary 2).

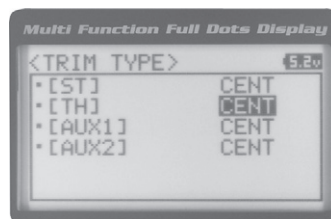

- 4) Press the ENTER key, then scroll UP or DOWN to choose the desired Trim Type option for that channel.

TRIM TYPE setting range is CENT and PARA. The default setting for all channels is CENT.

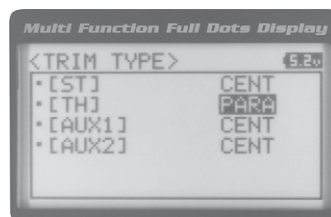

## 05.AUX TYPE (AUXILIARY TYPE)

The Auxiliary Type function allows you choose which Auxiliary function is assigned to Auxiliary 1 Channel 3 or Auxiliary 2 Channel 4. One Auxiliary function can be assigned to each Auxiliary Channel and both Auxiliary Channels can be Active and controlled at the same time using different controls. For example, you can control Auxiliary 1 Channel 3 using the Rotary Dial and Auxiliary 2 Channel 4 using the Auxiliary Lever.

 This section details how to assign the different Auxiliary functions to the Auxiliary Channels. For details about programming and using each of the Auxiliary functions, see the *Auxiliary 1 Programming* section on pages 29 ~ 35 or the *Auxiliary 2 Programming* section on pages 36 ~ 42.

## Changing the Auxiliary Function

- 1) From within the SYSTEM menu, scroll UP or DOWN to highlight the AUX TYPE menu.

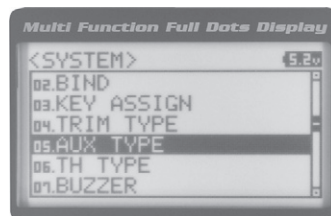

- 2) Press the ENTER key. The AUX TYPE menu will be displayed and AUX1 : STEP AUX will be highlighted.

- 3) Scroll UP or DOWN to highlight the desired channel you would like to change the Auxiliary function for, either AUX1 [TYPE] (Auxiliary 1) or AUX 2 [TYPE] (Auxiliary 2).

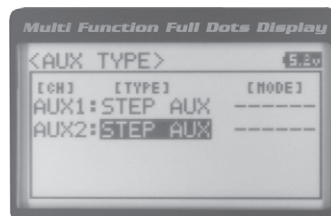

- 4) Press the ENTER key, then scroll UP or DOWN to choose the desired Auxiliary function to be controlled by that channel.

AUX TYPE setting range is STEP AUX, POINT AUX, 4WS MIX, MOA MIX and AUX MIX. The default setting for both channels is STEP AUX.

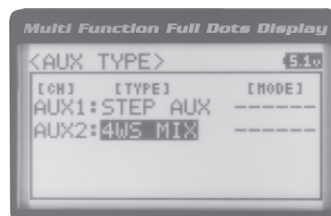

 Some Auxiliary functions allow you to change the Mode. Details of the various Mode options and how to change them from within the Auxiliary Type function menu can be found in the specific Auxiliary function programming sections detailed in the *Auxiliary 1 Programming* section on pages 29 ~ 35 or the *Auxiliary 2 Programming* section on pages 36 ~ 42.

# SYSTEM MENUS

## 06.TH TYPE (THROTTLE TYPE)

The Throttle Type function allows you to change the proportion between Throttle High Side servo travel and Throttle Brake Side servo travel. In the default configuration, the Throttle Type is set to F70:B30. This Throttle Type shifts the throttle Neutral point toward the Brake Side, resulting in more servo travel toward the High Side and less servo travel toward the Brake Side. Some users may prefer the proportion between Throttle High Side servo travel and Throttle Brake Side servo travel to be balanced (F50:B50). The F70:B30 Throttle Type is most common for general use and racing, while the F50:B50 Throttle Type is most common for Rock Crawling.

Two Throttle Types are available:

**F70:B30** - When selected, the throttle Neutral point is shifted toward the Brake Side. This is most common for general use and racing.

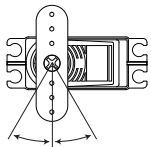
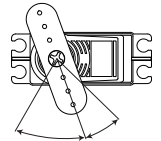

**F50:B50** - When selected, the throttle Neutral point is centered. This is most common for Rock Crawling.

### Changing the Throttle Type

- 1) From within the SYSTEM menu, scroll UP or DOWN to highlight the TH TYPE menu.
- 2) Press the ENTER key. The TH TYPE menu will be displayed and MODE F70:B30 will be highlighted.
- 3) Press the ENTER key, then scroll UP or DOWN to choose the desired Throttle Type option.

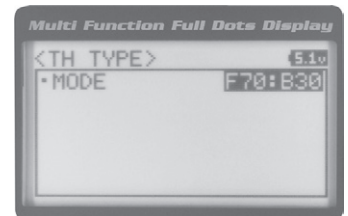
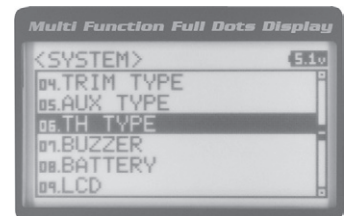

TH TYPE setting range is F70:B30 and F50:B50. The default setting is F70:B30.

- 4) Press the ENTER key. Either Set to F70:B30? NO/YES will be displayed or Set to F50:B50? NO/YES will be displayed. Scroll DOWN to highlight YES, then press the ENTER key to Activate the chosen Throttle Type.

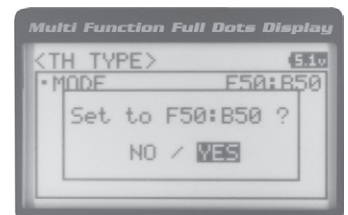

 The current Throttle Type will be displayed on the Top Screen. 7:3 will be displayed to indicate the current Throttle Type is F70:B30 or 5:5 will be displayed to indicate the current Throttle Type is F50:B50.

## 07.BUZZER (AUDIBLE KEY TONE)

The Audible Key Tone function allows you to change the Volume and Tone of the audible sounds that are made when you use the Trim Switches, Rotary Dial, Auxiliary Lever, Push-Button Rotary Dial and the Timer function. The Volume can be Increased or Decreased (or Muted) and the Tone can be changed to suit your preference.

 Changes made using the Audible Key Tone function also affect the audible sounds that are part of the Timer function. For example, if you Mute the Audible Key Tones, the sounds that are part of the Timer function will also be Muted. Transmitter warning alarms, such as the Low Voltage Alert alarm, are unaffected.

# SYSTEM MENUS

## 07. BUZZER (AUDIBLE KEY TONE), CONTINUED....

### Changing the Audible Key Tone Volume

1) From within the SYSTEM menu, scroll UP or DOWN to highlight the BUZZER menu.

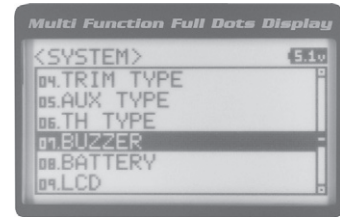

2) Press the ENTER key. The BUZZER menu will be displayed and VOLUME 4 will be highlighted.

3) Press the ENTER key, then scroll UP or DOWN to choose the desired Volume value. Increasing the Volume value will increase the Volume of the Audible Key Tones and decreasing the Volume value will decrease the Volume of the Audible Key Tones.

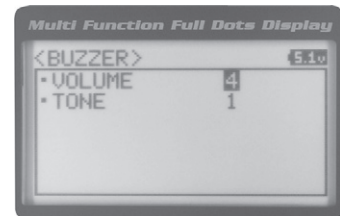

BUZZER VOLUME setting range is OFF to 5. The default setting is 4. When OFF is selected, Audible Key Tones will be Muted.

### Changing the Tone

1) From within the BUZZER menu, scroll DOWN to highlight TONE 1.

2) Press the ENTER key, then scroll UP or DOWN to choose the desired Tone value. Increasing the Tone value will increase the Tone of the Audible Key Tones and decreasing the Tone value will decrease the Tone of the Audible Key Tones.

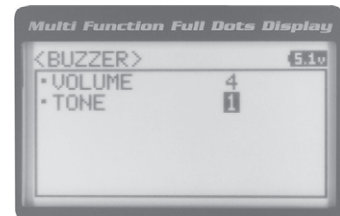

BUZZER TONE setting range is 1 to 7. The default setting is 1.

## 08. BATTERY (VOLTAGE ALARM)

The Voltage Alarm function allows to specify the voltage at which the Low Voltage Alert and Low Voltage Limit alarms will sound. This allows you to choose custom voltage settings to match the type of transmitter battery you're using. For example, if you're using a 6 cell Ni-MH battery pack or a 2S Li-Po battery pack, you can set the Low Voltage Alert alarm and the Low Voltage Limit alarm voltage values to suit.

This table shows the different Alert and Limit Voltage values we recommend programming.

BATTERY TYPE	ALERT VOLTAGE	LIMIT VOLTAGE
4 Cell Alkaline	4.6 Volts	4.4 Volts
6 Cell Ni-CD/Ni-MH	7.0 Volts	6.6 Volts
2S Li-Po	7.2 Volts	6.8 Volts
2S Li-Fe/A123	6.3 Volts	5.8 Volts

! To ensure the safety of your model and your transmitter battery, we suggest using the Alert and Limit Voltage values shown in the table above. We don't suggest using values lower than recommended.

### Changing the Low Voltage Alert Alarm Value

The Low Voltage Alert alarm will sound to indicate the transmitter batteries are getting low and should be replaced or recharged. We suggest stopping use as soon as safely possible and replacing or recharging the transmitter batteries. The Low Voltage Alert alarm will sound each time the transmitter battery voltage decreases by 0.1 volt. To clear this alarm, press the Back/Cancel key or the Push-Button Rotary Dial.



## Changing the Low Voltage Alert Alarm Value, Continued....

- 1) From within the SYSTEM menu, scroll UP or DOWN to highlight the BATTERY menu.
- 2) Press the ENTER key. The BATTERY menu will be displayed and ALERT VOLT 4.6v will be highlighted.
- 3) Press the ENTER key, then scroll UP or DOWN to choose the desired Low Voltage Alert alarm value. Increasing the Low Voltage Alert alarm value will cause the Low Voltage Alert alarm to sound at a higher voltage and decreasing the Low Voltage Alert alarm value will cause the Low Voltage Alert alarm to sound at a lower voltage.

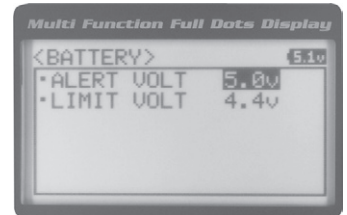
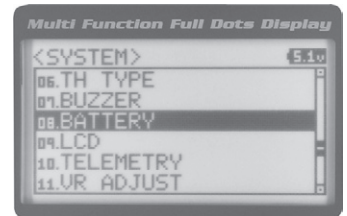

BATTERY ALERT VOLT setting range is 4.1v to 9.0v. The default setting is 4.6v.



The Low Voltage Alert alarm voltage value cannot be set lower than the Low Voltage Limit alarm voltage value.

## Changing the Low Voltage Limit Alarm Value

The Low Voltage Limit alarm will sound to indicate the transmitter batteries are dangerously low and should be replaced or recharged right away. The Low Voltage Limit alarm cannot be cancelled. When the Low Voltage Limit alarm sounds, you should stop use as soon as it's safe, then replace or recharge the transmitter batteries.

- 1) From within the BATTERY menu, scroll DOWN to highlight LIMIT VOLT 4.4v.
- 2) Press the ENTER key, then scroll UP or DOWN to choose the desired Low Voltage Limit alarm value. Increasing the Low Voltage Limit alarm value will cause the Low Voltage Limit alarm to sound at a higher voltage and decreasing the Low Voltage Limit alarm value will cause the Low Voltage Limit alarm to sound at a lower voltage.

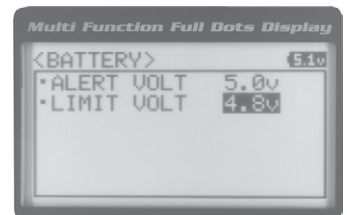

BATTERY LIMIT VOLT setting range is 4.0v to 4.9v. The default setting is 4.4v.

**WARNING:** Continuing to use the transmitter after the Low Voltage Limit alarm sounds can result in loss of control of your model. When the Low Voltage Alert alarm sounds, stop use as soon as is safe, then replace or recharge the transmitter batteries.

## 9.LCD (LCD CONTRAST)

The LCD Contrast function allows you to change the contrast of the Multi-Function LCD to make it easier to read in all types of lighting conditions. In general, increasing the Contrast will make the Multi-Function LCD easier to read in bright sunlight and decreasing the Contrast will make the Multi-Function LCD easier to read in low light levels.

## Changing the Contrast Value

- 1) From within the SYSTEM menu, scroll UP or DOWN to highlight the LCD menu.

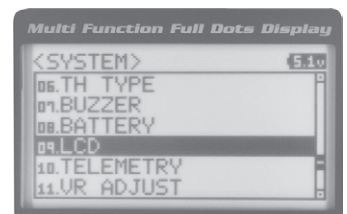

# SYSTEM MENUS

## Changing the Contrast Value. Continued....

- 2) Press the ENTER key. The LCD menu will be displayed and CONTRAST 15 will be highlighted.
- 3) Press the ENTER key, then scroll UP or DOWN to choose the desired LCD Contrast value. Increasing the LCD Contrast value will increase the Contrast of the Multi-Function LCD and decreasing the LCD Contrast value will decrease the Contrast of the Multi-Function LCD.

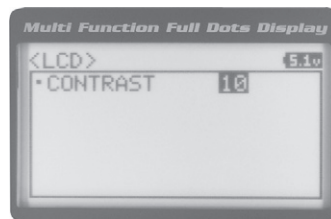

LCD CONTRAST setting range is 0 to 30. The default setting is 15.

⚠ Increasing or decreasing the LCD Contrast values to the extreme limits can result in blacking out the Multi-Function LCD, making it impossible to read. We do not suggest using an LCD Contrast value lower than 5 or higher than 22.

## **10. TELEMETRY (TELEMETRY)**

The Telemetry menu allows you to change different options to configure how the various Telemetry functions are displayed on the Telemetry Screen, and how the Telemetry Logger operates. For example, you are able to change the Telemetry Temperature reading from Fahrenheit to Celsius, change the values at which Telemetry Sensor alarms sound and more. In addition, you are also able to change the Telemetry Log Interval, to customize how much Telemetry Data can be stored for review later.

⚠ For information about plugging the Telemetry Sensors into your receiver and installing them into your model, see the *Telemetry Connections and Mounting* section on page 13. For information about using the Telemetry function, see the *Telemetry Screen* section on page 16. Telemetry is NOT supported when using FHSS-2 or FHSS-3 receivers.

## **TEMP1 AND TEMP2 SETTING (TEMPERATURE TELEMETRY DISPLAY OPTIONS)**

The Temperature 1 and Temperature 2 Settings allow you change how Temperature information is displayed on the Telemetry Screen and when the Temperature Alert alarm sounds.

⚠ The *MT-4 2.4GHz FHSS-4T* radio control system includes one Temperature Sensor. If you want to utilize both Temperature Inputs on the receiver at the same time, you will need to purchase a second Temperature Sensor separately. For more information, see your local Airtronics retailer or the Airtronics website at [www.airtronics.net](http://www.airtronics.net).

## Changing the Temperature Unit Value

If desired, the Temperature Unit value can be changed from Fahrenheit to Celsius.

- 1) From within the SYSTEM menu, scroll UP or DOWN to highlight the TELEMETRY menu.
- 2) Press the ENTER key. The TELEMETRY menu will be displayed and TEMP1 SETTING will be highlighted.
- 3) Scroll UP or DOWN to highlight TEMP1 SETTING or TEMP2 SETTING.
- 4) Press the ENTER key. The TEMP1 or TEMP2 menu will be displayed and TEMP UNIT °F will be highlighted.
- 5) Press the ENTER key, then scroll UP or DOWN to change the Temperature Unit to the desired value. When °F is chosen, all Telemetry Temperatures will be displayed in Fahrenheit and when °C is chosen, all Telemetry Temperatures will be displayed in Celsius.

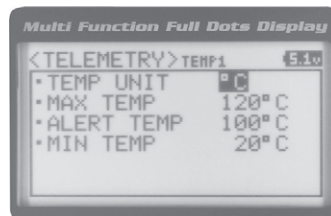
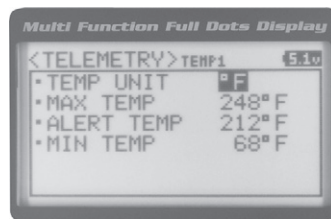
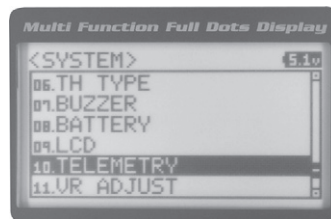

TELEMETRY TEMP UNIT setting range is °F and °C. The default setting is °F.

## TEMP1 AND TEMP2 SETTING (TEMPERATURE TELEMETRY DISPLAY OPTIONS), CONTINUED....

Temperature Display Monitors

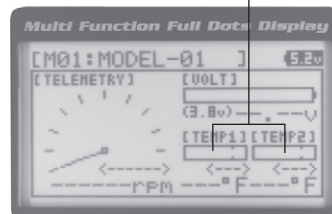

### Changing the Maximum Temperature Value

The Maximum Temperature value determines the maximum temperature shown on the [TEMP1] or [TEMP2] Telemetry Screen Temperature Display Monitors. This allows you to calibrate each Temperature Display Monitor to match what the Temperatures Sensor is attached to. This setting does not effect the TEMP1 or TEMP2 Digital Displays.

- 1) From within the TEMP1 or TEMP2 menu, scroll UP or DOWN to highlight MAX TEMP 248°F (or 120°C).
- 2) Press the ENTER key, then scroll UP or DOWN to change the Maximum Temperature value. The Temperature Display Monitor on the Telemetry Screen will not display temperature values above the Maximum Temperature value programmed.

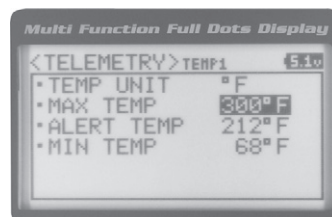

TELEMETRY MAX TEMP setting range is 68°F to 302°F (0°C to 150°C). The default setting is 248°F (120°C).

 The Maximum Temperature value cannot be set lower than the Alert Temperature value or the Minimum Temperature value. In some cases, you may need to lower the Alert Temperature value prior to lowering the Maximum Temperature value.

### Changing the Alert Temperature Value

The Alert Temperature value determines the temperature at which the Temperature Alert alarm will sound. For example, you can set an Alert Temperature value for your Nitro engine that will alert you when your engine's cylinder head temperature is getting too hot. When the Alert Temperature value is reached, the Temperature Alert alarm will sound and LED2 (Red) will flash. The Temperature Alert alarm will sound for approximately 5 seconds, however, LED2 will continue to flash until the temperature drops below the Alert Temperature value. The audible portion of the Temperature Alert alarm can be cleared by pressing the Back/Cancel key or the Push-Button Rotary Dial.

- 1) From within the TEMP1 or TEMP2 menu, scroll UP or DOWN to highlight ALERT TEMP 212°F (or 100°C).
- 2) Press the ENTER key, then scroll UP or DOWN to change the Alert Temperature value. The Alert Temperature value is the temperature that the Temperature Alert alarm will sound at.

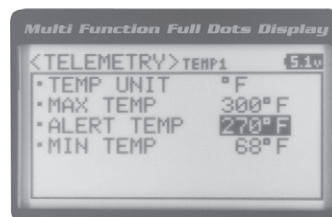

TELEMETRY ALERT TEMP setting range is 68°F to 302°F (0°C to 150°C). The default setting is 212°F (100°C).

 The Alert Temperature value cannot be set higher than the Maximum Temperature value. In addition, the Alert Temperature value cannot be set lower than the Minimum Temperature value. In some cases, you may need to lower the Minimum Temperature value prior to lowering the Alert Temperature value.

Temperature Display Monitors

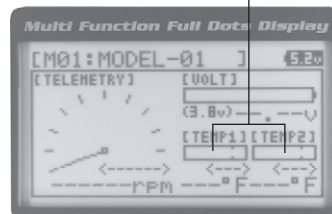

### Changing the Minimum Temperature Value

The Minimum Temperature value determines the Minimum temperature shown on the [TEMP1] or [TEMP2] Telemetry Screen Temperature Display Monitors. This allows you to calibrate each Temperature Display Monitor to match what the Temperatures Sensor is attached to. This does not effect the TEMP1 or TEMP2 Digital Displays.

# SYSTEM MENUS

## Changing the Minimum Temperature Value, Continued....

- 1) From within the TEMP1 or TEMP2 menu, scroll UP or DOWN to highlight MIN TEMP 68°F (or 20°C).
- 2) Press the ENTER key, then scroll UP or DOWN to change the Minimum Temperature value. The Temperature Display Monitor on the Telemetry screen will not display temperature values below the Minimum Temperature value programmed.

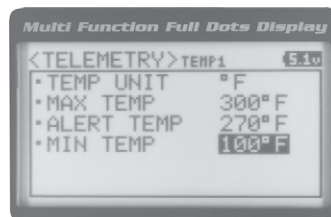

TELEMETRY MIN TEMP setting range is 32°F to 302°F (0°C to 150°C). The default setting is 68°F (20°C).

 The Minimum Temperature value cannot be set higher than the Alert Temperature value or the Maximum Temperature value. In some cases, you may need to increase these values prior to increasing the Minimum Temperature value.

## VOLT SETTING (RECEIVER BATTERY VOLTAGE TELEMETRY DISPLAY OPTIONS)

The Voltage Setting you to change the way receiver battery Voltage information is displayed on the Telemetry Screen and when the Voltage Alert alarm sounds.

### Changing the Maximum Voltage Value

The Maximum Voltage value determines the maximum receiver battery Voltage that will be shown on the [VOLT] Telemetry Screen Display Monitor. This allows you to calibrate the Voltage Display Monitor to match your model's receiver battery. This setting does not effect the VOLT Digital Display.

- 1) From within the TELEMETRY menu, scroll UP or DOWN to highlight VOLT SETTING.
- 2) Press the ENTER key. The VOLT menu will be displayed and MAX VOLT 9.0v will be highlighted.
- 3) Press the ENTER key, then scroll UP or DOWN to change the Maximum Voltage value. The Voltage Display Monitor on the Telemetry Screen will not display receiver battery Voltage values above the Maximum Voltage value programmed.

Voltage Display Monitor

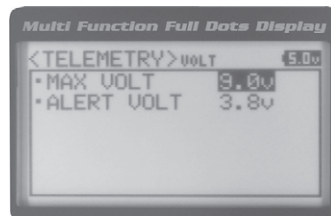
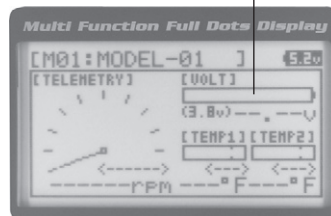

TELEMETRY MAX VOLT setting range is 3.0v to 9.0v. The default setting is 9.0v.

 The Maximum Voltage value cannot be set lower than the Alert Voltage value. If necessary, you may need to lower the Alert Voltage value prior to lowering the Maximum Voltage value.

### Changing the Alert Voltage Value

The Alert Voltage value determines the voltage at which the Voltage Alert alarm will sound. For example, you can set the Alert Voltage value to alert you to when your model's receiver battery is getting low and needs to be recharged. When the Alert Voltage value is reached, the Voltage Alert alarm will sound and LED2 (Red) will flash. The Voltage Alert alarm will sound for approximately 5 seconds, however, LED2 will continue to flash until you recharge the receiver battery. The audible portion of the Voltage Alert alarm can be cleared by pressing the Back/Cancel key or the Push-Button Rotary Dial.

 Refer to the manufacturer of your model's receiver battery to determine the safest Alert Voltage value to use. In general, the Alert Voltage value should be high enough to alert you when it's time to recharge your receiver battery, but not so low that the receiver battery loses power and can no longer control your model.

# SYSTEM MENUS

## Changing the Alert Voltage Value. Continued....

- 1) From within the VOLT menu, scroll UP or DOWN to highlight ALERT VOLT 3.8v.
- 2) Press the ENTER key, then scroll UP or DOWN to change the Alert Voltage value. The Alert Voltage value is the voltage that the Voltage Alert alarm will sound at.

TELEMETRY ALERT VOLT setting range is 3.0v to 9.0v. The default setting is 3.8v.

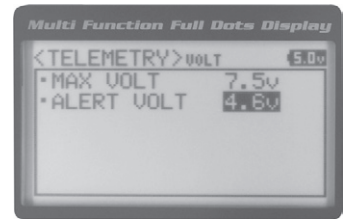

 The Alert Voltage value cannot be set higher than the Maximum Voltage value. In some cases, you may need to raise the Maximum Voltage value prior to raising the Alert Voltage value.

## RPM SETTING (RPM TELEMETRY DISPLAY OPTIONS)

The RPM Setting allows you to change the way RPM information is displayed on the Telemetry Screen. For example, you can choose to display RPMs, MPH or KM/H. In addition, if MPH or KM/H is chosen, the RPM sensor can be calibrated to ensure that the most accurate speed is displayed.

### Changing the RPM Unit Value

- 1) From within the TELEMETRY menu, scroll UP or DOWN to highlight RPM SETTING.
- 2) Press the ENTER key. The RPM menu will be displayed and UNIT RPM will be highlighted.
- 3) Press the ENTER key, then scroll UP or DOWN to change the RPM Unit to the desired value. When RPM is chosen, the Revolutions Per Minute of whatever the RPM Sensor is attached to will be displayed. When MPH or KM/H is chosen, the speed of your model will be displayed in either Miles Per Hour or Kilometers Per Hour, respectively.

TELEMETRY RPM UNIT setting range is RPM, MPH and KM/H. The default setting is RPM.

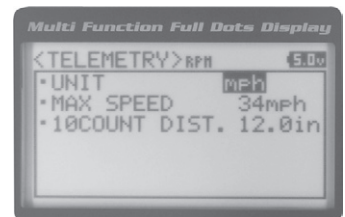
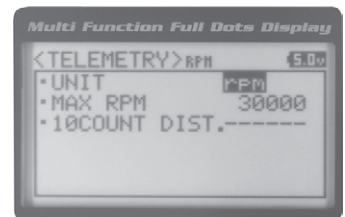

RPM Gauge

### Changing the Maximum Speed Value

The Maximum Speed value determines the maximum RPM or Speed value that will be shown on the Telemetry RPM Gauge. This setting does not effect the RPM Digital Display.

 The RPM Gauge and RPM Digital Display names will change from RPM to MPH or KM/H depending on the RPM Unit value chosen.

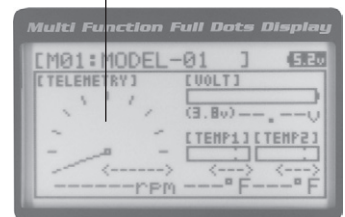

- 1) From within the RPM menu, scroll UP or DOWN to highlight MAX RPM 30000 (or MAX SPEED 34mph or MAX SPEED 54km/h).
- 2) Press the ENTER key, then scroll UP or DOWN to change the Maximum RPM or Maximum Speed value. The RPM Gauge on the Telemetry Screen will not display RPM or Speed values above the Maximum value programmed.

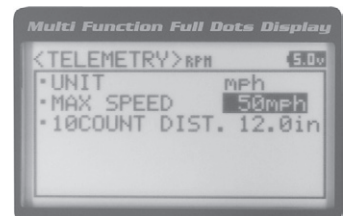

TELEMETRY MAX RPM setting range is 500 to 127500. The default setting is 30000. TELEMETRY MAX SPEED setting range is 1mph to 335mph (1km/h to 539km/h). The default setting is 34mph (54km/h). The Maximum Speed setting range will vary based on the 10 Count Distance value programmed when you calibrate the RPM Sensor. For more information, see the *Calibrating the RPM Sensor* section on page 70.

# SYSTEM MENUS

## RPM SETTING (RPM TELEMETRY DISPLAY OPTIONS), CONTINUED....

### Calibrating the RPM Sensor

When you choose to use the RPM Sensor to display MPH or KM/H, the RPM Sensor must be calibrated to ensure that the most accurate speed is displayed.

**IMPORTANT:** Prior to Calibrating the RPM Sensor, you must connect the RPM Sensor to the receiver and correctly install the RPM Sensor onto your model. For more information, see the *Mounting the RPM Sensor* section page 13.

! When the reflective tape attached to your model's clutch bell, flywheel, etc., crosses the RPM sensor, the Bind LED on the receiver will flash Green once. This indicates 1 full revolution. Use this as a guide during the calibration process.

- 1) With the *MT-4 2.4GHz FHSS-4T* radio control system turned 'ON' and the RPM Sensor installed on your model as described in the *Mounting the RPM Sensor* section page 13, place your model on the ground.
- 2) Measuring from where you set your model on the ground, push your model and measure the distance covered to complete 10 full revolutions of the RPM Sensor (the Bind LED on the receiver will flash 10 times, indicating 10 full revolutions).
- 3) From within the RPM menu, scroll UP or DOWN to highlight 10COUNT DIST. 12.0in (or 10COUNT DIST. 30cm).
- 4) Press the ENTER key, then scroll UP or DOWN to change the 10 Count Distance value to the measurement obtained in step 2 above. For example, if your model traveled 2 feet (61cm) to complete 10 full revolutions, enter 24.0in (61cm).

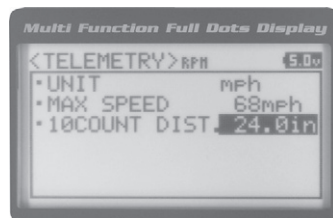

TELEMETRY 10COUNT DIST setting range is 0.5in to 118.0in (1cm to 300cm). The default setting is 12.0in (30cm).

! RPM Sensor calibration is only required if you choose to use the RPM Sensor to display MPH or KM/H. Calibration is not required if you're displaying RPM.

! Adjusting the 10 Count Distance value will change the Maximum Speed value you changed in the previous step. After calibration, you should go back and reset the Maximum Speed value to the desired setting.

## TELEMETRY SETTING (TELEMETRY AND TELEMETRY LOG OPTIONS)

The Telemetry Setting allows you to choose whether the Telemetry System is turned 'ON' or 'OFF' and change the interval that Telemetry Data is read and stored.

### Turning the Telemetry System 'ON' and 'OFF'

- 1) From within the TELEMETRY menu, scroll UP or DOWN to highlight TELEMETRY SETTING.
- 2) Press the ENTER key. The SETTING menu will be displayed and ON/OFF ON will be highlighted.
- 3) Press the ENTER key, then scroll UP or DOWN to change the Telemetry ON/OFF value. When ON is selected, the Telemetry System is turned 'ON'. When OFF is selected, the Telemetry System is turned 'OFF'.

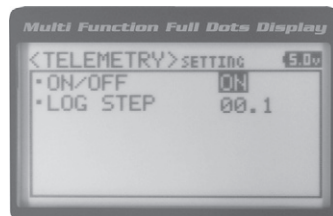
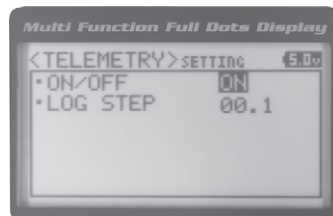

TELEMETRY SETTING ON/OFF setting range is ON or OFF. The default setting is ON.

! If the Telemetry Log function is started when the Telemetry System is 'OFF', default values will be stored in the Telemetry Log. This is normal.

# SYSTEM MENUS

## TELEMETRY SETTING (TELEMETRY LOG OPTIONS), CONTINUED...

### Changing the Telemetry Log Step Value

The Telemetry Log Step value can be changed to customize how much Telemetry Data and the time interval Telemetry Data is recorded. The Telemetry Log can store up to 120 separate entries. If the Log Step value is set to 00.1 seconds, the Telemetry Log can record for 12 seconds. If the Log Step value is set to 45.1 seconds, the Telemetry Log can record for 90 minutes.

- 1) From within the SETTING menu, scroll UP or DOWN to highlight LOG STEP 00.1.
- 2) Press the ENTER key, then scroll UP or DOWN to change the Telemetry Log Step value. Programming a lower Telemetry Log Step value results in narrower, higher resolution readings, but for a shorter period of time. Programming a higher Telemetry Log Step value results in broader, lower resolution readings, but for a longer period of time.

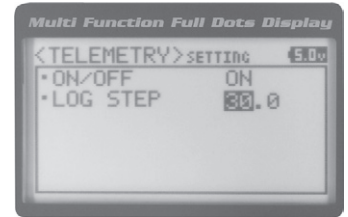

TELEMETRY LOG STEP setting range is 00.1 to 45.9. The default setting is 00.1.

## TE-CLR (TELEMETRY CLEAR FUNCTION)

The Telemetry Clear function allows you to Reset the High Temperature 1, High Temperature 2 and High RPM values that are displayed on the Telemetry Screen. The Telemetry Clear function can be assigned to either Push-Button Switch Sw1 or Push-Button Switch Sw2. When you press the Push-Button Switch the Telemetry Clear function is assigned to, the High Temperature 1, High Temperature 2 and High RPM values will be Reset the Current values read by the Telemetry Sensors. For more information see the *Push-Button Key Assignments* section on pages 56 and 57.

## 11.VR ADJUST (VARIABLE RATE ADJUSTMENT)

Over time during use, it's possible that the End Points and/or Neutral positions of the controls may change slightly or you may purposely limit the travel of the Steering Wheel to suit the best feel of the steering wheel and your driving style. The Variable Rate Adjustment function allows you to calibrate the operation of the Steering Wheel, Throttle Trigger and Auxiliary Lever End Points and Neutral positions to ensure precise operation.

- ! We recommend using this function as part of a periodic maintenance schedule or after adjusting Steering Wheel travel as described in the *Steering Wheel Travel Adjustment* section on page 15.
- ! After using the Variable Rate Adjustment function, you should double-check the End Point Adjustments of each saved model. If the End Points have moved, they will need to be readjusted using the End Point Adjustment function.
- ! The Steering Wheel, Throttle Trigger and Auxiliary Lever are calibrated individually.

### Calibrating Control Operation

- 1) From within the SYSTEM menu, scroll UP or DOWN to highlight the VR ADJUST menu.
- 2) Press the ENTER key. The VR ADJUST menu will be displayed and STEERING <0> will be highlighted.
- 3) Scroll UP or DOWN to highlight the control you would like to calibrate. Choose from STEERING <0>, THROTTLE <0> or LEVER <0>.

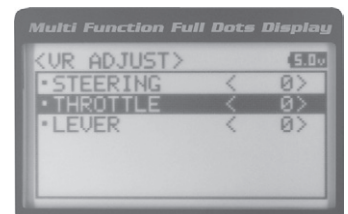
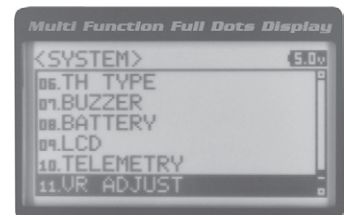

- ! <0> indicates the current position of the specific channel relative to its specific control. For example, if the Steering Wheel is in the Neutral position, but an L or R value is displayed, the Steering Channel 1 Neutral position has shifted and should be calibrated.

# SYSTEM MENUS

## Calibrating Control Operation, Continued...

- 4) With the Steering Wheel, Throttle Trigger or Auxiliary Lever in the Neutral position, press the ENTER key. [NEUT] POS <-----> will be displayed.

 The Auxiliary Lever features a detent to indicate its Neutral position.

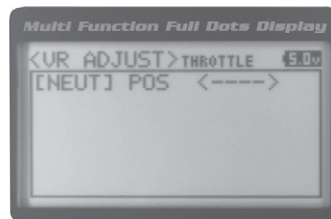

- 5) Press the ENTER key a second time. A menu with several position indicators will be displayed.
- 6) Slowly move the Steering Wheel, Throttle Trigger or Auxiliary Lever all the way in one direction. Allow the control to return to Neutral, then slowly move the Steering Wheel, Throttle Trigger or Auxiliary Lever all the way in the opposite direction. A series of values and Adjust ok? NO/YES will be displayed.

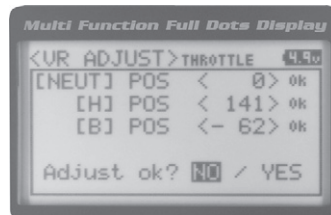

- 7) Scroll DOWN to highlight YES, then press the ENTER key. Executed will flash, indicating that the calibration process is complete.

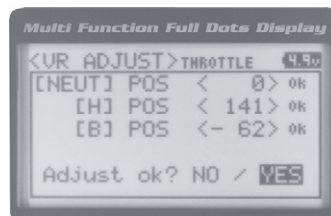

 To cancel the calibration process, scroll UP or DOWN to highlight NO, then press the ENTER key. You can then return to VR ADJUST menu by pressing the Back/Cancel key.

- 8) If necessary, repeat steps 3 through 7 to calibrate the remaining controls.

**THIS SPACE INTENTIONALLY LEFT BLANK**



# REFERENCE

## TROUBLESHOOTING GUIDE



This troubleshooting guide can help you diagnose and solve some of the more common problems that you may encounter with your *MT-4 2.4GHz FHSS-4T* radio control system. If you cannot solve the problem using this troubleshooting guide, please contact Airtronics Customer Service using the information on the back cover of this Operating Manual.

PROBLEM	CAUSE	SOLUTION
Transmitter does not turn 'ON'	Batteries not installed correctly	Reinstall batteries. Observe correct polarity
	Battery tray not plugged in	Plug in battery tray. Observe correct polarity
	Damage caused by using incorrect charger or reverse polarity	Contact Airtronics Customer Service
	Low transmitter battery voltage	Replace or recharge transmitter batteries
Transmitter will not bind to receiver	Modulation incorrect	Change Modulation Type to match receiver
	Too much time elapsed after pressing receiver Bind Button	Quickly press the ENTER key in the BIND menu after releasing the receiver Bind Button
	Attempting to bind incompatible receiver	Use only Airtronics 2.4GHz FHSS-2, FHSS-3 or FHSS-4T surfaces receivers
	Using ESC with BEC	Disconnect ESC and use dry cell battery for Binding procedure, then reconnect ESC after binding
	Low receiver battery voltage	Recharge receiver battery
Alarm beeps continuously	Transmitter battery voltage at Low Voltage Limit	Replace or recharge transmitter batteries
	Transmitter left 'ON' more than 10 minutes without control input	Move steering wheel or throttle trigger, or press any button to continue use
No sound when keys are pressed	Audible Key Tones are Muted	Increase Audible Key Tone volume
No Timer function sounds	Audible Key Tones are Muted	Increase Audible Key Tone volume
Servo movement is slow	Receiver battery voltage low	Recharge receiver battery
	A negative Servo Speed value is programmed	Increase Servo Speed programming value
	Control linkages binding	Adjust control linkages to operate smoothly
Servo does not move when using Trim Switch	Trim is outside of operational range	Reset Trim to zero and center the servo horn and control linkage
Inadequate transmitting range	Low transmitter or receiver battery voltage	Replace or recharge transmitter and receiver batteries
	Receiver antenna not mounted correctly in your model	Mount receiver antenna as recommended
Servo moves too much, or doesn't move enough, when Trim Switch is moved	Trim Step resolution requires adjustment	Adjust Trim Step resolution
Throttle servo or ESC moves to programmed position without input	Receiver battery voltage has reached the programmed Battery Fail Safe voltage level	Recharge receiver battery
Cannot program receiver Battery Fail Safe Voltage level	Throttle channel Fail Safe set to FREE or HOLD	Set Throttle channel Fail Safe to a percentage value
No Telemetry connection	Using FHSS-2 or FHSS-3 receiver	Use FHSS-4T receiver
	Telemetry System turned 'OFF'	Turn Telemetry System 'ON'
	Distance between transmitter and receiver too far	Shorten distance between transmitter and receiver
RPM Sensor not functioning	Sensor Pickup not facing reflective decal	Mount RPM Sensor so that Sensor Pickup faces and is aligned with reflective decal
	Not using reflective decal for Sensor Pickup	Use contrasting reflective decal included for Sensor Pickup
	Sensor Pickup too far away from reflective decal	Pickup Sensor should be 1mm away from reflective decal
Can't read Multi-Function LCD	Contrast setting too high or too low	Readjust Multi-function LCD contrast setting

# REFERENCE

## GLOSSARY OF TERMS

**Activate:** To turn 'ON' a particular function.

**Antenna:** Transmits the signal from the transmitter to the receiver in the model. Never touch the Antenna during use. Doing so may result in a weakened RF signal or complete loss of control of your model.

**Antenna Reception Wire:** The portion of the receiver antenna that receives the transmitter signal. The Antenna Reception Wire should never be bent or it could be damaged and limit the range of your model.

**Anti-Lock Braking:** Makes it possible to achieve stable braking even on slippery surfaces. With stable braking, your model is better able to trace an exact line under braking.

**ARC:** Adjustable Rate Control (ARC) allows you to vary the amount of servo travel in relation to the movement of the steering wheel, throttle trigger and auxiliary lever near the Neutral positions to change the way those functions react to control movement. The position that the Rate can be controlled from is adjustable along the length of control travel.

**Audible Key Tone:** An audible tone that is emitted from the transmitter each time the Push-Button Rotary Dial, Trim Switch, Push-Button Switch or Rotary Dial is used.

**Auxiliary Lever:** The Auxiliary Lever is programmable and will perform a different function depending on what function is assigned to it. For example, it can be used to control Auxiliary 1 Channel 3 or to control the Servo Speed function. The Auxiliary Lever features a detent and an audible tone to let you know it's in the Neutral position.

**Auxiliary Lever Position Display:** Displays the current position of the Auxiliary Lever on the Top Screen.

**Auxiliary Mixing:** Allows you to Mix either Steering Channel 1 or Throttle Channel 2 to Auxiliary 1 Channel 3 or Auxiliary 2 Channel 4, while maintaining separate Sub-Trim, End Point Adjustments, Servo Reversing and other channel-specific settings. The Auxiliary Mixing function is used when a custom Mix is necessary.

**Back/Cancel Key:** Returns to the previous menu. Press and HOLD to return to the Top Screen. In addition, cancels certain warning alarms, such as the Low Voltage Alert alarm.

**Battery Compartment:** Houses the four 'AA' Alkaline cells that power the transmitter. Alternatively, the transmitter can be powered using four 'AA' Ni-Cd or Ni-MH rechargeable batteries or a 2S Li-Po or 2S Li-Fe/A123 battery pack.

**Binding:** The act of pairing the transmitter and receiver to prevent interference from transmitters operated by other users. The transmitter and receiver must be paired so that the two can 'talk' to each other. Once the Binding process is complete, the setting is remembered even when the transmitter and receiver are turned 'OFF'.

**Bind Button:** Used in the process of Binding the transmitter and receiver.

**Bind LED:** Displays the current status of the receiver.

**Brake Side:** Refers to the throttle trigger stroke that engages the brakes on your model (pushing the throttle trigger).

**Burn:** Used with the Motor on Axle function (dual ESCs), the front motor is inhibited while keeping full control of the rear motor during rock crawling.

**Center Trim Type:** A Trim technology, that when selected, the servo End Points remain stationary when you apply Trim using the Trim Switches. This can result in unbalanced servo travel. In order to balance servo travel, servo End Points need to be manually readjusted.

**Channel Set:** Allows you to make programming changes to each of the four channels without the need to enter each Programming Menu separately.

**Charging Jack:** Used for onboard charging of optional Ni-Cd or Ni-MH batteries. Do not attempt to charge Alkaline batteries. Only the recommended Airtronics 110v AC charger should be used through the Charging Jack. If using an after-market Peak-Detection charger or other type of fast charger, the batteries should be removed from the transmitter to avoid damage to the transmitter circuitry and/or your batteries. Do not attempt to charge a Li-Po or Li-Fe/A123 battery pack through the Charging Jack.

**Coaxial Cable:** The portion of the receiver antenna that extends the Antenna Reception Wire. The Coaxial Cable can be bent into gentle curves, however, do not bend it acutely, or repeatedly bend it, or the antenna core can be damaged. The Coaxial Cable should be installed into a nylon tube (antenna tube) and positioned vertically in your model for the best reception.

**Countdown Timer:** Used to notify you of your model's running time. For example, you can set the Countdown Timer to alert you when it's time to refuel. When the Countdown Timer expires a long audible tone will sound and the Count Up Timer function begins automatically. This allows you to check the time elapsed since the timer ran out.

**Dial Knob:** The Dial Knob can rotate 360° and is programmable to perform a different function depending on what function is assigned to it. For example, it can be used to increase and decrease programming values, control a Trim function or control an Auxiliary Channel.

## GLOSSARY OF TERMS, CONTINUED....

**Dig:** Used with the Motor on Axle function (dual ESCs), the rear motor is inhibited while keeping full control of the front motor during rock crawling.

**Digital RPM Display:** Displays the current RPM from the RPM Sensor in digital format on the Telemetry Screen.

**Digital Temperature Display:** Displays the current temperature from the TEMP1 and TEMP2 Temperature Sensors in digital format on the Telemetry Screen.

**Dual Rate:** The Dual Rate function allows you to change the control authority of the Steering, Throttle High Side and Throttle Brake Side by changing the amount of servo travel relative to control input. For example, by increasing the Steering Dual Rate, you can make the steering servo travel more which might prevent your model from pushing during turns. If your model oversteers during turns, you can reduce the amount of Steering Dual Rate.

**Digital Trim Memory:** Allows the transmitter to store Trim values in its memory. Any amount of Trim that you set during use using the Trim Switches is automatically stored in memory for that specific channel and for that specific model. The Trim values for each model will automatically be loaded when the transmitter is turned 'ON'.

**Digital Voltage Indicator:** Indicates the current Voltage of the transmitter batteries on both the Top Menu and the Telemetry Screen.

**End Point Adjustment:** Used to adjust the desired amount of servo travel in both directions independently. This makes it possible to balance servo travel in both directions.

**Enter Key:** Opens the selected menu or programming option. Press and HOLD to reset the selected programming option to its default value.

**Exponential:** Allows you to vary the amount of servo travel in relation to the movement of the steering wheel, throttle trigger and auxiliary lever near the Neutral positions to change the way those functions react to control movement. The position that the Rate can be controlled from is fixed.

**Fail Safe:** Automatically moves the servos to a predetermined position in the event that the signal between the transmitter and the receiver is interrupted, whether due to signal degradation or low transmitter battery.

**FH2 Modulation:** Frequency Hopping 2nd generation FHSS technology. FH2 Modulation is used in legacy Airtronics 2.4GHz FHSS-2 transmitters and receivers, such as the Airtronics M11, M11 FHSS-2, and MX-3FG radio control systems.

**FH3 Modulation:** Frequency Hopping 3rd generation FHSS technology. FH3 Modulation is used in new-generation Airtronics radio control systems, such as the M11X and MX-3X.

**FH3F Modulation:** Frequency Hopping 3rd generation FHSS technology used only in France. This is a special modulation type typically used in France. It should not be selected for use in North America.

**FH4T Modulation:** Frequency Hopping 4th generation FHSS technology. FH4T Modulation is the latest Airtronics 2.4GHz frequency modulation and supports Telemetry.

**FHSS:** Frequency Hopping Spread Spectrum. FHSS is a modulation type which transmits data across the entire frequency spectrum by transmitting data on different channels at an extremely fast interval.

**Four Wheel Steering Mixing:** Used to control either the Front or Rear steering independently, or Mix the Front and Rear steering so that they can be used together. Front or Rear Independent Steering, Parallel Four Wheel Steering and Tandem Four Wheel Steering options are available.

**Grip:** The Grip is molded from rubber in an ergonomic shape for increased comfort, control and feel. An optional Grip is included that is molded in a different shape that some users may find feels more comfortable.

**High RPM Display:** Displays the last highest RPM value on the Telemetry Screen.

**High Temperature Display:** Displays the last highest Temperature value on the Telemetry Screen.

**High Side:** Refers to the throttle trigger stroke that opens the throttle and powers your model (pulling the throttle trigger).

**Hold:** Determines how quickly the Brake moves from the Stroke setting to Neutral when the Anti-Lock Braking function is Active.

**Inactivity Alarm (Power ON Alarm):** The Inactivity Alarm will sound if the transmitter is left on for a period of 10 minutes without any control input from the user. This alarm alerts you to prevent unwanted draining of the transmitter battery. To clear this alarm, either turn the transmitter 'OFF' or press the Back/Cancel key or the Push-Button Rotary Dial.

**Inhibit:** To deactivate or turn 'OFF' a particular function.

# REFERENCE

## GLOSSARY OF TERMS, CONTINUED....

**Interval Timer:** Notifies you when a set interval elapses while you are driving, giving you an idea of how close you are to your target time.

**KM/H:** Kilometers per Hour.

**Lag:** Controls the amount of delay before the Anti-Lock Brake Activates after reaching the POINT setting.

**Lap Timer:** Allows you to measure and record times for up to 99 laps. The number of laps completed is displayed in the Timer menu, and when a lap is completed, the lap time is displayed momentarily on the Top Screen.

**LED 1/2:** Displays the current signal output status of the transmitter (LED 1 - Blue) and the Telemetry connection (LED 2 - Red). In addition, one or both LEDs are used to indicate various transmitter conditions. For example, when a Throttle Offset percentage value is programmed, the blue LED will flash.

**Low Voltage Alert Alarm:** The Low Voltage Alert alarm will sound when the transmitter batteries reach the Alert Voltage value programmed in the SYSTEM - ALARM menu. The alarm will sound each time the transmitter battery voltage decreases by 0.1 volt. To clear this alarm, press the Back/Cancel key or the Push-Button Rotary Dial.

**Low Voltage Limit Alarm:** The Low Voltage Limit alarm will sound when the transmitter batteries reach the Limit Voltage value programmed in the SYSTEM - ALARM menu. This alarm can only be cleared by turning the transmitter 'OFF' and recharging or replacing the transmitter batteries.

**Multi-Function LCD:** The heart of the programming and display features of the transmitter. All programming and transmitter display functions are shown on the Multi-Function LCD.

**Modulation Type Indicator:** Indicates the current Modulation Type on the Top Screen that the transmitter is set to.

**Model Number and Name:** Displays the Model Number and Model Name of the currently selected model on both the Top Screen and the Telemetry Screen.

**Model Clear:** Used to reset the selected model's Programming Data to the default values. All model-specific Programming Data, including the Model Name and Modulation Type will be Reset to the default values.

**Model Naming:** Used to name the different models you have saved in the transmitter. This makes it easy to keep track of multiple models. The Model Name can consist of up to 10 letters, numbers, or symbols. Choose from capital letters, lower case letters, numbers, and various symbols.

**Model Select:** Used to store and retrieve Programming Data for any model 1 through 18. If you have Programming Data stored for more than one model, using the Model Select function to load the Programming Data for the particular model that you wish to use. The currently selected Model Number and Model Name is displayed on both the Top Screen and the Telemetry Screen.

**Motor on Axle Mixing:** Used to control either the Front and Rear throttles together or independently, giving you Dig and Burn functions. These functions are mostly used in Rock Crawling.

**MPH:** Miles Per Hour.

**Operating Voltage:** The safe voltage that the transmitter or receiver can operate within. Exceeding the minimum operating voltage can result in loss of power to the device(s). Exceeding the maximum operating voltage can result in damage to the devices(s).

**Output Power:** The power (in Milliwatts) that your transmitter transmits a signal. Output power is defined by government guidelines and differs by region.

**Over Voltage Alarm:** The Over Voltage Alarm will sound if the transmitter battery voltage is greater than 9.6 volts. To clear this alarm, turn the transmitter 'OFF' and replace the transmitter battery with one that when fully charged does not exceed 9.6 volts.

**Parallel Steering:** Used with Four Wheel Steering, both front and rear wheels pivot right and left together.

**Parallel Trim:** A Trim technology that when selected, the servo End Points move in equal amounts as the Trim when you use the Trim Switches. This results in balanced servo travel without the need to manually readjust the End Points.

**Point Setting:** Locates the actual point in the servo travel that you want a specific programming setting to occur. This setting can vary depending on the actual programming setting the Point setting is controlling.

**Point Auxiliary:** Used to program Auxiliary Channel 3 or Auxiliary Channel 4 to move the servo to up to 6 different points along its travel, then cycle through those Points. For example, if your model requires a separate 3-position or more switch to operate a feature, the Point Auxiliary function can be customized to control this.

**Power Switch:** Turns the transmitter 'ON' and 'OFF'.

**Push-Button Rotary Dial:** The Push-Button Rotary Dial (also referred to as the Up Key, Down Key, or Enter key) is used along with the Back/Cancel Key to facilitate transmitter programming. It allows you to quickly and easily navigate the various Programming and System Menus and switch between the Top Screen and the Telemetry Screen.

## GLOSSARY OF TERMS, CONTINUED....

**Push-Button Switch:** The transmitter features two separate Push-Button Switches in different locations (Sw1 and Sw2). Each Push-Button Switch is programmable and will perform a different function depending on what function is assigned to it.

**Receiver Battery Voltage Fail Safe:** Used to set a custom voltage that the Receiver Battery Fail Safe function will Activate at. When your receiver battery voltage drops to the programmed voltage, the throttle servo will move to the predetermined position programmed using the Fail Safe function. If this occurs, recharge or replace your receiver batteries.

**Receiver Voltage Display:** Displays the current voltage of the receiver battery on the Telemetry Screen.

**Release:** Determines how quickly the Brake moves from Neutral to the percentage value determined by the Stroke setting when the Anti-Lock Braking function is Active.

**RPM:** Revolutions Per Minute.

**RPM Display Monitor:** Displays the current RPM on the Telemetry Screen from the RPM Sensor in graphical format.

**Servo Monitor Display:** Displays the output levels of the four different channels in bar graph form, allowing you to monitor servo operation in a virtual manner.

**Servo Reversing:** Used to electronically switch the direction of servo travel. For example, if you move the steering wheel to the right, and the steering servo moves to the left, you can use the Servo Reversing function to make the steering servo move to the left.

**Servo Speed:** Used to slow down the transit speed of the servos. Servo transit speed can be slowed in both the Forward and the Return to Center directions.

**Servo Sub-Trim:** Used to correct the Neutral Trim setting for the servos, making it possible to center the Trim switches while ensuring the servo horns remain centered.

**SHR Servo Mode:** Using this setting with Digital servos will increase the servo's response time, even above the manufacturer's stated specification. Do not use with Analog servos!

**SSR Servo Mode:** If you're using Airtronics SRG Digital servos, you can use the SSR setting for the fastest response time. This results in the ultimate feel and response, making you feel more in control of your model than ever. Use only with Airtronics SRG Digital servos!

**Steering Program Indicator:** Indicates up to four different programming options that are currently programmed to the Steering channel. The Steering Program Indicator will only be displayed if a Steering channel programming value is programmed.

**Steering Trim Display:** Displays the current position of the Steering Trim Switch on the Top Screen.

**Steering Wheel:** Proportionally operates the model's right and left steering control. The Steering Wheel features a foam grip for increased comfort, control and feel. In addition, the Steering Wheel spring tension and travel limits can be adjusted.

**Steering Wheel Tension Adjustment Screw:** Used to adjust the spring tension of the steering wheel to best suit the feel of the user.

**Step Auxiliary:** Allows you to program the Auxiliary 1 servo or Auxiliary 2 servo to move a defined amount when toggled 'ON' and 'OFF' using a Push-Button Switch.

**Step Value:** A preset amount that the servo will travel when a Trim Switch is pressed once. The step value can be adjusted so that the servo either moves more or moves less when the Trim Switch is pressed.

**Stroke:** Determines the amount of Brake that's applied automatically when the Anti-Lock Braking function Activates.

**Suppression Capacitor:** Primarily used on brushed electric motors, a suppression capacitor helps eliminate electrical noise that could interfere with the operation of your radio control system.

**Tandem Steering:** Used with Four Wheel Steering, the front wheels pivot opposite to the rear wheels.

**Telemetry:** A connection between the receiver and the transmitter that transfers Sensor data from the receiver to the transmitter that can be viewed in real-time on the Telemetry Screen. Data such as Temperature, Receiver Voltage and RPM or Speed can be viewed.

**Telemetry Inputs:** Located under a removable protective cover, the Telemetry Inputs are where you plug the Temperature and RPM Sensors into. Two separate temperature inputs and one RPM input are available.

**Telemetry Signal Indicator:** Indicates the current signal strength of the Telemetry connection between the transmitter and receiver. The Telemetry Signal Indicator will only be displayed when the receiver is turned 'ON' and there is a Telemetry connection Active.

# REFERENCE

## GLOSSARY OF TERMS, CONTINUED....

**Temperature Alert Alarm:** The Temperature Alert alarm will sound when the TEMP1 and/or TEMP2 temperature reaches the Alert Temperature value programmed in the SYSTEM - TELEMETRY menu. To clear this alarm, press the Back/Cancel key or the Push-Button Rotary Dial.

**Temperature Display Monitor:** Displays the current TEMP1 and TEMP2 temperatures in bar graph format on the Telemetry Screen.

**Throttle Mode Indicator:** Indicates the current Throttle Mode type on the Top Screen.

**Throttle Offset:** Allows you to shift the Neutral position of the throttle servo, either toward the High Side or the Brake Side. When used in conjunction with a Push-Button Switch, this function can be used several different ways. For example, if you're driving a glow- or gas-powered model, you can program the Throttle Offset function to shut down your engine with the press of a button. In addition, you can program the Throttle Offset function to increase to a steady idle while you're refueling during a race.

**Throttle Offset Indicator:** Indicates that the Throttle Offset function is programmed. The Throttle Offset Indicator will only be displayed if a Throttle Offset percentage value is programmed.

**Throttle Program Indicator:** Indicates up to four different programming options that are currently programmed to the Throttle channel. The Throttle Program Indicator will only be displayed if a Throttle channel programming value is programmed.

**Throttle Trigger:** Controls the speed of the model, both forward and backward, or the model's brake. The Throttle Trigger position, angle and spring tension can all be adjusted.

**Throttle Trigger Position Adjustment Indicator:** Indicates the current position of the Throttle Trigger. As the throttle trigger position is adjusted forward or backward, the Throttle Trigger Position Adjustment Indicator will move forward or backward.

**Throttle Trigger Position Adjustment Screw:** Used to adjust the position of the Throttle Trigger either forward or backward.

**Throttle Trigger Tension Adjustment Screw:** Used to adjust the spring tension of the throttle trigger to best suit the feel of the user. Turning the Throttle Trigger Tension Adjustment Screw clockwise increases throttle trigger tension and turning the Throttle Trigger Tension Adjustment Screw counter-clockwise decreases throttle trigger tension.

**Throttle Trim Display:** Displays the current position of the Throttle Trim Switch on the Top Screen.

**Timer Display:** Displays the time of the currently selected Timer on the Top Screen.

**Timer Type Indicator:** Indicates the current Timer Type selected, either LAP or INT (Interval) on the Top Screen.

**Trim Switch:** The transmitter features four separate Trim Switches positioned around the steering wheel (Trm1, Trm2, Trm3 and Trm4). Each Trim Switch is programmable and will perform a different function depending on what function is assigned to it. For example, Trm1 and Trm2 can be used to adjust steering and throttle Trim and Trm4 and Trm5 can be used to adjust Dual Rate and steering EPA.

**Trim Step Resolution:** Used to adjust how far the servos travel when the Trim Switches are pressed. You can increase the resolution, so that the servos travel less when you press the Trim Switches. This makes it possible to fine-tune the settings extremely accurately. In addition, you could decrease the resolution, so that the servos travel more when you press the Trim Switches. This setting may not be as accurate, although you can set large amounts of Trim faster.

**Variable Rate Adjustment:** The Variable Rate Adjustment function allows you to recalibrate the operation of the Steering, Throttle and Auxiliary Lever End Points and Neutral positions to ensure precise control operation.

**Voltage Alert Alarm:** The Voltage Alert alarm will sound when the receiver battery in your model reaches the Alert Voltage value you've programmed in the SYSTEM - TELEMETRY menu. To clear this alarm, press the Back/Cancel key or the Push-Button Rotary Dial.

**Voltage Alert Indicator:** Indicates the currently programmed Voltage value on the Telemetry Screen that the receiver Voltage Alert alarm will sound at.

**Voltage Display Monitor:** Displays the current receiver battery voltage on the Telemetry Screen in bar graph format.

**Wrist Strap Anchor Slot:** Used to attach the wrist strap anchor to the transmitter.

**Z-Connector:** The type of servo and battery connector used by Airtronics. The Z-Connector is a universal connector which is electronically compatible with the airborne components of other radio control system manufacturers.

## INDEX

### Symbols

- 2.4GHz Frequency Band Precautions 4
- 2CH Mode, Changing 55
- 4CH Mode, Changing 55

### A

- Activate, Definition of 74
- Alarms. *See* Over Voltage Alarm
  - See* Inactivity (Power ON) Alarm
  - See* Low Voltage Alert Alarm
  - See* Low Voltage Limit Alarm
  - See* Temperature Alert Alarm
  - See* Voltage Alert Alarm
- Antenna - Receiver, Orientation of 4
- Antenna Reception Wire - Receiver, Definition of 8, 74
- Antenna Reception Wire - Receiver, Diagram of 8
- Antenna - Transmitter, Definition of 8, 74
- Antenna - Transmitter, Diagram of 6, 7
- Antenna - Transmitter, Orientation of 6
- Anti-Lock Braking, Adjusting the Lag Value 28
- Anti-Lock Braking, Adjusting the Point Percentage Value 27
- Anti-Lock Braking, Adjusting the Release and Hold Values 27
- Anti-Lock Braking, Adjusting the Stroke Percentage Value 27
- Anti-Lock Braking, Controlling 28
- Anti-Lock Braking, Definition of 74
- Anti-Lock Braking, Overview 27
- ARC (Adjustable Rate Control). *See* Exponential and ARC Adjustment, Overview
- ARC (Adjustable Rate Control), Definition of 74
- Audible Key Tone, Overview 63
- Audible Key Tone, Changing the Audible Key Tone Volume 64
- Audible Key Tone, Changing the Tone 64
- Audible Key Tone, Definition of 74
- Auxiliary 1 Programming, Function Chart 29
- Auxiliary 2 Programming, Function Chart 36
- Auxiliary Lever, Definition of 8, 74
- Auxiliary Lever, Diagram of 6
- Auxiliary Lever Key Assignments, Changing the Auxiliary Lever Function 60
- Auxiliary Lever Key Assignments, Changing the High and Low Tweak Values 61
- Auxiliary Lever Key Assignments, Overview and Function Table 57
- Auxiliary Lever Position Display, Definition of 16, 74
- Auxiliary Lever Position Display, Diagram of 16
- Auxiliary Mixing, Adjusting the Rate Percentage Value 35
- Auxiliary Mixing, Choosing the Auxiliary Mixing Function and the Mixing Type 35
- Auxiliary Mixing, Controlling 35
- Auxiliary Mixing, Definition of 74
- Auxiliary Mixing, Overview 34
- Auxiliary Type, Changing the Auxiliary Function 62
- Auxiliary Type, Overview 62

### B

- Back/Cancel Key. *See also* Programming Keys
- Back/Cancel Key, Diagram of 7
- Battery Compartment, Definition of 8, 74
- Battery Compartment, Diagram of 6
- Battery Installation. *See* Transmitter, Battery Installation
- Battery Options, Transmitter 11
- Battery Plug - Transmitter, Diagram of 11
- Battery - Receiver, Installation 12
- Bind Button, Definition of 8, 74
- Bind Button, Diagram of 8
- Binding. *See also* Transmitter and Receiver Binding

### B

- Binding, Changing the Channel Mode (FH2 Modulation Only) 55
- Binding, Changing the Modulation Type 54
- Binding, Changing the Servo Mode Setting 55
- Binding, Definition of 74
- Binding, Overview 54
- Bind LED. *See also* Receiver Bind LED Condition Indicator
- Bind LED, Definition of 8, 74
- Bind LED, Diagram of 8
- Brake Side, Definition of 74
- Burn. *See* Motor on Axle Mixing, Changing Motor on Axle Power Distribution Options
- Burn, Definition of 74

### C

- Center Trim. *See* Trim Type
- Center Trim Type, Definition of 74
- Channel Mode, Changing the Channel Mode (FH2 Modulation Type Only) 55
- Channel Set Menu, Functions List 20
- Channel Set Menu, Using 19
- Channel Slots. *See* Receiver Channel Slots
- Charging. *See* Transmitter Battery Charging, Options
- Charging Jack, Definition of 8, 74
- Charging Jack, Diagram of 7
- Coaxial Cable - Receiver, Definition of 8, 74
- Coaxial Cable - Receiver, Diagram of 8
- Contrast. *See* Multi-Function LCD, Changing the Contrast Value
- Countdown Timer, Definition of 74
- Countdown Timer, Overview 47
- Countdown Timer, Setting the Alarm 47
- Countdown Timer, Starting the Countdown Timer 47
- Countdown Timer, Stopping the Countdown Timer 47
- Curves. *See* Exponential and ARC Adjustment

### D

- Dial Knob, Definition of 8, 74
- Dial Knob, Diagram of 6, 7
- Dig. *See* Motor on Axle Mixing, Changing Motor on Axle Power Distribution Options
- Dig, Definition of 75
- Digital RPM Display, Definition of 75
- Digital RPM Display, Diagram of 16
- Digital Temperature Display, Definition of 75
- Digital Temperature Display, Diagram of 16
- Digital Voltage Indicator, Diagram of 16
- Dual Rate, Adjusting the Brake Dual Rate Percentage Value 21
- Dual Rate, Adjusting the Dual Rate Steering Percentage Value 21
- Dual Rate, Adjusting the Throttle Dual Rate Percentage Value 21
- Dual Rate, Controlling 21
- Dual Rate, Overview 20

### E

- End Point Adjustment, Adjusting the Auxiliary 1 Channel 3 and Auxiliary 2 Channel 4 End Point Adjustment Percentage Values 23
- End Point Adjustment, Adjusting the Steering End Point Adjustment Percentage Values 22
- End Point Adjustment, Adjusting the Throttle End Point Adjustment Percentage Values 22
- End Point Adjustment, Definition of 75
- End Point Adjustment, Overview 22
- Enter Key. *See* Programming Keys
- Exponential and ARC Adjustment, Adjusting the Point Percentage Value (ARC Only) 25
- Exponential and ARC Adjustment, Adjusting the Rate Percentage Value 25
- Exponential and ARC Adjustment, Choosing a Channel 24
- Exponential and ARC Adjustment, Choosing the Curve Type 24
- Exponential and ARC Adjustment, Controlling 25



### E

Exponential and ARC Adjustment, Overview 23  
Exponential, Definition of 75

### F

Fail Safe, Definition of 75  
Fail Safe Limit, Receiver Specification 5  
Fail Safe, Overview 48  
Fail Safe, Receiver Battery Voltage Fail Safe Function. *See* Setting the Receiver Battery Voltage Fail Safe Function  
Fail Safe, Setting the Fail Safe 48  
Fail Safe, Setting the Receiver Battery Voltage Fail Safe Function 49  
FCC Compliance Statement 3  
Features. *See* System Features  
FH2 Modulation, Definition of 75  
FH3F Modulation, Definition of 75  
FH3 Modulation, Definition of 75  
FH4T Modulation, Definition of 75  
FHSS, Definition of 75  
Four Wheel Steering Mixing, Choosing Four Wheel Steering Mixing Options 32  
Four Wheel Steering Mixing, Choosing the Four Wheel Steering Function 31  
Four Wheel Steering Mixing, Controlling 33  
Four Wheel Steering Mixing, Definition of 75  
Four Wheel Steering Mixing, Overview 31  
Front Wheel Steering. *See* Four Wheel Steering Mixing, Choosing Four Wheel Steering Mixing Options

### G

Grip, Changing 14  
Grip, Definition of 8, 75  
Grip, Diagram of 6, 7

### H

High RPM Display, Definition of 75  
High RPM Display, Diagram of 16  
High Side, Definition of 75  
High Temperature Display, Definition of 75  
High Temperature Display, Diagram of 16  
Hold, Definition of 75

### I

Inactivity Alarm (Power ON Alarm), Definition of 75  
Inactivity (Power ON) Alarm, Overview 10  
Inhibit, Definition of 75  
Input Voltage. *See* Nominal Input Voltage, Receiver Specification  
*See* Nominal Input Voltage, Transmitter Specification  
Interval Timer, Definition of 76  
Interval Timer, Overview 46  
Interval Timer, Setting the Alarm (Goal Time) 46  
Interval Timer, Setting the Interval Timer (Target Time) 46  
Interval Timer, Starting the Interval Timer 46  
Interval Timer, Stopping the Interval Timer 46

### K

Key Assignments. *See* Push-Button Switch Key Assignments  
*See* Auxiliary Lever Key Assignments  
*See* Rotary Dial Key Assignments  
*See* Trim Switch Key Assignments  
Key Assignments, Diagram of Default Key Assignments 56  
Key Tone. *See* Audible Key Tone  
KM/H, Acronym 76

### L

Lag, Definition of 76

# REFERENCE

## INDEX, CONTINUED....

### L

- Lap Timer, Definition of 76
- Lap Timer, Overview 45
- Lap Timer, Setting the Alarm (Goal Time) 45
- Lap Timer, Setting the Interval Timer (Target Time) 45
- Lap Timer, Starting the Lap Timer 45
- Lap Timer, Stopping the Lap Timer 45
- Lap Times, Viewing Lap Times 47
- LCD. *See* Multi-Function LCD
- LED 1/2 Condition Indicators, Overview 10
- LED 1/2, Definition of 8, 76
- LED 1/2, Diagram of 7
- Li-Po, Li-Fe/A123 Batteries, Using with Receiver 12
- Li-Po, Li-Fe/A123 Batteries, Using with Transmitter 11
- Li-Po, Li-Fe/A123 Batteries, Warnings When Using 11
- Low Voltage Alert Alarm, Changing the Low Voltage Alert Alarm Value 64
- Low Voltage Alert Alarm, Definition of 76
- Low Voltage Alert Alarm, Overview 10
- Low Voltage Alert Alarm, Voltage Recommendations Table 64
- Low Voltage Limit Alarm, Changing the Low Voltage Limit Alarm Value 65
- Low Voltage Limit Alarm, Definition of 76
- Low Voltage Limit Alarm, Overview 10
- Low Voltage Limit Alarm, Voltage Recommendation Table 64

### M

- Model Clear, Clearing Model Programming Data 53
- Model Clear, Overview 53
- Model Copy, Copying Model Programming Data 53
- Model Copy, Overview 53
- Model Naming, Deleting a Character 52
- Model Naming, Deleting a Model Name 53
- Model Naming, Entering a Model Name 52
- Model Naming, Overview 52
- Model Number and Name, Definition of 76
- Model Number and Name, Diagram of 16
- Model Select, Definition of 76
- Model Select, Overview 51
- Model Select, Selecting a Model 51
- Model Select, Using the Model Select Shortcut Function (Direct Model) 52
- Modulation Type, Changing the Modulation Type 54
- Modulation Type Indicator, Definition of 76
- Modulation Type Indicator, Diagram of 16
- Modulation Type, Overview 54
- Motor on Axle Mixing, Changing Motor on Axle Power Distribution Options 33
- Motor on Axle Mixing, Choosing the Motor on Axle Mixing Function 33
- Motor on Axle Mixing, Controlling 34
- Motor on Axle Mixing, Definition of 76
- Motor on Axle Mixing, Overview 33
- MPH, Acronym 76
- Multi-Function LCD, Changing the Contrast Value 65
- Multi-Function LCD, Definition of 8, 76
- Multi-Function LCD, Diagram of 7

### N

- Nominal Input Voltage, Receiver Specification 5
- Nominal Input Voltage, Transmitter Specification 5

### O

- Offset. *See* Throttle Offset, Overview
- Operating Voltage, Definition of 76
- Operating Voltage Range, Receiver Specification 5

### O

Operating Voltage Range, Transmitter Specification 5  
 Output Power, Definition of 76  
 Output Power, Transmitter Specification 5  
 Over Voltage Alarm, Definition of 76  
 Over Voltage Alarm, Overview 9

### P

Packaging 2  
 Parallel Steering. *See* Four Wheel Steering Mixing, Choosing Four Wheel Steering Mixing Options  
 Parallel Steering, Definition of 76  
 Parallel Trim. *See* Trim Type  
 Parallel Trim, Definition of 76  
 Point Auxiliary, Adjusting the Point Values 31  
 Point Auxiliary, Choosing the Point Auxiliary Function and the Number of Points 30  
 Point Auxiliary, Controlling 31  
 Point Auxiliary, Definition of 76  
 Point Auxiliary, Overview 30  
 Point Setting, Definition of 76  
 Power Indicator, Definition of 76  
 Power Indicator Light, Definition of 76  
 Power Indicator Light, Diagram of 6  
 Power Switch, Definition of 9, 76  
 Power Switch, Diagram of 6, 7  
 Precautions, Receiver 4. *See also* Receiver Precautions  
 Precautions, Transmitter 4. *See also* Transmitter Precautions  
 Programming Keys, Overview 17  
 Programming Menus, Overview and Menu List 19  
 Push-Button Rotary Dial. *See also* Programming Keys, Overview  
 Push-Button Rotary Dial, Definition of 9, 76  
 Push-Button Rotary Dial, Diagram of 7  
 Push-Button Switch, Definition of 9, 76  
 Push-Button Switches, Diagram of 6  
 Push-Button Switch Key Assignments, Changing the Push-Button Switch Function 57  
 Push-Button Switch Key Assignments, Changing the Switch Mode 57  
 Push-Button Switch Key Assignments, Overview and Function Table 56

### R

Rear Wheel Steering. *See* Four Wheel Steering Mixing, Choosing Four Wheel Steering Mixing Options  
 Receiver Antenna Wire Routing Diagram 4  
 Receiver Battery Voltage Fail Safe, Definition of 76  
 Receiver Battery Voltage Fail Safe Function. *See* Fail Safe, Setting the Receiver Battery Voltage Fail Safe Function  
 Receiver Bind LED Condition Indicator 12  
 Receiver Channel Slots, Diagram of 8  
 Receiver Connections and Mounting 12  
 Receiver Features Diagram 8  
 Receiver Input Voltage Specification 5  
 Receiver Precautions 4  
 Receiver Specifications 5  
 Receiver, Using 7.4 Volt Servos 12  
 Receiver Voltage Display, Definition of 77  
 Receiver Voltage Display, Diagram of 16  
 Release, Definition of 77  
 RF Exposure Statement 3  
 Rotary Dial Key Assignments, Changing the Rotary Dial Direction of Travel 60  
 Rotary Dial Key Assignments, Changing the Rotary Dial Function 59  
 Rotary Dial Key Assignments, Changing the Rotary Dial Step Value 59  
 Rotary Dial Key Assignments, Overview and Function Table 57  
 RPM, Acronym 77  
 RPM Display Monitor, Definition of 77  
 RPM Display Monitor, Diagram of 16  
 RPM Sensor, Calibrating the RPM Sensor 70

# REFERENCE

## INDEX, CONTINUED....

### S

Safety 3

Servo Connectors, Overview 9

Servo Mode, Changing the Servo Mode Setting 55

Servo Mode, Overview 55

Servo Monitor Display, Definition of 77

Servo Monitor Display, Diagram of 16

Servo Recommendations 5

Servo Reversing, Changing the Servo Reversing Values 44

Servo Reversing, Definition of 77

Servo Reversing, Overview 44

Servo Speed, Adjusting the Forward Speed Value 26

Servo Speed, Adjusting the Return to Neutral Speed Value 26

Servo Speed, Controlling 26

Servo Speed, Definition of 77

Servo Speed, Overview 25

Servo Sub-Trim. *See* Trim and Servo Sub-Trim, Overview

Servo Sub-Trim, Definition of 77

Servos, Using 7.4 Volt. *See* Receiver, Using 7.4 Volt Servos

Servos, Using Analog, SHR or SRG Digital. *See* Changing the Servo Mode Setting

SHR Servo Mode. *See* Servo Mode, Changing the Servo Mode Setting

SHR Servo Mode, Definition of 77

Specifications, Transmitter and Receiver 5

SSR Servo Mode. *See* Servo Mode, Changing the Servo Mode Setting

SSR Servo Mode, Definition of 77

Steering Mixing. *See* Auxiliary Mixing, Overview

Steering Program Indicator, Definition of 77

Steering Program Indicator, Diagram of 16

Steering Trim Display, Definition of 77

Steering Trim Display, Diagram of 16

Steering Wheel, Definition of 9, 77

Steering Wheel, Diagram of 6

Steering Wheel Spring Tension, Changing 15

Steering Wheel Tension Adjustment Screw, Definition of 9, 77

Steering Wheel Tension Adjustment Screw, Diagram of 6

Steering Wheel Travel, Changing 15

Step Auxiliary, Adjusting the Step Auxiliary Value 30

Step Auxiliary, Choosing the Step Auxiliary Function 30

Step Auxiliary, Controlling 30

Step Auxiliary, Definition of 77

Step Auxiliary, Overview 29

Step Value, Definition of 77

Stroke, Definition of 77

Sub-Trim. *See* Trim and Servo Sub-Trim, Overview

Suppression Capacitor. *See* Receiver Precautions

Suppression Capacitor, Definition of 77

System Features 5

System Menus, Overview and Menu List 51

### T

Tandem Steering. *See* Four Wheel Steering Mixing, Choosing Four Wheel Steering Mixing Options

Tandem Steering, Definition of 77

Telemetry, Calibrating the RPM Sensor 70

Telemetry Clear Function, Overview and Using 71

Telemetry Data. *See* Telemetry Log, Viewing Telemetry Data

Telemetry, Definition of 77

Telemetry Inputs, Definition of 9, 77

Telemetry Inputs, Diagram of 8

Telemetry Log, Changing the Telemetry Log Step Value 71

Telemetry Log, Overview 49

Telemetry Log, Starting and Stopping the Telemetry Log 49

### T

- Telemetry Log, Viewing Telemetry Data 50
- Telemetry, Mounting the RPM Sensor 13
- Telemetry, Mounting the Temperature Sensor 13
- Telemetry, Overview 66
- Telemetry RPM Display, Changing the Maximum Speed Value 69
- Telemetry RPM Display, Changing the RPM Unit Value 69
- Telemetry RPM Sensor, Diagram of 13
- Telemetry Screen, Overview and Using 16
- Telemetry Sensors, Connecting to Receiver 13
- Telemetry Sensors, Overview 13
- Telemetry Signal Indicator, Definition of 77
- Telemetry Signal Indicator, Diagram of 16
- Telemetry Temperature Display, Changing the Alert Temperature Value 67
- Telemetry Temperature Display, Changing the Maximum Temperature Value 67
- Telemetry Temperature Display, Changing the Minimum Temperature Value 67
- Telemetry Temperature Display, Changing the Temperature Unit Value 66
- Telemetry Temperature Sensor, Diagram of 13
- Telemetry, Turning 'ON' and 'OFF' 70
- Telemetry Voltage Display, Changing the Alert Voltage Value 68
- Telemetry Voltage Display, Changing the Maximum Voltage Value 68
- Temperature Alert Alarm 78
- Temperature Alert Alarm, Overview 10
- Temperature Display Monitor, Definition of 78
- Temperature Display Monitor, Diagram of 16
- Temperature Sensor, Mounting the Temperature Sensor 13
- Throttle Mixing. *See* Auxiliary Mixing, Overview
- Throttle Mode Indicator, Definition of 78
- Throttle Mode Indicator, Diagram of 16
- Throttle Offset, Adjusting the Throttle Offset Position Percentage Value 29
- Throttle Offset, Controlling 29
- Throttle Offset, Definition of 78
- Throttle Offset Indicator, Definition of 78
- Throttle Offset Indicator, Diagram of 16
- Throttle Offset, Overview 28
- Throttle Offset, Turning the Throttle Offset Function 'ON' or 'OFF' 28
- Throttle Program Indicator, Diagram of 16
- Throttle Program Indicator, Definition of 78
- Throttle Trigger Angle Adjustment, Changing 14
- Throttle Trigger, Definition of 9, 78
- Throttle Trigger, Diagram of 6
- Throttle Trigger Position Adjustment, Changing 14
- Throttle Trigger Position Adjustment Indicator, Definition of 9, 78
- Throttle Trigger Position Adjustment Indicator, Diagram of 7
- Throttle Trigger Position Adjustment Screw, Definition of 9, 78
- Throttle Trigger Position Adjustment Screw, Diagram of 6
- Throttle Trigger Spring Tension, Changing 15
- Throttle Trigger Tension Adjustment Screw, Definition of 9, 78
- Throttle Trigger Tension Adjustment Screw, Diagram of 6
- Throttle Trim Display, Definition of 78
- Throttle Trim Display, Diagram of 16
- Throttle Trim Switch, Definition of 8, 74
- Throttle Trim Switch, Diagram of 6
- Throttle Type, Changing the Throttle Type 63
- Throttle Type, Overview 63
- Timer Display, Diagram of 16
- Timer Type Indicator, Definition of 78
- Timer Type Indicator, Diagram of 16
- Top Screen, Overview 16

# REFERENCE

## INDEX, CONTINUED....

### T

- Track Timers. *See* Lap Timer, Overview
  - See* Interval Timer, Overview
  - See* Countdown Timer, Overview
- Track Timers, Choosing the Timer Type 44
- Track Timers, Overview 44
- Transmitter and Receiver Binding 18
- Transmitter Battery Charging Options 11
- Transmitter Battery Holder Connector, Diagram of 11
- Transmitter Battery Installation 11
- Transmitter Features Diagrams 6
- Transmitter Input Voltage 11
- Transmitter Precautions 4
- Transmitter Specifications 5
- Transmitter, Using Alkaline Batteries 11
- Transmitter, Using Li-Po or Li-Fe/A123 Batteries 11
- Transmitter, Using Ni-Cd or Ni-MH Batteries 11
- Trim and Servo Sub-Trim, Adjusting the Servo Sub-Trim Values 42
- Trim and Servo Sub-Trim, Adjusting the Trim Values 43
- Trim and Servo Sub-Trim, Controlling Trim 43
- Trim and Servo Sub-Trim, Overview 42
- Trim Step Resolution, Definition of 78
- Trim Switch, Definition of 9, 78
- Trim Switches, Diagram of 6, 7
- Trim Switch Key Assignments, Overview and Function Table 57
- Trim Switch Key Assignments, Changing the Trim Switch Direction of Travel 59
- Trim Switch Key Assignments, Changing the Trim Switch Function 58
- Trim Switch Key Assignments, Changing the Trim Switch Step Value 58
- Trim Type, Changing the Trim Type 61
- Trim Type, Overview 61
- Troubleshooting Guide 73

### V

- Variable Rate Adjustment, Calibrating Control Operation 71
- Variable Rate Adjustment, Definition of 78
- Variable Rate Adjustment, Overview 71
- Voltage Alert Alarm, Definition of 78
- Voltage Alert Alarm, Overview 10
- Voltage Alert Indicator, Definition of 78
- Voltage Alert Indicator, Diagram of 16
- Voltage Display Monitor, Definition of 78
- Voltage Display Monitor, Diagram of 16
- Voltage Indicator. *See also* Digital Voltage Indicator

### W

- Wrist Strap Anchor, Definition of 8, 78
- Wrist Strap Anchor, Installing 15
- Wrist Strap Anchor Slot, Definition of 9
- Wrist Strap Anchor Slot, Diagram of 7

### Z

- Z-Connector. *See* Servo Connectors, Overview
- Z-Connector, Definition of 78

**THIS SPACE INTENTIONALLY LEFT BLANK**

# NOTES



**Airtronics is Distributed Exclusively in North America by:**

**Global Hobby Distributors  
18480 Bandilier Circle  
Fountain Valley, CA 92708**

**Telephone: (714) 963-0329  
Fax: (714) 964-6236**

**Email: [service@airtronics.net](mailto:service@airtronics.net)  
<http://globalservices.globalhobby.com>  
<http://www.airtronics.net>**

Features and Specifications are Subject to Change Without Notice.

All contents © 2011 Airtronics, Inc.

All Rights Reserved. Revision 1-01.28.2011