

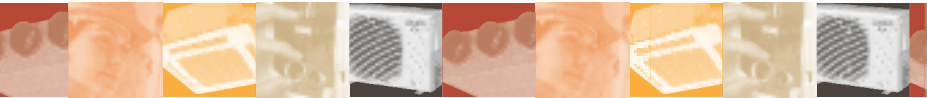









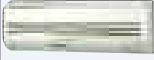
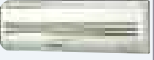



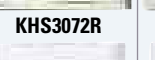
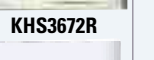
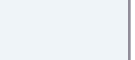

























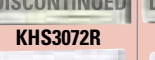
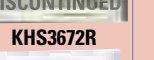



















Air Conditioning & Heat Pump Products

**7 Year Compressor
Warranty**
**5 Year Parts
Warranty**



SANYO Air Conditioners & Heat Pumps





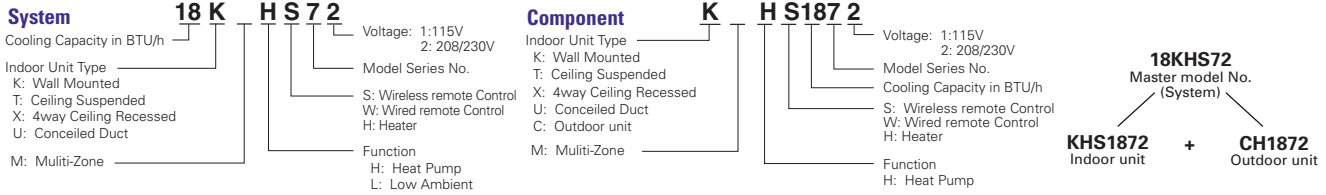

Btu/h		9,000		12,000		18,000		24,000		26,000	30,000	36,000	42,000																									
Type	Standard	Low Ambient	Standard	Low Ambient	Standard	Low Ambient	Standard	Low Ambient	Standard	Low Ambient	Low Ambient	Low Ambient	Low Ambient																									
MODEL (System)	09KS71	09KLS71	12KS71	12KLS71	12XS71	12XLS71	18KS72	18KLS72	18XS72	18XLS72	24KS72	24KLS72	26KS72R	26TW72R	26XW72R	26UW72R	30KS72R	30KS82	36KS72R	36TW72R	36XW72R	36UW72R	36KS82	42TW72R	42XW72R													
AIR CONDITIONER	Wall Mounted	 KS0971	 KS1271	 KS1872	 KS2472	 KHS2672R	 KHS3072R	 KHS3672R	 KS3082	 KS3682																												
	Ceiling Suspended										 THW2672R		 THW3672R	 THW4272R																								
	Ceiling Recessed			 XS1271	 XS1872					 XHW2672R		 XHW3672R	 XHW4272R																									
	Concealed Duct									 UHW2672R		 UHW3672R																										
	Outdoor	 C0971	 CL0971	 C1271	 CL1271	 C1872	 CL1872	 C2472	 CL2472	 C2672R	 C3072R	 C3082	 C3672R	 C3682	 C4272R																							
MODEL (System)	09KHS71		12KHS71		12XHS71		18KHS72		18XHS72		24KHS72		26KHS72R		26THW72R		26XHW72R		26UHW72R		30KHS72R		30KHS82		36KHS72R		36THW72R		36XHW72R		36UHW72R		36KHS82		42THW72R		42XHW72R	
HEAT PUMP WITHOUT HEATER	Wall Mounted	 KHS0971	 KHS1271	 KHS1872	 KHS2472	 KHS2672R	 KHS3072R	 KHS3672R	 KHS3082	 KHS3682																												
	Ceiling Suspended									 THW2672R		 THW3672R	 THW4272R																									
	Ceiling Recessed			 XHS1271	 XHS1872					 XHW2672R		 XHW3672R	 XHW4272R																									
	Concealed Duct									 UHW2672R		 UHW3672R																										
	Outdoor	 CH0971	 CH1271	 CH1872	 CH2472	 CH2672R	 CH3072R	 CH3082	 CH3672R	 CH3682	 CH4272R																											
MODEL (System)													26KHHS72R	26THHW72R											36THHW72R													
HEAT PUMP WITH HEATER	Wall Mounted									 KHHS2672R		 KHHS3672R																										
	Ceiling Suspended									 THHW2672R		 THHW3672R																										
	Outdoor									 CH2672R		 CH3672R																										



Model Identification



Flexi Multi Inverter

AIR CONDITIONER	Btu/h	7,000	9,000	12,000	18,000	24,000
	Type	Standard	Standard	Standard	Standard	Standard
	Wall Mounted					
		KMS0772	KMS0972	KMS1272	KMS1872	KMS2472
	Ceiling Recessed					
		XMS0972		XMS1272	XS1872	
Btu/h	19,000		24,000		31,000	
Type	Standard		Standard		Standard	
Outdoor	 Up to 3 Rooms CM1972A	 Up to 4 Rooms CM2472A	 Up to 4 Rooms CM3172A			

HEAT PUMP	Btu/h	7,000	9,000	12,000	18,000	24,000
	Wall Mounted					
		KMHS0772	KMHS0972	KMHS1272	KMHS1872	KMHS2472
	Ceiling Recessed					
		XMHS0972		XMHS1272	XHS1872	
	Btu/h	19,000		24,000		31,000
Outdoor	 Up to 3 Rooms CMH1972A	 Up to 4 Rooms CMH2472A	 Up to 4 Rooms CMH3172A			

Features



Microprocessor-Controlled Operation

Microprocessor control ensures that the temperature and humidity levels in the room are always comfortable.



Wireless Remote Control

Sanyo's infrared Remote Control with an easy to read LCD Display, gives the user the capability to adjust & set: temperature, sweep (louver control), fan speeds, timer, night setback and more, for complete automatic operation.



Dry Mode

By coupling compressor and fan operation, intermittent operation can be precisely controlled according to room temperature, so that air is efficiently dehumidified.



3 Fan Speeds and Automatic Fan Operation

Convenient microprocessor control automatically adjusts fan speed to High, Medium or Low. According to room temperature to maintain a comfortable airflow throughout the room.



Air Sweep Control

The air sweep function moves the louver up and down in the air outlet, directing air in a "sweeping" motion around the room and providing comfort in every corner.

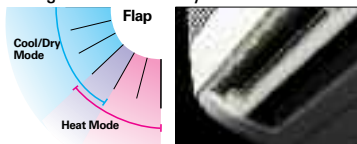

Louver Control

Louver can be manually set to the desired angle by remote control.



Negative Ions Generator

The negative ions generator fills your room with negative ions throughout the year.

*Ion generating power - over 100,000 parts/cc



Automatic Heating and Cooling Changeover

After setting the temperature and functions you desire, just relax. If the room temperature is higher than the set temperature, cooling operation begins. If the room temperature is lower than the set temperature, heating operation begins. During normal thermostat cycle operation, cooling and heating operations automatically change in accordance with set temperature, time and room temperature. (Single Zone Heat Pump unit only)



1-hour OFF Timer

When this button is pushed either while the unit is operating or while it is stopped, the unit will operate for one hour and then switch off automatically.



24-hour Clock with ON/OFF Program Timer

The remote control unit allows you to set a wide variety of timer-based operations. Such functions include automatic ON/OFF with a timer setting, same time ON/OFF every day, ON timer, OFF timer and Combination timer.



72-hour ON/OFF Remote controller

ON/OFF timer can be set to 0.5 hour gradations (max. 72 hours).



Night Setback Mode for Cooling and Heating

Cooling and DRY Mode: With the Night Setback Mode, the air conditioner automatically raises the setting temperature 2°F after 30 minutes, and then another 2°F after the next 30 minutes.

Heating Mode: With the Night Setback Mode, the setting temperature is automatically lowered 4°F after 30 minutes, and then another 4°F after the next 30 minutes. This saves energy without sacrificing comfort and is ideal for gentle cooling and heating.

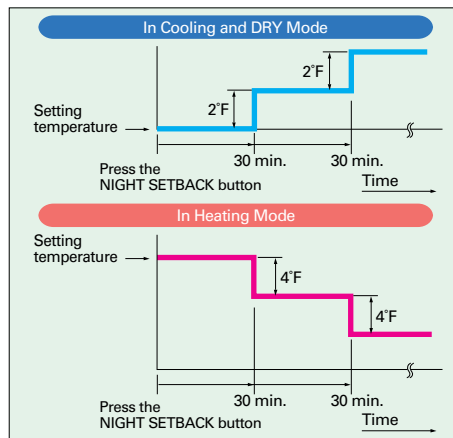

Automatic Restart Function after Power Failure

This feature allows the system to automatically resume operation at its preset program, after power is restored from a power failure.



Hot Start Heating System

Right from the start, air is warm and comfortable. The Hot Start Heating System prevents any cold blasts at the beginning while the heat pump is warming up. (Heat pump unit only)



Air Clean Apatite Filter

Apatite or calcium phosphate is highly effective in trapping germs, mites and mite excrement, pollen, dirt and dust, and cigarette odor. The triple layered air clean apatite filter consists of antibacterial, deodorizing, and dust-collecting sections that maintain healthy, clean air in your room.



Anti-Mold Filter

Filter is treated with anti-mold coatings to prevent mold or bacteria from occurring.



Built-In Drain Pump

Max. head 20 inches from the discharge of the indoor unit. Condensate pump is only for allowing drain line to meet minimum gravity flow requirements.



Electric Refrigerant Control Valve

The circulation volume of the refrigerant is controlled by a pulse type electric control valve. In order to attain optimum efficiency, when the power is switched ON, the opening degree of the electric control valve is controlled between 90 and 480 steps.



Quiet Mode

LOW, low fan speed for extra quiet operation.

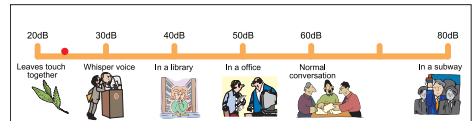

Filter Sign

Filter sign informs you when filter maintenance is necessary.

2,500 hrs: X, T-types

150 hrs: K-type



(RCS-TM80BG)



Self-Diagnosing Function

Details of previous warnings are stored and can be verified on the liquid crystal display. This makes it easier to diagnose malfunctions, greatly reducing service labor. (Wired remote controller)

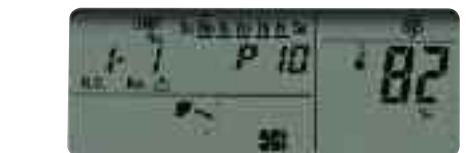

(Example of RCS-TM80BG)

Remote Controller Options for Models 26000 Btu's and Larger

Wired Remote Controllers (Except 82 Series)

Simple Remote Controller



(RCS-KR1EG)

Key Features (Simple Remote):

- Thin and Easy To Read
- Simple To Install and Use
- Can Be Adapted for Use On All ECO-i Indoor Units
- Mode
- Fan Speed Control
- Set Temperature
- On/Off
- Airflow Direction
- Perfectly Suited for Applications Where Simpler Functionality is Required (ie: Hotel Rooms, Nursing Homes, Offices)



RCS-TM80BG

Key Features (Standard Remote/7 Day Timer):

- Thin and Easy To Read
- Simple To Install and Use
- Can Be Adapted for Use On All ECO-i Indoor Units
- Fan Speed Control
- Airflow Direction
- Operating Mode (Heating/Cooling/Auto/Dry/Fan)
- Vacation Mode for Continued Energy Efficiencies
- Full 7 Day Set-Back Functionality, With Up To 6 Time Periods/Day
- Full System Diagnostic Capability

(Diagnostic History Provides Immediate View of System Past and Present.)

System Controller



(SHA-KC64UG)

Multiple Zone Controllers.

The Air Conditioning Gateway.

Sanyo's system and intelligent controls are the central nervous system to the conditioning system. The gateway to all data, temperature and system diagnostics. The heart and soul of conditioning.

Key Features (System Control):

- Controls Up To 64 Units Into 4 Individualized Zones
- Alarm and Operational Signal Output
- Single Access Points for All Connected Wired Remotes

Wireless Remote Controllers

Wireless Remote Controller	Applicable Unit	X-series (Ceiling Recessed Type)	T-series (Ceiling Suspended Type)	For All Indoor Units
				U-series X-series T-series
<p>K-series</p> <p>RCS-SH1UA</p>		<p>BUILT-IN TYPE</p> <ul style="list-style-type: none"> • Signal receiving unit can be installed in the outer panel of indoor unit. • Control panel can be installed in the inside indoor unit. <p>RCS-SH80UA-WL</p>	<p>EXTERNAL TYPE</p> <ul style="list-style-type: none"> • Separate type signal receiving unit. <p>RCS-BH80UA-WL</p>	

Remote Controllers Functions

		Timer Remote Controller (RCS-TM80BG)	System Controller (SHA-KC64UG)	
Function	ON/OFF	●	● (Collective/Individual)	
	Operation mode switch	Heating	●	● (Individual)
		Dry	●	● (Individual)
		Cooling	●	● (Individual)
		Fan	●	● (Individual)
	Temp setting	●	● (Individual)	
	Fan speed setting (Hi/Mid./Lo/Auto)	●	● (Individual)	
	Auto flap	Auto airflow direction setting	●	●
		Arbitrary airflow direction setting	●	●*
	Sweep (Flap swing)	●	●*	
Sensor temp. display	●	×		
Self-diagnostic function	●	●		
System	Central control (at hand inhibited)	×	●	
	Group control	● (Up to 8 units)	● (Up to 16 groups)	
	Concurrent use with weekly timer	●	●	
Setting Range	Cooling, dry (°F)		65 - 86	
	Heating (°F)		61 - 79	

●: Controllable
×: Uncontrollable

NOTE:
If you use both remote controller and system controller concurrently, both controllers can be used on a last-signal priority basis.

Benefits

- High Efficiency systems up to 20 SEER
- Inverter Driven variable speed twin rotary compressors
- Precise compressor speed to match the building needs
- Quiet operation
- Designed to run longer periods at reduced speeds to improve dehumidification
- Quick and easy installation of indoor and outdoor units
- Wired & wireless remote controllers available on all models
- Single Point Power Supply reduces installation costs (Comply with local codes on wire size)
- 7 Year compressor warranty and 5 year parts warranty

9,000 - 24,000 Btu/h single zone, 30/36 KS/KHS82 Models wiring schematic

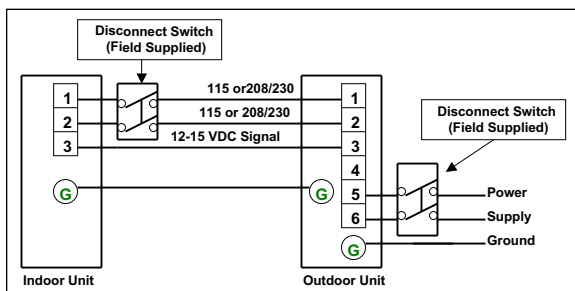

26,000 - 42,000 Btu/h single zone wiring schematic (control wiring to be 18/2 shielded; grounded on both ends)

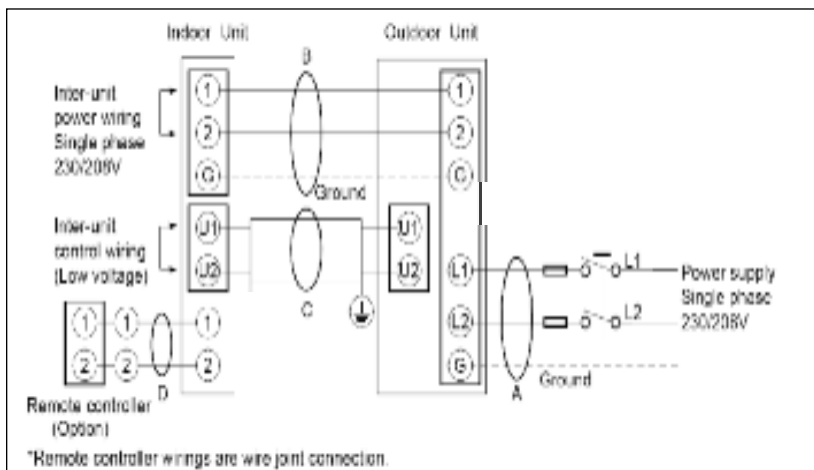

(Except 82 Series.)

Flexi Multi wiring schematic (example shown is with 3 indoor units)

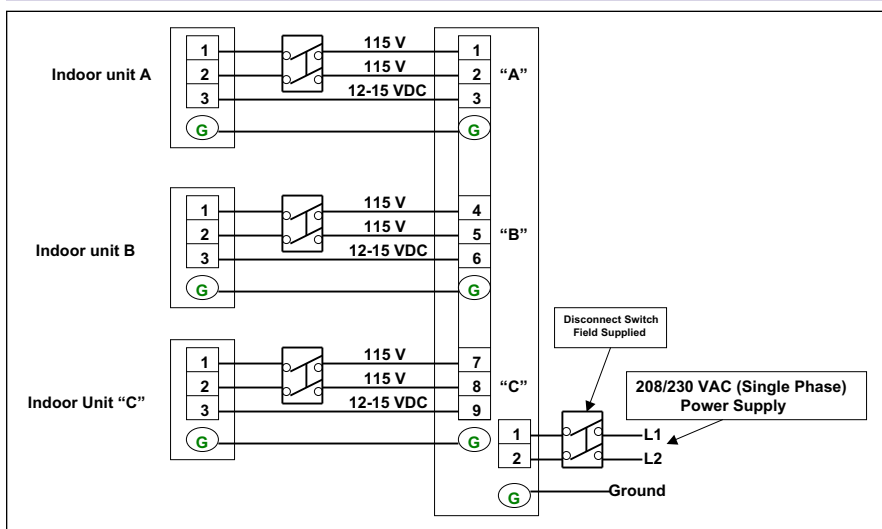

Wall-Mounted Air Conditioners



09KS71 / 09KLS71
12KS71 / 12KLS71

Indoor Unit
KS0971
KS1271



Outdoor Unit
C0971 / CL0971
C1271 / CL1271



Wireless Remote Controller



18KS72 / 18KLS72
24KS72 / 24KLS72

Indoor Unit
KS1872
KS2472



Outdoor Unit
C1872 / CL1872



Outdoor Unit
C2472 / CL2472



WASHABLE FRONT GRILLE



Only for 09KLS71, 12KLS71, 18KLS72, 24KLS72

Wall Mounted Air Conditioners

Model No.	09KS71 / 09KLS71		12KS71 / 12KLS71		18KS72 / 18KLS72		24KS72 / 24KLS72	
	Indoor Unit	Outdoor Unit	Indoor Unit	Outdoor Unit	Indoor Unit	Outdoor Unit	Indoor Unit	Outdoor Unit
Unit Model No.	KS0971	C0971 / CL0971	KS1271	C1271 / CL1271	KS1872	C1872 / CL1872	KS2472	C2472 / CL2472
Performance & Electrical Ratings								
Capacity	Cooling Btu/h	9,000 (3,000-9,000)	11,900 (3,000-11,900)	17,500 (4,000-17,500)	24,200 (4,000-24,200)			
	Heating Btu/h	---	---	---	---			
Moisture Removal	High Pints/H	3.4	4.26	4.89	4.89			
Dry Air Flow	Hi / Med / Low CFM	282 / 247 / 200	294 / 259 / 212	524 / 470 / 417	600 / 541 / 482			
SEER	Cooling	16	17	20	17			
EER	Cooling	12	10.9	11.7	9.8			
HSPF	Heating	---	---	---	---			
Power Supply	V, Phase, Hz	115V, 1PH, 60Hz	115V, 1PH, 60Hz	230 / 208V, 1PH, 60Hz	230 / 208V, 1PH, 60Hz			
Running Amps	Cooling A	7.6 (2.5-7.6)	10.9 (2.5-10.9)	7 / 7.7 (1.2-7.7)	10.8 / 12.1 (1.3-12.1)			
	Heating A	---	---	---	---			
Power Input	Cooling W	755 (250-755)	1,090 (250-1,090)	1,500 / 1,500 (250-1,500)	2,355 / 2,355 (280-2,355)			
	Heating W	---	---	---	---			
Back-up Heater	kW	---	---	---	---			
Fuse or Circuit Breaker Capacity	A	20	20	20	20			
Features								
Controls	Microprocessor		Microprocessor		Microprocessor		Microprocessor	
Low Ambient Control	09KLS71 Equip.		12KLS71 Equip.		18KLS72 Equip.		24KLS72 Equip.	
Wireless Remote Controller	Included		Included		Included		Included	
Wired Remote Control (optional)	STK-RCS-7TWSUA & STK-KCW1		STK-RCS-7TWSUA & STK-KCW1		STK-RCS-7TWSUA & STK-KCW1		STK-RCS-7TWSUA & STK-KCW1	
Fan Speeds	Hi / Me / Lo & Auto		Hi / Me / Lo & Auto		Hi / Me / Lo & Auto		Hi / Me / Lo & Auto	
Timer	1hr OFF and 24-hr PROGRAM		1hr OFF and 24-hr PROGRAM		1hr OFF and 24-hr PROGRAM		1hr OFF and 24-hr PROGRAM	
Air Deflection	Horizontal	Manual	Manual	Manual	Manual	Manual	Manual	Manual
	Vertical	Automatic	Automatic	Automatic	Automatic	Automatic	Automatic	Automatic
Air Filter	Washable + Apatite		Washable + Apatite		Washable + Apatite		Washable + Apatite	
Refrigerant	R-410A		R-410A		R-410A		R-410A	
Refrigerant control	Electric Expansion Valve		Electric Expansion Valve		Electric Expansion Valve		Electric Expansion Valve Control	
Operation Sound	In(Hi / Me / Lo / Qt) dB-A	34 / 31 / 28 / 23	36 / 33 / 29 / 25	42 / 38 / 30 / 28	47 / 44 / 41 / 30			
	Outdoor(Hi) dB-A	46	47	51	55			
Refrigerant Piping	Type	Flare Type	Flare Type	Flare Type	Flare Type			
	Discharge inches	1/4" Discharge	1/4" Discharge	1/4" Discharge	1/4" Discharge			
	Suction inches	3/8" Suction	3/8" Suction	1/2" Suction	5/8" Suction			
Refrigerant Pipe Length	Ft.	Max. 50Ft	Max. 65Ft	Max. 98Ft	Max. 131Ft			
Elevation Difference**	Outdoor Above Ft.	Max. 23Ft	Max. 23Ft	Max. 50Ft	Max. 50Ft			
	Outdoor Below Ft.	Max. 23Ft	Max. 23Ft	Max. 50Ft	Max. 50Ft			
Dimensions & Weight								
Height	Indoor Unit	11-7/32"	Outdoor Unit	21-9/16"	Indoor Unit	11-7/32"	Outdoor Unit	21-9/16"
	inches	11-7/32"	21-9/16"	11-7/32"	21-9/16"	11-23/32"	26-3/8"	11-23/32"
Width	Indoor Unit	32-15/32"	Outdoor Unit	28-11/32"	Indoor Unit	41-15/16"	Outdoor Unit	34-21/32"
	inches	32-15/32"	28-11/32"	32-15/32"	28-11/32"	41-15/16"	34-21/32"	41-15/16"
Depth	Indoor Unit	7-7/16"	Outdoor Unit	10-7/16"	Indoor Unit	8-19/32"	Outdoor Unit	11-7/32"
	inches	7-7/16"	10-7/16"	7-7/16"	10-7/16"	8-19/32"	11-7/32"	8-19/32"
Net Weight	Indoor Unit	19.8	Outdoor Unit	72.8	Indoor Unit	19.8	Outdoor Unit	75.0
	Lbs.	19.8	72.8	19.8	75.0	26.5	90.4	26.5
								119.0

** This is maximum elevation difference when the indoor unit is located above the outdoor unit. (Refer to the table on the back of the catalogue for more detail.)

Wall-Mounted Air Conditioners



26KS72R

**Indoor Unit
KHS2672R**



**Outdoor Unit
C2672R**



Wireless Remote Controller (RCS-SH1UA)



30KS72R

36KS72R

**Indoor Unit
KHS3072R
KHS3672R**



**Outdoor Unit
C3072R
C3672R**



Wall Mounted Air Conditioners						
Model No.	26KS72R		30KS72R		36KS72R	
	Indoor Unit	Outdoor Unit	Indoor Unit	Outdoor Unit	Indoor Unit	Outdoor Unit
Unit Model No.	KHS2672R	C2672R	KHS3072R	C3072R	KHS3672R	C3672R
Performance & Electrical Ratings						
Capacity	Cooling	Btu/h	25,200 (9,500-25,200)		29,800 (9,500-29,800)	
	Heating	Btu/h	---		---	
Moisture Removal	High	Pints/H	8.1		9.7	
Dry Air Flow	Hi / Med / Low	CFM	559 / 475 / 390		840 / 740 / 620	
SEER	Cooling		14.9		15.0	
EER	Cooling		8.9		8.10	
HSPF	Heating		---		---	
Power Supply		V, Phase, Hz	230 / 208V, 1PH, 60Hz		230 / 208V, 1PH, 60Hz	
Running Amps	Cooling	A	15.3 / 16.9		17.7 / 19.6	
	Heating	A	---		---	
Power Input	Cooling	W	2,840 / 2,840		3,690 / 3,690	
	Heating	W	---		---	
Back-up Heater		kW	---		---	
Fuse or Circuit Breaker Capacity		A	15	30	15	35
Features						
Controls	Microprocessor		Microprocessor		Microprocessor	
Low Ambient Control	Built-in 0°F		Built-in 0°F		Built-in 0°F	
Wireless Remote Controller	RCS-SH1UA (included)		RCS-SH1UA (included)		RCS-SH1UA (included)	
Wired Remote Controller	RCS-TM80BG (optional)		RCS-TM80BG (optional)		RCS-TM80BG (optional)	
Fan Speeds	3 and Automatic Control / Variable		3 and Automatic Control / Variable		3 and Automatic Control / Variable	
Timer	Option		Option		Option	
Air Deflection	Horizontal		---		---	
	Vertical		Automatic		Automatic	
Air Filter	Washable		Washable		Washable	
Refrigerant	R-410A		R-410A		R-410A	
Refrigerant control	Electric Expansion Valve		Electric Expansion Valve		Electric Expansion Valve	
Operation Sound	In(Hi / Me / Lo)	dB-A	48 / 42 / 38		48 / 44 / 40	
	Outdoor(Hi)	dB-A	49		52	
Refrigerant Piping	Type		Flare Type		Flare Type	
	Discharge	inches	3/8" Discharge		3/8" Discharge	
	Suction	inches	5/8" Suction		5/8" Suction	
Refrigerant Pipe Length		Ft.	Max. 165Ft		Max. 165Ft	
Elevation Difference**	Outdoor Above	Ft.	Max. 100Ft		Max. 100Ft	
	Outdoor Below	Ft.	Max. 50Ft		Max. 50Ft	
Dimensions & Weight						
Height		inches	Indoor Unit	Outdoor Unit	Indoor Unit	Outdoor Unit
Width		inches	12-63/64"	30-23/32"	14-9/16"	30-23/32"
Depth		inches	44-7/8"	37"	59-1/16"	37"
Net Weight		Lbs.	8-31/32"	13-3/8"	9-7/16"	13-3/8"
			40.0	128.0	63.9	143.0

** This is maximum elevation difference when the indoor unit is located above the outdoor unit. (Refer to the table on the back of the catalogue for more detail.)

Wall-Mounted Air Conditioners



Outdoor Unit
C3082
C3682

30KS82
36KS82

Indoor Unit
KS3082
KS3682

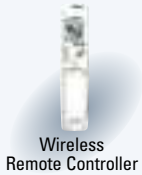

Wall Mounted Air Conditioners					
Model No.		30KS82		36KS82	
Unit Model No.		Indoor Unit KS3082	Outdoor Unit C3082	Indoor Unit KS3682	Outdoor Unit C3682
Performance & Electrical Ratings					
Capacity	Cooling	30,600 (10,900-30,600)		34,000 (10,900-34,000)	
	Heating	---		---	
Moisture Removal	High	9.57		10.64	
Dry Air Flow	Hi / Med / Low	700 / 900 / 1070		700 / 900 / 1070	
SEER	Cooling	16		16	
EER	Cooling	9.3		8.5	
HSPF	Heating	---		---	
Power Supply	V, Phase, Hz	230/208V, 1PH, 60Hz		230/208V, 1PH, 60Hz	
Running Amps	Cooling	16.5 (5 - 16.5)		20 (5 - 20)	
	Heating	---		---	
Power Input	Cooling	3,290		4,000	
	Heating	---		---	
Back-up Heater		kW		---	
Fuse or Circuit Breaker	Capacity	A		45	
Features					
Controls		Microprocessor		Microprocessor	
Low Ambient Control		Built in 0°F		Built in 0°F	
Wireless Controller		Included		Included	
Wired Remote Control (optional)		STK-RCS-7TWSUA & STK-KCW2		STK-RCS-7TWSUA & STK-KCW2	
Fan Speeds		Hi / Me / Lo & Auto		Hi / Me / Lo & Auto	
Timer		1hr & 24hr		1hr & 24hr	
Air Deflection		Horizontal		Manual	
		Vertical		Automatic	
Air Filter		Washable + Apatite		Washable + Apatite	
Refrigerant		R-410A		R-410A	
Refrigerant control		Electric Expansion Valve		Electric Expansion Valve	
Operation Sound	In(Hi / Me / Lo/ Qt) dB-A	49 / 44 / 39		49 / 44 / 39	
	Outdoor(Hi) dB-A	55		55	
Refrigerant Piping	Type	Flare Type		Flare Type	
	Discharge	inches		3/8"	
	Suction	inches		5/8"	
Refrigerant Pipe Length		Ft.		Max. 164Ft	
Elevation Difference**	Outdoor Above	Ft.		Max. 100Ft	
	Outdoor Below	Ft.		Max. 50Ft	
Dimensions & Weight					
Height	inches	Indoor Unit	Outdoor Unit	Indoor Unit	Outdoor Unit
Width	inches	11-3/16"	35-13/16"	11-3/16"	35-13/16"
Depth	inches	41-15/16"	37-1/32"	41-15/16"	37-1/32"
Net Weight	Lbs.	9-1/16"	13-3/8"	9-1/16"	13-3/8"
		32	183	32	183

** This is maximum elevation difference when the indoor unit is located above the outdoor unit. (Refer to the table on the back of the catalogue for more detail.)



Wall-Mounted Heat Pumps



Indoor Unit
KHS0971
KHS1271



Outdoor Unit
CH0971
CH1271



09KHS71 ← Qualifies for Tax Credit
12KHS71



Indoor Unit
KHS1872
KHS2472



Outdoor Unit
CH1872
CH2472



WASHABLE FRONT GRILLE

18KHS72
24KHS72



Above models do not have back up heater

Wall Mounted Heat Pump

Model No.	09KHS71		12KHS71		18KHS72		24KHS72	
	Indoor Unit KHS0971	Outdoor Unit CH0971	Indoor Unit KHS1271	Outdoor Unit CH1271	Indoor Unit KHS1872	Outdoor Unit CH1872	Indoor Unit KHS2472	Outdoor Unit CH2472
Performance & Electrical Ratings								
Capacity	Cooling	Btu/h	9,000 (3,000-9,000)	11,900 (3,000-11,900)	17,500 (4,000-17,500)	24,200 (4,000-24,200)		
	Heating	Btu/h	12,200 (3,000-12,200)	13,300 (3,000-13,300)	20,400 (4,400-20,400)	29,000 (4,400-29,000)		
Moisture Removal	High	Pints/H	3.4	4.26	4.89	4.89		
Dry Air Flow	Hi / Med / Low	CFM	200 / 247 / 282	212 / 259 / 294	417 / 479 / 524	482 / 541 / 600		
SEER	Cooling		16	17	20	17		
EER	Cooling		12.5	10.9	11.7	10.3		
HSPF	Heating		8.5	9.3	10	8.5		
Power Supply	V, Phase, Hz		115V, 1PH, 60Hz	115V, 1PH, 60Hz	230V / 208V, 1PH, 60Hz	230V / 208V, 1PH, 60Hz		
Running Amps	Cooling	A	7.6 (2.5-7.6)	10.9 (2.5-10.9)	7 / 7.7 (1.2-7.7)	10.8/12.1 (1.3-12.1)		
	Heating	A	10.3 (2.6-10.3)	11.7 (2.5-11.7)	7.4 / 8.1 (1.3-8.1)	12/13.5 (1.3-13.5)		
Power Input	Cooling	W	755 (250-755)	1,090 (250-1090)	1,500 / 1,500 (250-1500)	2,355 / 2,355 (280-2355)		
	Heating	W	995 (250-995)	1,165 (250-1165)	1,575 / 1,575 (270-1575)	2,490 / 2,490 (290-2490)		
Back-up Heater	kW		---	---	---	---		
Fuse or Circuit Breaker Capacity	A		20	20	20	20		
Features								
Controls	Microprocessor		Microprocessor		Microprocessor		Microprocessor	
Low Ambient Control	Built-in 0°F		Built-in 0°F		Built-in 0°F		Built-in 0°F	
Wireless Remote Controller	Included		Included		Included		Included	
Wired Remote Control	STK-RCS-7TWSUA & STK-KCWI (optional)		STK-RCS-7TWSUA & STK-KCWI (optional)		STK-RCS-7TWSUA & STK-KCWI (optional)		STK-RCS-7TWSUA & STK-KCWI (optional)	
Fan Speeds	Hi / Me / Lo & Auto		Hi / Me / Lo & Auto		Hi / Me / Lo & Auto		Hi / Me / Lo & Auto	
Timer	1hr OFF and 24-hr PROGRAM		1hr OFF and 24-hr PROGRAM		1hr OFF and 24-hr PROGRAM		1hr OFF and 24-hr PROGRAM	
Air Deflection	Horizontal	Manual	Manual	Manual	Manual	Manual	Manual	Manual
	Vertical	Automatic	Automatic	Automatic	Automatic	Automatic	Automatic	Automatic
Air Filter	Washable		Washable		Washable		Washable	
Refrigerant	R-410A		R-410A		R-410A		R-410A	
Refrigerant control	Electric Expansion Valve		Electric Expansion Valve		Electric Expansion Valve		Electric Expansion Valve	
Operation Sound	In(Hi / Me / Lo / Qt)	dB-A	34 / 31 / 28 / 23	36 / 33 / 29 / 25	42 / 38 / 30 / 28	47 / 44 / 41 / 30		
	Outdoor(Hi)	dB-A	46	47	51	52	55	56
Refrigerant Piping	Type	Flare Type	Flare Type	Flare Type	Flare Type	Flare Type	Flare Type	Flare Type
	Discharge	inches	1/4" Discharge	1/4" Discharge	1/4" Discharge	1/4" Discharge	1/4" Discharge	1/4" Discharge
	Suction	inches	3/8" Suction	3/8" Suction	1/2" Suction	5/8" Suction		
Refrigerant Pipe Length	Ft.		Max. 50Ft	Max. 65Ft	Max. 98Ft	Max. 98Ft		
Elevation Difference**	Outdoor Above	Ft.	Max. 23Ft	Max. 23Ft	Max. 50Ft	Max. 50Ft		
	Outdoor Below	Ft.	Max. 23Ft	Max. 23Ft	Max. 50Ft	Max. 50Ft		
Dimensions & Weight								
Height	inches		Indoor Unit 11-7/32" Outdoor Unit 21-9/16"	Indoor Unit 11-7/32" Outdoor Unit 21-9/16"	Indoor Unit 11-23/32" Outdoor Unit 26-3/8"	Indoor Unit 11-23/32" Outdoor Unit 29-1/8"		
Width	inches		32-15/32" 28-11/32"	32-15/32" 28-11/32"	41-15/16" 34-21/32"	41-15/16" 35-7/16"		
Depth	inches		7-7/16" 10-7/16"	7-7/16" 10-7/16"	8-19/32" 11-7/32"	8-19/32" 12-19/32"		
Net Weight	Lbs.		19.8 75.0	19.8 77.2	26.5 97.0	26.5 130.1		

** This is maximum elevation difference when the indoor unit is located above the outdoor unit. (Refer to the table on the back of the catalogue)



Wall-Mounted Heat Pumps



26KHS72R

**Indoor Unit
KHS2672R**



**Outdoor Unit
CH2672R**



26KHHS72R

**Indoor Unit
KHHS2672R**

"While Supplies Last"



**Outdoor Unit
CH2672R**



30KHS72R

36KHS72R

**Indoor Unit
KHS3072R
KHS3672R**

"While Supplies Last"



**Outdoor Unit
CH3072R
CH3672R**



Model No.	Wall Mounted Heat Pump W/ Heater				Wall Mounted Heat Pump			
	26KHHS72R		26KHS72R		30KHS72R		36KHS72R	
Unit Model No.	Indoor Unit KHS2672R	Outdoor Unit CH2672R	Indoor Unit KHS2672R	Outdoor Unit CH2672R	Indoor Unit KHS3072R	Outdoor Unit CH3072R	Indoor Unit KHS3672R	Outdoor Unit CH3672R
Performance & Electrical Ratings								
Capacity	Cooling	Btu/h	23,000 (9,500-23,000)	25,200 (9,500-25,200)	29,800 (9,500-29,800)	31,400 (9,500-31,400)	34,800 (8,000-34,800)	36,400 (8,000-36,400)
	Heating	Btu/h	27,600 (8,000-27,600)	29,200 (8,000-29,200)	34,800 (8,000-34,800)	36,400 (8,000-36,400)	34,800 (8,000-34,800)	36,400 (8,000-36,400)
Moisture Removal	High	Pints/H	7.4	8.1	9.7	10.0	10.0	10.0
Dry Air Flow	Hi / Med / Low	CFM	540 / 460 / 380	559 / 475 / 390	840 / 740 / 620	830 / 710 / 590	830 / 710 / 590	830 / 710 / 590
SEER	Cooling		15.9	14.9	15.0	15.0	15.9	15.9
HSPF	Heating		10.3	10.2	9.0	9.0	9.0	9.0
COP	Heating							
Power Supply		V, Phase, Hz	230V / 208V		230V / 208V		230V / 208V	
Running Amps	Cooling	A	14.0 / 15.5	15.3 / 16.9	17.7 / 19.6	17.9 / 19.8	17.9 / 19.8	17.9 / 19.8
	Heating	A	14.6 / 16.1	14.0 / 15.5	16.2 / 17.9	15.9 / 17.6	15.9 / 17.6	15.9 / 17.6
Power Input	Cooling	W	2,610 / 2,610	2,840 / 2,840	3,690 / 3,690	3,750 / 3,750	3,690 / 3,690	3,750 / 3,750
	Heating	W	2,720 / 2,720	2,620 / 2,620	3,390 / 3,390	3,320 / 3,320	3,390 / 3,390	3,320 / 3,320
Back-up Heater		kW	1.8 / 1.47					
Fuse or Circuit Breaker Capacity		A	15	30	15	35	15	35
Features								
Controls			Microprocessor	Microprocessor	Microprocessor	Microprocessor	Microprocessor	Microprocessor
Low Ambient Control			Built-in 0°F	Built-in 0°F	Built-in 0°F	Built-in 0°F	Built-in 0°F	Built-in 0°F
Wireless Remote Controller			RCS-SHIUA (included)	RCS-SHIUA (included)	RCS-SHIUA (included)	RCS-SHIUA (included)	RCS-SHIUA (included)	RCS-SHIUA (included)
Wired Remote Controller			RCS-TM80BG (optional)	RCS-TM80BG (optional)	RCS-TM80BG (optional)	RCS-TM80BG (optional)	RCS-TM80BG (optional)	RCS-TM80BG (optional)
Fan Speeds			3 and Automatic Control / Variable	3 and Automatic Control / Variable	3 and Automatic Control / Variable	3 and Automatic Control / Variable	3 and Automatic Control / Variable	3 and Automatic Control / Variable
Timer			24hr/72hr	24hr/72hr	24hr/72hr	24hr/72hr	24hr/72hr	24hr/72hr
Air Deflection	Horizontal		---	---	---	---	---	---
	Vertical		---	---	---	---	---	---
Air Filter			Automatic Washable	Automatic Washable	Automatic Washable	Automatic Washable	Automatic Washable	Automatic Washable
Refrigerant			R-410A	R-410A	R-410A	R-410A	R-410A	R-410A
Refrigerant control			Electric Expansion Valve	Electric Expansion Valve	Electric Expansion Valve	Electric Expansion Valve	Electric Expansion Valve	Electric Expansion Valve
Operation Sound	In(Hi / Me / Lo)	dB-A	45 / 42 / 40	41 / 37 / 34	46 / 42 / 38	48 / 44 / 40	46 / 42 / 38	48 / 44 / 40
	Outdoor(Hi)	dB-A	49	49	52	52	49	49
Refrigerant Piping	Type		Flare Type	Flare Type	Flare Type	Flare Type	Flare Type	Flare Type
	Discharge	inches	3/8" Discharge	3/8" Discharge	3/8" Discharge	3/8" Discharge	3/8" Discharge	3/8" Discharge
	Suction	inches	5/8" Suction	5/8" Suction	5/8" Suction	5/8" Suction	5/8" Suction	5/8" Suction
Refrigerant Pipe Length		Ft.	Max. 165Ft	Max. 165Ft	Max. 165Ft	Max. 165Ft	Max. 165Ft	Max. 165Ft
Elevation Difference**	Outdoor Above	Ft.	Max. 100Ft	Max. 100Ft	Max. 100Ft	Max. 100Ft	Max. 100Ft	Max. 100Ft
	Outdoor Below	Ft.	Max. 50Ft	Max. 50Ft	Max. 50Ft	Max. 50Ft	Max. 50Ft	Max. 50Ft
Dimensions & Weight								
Height		inches	14-9/16"	30-23/32"	14-9/16"	30-23/32"	14-9/16"	30-23/32"
Width		inches	49-7/32"	37"	44-7/8"	37"	59-1/16"	37"
Depth		inches	8-9/32"	13-3/8"	8-31/32"	13-3/8"	9-7/16"	13-3/8"
Net Weight		Lbs.	44.1	128.0	40.0	128.0	63.9	143.0

** This is maximum elevation difference when the indoor unit is located above the outdoor unit. (Refer to the table on the back of the catalogue)

Wall-Mounted Heat Pumps



Outdoor Unit
CH3082
CH3682

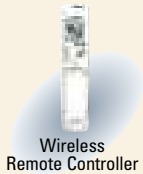

30KHS82 Indoor Unit
KHS3082
36KHS82 Indoor Unit
KHS3682



WASHABLE FRONT GRILLE



Wall Mounted Heat Pumps					
Model No.	30KHS82			36KHS82	
	Unit Model No.	Indoor Unit KHS3082	Outdoor Unit CH3082	Indoor Unit KHS3682	Outdoor Unit CH3682
Performance & Electrical Ratings					
Capacity	Cooling	30,600 (10,900-30,600)		34,000 (10,900-34,000)	
	Heating	33,000 (14,000-33,000)		36,000 (14,000-36,000)	
Moisture Removal	High	9.57		10.64	
Dry Air Flow	Hi / Med / Low	700 / 900 / 1070		700 / 900 / 1070	
SEER	Cooling	16		16	
EER	Cooling	9.3		8.5	
HSPF	Heating	9		9	
Power Supply	V, Phase, Hz	230/208V, 1PH, 60Hz		230/208V, 1PH, 60Hz	
Running Amps	Cooling	16.5 (5 ~ 16.5)		20 (5 ~ 20)	
	Heating	15.3 (4.5 ~ 15.3)		18.2 (4.5 ~ 18.2)	
Power Input	Cooling	3,290		4,000	
	Heating	3,070		3,650	
Back-up Heater		---		---	
Fuse or Circuit Breaker	Capacity	35		45	
Features					
Controls		Microprocessor		Microprocessor	
Low Ambient Control		Built in 0°F		Built in 0°F	
Wireless Controller		Included		Included	
Wired Remote Control	(optional)	STK-RCS-7TWSUA & STK-KCW2		STK-RCS-7TWSUA & STK-KCW2	
Fan Speeds		Hi / Me / Lo & Auto		Hi / Me / Lo & Auto	
Timer		1hr & 24hr		1hr & 24hr	
Air Deflection	Horizontal	Manual		Manual	
	Vertical	Automatic		Automatic	
Air Filter		Washable + Apatite		Washable + Apatite	
Refrigerant		R-410A		R-410A	
Refrigerant control		Electric Expansion Valve		Electric Expansion Valve	
Operation Sound	In(Hi / Me / Lo/ Qt) dB-A	49 / 44 / 39		49 / 44 / 39	
	Outdoor(Hi) dB-A	55		55	
Refrigerant Piping	Type	Flare Type		Flare Type	
	Discharge	3/8"		3/8"	
	Suction	5/8"		5/8"	
Refrigerant Pipe Length	Ft.	Max. 164Ft		Max. 164Ft	
Elevation Difference**	Outdoor Above	Max. 100Ft		Max. 100Ft	
	Outdoor Below	Max. 50Ft		Max. 50Ft	
Dimensions & Weight					
Height	inches	Indoor Unit 11-3/16"	Outdoor Unit 35-13/16"	Indoor Unit 11-3/16"	Outdoor Unit 35-13/16"
Width	inches	41-15/16"	37-1/32"	41-15/16"	37-1/32"
Depth	inches	9-1/16"	13-3/8"	9-1/16"	13-3/8"
Net Weight	Lbs.	32	183	32	183

** This is maximum elevation difference when the indoor unit is located above the outdoor unit. (Refer to the table on the back of the catalogue for more detail.)

Flexi-Multi System Indoor Units

Fits with Various Sizes of Room and Life Style

The multi-system type allows a single outdoor unit to be connected to 2 to 4 indoor units. It also solves the problem of limited installation space and does not clutter the exterior of your home.



Optional Wired controller
STK-RCS-7TWSUA
& STK-KCWI



Wireless Remote Controller
"Included" with each indoor



KMS0772 / KMS0972 / KMS1272 / KMS1872 / KMS2472

KMHS0772 / KMHS0972 / KMHS1272 / KMHS1872 / KMHS2472

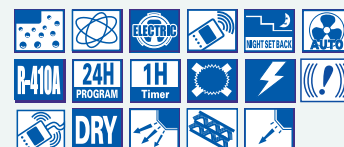

Indoor Unit: Wall Mounted Type

Cooling Only						
Model No.		KMS0772	KMS0972	KMS1272	KMS1872	KMS2472
Power Source		230V / 208V, 1 PH, 60 Hz				
Running Ampere	A	0.11	0.15	0.15	0.15	0.20
Power Input	W	25	35	35	35	45
Capacity	Cooling Btu/h	7,500	9,000	11,900	17,500	24,200
Moisture Removal High Prints/H		2.77	3.40	4.26	4.89	4.89
Unit Dimensions (HxWxD)	inch	11"-7/32" x 32"-15/32" x 7"-7/16"			11"-23/32" x 41"-15/16" x 8"-19/32"	
Net Weight	Lbs	19.8	19.8	19.8	26.5	26.5
Air Circulation (High)	Cooling CFM	241	259	282	500	541
Operating Sound (H/L)	Cooling dB-A	33 / 23	34 / 23	36 / 25	41 / 28	44 / 30
	Heating dB-A	-	-	-	-	-
Refrigerant	Narrow Tube inch	1/4"	1/4"	1/4"	1/4"	1/4"
Tube Diameter	Wide Tube inch	3/8"	3/8"	3/8"	1/2"	5/8"
Elevation Difference**	Outdoor Above Ft.	Max 50Ft	Max 50Ft	Max 50Ft	Max 50Ft	Max 50Ft
	Outdoor Below Ft.	Max 50Ft	Max 50Ft	Max 50Ft	Max 50Ft	Max 50Ft

Heat Pump						
Model No.		KMHS0772	KMHS0972	KMHS1272	KMHS1872	KMHS2472
Power Source		230V-208V, 1 PH, 60 Hz				
Running Ampere		0.11	0.15	0.15	0.15	0.20
Power Input		25	35	35	35	45
Capacity	Cooling Btu/h	7,500	9,000	11,900	17,500	24,200
	Heating Btu/h	8,500	12,200	14,300	20,400	29,000
Moisture Removal High Prints/H		2.77	3.40	4.26	4.89	4.89
Unit Dimensions (HxWxD)	inch	11"-7/32" x 32"-15/32" x 7"-7/16"			11"-23/32" x 41"-15/16" x 8"-19/32"	
Net Weight	Lbs	19.8	19.8	19.8	26.5	26.5
Air Circulation (HIGH)	Cooling CFM	241	259	282	500	541
	Heating CFM	271	282	294	500	541
Hi / Me / Lo / Qt	Cooling dB-A	33 / 30 / 27 / 23	34 / 31 / 28 / 23	36 / 33 / 29 / 25	41 / 38 / 34 / 28	44 / 41 / 38 / 30
Operating Sound	Heating dB-A	33 / 30 / 27 / 23	34 / 31 / 28 / 23	34 / 31 / 29 / 25	40 / 37 / 34 / 28	43 / 40 / 37 / 30
Refrigerant	Narrow Tube inch	1/4"	1/4"	1/4"	1/4"	1/4"
Tube Diameter	Wide Tube inch	3/8"	3/8"	3/8"	1/2"	5/8"
Elevation Difference**	Outdoor Above Ft.	Max 50Ft	Max 50Ft	Max 50Ft	Max 50Ft	Max 50Ft
	Outdoor Below Ft.	Max 50Ft	Max 50Ft	Max 50Ft	Max 50Ft	Max 50Ft

** This is maximum elevation difference when the indoor unit is located above the outdoor unit. (Refer to the table on the back of the catalogue)



Flexi-Multi System Indoor Units

Fits with Various Sizes of Room and Life Style

The multi-system type allows a single outdoor unit to be connected to 2 to 4 indoor units. It also solves the problem of limited installation space and does not clutter the exterior of your home.

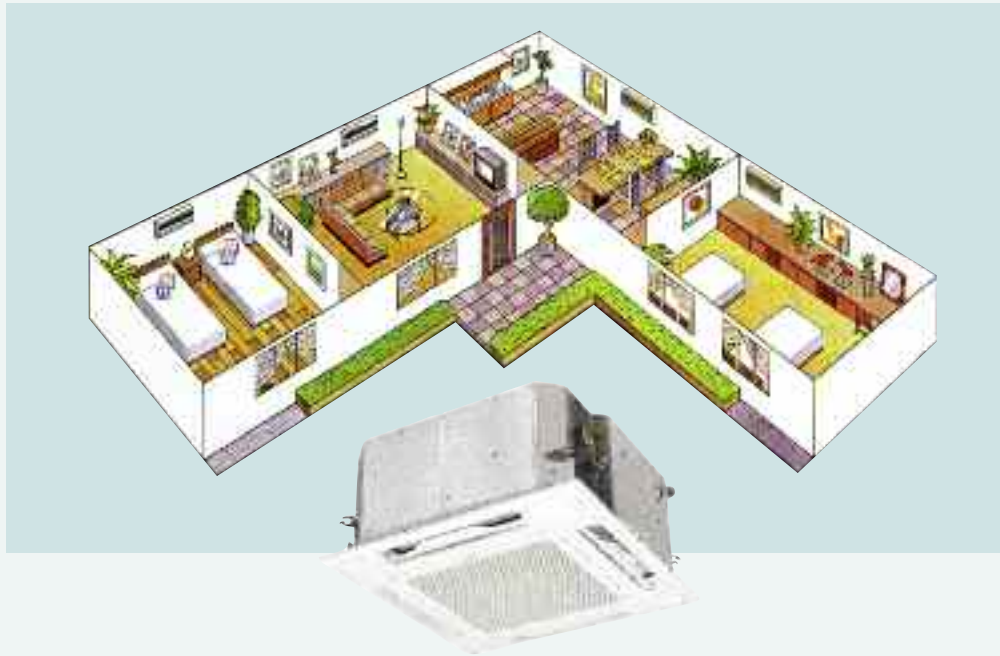

Optional Wired controller
STK-RCS-7TWSUA
& STK-KCWI



Wireless Remote Controller
"Included" with each indoor

XMS0972 / XMS1272 / XS1872
XMHS0972 / XMHS1272 / XHS1872

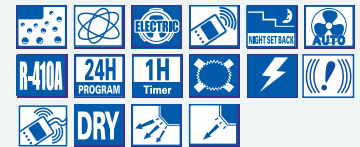

Indoor Unit: Wall Mounted Type

Cooling Only					
Model No.	XMS0972		XMS1272		XS1872
Grille Assembly	PNR-XS1872				
Power Source	230V / 208V, 1 PH, 60 Hz				
Running Ampere	A	0.1	0.11	0.15	
Power Input	W	16	17	22	
Capacity	Cooling	Btu/h	9,000	11,900	17,500
Moisture Removal High Prints/H			3.4	4.26	4.89
Unit Dimensions (HxWxD)	inch	12"-5/16" x 24"-19/32" x 24"-19/32"			
Net Weight	Lbs	41.3			
Air Circulation (High)	Cooling	CFM	221	235	341
Operating Sound (H/L)	Cooling	dB-A	33	34	44
	Heating	dB-A	-		
Refrigerant	Narrow Tube	inch	1/4"	1/4"	1/4"
Tube Diameter	Wide Tube	inch	3/8"	3/8"	1/2"
Elevation Difference**	Outdoor Above	Ft.	Max 50Ft	Max 50Ft	Max 50Ft
	Outdoor Below	Ft.	Max 50Ft	Max 50Ft	Max 50Ft

Heat Pump					
Model No.	XMHS0972		XMHS1272		XHS1872
Grille Assembly	PNR-XS1872				
Power Source	230V / 208V, 1 PH, 60 Hz				
Running Ampere	A	0.1	0.11	0.15	
Power Input	W	16	17	22	
Capacity	Cooling	Btu/h	9,000	11,900	17,500
Capacity	Heating	Btu/h	12,300	13,600	20,400
Moisture Removal High Prints/H			3.4	4.26	4.89
Unit Dimensions (HxWxD)	inch	12"-5/16" x 24"-19/32" x 24"-19/32"			
Net Weight	Lbs	41.3			
Air Circulation (High)	Cooling	CFM	221	235	
Operating Sound (H/L)	Heating	CFM	247	268	341
	Cooling	dB-A	33	34	44
Operating Sound (H/L)	Heating	dB-A	34	35	44
	Heating	dB-A	34	35	44
Refrigerant	Narrow Tube	inch	1/4"	1/4"	1/4"
Tube Diameter	Wide Tube	inch	3/8"	3/8"	1/2"
Elevation Difference**	Outdoor Above	Ft.	Max 50Ft	Max 50Ft	Max 50Ft
	Outdoor Below	Ft.	Max 50Ft	Max 50Ft	Max 50Ft

** This is maximum elevation difference when the indoor unit is located above the outdoor unit. (Refer to the table on the back of the catalogue)

Flexi-Multi System Outdoor Units



Connectable from 2 to 3 Indoor Units



Up to **3** Rooms



CM1972A



CMH1972A

Qualifies for Tax Credit

Model No.	Outdoor Unit	CM1972A	CMH1972A	
Performance		Cooling	Cooling	Heating
Capacity	Btu/h	19,700	19,100	24,800
Air Circulation	High CFM	1,707	1,707	1,707
Number of Connectable Indoor Units		2 - 3	2 - 3	2 - 3
SEER	Cooling	16.5	16.4	16.4
EER	Cooling	12.5	12.7	12.7
HSPF	Heating	-	8.8	8.8
Electrical Rating				
Power Supply	V, Phase, Hz	230V / 208V, 1Ph, 60Hz	230V / 208V, 1Ph, 60Hz	
Running Ampere	A	7.0 / 7.7	7.4	8.5
Power Input	W	1,570 / 1,570	1,500	1,735
Maximum Fuse Size	Amps	20A	20A	
Features				
Controls		Microprocessor	Microprocessor	
Fan Speeds		Auto (Hi, Me, Lo)	Auto (Hi, Me, Lo)	
Compressor		DC Inverter	DC Inverter	
Refrigerant / Amount Charged at Shipment	1b	R410A / 6.17	R410A / 6.17	
Refrigerant Control		Electric Expansion Valve	Electric Expansion Valve	
Operation Sound	Hi dB-A	50	50	52
Refrigerant Tubing Connections		Flare Type	Flare Type	
Max. Allowable Tubing Length	Ft	82 (per Unit) 150 (per System)	82 (per Unit) 150 (per System)	
Refrigerant Tube Diameter	Narrow Tube inch	1/4" x 3	1/4" x 3	
	Wide Tube inch	3/8" x 3	3/8" x 3	
Dimensions & Weight				
Unit Dimensions	H x W x D inch	29-1/8" x 35-7/16" x 12-19/32"	29-1/8" x 35-7/16" x 12-19/32"	
Net Weight	Lbs	138.9	143.3	

IMPORTANT

It is not possible to connect an outdoor unit to only a single indoor unit. If operated with only ONE indoor unit installed, the returning refrigerant to the compressor may cause a malfunction.



Flexi-Multi System Outdoor Units

Connectable from 2 to 4 Indoor Units



Up to **4** Rooms



CM2472A



CMH2472A

Model No.	Outdoor Unit	CM2472A		CMH2472A	
		Cooling		Cooling	Heating
Capacity	Btu/h	25,400		23,200	29,200
Air Circulation	High	1,707		1,707	
Number of Connectable Indoor Units		2 ~ 4		2 ~ 4	
SEER	Cooling	16.2		16.5	
EER	Cooling	9.9		11.4	
HSPF	Heating	-		8.4	
Electrical Rating					
Power Supply	V, Phase, Hz	230V / 208V, 1Ph, 60Hz		230V / 208V, 1Ph, 60Hz	
Running Ampere	A	11.3 / 12.5		9.0 / 100	10.1 / 11.1
Power Input	W	2,560 / 2,560		2,040 / 2,040	2,270 / 2,270
Maximum Fuse Size	Amps	20A		20A	
Features					
Controls		Microprocessor		Microprocessor	
Fan Speeds		Auto (Hi, Me, Lo)		Auto (Hi, Me, Lo)	
Compressor		DC Inverter		DC Inverter	
Refrigerant/Amount Charged at Shipment	g	R410A / 6.17		R410A / 6.17	
Refrigerant Control		Electric Expansion Valve		Electric Expansion Valve	
Operation Sound	Hi	50		50	52
Refrigerant Tubing Connections		Flare Type		Flare Type	
Max. Allowable Tubing Length	Ft	82 (per Unit) 200 (per System with additional Refrigerant)		82 (per Unit) 200 (per System with additional Refrigerant)	
Refrigerant Tube Diameter	Narrow Tube	1/4" x 4		1/4" x 4	
	Wide Tube	3/8" x 3 + 1/2" x 1		3/8" x 3 + 1/2" x 1	
Dimensions & Weight					
Unit Dimensions	H x W x D	29-1/8" x 35-7/16" x 12-19/32"		29-1/8" x 35-7/16" x 12-19/32"	
Net Weight	Lbs	138.9		143.3	

IMPORTANT

It is not possible to connect an outdoor unit to only a single indoor unit. If operated with only ONE indoor unit installed, the returning refrigerant to the compressor may cause a malfunction.



Flexi-Multi System Outdoor Units

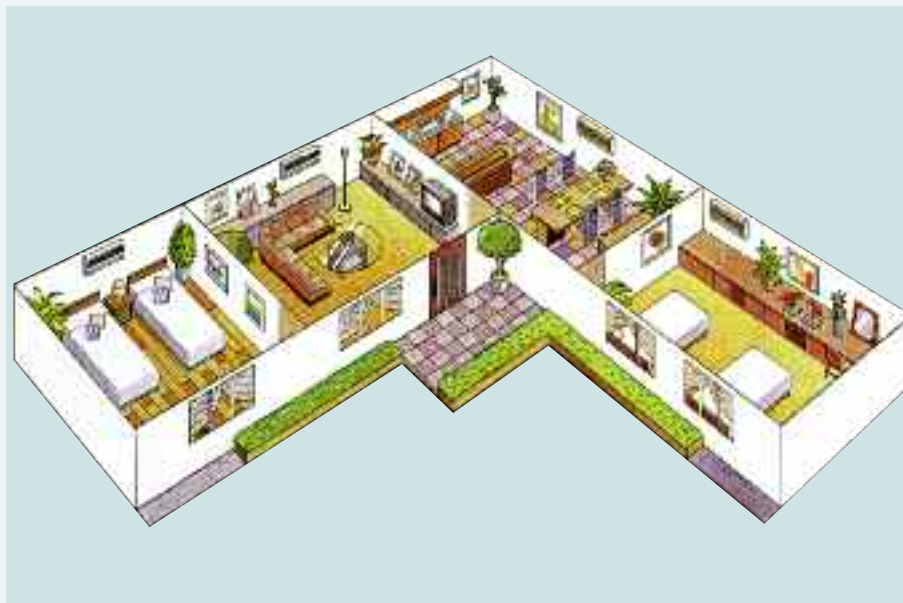

Connectable from 2 to 4 Indoor Units



Up to **4** Rooms



CM3172A



CMH3172A

Model No.	Outdoor Unit	CM3172A	CMH3172A	
Performance		Cooling	Cooling	Heating
Capacity	Btu/h	30,600	30,600 / 28,600	32,000
Air Circulation	High	1,942	1942	1807
Number of Connectable Indoor Units		2 ~ 4		2 ~ 4
SEER	Cooling	17.6		17.2
EER	Cooling	10.9		10.9
HSPF	Heating	-		9.3
Electrical Rating				
Power Supply	V, Phase, Hz	230V / 208V, 1Ph, 60Hz	230V / 208V, 1Ph, 60Hz	
Running Ampere	A	12.3 / 13.6	12.3 / 13.6	10.3 / 11.4
Power Input	W	2,800 / 2,800	2,800 / 2,800	2,350 / 2,350
Maximum Fuse Size	Amps	20A	20A	
Features				
Controls		Microprocessor	Microprocessor	
Fan Speeds		Auto (Hi, Me, Lo)	Auto (Hi, Me, Lo)	
Compressor		DC Inverter	DC Inverter	
Refrigerant/Amount Charged at Shipment	g	R410A / 8.38	R410A / 8.38	
Refrigerant Control		Electric Expansion Valve	Electric Expansion Valve	
Operation Sound	Hi	53	53	52
Refrigerant Tubing Connections		Flare Type	Flare Type	
Max. Allowable Tubing Length	Ft	100 (per Unit) 230 (per System with additional Refrigerant)	100 (per Unit) 230 (per System with additional Refrigerant)	
Refrigerant Tube Diameter	Narrow Tube	1/4" x 4	1/4" x 4	
	Wide Tube	3/8" x 2 + 1/2" x 2	3/8" x 2 + 1/2" x 2	
Dimensions & Weight				
Unit Dimensions	H x W x D	35-1/32" x 35-7/16" x 12-19/32"	35-1/32" x 35-7/16" x 12-19/32"	
Net Weight	Lbs	174.2	180.8	

IMPORTANT

It is not possible to connect an outdoor unit to only a single indoor unit. If operated with only ONE indoor unit installed, the returning refrigerant to the compressor may cause a malfunction.

Flexi-Multi Combination Tables-Cooling

Most popular combinations, refer to technical manual for complete listing of combinations.

	CMH1972A/CM1972A						Cooling									
	Room					Total Capacity	Room						Total Performance			
	A	B	C				A	B	C							
Dual Zone	7500	+	7500		=	15000	7500	100.0%	7500	100.0%				15,000	100.0%	
	7500	+	9000		=	16500	7485	99.8%	9015	100.2%				16,500	100.0%	
	7500	+	11900		=	19400	6716	89.5%	10684	89.8%				17,400	89.7%	
	9000	+	9000		=	18000	8500	94.4%	8500	94.4%				17,000	94.4%	
	9000	+	11900		=	20900	7627	84.7%	10073	84.6%				17,700	84.7%	
	11900	+	11900		=	23800	9200	77.3%	9200	77.3%				18,400	77.3%	
Tri Zone	7500	+	7500	+	7500	=	22500	6000	80.0%	6000	80.0%	6000	80.0%		18,000	80.0%
	7500	+	7500	+	9000	=	24000	5742	76.6%	5742	76.6%	6916	76.8%		18,400	76.7%

	CMH2472A/CM2472A						Cooling									
	Room					Total Capacity	Room						Total Performance			
	A	B	C				A	B	C							
Dual Zone	7500	+	7500		=	15000	7500	100.0%	7500	100.0%				15000	100.0%	
	7500	+	9000		=	16500	7485	99.8%	9015	100.2%				16500	100.0%	
	7500	+	11900		=	19400	7488	89.8%	11912	100.1%				19400	100.0%	
	7500	+	17500		=	25000	6705	89.4%	15695	89.7%				22400	89.6%	
	9000	+	9000		=	18000	9000	100.0%	9000	100.0%				18000	100.0%	
	9000	+	11900		=	20900	8618	95.8%	11382	95.6%				20000	95.7%	
	9000	+	17500		=	26500	7746	86.1%	15054	86.0%				22800	86.0%	
	11900	+	11900		=	23800	11200	94.1%	11200	94.1%				22400	94.1%	
	11900	+	17500		=	29400	9387	78.9%	13813	78.9%				23200	78.9%	
Tri Zone	7500	+	7500	+	7500	=	22500	7333	97.8%	7333	97.8%	7333	97.8%		22000	97.8%
	7500	+	7500	+	9000	=	24000	6990	93.2%	6990	93.2%	8420	93.6%		22400	93.3%
	7500	+	7500	+	11900	=	26900	6405	85.4%	6405	85.4%	10190	85.6%		23000	85.5%
	7500	+	9000	+	9000	=	25500	6688	89.2%	8056	89.5%	8056	89.5%		22800	89.4%
	7500	+	9000	+	11900	=	28400	6113	81.5%	7363	81.8%	9725	81.7%		23200	81.7%
	9000	+	9000	+	9000	=	27000	7733	85.9%	7733	85.9%	7733	85.9%		23200	85.9%

	CMH3172A/CM3172A						Cooling												
	Room					Total Capacity	Room						Total Performance						
	A	B	C	D			A	B	C	D									
Dual Zone	7500	+	7500			=	15000	7500	100.0%	7500	100.0%					15000	100.0%		
	7500	+	9000			=	16500	7500	100.0%	9000	100.0%					16500	100.0%		
	7500	+	11900			=	19400	7500	100.0%	11900	100.0%					19400	100.0%		
	7500	+	17500			=	25000	7320	97.6%	17080	97.6%					24400	97.6%		
	7500	+	24200			=	31700	6625	88.3%	21375	88.3%					28000	88.3%		
	9000	+	9000			=	18000	9000	100.0%	9000	100.0%					18000	100.0%		
	9000	+	11900			=	20900	8957	99.5%	11843	99.5%					20800	99.5%		
	9000	+	17500			=	26500	8626	95.8%	16774	95.9%					25400	95.8%		
	9000	+	24200			=	33200	7861	87.3%	21139	87.4%					29000	87.3%		
	11900	+	11900			=	23800	11900	100.0%	11900	100.0%					23800	100.0%		
	11900	+	17500			=	29400	10848	91.2%	15952	91.2%					26800	91.2%		
	11900	+	24200			=	36100	9625	80.9%	19575	80.9%					29200	80.9%		
	17500	+	17500			=	35000	14500	82.9%	14500	82.9%					29000	82.9%		
	Tri Zone	7500	+	7500	+	7500	=	22500	7467	99.6%	7467	99.6%	7467	99.6%			22400	99.6%	
7500		+	7500	+	9000	=	24000	7500	100.0%	7500	100.0%	9000	100.0%			24000	100.0%		
7500		+	7500	+	11900	=	26900	7082	94.4%	7082	94.4%	11236	94.4%			25400	94.4%		
7500		+	7500	+	17500	=	32500	6600	88.0%	6600	88.0%	15400	88.0%			28600	88.0%		
7500		+	9000	+	9000	=	25500	7294	97.3%	8753	97.3%	8753	97.3%			24800	97.3%		
7500		+	9000	+	11900	=	28400	6972	93.0%	8366	93.0%	11062	93.0%			26400	93.0%		
7500		+	9000	+	17500	=	34000	6309	84.1%	7571	84.1%	14721	84.1%			28600	84.1%		
7500		+	11900	+	11900	=	31300	6613	88.2%	10493	88.2%	10493	88.2%			27600	88.2%		
7500		+	11900	+	17500	=	36900	5935	79.1%	9417	79.1%	13848	79.1%			29200	79.1%		
9000		+	9000	+	9000	=	27000	8533	94.8%	8533	94.8%	8533	94.8%			25600	94.8%		
9000		+	9000	+	11900	=	29900	8187	91.0%	8187	91.0%	10825	91.0%			27200	91.0%		
9000		+	9000	+	17500	=	35500	7352	81.7%	7352	81.7%	14296	81.7%			29000	81.7%		
9000		+	11900	+	11900	=	32800	7848	87.2%	10376	87.2%	10376	87.2%			28600	87.2%		
11900		+	11900	+	11900	=	35700	9267	77.9%	9267	77.9%	9267	77.9%			27800	77.9%		
Quad Zone	7500	+	7500	+	7500	+	7500	=	30000	6800	90.7%	6800	90.7%	6800	90.7%	6800	90.7%	27200	90.7%
	7500	+	7500	+	7500	+	9000	=	31500	6667	88.9%	6667	88.9%	6667	88.9%	8000	88.9%	28000	88.9%
	7500	+	7500	+	7500	+	11900	=	34400	6235	83.1%	6235	83.1%	6235	83.1%	9894	83.1%	28600	83.1%
	7500	+	7500	+	9000	+	9000	=	33000	6409	85.5%	6409	85.5%	7691	85.5%	7691	85.5%	28200	85.5%
	7500	+	7500	+	9000	+	11900	=	35900	6058	80.8%	6058	80.8%	7270	80.8%	9613	80.8%	29000	80.8%
	7500	+	9000	+	9000	+	9000	=	34500	6217	82.9%	7461	82.9%	7461	82.9%	7461	82.9%	28600	82.9%
	7500	+	9000	+	9000	+	11900	=	37400	6136	81.8%	7364	81.8%	7364	81.8%	9736	81.8%	30600	81.8%
	9000	+	9000	+	9000	+	9000	=	36000	7650	85.0%	7650	85.0%	7650	85.0%	7650	85.0%	30600	85.0%

Flexi-Multi Combination Tables-Heating

Most popular combinations, refer to technical manual for complete listing of combinations.

	CMH1972A						Heating								
	Room					Total Capacity	Room						Total Performance		
	A	B	C				A	B	C						
Dual Zone	8500	+	8500		=	17000	8500	100.0%	8500	100.0%			17,000	100.0%	
	8500	+	12200		=	20700	8525	100.3%	12275	100.6%			20,800	100.5%	
	8500	+	14300		=	22800	8358	98.3%	14042	98.2%			22,400	98.2%	
	12200	+	12200		=	24400	11600	95.1%	11600	95.1%			23,200	95.1%	
	12200	+	14300		=	26500	10800	88.5%	12600	88.1%			23,400	88.3%	
	14300	+	14300		=	28600	11900	83.2%	11900	83.2%			23,800	83.2%	
Tri Zone	8500	+	8500	+	8500	=	25500	7800	91.8%	7800	91.8%	7800	91.8%	23,400	91.8%
	8500	+	8500	+	12200	=	29200	6919	81.4%	6919	81.4%	9963	81.7%	23,800	81.5%

	CMH2472A						Heating								
	Room					Total Capacity	Room						Total Performance		
	A	B	C				A	B	C						
Dual Zone	8500	+	8500		=	17000	8500	100.0%	8500	100.0%			17,000	100.0%	
	8500	+	12200		=	20700	8525	100.3%	12275	100.6%			20,800	100.5%	
	8500	+	14300		=	22800	8507	100.1%	14293	100.0%			22,800	100.0%	
	8500	+	20400		=	28900	8294	97.6%	19906	97.6%			28,200	97.6%	
	12200	+	12200		=	24400	12200	100.0%	12200	100.0%			24,400	100.0%	
	12200	+	14300		=	26500	11908	97.6%	13892	97.1%			25,800	97.4%	
	12200	+	20400		=	32600	10725	87.9%	17875	87.6%			28,600	87.7%	
	14300	+	14300		=	28600	13600	95.1%	13600	95.1%			27,200	95.1%	
	14300	+	20400		=	34700	11941	83.5%	17059	83.6%			29,000	83.6%	
Tri Zone	8500	+	8500	+	8500	=	25500	8467	99.6%	8467	99.6%	8467	99.6%	25,400	99.6%
	8500	+	8500	+	12200	=	29200	7907	93.0%	7907	93.0%	11386	93.3%	27,200	93.2%
	8500	+	8500	+	14300	=	31300	7663	90.2%	7663	90.2%	12874	90.0%	28,200	90.1%
	8500	+	12200	+	12200	=	32900	7371	86.7%	10614	87.0%	10614	87.0%	28,600	86.9%
	8500	+	12200	+	14300	=	35000	7039	82.8%	10136	83.1%	11825	82.7%	29,000	82.9%
	12200	+	12200	+	12200	=	36600	9733	79.8%	9733	79.8%	9733	79.8%	29,200	79.8%

	CMH3172A						Heating										
	Room					Total Capacity	Room						Total Performance				
	A	B	C	D	A		B	C	D								
Dual Zone	8500	+	8500		=	17000	8500	100.0%	8500	100.0%			17,000	100.0%			
	8500	+	12200		=	20700	8541	100.5%	12259	100.5%			20,800	100.5%			
	8500	+	14300		=	22800	8500	100.0%	14300	100.0%			22,800	100.0%			
	8500	+	20400		=	28900	8529	100.3%	20471	100.3%			29,000	100.3%			
	8500	+	29000		=	37500	6800	80.0%	23200	80.0%			30,000	80.0%			
	12200	+	12200		=	24400	12200	100.0%	12200	100.0%			24,400	100.0%			
	12200	+	14300		=	26500	11878	97.4%	13922	97.4%			25,800	97.4%			
	12200	+	20400		=	32600	11002	90.2%	18398	90.2%			29,400	90.2%			
	12200	+	29000		=	41200	9061	74.3%	21539	74.3%			30,600	74.3%			
	14300	+	14300		=	28600	13600	95.1%	13600	95.1%			27,200	95.1%			
	14300	+	20400		=	34700	12281	85.9%	17519	85.9%			29,800	85.9%			
	14300	+	29000		=	43300	10238	71.6%	20762	71.6%			31,000	71.6%			
	20400	+	20400		=	40800	15300	75.0%	15300	75.0%			30,600	75.0%			
	Tri Zone	8500	+	8500	+	8500	=	25500	8467	99.6%	8467	99.6%	8467	99.6%	25,400	99.6%	
		8500	+	8500	+	12200	=	29200	8442	99.3%	8442	99.3%	12116	99.3%	29,000	99.3%	
8500		+	8500	+	14300	=	31300	7930	93.3%	7930	93.3%	13341	93.3%	29,200	93.3%		
8500		+	8500	+	20400	=	37400	6818	80.2%	6818	80.2%	16364	80.2%	30,000	80.2%		
8500		+	12200	+	12200	=	32900	7596	89.4%	10902	89.4%	10902	89.4%	29,400	89.4%		
8500		+	12200	+	14300	=	35000	7237	85.1%	10387	85.1%	12175	85.1%	29,800	85.1%		
8500		+	12200	+	20400	=	41100	6328	74.4%	9083	74.5%	15188	74.5%	30,600	74.5%		
8500		+	14300	+	14300	=	37100	6873	80.9%	11563	80.9%	11563	80.9%	30,000	80.9%		
8500		+	14300	+	20400	=	43200	6100	71.8%	10262	71.8%	14639	71.8%	31,000	71.8%		
12200		+	12200	+	12200	=	36600	10000	82.0%	10000	82.0%	10000	82.0%	30,000	82.0%		
12200		+	12200	+	14300	=	38700	9520	78.0%	9520	78.0%	11159	78.0%	30,200	78.0%		
12200		+	12200	+	20400	=	44800	8496	69.6%	8496	69.6%	14207	69.6%	31,200	69.6%		
12200		+	14300	+	14300	=	40800	9150	75.0%	10725	75.0%	10725	75.0%	30,600	75.0%		
14300		+	14300	+	14300	=	42900	10333	72.3%	10333	72.3%	10333	72.3%	31,000	72.3%		
Quad Zone		8500	+	8500	+	8500	+	8500	=	34000	7400	87.1%	7400	87.1%	7400	87.1%	29,600
	8500	+	8500	+	8500	+	12200	=	37700	6764	79.6%	6764	79.6%	6764	79.6%	30,000	79.6%
	8500	+	8500	+	8500	+	14300	=	39800	6492	76.4%	6492	76.4%	6492	76.4%	30,400	76.4%
	8500	+	8500	+	12200	+	12200	=	41400	6324	74.4%	6324	74.4%	9076	74.4%	30,800	74.4%
	8500	+	8500	+	12200	+	14300	=	43500	6097	71.7%	6097	71.7%	8750	71.7%	31,200	71.7%
	8500	+	12200	+	12200	+	12200	=	45100	5880	69.2%	8440	69.2%	8440	69.2%	31,200	69.2%
	8500	+	12200	+	12200	+	14300	=	47200	5691	67.0%	8168	67.0%	8168	67.0%	31,600	66.9%
	12200	+	12200	+	12200	+	12200	=	48800	8000	65.6%	8000	65.6%	8000	65.6%	32,000	65.6%

Ceiling-Suspended Air Conditioners & Heat Pumps

Wired Remote Controller (RCS-TM808G) (Included)



26TW72R / 26THW72R

Indoor Unit THW2672R

Wired Remote Controller (RCS-TM808G) (Included)



36TW72R / 42TW72R

36THW72R / 42THW72R

Indoor Unit THW3672R THW4272R



Outdoor Unit C2672R CH2672R



Outdoor Unit C3672R CH3672R



Outdoor Unit C4272R CH4272R

Wired Remote Controller (RCS-TM808G) (Included)



26THHW72R

"While Supplies Last"

Indoor Unit THHW2672R

Wired Remote Controller (RCS-TM808G) (Included)



36THHW72R

"While Supplies Last"

Indoor Unit THHW3672R



Outdoor Unit CH3672R



Outdoor Unit CH2672R



Quiet Operation

The ceiling-mounted unit is equipped with a highly efficient, multi-blade centrifugal fan that generates a powerful yet gentle airflow throughout the room. A redesigned aerodynamically tested louver structure minimizes operational sound even at high fan speed.



Improved Serviceability / Easy Installation

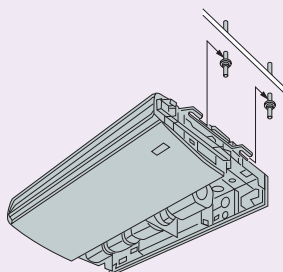

External suspension method. Installation time can be shortened.



Improved accessibility to electronic components (control box) for servicing.



Ceiling-Suspended Air Conditioners & Heat Pumps

Auto Louver Function Provides Optimum Airflow During Heating or Cooling Operation

Auto louver function is a standard feature which provide optimum airflow during heating or cooling operation. Angle of louver is automatically set for heating or cooling. For example, when heating with fan speed set to low, the discharge is aimed downward so that warm air reaches the floor. The louver angle can be set to between 4° above and 80° below the horizontal in five steps. An auto sweep function to distribute the airflow over a wide area is also provided. Wind direction is adjusted automatically in both heating and cooling operation. The louver can also be set to swing automatically from F1 to F5 in any operation mode (heat pump type only).

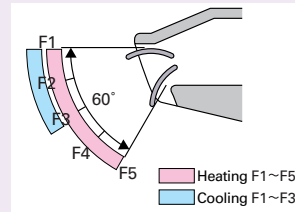

Fresh Air Intake Capability & Duct Extension

Ceiling Suspended models (T-series) have the capability of bringing fresh air from outside using an air intake duct (field supplied).

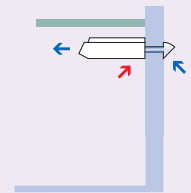

“While Supplies Last”

Ceiling - Suspended Air Conditioners				Ceiling - Suspended Heat Pumps w/ Heater				Ceiling - Suspended Heat Pumps				
Model No.	26TW72R		36TW72R		42TW72R		26THHW72R		36THHW72R		42THW72R	
Unit Model No.	Indoor Unit	Outdoor Unit	Indoor Unit	Outdoor Unit	Indoor Unit	Outdoor Unit	Indoor Unit	Outdoor Unit	Indoor Unit	Outdoor Unit	Indoor Unit	Outdoor Unit
	THW2672R	C2672R	THW3672R	C3672R	THW4272R	C4272R	THHW2672R	CH2672R	THHW3672R	CH3672R	THW4272R	CH4272R
Performance & Electrical Ratings												
Capacity	Cooling Btu/h	24,400 (9,500-24,400)	31,200 (9,500-31,200)	39,000 (9,500-39,000)	24,400 (9,500-24,400)	31,200 (9,500-31,200)	24,400 (9,500-24,400)	31,200 (9,500-31,200)	24,400 (9,500-24,400)	31,200 (9,500-31,200)	39,000 (9,500-39,000)	44,500 (8,000-44,500)
	Heating Btu/h	---	---	---	30,800 (8,000-30,800)	37,400 (8,000-37,400)	30,800 (8,000-30,800)	37,400 (8,000-37,400)	30,800 (8,000-30,800)	37,400 (8,000-37,400)	44,500 (8,000-44,500)	---
Moisture Removal	High Pints/H	7.7	10.0	12.6	7.7	0.0	7.7	0.0	7.7	10.0	12.6	---
Dry Air Flow	Hi / Med / Low CFM	550 / 490 / 460	1100 / 930 / 750	1130 / 950 / 775	550 / 490 / 460	1100 / 930 / 750	550 / 490 / 460	1100 / 930 / 750	550 / 490 / 460	1100 / 930 / 750	1130 / 950 / 775	---
SEER	Cooling	14.5	15.1	15.6	14.5	15.1	14.5	15.1	14.5	15.1	15.6	---
EER	Cooling	8.5	8.10	9.4	8.5	8.1	8.5	8.1	8.5	8.10	9.4	---
HSPF	Heating	---	---	---	9.4	8.8	9.4	8.8	9.4	8.8	9.5	---
Power Supply	V, Phase, Hz	230 / 208 / 1 / 60	230 / 208 / 1 / 60	230 / 208 / 1 / 60	230 / 208 / 1 / 60	230 / 208 / 1 / 60	230 / 208 / 1 / 60	230 / 208 / 1 / 60	230 / 208 / 1 / 60	230 / 208 / 1 / 60	230 / 208 / 1 / 60	230 / 208 / 1 / 60
Running Amps	Cooling A	15.6 / 17.3	18.2 / 20.1	21.1 / 23.3	5.6 / 17.3	18.2 / 20.1	15.6 / 17.3	18.2 / 20.1	15.6 / 17.3	18.2 / 20.1	21.1 / 23.3	---
	Heating A	---	---	---	16.4 / 18.1	15.6 / 17.3	16.4 / 18.1	15.6 / 17.3	16.4 / 18.1	15.6 / 17.3	18.6 / 20.6	---
Power Input	Cooling W	2,880 / 2,880	3,840 / 3,840	4,140 / 4,140	2,880 / 2,880	3,840 / 3,840	2,880 / 2,880	3,840 / 3,840	2,880 / 2,880	3,840 / 3,840	4,140 / 4,140	---
	Heating W	---	---	---	3,000 / 3,000	3,250 / 3,250	3,000 / 3,000	3,250 / 3,250	3,000 / 3,000	3,250 / 3,250	3,630 / 3,630	---
Back-up Heater	kW	---	---	---	1.8 / 1.47	2.4 / 1.95	---	---	---	---	---	---
Fuse or Circuit Breaker Capacity	A	15 30	15 35	15 40	15 30	15 35	15 30	15 35	15 30	15 35	15 40	---
Features												
Controls		Microprocessor	Microprocessor	Microprocessor	Microprocessor	Microprocessor	Microprocessor	Microprocessor	Microprocessor	Microprocessor	Microprocessor	Microprocessor
Low Ambient Control (for Cooling)		Built-in 0°F	Built-in 0°F	Built-in 0°F	Built-in 0°F	Built-in 0°F	Built-in 0°F	Built-in 0°F	Built-in 0°F	Built-in 0°F	Built-in 0°F	Built-in 0°F
Wireless Remote Controller (optional)		(RCS-SH80UA-WL, RCS-BH80UA-WL)	(RCS-SH80UA-WL, RCS-BH80UA-WL)	(RCS-SH80UA-WL, RCS-BH80UA-WL)	(RCS-SH80UA-WL, RCS-BH80UA-WL)	(RCS-SH80UA-WL, RCS-BH80UA-WL)	(RCS-SH80UA-WL, RCS-BH80UA-WL)	(RCS-SH80UA-WL, RCS-BH80UA-WL)	(RCS-SH80UA-WL, RCS-BH80UA-WL)	(RCS-SH80UA-WL, RCS-BH80UA-WL)	(RCS-SH80UA-WL, RCS-BH80UA-WL)	(RCS-SH80UA-WL, RCS-BH80UA-WL)
Wired Remote Controller (included)		RCS-TM80BG	RCS-TM80BG	RCS-TM80BG	RCS-TM80BG	RCS-TM80BG	RCS-TM80BG	RCS-TM80BG	RCS-TM80BG	RCS-TM80BG	RCS-TM80BG	RCS-TM80BG
Fan Speeds		3 and Automatic Control / Variable	3 and Automatic Control / Variable	3 and Automatic Control / Variable	3 and Automatic Control / Variable	3 and Automatic Control / Variable	3 and Automatic Control / Variable	3 and Automatic Control / Variable	3 and Automatic Control / Variable	3 and Automatic Control / Variable	3 and Automatic Control / Variable	3 and Automatic Control / Variable
Timer		7 Days/6 Events	7 Days/6 Events	7 Days/6 Events	7 Days/6 Events	7 Days/6 Events	7 Days/6 Events	7 Days/6 Events	7 Days/6 Events	7 Days/6 Events	7 Days/6 Events	7 Days/6 Events
Air Deflection	Horizontal	---	---	---	---	---	---	---	---	---	---	---
	Vertical	Automatic	Automatic	Automatic	Automatic	Automatic	Automatic	Automatic	Automatic	Automatic	Automatic	Automatic
Air Filter		Washable	Washable	Washable	Washable	Washable	Washable	Washable	Washable	Washable	Washable	Washable
Refrigerant		R-410A	R-410A	R-410A	R-410A	R-410A	R-410A	R-410A	R-410A	R-410A	R-410A	R-410A
Refrigerant control		Electric Expansion Valve	Electric Expansion Valve	Electric Expansion Valve	Electric Expansion Valve	Electric Expansion Valve	Electric Expansion Valve	Electric Expansion Valve	Electric Expansion Valve	Electric Expansion Valve	Electric Expansion Valve	Electric Expansion Valve
Operation Sound	In (Hi / Me / Low) dB-A	39 / 37 / 33	42 / 40 / 35	44 / 41 / 3	39 / 37 / 33	42 / 40 / 35	39 / 37 / 33	42 / 40 / 35	39 / 37 / 33	42 / 40 / 35	44 / 41 / 37	---
	Outdoor(Hi) dB-A	49	52	53	49	52	49	52	49	52	53	---
Refrigerant Piping	Type	Flare Type	Flare Type	Flare Type	Flare Type	Flare Type	Flare Type	Flare Type	Flare Type	Flare Type	Flare Type	Flare Type
	Discharge inches	3/8" Discharge	3/8" Discharge	3/8" Discharge	3/8" Discharge	3/8" Discharge	3/8" Discharge	3/8" Discharge	3/8" Discharge	3/8" Discharge	3/8" Discharge	3/8" Discharge
	Suction inches	5/8" Suction	5/8" Suction	5/8" Suction	5/8" Suction	5/8" Suction	5/8" Suction	5/8" Suction	5/8" Suction	5/8" Suction	5/8" Suction	5/8" Suction
Refrigerant Pipe Length	Ft.	Max. 165Ft	Max. 165Ft	Max. 165Ft	Max. 165Ft	Max. 165Ft	Max. 165Ft	Max. 165Ft	Max. 165Ft	Max. 165Ft	Max. 165Ft	Max. 165Ft
Elevation Difference**	Outdoor Above Ft.	Max. 100Ft	Max. 100Ft	Max. 100Ft	Max. 100Ft	Max. 100Ft	Max. 100Ft	Max. 100Ft	Max. 100Ft	Max. 100Ft	Max. 100Ft	Max. 100Ft
	Outdoor Below Ft.	Max. 50Ft	Max. 50Ft	Max. 50Ft	Max. 50Ft	Max. 50Ft	Max. 50Ft	Max. 50Ft	Max. 50Ft	Max. 50Ft	Max. 50Ft	Max. 50Ft
Dimensions & Weight												
Height	inches	7-17/32" 30-23/32"	9-7/16" 30-23/32"	9-7/16" 48-7/16"	7-17/32" 30-23/32"	9-7/16" 30-23/32"	7-17/32" 30-23/32"	9-7/16" 30-23/32"	7-17/32" 30-23/32"	9-7/16" 30-23/32"	9-7/16" 48-7/16"	9-7/16" 48-7/16"
Width	inches	51-3/16" 37"	62-1/32" 37"	62-1/32" 37"	51-3/16" 37"	62-1/32" 37"	51-3/16" 37"	62-1/32" 37"	51-3/16" 37"	62-1/32" 37"	62-1/32" 37"	62-1/32" 37"
Depth	inches	26-3/8" 13-3/8"	26-3/8" 13-3/8"	26-3/8" 13-3/8"	26-3/8" 13-3/8"	26-3/8" 13-3/8"	26-3/8" 13-3/8"	26-3/8" 13-3/8"	26-3/8" 13-3/8"	26-3/8" 13-3/8"	26-3/8" 13-3/8"	26-3/8" 13-3/8"
Net Weight	Lbs.	57.0 128.0	84.0 143.0	84.0 220.0	64.0 128.0	90.0 143.0	57.0 128.0	84.0 143.0	57.0 128.0	84.0 143.0	84.0 220.0	84.0 220.0

** This is maximum elevation difference when the indoor unit is located above the outdoor unit. (Refer to the table on the back of the catalogue)

Ceiling-Suspended Air Conditioners & Heat Pumps



Indoor Unit
XS1271
XS1872
XHS1271
XHS1872

Grille Assembly
PNR-XS1872



Outdoor Unit
C1271/CL1271
C1872/CL1872
CH1271
CH1872



12XS71/12XLS71
18XS72/18XLS72
12XHS71/18XHS72



Outdoor Unit
C2672R
C3672R
CH2672R
CH3672R



Indoor Unit
XHW2672R
XHW3672R
XHW4272R

Grille Assembly
PNR-XH2442
PNR-XH3642



Outdoor Unit
C4272R
CH4272R



26XW72R/26XHW72R
36XW72R/36XHW72R
42XW72R/42XHW72R



4-Way Airflow Design Sends Cool Air in all Directions

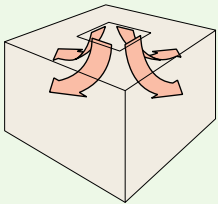

Air is returned through the center of the grille, while evenly distributing air through each of the 4 supply air openings. Installation in the center of the room provides for the greatest comfort. However, 1 or 2 supply louvers can be closed for installation near 1 wall to provide 3 or 2 way airflow. Also, by closing off 1 supply louver, you may attach a duct (field supply) to the upper plenum and provide conditioned air to another, separate area.

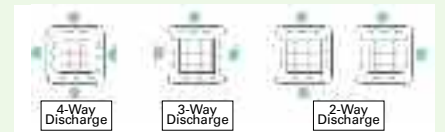

Whisper-Quiet Operation

Thanks to the newly developed turbo fan and decreased resistance of the air path, one of the industry's lowest levels of noise has been achieved.



Integrated Drain Pump

Drain pump is built into the unit to raise the condensate up 20 inches from the drain pump discharge.

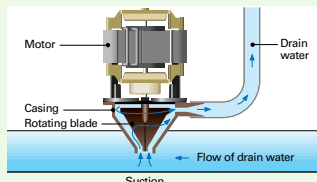

Fresh Air Intake Plenum (Option)

When used to take in fresh air, attach the fresh air-intake plenum to the unit. Air-intake plenum is optionally supplied.
 CMB-GSJ80U for XHW2672R
 CMB-GSJ140U for XHW3672R,
 XHW4272R



Ceiling - Recessed Air Conditioners										Ceiling-Recessed H/P					
Model No.	12XS71		12XLS71		18XS72		18XLS72		12XHS71		18XHS72				
	Indoor Unit	Outdoor Unit	Indoor Unit	Outdoor Unit	Indoor Unit	Outdoor Unit	Indoor Unit	Outdoor Unit	Indoor Unit	Outdoor Unit	Indoor Unit	Outdoor Unit			
Unit Model No.	XS1271	C1271	XS1271	CL1271	XS1872	CL1872	XS1872	CL1872	XHS1271	CH1271	XHS1872	CH1872			
Grille Assembly	PNR-XS1872		PNR-XS1872		PNR-XS1872		PNR-XS1872		PNR-XS1872		PNR-XS1872				
Performance & Electrical Ratings															
Capacity	Cooling	Btu/h	11,900 (3,000 ~ 11,900)		11,900 (3,000 ~ 11,900)		17,500 (4,000 ~ 17,500)		17,500 (4,000 ~ 17,500)		11,900 (3,000 ~ 11,900)		17,500 (4,000 ~ 17,500)		
	Heating	Btu/h	---		---		---		---		13,600 (3,000 ~ 13,600)		20,400 (4,400 ~ 20,400)		
Moisture Removal	High	Pints/H	4.26		4.26		4.89		4.89		4.26		4.89		
Dry Air Flow	Hi / Med / Low	CFM	235 / 206 / 194		235 / 206 / 194		341 / 294 / 253		341 / 294 / 253		235 / 206 / 194		341 / 294 / 253		
SEER	Cooling	Btu/Wh	16		16		16		16		16		16		
EER	Cooling	Btu/Wh	9.4		9.4		9.41		9.41		9.4		9.4		
HSPF	Heating	Btu/Wh	---		---		---		---		8.5		8.5		
Power Supply	V, Phase, Hz		115V, Single phase, 60Hz		115V, Single phase, 60Hz		208 / 230V, Single phase, 60Hz		208 / 230V, Single phase, 60Hz		115V, Single phase, 60Hz		208 / 230V, Single phase, 60Hz		
Running Amps	Cooling	A	12.6 (2.5-12.6)		12.6 (2.5-12.6)		8.3 (1.2-8.3)		8.3 (1.2-8.3)		12.6 (2.5-12.6)		8.3 (1.2-8.3)		
	Heating	A	---		---		---		---		14.6 (2.5-14.6)		10.5 (1.3-10.5)		
Power Input	Cooling	W	1,260 (250-1,260)		1,260 (250-1,260)		1,860 (250-1,860)		1,860 (250-1,860)		1,260 (250-1,260)		1,860 (250-1,860)		
	Heating	W	---		---		---		---		1,460 (250-1,460)		2,340 (270-2,340)		
Back-up Heater		kW	n/a		n/a		n/a		n/a		n/a		n/a		
Fuse or Circuit Breaker Capacity		A	20		20		20		20		20		20		
Features															
Controls	Microprocessor		Microprocessor		Microprocessor		Microprocessor		Microprocessor		Microprocessor		Microprocessor		
Low Ambient Control (for Cooling)	n/a		Equipped		n/a		Equipped		Equipped		Equipped		Equipped		
Wireless Remote Controller	Included		Included		Included		Included		Included		Included		Included		
Wired Remote Controller	STK-RCS-7TWSUA (optional)		STK-RCS-7TWSUA (optional)		STK-RCS-7TWSUA (optional)		STK-RCS-7TWSUA (optional)		STK-RCS-7TWSUA (optional)		STK-RCS-7TWSUA (optional)		STK-RCS-7TWSUA (optional)		
Fan Speeds	Hi/Me/Lo & Auto		Hi/Me/Lo & Auto		Hi/Me/Lo & Auto		Hi/Me/Lo & Auto		Hi/Me/Lo & Auto		Hi/Me/Lo & Auto		Hi/Me/Lo & Auto		
Timer	1 hr OFF and 24-hr PROGRAM		1 hr OFF and 24-hr PROGRAM		1 hr OFF and 24-hr PROGRAM		1 hr OFF and 24-hr PROGRAM		1 hr OFF and 24-hr PROGRAM		1 hr OFF and 24-hr PROGRAM		1 hr OFF and 24-hr PROGRAM		
Air Deflection	Horizontal		n/a		n/a		n/a		n/a		n/a		n/a		
	Vertical		Automatic		Automatic		Automatic		Automatic		Microprocessor		Automatic		
Air Filter	Washable Anti-Mold		Washable Anti-Mold		Washable Anti-Mold		Washable Anti-Mold		Washable Anti-Mold		Washable Anti-Mold		Washable Anti-Mold		
Refrigerant	R-410A		R-410A		R-410A		R-410A		R-410A		R-410A		R-410A		
Refrigerant control	Electric Expansion Valve		Electric Expansion Valve		Electric Expansion Valve		Electric Expansion Valve		Electric Expansion Valve		Electric Expansion Valve		Electric Expansion Valve		
Operation Sound	In(Hi / Me / Lo)	dB-A	34 / 32 / 31		34 / 32 / 31		44 / 40 / 36		44 / 40 / 36		34 / 32 / 31		44 / 40 / 36		
	Outdoor(Hi)	dB-A	47		47		47		47		51		51		
Refrigerant Piping (Cooling)	Type		Flare Type		Flare Type		Flare Type		Flare Type		Flare Type		Flare Type		
	Discharge	inches	1/4" Discharge		1/4" Discharge		1/4" Discharge		1/4" Discharge		1/4" Discharge		1/4" Discharge		
	Suction	inches	3/8" Suction		3/8" Suction		1/2" Suction		1/2" Suction		3/8" Suction		1/2" Suction		
Refrigerant Pipe Length		Ft.	65 Ft		65 Ft		98 Ft		98 Ft		65 Ft		98 Ft		
Elevation Difference**	Outdoor Above	Ft.	23 Ft		23 Ft		50 Ft		50 Ft		23 Ft		50 Ft		
	Outdoor Below	Ft.	23 Ft		23 Ft		50 Ft		50 Ft		23 Ft		50 Ft		
Dimensions & Weight															
Height		inches	12-5/16" 21-9/16"		12-5/16" 21-9/16"		12-5/16" 26-3/8"		12-5/16" 26-3/8"		12-5/16" 21-9/16"		12-5/16" 26-3/8"		
Width		inches	24-19/32" 28-11/32"		24-19/32" 28-11/32"		24-19/32" 34-21/32"		24-19/32" 34-21/32"		24-19/32" 28-11/32"		24-19/32" 34-21/32"		
Depth		inches	24-19/32" 10-7/16"		24-19/32" 10-7/16"		24-19/32" 11-7/32"		24-19/32" 11-7/32"		24-19/32" 10-7/16"		24-19/32" 11-7/32"		
Net Weight		Lbs.	41.3 75		41.3 75		41.3 90.4		41.3 90.4		41.3 75		41.3 97		

Ceiling - Recessed Air Conditioners										Ceiling-Recessed H/P					
Model No.	26XW72R		36XW72R		42XW72R		26XHW72R		36XHW72R		42XHW72R				
	Indoor Unit	Outdoor Unit	Indoor Unit	Outdoor Unit	Indoor Unit	Outdoor Unit	Indoor Unit	Outdoor Unit	Indoor Unit	Outdoor Unit	Indoor Unit	Outdoor Unit			
Unit Model No.	XHW2672R	C2672R	XHW3672R	C3672R	XHW4272R	C4272R	XHW2672R	CH2672R	XHW3672R	CH3672R	XHW4272R	CH4272R			
Grille Assembly	PNR-XH2442		PNR-XH3642		PNR-XH3642		PNR-XH2442		PNR-XH3642		PNR-XH3642				
Performance & Electrical Ratings															
Capacity	Cooling	Btu/h	24,800 (9,500 ~ 24,800)		32,600 (9,500 ~ 32,600)		39,500 (9,500 ~ 39,500)		24,800 (9,500 ~ 24,800)		32,600 (9,500 ~ 32,600)		39,500 (9,500 ~ 39,500)		
	Heating	Btu/h	---		---		---		29,800 (8,000 ~ 29,800)		37,600 (8,000 ~ 37,600)		48,000 (8,000 ~ 48,000)		
Moisture Removal	High	Pints/H	8.1		10.6		12.6		8.1		10.6		12.6		
Dry Air Flow	Hi / Med / Low	CFM	710 / 530 / 450		1050 / 840 / 720		1050 / 840 / 720		710 / 530 / 450		1050 / 840 / 720		1050 / 840 / 720		
SEER	Cooling		14.1		14.6		14.6		14.1		14.6		14.6		
EER	Cooling		8.5		8.1		8.7		8.5		8.1		8.7		
HSPF	Heating		---		---		---		9.6		8.4		9.7		
Power Supply	V, Phase, Hz		230 / 208 / 1 / 60		230 / 208 / 1 / 60		230 / 208 / 1 / 60		230 / 208 / 1 / 60		230 / 208 / 1 / 60		230 / 208 / 1 / 60		
Running Amps	Cooling	A	15.6 / 17.3		18.7 / 20.7		23.0 / 25.4		15.6 / 17.3		18.7 / 20.7		23.0 / 25.4		
	Heating	A	---		---		---		14.8 / 16.4		15.9 / 17.6		22.4 / 24.8		
Power Input	Cooling	W	2,920 / 2,920		3,950 / 3,950		4,520 / 4,520		2,920 / 2,920		3,950 / 3,950		4,520 / 4,520		
	Heating	W	---		---		---		2,790 / 2,790		3,350 / 3,350		4,360 / 4,360		
Back-up Heater		kW	---		---		---		---		---		---		
Fuse or Circuit Breaker Capacity		A	15 30		15 35		15 40		15 30		15 35		15 40		
Features															
Controls	Microprocessor		Microprocessor		Microprocessor		Microprocessor		Microprocessor		Microprocessor		Microprocessor		
Low Ambient Control (for Cooling)	Built-in 0°F		Built-in 0°F		Built-in 0°F		Built-in 0°F		Built-in 0°F		Built-in 0°F		Built-in 0°F		
Wireless Remote Controller (optional)	RCS-SH80UA-WL, RCS-BH80UA-WL		RCS-SH80UA-WL, RCS-BH80UA-WL		RCS-SH80UA-WL, RCS-BH80UA-WL		RCS-SH80UA-WL, RCS-BH80UA-WL		RCS-SH80UA-WL, RCS-BH80UA-WL		RCS-SH80UA-WL, RCS-BH80UA-WL		RCS-SH80UA-WL, RCS-BH80UA-WL		
Wired Remote Controller (included)	RCS-TM80BG		RCS-TM80BG		RCS-TM80BG		RCS-TM80BG		RCS-TM80BG		RCS-TM80BG		RCS-TM80BG		
Fan Speeds	3 and Automatic Control / Variable		3 and Automatic Control / Variable		3 and Automatic Control / Variable		3 and Automatic Control / Variable		3 and Automatic Control / Variable		3 and Automatic Control / Variable		3 and Automatic Control / Variable		
Timer	7 Days/6 Events		7 Days/6 Events		7 Days/6 Events		7 Days/6 Events		7 Days/6 Events		7 Days/6 Events		7 Days/6 Events		
Air Deflection	Horizontal		---		---		---		---		---		---		
	Vertical		Automatic		Automatic		Automatic		Automatic		Automatic		Automatic		
Air Filter	Washable		Washable		Washable		Washable		Washable		Washable		Washable		
Refrigerant	R-410A		R-410A		R-410A		R-410A		R-410A		R-410A		R-410A		
Refrigerant control	Electric Expansion Valve		Electric Expansion Valve		Electric Expansion Valve		Electric Expansion Valve		Electric Expansion Valve		Electric Expansion Valve		Electric Expansion Valve		
Operation Sound	In(Hi / Me / Lo)	dB-A	38 / 35 / 31		44 / 37 / 33		45 / 38 / 34		38 / 35 / 31		44 / 37 / 33		45 / 38 / 34		
	Outdoor(Hi)	dB-A	49		52		53		49		52		53		
Refrigerant Piping	Type		Flare Type		Flare Type		Flare Type		Flare Type		Flare Type		Flare Type		
	Discharge	inches	3/8" Discharge		3/8" Discharge		3/8" Discharge		3/8" Discharge		3/8" Discharge		3/8" Discharge		
	Suction	inches	5/8" Suction		5/8" Suction		5/8" Suction		5/8" Suction		5/8" Suction		5/8" Suction		
Refrigerant Pipe Length		Ft.	Max. 165Ft		Max. 165Ft		Max. 165Ft		Max. 165Ft		Max. 165Ft		Max. 165Ft		
Elevation Difference**	Outdoor Above	Ft.	Max. 100Ft		Max. 100Ft		Max. 100Ft		Max. 100Ft		Max. 100Ft		Max. 100Ft		
	Outdoor Below	Ft.	Max. 50Ft		Max. 50Ft		Max. 50Ft		Max. 50Ft		Max. 50Ft		Max. 50Ft		
Dimensions & Weight															
Height		inches	13-5/16" 30-23/32"		14-31/64" 30-23/32"		14-31/64" 48-7/16"		13-5/16" 30-23/32"		14-31/64" 30-23/32"		14-31/64" 48-7/16"		
Width		inches	33-55/64" 37"		45-9/32" 37"		45-9/32" 37"		33-55/64" 37"		45-9/32" 37"		45-9/32" 37"		
Depth		inches	33-55/64" 13-3/8"		33-55/64" 13-3/8"		33-55/64" 13-3/8"		33-55/64" 13-3/8"		33-55/64" 13-3/8"		33-55/64" 13-3/8"		
Net Weight		Lbs.	49.0 128.0		60.0 143.0		60.0 220.0		49.0 128.0		60.0 143.0		60.0 220.0		

** This is maximum elevation difference when the indoor unit is located above the outdoor unit. (Refer to the table on the back of the catalogue for more detail.)

Concealed Duct Air Conditioners & Heat Pumps



26UW72R / 26UHW72R

Indoor Unit
UHW2672R

Supplies are 8" dia



Outdoor Unit
C2672R
CH2672R



36UW72R / 36UHW72R

Indoor Unit
UHW3672R

Supplies are 8" dia



Outdoor Unit
C3672R
CH3672R

Outline diagram with medium or high-performance filter field installed.

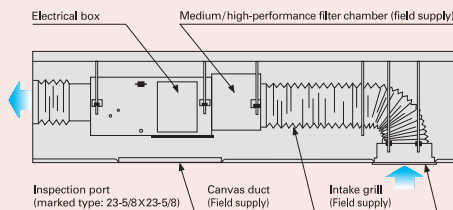

Built-In Drain Pump

Drain pump is built into the unit to raise the condensate up 20 inches from the drain pump discharge.

Installation Example

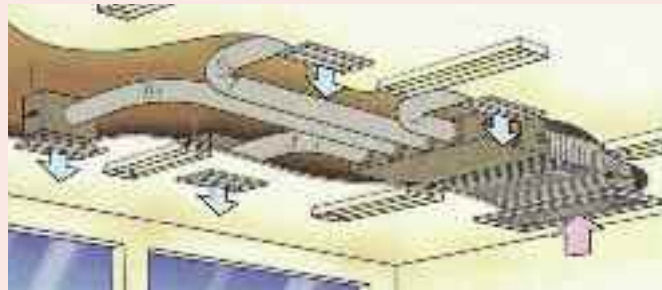

Above picture shows the standard ducting system, where air is taken in from the back of the unit. This system is useful for places which need extensive air conditioning, including conference halls, showrooms, and restaurants.

Concealed Duct Air Conditioners Concealed Duct Heat Pumps

Model No.	26UW72R		36UW72R		26UHW72R		36UHW72R	
	Indoor Unit	Outdoor Unit	Indoor Unit	Outdoor Unit	Indoor Unit	Outdoor Unit	Indoor Unit	Outdoor Unit
Unit Model No.	UHW2672R	C2672R	UHW3672R	C3672R	UHW2672R	CH2672R	UHW3672R	CH3672R
Performance & Electrical Ratings								
Capacity	Cooling Btu/h	24,000 (9,500 ~ 24,000)	31,200 (9,500 ~ 31,200)	24,000 (9,500 ~ 24,000)	31,200 (9,500 ~ 31,200)	24,000 (9,500 ~ 24,000)	31,200 (9,500 ~ 31,200)	31,200 (9,500 ~ 31,200)
	Heating Btu/h	-	-	-	-	28,600 (8,000 ~ 28,600)	36,200 (8,000 ~ 36,200)	36,200 (8,000 ~ 36,200)
Moisture Removal	High Pints/H	7.7	10.0	7.7	10.0	7.7	10.0	10.0
Dry Air Flow	Hi / Med / Low CFM	670 / 530 / 460	1060 / 920 / 750	670 / 530 / 460	1060 / 920 / 750	670 / 530 / 460	1060 / 920 / 750	1060 / 920 / 750
External Static Pressure	in. Aq							
SEER	Cooling	14.0	13.9	14.0	13.9	14.0	13.9	13.9
EER	Cooling	9.1	7.8	9.1	7.8	9.1	7.8	7.8
HSPF	Heating			9.0	8.5	9.0	8.5	8.5
Power Supply	V, Phase, Hz	230 / 208	230 / 208	230 / 208	230 / 208	230 / 208	230 / 208	230 / 208
Running Amps	Cooling A	13.6 / 15.0	18.6 / 20.6	13.6 / 15.0	18.6 / 20.6	13.6 / 15.0	18.6 / 20.6	18.6 / 20.6
	Heating A			12.5 / 13.8	15.9 / 17.6			
Power Input	Cooling W	2,600 / 2,600	3,920 / 3,920	2,600 / 2,600	3,920 / 3,920	2,600 / 2,600	3,920 / 3,920	3,920 / 3,920
	Heating W	---	---	2,400 / 2,400	3,340 / 3,340	---	---	---
External Static Pressure	in. WC	0.20	0.24	0.20	0.24	0.20	0.24	0.24
Fuse or Circuit Breaker Capacity	A	15 30	15 35	15 30	15 35	15 30	15 35	15 35
Features								
Controls		Microprocessor	Microprocessor	Microprocessor	Microprocessor	Microprocessor	Microprocessor	Microprocessor
Low Ambient Control		Built-in 0°F	Built-in 0°F	Built-in 0°F	Built-in 0°F	Built-in 0°F	Built-in 0°F	Built-in 0°F
Wireless Remote Controller (optional)		RCS-BH80UA-WL	RCS-BH80UA-WL	RCS-BH80UA-WL	RCS-BH80UA-WL	RCS-BH80UA-WL	RCS-BH80UA-WL	RCS-BH80UA-WL
Wired Remote Controller (included)		RCS-TM80BG	RCS-TM80BG	RCS-TM80BG	RCS-TM80BG	RCS-TM80BG	RCS-TM80BG	RCS-TM80BG
Fan Speeds		3 and Automatic Control / Variable	3 and Automatic Control / Variable	3 and Automatic Control / Variable	3 and Automatic Control / Variable	3 and Automatic Control / Variable	3 and Automatic Control / Variable	3 and Automatic Control / Variable
Timer		7 Days/6 Events	7 Days/6 Events	7 Days/6 Events	7 Days/6 Events	7 Days/6 Events	7 Days/6 Events	7 Days/6 Events
Air Deflection	Horizontal	---	---	---	---	---	---	---
	Vertical	---	---	---	---	---	---	---
Air Filter		---	---	---	---	---	---	---
Refrigerant		Electric Expansion Valve	Electric Expansion Valve	Electric Expansion Valve	Electric Expansion Valve	Electric Expansion Valve	Electric Expansion Valve	Electric Expansion Valve
Operation Sound	In(Hi / Me / Lo) dB-A	34 / 30 / 27	38 / 33 / 31	34 / 30 / 27	38 / 33 / 31	34 / 30 / 27	38 / 33 / 31	38 / 33 / 31
	Outdoor(Hi) dB-A	49	52	49	52	49	52	52
Refrigerant Piping	Type	Flare Type	Flare Type	Flare Type	Flare Type	Flare Type	Flare Type	Flare Type
	Discharge inches	3/8" Discharge	3/8" Discharge	3/8" Discharge	3/8" Discharge	3/8" Discharge	3/8" Discharge	3/8" Discharge
	Suction inches	5/8" Suction	5/8" Suction	5/8" Suction	5/8" Suction	5/8" Suction	5/8" Suction	5/8" Suction
Refrigerant Pipe Length	Ft.	Max. 165Ft	Max. 165Ft	Max. 165Ft	Max. 165Ft	Max. 165Ft	Max. 165Ft	Max. 165Ft
Elevation Difference**	Outdoor Above Ft.	Max. 100Ft	Max. 100Ft	Max. 100Ft	Max. 100Ft	Max. 100Ft	Max. 100Ft	Max. 100Ft
	Outdoor Below Ft.	Max. 50Ft	Max. 50Ft	Max. 50Ft	Max. 50Ft	Max. 50Ft	Max. 50Ft	Max. 50Ft
Dimensions & Weight								
Height	inches	12-7/32" 30-23/32"	12-7/32" 30-23/32"	12-7/32" 30-23/32"	12-7/32" 30-23/32"	12-7/32" 30-23/32"	12-7/32" 30-23/32"	12-7/32" 30-23/32"
Width	inches	39-3/8" 37"	58-9/32" 37"	39-3/8" 37"	58-9/32" 37"	39-3/8" 37"	58-9/32" 37"	58-9/32" 37"
Depth	inches	24-13/16" 13-3/8"	24-13/16" 13-3/8"	24-13/16" 13-3/8"	24-13/16" 13-3/8"	24-13/16" 13-3/8"	24-13/16" 13-3/8"	24-13/16" 13-3/8"
Net Weight	Lbs.	71.0 128.0	104.0 143.0	71.0 128.0	104.0 143.0	71.0 128.0	104.0 143.0	104.0 143.0
Approvals								

** This is maximum elevation difference when the indoor unit is located above the outdoor unit. (Refer to the table on the back of the catalogue for more detail.)

Optional Accessories

H.V.A.C. Accessories		
MODEL NO.	DESCRIPTION	USE WITH
DL04060815	Insulated Tubing Kit 1/4" x 3/8" x 1/2" x 15'	09KS71, 09KLS71, 09KHS71, 12KS71, 12KLS71, 12KHS71, 12XLS71, 12XHS71
DL04060820	Insulated Tubing Kit 1/4" x 3/8" x 1/2" x 20'	KMHS0772, KMHS0972, KMHS1272, KMS0772, KMS0972, KMS1272
DL04060835	Insulated Tubing Kit 1/4" x 3/8" x 1/2" x 35'	XMS0972, XMS1272, XMHS0972, XMHS1272
DL04080815	Insulated Tubing Kit 1/4" x 1/2" x 1/2" x 15'	CM1972A, CM2472A, CM3172A
DL04080820	Insulated Tubing Kit 1/4" x 1/2" x 1/2" x 20'	CMH1972A, CMH2472A, CMH3172A
DL04080835	Insulated Tubing Kit 1/4" x 1/2" x 1/2" x 35'	18KS72, 18KLS72, 18KHS72, 18XS72, 18XHS72
DL04100820	Insulated Tubing Kit 1/4" x 5/8" x 1/2" x 20'	KMHS1872, KMS1872,
DL04100830	Insulated Tubing Kit 1/4" and 5/8" x 1/2" x 30'	XS1872, XHS1872
DL04100850	Insulated Tubing Kit 1/4" and 5/8" x 1/2" x 50'	CM1972A, CMH1972A
DL06100830	Insulated Tubing Kit 3/8" x 5/8" x 1/2" x 30'	CM2472A, CMH2472A
DL06100850	Insulated Tubing Kit 3/8" x 5/8" x 1/2" x 50'	CM3172A, CMH3172A
CMB-GSJ80U	Fresh Air Intake Plenum	XH/XHW2672R
CMB-GSJ140U	Fresh Air Intake Plenum	XH/XHW3672R, XH/XHW4272R
Display Stand	Display Stand	09KS71, 09KLS71, 09KHS71, 12KS71, 12KLS71, 12KHS71
KA-KS0971	Indoor Display Shell	KS0971 Display Shell
KA-C0971	Outdoor Display Shell	C0971 Display Shell
RCS5PS4B	Locking Bracket for Remote Controller	RCS-SH1UA, RCS-SH80UA-WL, RCS-BH80UA-WL
RCS4MHVB	Locking Bracket for Remote Controller	KS0971, KS1271, KS1872, KS2472, KS3082, KS3682, KHS0971, KHS1271, KHS1872, KHS2472, KHS3082, KHS3682, ALL KMS/KMS/XS/XHS/XMS & XMHS Models
BS600	Mounting Bracket for Outdoor Unit	All C, CL, CH, CM, and CMH Models
SI3100-1	Condensate Pump	All 115 volt Models
SI3100-2	Condensate Pump	All 230 volt Models (up to 2ton)
SI1730-2	Condensate Pump	All 230 volt Models (High Vol. Condensate Removal) (2ton and higher)
STK-RCS-7TWSUA	Wired Remote	KS0971, KS1271, KS1872, KS2472, KS3082, KS3682, KHS0971, KHS1271, KHS1872, KHS2472, KHS3082, KHS3682, ALL KMS/KMS/XS/XHS/XMS & XMHS Models
RCS-KR1EG	Simple Wired Remote	All 26,000 Through 42,000 BTU/h Models, Except 82 Series
STK-KCW1	Wire Kit	PCB Wire Kit for STK-RCS-7TWSUA - Required for use with KS0971, KS1271, KS1872, KS2472, KHS0971, KHS1271, KHS1872, KHS2472, ALL KMS/KMS/XS/XHS/XMS/XMHS Models
STK-KCW2	Wire Kit	PCB Wire Kit for STK-RCS-7TWSUA - Required for use with KS3082, KS3682, KHS3082, KHS3682
RCS-TM80BG	Wired Timer Remote Controller	All 26,000 Through 42,000 BTU/h Models, Except 82 Series
RCS-SH1UA	Wireless Remote Controller	KH2672R, KH3072R, KH3672R, KH2672R
RCS-SH80UA-WL	Wireless Remote Controller	TH/THH/THW/THHW2672R, TH/THH/THW/THHW3672R, TH/THW4272R, XH/XHW2672R, XH/XHW3672R, XH/XHW4272R
RCS-BH80UA-WL	Wireless Remote Controller	UH/UHW2672R, UH/UHW3672R
SHA-KC64UG	System Controller	All 26,000 Through 42,000 BTU/h Models, Except 82 Series
STK-FDXB	Apatite Filter	KS0971, KS1271, KS1872, KS2472, KHS0971, KHS1271, KHS1872, KHS2472, KHS3082, KHS3682, KHS3682, ALL KMS/KMS Models
WINDB-1	Wind Baffle	All C, CL, CH, CM and CMH Models



Condensate Drain Pump
SI3100-1
SI3100-2
SI1730-2

Fresh Air Intake Plenum
CMB-GSJ80U
CMB-GSJ140U



Apatite Filter
STK-FDXB

Locking Bracket for Remote Control
RCS5PS4B
RCS4MHVB



System Controller
SHA-KC64UG

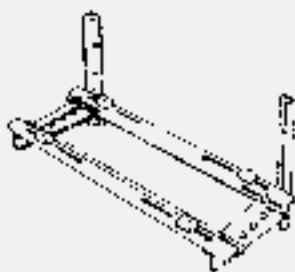

Outdoor Unit Mounting Bracket
BS600



Timer Remote Controller
RCS-TM80BG

OPERATION RANGE

Cooling Model 24,000 Btu and Less

	Temperature	Indoor Air Intake Temp.	Outdoor Air Intake Temp.
Cooling	Maximum	95°F DB / 71°F WB	115°F DB
	Minimum	67°F DB / 57°F WB	50°F DB

Heat Pump Model 24,000 Btu and Less

	Temperature	Indoor Air Intake Temp.	Outdoor Air Intake Temp.
Cooling	Maximum	95°F DB / 71°F WB	115°F DB
	Minimum	67°F DB / 57°F WB	0°F DB
Heating	Maximum	80°F DB / 67°F WB	75°F DB / 65°F WB
	Minimum	-°F DB / -°F WB	0°F DB

Low Ambient Model 24,000 Btu and Less

	Temperature	Indoor Air Intake Temp.	Outdoor Air Intake Temp.
Cooling	Maximum	95°F DB / 71°F WB	115°F DB
	Minimum	67°F DB / 57°F WB	0°F DB

Cooling Model above 26,000 Btu, Except 82 Series

	Temperature	Indoor Air Intake Temp.	Outdoor Air Intake Temp.
Cooling	Maximum	95°F DB / 71°F WB	115°F DB
	Minimum	67°F DB / 57°F WB	0°F DB

Cooling Model 30KS82/36KS82

	Temperature	Indoor Air Intake Temp.	Outdoor Air Intake Temp.
Cooling	Maximum	95°F DB / 71°F WB	115°F DB
	Minimum	67°F DB / 57°F WB	0°F DB

Heat Pump Model above 26,000Btu, Except 82 Series

	Temperature	Indoor Air Intake Temp.	Outdoor Air Intake Temp.
Cooling	Maximum	95°F DB / 71°F WB	115°F DB
	Minimum	67°F DB / 57°F WB	0°F DB
Heating	Maximum	80°F DB / 67°F WB	75°F DB / 65°F WB
	Minimum	-°F DB / -°F WB	5°F DB

Heat Pump Model 30KHS82/36KHS82

	Temperature	Indoor Air Intake Temp.	Outdoor Air Intake Temp.
Cooling	Maximum	95°F DB / 71°F WB	115°F DB
	Minimum	67°F DB / 57°F WB	0°F DB
Heating	Maximum	80°F DB / 67°F WB	75°F DB / 65°F WB
	Minimum	-°F DB / -°F WB	0°F DB

Flex Multi Cooling Model

	Temperature	Indoor Air Intake Temp.	Outdoor Air Intake Temp.
Cooling	Maximum	95°F DB / 71°F WB	115°F DB
	Minimum	67°F DB / 57°F WB	14°F DB

Flex Multi Heat Pump Model

	Temperature	Indoor Air Intake Temp.	Outdoor Air Intake Temp.
Cooling	Maximum	95°F DB / 71°F WB	115°F DB
	Minimum	67°F DB / 57°F WB	14°F DB
Heating	Maximum	80°F DB / 67°F WB	75°F DB / 65°F WB
	Minimum	-°F DB / -°F WB	0°F DB

TUBING SIZES, LENGTHS & ELEVATION DIFFERENCES, REFRIGERANT CHARGE ADJUSTMENT & INSULATION CHART

SYSTEM MODEL#	OD TUBE SIZE (Inches)		MAXIMUM LENGTH (Ft) OF TUBING BETWEEN IN/OUTDOOR	MAXIMUM ELEVATION DIFFERENCE (Ft) BETWEEN IN/OUTDOOR		MAXIMUM LENGTH (Ft) OF TUBING AT SHIPMENT*	REQUIRED ADDITIONAL REFRIGERANT OZ/FT	INSULATION
	NARROW	WIDE		OUTDOOR ABOVE	OUTDOOR BELOW			
09KS71			50'					
09KLS71								
09KHS71								
12KS71								
12KLS71		3/8"	65'	23'	23'		R410A 0.16	
12KHS71								
12XS71								
12XLS71						25'		
12XHS71	1/4"							
18KS72								
18KLS72								
18KHS72		1/2"	100'	50'	50'		R410A 0.27	
18XS72								
18XLS72								
18XHS72								
24KS72		5/8"	131'			33'		
24KLS72								
24KHS72			98'					
26KS72R								
26TW72R								
26XW72R								
26UW72R								
26KHS72R								
26THW72R								
26XHW72R							R410A 0.43	
26UHW72R								
26KHS72R								
26THHW72R								
30KS72R	3/8"	5.8"	165'	100'	50'	100'		Both Tubes
30KHS72R								
30KS82								
30KHS82							R410A 0.27	
36KS82								
36KHS82								
36KS72R								
36TW72R								
36XW72R								
36UW72R								
36KHS72R								
36THW72R								
36XHW72R							R410A 0.43	
36UHW72R								
36THHW72R								
42TW72R								
42XW72R								
42THW72R								
42XHW72R								
CM1972A		3/8"						
CMH1972A			82'					
CM2472A	1/4"	3/8"x3, 1/2"x1		50'	50'	150'	R410 0.22	
CMH2472A								
CM3172A		3/8"x2, 1/2"x2	100'					
CMH3172A								

Because its products are subject to continuous improvements, Sanyo reserves the right to modify product design and specifications without notice and without incurring any obligations. ©Copyright 2006, SANYO Air Conditioning Products.



SANYO North America
 Commercial Solutions Division / HVAC
 1690 Roberts Blvd. NW, Suite 110
 Kennesaw, GA 30152, USA
 website: <http://us.sanyo.com/hvac>
 1-800-851-1235

