

## SECTIONAL ASSEMBLY

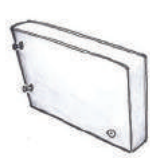

2 Arms

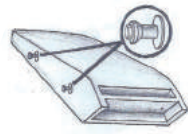

1 Seat Back per Seat



1 Seat Deck per Seat



Seat Cushions

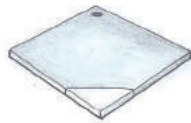

Corner Deck

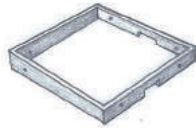

1 Corner Frame

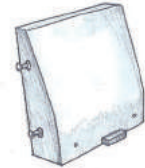

1 Left Corner Back

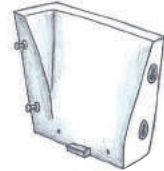

1 Right Corner Back



1 Corner Back



Back Cushions



12 Legs



7 Thumb Bolts

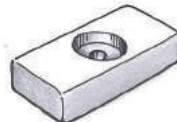

1 Block

Fig. 10

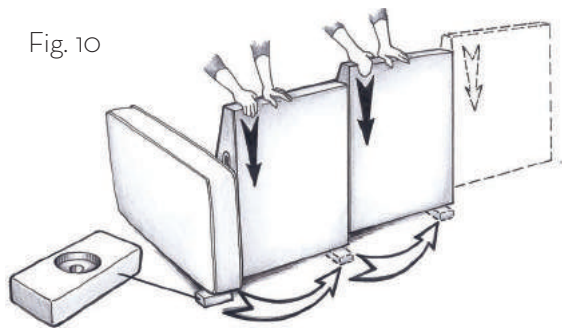

1. Complete steps 1 through 4 of the Sofa & Loveseat Assembly to create the Left Facing Assembly of your sectional (Fig. 5).
2. Place the Block under the Left Corner Back and align the connectors on the Left Corner Back with the openings on the Left Facing Assembly. Insert the connectors into the openings and push down on the Left Facing Assembly to engage the connectors (Fig 10 & 11).
3. Turn the Assembly on its back and insert the Seat Deck with the yellow arrow into the Seat Back with the yellow arrow (Left Facing Seat Back). Thread in two Thumb Bolts through the

Fig. 11

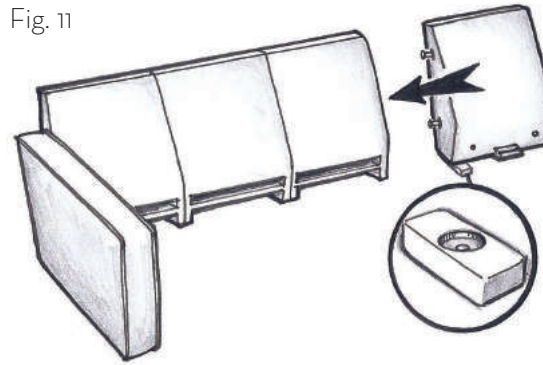

Fig. 12

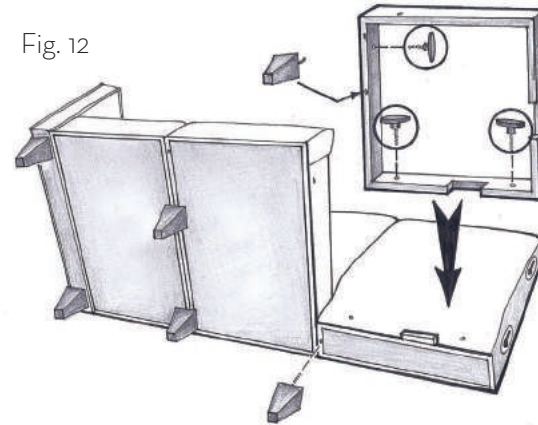
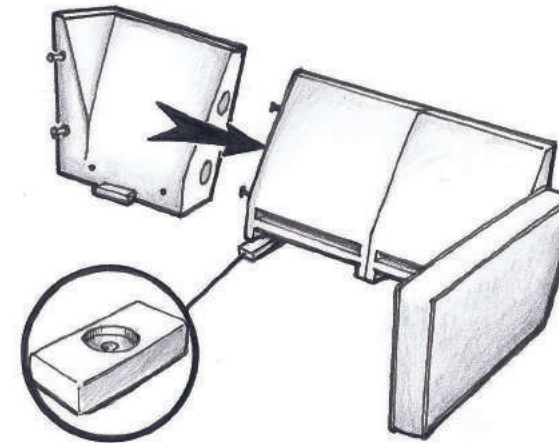

Fig. 13



bottom of the seat deck into the Seat Back. Repeat for each Seat Deck (Fig 7).

4. Attach the Corner Frame to the Corner Back and the Right Facing Seat using three Thumb Bolts (Fig 12).
5. Join the Seat Decks to each other by threading the Thumb Bolts from the left side Seat Deck into the next Seat Deck. Start all Thumb Bolts before tightening (Fig 7).
6. Attach the Dust Cover for each Seat (Fig 8).
7. Attach the Legs to the bottom of the frame (Fig. 8).
8. Assemble the Right Facing Assembly by connecting the Seat Backs to the Right Arm, just as you did to create the Left Facing Assembly (Fig 6). Complete for each seat.
9. Attach the Right Corner Back to the Right Facing Assembly placing the Block under the Right Corner Back and inserting the connectors into the openings on the Right Corner Back. Push down to engage the connectors (Fig 13).
10. Turn the Right Facing Assembly on its back and attach the Seat Decks, Dust Cover, and Legs just as you did for the Left Facing Assembly.

Fig. 14

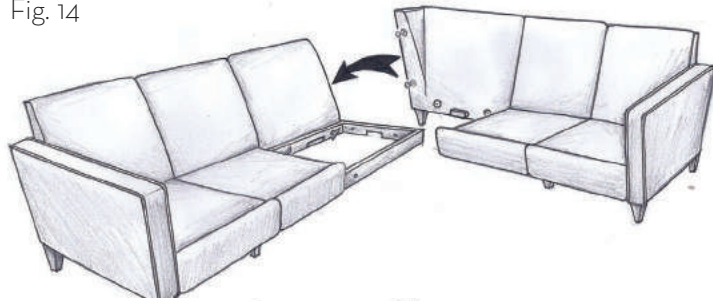

11. Turn both the Left and Right Facing Assemblies upright and move them into alignment with each other (Fig 14).

12. Place the Block under the back leg of the Left Facing Assembly and push the corner parts together, inserting the connectors in the openings.

13. Remove the Block and push down on the top of the Left Facing Assembly to engage the connectors.

14. Finish connecting the Corner Frame to the Right Facing Assembly using three Thumb Bolts (Fig. 15).

*Helpful Hint:* the block can be fastened with one of the Thumb Bolts to the inside of the Corner Seat Frame so it is handy if you want to expand or contract your sectional.

15. Add the Corner Deck with the Cover Fabric facing the front corner (Fig 15).

16. Add Seat Cushions and Back Cushions.

*Enjoy!*

Fig. 15

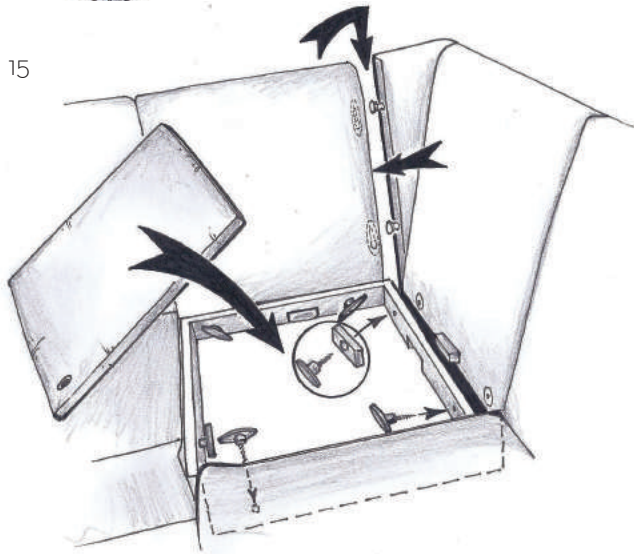
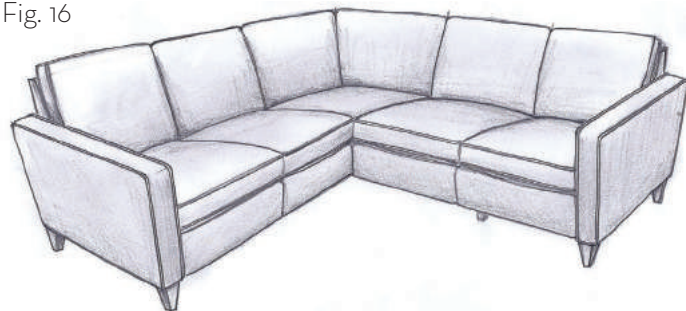

Fig. 16



Questions? Call us at 866 746-6303



homeware.com

Thank you!

(but let's not say goodbye)

