

SENCO®

Performance. Power.
Productivity.™



Product Catalog

SENCO®

Performance. Power.
Productivity.™

We Take Pride in Your Work.



Our Mission:

To be the undisputed provider of choice for quality fastening solutions that increase productivity and make work safer and easier to perform.

For nearly 60 years, the Senco Brand has been synonymous with professional results, productivity increases and pride in a job well done. Customers around the world have put Senco's innovative products to work in a variety of demanding applications, counting on them to perform every day. Today, Senco continues to pioneer new technologies – in both tool and fastener development – as the unique needs of its customers continue to evolve.

Leveraging the expertise and capabilities housed within the Company's Cincinnati, Ohio fastener manufacturing facility, Senco produces and delivers more than 700 types of fasteners to its global distribution network. Senco pride and expertise goes into each box of these fasteners – and end users benefit from the quality and ready availability this local manufacturing represents.

Long known for its innovative solutions, Senco once again raises this bar with the introduction of its revolutionary line of Cordless Pneumatic tools. Powered by Fusion Technology, this unique product line affords users cordless portability in a tool that "feels like a pneumatic." Its integrated screw systems, featuring DuraSpin Technology, has been the favorite of professionals for nearly 10 years.

Senco – A leader in the power fastening industry – continues to lead the way in innovative technology, pioneering the fastening industry today and tomorrow.

Senco Fasteners are as tough
as the people that make them.



TABLE OF CONTENTS

Tools

Cordless Finish & Trim Nailers

Fusion: F-15, F-16A	3
F-16S F-18	4
Gas: GT65DA, GT65RHA	5

Finish & Trim Nailers

FIP42XP, FIP35Mg	6
SFN30, FIP33Mg, FIP32	7
FIP25XP, SLP20XP, FIP18Mg	8
FIP2N1, FIP11, FIP10	9
Compare Tool Features	10-11

Cordless Gas Framing Nailers

GT90CH, GT90FRH	12
-----------------------	----

Framing & Sheathing

SN901XP, SN951XP, FP601	13
,SN902XP, SN952XP, FP602	14
PC1195 Hand Nailer, A20 Hand Nailer	15
Compare Tool Features	16-17

Roofing

RoofPro™455XP, RoofPro™450	18
WC150RXP, BC58 Button Cap Stapler	19
A11 Stapling Hammer	19
Cedar Shake Tools, Clay Roof Tile Tools	20
Compare Tool Features	21

Coil Nailer

SCN65XP, SCN60XP	22
SCN49, PalletPro57F, PalletPro™70	23
Carrier Strip Coil Siding Nails	24
PalletPro™100, PalletPro™130	25
Coil Flooring Nails	26
Compare Tool Features	27

Staplers

SFT10XP - 22-20 ga.	28
SFW09 - 22 ga.	29
SLS18Mg - 22-18 ga.	29
SLS20XP - 19-18 ga.	30
SLS25XP - 18 ga.	30
SKSXP - 18-16 ga.	30
MWXP, PW, WC150XP - 16 ga.	31
WC200XP 16 ga.	32
SNS41, SNS44XP - 17-16 ga.	32
SNS45XP - 17-16 ga.	33
SNS50XP - 16 Ga., SQS55XP - 16 ga.	33
Compare Tool Features	34-35

Specialty

Pin to Concrete and Steel tools	36
SC1XP Senclamp® & SC2 Sencor®	37
Vinyl Siding Attachment for RP455XP	37
SHF15 & SHF50 - L-head cleat nail	38
SLS20XP-HF - 19 ga. stapler	38
DFP & F Series Self-Clinching Staplers	39
HN150-250 Joist Hanger Nailers	39

Combo Kits - Compressor & Tool

PC0947-Brad Nailer 18 ga. plus Compressor ...	40
PC0974-Pinner 23 ga. plus Compressor	40

Compressors

PC0968-Twin stack tanks 1.5 (peak) hp.	41
PC1010 1.0 (peak) hp.	41
PC1130 1.5 (peak) hp.	41
PC1131-Twin stack tanks 2.5 (peak) hp.	42
Compare Applications and Features	42

Auto-Feed Screw Systems

DS110, DS210, DS310 Attachments	43
DS200-AC,, DS202-14v, DS275-18v	44
DS300-AC, DS325AC, DS340AC	45
Compare Applications and Features	46--47

Fasteners

Nails

Fastener Identification Code Charts	50
Finish 15 ga.	51
Finish 16 ga.	52
Brads 18 ga., Micro Pins 23 ga.	53
34° Clipped Head - Smooth	54
34° Clipped Head - Ring & Screw	55
34° RoundStrip Nails - Smooth & Ring	56
Metal Connector Nails 34° and 20°	57
20° Full Round Head - Smooth	58
20° Full Round Head - Ring	59
15° Coil - Smooth & Ring	60
15° Coil - Screw, Duplex & Wood to Masonry ..	61
15° Coil - Packaging, Siding & Drywall	62
Roofing Coil - Smooth & Ring	63

Staples

Fine Wire 22-20 ga.	64
Fine Wire 21-18 ga.	65
Medium Wire 19-18 ga.	66
Medium Wire 18-17 ga.	67
Heavy Wire 16 Ga.	68
Heavy Wire 16-15 Ga.	69

Specialty Fasteners

Concrete and Steel Pins	70
Senclamp® & Sencor®	70
L Head Flooring Cleat Nails	70
Button Cap and Washer Fasteners	71
Special Order Fasteners	72-73

Auto-Feed Screws

Screws Code Chart	74
Screw Reference Guide	75-76

Accessories

Auto-Feed Screw Accessories	77
Filters, Regulators & Lubricators	78
Pressure Gauges	79
Plugs & Couplers	79-81
Plug & Coupler Hose Assembly Sets	81
Hoses	82
Hose Accessories	83
Tool Oil, Pump Oil, Moisture Shield, Tool Lub., Tool Cleaner, Tool Coating	84
Tool Cases	84
Safety Glasses	85
Tool Belt Hooks	85
No-Mar Pads	85
Drain Plug	85
Gas Tools Accessories	86
Batteries and Chargers	86
Parts Kits	87

Item Code Tool Index	88
SENCO's Limited Warranty	89

Finish & Trim 3-11

15 Gauge
16 Gauge
18 Gauge
23 Gauge

Framing 12-17

Clipped Head
Full Round Head

Roofing 18-21

Asphalt/Fiberglass
Cedar Shakes/Clay Tiles

Coil Nailers 22-27

Framing/Sheathing
Siding/Fencing
Pallets/Packaging

Staplers 28-35

Light Wire
Medium Wire
Heavy Wire

Specialty 36-39

Pins to Concrete and Steel
Corrugated
Vinyl Siding
Flooring, Clinch,
Metal Connector

Combo Kits 40

Tools & Compressors

Compressors 41-42

Screw Systems 43-47

Fasteners 50-76

Finish Nails & Brads
Framing Nails
Coil Nails
Staples
Specialty
Screws

Accessories 77-87

Auto-Feed Screw Accessories
Filters, Regs. & Lubricators
Plugs & Couplers
Air Hoses & Hose Accessories
Miscellaneous

Item Code Tool Index 88

Warranty 89

No Gas. No Hose. No Competition.

The World's First Cordless Pneumatics

Senco Fusion Finish Nailers.

This is the game-changer for everyone in the power tool industry. Now you can enjoy the power of a pneumatic nailer with the portability of a cordless—in one premium tool. No compressor, no fuel cells, no exhaust smell and no “ramp up” time.

Fusion Technology has taken the entire industry by storm. And only one brand can put it on your shelf...Senco. For more information about how you can be a part of the latest innovation in fastening, visit Senco.com or call 800-543-4596.



SENCO®

FUSION TECHNOLOGY™

2
YEAR
LIMITED
WARRANTY

USE
GENUINE
SENCO
FASTENERS™



CORDLESS FINISH & TRIM WITH FUSION TECHNOLOGY



NO GAS. NO HOSE. NO COMPETITION. Our Li-ion powered nailers featuring Fusion Technology are available in 15, 16, and 18 gauge. All with the power and utility of a pneumatic tool combined with the convenience of a cordless tool. Our patented Reflex-Shot design provides an instant shot when the trigger is pulled with no ramp-up time. Save up to \$300 a year by not having to buy any fuel cells!

Cordless 15 Ga. 2½" 34° Angled Finish Nailer



Applications

Finish and Trim, Baseboard, Cabinets, Caskets, Chair Rail, Decorative Trim, Door & Window Casing, Furniture Trim, Paneling.

Features

- Patented Reflex-Shot Design
- Robust Aluminum Drive Cylinder
- Rugged Aluminum Magazine
- Eco-Friendly Energy - 18v Li-ion Battery
- Selectable Drive Switch
- Nose Mounted LED Light
- Adjustable Belt Hook
- Thumbwheel Depth-of-Drive
- Innovative EZ-Clear Feature
- Includes Case & Charger

Specifications

Item#: 5N0001N
 Tool Weight: 6.2 lbs (2.81 kg)
 Height: 13" (330 mm)
 Length: 13" (330 mm)
 Width: 3" (76 mm)
 Battery: Li-ion 18v
 Charger: 80% in 15 minutes, 100% in 45 Minutes
 Drives up to 500 fasteners on a single charge

Fastener

Capacity: 110
 Gauge: 15
 Range: 1¼" – 2½"
 Collation: 34° angled taped strip



For fasteners see p. 51 Series DA

F-15

The F-15 Finish Nailer is the world's first cordless pneumatic featuring Fusion Technology. Comes with a Li-ion battery, charger, rugged canvas carrying case.

Cordless 16 Ga. 2½" 20° Angled Finish Nailer



Applications

Finish and Trim, Baseboard, Cabinets, Caskets, Chair Rail, Decorative Trim, Door & Window Casing, Furniture Trim, Paneling.

Features

- Patented Reflex-Shot Design
- Robust Aluminum Drive Cylinder
- Rugged Aluminum Magazine
- Eco-Friendly Energy - 18v Li-ion Battery
- Selectable Drive Switch
- Nose Mounted LED Light
- Adjustable Belt Hook
- Thumbwheel Depth-of-Drive
- Innovative EZ-Clear Feature
- Includes Case & Charger

Specifications

Item#: 5P0001N
 Tool Weight: 6.2 lbs (2.81 kg)
 Height: 13" (330 mm)
 Length: 13" (330 mm)
 Width: 3" (76 mm)
 Battery: Li-ion 18v
 Charger: 80% in 15 minutes, 100% in 45 Minutes
 Drives up to 500 fasteners on a single charge

Fastener

Capacity: 110
 Gauge: 16
 Range: 1¼" – 2½"
 Collation: 20° angled glued strip

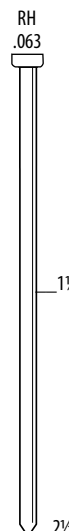

For fasteners see p. 52 Series RH

NEW F-16A

The freedom of a cordless tool with a 20° angled magazine to fit into tight spots and corners. Comes with a Li-ion battery, charger, rugged canvas carrying case.

CORDLESS FINISH & TRIM WITH FUSION TECHNOLOGY

Cordless 16 Ga. 2½" Finish Nailer



Applications

Finish and Trim, Baseboard, Cabinets, Caskets, Chair Rail, Decorative Trim, Door & Window Casing, Furniture Trim, Paneling.

Features

- Patented Reflex-Shot Design
- Robust Aluminum Drive Cylinder
- Rugged Aluminum Magazine
- Eco-Friendly Energy - 18v Li-ion Battery
- Selectable Drive Switch
- Nose Mounted LED Light
- Adjustable Belt Hook
- Thumbwheel Depth-of-Drive
- Innovative EZ-Clear Feature
- Includes Case & Charger

Specifications

Item#: 6U0001N
 Tool Weight: 6 lbs (2.72 kg)
 Height: 13" (330 mm)
 Length: 11" (276 mm)
 Width: 3" (76 mm)
 Battery: One Li-ion 18v
 Charger: 80% in 15 minutes, 100% in 45 Minutes
 Drives up to 500 fasteners on a single charge

Fastener

Capacity: 110
 Gauge: 16
 Range: ¼" – 2½"
 Collation: Straight glued strip

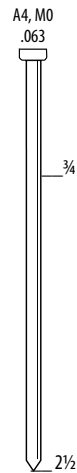

NEW F-16S

The F-16 with Fusion Technology saves time and money with no fuel cells, no hose and no compressor to drag around. Has the power to drive ¼" to 2½" finish nails into the hardest of woods.

For fasteners see p. 52 Series M0 & A4

Cordless 18 Ga. 2⅛" Brad Nailer



Applications

Molding and decorative trim, furniture trim, blind pinning of upholstered and trim panels, scribe molding, cabinets, drawers and picture frames.

Features

- Patented Reflex-Shot Design
- Robust Aluminum Drive Cylinder
- Rugged Aluminum Magazine
- Eco-Friendly Energy - 18v Li-ion Battery
- Selectable Drive Switch
- Nose Mounted LED Light
- Adjustable Belt Hook
- Thumbwheel Depth-of-Drive
- Innovative EZ-Clear Feature
- Includes Case & Charger

Specifications

Item#: 6E0001N
 Tool Weight: 6 lbs (2.72 kg)
 Height: 13" (330 mm)
 Length: 11" (276 mm)
 Width: 3" (76 mm)
 Battery: One Li-ion 18v
 Charger: 80% in 15 minutes, 100% in 45 Minutes
 Drives up to 700 fasteners on a single charge

Fastener

Capacity: 110
 Gauge: 18
 Range: ⅝" – 2⅛"
 Collation: Straight glued strip

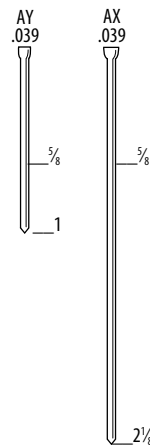

NEW F-18

The F-18, with Fusion Technology, drives both slight and medium headed brads into the hardest woods. Perfect for trim crews, remodelers, punch-out, or anyone who does not want to deal with the hassle of a hose and compressor. Save up to \$300 a year by not having to buy any fuel cells!

For fasteners see p. 53 Series AY & AX

No Gas. No Hose. No Competition.



1. Energy is stored in a permanently sealed cylinder as compressed nitrogen.

2. Trigger is pulled and energy is released to drive the nail.

3. Motor turns lifter cam which resets the piston for the next shot.



No Hoses, No Compressors, No Hassles. Introducing SENCO's Cordless Gas Finish nailers. Navigate the job site with no restrictions. Powerful motor & high-voltage ignition gives you more power and cleaner combustion.

15 Ga. 2½" Cordless Gas 34° Angled Finish Nailer



Applications

Finish and Trim, Baseboard, Cabinets, Caskets, Chair Rail, Decorative Trim, Furniture Trim, Paneling, Door & Window Casing.

Features

- Cordless convenience
- Powerful motor – High-voltage ignition gives you more power and cleaner combustion
- Metal magazine for increased durability
- Belt Hook
- Thumbwheel Depth-of-Drive
- EZ-Clear Feature
- Includes case, Ni-MH battery & charger



GT65DA

The GT65DA combines power and utility in a well balanced tool. Built with components that ensure all-day durability and reliability, the GT65DA comes with a Ni-MH battery, charger, durable case, service tools.

Specifications

Item#: 5R0001N, Sequential actuation trigger
 Tool Weight: 5.2 lbs (2.36 kg)
 Height: 14.2" (362 mm)
 Length: 12.5" (318 mm)
 Width: 3.6" (91 mm)
 Battery: Ni-MH 6v
 Charger: 100% in 2 hours
 Fuel Cell: SENCO 18g or other compatible fuel

Fastener

Capacity: 110
 Gauge: 15
 Range: 1¼" – 2½"
 Collation: 34° angled taped strip



For fasteners see p. 51 Series DA

16 Ga. 2½" Cordless Gas 20° Angled Finish Nailer



Applications

Finish and Trim, Baseboard, Cabinets, Caskets, Chair Rail, Decorative Trim, Furniture Trim, Paneling, Door & Window Casing.

Features

- Cordless convenience
- Powerful Motor – High-voltage ignition gives you more power and cleaner combustion
- Consistent drives in all weather conditions
- Metal magazine for increased durability
- Belt Hook
- Thumbwheel Depth-of-Drive
- EZ-Clear Feature
- Includes case, Ni-MH battery & charger



GT65RHA

The GT65RHA is perfect for trim crews, remodelers, punch-out work and anyone wanting the freedom of a cordless tool. Built with components that ensure all-day durability and reliability. Comes with a Ni-MH battery, charger, durable case, service tools.

Specifications

Item#: 5S0001N, Sequential actuation trigger
 Tool Weight: 4.9 lbs (2.22 kg)
 Height: 12" (305 mm)
 Length: 12.5" (318 mm)
 Width: 3.6" (91 mm)
 Battery: 6v Ni-MH
 Charger: 100% in 2 hours
 Fuel Cell: SENCO 18g or other compatible fuel

Fastener

Capacity: 110
 Gauge: 16
 Range: 1¼" – 2½"
 Collation: 20° angled glued strip

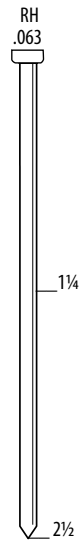

For fasteners see p.52 Series RH





Whether it's finish & trim, cabinets, furniture, hardwood flooring, trim to steel studs, baseboards, upholstery trim panels to door or window casings, we have the finish tool for you. Senco offers a wide selection of 15 through 23 gauge finish nailers.

15 Ga. 2½" 34° Angled Finish Nailer



Applications

Baseboards, cabinets, case goods, caskets, chair rails, decorative trim, door & window casing, sash & millwork, exterior trim, finish applications/trim, furniture and paneling.

Features

- Rugged Internal Engine Design
- Never-Lube® Design
- Magnesium Mainbody - durable & ultra-light
- Adjustable Depth-of-Drive
- EZ-Clear™ Latch
- 360° Adjustable Exhaust
- Comfort Grip and Belt hook
- No-Mar Pad
- Includes Case

Specifications

Item#: 4G0001N Sequential actuation trigger
 Reg. Operating Pressure: 70-120 psi (4.8-8.3 bar)
 Air Consumption (60 cycles per min.): 3.87 scfm
 Air Inlet: 1/4" NPT
 Tool Weight: 4.7 lbs (2.1 kg)
 Height: 11.25" (286 mm)
 Length: 13" (330 mm)
 Width: 3.5" (89 mm)

Fastener

Capacity: 104
 Gauge: 15
 Range: 1¼" – 2½"
 Collation: 34° angled taped strip

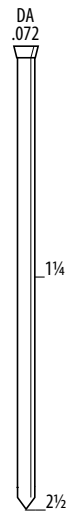

FinishPro® 42XP

The FinishPro® 42XP has established itself as the marquee tool for professional finish carpenters. The FinishPro 42XP has great durability and superior performance.

For fasteners see p. 51 Series DA

15 Ga. 2½" 34° Angled Finish Nailer



Applications

Finish and trim, baseboard, cabinets, caskets, chair rail, decorative trim, door & window casing, furniture trim and paneling.

Features

- Magnesium Mainbody - durable & ultra-light
- Oil-free design
- Adjustable Depth-of-Drive
- EZ-Clear™ Latch
- 360° Adjustable Exhaust
- Comfort Grip and Belt hook
- No-Mar Pad
- Includes Case

Specifications

Item#: 6G0001N Sequential actuation trigger
 Reg. Operating Pressure: 70-120 psi (4.8-8.3 bar)
 Air Consumption (60 cycles per min.): 3.2 scfm
 Air Inlet: 1/4" NPT
 Tool Weight: 4.65 lbs (2.1 kg)
 Height: 12.25" (311 mm)
 Length: 13" (330 mm)
 Width: 3.4" (896 mm)

Fastener

Capacity: 110
 Gauge: 15
 Range: 1¼" – 2½"
 Collation: 34° angled taped strip

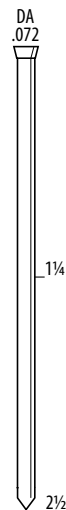

NEW FinishPro® 35Mg

The FIP35Mg's magnesium body delivers an ultra light tool with Senco dependability. The oil-free design, selective actuation, rear exhaust, rotating belt hook, and push-button air blower combine to provide a tool that will perform the toughest jobs while delivering professional results and comfortable operation.

For fasteners see p. 51 Series DA

15 Ga. 2" 34° Angled Finish Nailer



Applications

Baseboards, cabinets, case goods, caskets, chair rails, decorative trim, door & window casing, sash & millwork, exterior trim, finish applications/trim, furniture and paneling.

Features

- Lightweight – 3.6 lbs.
- Never-Lube® Design
- Belt Hook – attached to either side
- Adjustable Depth-of-Drive
- EZ-Clear™ Latch
- Adjustable Exhaust for user comfort
- Ergonomically Designed Comfort Grip handle
- No-Mar Pad – to protect work surfaces
- Includes Case

Specifications

Item#: 620002N Sequential actuation trigger
 Reg. Operating Pressure: 70-120 psi (4.8-8.3 bar)
 Air Consumption (60 cycles per min.): 2.16 scfm
 Air Inlet: ¼" NPT
 Tool Weight: 3.6 lbs (1.6 kg)
 Height: 9.62" (244 mm)
 Length: 12" (305 mm)
 Width: 3.25" (82.5 mm)

Fastener

Capacity: 104
 Gauge: 15
 Range: 1" – 2"
 Collation: 34° angled taped strip

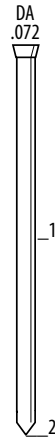

SFN30

Perfect for construction, furniture, cabinets and picture frames, it is one of the lightest 15 gauge tools around.

For fasteners see p. 51 Series DA

16 Ga. 2½" 20° Angled Finish Nailer



Applications

Finish and Trim, Baseboard, Cabinets, Caskets, Chair Rail, Decorative Trim, Door & Window Casing, Furniture Trim and Paneling.

Features

- Magnesium Mainbody-durable & ultra-light
- Oil-Free Motor eliminates oil carryover onto the work surface
- Selectable Trigger lets you control the fastening method with the flip of a switch
- Adjustable Depth-of-Drive
- EZ-Clear™ Latch
- Rotatable Belt Hook and Exhaust
- Includes Case, Swivel Plug and Wrench

Specifications

Item#: 6F0001N Selectable actuation trigger
 Reg. Operating Pressure: 70-120 psi (4.8-8.3 bar)
 Air Consumption (60 cycles per min.): 2.16 scfm
 Air Inlet: ¼" NPT
 Tool Weight: 3.83 lbs (1.74 kg)
 Height: 11.5" (91 mm)
 Length: 12" (305 mm)
 Width: 3" (76 mm)

Fastener

Capacity: 110
 Gauge: 16
 Range: 1¼" – 2½"
 Collation: 20° angled strip

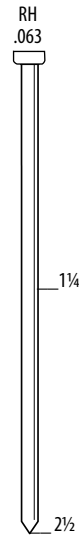

For fasteners see p. 52 Series RH

NEW FinishPro®33Mg

FIP33Mg's magnesium body delivers an ultra light FIP tool with SENCO dependability to provide a tool that will perform the toughest jobs while delivering professional results and comfortable operation.

16 Ga. 2½" Finish Nailer



Applications

Baseboards, cabinets, case goods, chair rail, crown molding, decorative trim, door & window casing, sash and millwork, book shelves and exterior and interior trim.

Features

- Adjustable Depth-Of-Drive
- Ez-Clear™ Latch
- 360° Adjustable Exhaust
- Comfort Grip
- Belt Hook
- No-Mar Pad
- Includes Case

Specifications

Item#: 1X0201N Sequential actuation trigger
 Reg. Operating Pressure: 70-120 psi (4.8-8.3 bar)
 Air Consumption (60 cycles per min.): 2.16 scfm
 Air Inlet: ¼" NPT
 Tool Weight: 4.2 lbs (1.9 kg)
 Height: 10.88" (276 mm)
 Length: 12.16" (307 mm)
 Width: 3" (76 mm)

Fastener

Capacity: 110
 Gauge: 16
 Range: 1¼" – 2½"
 Collation: Straight glued strip

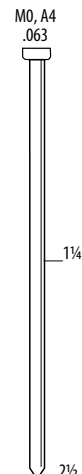

For fasteners see p. 52 Series MO & A4

FinishPro®32

FinishPro®32 provides the versatility a professional contractor demands with redesigned piston and driver for improved performance and durability. Reversed safety foot improves line of sight.

FINISH & TRIM

18 Ga. 2 1/8" Brad Nailer



Applications

Decorative trim, furniture trim, window beading, blind pinning of upholstered and trim panels, rattan, scribe molding, cabinets, drawers and picture frame assembly.

Features

- Drives both slight and medium head brads
- Adjustable depth-of-drive.
- Never-lube® design
- Comfort grip
- Belt hook
- No-mar pad
- Includes case

Specifications

Item#: 760102N Sequential actuation trigger
 Reg. Operating Pressure: 70-120 psi (4.8-8.3 bar)
 Air Consumption (60 cycles per min.): 1.92 scfm
 Air Inlet: 1/4" NPT
 Tool Weight: 2.7 lbs (1.2 kg)
 Height: 9.9" (251 mm)
 Length: 9.8" (249 mm)
 Width: 2.2" (56 mm)

Fastener

Capacity: 110
 Gauge: 18
 Range: 3/8" – 2 1/8"
 Collation: Straight glued strip

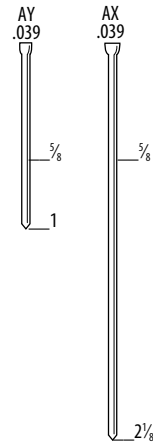

For fasteners see p. 53 Series AY & AX

FinishPro® 25XP

This lightweight, power-packed nailer drives both slight and medium headed brads into the hardest woods. The "on-tool" power adjustment allows the user to increase power by 30% when needed.

18 Ga. 1 5/8" Brad Nailer



Applications

Decorative trim, furniture trim, window beading, blind pinning of upholstered and trim panels, rattan, scribe molding, cabinets, drawers and picture frame assembly.

Features

- Drives both slight and medium-headed brads
- Requires minimum maintenance for trouble-free upkeep
- Muffler ensures quieter operation
- Never-Lube® Design
- Includes Case

Specifications

Item#: 430101N Sequential actuation trigger
 Reg. Operating Pressure: 70-120 psi (4.8-8.3 bar)
 Air Consumption (60 cycles per min.): 1.92 scfm
 Air Inlet: 1/4" NPT
 Tool Weight: 2.3 lbs (1 kg)
 Height: 8.25" (210 mm)
 Length: 9.5" (241 mm)
 Width: 2" (50 mm)

Fastener

Capacity: 110
 Gauge: 18
 Range: 3/8" – 1 1/8"
 Collation: Straight glued strip

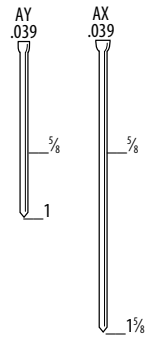

For fasteners see p. 53 Series AX & AY

SLP20XP

The SLP20XP design ensures unmatched ease of use as well as superior precision and driving power, which makes this tool perfect for fastening a variety of material types and thicknesses.

18 Ga. 2 1/8" Brad Nailer



Applications

Decorative trim, furniture trim, window beading, blind pinning of upholstered and trim panels, rattan, scribe molding, cabinets, drawers and picture frame assembly.

Features

- Magnesium Mainbody - durable & ultra-light
- Metal Cylinder for increased durability
- Oil-Free Design
- Adjustable Depth-of-Drive
- Selective Actuation Trigger
- Rotatable Rear Exhaust and Belt Hook
- Swivel Air Plug
- Over-Mold Rubber Comfort Grip
- Includes Case and Wrench

Specifications

Item#: 1U0021N Selectable actuation trigger
 Reg. Operating Pressure: 70-120 psi (4.8-8.3 bar)
 Air Consumption (60 cycles per min.): 2.4 scfm
 Air Inlet: 1/4" NPT
 Tool Weight: 2.48 lbs (1.12 kg)
 Height: 9.75" (248 mm)
 Length: 10.5" (267 mm)
 Width: 2.5" (63.5 mm)

Fastener

Capacity: 110
 Gauge: 18
 Range: 3/8" – 2 1/8"
 Collation: Straight glued strip



For fasteners see p. 53 Series AX

FinishPro® 18Mg

FIP18Mg's magnesium body delivers an ultra light tool with SENCO dependability and the power to drive up to 2 1/8" brads.

18 Ga. 1¼" Brads and 1" Staples



Applications

Nailing: Furniture repair, cabinets, drawer assembly, case backs, small trim, chair rails, picture frames and ornamentals.

Stapling: Shelving, soffits, fascia, cabinets, picture frames and craft assembly.

Features

- Drives both brads and staples
- Rear Exhaust
- Adjustable Depth-Of-Drive
- Comfort Grip
- No-Mar Pad
- Includes Case, Fitting, Oil and Hex Wrench

Specifications

Item#: 2D0101N, Sequential actuation trigger
 Reg. Operating Pressure: 70-120 psi (4.8-8.3 bar)
 Air Consumption (60 cycles per min.): 3.2 scfm
 Air Inlet: ¼" NPT
 Tool Weight: 2.75 lbs (1.25 kg)
 Height: 10" (254 mm)
 Length: 13" (330 mm)
 Width: 3.4" (86 mm)

Fastener

Capacity: 110
 Gauge: 18
Brad range: ⅝" – 1¼"
Staple range: ¼" crown, ½" – 1"
 Collation: Glued strip

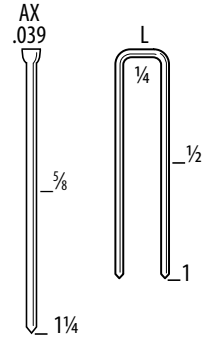

FinishPro®2N1

The 2N1 offers both brad nailing and stapling in a single tool for maximum versatility.

For fasteners see p. 53 Series AX and p. 66 Series L

23 Ga. 2" Micro Pinner



Applications

Cabinet, decorative trim, glazing bead, carvings, picture frames and molding.

Features

- Extra Power – for use with hard wood
- Rear Exhaust – directs oil and dust away from work surface
- Switchable Trigger With Lock
- Comfort Grip
- Belt Hook
- No-Mar Pad
- Includes Case, Fittings, Wrench and Tool Oil

Specifications

Item#: 4N0001N Switchable trigger with lock
 Reg. Operating Pressure: 70-120 psi (4.8-8.3 bar)
 Air Consumption (60 cycles per min.): 1.2 scfm
 Air Inlet: ¼" NPT
 Tool Weight: 2.7 lbs (1.2 kg)
 Height: 9.6" (243 mm)
 Length: 10" (256 mm)
 Width: 2.38" (61 mm)
 Lip Length: 1" (25 mm)

Fastener

Capacity: 106
 Gauge: 23
 Range: 1" – 2"
 Collation: Straight glued strip

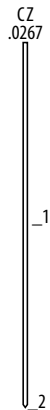

FinishPro®11

The FIP11 23 ga. Micro Pinner has the power to drive 1" – 2" headless pins into hardwoods. The pins fasten the smallest of decorative trim securely and leave a nearly invisible hole – no splitting or puttying.

For fasteners see p. 53 for SENCO Micro Pins

23 Ga. 1" Micro Pinner



Applications

Cabinet, decorative trim, glazing bead, carvings, picture frames and molding.

Features

- Extra Power – for use with hard wood
- Easy Fastener Length Adjustment
- Rear Exhaust
- Low Load Fastener Indicator
- Magazine Bumper Pad
- Includes Case, Fittings, Wrench and Tool Oil

Specifications

Item#: 2C0001N Sequential actuation trigger
 Reg. Operating Pressure: 70-95 psi (4.8-6.5 bar)
 Air Consumption (60 cycles per min.): 0.84 scfm
 Air Inlet: ¼" NPT
 Tool Weight: 2.4 lbs (1.1 kg)
 Height: 6.75" (171 mm)
 Length: 8.89" (225 mm)
 Width: 1.64" (41 mm)

Fastener

Capacity: 110
 Gauge: 23
 Range: ½" – 1"
 Collation: Straight glued strip

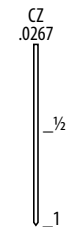

FinishPro®10

This 23 ga. Micro Pinner is the perfect tool for your intricate finish and trim projects. The pins fasten the smallest of decorative trim securely and leave a nearly invisible hole – no splitting or puttying.

For fasteners see p. 53 for SENCO Micro Pins

COMPARE APPLICATIONS & FEATURES



	15 Gauge	15 Gauge	15 Gauge	15 Gauge	15 Gauge	16 Gauge	16 Gauge	16 Gauge
APPLICATIONS	F-15	GT65DA	FIP42XP	FIP35Mg	SFN30	F-16A	F-16S	GT65RHA
Cabinets	X	X	X	X	X	X	X	X
Baseboards	X	X	X	X	X	X	X	X
Chair rail	X	X	X	X	X	X	X	
Decorative trim						X	X	X
Door/window casings	X	X	X	X	X	X	X	X
Furniture	X	X	X	X	X	X	X	X
Hardwood floors	X	X	X	X	X			
Molding & trim	X	X	X	X	X	X	X	X
Picture frames						X	X	X
Scribe molding								X
Trim to steel studs	X	X	X	X	X			
Window beading								
FEATURES								
Fastener Range	1¼"-2½"	1¼"-2½"	1¼"-2½"	1¼"-2½"	1"-2"	1¼"-2½"	¾"-2½"	1¼"-2½"
Shank	.072"	.072"	.072"	.072"	.072"	.063"	.063"	.063"
Fastener Capacity	110	110	104	110	104	110	110	110
Weight	6.2 lbs	5.2 lbs	4.7 lbs	4.65 lbs	3.6 lbs	6.2 lbs	6 lbs	4.9 lbs
Height	13"	14.2"	11.25"	12.25"	9.62"	13"	13"	12"
Length	13"	12.5"	13"	13"	12"	13"	11"	12.5"
Mainbody	Al / Composite	Composite	Mg	Mg	Composite	Al / Composite	Al / Composite	Composite
Depth-of-Drive	X	X	X	X	X	X	X	X
Jam EZ-Clear	X	X	X	X	X	X	X	X
Trigger Actuation*	Sel	S	S,C	S	S,C	Sel	Sel	S
Belt Hook	X	X	X	X	X	X	X	X
NeverLube/No-oil design	X		X	X		X	X	X
Exhaust		Fixed	Adjustable	Adjustable	Adjustable			Fixed
Warranty	2 yrs	2 yrs	5 yrs	1 yr	1 yr	2 yrs	2 yrs	2 yrs
	F-15	GT65DA	FIP42XP	FIP35Mg	SFN30	F-16A	F-16S	GT65RHA

* Trigger Actuation:
S: Sequential, C: Contact, Sel: Selectable

FINISH & TRIM



16 Gauge	18 Gauge	18 Gauge	18 Gauge	18 Gauge	18 Gauge	18 Gauge	23 Gauge	23 Gauge
FIP33Mg	FIP32	F-18	FIP25XP	SLP20XP	FIP18Mg	FIP2N1	FIP11	FIP10
X	X	X	X	X	X	X		
X	X	X	X	X	X	X		
X	X	X	X	X	X	X	X	X
X	X	X	X	X	X	X	X	X
X								
X	X	X	X	X	X	X		
X	X	X	X	X	X	X		
X	X	X	X	X	X	X		
X	X	X	X	X	X	X		
X	X	X	X	X	X	X		
							X	X
1¼"-2½"	1¼"-2½"	⅝"-2⅞"	⅝"-2⅞"	⅝"-1⅝"	⅝"-2⅞"	½"-1¼"	1"-2"	½"-1"
.063"	.063"	.039"	.039"	.039"	.039"	.039"	.0267"	.0267"
110	110	110	110	110	110	110	106	110
3.83 lbs	4.2 lbs	6 lbs	2.7 lbs	2.3 lbs	2.48 lbs	2.75 lbs	2.7 lbs	2.4 lbs
11.5"	10.88"	13"	9.9"	8.25"	9.75"	10"	9.6"	6.75"
12"	12.16"	11"	9.8"	9.5"	10.5"	13"	10"	8.89"
Mg	Mg	Al / Composite	Al	Al	Mg	Al	Al	
X	X	X	X		X			
X	X	X	X	X	X	X		
Sel	S	Sel	S, C	S, C	Sel	S	S	S
X	X	X	x		X	X		
X	X							
Adjustable	Adjustable		Adjustable	Fixed	Rear Adj.	Rear	Rear Adj.	Rear
1 yr	1 yr	2 yrs	5 yrs	5 yrs	1 yr	1 yr	1 yr	1 yr
FIP33Mg	FIP32	F-18	FIP25XP	SLP20XP	FIP18Mg	FIP2N1	FIP11	FIP10

FRAMING & SHEATHING



Whether you are framing, sheathing, truss building, sub-flooring, decking, crate and box assembly, pallet making or fencing, we have the tool for you. SENCO offers a wide selection of strip and coil framing and sheathing nailers.

CORDLESS GAS POWERED FRAMING & SHEATHING

No Hoses, No Compressors, No Hassles.

3½" 34° Clipped Head Framing Nailer



GT90CH

GT90CH cordless clipped gas framer combines the convenience of a cordless tool with the power and utility of a pneumatic framing nailer.

Applications

Perfect for framing crews, remodelers, punch-out or service crews. Built for durability and reliability, the GT90CH comes with a Ni-MH battery, charger, case and service tools.

Features

- Power to drive 3½" framing nails
- Cordless Convenience
- Powerful Motor
- Adjustable Depth-of-Drive
- Durable Metal Magazine
- Rafter Hook
- Full Comfort Grip
- Includes Plastic Case, Ni-Mh Battery, Charger, Service Tools

Specifications

Item#: 5F0001N Sequential actuation trigger
 Tool Weight: 7.9 lbs (3.6 kg)
 Height: 14.8" (376 mm)
 Length: 14.6" (371 mm)
 Width: 4.2" (107 mm)
 Battery: 6 volt Ni-MH
 Charger: 2 hours
 Fuel Cell: SENCO 40g or other compatible fuel

Fastener

Capacity: 70
 Shank Diameter: .113" - .131"
 Range: 2" - 3½"
 Collation: 34° angled taped strip

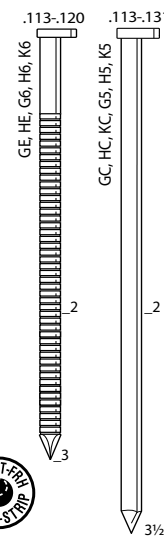

For fasteners see p. 54-55 Series GE, HE, GC, HC, KC RoundStrip P.56: G5, H5, K5, G6, H6, K6

3½" 20° Full Round Head Framing Nailer



GT90FRH

GT90FRH cordless full round head gas framer combines the convenience of a cordless tool with the power and utility of a pneumatic framing nailer.

Applications

Perfect for framing crews, remodelers, punch-out or service crews. Built for durability and reliability, the GT90FRH comes with a Ni-MH battery, charger, case and service tools.

Features

- Power to drive 3½" framing nails
- Cordless convenience
- Powerful Motor
- Adjustable Depth-of-Drive
- Durable Metal Magazine
- Rafter Hook
- Full Comfort Grip
- No-Mar Pad
- Includes Plastic Case, Ni-Mh Battery, Charger, Service Tools

Specifications

Item#: 5G0001N Sequential actuation trigger
 Tool Weight: 7.9 lbs (3.6 kg)
 Height: 14.5" (370 mm)
 Length: 14.7" (373 mm)
 Width: 4.2" (107 mm)
 Battery: 6 volt Ni-MH
 Charger: 2 hours
 Fuel Cell: SENCO 40g or other compatible fuel

Fastener

Capacity: 32
 Shank Diameter: .113" - .131"
 Range: 2" - 3½"
 Collation: 20° angled glued strip

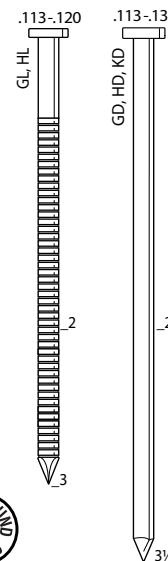

For fasteners see p. 58-59 Series GL, HL, GD, HD, KD

3 1/4" 34° Clipped Head Framing Nailer



Applications

Framing, sheathing, truss building, sub-flooring and decks. Other applications include crate and box assembly, pallet making, furniture frame assembly and fencing.

Features

- Well balanced and ultra-light – 7.8 lbs.
- Uses less air to drive nails – Highly efficient internal design
- Dry file Lockout
- Reduced jams and mis-feeds – Easier jam clearing, one nail magazine removal
- Easily fits between studs and joists
- Retractable Rafter Hanger
- Contact or Sequential Trigger Actuation – Patented drive selector

Specifications

Item#: 4Z0001N Selectable actuation trigger
Reg. Operating Pressure: 70-120 psi (4.8-8.3 bar)
Air Consumption (60 cycles per min.): 5.2 scfm
Air Inlet: 3/8" NPT
Tool Weight: 7.8 lbs (3.54 kg)
Height: 11.9" (302 mm)
Length: 17.3" (440 mm)
Width: 4.5" (114 mm)

Fastener

Capacity: 83
Shank Diameter: .113" - .131"
Range: 2" – 3 1/4"
Collation: 34° angled taped strip

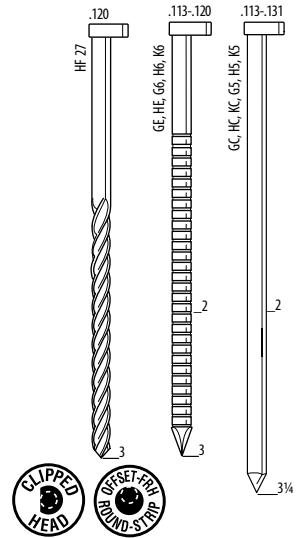

For fasteners see p. 54-55 Series HF, GE, HE, GC, HC, KC
RoundStrip P. 56: G5, H5, K5, G6, H6, K6

SN901XP

This SN901XP framing nailer packs plenty of power. Specifically engineered for demanding pros and demanding environments. Built with enhanced features and superior components.

4" 34° Clipped Head Framing Nailer



Applications

For engineered lumber, framing, sheathing, truss building, sub-floor, decking, crate, box assembly, pallet making, furniture frame assembly, fencing and industrial applications.

Features

- 20% more powerful than standard framing nailers – yet weighs only 8.5 lbs.
- Tool-Free Depth-of-Drive
- Retractable Rafter Hanger
- Reduced jams and mis-feeds – Patented TrueDrive™ Magazine
- Low profile design fits easily between studs and joists.
- Contact or Sequential Trigger Actuation – Patented drive selector

Specifications

Item#: 5B0001N Selectable actuation trigger
Reg. Operating Pressure: 70-120 psi (4.8-8.3 bar)
Air Consumption (60 cycles per min.): 7.9 scfm
Air Inlet: 3/8" NPT
Tool Weight: 8.5 lbs (3.86 kg)
Height: 13.8" (351 mm)
Length: 17.3" (440 mm)
Width: 4.76" (121 mm)

Fastener

Capacity: 83
Shank Diameter: .113" – .131"
Range: 2 3/8" – 4"
Collation: 34° angled taped strip

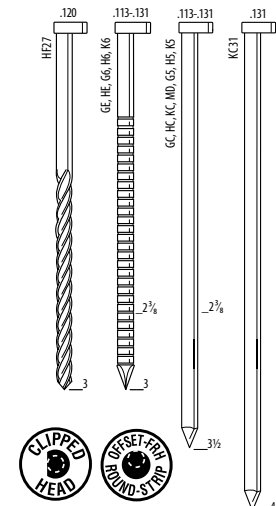

For fasteners see p. 54-55 Series HF, GE, HE, GC, HC, KC
RoundStrip P. 56: G5, H5, K5, G6, H6, K6

SN951XP

The SN951XP will consistently drive up to a 4" x .131" nail making it both versatile and exceptionally powerful.

3 1/2" 34° Clipped Head Framing Nailer



Applications

Framing, truss building, subflooring, sheathing, decking, siding, fencing, pallets and crate assembly

Features

- Selectable Trigger Actuation
- Sawtooth Safety that digs in for precision toenailing
- Shorter, straight-line 34° magazine for better line of sight and superior maneuverability
- Reliable Internal Design with full round driver
- Tool-Free Adjustable Exhaust
- Well-balance and powerful
- Tool-Free Adjustable Depth-of-Drive Control
- Soft Comfort Grip handle reduces fatigue

Specifications

Item#: 1G0101N Selectable actuation trigger
Reg. Operating Pressure: 70-120 psi (4.8-8.3 bar)
Air Consumption (60 cycles per min.): 10 scfm
Air Inlet: 3/8" NPT
Tool Weight: 8 lbs (3.62 kg)
Height: 13.5" (343 mm)
Length: 15.13" (384 mm)
Width: 4.17" (106 mm)

Fastener

Capacity: 70
Shank Diameter: .113" – .131"
Range: 2" – 3 1/2"
Collation: 34° angled taped strip

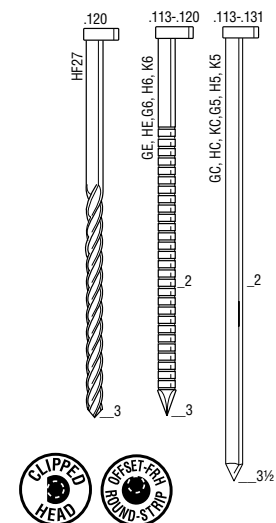

For fasteners see p. 54-55 Series GE, HC, KC, HF, GE, HE
RoundStrip P. 56: G5, H5, K5, G6, H6, K6

NEW FramePro601

This clipped head nailer provides all the important features you want at an affordable price. Drives a wide range of fasteners in three gauges (.120, .113, .131) from 2" to 3 1/2" to handle virtually any job.

FRAMING & SHEATHING

3/4" 20° Full Round Head Framing Nailer



Applications

Framing, sheathing, truss building, sub-flooring and decks. Other applications include crate and box assembly, pallet making, furniture frame assembly and fencing.

Features

- Well balanced and ultra-light – 7.9 lbs.
- Uses less air to drive nails – Highly efficient internal design
- Reduced jams and mis-feeds – Patented TrueDrive™ magazine
- Easily fits between studs and joists
- Retractable rafter hanger
- Contact or sequential trigger actuation – Patented drive selector

Specifications

Item#: 4H0001N Selectable actuation trigger
 Reg. Operating Pressure: 70-120 psi (4.8-8.3 bar)
 Air Consumption (60 cycles per min.): 5.2 scfm
 Air Inlet: 3/8" NPT
 Tool Weight: 7.9 lbs (3.58 kg)
 Height: 11.9" (302 mm)
 Length: 17.3" (440 mm)
 Width: 4.5" (114 mm)

Fastener

Capacity: 64
 Shank Diameter: .113"– .148"
 Range: 2"– 3 1/4"
 Collation: 20° angled glued strip

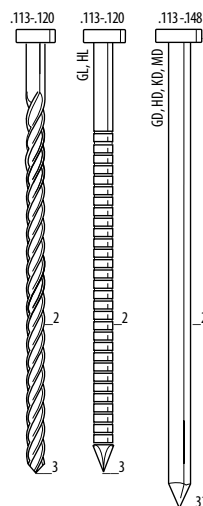

For fasteners see p 58-59
 Series GL, HL, GD, HD, KD, MD

SN902XP

This well-balanced ultra-light SN902XP framing nailer packs plenty of power and won't leave you fatigued at the end of the day.

3 1/2" 20° Full Round Head Framing Nailer



Applications

Framing, sheathing, truss building, sub-flooring and decks. Other applications include crate and box assembly, pallet making, furniture frame assembly and fencing.

Features

- Well balanced and weight only 8.4 lbs.
- Uses less air to drive nails – Highly efficient internal design
- Reduced jams and mis-feeds – Patented TrueDrive™ magazine
- Easily fits between studs and joists
- Retractable rafter hanger
- Contact or sequential trigger actuation – Patented drive selector

Specifications

Item#: 5A0001N Selectable actuation trigger
 Reg. Operating Pressure: 70-120 psi (4.8-8.3 bar)
 Air Consumption (60 cycles per min.): 7.9 scfm
 Air Inlet: 3/8" NPT
 Tool Weight: 8.4 lbs (3.8 kg)
 Height: 13.57" (345 mm)
 Length: 20.3" (516 mm)
 Width: 4.75" (121 mm)

Fastener

Capacity: 64
 Shank Diameter: .120"– .162"
 Range: 2 3/8"– 3 1/2"
 Collation: 20° angled glued strip

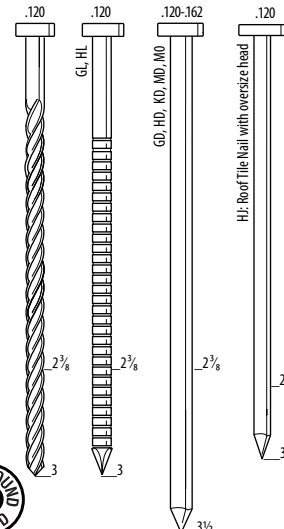

For fasteners see p.58-59
 Series GL, HL, GD, HD, KD, MD

SN952XP

Drives up to .162" shank, 3 1/2" nails into the toughest engineered lumbers. This tool has the power and fastener range to dominate the toughest jobs.

3 1/2" 20° Full Round Head Framing Nailer

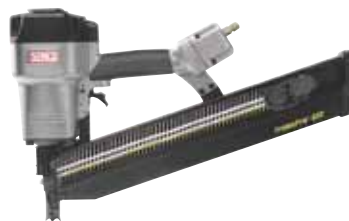

Applications

Framing, truss building, subflooring, sheathing, decking, siding, fencing, pallets and crate assembly.

Features

- Sawtooth safety that digs in for precision toenailing
- 20" In-line magazine for better line of sight and superior maneuverability
- Reliable internal design with full round driver
- Dry fire lockout
- Adjustable exhaust
- Well-balance and powerful
- Adjustable depth-of-drive control
- Soft comfort grip handle reduces fatigue

Specifications

Item#: 1E0003N Selectable actuation trigger
 Reg. Operating Pressure: 70-120 psi (4.8-8.3 bar)
 Air Consumption (60 cycles per min.): 10 scfm
 Air Inlet: 3/8" NPT
 Tool Weight: 8.4 lbs (3.8 kg)
 Height: 13.5" (343 mm)
 Length: 20" (508 mm)
 Width: 4.17" (106 mm)

Fastener

Capacity: 60
 Shank Diameter: .113"– .148"
 Range: 2"– 3 1/2"
 Collation: 20° angled taped strip

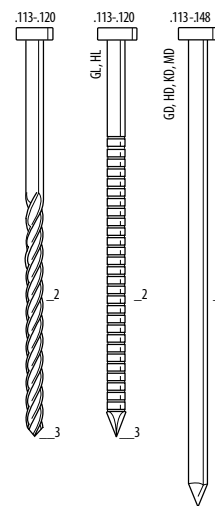

For fasteners see p. 58-59
 Series GL, HL, GD, HD, KD, MD

FramePro602

A Full Round Head Nailer that provides all the important features you want at an affordable price. Power to drive a wide range of fasteners in four gauges (.113 - 148) from 2" to 3 1/2" to handle virtually any job.



2" - 3½" Bulk Nailer



Applications

Joist hangers, foundation anchors, seismic and hurricane straps, ties and other metal framing hardware.

Features

- Compact & powerful enough to drive 2" - 3½" bulk nails
- Small size for accessibility
- Ultra-light at just 1 lbs
- Magnetic Nose holds nail in place for safe, accurate placement
- Nail point can be easily placed within a recess for safe, efficient fastening
- Included Fitting provides plug-and-play convenience out of the box

Specifications

Item #: PC1195
 Reg. Operating Pressure: 60-110 psi (4-7.6 bar)
 Air Consumption (60 cycles per min.): 2-4 scfm
 Air Inlet: 1/4" NPT
 Tool Weight: 1 lbs (.45 kg)
 Height: 4" (101 mm)
 Length: 2.75" (70 mm)
 Width: 2" (55.6 mm)

Fastener

Capacity: 1
 Range: Bulk nails from 2" - 3½"

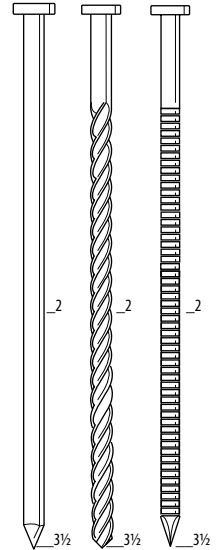

PC1195 Mini Hand Nailer

Drives bulk nails up to 3½" in applications to tight to swing a hammer.

2" - 7" Bulk Nailer



Applications

Joist hangers, foundation anchors, seismic and hurricane straps, ties and other metal framing hardware.

Features

- Drives bulk nails from 2" to 7"
- Soft rubber palm pad for comfortable grip
- Magnetic Nose holds nail in place for safe, accurate placement
- Includes Leather Strap - reduces fatigue

Specifications

Item #: PC0781
 Reg. Operating Pressure: 50-125 psi (3.5-8.4 bar)
 Air Consumption (60 cycles per min.): 2-4 scfm
 Air Inlet: 3/8" NPT
 Tool Weight: 2.4 lbs (1.1 kg)
 Height: 5.8" (122 mm)
 Length: 4" (101 mm)
 Width: 3.25" (83 mm)

Fastener

Capacity: 1
 Range: Bulk nails from 2" - 3½" and up to 7" with optional guide tips

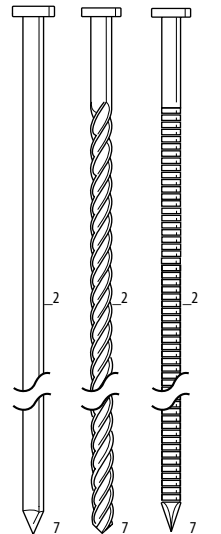

A20 Hand Nailer

The Senco A20 bulk pneumatic hand nailer is the ideal tool for tight space nailing and metal connector attachment.

COMPARE APPLICATIONS & FEATURES

Clipped Head Nailers



APPLICATIONS	GT90CH	SN901XP	SN951XP	FramePro601
Framing/Sheathing	X	X	X	X
Truss building	X	X	X	X
Subflooring	X	X	X	X
Decking	X	X	X	X
Fencing	X	X	X	X
Pallets	X	X	X	X
Crate, boxes				
Siding				
Clay tiles				
Wood to green concrete			X	
Metal framing hardware				
FEATURES				
Fastener Range	2"-3½"	2"-3¼"	2¾" - 4"	2"-3½"
Shank	.113"-.131"	.113"-.131"	.113"-.131"	.113"-.131"
Fastener Capacity	70	83	83	70
Weight	7.9 lbs	7.8 lbs	8.5 lbs	8 lbs
Height	14.8"	11.9"	13.8"	13.5"
Length	14.6"	17.3"	17.3"	15.13"
Depth-of-Drive	X	X	X	X
Trigger Actuation*	S	Sel.	Sel.	Sel.
Rafter Hook	X	X	X	
Warranty	2 yrs	5 yrs	5 yrs	1 yr
	GT90CH	SN901XP	SN951XP	FramePro601

* Trigger Actuation:
S: Sequential, C: Contact, Sel: Selectable

Round Head Nailers



GT90FRH

SN902XP

SN952XP

FramePro602

PC1195

A20

X

X

X

X

X

X

X

X

X

X

X

X

X

X

X

X

X

X

X

X

X

X

X

X

X

X

X

X

X

X

X

X

X

X

X

X

X

X

X

X

X

X

X

X

X

X

X

X

X

X

X

X

X

2"-3½"

2"-3¼"

2¾"-3½"

2"-3½"

2"-3½"

2"-7"

.113"-.131"

.113"-.148"

.120"-.162"

.113"-.148"

Bulk

Bulk

32

64

64

60

1

1

7.9 lbs

7.9 lbs

8.4 lbs

8.4 lbs

1 lb

2.4 lbs

14.5"

11.9"

13.57"

13.5"

4"

5.8"

14.7"

17.3"

20.3"

20"

2.75"

4"

X

X

X

X

S

Sel.

Sel.

Sel.

X

X

X

2 yrs

5 yrs

5 yrs

1 yr

1 yr

1 yr

GT90FRH

SN902XP

SN952XP

FramePro602

PC1195

A20

ROOFING



SENCO has dependable tools for all your roofing applications, including our popular RoofPro™ Coil Nailers and our 1" Wide Crown WC150RXP Stapler for asphalt and fiberglass shingle fastening. For installing house wrap and felt paper we offer the BC58 Button Cap Stapler and A11 Stapler.

1 3/4" Coil Nailer



RoofPro™ 455XP

Step up to the tough and dependable RoofPro 455XP Coil Nailer. It's loaded with the features you asked for, yet is light enough for one-handed operation. Simply the best roofing nailer money can buy.

Applications

For asphalt and fiberglass shingle nailing, for both new roofs and reroofing. Also for attaching waterproof tar paper, metal drip edges, insulation board, and with an optional attachment for vinyl and aluminum siding.

Features

- Aluminum Mainbody and Cap
- Easy one-handed operation, just 5.4 lbs.
- Tool-Free Adjustable Depth-of-Drive
- Durable Molded Comfort Grip
- 360° Tool-Free Adjustable Exhaust
- Adjustable Shingle Guide
- Steel Wear plates reduce shingle abrasion
- Adjustable Nail Canister
- Tool Includes Case, Tool Oil and Wrench

Specifications

Item#: 3D0101N Sequential actuation trigger
 Reg. Operating Pressure: 70-120 psi (4.8-8.3 bar)
 Air Consumption (60 cycles per min.): 6.54 scfm
 Air Inlet: 1/4" NPT
 Tool Weight: 5.4 lbs (2.5 kg)
 Height: 10.5" (267 mm)
 Length: 10.25" (260 mm)
 Width: 4.5" (50 mm)

Fastener

Capacity: 120
 Gauge: 11 (.120") (3.0 mm)
 Range: 3/4" – 1 3/4"
 Collation: Angular, flat wire wound coil

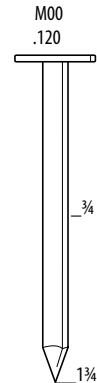

For fasteners see p.63 coil roofing nails

1 3/4" Coil Nailer



RoofPro™ 450

The RoofPro450 Coil Nailer has steel wear plates and fully adjustable shingle guide, drive depth and exhaust.

Applications

For asphalt and fiberglass shingle nailing, for both new roofs and reroofing. Also for attaching waterproof tar paper, metal drip edges, insulation board.

Features

- Aluminum Mainbody and Cap
- Adjustable Depth-of-Drive
- 360° Adjustable Exhaust and Adjustable Shingle Guide
- Steel Wear plates reduces shingle abrasion
- Adjustable Nail Canister
- Tool Includes Case, Tool Oil and Wrench

Specifications

Item#: 3C0001N Sequential actuation trigger
 Reg. Operating Pressure: 70-120 psi (4.8-8.3 bar)
 Air Consumption (60 cycles per min.): 5.79 scfm
 Air Inlet: 1/4" NPT
 Tool Weight: 5.62 lbs (2.55 kg)
 Height: 10.88" (276 mm)
 Length: 10.25" (260 mm)
 Width: 4.5" (114 mm)

Fastener

Capacity: 120
 Gauge: 11 (.120") (3.0 mm)
 Range: 3/4" – 1 3/4"
 Collation: Angular, flat wire wound coil

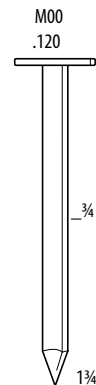

For fasteners see p.63 coil roofing nails

16 Ga. 1" Crown 1½" Roofing Stapler



Applications:

Asphalt and fiberglass shingles, roofing felt, carton-to-skid, furniture frames, wire lathing, butt-joints, and foam insulation board.

Features

- Adjustable Depth-of-Drive
- Carbide Wear Plates protect tool from shingles
- High-Strength Composite Magazine helps eliminate skipping, jams, and misfires
- EZ-Clear Latch provides easy access to clear fasteners
- Long Lasting Wear Plates and Carbide Safety
- Rotating Belt Hook makes the tool portable and easily to stow

Specifications

Item#: 4X0001N: Contact actuation trigger
 Operating Pressure: 70-120 psi (4.8-8.3 bar)
 Air Consumption (60 cycles per min.): 3.18 scfm
 Air Inlet: 3/8" NPT
 Tool Weight: 5.5 lbs (2.5 kg)
 Height: 9" (229 mm)
 Length: 15.25" (387 mm)
 Width: 4" (105 mm)

Fastener

Capacity: 160
 Gauge: 16
 Crown: 1"
 Range: 5/8" – 1½"
 Collation: Straight glued taped strip

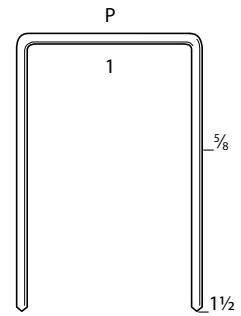

WC150RXP

This heavy-duty wide crown roofing stapler is capable of handling a variety of applications. Constructed of durable, high-quality, high-strength materials, the WC150RXP is designed for extreme performance and long life.

For fasteners see p. 69 Series P

½" Crown 5/8" Staple + 1" Button Cap



Applications

For house wrap and roofing felt installation.

Features

- Cap Capacity – 110 cap collation
- Easy Load System for staples and caps
- Aluminum Housing – ultra-light 4.1 lbs.
- Balanced and fast for high production
- Belt Hook
- Side Mount Cap Collator – holds caps regardless of tool position
- Includes Case, Hex Wrenches, Tool Oil, ¼" Male Coupler and Manual

Specifications

Item#: 4A0001N Contact actuation trigger
 Reg. Operating Pressure: 60-95 psi (4.1-6.5 bar)
 Air Inlet: 1/4" NPT
 Tool Weight: 4.1 lbs (2 kg)
 Height: 8.5" (216 mm)
 Length: 12.5" (317 mm)
 Width: 3.5" (89 mm)

Fastener

Capacity: 110
 Item#: M004092
 2200 button caps and staples per box.
 Staple:
 Gauge: 21, Crown ½"
 Range: 5/8" galv.
 Cap: 1" plastic, driven with staple in tandem.

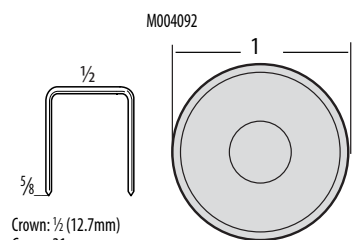

Crown: ½" (12.7mm)
 Gauge: 21
 2200 button caps and staples per box.
 Drives 21 ga. staples with 1" plastic caps in tandem.

BC58 Button Cap Stapler

SENCO's BC58 Button Cap Stapler saves time and money when installing felt paper and house wrap. Drives 21 gauge ½" crown, 5/8" staples with plastic caps in tandem.

For fasteners see p 71 Series M004092 Button Cap

20 Ga. 7/16" Crown 3/8" Hammer Stapler



Applications

For house wrap and roofing felt installation.

Features

- Rugged all-Steel Construction
- Easy to service and maintain
- Comfortable Fluted Handle with Grip
- Magazine holds 168 staples

Specifications

Item#: PC0700
 Tool Weight: 2 lbs (.9 kg)
 Height: 1.75" (44.4 mm)
 Length: 12.3" (312.4 mm)

Fastener

Capacity: 168
 Gauge: 20
 Range: 3/8"
 Crown: 7/16"

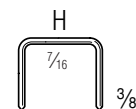

A11 Stapling Hammer

Fast and hose free stapler for installation of roofing felt, plastic sheeting, moisture wrap and insulation.

For fasteners see p. 65 Series H

SPECIALTY ROOFING APPLICATIONS



When installing wood shakes go with our SCN49 Coil Nailer or the SNS Series of Staplers using our stainless steel nails or staples. Clay tiles can be laid faster without breakage with our SN952XP Nailers driving the HJ oversized head roof tile nail.

Cedar Shakes: 2½" Coil Nailer



SCN49

Item #: 5J0001N

Specifications:

See page 23 for tool specifications

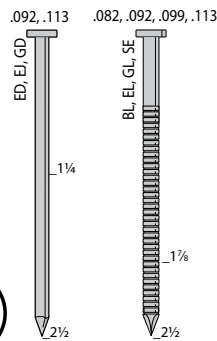

Fastener:

Drives hot dipped galv. and stainless
Shank Diameter: .082-.113
Range: 1¼" - 2½"

For fasteners see p. 60-62 Series ED, EJ, GD, BL, EL, GL

Cedar Shakes: 16 Ga. 7/16" Crown 2" Heavy Wire Staples



SNS Series

SNS41, SNS44XP,
SNS45XP, SNS50XP

Specifications

See pages 32-33 for tool specifications

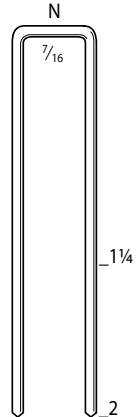

Fastener

Capacity 160, Gauge: 16, Crown: 7/16"
Range: 1¼" - 2" stainless steel staples

For fasteners see p. 68 Series N stainless

Clay Roof Tiles: 3½" 20° Full Round Head Nailers



SN952XP

Item #: 5A0001N

See page 14 for tool specifications

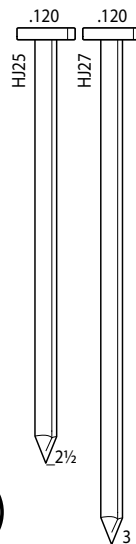

Tile Fastener

Drives oversized head roof tile nails
20° smooth shank
Shank Diameter: .120"
HJ Tile Nail Range: 2½" - 3"

For fasteners see p. 58 Series HJ

COMPARE APPLICATIONS & FEATURES



COIL NAIL



COIL NAIL



1" CROWN STAPLE



1" BUTTON CAP



7/16" CROWN STAPLE



COIL NAIL



7/16" CROWN STAPLE



20° FRH NAILER

APPLICATIONS	RP455XP	RP450	WC150RXP	BC58	A11	SCN49	SNS SERIES	SN952XP
Composite Shingles	X	X	X					
Wood Shakes						X	X	
Clay Tile Shingles								X
Roofing Felt	X	X	X	X	X			
Vapor Barriers			X	X	X			
Insulation Board	X	X	X	X			X	
Cement Board	X	X	X			X	X	
FEATURES								
Fastener Range	¾"-1¾"	¾"-1¾"	⅝"-1½"	⅝", 1" Cap	⅜"	1¼"-2½"	1"-2"	2⅜"-3½"
Shank/Crown	.120"	.120"	16 ga. x 1"	½" Cr.	20 ga. x 7/16"	.082"-.113"	16 ga. x 7/16"	.120"-.162"
Fastener Capacity	120	120	160	110	168	250-375	140-160	64
Weight	5.4 lbs.	5.62 lbs.	5.5 lbs.	4.1 lbs.	2 lbs.	5.1 lbs.	See pages 34-35 for Model Dimensions	8.4 lbs.
Height	10.5"	10.88"	9"	8.5"	1.75"	12"		13.57"
Length	10.25"	10.25"	15.25"	12.5"	12.3"	12.25"		20.3"
Depth-of-Drive	X	X	X			X	X	X
Jam EZ-Clear	X	X	X			X	X	
Trigger Actuation*	S, C	S, C	C	C		Sel.	S, C	Sel.
Exhaust	Adjustable	Adjustable	Cap-fixed	Adjustable		Adjustable	Adjustable	Cap-fixed
Warranty	5 yrs	1 yr	5 yrs	1 yr	1 yr	1 yr	1-5 yrs	5 yrs
	RP455XP	RP450	WC150RXP	BC58	A11	SCN49	SNS SERIES	SN952XP

* Trigger Actuation:
S: Sequential, C: Contact, Sel: Selectable

COIL NAILERS



SENCO has the right Coil Nailer for your application, be it framing and sheathing, decking, subflooring, wood to masonry, cement board, underlayment, pallets, packaging, crate and box assembly, siding or fencing. Available in XtremePro™, ProSeries™ and PalletPro™ with nail ranges from 1¼" - 5½".

3½" Coil Nailer



SCN65XP

This rugged coil nailer drives up to a 3½" nail, while still being light enough for a one-handed operation. It can hold up to 275 nails for maximum productivity in a wide variety of applications.

Applications

For on-site, manufactured housing, including framing, sheathing, decking, subflooring, and exterior decks. Also, industrial markets such as heavy-duty pallet construction, pallet repair, and crate and box assembly.

Features

- Highest Power-to-Weight Ratio in its class
- Light enough for one-handed operation
- Adjustable Depth-of-Drive
- Fast cycle time increases productivity
- E-Z Load Design saves time

Specifications

Framers Item#: 540104N Contact actuation trigger with toenail safety
540101N Contact actuation trigger
Reg. Operating Pressure: 70-120 psi (4.8-8.3 bar)
Air Consumption (60 cycles per min.): 9.54 scfm
Air Inlet: 3/8" NPT
Tool Weight: 8 lbs (3.6 kg)
Height: 14.1" (359 mm)
Length: 12.88" (327 mm)
Width: 5.38" (137 mm)

Fastener

Capacity: 225-275
Shank Diameter: .099" - .131"
Range: 2" - 3½"
Collation: Flat, 15° angled coil wire

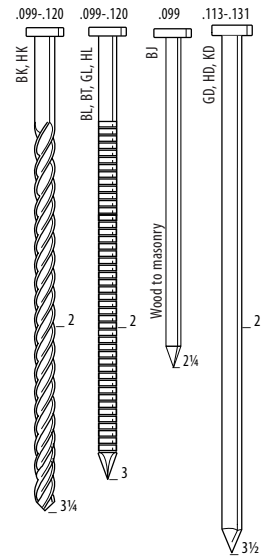

For fasteners see p. 60-61 Series BK, HK, BL, BT, GL, HL, BJ, GD, HD, KD

2¾" Coil Nailer



SCN60XP

Powerful yet lightweight, this coil nailer drives up to a 2¾" nail. It can hold up to 275 nails for maximum productivity in a wide variety of applications.

Applications

For on-site, manufactured housing, including sheathing, decking, subflooring, and exterior decks. Also, industrial markets such as heavy-duty pallet construction, pallet repair, and crate and box assembly.

Features

- Light and fast for greater productivity
- Adjustable Depth-of-Drive
- High Load Capacity
- Fast Cycle Time increases productivity
- E-Z Load Design saves time

Specifications

Item#: 520101N Contact actuation trigger
Reg. Operating Pressure: 70-120 psi (4.8-8.3 bar)
Air Consumption (60 cycles per min.): 8.29 scfm
Air Inlet: 3/8" NPT
Tool Weight: 7.5 lbs (3.4 kg)
Height: 12.38" (314 mm)
Length: 12.88" (327 mm)
Width: 5.38" (137 mm)

Fastener

Capacity: 250-275
Shank Diameter: .099" - .113"
Range: 2" - 2¾"
Collation: Flat, 15° angled coil wire

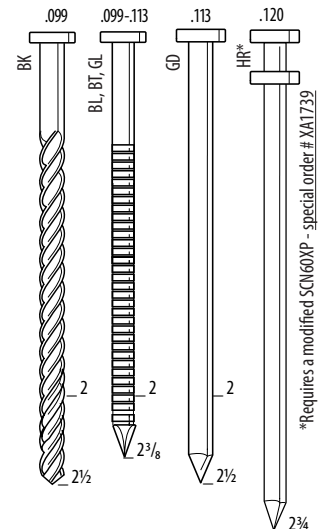

For fasteners see p. 60-61 Series BK, BL, BT, GL, GD, HR*

2½" Coil Nailer



SCN49

The SCN49 is perfect for a wide range of siding applications including fiber cement products from Hardi™ and Certaineed™. This tool drives smooth, ring, and screw shank coil nails in both wire and plastic sheet collation.

Applications

Siding, exterior decks, decking, exterior trim, fencing, subflooring, wood shingles, crate and box assembly and floor sheathing.

Features

- Well balanced and lightweight
- Selectable Trigger – you select mode of operation
- Dual Collation – Allows the choice between wire or plastic collation
- Adjustable Depth-of-Drive

Specifications

Item#: 5J0001N Selectable actuation trigger
 Reg. Operating Pressure: 70-120 psi (4.8-8.3 bar)
 Air Consumption (60 cpm.): 3.9 scfm
 Air Inlet: 3/8" NPT
 Tool Weight: 5.1 lbs (2.31 kg)
 Height: 12" (304 mm)
 Length: 12.25" (314 mm)
 Width: 5.19" (132 mm)

Fastener

Capacity: 250-375
 Shank: .082"- .113"
 Range: 1¼" – 2½"
 Collation: 15° angular flat wire wound or plastic carrier strip

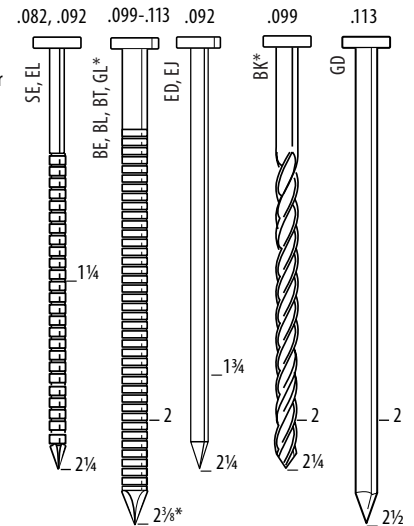

* For soft woods only when driving 2½" Screw or Ring nails.

For fasteners see p. 60-62 Series SE, BE, BL, BT, GL, ED, EJ, BK, GD

2¼" Coil Nailer



PalletPro™ 57F

The PalletPro 57F Coil Nailer is designed to drive up to a 2¼" nail. Built for high speed operations and designed to handle the toughest production applications. For boxes, crates, carton-to-skid and pallet applications.

Applications

A lightweight and versatile tool for boxes and crates, carton-to-skid and pallets.

Features

- Collation – wire weld
- Aluminum Mainbody – weighs 5.9 lbs.
- Adjustable Nail Canister accommodates wide range of nails
- High Capacity Nylon Magazine – fast and easy loading
- Body Protection – Side Steel Wear plates reduce abrasion of tool
- High Durability Driver and Piston Bumper for long life

Specifications

Item#: 4L0001N Contact actuation trigger
 Reg. Operating Pressure: 70-120 psi (4.9-8.4 bar)
 Air Consumption (60 cycles per min.): 3.07 scfm
 Air Inlet: 3/8" NPT
 Tool Weight: 5.9 lbs (2.67 kg)
 Height: 11.25" (286 mm)
 Length: 11.88" (302 mm)
 Width: 5.25" (133 mm)

Fastener

Capacity: 300-350
 Shank: .082"- .092"
 Range: 1" – 2¼"
 Collation: 15° angular, flat wire wound coil

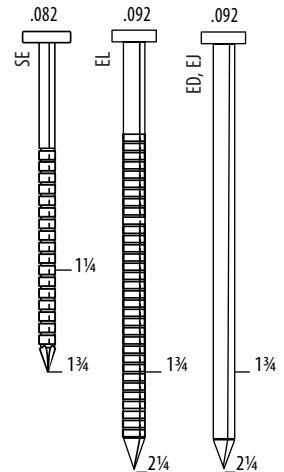

For fasteners see p. 62 Series SE, EL, ED, EJ

2¾" Coil Nailer



PalletPro™ 70

The PalletPro 70 Coil Nailer is designed to drive up to a 2¾" nail. Well balanced and powerful and designed with the toughest applications in mind. Drives smooth, ring and screw shank coil nails.

Applications

For boxes and crates, carton-to-skid, fencing, packaging and pallets.

Features

- Aluminum Mainbody – weighs 7.9 lbs.
- Balanced and powerful for heavy duty applications
- Adjustable Nail Canister accommodates wide range of nails
- High Capacity Magazine – fast and easy loading
- Body Protection – side steel wear plates reduce abrasion of tool

Specifications

Item#: 4M0001N Contact actuation trigger
 Reg. Operating Pressure: 70-120 psi (4.9-8.4 bar)
 Air Consumption (60 cycles per min.): 4.78 scfm
 Air Inlet: 3/8" NPT
 Tool Weight: 7.9 lbs (3.6 kg)
 Height: 12.25" (317 mm)
 Length: 13.25" (339 mm)
 Width: 5" (129 mm)

Fastener

Capacity: 250-300
 Shank: .092"- .113"
 Range: 1¾" – 2¾"
 Collation: 15° angular, flat wire wound coil

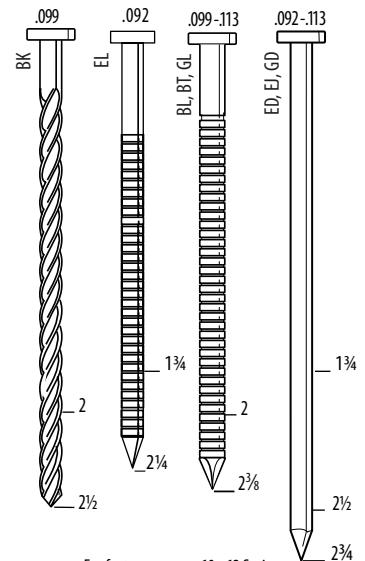

For fasteners see p. 60-62 Series BK, BL, BT, GL, ED, EJ, EL, GD

Plastic Carrier Strip Hot Dipped Galvanized Coil Siding Nails

SENCO's hot-dipped, full round head, plastic carrier strip coil siding nails eliminate the wire flagging that may occur with wire collated siding nails. By using Plastic Carrier Strip Nails you eliminate wire flagging, improve the overall appearance of your work, reduce the risk of rust, stains and improve the application of paints and sealants. Our hot-dipped galvanization meets or exceeds ASTM A153 Class D, the accepted and code-specified standard for hot-dipped galvanization. These nails may be used with pressure treated lumber, including ACQ.

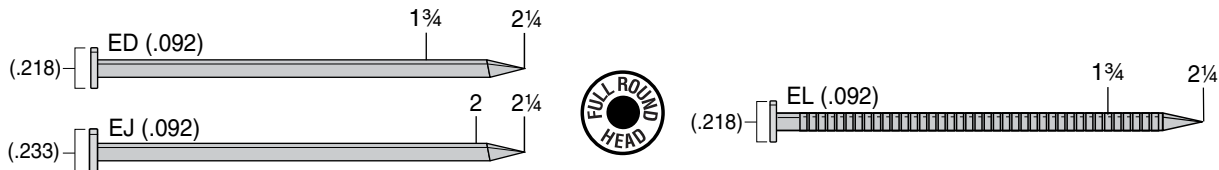
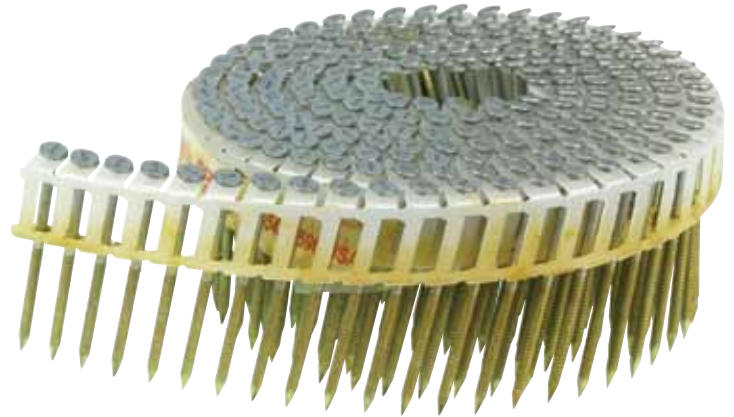

Fastener Specifications: Plastic Carrier Strip Coil Nails: 1 3/4" – 2 1/4"

Item Code	Diameter	Wound/Shank/Head	Length	Point	Finish	Coating	Features	M/Box	Wt/Box	Box/Skid	UPC Code
ED19ASBC	.092	Flat., Smooth FRH (.218)	1 3/4	Diamond	Hot Dip Galv.	Sencote	Plastic Carrier Strip, Coil	3.6	14 lbs	24	7-41474-06104-2
ED23ASBC	.092	Flat., Smooth FRH (.218)	2 1/4	Diamond	Hot Dip Galv.	Sencote	Plastic Carrier Strip, Coil	3.6	17 lbs	24	7-41474-06105-9
EJ21ASBC	.092	Flat., Smooth, Oversize FRH (.233)	2	Diamond	Hot Dip Galv.	Sencote	Plastic Carrier Strip, Coil	3.6	15 lbs	24	7-41474-06106-6
EJ23ASBC	.092	Flat., Smooth, Oversize FRH (.233)	2 1/4	Diamond	Hot Dip Galv.	Sencote	Plastic Carrier Strip, Coil	3.6	17 lbs	24	7-41474-06107-3
EL19ASBC	.092	Flat., Ring, FRH (.218)	1 3/4	Diamond	Hot Dip Galv.	Sencote	Plastic Carrier Strip, Coil	3.6	14 lbs	24	7-41474-06108-0
EL23ASBC	.092	Flat., Ring, FRH (.218)	2 1/4	Diamond	Hot Dip Galv.	Sencote	Plastic Carrier Strip, Coil	3.6	17 lbs	24	7-41474-06109-7

Applications

These nails are primarily intended for siding, fencing, light pallets, packaging and crating.

Features and Benefits

- No flagging or wire fragments under the nail head results in no rust stains or cut fingers from sharp wire
- Hot-dipped galvanization provides excellent corrosion resistance

Works best with SCN49

1 3/4" - 2 1/2" Coil Nailer Item#: 5J0001N
See page 23 for tool specifications



Also Fits:

SENCO: SCN56, HITACHI: NV65AH, NV75AG

4" Coil Nailer



Applications

Truss Attachment, Heavy Duty Framing, Engineered Lumber, Docks and Commercial Application.

Features

- Includes Heavy Duty Threaded T-handle for use when appropriate, or removal when not desired
- Flexible Collation Deflector and dust guard for improved safety in commercial environments
- Strengthened Driver and Bumper for extended use and reliable service

Specifications

Item#: 5L0001N Contact actuation trigger
 Reg. Operating Pressure: 70-120 psi (4.9-8.4 bar)
 Air Consumption (60 cycles per min.): 11.4 scfm
 Air Inlet: 3/8" NPT
 Tool Weight: 11.5 lbs (5.24 kg)
 Height: 16.5" (418 mm)
 Length: 13.25" (338 mm)
 Width: 6" (153 mm)

Fastener

Capacity: 225-300
 Shank: .099"-.148"
 Range: 2 1/4" - 4"
 Collation: 15° angular, flat wire wound coil

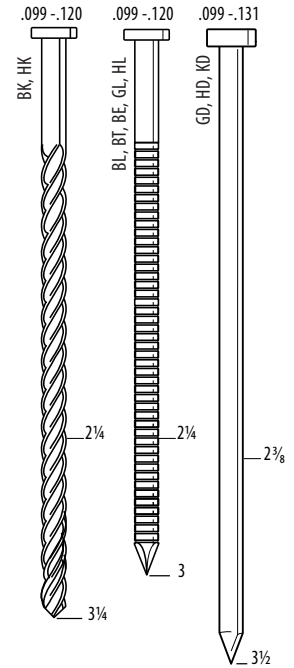

PalletPro™ 100

PalletPro™ 100 has the muscle and durability to consistently and reliably drive up to 4" x .148 nails all day long. The included T-handle helps comfortably maneuver and securely control the tool during operation. If your application needs large nails driven completely and reliably then the PalletPro™ 100 was designed for you.

Note: A special order tool

For fasteners see p. 60-61 Series BK, HK, BL, BT, BE, GL, HL, GD, HD, KD,

5 1/8" Coil Nailer



Applications

Truss Attachment, Heavy Duty Framing, Engineered Lumber, Docks and Commercial Application.

Features

- Includes heavy duty threaded T-handle for use when appropriate, or removal when not desired
- Flexible collation deflector and dust guard for improved safety in commercial environments
- Strengthened driver and bumper for extended use and reliable service

Specifications

Item#: 5M0001N Sequential actuation trigger
 Reg. Operating Pressure: 70-120 psi (4.8-8.3 bar)
 Air Consumption (60 cycles per min.): 11.4 scfm
 Air Inlet: 3/8" NPT
 Tool Weight: 13 lbs (5.9 kg)
 Height: 18" (57 mm)
 Length: 13" (330 mm)
 Width: 6.6" (168 mm)

Fastener

Capacity: 120-225
 Shank: .120"-.148"
 Range: 3" - 5 1/8"
 Collation: 15° angular, flat wire wound coil

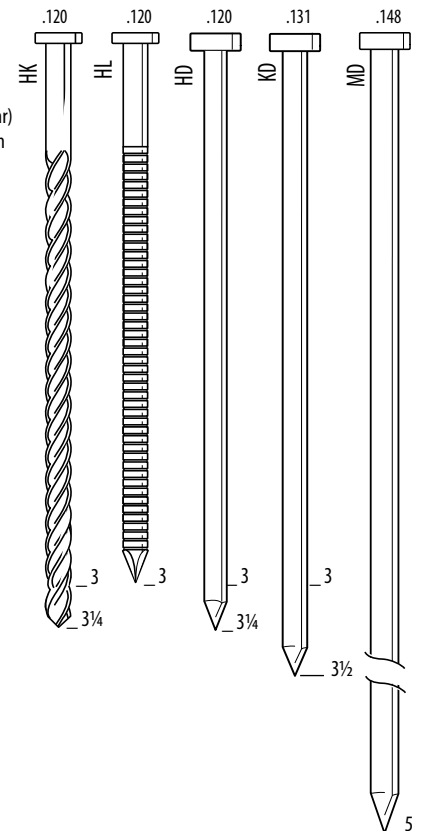

PalletPro™ 130

PalletPro™ 130 has the muscle and durability to consistently and reliably drive up to 5 1/8" x .148 nails all day long. It can hold up to 225 nails for maximum productivity in a wide variety of applications. For truss attachment, heavy duty framing, engineered lumber, docks and commercial applications.

Note: A special order tool

For fasteners see p. 60-61 Series HK, HL, HD, KD, MD

COIL NAILERS



SENCO's BT21APBF Coil Flooring Nails

Superior to any fastener currently being used in manufactured housing floor applications.

Idle boasting? Absolutely not! The BT21APBF has been tested and proven under actual plant conditions.

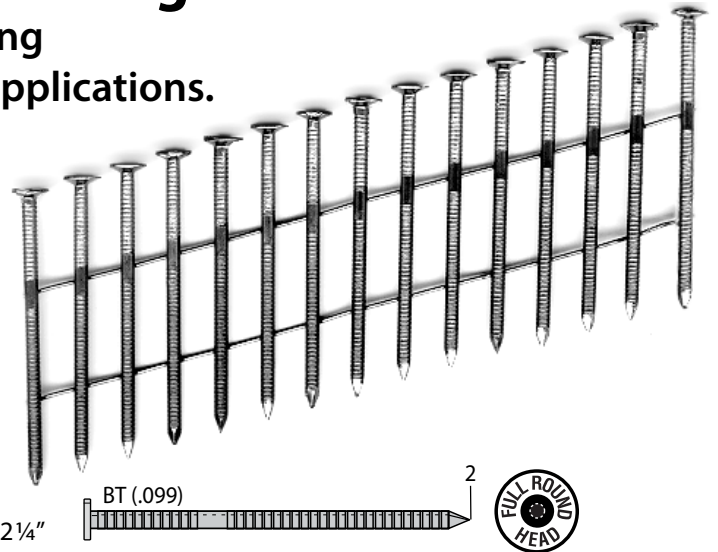

Fastener Specifications: Full Ring Shank Coil Nail: .099" x 2 1/4"

Item Code	Diameter	Wound/Shank	Length	Point	Finish	Coating	Features	M/Box	Wt/Box
BT21APBF	.099	Coil, angular, flat wound	2	Diamond	Bright Basic.	Sencote	Unique ring shank design	6.6	30.5 lbs

Features and Benefits:

- Its' unique ring shank design virtually eliminates the possibility of the nail "backing out" of floor decking material, even if the floor joist is missed! The nail's ring shank design is so good that we've had it patented, so problems commonly associated with improperly fastened floors will be a thing of the past. These include: squeaky floors due to the decking material not being fastened to the floor joist, humps in the floor, the result of a "dead board" not being pulled down against the floor joist. Raised fasteners that could eventually pop through linoleum or vinyl floor covering. With these problems minimized, you can expect to experience a reduction in the number of service call-backs.
- Works best with SENCO's standard SCN60XP nailer, (see page 22)
- Superior withdrawal resistance. The full ring shank nail and two SENCO fasteners commonly used in the industry (the Q19BRB and BL21BPB) were tested in-house for withdrawal strength, using three different types of decking material and two types of glue. The full ring shank nail's performance was superior to the other two in all categories.
- It has better pull-down power. As a result, the operator no longer has to step on the decking material and hold it down, as is commonly done with staples, when fastening the decking material to the floor joist with the BT21APBF.

COMPARE APPLICATIONS & FEATURES

COIL NAILERS



APPLICATIONS	SCN65XP	SCN60XP	SCN49	PAL57F	PAL70	PAL100	PAL130
Pallets	X	X	X	X	X	X	X
Packaging	X	X	X	X	X	X	X
Crates/Boxes	X	X	X	X	X	X	X
Carton to Skid			X	X	X	X	
Framing/Sheathing	X	X		X	X	X	X
Subfloor/Decking	X	X	X	X	X	X	X
Underlayment	X	X	X	X	X	X	X
Cement Board			X				
Siding			X		X		
Fence Boards			X	X			
Wood Shakes			X				
FEATURES							
Fastener Range	2"-3½"	2"-2¾"	1¼"-2½"	1" - 2¼"	1¾"-2¾"	2¼"-4"	3"-5½"
Shank	.099"-.131"	.099"-.113"	.082"-.113"	.082"-.092"	.092"-.113"	.099"-.148"	.120"-.148"
Fastener Capacity	225-275	250-275	250-375	300-350	250-300	225-300	120-225
Weight	8 lbs	7.5 lbs	5.1 lbs	5.9 lbs	7.9 lbs	11.5 lbs	13 lbs
Height	14.1"	12.38"	12"	11.25"	12.25"	16.5"	18"
Length	12.88"	12.88"	12.25"	11.88"	13.25"	13.25"	13"
Depth-of-Drive	X	X	X				
Jam EZ-Clear	X	X	X	X	X	X	X
Trigger Actuation*	S, C	C	Sel.	C	C	C	S, C
Exhaust	Adj.	Adj.	Adj.	Adj.	Fixed	Fixed	Fixed
Warranty	5 yrs	5 yrs	1 yr	1 yr	1 yr	1 yr	1 yr
	SCN65XP	SCN60XP	SCN49	PAL57F	PAL70	PAL100	PAL130

* Trigger Actuation:
 S: Sequential, C: Contact, Sel: Selectable

STAPLERS



SENCO has three categories of staplers; Fine, Medium and Heavy Wire. For upholstery, felt insulation, shoe making, dust cover, roof shingles and felt, spring attachments, insulating sheathing, underlayment, hardwood floors, drawers, sheathing, siding, wood shakes, manufactured housing, packaging, furniture frames, subflooring, pallets and box assembly
Available with staples from 22 - 15 Gauge.

22-20 Ga. $\frac{3}{16}$ ", $\frac{3}{8}$ ", $\frac{7}{16}$ ", $\frac{1}{2}$ " Crowns, $\frac{5}{8}$ " Fine Wire Staplers



Applications

Upholstery, furniture assembly, cabinets, bedding, picture frames, molding, roof felt, house wrap, RV construction.

Features

- Heavy-Duty Steel Cap – minimal recoil
- Rear Exhaust – keeps oil off fabric
- Short Trigger Stroke – quick precise operation
- Compact Tool Design
- One-Handed Magazine opening -fast reloads
- Optional Automatic Fire – up to 30 drives/second
- Optional Double Length Magazines

Specifications

Item#: See below
Reg. Operating Pressure: 60-95 psi (4.1-6.5 bar)
Air Consumption (60 cycles per min.): .77 scfm
Air Inlet: 1/4" NPT
Tool Weight: 2.1 lbs (0.955 kg)
Height: 6.57" (167 mm)
Length: 8.58" (42 mm)
Fastener capacity: 180
Double Length Magazine: 390

Fastener

Gauges: 22 – 20
Range: $\frac{5}{32}$ " - $\frac{5}{8}$ "
Crowns: $\frac{3}{16}$ ", $\frac{3}{8}$ ", $\frac{7}{16}$ ", $\frac{1}{2}$ "
Collation: Straight glued strip

22 Gauge

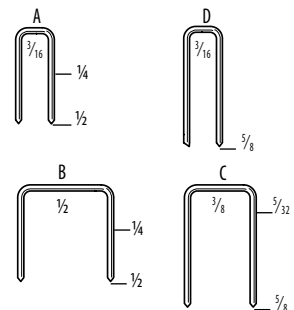

20 Gauge

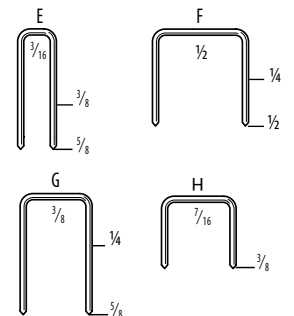

NEW SFT10XP

Various SFT10XP models drive staples ranging in length from $\frac{5}{32}$ " to $\frac{5}{8}$ " and crowns from $\frac{3}{16}$ ", $\frac{3}{8}$ ", $\frac{7}{16}$ " and $\frac{1}{2}$ ".

SFT10XP Models

	Item Code	Description	Crown	Ga.	UPC
A/D Wire	6S0001N	SFT10XP A/D-wire stapler	3/16"	22	741474123832
	6S0101N	SFT10XP A/D-wire auto stapler	3/16"	22	741474124419
B Wire	6S0011N	SFT10XP B-wire stapler	1/2"	22	741474124433
	6S0211N	SFT10XP B-wire D/L stapler	1/2"	22	741474124471
	6S0311N	SFT10XP B-wire auto D/L stapler	1/2"	22	741474124495
C Wire	6S0021N	SFT10XP C-wire stapler	3/8"	22	741474123856
	6S0121N	SFT10XP C-wire auto stapler	3/8"	22	741474124518
	6S0221N	SFT10XP C-wire D/L stapler	3/8"	22	741474124532
	6S0321N	SFT10XP C-wire auto D/L stapler	3/8"	22	741474124556
	6S0421N	SFT10XP C-wire long nose stapler	3/8"	22	741474124570
E Wire	6S0031N	SFT10XP E-wire stapler	3/16"	20	741474124594
F Wire	6S0041N	SFT10XP F-wire stapler	1/2"	20	741474124617
	6S0341N	SFT10XP F-wire auto D/L stapler	1/2"	20	741474124655
G Wire	6S0051N	SFT10XP G-wire stapler	3/8"	20	741474124679
	6S0251N	SFT10XP G-wire D/L stapler	3/8"	20	741474124693
	6S0351N	SFT10XP G-wire auto D/L stapler	3/8"	20	741474124716
H Wire	6S0361N	SFT10XP H-wire auto D/L stapler	7/16"	20	741474124730

For Fasteners see p. 64-65 Series A, B, C, D, E, F, G, H

22 Ga. 3/8" Crowns, 5/8" Fine Wire Stapler



Applications

Upholstering operations, furniture assembly, cabinets, automotive vinyl roofs and interior trim, bedding manufacture, TV and stereo grill cloth, picture frames, shoe making, molding, house wrap, and roofing felt.

Features

- Full 1" lip length - makes getting into tight spots easier
- Rounded Steel Cap - won't snag fabric
- Rear Exhaust - keeps oil off fabric
- Rear Magazine Bumper - protects fabric
- Comfort Grip - reduces fatigue

Specifications

Item#: 4C0001N
 Reg. Operating Pressure: 60-95 psi (4.1-6.5 bar)
 Air Consumption (60 cycles per min.): .77 scfm
 Air Inlet: 1/4" NPT
 Tool Weight: 2.1 lbs (0.95 kg)
 Height: 6" (152 mm)
 Length: 9.25" (235 mm)

Fastener Capacity: 110-168
 Gauge: 22
 Range: 5/32" - 5/8"
 Crown: 3/8"
 Collation: Straight glued strip

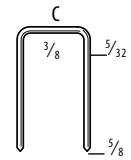

For Fasteners see p. 64 Series C

SFW09

Compact and durable, the SFW09 fine-wire stapler will handle any upholstery task with ease. With all-metal construction and a smooth profile, this tool works all day, everyday and won't snag or scuff fabric.

18 Ga. 1/4" Crown, 1 5/8" Medium Wire Stapler



Applications

Cabinets, soffit, fascia, drawer assembly, picture frames, case backs, craft assembly.

Features

- Magnesium Mainbody - durable & ultra-light
- Metal Cylinder for increased durability
- Oil-Free Design
- Adjustable Depth-of-Drive
- Selective Actuation Trigger
- Rotatable Rear Exhaust and Belt Hook
- Swivel Air Plug
- Over-Mold Rubber Comfort Grip
- Includes Case and Wrench

Specifications

Item #: 1W0021N Selectable actuation trigger
 Reg. Operating Pressure: 75-120 psi (4.8-8.3 bar)
 Air Consumption (60 cycles per min.): 2.4 scfm
 Air Inlet: 1/4" NPT
 Tool Weight: 2.6 lbs (1.8 kg)
 Height: 9.5" (241 mm)
 Length: 10.25" (260 mm)
 Width: 2.5" (63.5 mm)

Fastener

Capacity: 110
 Gauge: 18
 Range: 3/8" - 1 1/8"
 Crown: 1/4"
 Collation: Straight glued strip

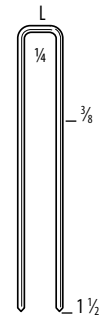

For fasteners see p 66 Series L

NEW SLS18Mg

The SLS18Mg's magnesium body delivers an ultra-light tool. Selectable trigger lets you choose between high productivity or precision placement.



STAPLERS

19 -18 Ga. $\frac{3}{16}$ ", $\frac{1}{4}$ ", $\frac{3}{8}$ " Crowns, $1\frac{1}{2}$ " Fine & Medium Wire Staplers



SLS20XP

The ergonomically designed SLS20XP increases quality and productivity in a wide variety of applications.

Applications

Upholstery, furniture manufacturing, cabinet frame assembly, underlayment sheathing, paneling, molding/trim, soffits, pre-finished gypsum, and siding for on-site and manufactured housing.

Features

- Ultra-Light (2.5 lbs.) for ease of handling
- Ergonomically Designed with Comfort-Grip
- Adjustable Depth-of-Drive
- No-Mar Pad
- Never-Lube® Design means easier maintenance and no lubrication to stain fine wood

Specifications

Item #: SLS20XP-K: 490101N
 SLS20XP-L: 490103N
 SLS20XP-L W/Case: 490105N
 SLS20XP-L Sencomatic:490015N
 SLS20XP-M: 490107N
 SLS20XP-R: 490111N
 Sequential actuation triggers
 Reg. Operating Pressure: 70-120 psi (4.8-8.3 bar)
 Air Consumption (60 cycles per min.): 1.92 scfm
 Air Inlet: 1/4" NPT
 Tool Weight: 2.5 lbs (1.13 kg)
 Height: 8.5" (216 mm)
 Length: 12" (305 mm)

Fastener

Capacity: 168
 Gauge: 19, 18
 Range: $\frac{3}{8}$ " - $1\frac{1}{2}$ "
 Crowns: $\frac{3}{16}$ ", $\frac{1}{4}$ ", $\frac{3}{8}$ "
 Collation: Straight glued strip

19 Gauge

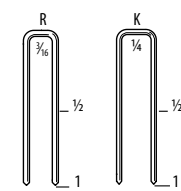

18 Gauge

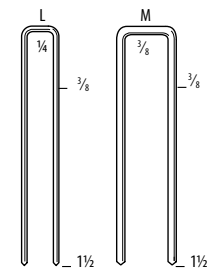

For fasteners see p. 66-67 Series K, R, M, L

18 Ga. $\frac{1}{4}$ ", $\frac{3}{8}$ " Crowns, $1\frac{1}{2}$ " Medium Wire Staplers



SLS25XP

Has the power to drive $1\frac{1}{2}$ " staples into hard woods.

Applications

Drawers, casebacks, cabinet frame assembly, underlayment sheathing, paneling, molding/trim, soffits, pre finished gypsum and siding for on-site and manufactured housing.

Features

- Ultra-Light (2.67 lbs.) for ease of handling
- Ergonomically Designed with comfort-grip
- Adjustable Depth-of-Drive
- Heavy Duty Components, including an aluminum sleeve and piston, rugged durability even in high volume production environments
- Never-Lube® Design means easier maintenance and no lubrication to stain fine wood

Specifications

Item #: SLS25XP-L: 820103N Contact actuation trigger
 SLS25XP-M: 820107N Contact actuation trigger
 (Is available with Sequential actuation trigger)
 Reg. Operating Pressure: 75-120 psi (4.8-8.3 bar)
 Air Consumption (60 cycles per min.): 1.92 scfm
 Air Inlet: 1/4" NPT
 Tool Weight: 2.67 lbs (1.21 kg)
 Height: 9" (229 mm)
 Length: 12" (305 mm)
 Width: 2" (51 mm)

Fastener

Capacity: 168
 Gauge: 18
 Range: $\frac{3}{8}$ " - $1\frac{1}{2}$ "
 Crowns: $\frac{1}{4}$ ", $\frac{3}{8}$ "
 Collation: Straight glued strip

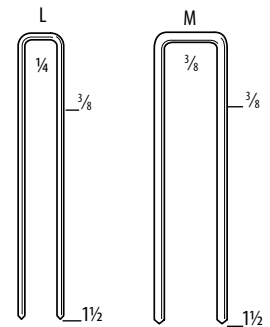

For fasteners see p. 66-67 Series L, M

18 -16 Ga. $\frac{1}{4}$ ", $\frac{3}{8}$ ", $\frac{7}{16}$ " Crowns, $1\frac{1}{2}$ " Medium-Heavy Wire Stapler



SKSXP

SKSXP is available for use in a wide variety of wood-working applications. It is offered in 18 and 16 gauge and 3 different crown widths in staple lengths up to $1\frac{1}{2}$ ".

Applications

Drawer assembly, cabinets, corner and glue block fastening, and spring clip attachment in furniture assembly, doors and window casings, trim, and moldings. On-site construction uses for aluminum and vinyl siding, underlayment, and attachment of roofing sheathing and decking materials.

Features

- E-Z Load, EZ-Clear™ System
- Only 2 moving O-rings - less maintenance
- Quiet operation
- Long 1" Lip to get into tight spots
- Never-Lube® Design

Specifications

Item #: SKSXP L11-17: 300120N
 SKSXP M11-17: 300152N
 SKSXP N11-17 300184N
 Reg. Operating Pressure: 70-120 psi (4.8-8.3 bar)
 Air Consumption (60 cycles per min.): 2.16 scfm
 Air Inlet: 1/4" NPT
 Tool Weight: 4.2 lbs (1.9 kg)
 Height: 9.25" (238 mm)
 Length: 12.38" (314 mm)

Fastener

Capacity: 145
 Gauge: 18, 16
 Range: $\frac{3}{4}$ " - $1\frac{1}{2}$ "
 Crowns: $\frac{1}{4}$ ", $\frac{3}{8}$ ", $\frac{7}{16}$ "
 Collation: Straight glued strip

18 Gauge

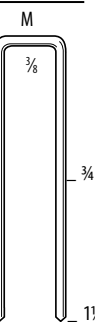
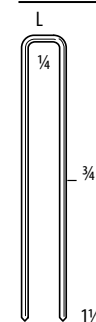

16 Gauge

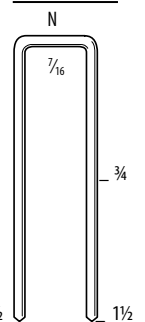

For fasteners see p. 66-68 Series L, N, M

16 Ga. 1" Wide Crown, 1½" Heavy Wire Stapler



Applications

For butt joints, lathing, insulation, and belt line attachment on mobile homes. Felt applications & foam insulation in building construction. Corrugated carton to skid, furniture & cabinet frames.

Features

- High Load Capacity (140 plus staples)
- Special Wearplate and hardened safety
- EZ-Clear™ Latch provides quick and easy clearing of occasional jams

Specifications

Item #: 120120N Contact actuation trigger.
 Operating Pressure: 80-110 psi (4.8-8.3 bar)
 Air Consumption (60 cycles per min.): 3.7 scfm
 Air Inlet: 3/8" NPT
 Tool Weight: 6.5 lbs (3 kg)
 Height: 9.75" (247 mm)
 Length: 12.5" (317 mm)

Fastener

Capacity: 140
 Gauge: 16
 Range: ¾" - 1½"
 Crown: 1"
 Collation: Straight glued strip

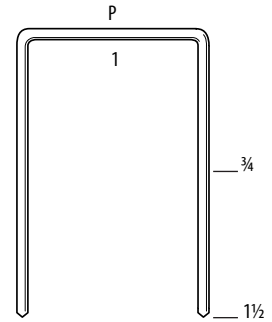

MWXP

The MWXP is a proven workhorse with impressive power and unrivaled durability. Has excellent power and speed to handle the most demanding applications.

For fasteners see p. 69 Series P

16 Ga. 1" Wide Crown, 1¼" Heavy Wire Stapler



Applications

Butt-joints, lathing, carton to skid, belt lines, roofing felt, cabinets, insulating sheathing, shingles.

Features

- High Load Capacity (140 plus staples)
- Lightweight (4.9 lbs) for ease of handling
- Designed for fast loading, consistent flush drives
- EZ-Clear™ Latch provides quick and easy clearing of occasional jams

Specifications

Item #: 130002N: ¾" - 1¼"
 130039N: ¾" - ¾"
 130010N: ¾" - ¾" Sencomatic
 XA1344: ¾" - 1¼" Sencomatic
 Contact actuation trigger.
 Operating Pressure: 80-100 psi (5.5 - 7 bar)
 Air Consumption (60 cycles per min.): 3.7 scfm
 Air Inlet: 3/8" NPT
 Tool Weight: 4.9 lbs (3 kg)
 Height: 8" (247 mm)
 Length: 12.5" (317 mm)
 Lip Length: .25"

Fastener

Capacity: 140
 Gauge: 16
 Range: ¾" - 1¼"
 Crown: 1"
 Collation: Straight glued strip

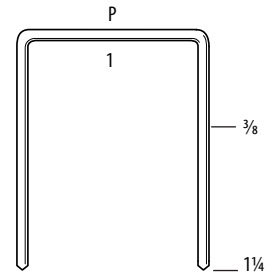

PW

The classic design of the PW wide-crown stapler is a proven workhorse with unrivaled durability.

For fasteners see p. 69 Series P

16 Ga. 1" Wide Crown, 1½" Heavy Wire Stapler



Applications

Wire lathing, corrugated carton to skid, butt-joints and furniture/cabinet frames and attaching foam insulation board.

Features

- Lightweight 5.0 pounds
- Robust Firing Valve Design makes the tool fast, powerful, efficient and easy to maintain
- Positive-Locking Adjustable Depth-of-Drive ensures consistently flush drives
- EZ-Clear™ virtually eliminates downtime caused by fastener jams.

Specifications

Item #: 4W0001N Contact actuation trigger
 Reg. Operating Pressure: 70-120 psi (4.8-8.3 bar)
 Air Consumption (60 cycles per min.): 3.18 scfm
 Air Inlet: 3/8" NPT
 Tool Weight: 5 lbs (2.3 kg)
 Height: 9" (229 mm)
 Length: 15.25" (387 mm)
 Width: 3.5" (89 mm)

Fastener

Capacity: 160
 Gauge: 16
 Range: ¾" - 1½"
 Crown: 1"
 Collation: Straight glued strip

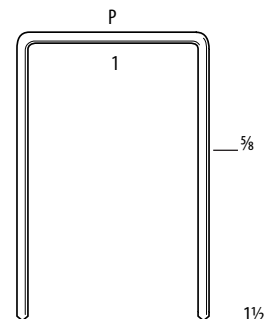

WC150XP

This heavy-duty wide crown stapler is capable of handling a variety of applications. Constructed of durable, high-quality, high-strength materials, the WC150XP is designed for extreme performance and long life.

For fasteners see p. 69 Series P

STAPLERS

16 Ga. 1" Wide Crown, 2" Heavy Wire Stapler



Applications

Wire lathing, corrugated carton to skid, furniture/cabinet frames, and butt-joints. Also capable of handling asphalt roof shingles and attaching foam insulation board.

Features

- Robust Firing Valve Design makes the tool fast and powerful
- Positive-Locking Adjustable Depth-of-Drive
- EZ Clear Latch provides easy access to clear fasteners
- High-Strength Composite Magazine and Metal Magazine Guide prevents wear
- Large 3/8" Inlet for increased air flow during high volume usage
- Durable Deflector Cap for superior impact resistance

Specifications

Item #: 4Y0001N Contact actuation trigger
 Reg. Operating Pressure: 70-120 psi (4.8-8.3 bar)
 Air Consumption (60 cycles per min.): 3.45 scfm
 Air Inlet: 3/8" NPT
 Tool Weight: 5.3 lbs (2.4 kg)
 Height: 10" (254 mm)
 Length: 15.25" (387 mm)
 Width: 3.5" (89 mm)

Fastener

Capacity: 160
 Gauge: 16
 Range: 7/8" - 2"
 Crown: 1"
 Collation: Straight glued strip

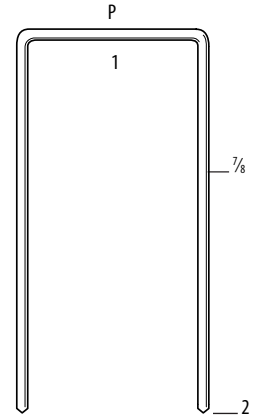

WC200XP

This heavy-duty wide crown stapler is capable of handling a wide variety of applications. Constructed of durable, high-quality, high-strength materials, the WC200XP is designed for extreme performance and long life. It is also light and well-balanced to minimize operator fatigue.

For fasteners see p. 69 Series P

17-16 Ga. 7/16" Crown, 2" Heavy Wire Stapler



Applications

Sheathing, sub-flooring, fascia and soffits, aluminum and vinyl siding, cedar shingles, furring, ridge beam assembly, and metal tie down straps, crate-box assembly and light furniture framing.

Features

- Durable Construction, minimizes downtime and operating costs
- Adjustable Depth-of-Drive
- EZ-Clear™ Latch
- Comfort Grip Handle

Specifications

Item #: 3L0003N: Contact actuation trigger
 Reg. Operating Pressure: 80-120 psi (5.5-8.3 bar)
 Air Consumption (60 cycles per min.): 5.4 scfm
 Air Inlet: 3/8" NPT
 Tool Weight: 4.6 lbs (2.1 kg)
 Height: 10.75" (273 mm)
 Length: 15" (381 mm)

Fastener

Capacity: 160
 Gauge: 17, 16
 Range: 1" - 2"
 Crown: 7/16"
 Collation: Straight glued strip

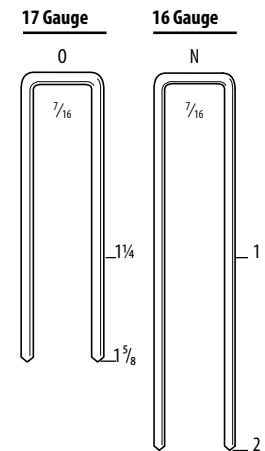

For fasteners see p. 67-68 Series O, N

SNS41

Fast, multi-directional stitching is a major benefit in applications like ridge beams and all types of sheathing.

17-16 Ga. 7/16" Crown, 2" Heavy Wire Stapler



Applications

Sheathing, subflooring, furniture framing, fascia and soffits, lathing, fencing, cedar shingles, boxes, crates, pallets and pallet repair.

Features

- Magnesium Main Body - reduced weight for less operator fatigue
- Adjustable Depth-of-Drive
- Molded Comfort Grip, 360° Adjustable Exhaust, and Overmold Trigger
- EZ-Clear™ Latch
- Includes Case

Specifications

Item #: 3B0101N: Contact actuation trigger
 Reg. Operating Pressure: 80-120 psi (5.5-8.3 bar)
 Air Consumption (60 cycles per min.): 6.3 scfm
 Air Inlet: 3/8" NPT
 Tool Weight: 4.5 lbs (2 kg)
 Height: 11" (279 mm)
 Length: 15" (381 mm)
 Width: 3.24" (82 mm)

Fastener

Capacity: 160
 Gauge: 17, 16
 Range: 1" - 2"
 Crown: 7/16"
 Collation: Straight glued strip



For fasteners see p. 67-68 Series O, N

SNS44XP

Power, speed and balance, designed for construction, remodeling and in-plant industrial.

17-16 Ga. 7/16" Crown, 2" Heavy Wire Stapler



Applications

Sheathing, sub-flooring, fascia and soffits, aluminum and vinyl siding, cedar shingles, furring, ridge beam assembly, and metal tie down straps, crate-box assembly and light furniture framing.

Features

- Durable Construction, minimizes downtime and operating costs
- Adjustable Depth-of-Drive
- EZ-Clear™ Latch
- Comfort Grip Handle
- Reload Indicator

Specifications

Item #: 580101N: Contact actuation trigger
 Reg. Operating Pressure: 80-120 psi (5.5-8.3 bar)
 Air Consumption (60 cycles per min.): 5.52 scfm
 Air Inlet: 3/8" NPT
 Tool Weight: 5.1 lbs (2.3 kg)
 Height: 11" (279 mm)
 Length: 14" (356 mm)
 Width: 3.5" (90 mm)

Fastener

Capacity: 160
 Gauge: 17, 16
 Range: 1" - 2"
 Crown: 7/16"
 Collation: Straight glued strip

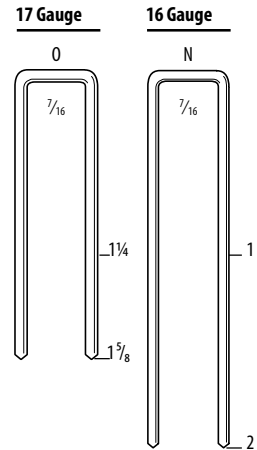

For fasteners see p. 67-68 Series O, N

SNS45XP

It's fast, multi-directional stitching is a major benefit in applications like ridge beams and all types of sheathing.

16 Ga. 7/16" Crown, 2" Heavy Wire Stapler



Applications

Framing, decking, furniture frames, furring, roof deck, sidewall sheathing, subflooring, window units, crate and box assembly, boxes, crates, pallets and pallet repair.

Features

- Adjustable Power - can increase 20%
- Rugged Construction
- Fast - up to 15 staples per second
- Adjustable Depth-of-Drive
- EZ-Clear™ Latch
- Top Loading with Reload Indicators
- Adjustable Exhaust

Specifications

Item #: 750101N: Contact actuation trigger
 Reg. Operating Pressure: 80-120 psi (5.5-8.3 bar)
 Air Consumption (60 cycles per min.): 6.54 scfm
 Air Inlet: 3/8" NPT
 Tool Weight: 5.9 lbs (2.7 kg)
 Height: 12" (305 mm)
 Length: 14.38" (365 mm)
 Width: 3.6" (92 mm)

Fastener

Capacity: 160
 Gauge: 16
 Range: 1 1/4" - 2"
 Crown: 7/16"
 Collation: Straight glued strip

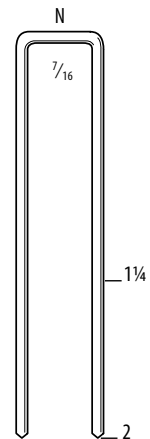

For fasteners see p. 68 Series N

SNS50XP

Has all the power and speed needed for the toughest 16 gauge staple applications

15 Ga. 7/16" Crown, 2 1/2" Heavy Wire Stapler



Applications

Framing, decking, furniture frames, furring, sidewall sheathing, subflooring, window units, crate and box assembly, boxes, crates, pallets and pallet repair.

Features

- Rugged Dependability
- Fast - up to 15 staples per second
- Adjustable Depth-of-Drive
- All the features you want, including adjustable power for softer drives
- EZ-Clear™ latch
- Adjustable exhaust

Specifications

Item #: 660101N: Contact actuation trigger
 Reg. Operating Pressure: 80-120 psi (5.5-8.3 bar)
 Air Consumption (60 cycles per min.): 6.54 scfm
 Air Inlet: 3/8" NPT
 Tool Weight: 5.9 lbs (2.7 kg)
 Height: 12" (305 mm)
 Length: 14.38" (365 mm)
 Width: 3.6" (92 mm)

Fastener

Capacity: 130
 Gauge: 15
 Range: 1 1/4" - 2 1/2"
 Crown: 7/16"
 Collation: Straight glued strip

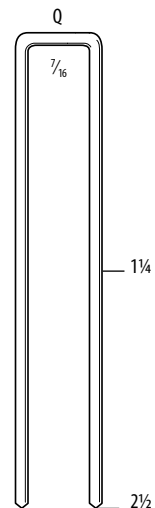

For fasteners see p. 69 Series Q

SQS55XP

Has the power and speed needed for the toughest framing and sheathing applications. Designed with today's harder woods and laminates in mind.

COMPARE APPLICATIONS & FEATURES



APPLICATIONS	SFT10XP	SFW09	SLS18Mg	SLS20XP	SLS25XP	SKSXP	MWXP
Upholstery	X	X					
Shoe making	X	X					
Casebacks	X	X	X	X	X	X	
Trim & molding	X	X	X	X	X		
Cabinets & drawers			X	X	X		
Picture frames	X		X	X	X	X	
Furniture frames				X	X	X	X
Underlayment				X	X	X	X
Decking						X	X
Fascia & soffits			X	X	X	X	
Felt insulation	X	X					
Insulative sheathing							X
Window & door units			X	X	X	X	
Siding				X	X	X	
Fencing			X	X	X	X	
Wood Shakes						X	
Framing & sheathing							
Lathing				X			X
Packaging				X	X	X	X
Pallets						X	
FEATURES							
Fastener Range	5/32" - 5/8"	5/32" - 5/8"	3/8" - 15/8"	3/8" - 1 1/2"	3/8" - 1 1/2"	3/4" - 1 1/2"	3/4" - 1 1/2"
Crown	3/16" - 1/2"	3/8"	1/4"	3/16", 1/4", 3/8"	1/4", 3/8"	1/4", 3/8", 7/16"	1"
Gauge	22-20	22	18	19,18	18	18-16	16
Fastener Capacity	180	110-168	110	168	168	145	140
Weight	2.1 lbs	2.1 lbs	2.6 lbs	2.5 lbs	2.67 lbs	4.2 lbs	6.5 lbs
Height	6.57"	6"	9.5"	8.5"	9"	9.25"	9.75"
Length	8.58"	9.25"	10.25"	12"	12"	12.38"	12.5"
Belt Hook			X				
Depth of Drive			X	X	X		
Jam EZ Clear	X	X	X	X	X	X	X
Trigger Actuation*	Sen.	D	Sel.	S, C, Sen.	S, C	C	S, C
Never Never-Lube/No-oil Design			X	X	X	X	
Exhaust	Rear	REAR	Rear Adj.	Cap fixed	Cap fixed	Cap fixed	Cap fixed
Warranty	5 yrs	1 yr	1 yr	5 yrs	5 yrs	5 yrs	5 yrs
	SFT10XP	SFW09	SLS18Mg	SLS20XP	SLS25XP	SKSXP	MWXP

* Trigger Actuation:

S: Sequential, C: Contact, D: Dual Triggers, Sel: Selectable, Sen: Sencomatic

STAPLERS



PW	WC150XP	WC200XP	SNS41	SNS44XP	SNS45XP	SNS50XP	SQS55XP
X	X	X	X	X	X	X	X
X	X	X	X	X	X	X	X
X	X	X	X	X	X	X	X
X	X	X	X	X	X	X	X
X	X	X					
			X	X	X	X	X
	X		X	X	X	X	X
			X	X	X	X	X
	X		X	X	X	X	X
			X	X	X	X	X
X	X	X					
X	X	X	X	X	X	X	X
			X	X	X	X	X
3/8" - 1 1/4"	5/8" - 1 1/2"	7/8" - 2"	1" - 2"	1" - 2"	1" - 2"	1 1/4" - 2"	1 1/4" - 2 1/2"
1"	1"	1"	7/16"	7/16"	7/16"	7/16"	7/16"
16	16	16	17-16	17-16	17-16	16	15
140	160	160	160	160	160	160	130
4.9 lbs	5 lbs	5.3 lbs	4.6 lbs	4.5 lbs	5.1 lbs	5.9 lbs	5.9 lbs
8"	9"	10"	10.75"	11"	11"	12"	12"
12.5"	15.25"	15.25"	15"	15"	14"	14.38"	14.38"
	X	X					
	X	X	X	X	X	X	X
X	X	X	X	X	X	X	X
C	C	C	C	S, C	S, C	C	C
Cap fixed	Cap fixed	Cap fixed	Adjustable	Adjustable	Adjustable	Adjustable	Rear
5 yrs	5 yrs	5 yrs	1yr	5 yrs	5 yrs	5 yrs	5 yrs
PW	WC150XP	WC200XP	SNS41	SNS44XP	SNS45XP	SNS50XP	SQS55XP