

SHIMANO 105 Front Derailleur

FD-5700-S Silver Version

FD-5700-L Black Version

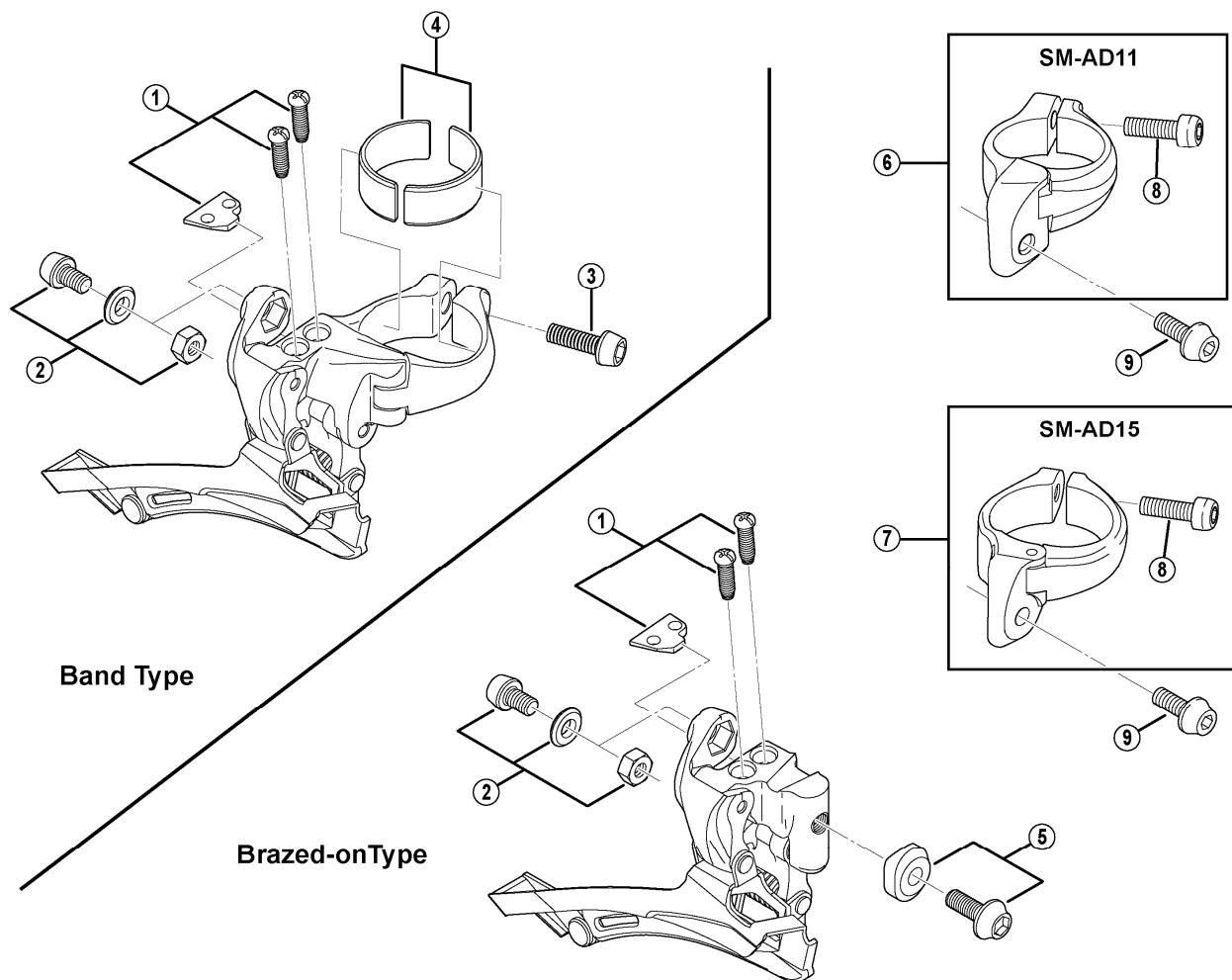

FD-8700

FD-5600

ITEM NO.	SHIMANO CODE NO.	DESCRIPTION	INTERCHANGEABILITY		
1	Y5MR98010	Stroke Adjust Screws (M4 x 13) & Plate			
* 2	Y5MR98020	Cable Fixing Bolt Unit (M5 x 8)			
3	Y5A407020	Clamp Bolt (M5 x 15)	A		
4	Y5JD98020	Clamp Band Adapter (2 pcs.) for S-size / ϕ 28.6 mm (1-1/8")	A	A	
5	Y5JD98030	Clamp Bolt (M5 x 13.5) & Radius Washer for Brazed-on Type	A		
6	Y5JD98040	SM-AD11 Clamp Band Unit ϕ 31.8 mm (1-1/4") for Brazed-on Type	A		
7	Y5JD98050	SM-AD15 Clamp Band Unit ϕ 34.9 mm (1-3/8") for Brazed-on Type	A		
8	Y59L19100	Clamp Bolt (M5 x 17.5) for SM-AD11 / AD15	A		
9	Y5C252000	Clamp Bolt (M5 x 13.5) for SM-AD11 / AD15	A	A	

A: Same parts.

B: Parts are usable, but differ in materials, appearance, finish, size, etc.

Absence of mark indicates non-interchangeability.

Sep.-2012-3022A

© Shimano Inc. A

Specifications are subject to change without notice.

SHIMANO

General Safety Information

WARNING

- Obtain and read the service instructions carefully prior to installing the parts. Loose, worn or damaged parts may cause the bicycle to fall over and serious injury may occur as a result. We strongly recommend only using genuine Shimano replacement parts.
- Obtain and read the service instructions carefully prior to installing the parts. If adjustments are not carried out correctly, the chain may come off and this may cause you to fall off the bicycle which could result in serious injury.
- Be careful not to let the cuffs of your clothes get caught in the chain while riding, otherwise you may fall off the bicycle.
- Read these Technical Service Instructions carefully, and keep them in a safe place for later reference.

Note

- If gear shifting operations cannot be carried out smoothly, clean the derailleur and lubricate all moving parts.
- If the amount of looseness in the links is so great that adjustment is not possible, you should replace the derailleur.
- When the chain is in the position shown in the illustration, the chain may contact the front chainrings or front derailleur and generate noise. If the noise is a problem, shift the chain onto the next-larger rear sprocket or the one after.
- For smooth operation, use the specified outer casing and the bottom bracket cable guide.
- Grease the inner cable and the inside of the outer casing before use to ensure that they slide properly.
- Parts are not guaranteed against natural wear or deterioration resulting from normal use.
- For maximum performance we highly recommend Shimano lubricants and maintenance products.
- For any questions regarding methods of installation, adjustment, maintenance or operation, please contact a professional bicycle dealer.

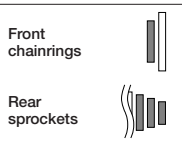

Technical Service Instructions

SI-5LW0B-001

FD-6700 / FD-5700

Front derailleur

In order to realize the best performance, we recommend that the following combination be used.

Series	ULTEGRA	105
Shifting lever	ST-6700	ST-5700
Outer casing	SP41	
Gears	20	
Front derailleur	FD-6700	FD-5700
Front chainwheel	FC-6700 / FC-6750	FC-5700 / FC-5750
Rear derailleur	RD-6700	RD-5700
Freehub	FH-6700	FH-5700
Cassette sprocket	CS-6700	CS-5700
Chain	CN-7901 / CN-6701 / CN-5701	
Bottom bracket cable guide	SM-SP17	

Specifications

Type	Band type / Brazed on type
Front derailleur installation band diameter	S (28.6mm), M (31.8mm), L (34.9mm)
Front chainwheel tooth difference	16 teeth or less
Chainstay angle (α)	61° - 66°
Chain line	43.5mm

Installation of the front derailleur

- Adjust so that the clearance between the chain guide outer plate and the large gear is 1 - 3 mm before installing.

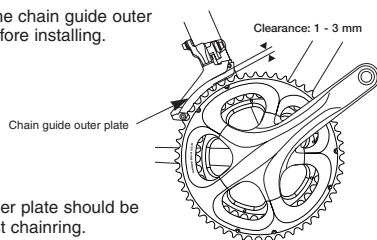

- The level section of the chain guide outer plate should be directly above and parallel to the largest chainring.

- Secure using a 5mm Allen key.

Tightening torque:
5 - 7 N·m
{44 - 60 in. lbs.}

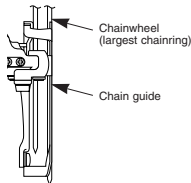

In the case of carbon frames, it may be necessary to lower the tightening torque in order to prevent damage to the frame. Please consult the bicycle or frame manufacturer regarding the appropriate level of tightening torque for carbon frames.

SHIMANO

SHIMANO AMERICAN CORPORATION
One Holland, Irvine, California 92618, U.S.A. Phone: +1-949-951-5003

SHIMANO EUROPE B.V.
Industrieweg 24, 8071 CT Nunspeet, The Netherlands Phone: +31-341-272222

SHIMANO INC.
3-77 Oimatsu-cho, Sakai-ku, Sakai-shi, Osaka 590-8577, Japan

* Service Instructions in further languages are available at : <http://techdocs.shimano.com>
Please note: specifications are subject to change for improvement without notice. (English)
© Dec. 2009 by Shimano Inc. XBC SZK Printed in Japan.

SIS adjustment

1. Low adjustment

Set so that the clearance between the chain guide inner plate and the chain is 0 - 0.5 mm.

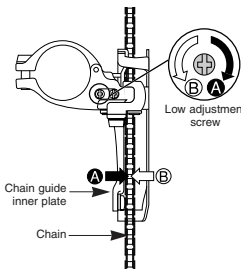
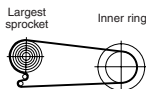

2. Connection and securing of cable

While pulling the inner cable, tighten the wire fixing bolt with a 5 mm allen key to secure the cable.

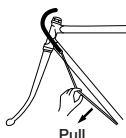

Tightening torque:
6 - 7 N·m {52 - 60 in. lbs.}

After taking up the initial slack in the cable, re-secure to the front derailleur as shown in the illustration.

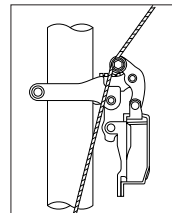

3. Top adjustment

Set so that the clearance between the chain guide outer plate and the chain is 0 - 0.5 mm.

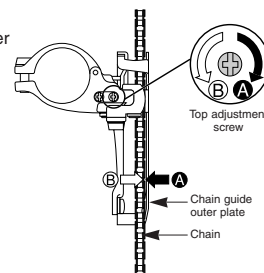
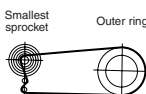

4. Adjustment of the cable tension

- Set the chain to the largest rear sprocket, and shift the front to top gear.

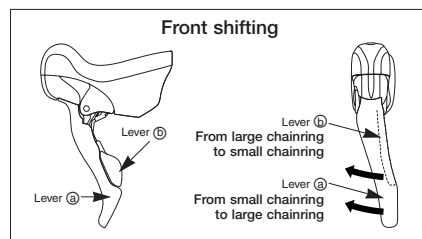
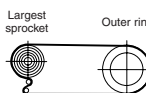

- Perform the trimming. (ST-6700 / ST-5700)

■ Trimming (noise-prevention mechanism)
Gently press the lever (b).
(A "click" sound will be heard.)

While turning the crank arm, gently operate lever (b) and check that the front derailleur moves slightly toward the small chainring. If the front derailleur moves by a large amount and the chain is set onto the small chainring at this time, loosen the top adjustment bolt by 1/8th of a turn. Then, after returning the chain to its original position, adjust and check the trimming mechanism.

- After trimming, adjust the clearance (by using the cable-adjustment bolt) of the chain and chain guide to the minimum (0 - 0.5 mm).

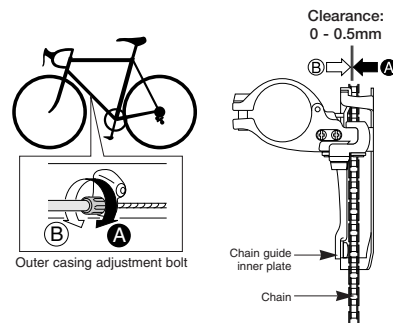
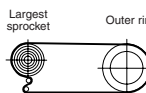

5. Troubleshooting chart

After completion of steps 1 - 4, move the shifting lever to check the shifting. (This also applies if shifting becomes difficult during use.)

If the chain falls to the crank side	Tighten the top adjustment screw clockwise (about 1/4 turn).
If shifting is difficult from the small chainring to the large chainring	Loosen the top adjustment screw counterclockwise (about 1/8 turn).
If shifting is difficult from the large chainring to the small chainring	Loosen the low adjustment screw counterclockwise (about 1/8 turn).
If the chain falls to the bottom bracket side.	Tighten the low adjustment screw clockwise (about 1/2 turn).
If the gear shifting to the small chainring is stiff and difficult to carry out after trimming.	Turn the outer casing adjustment bolt clockwise (1/8 of a turn at a time) until shifting to the small chainring becomes smooth. Be careful not to turn the outer casing adjustment bolt too far at this time, otherwise shifting to the large chainring will become more difficult.

Be sure to read these service instructions in conjunction with the service instructions for the ST-6700 / ST-5700 before use.