

ULTEGRA Dual Control Lever

ST-6700 FLIGHT DECK Compatible

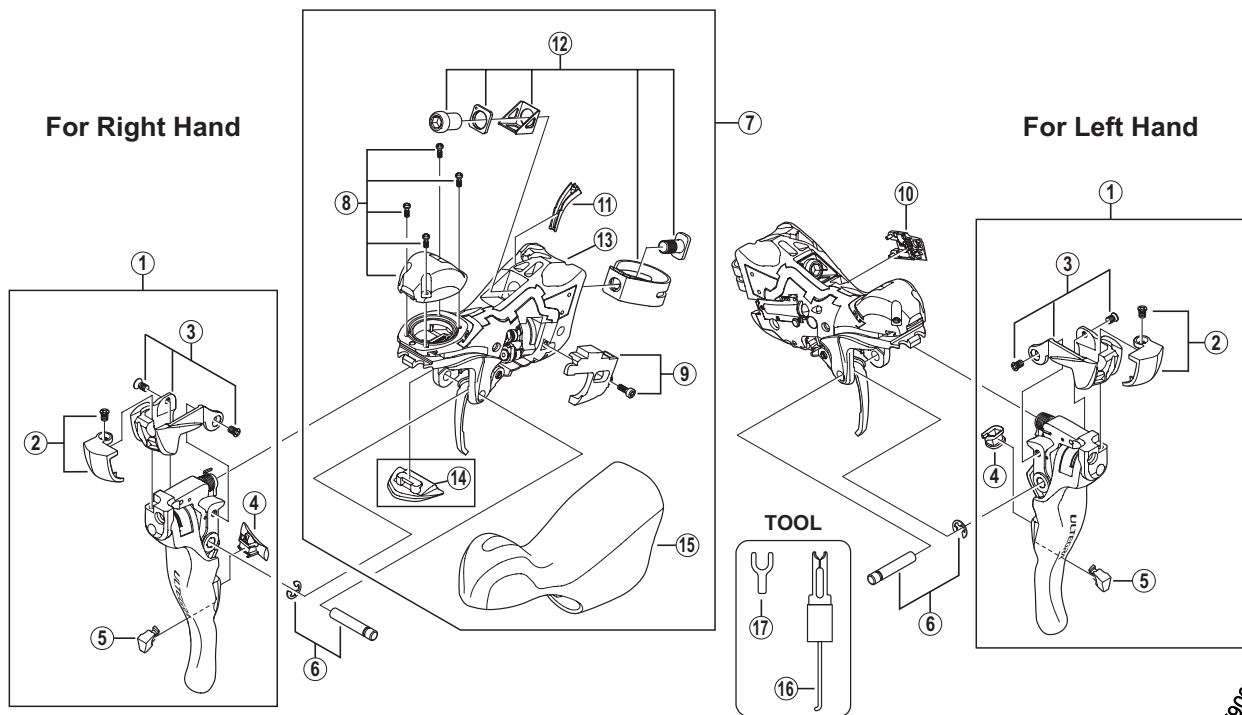

ITEM NO.	SHIMANO CODE NO.	DESCRIPTION	INTERCHANGEABILITY
1	Y6SC98010	R.H. Main Lever Assembly	
	Y6SC98020	L.H. Main Lever Assembly	
2	Y6SC98030	R.H. Name Plate A & Fixing Screw	
	Y6SC98040	L.H. Name Plate A & Fixing Screw	
3	Y6SC98050	R.H. Name Plate B & Fixing Screws	
	Y6SC98060	L.H. Name Plate B & Fixing Screws	
4	Y6SC20000	R.H. Main Lever Support	
	Y6SD70000	L.H. Main Lever Support	
5	Y6RT37010	R.H. Release Lever Support	A
	Y6RU87010	L.H. Release Lever Support	A
6	Y6SC98070	Lever Axle & E-ring	
7	Y6SC98190	R.H. Shifting Lever Unit (Bracket Cover: Black)	
	Y6SC98200	L.H. Shifting Lever Unit (Bracket Cover: Black)	
8	Y6SC98100	R.H. Top Cover Unitless & Fixing Screws	
	Y6SC98110	L.H. Top Cover Unitless & Fixing Screws	
9	Y6SC98210	Unit Cover & Fixing Screw	
10	Y6RU54000	SL Cable Cover	A
11	Y6RT46000	R.H. SL Cable Guide	A
	Y6SD66000	L.H. SL Cable Guide	
12	Y6SC98150	Clamp Band Unit (ø23.8 mm - ø24.2 mm)	
13	Y6SC98220	R.H. Bracket	
	Y6SC98230	L.H. Bracket	
14	Y6SC76000	R.H. Adjustment Block (5 mm)	
	Y6SC76010	L.H. Adjustmen Block (5 mm)	
	Y6SC75000	R.H. Adjustment Block (10 mm)	
	Y6SC75010	L.H. Adjustmen Block (10 mm)	
* 15	Y6SC98180	Bracket Covers (Black/Pair)	
	Y6SC98240	Bracket Covers (White/Pair)	
16	Y6RT68000	Tool A for E-ring	A
17	Y6RT66000	Tool B for E-ring	A

A: Same parts.

B: Parts are usable, but differ in materials, appearance, finish, size, etc.

Absence of mark indicates non-interchangeability.

Apr.-2012-2936B

© Shimano Inc. I

Specifications are subject to change without notice.

SHIMANO

WARNING

- Obtain and read the service instructions carefully prior to installing the parts. Loose, worn or damaged parts may cause the bicycle to fall over and serious injury may occur as a result. We strongly recommend only using genuine Shimano replacement parts.
- Obtain and read the service instructions carefully prior to installing the parts. If adjustments are not carried out correctly, the chain may come off and this may cause you to fall off the bicycle which could result in serious injury.
- Use the ST-6700/6703, BL-TT79 with the BR-6700. Do not use the BR-6700 in combination with previous ST1 levers for road riding or with the BL-R770/BL-R550 brake levers for flat handlebars, otherwise the braking performance provided will be much too strong.
- Because of the characteristics of the carbon fiber material, you must never modify the levers, otherwise the lever may break and the brakes may no longer work as a result.
- Before riding the bicycle, check that there is no damage such as carbon fiber peeling or cracking. If there is any damage, replace with a new part immediately without trying to repair the damage, otherwise the lever may break and the brakes may no longer work as a result.
- Read these Technical Service Instructions carefully, and keep them in a safe place for later reference.

Note

- For triple front chainwheel specifications, be sure to read these Service Instructions in conjunction with the Service Instructions for the ST-6703 and FD-6703.
- Use a soft cloth to clean the carbon fiber levers, and be sure to moisten the cloth with neutral detergent before using it, otherwise the lever material may become damaged and lose its strength.
- Avoid leaving the carbon fiber levers in places where high temperatures are present. Also keep them well away from fire.
- Operation of the levers related to gear shifting should be made only when the front chainwheel is turning.
- For smooth operation, use the specified outer casing and the bottom bracket cable guide.
- Grease the inner cable and the inside of the outer casing before use to ensure that they slide properly.
- Because the high cable resistance of a frame with internal cable routing would impair the SIS function, this type of frame should not be used.
- A special grease is used for the gear shifting cable. Do not use DURA-ACE grease or other types of grease, otherwise they may cause deterioration in gear shifting performance.
- Parts are not guaranteed against natural wear or deterioration resulting from normal use.
- For maximum performance we highly recommend Shimano lubricants and maintenance products.
- For any questions regarding methods of installation, adjustment, maintenance or operation, please contact a professional bicycle dealer.

Operation of rear derailleur lever

- Lever (A) : Shifts from smaller to larger rear sprocket. Lever (A) has a click stop at positions (1) and (2).

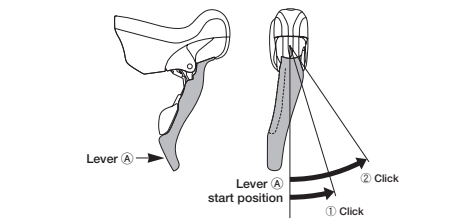

(1) : Shifts one sprocket
E.x. : from 3rd to 4th

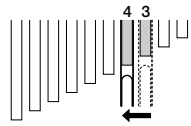

(2) : Quick-shifts two sprockets
E.x. : from 3rd to 5th

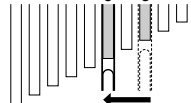

- Lever (B) : Shifts from larger to smaller rear sprocket. Press lever (B) once to shift from a larger to one smaller sprocket.

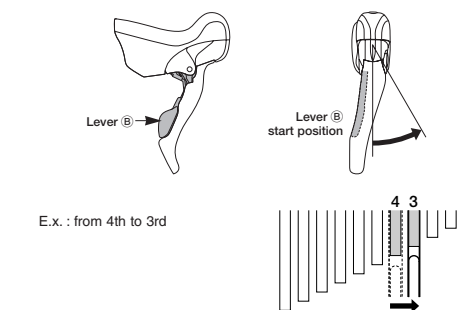

Lever stroke adjustment

If you would like to make the lever stroke larger, remove the pad spacer.
If you would like to make the lever stroke smaller, replace the pad spacer with the accessory pad spacer (10 mm).

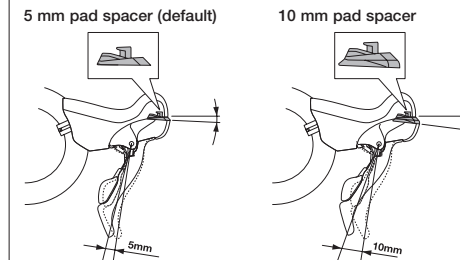

Installation and removal of the pad spacer

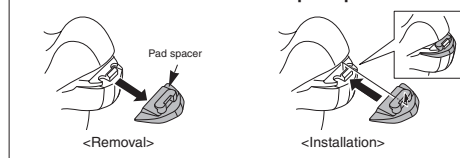

Operation of front derailleur levers (FD-6700)

- Lever (a) : Shifts from smaller to larger front chainring.

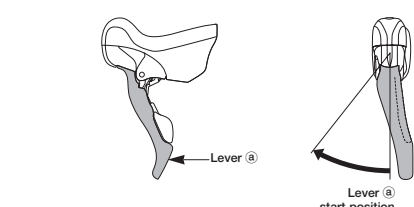

If operation of lever (a) does not complete the chainring shift stroke, operate lever (a) again for the distance (X') to complete that part of the lever stroke (X) which was short.

- Lever (b) : Shifts from larger to smaller front chainring.

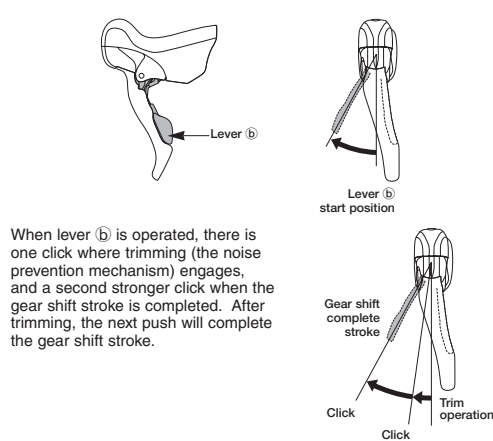

When lever (b) is operated, there is one click where trimming (the noise prevention mechanism) engages, and a second stronger click when the gear shift stroke is completed. After trimming, the next push will complete the gear shift stroke.

Trimming (noise prevention operation)

If the chain is on the large front chainwheel and the larger rear sprocket, the chain will rub in the front derailleur plate, producing a characteristic noise. When this happens, press lever (b) lightly (to the point where it clicks); this causes the front derailleur to move slightly towards the smaller chainwheel, thereby eliminating the noise.

If the chain is on the smallest front chainring and a smaller rear sprocket, the chain will rub in the front derailleur plate, producing a characteristic noise. When this happens, press lever (a) lightly (to the point where it clicks); this causes the front derailleur to move slightly towards the larger chainring, thereby eliminating the noise.

Be sure to read these service instructions in conjunction with the service instructions for the RD-6700, FD-6700 before use.

Installation of the brake cable

- Cable used
 - Inner cable (stainless steel) $\phi 1.6$ mm
 - SLR outer casing
- Be sure to leave some excess cable, even if cutting it to the full length of the handlebars.

- Loosen the screw and remove the name plate.

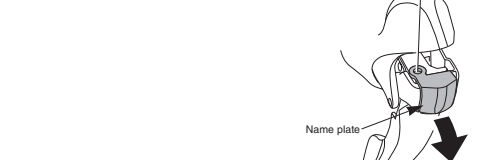

When installing the components to carbon frame/handle bar surfaces, verify with the manufacturer of the carbon frame/parts for their recommendation on tightening torque in order to prevent over tightening that can cause damage to the carbon material and/or under tightening that can cause lack of fixing strength for the components.

- Pass the inner cable through as shown in the illustration, and then set the inner cable drum into the cable hook.

3. Install the name plate.
Tightening torque: 0.15 - 0.2 N·m {1.3 - 1.8 in. lbs.}

Installing the shifting cable

- Cable used
 - Inner cable (PTFE inner cable) $\phi 1.2$ mm
 - SP41 sealed outer casing (1) $\phi 4$ mm
 - SP41 outer casing (2) $\phi 4$ mm

Cutting the outer casing
When cutting the outer casing, cut the opposite end to the end with the marking. After cutting the outer casing, make the end round so that the inside of the hole has a uniform diameter.

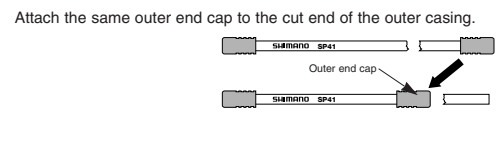

Rear lever

Operate lever (B) at least 9 times to set the lever to the highest position.

Pass the inner cable through the cable hole. The outer casing can be routed in two directions: either through cable guide (1) (inside) or cable guide 2 (outside).

Note:
Insert the inner cable so that the inner cable drum goes into the winder unit as far as it can go.

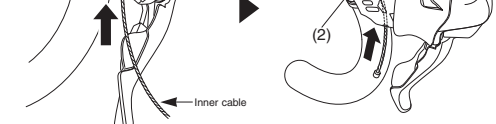

When removing parts in order to replace the inner cable, the work can be carried out more easily if the unit cover is removed as shown in the illustration.

Tightening torque: 0.2 N·m {1.8 in. lbs.}

Be careful not to cover the cable holes or the unit cover when wrapping on the handlebar tape. If the handlebar tape covers these places, it will not be possible to replace the inner cable.

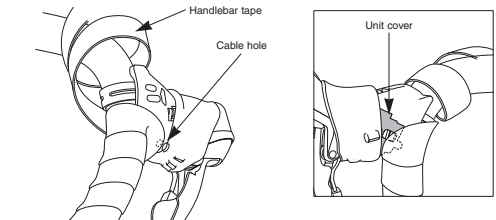

Front lever

Operate lever (b) once or more to set the lever to the low position.

Pass the inner cable through the cable hole. The outer casing can be routed in two directions: either through cable guide (1) (inside) or cable guide 2 (outside).

Note:
Insert the inner cable so that the inner cable drum goes into the winder unit as far as it can go.

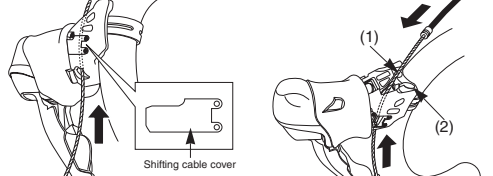

CAUTION
Be sure to install the shifting cable cover before use. If it is not installed, injury may occur.

Do not disassemble the unit cover at the front, otherwise it may cause problems with operation.

Outer stopper

- Install the outer stopper to the down tube.
Tightening torque: 1.5 - 2 N·m {13 - 18 in. lbs.}

Install with the adjustment bolt tightened. The adjustment range for the adjustment bolt is six full turns.

- Pass the inner cable through, and set the outer casing.
- Be sure leave some excess in the outer casing, even if cutting it to the full length of the handlebars.

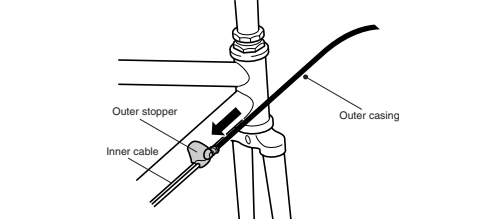

Confirm
Make sure the outer casing is firmly seated in the outer stopper.

Maintenance

* The illustration shows the right-hand lever.
Bracket and lever disassembly

- First use the special tool to remove the E-ring. Use part (B) of the special tool (2) to align the E-ring with the direction of removal. Next, set part A against the E-ring and remove the E-ring.

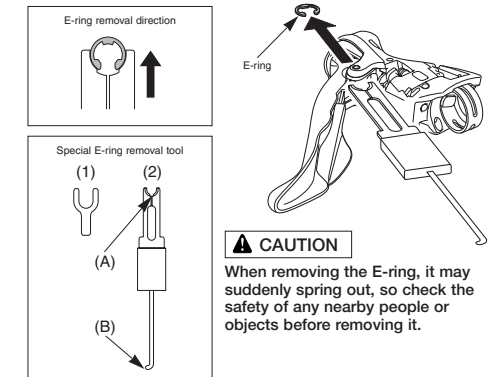

CAUTION
When removing the E-ring, it may suddenly spring out, so check the safety of any nearby people or objects before removing it.

- Insert an Allen key or similar tool into the lever stud hole, and then tap it gently with a plastic mallet to push out the lever stud. When the lever stud comes out, the bracket body and lever body can be disassembled.

Assembling the bracket body and lever body

- Insert the connector lever into the main lever support, and then assemble the bracket body and lever body. Next, insert the end of the return spring into the notch.

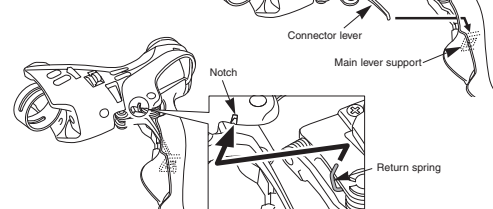

- Align the stud holes, and then set the special tool (1) in the position shown in the illustration to press-fit the lever stud.

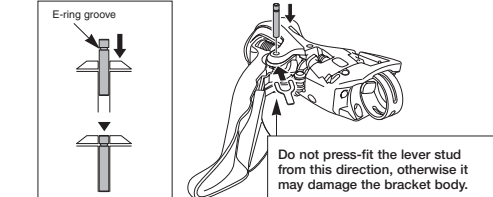

- The correct direction for the lever stud to face is with the E-ring groove at the top.
- Check that the surface of the bracket body is flush with the top of the lever stud to ensure that the E-ring can fit into the groove.

- Remove the special tool (1), and then use the special tool (2) to install the E-ring.



Replacing the main lever support

Installation:
Insert the main lever support so that it pushes against the lever body drop-prevention notch.

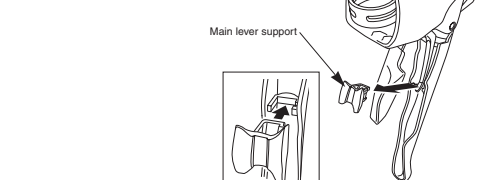

Replacing the cable guide

Use this hole to replace the cable guide.



Replacing the bracket cover

The tabs on the bracket cover each fit to a matching slot on the bracket.

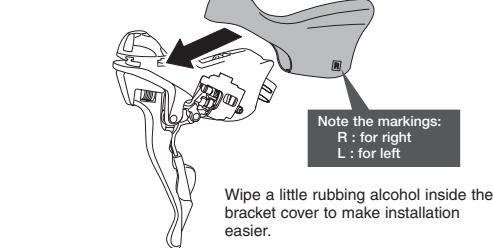

Note the markings:
R : for right
L : for left

Wipe a little rubbing alcohol inside the bracket cover to make installation easier.

Technical Service Instructions SI-6SC0A-002

ST-6700
Shimano Total Integration

In order to realize the best performance, we recommend that the following combination be used.

Series	ULTEGRA
Shifting lever	ST-6700
Outer casing	OT-SP41 (SIS-SP41)
Gears	20
Front derailleur	FD-6700
Front chainwheel	FC-6700/6750
Rear derailleur	RD-6700-SS
Freehub	FH-6700
Cassette sprocket	CS-6700
Chain	CN-6700
Bottom bracket cable guide	SM-SP17
Cable adjuster	SM-CA70 / SM-CA50

Operation

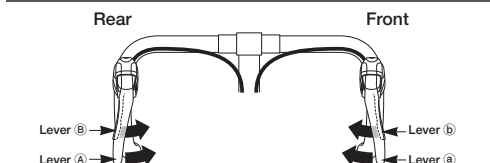

- Lever (A) : Shifts from smaller to larger rear sprocket.
- Lever (B) : Shifts from larger to smaller rear sprocket.
- Lever (a) : Shifts from smaller to larger chainring.
- Lever (b) : Shifts from larger to smaller chainring.

All levers return to the starting position when released.

SHIMANO

SHIMANO AMERICAN CORPORATION
One Holland, Irvine, California 92618, U.S.A. Phone: +1-949-951-5003

SHIMANO EUROPE B.V.
Industrieweg 24, 8071 CT Nunspeet, The Netherlands Phone: +31-341-272222

SHIMANO INC.
3-77 Oimatsu-cho, Sakai-ku, Sakai-shi, Osaka 590-8577, Japan

* Service Instructions in further languages are available at : <http://techdocs.shimano.com>

Please note: specifications are subject to change for improvement without notice. (English)
© Mar. 2010 by Shimano Inc. XBC SZK Printed in Japan.