

DEORE XT Rear Derailleur

RD-M772 (GS) Long Cage

RD-M772 (SGS) Super Long Cage

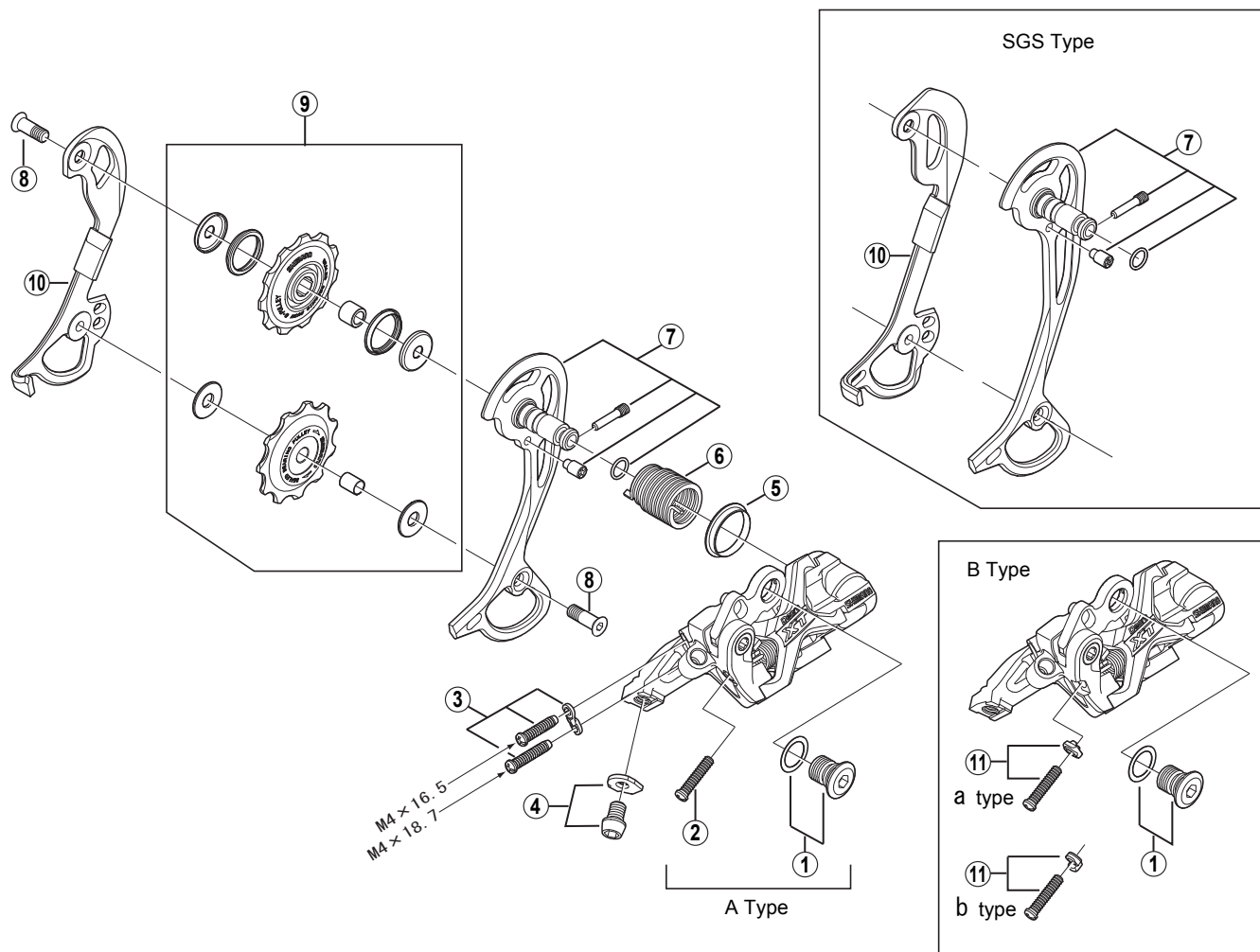

RD-M972
RD-M770
RD-M771

ITEM NO.	SHIMANO CODE NO.	DESCRIPTION	INTERCHANGEABILITY		
1	Y-5W7 98110	B-Axle Assembly			
2	Y-556 25060	B-Tension Adjusting Screw (M4 x 18) B-type	B		
	Y-556 25040	B-Tension Adjusting Screw (M4 x 18) A-type	B		
3	Y-5W7 98020	Stroke Adjusting Screws & Plate	B		
4	Y-5W7 98030	Cable Fixing Bolt (M5 x 8) & Plate			
5	Y-5UC 14000	P-Seal Ring	A	A	A
6	Y-5W7 22000	P-Tension Spring	B		
	Y-5W7 98040	Outer Plate Assembly (GS-Type)			
	Y-5W7 98050	Outer Plate Assembly (SGS-Type)			
* 8	Y-53M 24400	Pulley Bolt			
9	Y-5W7 98080	Guide & Tension Pulley Unit			
10	Y-5W7 09000	Inner Plate (GS-Type)	B		
	Y-5W7 10000	Inner Plate (SGS-Type)	B		
11	Y-5W7 98100	B-Tension Adjusting Screw (M4 x 18) & Plate a-Type			
	Y-5W7 98120	B-Tension Adjusting Screw (M4 x 18) & Plate b-Type			

A: Same parts.

B: Parts are usable, but differ in materials, appearance, finish, size, etc.

Absence of mark indicates non-interchangeability.

Mar.-2010-2707F
(C) Shimano Inc.



Specifications are subject to change without notice.

SHIMANO

General Safety Information

WARNING

- If it is difficult to install the wheel, install the quick release lever on the rotor side. If doing this, make sure that the quick release lever does not interfere with the rotor and that burns do not occur.
- Use neutral detergent to clean the chain. Do not use alkali-based or acid based detergent such as rust cleaners as it may result in damage and/or failure of the chain.
- Use the reinforced connecting pin only for connecting the narrow type of chain.
- There are two different types of reinforced connecting pins available. Be sure to check the table below before selecting which pin to use. If connecting pins other than reinforced connecting pins are used, or if a reinforced connecting pin or tool which is not suitable for the type of chain is used, sufficient connection force may not be obtained, which could cause the chain to break or fall off.

Chain	Reinforced connecting pin	Chain tool
9-speed super narrow chain such as CN-7701 / CN-HG93	 Silver	TL-CN32 / TL-CN27
8-/7-/6-speed narrow chain such as CN-HG50 / CN-HG40	 Black	TL-CN32 / TL-CN27

- If it is necessary to adjust the length of the chain due to a change in the number of sprocket teeth, make the cut at some other place than the place where the chain has been joined using a reinforced connecting pin or an end pin. The chain will be damaged if it is cut at a place where it has been joined with a reinforced connecting pin or an end pin.

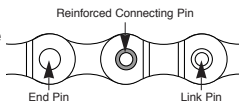

- Check that the tension of the chain is correct and that the chain is not damaged. If the tension is too weak or the chain is damaged, the chain should be replaced. If this is not done, the chain may break and cause serious injury.
- Obtain and read the service instructions carefully prior to installing the parts. Loose, worn or damaged parts may cause the bicycle to fall over and serious injury may occur as a result. We strongly recommend only using genuine Shimano replacement parts.
- Obtain and read the service instructions carefully prior to installing the parts. If adjustments are not carried out correctly, the chain may come off and this may cause you to fall off the bicycle which could result in serious injury.
- Read these Technical Service Instructions carefully, and keep them in a safe place for later reference.

Note

- If gear shifting operations do not feel smooth, wash the derailleur and lubricate all moving parts.
- If the amount of looseness in the links is so great that adjustment is not possible, you should replace the derailleur.
- You should periodically clean the derailleur and lubricate all moving parts (mechanism and pulleys).
- If gear shifting adjustment cannot be carried out, check the degree of parallelism at the rear end of the bicycle. Also check if the cable is lubricated and if the outer casing is too long or too short.
- If you hear abnormal noise as a result of looseness in a pulley, you should replace the pulley.
- If the chain keeps coming off the sprockets during use, replace the sprockets and the chain.
- Use a frame with internal cable routing is strongly discouraged as it has tendencies to impair the SIS shifting function due to its high cable resistance.
- Always be sure to use the sprocket set bearing the same group marks. Never use in combination with a sprocket bearing a different group mark.
- Use an outer casing which still has some length to spare even when the handlebars are turned all the way to both sides. Furthermore, check that the shifting lever does not touch the bicycle frame when the handlebars are turned all the way.
- A special grease is used for the gear shifting cable (SIS-SP41). Do not use DURA-ACE grease or other types of grease, otherwise they may cause deterioration in gear shifting performance.
- Grease the inner cable and the inside of the outer casing before use to ensure that they slide properly.
- For smooth operation, use the specified outer casing and the bottom bracket cable guide.
- Operation of the levers related to gear shifting should be made only when the front chainwheel is turning.
- Parts are not guaranteed against natural wear or deterioration resulting from normal use.
- For maximum performance we highly recommend Shimano lubricants and maintenance products.
- For any questions regarding methods of installation, adjustment, maintenance or operation, please contact a professional bicycle dealer.



This service instruction explains how to use and maintain the Shimano bicycle parts which have been used on your new bicycle. For any questions regarding your bicycle or other matters which are not related to Shimano parts, please contact the place of purchase or the bicycle manufacturer.

SHIMANO

SHIMANO AMERICAN CORPORATION
One Holland, Irvine, California 92618, U.S.A. Phone: +1-949-951-5003

SHIMANO EUROPE B.V.
Industrieweg 24, 8071 CT Nunspeet, The Netherlands Phone: +31-341-272222

SHIMANO INC.
3-77 Oimatsu-cho, Sakai-ku, Sakai-shi, Osaka 590-8577, Japan

Please note: specifications are subject to change for improvement without notice. (English) © May 2008 by Shimano Inc. XBC SZK Printed in Japan.

Technical Service Instructions

SI-5W70A-005

RD-M972 RD-M772

Rear derailleur

In order to realize the best performance, we recommend that the following combination be used.

Series	XTR	XT
RAPIDFIRE (Shifting lever)	SL-M970	SL-M770
Outer casing	SIS-SP41	SIS-SP41
Rear derailleur	RD-M972	RD-M772
Type	SGS / GS	SGS / GS
Freehub	FH-M970 / FH-M975	FH-M770 / FH-M775
Gears	9	9
Cassette sprocket	CS-M970	CS-M770
Chain	CN-7701	CN-HG93
Bottom bracket guide	SM-SP17 / SM-BT17	SM-SP17 / SM-BT17

Specifications

Rear Derailleur

Model number	RD-M972 / RD-M772	
Type	SGS	GS
Gears	9	9
Total capacity	45T	33T
Applicable sprocket combination	11 - 32T, 11 - 34T, 12 - 34T	
Smallest sprocket	11T	11T
Front chainwheel tooth difference	22T	22T

Installation of the rear derailleur

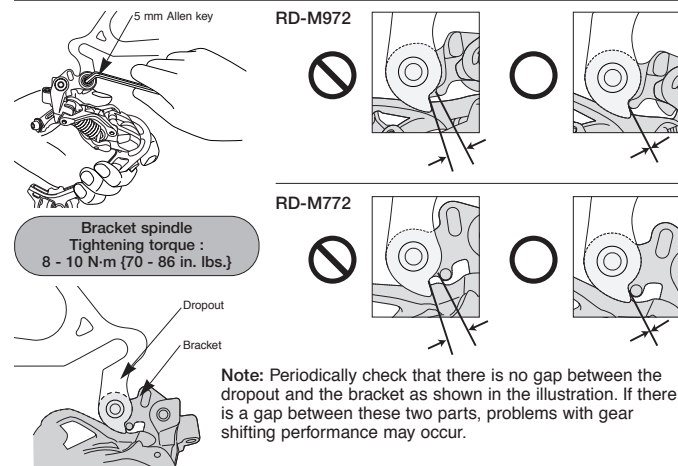

SIS Adjustment

1. Top adjustment

Turn the top adjustment screw to adjust so that the guide pulley is in line with the outer line of the smallest sprocket when looking from the rear.

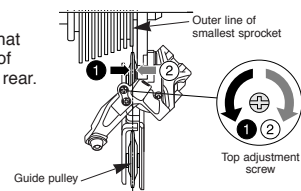

2. Low adjustment

Turn the low adjustment screw so that the guide pulley moves to a position directly in line with the largest sprocket.

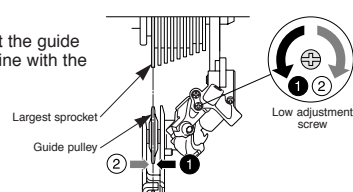

3. Chain length on bicycles with rear suspension

The length of A will vary depending on the movement of the rear suspension. Because of this, an excessive load may be placed on the drive system if the chain length is too short. Set the length of the chain by adding two links to the chain when the rear suspension is at a position where dimension "A" is longest and the chain is on the largest sprocket and the largest chainring. If the amount of movement of the rear suspension is large, the slack in the chain may not be taken up properly when the chain is on the smallest chainring and smallest sprocket.

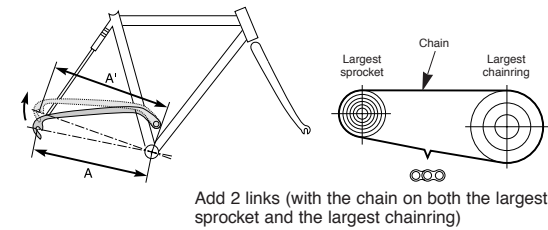

4. Outer casing length

- Loosen the B-tension adjustment screw until it is in the position shown in the illustration.
- Check that there is enough slack in the outer casing. Next, align the outer casing with the bottom edge of the outer casing holder at the rear derailleur and then cut off any excess length of outer casing.

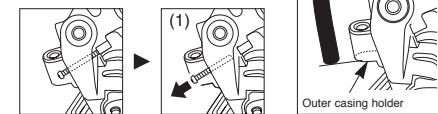

Note:

The distance between the outer stopper to the outer casing holder of the rear derailleur may change when the rear suspension moves, so determine the length of the outer casing at the point where this length is at its greatest.

Cutting the outer casing

After cutting the outer casing, make the end round so that the inside of the hole has a uniform diameter.

Attach the same outer end cap to the cut end of the outer casing.

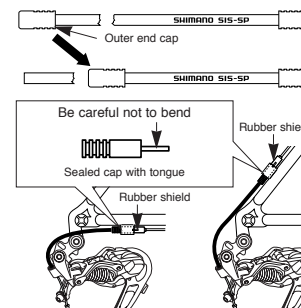

* If the rear derailleur moves to a large degree, such as in bicycles with rear suspension, it is recommended that you replace the cap with the accessory aluminum cap.

The end of the outer casing which has the aluminum cap should be at the derailleur side.

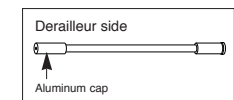

Connect the cable to the rear derailleur and, after taking up the initial slack in the cable, re-secure to the rear derailleur as shown in the illustration.

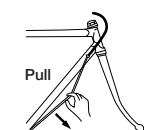

Note: Be sure that the cable is securely in the groove.

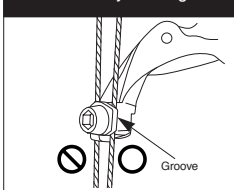

Tightening torque :
5 - 7 N·m [44 - 60 in. lbs.]

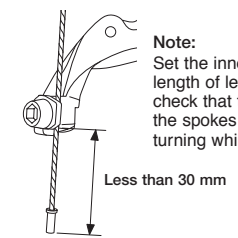

Note:

Set the inner cable so that it protrudes by a length of less than about 30 mm, and then check that the inner cable does not interfere with the spokes of the wheel. Stop the wheel from turning while carrying out this step.

5. How to use the B-tension adjustment screw

Mount the chain on the smallest chainring and the largest sprocket, and turn the crank arm to shift gears. Then turn the B-tension adjustment screw to adjust so that the guide pulley does not interfere with the sprocket but not so close that it touches the chain. Next, set the chain to the smallest sprocket and repeat the above to make sure that the pulley does not touch the sprocket.

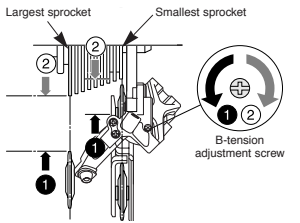

<Checking the distance between the largest sprocket and the guide pulley>

Set the rear derailleur to the lowest gear position, stop the wheel from turning, and then check that the distance from the edge of the guide pulley to the edge of the largest sprocket is within the range of 5 - 6 mm. Turn the crank arm to shift gears and check that there is no roughness in the feel. If the number of teeth for the cassette sprocket is changed, carry out this setting again.

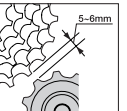

6. SIS Adjustment

Operate the shifting lever several times to move the chain to the 2nd sprocket. Then, while pressing the lever just enough to take up the play in the lever, turn the crank arm.

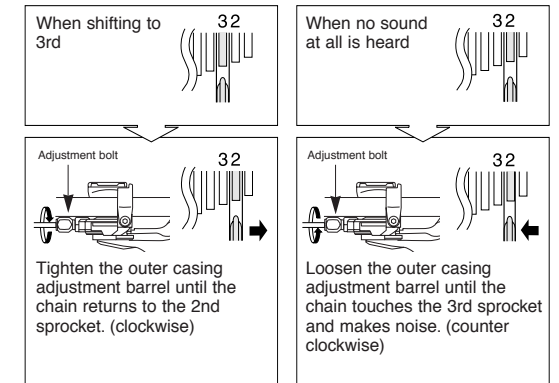

Best setting

The best setting is when the shifting lever is operated just enough to take up the play and the chain touches the 3rd sprocket and makes noise.

* Return the lever to its original position (the position where the lever is at the 2nd sprocket setting and it has been released) and then turn the crank arm clockwise. If the chain is touching the 3rd sprocket and making noise, turn the outer casing adjustment barrel clockwise slightly to tighten it until the noise stops and the chain runs smoothly.

Operate lever to change gears, and check that no noise occurs in any of the gear positions.

For the best SIS performance, periodically lubricate all power-transmission parts.

Replacing the rear derailleur (RD-M972)

Note: When removing the tension pulley in order to replace the rear derailleur, remove the E-ring first.

Guide pulley / Tension pulley
Tightening torque :
2.45 - 4.9 N·m [21 - 43 in. lbs.]

