

---

Slic3r

---

## 2.1 Introduction

### Overview

Slic3r is a tool which translates digital 3D models into instructions that are understood by a 3D printer. It slices the model into horizontal layers and generates suitable paths to fill them.

Slic3r is already bundled with the many of the most well-known host software packages: Pronterface, Repetier-Host, ReplicatorG, and can be used as a standalone program.

This manual will provide guidance on how to install, configure and utilize Slic3r in order to produce excellent prints.

This portion of the manual is derived from the complete Slic3r manual. It has been customized for Mini users. The original unabridged version can be found at [manual.slic3r.org](http://manual.slic3r.org).

### Goals & Philosophy

Slic3r is an original project started in 2011 by Alessandro Ranellucci (aka. Sound), who used his considerable knowledge of the Perl language to create a fast and easy to use application. Readability and maintainability of the code are among the design goals.

The program is under constant refinement, from Alessandro and the other contributors to the project, with new features and bug fixes being released on a regular basis.

### Donating

Slic3r started as a one-man job, developed solely by Alessandro in his spare time, and as a freelance developer this has a direct cost for him. By generously releasing Slic3r to the public as open source software, under the GPL license, he has enabled many to benefit from his work.

The opportunity to say thank you via a donation exists. More details can be found at: <http://slic3r.org/donations>.

## 2.2 Getting Slic3r

Slic3r is Free Software, and is licensed under the GNU Affero General Public License, version 3.

### Downloading

#### From LulzBot

The Slic3r version that has been tested for the Mini 3D printer can be downloaded from the LulzBot.com downloads page: <https://www.lulzbot.com/support/downloads>.

Pre-compiled packages are available for Windows, Mac OS X and Linux. Windows and Linux users can choose between 32 and 64 bit versions to match their system.

#### Slic3r

Slic3r can be downloaded directly from: <http://slic3r.org/download>.

Pre-compiled packages are available for Windows, Mac OS X and Linux. Windows and Linux users can choose between 32 and 64 bit versions to match their system.

#### Manual

The latest version of full Slic3r manual, with  $\LaTeX$  source code, can be found at: <https://github.com/alexrj/Slic3r-Manual>

#### Source

The source code is available via GitHub: <https://github.com/alexrj/Slic3r>. For more details on building from source see §2.2 below.

### Installing

#### Linux

Extract the archive to a folder of your choosing. Either:

- Start Slic3r directly by running the Slic3r executable, found in the bin directory, or
- Install Slic3r by running the do-install executable, also found in the bin folder.

The archive file may then be deleted.

### Windows

Unzip the downloaded zip file to a folder of your choosing, there is no installer script. The resulting folder contains two executables:

- `slic3r.exe` - starts the GUI version.
- `slic3r-console.exe` - can be used from the command line.

The zip file may then be deleted.

### Mac OS X

Double-click the downloaded dmg file, an instance of Finder should open together with an icon of the Slic3r program. Navigate to the Applications directory and drag and drop the Slic3r icon into it. The dmg file may then be deleted.

## Building from source

For those wishing to live on the cutting edge, Slic3r can be compiled from the latest source files found on GitHub <https://github.com/alexrj/Slic3r>.

Up-to-date instructions for compiling and running from source can be found on the Slic3r wiki.

## 2.3 First Print

### Calibration

Before even attempting the first print it is vital that the printer is correctly calibrated. Skipping or rushing this step will result in frustration and



## 2.3. FIRST PRINT

failed prints later, so it is important to take the time to make sure the machine is correctly set up. Your LulzBot™ Mini 3D printer has already been calibrated prior to leaving the factory. Be sure to complete the Setup and First Print section of this manual before moving forward with Slic3r.

If you are just beginning with 3D printing or Slic3r, LulzBot recommends starting with our pre-set Slic3r profiles. You can find the Mini Slic3r profiles at <https://www.lulzbot.com/support/downloads>. For information on loading and export Slic3r profiles please see page 109. Note that the pre-set profiles will only work correctly when Slic3r is in Expert mode.

The pre-set profiles will give you Slic3r settings that will work great on most designs. The Slic3r manual can be used as a reference in building knowledge of Slic3r settings while using the pre-set profiles. Once you have a number of prints completed you can use the Slic3r manual as a reference to make small adjustments to the pre-set profiles or begin creating your own profiles.

## Configuration Wizard

Slic3r has two features to aid newcomers: the configuration wizard, and simple mode.

Sometimes it is nice to have a helping hand when starting out with new software. The configuration wizard asks a series of questions and creates a configuration for Slic3r to start with.

When using the pre-set Mini Slic3r profiles you do not need to complete the Configuration Wizard. The Configuration Wizard can be later accessed from the top menu once you are ready to start creating your own Slic3r profiles.



Figure 2.1: Configuration Wizard: Welcome Screen

## 2.3. FIRST PRINT

### 1. Firmware Type

The gcode produced by Slic3r is tailored to particular types of firmware. The first step prompts for the firmware that the printer uses. For the Mini 3D printer select RepRap (Marlin/Sprinter)

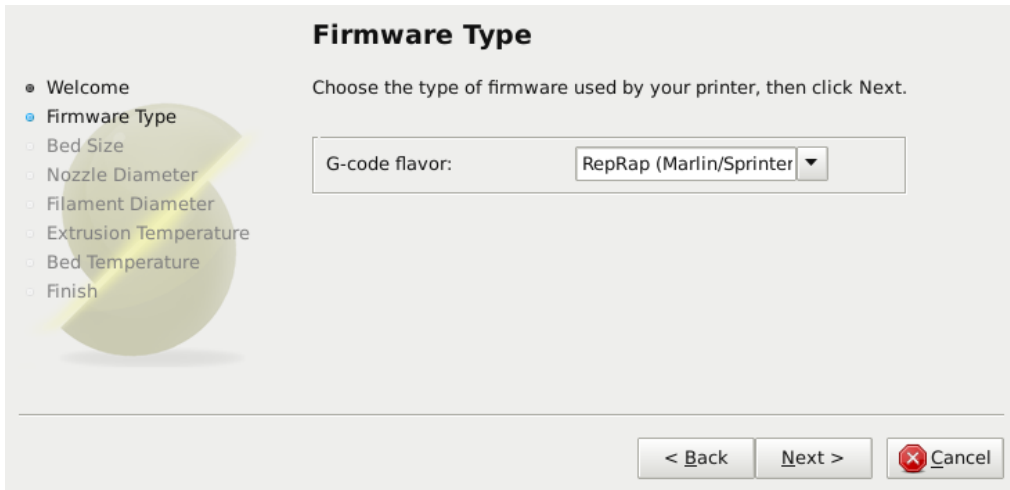

Figure 2.2: Configuration Wizard: Firmware Type

## 2. Bed Size

This setting defines the maximum distance the extruder may travel along the X and Y axis. The dimensions of the Mini 3D print surface are X: 160 and Y: 160.

Be sure to measure from the lower left corner where the extruder nozzle rests when are the home position to the maximum distance the nozzle can travel in each direction.



Figure 2.3: Configuration Wizard: Bed Size

### 3. Nozzle Diameter

The diameter of the hot-end nozzle is usually clearly displayed either in the description of the hot-end, or in the associated documentation, when the hot-end is purchased. The default nozzle size on the Mini hot end is 0.5mm.

If the nozzle was home-made, or came from a source without a diameter given, then carefully measure the aperture as accurately as possible. One way of determining nozzle size is to very slowly (1mm/s) extrude some filament into free air and measure the thickness of the resulting extrusion<sup>1</sup>. This has the benefit of taking die swell into account.

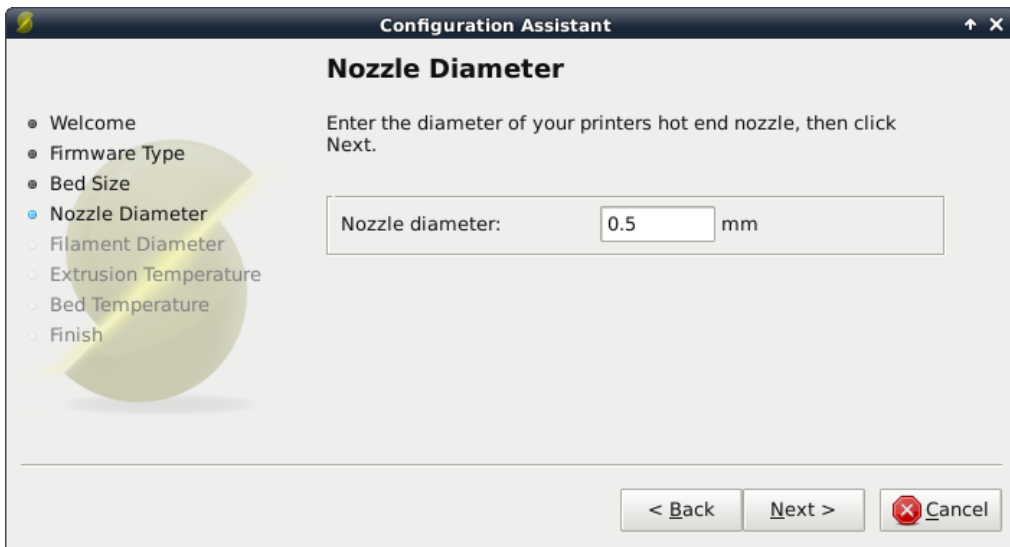

Figure 2.4: Configuration Wizard: Nozzle Diameter

<sup>1</sup> <http://forums.reprap.org/read.php?1,113374,113953>

#### 4. Filament Diameter

For Slic3r to produce accurate results it must know as accurately as possible how much material is pushed through the extruder. Therefore it is vital to give it as precise a value as possible for the filament diameter.

Although the filament used in FFF printers is sold as being either 3mm or 1.75mm this is only a general guide. The diameter can vary between manufacturers and even between batches. Therefore it is highly recommended to take multiple measurements from along a length of the filament and use the average. For example, measurements of 2.89, 2.88, 2.90 and 2.91 would yield an average of 2.895, and so this would be used.

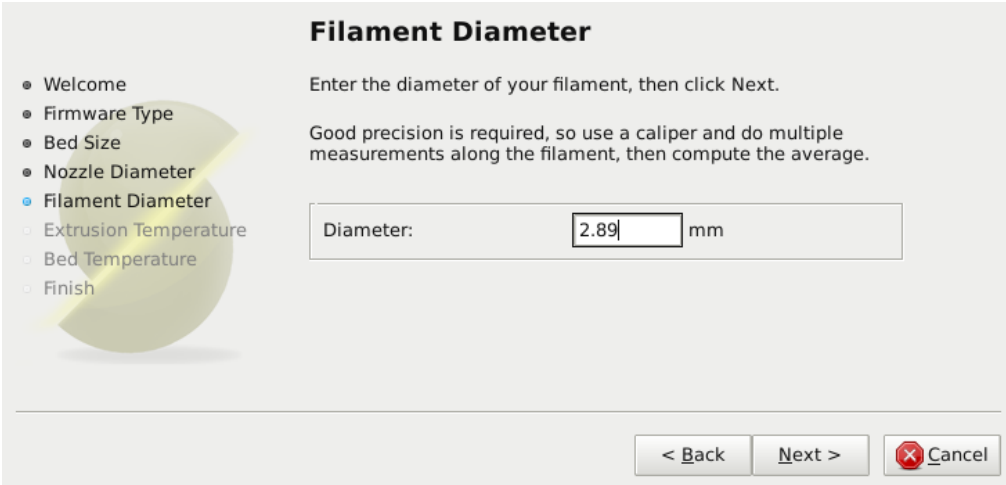

The screenshot shows the 'Filament Diameter' step of the Slic3r Configuration Wizard. On the left, a vertical list of steps is shown with radio buttons: 'Welcome', 'Firmware Type', 'Bed Size', 'Nozzle Diameter', 'Filament Diameter' (selected with a blue dot), 'Extrusion Temperature', 'Bed Temperature', and 'Finish'. The main area is titled 'Filament Diameter' and contains the instruction: 'Enter the diameter of your filament, then click Next. Good precision is required, so use a caliper and do multiple measurements along the filament, then compute the average.' Below this is a text input field labeled 'Diameter:' containing the value '2.89' followed by 'mm'. At the bottom right, there are three buttons: '< Back', 'Next >', and a red 'X' button labeled 'Cancel'.

Figure 2.5: Configuration Wizard: Filament Diameter

### 5. Extrusion Temperature

The extrusion temperature will depend on the material, and most can operate over a range of temperatures. The supplier should provide guidance as to which temperatures are suitable. A very general rule of thumb is that PLA lies between 160°C and 230°C, and ABS lies between 220°C and 240°C. More exotic materials will have a different range.

This is one parameter which you will want to fine tune when you start producing prints. The optimal temperature can vary even between colors of the same material. Another factor which may affect the chosen temperature is how fast the extrusion is, where generally faster extrusion runs hotter.

Note: One may choose to control the extruder temperature manually from the printer controller. In this case the temperature can be set to zero.

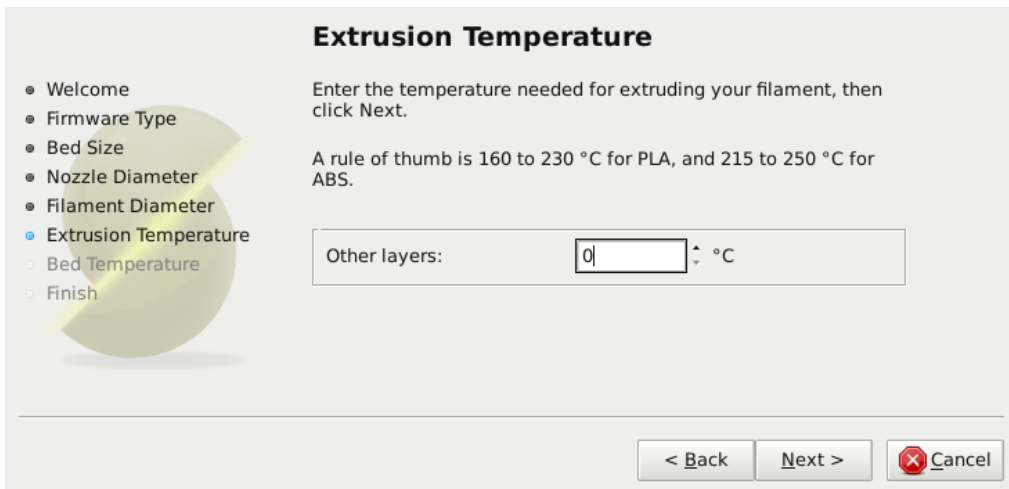

**Extrusion Temperature**

- Welcome
- Firmware Type
- Bed Size
- Nozzle Diameter
- Filament Diameter
- **Extrusion Temperature**
- Bed Temperature
- Finish

Enter the temperature needed for extruding your filament, then click Next.

A rule of thumb is 160 to 230 °C for PLA, and 215 to 250 °C for ABS.

Other layers:  °C

< Back   Next >    Cancel

Figure 2.6: Configuration Wizard: Extrusion Temperature

## 6. Bed Temperature

If the printer has a heated bed then this parameter may be set. As with the extruder temperature, the value will depend on the material used. A rule of thumb is that PLA requires 35°C - 60°C and ABS requires 85°C.

Note: One may choose to control the bed temperature manually from the printer controller. In this case the temperature can be set to zero.

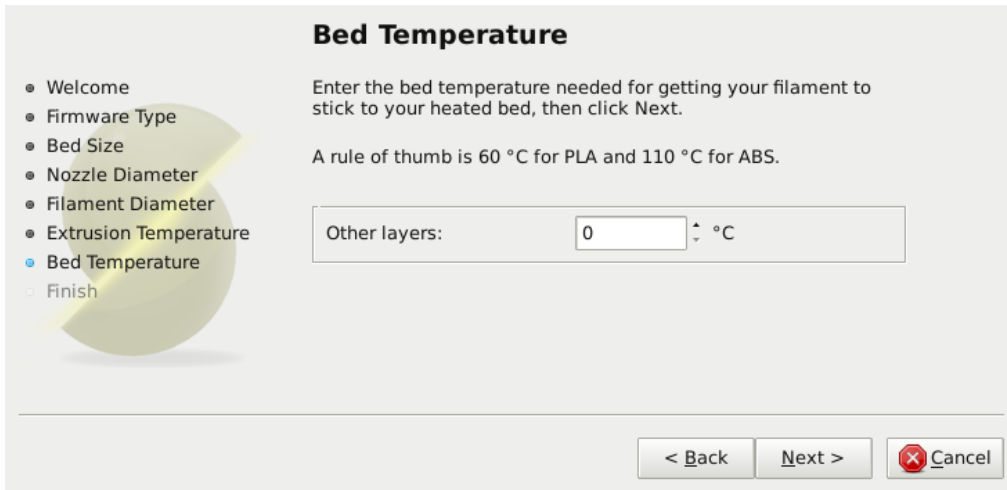

Figure 2.7: Configuration Wizard: Bed Temperature



## 2.3. FIRST PRINT

At this stage the wizard is complete and the basic configuration is defined.



Figure 2.8: Configuration Wizard: End

## The Important First Layer

Before delving into producing the first print it is worthwhile taking a little detour to talk about the importance of getting the first layer right. As many have found through trial and error, if the first layer is not the best it can be then it can lead to complete failure, parts detaching, and warping. There are several techniques and recommendations one can heed in order to minimise the chance of this happening.

**Level bed.** Having a level bed is critical. If the distance between the nozzle tip and the bed deviates by even a small amount it can result in either the material not lying down on the bed (because the nozzle is too close and scrapes the bed instead), or the material lying too high from the bed and not adhering correctly.

**Higher temperature.** The extruder hot-end and bed, if it is heated, can be made hotter for the first layer, thus decreasing the viscosity of the material being printed. As a rule of thumb, an additional 5° is recommended.

**Lower speeds.** Slowing down the extruder for the first layer reduces the forces applied to the molten material as it emerges, reducing the chances of it being stretched too much and not adhering correctly. 30% or 50% of the normal speed is recommended.

**Correctly calibrated extrusion rates.** If too much material is laid down then the nozzle may drag through it on the second pass, causing it to lift off the bed (particularly if the material has cooled). Too little material may result in the first layer coming loose later in the print, leading either to detached objects or warping. For these reasons it is important to have a well-calibrated extrusion rate as recommended in §2.3).

**First layer height.** A thicker layer height will provide more flow, and consequently more heat, making the extrusion adhere to the bed more. It also gives the benefit of giving more tolerance for the levelness of the bed. It is recommended to raise the first layer height to match the diameter of the nozzle, e.g. a first layer height of 0.35mm for a 0.35mm nozzle. Note: The first layer height is set this way automatically in simple mode.

## 2.3. FIRST PRINT

Fatter extrusion width. The more material touching the bed, the better the object will adhere to it, and this can be achieved by increasing the extrusion width of the first layer, either by a percentage or a fixed amount. Any spaces between the extrusions are adjusted accordingly.

A value of approximately 200% is usually recommended, but note that the value is calculated from the layer height and so the value should only be set if the layer height is the highest possible. For example, if the layer height is 0.1mm, and the extrusion width is set to 200%, then the actual extruded width will only be 0.2mm, which is smaller than the nozzle. This would cause poor flow and lead to a failed print. It is therefore highly recommended to combine the high first layer height technique recommended above with this one. Setting the first layer height to 0.35mm and the first extrusion width to 200% would result in a nice fat extrusion 0.65mm wide.

Bed material. Many options exist for the material to use for the bed, and preparing the right surface can vastly improve first layer adhesion.

PLA is more forgiving and works well on PET, Kapton, or blue painters tape.

ABS usually needs more cajoling and, whilst it can print well on PET and Kapton, there are reports that people have success by applying hairspray to the bed before printing. Others have reported that an ABS slurry (made from dissolving some ABS in Acetone) thinly applied can also help keep the print attached.

No cooling. Directly related with the above, it makes no sense to increase the temperature of the first layer and still have a fan or other cooling mechanism at work. Keeping the fan turned off for the first few layers is generally recommended.

## Working with Models

Yet another step lies between now and the first print - a model has to be found and then sliced.

### Model Formats

Slic3r accepts the following file types.

- STereoLithography (STL) files can come from a wide variety of sources and are now a de facto standard in 3D printing. The files simply describe the surface geometry of a 3D object without any additional information (such as color or material), and it is this simplicity that has probably made the format ubiquitous.
- Wavefront OBJ files are an open format originally used in an animation application from Wavefront Technologies, but has since been adopted by the wider 3D modelling community. It is similar to the STL format.
- Additive Manufacturing File Format (AMF) was developed in response to the limited nature of the STL format. In addition to describing the geometry of the 3D model it can also describe colors and materials, as well as more complex attributes, such as gradient mixes and multiple object arrangements (constellations). Whilst the format is deemed a standard it has yet to be widely adopted in the 3D maker community.

### Finding Models

The 3D model files may come from an online repository, such as Thingiverse<sup>2</sup> or GrabCAD<sup>3</sup>, or be created from a CAD program, such as FreeCAD<sup>4</sup>, Sketchup<sup>5</sup>, or OpenSCAD<sup>6</sup>, or an online CAD tool such as Shapsmith<sup>7</sup>.

<sup>2</sup><http://www.thingiverse.com>

<sup>3</sup><http://grabcad.com>

<sup>4</sup><http://sourceforge.net/projects/free-cad>

<sup>5</sup><http://www.sketchup.com>

<sup>6</sup><http://www.openscad.org>

<sup>7</sup><http://shapsmith.net>

## 2.3. FIRST PRINT

You may wish to view the files before slicing and there are many free applications available, one of which is Meshlab<sup>8</sup> - a comprehensive tool for viewing and working with 3D files.

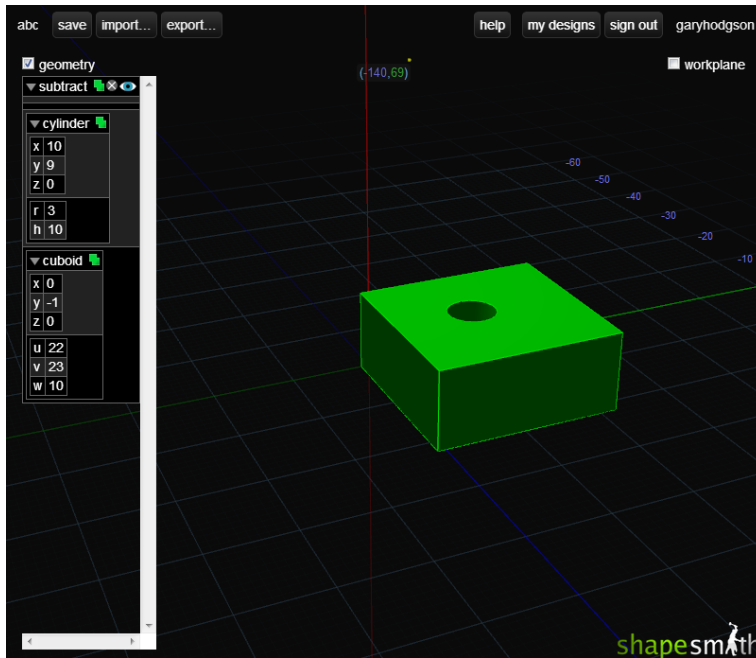

Figure 2.9: Shapsmith online CAD tool.

### Working with Plater

Slic3r has a tool, called Plater, which allows one or more models to be loaded and arranged before being sliced.

<sup>8</sup><http://www.meshlab.org>

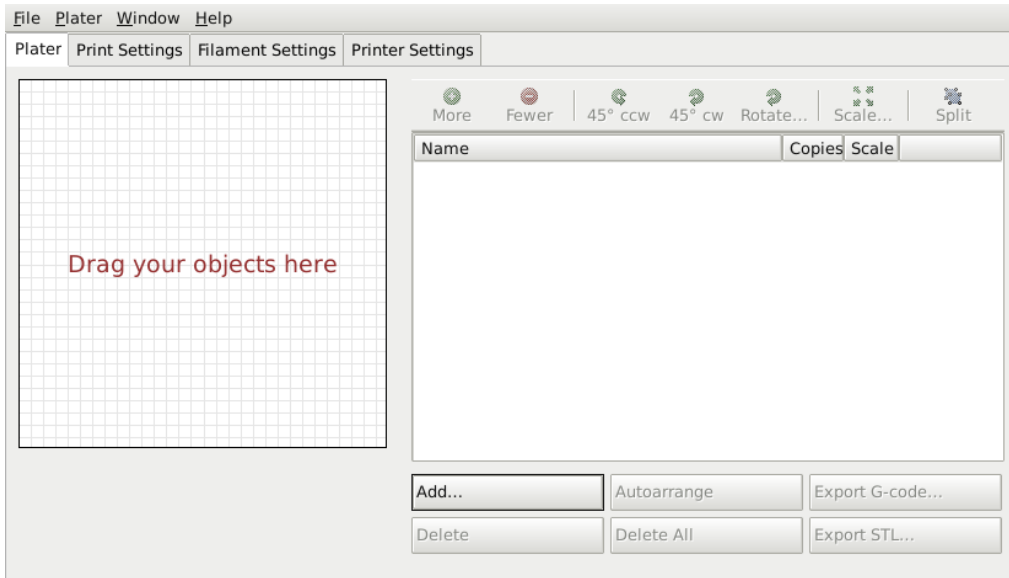

Figure 2.10: Plater

Once you have acquired a model, drag it onto the Plater window (or use the Add button below the file list) to load it into Slic3r. In the figure below, the traditional RepRap Minimug<sup>9</sup> is loaded, and is viewed from above. The ring around the model is a skirt - a single perimeter, several millimeters away from the model, which is extruded first. This is useful in making sure the plastic is flowing smoothly from the nozzle when the model is starting to be printed.

<sup>9</sup><http://www.thingiverse.com/thing:18357>

### 2.3. FIRST PRINT

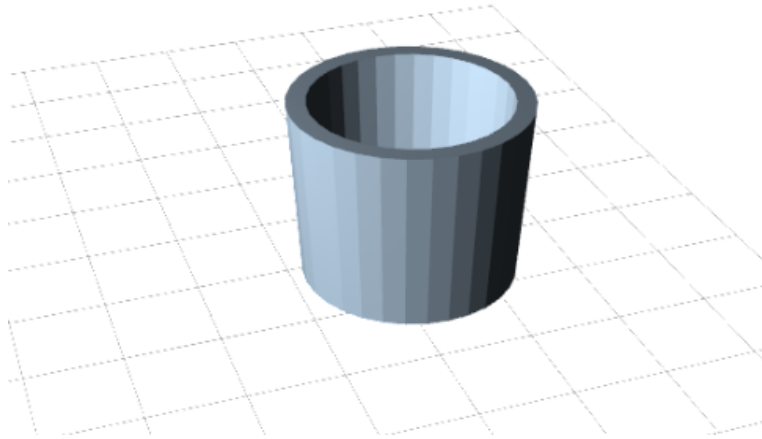

Figure 2.11: Minimug model.

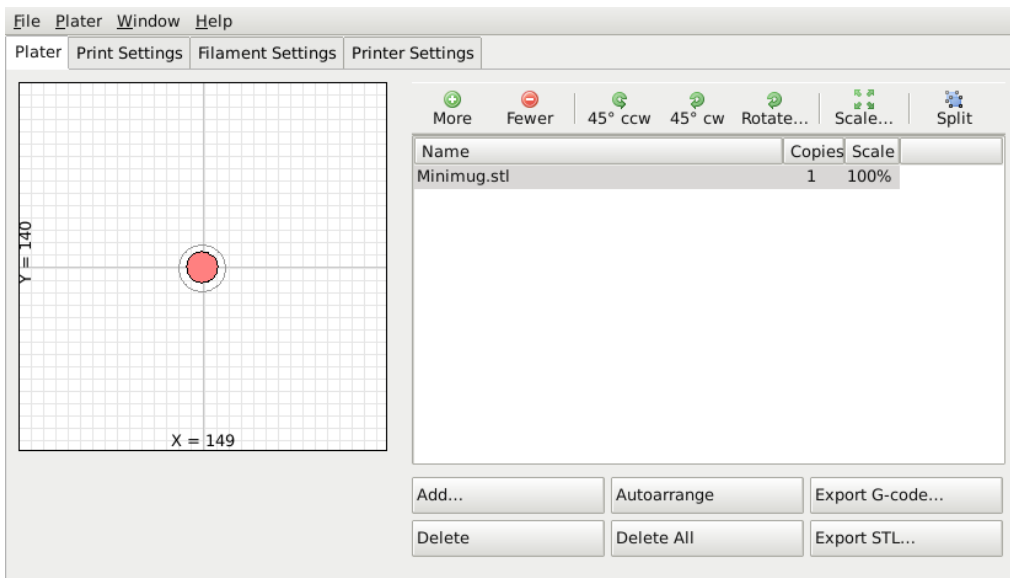

Figure 2.12: STL file loaded.

The model can be repositioned by dragging the representation of it on the left of the screen around the bed. Note that the dimensions of the bed should match your printer, as given during the initial configuration above.

On the right-hand side is the list of currently loaded files. The buttons along the top of the file list allow you to arrange the models.

- More/Less - Adjust how many copies should be printed.
- 45°/Rotate - Rotate the selected model around the Z axis, either in 45° increments clockwise or counter-clockwise, or by a given amount.
- Scale - Increase or decrease the size of the printed model.
- Split - Divides a model which consists of more than one part into its constituent parts, allowing each one to be arranged individually.

The buttons along the bottom of the file list allow you to add, remove, auto-arrange, or export the models.

- Add - Opens a file dialog to add a model to the plater, as an alternative to dropping a file directly.
- Delete/Delete All - Remove one or all models from the plater.
- Autoarrange - Attempt to arrange the models to give the optimal layout.
- Export G-code - Starts slicing the model and produces a G-Code file.
- Export STL - Save the current set of models as a single STL file.

### Cleaning STLs

If the 3D mesh described in the model contains holes, or edges are misaligned (known as being non-manifold), then Slic3r may have problems working on it. Slic3r will attempt to fix any problems it can, but some problems are out of its reach. If the application complains that a model cannot be sliced correctly then there are several options available: see the chapter about Repairing Models.



## Printing

At this stage Slic3r has been configured and a model has been acquired, sliced and made ready for print. Now would be the time to fire up the printer and try it out.

A variety of host software is available to send the G-code to the printer. Amongst the open-source solutions are: Printrun<sup>10</sup>, Repetier<sup>11</sup> and Reprapster<sup>12</sup>.

The following subsections will cover the options available in expert mode, and look at advanced printing techniques, including special cases and troubleshooting.

## 2.4 Simple Mode

### Simple Mode

Slic3r has two modes of operation, Simple and Expert. These may be chosen from the **Preferences** window (found under the **File** menu).

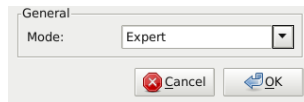

Figure 2.13: Preferences.

Simple mode offers a reduced set of options, enough for the beginner to get started with. Expert mode gives more control over how Slic3r produces the G-code and will be looked at later.

### Print Settings

The **Print Settings** tab provides the opportunity to change settings related to the actual print. Whereas the other tabs are changed rarely, the settings on this tab will be modified regularly, possibly for each model printed.

<sup>10</sup><https://github.com/kliment/Printrun>

<sup>11</sup><http://www.repetier.com/>

<sup>12</sup><https://github.com/timschmidt/reprapster>

File Plater Window Help

Plater Print Settings Filament Settings Printer Settings

General

Layer height: 0.3 mm

Perimeters (minimum): 2

Solid layers: Top: 3 Bottom: 3

Infill

Fill density: 0.3

Fill pattern: rectilinear

Support material

Generate support material:

Pattern spacing: 2.5 mm

Raft layers: 0 layers

Speed

Perimeters: 30 mm/s

Infill: 60 mm/s

Travel: 130 mm/s

Brim

Brim width: 0 mm

Sequential printing

Complete individual objects:

Extruder clearance (mm): Radius: 20 Height: 20

Want more options? Switch to the Expert Mode.

Figure 2.14: Simple Mode: Print Settings.

General. **Layer height** is the thickness of each layer, and it is the step along the vertical axis taken before extruding a new layer atop the previous one. There are several factors that influence how high each layer should be:

- Desired resolution - Lower layer height should result in prints with less noticeable ribs or bands, as each layer is smaller. Aesthetics plays a role here, but also the type of model, for example, a mechanical part may not need such a high resolution finish, whereas a presentation piece may do so.

## 2.4. SIMPLE MODE

- Print speed - Shorter layers will result in smoother prints but each print will take longer, simply because the extruder must trace the pattern more times. A later goal will be to strike a balance between layer height, the speed of the printer, and the quality of the resulting print.

**Perimeters** defines the minimum number of vertical shells (i.e. walls) a print will have. Unless the model requires single width walls it is generally recommended to have a minimum of two perimeters as this gives some insurance that if a subsection of the perimeter is not printed correctly then the second perimeter will help cover it.

The upper and lowermost layers that sandwich the model are filled with a **Solid layers** pattern. For the bottom layers the important factor to consider is how the surface will look should there be a mistake whilst laying down the first layer, and for this reason it is recommended to have at least two bottom layers.

A similar consideration is required for the top layers. Because the intermediate layers are likely to be filled with a pattern set less than 100% then the covering layers will have to bridge this pattern and this can require more than one pass to cover completely.



Figure 2.15: An example of insufficient top layers.

Another tip to consider: Setting the top solid layer to zero, and setting the infill also to zero, will result in a hollow receptacle, ideal for turning models into vases<sup>13</sup> for example. Here manipulating the settings within Slic3r can be used to generate different kinds of prints, and not only be used to control surface accuracy.

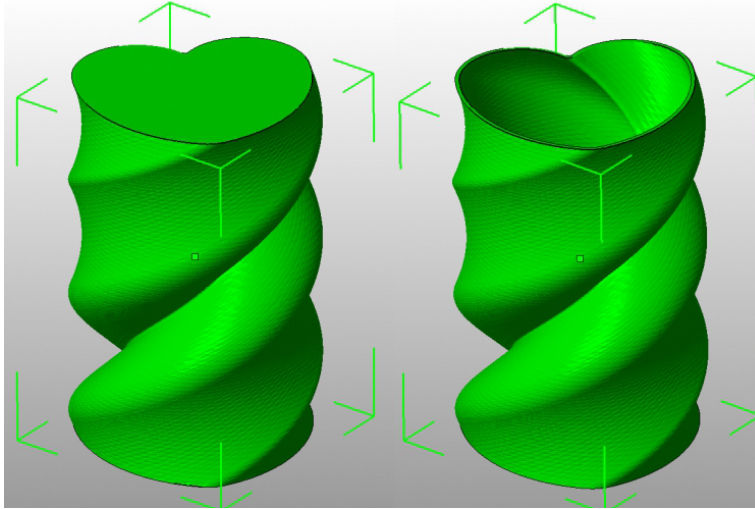

Figure 2.16: Creating a vase from a solid model.

**Infill.** **Fill density** is defined on a scale of between 0 and 1, where 1 is 100% and 0.4 would be 40%. For the majority of cases it makes no sense to 100% fill the model with plastic, this would be a waste of material and take a long time. Instead, most models can be filled with less material which is then sandwiched between layers filled at 100% (see **Solid layers** above).

A density value of 0.4 is enough to give almost all models good mechanical strength. A value of 0.2 is usually the minimum required to support flat ceilings.

Slic3r offers several fill patterns which will be discussed in more depth in subsection 2.5 - Infill Choices. Choosing a **Fill pattern** will depend on the kind of model, the desired structural strength, print speed, and personal taste. The more exotic fill methods are usually too slow and unnecessarily complex for most use cases, and so most of the time the infill

<sup>13</sup><http://slic3r.org/blog/tip-printing-vases>

## 2.4. SIMPLE MODE

pattern is either **rectilinear**, **line**, or **honeycomb**. Honeycomb gives the most strength but is slower than both rectilinear or line.

**Support material.** Printing a model from the bottom up, as with FDM, means that any significant overhangs will be printed in the air, and most likely droop or not print correctly. Choosing support material (**Generate support material**) will add additional structures around the model which will build up to then support the overhanging part. The **Pattern spacing** option determines how dense the support material is printed.

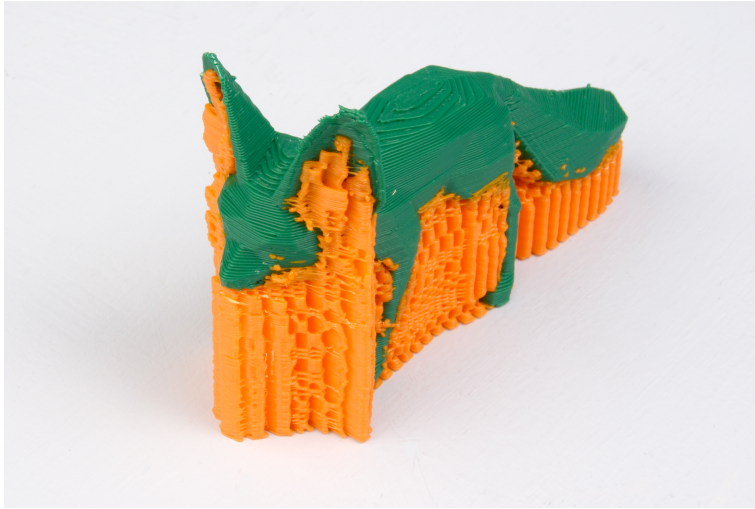

Figure 2.17: An example of an object printed with support material.

**Tip:** It is sometimes worth considering altering the orientation of the model in order to possibly reduce overhangs.

**Raft layers** will add additional layers underneath the model and stems from the early days of 3D printing. It can help with prints without a heated bed, or where the bed is not very flat, but it is usually not required and is not recommended. The raft also requires post-processing to remove it.

**Speed.** In simple mode there are only three speed settings to consider:

- **Perimeters** - The outline of the model may benefit from being printed slightly slower so that the outside skin of the print has fewer blemishes.

- **Infill** - As the infill is hidden this can be extruded a little faster. Take care though not to go too fast as higher speeds results in thinner extrusions, and this may affect how the extrusions bond.
- **Travel** - The jump between the end of one extrusion and the next should usually be performed as quickly as the printer will allow in order to minimise any mess caused by material oozing from the nozzle.

**Brim.** **Brim width** is used to add more perimeters to the first layer, as a base flange, in order to provide more surface area for the print to stick to the bed with in order to reduce warping (see §2.3). The brim is then cut away once the print is finished and removed from the bed.



Figure 2.18: An example of brim.

**Sequential Printing.** This feature allows to compose a plate of objects but have the printer complete each one individually before going back to  $Z = 0$  and starting with the next one. See the subsection about Sequential Printing in the Advanced Topics chapter.

### Filament Settings

The **Filament Settings** will normally be used infrequently, for example on receipt of a new roll of filament.

## 2.4. SIMPLE MODE

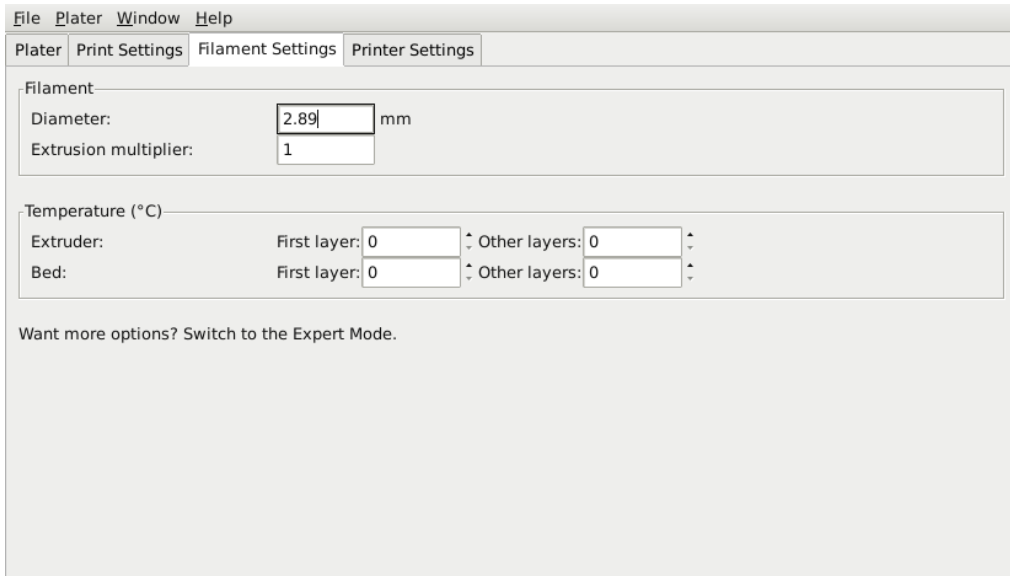

Figure 2.19: Simple Mode: Filament Settings.

**Filament.** The **Diameter** setting will already have been filled from the value given during the wizard (see p.60), but can be updated here.

The **Extrusion multiplier** setting allows the fine tuning of the extrusion flow rate, and is given as a factor, e.g. 1 means 100%, 1.5 would mean 150%. Whilst the value should ideally be set in the firmware it can be useful to test slight changes to the rate by altering this value. It varies the amount of plastic proportionally and should be changed in very small steps (e.g. +/- 0.05) as the effects are very visible.

**Temperature.** These values are also filled from the wizard, but here the opportunity exists to set the temperature for the first layer (see p.64).

### Printer Settings

The **Printer Settings** will be updated the least, unless Slic3r is going to be used for many printers, for example, in a 3D printer farm.

File Plater Window Help

Plater Print Settings Filament Settings Printer Settings

Size and coordinates

Bed size: x: 298 y: 280 mm

Print center: x: 149 y: 140 mm

Z offset: 0 mm

Firmware

G-code flavor: RepRap (Marlin/Sprinter)

Extruder

Nozzle diameter: 0.35 mm

Retraction

Length: 1.6 mm (zero to disable)

Lift Z: 0 mm

Start G-code

G28 ; home all axes

End G-code

```
M400 ;
M104 S0 ; turn off nozzle temperature
M140 S0 ; turn off bed temperature
G1 Y280
G28 X0 ; home X axis
M84 ; disable motors
```

Want more options? Switch to the Expert Mode.

Figure 2.20: Simple Mode: Printer Settings.

Size and coordinates. The **Bed size** setting is taken from the wizard (see p.58) and is only used for previewing the model in the plater.

The **Print center** is the point around which the print will be centered. A **Bed size** of 200mmx200mm and a **Print center** of 100mmx100mm would sit the print in the middle. Should it be desired to print away from the center, because of a scratch in the glass perhaps, then this option should be used.

**Z offset** can be used to compensate for an incorrectly calibrated Z end-stop. If the nozzle stops slightly too far from the bed, then adding a



## 2.4. SIMPLE MODE

negative value will offset all layers by that amount. The correct solution however is to fix the end-stop itself.

The optimal Z endstop position is where the nozzle tip barely touches the surface of the bed when homed. A sheet of paper makes a good gauge for this very small distance. It is not recommended to use this setting to try and improve layer adhesion, by "squashing" the bottom layer into the bed, instead look at the suggestions in subsection 2.3.

**Firmware.** As selected in the wizard (see p.57), `G-code flavour` defines the dialect of G-code generated.

**Extruder.** `Nozzle diameter` was defined in the wizard (see p.59).

**Retraction.** Unless the material being extruded has a very high viscosity it may ooze between extrusions due to gravity. This can be remedied by actively retracting the filament between extrusions. Setting the `Length` parameter to a positive value will cause the filament to be reversed by that many millimeters before travel. The retraction will then be compensated for by the same amount after the travel move, before starting the new extrusion path.

A value of between 1 and 2mm is usually recommended. Bowden extruders may need up to 4 or 5mm due to the hysteresis introduced by the tube. Setting the `Lift Z` parameter to a positive value will raise the entire extruder on the Z axis by that many millimeters during each travel. This can be useful to ensure the nozzle will not catch on any already laid filament, however it is usually not necessary and will slow the print speed. A value of 0.1mm is usually sufficient.

**Start, End and Layer Change G-codes.** Custom G-code commands can be run before a print starts and after a print finishes.

Placeholders can be inserted in the G-code commands<sup>14</sup>. For example `[next_extruder]` would return the index of the next extruder.

The RepRap wiki is a good resource to learn about the variety of G-codes available: <http://reprap.org/wiki/G-code>.

Note: Be sure to check that a given G-code is valid for your firmware.

<sup>14</sup><https://github.com/alexrj/Slic3r/wiki/FAQ#what-placeholders-can-i-use-in-custom-g-code>

The codes specified in **Start G-code** are inserted at the beginning of the output file, directly after the temperature control commands for extruder and bed. Note that if temperature control commands are specified (M104 and M190) then these will replace the temperature G-codes introduced by the **Filament** settings.

Some common G-codes to use before the print starts are:

- G28 - Homes all the axes.

Some common G-codes to use after the print ends are:

- M104 S0 - Sets the extruder temperature to zero.
- M140 S0 - Sets the heated bed temperature to zero.
- G28 X0 - Home the X axis.
- M84 - Disables the motors.

## 2.5 Expert Mode

### Speed

Once the printer is reliably producing good quality prints it may be desirable to increase the speed. Doing this provides several benefits, the most obvious of which is that the results are produced quicker, but also faster print times can be utilised in producing more layers, i.e. lower layer height, thus improving perceived print quality. An additional benefit is that a faster travel movement, between extrusions, can reduce the effects of oozing.

The best approach is to increment the various speed parameters in small steps and observe the effect each change has on print quality. Travel speed is a safe starting point, and it is not unrealistic to attain speeds of up to 250mm/s (if your printer can handle it). Adjusting the speed of perimeters, infill is available in simple mode, and the general rule is to have the perimeter go a little slower than the infill in order to reduce possible blemishes on the surface (infill can be faster because slight gaps will not matter as much).

Expert mode offers more parameters to fine tune printer speeds. Differentiation between external, small and other perimeters, infill locations,

## 2.5. EXPERT MODE

and bridges and gaps are available, as well as the ability to slow down for the first layer.

Speed for print moves		
Perimeters:	<input type="text" value="90"/>	mm/s
Small perimeters:	<input type="text" value="40"/>	mm/s or %
External perimeters:	<input type="text" value="70"/>	mm/s or %
Infill:	<input type="text" value="100"/>	mm/s
Solid infill:	<input type="text" value="100"/>	mm/s or %
Top solid infill:	<input type="text" value="50%"/>	mm/s or %
Support material:	<input type="text" value="60"/>	mm/s
Bridges:	<input type="text" value="60"/>	mm/s
Gap fill:	<input type="text" value="40"/>	mm/s

Speed for non-print moves		
Travel:	<input type="text" value="150"/>	mm/s

Modifiers		
First layer speed:	<input type="text" value="50%"/>	mm/s or %

Acceleration control (advanced)		
Perimeters:	<input type="text" value="0"/>	mm/s <sup>2</sup>
Infill:	<input type="text" value="0"/>	mm/s <sup>2</sup>
Bridge:	<input type="text" value="0"/>	mm/s <sup>2</sup>
Default:	<input type="text" value="0"/>	mm/s <sup>2</sup>

Figure 2.21: Expert mode speed options.

Where indicated a value can be given in percentage. This is in relation to the preceding value, e.g. 50% solid infill would be half of the value defined for infill.

A few general guidelines for each option:

- **Perimeters** - In expert mode this parameter can be increased slightly as the **External perimeters** option can be used to ensure blemish free external faces.

- **Small perimeters** - Meant for holes, islands and fine details, a slower speed here is recommended.
- **External perimeters** - A slightly slower value may ensure cleaner surfaces.
- **Infill** - As fast as you can without compromising the integrity of the fill structure. Faster extrusions can break and result in weak spots.
- **Solid infill** - The bottom of the model, and any additional solid layers is usually slightly slower than infill but faster than perimeters.
- **Top solid infill** - Allow time for the extrusion to cleanly cover the previous top layers and result in a tidy top surface. The last few layers should have bridged the infill structure nicely, preparing the way for a neat finish.
- **Support material** - Generally support structures are quick and dirty, and so long as the base is adequately supported they can be built as quickly as they can.
- **Bridges** - Having the extrusion span distances depends on the material and cooling. Going too slow will result in sagging, too fast will result in broken strands. Experimentation is the key here, but generally bridging runs slower than perimeters.
- **Gap fill** - Filling in small gaps results in the extruder quickly oscillating and the resulting shaking and resonance could have a detrimental affect on the printer. A smaller value here can guard against this. A setting of zero disables gap filling completely.
- **Travel** - As fast as your printer will allow in order to minimise ooze.
- **First layer speed** - As mentioned in subsection 2.3, the first layer is important to lay down correctly, and a slower pace helps enormously. Setting a value of 50%, or even less, can really help.

**Acceleration control** is an advanced setting allowing acceleration settings for perimeters, infill, bridge, as well as a default setting, to be made. Deciding which values to set depends on the capabilities of the machine. Any settings within the firmware may be a good starting point.

## 2.5. EXPERT MODE

Take into account any restrictions enforced by the firmware as many have settings for the maximum safe speed of each axis.

## Infill Patterns and Density

There are several considerations when choosing an infill pattern: object strength, time and material, personal preference. It can be inferred that a more complex pattern will require more moves, and hence take more time and material.

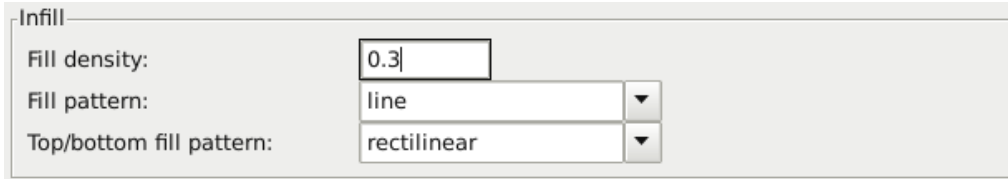

Figure 2.22: Infill pattern settings.

Slic3r offers several infill patterns, four regular, and three more exotic flavours. The numbers given in brackets below each figure are a rough estimate of material used and time taken for a simple 20mm cube model<sup>15</sup>. Note that this is only indicative, as model complexity and other factors will affect time and material.

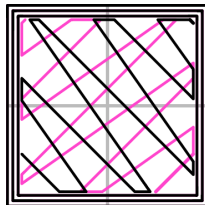

Figure 2.23: Infill pattern: Line (344.51mm / 5m:20s)

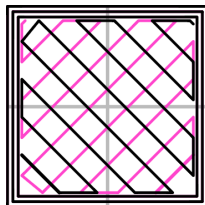

Figure 2.24: Infill pattern: Rectilinear (350.57mm / 5m:23s)

<sup>15</sup>Taken from <http://gcode.ws>

## 2.5. EXPERT MODE

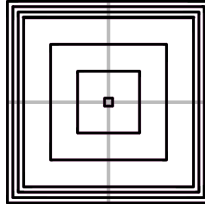

Figure 2.25: Infill pattern: Concentric (351.80mm / 5m:30s)

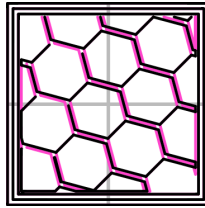

Figure 2.26: Infill pattern: Honeycomb (362.73mm / 5m:39s)

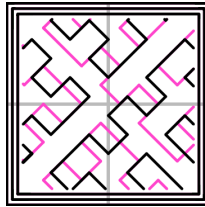

Figure 2.27: Infill pattern: Hilbert Curve (332.82mm / 5m:28s)

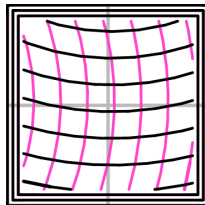

Figure 2.28: Infill pattern: Archimedean Chords (333.66mm / 5m:27s)

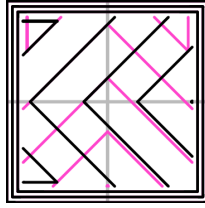

Figure 2.29: Infill pattern: Octagram Spiral (318.63mm / 5m:15s)

Certain model types are more suited for a particular pattern, for example organic versus mechanical types. Figure 2.30 shows how a honeycomb fill may suit this mechanical part better because each hexagon bonds with the same underlying pattern each layer, forming a strong vertical structure.

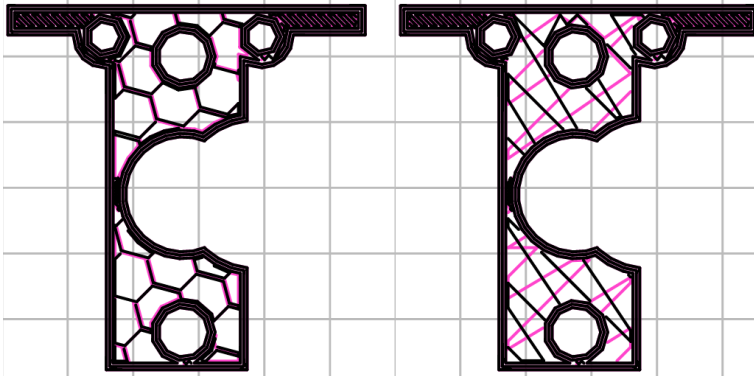

Figure 2.30: Infill pattern comparison in a complex object. Left to Right: honeycomb, line

Most models require only a low density infill, as providing more than, say, 50% will produce a very tightly packed model which uses more material than required. For this reason a common range of patterns is between 10% and 30%, however the requirements of the model will determine which density is best. Figure 2.31 shows how the patterns change as the density increases.



## 2.5. EXPERT MODE

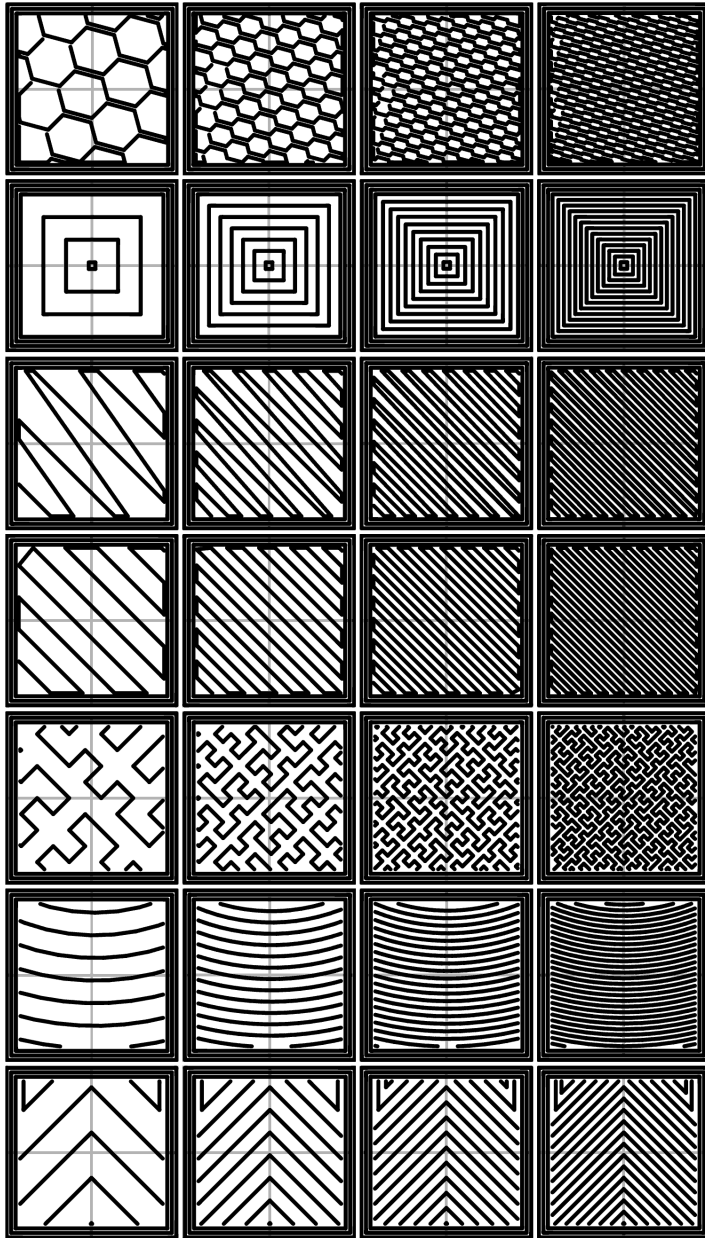

Figure 2.31: Infill patterns at varying densities. Left to Right: 20%,40%,60%,80%. Top to Bottom: Honeycomb, Concentric, Line, Rectilinear, Hilbert Curve, Archimedean Chords, Octagram Spiral

## Infill Optimization

Slic3r contains several advanced infill settings which can help produce better extrusions.

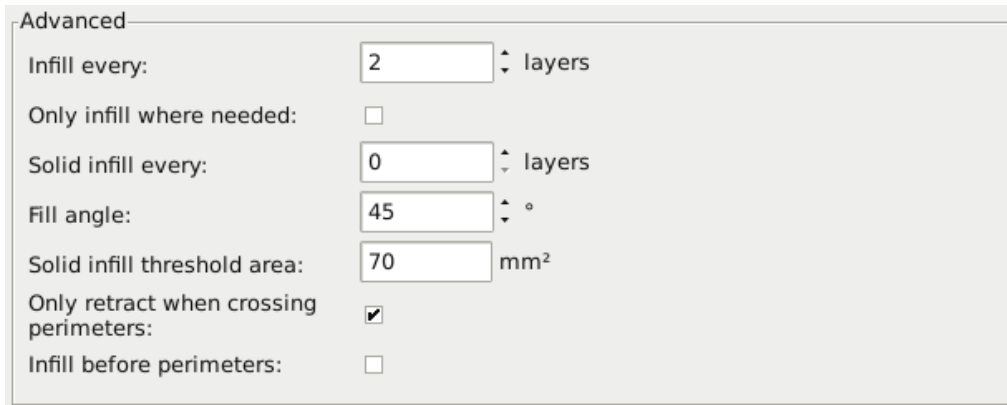

Figure 2.32: Infill advanced settings.

- **Infill every  $n$  layers** - Will produce sparse vertical infill by skipping a set number of layers. This can be used to speed up print times where the missing infill is acceptable.
- **Only infill where needed** - Slic3r will analyse the model and choose where infill is required in order to support internal ceilings and overhangs. Useful for reducing time and materials.
- **Solid infill every  $n$  layers** - Forces a solid fill pattern on the specified layers. Zero will disable this option.
- **Fill angle** - By default the infill pattern runs at 45° to the model to provide the best adhesion to wall structures. Infill extrusions that run adjacent to perimeters are liable to de-laminate under stress. Some models may benefit from rotating the fill angle to ensure the optimal direction of the extrusion.
- **Solid infill threshold area** - Small areas within the model are usually best off being filled completely to provide structural integrity. This will however take more time and material, and can result in parts being unnecessarily solid. Adjust this option to balance these needs.

## 2.5. EXPERT MODE

- **Only retract when crossing perimeters** - Retracting, to prevent ooze, is unnecessary if the extruder remains within the boundaries of the model. Care should be taken if the print material oozes excessively, as not retracting may result in enough material loss to affect the quality of the subsequent extrusion. However, most modern printers and materials rarely suffer from such extreme ooze problems.
- **Infill before perimeters** - Reverses the order in which the layer is printed. Usually the perimeter is laid down initially, followed by the infill, and this is usually the preferable as the perimeter acts as a wall containing the infill.

### Fighting Ooze

Unless the material being extruded has a very high viscosity it will ooze from the nozzle in between extrusions. There are several settings in Slic3r to which can help to remedy this.

The retraction settings, found in the **Printer** tab, tell the printer to pull back the filament between extrusion moves. This can alleviate the pressure in the nozzle, thus reducing ooze. After the subsequent travel move the retraction is reversed to prepare the extruder for the next extrusion.

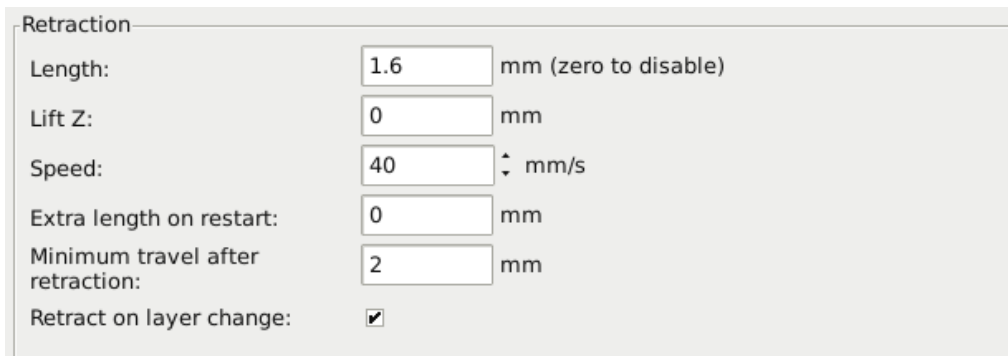

The image shows a screenshot of the 'Retraction' settings panel in Slic3r. The panel has a title bar 'Retraction' and contains the following settings:

Length:	<input type="text" value="1.6"/>	mm (zero to disable)
Lift Z:	<input type="text" value="0"/>	mm
Speed:	<input type="text" value="40"/>	mm/s
Extra length on restart:	<input type="text" value="0"/>	mm
Minimum travel after retraction:	<input type="text" value="2"/>	mm
Retract on layer change:	<input checked="" type="checkbox"/>	

Figure 2.33: Retraction settings.

- **Length** - The number of millimeters to retract. Note that the measurement is taken from the raw filament entering the extruder. A value of between 1 and 2mm is usually recommended. Bowden

extruders may need up to 4 or 5mm due to the hysteresis introduced by the tube.

- **Lift Z** - Raises the entire extruder on the Z axis by that many millimeters during each travel. This can be useful to ensure the nozzle will not catch on any already laid filament, however it is usually not necessary and will slow the print speed. A value of 0.1mm is usually sufficient.
- **Speed** - The speed at which the extruder motor will pull back the filament. The value should be set to as quick as the extruder can handle without skipping steps, and it is worth experimenting with this value to find the quickest retraction possible.
- **Extra length on restart** - Adds an extra length of filament after the retraction is compensated after the travel move. This setting is rarely used, however should the print show signs of not having enough material after travel moves then it may be useful to add a small amount of additional material.
- **Minimum travel after retraction** - Triggering a retraction after very short moves is usually unnecessary as the amount of ooze is usually insignificant and it slows down the print times. Set the number of millimeters minimum distance the nozzle must move before considering a retraction. If the printer handles ooze well this can be increased to 5 or 6mm.
- **Retract on layer change** - Movement along the Z axis must also be considered when dealing with oozing, otherwise blobs may occur. It is recommended to leave this setting on.
- **Wipe before retract** - Moves the nozzle whilst retracting so as to reduce the chances of a blob forming.

Additionally there are several settings in the **Print** tab which can help control oozing.

- **Only retract when crossing perimeters (Infill)** - Tells Slic3r to only retract if the nozzle will cross the threshold of the current island being extruded. Slight ooze within the walls of a part are not seen and can usually be accepted.

## 2.5. EXPERT MODE

- **Avoid crossing perimeters** (Layers and perimeters - Advanced)  
- Will force the nozzle to follow perimeters as much as possible to minimise the number of times it must cross them when moving around, and between, islands. This has a negative impact on both G-code generation and print times.
- **Randomize starting points** (Layers and perimeters - Vertical shells)  
- As the extruder moves up to the start of the next layer any ooze can result in blobs. If the same start point is used for every layer then a seam can form the length of the object. This setting will move the start point to a different location for each layer.

See also subsection: Sequential Printing, on page 112 for another technique which can minimise strings forming between objects.

### Skirt

The **Skirt** setting adds an extrusion a short distance away from the perimeter of the object. This can ensure that the material is flowing smoothly from the extruder before it starts on the model proper.

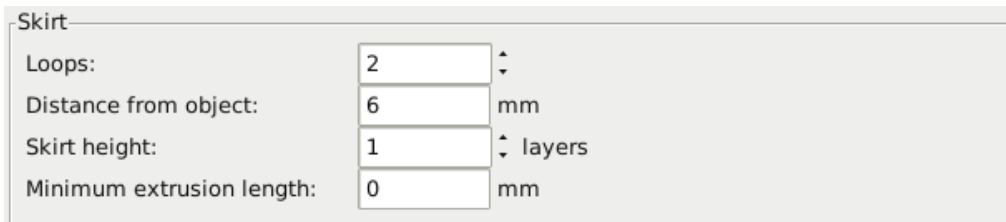

Skirt		
Loops:	<input type="text" value="2"/>	↕
Distance from object:	<input type="text" value="6"/>	mm
Skirt height:	<input type="text" value="1"/>	↕ layers
Minimum extrusion length:	<input type="text" value="0"/>	mm

Figure 2.34: Skirt settings.

- **Loops** - How many circuits should be completed before starting on the model. One loop is usually sufficient.
- **Distance from object** - The millimeters between the object and the skirt. The default of 6mm is usually sufficient.
- **Skirt height** - The number of layers to lay down a skirt for. For ensuring the material is flowing smoothly, one layer is sufficient,

however the skirt function can also be used to build walls around the object in case it should be protected from drafts.

- **Minimum extrusion length** - Dictates a minimum number of millimeters that the skirt should be, should the loop around the object not be enough.

## Cooling

Temperature plays a key part in determining print quality. Too hot and the material deforms, too cool and layer adhesion may be problematic. Applying cooling will allow the freshly deposited material to solidify enough to provide a good base for the next layer, helping with overhangs, small details and bridges.

There are two main techniques for cooling: adding a fan and slowing down the print speed. Slic3r may choose to use both techniques, using a fan first, and then slowing down the print if the layer time is too fast.

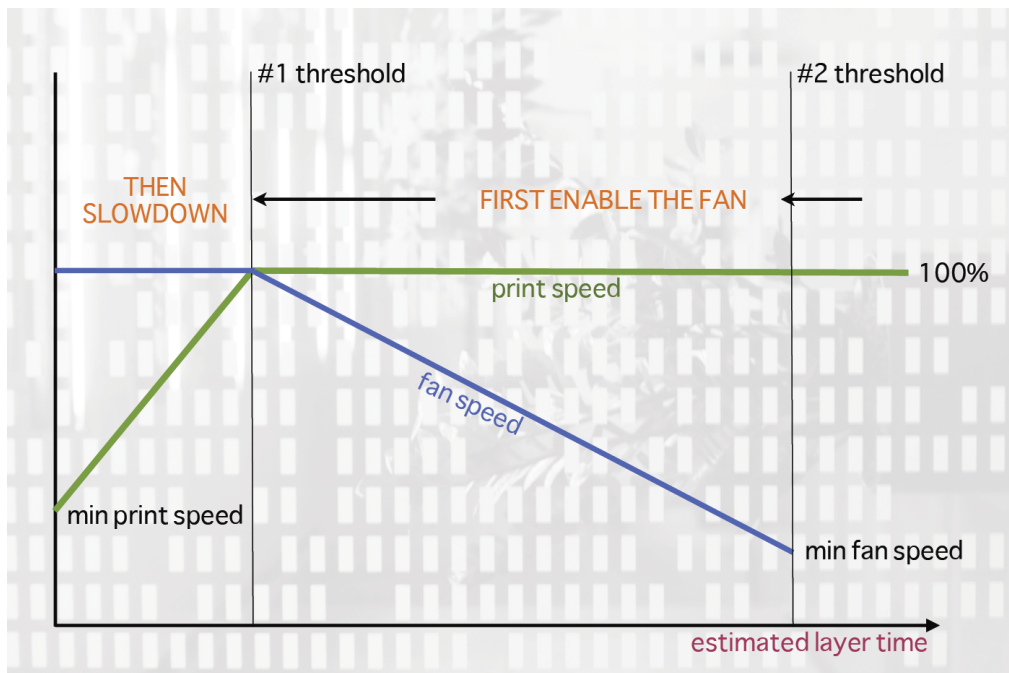

Figure 2.35: Cooling strategy.

## 2.5. EXPERT MODE

Figure 2.35 shows the strategy adopted by Slic3r. Reading from right to left, when the minimum fan threshold (#2) is reached the fan is turned on. This increases in intensity as the layer time decreases. The print speed remains constant until the estimated print time drops below a certain threshold (#1), this is when the print speed is reduced until it reaches its minimum value.

### Fans

Most electronics and firmware allow the addition of a fan via a spare connector. These can then be instructed with G-code, from Slic3r, to turn on or off as the model requires, and to rotate at different speeds.

Care should be taken with the positioning of the fan so that it does not cool any heated bed more than necessary. It should also not cool the heater block of the hot-end so as not to force it to do more work and waste energy. The air movement should aim for the nozzle tip, flowing over the freshly extruded material.

A duct may help in guiding the flow correctly, and there are several designs available online, for a wide variety of printers.

### Slowing Down

Slic3r can tell the printer to slow down if the estimated layer time is above a certain threshold.

Care must be taken as the intended effect could be mitigated by the nozzle not moving far enough away from the fresh extrusion, a problem with small, detailed layers. For this reason it is usually recommended to use a fan where possible.

### Configuring

In simple mode Slic3r will attempt to choose the optimal settings for both fans and speed. Expert mode gives more granular options.

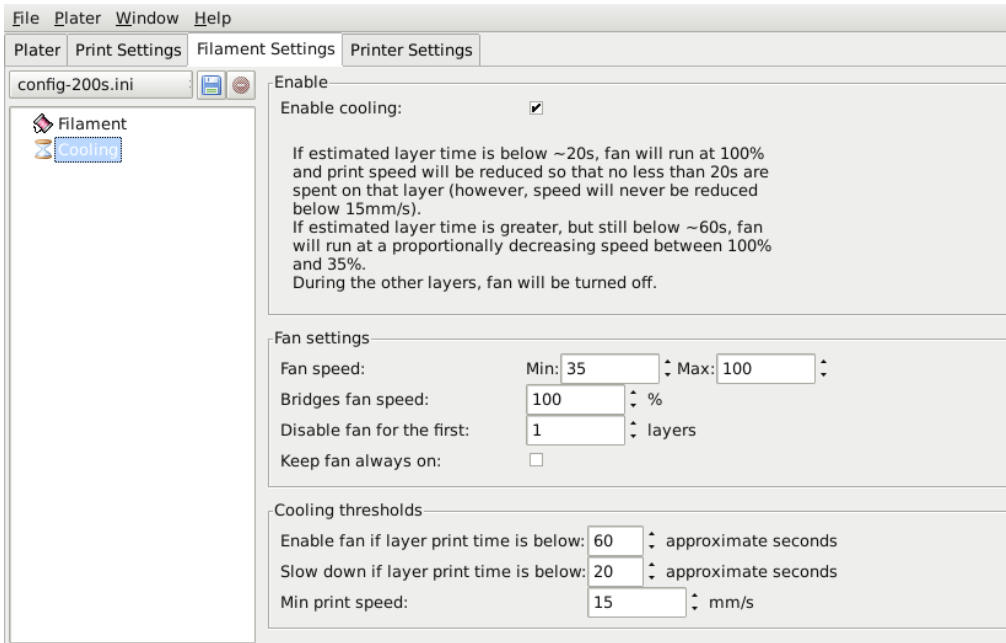

Figure 2.36: Cooling advanced settings.

- **Fan speed** - Determines the minimum and maximum speeds - useful for fans that run too fast by default.
- **Bridges fan speed** - As the material stretches over wide gaps, it makes sense to try and cool it as much as possible, therefore a full fan speed is recommended.
- **Disable fan for first  $n$  layers** - Section 2.3 detailed how important the first layer is, and so it makes sense not to apply the fan until sure the print is securely attached to the bed. Keeping the fan turned off for the first two or three layers is a good idea.
- **Keep fan always on** - Overrides any other choices and has the fan run continuously, at least at the minimum speed setting. This can be useful when printing with PLA, but is not recommended for ABS.
- **Enable fan if print time is below  $t$  seconds** - Triggers the fan if the layer will be completed within the given number of seconds.



## 2.5. EXPERT MODE

- **Slow down if layer print time is below  $t$  seconds** - Slows down the print if the layer will be completed within the given number of seconds.
- **Min print speed** - A lower limit on how slowly a layer can be printed.

### Support Material

Generally, most 3D models will print with overhanging parts by up to a certain degree. The angle is determined by several factors, most notably layer height and extrusion width, and is usually around  $45^\circ$ . For models with larger overhangs a support structure may have to be printed below it. This incurs the use of more material, longer print times, and post printing clean-up.

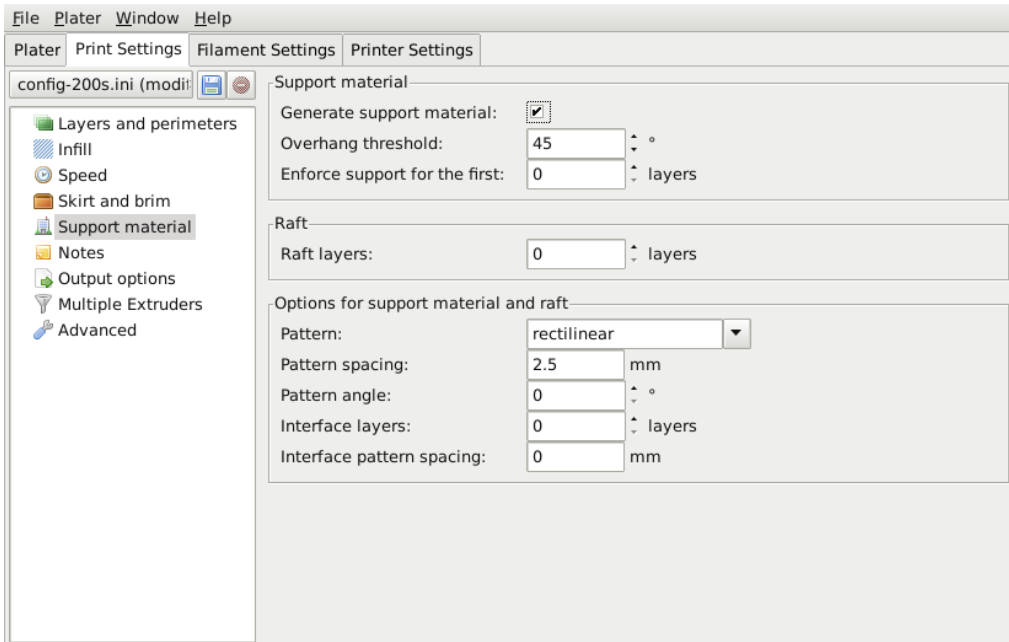

Figure 2.37: Support structure options.

The first thing to do is activate the support material option by checking the **Generate support material** box. Providing a value of zero to the **Overhang threshold** parameter tells Slic3r to detect places to provide

support automatically, otherwise the degrees given will be used. Support generation is a relatively complex topic, and there are several aspects which determine the optimal support, it is strongly recommended to set the threshold to zero and allow Slic3r to determine the support required.

Small models, and those with small footprints, can sometimes break or detach from the bed. Therefore the **Enforce support** option will cause support structures to be printed for the given number of layers, regardless of the angle threshold value.

To demonstrate the infill patterns the minimug model was tilted by  $45^\circ$  along the x axis, as shown in figure 2.38.

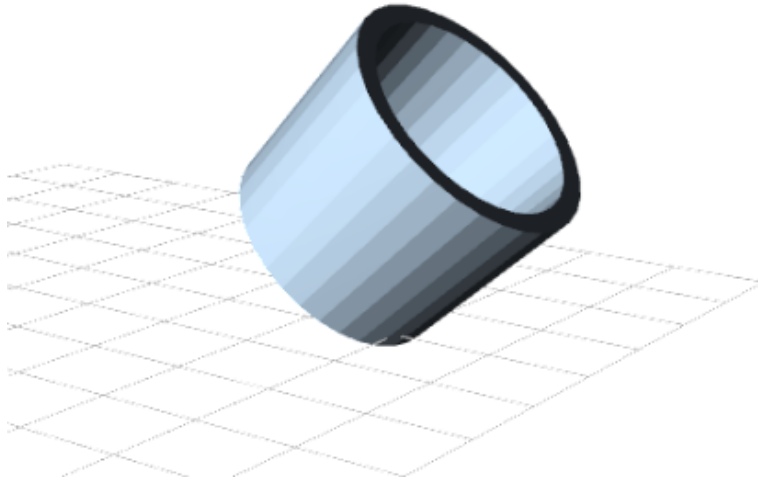

Figure 2.38: Minimug model, tilted  $45^\circ$ .

As with infill, there are several patterns available for the support structure.

## 2.5. EXPERT MODE

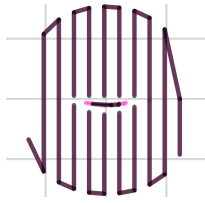

Figure 2.39: Support infill pattern: Rectilinear

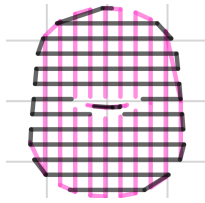

Figure 2.40: Support infill pattern: Rectilinear Grid

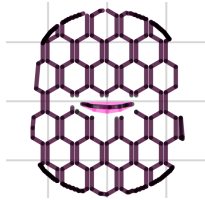

Figure 2.41: Support infill pattern: Honeycomb

**Pattern Spacing** determines the distance between support lines, and is akin to infill density apart from being defined only in mm. If changing this attribute take into account the width of the support extrusion and the amount of support material that will adhere to the object.

Care should be taken to choose a support pattern which matches the model, where the support material attaches perpendicularly to the wall of the object, rather than in parallel, so it will be easy to remove. If the support structure does run along the length of a wall then the **Pattern Angle** option allows the direction of the support lines to be rotated.

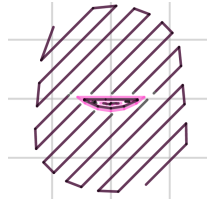

Figure 2.42: Example of pattern angle rotated 45°.

## Multiple Extruders

A printer with more than one extruder can be used in different ways: The additional extruder could print a different color or material; or it could be assigned to print particular features, such as infill, support or perimeters.

Multi-material printing requires a suitably designed object usually written in AMF format as this can handle multiple materials (see Model Formats in §2.3). Details on how to create such a file are given below.

### Configuring Extruders

In the **Printer Settings** tab there is an **Extruders** option, under **Capabilities**, which allows the number of extruders to be defined. Incrementing this value will dynamically add another extruder definition to the left-hand pane.

## 2.5. EXPERT MODE

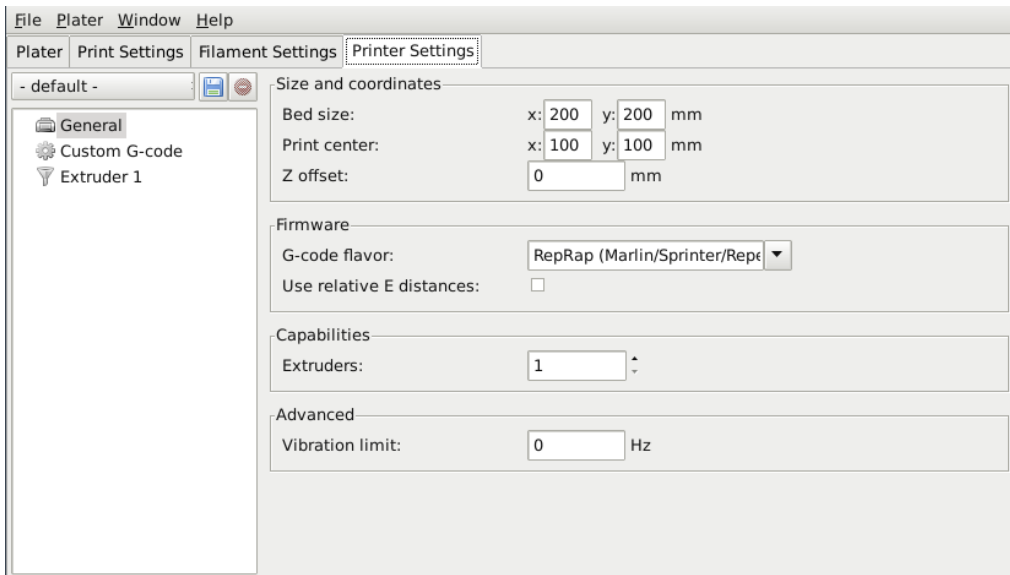

Figure 2.43: Multiple extruder options - Printer Settings Tab (General). Note the two extruders defined in the left-hand pane.

Each extruder can be configured as usual, however there are additional settings which must be set which are particular to multi-extruder setups.

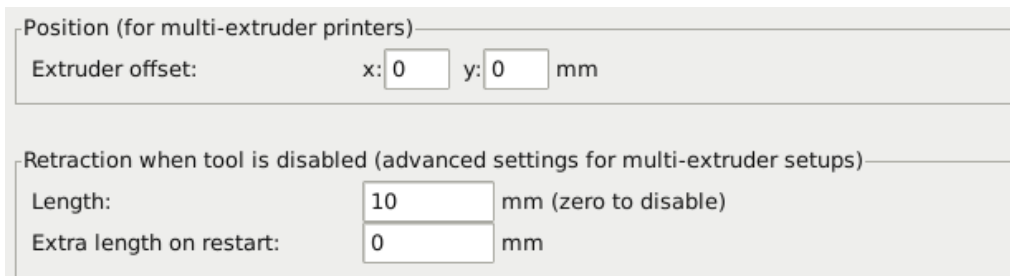

Figure 2.44: Multiple extruder options - Printer Settings Tab (Extruder).

The `Extruder offset` is to be used should the firmware not handle the displacement of each additional nozzle. Your firmware documentation should tell you if this is the case. Each additional extruder is given an offset in relation to the first one. If the firmware does handle this then all offsets can remain at 0,0.

Because the secondary extruder will be dormant whilst the first is working, and vice-versa, it is important that the material is sufficiently retracted to stop oozing. As with the regular retraction settings (see p.89) the **Length** options is measured from the raw filament entering the extruder.

### Assigning Filaments

When a printer profile with multiple extruders has been selected the **Plater** tab allows the selection of a different filament for each extruder.

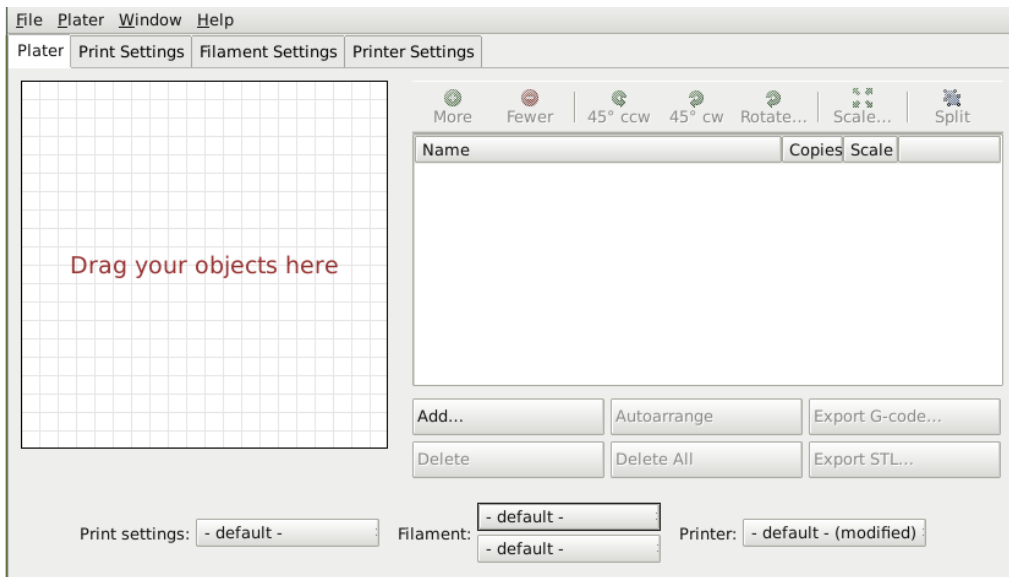

Figure 2.45: Plater with multiple filament options.

### Assigning Extruders for Single-material Objects

For single material prints, where the secondary extruder is to be tasked with a particular extrusion, the **Multiple Extruders** subsection of the **Print Settings** tab gives the ability to assign an extruder to each extrusion type.

## 2.5. EXPERT MODE

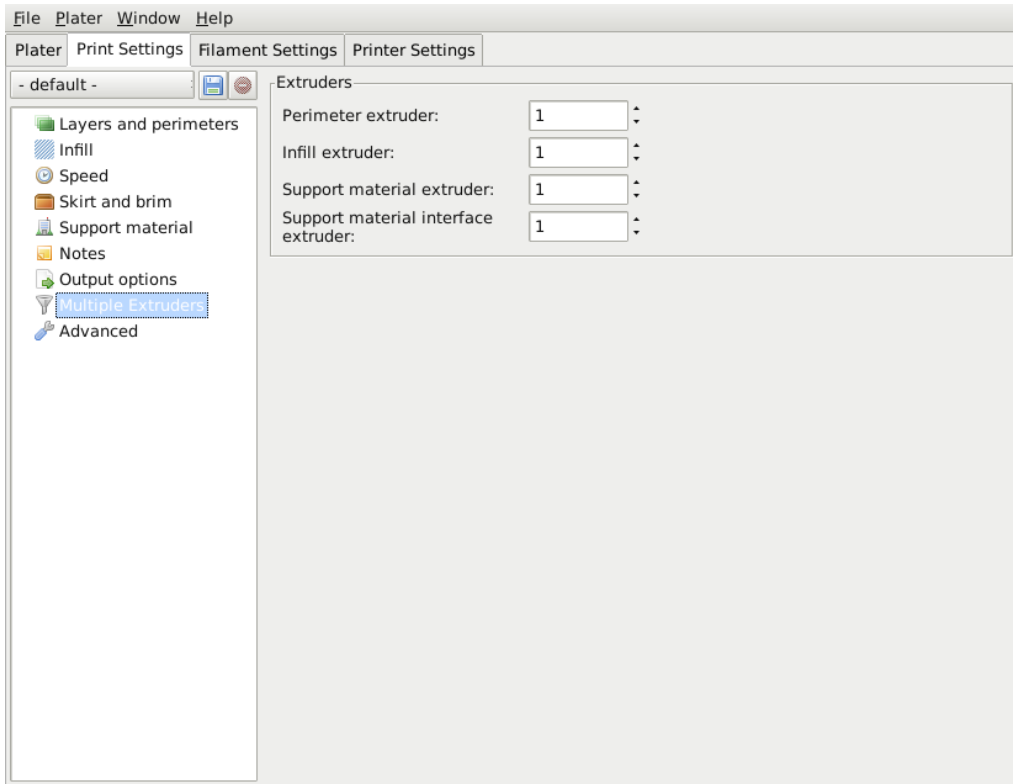

Figure 2.46: Multiple extruder options - Print Settings Tab.

### Configuring Tool Changes

The **Custom G-code** subsection of the **Printer Settings** tab has an option for inserting G-code between tool changes. As with all custom G-code subsections, placeholder variables can be used to reference Slic3r settings. This includes the `[previous_extruder]` and `[next_extruder]` variables.

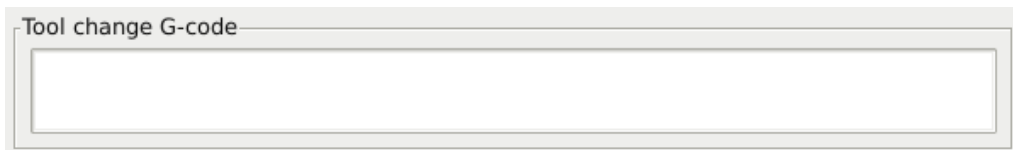

Figure 2.47: Multiple extruder options - Tool change G-code.

## Printing Multi-material Objects

If a multi-material AMF file already exists, because the CAD program can export such a format, then this can be loaded into Slic3r in the usual way. The mapping between object materials and extruders is sequential, i.e. the first material is assigned to the first extruder, etc.

## Generating multi-material AMF files

Slic3r has the feature to combine multiple STL files into a multi-material AMF file.

- Split the original design into the separate parts within the CAD program, and export each part as STL.
- Within Slic3r, choose **Combine multi-material STL files...** from the **File** menu.
- When prompted with a file dialog, choose the first STL, which will be assigned the first material (and hence the first extruder). Click **Open** to be prompted for the next STL, and so on until each STL is assigned a material. To signal there are no more STL files, choose **Cancel**.
- The following file dialog prompts for the location and name of the AMF file.

Once generated the file can be loaded and printed as described above.



## Extrusion Width

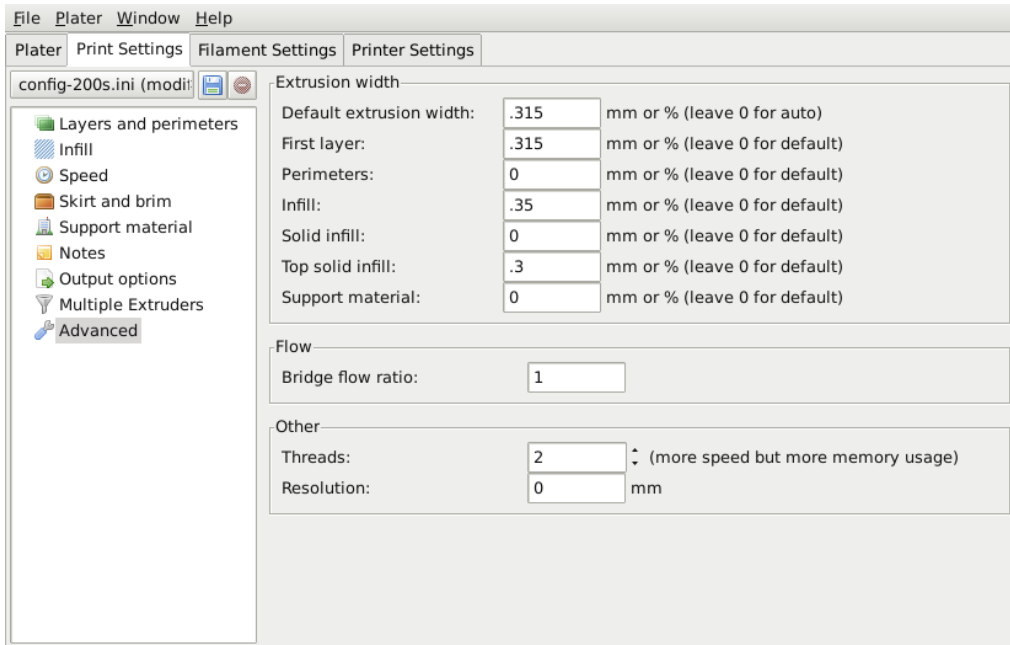

Figure 2.48: Extrusion widths options.

One reason for modifying the extrusion width has already been discussed: increasing first layer extrusion width in order to improve bed adhesion (see p.65). There are some further cases where it may be beneficial to modify extrusion widths.

- **Perimeter** - A lower value will produce thinner extrusions which in turn will produce more accurate surfaces.
- **Infill and Solid Infill** - A thicker extrusion for infill will produce faster prints and stronger parts.
- **Top infill** - A thinner extrusion will improve surface finish and ensure corners are tightly filled.
- **Support material** - As with the infill options, a thicker extrusion will speed up print time.

It is important to remember that if the extrusion width is expressed as a percentage then this is computed from the `Layer height` property, and not the `Default extrusion width` setting.

## Variable Layer Height

Slic3r gives the ability to adjust the layer height between arbitrary positions along the Z axis. That is, parts of the model could be printed with a coarse layer height, for example vertical subsections, and other parts could be printed with a finer layer height, for example sloping gradients where layering appears more pronounced.

The model in fig. 2.49 gives a rudimentary example of where variable layer heights could be used to improve print quality. The walls of the structure need not be rendered in high definition for acceptable quality, however the sloping roof shows layer artifacts as the layer height of 0.4mm is too coarse, particularly for the very top, which is flattened. This is shown in the G-Code rendering in fig. 2.50.

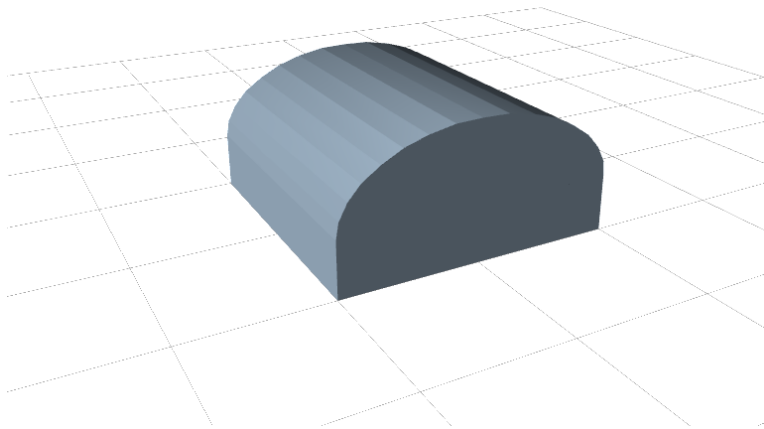

Figure 2.49: Example model highlighting use case for variable layer heights.

## 2.5. EXPERT MODE

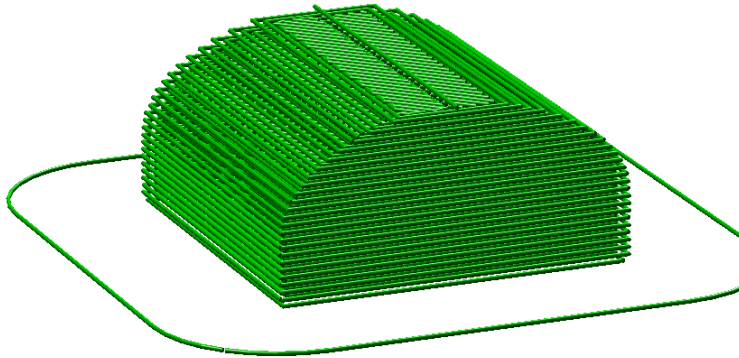

Figure 2.50: Example with normal layer height.

The variable layer height options are available by double clicking on a part name in the Plater window. This will cause a pop-up window to be displayed which contains two tabs. The first gives some information about the model, as shown in fig. 2.51.

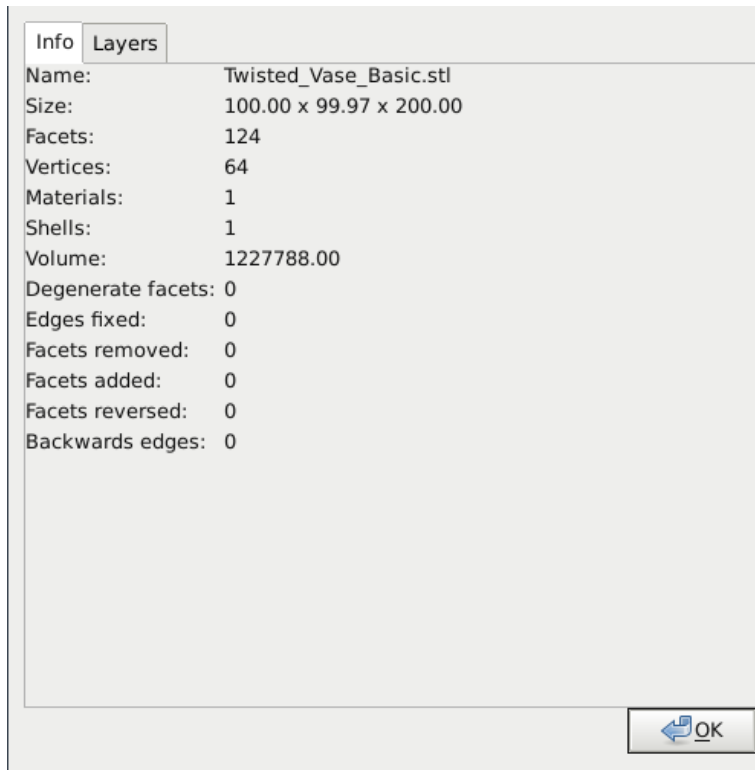

Figure 2.51: Variable layer height options - Info.

It is worth noting the height of the model, as this will be useful when calculating the maximum Z height.

The second tab (fig. 2.52) presents a table where each row defines a layer height for a particular range along the Z axis, given in millimeters. In this example the walls of the model are printed at 0.4mm, the steeper parts of the roof are printed at 0.2mm, and the less steep at 0.15mm. Note that each range divides exactly by the given layer height so there are no "gaps" between subsections.

## 2.5. EXPERT MODE

Info Layers

You can use this section to override the default layer height for parts of this object. Set layer height to zero to skip portions of the input file.

	Min Z (mm)	Max Z (mm)	Layer height (mm)
<b>1</b>	0	4	0.4
<b>2</b>	4	8.4	0.2
<b>3</b>	8.4	9.9	0.15
<b>4</b>			

OK

Figure 2.52: Variable layer height options - Layers.

The resulting G-Code (fig. 2.53) shows a higher definition which should result in a higher quality print.

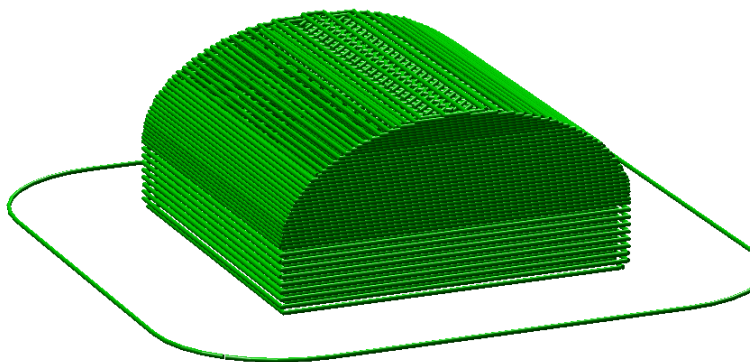

Figure 2.53: Example with variable layer height.

Fig. 2.54 shows the example model printed. The print on the left has 0.4mm layer height throughout, whereas the print on the right has the variable layer height.

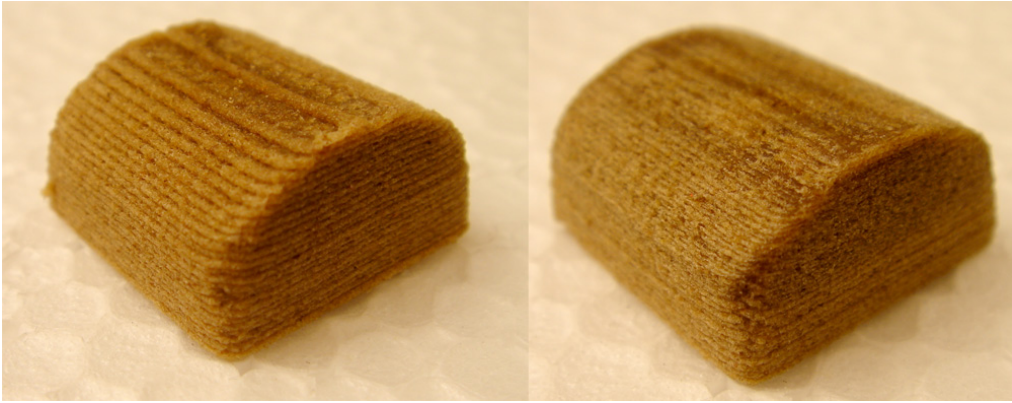

Figure 2.54: Example print with variable layer height.

An additional feature of the variable layers height option is that by entering a zero for a range that part of the model will not be printed. Fig. 2.55 shows the G-Code where layers between 0 and 4mm are skipped. This is a useful way of dividing a tall model into multiple, shorter subsections which can be printed individually and assembled afterwards.

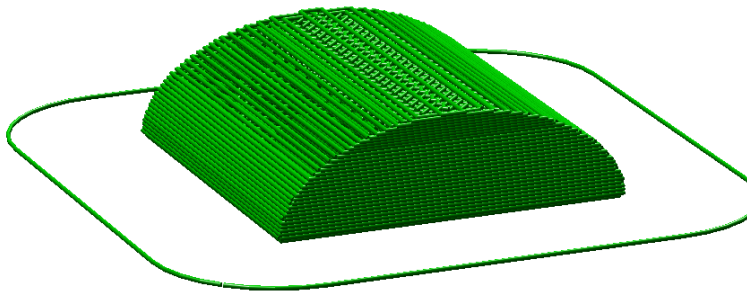

Figure 2.55: Example with skipped layers.

## 2.6 Configuration Organization

There are two ways in which to organize the configuration settings: exporting and importing the configuration settings, and profiles. The former is available in both simple and expert mode, whereas profiles is only available in expert mode.

### Exporting and Importing Configuration

The current set of configuration options can be simply exported via the **Export Config File** menu option. This saves all the values into a text file with a `.ini` extension. Previously saved files can be loaded with the **Load Config** menu option.

This gives a rudimentary means to store different configuration settings for different needs. For example a set with slightly faster print speeds, or a different infill pattern. However this way of organizing things will quickly become frustrating, as each minor change to a parameter may have to be duplicated across many configurations. For this reason, profiles are a more suitable way of managing multiple configurations.

This method also allows configuration to be transferred between machines, or stored remotely.

### Profiles

After a few prints it will become apparent that it is worth having a set of configuration options to choose from, and that some parameters change at different rates as others. In expert mode, profiles can be created for Print, Filament and Printer settings, with the expectation that the printer settings change least often, filament rarely, and the print settings could be changed for each model. These different profiles can be mixed and matched as desired, and can be selected either in their respective tabs, or directly from the plater.

### Creating Profiles

Open the desired tab and change the settings as necessary. Once satisfied, click the save icon to the left above the setting titles, and give a suitable name when prompted.

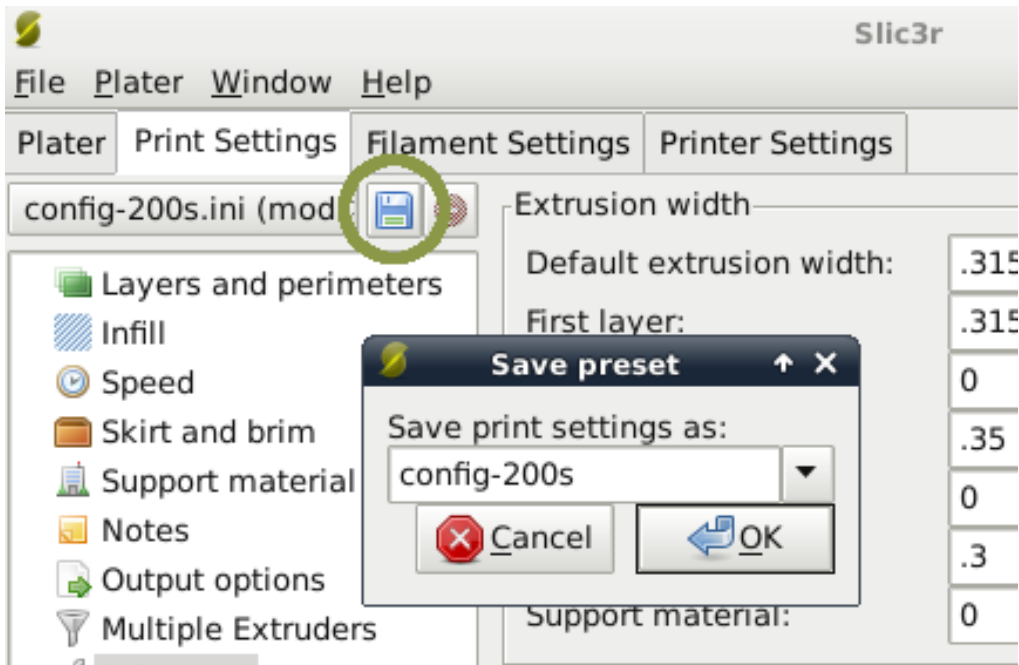

Figure 2.56: Saving a profile.

Profiles can be deleted by choosing the profile to delete and clicking the red delete button next to the save button.

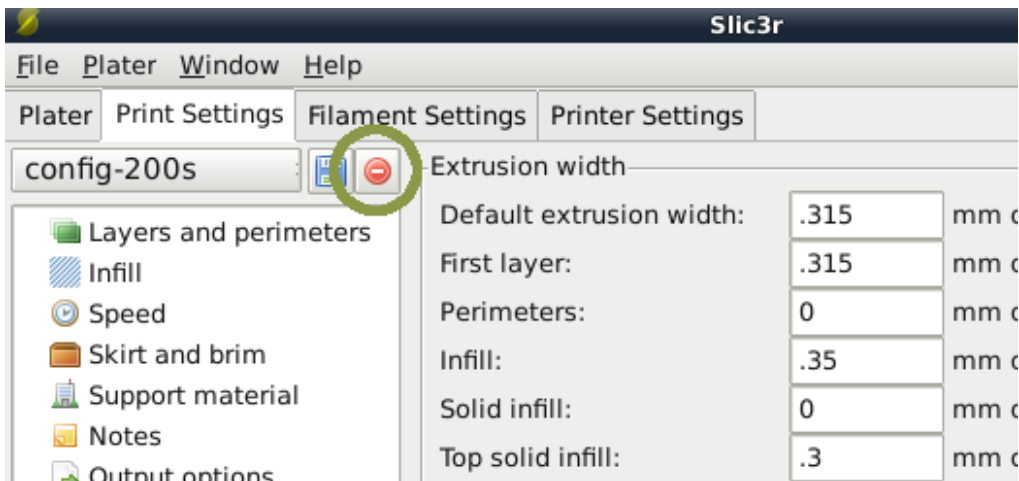

Figure 2.57: Deleting a profile.



## 2.7 Repairing Models

If the 3D mesh described in the model contains holes, or edges are misaligned (known as being non-manifold), then Slic3r may have problems working on it. Slic3r will attempt to fix any problems it can, but some problems are out of its reach. If the application complains that a model cannot be sliced correctly then there are several options available, and the ones described here are all free at the time of writing.

FreeCAD Freecad<sup>16</sup> is a comprehensive, and free, CAD program which comes with a mesh module, in which repairs to degenerate models can be made. The following steps outline how a problem model file can be analysed and repaired.

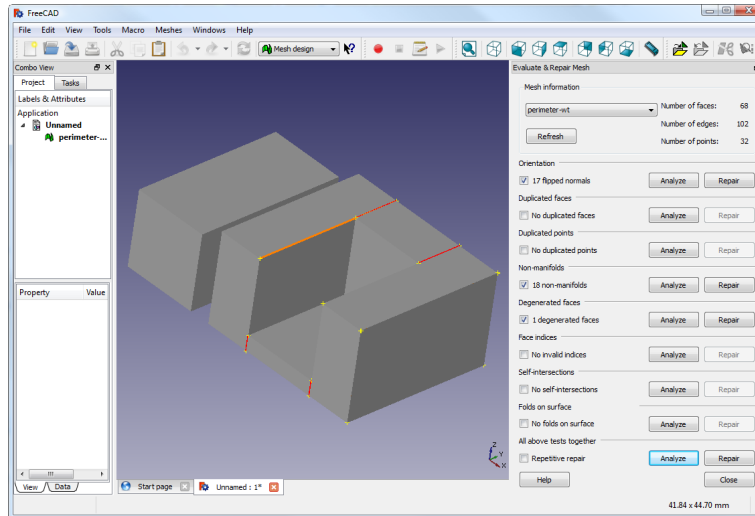

Figure 2.58: FreeCAD part repair.

- Start FreeCAD and from the start splash page choose **Working with Meshes**.
- Load the model by dragging and dropping it onto the workspace or via the **File** menu. A small message in the bottom left corner will indicate if the model appears to have problems.

<sup>16</sup><http://sourceforge.net/projects/free-cad>

- From the menu choose **Meshes->Analyze->Evaluate & Repair mesh** to bring up the repair options dialog.
- From the options dialog choose the loaded mesh, then perform each analysis by clicking the **Analyze** button by each problem type, or select **Repetitive Repair** at the bottom to perform all checks. If a corresponding problem is detected the **Repair** button becomes enabled.
- For each desired repair hit the **Repair** button.
- It is important to review the effect the repair script has made to the model. It may be the case that the script damages the file, rather than repair, for example by removing important triangles.
- Export the repaired model via the **Export** menu option or context menu.

## 2.8 Advanced Topics

### Sequential Printing

When printing several objects at once it can be useful to print each one separately as this will minimise oozing and strings running between the prints. It will also decrease the risk of a problem ruining the entire print - if one part detaches or fails in some way, it will not be dragged into other parts of the print during each layer.

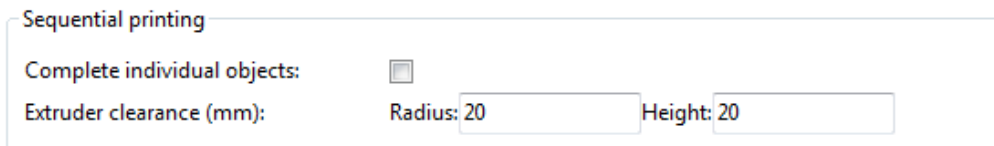

Figure 2.59: Sequential printing options.

Care has to be taken that the nozzle and extruder does not interfere with already printed parts. Slic3r should warn if it detects the nozzle or extruder will collide with a part, but double check that the layout of the

## 2.8. ADVANCED TOPICS

parts will not cause problems. The `Extruder clearance` parameters help Slic3r detect potential collisions:

- **Radius** - The clearance that should be given around the extruder. Take care if the extruder is not mounted centrally - take the largest safe value.
- **Height** - The vertical distance between the nozzle tip and the X axis rods, or lowest part which may interfere with a finished print.

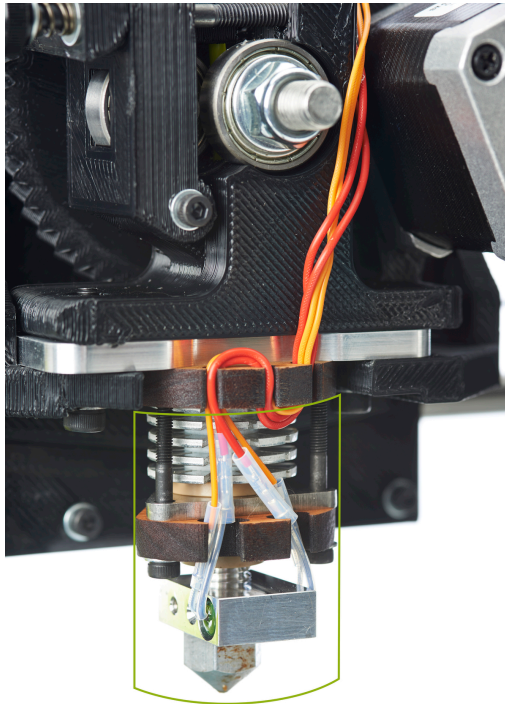

Figure 2.60: The clearance cylinder around an extruder.

## Command Line Usage

Slic3r can also be used from the command line instead of via the GUI, as part of a script, or as part of another tool, such as Printron<sup>17</sup>.

All options found in the GUI can be used from the command line in the form of switch parameters. The latest version of these are given below, and the most up-to-date information can be found by issuing the command:

```
perl slic3r.pl --help
```

Preset configurations can be loaded from a .ini file using the `--load` option, and options can be overridden further on the command line, e.g.

```
perl slic3r.pl --load config.ini --layer-height 0.25
file.stl
```

## Command Line Options

Usage: slic3r.pl [ OPTIONS ] file.stl

```
--help           Output this usage screen and exit
--version        Output the version of Slic3r and exit
--save <file>   Save configuration to the specified file
--load <file>   Load configuration from the specified file. It can be used
                more than once to load options from multiple files.
-o, --output <file> File to output gcode to (by default, the file will be saved
                into the same directory as the input file using the
                --output-filename-format to generate the filename)
-j, --threads <num> Number of threads to use (1+, default: 2)
```

### GUI options:

```
--no-plater      Disable the plater tab
--gui-mode       Overrides the configured mode (simple/expert)
```

### Output options:

```
--output-filename-format
                Output file name format; all config options enclosed in brackets
                will be replaced by their values, as well as [input_filename_base]
                and [input_filename] (default: [input_filename_base].gcode)
--post-process   Generated G-code will be processed with the supplied script;
                call this more than once to process through multiple scripts.
--export-svg     Export a SVG file containing slices instead of G-code.
-m, --merge     If multiple files are supplied, they will be composed into a single
                print rather than processed individually.
```

### Printer options:

```
--nozzle-diameter Diameter of nozzle in mm (default: 0.5)
--print-center    Coordinates in mm of the point to center the print around
                (default: 100,100)
--z-offset        Additional height in mm to add to vertical coordinates
                (+/-, default: 0)
```

<sup>17</sup><https://github.com/kliment/Printron>

## 2.8. ADVANCED TOPICS

--gcode-flavor        The type of G-code to generate  
                      (reprap/teacup/makerbot/sailfish/mach3/no-extrusion, default: reprap)  
--use-relative-e-distances Enable this to get relative E values  
--gcode-arcs         Use G2/G3 commands for native arcs (experimental, not supported  
                      by all firmwares)  
--g0                 Use G0 commands for retraction (experimental, not supported by all  
                      firmwares)  
--gcode-comments     Make G-code verbose by adding comments (default: no)  
--vibration-limit    Limit the frequency of moves on X and Y axes (Hz, set zero to disable;  
                      default: 0)

### Filament options:

--filament-diameter Diameter in mm of your raw filament (default: 3)  
--extrusion-multiplier  
                      Change this to alter the amount of plastic extruded. There should be  
                      very little need to change this value, which is only useful to  
                      compensate for filament packing (default: 1)  
--temperature        Extrusion temperature in degree Celsius, set 0 to disable (default: 200)  
--first-layer-temperature Extrusion temperature for the first layer, in degree Celsius,  
                      set 0 to disable (default: same as --temperature)  
--bed-temperature    Heated bed temperature in degree Celsius, set 0 to disable (default: 0)  
--first-layer-bed-temperature Heated bed temperature for the first layer, in degree Celsius,  
                      set 0 to disable (default: same as --bed-temperature)

### Speed options:

--travel-speed        Speed of non-print moves in mm/s (default: 130)  
--perimeter-speed    Speed of print moves for perimeters in mm/s (default: 30)  
--small-perimeter-speed  
                      Speed of print moves for small perimeters in mm/s or % over perimeter speed  
                      (default: 30)  
--external-perimeter-speed  
                      Speed of print moves for the external perimeter in mm/s or % over perimeter speed  
                      (default: 70%)  
--infill-speed        Speed of print moves in mm/s (default: 60)  
--solid-infill-speed Speed of print moves for solid surfaces in mm/s or % over infill speed  
                      (default: 60)  
--top-solid-infill-speed Speed of print moves for top surfaces in mm/s or % over solid infill speed  
                      (default: 50)  
--support-material-speed  
                      Speed of support material print moves in mm/s (default: 60)  
--bridge-speed        Speed of bridge print moves in mm/s (default: 60)  
--gap-fill-speed     Speed of gap fill print moves in mm/s (default: 20)  
--first-layer-speed Speed of print moves for bottom layer, expressed either as an absolute  
                      value or as a percentage over normal speeds (default: 30%)

### Acceleration options:

--perimeter-acceleration  
                      Overrides firmware's default acceleration for perimeters. (mm/s<sup>2</sup>, set zero  
                      to disable; default: 0)  
--infill-acceleration  
                      Overrides firmware's default acceleration for infill. (mm/s<sup>2</sup>, set zero  
                      to disable; default: 0)  
--bridge-acceleration  
                      Overrides firmware's default acceleration for bridges. (mm/s<sup>2</sup>, set zero  
                      to disable; default: 0)  
--default-acceleration  
                      Acceleration will be reset to this value after the specific settings above

## Slic3r

have been applied. (mm/s<sup>2</sup>, set zero to disable; default: 130)

### Accuracy options:

```
--layer-height      Layer height in mm (default: 0.4)
--first-layer-height Layer height for first layer (mm or %, default: 0.35)
--infill-every-layers
                    Infill every N layers (default: 1)
--solid-infill-every-layers
                    Force a solid layer every N layers (default: 0)
```

### Print options:

```
--perimeters        Number of perimeters/horizontal skins (range: 0+, default: 3)
--top-solid-layers  Number of solid layers to do for top surfaces (range: 0+, default: 3)
--bottom-solid-layers Number of solid layers to do for bottom surfaces (range: 0+, default: 3)
--solid-layers      Shortcut for setting the two options above at once
--fill-density      Infill density (range: 0-1, default: 0.4)
--fill-angle        Infill angle in degrees (range: 0-90, default: 45)
--fill-pattern      Pattern to use to fill non-solid layers (default: honeycomb)
--solid-fill-pattern Pattern to use to fill solid layers (default: rectilinear)
--start-gcode       Load initial G-code from the supplied file. This will overwrite
                    the default command (home all axes [G28]).
--end-gcode         Load final G-code from the supplied file. This will overwrite
                    the default commands (turn off temperature [M104 S0],
                    home X axis [G28 X], disable motors [M84]).
--layer-gcode       Load layer-change G-code from the supplied file (default: nothing).
--toolchange-gcode Load tool-change G-code from the supplied file (default: nothing).
--extra-perimeters Add more perimeters when needed (default: yes)
--randomize-start   Randomize starting point across layers (default: yes)
--avoid-crossing-perimeters Optimize travel moves so that no perimeters are crossed (default: no)
--external-perimeters-first Reverse perimeter order. (default: no)
--only-retract-when-crossing-perimeters
                    Disable retraction when travelling between infill paths inside the same island.
                    (default: no)
--solid-infill-below-area
                    Force solid infill when a region has a smaller area than this threshold
                    (mm2, default: 70)
--infill-only-where-needed
                    Only infill under ceilings (default: no)
--infill-first      Make infill before perimeters (default: no)
```

### Support material options:

```
--support-material  Generate support material for overhangs
--support-material-threshold
                    Overhang threshold angle (range: 0-90, set 0 for automatic detection,
                    default: 0)
--support-material-pattern
                    Pattern to use for support material (default: rectilinear)
--support-material-spacing
                    Spacing between pattern lines (mm, default: 2.5)
--support-material-angle
                    Support material angle in degrees (range: 0-90, default: 0)
--support-material-interface-layers
                    Number of perpendicular layers between support material and object
                    (0+, default: 0)
--support-material-interface-spacing
                    Spacing between interface pattern lines
                    (mm, set 0 to get a solid layer, default: 0)
```

## 2.8. ADVANCED TOPICS

--raft-layers       Number of layers to raise the printed objects by (range: 0+, default: 0)  
--support-material-enforce-layers  
                  Enforce support material on the specified number of layers from bottom,  
                  regardless of --support-material and threshold (0+, default: 0)

### Retraction options:

--retract-length    Length of retraction in mm when pausing extrusion (default: 1)  
--retract-speed     Speed for retraction in mm/s (default: 30)  
--retract-restart-extra  
                  Additional amount of filament in mm to push after  
                  compensating retraction (default: 0)  
--retract-before-travel  
                  Only retract before travel moves of this length in mm (default: 2)  
--retract-lift      Lift Z by the given distance in mm when retracting (default: 0)  
--retract-layer-change  
                  Enforce a retraction before each Z move (default: yes)  
--wipe              Wipe the nozzle while doing a retraction (default: no)

### Retraction options for multi-extruder setups:

--retract-length-toolchange  
                  Length of retraction in mm when disabling tool (default: 1)  
--retract-restart-extra-toolchnage  
                  Additional amount of filament in mm to push after  
                  switching tool (default: 0)

### Cooling options:

--cooling           Enable fan and cooling control  
--min-fan-speed     Minimum fan speed (default: 35%)  
--max-fan-speed     Maximum fan speed (default: 100%)  
--bridge-fan-speed   Fan speed to use when bridging (default: 100%)  
--fan-below-layer-time Enable fan if layer print time is below this approximate number  
                  of seconds (default: 60)  
--slowdown-below-layer-time Slow down if layer print time is below this approximate number  
                  of seconds (default: 30)  
--min-print-speed   Minimum print speed (mm/s, default: 10)  
--disable-fan-first-layers Disable fan for the first N layers (default: 1)  
--fan-always-on     Keep fan always on at min fan speed, even for layers that don't need  
                  cooling

### Skirt options:

--skirts            Number of skirts to draw (0+, default: 1)  
--skirt-distance    Distance in mm between innermost skirt and object  
                  (default: 6)  
--skirt-height      Height of skirts to draw (expressed in layers, 0+, default: 1)  
--min-skirt-length  Generate no less than the number of loops required to consume this length  
                  of filament on the first layer, for each extruder (mm, 0+, default: 0)  
--brim-width        Width of the brim that will get added to each object to help adhesion  
                  (mm, default: 0)

### Transform options:

--scale             Factor for scaling input object (default: 1)  
--rotate            Rotation angle in degrees (0-360, default: 0)  
--duplicate         Number of items with auto-arrange (1+, default: 1)  
--bed-size          Bed size, only used for auto-arrange (mm, default: 200,200)  
--duplicate-grid    Number of items with grid arrangement (default: 1,1)  
--duplicate-distance Distance in mm between copies (default: 6)

## Slic3r

### Sequential printing options:

- complete-objects When printing multiple objects and/or copies, complete each one before starting the next one; watch out for extruder collisions (default: no)
- extruder-clearance-radius Radius in mm above which extruder won't collide with anything (default: 20)
- extruder-clearance-height Maximum vertical extruder depth; i.e. vertical distance from extruder tip and carriage bottom (default: 20)

### Miscellaneous options:

- notes Notes to be added as comments to the output file
- resolution Minimum detail resolution (mm, set zero for full resolution, default: 0)

### Flow options (advanced):

- extrusion-width Set extrusion width manually; it accepts either an absolute value in mm (like 0.65) or a percentage over layer height (like 200%)
- first-layer-extrusion-width Set a different extrusion width for first layer
- perimeter-extrusion-width Set a different extrusion width for perimeters
- infill-extrusion-width Set a different extrusion width for infill
- solid-infill-extrusion-width Set a different extrusion width for solid infill
- top-infill-extrusion-width Set a different extrusion width for top infill
- support-material-extrusion-width Set a different extrusion width for support material
- bridge-flow-ratio Multiplier for extrusion when bridging (> 0, default: 1)

### Multiple extruder options:

- extruder-offset Offset of each extruder, if firmware doesn't handle the displacement (can be specified multiple times, default: 0x0)
- perimeter-extruder Extruder to use for perimeters (1+, default: 1)
- infill-extruder Extruder to use for infill (1+, default: 1)
- support-material-extruder Extruder to use for support material (1+, default: 1)



## Post-Processing Scripts

There may be times when the G-Code generated by Slic3r has to be tweaked or modified after it has been created. For this reason there exists the ability to run arbitrary scripts as part of the final steps in the slicing process<sup>18</sup>.

In the **Output options** subsection of the **Print Settings** tab lies the **Post-processing scripts** option. The absolute path to each script can be added, separated by semicolons. Each script should be recognised by the host system, and be executable.

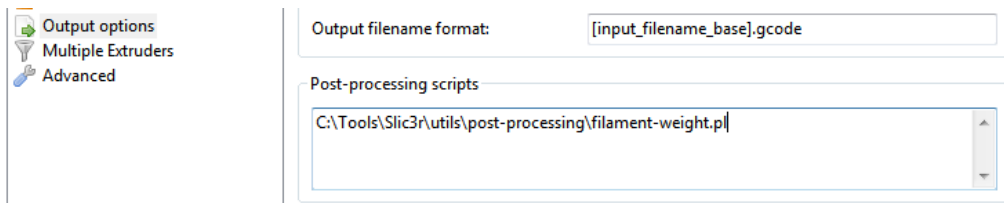

Figure 2.61: Post-processing script option.

Each script will be passed the absolute path of the G-Code file that Slic3r generates. All Slic3r configuration options are made available to the scripts by way of environment variables. These all begin with `SLIC3R_`. The following script would write out all Slic3r options to standard output:

```
#!/bin/sh
echo "Post-processing G-code file: $*"
env | grep ^SLIC3R
```

Figure 2.62: Example post-processing script to display Slic3r environment variables.

Example scripts can be found in the GitHub repository<sup>19</sup>.

Perl's in-place mode (`perl -i`) makes it easy to modify the contents of the G-Code file, without having to copy, edit, then replace the original. The following example will simply output the contents to standard output:

<sup>18</sup><https://github.com/alexrxj/Slic3r/wiki/Writing-post-processing-scripts>

<sup>19</sup><https://github.com/alexrxj/Slic3r/tree/master/utils/post-processing>

```
#!/usr/bin/perl -i
use strict;
use warnings;

while (<>) {
    # modify $_ here before printing
    print;
}
```

Figure 2.63: Example post-processing script to print each line to output.

## 2.9 Troubleshooting

### Z Wobble

Undulations in the walls of a print may be due to wobble in the Z axis. A thorough analysis of the potential causes is given by whosawhatsis<sup>20</sup> in his article "Taxonomy of Z axis artifacts in extrusion-based 3d printing"<sup>21</sup>, however one point of particular interest for users of Slic3r is the wobble caused by motor steps not matching the pitch of the Z rods thread. This can be addressed by ensuring the **Layer Height** setting is a multiple of the full step length.

The relevant part of the above paper is quoted here:

To avoid Z ribbing, you should always choose a layer height that is a multiple of your full-step length. To calculate the full-step length for the screws you're using, take the pitch of your screws (I recommend M6, with a pitch of 1mm) and divide by the number of full-steps per rotation on your motors (usually 200). Microsteps are not reliably accurate enough, so ignore them for this calculation (though using microstepping will still make them smoother and quieter). For my recommended M6 screws, this comes out to 5 microns. It's 4 microns for the M5 screws used by the i3, and 6.25 microns for the M8 screws used by most other repraps. A layer height of 200 microns (.2mm), for example, will work with any of these because  $200 = 6.25 * 32 = 5 * 40 = 4 * 50$ .

<sup>20</sup><http://goo.gl/i0YoK>

<sup>21</sup><http://goo.gl/ci9Gz>

## 2.10 Slic3r Support

### Slic3r Support

A variety of resources are available to provide support for Slic3r.

#### Wiki and FAQ

The wiki provides up-to-date documentation, and a FAQ subsection which may help resolve any queries or issues.

- <https://github.com/alexrj/Slic3r/wiki/Documentation>
- <https://github.com/alexrj/Slic3r/wiki/FAQ>

#### Blog

The Slic3r blog contains tips, hints, and advice.

- <http://slic3r.org/blog>

#### IRC

Found on the `irc.freenode.net` server, the following chat rooms are often filled with people who can provide real-time help:

- `#reprap`: Highly active community of the RepRap project with many users of Slic3r.
- `#slic3r`: Slic3r chat room where Slic3r developers and users can provide help.

#### RepRap.org Forum

The RepRap forums contain a dedicated forum for Slic3r.

- [forums.reprap.org/list.php?263](http://forums.reprap.org/list.php?263)

### Issue Tracker

If you find a bug in the software, then raise the issue in the project issue tracker.

- [github.com/alexrj/Slic3r/issues](https://github.com/alexrj/Slic3r/issues)

Please take the time to read through the existing issues to see whether the problem has already been submitted. Also make sure that the problem is a bug in the application; do not submit support related questions here. If the bug appears to be unreported then please read the bug report guide before submitting: [http://git.io/11Hy\\_w](http://git.io/11Hy_w).