

UNIVERSAL

Part#	O.E.M	Application
<b>780-630</b> <b>NEW</b>	Universal	
<p><b>Skid Pad Set</b> Universal Deluxe Poly Skid Pad Set. Includes mounting hardware: (4) 5/16"-18 bolts &amp; lock nuts, (4) 3/8"-16 bolts &amp; lock nuts, (4) washers, (2) adjustable plastic inserts and (2) plastic skid plates. Skids measures: 10" Long X 3-1/2" High X 3/4" Thick.</p>		
<b>780-635</b>	Universal	
<p><b>Universal Skid Plate</b> Fits on many manufacturers snowblowers. Includes: bolts, nuts and spacers.</p>		







ARIENS

<b>875-067</b>	72074 07207400	(Priced and Sold as a set of 2 belts)	
<p><b>Traction Drive Belt Set</b> For 6 Hp Sno-Tro models. Fits models: 922003, 922006, 922007, 922007, 922008, 922008, 922009, 922010, 922012, 922013, 922014, 922015, 922016, 922017, 922018, 922019, 922020, 922021, 922022, 922023, 922024 and 922025. (Priced and Sold as a set of 2 belts). <b>Size: 1/4" W X 27" L</b></p>			
<b>875-069</b>	72023 07202300	(Priced and Sold as a set of 2 belts) (Pkg in lots of 2 belts)	
<p><b>Traction Drive Belt Set</b> Fits models 1975 thru 1978 and Sno-Tro model. Drive belt 4 and 5 Hp, 1969 thru 1974 models: 922018, 922019, 922021. <b>Size: 1/4" W X 27-3/4" L</b></p>			
<b>875-104</b>	72066 07206600		
<p><b>Auger Drive Belt.</b> For 8 thru 12 Hp. Fits models: 924013, 924016, 924018, 924020, 924022, 924023, 924024, 924025, 924026, 924027, 924028, 924029, 924032, 924033, 924034, 924035, 924036, 924038, 924039, 924040, 924042, 924044, 924046, 924048, 924049, 924050, 924051, 924052, 924054, 924071, 924072, 924073, 924074, 924075, 924076, 924077, 924080, 924082, 924083, 924084, 924085, 924086, 924087, 924091, 924092, 924093, 924100, 924101, 924102, 924103, 924104, 924105, 924106, 924107, 924311, 924312, 924313, 924317, 924318, 924319, 924320, 924321, 924322, 924323, 924324, 924325, 924326. <b>Size: 3/8" W X 33-7/8" L</b></p>			

ARIENS continued

Part#	O.E.M	Application	
<b>875-098</b>	72047 07204700		
<p><b>Auger Drive Belt</b> For older models with single belt. Fits models: ST624, ST824; ALL 24" and 32"; ST524, ST724, ST732; ALL 29" and 32". <b>Size: 3/8" W X 35-1/2" L</b></p>			
<b>875-096</b>	72108 07210800		
<p><b>Auger Drive Belt.</b> Fits Snowblower models: 924024, 924026, 924028, 924029, 924032, 924036, 924038, 924039, 924042, 924044, 924046, 924048, 924052, 924054, 924081, 924083, 924084, 924086, 924161, 924312 and 924313; 910009, 910010, 910018, 910050, 910051, 910052, 910054, 910072, 910073, 910074, 910083, 910084 and 910086. <b>Size: 1/2" W X 36-1/2" L</b></p>			
<b>875-117</b>	72086 07208600		
<p><b>Auger Drive Belt.</b> Fits models: 924027, 924040, 924050, 924051, 924071, 924072, 924073, 924074, 924075, 924076, 924077, 924079, 924080, 924082, 924085, 924087, 924091, 924092, 924093, 924100, 924101, 924102, 924103, 924104, 924105, 924317, 924318, 924319, 924320, 924321, 924322, 924323, 924324, 924325, 924326, 924327, 924328, 924329, 924330, 924500. <b>Size: 1/2" W X 39-1/2" L</b></p>			
<b>877-020</b> <b>NEW</b>	7200431 07200431	(Priced and Sold as a set of 2 belts) (Pkg in lots of 2 belts)	
<p><b>Snowblower Blower Belt Set</b> Fits models: 921001, 921002, 921003, 921004, 921005, 921006, 921007, 921008, 921009, 921010, 921300, 921301, 921302, 921303. <b>Size: 1/2" W X 39-1/2" L.</b> (For use with our 875-99036 traction belt).</p>			
<b>875-909</b>	7200021		
<p><b>Auger Drive Belt</b> For 926 series. Fits models: 926003, 926006, 926103, 926302, 926303, 926500, 926501. (Raw Edge Belt) <b>Size: 1/2" X 38.1"</b></p>			
<b>875-084</b>	72114 07211400		
<p><b>Auger Drive Belt (cogged belt)</b> Fits snowblower models: 924092, 932001, 932004, 932006, 932007, 932016, 932023, 932025, 932030, 932102, 932103, 932310, 932400 and 932500; <b>Size: 1/2" W X 34.9" L</b></p>			
<b>875-080</b>	72056 07205600		
<p><b>Auger Drive Belt.</b> Fits models: 922002, 922003, 922006, 922007, 922008, 922009, 922010, 922012, 922014, 922016, 922018, 922019, 922020, 922021, 922022, 922023, 922024 and 922999. <b>Size: 1/2" W X 32" L</b></p>			

## ARIENS continued

Part#	O.E.M	Application
<b>875-907</b>	7200007 07200007	
<b>Auger Drive Belt</b> For 932 series. Fits models: 932105 and 932506. (Raw Edge Belt). <b>Size: 1/2" X 34-7/8"</b>		
<b>875-906</b>	7200004 07200004	
<b>Auger Drive Belt</b> For 924 series. Fits models: 924124, 924125, 924126, 924127, 924335, 924336, 924337 and 924518. (Raw Edge Belt). <b>Size: 1/2" X 35.4"</b>		
<b>875-908</b>	7200020 07200020	
<b>Auger Drive Belt</b> For 926 series. Fits models: 926001, 926002, 926004, 926005, 926101, 926102, 926300, 926301, 926304, 926502 thru 926505. (Raw Edge Belt). <b>Size: 1/2" X 37.1"</b>		
<b>875-983</b>	7236200 07236200	
<b>Auger Drive Belt</b> For 1132 series. Fits models: 924500, 924503 and 924506. (Raw Edge Belt). <b>Size: 1/2" X 37.5"</b>		
<b>875-99036</b>	072001110 7200111	
<b>Belt, Traction Drive.</b> Fits many Snowblower applications (2003 thru 2009). Ariens: 921001, 02, 03, 04, 05, 06, 07, 08, 09, 010, 300, 301, 302, 303. Raw Edge, Cogged belt. <b>Size: 1/2" W X 34.4" L.</b> (For use with our 877-020 belt set).		
More Ariens belts - see "BELTS - OEM EXACT REPLACEMENT" section, PG 05-01		
<b>230-038</b>	54136 54177 05413600 05417700	
<b>Bearing</b> Fits model 924 - (New) , (Bearing# 8276-1) <b>Size: 1-1/8" ID X 2-3/16" OD X 5/8" HT</b>		
<b>215-214</b>	54093 05409300	
<b>Wheel Bearing</b> Fits Snowblower model: 924. (old style). Carrier shaft bearing. (Ariens & John Deere). (Bearing# 8186) <b>Size: 7/8" ID X 1-3/4" OD X 1/2" HT.</b>		







## ARIENS continued

Part#	O.E.M	Application
<b>230-300</b>	54063 05406300	
<b>Bearing</b> Snowblower input shaft support bearing. Fits snowblower models: ST424, ST524, ST624, ST724, ST732, ST824, ST832, 824, 932 and 1032. Model numbers: 924022, 024, 026, 028, 029, 032, 046, 048, 050, 072, 074, 075 and 079. (Bearing# 1635-2RS and SCO493LU). <b>Size: 3/4" ID X 1-3/4" OD X 1/2" HT</b>		
<b>230-003</b>	54039 05403900 05435100	
<b>Bearing</b> For 24" and 32" snowblowers. (Bearing# 99502H). <b>Size: 5/8" ID X 1-3/8" OD X 7/16" HT</b>		
<b>230-060</b>	54188 05418800	
<b>Bearing</b> Fits 93700 series. (Bearing# 6203-2RS-LG) <b>Size: .669" ID X 1.575" OD X .471" HT</b>		
<b>230-276</b>	54080 / 05408000	
<b>Bearing</b> Drive support. Fits model: 824. (Bearing# 1621-2RS) <b>Size: 1/2" ID X 1-3/8" OD X 7/16" HT</b>		
<b>230-032</b>	54052 / 54160 05405200 05416000	
<b>Bearing</b> Fan bearing. (Bearing# 1641-2RS) <b>Size: 1" ID X 2" OD X 9/16" HT</b>		
<b>230-036</b>	54182 05418200	
<b>Bearing</b> Fan bearing Dome style bearing. Fits models: 924084, 924085, 924086, 924087, 924091, 924092, 924313, 924314, 924315, 924316. (Bearing# 8446RS). <b>Size: 1" ID X 2" OD X .560" HT</b>		
<b>225-334</b>	55110 05511000	
<b>Bronze Flange Bushing</b> For Sno Thro 932 series blowers <b>Size: 1/2" ID X 3/4" OD X 5/8" HT, Flange OD: 1"</b>		
<b>225-839</b>	55035 05503500	
<b>Bronze Bushing</b> Auger shaft. Fits models: 824, 910, 922 and 924. <b>Size: 1" ID X 1-1/8" OD X 5/8" HT, Flange OD: 1-1/2" X 1/8"</b>		









ARIENS continued

Part#	O.E.M	Application
<b>225-862</b>	55030 05503000	
<p><b>Bronze Bushing</b> Snowblower axles / non-differential, models: 824, 24" &amp; 32" snowblower attachment drive train, 910 and 924 non-differential. <b>Size: 7/8" ID X 1" OD X 5/8" HT,</b> <b>Flange OD: 1-1/4" X 1/8"</b></p>		
<b>225-850</b>	55022 05502200	
<p><b>Bronze Bushing</b> Fits model: 924. <b>Size: 7/8" ID X 1-1/8" OD X 5/8" HT</b> <b>Flange OD: 1-1/2" X 1/8"</b></p>		
<b>225-822</b>	55026 00550260	
<p><b>Traction Bushing</b> Fits model: 924. <b>Size: 5/8" ID X 3/4" OD X 1/2" HT,</b> <b>Flange OD: 7/8" X 1/8"</b></p>		
<b>225-826</b>	55122 / 00551220	
<p><b>Bronze Bushing</b> Fits on each side of the worm shaft. <b>Size: 1" ID X 1-1/8" OD X 5/8" HT</b> <b>Flange OD: 1-1/2" X 1/8"</b></p>		
<b>225-854</b>	55039 05503900	
<p><b>Bronze Flange Bushing.</b> Fits on 6 and 7 Hp Snowblower auger shafts, Fits models: 832 and 1032, 20", 24" and 32" snowblowers. Fits 923001, 923004, 923006, 923014, 923017, 923018, 923019, 923020, 923022 and 923023. <b>Size: 3/4" ID X 1" OD X 5/8" HT,</b> <b>Flange OD: 1-1/4"</b>. Note: Can use part# 225-167 &gt; Part# 225-854 is bronze and has a Flange OD: 1-1/4", part# 225-167 is graphite impregnated and has a 1-1/2" Flange OD</p>		
<b>225-847</b>	55036 05503600	
<p><b>Plastic Bushing</b> Nylon flange bushing. <b>Size: 3/8" ID X 1/2" OD X 3/8" HT,</b> <b>Flange OD: 5/8"</b></p>		
<b>225-823</b>	55111 05511100	
<p><b>Bronze Flange Bushing.</b> Front worm shaft bushing on Snowblowers. <b>Size: 1/2" ID X 3/4" OD X 3/4" HT,</b> <b>Flange OD: 1" X 1/8"</b></p>		
<b>225-828</b>	55037 05503700	
<p><b>Bronze Bushing</b> Clutch level bushing. <b>Size: 1/2" ID X 5/8" OD X 5/8" HT,</b> <b>Flange OD: 3/4"</b></p>		









ARIENS continued

Part#	O.E.M	Application
<b>225-851</b>	55216 55151 05521600	
<p><b>Graphite Impregnated Hexagon Bushing</b> Fits newer Snowblower models: 932026, 932027, 932029, 932302 and 932303. Model ST-524 and ST-724. <b>Size: 3/4" ID X 7/8" OD (Hexagon) X 21/32" HT;</b> <b>Flange: 1-3/16" X 1/8"; 7/8" across the flats.</b></p>		
<b>225-825</b>	55112 05511200	
<p><b>Bronze Flange Bushing.</b> Rear worm shaft bushing on Ariens &amp; John Deere Snowblowers. Fits models: 924036, 38, 39, 40, 46, 48, 50, 71, 72 and 924073, also models 832003, 20" and 24" snow attachments; 901011 20" rear tillers. <b>Size: 3/4" ID X 1" OD X 3/4" HT, Flange: 1-1/4"</b></p>		
<p>For more Ariens Bearings / Bushings - see our "BEARING and BUSHINGS", section 03</p>		
<b>240-910</b>	22013 02201300	
<p><b>Drive Disc</b> Fits Ariens 911000 series. <b>Size: 2-1/4" ID X 4-3/8" OD.</b> (3) mounting holes.</p>		
<b>240-900</b>	3003 00300300 Bolens# 1720859 Case# 2289 Case# C2289 Gilson# 32222 Gilson# 18915	
<p><b>Drive Disc</b> Found on many 2 Stage units <b>Size: 5-3/8" ID X 6" OD.</b> (Use our 240-325 brake lining if required).</p>		
<b>280-594</b>	12132 01213200	
<p><b>Flat Idler</b> Heavy duty idler with flange. Fits models: 932000, 924028, 924029 and 922003 series; also fits models 924028, 924029, 922003 for 20", 24" and 32" snowblower attachments. <b>Size: 1/2" ID X 2-1/2" OD X 3/4" W.</b></p>		
<b>430-492</b>	07532000	
<p><b>Ignition Key</b> Fits models: ST524, ST724, ST824, ST1024, ST1028, ST1128, ST1332 and ST1336.</p>		





## ARIENS continued

Part#	O.E.M	Application
<b>780-380</b>	12023 01202300	
<b>Wheel Support Retainer</b> Nylon Wheel Retainer. Fits on 20", 24" and 32" Snowblowers. (For use with our 225-854 and 225-862 bushings) <b>Size: 1" ID X 3" L X 2-1/2" W X 31/64" HT.</b> Three 17/64" mounting holes, triangle shape.		
<b>780-038</b>	32038	
<b>Gear Box Gasket</b> For Ariens Snowblowers. (Made by O.E.M. supplier)		
<b>495-061</b>	56061	
<b>Oil Seal</b> For Ariens Snowblowers. <b>Size: 15/16" ID X 1-9/32" OD X 1/8" HT</b> (Made by O.E.M. supplier)		
<b>495-062</b>	56062	
<b>Oil Seal</b> For Ariens Snowblowers. <b>Size: 3/4" ID X 1-1/2" OD</b> (Made by O.E.M. supplier)		
<b>780-004</b>	83004	
<b>Idle Spring</b> For Ariens Snowblowers. <b>Size: 4-7/8" overall length X 4-1/4" coil length.</b>		
<b>780-056</b>	532018	
<b>Paddle Set</b> Fits 2 + 2 models (8 piece set) <b>Size: 9-5/8" L X 2-1/2" W</b> (Use with our 780-510 scraper bar).		
<b>780-510</b>	32159	
<b>Scraper Bar</b> Fits 2 + 2 model <b>Size: 20" L X 2-5/8" W, Mounting holes: 7/8"</b>		
<b>780-566</b>	10164 / 01016400 / 01016459	
<b>Scraper Bar</b> Fits 924082, For 24" models. <b>Size: 23-3/4" L X 2" W X 1/4" Thick.</b> (5) Mounting hole: 5/16" square		
<b>780-570</b>	03809400	
<b>Scraper Bar</b> Fits models: SS522, SS722E and S322.		



## ARIENS continued

Part#	O.E.M	Application
<b>780-567</b>	22107 02210700	
<b>Scraper Bar</b> Fits all 20" augers. <b>Size: 19-1/4" L X 1-5/8" W;</b> Mounting hole: 1/4".		
<b>780-221</b>	532005 053200500	
<b>Shear Bolts</b> Fits models: ST524, ST624, ST724, ST824 and ST520 <b>Size: 1-7/16" L X 1/4"-20 threads.</b> (Priced individually) (Sold in multiples of 10)		
<b>780-213</b>	510016 051001600 342449	
<b>Shear Bolts</b> <b>Size: 1-5/8" L X 1/4"-20 threads</b> (Priced individually) (Sold in multiples of 10)		
<b>780-205</b>	510015 051001500	
<b>Shear Bolts</b> Fits models: ST420, ST520, ST524, ST624, ST824, ST832 & ST924; <b>Size: 2" L X 5/16"-18 threads.</b> The two shear bolt grooves Center to center: 15/16". (Priced individually) (Sold in multiples of 10)		
<b>780-200</b>	520010 52100100	
<b>Shear Bolt</b> For snowblowers. Fits new 2007 model series 921001, 921002 and 921003 that take the NEW black shear bolt. The two shear bolt grooves Center to center: 1". The groove closer to the bolt head is 1/8" CC from the underside of bolt head; 1/2" wrench size. <b>Size: 2" L X 5/16"-18 threads.</b> (Sold in multiples of 5)		
<b>780-270</b>	10165 01016500	
<b>Skid Plate</b> Fits Ariens Snowblowers. <b>Size: 5-1/4" L X 3-1/4" W X 7/8" HT,</b> <b>(2) 7/16" X 2" mounting slots on 3" Centres.</b>		
<b>780-290</b>	24599 02459900	
<b>Skid Plate</b> Fits Ariens Snowblowers. Fits models: 924080 and 924082 with 24" auger. 1960 to present <b>Size: 5-3/4" L X 3" W X 15/16" HT,</b> <b>(2) 7/16" X 2" mounting slots, 3" Centres.</b>		
<b>780-300</b>	02483851 02483859	
<b>Skid Plate</b> Double sided, reversible runner. Fits Ariens Snowblowers from 60's to present. Fits models 924080 and 924082 with 24" auger, (Orange in colour) <b>Size: 5-3/4" L X 3-5/8" W X 1-1/16" HT,</b> <b>(2) 7/16" X 1-3/4" mounting slots, 3" Centres</b>		



ARIENS continued

Part#	O.E.M	Application
<b>290-328</b>	69032	
<p><b>Throttle Control</b> Fits Snowblower models: 10954, 10962, 10965, 10969 and 10970. Negative action "F" to "S", bracket for side mounting. <b>Conduit Length: 27-1/8"</b>, <b>Inner wire length: 29"</b>, <b>Wire travel: 1-3/4"</b></p>		
<b>290-112</b> <b>NEW</b>	06908000 69080	
<p><b>Throttle Control</b> Found on Ariens, Murray / Noma snowblowers. <b>Conduit length: 30-1/4"</b>, <b>Inner wire length: 33"</b>, <b>Conduit size: 3/16"</b>, <b>Inner wire size: .055"</b>, <b>Wire travel: 1-3/4"</b>.</p>		
<b>285-483</b> <b>NEW</b>	06900011	
<p><b>Traction control cable</b> For Ariens snowblowers. Fits models: 926001 / 002 / 003 / 004 / 005 / 006 / 007 / 008 / 009 / 010 / 011 / 012 / 013 / 014 / 015 / 016 / 017 / 021 / 022 / 023 / 024 / 025 / 026 / 027 / 101 / 102 / 103 / 300 / 301 / 302 / 303 / 304 / 305 / 306 / 307 / 308 / 310 / 311 / 312 / 313 / 314 / 315 / 316 / 500 / 501 / 502 / 504. <b>Overall Adjustable Length: 38-1/2" to 39-1/4"</b>, <b>Coil Length: 4-1/4" (Adjustable end)</b>, <b>Coil Length: 4-5/8" (fixed end)</b>.</p>		
<b>285-484</b> <b>NEW</b>	06900012	
<p><b>Clutch blower control cable</b> For Ariens snowblowers. Fits models: 926001 / 002 / 003 / 004 / 005 / 006 / 007 / 008 / 009 / 010 / 011 / 012 / 013 / 014 / 015 / 016 / 017 / 021 / 022 / 023 / 024 / 025 / 026 / 027 / 101 / 102 / 103 / 300 / 301 / 302 / 303 / 304 / 305 / 306 / 307 / 308 / 310 / 311 / 312 / 313 / 314 / 315 / 316 / 500 / 501 / 502 / 504. <b>Overall Adjustable Length: 25-1/4 to 26"</b>, <b>Coil Length: 4-1/4"</b>, <b>Eyelet hole ID: 1/4"</b>.</p>		
<b>285-485</b> <b>NEW</b>	06900018	
<p><b>Chute control cable</b> For Ariens snowblowers. Fits models: 921001 / 002 / 003 / 004, 921300 and 921301, 926016 / 017 / 021 / 022 / 023 / 302 / 310 / 311 / 312 / 313 / 314 / 315 / 316 / 500 / 501 etc. <b>Measures: 61-3/8" Overall Length</b>, <b>Wire Travel: 5-3/8"</b>, <b>Eyelet hole ID: 1/4"</b>.</p>		





ARIENS continued

Part#	O.E.M	Application
<b>285-486</b> <b>NEW</b>	06900019	
<p><b>Chute control cable</b> For Ariens snowblowers. Fits models: 921002 / 003 / 004 / 301, 926001 / 002 / 003 / 004 / 005 / 006 / 007 / 008 / 009 / 010 / 011 / 012 / 013 / 014 / 015 / 016 / 017 / 021 / 022 / 023 / 101 / 102 / 103 / 300 / 301 / 302 / 303 / 304 / 305 etc. <b>Measures: 54" Overall Length</b>, <b>Wire Travel: 2"</b>, <b>Both Ball Ends: 1/4" diameter</b>.</p>		
<b>285-487</b> <b>NEW</b>	06900313	
<p><b>Traction control cable</b> For Ariens snowblowers. Fits models: 921001 / 002 / 003 / 004 / 005 / 006 / 007 / 008 / 009 / 300 / 301 / 302 / 303 etc. <b>Measures: 24-5/8" Overall Length</b>, <b>Both Eyelet holes: 5/16" ID</b>.</p>		



AYP (Husqvarna)

<b>230-054</b> <b>NEW</b>	175323 Husqvarna# 532 17 53-23	
<p><b>Bearing with cage assembly</b> For Snowblowers. Fits many manufacturers snowblowers - AYP, Craftsman, Husqvarna and Poulan etc. Bearing ID: .669" ID. Cage measures: 3-5/8" L X 2-5/8" W; Bolt holes are on 2-7/8" centres. (Uses our 230-060 replacement bearing)</p>		
<b>875-99036</b>	179092 416954 532179090 532416954	
<p><b>Belt, Traction Drive</b> Fits many Snowblower applications (2003 thru 2009). AYP, Husqvarna and Sears. Found on the following AYP / Husqvarna snowblower models: 1027, 10527, 10530, 1130, 5224, 524, 5524, 8024, 8524, 8527, 9027, 924, 927, 9527 etc. Fits Sears model DR524 etc. Raw Edge, Cogged belt. <b>Size: 1/2" W X 34.3" L</b></p>		
<b>875-14117</b> <b>NEW</b>	183533 408010 532183533 532408010	
<p><b>Belt, Impeller Drive / Auger</b> Drive for AYP / Husqvarna and Sears snowblowers. Found on the following AYP / Husqvarna snowblower models: 1027 STE (2003 - 07), 10527 SBE and STE (2003 - 07), 10530 STE / SBE &amp; SBEB (2005 -06), 1130 STE (2002 -09), 524 S (2006), 524 STE(2004 -08), 5524 SE &amp; SEB (2005 on), 8024 ST (2002 -09), 8024 STE (2004 -08), 924 STE, 924 SBE (2006 -08), 9027 STE XP (2004 -07) and HL 1027 (2004 -09). Raw Edge Belt. <b>Size: 5/8" Wide X 37-1/2" Long</b>.</p>		

## AYP (Husqvarna) continued

Part#	O.E.M	Application
<b>285-560</b> <b>NEW</b>	428311 532428311 Husqvarna# 532 42 83-11	
<b>Chute Control Cable</b> For AYP / Craftsman / Husqvarna / Sears snowblowers. Models 2009 on. <b>Measures: 45-3/4" Overall Length, Conduit Length: 31-3/4", Wire Travel: 11-3/4"</b> . (Includes a heat resistant conduit cover = 14" long approximately)		
<b>285-562</b> <b>NEW</b>	428274 532428274 Husqvarna# 532428274	
<b>Chute Control Cable</b> For AYP / Craftsman / Husqvarna / Sears snowblowers. Models 2009 on. <b>Measures: 46-1/2" Overall Length, Conduit Length: 32-7/8", Wire Travel Adjustable: 11" thru 11-3/4"</b> .		
<b>285-564</b> <b>NEW</b>	178674 / 198475 420673 / 421164 Husqvarna#'s 532 17 86-74 / 532 42 06-73	
<b>Chute Control Cable</b> For AYP / Craftsman / Husqvarna / Sears snowblowers. Cable only. <b>Measures: 59-1/4" Overall Length, Conduit Length: 50-3/4", Inner Wire Length: 57-1/2", Wire Travel: 3"</b> , Eyelet hole ID: 5/16" with a Cast Z-Bend on the other.		
<b>240-950</b>	179831 532 17 98-31	
<b>Drive Ring</b> Fits many AYP / Husqvarna snowblowers built from 2002 on. <b>Measures: 4-1/2" OD X 3-5/8" ID X 1/2" Width.</b>		
<b>780-088</b>	53688547	
<b>Scraper Bar</b> Fits model: TRS21. Size: 20-15/16" long with (4) 5/16" ID mounting holes on 6-3/4" centres. (Use with 780-118 paddle set)		
<b>780-241</b>	714001 Husqvarna# 531 00 25-13 506 71 40-01	
<b>Shear Bolts</b> Fits 2004 models: PO10527SA, PO8527ESA, PP1130ESC, PP524B, PP5524ESC, PP997ESC, PR10527ESA, PR524ESA and PR8527ESB. Size: 1-15/16" (49mm) L X 6 mm thread, 12mm shoulder. (Also see Noma shear bolts)		

## AYP (Husqvarna) continued

Part#	O.E.M	Application
<b>780-320</b> <b>NEW</b>	174762	
<b>Skid Plate / Skid Pad</b> For AYP / Husqvarna / Poulan built snowblowers. (LEFT side). <b>Size: 4-1/4" Long X 3" High X 7/8" Bottom Plate Width. (2) 5/16" X 2-3/8" mounting slots on 3/4" centers.</b>		
<b>780-322</b> <b>NEW</b>	178777	
<b>Skid Plate / Skid Pad</b> For AYP / Husqvarna / Poulan built snowblowers. (RIGHT side). <b>Size: 4-1/4" Long X 3" High X 7/8" Bottom Plate Width. (2) 5/16" X 2-3/8" mounting slots on 3/4" centers.</b>		

## BRIGGS

<b>285-589</b> <b>NEW</b>	1502113MA	
<b>Drive Control Cable</b> For Murray / Briggs and Stratton snowblowers. FR-DR P7 5-13B. <b>Measures: 31-1/4" Overall Length,</b> Cast Z-Bends on both ends.		
<b>287-001</b> <b>NEW</b>	761131 / 761131MA	
<b>Chute control cable</b> For Murray / Briggs and Stratton snowblowers. <b>Measures: 69-1/2" Overall Length, Conduit Length: 62", Wire Travel: 5-1/4", Eyelet hole ID: 5/16"</b> .		
<b>287-002</b> <b>NEW</b>	761775 / 761775MA	
<b>Chute control cable</b> For Murray / Briggs and Stratton snowblowers. <b>Measures: 63-3/4" Overall Length, Conduit Length: 57-1/2", Wire Travel: 3-1/4", Eyelet hole ID: 5/16"</b> with a Cast Z-Bend on the other.		
<b>120-213</b>	494769 / 697944 / 698181	
<b>In Line Fuel Shut-off</b> Fits 3-1/2 and 5 Hp, Industrial Plus models. Used on many snowblower applications. Fits 1/4" ID fuel line, 90 degree valve. (Composite material)		
<b>120-212</b>	493960 / 494768 / 698183	
<b>In Line Fuel Shut-off</b> Fits 1/4" ID fuel line. Red knob opens and closes easily with a quarter turn. (Composite material)		

BRIGGS continued

Part#	O.E.M	Application
<b>140-103</b>	398101 / 695740 699334 John Deere# PT10615 Noma# 315542	
<b>Starter Handle</b> "D" style mitten grip handle. Used on many snowblowers with pull starters.		

**HUSQVARNA - see AYP**  
**HONDA**

<b>230-274</b>	96150-62030-10	
<b>Bearing with Retainer</b> Transmission input shaft bearing with retainer ring. Snowblower fan bearing for models: HS624 and HS828. (Bearing# 6203-2RS / 6203-2Z) <b>Size: 17mm ID X 40mm OD X 12mm HT or .669" ID X 1.574" OD X .471" HT.</b>		

<b>230-060</b>	96150-62030-10	
<b>Bearing</b> Transmission input shaft bearing For models: HS624 and HS828. (Bearing# 6203-2RS / 6203-2Z) <b>Size: 17mm ID X 40mm OD X 12mm HT or .669" ID X 1.574" OD X .471" HT.</b>		

<b>230-134</b>	0876904 96140-60020-10 96150-60020-10	
<b>Bearing</b> Snowblower friction disc plate bearing. Fits Honda models: HS50, HS70 and HS80. Wheel bearing on most commercial mowers. (Bearing# 6002-2RS) <b>Size: 15 mm ID X 32mm OD X 9mm HT</b>		

<b>230-140</b>	96150-60040-10	
<b>Bearing</b> Auger / Crawler and Transmission. Fits models: HS50, HS55, HS70, HS80, HS624 and HS828. (Bearing# 6004-2RS) <b>Size: 20 mm ID X 42 mm OD X 12 mm HT</b>		

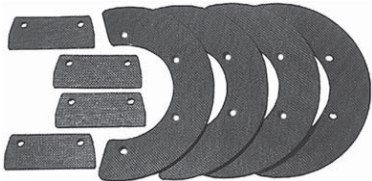
<b>780-031</b>	72521-730-003 / 72552-730-003 1003375 (4 ea.) / 1003391 (4 ea.)	
<b>Paddle Set</b> Honda Snowblower (8 piece set) Fits model: HS35. Rectangle measurement: 4-3/4" X 1-7/8" X Crescent measurements: 9-5/8" X 2-3/16"		

HONDA continued

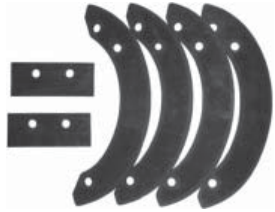
Part#	O.E.M	Application
<b>780-048</b>	06720-V10-030 Code# 6672448 Code# 6813166	
<b>Paddle Set</b> Fits model: HS520 Snowblower. (6) piece set		

<b>780-032</b>	72521-747-000 <b>NEW</b> 72522-747-000 72523-747-000	
<b>Paddle Set</b> Honda Snowblower (6 piece set). Fits models: 521 and 621. Replaces Honda 72523-747-000 (1) pcs. & 72522-747-000 (2) pcs. & 72521-747-000 (3) pcs.		



<b>780-180</b>	76322-747-A10 Code# 3526985	
<b>Scraper Bar</b> Fits model: HS621 Snowblower. <b>Size: 19-5/8" L X 2-7/8" W Mounting holes: 1-3/16"</b>		

<b>780-049</b>	76322-V10-010 Code# 6672448	
<b>Scraper Bar</b> Fits model: HS520 Snowblower. <b>Size: 19-3/8" L X 2-1/2" W; Mounting holes: 5/16"</b>		

<b>780-310</b>	1878628 76153736000 76153736010	
<b>Skid Plate</b> Fits snowblower models: HS50, HS55, HS55K1, HS55K2, HS70, HS80, HS80K1. <b>Size: 135mm / 5-3/8" OL X 68mm / 2-3/4" HT, (2) 9mm slots X 52mm L on 60mm / 2-3/8" centers.</b>		

<b>780-257</b>	90102-732-010 (bolt) 90114-SAO-00 (nut) Code# 1410182 / 1533355	
<b>Shear Bolts</b> Honda# 90102-732-010 (bolt), 90114-SAO-000 (nut). Also fits Yamaha Snowblowers <b>Size: 1-15/16" (49mm) L X 6 mm thread, 10mm shoulder.</b>		







## HONDA continued

Part#	O.E.M	Application
<b>240-900</b>	158458 990152	
<b>Drive Disc</b> Our most popular selling drive disc. Found on many different manufacturers equipment. <b>Size: 5-3/8" ID X 6" OD.</b> (Use our 240-325 brake lining if required).		
<b>240-910</b>		
<b>Drive Disc</b> Found on snowblowers. <b>Size: 2-1/4" ID X 4-3/8" OD;</b> (3) mounting holes.		
<b>780-221</b>		
<b>Shear Bolts</b> Size: 1-7/16" L X 1/4"-20 threads. (Priced individually) (Sold in multiples of 10)		

## JOHN DEERE



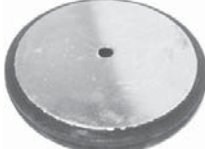



<b>230-276</b>	AM122108	
<b>Bearing</b> Fits models: 524D, 724D, 826D, 828D and 1032D. (Bearing# 1621-2RS) <b>Size: 1/2" ID X 1-3/8" OD X 7/16" HT</b>		
<b>230-038</b>	AM122105	
<b>Axle bearing</b> Fits Snowblower model: 924. (new style) (Bearing# 8276-1) <b>Size: 1-1/8" ID X 2-3/16" OD X 5/8" HT.</b>		
<b>230-300</b>	AM122158	
<b>Input Shaft Bearing.</b> Fits models: 524D, 724D, 826D and 1032 walk behinds and snowblowers. (Bearing# 1635-2RS and SCO493LU) <b>Size: 3/4" ID X 1-3/4" OD X 1/2" HT</b>		
<b>225-334</b>	M127164	
<b>Bronze Flange Bushing</b> Used on many impeller shafts found on Snowblowers. <b>Size: 1/2" ID X 3/4" OD X 5/8" HT, Flange OD: 1".</b>		
<b>225-839</b>	M124417	
<b>Bronze Bushing</b> Fits models: 828D, 924DE, 1032D, 1128DE and 1332DE. walk behind snowblowers. <b>Size: 1" ID X 1-1/8" OD X 5/8" HT</b>		

## JOHN DEERE continued



Part#	O.E.M	Application
<b>225-854</b>	M127082	
<b>Bronze Bushing</b> Fits models: 524D, 724D (PC2569) and 826D (PC2570). (Bushing# 8276-1) <b>Size: 3/4" ID X 1" OD X 5/8" HT</b>		
<b>225-825</b>	M127538	
<b>Bronze Bushing</b> Rear worm shaft bushing. Fits models: 924036, 924038, 924039, 924040, 924046, 924048, 924050, 924071, 924072 and 924073. <b>Size: 3/4" ID X 1" OD X 3/4" HT</b>		
<b>780-580</b>	AM119482 Murray# 579726 Murray# 579726MA Noma# 579726 Noma# 579726MA	
<b>NEW</b>		
<b>Impeller Bearing Housing only</b> For John Deere, Murray / Noma snowblowers. Found on John Deere snowblower model 826 etc. (Made of Aluminum). <b>Size: 1-1/4" ID X 7/8" Overall Height.</b> <b>(3) 5/16" Mounting holes on 2.35" centers.</b> (Uses our 225-677 Bronze Bushing in many applications).		
<b>240-925</b>	AM38356 M114485	
<b>Drive Disc</b> For older Snowblowers. <b>Size: 7/16" ID X 6" OD</b>		
<b>240-910</b>	AM123355	
<b>Drive Disc</b> For John Deere manufactured Snowblowers. <b>Size: 2-1/4" ID X 4-3/8" OD, (3) bolt holes.</b>		
<b>240-900</b>	AM122115 AM123355 Bolens# 1720859 Case# 2289 Case# C2289 Gilson# 32222 Gilson# 18915	
<b>Drive Disc</b> Found on many newer snowblowers Use with our 240-325 brake liner. See our "DRIVE, RIDER and PUSH MOWER PARTS" section. <b>Size: 5-3/8" ID X 6" OD.</b>		





JOHN DEERE continued

Part#	O.E.M	Application
<b>120-430</b>	AM116304 GY20709	
<p><b>Universal In-Line Fuel Filter</b> - 80 micron. Dual hose barbs that fit both 1/4" and 5/16" ID hose. Features a new high impact polymer-copolymer blend that will stand up to all standard and bio-based fuels including E85. <b>Size: 3-5/8" overall length.</b></p>		
<b>120-212</b>	AM107340 AM107922	
<p><b>In Line Fuel Shut-off</b> Fits 1/4" ID fuel line. Red knob opens and loses easily with a quarter turn. (Composite material)</p>		
<b>120-214</b>	AM36141	
<p><b>In Line Fuel Shut-off</b> Fits 1/4" ID fuel line (Metal)</p>		
<b>780-118</b>	M94576 (4 pcs.) / M94574 (2 pcs.) Noma# 302565 (4 pcs.) / 57121 (2 pcs.)	
<p><b>Paddle Set</b> For model: TRS21 (6 piece set) Rectangle measurements: 1-3/4" X 3-3/4" (3) mounting holes on 2-3/4" centres. Crescent measurements: 11" X 2-5/16" (Use with our 780-088 scraper bar)</p>		
<b>780-088</b>	M94511	
<p><b>Scraper Bar</b> Fits model: TRS21. <b>Size: 20-15/16" long with (4) 5/16" ID mounting holes on 6-3/4" centres.</b> (Use with 780-118 paddle set)</p>		
<b>780-221</b>	AM123342	
<p><b>Shear Bolts</b> Fits models: 524D, 724D, 826D and 1332DDE. <b>Size: 1-7/16" L X 1/4"-20 threads.</b> (Priced individually) (Sold in multiples of 10)</p>		
<b>780-205</b>	AM122156 AM136890	
<p><b>Shear Bolts</b> Fits models: 828D, 924D, 1032D, 1128DDE, 1128DE and 1332DDE. <b>Size: 2" L X 5/16"-18 threads.</b> The two shear bolt grooves Center to center: 15/16"</p>		

JOHN DEERE continued

Part#	O.E.M	Application
<b>780-290</b>	M124413 M144012	
<p><b>Skid Pad</b> Fits models: 524D, 724D, 826D, 828D, 924D, 1032D, 1128DDE and 1332DDE. <b>Size: 7/16" X 2" slots, 3" center to center.</b> <b>Size: 5-3/4" L X 3" W X 15/16" HT.</b> (For double sided skid plate see our 780-300)</p>		
<b>780-300</b>	M124413 M144012	
<p><b>Skid Pad</b> Double sided, reversible runner <b>Size: 5-3/4" L X 3-5/8" W X 1-1/16" HT,</b> <b>(2) 7/16" X 1-3/4" mounting slots on 3" Centres.</b></p>		

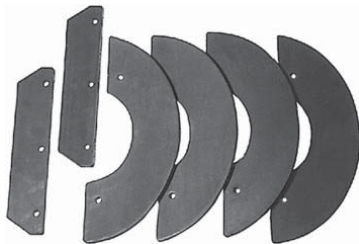



LAWN BOY

<b>240-900</b>	741316	
<p><b>Drive Disc</b> Found on many Ariens 2 Stage units <b>Size: 5-3/8" ID X 6" OD.</b> (Use our 240-325 brake lining if required).</p>		
<b>780-064</b>	610206 / 700371 / 700504 Gilson# 207527 / 207141	
<p><b>Paddle Set</b> Snowblower (6 piece set) Fits models: 55190, 55185, 55131, 55203 and 55312. Rectangle <b>Size: 1-1/2" X 7-1/2" (3) mounting holes on 2-7/8" centres.</b> Crescent measurements" 2" X 9.308" (Use with our 780-179 scaper bar)</p>		
<b>780-179</b>	700321 / 610191 Gilson# 201879	
<p><b>Scraper Bar</b> Fits Snow Cannon model. Measures: 20" long with (3) mounting holes on 9-11/16" centres. Mounting holes are slotted .220" X .365" (Use with our 780-064 paddle set)</p>		







MTD

<b>875-3810</b>	954-04014 754-04014	
<p><b>Auger Drive Belt</b> Fits 300 series compact frame snowblowers, (5 Hp - 22"; 2002 &gt;). <b>Size: 3/8" W X 26-1/2" L.</b> (Cogged Type Belt).</p>		



## MTD continued

Part#	O.E.M	Application
<b>875-3811</b>	954-0456 754-0456	
<b>Drive Belt</b> Fits MTD two stage snowblowers, 2005 and newer. <b>Size: 3/8" W X 28-3/4" L.</b>		
<b>875-091</b>	954-0346 754-0346	
<b>Wheel Drive Belt</b> For 600, 700 series Snowblowers, 8 Hp or greater, model 400, self propelled with gearbox rear drive, rear discharge mowers - 462R and 479R series. (1986-98) <b>Size: 3/8" W X 30" L</b>		
<b>875-157</b>	954-0367 754-0367	
<b>Auger Drive Belt</b> For MTD single stage units (1990 thru 1996). Fits models: 310-180, 310-181, 310-183, 311-180, 311-181, 311-183, 311-184, 312-180, 312-181, 313-180, 313-181, 314-180, 314-181, 315-140, 315E-140, 316-140, 316E-140, 317-140, 317E-140, 31AS231, 31AE5KL, 31A-140, 31A-150, 31A-240, 31A-242, 31A-250, 31A-260, 31AE-150, 31AE-162, 31A-62EW, 31AH62E, 31AH6ZF, 31AH6ZL, 31AH9J6, 31AM62E, 31AM62K, 31AM63E, 31AM63F, 31AM63L, 31AS230, 31AS231, 31AS250, 31AS6DE, 31AS6WS, 31B-140, 31BE150, 31B-140, 31C-140, 31D-140; Wheel Drive Belt for models: 31AE5HT, 31AE6FF, 31AH5WT, 31AM62E, 31AM63T, 31AS6BC, 31AS6BE, 31AS6FE, 31AS6DT, 31AS6HE and 31AS6WE. <b>Size: 3/8" W X 34-1/2" L</b>		
<b>875-158</b>	954-0430 754-0430	(Priced and Sold as a set of 2 belts) 
<b>Auger Drive Belt Set (cogged belt).</b> For 5 Hp dual stage snowblowers (1992 thru 1997). Fits models: 312-640, 312-660, 312-642, 313-640, 313-642, 313-660, 314-640, 314-642, 314-616, 314-660, 314-666, 31A-611, 31A614, 31A-615, 315-611, 315-613, 315-641, 315-718, 315E610, 315E640, 315E641, 315E643, 315E663, 315E740, 315E748, 315E753, 316-611, 316-613, 316-641, 316E610, 316E611, 316E613, 316E633, 316E640, 316E641, 316E643, 316E660, 316E661, 316E663, 316E733, 316E740, 316E753, 316E760, 317-611, 317E610, 317E611, 317E613, 317E733, 317E738, 317E740, 317E742, 317E753, 317E760, 317E762, 31AE600, 31AE610, 31AE611, 31AE613, 31AE614, 31AE633, 31AE640, 31AE644, 31AE645, 31AE653, 31AE660, 31AE662, 31AE663, 31AE664, 31AE665, 31AE740, 31AE753, 31AE765, 31AE6C0, 31AE740, 31AE6A4 & 31BE640. <b>Size: 3/8" W X 35-1/8" L (cogged belt)</b>		
<b>875-148</b>	754-0101A 954-0101A	
<b>Auger Drive Belt</b> Fits 2 thru 5 Hp - 20" single stage snowblowers. (1987 and newer). <b>Size: 1/2" W X 35" L (covered belt)</b>		

## MTD continued

Part#	O.E.M	Application
<b>875-092</b>	954-0935 754-0935	
<b>Traction Drive Belt</b> Fits models: 640, 642, 646, 660 and 666. <b>Size: 1/2" W X 30-7/8" L</b>		
<b>875-365</b>	754-0131 954-0131	
<b>Traction Drive Belt</b> For models: 310-840, 310-850, 310-965, 311-840, 311-850, 311-965, 312-980, 313-980, 314-980, 315-800, 315-860, 315-960, 315-980, 316-800, 317-841, 317-850, 317-960, 318-840, 318-850, 319-840, 319-850, 319-960, 840-027, 840-031, 840-050, 840-095, 840-105, 840-205, 840-206, 840-327, 850-031, 850-054, 850-105, 850-205, 850-327, 960-206, 960-327, 31AE880, 31AE983, 31AE993, 31AE993J401 (2002), 31AE9P3, 31AE906, 31AE9P6, also rider model 50748. <b>Size: 3/8" W X 35-1/2" L (cogged belt).</b>		
<b>875-090</b>	954-0194 754-0194	
<b>Auger Drive Fan Drive Belt.</b> For 8 thru 10 Hp large frame snowblowers. Fits models: 310-840, 310-850, 310-965, 311-840, 311-850, 311-965, 312-980, 313-980, 314-980, 315-800, 315-860, 315-960, 315-980, 316-800, 317-841, 317-850, 317-960, 318-840, 318-850, 319-840, 319-850, 319-960, 840-027, 840-031, 840-050, 840-095, 840-105, 840-205, 840-206, 840-327, 820-031, 850-054, 850-105, 850-205, 850-327, 960-206, 960-327, 31AE880, 31AE983, 31AE993, 31AE9P3, 31AE906 and 31AE9P6. <b>Size: 1/2" W X 45-1/4" L</b>		
<b>875-99010</b>	754-04088	
<b>Drive Belt</b> Fits many 2 stage MTD snowblower snow thrower applications. (2006 and newer). (2L 330). <b>Size: 1/4" W X 33" L (Raw Edge Belt)</b>		
<b>875-3809</b>	754-04013 954-04013	
<b>Traction Drive belt.</b> Fits MTD 300 series compact frame snowblowers, (5 Hp - 22"; 2002 >). <b>Size: 3/8" W X 21.2" L. (Raw Edge Belt)</b>		
<b>875-99000</b>	754-0133 954-0205	
<b>Auger / Traction Drive</b> For 20" and 21" single stage snowthrower applications. (Replaces belt# 3VX315) <b>Size: 3/8" W X 31.5" L (Raw Edge, Cogged belt)</b>		
<b>875-99001</b>	754-0132	
<b>V-Belt.</b> Fits many MTD snowblower applications. <b>Size: 3/8" W X 37.3" L (Raw Edge, Cogged belt)</b>		

MTD continued

Part#	O.E.M	Application
<b>875-99036</b>	Sears models	
<p><b>Traction Drive Belt</b> Fits many Snowblower applications (2003 thru 2009). <b>Size: 1/2" W X 34.4" L</b> (Raw Edge, Cogged belt) (Sometimes used with our 877-020 belt set or our 875-14511 Impeller drive belt).</p>		
<b>875-99037</b>	754-04050 954-04050	
<p><b>Belt, Auger Drive.</b> Fits 2 Stage snowthrowers; 2005 on. For 500 and 600 series. <b>Size: 1/2" W X 34.9" L</b> ( Raw Edge, Cogged belt)</p>		

For more MTD belts - see  
our "BELTS - OEM EXACT  
REPLACEMENT" section 03

<b>285-388</b>	914-0143 714-0143	
<p><b>Lynch Pin</b> Fits models two-stage snowblowers. <b>Size: Pin dia: 1/4", Pin length: 1-3/4" under head.</b></p>		
<b>230-002</b>	741-0309 941-0309	
<p><b>Snowblower Axle Bearing / Fan Bearing</b> For snowblowers - self aligning. Fits 22" thru 40" blowers. Snowblower axle bearing. Fits MTD 20" thru 24" and 36 thru 40" Snowblowers. <b>Size: 3/4" ID X 1-7/8" OD X 1.22"</b> overall height. NOTE: Will also replace MTD# 741-0310 and 941-0310 if old collar is re-used. (Bearing# SA204-12)</p>		
<b>230-250</b>	741-0185 941-0185 941-04024	
<p><b>Snowblower Axle Bearing</b> Found on MTD and Toro snowblowers. For 800 and 900 series on 28" and 33" MTD snowblowers. Fits Toro models 310-230 thru 310-960 snowblowers. (Bearing# SB205-14) <b>Size: 7/8" ID X 2-1/32" OD X 1-1/16" HT w/collar.</b></p>		
<b>230-029</b>	941-0919 741-0919	
<p><b>Bearing</b> For MTD Snowblowers. Fits models: 491, 831, 832 and 930 series. (Bearing# 6204-2RS) <b>Size: .787" ID X 1.851" OD X .551" HT</b></p>		
<b>230-274</b>	741-0361 741-0563 / 941-0563	
<p><b>Snowblower Auger Bearing with Retainer Ring.</b> Fits models 400 thru 700 series. (Bearing# 6203-2RS / 6203-2Z) <b>Size: 17mm ID X 40mm OD X 12mm HT or .669" ID X 1.574" OD X .471" HT.</b></p>		

MTD continued

Part#	O.E.M	Application
<b>230-003</b>	741-0155 941-0155 Bolens# 1185169 Bunton# PL4969	
<p><b>Bearing</b> Fits models: 020, 030, 406, 430, 700, 719, 730, 740, 756, 766 series. (Bearing# 99502H) <b>Size: 5/8" ID X 1-3/8" OD X 7/16" HT.</b></p>		
<b>230-060</b>	741-0124 741-0563 741-0600	
<p><b>Bearing</b> For 2 stage snowblowers and auger shaft bearing on single stage 400 thru 700 series. Fits Sears model: 917.270722. Mtd models: 074, 084, 114 &amp; 314 series. (Bearing# 6203-2RS) <b>Size: .669" ID X 1.578" OD X .475" HT.</b></p>		
<b>230-276</b>	741-0133	
<p><b>Bearing</b> For Snowblowers model: 824, 840, 850 and 960 series. (Bearing# 1621-2RS) <b>Size: 1/2" ID X 1-3/8" OD X 7/16" HT</b></p>		
<b>230-270</b>	741-04076	
<p><b>NEW</b> <b>Bearing with Retainer ring</b> For MTD built equipment. Found on MTD snowblower models: 31AH5ZLH704 (2008), 31AE5KLF795 (2006 -07), 31AE5KLF304 (2006), 31AE5KLF372 (2006), 31AE5KLF401 (2006), 31AE5KLF720 (2006), 31AE5MLH795 (2007) and 31AE5MLG729 (9 Hp MTD / Troy Bilt blowers) (Bearing# 1622-2RS) <b>Size: 9/16" ID X 1-3/3" OD X 7/16" HT.</b></p>		
<b>225-334</b>	748-0108 741-0248	
<p><b>Bronze Flange Bushing</b> Fits impeller shafts. For models: 610, 612, 640, 642 and 660. <b>Size: 1/2" ID X 3/4" OD X 13/16" HT</b></p>		
<b>225-110</b>	748-0184	
<p><b>Bronze Flange Bushing</b> Fits models: 440, 450, 550, 552, 586, 588, 840, 841 and 850. <b>Size: 5/8" ID X 3/4" OD X 3/4" HT</b> <b>Flange OD: 1-1/8"</b></p>		
<b>225-045</b>	948-0110 748-0110	
<p><b>Bronze Flange Bushing</b> Fits models: 31245S, 31250S (1985) and 225 (1988-89) series snowblowers. <b>Size: 5/8" ID X 7/8" OD X 5/8" HT</b></p>		

## MTD continued

Part#	O.E.M	Application
<b>225-128</b>	748-0227 748-0229 / 948-0227A	
<b>Bronze Flange Bushing</b> Hex Nut Flange Bushing Size: 5/8" ID X 1" OD X 5/8" HT		
<b>225-170</b> <b>NEW</b>	741-0339 / 941-0339 Cub Cadet# 7410339 Cub Cadet# 9410339 Troy Bilt# 7410339 Troy Bilt# 9410339	
<b>Bronze flange bushing</b> For MTD. Found in MTD 400, 500 and 600 series. 600 series (1992 thru 1993) and 400, 500 and 600 series (1994 thru 2004). Size: 3/4" ID X 1" OD X 1" HT including flange, Flange OD: 1-1/8".		
<b>225-534</b> <b>NEW</b>	741-0245	
<b>Wheel Shaft Bushing</b> Plastic hexagon bushing, found on MTD built equipment. Size: 3/4" ID X 1-1/16" OD (Hexagon) X 3/4" HT with flange; Flange OD: 1-1/4"; 1" across the flats.		
<b>225-538</b> <b>NEW</b>	741-0598 941-0598 Cub Cadet# 7410598 Troy Bilt# 9410598	
<b>Flange Bushing</b> Bronze hexagon bushing, found on MTD built equipment. Size: 3/4" ID X 1-1/4" OD (Hexagon) X 3/4" HT with flange; Flange OD: 1-3/8"; 1-1/8" across the flats.		
<b>225-167</b>	741-0662 741-0376	
<b>Graphite Impregnated Flange Bushing</b> Snowblower Bushing Size: 3/4" ID X 1" OD X 5/8" HT, Flange OD: 1-1/2" NOTE: Banta Saw part# 225-854 is brass flange bushing with the same measurements but with a Flange OD: 1-1/4"		
<b>225-144</b>	741-0293 / 941-0293 748-0143 / 741-0339	
<b>Plastic Flange Bushing</b> For Augers on models: 450, 550, 552, 586, 588 (1987-88) series snowblowers. Size: 3/4" ID X 1" OD X 3/4" HT Flange OD: 1-1/4".		
<b>225-235</b>	941-0490 / 741-0490 741-0199 / 748-0151	
<b>Plastic Flange Bushing / Axle bushing</b> Fits models: 311-100A, 311-430A, 311-600A, 450, 550 and 580 snowblowers Size: 3/4" ID X 1-1/4" OD X 3/4" HT, Flange OD: 1-3/8", measures: 15/16" (.940") across the flats		







## MTD continued

Part#	O.E.M	Application
<b>225-314</b>	741-0300 941-0300	
<b>Plastic flange bushing</b> Fits many MTD Snowblowers. Size: 3/4" ID X 1-1/2" OD X 3/4" HT Flange OD: 1-3/4", Measures: 1-1/4" across the flats		
<b>225-536</b> <b>NEW</b>	741-0493A	
<b>Plastic Auger Bushing.</b> Found on MTD built equipment / blowers. Size: 13/16" ID X 7/8" OD X 5/8" HT. Flange OD: 1-1/16".		
<b>225-673</b> <b>NEW</b>	741-0401 Cub Cadet# 7410401 Murray# 585581 Noma# 578572	
<b>Plastic wheel bushing</b> For MTD. Used to reduce wheels from 7/8" to 3/4" inside diameter. Size: 3/4" ID X 7/8" OD X 1" HT		
<b>225-160</b>	741-0661 741-0661A	
<b>Graphite Impregnated Flange bushing.</b> Auger shaft bushing found in MTD snowblower gearbox. Fits models: 400, 500 and 600 series. (2004, 2005). Size: .754" ID X 1" OD X 1" HT (Including Flange), Flange OD: 1-1/4"		
<b>225-674</b>	741-0217	
<b>Bronze Bushing</b> Fan bushing (front / rear) found in snowblowers made by MTD. Fits models: 600 thru 900 series snowblowers. Size: 7/8" ID X 1-1/8" OD X 1" HT		
<b>285-705</b> <b>NEW</b>	731-1313 / 731-1313C Cub Cadet# 7311313 / 7311313C	
<b>Chute Tilt Guide</b> For MTD built snowblowers equipped with remote chute tilt. Requires 2 per unit, on most applications. Size: 3-1/16" HT X 3-1/16" W (Two images shown for reference)		
<b>240-945</b>	735-0243 935-0243	
<b>Drive Disc Ring</b> For MTD Snowblowers. Made of quality rubber. Size : 4-7/8" OD X 3-7/8" ID		





MTD continued

Part#	O.E.M	Application
<b>240-944</b> <b>NEW</b>	73504054 735-04054	
<p><b>Drive Disc Ring</b> Fits on MTD Snowblowers. Measures: 5-1/2" OD X 4-1/2" ID. Made of rubber.</p>		
<b>240-915</b>	05080 05080A	
<p><b>Drive Disc</b> For Snowblowers &amp; Riders. Fits models: 500, 510, 520 and 600. Also found on John Deere Snowblowers - made by MTD. <b>Size: 6" OD X 1-1/8" ID, (3) bolt hole pattern.</b></p>		
<b>240-918</b>	718-0494	
<p><b>Drive Disc / Friction Wheel Assy.</b> Fits MTD, Cub Cadet, Troy Bilt, White, Bolens, Garden Way, Yardman and Yard Machine application. For 800 &amp; 900 series large frame snowblowers with 6 bolt mounting. (1998 thru 2002). <b>Size: 6" OD X 2" ID (6) bolt hole pattern.</b></p>		
<b>240-919</b>	718-04034	
<p><b>Drive Disc / Friction Wheel Assy.</b> Fits MTD, Cub Cadet, Troy Bilt, White, Bolens, Garden Way, Yardman and Yard Machine application. For 800 &amp; 900 series large frame snowblowers with 4 bolt mounting. (200 3 on). <b>Size: 6" OD X 2" ID (4) bolt hole pattern.</b></p>		
<b>240-194</b>	913-0194 713-0194 713-0194-1	
<p><b>Drive Sprocket &amp; Hub Assembly</b> Used on large frame Snowblowers 1975 thru 1997. Large Gear: 5-1/2" OD with 32 teeth, Small gear: 1-3/4" OD with 9 teeth, Bore; 3/4", Includes: (2) 225-110 brass bushings. (MTD# 748-0184)</p>		
<b>780-717</b>	717-1425 917-1425 717-0300 917-0300	
<p><b>Worm Gear</b> Left hand double thread. For models: 800 and 900, 28" and 33" width <b>Size: 2.875" OD X 1.5" ID X .875" HT, 20 tooth gear, 1/4" keyway.</b> (Made of brass/bronze material)</p>		

MTD continued

Part#	O.E.M	Application
<b>780-733</b>	717-0528 917-0528	
<p><b>Worm Gear</b> Fits on many MTD 2-stage Snowblowers. Fits models since 1992. <b>Size: 1.90" OD X .750" ID X .650 hub width, 20 tooth gear, 3/16" keyway.</b> (Made of brass/bronze material) (For use with our 780-530 Impeller Shaft).</p>		
<b>780-720</b> <b>NEW</b>	717-0299 / 917-0299 Cub Cadet# 7170299 / 9170299 Troy Bilt# 7170299 / 9170299	
<p><b>Double Threaded Worm Gear (Left Hand)</b> For MTD snowblowers. Fits MTD Snow Pro models: 4051 / 850-0795; 317-851-101. Found on 45" snowblowers (1987 &amp; newer) plus many other models - see dimensions. <b>Size: 7/8" ID X 1-3/4" OD X 1-3/4" HT. Keyway: 3/16".</b> (Install with our 780-717 Brass Worm Gear). (Two images shown for reference)</p>		
<b>495-145</b>	721-0145	
<p><b>Oil Seal</b> Fits on MTD Snowblowers. <b>Size: .875" ID X 1-1/4" OD</b> (Garlock# 76 X 6)</p>		
<b>495-146</b>	721-0146	
<p><b>Oil Seal</b> Fits on MTD Snowblowers. <b>Size: 1-1/2" ID X 1-7/8" OD</b> (Garlock# 76 X 62)</p>		
<b>495-147</b> <b>NEW</b>	721-0179 / 921-0179 Cub Cadet# 7210179 / 9210179 Troy Bilt# 7210179 / 9210179	
<p><b>Oil Seal</b> Fits on MTD Snowblowers. Fits MTD 600 series (1992 thru 1993) and 400, 500 and 600 series (1994 thru 2004). <b>Size: 3/4" ID X 1-1/8" OD X 1/8" HT.</b></p>		
<b>780-050</b> <b>NEW</b>	684-04025 / 684-04025A 684-04027 / 684-04027A 784-5485 / 984-04027 984-04027A / 984-5485 706-15686-00-11	
<p><b>Complete Auger Assembly</b> For MTD built 21" single stage snow blowers. Models: 31**1** and 31**2** built between 1990 thru 2005. Shaft length overall: 20-5/8", Diameter with rubber paddles: 9".</p>		

## MTD continued

Part#	O.E.M	Application
<b>780-016</b>	731-0782 (Bar) 731-0781 (LT curve) 731-0780 (RT curve) 721-0287 753-0613 931-0780A 931-0782A	
<p><b>Paddle Set</b> MTD Snowblower (6 piece set) Fits model 21" Snow Wolf. Rectangle measurement: 1-1/2" X 3-3/8", (2) mounting holes on 2" centres. Crescent measurement: 1-1/2" X 11-1/4" (Use with our 780-017 scaper bar)</p>		
<b>780-120</b>	735-04032 735-04033 753-04472	
<p><b>Paddle Set</b> MTD Snowblower (6 piece set). Fits newer 21" single stage snowblowers; 2004 and newer. Includes: (4) 735-04032 spirals and (2) 735-04033 paddles. Rectangle paddles have two mounting hole and measure: 1 7/8" W x 4" L x 1/4" HT; Half round paddles have four mounting holes and measure: 1 7/8" W x 11 1/4" L x 1/4" HT.</p>		
<b>780-017</b>	731-1033 731-0778 731-0812	
<p><b>Scaper Bar</b> Fits models: 191, 174, 180, 181, 196 Snow Wolf Snowblowers made since 1988. <b>Size: 19-7/8" long with (4) 1/4" X 1" mounting holes on 6" centres.</b> (Use with our 780-016 paddle set)</p>		
<b>790-022</b> <b>NEW</b>	784-5576 784-5576-0637 790-00117-0637	
<p><b>Scaper Bar / Shave Plate</b> Fits MTD built 22" two-stage snowblower models. 1995 and newer. <b>Size: .474" ID X 2-1/4" W X 22" L; 4 mounting holes. Thickness: .105".</b></p>		
<b>790-024</b> <b>NEW</b>	784-5581 784-5581A 784-5581A-0637 784-5581A-0662 784-5581A-0687 790-00120-0637	
<p><b>Scaper Bar / Shave Plate</b> Fits MTD built 24" two-stage snowblower models. 1992 and newer. <b>Size: .490" ID X 2-1/4" W X 24" L; 4 mounting holes. Thickness: .107".</b></p>		









## MTD continued

Part#	O.E.M	Application
<b>790-026</b> <b>NEW</b>	753C0628 784-5579 784-5579-0638 784-5579-0692 784-5579A 784-5579A-0629 784-5579A-0667 784-5579A-0691 790-00121-0637	
<p><b>Scaper Bar / Shave Plate</b> Fits MTD built 26" two-stage snowblower models. 1992 and newer. <b>Size: .473" ID X 2-1/4" W X 26" L; 4 mounting holes. Thickness: .108".</b></p>		
<b>790-028</b> <b>NEW</b>	753C0629 784-5582 784-5582A 790-00118-0637	
<p><b>Scaper Bar / Shave Plate</b> Fits MTD built 28" two-stage snowblower models. 1992 and newer. <b>Size: .473" ID X 2-1/4" W X 28" L; 4 mounting holes. Thickness: .109".</b></p>		
<b>790-030</b> <b>NEW</b>	790-00119-0637	
<p><b>Scaper Bar / Shave Plate</b> Fits MTD built 30" two-stage snowblower models. <b>Size: .473" ID X 2-1/4" W X 30" L; 4 mounting holes. Thickness: .109".</b></p>		
<b>150-695</b> <b>NEW</b>	751-11196 951-11196	
<p><b>Electric Starter Motor</b> <b>120 volt</b> Fits MTD built snow blowers using 478-SU, 483-SU and 490-SU engines built 2009 thru 2010. &gt; 14 tooth gear. INCLUDES: Starter with 110V starter button attached. <b>Measures: 7-1/2" overall length, Starter Body OD: 3-1/8", (2) .350" ID mounting holes on 3.15" centers.</b> Note: Starter cord NOT included.</p>		
<b>150-696</b> <b>NEW</b>	684-04025 684-04025A 684-04027 684-04027A 784-5485 984-04027 984-04027A 984-5485	
<p><b>Electric Starter Motor</b> <b>120 volt.</b> Fits MTD built snow blowers using 265-JU, 270-JU, 165-SU, 370-SU, 365-SUA, 365-SUB, 370-SUA, 370-SUB, 270-V engines built 2007 thru 2010. &gt; 17 tooth gear. INCLUDES: Starter with 110V starter button attached. <b>Measures: 7-1/4" overall length, Starter Body OD: 2-5/16", (2) .256" ID mounting holes on 2.96" centers.</b> Note: Starter cord NOT included.</p>		

MTD continued

Part#	O.E.M	Application
<b>275-780</b> <b>NEW</b>	1824049 706-15931-01 / 756-0241 756-0241B / GW1824049 Cub Cadet# 7061593101 Cub Cadet# 7560241 Cub Cadet# 7560241B Troy Bilt# 7560241	
<p><b>Double Engine Pulley</b> Fits MTD models. Found on MTD / Sears / Craftsman snowblower model 247.886510 etc. <b>Top pulley: 2-3/4" OD X 3-1/8" Bottom pulley. Overall Height: 3-1/8"; Bore: 1" with a 1/4" keyway, Centre to Centre of pulleys: 1-5/8".</b></p>		
<b>275-812</b> <b>NEW</b>	756-0243 Cub Cadet# 7560243	
<p><b>Steel Pulley</b> For MTD built snowblowers. Fits 900 series large frame blowers. Found on models: 311965, 311-840-000, 311-850-000 (1991), 312-980L000 (1992), 313-980L000 (1993), 314-980L000 (1994), 315-980L000 (1995), 317-E980L000. Size: 7/8" ID X 10-3/16" OD; welded washer ID: 5/16"; Keyway: 3/16". For 1/2" wide belts.</p>		
<b>285-704</b> <b>NEW</b>	756-0625 Cub Cadet# 7560625	
<p><b>Cable Roller Guide</b> For MTD built snowblowers. (Made of plastic). Size: 1-1/8" OD X 3/8" ID X 5/16" overall HT.</p>		
<b>417-691</b>	715-0143	
<p><b>Roll Pin</b> Fits on MTD Snowblowers. (Priced individually) (Sold in multiples of 10) Size: 1/4" diameter X 1-1/4" long</p>		
<b>780-254</b>	710-0890 (bolt) 712-0158 (nut)	
<p><b>Shear Bolts</b> For two-stage models, (Priced individually) (Sold in multiples of 10) Size: 1-1/2" L X 5/16"-18 threads</p>		
<b>780-256</b>	710-0891 (bolt) 712-0158 (nut)	
<p><b>Shear Bolts</b> Fits models with auger drive. (Priced individually) (Sold in multiples of 10) Size: 1-3/4" L X 5/16"-18 threads</p>		
<b>780-249</b>	738-04124 738-04124A	
<p><b>Shear Pin</b> Fits newer style MTD snowblowers. (Priced individually) (Sold in multiples of 10) Shear pin hair pin type, non threaded. Fits models: 31A-3BAD700 thru 31A-S6LEG752 series; 2005 and newer snowthrowers. Size: 1-1/2" long X 1/4" diameter, Overall length: 1-5/8". (Hair pin / Bow Tie pin included)</p>		







MTD continued

Part#	O.E.M	Application
<b>780-248</b>	738-04155	
<p><b>Shear Pin</b> Fits newer style MTD snowblowers. (Priced individually) (Sold in multiples of 10) Shear pin hair pin type, non threaded. Shear pins fits all late model 2 stage MTD Snowthrowers with 1" auger shaft and stamped steel augers. Size: 1-3/4" long X 1/4" diameter, Overall length: 1-7/8". (Hair pin / Bow Tie pin included)</p>		
<b>780-251</b>	714-04040	
<p><b>Hair Pin</b> Fits newer style MTD Snowblowers. (Use with our 780-248 and 780-249 shear pin)</p>		
<b>285-388</b>	714-0143 914-0143	
<p><b>Linch Pin</b> Fits all two-stage MTD snowblowers models. Size: Pin dia. 1/4", Pin length: 1-3/4" under pin head.</p>		
<b>430-492</b>	725-1660 TC-35062	
<p><b>Starter Key</b> Found MTD models: 314-180-000, 314-180-088, TMO-3525203, 314-180-131 and 314-181-000. Fits snowblower models: ST524, ST724, ST824, ST1024, ST1028, ST1128, ST1332 and ST1336. Push / Pull key (Red Plastic)</p>		
<b>430-386</b>	951-10630	
<p><b>Ignition Key</b> Fit snowblowers with Zongshen engines. Used on Craftsman and Huskee snowblowers. Fits our 430-390 ignition switch, replacement key for MTD# 951-10637</p>		
<b>430-390</b>	951-10637	
<p><b>Ignition Key</b> Fit snowblowers with Zongshen engines. Used on Craftsman and Huskee / Husqvarna snowblowers. (2) positions, (2) terminal (uses our 430-386 ignition key) see: www.lawnmowerpartstore.com</p>		
<b>285-062</b>	732-0303	
<p><b>Clutch Spring</b> For MTD Snowblowers. Size: 3-1/4" overall length. Thickness: .052" Coil length: 2-3/8" X Coil diameter: 3/8".</p>		
<b>285-059</b> <b>NEW</b>	732-0264 Cub Cadet# 7320264	
<p><b>Traction Spring</b> For MTD. Found on 8 and 10 Hp models. Measures: 2-5/8" overall length, Coil Length: 1-1/2", Coil diameter: 3/8". Thickness: .055"</p>		

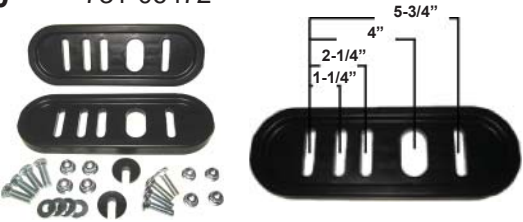
## MTD continued







Part#	O.E.M	Application
<b>285-061</b> <b>NEW</b>	732-0710 Cub Cadet# 7320710	
<b>Traction Spring</b> For MTD. Found on 8 and 10 Hp models. <b>Measures: 2-3/4" overall length, Coil Length: 1-1/2", Coil diameter: 3/8". Thickness: .050"</b>		
<b>285-063</b> <b>NEW</b>	732-0611	
<b>Auger Spring</b> For MTD built snowblowers. Found on 8 and 10 Hp models. <b>Measures: 3-11/16" overall length X 2-7/16" coil length X coil diameter: 3/8". Thickness: .050"</b>		
<b>780-270</b>	5002 05002	
<b>Skid Plate</b> For 1988 -89, 20" & 26" Snowblowers. Fits models: 225 and 590. <b>Size: 5-1/4" L X 3-1/4" W X 7/8" HT; (2) 7/16" X 2" mounting slots on 3" centres.</b>		
<b>780-280</b>	784-5038A 784-5038B	
<b>Skid Plate</b> For all 2-stage Snowblowers. Fits models: 449, 450, 550, 552, 586 and 588. <b>Size: 10-1/4" L X 3-1/2" W, (5) 7/16" X 2-1/2" mounting slots on 1-1/2" centres.</b>		
<b>780-285</b>	784-5580 784-5580-0637	
<b>Skid Plate</b> For MTD 2-stage Snowblowers. Found on models: 312-610E000 (1992), 313-610E000 (1993), 314-612E000 (1994), 315E610E000 (1995) and 316-E610E000 (1996). <b>Size: 4-7/8" L X 3" W X 3/4" HT; (2) 3/8" X 2-1/8" mounting slots on 2-3/4" centers.</b>		
<b>780-290</b>	05002 050020637	
<b>Skid Plate</b> Fits John Deere and MTD models: 524D, 724D, 826D, 828D, 924D, 1032D, 1128DDE and 1332DDE. <b>Measures: 7/16" X 2" slots, 3" center to center.</b> <b>Size: 5-3/4" L X 3" W X 15/16" HT.</b> (For double sided skid plate see our 780-300)		
<b>780-300</b>	05002-0637 05002	
<b>Skid Plate</b> Double sided, reversible runner. Fits models: 190-486-000, 19486C, 196-486-000, 310345, 311345, 31340-7, 8, C, 31345-9 and 31350C. <b>Size: 5-3/4" L X 3-5/8" W X 1-1/16" HT; (2) 7/16" X 1-3/4" mounting slots on 3" centers.</b>		

## MTD continued







Part#	O.E.M	Application
<b>780-630</b> <b>NEW</b>	731-06472	
<b>Skid Pad Set</b> Universal Deluxe Poly Skid Pad Set. Includes mounting hardware: (4) 5/16"-18 bolts & lock nuts, (4) 3/8"-16 bolts & lock nuts, (4) washers, (2) adjustable plastic inserts and (2) plastic skid plates. Skids measures: 10" Long X 3-1/2" High X 3/4" Thick.		
<b>285-608</b>	746-0694	
<b>Lock-out Cable</b> Fits models: 800 to 996 series. 1989 & later. <b>Overall Length: 28-3/4", Cable Length: 23-3/4"</b>		
<b>285-609</b>	746-0367	
<b>Blower Cable</b> Fits older models: Before 1992 <b>Overall Length: 31-1/2", Cable Length: 26-1/4"</b>		
<b>285-610</b>	746-0435	
<b>Traction Cable</b> Fits older models: Before 1992. <b>Overall Length: 37-1/2", Thread Length: 4".</b>		
<b>285-002</b>	746-0506 746-0573	
<b>Auger Drive Cable</b> Fits on MTD Snowblowers. For 21" snowblowers. <b>Conduit Length: 33-1/4", Overall Length: 42-1/2"</b>		
<b>285-600</b>	946-0898 746-0898A 746-0898	
<b>Clutch Drive Cable</b> Fits 600 model series MTD snow blowers built 1995 thru 2002 & 700 series built in 2003. Models 312-610E000 (1992), 313-610E120 (1993) and 314-616E131 (1994) snowblowers. Auger Clutch Cable - Fits 400 thru 600 series MTD snow blowers built 1992 thru 2004. <b>Conduit Length: 38-1/4", Overall Length with spring: 39-3/4". Threaded Rod: 4-3/8" overall length.</b> Note: Our 285-600 includes: Conduit, spring & threaded rod. (Threaded rod is also sold separately, see part# 285-590).		



MTD continued

Part#	O.E.M	Application
<b>285-594</b> <b>NEW</b>	746-04229 Cub Cadet# 74604229	
<p><b>Wheel Drive / Clutch Cable</b> For MTD built snowblowers. <b>Overall Length including spring: 45-3/8", Overall Spring Length: 2-1/8".</b></p>		
<b>285-596</b> <b>NEW</b>	746-04230 Cub Cadet# 74604230	
<p><b>Wheel Drive / Clutch Cable</b> For MTD built snowblowers. Found on MTD snowblower models: 31AH5ZLH704, 31AM63LF704, 31AH6ZLG704 (2008), 31AE5KLF795, 31AE6GFF795, 31AE5MLH795 (2007), 31AE5KLF796 (2006), 31AE6BHE718 (2005 on). <b>Overall Length including spring: 48", Overall Spring Length: 2-1/8".</b></p>		
<b>285-598</b>	746-0896 946-0896	
<p><b>Chute Control Cable</b> For MTD Snowblowers. Fits newer models built since 1993. <b>Conduit Length: 47", Overall Length: 54-1/4"; Wire Travel: 6-3/4"</b></p>		
<b>285-405</b>	746-0910A	
<p><b>Auger Drive &amp; Traction Cable</b> For many MTD snowblowers since 1995. Fits 180 series single stage snowblowers. <b>Conduit Length: 35-3/8", Total Length: 41-1/2"</b></p>		
<b>285-586</b> <b>NEW</b>	746-0951 946-0951 Cub Cadet# 7460951 Cub Cadet# 9460951 Troy Bilt# 7460951	
<p><b>Auger Idler Control Cable</b> For MTD snowblowers. Found on 800 &amp; 900 series (large frame) snowblowers; 1998 &amp; newer. <b>Measures: 16-1/4" Overall Length, Cast Z-Bends on both ends.</b></p>		
<b>285-587</b> <b>NEW</b>	746-04227A Cub Cadet# 74604227 Cub Cadet# 74604227A	
<p><b>Speed Selector Control Cable</b> For MTD snowblowers. Found on MTD Pro series model 31AE6BHE718 (2005 and newer). <b>Measures: 22-1/8" Overall Length, Cast Z-Bends on one end and a cast barrel end on the other.</b></p>		

MTD continued

Part#	O.E.M	Application
<b>285-588</b> <b>NEW</b>	746-04228A Cub Cadet# 74604228A Troy Bilt# 74604228	
<p><b>Speed Selector Control Cable</b> For MTD snowblowers. Found on MTD / While models: 31AE6BHE718, 31AE6GLF00, 09, 19, 26, 31AE6GLF795, 31AE6L04766, 31AH6BHE790, 31AS6BEE700, 31AS6BEE731, 31AS6FEF700. <b>Measures: 24-1/8" Overall Length, Cast Z-Bend on one end and a cast barrel end on the other.</b></p>		
<b>285-584</b> <b>NEW</b>	746-04396 746-04396A 946-04396 946-04396A Cub Cadet# 74604396 Cub Cadet# 94604396A	
<p><b>Speed Selector Control Cable</b> For MTD snowblowers. Found on MTD . <b>Measures: 22-1/8" Overall Length, Cast Z-Bend on one end and a cast hammer head end on the other.</b></p>		
<b>285-599</b>	746-0897 / 946-0897 746-0778 / 946-0778 746-0897A / 946-0897A	
<p><b>Auger Clutch Cable</b> Fits 400 thru 600 series MTD snow blowers built 1992 thru 2004. <b>Overall Length with spring: 44-3/4".</b> (NOTE: Threaded rod NOT included, sold separately - see our part# 285-590).</p>		
<b>285-591</b> <b>NEW</b>	746-0716 Cub Cadet# 7460716 Troy Bilt# 7460716	
<p><b>Lock-out Cable / Auger Clutch Cable</b> For MTD built snowblowers. <b>Overall Length: 23-1/4". Cast Z-Bend on one end with a 1/4" diameter threaded end on the other.</b></p>		
<b>285-592</b> <b>NEW</b>	746-0952 / 946-0952 Cub Cadet# 7460952 9460952	
<p><b>Lock-out Cable / Auger Clutch Cable</b> For MTD built snowblowers. Fits MTD 800 and 900 series, large frame snowblower. (1998 and newer). <b>Overall Length: 26-1/2". Cast Z-Bend on one end with a 1/4" diameter threaded end on the other.</b></p>		
<b>285-593</b> <b>NEW</b>	746-04086 946-04086 Cub Cadet# 74604086 Cub Cadet# 94604086 Troy Bilt# 74604086	
<p><b>Lock-out Cable / Auger Clutch Cable</b> For MTD built snowblowers. Fits MTD 500 and 600 series snowblower. <b>Overall Length: 42-3/4", Coil Spring Length: 2-1/2".</b></p>		







## MTD continued

Part#	O.E.M	Application
<b>285-590</b>	746-0778	
<p><b>Threaded Control Cable End.</b> Used on many MTD, Murray and Noma / Canadiana snowblowers. Size: 4-3/8" Overall Length. (Used on our 285-600 and 285-599 control cables).</p>		
<b>290-025</b> <b>NEW</b>	746-0390 / 746-0390A / 746-547 Cub Cadet# 7460390 / 7460390A / 746547	
<p><b>Throttle control</b> For MTD built snowblowers. Found on MTD, Yardman, Columbia models 250, 280, 281, 450, 510, 511, 520, 580, 761, 766, 821, 840, 961. <b>Inner Wire Length: 32-1/2"</b>, <b>Conduit Length: 30"</b>, <b>Wire Travel: 1-1/2"</b>.</p>		
<b>780-546</b>	738-0276	
<p><b>Snowblower Axle</b> Fits MTD two stage 28" and 33", (1996 &amp; older) models: 800 and 900. <b>Measures: 19-1/8" Overall length X 7/8" OD, (2) 5/16" holes on 1-1/8" centers, (2) 3/16 keyways</b></p>		
<b>780-532</b> <b>NEW</b>	711-0910 711-0910A	
<p><b>Auger Axle</b> For MTD built snowblowers. Found on Cub Cadet, Troy Bilt and MTD branded snowblowers. 28" Blowers. Models: 400 thru 600 series. Measures: 27-1/2" Long X 3/4" Shaft OD. Two 5/16" ID holes centered @ 6-11/16" from both ends. One 3/16" X 9/16" half moon keyway centered @ 13-3/4".</p>		
<b>780-545</b>	738-0284	
<p><b>Differential Connecting Shaft</b> Fits MTD snowblowers. <b>Measures: 11-7/8" Overall length X 5/8" OD, (2) 1/4" holes on 5/8" centers, (2) 3/16" holes on 1-1/8" centers.</b></p>		







## MTD continued

Part#	O.E.M	Application
<b>780-530</b> <b>NEW</b>	717-0526	
<p><b>Impeller / Fan Shaft</b> Fits MTD built snowblowers. Models: 400 thru 600 series. (1992 thru 1993). <b>Measures: 13-1/2" Overall Length X 3/4" diameter. Shaft has a spline on one end and 1/2" OD X 5/8" Long end on the other.</b> (For use with our 780-733 worm gear).</p>		

## MURRAY / NOMA

<b>875-8760</b>	585416 585416C 585416MA	
<p><b>Auger Drive Belt</b> Fits many 8 and 10 HP models with 16-inch diameter wheels and a 12-inch diameter auger <b>(Dealers have stated to us that this belt will replace Noma / Murray# 585416C.</b> NOTE: The Original (OEM) belt measures: 17/32" W X 37.6" L). <b>Size: 1/2" W X 37.8" L</b> (Cogged belt)</p>		
<b>875-10039</b>		
<p><b>V Belt</b> For snowblowers. <b>Size: 1/2" W X 38.5" L</b></p>		
<b>875-192</b>	360928 37X132 760928 760928MA MT760928MA	
<p><b>Auger Drive Belt</b> Fits Murray / Noma / Amf / Canadiana snowblowers. Single stage, sub compact frame with 2 cycle engine. (20" - 21"). Kevlar belt, Raw Edge. <b>Size: 3/8" W X 34.7" L</b></p>		
<b>875-584802</b>	584802 584802MA	
<p><b>Belt</b> <b>For Murray / Noma &amp; Sears snowblowers.</b> <b>Size: 17/32" W X 34.5" L</b> (Raw Edge belt)</p>		
<b>875-99029</b>	3526 3526MA	
<p><b>Auger Drive Belt</b> Belt for AMF / Noma snowblowers. <b>Size: 1/2" W X 30-1/8" L.</b> (Kevlar, Raw Edge belt)</p>		
<b>875-99030</b>	3887 3887MA	
<p><b>Drive Belt</b> For Murray / Noma snowblower. For Snowblowers - 8 Hp. <b>Size: 1/2" W X 30-7/8" L</b> (Kevlar belt, Raw Edge)</p>		

MURRAY / NOMA cont.

Part#	O.E.M	Application
<b>815-014</b>	579932 / 173334 579932MA / 302507	
<p><b>Traction Drive Belt</b> For Murray built snowblowers, built between 2000 thru 2008. For models: 622505, 622515, 622518, 624504, 624505, 624604, 624650, 629117, 62451, 6271200, 6271201, 6271500, 624808, 624858, 626750, 626752, 627107, 627108, 627109, 627117, 627118, 627804, 627808, 627809, 627815, 627850, 627858, 627904, 627954, 628102, 628104, 629105, 629106, 629108, 629109, 629110, 629111, 629118, 629119, 629159, 629924, 631108, 6240810, 6271100, 6240900, 6271200, 6271201, 6271270, 6271271. Found on Sno Super, Sno Blizzard, Alpina, Sno Unlimited. Fits 22" thru 24" and 26" thru 33" models built after 1995 - except 12 Hp. Found on Sno Super, Sno Blizzard, Alpina, Sno Unlimited. <b>Size: 3/8" W X 33-1/4" L</b></p>		
<b>875-99038</b>	518416 518416MA	
<p><b>Auger Drive Belt</b> For 2 Stage snowblowers, Mid frame wheel drive, (1997 thru 2000). <b>Size: 1/2" W X 38.3" L</b> (Kevlar belt, Raw Edge)</p>		
<b>875-99039</b>	585436 585436MA	
<p><b>Auger Drive Belt</b> For 2 Stage snowblowers, Large frame track drive on 31" and 33" blowers. <b>Size: 1/2" W X 37.8" L</b> (Kevlar belt, Raw Edge)</p>		
<b>230-265</b>	9648 / 780048 / 761507	
<p><b>Bearing with cage assembly</b> Fits many manufacturers snowblowers - Amf, Canadian, Noma, Murray etc. <b>Bearing ID: 7/8" ID with .200" keyway (included). Cage measures: 3-3/4" L X 2-3/4" W; Bolt holes are on 3" centres.</b> (Uses our 230-267 replacement bearing)</p>		
<b>230-267</b>	9648 780048 761507	
<p><b>Bearing only</b> For Noma Snowblowers. <b>Size: 7/8" ID X 2" OD X 9/16" HT Keyway: .200"</b></p>		
<b>230-034</b>	85087 761508 MJ761508	
<p><b>Bearing</b> For Noma &amp; Murray Snowblowers. (Bearing# 1640-2RS) <b>Size: 7/8" ID X 2" OD X 9/16" HT</b></p>		

MURRAY / NOMA cont.

Part#	O.E.M	Application
<b>230-032</b>	85086 579863 MJ579863	
<p><b>Bearing</b> For Noma Snowblowers. (Bearing# 1641-2RS) <b>Size: 1" ID X 2" OD X 9/16" HT</b></p>		
<b>230-060</b>	12325MA / 1255MA 1501389MA / 49562MA 782973MA / 49562	
<p><b>Bearing</b> Found Murray / Noma snowblowers (Bearing# 6203-2RS) <b>Size: .669" ID X 1.578" OD X .475" HT</b> Bearing with retainer ring use our Part# 230-274.</p>		
<b>230-276</b>	423756	
<p><b>Bearing</b> Found Murray / Noma snowblowers. (Bearing# 1621-2RS) <b>Size: 1/2" ID X 1-3/8" OD X 7/16" HT</b></p>		
<b>230-006</b>	579863	
<p><b>Bearing</b> Fits models: N1030DEL &amp; N1232DEL. (Bearing# 6001-2RS) <b>Size: .472" ID X 1.102" OD X .315" HT</b></p>		
<b>230-003</b>	580781 MJ49562	
<p><b>Bearing</b> Fits models 1994 and newer. (Bearing# 99502H / 1623-2RS) <b>Size: 5/8" ID X 1-3/8" OD X 7/16" HT</b></p>		
<b>225-470</b>	MJ780073 50673	
<p><b>NEW</b> <b>Needle bearing</b> For Murray / Noma snowblowers. Found on models: 826, 1026 and 1032. <b>Size: 3/4" (.750") ID X 1" OD X 3/4" (.750") HT.</b> (Taller version of our 225-466).</p>		
<b>225-334</b>	MJ85504 53829	
<p><b>Bronze Flange Bushing</b> Noma and Murray snowblowers <b>Size: 1/2" ID X 3/4" OD X 5/8" HT</b></p>		
<b>225-850</b>	85084 MJ780037	
<p><b>Bronze Flange Bushing</b> Noma and Murray snowblowers Model: 924 <b>Size: 7/8" ID X 1-1/8" OD X 5/8" HT</b></p>		



## MURRAY / NOMA cont.

Part#	O.E.M	Application
<b>225-150</b> <b>NEW</b>	53731 53731MA Swisher# 53731 Swisher# 53731MA	
<b>Bronze Bushing / Bearing Sleeve</b> For Murray / Noma / Canadiana. Impeller shaft bushing / bearing sleeve. Found on many Sears / Craftsman Dual Stage snowblowers. Models 536-888110 etc. <b>Size: 3/4" ID X 7/8" OD X 3/4" HT.</b>		
<b>225-851</b>	53836 MJ313887	
<b>Graphite Impregnated Hex Flange Bushing</b> <b>Size: 3/4" ID X 7/8" OD X 21/32" HT.</b> <b>Measures 7/8" across the flats.</b>		
<b>225-852</b>	581730	
<b>Bronze Flange Bushing</b> Axle bushing. <b>Size: 3/4" ID X 1-1/8" OD X 3/4" HT</b>		
<b>230-025</b>	54837 577023	
<b>Auger Bushing</b> Plastic - Noma Snowblowers. <b>Size: 43/64" ID X 1-7/8" W X 3-3/4" L</b> <b>Bolt holes: 1/4" on 2.932" centres. HT: .925"</b>		
<b>225-673</b> <b>NEW</b>	Murray# 585581 Noma# 578572 MTD# 741-0401 Cub Cadet# 7410401	
<b>Plastic wheel bushing</b> For MTD. Used to reduce wheels from 7/8" to 3/4" inside diameter. <b>Size: 3/4" ID X 7/8" OD X 1" HT</b>		
<b>230-268</b> <b>NEW</b>	780013 / 780013MA 85504 / 85504MA / 85504	
<b>Bushing with cage assembly</b> For Murray / Noma / Canadiana Snowblowers. Bushing ID: 1/2" ID X 3/4" OD. Cage measures: 2-1/2" X 2" W. (Uses our 225-334 bushing - included).		
<b>230-262</b> <b>NEW</b>	1413 Murray# 334163 Swisher# 334163	
<b>Bearing with cage assembly</b> For Snowblowers. Fits many manufacturers snowblowers - Murray / Noma / Canadiana, Sears / Craftsman, Swisher etc. Self-Aligning Bronze Bushing ID: 7/16" X 1/2" HT. (2) 5/16-18" threaded mounting holes on 1-3/4" centers.		

## MURRAY / NOMA cont.

Part#	O.E.M	Application
<b>780-580</b> <b>NEW</b>	579726 579726MA John Deere# AM119482	
<b>Impeller Bearing Housing only</b> For John Deere, Murray / Noma snowblowers. Found on John Deere snowblower model 826 etc. (Made of Aluminum). <b>Size: 1-1/4" ID X 7/8" Overall Height.</b> <b>(3) 5/16" Mounting holes on 2.35" centers.</b> (Uses our 225-677 Bronze Bushing in many applications). (Two Images shown for reference)		
<b>240-910</b>	53830 / 313883 9005383 MJ313883 1501435 1501435MA	
<b>Drive Disc</b> Noma 23", 25" & 30" Snowblowers. Also found on 21" self propelled mowers, 1983 to present <b>Size: 4-3/8" OD X 2-1/4" ID, (3) bolt holes</b>		
<b>240-900</b>	5550 35550 MJ780086 6779	
<b>Drive Disc</b> Our most popular selling drive disc. Found on many different manufacturers equipment. <b>Size: 5-3/8" ID X 6" OD.</b> (Use our 240-325 brake lining if required).		
<b>240-955</b>	780086 780086MA	
<b>Drive Disk / Friction Disc Conversion Kit</b> For Murray / Noma snowblowers etc. Comes complete as shown mounted to our 240-900 drive disc. Found on several models including Noma model# CN825ET etc. (Fits our 240-035 and 240-041 - shaft & gear assemblies)		
<b>275-782</b> <b>NEW</b>	313858 / 53715MA MJ313858 / 53715	
<b>Engine Pulley</b> For Sears / Craftsman, Murray / Noma / Canadiana snowblowers. Found on Sears / Craftsman 5 Hp model, 24" Dual Stage (Model: 536-885471 etc). <b>Measures: 3/4" ID X 3" OD with a 3/16" built-in keyway.</b> <b>For 1/2" belts.</b> (Two Images shown for reference)		







MURRAY / NOMA cont.

Part#	O.E.M	Application
<b>275-090</b> <b>NEW</b>	53759MA 53759	
<p><b>Steel Pulley</b> Used on Murray / Noma built snowblowers. Measures: 7/8" ID X 6-1/2" OD X 1-1/4" Hub Length. Keyway: 3/16". Complete with (2) set screws. (For 1/2" V-belts).</p>		
<b>275-094</b> <b>NEW</b>	50796MA 50796	
<p><b>Steel Pulley</b> Used on Murray / Noma built snowblowers. Measures: 7/8" ID X 8-1/2" OD X 1-3/8" Hub Length. Keyway: 3/16". Complete with (2) set screws. (For 1/2" V-belts).</p>		
<b>780-735</b>	51405 51405MA	
<p><b>Worm Gear</b> Fits small frame snowblowers. <b>Size: 2" OD X 3/4" ID.</b> <b>Hub Width: .645" Gear Width: .495",</b> <b>Keyway: 3/16", Teeth: 22</b></p>		
<b>780-737</b>	53730 53730MA	
<p><b>Worm Gear</b> Fits large frame snowblowers. Fits model: 627808X61E and others. <b>Size: 3-1/8" OD X 1" ID X 7/8" Thick,</b> <b>Keyway: 1/4", Teeth: 22.</b> (Made of Brass / Bronze material).</p>		
<b>780-260</b>	73754 / 70971 301171 / 301172 500026MA	
<p><b>Shear Bolts</b> Fits 22", 23", 24", 25", 27" blowers with 12" augers. Includes: bolt, spacer washer and nut. <b>Size: 1-3/4" L X 1/4"-20 thread.</b> (Priced individually) (Sold in multiples of 10)</p>		
<b>780-259</b>	235 (bolt) 3944 (spacer) 00235 (nut)	
<p><b>Shear Bolts</b> Found on many older snowblowers. <b>Size: 2" L X 5/16"-18 thread.</b> Includes: bolt, spacer washer and nut (Priced individually) (Sold in multiples of 10)</p>		
<b>240-035</b>	6549 / 6549MA	
<p><b>Drive Shaft &amp; Gear</b> Sprocket uses #35 roller chain and has 8 teeth. Overall length: 5-1/8". <b>(#35 roller chain X 8 Tooth).</b> The outside diameter of the 8 tooth drive gear teeth = 1-1/8" OD approximately. Shaft diameters: .625" (5/8") OD X .500" (1/2") keyed OD X .375" (3/8") OD threaded end. All measurements are approximate. Keyway: .125" (1/8"). Used in conjunction with our 240-955 Friction Disk Conversion Kit.</p>		





MURRAY / NOMA cont.

Part#	O.E.M	Application
<b>240-041</b> <b>NEW</b>	6550 6550MA	
<p><b>Drive Shaft &amp; Gear</b> Sprocket uses #41 roller chain and has 8 teeth. Overall length: 5-1/8". <b>(#41 roller chain X 8 Tooth).</b> The outside diameter of the 8 tooth drive gear teeth = 1-7/16" OD approximately. Shaft diameters: .625" (5/8") OD X .500" (1/2") keyed OD X .375" (3/8") OD threaded end. All measurements are approximate. Keyway: .125" (1/8"). Used in conjunction with our 240-955 Friction Disk Conversion Kit.</p>		
<b>240-043</b> <b>NEW</b>	4062 / 4062MA	
<p><b>Friction Axle Shaft &amp; Gear</b> For Murray / Noma snowblowers. Sprocket uses our 250-027 (#41) roller chain and has 8 teeth. <b>Overall length: 11".</b> The outside diameter of the 8 tooth drive gear teeth = 1-1/2" OD approximately. Shaft diameters: .750" (3/4") OD X 9" Long; Shaft ends (both) .500" (1/2") OD X 11/16" Long.</p>		
<b>780-540</b> <b>NEW</b>	Noma# 6177	
<p><b>Wheel Shaft with Gear</b> For older Noma / Canadian / Amf snowblowers. Found on Canadian Small Frame blowers. Complete Shaft <b>Measures: 24-3/4" Overall Length.</b> <b>42 Tooth Gear measures: 7" OD</b> <b>and uses #41 roller chain.</b> <b>Shaft OD: 3/4".</b></p>		
<b>495-160</b> <b>NEW</b>	530552 / 780151 780151MA / 530552 53744 / 53744MA / 780151 Swisher# 53744 / 780151MA	
<p><b>Oil Seal</b> Gear box housing seal for both left and right hand sides. Found on Murray / Noma built snowblowers. <b>Size: 1" ID X 1-1/4" OD.</b></p>		
<b>780-118</b>	302565 (4) pcs. / 57121 (2) pcs.	
<p><b>Paddle Set</b> Fits 20" snowblower. For model: C2030-010 and Craftsman 20" snowblower C950-52103 models. Square paddles are 1-3/4" W X 3-3/4" L X 1/4" Thick. Half round paddles are 11-1/8" OD X 1/4" thick. Half round paddles have (6) mount holes. (Use with our 780-088 scraper bar)</p>		







## MURRAY / NOMA cont.

Part#	O.E.M	Application
<b>780-088</b>	302418 / M94511 / 53688547	
<b>Scrapers Bar</b> Fits Noma, Sears and John Deere 5 Hp models. <b>Size: 20-15/16" L with (4) 5/16" ID mounting holes on 6-3/4" centers.</b> (Use with our 780-118 paddle set)		
<b>780-287</b>	85105 74-1440	
<b>Skid Plate</b> For snowblowers. <b>Size: 6" Overall length X 3-3/8" HT, (2) 5/16" slot X 2-3/16" L on 2-1/2" centers. Center hole: 5/8" OD</b>		
<b>780-288</b>	780061 760061MA 301380E701 1740718HMA 301380E717MA	
<b>Skid Plate</b> Fits models: 1695557 - C950-52846-0, 1695558 - C950-52847-0. <b>Size: 80mm / 3-3/16" Overall length X 76mm / 3-1/16" HT, (2) 9mm slots X 40mm L on 50mm / 2" centers.</b>		
<b>285-043</b> <b>NEW</b>	51477	
<b>Traction Spring</b> For Noma / Canadiana. Found on older snowblowers. <b>Measures: 5-1/16" overall length, Coil Length: 3-1/4", Coil diameter: 1/2"</b>		
<b>285-044</b> <b>NEW</b>	318468 318468MA 7030 Simplicity# 723379	
<b>Tension Spring</b> For chute. Found on many Murray / Noma / Canadian and Simplicity snowblowers. Also found on Craftsman Dual Stage model C950-52313-3 (2005) etc. <b>Measures: 3-3/4" overall length, Coil Length: 2-3/8", Coil diameter: 1/2"</b> .		
<b>285-045</b> <b>NEW</b>	313855 313855MA 53710MA 53710	
<b>Clutch Return Spring</b> Found on many Murray / Noma / Canadian snowblowers. Models: 826, 1026 and 1032. <b>Measures: 2-3/4" overall length, Coil Length: 1-5/8", Coil diameter: 1/2"</b> .		
<b>285-046</b> <b>NEW</b>	1673 1673MA 585884 585884MA	
<b>Auger Clutch Spring</b> Found on many Murray / Noma snowblowers. <b>Measures: 5-1/2" overall length, Coil Length: 3-1/2", Coil diameter: 3/4"</b> .		

## MURRAY / NOMA cont.

Part#	O.E.M	Application
<b>780-544</b>	1401 / MJ1401	
<b>Fan Shaft / Gearbox</b> Input Shaft, Fits Noma and Murray snowblowers. <b>Size: 19-3/16" L X 7/8" OD (large end) X 3/4" OD (small end), (2) 1/4" holes on 3/4" centers, (1) 3/16" keyway for woodruff key and (1) 3/16" keyway - 2-5/16" long</b>		
<b>285-710</b> <b>NEW</b>	1501124 1501124MA 762259MA 1501124MA 762259MA	
<b>Auger Clutch Cable</b> Found on Murray / Noma snowblowers. <b>Overall Length: 32-3/4", Cable Length: 31"</b> .		
<b>285-708</b> <b>NEW</b>	1501122MA 1501122	
<b>Control Cable</b> Lower Drive Cable. Found on Murray / Noma snowblowers. <b>Overall Length: 12-3/4", Cable Length: 12"</b> .		
<b>285-597</b>	4052MA 780059 MJ4052 MJ780059 4052 4052MA 780059	
<b>Chute Control Cable</b> For Murray / Noma snowblowers. <b>Size: 59-3/8" Overall Length, Conduit Length with both threaded end: 52", Wire Travel: 5-1/2"</b>		
<b>285-595</b>	1580	
<b>Clutch Drive Cable</b> For Murray / Noma snowblower. Fits Small Frame snowblower models: 523, 825 etc. <b>Overall Length: 32-5/8", Cable Length: 27-5/8"</b> .		
<b>285-711</b> <b>NEW</b>	501452MA 1501452 1501452MA	
<b>Drive Cable</b> Found on Murray / Noma snowblowers. <b>Overall Length: 35-3/4", Cable Length: 34"</b> .		

MURRAY / NOMA cont.

Part#	O.E.M	Application
<b>285-608</b>	1579MA 1579	
<p><b>Clutch Cable</b> Fits small frame Noma snowblowers. Models: 523, 825. <b>Overall Length: 28-3/4", Cable Length: 23-3/4"</b></p>		
<b>285-709</b> <b>NEW</b>	1501123MA 1501123	
<p><b>Clutch Cable</b> Found on Murray / Noma snowblowers. <b>Overall Length: 30-1/2", Cable Length: 29-1/2"</b></p>		
<b>285-589</b> <b>NEW</b>	1502113MA	
<p><b>Drive Control Cable</b> For Murray / Briggs and Stratton snowblowers. FR-DR P7 5-13B. <b>Measures: 31-1/4" Overall Length, Cast Z-Bends on both ends.</b></p>		
<b>287-001</b> <b>NEW</b>	761131 / 761131MA	
<p><b>Chute control cable</b> For Murray / Briggs and Stratton snowblowers. <b>Measures: 69-1/2" Overall Length, Conduit Length: 62", Wire Travel: 5-1/4", Eyelet hole ID: 5/16"</b></p>		
<b>287-002</b> <b>NEW</b>	761775 / 761775MA	
<p><b>Chute control cable</b> For Murray / Briggs and Stratton snowblowers. <b>Measures: 63-3/4" Overall Length, Conduit Length: 57-1/2", Wire Travel: 3-1/4", Eyelet hole ID: 5/16" with a Cast Z-Bend on the other.</b></p>		
<b>285-712</b> <b>NEW</b>	339496MA / 339496	
<p><b>Chute Control Cable</b> For Murray / Noma snowblowers. <b>Measures: 50" Overall Length, Conduit Length: 43", Wire Travel: 6"</b></p>		
<b>285-707</b> <b>NEW</b>	579856MA MC579856 579856	
<p><b>Traction Cable</b> Found on Murray / Noma snowblowers. <b>Overall Length: 6-5/8", Cable Length: 5-1/8"</b></p>		



MURRAY / NOMA cont.

Part#	O.E.M	Application
<b>290-112</b> <b>NEW</b>	780232 / 780232MA 50877 / 51223 / 53943	
<p><b>Throttle Control</b> Found on Ariens, Murray / Noma snowblowers. <b>Conduit length: 30-1/4", Inner wire length: 33", Conduit size: 3/16", Inner wire size: .055", Wire travel: 1-3/4"</b></p>		
<b>780-543</b>	50660 / 577412 / MJ577412	
<p><b>Impeller / Fan Shaft</b> Fits Noma and Murray snowblowers. <b>Size: 19-1/4" Overall Length (7/8" OD X 15" long, 3/4" OD X 4-1/4" long)</b> Large diameter end (7/8" OD) has a 3/16" keyway - 2-1/4" long, and (2) 1/4" holes measuring 3/4" centre to centre. Small diameter end (3/4" OD) has (1) 3/16" hole</p>		







SIMPLICITY

<b>875-066</b>	1663885	
<p><b>Snowblower belt (6 rib style)</b> Fits Simplicity single stage. Model: Snow-Whiz 220 (1979 thru 1984), Snow Buster 220 (1979 thru 1984). Belt type: 6 rib X 34" (also known as multi rib). <b>Size: 6 RIB (9/16") W X 34" L</b></p>		

SNAPPER

<b>875-727</b>	29604 7029604	
<p><b>Blower belt</b> Fits models: 3200 series snowblowers; 3201-3203 and C3203 single stage series 3. <b>Size: 3/8" W X 33" L</b></p>		
<b>240-900</b>	1-0765 7010765 7018782 Case# 2289 Case# C22891 Gilson# 32222 Gilson# 18915	
<p><b>Drive Disc</b> Fits Snapper Snowblowers and also found on Lawn &amp; Garden equipment. <b>Size: 6" OD X 5-3/8" ID</b> (Use with our 240-325 brake lining)</p>		

## SNAPPER continued

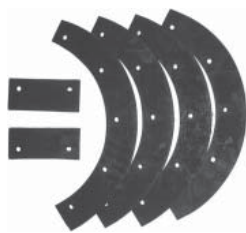
Part#	O.E.M	Application
<b>240-325</b>	5-3103 5-7423	
<b>Brake Lining</b> Made of non asbestos material. For use with our 240-900 drive disc. Can be use with other 6" OD Drive Discs.		
<b>240-930</b>	1-7226 7017226	
<b>Drive Disc</b> For 4, 5 and 8 Hp snowblower models: 4222, 5222, 5242, 7222, 7242 and 8264; also found on some smaller Toro snowblowers. <b>Size: 4-1/2" OD X 1" ID with (4) 1/4" bolt holes</b>		
<b>240-275</b>	10927 23364 7023364	
<b>Drive Ring</b> For Snapper self propelled mowers also fits 22" and 24" 2-stage snowblower models. <b>Measures: 4" OD X 3" ID X 1/2" HT - Made of rubber</b>		
<b>780-205</b>	1-3865 9-1550	
<b>Shear Bolts</b> For many snowblower models. <b>Size: 2" L X 5/16"-18 threads.</b> (Priced individually) (Sold in multiples of 10)		
<b>120-212</b>	16325 / 24507 7034212	
<b>In Line Fuel Shut-off</b> Fits 1/4" ID fuel line. Red knob opens and closes easily with a quarter turn. (Composite material)		
<b>780-044</b>	2-4619 2-8425	
<b>Scrapper Bar</b> Fits model: LE-17 snowblower.		
<b>780-043</b>	6-1215 7061215 70761215	
<b>Paddle Set</b> Fits 17" for model: LE-17 snowblower.		

## TECUMSEH







<b>120-213</b>	35857	
<b>Fuel Shut Off</b> Used on many snowblowers. Fits 1/4" fule line - 90 degree style Red knob opens & closes easily with a quarter turn.		

## TECUMSEH continued



Part#	O.E.M	Application
<b>100-226</b>	36905	
<b>Air Filter</b> Fits 4-1/2, 5 and 5-1/2 Hp entgines. For 5-1/2 Hp Sears mowers. Fits models: LEV100, LEV115, LEV120, OVRM105, OVRM65, OVRM120 and LV195EA. <b>Size: 2-3/4" L X 1-3/4" W X 2-7/8" HT</b> Top and bottom pictures shown (1) air filter		
<b>100-443</b>	37360	
<b>Air Filter</b> Fits OV, TVT and VTX series engines. For models: OV691EA, OV691EP, TVT69 and VTX691. <b>Size: 7-1/4" L X 6-7/8" W X 1-1/4" HT</b>		
<b>105-205</b>	32401	
<b>Muffler</b> For 4 thru 7 Hp horizontal engines. Found on Snowblowers with horizontal engines. Fits models: H40 thru H70, V50, V60, V70 and TVM140. Bolt on style. <b>Size: 2-13/16" W X 5-5/8" L X 1-5/8" HT.</b> (Uses our 485-904 mount gasket)		
<b>105-114</b>	33280 33280A 34185B	
<b>Muffler</b> For 7 thru 10 Hp engines. Fits models VM100, TVM170 thru TVM220 and HM70 thru HM100 and VM100. <b>Size: 3-3/4" W X 5-1/2" L X 2-3/8" HT.</b> (Use with our 485-924 exhaust gasket). Note: requires (2) 5/16"-18 X 3" long bolts - NOT included)		
<b>105-365</b>	35056 94058	
<b>Muffler</b> For 8 thru 10 Hp engines. Found on newer style Snowblowers, Snow King etc. Heavy gauge steel construction with bracket welded in place. Bolt on type. (Use with our 485-924 exhaust gasket). Note: requires (2) 5/16"-18 X 4" long bolts - NOT included)		
<b>105-213</b>	32648A 33697A 35771	
<b>Muffler</b> For 4 thru 7 Hp horizontal engines. Fits models: HS40, HS50, LAV40, LAV50, H60, H70, TVS75 thru TVS120 and TVXL105. Bolt on style. (Uses our 485-714 mount gasket)		



TECUMSEH continued

Part#	O.E.M	Application
<b>485-924</b>		
<p><b>Exhaust Gasket</b> Fits models: 130200, 133700, 193700, 196400 and 197400 series. <b>(Fits our 105-114 &amp; 105-365 mufflers for Tecumseh)</b></p>		
<b>110-003</b> <b>NEW</b>	650729	
<p><b>Muffler / Exhaust Bolt</b> Size: 5/16-18 X 3" Long. (Use with our 105-114 muffler).</p>		
<b>110-004</b> <b>NEW</b>	792093	
<p><b>Muffler / Exhaust Bolt</b> Size: 5/16-18 X 4" Long. (Use with our 105-365 muffler).</p>		
<b>619-640</b> <b>NEW</b>	632107 632107A 640084 640084B	
<p><b>Carburetor</b> Fits models: HSSK50-67388S, HSSK50-67368R, HSSK50-67317N, HSSK50-67376P, HSSK50-67334P, HSSK50-67334L, HS50-67225E, HS50-67183, HS50-67267J, HS50-67225F, HS50-67074C, HS50-67008C, HSSK50-67377S, HSSK50-67272P, HSSK50-67366M, HS50-67259H, HSSK50-67272P, HSSK50-67364R, HS50-67248F, HS50-67175C, HS50-67074C, HSSK50-67364S, HSSK50-67360N, HSK40 &amp; LH195SP. <b>(This is an aftermarket carburetor)</b></p>		
<b>619-642</b>	632334A	
<p><b>Carburetor</b> Fits models: HM80-155448P, HMSK80-155418S, HM80-155418P, HM80-155310N, HMSK80-155545T, HMSK80-155556T, HM80-155355P, HM-155445, HMSK80-155480S, HMSK80-155497S, HM80-155390P, HM80-155209J, HM80-155132H, HM80-155128F, HM80-155245J, HM70 &amp; HM80. <b>(This is an aftermarket carburetor)</b></p>		
<b>619-655</b>	640152 640152A	
<p><b>Carburetor</b> Fits models: HM80, HM100-159402P, HM100-159409P, HM100-159409P. <b>(This is an aftermarket carburetor)</b></p>		



TECUMSEH continued

Part#	O.E.M	Application
<b>619-656</b>	640260A 640260B	
<p><b>Carburetor</b> Used on models: 143.001001, 143.008001, 143.008501, 143.009005, 143.009007, 143.009009. Fits engine models: HM80-155236 / 375, 406, 477, 481, 482, 483, 521, 564, 571, 578, 603, 622, 623, 624, 625, 628, 630, 638, 651, 688T. HM90, HM100-159090, 287, 291, 317, 351, 358, 375, 376, 377, 379, 380, 383, 386, 400, 402 thru 405, 409, 411, 413, 416, 421, 423, 424, 425, 430, 435, 436, 446, 449, 450, 452, 454, 461 thru 465, 467, 469, 475, 481, 483, 484, 486, 487, 491, 493, 528, 537 thru 540. LH318XA &amp; LH358EA. <b>(This is an aftermarket carburetor)</b></p>		
<b>619-659</b>	640052 640054 640349	
<p><b>Carburetor</b> Fits models: HMSK80, HMSK85, HMSK90, HMSK100, HMSK105, LH318SA, LH358SA. Replaces Mfg. # 5313, 5002 and 5036. <b>(This is an aftermarket carburetor)</b></p>		

For more aftermarket carburetors to fit TECUMSEH - see our main catalogue "SECTION 10"

<b>520-320</b>	631978	
<p><b>Carb Repair kit</b> Fits Tecumseh built carburetors. Fits models: ECH90, ECV100 thru ECV120, H22 thru 80, HH40 thru 70, HM80, HS40, HS50, LAV25 thru 50, TVS70 thru 120, TVXL105, 380, 660, 670, V, VH40 thru 70.</p>		
<b>520-114</b>	631029 631240	
<p><b>Carb Repair kit</b> Fits Tecumseh built carburetors. Fits models: H25 thru 50, LAV25 thru 35, HS, HM40 thru 70, V and VH50 thru 70.</p>		
<b>520-338</b>	31840 631840	
<p><b>Carb Repair kit</b> Fits Tecumseh built carburetors. Fits models: H25 thru 70, LAV25, LAV30, HS, HM40 thru 70, V, VH40 thru 70, TVS105 and HH60.</p>		

TECUMSEH continued

Part#	O.E.M	Application
<b>520-247</b>	631584 631839	
<b>Carb Repair kit</b> For models: H25 thru H70, LAV25 thru 35, HS, HM40 thru 70V, VH50 thru 70, for 2 thru 7 Hp engines.		
<b>520-239</b>	631782	
<b>Carb Repair kit</b> Fits models: H25 thru H70, LAV25 thru 35, HS, HM40 thru 70, V, VH50 thru 70, VM80, H80, HM80 and TVM140.		
<b>520-336</b>	632347	
<b>Carb Repair kit</b> Fits models: HH100, HHM80, HMSKSK, HM70, HM80, HM90, HM100, OHM120, OHSK120, OHV125, OVM120, OXVL120, TVM170, TVM195, TVM220, TVXL195, TVXL220 and VH100.		

For more Carburetor Kits see main catalogue "SECTION 10"

<b>525-591</b>	631700	
<b>Carburetor Bowl</b> For float style carburetors without bowl drain. (aluminum material) <b>Size: 13/32" ID X 2.193" OD X 1.155" HT</b>		
<b>525-526</b>	631867	
<b>Carburetor Bowl</b> For float style carburetors without bowl drain. (aluminum material) For use with our 525-240 float <b>Size: 11/32" ID X 2.193" OD X 1.155" HT</b>		
<b>485-862</b>	631028	
<b>Carburetor Bowl Gasket</b> Fits all Tecumseh made carburetors. (Large bowl) Fits Tecumseh float bowls: Tecumseh# 631867 (Banta# 525-526) and Tecumseh# 631700 (Banta# 525-591)		
<b>485-870</b>	27109	
<b>Carburetor Bowl Gasket</b> Fits Walbro & Carter made carburetors. (Large bowl) Fits Carter and Walbro large bowl carburetors. <b>Size: 2-3/8" diameter</b>		

TECUMSEH continued

Part#	O.E.M	Application
<b>485-888</b>	30356	
<b>Carburetor Bowl Gasket</b> Fits Walbro & Carter made carburetors (small bowl). <b>Size: 1-15/16" diameter</b>		
<b>485-755</b>	33263 33861	
<b>Carburetor Mount Gasket</b> Fits Tecumseh models: VM70 thru VM100, V80 and HM70 thru HM100.		
<b>525-240</b>	632019	
<b>Carburetor Float</b> Fits most float carburetors. Use with our 525-526 and 525-591 carburetor bowls and our 525-220 bowl drain assembly. <b>Size: 1-3/4" OD X 1" ID X 7/16" HT</b>		
<b>525-212</b>	631021 631021A	
<b>Needle &amp; Seat Kit.</b> Fits Tecumseh models: LAV, V, VH, VM, TNT, TVS, H22 thru H80, HH40 thru HH70, HM80 thru HM100, HS, 638, 650 & 670. (Float type carburetors)		
<b>525-213</b>	631021B	
<b>Needle &amp; Seat Kit</b> Fits Tecumseh carburetor. (Same as our 525-212 but includes float bowl gasket and washer)		
<b>120-210</b>	632047 632047A	
<b>Primer Bulb</b> Fits models: LAV, V, VH, H22 thru H35, HS40, 638, 650 and 670, also TNT100, TNT120, ECV100, ECV105, ECV110, ECV120; CA-631849A thru CA-632795 carburetors; TEC-632804, TEC-640173 & TEC-640196.		
<b>120-807</b>	632694A	
<b>Primer Bulb</b> For VLV and ELV engines. (with vented hole) Fits carburetor models: 632646, 632669, 632670, 632681 and 632756.		
<b>120-289</b>	36045 36045A 0036045A	
<b>Primer Bulb</b> For Vector carburetors - Includes lock washer. Fits Vector carburetor models VLV-50, VLV-60, VLV-65, VLV-66, VLV-126 and TVS90.		
<b>125-049</b>	35355	
<b>Gas Cap</b> Fits Premier series engines. Red plastic gas cap <b>Size: 1-15/16" diameter.</b>		

TECUMSEH continued

Part#	O.E.M	Application
<b>125-050</b>	37845	
<p><b>Fuel cap</b> For Tecumseh. <b>Size: 1-3/4" diameter (Red)</b></p>		
<b>120-003</b>	34279 / 34279A 34272B / 740003B	
<p><b>Fuel Filter</b> Fits 1/4" ID fuel lines (80 micron). Clear plastic with polymer treated paper screen. Fits Tecumseh models: HM80, HM90, HM100, OHV125, OVM120, OVXL120, TVM195, TVM220 and TVXL220.</p>		
<b>120-117</b>	26460	
<p><b>Clamp</b> Fits 7/16" OD fuel line. (green)</p>		
<b>150-736</b>	33290C / 33290D / 33290E / 33517B / 34601C / 35251 / 35601A	
<p><b>Starter Motor - 120 V (Standard Duty)</b> This 120 volt electric starter motor kit fit the following Tecumseh engine models: HSSK40 thru 55, H30 thru 35, HS40 thru 50, HSK35, HSK40, LH195, OH195, OHSK50 thru 70. &gt; 9 tooth gear. KIT INCLUDES: Starter, starter button, hardware and extension cord. <b>(For the HEAVY DUTY version see our 150-742)</b></p>		
<b>150-742</b>	33290C / 33290D / 33290E 33517B / 34601B / 35251 / 35601A	
<p><b>Starter Motor (Heavy Duty)</b> This 120 volt electric starter motor kit, fits the following engine models: HSSK40 thru 55, H30 thru 35, HS40 thru 50, HSK35, HSK40, LH195, OH195, OHSK50 thru 70. &gt; 9 tooth gear. KIT INCLUDES: Starter, starter button, hardware and extension cord. <b>(For the Standard Duty version see our 150-736)</b></p>		





TECUMSEH continued

Part#	O.E.M	Application
<b>150-737</b>	33228D / 33328D / 33328E	
<p><b>Starter Motor</b> This 120 volt electric starter motor kit, fits the following engine models: H50 thru 70, TVM125 thru 140, HSK50 thru 70, HH60 and HMSK105. For 7 Hp Snow King engines. &gt; 16 tooth gear. KIT INCLUDES: Starter, starter button, hardware and extension cord.</p>		
<b>150-738</b>	33329C / 33329D / 33329E 33519A / 33542A / 35096 Oregon - 37000 / 88921 / 88922 Made in China 88923 88924 / 88925	
<p><b>Starter Motor (Standard Duty)</b> This 120 volt electric starter motor kit, fits the following engine models: HMSK70 thru 100, HMSK105, HMSK110, HM70 thru 100, OMH110, LH-318SA, OH-318SA, OHSK-80, OHSK-90, OHSK-100, OHSK-110, OHSK-120, OHSK-125 and OHSK-130. For 8, 10, 11 and 12 Hp Snow King engines. &gt; 16 tooth gear. KIT INCLUDES: Starter with 110V starter button, mounting hardware and extension cord. Note: Also Popular on Honda GXV340 &amp; GXV390 Propane Floor Care / Buffer Equipment. (H.D. version 150-740)</p>		
<b>150-740</b>	33329C / 33329D / 33329E 33519A / 33542A / 35096 37000 / 88921 / 88922 88923 88924 / 88925	
<p><b>Starter Motor 120 V (Heavy Duty)</b> This 120 volt electric starter motor kit, fits the following engine models: HMSK70 thru 100, HMSK105, HMSK110, HM70 thru 100, OMH110, LH-318SA, OH-318SA, OHSK-80, OHSK-90, OHSK-100, OHSK-110, OHSK-120, OHSK-125 and OHSK-130. For 8, 10, 11 and 12 Hp Snow King engines. &gt; 16 tooth gear. KIT INCLUDES: Starter with 110V starter button, mounting hardware and extension cord. Note: Also Popular on Honda GXV340 &amp; GXV390 Propane Floor Care / Buffer Equipment. (Std. version 150-738)</p>		

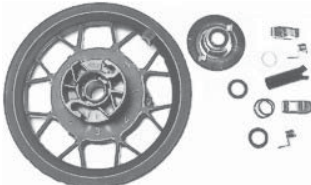

## TECUMSEH continued

Part#	O.E.M	Application
<b>150-047</b>	33432 37050 / 37052A	
<b>Starter Drive Gear</b> Replacement starter gear for our 150-712 (12 Volt) and 150-737, 150-738 and 150-740 (120 Volt) starter motors. > Number of Teeth: 16		
<b>150-065</b> <b>NEW</b>	37050 37052A	
<b>Starter Drive Kit</b> Replacement starter drive kit for our 150-712 (12 Volt) and 150-737, 150-738 and 150-740 (120 Volt) starter motors. > Number of Teeth: 16. Includes: (1) Gear (Will replace Tecumseh# 33432), (1) Drive Nut (Will replace Tecumseh# 33433A) and (1) Retainer Snap Ring (Will replace Tecumseh# 33842). For Gear only see our 150-047.		
<b>150-003</b>	590420A 590706	
<b>Starter Rewind Assembly</b> Fits models: LAV, TVS, H, HS25 thru HS40, AH600, AV520, ECV, HH, TVXL105, HXL35 and OVRM40 (small and medium frame engines), TVM125 & TVM140. > (4) bolt mounting pattern. Fits most engines built before 1990. Fits most Snow King applications.		
<b>150-004</b>	590646 / 590648 590742 / 590787	
<b>Starter Rewind Assembly</b> Fits models: HSSK50 and HSK70, also some AV, H35, HSK, HSSK, LH and TV085 models. Comes complete with (2) steel starter dogs installed, starter pulley, starter rope and housing. <b>Size: 5-7/8" OD (Base).</b> (4) 1/4" diameter holes and (4) 3/16" diameter holes around the outside. Note: The main difference between our 150-004 and 150-005 is the starter pulley.		
<b>150-005</b>	590739	
<b>Starter Rewind Assembly</b> For Tecumseh. Fits models: LEV80, LEV100, LEV105, LEV115, LEV120, LV148, LV195, OV195, OVRM60, OVRM65, OVRM105, OVRM120, TVS90, TVS100, TVS115, TVS120, TVS600VLV55, VLV60, VLV65, VLV66, VLV126. For 3-1/2 to 4 Hp engines. <b>Size: 5-7/8" OD (Base).</b> (4) 1/4" diameter and (4) 3/16" diameter holes around the outside. Comes complete with (2) steel starter dogs. (None Winter pulley) Note: The main difference between our 150-005 and 150-004 is the starter pulley.		
<b>150-008</b>	590746 / 590788 590748 / A	
<b>Starter Rewind Assembly</b> For small and medium frame engines. Bolt on rewind assembly. (For Non Snow King engines). Fits models: HM80, HM90, HM100, LH318XA, LH358EA, OH195, OH318, TVM220, OHH50, OHH55, OHH60 and OHH65. <b>Size: 7" OD; (8) mounting holes; 2 Steel Cogs</b>		



## TECUMSEH continued

Part#	O.E.M	Application
<b>150-006</b>	590732A / 590737 590785 / 590086 590621 / 590686 590694	
<b>Starter Rewind Assembly</b> Fits small and medium frame E-Z pull starts. Used on models: AV520, H30, H35, H40, H50, H60, HS40, HS50, HXL840, LEV90, LEV100, LEV115, LEV120, LV148, LV156, LV195, OH195, OHH60, OVRM50, OVRM55, OVRM60, OVRM65, OVRM120, TVM125, TVM140, TVS90, TVS100, TVS105, TVS115, TVS120, TVS600, TVS840, TVXL840, VLV50, VLV55, VLV60, VLV126, OVRM105, OVRM120, ECV series (Sears), TVS series 90 thru 120 - 1990 production and up.		
<b>150-007</b>	590749 / A 590789	
<b>Starter Rewind Assembly</b> Fits models: HMSK80, HMSK100 snow engines and HMSK105. For small and medium frame engines. (Snow King applications only). <b>Size: 7" OD; (8) 3/8" OD mounting holes; 2 Steel Cogs.</b> Note: The main difference between our 150-007 and 150-008 is that the 150-007 starter pulley has a raised lip around the starter dogs. It measures 3-1/4" OD X 5/8" HT approximately. Also it has a receiving cup built in for the starter handle.		
<b>150-169</b>	590478 590413A	
<b>Starter Pulley</b> Fits our 150-003. (3) dog style pulley, will also replace (1) dog style. Fits models: TVS & ECV series, H30 thru H70, LAV30 thru LAV50, V50 thru V70, TVM125 and TVM140. <b>Size: 4-3/8" diameter.</b>		
<b>150-616</b>	590616 / 590618 / 590618A	
<b>Starter Pulley &amp; Spring</b> Fits our 150-006. Includes all hardware as shown & starter spring. <b>Size: 5-1/2" OD.</b>		
<b>150-618</b>	Fits 150-006	
<b>Pulley only</b> Same as our 150-616 but without the starter spring or hardware. Fits our 150-006 rewind assembly. Uses our 155-1038 starter spring. <b>Size: 5-1/2" OD</b>		

TECUMSEH continued

Part#	O.E.M	Application
<b>430-492</b>	35062	
<b>Starter Key</b> Fits snowblower models: ST524, ST724, ST824, ST1024, ST1028, ST1128, ST1332 and ST1336. Push / Pull key (Red Plastic)		
<b>125-336</b>	33679	
<b>Rubber fuel tank bushing</b> For use on many applications. Fits 33/64" diameter fuel tank holes. <b>Size: .356" ID X .615" OD</b>		
<b>140-103</b>	590574	
<b>Starter Handle</b> "D" style mitten grip handle. Used on many snowblowers with pull starters.		





For more TECUMSEH  
 " Starter Rewind Assemblies"  
 see STARTER PARTS

<b>150-741</b>	
<b>Hardware Kit</b> For our 150-738 and 150-740. Used to mount 120 V electric starter motors found on Tecumseh engines.	
<b>150-743</b>	
<b>NEW</b> <b>Hardware Kit</b> For our 150-737. Used to mount 120 Volt electric starter motors found on Tecumseh engines	
<b>150-744</b>	
<b>NEW</b> <b>Hardware Kit</b> For our 150-736 and 150-742. Used to mount 120 Volt electric starter motors found on Tecumseh engines.	

TORO / WHEEL HORSE

<b>780-582</b>	201730	
<b>NEW</b> <b>Axle Bearing / Wheel Mount</b> Support for Toro snowblowers. Found on many 524, 624, 724 and 824 models. Bronze Bushing measures: 7/8" ID X 1-1/8" OD X 3/4" HT. Aluminum Plate measures: 3-1/4" L X 1-3/4" W X 1/4" Thick. (2) 3/8" ID mounting holes on 2-5/16" centers.		







TORO / WHEEL HORSE

Part#	O.E.M	Application
<b>230-250</b>	251-224	
<b>Bearing</b> Fits Axles on Snowblowers. Fits models 310-230 thru 310-960. (Bearing# SB205-14) <b>Size: 7/8" ID X 2-1/32" OD X 1-1/16" HT</b>		
<b>230-060</b>	38-7820 109966	
<b>Bearing</b> Fits Toro Snowblowers. Fits models S-200, S-620, CCR2000 and CR20. (Bearing# 6203-2DRS-LG) <b>Size: .669" ID X 1.575" OD X .471" HT.</b>		
<b>230-300</b>	251-207	
<b>Input Shaft Support Bearing</b> Fits models: 824 and 932. (Bearing# 1635-2RS and SCO493LU) <b>Size: 3/4" ID X 1-3/4" OD X 1/2" HT</b>		
<b>225-896</b>	63-3450 26-6100 12-8789	
<b>Spherical Bushing</b> For Impeller shafts on Snowblowers. Fits models 521 thru 824. <b>Size: 7/8" ID X 1-45/64" OD X 1-1/4" HT</b>		
<b>285-489</b>	559322	
<b>Clutch Cable</b> Found on Toro snowblowers. <b>Overall Length: 30-3/4",</b> <b>Cable Length: 29-1/4".</b> <b>Cast Z-Bends on both ends.</b>		
<b>875-060</b>	25-6430	
<b>Drive Belt (multi-rib)</b> Fits models: S200, E200, 200E, 620, 620E, S620 and CR20. <b>Size: 6 RIB (9/16") W X 33" L</b>		
<b>875-066</b>	55-9300	
<b>Drive Belt (multi-rib)</b> Snowblower Auger Drive Belt Fits snowblower model: CCR2000. <b>Size: 6 rib style (9/16"W) X 34" L</b>		







For more V-Belts - see our "BELTS -  
 UNIVERSAL and O.E.M" section

<b>875-225</b>	38175 75-9010	
<b>Auger Drive Belt</b> Fits snowblower model: Powerlite, 38170, 38171, 38175 and 38176. <b>Size: 3/8" W X 29-1/4" L</b>		

TORO / WHEEL HORSE

Part#	O.E.M	Application
<b>875-192</b>	71-5381 71-5380	
<p><b>Drive Belt</b> Fits snowblowers. Fits model: CCR1000 Snowblower. <b>Size: 3/8" W X 34.7" L</b></p>		
<b>875-980</b>	379080	
<p><b>Drive Belt</b> Fits models: 3521, 421, 521 and 522.. <b>Size: 3/8" W X 29-7/8" L</b></p>		
<b>875-939</b>	956151	
<p><b>Auger Drive Belt.</b> Fits models: CCR2400, CCR2450, CCR2500, CCR3000, CCR3600 and CCR3650. <b>Size: 5 RIB X 33-7/8" L</b></p>		
<b>875-064</b>	632951	
<p><b>Traction belt</b> For Toro snowblowers. <b>Size: 1/2" W X 32-1/2" L.</b> (Raw Edge Belt).</p>		
<b>240-930</b>	37-6570 1-7226	
<p><b>Drive Disc</b> Fits on smaller Toro units. <b>Size: 4-1/2" OD X 1" ID,</b> <b>(4) 1/4" mounting bolt holes.</b></p>		
<b>240-920</b>	40-8170	
<p><b>Drive Disc</b> Fits on larger Toro units. <b>Size: 6" OD X 1-3/4" ID,</b> <b>(4) mounting bolt holes.</b></p>		
<b>280-980</b>	93-1614 AG2318-A	
<p><b>Sprocket Idler</b> Found on many Toro / Wheel Horse single stage snowblower attachments. These snowblower attachments have been around for years. Mainly in the 37" wide variety. This sprocket idler acts as a tensioner for the main auger drive chain. (Aetna# AG2318-A). <b>Size: 3" OD X .516" ID (13mm ID) X 18 Tooth gear</b> (Two pictures shown for reference)</p>		

TORO / WHEEL HORSE

Part#	O.E.M	Application
<b>430-523</b>	29-5560 40-5940	
<p><b>Stop Switch</b> For models: S200, S620, 38120 &amp; 38130 snowblowers. Also fits 32", 36", 37", 44" and 52" mid sized commercial mowers with pull start. (2) position, (2) terminal, 5/8" mounting stem.</p>		
<b>125-680</b>	42-0680	
<p><b>Gas Cap</b> Fits S200 &amp; S620 Snowblowers. <b>Size: 1-1/2" diameter,</b> vented gas cap.</p>		
<b>780-007</b>	23-3730	
<p><b>Paddle</b> Fits models S200 and S620. <b>Size: 17-5/8" long X 2-5/8" wide</b> (7) 1/4" mounting holes on 2-7/8" centers. (Use with our 780-016 scraper bar)</p>		
<b>780-106</b>	23-3170	
<p><b>Scraper Bar</b> Fits models: S200 &amp; S620. <b>Size: 19-5/8" L X 1-3/4" W</b> (Use with our 780-007 paddles)</p>		
<b>780-034</b>	80-0660 84-1980	
<p><b>Paddle</b> Fits model 16" Powerlite snowblower. <b>Size: 16-15/16" Long,</b> (7) mounting holes (Use with our 780-027 scraper bar)</p>		
<b>780-081</b>	84-1980	
<p><b>NEW</b> <b>Snowblower paddle.</b> Made of TICOR material from recycled tires. Resist aging and abrasion, long lasting. Can withstand extreme temperatures. Environmentally friendly construction. USA Made. Similar to our 780-034. Fits Toro model: 16" Powerlite snowblower. (7) mounting holes, 16-15/16" L. (Use with our 780-027 scraper bar)</p>		
<b>780-027</b>	75-8780	
<p><b>Scraper Bar</b> Fits model: Powerlite snowblower. <b>Size: 15-1/2" L X 2-1/4" W</b> (Use with our 780-034 &amp; 780-081 paddles).</p>		



TORO / WHEEL HORSE

TORO / WHEEL HORSE

Part#	O.E.M	Application
<b>780-084</b>	54-9921 104-2753	
<p><b>Paddle</b> Fits model CCR1000 Snowblower. <b>Size: 21-1/2" L X 2-3/4" W</b> <b>(8) 7/16" ID mounting holes on 3-1/16" centers.</b> (Use with our 780-114 scraper bar)</p>		
<b>780-114</b>	71-5390	
<p><b>Scraper Bar</b> Fits model: CCR1000 Blowers. <b>Size: 19-1/2" L X 2" W,</b> <b>(3) 1/4" X 3/8" ID mounting holes, 8-1/8" centers.</b> (Use with our 780-084 paddles)</p>		
<b>780-080</b>	55-9251 99-9313	
<p><b>Paddle</b> Fits model: CCR2000 Snowblower. <b>Size: 22" L X 3" W</b> <b>(8) mounting holes on 3-1/8" centers.</b> (Use with our 780-110 scraper bar)</p>		
<b>780-110</b>	55-8760	
<p><b>Scraper Bar</b> Fits models: CCR2000, CCR3000, CCR3650 and 2450 snowblowers. <b>Size: 19-1/16" L X 2" W</b> <b>(3) mounting holes on 8-1/2" centers.</b> (Use with our 780-046 paddles)</p>		
<b>780-046</b>	55-9250 99-9313 88-0771	
<p><b>Paddle</b> Fits models: CCR3650, CCR3000 &amp; 2450 Snowblowers. <b>Size: 22" L X 3" W</b> <b>(8) mounting holes on 3-1/8" centers.</b> (Use with our 780-110 scraper bar) NOTE: Part# 780-080 and 780-046 are exactly the same except for the cut outs on the 780-046.</p>		
<b>780-082</b>	99-9313	
<p><b>NEW</b> <b>Snowblower paddle.</b> Made of TICOR material from recycled tires. Resist aging and abrasion, long lasting. Can withstand extreme temperatures. Environmentally friendly construction. USA Made. Similar to our 780-046. Fits Toro models: CCR3650, CCR3000 and 2450 Snowblowers. <b>Measures: 22" L X 3" W, (8) mounting holes on 3-1/8" centers.</b> (Use with our 780-047 scraper bar). NOTE: Part# 780-080 and 780-046 are exactly the same except for the cut outs on the 780-046.</p>		

Part#	O.E.M	Application
<b>780-238</b>	40-8160 40-8160-01	
<p><b>Skid Pad / Plate</b> Fits Snowblowers. <b>Size: 5" L X 2-3/4" W, (2) 5/16" X 1-5/8" long mounting slots on 2" centers.</b></p>		
<b>780-287</b>	74-1440 85105	
<p><b>Skid Pad / Plate</b> Fits snowblowers. <b>Size: 6" Overall length X 3-3/8" HT, (2) 5/16" X 2-3/16" long mounting slots on 2-1/2" centers. Center hole: 5/8" OD</b></p>		
<b>780-236</b>	202840	
<p><b>NEW</b> <b>Skid Pad / Plate</b> Fits Toro Snowblowers. (Made on Plastic). Found on 524, 624, 724, 826, 832, 1032 and 1132 models. <b>Measures: 5-7/8" L X 3-3/4" HT, (2) 7/16" X 2" long mounting slots on 3" centers.</b></p>		
<b>780-026</b>	52-7060 39-1540	
<p><b>Air Vane</b> Fits Toro Snowblowers. Fits models: S200 and S620. Made of black plastic</p>		

YAMAHA

<b>230-060</b>	9330620331	
<p><b>Bearing</b> Found on Yamaha snowblowers. (Bearing# 6203-2RS) Bearing with retainer ring use our Part# 230-274. <b>Size: .669" ID X 1.578" OD X .475" HT</b></p>		
<b>780-257</b>	7Y65164701 7Y65164702 901850612200	
<p><b>Shear Bolt</b> Fits Yamaha Snowblowers. <b>Size: 1-15/16" (49mm) L X 6 mm thread, 10mm shoulder</b></p>		