

Digital Paper System

User Guide

DPT-S1

Table of Contents

Getting Started

Welcome!.....	4
Features of the Digital Paper device	4
About this User Guide.....	4
Digital Paper Device Features and Functions	5
Battery	6
Charging the Digital Paper Device	6
Maximizing Battery Life	7
Power On/Off	8
Turning the Power On/Off.....	8
Parts and Controls	9
Overview	9
Buttons	10
Stylus	10
microSD Card Slot	11

Basic Operations

Touchscreen Operations	12
[Home] Screen	13
[Home] Screen and Applications.....	13
On-Screen Keyboard	15

Adding/Getting Content

Adding Content	17
Transferring Documents	17

Browsing Document Lists

Document Lists.....	19
Browsing Document List Pages.....	19
Browsing in Document View and Folder View	19
Finding a Document with a Keyword	20
Tools	20
Using Menu Items	20

Deleting	21
Deleting a Single Item	21
Deleting Multiple Items at One Time	21

Reading

Reading Documents	22
Opening a Document	22
Opening Multiple Documents Simultaneously.....	22
Navigating Pages.....	23
Using the Page Control Panel.....	23
Viewing Four/Nine Pages.....	24
Zooming in the Display.....	24
Operating Tabs	25
Adding a Page Flag.....	26
Searching Pages by Keyword	26
Using Menu Items	27
Using the [Workspace] Application	27
Registering a Workspace.....	27
Opening a Registered Workspace.....	28
Deleting a Registered Workspace.....	28
Using Menu Items	28

Writing

Annotating the document	29
Using the Toolbox.....	29
Handwriting a Note on a Page	30
Highlighting Words on a Page	30
Erasing Handwriting or Highlight with the Erase Icon	31
Adding a Sticky Note to a Page	32
Adding a Handwritten Sticky Note	33
Searching Annotations in a Document ...	34

Using the [Note] Application	35
Creating a Note	35
Editing a Note	36
Deleting a Note	36
Transferring a Note from This Device to the Network Drive.....	36
Tools	37
Using Menu Items	37

Network

Setting up a Wi-Fi® Network	38
Preparing to Set Up a Wi-Fi	
Connection	38
Selecting a Connection Type	38
Using the Network Drive	43
Setting the Network Drive	43
Synchronizing the Digital Paper Device with	
the Network Drive	44
Opening a Synchronized Document in the	
Digital Paper Device	45
Deleting a Synchronized Document	45
Transferring a Document from the Digital	
Paper Device to the Network Drive	45
Using Menu Items	47
Browser	47
Browsing the Web	47
Zooming in on the Web.....	47
Downloading.....	48
Using Multiple Windows.....	48
Bookmarks and History.....	49
Browser Settings	50
Using Menu Items	51

Settings

Changing the Settings	52
Changing the Settings	52
General Settings	52
Wireless Network Settings.....	52
Network Drive Settings	52
Application Preferences	53
Date & Time Settings	53
System Management.....	53
Initialization.....	54
About.....	54
Device Shutdown	54

Other Information

Troubleshooting	55
Troubleshooting Tips.....	55
Re-attaching the stylus holder	55
Replacing the Nib.....	55

Digital Paper Device.....	56
Wireless Connectivity.....	57
Reading Documents	58
Connecting to Your Computer	58
microSD Card	59
Precautions	59
Safety Information	59
Applications on the Digital Paper	
Device	61
Notes on microSD Cards	62
Legal Notice	64
Legal Notice	64
Appendix	65
Specifications	65
Supported File Types	66
System Requirements.....	66
Limited Warranty and Service	67
Limited Warranty	67
Service	67

Getting Started

Welcome!

Features of the Digital Paper device

- **Wide, slim and lightweight e-paper screen**
The flexible e-paper screen provides a large A4-size yet lightweight display.
- **Supplied dedicated stylus for small letter writing**
The electromagnetic induction-type stylus enables easy writing of small characters.
- **Hybrid touchscreen for writing with your finger or supplied stylus**
The optical and electromagnetic induction touchscreen allows you to flip through pages or operate menus with a finger, as well as write characters or draw pictures with the supplied stylus.
- **Carry thousands of personal documents anywhere you go**
You can carry a large amount of original document (PDF) file data transferred from a computer to the Digital Paper device.
The internal memory of the Digital Paper device can store about 2,800 files*. The Digital Paper device supports microSD memory cards of up to 32 GB to further increase data storage capacity.
- **Writing/drawing like that of a digital notebook**
You can use the supplied stylus to hand write notes or draw pictures with fine lines in a document. You can also highlight words and add bookmarks, handwritten notes or sticky notes. Furthermore, you can use the [Note] application to create a notepad for hand writing memos.
- **Digital Paper device lock**
You can lock the Digital Paper device using a 4-digit number. Documents cannot be read without inputting the 4-digit number, even while the Digital Paper device is turned on.

- **Workspace to preserve current job status**
You can name and save an image of the currently opened document. By preserving the current tab status and page location, a registered Workspace allows you to resume your work from the preserved tab status.
- **High speed visual search by changing page view**
By displaying 4 or 9 pages in one screen, you can search through many pages visually at high speed. Text/handwritten sticky notes appear as icons on a page.
Moreover, by moving your finger in the direction to turn a page, then holding it, you can flip pages at high speed.
- **Easy file transfer between the Digital Paper device and a computer via USB connection**
By connecting the Digital Paper device to your computer with a USB cable, you can transfer files easily. Handwritten sticky note on the Digital Paper device will be transferred to the computer as an attached PDF file.
- **Synchronization with a network drive via Wi-Fi connection**
You can access a specific network drive, and then synchronize documents on the Digital Paper device with documents on the network drive.

* Based on 1 MB one file

About this User Guide

Please read the Quick Start Guide in this package and the Basic Operation Guide in the Digital Paper device to help you get started.

This User Guide describes key features of your Digital Paper device.

Note

- Screenshots in the User Guide may depict screens different from the device.
- Names of persons and documents in this guide are provided as examples only, and do not in any way represent any specific person or existing document.



Searching for a specific topic in this User Guide

Use the [Table of Contents] feature of your Digital Paper device to search for topics, and then tap a topic to jump to it.

While viewing this User Guide on your device, press the  (Menu) button → tap [Table of Contents] to view the Table of Contents.

Jumping to a linked section in this User Guide

Tap the link to a chapter or section indicated with a dotted under line to open the page.

To return to the page you were previously viewing, press the  (Menu) button → tap [Page Controls] →  (Previous view).

Digital Paper Device Features and Functions

Transferring documents

You can transfer documents to the Digital Paper device from your computer (page 17).

Useful features

Resize

- Change the page view mode (page 24)
 - 1 Pinch in → 1/4 page view
 - 2 Pinches in → 1/9 page viewThis mode can be useful for quickly checking page annotations.
- Zoom in the display (page 24)

When you pinch out the document (default view), the document is zoomed in. Pinching in returns to the default view.

Tab operation (page 25)

Annotation

- Add page flags (page 26)
- Handwrite notes on a page (page 30)

You can select fine/bold or color for lines.
- Highlight words (page 30)
- Sticky note (page 32)
- Handwritten sticky note (page 33)

Search

- Search for text in a document by keyword (page 26)
- Search annotations (page 34)
- Search for a document by keyword (page 20)

Jump to pages (page 5)

Workspace (page 27)

You can register the current tab status as a Workspace, which allows you to resume your work at any time.

Note (page 35)

Network

- Use the Network Drive (page 43)
- Use the Web browser for internet access (page 47)

Battery

Charging the Digital Paper Device

The charge/battery status icon at the right side of the status bar shows the battery level (page 7).

When the battery level becomes low, select either one of the methods below to charge the device.

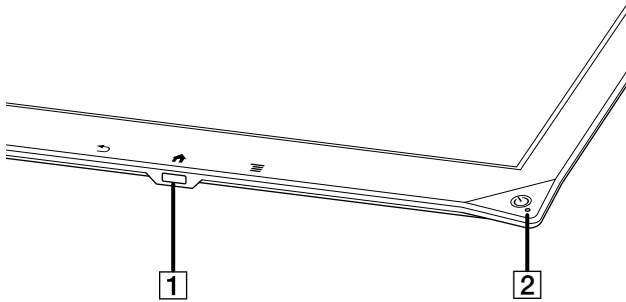



1 USB Micro connector

2 Charge indicator

Charging via an AC outlet

1 Connect one end of the supplied USB cable to the micro USB connector of your device, and the other end to the AC adapter.

2 Connect the AC adapter to an AC outlet. The icon turns into  and the Charge indicator will light up red while charging. When charging is complete, the icon turns into  and the indicator turns off.

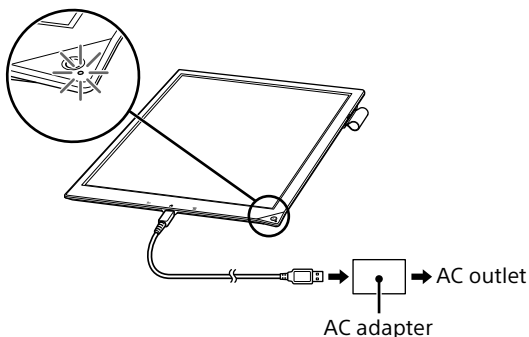

Note

- Charge the Digital Paper device within the recommended temperature range of 5 °C (41 °F) to 35 °C (95 °F).

If the room is too hot or cold, adjust room temperature accordingly, then reconnect the USB cable and charge the device.



Tip

- It will take approximately 2.5 hours to fully charge via AC Adapter.

Charging via your computer

1 Power on your computer.

2 Connect the Digital Paper device to your computer with the supplied USB cable.

The icon turns into  and the Charge indicator will light up red while charging. When charging is complete, the icon turns into  and the indicator turns off.

3 When charging is complete, disconnect the USB cable from the device and your computer.

Note

- Your computer must be turned on to charge the Digital Paper device. The device will not be charged if your computer enters sleep mode, standby mode or hibernation. Keep your computer turned on with a stable and continuous power supply while charging the device.
- The  (Power) button cannot be used when the device is connected to your computer.

Tip

- It will take approximately 3.5 hours to fully charge via a computer.
- The Charge indicator may blink red 3 times if the  (Power) button is pressed when the remaining battery is very low. In this case, it may take up to 5 minutes before the Digital Paper device turns on automatically.

Charge/Battery status icon

The charge/battery status icon shows the charging status or remaining battery level.

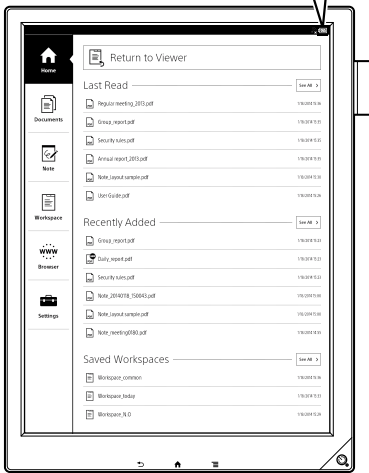
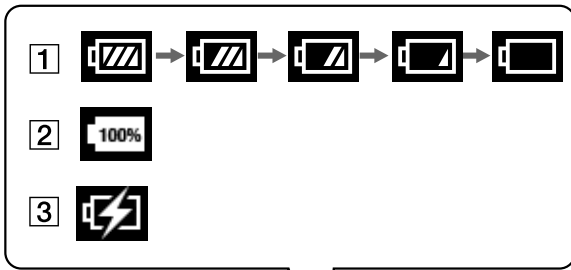

Icon	Description
1	Four bars in the battery icon indicate a fully charged or almost-fully charged battery. The number of bars decreases with the battery's charge. Zero bars indicate that the battery has almost no remaining charge.
2	The battery is fully charged.
3	The battery is charging.

Maximizing Battery Life

- When the Digital Paper device is not in use, power it off completely.
- Do not leave the device with the battery depleted for a prolonged period of time. Battery capacity may decrease.
- Use and store the device within the recommended temperature range of 5°C to 35°C (41°F to 95°F).
- Turn off the Wi-Fi function when no wireless communication is necessary.
- Turn on [Wireless Standby].
- Set [Auto Sync] to Off so as not to synchronize the Digital Paper device and network drive.

Battery life decreases in the following cases

- Wi-Fi communications
- Displaying the [Wi-Fi Settings] screen continuously
- Displaying graphic-intensive documents or Web sites
- Displaying a document in a microSD card
- Frequent insertion and removal of a microSD card
- Loading a large volume of content stored on a microSD card
- Annotations and keyword searches
- Frequent handwriting
- Setting [Wireless Standby] to Off
- Setting [Auto Sync] to On

Power On/Off

Turning the Power On/Off

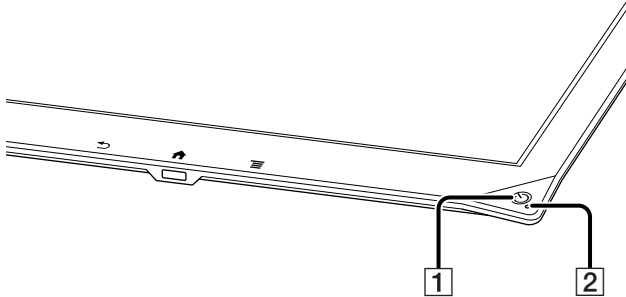

1 ⏻ (Power) button

2 Charge indicator

Turning on the power

- 1 Press the ⏻ (Power) button.
If the Charge indicator blinks red 3 times, the battery is depleted.
Connect the Digital Paper device to the supplied AC adapter or to your computer via the supplied USB cable to charge the device.

Turning off the power (Shutdown)

- 1 Press and hold the ⏻ (Power) button for about 3 seconds.
- 2 Tap [Yes] to turn off the Digital Paper device.
Turning it off reduces battery consumption more than the sleep mode. It is recommended to turn off the device when you do not use it for a prolonged period of time.

The same operation can be done via [Settings].

- 1 Press the 🏠 (Home) button → tap [Settings] → [Device Shutdown] → [Yes].

Sleep mode

To extend battery life and prevent unintentional operation of the touchscreen, set the Digital Paper device to sleep mode by pressing the ⏻ (Power) button. The standby screen appears.

To wake the device, press the ⏻ (Power) button again.

Automatic power-saving

The Digital Paper device will enter sleep mode after 1 hour of inactivity. After 3 days in sleep mode, it will turn off (shut down) automatically. The automatic power-saving cannot be turned off.

Parts and Controls

Overview

This section describes the parts and controls of the Digital Paper device.

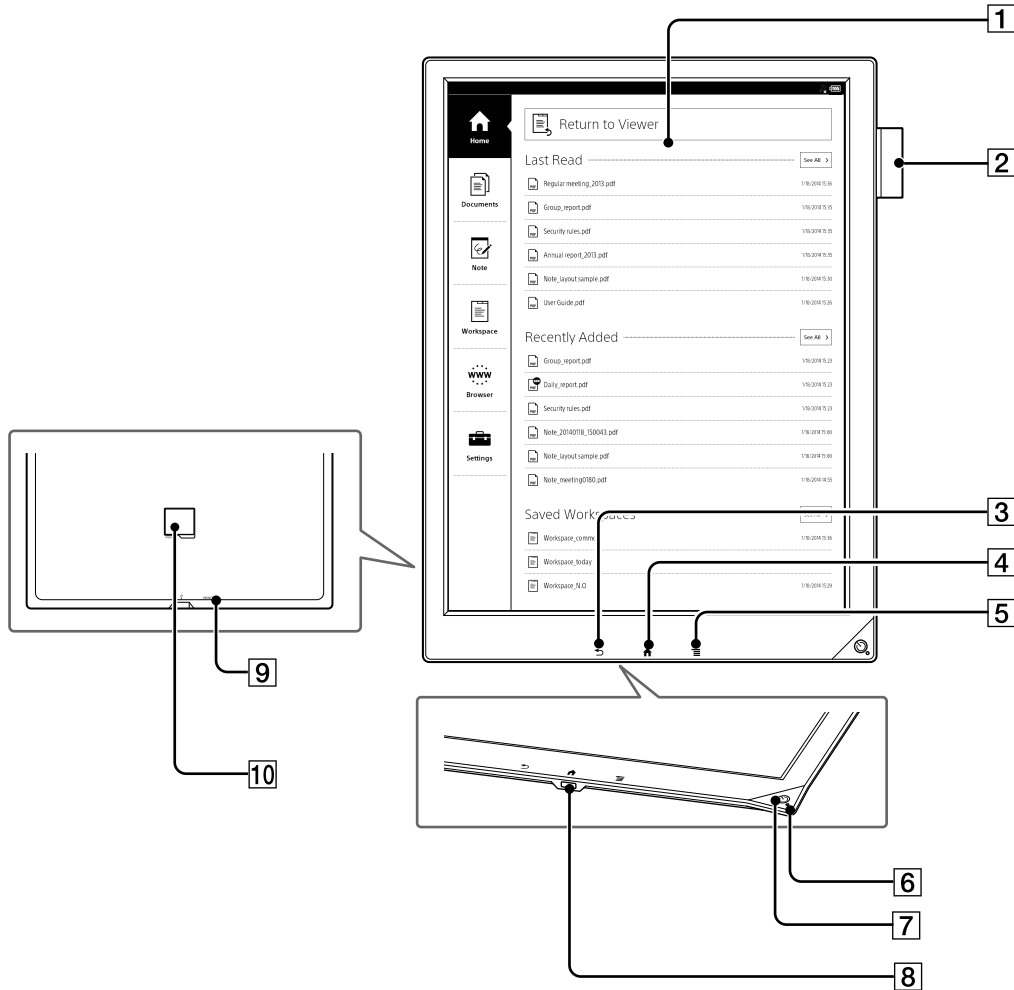

1 Touchscreen

2 Stylus holder

3 ↶ (Back) button

4 🏠 (Home) button

5 ☰ (Menu) button

6 🔌 Charge indicator

7 ⏻ (Power) button

8 📶 Micro USB connector

9 🔄 RESET button

10 📄 microSD card slot

Supplied accessories

- AC adapter × 1
- USB cable × 1

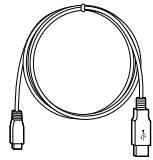

- Stylus × 1

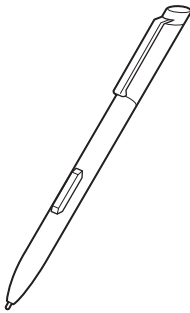

- Sleeve case × 1

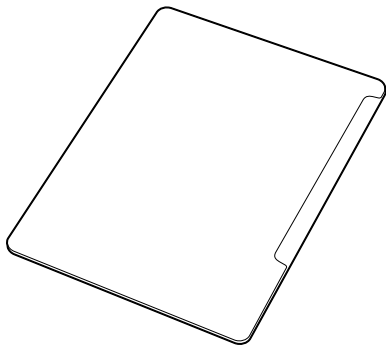

- Replacement nibs × 3

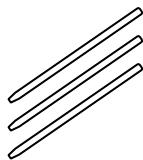

- Nib puller × 1



Buttons

(Power)

Turns the device on/off, and sets it to sleep mode (page 8).

(Home)

Displays the [Home] screen.

(Back)

Returns to the previous screen, or returns to the document list from a document.

(Menu)

Displays the available option items for each application.

Stylus

The supplied stylus enables you to handwrite notes and erase on the touchscreen. Pushing the stylus button allows you to add highlights, or open/delete annotations.

Note

- Use only the supplied stylus. Use of another stylus will cause incorrect operation.
- When the stylus is not in use, place it in the stylus holder of the Digital Paper device. If the tip of the stylus is continually pressed, it may not function properly or may be damaged.

microSD Card Slot

The microSD card slot is located on the back of the device. Hold the microSD card with the contacts facing down and the arrow pointing toward the microSD card slot, and then insert it until it clicks into place. The access indicator lights up in orange while the device is accessing the microSD card.

Close the slot cover when using a microSD card.

To format a microSD card, see page 54.

Note

- Do not remove the microSD card while the access indicator is lit.
To remove a microSD card, push it in once, then slide it out slowly with your finger.

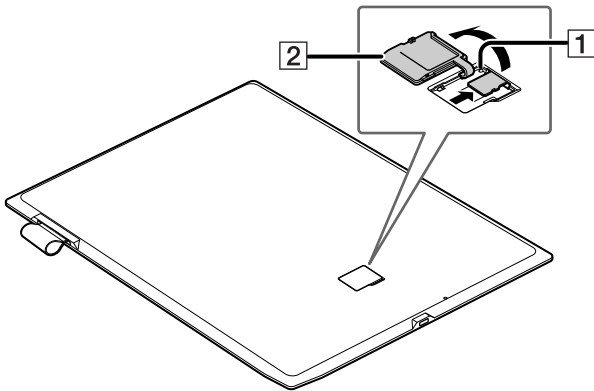

1 microSD access indicator

2 Slot cover

Basic Operations

Touchscreen Operations

The touchscreen recognizes the following gestures. You can also use the supplied stylus for more precise touchscreen operation.

Operation with the stylus makes it easier to select small items or specific areas of text.

Tap

Tap an icon, a button or a menu item and raise your finger quickly to select or perform an action.

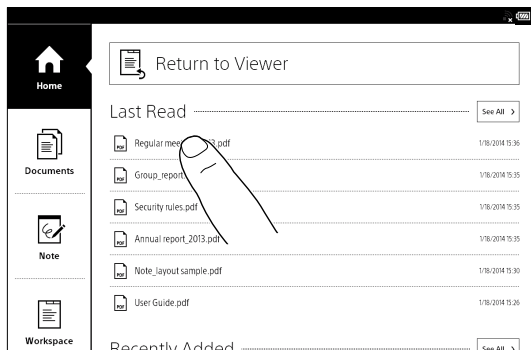

Tap and hold

Tap and hold your finger to select a word and display a pop-up menu for available operations.

You can also tap and hold your finger to open option items in document lists.

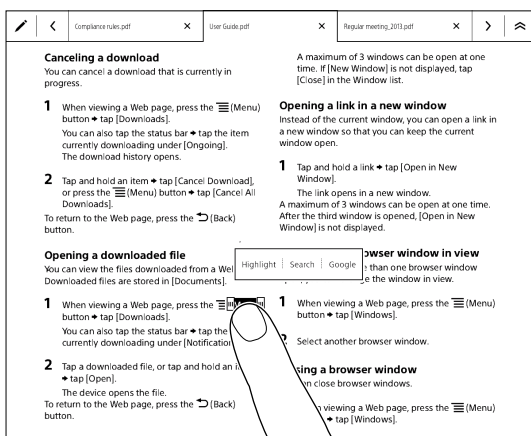

Swipe

Slide your finger gently and swiftly on the touchscreen to turn the page forward or backward. To change the page flow for a document, press the (Menu) button → tap [Page Flow]. You can also navigate pages of document lists by swiping up or down.

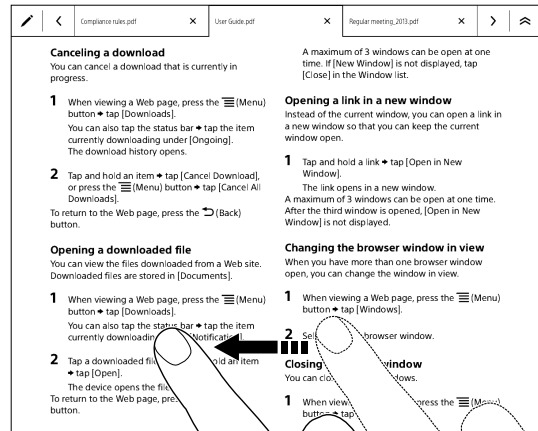

Swipe and hold

Swipe and hold your finger on the touchscreen to turn multiple pages continuously.

Pinch in/out

When you pinch in the screen (default view), the screen splits into four pages. When you pinch in again, the screen splits into nine pages (page 24). Pinch out to return to the default view. Pinching out/in further zooms the display in/out (page 24).

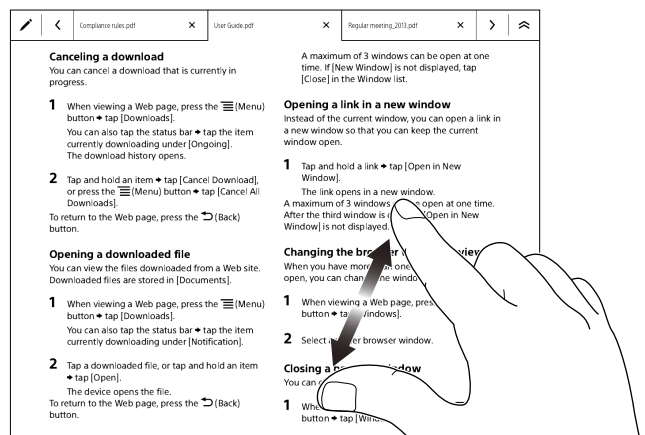

Tip

- When you tap a desired page in four or nine page view, it will display as one page.

Drag

Touch and drag your finger to reposition a zoomed-in page. The page is repositioned after you release your finger.

Note

- When the pen is near the touchscreen, the finger operation is inactive.

[Home] Screen

[Home] Screen and Applications

Press the  (Home) button to display the [Home] screen. The [Home] screen allows you to navigate applications on the Digital Paper device.

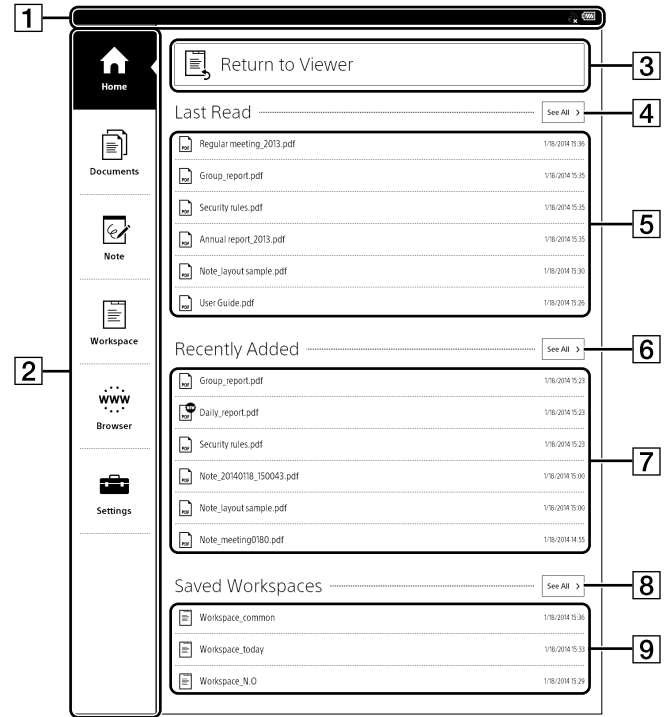

- 1 Status bar
When you set the user name, it will appear under the status bar.
- 2 Applications
- 3 Return to Viewer
- 4 Shows all recently read documents
- 5 Recently read documents
- 6 Shows all recently added documents
- 7 Recently added documents
- 8 Shows all Workspaces

9 Recently saved Workspaces

Tip

- The most recently opened documents are shown under [Last Read] on the [Home] screen. Tap a previously read page to open it.
- The most recently added documents are displayed under [Recently Added] on the [Home] screen. Tap a document to open it.

Application	Description
[Home]	Opens the [Home] screen.
[Documents]	Lists the documents in the Digital Paper device (page 19).
[Note]	Lists the notes. Allows you to create a new note (page 35).
[Workspace]	Allows you to preserve the current tab status and page location as a Workspace, from which you can easily resume at any time (page 27).
[Browser]	Launches the Web browser (page 47).
[Settings]	Displays the settings items for the Digital Paper device (page 52).

Status bar

The status bar shows a variety of information about the Digital Paper device, such as Wi-Fi status, battery level and downloading status.

The following items are displayed in the status bar.

Icon	Indication
	Connecting to a network.
	Downloading a document or software update.
	A download has completed. If downloading fails, will be displayed. To hide the icon, open the notification window and tap [Clear], or when you tap the downloaded items in the Notification list. This icon is also shown when system software download is complete.
	Updating database.
	Wi-Fi network signal strength (page 38).
	Current battery level (page 7).

Icon	Indication
	The icon appears when new system software is found.
	Synchronization between Digital Paper device and network drive is in progress.
	Synchronization between the Digital Paper device and network drive has completed. If synchronization fails, will be displayed. To hide the icon, open the notification window and tap [Clear].

Note

- Depending on the situation, not all icons will be displayed at once.



Tip

- When you press the (Menu) button from the [Home] screen, the time is displayed at the left side of the status bar for approximately 5 seconds.

Notification window

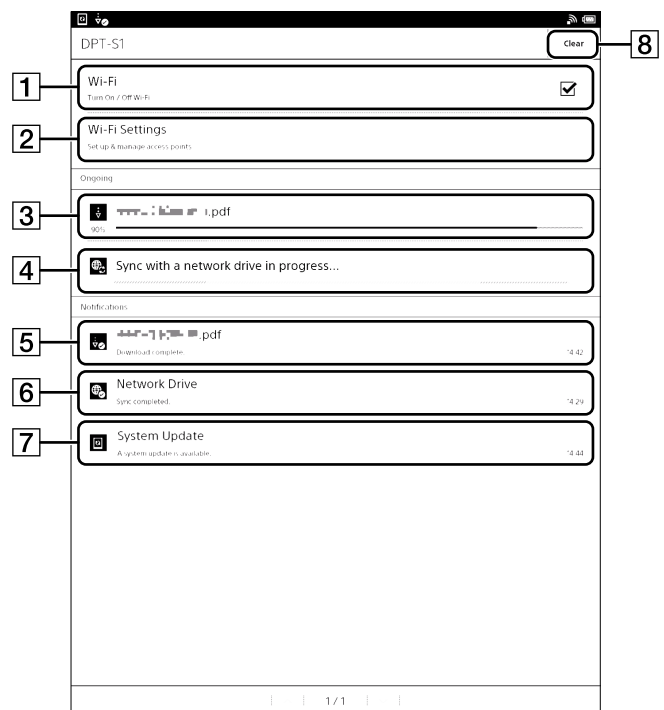
Tapping on the status bar reveals the notification window, which contains network-related items and other current operations.



Item	Description
1	Turn [Wi-Fi] on/off (page 38).
2	Go to the [Wi-Fi Settings] screen (page 38).
3	Displays the status of items that are downloading from the Web. The progress bar indicates how long an item download will take from the Web.
4	Displayed when the Digital Paper device and network drive are synchronizing.
5	An item that has been downloaded. Tap to open the item.
6	Displays the synchronization result. If synchronization fails, tap to check the reason.
7	Displayed when new system software is found.
8	Displayed when notifications are displayed. Tap to clear the notification list. The  (Download complete) icon and  (New system software is found) icon also disappear from the status bar.

Depending on the status of the Digital Paper device, other items may also appear in the notification window. Press the  (Back) button or tap the status bar to close the notification window.

On-Screen Keyboard

The on-screen keyboard is used when you need to type. If the keyboard does not automatically appear, tap the input area on the screen.

On-screen keyboard layout

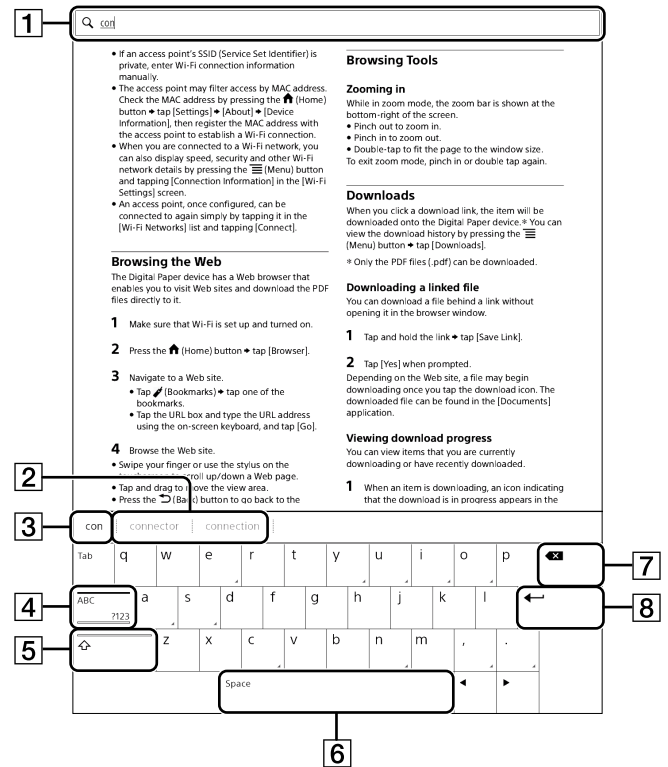

On-screen number keyboard layout

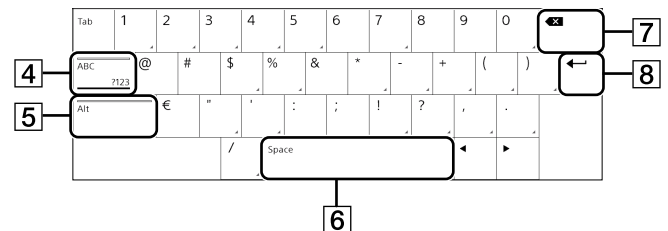







- 1 Input area
- 2 Keyboard history
- 3 Current word input box
- 4 [ABC]/[?123]
- 5 Shift key/[Alt]

6 Space

7 Backspace

8 ← (Line feed icon)

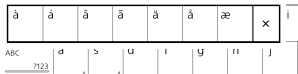
To	Do this
Input text	Tap the input area.
Delete a character	Tap  .
Insert line feed	Tap the  key. The  key is enabled only when multi-line input is available.
Switch the keyboard type	Tap [?123] to display the symbol keyboard. Tap [Alt] to switch to additional characters. Tap [ABC] to return to the alphabetical keys.
Capitalize a single letter	Tap  . Tap and hold  to activate caps lock. To cancel, tap  again.
Enter a space	Tap the space key.
Enter a previously registered word	A list of words you registered to the keyboard history is displayed next to the current word input box. Tap the desired word to enter it. Tap and hold the current word input box to register the word in it to the keyboard history. (The word must be at least 3 letters.)
Move the cursor in the input area	Tap the location to which you want to move the cursor.
Type extended characters	Tap and hold a key and select an extended character. 

Note

- The available types of keyboards and input methods differ depending on the application.

Tip

- To clear the keyboard history, press the  (Home) button → tap [Settings] → [Initialization] → [Clear Keyboard History].

Adding Content

Transferring Documents

You can directly transfer content by drag-and-drop from your computer.

Tip

- You can transfer files other than PDF; however, only PDF files (.pdf) are displayed.

- 1 Connect the Digital Paper device to your computer using the supplied USB cable.
The message [This device is correctly recognized by the computer] will display when a USB cable connection is established.

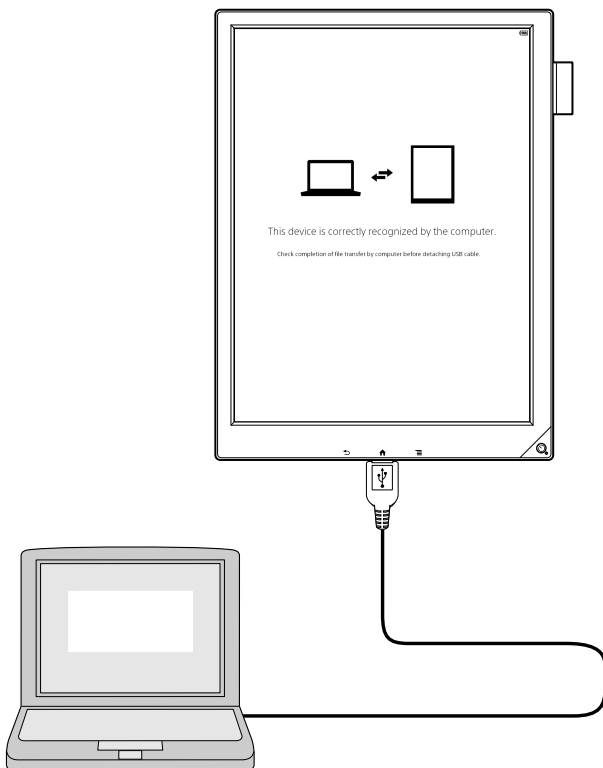

- 2 Add a document from your computer.
For Windows users:
From your computer, click on the "Start" menu → "Computer" or "My Computer" → double-click the "DPT-S1" drive, then drag and drop data onto the "DPT-S1" drive.

For Mac users:

From your computer, double-click the "DPT-S1" drive, and drag and drop data onto the "DPT-S1" drive.

- 3 When transfer is complete, use the Safely Remove Hardware function of your computer before disconnecting the USB cable from the device and your computer.

Documents will be sent to the [Documents] application.

Transferring documents to your computer

- 1 Connect Digital Paper device via USB to the computer.
A "DPT-S1" device is indicated as an external device to the computer.
- 2 Move a document from DPT-S1 to the intended folder on the computer by drag and drop.

Note

- You can also transfer content via microSD card.
- Do not delete the .dps_device_system folder or its sub-folder that were created by the Digital Paper device on the "DPT-S1" drive or the microSD card.
- If you disconnect the USB cable while data is being transferred, data corruption may occur. To disconnect the Digital Paper device from your computer, be sure to perform the following.
For Windows users:
Use the Safely Remove Hardware function of your computer before disconnecting the USB cable from the device and your computer.
For Mac users:
Click the "Eject" icon, finish the removing procedure, then disconnect the cable.

- Do not format the device or your microSD card via your computer. If you have formatted the device or microSD card on your computer, the device may not be able to display transferred content. In this case, use the device's [Format Memory] function to reformat the device and your microSD card (page 54).
- Sony recommends that you create a backup of the contents of the device in case of operation error or data corruption.
- Sony does not provide any guarantee in the event of the following.
 - Download/transfer failure
 - Document/annotations, etc., corruption or deletion

Tip

- When you transfer data to the microSD card, insert the microSD card in the device, and drag-and-drop to the microSD (removable disk) drive.
- For details on supported file formats, see page 66.

Browsing Document Lists

Document Lists

Browsing Document List Pages

The Digital Paper device organizes your documents into the [Documents] application. Document list pages allow you to sort documents, as well as search for documents on the device.

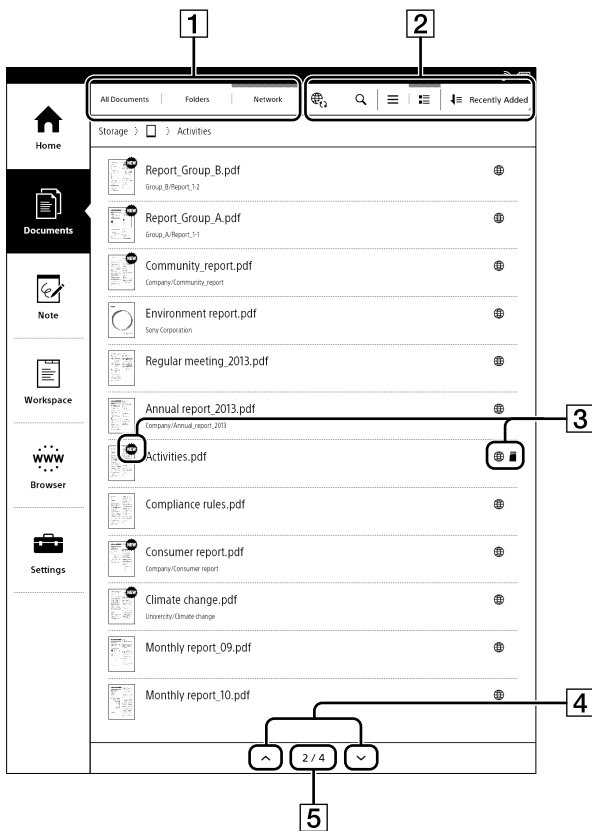

- 1 View change icons
- 2 Tool icons
- 3 Status icons
- 4 Page navigation icons
- 5 Page indicator

Status icons

Icon	Description
	The item is stored on the microSD card.
	The item has not been opened.
	The item is synchronized with the network drive (page 43).

Navigation

Navigation method	Description
Page indicator	Display the current page.
^ (page navigation icon)	View the previous item.
v (page navigation icon)	View the next item.

Tip

- Tap and hold the page navigation icon to turn pages continuously every 10 pages.

Browsing in Document View and Folder View

Document can be displayed as list or folder view. You can also display network drive synchronized documents in list view (page 45).

- 1 Press the (Home) button → tap [Documents].
- 2 Tap [All Documents] or [Folders].
[All Documents] displays a list of content.
[Folders] displays a list of content with folder view.
[Network] displays a list of synchronized documents.

Adjusting the thumbnail view

Document lists can be displayed with thumbnail view.

- 1 Press the (Home) button → tap [Documents].
 - 2 Tap or .
- displays document lists with file type icons.
 displays document lists with thumbnails.

Tip

- When you tap , the document title and author name can be seen.

Finding a Document with a Keyword

You can find a specific document quickly with a keyword search.



1 Search icon



1 Press the  (Home) button ► tap [Documents].

2 Tap .

The keyword input area and the on-screen keyboard appear.

3 Input a search keyword and tap .

The view shows only the documents that satisfy the search criteria.





To exit the search result view, tap  (close) at the top of the screen, or press the  (Back) button.

Tip

- When you browse the document list in the folder view, you can search for the document within the folder and its sub-folder.

Tools

Below is a list of the tools available on the document list page.

Tool icon	Description
	Synchronizes documents with the Digital Paper device and network drive (page 44).
	Finds content with a keyword (page 20).
	Changes the view with the file type icon (page 19).
	Changes the view with the thumbnail (page 19).
	Changes the sort order with file name, author name, etc.

Using Menu Items

Below is a list of option items available when you press the  (Menu) button on document list page.

Option	Description
[Sync]*	Synchronizes documents with the Digital Paper device and network drive (page 44).
[Cancel]*	Cancels synchronization between the Digital Paper device and network drive (page 44).
[Open]	Opens a document or multiple documents simultaneously (page 22).
[Delete]	Deletes a document or multiple documents simultaneously.
[Send]*	Transfers documents from the Digital Paper device to the network drive (page 45).

* Appears when selecting [Network] in the View change icons.

Deleting

Deleting a Single Item

- 1 Press the  (Home) button ► tap [Documents].
- 2 Tap and hold an item.
The option items appear.
- 3 Tap [Delete].
The confirmation screen is displayed.
- 4 Tap [Yes].
The item is deleted from the Digital Paper device.



Note

- Sony recommends that you create a backup of the contents of the device before deleting an item.

Deleting Multiple Items at One Time

You can delete multiple items at one time. This is convenient for clearing up space on the Digital Paper device.

The following instructions use the [Documents] application as an example; this feature is also available in other applications.

- 1 Press the  (Home) button ► tap [Documents].
- 2 Press the  (Menu) button.
- 3 Tap [Delete].
Boxes appear next to the thumbnails or list entries.

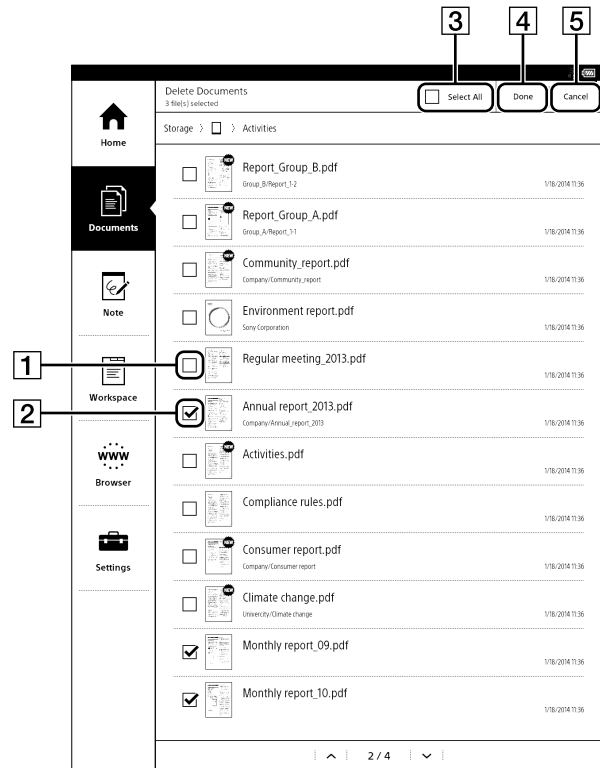

- 1 Check box Off
- 2 Check box On (target to delete)
- 3 [Select All]
- 4 [Done]
- 5 [Cancel]
- 4 Tap to check the items to delete.
Check the check box of [Select All] if you wish to delete all items.
- 5 Tap [Done].
The confirmation screen is displayed.
- 6 Tap [Yes].
The selected items are deleted from the device.

Note

- Sony recommends that you create a backup of the contents of the device before deleting an item.

Reading Documents

Opening a Document

1 Press the  (Home) button → tap [Documents].
The document list opens (page 19).



2 Tap a document.
The document opens.
You can also open a document by tapping and holding the document you want to open.
To navigate the Page Controls, see page 23.

If you tap and hold a document on the document list, the following options appear.

Option	Description
[Open (New Tab)]	Opens a new tab.
[Open (Current Tab)]	Replaces the current tab with a new tab.
[Open (Close Tabs)]	Closes all tabs and opens the document.
[Delete]	Deletes a document.
[Send]	Sends the selected document to the network drive from this device (page 45). This option is displayed only if the [Network Drive Settings] are complete.
[Reply]	Returns the document to the sender (page 46). This option is displayed if the [Network Drive Settings] are complete and this device can identify the sender from the document name.

Press the  (Back) button to return to the document list.

Opening Multiple Documents Simultaneously

- 1** Press the  (Home) button → tap [Documents].
- 2** Press the  (Menu) button.
- 3** Tap [Open].
The check box is displayed at left side of the document.

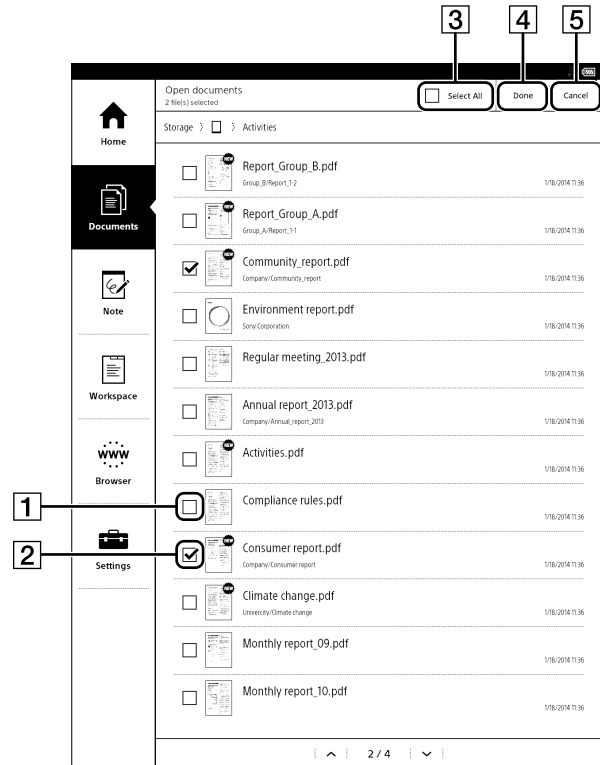

- 1** Check box Off
 - 2** Check box On (target to open)
 - 3** [Select All]
 - 4** [Done]
 - 5** [Cancel]
- 4** Tap a document you want to open. A checkmark will appear in its checkbox.
Tap [Select All] to set all checkboxes on.
- 5** Tap [Done].

The selected documents open.

Press the  (Back) button to return to the document list.

Note

- Any documents already open are closed.

Navigating Pages

There are several ways to operate on the pages.

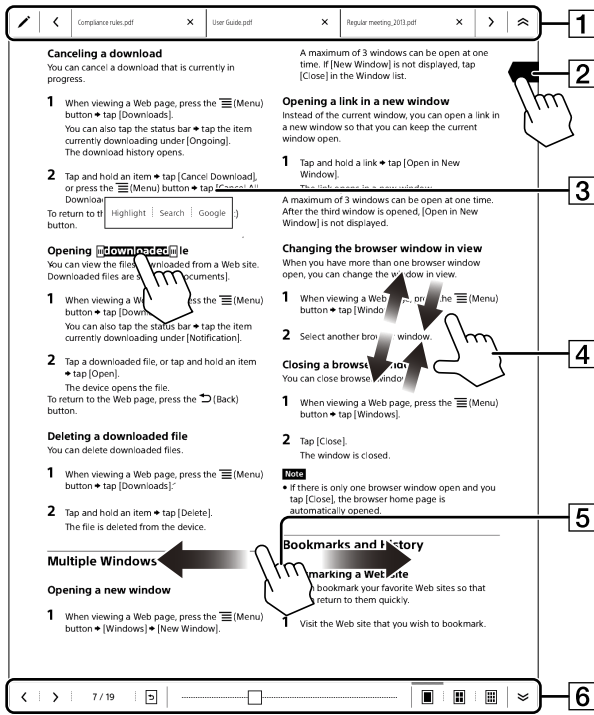

- 1 The tab panel is displayed when you tap this area.
- 2 A page flag is added when you tap this area (page 26).
- 3 The pop-up menu is displayed when you tap and hold this area (page 26).
- 4 Pinch out this area to zoom in and pinch in this area to zoom out.
- 5 Swipe the screen to turn the page.
- 6 The page control panel is displayed when you tap this area.

Tip

- If you set [Refresh Display] to On from [Application Preferences], the display refreshes at each page turn (page 53).

Using the Page Control Panel

- 1 Press the  (Menu) button → tap [Page Controls].

The page control panel is displayed.

Tip

- Alternatively, tap the bottom of the touchscreen to display the page control panel.

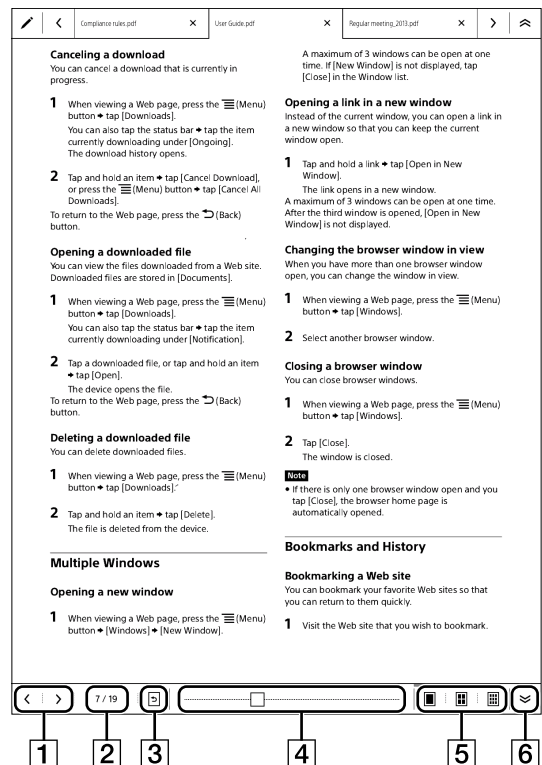

- 1 Previous/next page icons
Displays the previous/next page. To change the page flow, press the  (Menu) button and tap [Page Flow] to select [Right to Left] or [Left to Right].
- 2 Page indicator
- 3 Previous view icon
Returns to the previous page after you tap a link in a document, an annotation from

[Annotation List] or a topic from [Table of Contents].

4 Page slider

5 One/four /nine pages view icon (page 24)

6 Close icon

Tip

- Tapping and holding the previous or next page icon turns pages continuously.

Viewing Four/Nine Pages

You can split the view into four or nine pages on a single screen. The setting applies only to the current document.

1 Pinch your fingers in or out to split the view into four or nine pages.

When you pinch in the screen (default view), the screen splits into four pages. When you pinch in again, the screen splits into nine pages. When you pinch out in nine pages view, the screen changes to four pages.

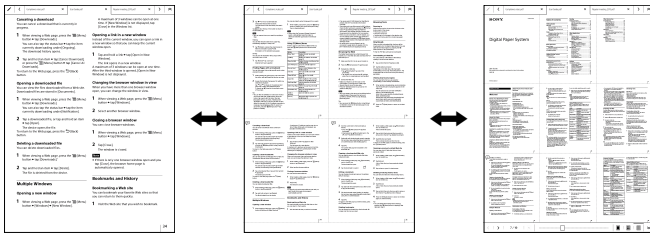

Tip

- When you tap a desired page in four or nine page view, it will display as one page (default view).

Using the page control panel

1 Press the (Menu) button → tap [Page Controls] or tap the bottom of the touchscreen. The page control panel appears.

2 Tap the icon you wish to set as the view icon.

Icon	Description
	Displays one page (default view).

Icon	Description
	Displays four pages on a single screen.
	Displays nine pages on a single screen.

Zooming in the Display

1 Pinch out the document (default view).

The display zooms in and [Zoom] appears at the bottom of the screen. Pinching out/in further zooms the display in/out.

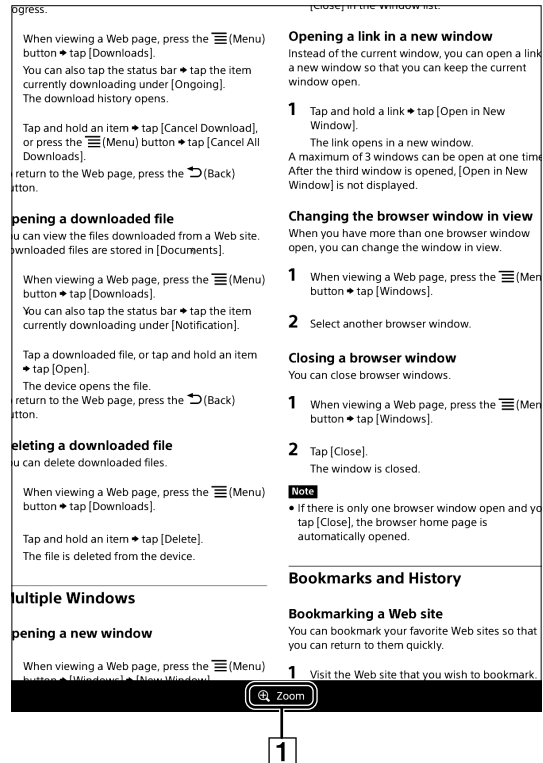

1 Status indication of zoom

Press the (Back) button to return to the default view.

Operating Tabs

Tab operation allows you to browse multiple documents.

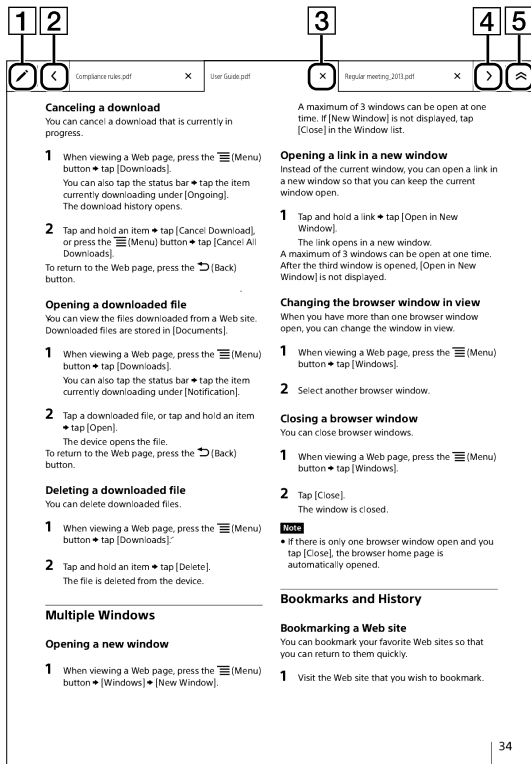

Adding a duplicate tab

You can add a duplicate tab from the currently active tab. The newly added tab will be placed next to the active tab.

- 1 Press the (Menu) button → tap [Duplicate Tab].

The newly added tab will be displayed for the same document.

Tip

- A document is displayed as duplicated tab. Both tabs relate to the same document.

Closing all tabs

You can close all tabs at one time.

- 1 Press the (Menu) button → tap [Close All Tabs].

Displaying the tab list

You can select a document from the tab list.

- 1 Press the (Menu) button → tap [Tab List].
The tab list appears.

- 1 Toolbox display icon

- 2 Left scroll icon
Displays the left tab.

- 3 Tab close icon
Closes the current tab and opens the right tab.

- 4 Right scroll icon
Displays the right tab.

- 5 Tab panel close icon
Closes the tab panel. Tap the top of the screen to display the tab panel again. Alternatively, press the (Menu) button → tap [Show Tabs] to display the tabs again.

Tip

- The file name is displayed on the tab.
- A maximum of three tabs can be shown on the touchscreen.

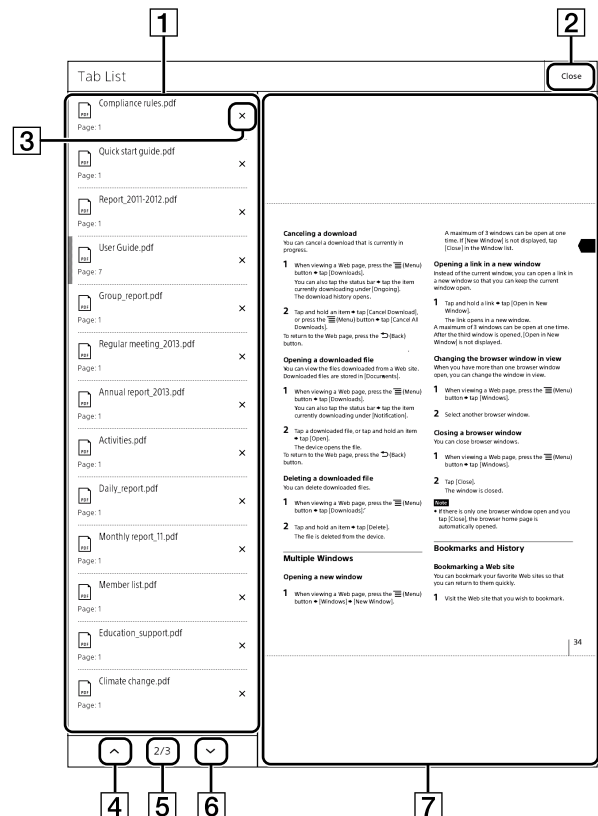

1 Tab list

2 Tap to close the tab list

3 Close icon

Tap to close a tab.

4 Previous page icon

5 Page indicator

6 Next page icon

7 Preview area

2 Tap a tab in the list.

3 Tap a preview area.

The tab list is closed. The document for the selected tab is displayed full-screen.

Adding a Page Flag

You can add a page flag to a page.

1 Tap the top-right corner of the page.

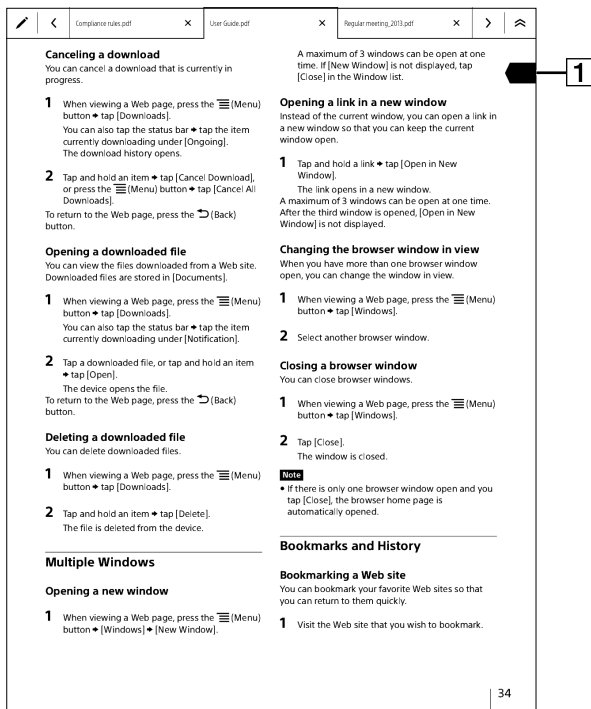

1 Page flag

Tip

- Alternatively, press the (Menu) button → tap [Add Page Flag] to add a page flag (page 27).
- To search for the page flag in the currently open document, press the (Menu) button → tap [Annotation List] (page 34).
- If you switch the orientation of the screen, the position or size of the page flag may change.

Removing a page flag

1 Tap a page flag.

Tip

- Alternatively, press the (Menu) button → tap [Delete Page Flag] to remove the page flag (page 27).

Searching Pages by Keyword

You can select a string as keyword and search a document.

1 Tap and hold the first word of the string you want to search for.

2 Drag the end cursor over other words to be searched.

3 Tap [Search] in the pop-up menu.

A page that includes the keyword is displayed.

4 Tap or .

The page turns to the previous/next page that contains the keyword.

To cancel, tap (close) in the top-right corner of the screen.

Tip

- You can also search for a keyword by tapping with the stylus while pushing its button.
- End cursors are not displayed when selecting a link word.
- You can search for a keyword at the Google Web site. Select a keyword and tap [Google] in the pop-up menu. The [Browser] application will open to the Google Web site and search for the word. (A Wi-Fi

network connection is necessary (page 38).) To return to a document, press the  (Menu) button → tap [Return to Viewer].

Using the on-screen keyboard to enter a keyword

- 1 Press the  (Menu) button → tap [Search], and enter the keyword using the on-screen keyboard.

Note

- Keyword search is not case-sensitive.

Using Menu Items



Below is a list of option items available when you press the  (Menu) button from the document viewer.

Option	Description
[Orientation]	Switches the orientation of the screen
[Send]	Sends a selected document to the network drive from this device (page 45).
[Reply]	Returns a document to the sender (page 46).
[Show Tabs]	Displays the tab panel (page 25).
[Page Controls]	Displays the page control panel (page 23).
[Save Workspace]	Saves the currently registered Workspace.
[Save as New]	Saves as a new Workspace (page 27).
[Tab List]	Opens the tab list (page 25).
[Close All Tabs]	Closes all tabs (page 25).
[Duplicate Tab]	Adds a duplicate of the currently active tab (page 25).
[Add Page Flag]	Adds a page flag (page 26).
[Delete Page Flag]	Deletes a page flag (page 26).
[Annotation List]	Opens the annotation list (page 34).
[Table of Contents]	Opens the table of content.
[Search]	Finds pages with a keyword (page 26).
[Page Flow]	Changes the page flow for a document.

Using the [Workspace] Application

You can name and save an image of the currently opened documents. By preserving the current tab status and page location, a registered Workspace allows you to resume your work from the preserved tab status.

Registering a Workspace

- 1 Press the  (Home) button → tap [Documents].
- 2 Tap a document page to register to the Workspace.
- 3 Press the  (Menu) button → tap [Save as New].

The dialog box for saving as a new workspace opens.

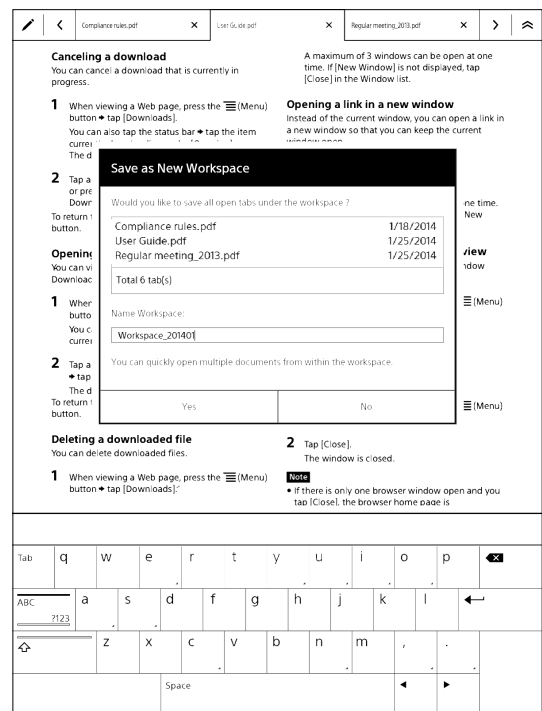

- 4 Tap an input area and enter the Workspace name using the on-screen keyboard, then tap [Yes]. The current tab status and page location are preserved.

Tip

- To change the registered Workspace name, tap and hold the Workspace on the [Workspace] list and tap [Rename] from the option menu.
- To overwrite the current Workspace, press the ☰ (Menu) button → tap [Save Workspace].

Opening a Registered Workspace

- 1 Press the 🏠 (Home) button → tap [Workspace].

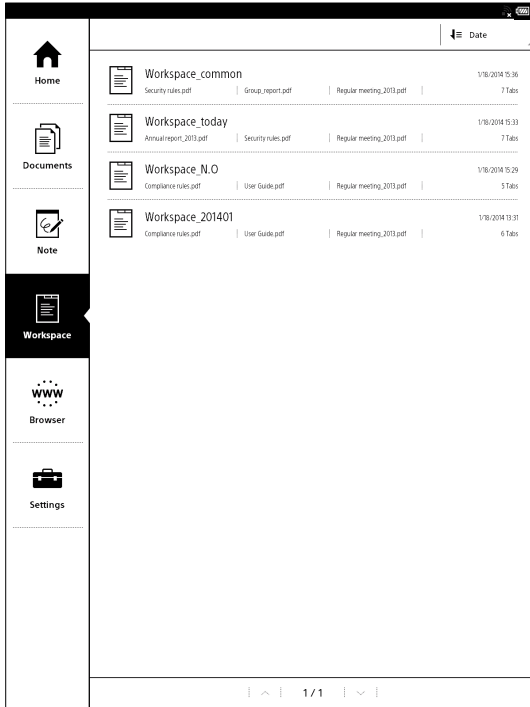

- 2 Tap the registered Workspace that you want to open.

The Workspace opens.

Alternatively, you can open a Workspace by tapping and holding it in the [Workspace] list, then tapping [Open] from the option menu.

Note

- If you open another workspace, the tab and page information of the current workspace will be deleted.

Deleting a Registered Workspace

You can delete one or more Workspaces.

- 1 Press the 🏠 (Home) button → tap [Workspace].
- 2 Tap and hold the Workspace you want to delete, then tap [Delete] from the option menu.
The confirmation screen is displayed.
- 3 Tap [Yes].

Tip

- To delete multiple Workspaces at one time, press the ☰ Menu button → tap [Delete]. For details, see page 21.

Using Menu Items

Below is a list of option items available when you press the ☰ (Menu) button from the [Workspace] list.

Option	Description
[Delete]	Deletes a selected Workspace(s) (page 21).

Annotating the document

You can directly handwrite, highlight on the touchscreen, and add a sticky note or handwritten sticky note.

Annotations are automatically saved after editing, closing a document/note, changing a tab, or displaying for a certain period of time.

Note

- When the battery charge level decreases, an edited document is saved and becomes read-only. In this state, adding/editing/deleting/saving cannot be done.

To resume editing, connect the supplied AC adapter to charge the Digital Paper device. Note that if charging is interrupted, annotations might not be saved. Use the device when fully charged.

Using the Toolbox

You can use the toolbox to add handwriting or annotations. Newly added handwriting or annotations will be saved as a PDF file.

- 1 Tap to display the tab panel (page 23).
- 2 Tap  (Toolbox).
The toolbox is displayed.

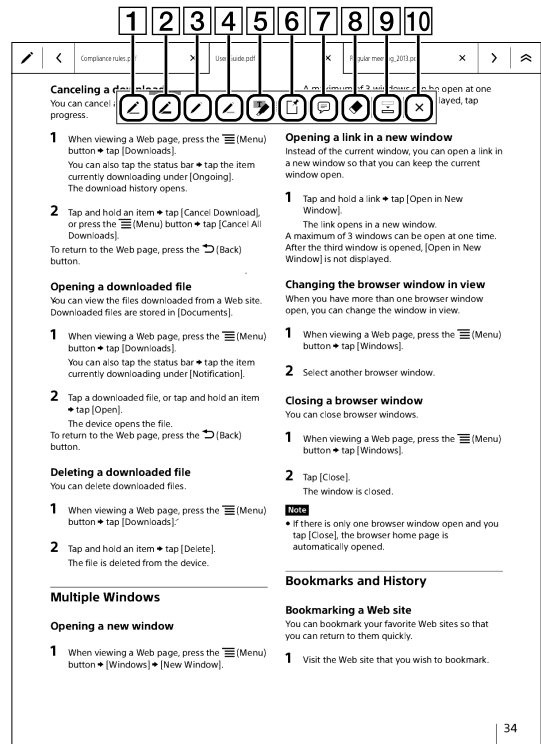

- 1 Handwriting icon (fine/navy) (page 30)
- 2 Handwriting icon (bold/navy) (page 30)
- 3 Handwriting icon (fine/red) (page 30)
- 4 Handwriting icon (bold/red) (page 30)
- 5 Highlight icon (page 30)
- 6 Handwritten sticky note icon (page 33)
- 7 Sticky note icon (page 32)
- 8 Erase icon (page 31)
- 9 Toolbox move icon
Moves the toolbox to a lower or upper position.
- 10 Close the toolbox

Handwriting a Note on a Page

You can use the stylus to draw directly on a page.

1 Handwrite with the stylus.

Select the line type from the toolbox.

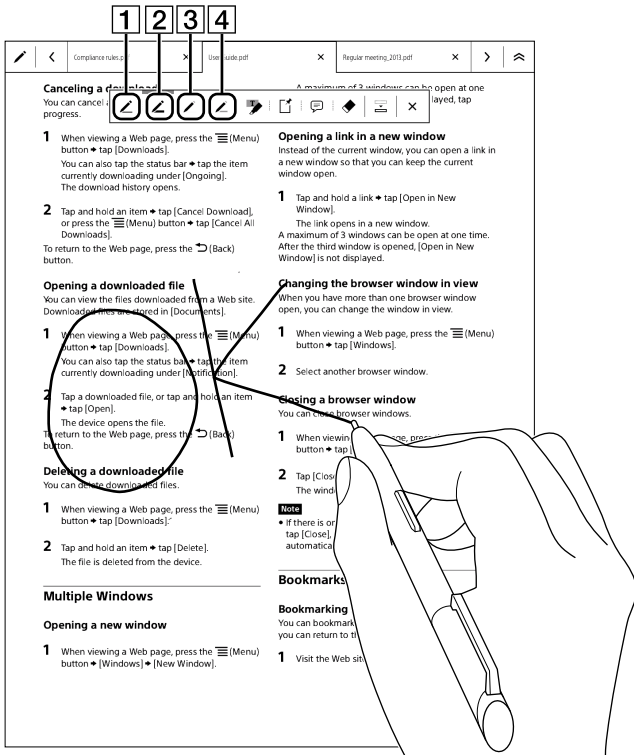

1 Handwriting icon (fine/navy)

2 Handwriting icon (bold/navy)

3 Handwriting icon (fine/red)

4 Handwriting icon (bold/red)

Note

- When [Pen settings] → [Highlighting with pen button] → [Set as ON (highlight active)] is set, you cannot handwrite while pushing the stylus button (page 53).
- Lines will not appear red or navy immediately after being drawn. Red lines will turn light gray after being saved by page turning, etc. Navy and red lines will be correctly displayed on files transferred to a computer.

Tip

- You can use the stylus (handwrite) while resting your hands on the touchscreen.

Highlighting Words on a Page

You can use the stylus or your finger to highlight words directly on a page.

When using the stylus

- 1 While pushing the stylus button, tap the first word and drag across to the last word of the section you want to highlight.

The selected words are now highlighted.

Note

- When [Pen settings] → [Highlighting with pen button] → [Set as OFF (handwriting)] is set, you cannot highlight while pushing the stylus button (page 53).

Tip

- Alternatively, while pushing the stylus button, select the words to highlight → tap [Highlight] from the pop-up menu.
- To search for a highlighted word in the currently open document, press the (Menu) button → tap [Annotation List] (page 34).

When using your finger

- 1 Tap and hold the first word of the section that you want to highlight.

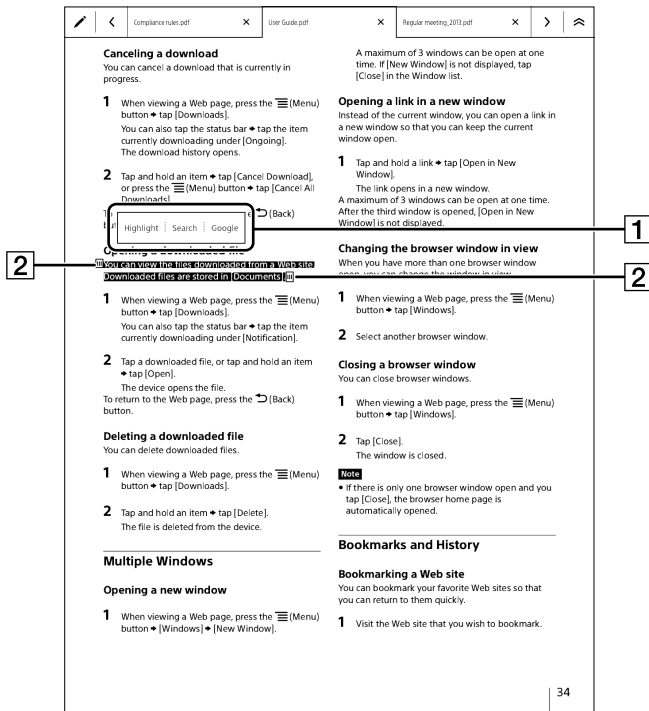

1 Pop-up menu

2 Highlight bar edge

2 Drag across to the last word of the section you want to highlight.



3 Tap [Highlight] from the pop-up menu.

Removing highlights

1 While pushing the stylus button, tap the word that you want to remove with the stylus.

2 Tap [Remove Highlight] from the pop-up menu.

Tip

- Alternatively, you can tap and hold your finger to display the pop-up menu.
- You can also delete a highlight by tapping  (Erase) in the toolbox and tapping the highlight.
- To search for a highlighted word in the currently open document, press the  (Menu) button \rightarrow tap [Annotation List] (page 34).

Erasing Handwriting or Highlight with the Erase Icon

1 Tap  (Toolbox) in the tab panel to display the toolbox.

The toolbox is displayed.

2 Tap , move the stylus across the handwriting or highlight, then lift the stylus.

The handwriting or highlighted words will be erased.

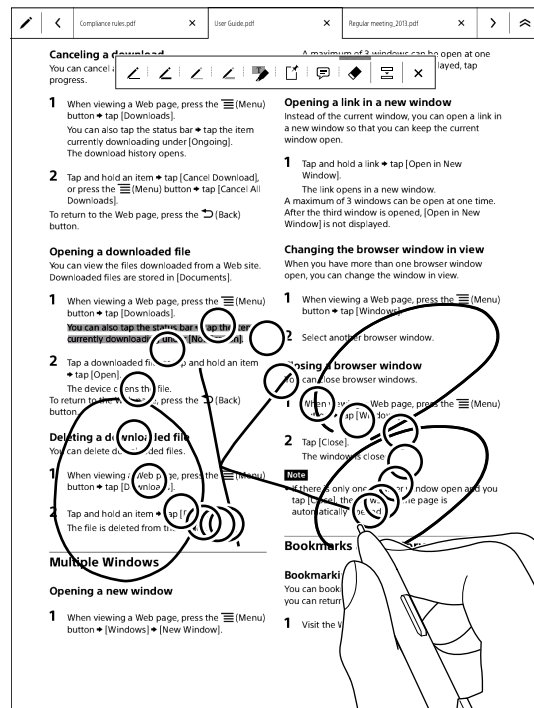

You cannot draw a line or character while selecting the Erase icon. To continue to draw a line or character, select a Handwriting icon from the toolbox.

Tip

- You can erase a line by only selecting a part of the line across the touchscreen. You do not need to select all parts you want to erase. When selecting multiple lines, all lines are erased at one time.

Example of erasing on real paper

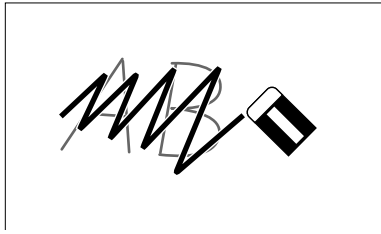

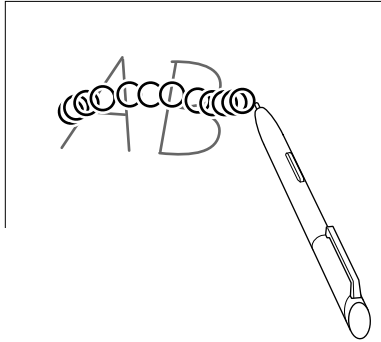

Example of erasing with this device



- You can set whether to display the erasing effect (animated circles) from [Pen settings] ▶ [Eraser Animation] (page 53).

Adding a Sticky Note to a Page

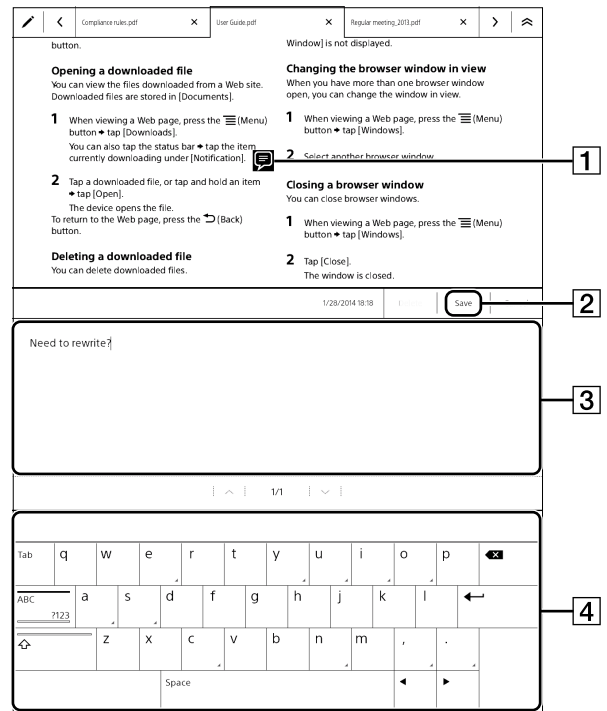

You can input the comment with using on-screen keyboard and add a sticky note to a page.

- 1 Tap  (Toolbox) in the tab panel to display the toolbox.
The toolbox is displayed.
- 2 Tap  (Sticky note) and place it on the page by the stylus.
The notepad and on-screen keyboard appear.



- 1 Sticky note icon
 - 2 [Save]
 - 3 Input area
 - 4 On-screen keyboard
- 3 Create a note using the on-screen keyboard.
 - 4 Tap [Save].

Editing a sticky note

- 1 While pushing the stylus button, tap  (Sticky note) or tap and hold your finger on  (Sticky note) on the page.

Note

- Tapping  (Sticky note) without pushing the stylus button will only draw on the icon, not open it. Push the stylus button then tap, or tap your finger on the page.
- 2 Tap the [View] from the pop-up menu.
The sticky note appears.
 - 3 Tap [Edit].



The on-screen keyboard appears.

4 Edit the note using the on-screen keyboard.

5 Tap [Save].

The notepad and on-screen keyboard close.

Removing a sticky note

1 While pushing the stylus button, tap  (Sticky note) or tap and hold your finger on  (Sticky note) on the page.

2 Tap [Delete] ► [Yes] from the pop-up menu.

Adding a Handwritten Sticky Note

You can add a handwritten sticky note to a page.

1 Tap  (Toolbox) in the tab panel to display the toolbox.

The toolbox is displayed.

2 Tap  (Handwritten sticky note) and place it on the page by the stylus.

The Handwritten sticky note is created.

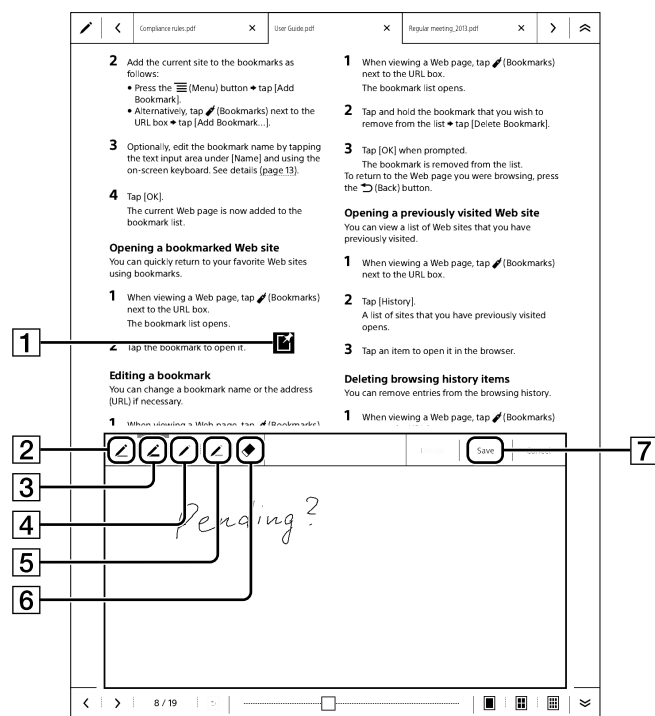

1 Handwritten sticky note icon

2 Handwriting icon (fine/navy)

3 Handwriting icon (bold/navy)

4 Handwriting icon (fine/red)

5 Handwriting icon (bold/red)

6 Erase icon

7 [Save]



3 Tap the Handwriting and Erase icons to draw a character or picture with the stylus.

4 Tap [Save].

Tip

- For details about handwriting, see “Handwriting a Note on a Page” (page 30).
- When the document is transferred from this device to the computer, the handwritten sticky note is saved as a PDF file.

Editing a handwritten sticky note



1 While pushing the stylus button, tap  (Handwritten sticky note) or tap and hold your finger on  (Handwritten sticky note) on the page.

2 Tap the [View] from the pop-up menu.
The handwritten sticky note appears.

3 Edit the handwritten sticky note.

4 Tap [Save].

Removing a handwritten sticky note

1 While pushing the stylus button, tap  (Handwritten sticky note) or tap and hold your finger on  (Handwritten sticky note) on the page.

2 Tap [Delete] from the pop-up menu ► [Yes].

Searching Annotations in a Document

You can search, filter, or sort annotations (page flags/highlights/sticky notes/handwritten sticky notes) in the current document.

1 Press the  (Menu) button \blacktriangleright tap [Annotation List].

The annotations in the document are listed.

Note

- It may take a while to display the annotation list at first time.

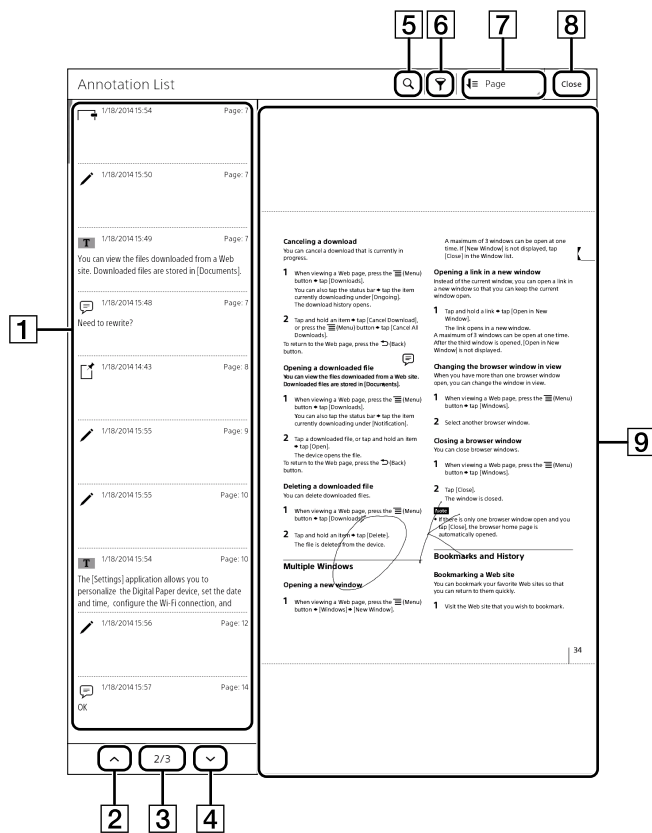

1 Annotation list

2 Previous list icon

3 Page indicator

4 Next list icon

5 Search icon

6 Filter icon

7 Sort icon

8 Tap to close the annotation list

9 Preview area

Tip

- When you tap and hold the previous list or next list icon, lists scroll continuously.
- Press the  (Back) button to return to the document.





2 Tap the page you want to display in the annotation list.

The page containing the selected annotation is displayed on the preview area.

3 To switch the preview to full-screen, tap the preview area.

The annotation list is closed, and the screen is switched to full-screen.

Annotation icons

Icon	Description
	Page flag
	Handwritten note
	Highlight
	Sticky note
	Handwritten sticky note



Searching annotations by keyword

You can search annotations by entering a keyword. You can also filter the annotation type. The search target changes depending on the annotation type.

Targeted items

Item type is limited to 140 characters.

- Text on a page with a page flag
- Highlighted text
- Annotation author name
- Sticky note text

- 1 Tap  (Search).
- 2 Type a search keyword using the on-screen keyboard.
- 3 Tap  of the on-screen keyboard.
The search result is shown on the annotation list.
Tap  (close) at the top of the screen to finish searching.

Tip

- You can narrow down your search by applying a filter.

Filtering

You can filter the annotation list by page flag, handwriting, highlight, sticky note, or handwritten sticky note.

- 1 Tap  (Filter) → uncheck the check box(es) to filter the annotation type(s) → [OK].
Annotations of the selected type appear.

Sorting

You can sort the annotation list by page, author, annotation type, or date.

- 1 Tap  (Sort) → tap a sort type.
The selected sort type is applied.



Using the [Note] Application

You can use the [Note] application to create a handwritten note. Notes of up to 10 pages can be created.

Creating a Note

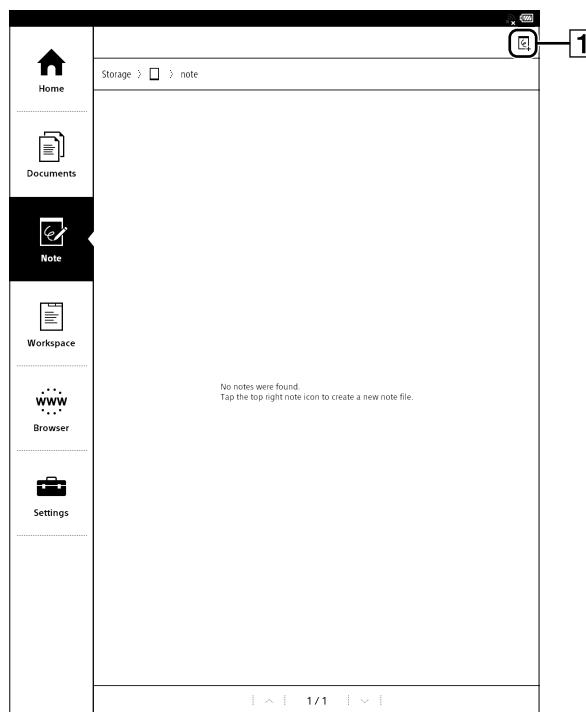
- 1 Press the  (Home) button → tap [Note].



- 1 Create new note icon
- 2 Tap  in the top-right corner of the screen.
The dialog box opens.
- 3 Enter a note name using the on-screen keyboard and tap [OK].
A notepad opens.
- 4 Edit the note with the stylus.
Tap  (Toolbox) in the tab panel to display the toolbox, you can select the type of lines.
- 5 Tap  (Tab close) to close the note.
A newly created note is saved automatically.

Tip

- Newly created notes will be saved as a PDF.
- Newly created notes will be saved only in the internal memory.
- To change the name of note, tap and hold in the [Note] list and tap [Rename] from the option menu.
- When the Digital Paper device is connected to a computer, the created note (PDF file) will be shown in the "note" folder in "DPT-S1".

Editing a Note

- 1 Press the **Home** button → tap [Note] → tap the note that you want to edit.

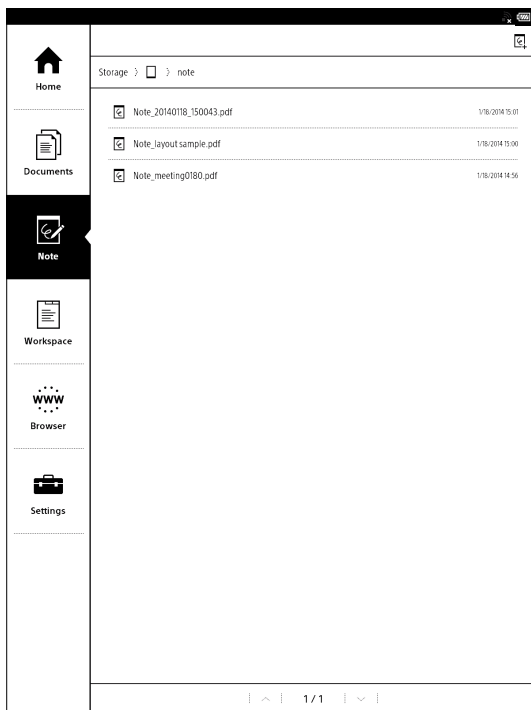

- 2 Edit the note using the stylus.
Tap **Toolbox** in the tab panel to display the toolbox and select the line type or erase.
- 3 Tap the **Tab close** to finish editing.

Deleting a Note

You can delete one or more notes.

- 1 Press the **Home** button → tap [Note].
- 2 Tap and hold the note that you want to delete, then tap [Delete] from the option menu.
The confirmation screen is displayed.
- 3 Tap [Yes].

Tip

- To delete multiple notes at one time, press **Menu** button, then tap [Delete]. To delete notes, see page 21.

Transferring a Note from This Device to the Network Drive

You can transfer the note from this device to the destination folder in the network drive. Connect to the Wi-Fi network and network drive in advance (page 38).

The transferred file is named "previous name_from_Sync folder_date_time.pdf".

- 1 Connect to a Wi-Fi network.
- 2 Press the **Home** button → tap [Note].
- 3 Tap and hold the note that you want to transfer, then tap [Send] in the option menu.
The confirmation screen is displayed.
- 4 Tap the destination and check the check box.
To select all destinations, tap [Select All].
- 5 Tap [OK].
The confirmation screen is displayed.
- 6 Tap [Yes].
The note is transferred to just below the destination folder.

Note

- If a note with the same name already exists in the destination folder, it is overwritten.

Tools

Below is a list of the tools available on the [Note] list page.

Tool icon	Description
	Creates a new note.

Using Menu Items

Below is a list of option items available when you press the  (Menu) button on the [Note] list.

Option	Description
[Delete]	Deletes a selected note(s) (page 21).

Setting up a Wi-Fi® Network

To connect to the internet wirelessly, set up a wireless (Wi-Fi) internet connection by the following steps.

Tip

- Supported security methods are WEP, WPA/WPA2 PSK, and 802.1x EAP.

Wi-Fi status icons

The following icons in the status bar indicate the status of the Wi-Fi connection.

Icon	Status
	Wi-Fi is activated. The number of bars indicates the Wi-Fi signal strength.
	Wi-Fi is in standby mode (page 53).
	There is no Wi-Fi access point.
	The [Wi-Fi] setting is turned off.

Preparing to Set Up a Wi-Fi Connection

Before connecting to a Wi-Fi access point, turn on [Wi-Fi] on the Digital Paper device.

- Press the (Home) button → tap [Settings] → [Wireless Network Settings].

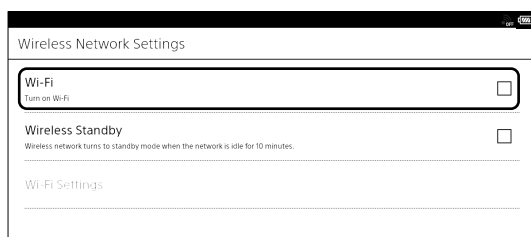

- Tap [Wi-Fi] to check the check box. A check indicates that [Wi-Fi] is turned on. Wi-Fi is turned off by default.

Tip

- Alternatively, you can tap the status bar → tap [Wi-Fi] to turn on the Wi-Fi (page 14).
- Turn off [Wi-Fi] when it is not in use in order to extend the battery life of the device.
- Turn on [Wireless Standby] to extend the battery life (page 7).

Selecting a Connection Type

Depending on your Wi-Fi environment, connect to an access point via one of the following methods. The following questions will determine the most suitable case for setting the Wi-Fi network connection.

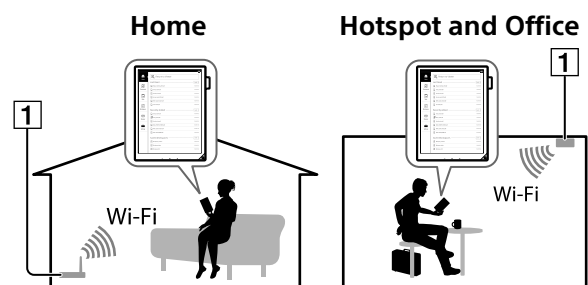

- Internet

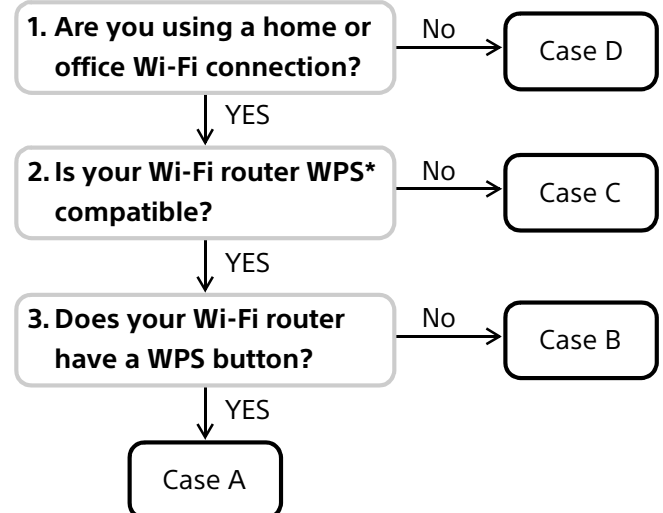

* WPS: Wi-Fi Protected Setup

Note

- Connection and communication fees apply when using a Wi-Fi router.
- Wireless communication exposes risks to wiretapping, manipulation and illegal invasion into the network.

Unless absolutely necessary, Sony recommends that you use safe security methods (WPA/WPA2-PSK, etc.) and avoid non secure or WEP access.

Case A

Connecting to a Wi-Fi router with a WPS button (page 39)

Case B

Connecting to a Wi-Fi router with WPS PIN input (page 39)

Case C

Connecting to a Wi-Fi router by selecting a network name (page 40)

Case D

Connecting to a public Wi-Fi network (page 40)

Other than case A to D (Manual setup)

Set up a Wi-Fi network connection manually when connecting to an access point for which the SSID is hidden (page 41).

Case A: Connecting to a Wi-Fi router with a WPS button

The Digital Paper device is compatible with WPS (Wi-Fi Protected Setup), which lets you easily make a Wi-Fi connection using the “WPS” button on your WPS-compatible Wi-Fi router.

- 1 Turn on [Wi-Fi] on the device (page 38).
- 2 Tap [Wi-Fi Settings].
- 3 Tap [WPS Push-Button Configuration] → [Start].

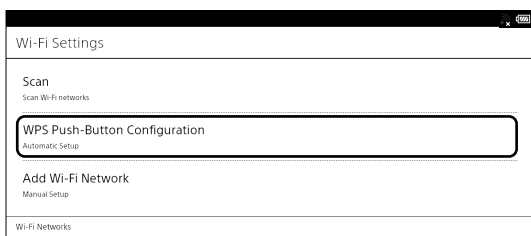

- 4 On your Wi-Fi router, press the “WPS”* button within 2 minutes.
The device automatically attempts to establish a Wi-Fi connection.

* The name of the button on your Wi-Fi router may vary.

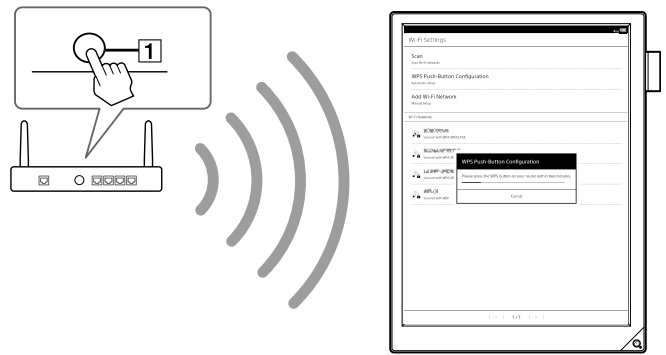

- 1 “WPS” button

- 5 After the setup completion screen appears, tap [OK].

You can check the Wi-Fi connection status by the Wi-Fi icon on the status bar (page 14).

For details on Wi-Fi settings, see page 43.

Case B: Connecting to a Wi-Fi router with WPS PIN input

If your WPS-compatible Wi-Fi router does not support push-button configuration, connect by using a PIN (Personal Identification Number).

- 1 Turn on [Wi-Fi] on the device (page 38).
- 2 Tap [Wi-Fi Settings].
- 3 Tap [Add Wi-Fi Network] → [WPS PIN Method] → [Start].

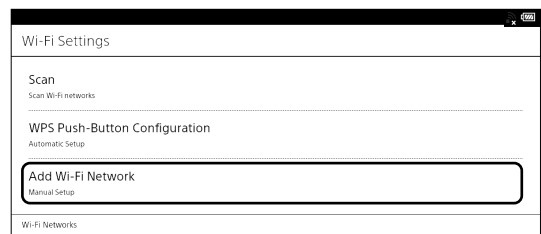

A PIN code will be shown on the screen of the device.

- 4 Enter the PIN code into your Wi-Fi router.
Refer to your Wi-Fi router’s instruction manual for details.
- 5 Tap [OK] on the screen of the device.

After a moment, the device connects to the Wi-Fi network automatically.

You can check the Wi-Fi connection status by the Wi-Fi icon on the status bar (page 14).

For details on Wi-Fi settings, see page 43.

Case C: Connecting to a Wi-Fi router without WPS support

Connect to one of the available Wi-Fi networks listed.

Note

- Depending on the security method of the Wi-Fi router, a password may be required.
- For an access point that is secured by 802.1x EAP, additional settings are required. For details, see "Other than case A to D" (page 41).

- 1 Turn on [Wi-Fi] on the device (page 38).
- 2 Tap [Wi-Fi Settings].
- 3 Tap [Scan].
The available access points are listed under [Wi-Fi Networks].

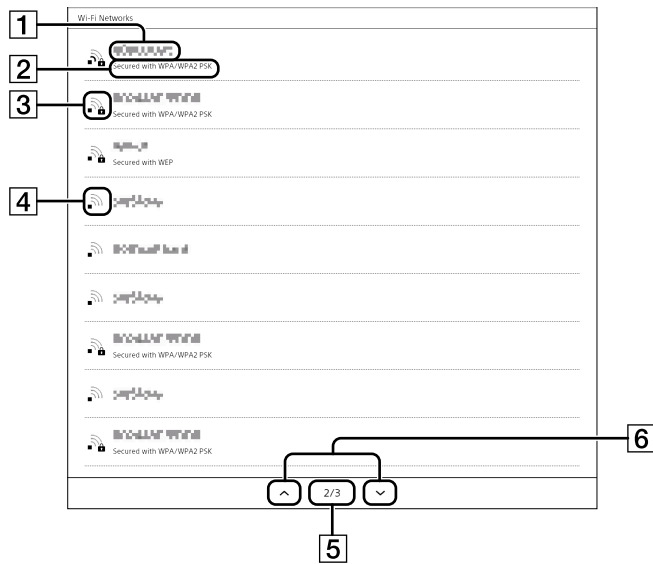

Number	Description
1	Network SSID (Service Set Identifier)
2	Security method
3	Secured Wi-Fi network. When connecting to the network, enter the password. A password may also be called a WEP key, WPA key, encryption key, network key, etc.
4	Unsecured Wi-Fi network
5	Page indicator
6	Page turn icons

- 4 Tap your Wi-Fi router's SSID in the [Wi-Fi Networks] list.
For details on the Wi-Fi router's SSID, refer to your Wi-Fi router's instruction manual.
- 5 If prompted for a password, tap the input area and enter the password using the on-screen keyboard.
- 6 Tap [Connect].
The device connects to the Wi-Fi network.
You can check the Wi-Fi connection status by the Wi-Fi icon on the status bar (page 14).
For details on Wi-Fi settings, see page 43.

Case D: Connecting to a public Wi-Fi network

Connect to one of the available public Wi-Fi networks.

Note

- Connecting to a public Wi-Fi network may require a user ID and password. For details, contact the homepage, etc., of the Wi-Fi service provider.
- 1 Turn on [Wi-Fi] on the device (page 38).
 - 2 Tap [Wi-Fi Settings].
 - 3 Tap [Scan]
The available access points are listed under [Wi-Fi Networks].

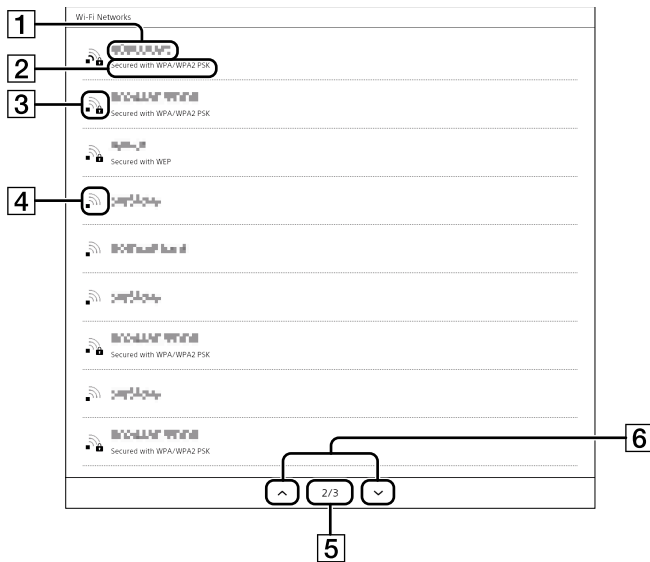

Number	Description
1	Network SSID (Service Set Identifier)
2	Security method
3	Secured Wi-Fi network. When connecting to the network, enter the password. A password may also be called a WEP key, WPA key, encryption key, network key, etc.
4	Unsecured Wi-Fi network
5	Page indicator
6	Page turn icons

- 4 Tap your Wi-Fi router's SSID in the [Wi-Fi Networks] list.
- 5 If prompted for a password, tap the input area and enter the password using the on-screen keyboard.
- 6 Tap [Connect].
- 7 The [Browser] application may start automatically to connect to a public access point. Otherwise, press the  (Home) button, then tap [Browser].
- 8 Follow the instructions shown on the [Browser] screen to complete the Wi-Fi connection. You can check the Wi-Fi connection status by the Wi-Fi icon on the status bar (page 14). For details on Wi-Fi settings, see page 43.

Other than case A to D: Manually connecting to an unlisted access point

When connecting to a Wi-Fi network in an office or group, check with the network administrator for details on installing the certification and proxy server settings.

When connecting to a Wi-Fi network at home, it is not necessary to install certification, or perform proxy server settings. See "Manually setting a Wi-Fi connection" (page 42).

Installing the certification

Transfer and install the CA certificate and user certificate from the computer to the Digital Paper device. It only requires the user certificate to use TLS under 802.1x EAP.

- 1 Connect the Digital Paper device to your computer using the supplied USB cable. Then transfer the CA certificate and user certification to the first layer of internal memory. To transfer the certification, see page 17.
- 2 Turn on [Wi-Fi] on the device (page 38).
- 3 Tap [Wi-Fi Settings].
- 4 Press the  (Menu) button → tap [Advanced].

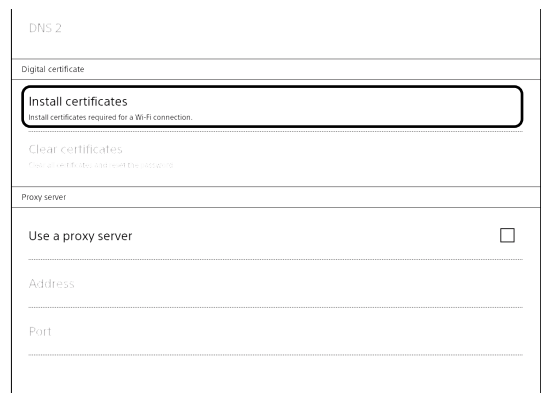

- 5 Tap [Install certificates].
- 6 Tap the certificate that you want to install.
- 7 When selecting the user certificate, enter the password, using the on-screen keyboard, then tap [OK].

8 Enter the certification name using the on-screen keyboard, then tap [OK].

Press the  (Back) button to close the settings.

Setting the proxy server

When connecting via proxy server, settings are necessary.

1 Turn on [Wi-Fi] on the device (page 38).

2 Tap [Wi-Fi Settings].

3 Press the  (Menu) button, then tap [Advanced].



1 [Use a proxy server]

2 [Address]

3 [Port]

4 Tap [Use a proxy server].
The check box is checked.

5 Tap [Address], input a valid address using the on-screen keyboard, then tap [OK].

6 Tap [Port], input a valid port, using the on-screen keyboard, then tap [OK].

Press the  (Back) button to close the settings.

Manually setting a Wi-Fi connection

1 Turn on [Wi-Fi] on the device (page 38).

2 Tap [Wi-Fi Settings].

3 Tap [Add Wi-Fi Network].

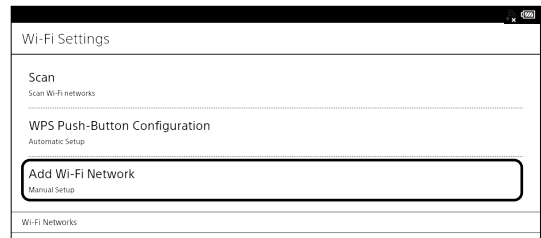

4 Tap [Manual Registration].

5 Register the settings.

The option items differ depending on the security method. For further setting information, contact the network administrator.

Item	Description
[SSID]	Enters the SSID (Service Set Identifier), using the on-screen keyboard.
[Security Method]	Selects the security method corresponding to the Wi-Fi router.
[EAP method]*	Selects the authentication method.
[Phase 2 authentication]*	Selects Phase 2 authentication.
[CA certificate]*	Selects the CA certificate.
[User certificate]*	Selects the user certificate when [TLS] is selected in [EAP method].
[Identity]*	Enters the user ID using the on-screen keyboard.
[Anonymous identity]*	Enters an anonymous user ID using the on-screen keyboard when [PEAP] is selected in [EAP method].
[Password]	When connecting to a secured Wi-Fi network, enter the password using the on-screen keyboard. A password may also be called a WEP key, WPA key, encryption key, network key, etc. It is not necessary to enter the password when [TLS] is selected in [EAP method].

* Appears only when [802.1x EAP] in [Security Method] is selected.





6 Tap [Save].

The Digital Paper device connects to the wireless network.

You can check the Wi-Fi connection status by the Wi-Fi icon on the status bar (page 14).

For details on Wi-Fi settings, see page 43.

General notes on Wi-Fi connectivity

- Tap a network SSID in the [Wi-Fi Networks] list to display the access point's status and related information.
- Before setting the Wi-Fi network connection, refer to the instructions of the Wi-Fi router, and check the SSID and security method.
- You can configure up to 20 Wi-Fi network connections.
- The device does not support certain custom Wi-Fi network security systems. For details, refer to your Wi-Fi router's instruction manual.
- If you change the password of the connected Wi-Fi router, enter the new password and reconnect it.
- To use a static IP address, press the  (Menu) button in [Wi-Fi Settings] → tap [Advanced] → tap [Use Static IP]. Select the option and enter the address. When the setting is completed, press the  (Back) button to return to [Wi-Fi Settings]. Do not change this setting unless instructed to by a network administrator, as the Wi-Fi network connection may not be established correctly.
- If the SSID is hidden on the Wi-Fi router, it will not be displayed in the [Wi-Fi Networks] list of the device. In this case, manually set up the Wi-Fi network.
- The access point may filter access by MAC address. Check the MAC address by pressing the  (Home) button → tap [Settings] → [About] → [Device Information], then register the MAC address with the access point to establish a Wi-Fi connection.
- To check the network speed and security method for the connected Wi-Fi network, press the  (Menu) button in [Wi-Fi Settings] → tap [Connection Information].
- An access point, once configured, can be connected to again simply by tapping it in the [Wi-Fi Networks] list and tapping [Connect].

Using the Network Drive

By using the WebDAV protocol, you can access a specific network drive to synchronize documents between the Digital Paper device and the network drive, or transfer documents from the device to the network drive. Connect to a Wi-Fi network beforehand (page 38).

Setting the Network Drive

You can set the log in information, On/Off of Auto Sync, and download destination. Check with the network administrator for setup information.

- 1 Press the  (Home) button → tap [Settings] → [Network Drive Settings].
- 2 Tap [Server Settings] → tap the input area and enter each item using the on-screen keyboard.

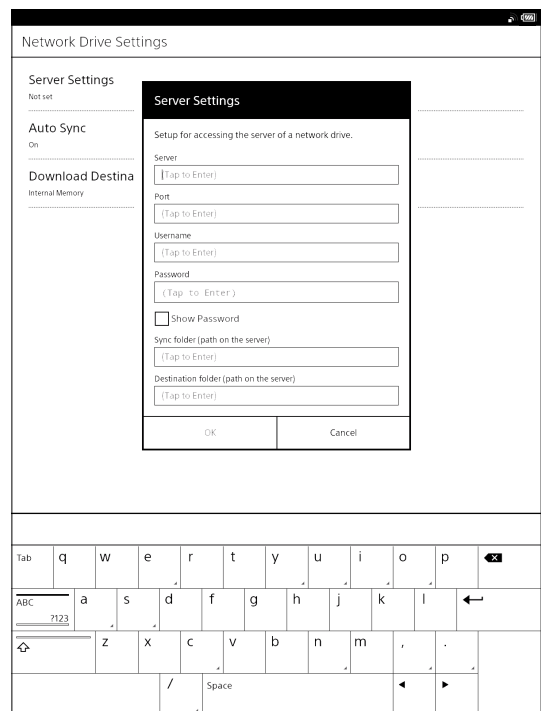

Item	Description
[Server]	Enters the URL of the network drive.
[Port]	Enters the port number.
[Username]	Enters the username to log in the network drive.
[Password]	Enters the password to log in the network drive.

Item	Description
[Sync folder (path on the server)]	Enters the sync folder (path on the server) for the network drive.
[Destination folder (path on the server)]	Enters the destination folder (path on the server) when transferring to the network drive.

- 3 Tap [OK] when the setting is finished.
- 4 Tap [Auto Sync], then select [On] or [Off].
If [On] is set, the Digital Paper device and network drive are synchronized every 90 minutes automatically.
- 5 Tap [Download Destination], then select the destination in the Digital Paper device.
When setting [SD Card] as the destination, insert a microSD card beforehand.

Tip

- If you change [Server Settings] or [Download Destination], the previous synchronized documents will be deleted. It is recommended to synchronize the document in the Digital Paper device with the network drive beforehand.

Synchronizing the Digital Paper Device with the Network Drive

When synchronizing with the network drive for the first time, documents in the network device are downloaded to the Digital Paper device. Whenever you synchronize again, any editing to documents in the Digital Paper device will be reflected in the respective file in the network device.

- 1 Connect to the Wi-Fi network.
- 2 Press the  (Home) button → tap [Documents].
- 3 Tap [Network].

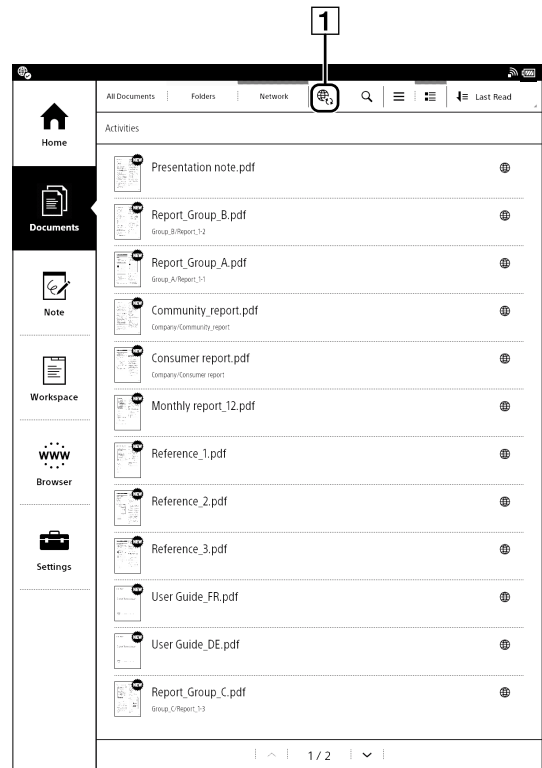

- 1 Sync icon



- 4 Tap  (Sync).

The documents in the folders of the Digital Paper device and the network drive are synchronized. The status or result of synchronization is displayed in the status bar (page 14). To check for detailed information, tap the status bar to display the notification window.

Tip

- When [Auto Sync] is set to [On], the Digital Paper device and the network drive is synchronized automatically (page 43).

Cancel the synchronization

- 1 Tap  (Cancel Sync) during the synchronization. To cancel auto synchronization, press the  (Home) button → tap [Documents] → [Network] → .

Opening a Synchronized Document in the Digital Paper Device

You can open a synchronized document from [Documents] in the Digital Paper device.

- 1 Press the **⬆** (Home) button → tap [Documents].
- 2 Tap [Network].

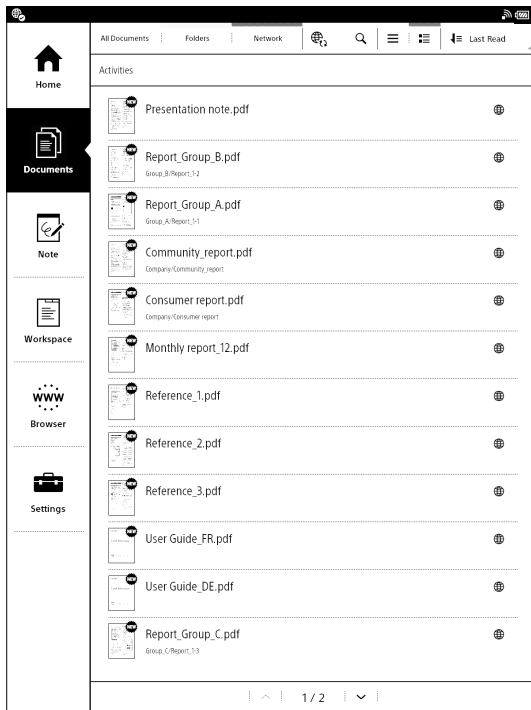

- 3 Tap the document you want to open.
The document opens.
For more details on opening a document, see page 22.

Tip

- Alternatively, you can open the document from [All Documents] or [Folders].
- For details on document lists, see page 19. For details on the page control, see page 23.

Deleting a Synchronized Document

When a synchronized document is deleted in the Digital Paper device, the document is deleted from the network drive the next time synchronization is performed.

- 1 Press the **⬆** (Home) button → tap [Documents].
- 2 Tap [Network].
- 3 Tap and hold the document you want to delete → tap [Delete] from the option menu.
The confirmation screen is displayed.
- 4 Tap [Yes].

Tip

- When deleting multiple documents at one time, press the **☰** (Menu) button → tap [Delete]. For details, see page 21.
- A document deleted and synchronized in the network drive will not be deleted in the Digital Paper device.

Transferring a Document from the Digital Paper Device to the Network Drive

You can transfer a document from the Digital Paper device to the destination folder in the network drive. You can also transfer a non-synchronized document. The transferred document is assigned the same name as the previous document, with the suffix "from_Sync folder_date_time.pdf".

- 1 Connect to the Wi-Fi network.
- 2 Press the **⬆** (Home) button → tap [Documents].
- 3 Tap [All Documents], [Folders] or [Network].
- 4 Tap and hold the document that you want to transfer, then tap [Send] in the option menu.
The destination screen is displayed.
- 5 Tap the destination, and check the check box.
To select all destinations, tap [Select All].
- 6 Tap [OK].
The confirmation screen is displayed.

7 Tap [Yes].

Synchronized documents are transferred to the same layer in the destination folder. Non-synchronized documents are transferred to just below the layer in the destination folder.



Note

- If a document of the same name already exists in the destination folder, it will be overwritten.

Tip

- Alternatively, press the  (Menu) button, then tap [Send], while the document is displayed.

Sending multiple documents simultaneously

- 1 Connect to the Wi-Fi network.
- 2 Press the  (Home) button → tap [Documents].
- 3 Tap [Network].
- 4 Press the  (Menu) button → tap [Send].
Boxes appear next to the thumbnails or list entries.

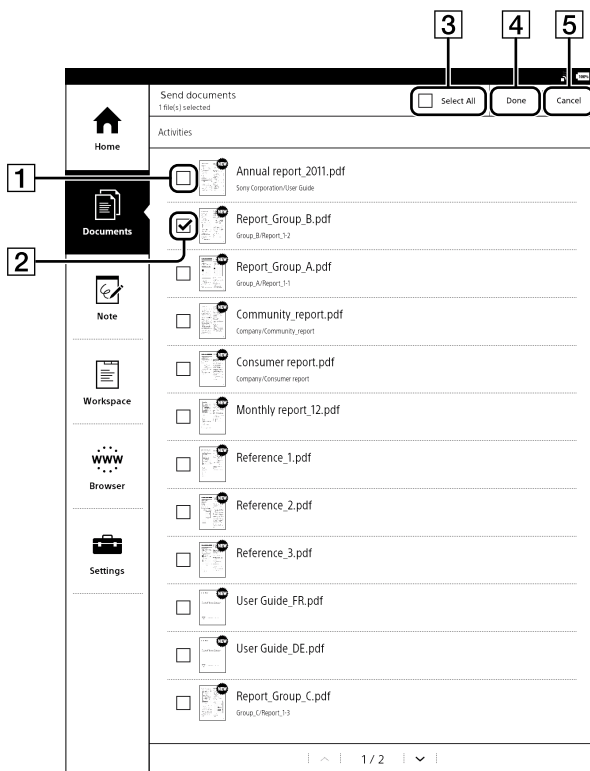

- 1 Check box Off

- 2 Check box On (Target destination)

- 3 [Select All]

- 4 [Done]

- 5 [Cancel]

- 5 Tap to check the document(s) to send.
Tap [Select All] to check all check boxes.

- 6 Tap [Done].
The destination screen is displayed.

- 7 Tap the destination and check the check box.
To select all destinations, tap [Select All].

- 8 Tap [OK].
The confirmation screen is displayed.

- 9 Tap [Yes].

Returning the document

You can return a document when the Digital Paper device can identify the sender from the name of the document (page 45). The returned document will be stored in the network drive. When the sender synchronizes with the network drive, the document will be returned to the sender.

- 1 Connect to the Wi-Fi network.
- 2 Press the  (Home) button → tap [Documents].
- 3 Tap [All Documents], [Folders] or [Network].
- 4 Tap and hold the document that you want to return → tap [Reply] in the option menu.
The confirmation screen is displayed.
- 5 Tap [Yes].

Tip

- Alternatively, press the  (Menu) button, then tap [Reply], while the document is displayed.

Using Menu Items



Below is a list of option items available when you press the  (Menu) button on the synchronized documents list.

Option	Description
[Sync]	Synchronizes documents with the Digital Paper device and network drive (page 44).
[Cancel Sync]	Cancels synchronization between the Digital Paper device and network drive (page 44).
[Open]	Opens a document (page 22).
[Delete]	Deletes a document (page 45).
[Send]	Transfers documents from the Digital Paper device to the network drive (page 45).

Browser

The Digital Paper device has a Web browser that enables you to visit Web pages and download PDF files. Connect to the Wi-Fi network beforehand (page 38).

Browsing the Web

- 1 Connect to the Wi-Fi network.
- 2 Press the  (Home) button → tap [Browser].
- 3 Navigate to a Web page.
 - Tap  (Bookmarks) → tap a Web page, or
 - Tap the URL box and type the URL address using the on-screen keyboard, and tap [Go].
- 4 Browse the Web page.
 - Swipe your finger or use the stylus on the touchscreen to scroll up/down a Web page.
 - Tap and drag to move the view area.
 - Press the  (Back) button to return to the previous Web page.

Note

- You must agree to the terms and conditions before using the [Browser] application. Please read the terms and conditions carefully. When you tap [Accept], the [Browser] application opens.

Tip

- To return to your last read document, press the  (Menu) button → tap [Return to Viewer].

Zooming in on the Web

While in zoom mode, the zoom bar is shown at the bottom-left of the screen.

- Pinch out to zoom in.
 - Pinch in to zoom out.
 - Double-tap to fit the page to the window size.
- To exit zoom mode, pinch in or double tap again.

Downloading

When you click a download link, the item will be downloaded onto the device. Only the PDF files (.pdf) can be downloaded.

- 1 Tap the link on the Web page.
- 2 Tap [Yes] when the confirmation screen is displayed.

Downloaded files are stored in [Documents].

Tip

- You can also tap and hold the link → tap [Save Link] to download a linked file.

Viewing download progress

You can check the download progress and result.

- 1 Check the download progress by the icon on the status bar.
Tap the status bar to open the notification window (page 14).
The document currently downloading is listed under [Ongoing].
Documents that have been downloaded or failed to download are listed under [Notifications].
Press the ↶ (Back) button to return to the Web page.

Canceling a download

You can cancel a download that is currently in progress.

- 1 When viewing a Web page, press the ≡ (Menu) button → tap [Downloads].
The download history opens.
You can also tap the status bar → tap the item currently downloading under [Ongoing].
- 2 Tap and hold the document to cancel → tap [Cancel Download], or press the ≡ (Menu) button → tap [Cancel All Downloads].

To return to the Web page, press the ↶ (Back) button.

Opening a downloaded file

You can view files downloaded from a Web page. Downloaded files are stored in [Documents].

- 1 While viewing a Web page, press the ≡ (Menu) button → tap [Downloads].
- 2 Tap the file to open, or tap and hold the document → tap [Open].
The file opens.

Deleting a downloaded file

You can delete downloaded files from the Digital Paper device.

- 1 While viewing a Web page, press the ≡ (Menu) button → tap [Downloads].
- 2 Tap and hold the document to delete → tap [Delete].
The confirmation screen is displayed.
- 3 Tap [OK].
The document is deleted from the Digital Paper device.

Using Multiple Windows

Opening a new window

- 1 While viewing a Web page, press the ≡ (Menu) button, tap → [Windows] → [New Window].
Up to 3 windows can be open at one time. If [New Window] is not displayed, tap [Close] to close a currently open window.

Opening a link page in a new window

You can open a link page in a new window without closing the current window.

- 1 Tap and hold a link → tap [Open in New Window].
The link opens in a new window.
Up to 3 windows can be open at one time. You cannot open a new window if three windows are currently open.

Changing the browser window in view

When you have more than one browser window open, you can change the window in view.

- 1 While viewing a Web page, press the  (Menu) button → tap [Windows].
- 2 Select the window you want to view.

Closing the browser window

You can close browser windows.

- 1 When viewing a Web page, press the  (Menu) button → tap [Windows].
- 2 Tap [Close].
The window is closed.



Tip

- When all windows are closed, the browser home page is automatically opened.

Bookmarks and History

Bookmarking a Web page

You can bookmark your favorite Web pages to review them quickly.

- 1 Visit the Web page that you want to bookmark.
- 2 Add the current site to the bookmarks.
 - Press the  (Menu) button → tap [Add Bookmark], or
 - Tap  (Bookmarks) next to the URL box → tap [Add Bookmark...].
- 3 If you want to change the name, tap the input area under [Name] and enter a new name using the on-screen keyboard.
- 4 Tap [OK].
The current Web page is added to the bookmark list.

Opening a bookmarked Web page

You can quickly return to your favorite Web pages using bookmarks.



- 1 When viewing a Web page, tap  (Bookmarks) next to the URL box.

The bookmark list opens.

- 2 Tap the Web page to open.



Editing a bookmark

You can change a bookmark name or address (URL) if necessary.

- 1 When viewing a Web page, tap  (Bookmarks) next to the URL box.
The bookmark list opens.
- 2 Tap and hold the bookmark to edit → tap [Edit Bookmark].
- 3 Tap the input area under [Name]/[Location] and change the name/URL using the on-screen keyboard.
- 4 Tap [OK].
To return to the Web page, press the  (Back) button.

Deleting bookmarks

You can remove bookmarks from the bookmark list.

- 1 When viewing a Web page, tap  (Bookmarks) next to the URL box.
The bookmark list opens.
- 2 Tap and hold the bookmark to remove → tap [Delete Bookmark].
- 3 Tap [OK].
The bookmark is removed from the list.
To return to the Web page, press the  (Back) button.

Opening a previously visited Web page

You can view a list of Web pages that you have previously visited.

- 1 When viewing a Web page, tap  (Bookmarks) next to the URL box.
- 2 Tap [History].

A list of Web pages that you have previously visited opens.

- 3 Tap the document to open in the browser.

Deleting browsing history

You can remove entries from the browsing history.

- 1 When viewing a Web page, tap  (Bookmarks) next to the URL box.
- 2 Tap [History].
A list of Web pages that you have previously visited opens.
- 3 Tap and hold the entry to remove from the list ▶ tap [Remove from History].

To return to the Web page, press the  (Back) button.

Tip

- You can delete all the browsing history by pressing the  (Menu) button ▶ tapping [Clear History] in Step 3.

Browser Settings

You can change the following browser settings to your preference. When viewing a Web page, press the  (Menu) button and tap [Settings] to change the settings.

Setting	Description
[Default Zoom]	Sets the default zoom ratio. [Medium] is set by default.
[Open Pages in Overview]	Opens the page scaled to the window size. Enabled by default.
[Text Encoding]	Sets the default text encoding. [Unicode (UTF-8)] is set by default. The browser supports the following encodings: <ul style="list-style-type: none"> • Latin-1 (ISO-8859-1) • Unicode (UTF-8)
[Block Pop-up Windows]	Blocks pop-up windows. Enabled by default.
[Load Images]	Loads images on a Web page. Enabled by default.

Setting	Description
[Auto-fit Pages]	Formats Web pages to the window size. Enabled by default.
[Enable JavaScript]	Enables JavaScript. Enabled by default.
[Set Home Page]	Sets the default Web page to display as the home page.
[Page Information]	Displays the details of a Web page.
[Clear Cache]	Empties the cache.
[Clear History]	Deletes the browsing history.
[Accept cookies]	Accepts cookies from Web pages. Enabled by default.
[Clear All Cookie Data]	Removes all cookies.
[Remember Form Data]	Allows the browser to remember the search and form history. Enabled by default.
[Clear Form Data]	Empties the search and form history.
[Remember Passwords]	Allows the browser to remember entered passwords. Enabled by default.
[Clear Passwords]	Deletes passwords saved by the browser.
[Reset to Default]	Restores the default settings, and deletes all browser data.
[Legal Information]	Displays the terms and conditions of use of the browser.

To return to the Web page you were browsing, press the  (Back) button.

Using Menu Items

Below is a list of option items available when you press the  (Menu) button from a browser window.

Option	Description
[Browse Home]	Displays the home page (page 50).
[Refresh]	Updates the content displayed on a Web page.
[Stop]	Stops loading a Web page.
[Forward]	Advances to a previously viewed page.
[Return to Viewer]	Closes the [Browser] application and returns to the last read page of your last read document.
[Windows]	Opens the window list (page 48).
[Add Bookmark]	Bookmarks a Web page (page 49).
[Page Information]	Opens the page information.
[Downloads]	Opens the download history (page 48).
[Settings]	Changes the browser settings (page 50).

Settings

Changing the Settings

Changing the Settings

The [Settings] application allows you to personalize the Digital Paper device, set the date and time, configure the Wi-Fi connection, and other device settings.

General Settings

Setting	Description
[User Name]	Sets the user name to help identify the user of the Digital Paper device, and the author name of an annotation. The user name will be shown in the top-right corner of the [Home] screen.

Wireless Network Settings

Setting	Description
[Wi-Fi]	Turns Wi-Fi on/off (page 38).

Setting	Description
[Wireless Standby]	Wireless standby helps avoid unnecessary battery consumption caused by wireless communication. If you do not perform any wireless operations for more than 10 minutes, the wireless feature automatically enters standby mode. Note <ul style="list-style-type: none">• Accessing the [Browser] application from wireless standby mode takes more time than accessing when the Digital Paper device is connected to the wireless network.• If you deactivate wireless standby, the Digital Paper device retains a wireless connection at all times, resulting in higher battery consumption.
[Wi-Fi Settings]	Wi-Fi settings enable the Digital Paper device to use local Wi-Fi networks to connect to the Internet (page 38).

Network Drive Settings

Setting	Description
[Server Settings]	Sets the network drive settings (page 45). Check with the network administrator for setup information. Tip <ul style="list-style-type: none">• If you change [Server Settings], the previous synchronized documents in the network drive will be deleted. Before changing, it is recommended to synchronize the documents in the Digital Paper device with the network drive.
[Auto Sync]	Sets Auto Sync to [On] or [Off]. When [Auto Sync] is set to [On], the Digital Paper device and network drive are synchronized every 90 minutes.

Setting	Description
[Download Destination]	<p>Sets the destination for synchronized documents downloaded from the browser. Select either [Internal Memory] or [SD Card].</p> <p>Tip</p> <ul style="list-style-type: none"> If you change [Download Destination], the previous synchronized documents will be deleted. Before changing, it is recommended to synchronize the documents in the Digital Paper device with the network drive.

Application Preferences

Setting	Description
[Documents]	Sets preferences for all documents. [Refresh Display]: Refreshes the display at each page turn.
[Browser]	Sets the browser preferences.

Date & Time Settings

Setting	Description
[Date]	Sets the date.
[Time]	Sets the time.
[Date Format]	Sets the date format.
[24-Hour Format]	Checks to display time in 24 hour-format.
[Time Zone]	Sets the time zone.

Tip

- When the Wi-Fi connection is turned on, the Digital Paper's time setting is adjusted automatically.

System Management

Setting	Description
[Device Lock]	<p>Sets a 4-digit PIN for the Digital Paper device to prevent unauthorized use.</p> <p>To set [Device Lock] to [On], input your 4-digit PIN ► tap [OK] to enter it again ► tap [OK]. When [Device Lock] is set to [On], you must unlock the device with the 4-digit PIN when waking it up from sleep mode, or when turning on the power.</p> <p>To set [Device Lock] to [Off], input your 4-digit PIN and tap [Continue].</p> <p>Note</p> <ul style="list-style-type: none"> Sony recommends that you make a note of your 4-digit PIN and keep it in a safe place separate from the device. If you forget your 4-digit PIN, contact the Sony Support Center. Note that in unlocking your device, all content on it will be erased.
[Download Destination]	Sets the destination for files downloaded from the browser. Select [Internal Memory] or [SD Card].
[Pen settings]	<p>[Pen Grip Style] Selects the style that is closest to the way you hold your pen.</p> <p>[Advanced Calibration] Adjusts positioning between the screen's surface and the pen's nib.</p> <p>[Highlighting with pen button] Sets the highlight when the pen button is pressed and dragged.</p> <p>[Eraser Animation] Sets the erasing effect of the animated circle (page 31).</p>
[Check for Updates]	Checks the update information.

Initialization

Setting	Description
[Restore Defaults]	Restores the default device settings. Note <ul style="list-style-type: none">Settings are returned to their factory values. However, documents in internal memory will not be deleted.
[Clear Keyboard History]	Deletes words registered to the on-screen keyboard history.
[Format Memory]	Allows you to format the Digital Paper's internal memory and the microSD card. Note <ul style="list-style-type: none">If you have formatted the device or microSD card on your computer, the device may not be able to display transferred content. In this case, use the device's [Format Memory] function to reformat the device and your microSD card.When either memory is formatted, content download stops. Tip <ul style="list-style-type: none">Before formatting, make sure to back up data you wish to keep to a computer via the device software.

Device Shutdown

Enables you to shut down (turn off) the device, instead of leaving it in sleep mode.

About



Setting	Description
[Device Information]	Displays the device details including the memory capacity and MAC address in use.
[Legal Information]	Displays trademark and copyright information.
[Regulatory Information]	Displays the VCCI mark based on RULES FOR VOLUNTARY CONTROL MEASURES, and the marks and registration numbers of the radio wave and radio communication acts.
[End User License Agreement]	Displays the terms and conditions on use of the device.

Other Information

Troubleshooting

Troubleshooting Tips

Troubleshooting tips may help you quickly resolve technical issues.

- 1 Charge the Digital Paper device completely.
- 2 Press the  (Power) button to restart the device.
- 3 Press the RESET button if the screen freezes and the  (Power) button is inoperable.

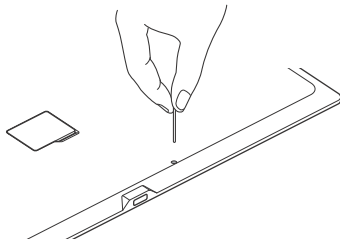

Press the RESET button with a small pin or clip.

Note

- Page flags, highlights, sticky notes or setting information may be deleted by resetting.
- Do not push the RESET button with a breakable point, such as the lead of a mechanical pencil. It can block the RESET button.

Re-attaching the stylus holder

If the stylus holder becomes detached, re-attach it as illustrated below.

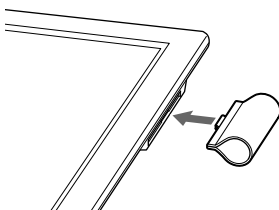

Replacing the Nib

The effectiveness of the supplied nib differs from that of the attached nib. Sony recommends replacing the nib when it becomes shorter than 1.5 mm (1/16 inch). Replacement nibs and a nib puller are supplied with the Digital Paper device.

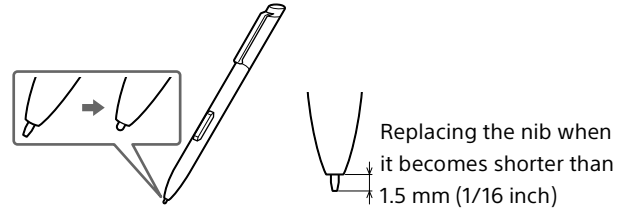

- 1 Pinch the nib with the supplied nib puller, then pull it out squarely.

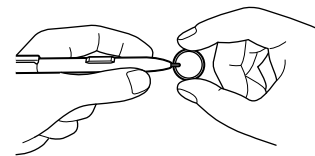

- 2 Pinch the replacement nib of the pen, then push it squarely into the pen.

- 3 Push the nib firmly with your finger.

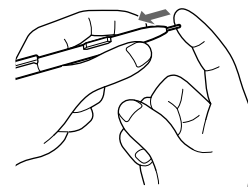

Note

- Keep out of reach of children, as the nib may be swallowed. If the pen is in your mouth, the pen's nib or the button may fall out.
- Pressing on the nib with excessive pressure will wear it out more quickly.

Tip

- Replace the pen's nib periodically to prevent damage to the Digital Paper device and maintain smooth operation.
- If the pen's nib is lost, contact the Sony Support Center.

Digital Paper Device

Power On/Off

The Digital Paper device will not turn on.

- The device cannot be operated if connected to your computer and set to transfer data. Use the Safely Remove Hardware function of your computer, and then disconnect the USB cable from the device.
- Moisture condensation may have occurred. Wait for a few hours, then turn it on.
- If the battery is completely depleted, you may not be able to turn on the device. In this case, connect the device to the supplied AC adapter or your computer via the supplied USB cable; the device will turn on immediately. If it does not turn on, press the  (Power) button. If the Charge indicator blinks red 3 times, disconnect the AC adapter or the USB cable from the device, then reconnect it. If the battery is completely depleted, it may take up to 5 minutes for the Digital Paper device to turn on.

The Digital Paper device automatically enters sleep mode or turns off.



- To conserve the battery's charge, the device includes automatic power saving modes. The device will enter sleep mode after 1 hour of inactivity. After 3 days* in sleep mode, it will shut down/power off automatically.

* If the battery's charge is low, the device may automatically turn off within 3 days.



Battery

Cannot charge the Digital Paper device.

- If you use equipment other than the supplied USB cable or AC adapter to charge the device, it may not charge correctly. We do not guarantee the performance and safety of the device. To charge the device, use only the supplied USB cable, or the supplied AC adapter (page 6).
- If you are charging from the USB port on your computer, make sure that the device is connected directly to the USB port with the supplied USB cable. Do not use a USB hub.

- The battery has not been given enough time to fully charge. Charge the device until the  icon changes to the  icon. (The charge icon does not indicate the remaining battery power while charging.)
- If you are charging from a USB port on your computer, your computer must be turned on to charge the device. The device will not be charged if your computer enters sleep mode, standby mode or hibernation. Keep your computer turned on with a stable and continuous power supply while charging the device.
- If your computer enters sleep mode while the device is connected and charging, the device battery's charge will gradually drain, the device will shut down and its battery will not charge. In this case, disconnect the USB cable from the device, wake the computer from sleep mode, then reconnect the USB cable to the device.
- Your computer may not be supplying sufficient power. If you connect the device to your laptop computer, maintain a stable and continuous power supply to the laptop computer while charging the device.
- If the ambient temperature is too cold or too hot for the device to charge, adjust the room temperature to between 5°C (41°F) and 35°C (95°F), then disconnect and reconnect the USB cable.

Battery life seems short.

- The device may not have been fully charged. Make sure that you charge it until  changes to .
- The operating temperature is below 5°C (41°F). This is due to the battery characteristics and not a malfunction.
- The device requires power while in sleep mode. If you are not planning to use the device, turn it off instead of leaving it in sleep mode.
- If you are not browsing on the Web, exit [Browser] by pressing the  (Home) button.
- The device battery gradually discharges when not in use for a prolonged period of time. Before turning on the device after the device has not been used for a long time, recharge it.
- If you are not using wireless communications, turn off Wi-Fi (page 38).

- If you are charging the device during data transfer and the computer enters sleep mode, standby mode or hibernation, the device will be unable to charge, and the battery may drain. When charging the device via computer, confirm that your computer is on, and completely charge the device before using it.

Touchscreen

The Digital Paper device does not wake up or start immediately.

- When using the device in an environment that is too cold, the screen may change at a slower speed. Use the Digital Paper device within the recommended temperature range of 5 °C (41 °F) to 35 °C (95 °F).

The touchscreen does not respond.

- Reset the device (page 55).

Characters are not displayed.

- Some user-defined characters or special symbols may not be displayed.



The touchscreen responds slowly.

- If the touchscreen becomes dirty, it may not function correctly. Clean the touchscreen with a soft cloth, such as a cleaning cloth for eyeglasses.

Cannot pinch in or out.

- The touchscreen may not respond if other fingers are in contact with the screen.

The pen's nib position and the mark it makes are offset

- Check the pen grip. Press the  (Home) button, tap [Settings] → [System Management] → [Pen settings] → [Pen Grip Style] to check the settings.
- Adjust the position of the pen's nib. Press the  (Home) button, tap [Settings] → [System Management] → [Pen settings] → [Advanced Calibration] to check the settings.

Wireless Connectivity

Wi-Fi connection

The Digital Paper device does not connect to the Wi-Fi network.

- The network feature could not be turned on because the remaining battery power is too low. Charge the device for a few minutes, then try again.
- Make sure that Wi-Fi is turned on and check the signal strength of the access point.
- Tap [Wi-Fi Settings] → [Scan] to select an available access point.
- Make sure that the security method (WEP, WPA/WPA2 PSK, 802.1x EAP), the static IP address and the proxy settings are correct.
- The access point is using an unsupported security method or encryption key.
- Public Wi-Fi networks may require a user ID and password. In this case, you must enter a correct user ID and password to establish a network connection.
- The access point has the MAC address filter enabled. To check the MAC address, press the  (Home) button → tap [Settings] → [About] → [Device Information]. Make sure that this MAC address is accepted by the access point.
- The Wi-Fi network settings of the access point are not correct. Adjust the settings as described in the manuals that came with the access point and in any information provided by the network administrator.
- The device is too far from the access point. Move it closer to the access point and scan again.
- Obstacles such as walls, metal or concrete between the device and an access point may adversely affect the connection. Try moving the device to a different location and scan again.
- There is other equipment nearby using the 2.4 GHz frequency band (such as a cordless phone, a microwave oven, or Bluetooth computer equipment). Move the equipment away or turn it off.
- The Wi-Fi network service is temporarily not available or degraded. Check with the network administrator for the status.

Cannot find the access point in the Wi-Fi networks list.

- The access point you want to use is set to not broadcast its SSID to users. In this case, the access point may not be shown on the Wi-Fi network list. Tap [Add Wi-Fi Network] and enter the SSID manually (page 42).

Network drive

Cannot find the destination.

- Check the network connection (page 57).
- There is a problem with the Destination folder (path on the server) or network drive. Check with the network administrator.
- When selecting [Reply], the Digital Paper device identifies the sender by the file name automatically. Check that the destination name is in the Destination folder list (page 45).

Browser

A Web page is not displayed properly.

- The Wi-Fi network connection may have been interrupted. Make sure that Wi-Fi is turned on and set up correctly, check the signal strength of the access point, then refresh the Web page.
- Due to the vast range of standards and technologies used to design Web pages, it is not possible to guarantee that all pages will be displayed correctly.
- When you pinch in/out to zoom in/out a Web page, the screen may be too bright to read. This is not a malfunction.

Reading Documents

Cannot open a document.

- The document may be an unsupported file type. For details on supported file types, see page 66.

[Return to Viewer] does not work, or the page flag is missing.

- If the file status has changed (such as in the case below), data under [Return to Viewer] or notes may be deleted.
 - A PDF file is edited.

Cannot find content on the Digital Paper device.

- If you have formatted the device on your computer, the device may not be able to display transferred content. In this case, use the device's [Format Memory] function to reformat the device (page 54).
- If you delete or modify folders or files in the "database" folder on your computer, content or notes may be deleted.

Cannot annotate a document.

- When a document is protected or opened as read-only, annotating/editing/saving/deleting cannot be done.
- The document is opened as read-only. This is indicated by the tab.
 - The file is read-only.
 - There may not be enough space in the internal memory or microSD card.
 - The remaining battery charge is too low.

Cannot open sticky notes by the stylus.

- To open a sticky note, tap it with a finger, with the stylus while pushing the button, or tap the sticky note in the toolbox.

Connecting to Your Computer

The computer does not detect the Digital Paper device.

- It may take a while for the computer to detect the device.
- Make sure that the device is connected directly to the USB port with the supplied USB cable. Do not use a USB hub.
- Try connecting to a different USB port on the computer.
- Try disconnecting the device and connecting it again.
- If none of the above solves the problem, reset the device (page 55).

Cannot transfer content to the Digital Paper device.

- There may not be enough space on the device or the memory card. Check [About] for the amount of free space on internal memory (page 54). Delete some content, or copy it to your computer to make some space on the device or memory card.

microSD Card

The Digital Paper device cannot detect a microSD card, or cannot open an item stored on a microSD card.

- If you have formatted the microSD card on the computer, the device may not be able to display transferred content. Use the device to format the microSD card (page 63).
- It may take a while for the device to detect the microSD card and load all files stored on it. Wait a little longer after inserting the microSD card into the card slot.
- Make sure that the microSD card is supported by the device (page 63).
- Make sure that the microSD card is inserted properly (page 11).
- Make sure that the gold contact point of the microSD card and the card slot are clean. If dirty or dusty, clean them carefully.

Cannot move a document to the microSD card.

- You cannot move a document directly from the internal memory to a microSD card. Connect the Digital Paper device to a computer, then move the document via the computer.

Precautions

Safety Information

Handling the Digital Paper device

- If the device causes interference to radio or television reception, turn the device off and move it away from the radio or television.
- Refrain from using the Digital Paper device according to the in-flight announcements during take off or landing in an aircraft.
- When you put the Digital Paper device into a bag, make sure no objects with sharp or hard edges come into direct contact with the device.
- When you carry the Digital Paper device, it is recommended to use the sleeve cover.
- Do not drop, or put any heavy object on top of the device or apply a strong shock to the device. It may cause a malfunction or damage.
- Never subject the device to extremes of light, temperature, moisture or vibration.
- If part of the device that generates heat contacts your skin for a prolonged period, you may suffer from symptom of burn, such as redness, swelling, even if temperature is moderate. Avoid prolonged contact, especially if you have sensitive skin.
- Do not leave the device on an unstable surface.
- Do not poke people using the supplied stylus.
- Do not treat or use the supplied stylus roughly, such as bending it, or scratching the touchscreen with it.
- Use the supplied stylus only for touchscreen operations.
- Do not use the stylus if it is damaged or deformed.
- Do not subject the stylus to shock or vibration.
- Do not apply any excessive pressure to the stylus tip and stylus button during operation.
- Do not keep the stylus tip pressed while the stylus is not in use.
- Do not locate the stylus close to a magnet.
- If any object is placed on the touchscreen, it may cause a malfunction. When not in use, leave the device in sleep mode, or turn it off.

- When using the device internationally, it is your responsibility to ensure that it is used in compliance with the following specifications:
 - AC voltage
 - Wireless products regulations
 - Other safety regulations or requirements
- Be sure not to short-circuit the terminals of the device with metallic objects.
- Never leave the device exposed to high temperature, such as in a car parked in the sun or under direct sunlight.
- Connect the AC adapter to an easily accessible AC outlet. Should you notice an abnormality in the AC adapter, disconnect it from the AC outlet.

Avoiding water and moisture

- Note that condensation may form temporarily in cases such as when the player is moved quickly from a low-temperature environment to a high temperature environment or used in a room that has a heater just turned on. Condensation creates a phenomenon where moisture in the air adheres to surfaces such as metal panels, etc., and then changes to liquid. If condensation forms in the device, leave it turned off until the condensation disappears. If you use the device with condensation present, a malfunction may result.
- The Digital Paper device is not waterproof. Remember to follow the precautions below.
 - Be careful not to drop the device into a sink or other container filled with water.
 - Do not use the device in humid locations or bad weather, such as in the rain or snow.
 - Do not get the device wet.

If you touch the device with wet hands, or put it in a damp article of clothing, the device may get wet and this may cause a malfunction.

Charging the Digital Paper device

- Heat may build up in the device while charging, or if it is used for an extended period of time.
- Use the supplied USB cable or the AC adapter only. Do not use any other USB cable or AC adapter.
- Never wrap the device in anything when it is being charged. Heat build-up in the device may cause malfunction or damage.
- If the battery quickly runs out of power after being fully charged, it may be reaching the end of its life

and should be replaced. Consult the Sony Support Center.

Cleaning the Digital Paper device

- Clean the device with a soft cloth, such as a cleaning cloth for eyeglasses. Make sure that there is no dust or dirt on the soft cloth, as the device may be damaged.
- Do not use any type of abrasive pad, scouring powder or solvent, such as alcohol or benzene, as it may mar the finish of the case.
- Wipe the stylus with a dry cloth when it gets dirty. Tapping or dragging on the touchscreen using a dirty stylus may damage the surface.
- Be sure to keep the device away from water or spills.

End User License Agreement

- You can display the End User License Agreement from the [Settings]. Tap [Settings] in the [Home] screen, then tap [About] ▶ [End User License Agreement].

Display

- The display is made of plastic film to be thin and lightweight. When the Digital Paper device is illuminated, distortion of the plastic film may occur. This is not malfunction.
- Do not apply excessive pressure to the touchscreen. The color or brightness may become uneven, and may cause malfunction to the device.
- When using the device in a cold environment, the screen may change at slower speed. This is not a malfunction.

Wi-Fi connectivity



- The Wireless LAN functionality has passed Wi-Fi certification and complies with the interoperability specifications established by WFA (Wi-Fi Alliance).

Wireless feature

- Turn off the wireless feature when you are in a location in which radio communications are prohibited. When you are in such a location, you must obtain permission from the appropriate authorities before enabling the wireless feature of this device.

- Turn off the wireless feature in health care facilities where any regulations posted in such areas instruct you to do so. Hospitals or health care facilities may be using equipment that could be affected by radio frequency (RF) energy which is generated by wireless communication.
- Do not use your device near medical equipment without first obtaining permission to do so.
- General notes on using the Wi-Fi (Wireless LAN) function.
In some countries or regions, use of Wi-Fi products may be restricted by the local regulations (e.g. limited number of channels).

Applications on the Digital Paper Device

Disclaimer: In no event will SONY be liable for any financial damage, or loss of profits, including claims made by third parties, arising out of the use of the software supplied with this device.

Sony is not responsible for incomplete recording/ downloading or damaged data due to problems of the device or computer.

- Copyright laws prohibit reproducing the software or the manual accompanying it in whole or in part, or renting the software without the permission of the copyright holder.
- Due to continued efforts to improve quality, software specifications may be changed without notice.
- Operation of this device with software other than that provided is not covered by the warranty.
- Depending on the types of the text and characters, the text shown on the device may not be displayed properly. This is due to:
 - The capacity of the device.
 - The device is not functioning normally.
 - Content information is written in the language or the character that is not supported by the device.
- We do not guarantee all the languages will be able to be displayed properly on your device.
- User-created characters and some special characters may not be displayed.

Touchscreen

- Do not press the screen or screen frame strongly or rub the screen. When operating the Digital Paper device, touch it softly.
- You can use the stylus while resting your hands on the touchscreen. When the pen is near the touchscreen, the finger operation is inactive.

Digital Paper device Disposal Reference

The built-in rechargeable battery of the device is recyclable. Do not remove the battery yourself; consult the Sony Support Center.

For customers in the USA

FCC Compliance Statement

NOTE:

This equipment has been tested and found to comply with the limits for a Class B digital device, pursuant to Part 15 of the FCC Rules. These limits are designed to provide reasonable protection against harmful interference in a residential installation. This equipment generates, uses and can radiate radio frequency energy and, if not installed and used in accordance with the instructions, may cause harmful interference to radio communications.

However, there is no guarantee that interference will not occur in a particular installation. If this equipment does cause harmful interference to radio or television reception, which can be determined by turning the equipment off and on, the user is encouraged to try to correct the interference by one or more of the following measures:

- Reorient or relocate the receiving antenna.
- Increase the separation between the equipment and receiver.
- Connect the equipment into an outlet on a circuit different from that to which the receiver is connected.
- Consult the dealer or an experienced radio/TV technician for help.

You are cautioned that any changes or modifications not expressly approved in this manual could void your authority to operate this equipment.

Declaration of Conformity

Trade Name: SONY

Model No.: DPT-S1

Responsible Party: Sony Electronics Inc.

Address: 16530 Via Esprillo, San Diego, CA 92127
U.S.A.

Telephone Number: 858-942-2230

This device complies with Part 15 of the FCC Rules. Operation is subject to the following two conditions: (1) this device may not cause harmful interference, and (2) this device must accept any interference received, including interference that may cause undesired operation of the device.

- In order to comply with FCC radio-frequency radiation exposure guidelines for an uncontrolled exposure, this device and its antenna must not be co-located or operating in conjunction with any other antenna or transmitter.

FCC Radiation Exposure Statement

This equipment complies with FCC radiation exposure limits set forth for an uncontrolled environment and meets the FCC radio frequency (RF) Exposure Guidelines.

This equipment has very low levels of RF energy that are deemed to comply without testing of specific absorption ratio (SAR).

Notice for customers: the following information is only applicable to equipment sold in countries applying EU directives

This product has been manufactured by or on behalf of Sony Corporation, 1-7-1 Konan Minato-ku Tokyo, 108-0075 Japan. Inquiries related to product compliance based on European Union legislation shall be addressed to the authorized representative, Sony Deutschland GmbH, Hedelfinger Strasse 61, 70327 Stuttgart, Germany. For any service or guarantee matters, please refer to the addresses provided in the separate service or guarantee documents.

Hereby, Sony Corp. declares that this equipment is in compliance with the essential requirements and other relevant provisions of Directive 1999/5/EC. For details, please access the following URL <http://www.compliance.sony.de/>



The validity of the CE marking is restricted to only those countries where it is legally enforced, which includes the countries in the EEA (European Economic Area).



Disposal of Old Electrical & Electronic Equipment
(Applicable in the European Union and other European countries with separate collection systems)

This symbol on the product or on its packaging indicates that this product shall not be treated as household waste. Instead it shall be handed over to the applicable collection point for the recycling of electrical and electronic equipment. By ensuring this product is disposed of correctly, you will help prevent potential negative consequences for the environment and human health, which could otherwise be caused by inappropriate waste handling of this product. The recycling of materials will help to conserve natural resources. For more detailed information about recycling of this product, please contact your local Civic Office, your household waste disposal service or the shop where you purchased the product.

Notes on microSD Cards

SD cards are made to standards and are commonly used as storage media for portable devices. microSD and microSDHC cards are members of the SD card family.

The device supports the following card types.

- microSD and microSDHC cards
 - Up to 32 GB
- microSD cards of up to 32 GB has been tested to work with the device; however, not all microSD cards are guaranteed to work.

Precautions

- Insert into the correct slot with the card's label side up until it clicks into place.
- To avoid a choking hazard, keep the microSD card out of the reach of children.
- Do not touch the gold contact point of the microSD card.
- Do not disassemble or modify a memory card.

- Do not allow a memory card to get wet.
- Avoid the following to prevent data damage. Sony does not provide any guarantee for damaged data.
 - Remove a memory card or turn off the device while reading or writing data.
 - Operate the device in the location where static charge or electrical noise is present.
- Do not strike, bend, drop, disassemble, open, crush, deform, puncture, shred, microwave, incinerate or paint the microSD card.
- Do not use force, a thin stick or tweezers to remove the microSD card. If you cannot remove the microSD card, contact customer support.
- Do not remove the microSD card or turn off the device while data on the memory card is being edited or accessed. Otherwise, edited data will not be saved.
- Do not insert a deformed microSD card into the device.
- If you change or erase a folder name via computer, or move a file to a folder other than “database”, there is a possibility that data recorded in a memory card might be lost or become unreadable by this product.
- You can use a microSD card (less than 2 GB) and microSDHC card (less than 32 GB), but CPRM (Content Protection for Recordable Media) is not supported.
- microSDXC card is not supported.
- FAT (File Allocation Table) is supported.
- exFAT (Extended File Allocation Table) is not supported.

Formatting a microSD card

You can use the device to format a microSD card if necessary.

WARNING

Formatting the microSD card will delete all files stored on it.

1 Press the  (Home) button → tap [Settings] → [Initialization] → [Format Memory] → [SD Card].

2 Tap [Yes].

To cancel, tap [No].

It may take a few minutes to finish formatting the microSD card.

Cannot guarantee the data

Sony is not responsible for damaged (or deleted) data due to problems with the device or computer.

Backup

Sony recommends that you create a backup of the contents of the device in case of operation error or data corruption.

Legal Notice

Further, the trademark™ and registered trademark® symbols are not indicated throughout this document.
Program © 2013 Sony Corporation
Documentation © 2013 Sony Corporation

Legal Notice

The contents of each book pre-loaded on this product are copyrighted works, edited with the cooperation of the publisher.

Copyright laws prohibit copying the data of this product or the contents of this manual (illustrations, related documents, etc.) in whole or in part without the permission of the copyright holder. Additionally, use of the data of this product or the contents of this manual is not allowed without Sony's permission except for personal use.

- Sony, the Sony logo are either trademarks or registered trademarks of Sony Corporation.
- Microsoft, Windows, Windows Vista and Windows Media are trademarks or registered trademarks of Microsoft Corporation in the United States and / or other countries.
- Macintosh and Mac OS are trademarks of Apple Inc., registered in the U.S. and other countries.
- This DPT-S1 contains Adobe® Reader® Mobile software under license from Adobe Systems Incorporated, Copyright © 1995-2011 Adobe Systems Incorporated. All rights reserved. Adobe and Reader are trademarks of Adobe Systems Incorporated.
- This product includes software developed by the OpenSSL Project for use in the OpenSSL Toolkit. (<http://www.openssl.org/>) Copyright © 1998-2011 The OpenSSL Project. All rights reserved.
- Wi-Fi, the Wi-Fi CERTIFIED logo, WPA, WPA2 and Wi-Fi Protected Setup are trademarks or registered trademarks of Wi-Fi Alliance.
- Google is a trademark of Google Inc.
- Foxit PDF SDK Copyright © 2013, Foxit Corporation www.foxitsoftware.com, All rights reserved
- Portions of this software are Copyright ©2005 The FreeType Project (www.freetype.org). All rights reserved.
- This software is based in part on the work of the Independent JPEG Group.

All other system names and product names appearing in this document are the registered trademarks or trademarks of their respective owners.

Appendix

Specifications

Model name

DPT-S1

Basic information

Display	338.0 mm (13.3 inch) diagonal electrophoretic display 1200 × 1600 pixel, 16-level gray scale
Touchscreen	The optical and electromagnetic induction touchscreen
Internal memory capacity (for data storage)/User available capacity	Approx. 4.0 GB/Approx. 2.8 GB Depending on size of pre-loaded. Available memory capacity may vary.
Storable PDF file in the internal memory	Approx. 2,800 files* ¹
Interface	microSD card slot* ² , micro USB terminal

Power source

Battery	Built-in rechargeable battery: 3.7 V DC, 1270mAh	
AC adapter	Input: AC100-240V 50/60Hz 0.2A Output: DC5V 1000mA	
Computer-based charging	Approx. 3.5 hours	
Supplied AC adapter-based charging	Approx. 2.5 hours	
Battery life (continuous page turn)	Maximum Battery	Wi-Fi Off: 3 weeks* ³ Wi-Fi On: 2 weeks* ⁴
	Page turn	Approx. 24,000 continuous page turns when reading only* ⁵
Operating/Charging temperature	5°C to 35°C (41°F to 95°F)	

Wi-Fi*⁶

Wireless standards	IEEE 802.11b/g/n compliant
Frequency band	2.4GHz band
Wireless security	WEP, WPA/WPA2 PSK, 802.1x EAP
Connection type	WPS(Wi-Fi Protected Setup)/ Manual setup
Wi-Fi authentication	Supported

Dimensions/Mass



Dimensions (w/h/d)	Approx. 233 × 310 × 6.8mm (9 1/4 × 12 1/4 × 9/32 inches)* ⁷
Mass	Approx. 12.6oz (358g)
USB cable length	Approx. 58 1/8 inches (1.5 m)
Supplied items	AC adapter × 1, USB cable × 1, Quick Start Guide × 1, Basic Operation Guide* ⁸ , User Guide* ⁸ , Stylus × 1, Sleeve case × 1, Warranty card × 1, Replacement nibs × 3, Nib puller × 1

Design and specifications are subject to change without notice.

*¹ Based on assumption that each PDF file is approximately 1MB.

*² You can use a microSD card (less than 2 GB) and microSDHC card (less than 32 GB), but CPRM (Content Protection for Recordable Media) is not supported. microSDXC card is not supported. FAT (File Allocation Table) is supported. exFAT (Extended File Allocation Table) is not supported.

*³ Using the Digital Paper device under the following conditions:

- Viewing text-based PDF documents for 60 minutes/day at the rate of approx. 2 minutes per page. Manual input using the pen for 10 seconds per page while the indicated remaining battery life is between  ~ .

Actual hours of continuous battery life will vary in accordance with the usage environment and equipment settings.

*⁴ Using the Digital Paper device under the following conditions:

- Viewing text-based PDF documents for 60 minutes/day at the rate of approx. 2 minutes per

page; manual input using the pen for 10 seconds per page

- Wireless standby On
- Auto Sync Off
- Synchronizing a document with the network drive twice a day
- Transferring a document to the network drive once a week

Actual hours of continuous battery life will vary in accordance with the usage environment and equipment settings.

Continuous battery life may be reduced in locations with poor signal strength. Actual time used depends on the customer's communication usage environment and product settings.

^{*5} Using the Digital Paper device under the following conditions:

- Approx. 1.2 seconds/1 page, continuously turning pages
- Wi-Fi function Off

Actual hours of continuous battery life will vary in accordance with the status of the usage environment and equipment.

^{*6} The communication speed may vary depending on factors such as the distance and/or obstacles between communication devices, the signal strength, and line congestion.

DPT-S1 is for domestic use.

There may be restrictions on viewing or using some web pages. Also, this device cannot display Flash content and is not compatible with video playback. Supported file format content can be downloaded. Some web pages cannot be downloaded.

^{*7} External dimensions excluding pen holder.

^{*8} Included with this device.

Supported File Types

The following files can be transferred to the Digital Paper device.

However, depending on the file size and format, it may not be possible to view some data.

Documents

- PDF files (.pdf)*

* Compliant with PDF 1.7 specifications.

System Requirements

Operating System*	Details
Microsoft Windows 8.1 (32/64 bit)	Windows 8.1
	Windows 8.1 Pro
	Windows 8.1 Enterprise
Microsoft Windows 8 (32/64 bit)	Windows 8
	Windows 8 Pro
	Windows 8 Enterprise
Microsoft Windows 7 (32/64 bit)	Windows 7 Starter
	Windows 7 Home Premium
	Windows 7 Professional
	Windows 7 Enterprise
	Windows 7 Ultimate
Microsoft Windows Vista (32/64 bit)	Windows Vista Home Basic with Service Pack 2 or later
	Windows Vista Home Premium with Service Pack 2 or later
	Windows Vista Business with Service Pack 2 or later
	Windows Vista Enterprise with Service Pack 2 or later
	Windows Vista Ultimate with Service Pack 2 or later
Mac OS X v10.9 Mavericks (64 bit only)	Mac OS X v10.9.1
Mac OS X v10.8 Mountain Lion (64 bit only)	Mac OS X v10.8.4
Mac OS X v10.7 Lion (64 bit only)	Mac OS X v10.7.5
Mac OS X v10.6 Snow Leopard (32/64 bit)	Mac OS X v10.6.8
Mac OS X v10.5 Leopard (32 bit only)	Mac OS X v10.5.8

* Operating systems that can recognize this device as an external storage device connected via USB.

The following system environments are not supported.

- Self-constructed computer
- Computer with a non-standard operating system
- Computer with multiple operating systems (multi-boot)

Limited Warranty and Service

Limited Warranty

- This warranty card is included with the Digital Paper device. Please keep it for future reference.
- Please check the coverage period of the warranty card.

Service

Check the Digital Paper device itself first should a problem occur

See "Troubleshooting" (page 55).

In the event you cannot recover the Digital Paper device

Consult the Sony Support Center. Please provide the below information.

- Model name (Description on the back panel)
- Serial number (Description in the microSD card slot cover)
- Purchase date

Warranty repair period

Sony will repair the Digital Paper device based on stipulations of the warranty card. This device contains consumable parts - even if the warranty is still valid, repair service may be subject to fees for replacing such parts. Refer to the warranty card for details.

Please refer to the PC support site for additional details.

<http://www.sony.com/digitalpapersupprt>