

HISTORY INFORMATION FOR THE FOLLOWING MANUAL:

SERVICE MANUAL

BA-6 CHASSIS

<u>MODEL NAME</u>	<u>REMOTE COMMANDER</u>	<u>DESTINATION</u>	<u>CHASSIS NO.</u>
KV-24FS100	RM-Y173	US	SCC-S61D-A
KV-24FS100	RM-Y173	CND	SCC-S59D-A
KV-25FS100	RM-Y173	LATIN NORTH	SCC-S60J-A
KV-25FS100	RM-Y173	LATIN SOUTH	SCC-S60K-A

ORIGINAL MANUAL ISSUE DATE: 5/2002

ALL REVISIONS AND UPDATES TO THE ORIGINAL MANUAL ARE APPENDED TO THE END OF THE PDF FILE.

<u>REVISION DATE</u>	<u>REVISION TYPE</u>	<u>SUBJECT</u>
5/2002	No revisions or updates are applicable at this time	
9/2002	Correction -1	Added step #4 to 2-4. SCREEN (G2) instructions. Replaced A Board IC Voltage List.
4/2003	Correction -2	Replaced A Board Transistor Voltage List (Q600, Q601) (Page 33) Replaced A Board IC Voltage List (IC600) (Page 34).

TRINITRON® COLOR TELEVISION
SONY®

SERVICE MANUAL

BA-6 CHASSIS

<u>MODEL NAME</u>	<u>REMOTE COMMANDER</u>	<u>DESTINATION</u>	<u>CHASSIS NO.</u>
KV-24FS100	RM-Y173	US	SCC-S61D-A
KV-24FS100	RM-Y173	CND	SCC-S59D-A
KV-25FS100	RM-Y173	LATIN NORTH	SCC-S60J-A
KV-25FS100	RM-Y173	LATIN SOUTH	SCC-S60K-A



KV-24FS100



RM-Y173

TRINITRON® COLOR TELEVISION
SONY®

TABLE OF CONTENTS

SECTION TITLE	PAGE
Specifications.....	4
Warnings and Cautions	5
Safety Check-Out.....	6
Self-Diagnostic Function.....	7
1. Disassembly	
1-1. Rear Cover Removal.....	9
1-2. Chassis Assembly Removal	9
1-3. Service Position	9
1-4. Picture Tube Removal	10
Anode Cap Removal Procedure.....	10
2. Set-Up Adjustments	
2-1. Beam Landing.....	11
2-2. Convergence.....	12
2-3. Focus	13
2-4. Screen (G2).....	13
2-5. Method of Setting the Service Adjustment Mode.....	14
2-6. White Balance Adjustments	14
3. Safety Related Adjustments	
3-1. <input checked="" type="checkbox"/> R565 Confirmation Method (HV Hold Down Confirmation) and Readjustments.....	15
3-2. B+ Voltage Confirmation and Adjustment	15
4. Circuit Adjustments	
4-1. Setting the Service Adjustment Mode.....	17
4-2. Memory Write Confirmation Method	17
4-3. Remote Adjustment Buttons and Indicators	17
Adjustment Items	18
4-4. ID Map Table	26
4-5. A Board Adjustments	26
5. Diagrams	
5-1. Circuit Boards Location.....	29
5-2. Printed Wiring Board and Schematic Diagram Information	29
5-3. Block Diagram and Schematics.....	30
A Board Schematic Diagram	31
CV Board Schematic Diagram	35
M3 Board Schematic Diagram	37
5-4. Semiconductors	39
6. Exploded Views	
6-1. Chassis	40
7. Electrical Parts List	41

SPECIFICATIONS

	KV-24FS100/ 25FS100 (N)	KV-25FS100 (S)
Power requirements	120V, 60Hz	220V, 50/60Hz
Number of Inputs/Outputs		
Video ¹⁾	2	
S Video ²⁾	1	
Y, P_B, P_R ³⁾	1	
Audio ⁴⁾	4	
Speaker output (W)	7.5W x 2	
Headphones ⁵⁾	1	
Power Consumption (W)		
In use (Max)	145W	
In Standby	1W	
Dimensions(W/H/D)		
mm	704 x 524 x 474 mm	
in	27 ^{3/4} x 20 ^{5/8} x 18 ^{1/2}	
Mass		
kg	35 kg	
lbs	77 lbs. 3 oz.	

- 1) 1 Vp-p 75 ohms unbalanced, sync negative
2) Y: 1 Vp-p 75 ohms unbalanced, sync negative
C: 0.286 Vp-p (Burst signal), 75 ohms
3) Y: 1.0 Vp-p, 75 ohms, sync negative; PB: 0.7 Vp-p, 75 ohms;
PR Vp-p, 75 ohms.
4) 500 mVrms (100% modulation), Impedance: 47 kilohms
5) More than 408 mVrms at the maximum volume setting (variable)
More than 408 mVrms (fix); Impedance (output): 2 kilohms

Television system

American TV Standard, NTSC

Visible screen size

24 inch picture measured diagonally

Antenna

75 ohm external terminal for VHF/UHF

Channel coverage

VHF: 2-13/ UHF: 14-69/ CATV: 1-125

Actual screen size

25 inch measured diagonally

Supplied Accessories

Remote Commander:
RM-Y173
Size AA (R6) batteries (2)
Antenna, Telescopic
(KV-25FS100 ONLY)

Picture tubeFD Trinitron[®] tube

Design and specifications are subject to change without notice.

WARNINGS AND CAUTIONS

CAUTION

Short circuit the anode of the picture tube and the anode cap to the metal chassis, CRT shield, or carbon painted on the CRT, after removing the anode.

WARNING!!

An isolation transformer should be used during any service to avoid possible shock hazard, because of live chassis. The chassis of this receiver is directly connected to the AC power line.



SAFETY-RELATED COMPONENT WARNING!!

Components identified by shading and mark on the schematic diagrams, exploded views, and in the parts list are critical for safe operation. Replace these components with Sony parts whose part numbers appear as shown in this manual or in supplements published by Sony. Circuit adjustments that are critical for safe operation are identified in this manual. Follow these procedures whenever critical components are replaced or improper operation is suspected.

ATTENTION!!

Après avoir déconnecté le cap de l'anode, court-circuiter l'anode du tube cathodique et celui de l'anode du cap au châssis métallique de l'appareil, ou la couche de carbone peinte sur le tube cathodique ou au blindage du tube cathodique.

Afin d'éviter tout risque d'électrocution provenant d'un châssis sous tension, un transformateur d'isolement doit être utilisé lors de tout dépannage. Le châssis de ce récepteur est directement raccordé à l'alimentation du secteur.



ATTENTION AUX COMPOSANTS RELATIFS A LA SECURITE!!

Les composants identifiés par une trame et par une marque sur les schémas de principe, les vues explosées et les listes de pièces sont d'une importance critique pour la sécurité du fonctionnement. Ne les remplacer que par des composants Sony dont le numéro de pièce est indiqué dans le présent manuel ou dans des suppléments publiés par Sony. Les réglages de circuit dont l'importance est critique pour la sécurité du fonctionnement sont identifiés dans le présent manuel. Suivre ces procédures lors de chaque remplacement de composants critiques, ou lorsqu'un mauvais fonctionnement suspecte.

SAFETY CHECK-OUT

After correcting the original service problem, perform the following safety checks before releasing the set to the customer:

1. Check the area of your repair for unsoldered or poorly soldered connections. Check the entire board surface for solder splashes and bridges.
2. Check the interboard wiring to ensure that no wires are "pinched" or touching high-wattage resistors.
3. Check that all control knobs, shields, covers, ground straps, and mounting hardware have been replaced. Be absolutely certain that you have replaced all the insulators.
4. Look for unauthorized replacement parts, particularly transistors, that were installed during a previous repair. Point them out to the customer and recommend their replacement.
5. Look for parts which, though functioning, show obvious signs of deterioration. Point them out to the customer and recommend their replacement.
6. Check the line cords for cracks and abrasion. Recommend the replacement of any such line cord to the customer.
7. Check the B+ and HV to see if they are specified values. Make sure your instruments are accurate; be suspicious of your HV meter if sets always have low HV.
8. Check the antenna terminals, metal trim, "metallized" knobs, screws, and all other exposed metal parts for AC leakage. Check leakage as described below.

Leakage Test

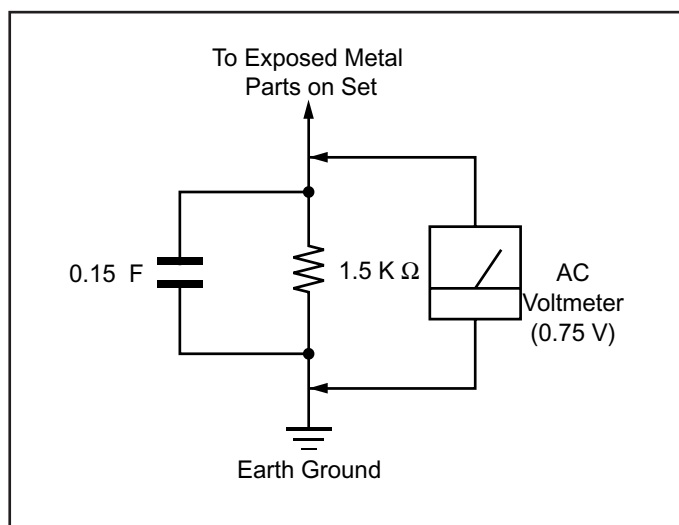

Figure A. Using an AC voltmeter to check AC leakage.

The AC leakage from any exposed metal part to earth ground and from all exposed metal parts to any exposed metal part having a return to chassis, must not exceed 0.5 mA (500 microamperes). Leakage current can be measured by any one of three methods.

1. A commercial leakage tester, such as the Simpson 229 or RCA WT-540A. Follow the manufacturers' instructions to use these instructions.
2. A battery-operated AC milliammeter. The Data Precision 245 digital multimeter is suitable for this job.
3. Measuring the voltage drop across a resistor by means of a VOM or battery-operated AC voltmeter. The "limit" indication is 0.75 V, so analog meters must have an accurate low voltage scale. The Simpson's 250 and Sanwa SH-63TRD are examples of passive VOMs that are suitable. Nearly all battery-operated digital multimeters that have a 2 VAC range are suitable (see Figure A).

How to Find a Good Earth Ground

A cold-water pipe is a guaranteed earth ground; the cover-plate retaining screw on most AC outlet boxes is also at earth ground. If the retaining screw is to be used as your earth ground, verify that it is at ground by measuring the resistance between it and a cold-water pipe with an ohmmeter. The reading should be zero ohms.

If a cold-water pipe is not accessible, connect a 60- to 100-watt trouble-light (not a neon lamp) between the hot side of the receptacle and the retaining screw. Try both slots, if necessary, to locate the hot side on the line; the lamp should light at normal brilliance if the screw is at ground potential (see Figure B).

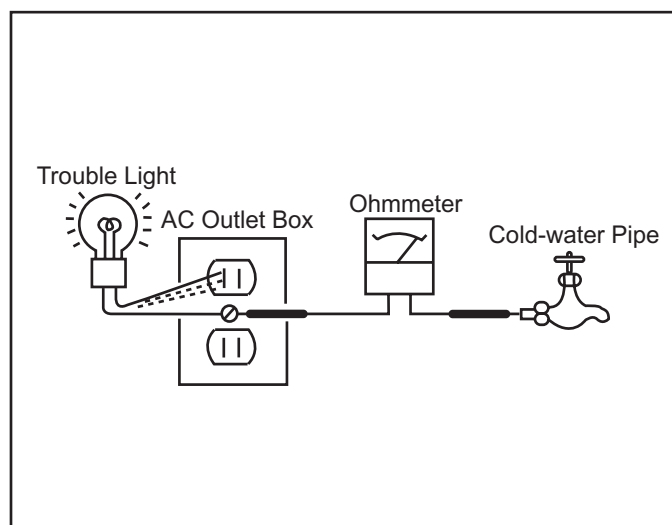

Figure B. Checking for earth ground.

SELF-DIAGNOSTIC FUNCTION



The units in this manual contain a self-diagnostic function. If an error occurs, the STANDBY/TIMER LED will automatically begin to flash. The number of times the LED flashes translates to a probable source of the problem. A definition of the STANDBY/TIMER LED flash indicators is listed in the instruction manual for the user's knowledge and reference. If an error symptom cannot be reproduced, the Remote Commander can be used to review the failure occurrence data stored in memory to reveal past problems and how often these problems occur.

Diagnostic Test Indicators

When an error occurs, the STANDBY/TIMER LED will flash a set number of times to indicate the possible cause of the problem. If there is more than one error, the LED will identify the first of the problem areas.

Results for all of the following diagnostic items are displayed on screen. No error has occurred if the screen displays a "0".

Diagnostic Item Description	No. of times STANDBY/ TIMER lamp flashes	Self-Diagnostic Display/ Diagnostic Result	Probable Cause Location	Detected Symptoms
Power does not turn on	Does not light	—————	<ul style="list-style-type: none"> Power cord is not plugged in. Fuse is burned out (F601). (A Board) 	<ul style="list-style-type: none"> Power does not come on. No power is supplied to the TV. AC Power supply is faulty.
+B overcurrent (OCP)*	2 times	2:0 or 2:1	<ul style="list-style-type: none"> H.OUT (Q505) is shorted. (A Board) IC1751 is shorted. (CV Board) 	<ul style="list-style-type: none"> Power does not come on. Load on power line is shorted.
I-Prot	4 times	4:0 or 4:1	<ul style="list-style-type: none"> +13V is not supplied. (A Board) IC545 is faulty. (A Board) 	<ul style="list-style-type: none"> Has entered standby state after horizontal raster. Vertical deflection pulse is stopped. Power line is shorted or power supply is stopped.
IK (AKB)	5 times	5:0 or 5:1	<ul style="list-style-type: none"> Viedo OUT (IC545) is faulty. (A Board) IC001 is faulty. (A Board) Screen (G2) is improperly adjusted.** 	<ul style="list-style-type: none"> No raster is generated. CRT Cathode current detection reference pulse output is small.

*If a +B overcurrent is detected, stoppage of the vertical deflection is detected simultaneously. The symptom that is diagnosed first by the microcontroller is displayed on the screen.

**Refer to Screen (G2) Adjustments in Section 2-4. of this manual.

Display of Standby/Timer LED Flash Count

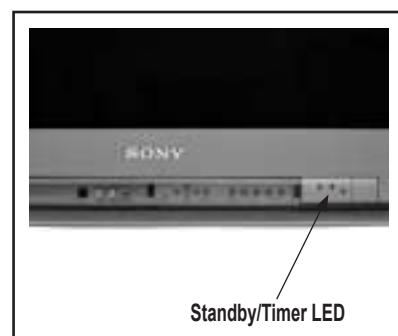
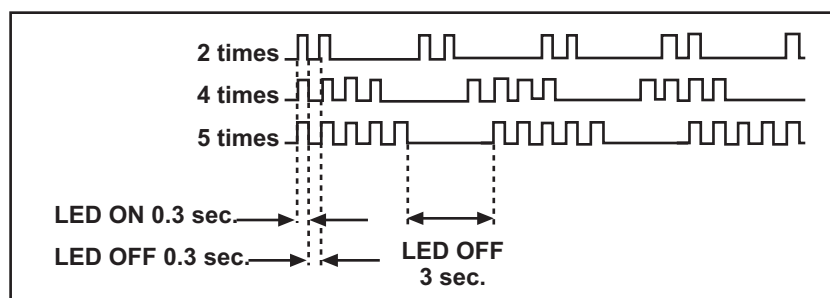

Diagnostic Item	Flash Count*
+B Overcurrent	2 times
I-Prot	4 times
IK (AKB)	5 times

*One flash count is not used for self-diagnostic.

Stopping the Standby/Timer LED Flash

Turn off the power switch on the TV main unit or unplug the power cord from the outlet to stop the STANDBY/TIMER LAMP from flashing.

Self-Diagnostic Screen Display

For errors with symptoms such as “power sometimes shuts off” or “screen sometimes goes out” that cannot be confirmed, it is possible to bring up past occurrences of failure on the screen for confirmation.

To Bring Up Screen Test

In standby mode, press buttons on the Remote Commander sequentially, in rapid succession, as shown below:

Display → Channel 5 → Sound Volume → Power ON

↑ Note that this differs from entering the Service Mode (Sound Volume +).

Self-Diagnostic Screen Display

SELF DIAGNOSTIC
2: 000
3: N/A
4: 000
5: 001
101: N/A

Numeral “0” means that no fault was detected.
Numerical “1” means a fault was detected one time only.

Handling of Self-Diagnostic Screen Display

Since the diagnostic results displayed on the screen are not automatically cleared, always check the self-diagnostic screen during repairs. When you have completed the repairs, clear the result display to “0”.

Unless the result display is cleared to “0”, the self-diagnostic function will not be able to detect subsequent faults after completion of the repairs.

Clearing the Result Display

To clear the result display to “0”, press buttons on the Remote Commander sequentially when the diagnostic screen is displayed, as shown below:

Channel 8 → ENTER

Quitting the Self-Diagnostic Screen

To quit the entire self-diagnostic screen, turn off the power switch on the Remote Commander or the main unit.

Self-Diagnostic Circuit

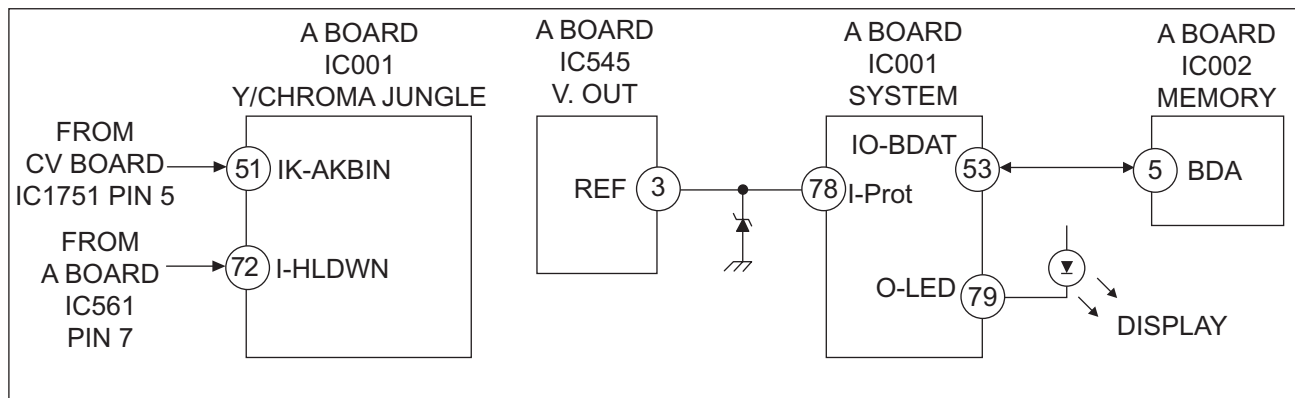

+B overcurrent (OCP)

Occurs when an overcurrent on the +B (135V) line is detected by pin 72 of IC001 (A Board). If the voltage of pin 72 of IC001 (A Board) is less than 1V when V.SYNC is more than seven verticals in a period, the unit will automatically turn off.

I-Prot

Occurs when an absence of the vertical deflection pulse is detected by pin 78 of IC001 (A Board). Power supply will shut down when waveform interval exceeds 2 seconds.

IK (AKB)

If the RGB levels* do not balance within 2 seconds after the power is turned on, this error will be detected by IC001 (A Board). TV will stay on, but there will be no picture.

* (Refers to the RGB levels of the AKB detection Ref pulse that detects 1K).

SECTION 1: DISASSEMBLY

1-1. REAR COVER REMOVAL

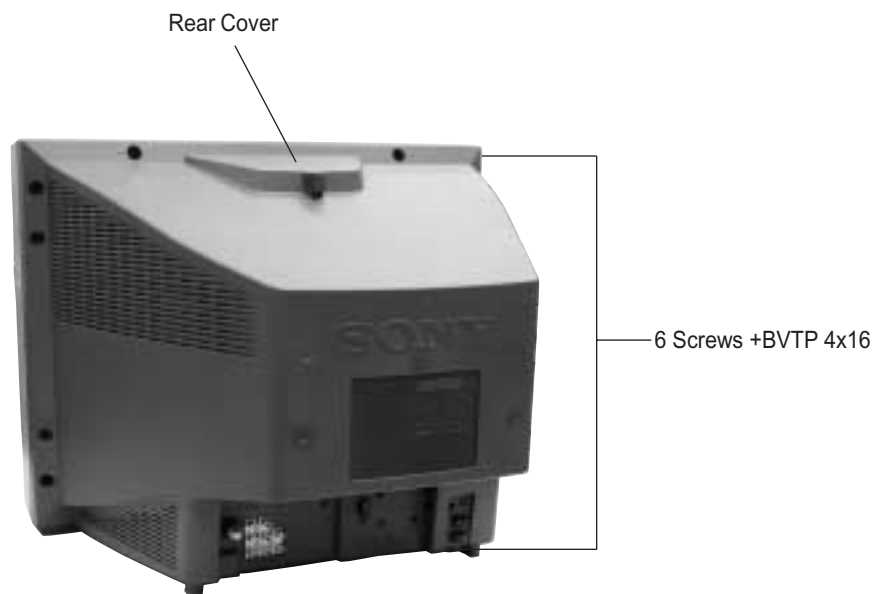

1-2. CHASSIS ASSEMBLY REMOVAL

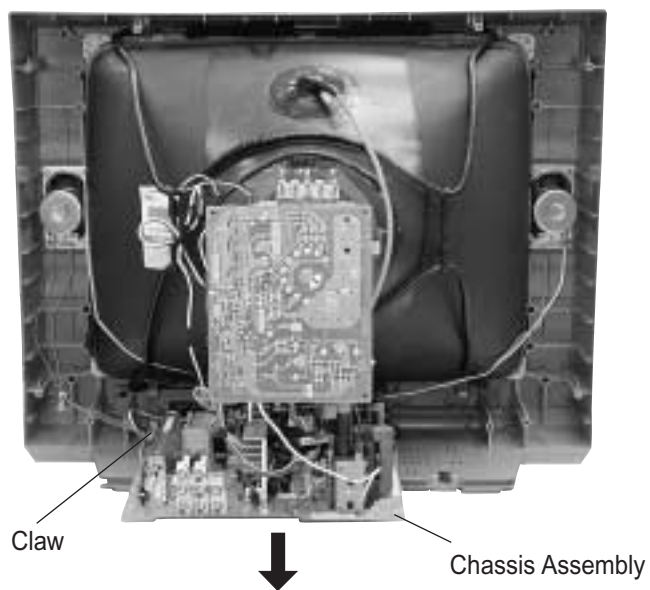

1-3. SERVICE POSITION

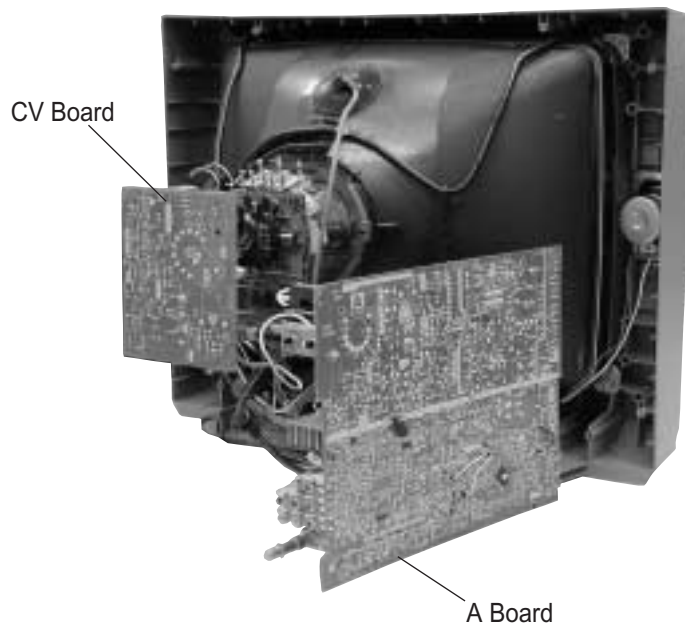

1-4. PICTURE TUBE REMOVAL

WARNING: BEFORE REMOVING THE ANODE CAP

High voltage remains in the CRT even after the power is disconnected. To avoid electric shock, discharge CRT before attempting to remove the anode cap. Short between anode and CRT coated earth ground strap.

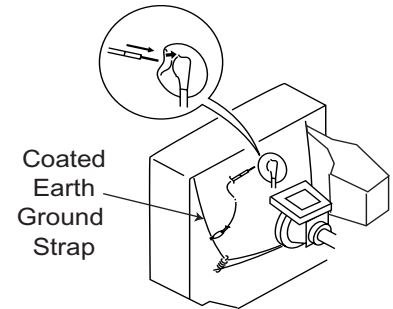
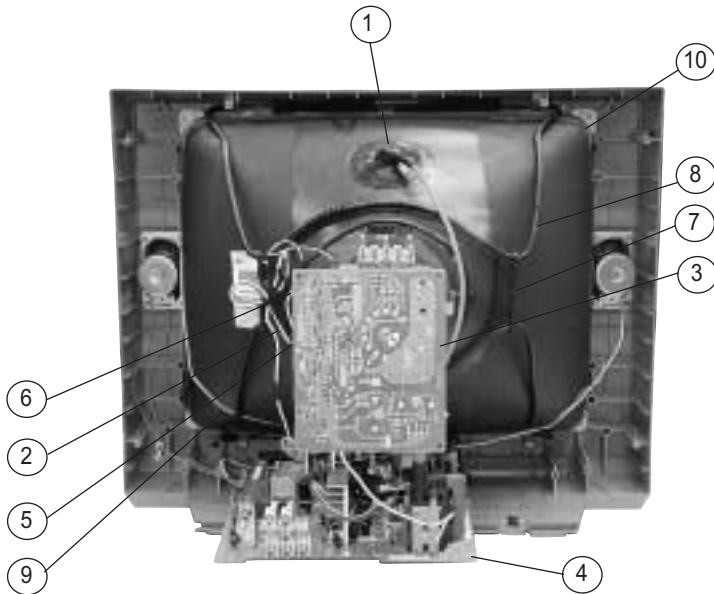

1. Discharge the anode of the CRT and remove the anode cap.
2. Unplug all interconnecting leads from the deflection yoke, neck assembly, degaussing coils and CRT grounding strap.
3. Remove the CV Board from the CRT.
4. Remove the chassis assembly.
5. Loosen the neck assembly fixing screw and remove.
6. Loosen the deflection yoke fixing screw and remove.
7. Place the set with the CRT face down on a cushion and remove the degaussing coil holders.
8. Remove the degaussing coils.
9. Remove the CRT grounding strap and spring tension devices.
10. Unscrew the four CRT fixing screws [located on each CRT corner] and remove the CRT [Take care not to handle the CRT by the neck].

ANODE CAP REMOVAL PROCEDURE

WARNING: High voltage remains in the CRT even after the power is disconnected. To avoid electric shock, discharge CRT **before** attempting to remove the anode cap. Short between anode and coated earth ground strap of CRT.

NOTE: After removing the anode cap, short circuit the anode of the picture tube and the anode cap to either the metal chassis, CRT shield, or carbon painted on the CRT.

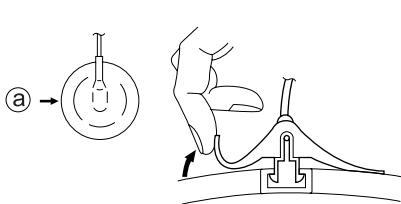

Turn up one side of the rubber cap in the direction indicated by arrow (a) .

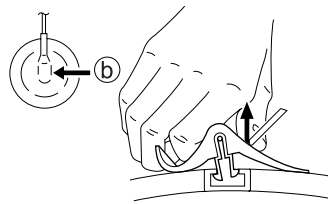

Use your thumb to pull the rubber cap firmly in the direction indicated by arrow (b) .

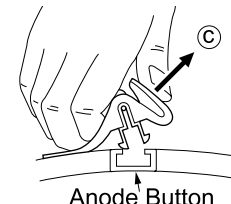

When one side of the rubber cap separates from the anode button, the anode cap can be removed by turning the rubber cap and pulling it in the direction of arrow (c) .

HOW TO HANDLE AN ANODE CAP

1. Do not use sharp objects which may cause damage to the surface of the anode cap.
2. To avoid damaging the anode cap, do not squeeze the rubber covering too hard. A material fitting called a shatter-hook terminal is built into the rubber.
3. Do not force turn the foot of the rubber cover. This may cause the shatter-hook terminal to protrude and damage the rubber.

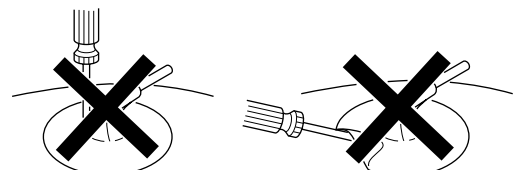

SECTION 2: SET-UP ADJUSTMENTS

The following adjustments should be made when a complete realignment is required or a new picture tube is installed.

These adjustments should be performed with rated power supply voltage unless otherwise noted.

Set the controls as follows unless otherwise noted:

VIDEO MODE: Standard

PICTURE CONTROL: Normal

BRIGHTNESS CONTROL: Normal

Perform the adjustments in order as follows:

1. Beam Landing
2. Convergence
3. Focus
4. Screen (G2)
5. White Balance

Note Test Equipment Required:

1. Color Bar Pattern Generator
2. Degausser
3. DC Power Supply
4. Digital Multimeter

2-1. BEAM LANDING

Before beginning adjustment procedure:

1. Degauss the entire screen.
2. Feed in the white pattern signal.

ADJUSTMENT PROCEDURE

1. Input a raster signal with the pattern generator.
2. Loosen the deflection yoke mounting screw, and set the purity control to the center as shown below:

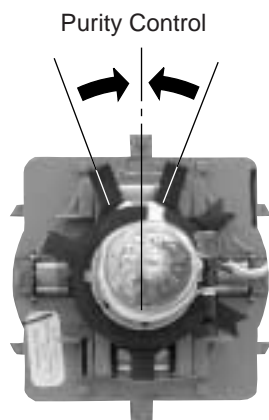

3. Turn the raster signal of the pattern generator to green.
4. Move the deflection yoke backward, and adjust with the purity control so that green is in the center and red and blue are even on both sides.

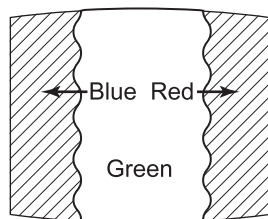

5. Move the deflection yoke forward, and adjust so that the entire screen becomes green.

6. Switch over the raster signal to red and blue and confirm the condition.
7. When the position of the deflection yoke is determined, tighten it with the deflection yoke mounting screw.
8. If landing at the corner is not right, adjust by using the disk magnets.

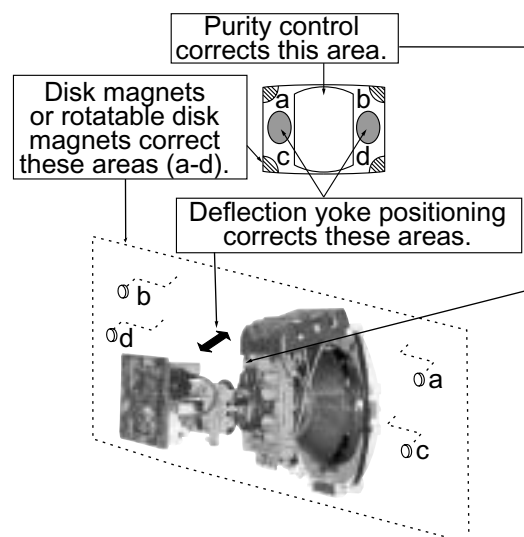
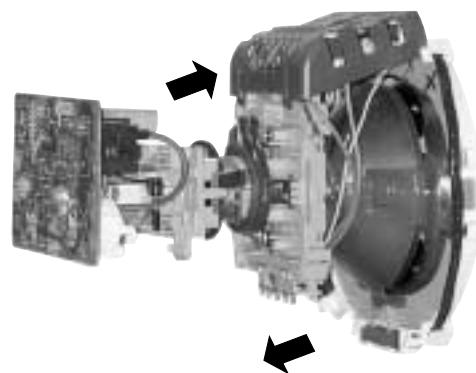

2-2. CONVERGENCE

Before starting convergence adjustments:

- 1 Perform FOCUS, VLIN and VSIZE adjustments.
2. Set BRIGHTNESS control to minimum.
3. Feed in dot pattern.

VERTICAL STATIC CONVERGENCE

1. Adjust V. STAT magnet to converge red, green and blue dots in the center of the screen (Vertical movement adjust S V.STAT RV1750 to converge).

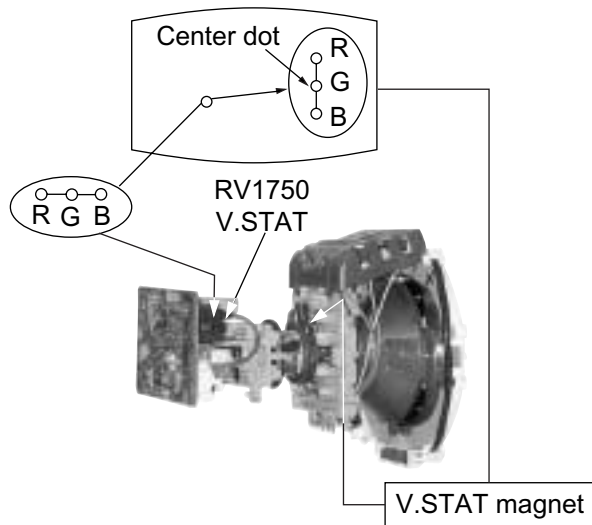

2. Tilt the V. STAT magnet and adjust static convergence to open or close the V. STAT magnet.

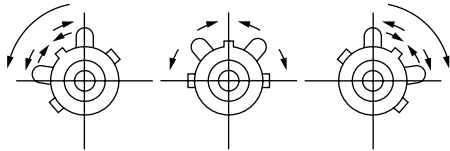

When the V. STAT magnet is moved in the direction of arrow a and b, red, green, and blue dots move as shown below:

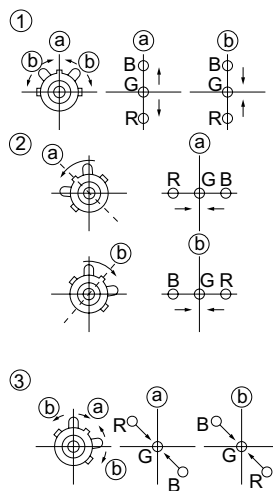

HORIZONTAL STATIC CONVERGENCE

If the blue dot does not converge with the red and green dots, perform the following:

1. Move BMC magnet (a) to correct insufficient H.Static convergence.
2. Rotate BMC magnet (b) to correct insufficient V.Static convergence.
3. After adjusting the BMC magnet, repeat Beam Landing Adjustment.

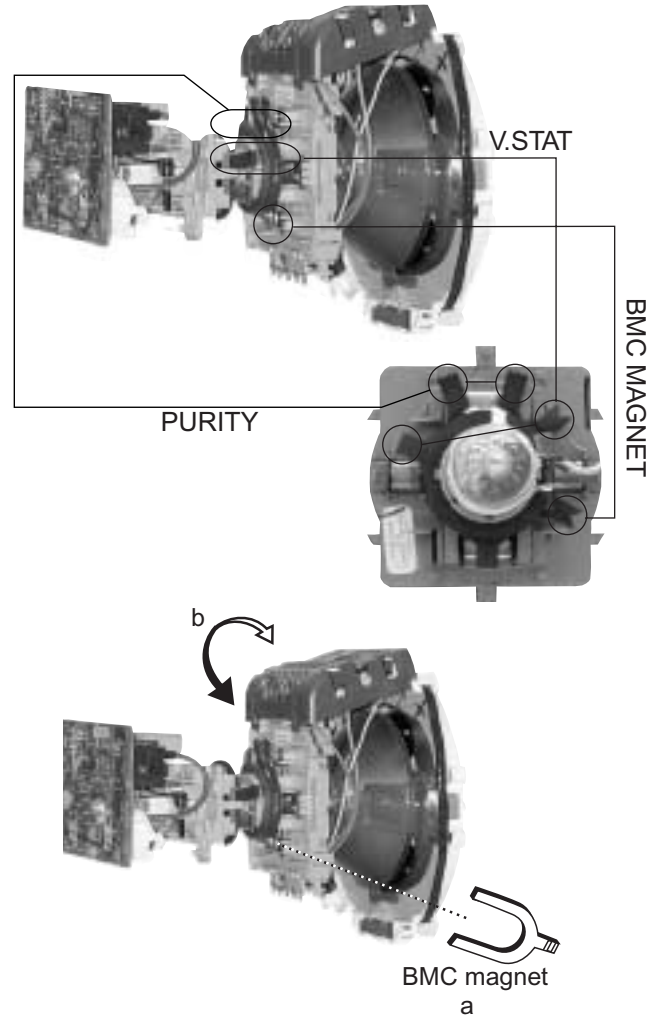

DYNAMIC CONVERGENCE ADJUSTMENT

Before performing this adjustment, perform Horizontal and Vertical Static Convergence Adjustment.

1. Slightly loosen deflection yoke screw.
2. Remove deflection yoke spacers.
3. Move the deflection yoke for best convergence as shown below:

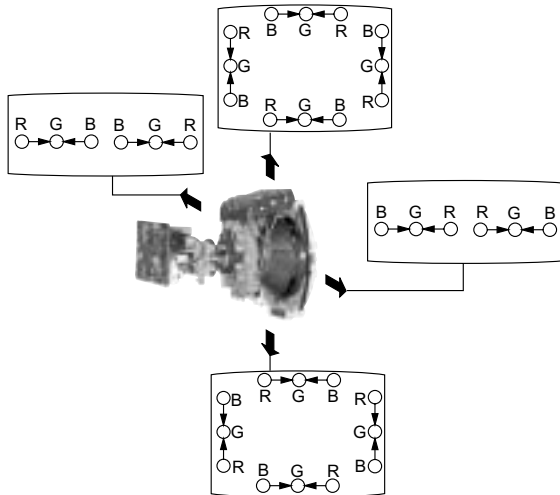

4. Tighten the deflection yoke screw.
5. Install the deflection yoke spacers.

TLH PLATE ADJUSTMENT

1. Input crosshatch pattern.
2. Adjust PICTURE QUALITY to standard, PICTURE and BRIGHTNESS to 50%, and OTHER to standard.
3. Adjust the Horizontal Convergence of red and blue dots by tilting the TLH plate on the deflection yoke.

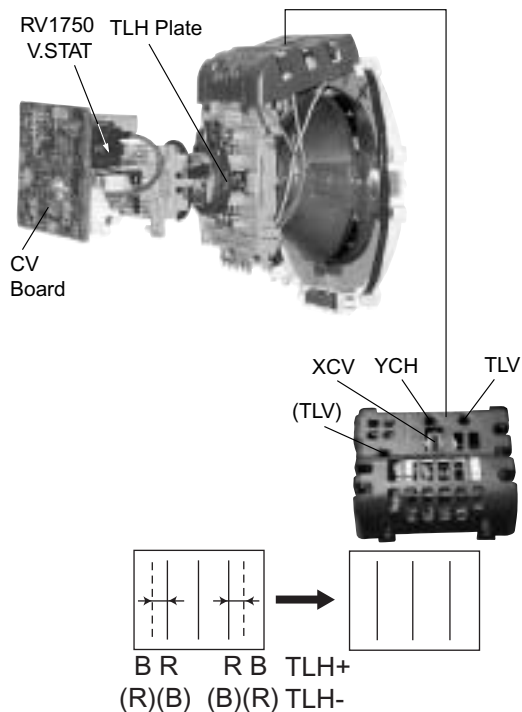

4. Adjust XCV core to balance X axis.
 5. Adjust YCH VR to balance Y axis.
 6. Adjust vertical red and blue convergence with V.TILT (TLV VR.)
- Note: Perform adjustment 3-6 while tracking items 1 and 2.

SCREEN-CORNER CONVERGENCE

1. Affix a permalloy assembly corresponding to the misconverged areas:

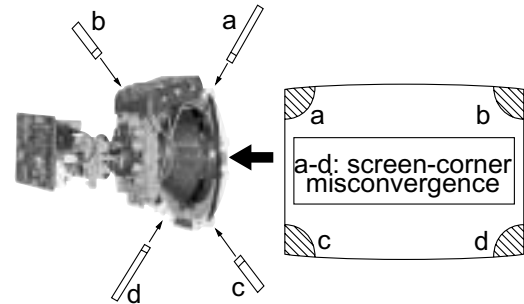

2-3. FOCUS

1. Adjust FOCUS control for best pictures.

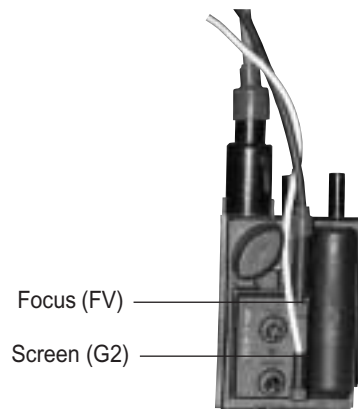

2-4. SCREEN (G2)

1. Input a dot pattern.
2. Set the PICTURE and BRIGHTNESS controls at minimum and COLOR control at normal.
3. Adjust SBRT, GCUT, BCUT in service mode with an oscilloscope as shown below so that voltages on the red, green, and blue cathodes are $160 \pm 2\text{VDC}$.

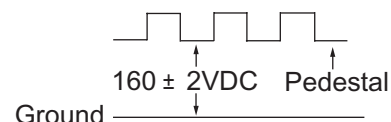

2-5. METHOD OF SETTING THE SERVICE ADJUSTMENT MODE

SERVICE MODE PROCEDURE

- Standby mode (power off).
- Press **[Display]** → Channel **[5]** → Sound Volume **[+]** → Power on the Remote Commander (press each button within a second).

SERVICE ADJUSTMENT MODE ON

- The CRT displays the time being adjusted.

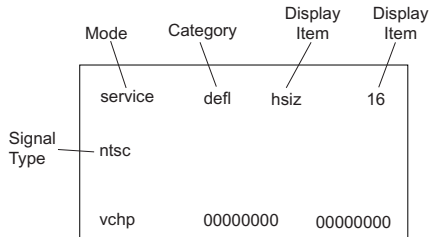

- Press **[1]** or **[4]** on the Remote Commander to select the time.
- Press **[3]** or **[6]** on the Remote Commander to change the data.
- Press **[MUTING]** then **[ENTER]** to save into the memory.

SERVICE ADJUSTMENT MODE MEMORY

Turn the set off then on to exit Service Adjustment Mode.

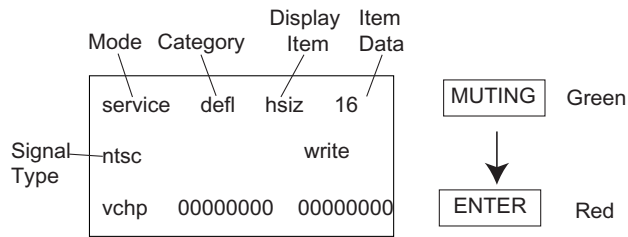



2-6. WHITE BALANCE ADJUSTMENTS

- Input an entire white signal with burst.
- Set to Service Adjustment Mode.
- Set the PICTURE and BRIGHTNESS to minimum.
- Adjust with SBRT if necessary.
- Select GCUT and BCUT with **[1]** and **[4]**.
- Adjust with **[3]** and **[6]** for the best white balance.
- Set the PICTURE and BRIGHTNESS to maximum.
- Select GDRV and BDRV with **[1]** and **[4]**.
- Adjust with **[3]** and **[6]** for the best white balance.
- To write into memory, press **[MUTING]** then **[ENTER]**.

SECTION 3: SAFETY RELATED ADJUSTMENTS

3-1. R565 CONFIRMATION METHOD (HV HOLD-DOWN CONFIRMATION) AND READJUSTMENTS

The following adjustments should always be performed when replacing the following components which are marked with  on the schematic diagram:

Part Replaced ()	Adjustment ()
DY, T585, CRT, IC001, IC561, C507, C508, C506, T511, L510, C588, L588, C566, C561, C563, D567, D568, D566, R567, R568, R565, R566, R562, R563, R561, R528.....A Board	HV HOLD-DOWN R565

PREPARATION BEFORE CONFIRMATION

- Using a Variac, apply AC input voltage: 120 ± 2 VAC.
- Turn the POWER switch ON.
- Input a white signal and set the PICTURE and BRIGHTNESS controls to maximum.
- Confirm that the voltage between C566 (+) or TP30 and ground is more than 105 VDC.

HOLD-DOWN OPERATION CONFIRMATION

- Connect the current meter between Pin 11 of the FBT (T585) and the PWB land where Pin 11 would normally attach (See Figure 1 on the next page).
- Input a dot signal and set PICTURE and BRIGHTNESS to minimum: $IABL = 100 \pm 100\mu A$.
- Confirm the voltage of A Board TP-23 is 138.0 ± 0.3 VDC.
- Connect the digital voltmeter and the DC power supply via Diode 1SS119 to C566 (+) and ground (See Figure 1 on next page).
- Increase the DC power voltage gradually until the picture blanks out.
- Turn DC power source off immediately.
- Read the digital voltmeter indication (standard < 117 VDC).
- Input a white signal and set PICTURE and BRIGHTNESS to maximum: $IABL = 1650 \pm 100\mu A$.
- Repeat steps 4 to 7.

HOLD-DOWN READJUSTMENT

If the setting indicated in Step 2 of Hold-Down Operation Confirmation cannot be met, readjustment should be performed by altering the resistance value of R565 component marked with .

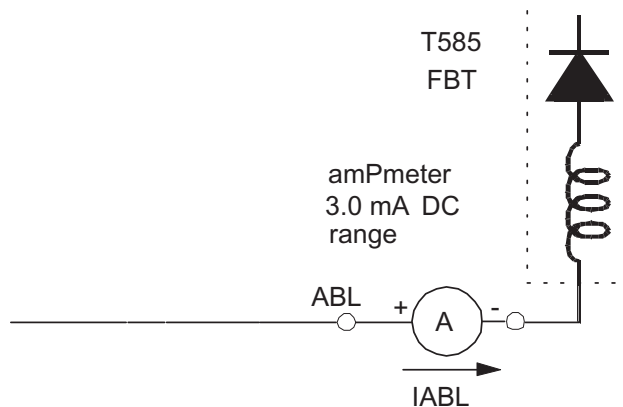

3-2. B+ VOLTAGE CONFIRMATION AND ADJUSTMENT

Note: The following adjustments should always be performed when replacing the following components, which are marked with  on the schematic diagram on the A Board:

A BOARD: IC604, PH602

- Using a Variac, apply AC input voltage: $130 + 2.0 / - 0.0$ VAC.
- Input a DOT pattern at Q.C.
- Set the PICTURE and the BRIGHTNESS controls to minimum.
- Confirm the voltage of A Board between TP-23 & Ground is < 136.6 VDC.
- If step 4 is not satisfied, replace the components listed above, then repeat Steps 1 – 3.

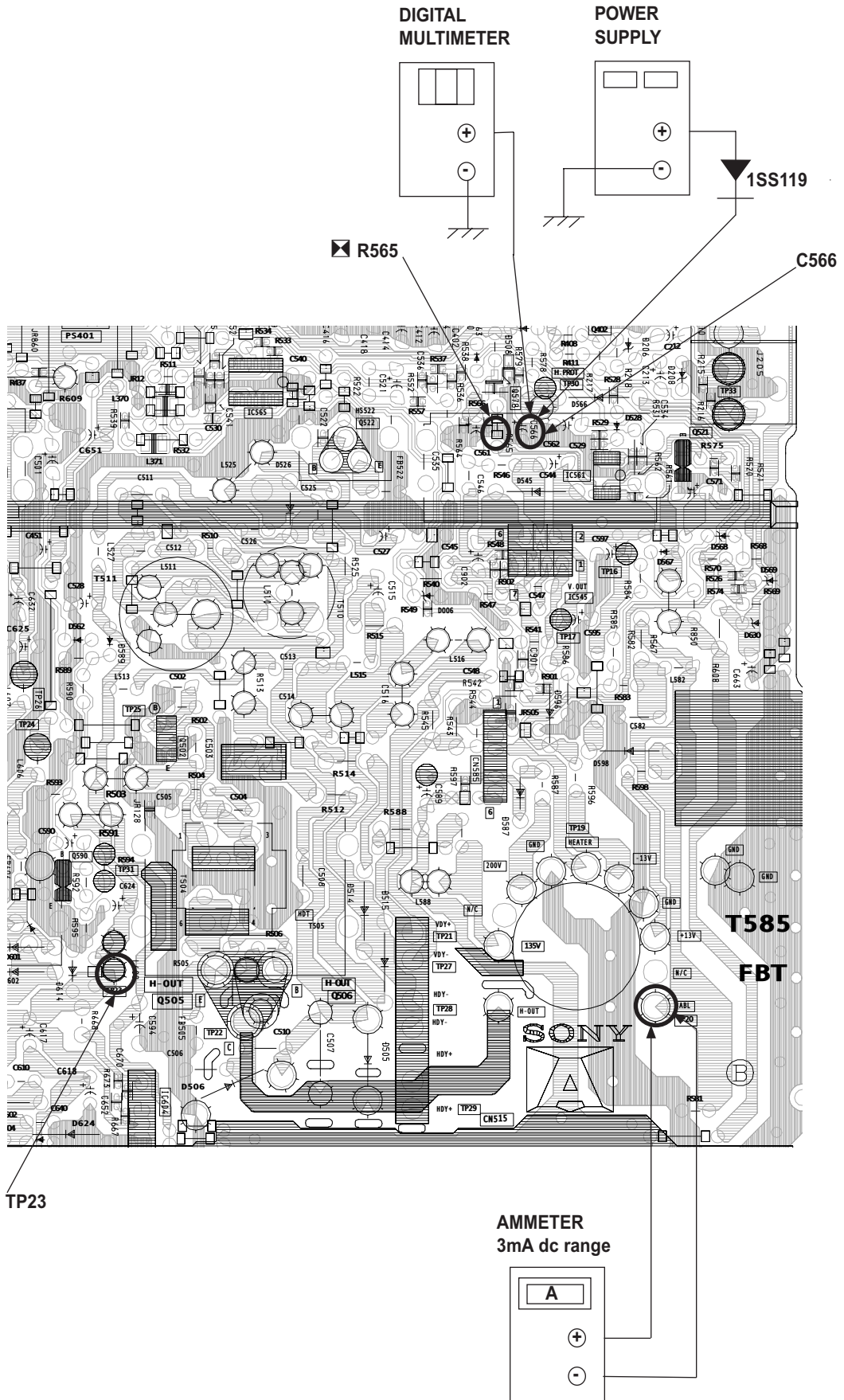

Figure 1

SECTION 4: CIRCUIT ADJUSTMENTS

ELECTRICAL ADJUSTMENTS BY REMOTE COMMANDER

Use the Remote Commander (RM-Y173) to perform the circuit adjustments in this section.

Test Equipment Required: 1. Pattern generator 2. Frequency counter 3. Digital multimeter 4. Audio oscillator

4-1. SETTING THE SERVICE ADJUSTMENT MODE

- Standby mode (Power off).
- Press the following buttons on the remote commander within a second of each other:

Display → Channel 5 → Sound Volume + → Power

SERVICE ADJUSTMENT MODE ON

- The CRT displays the item being adjusted.

	Mode	Category	Display Item	Item Data
	service	defl	hsiz	16
Signal Type	ntsc			
	vchp	00000000	00000000	

- Press **1** or **4** on the Remote Commander to select the item.
- Press **3** or **6** on the Remote Commander to change the data.
- Press **MUTING** then **ENTER** to write into memory.

SERVICE ADJUSTMENT MODE MEMORY

	Mode	Category	Display Item	Item Data
	service	defl	hsiz	16
Signal Type	ntsc			write
	vchp	00000000	00000000	

MUTING Green
 ↓
ENTER Red

- Press **8** then **ENTER** on the Remote Commander to initialize.

	Mode	Category	Display Item	Item Data
	service	defl	hsiz	16
Signal Type	ntsc			write
	vchp	00000000	00000000	

MUTING Green
 ↓
ENTER Red

Carry out Step 1 when adjusting IDs 0-7 and when replacing and adjusting IC002

- Turn set off then on to exit Service Adjustment Mode.

4-2. MEMORY WRITE CONFIRMATION METHOD

- After adjustment, pull out the plug from the AC outlet, then replace the plug in the AC outlet again.
- Turn the power switch ON and set to Service Mode.
- Call the adjusted items again to confirm they were adjusted.

4-3. REMOTE ADJUSTMENT BUTTONS AND INDICATORS

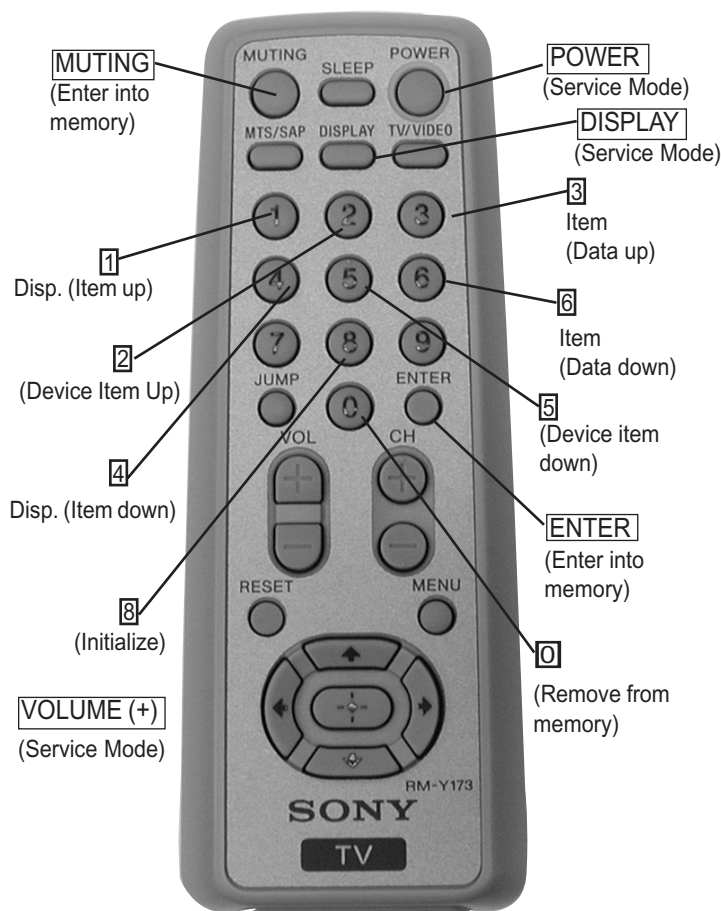

RM-Y173

ADJUSTMENT ITEMS (1 OF 8)

DEVICE "DEF"

Item#	OSD	DETAIL	Range (DEC)	Initial Data
1	HSIZ	H SIZE(EW DC)	00-63	25
2	HPOS	H POSITION	00-63	41
3	VSIZ	V RAMP SIZE	00-63	25
4	VPOS	V POSITION(RAMP DC)not useful	00-63	34
5	VLIN	V LINEARITY	00-63	36
6	SCOR	S CORRECTION	00-63	39
7	VBOW	BOW	00-63	36
8	VANG	ANGLE	00-63	35
9	TRAP	EW TRAPESIUM	00-63	29
10	PAMP	EW PIN	00-63	39
11	UPIN	UPPER PIN	00-63	28
12	LPIN	LOWER PIN	00-63	29
13	TROT	TROT	00-255	128
14	HBLK	H BLK mode select	00-01	0
15	LBLK	HBLK front timing	00-63	5
16	RBLK	HBLK rear timing	00-15	31
17	VBLK	V BLK width	00-03	0
18	HMSK	TOP VEND(when MACROVISION)prevent OFF	00-01	0
19	HDW	H PULSE WIDTH(25u/19u)	00-01	1
20	AFC	AFC GAIN	00-01	0
21	AFC1	AFC1 TIME CONSTANT	00-07	3
22	AFCW	AFC1 PULL IN WIDE	00-01	1
23	CDMD	V DET WINDOW SW TIMING	00-03	1
24	HSS	SYNC SLICE LEVEL(H sepa)	00-03	0
25	VSS	SYNC SLICE LEVEL(V sepa)	00-03	3
26	SLDN	Auto Slice level DOWN	00-03	0
27	SLUP	Auto Slicelevel UP	00-01	0
28	JPSW	Jump SW	00-01	0
29	HOSC	H VCO fo ADJUST	00-255	5
30	EHT	EHT	00-15	6
31	EHTG	EHT MODE	00-01	0

DEVICE "16:9"

Item#	OSD	DETAIL	Range (DEC)	Initial Data
1	PAMP	EW PIN	00-63	59
2	UPIN	UPPER PIN	00-63	15
3	LPIN	LOWER PIN	00-63	21
4	ACLV	ACL VTH	00-03	0
5	ABLV	ABL VTH	63-00	58

DEVICE "VP1"

Item#	OSD	DETAIL	Range (DEC)	Initial Data
1	RDRV	R DRIVE	00-127	55
2	GDRV	G DRIVE when Color Temp. is "Cool" and "Neutral"	00-127	38
3	BDRV	B DRIVE when Color Temp. is "Cool" and "Neutral"	00-127	47
4	RCUT		00-1023	130
5	GCUT		00-1023	90
6	BCUT		00-1023	72
7	SCON	CONTRAST LEVEL	00-127	20
8	SHUE	TINT	00-127	8
9	SCOL	COLOR LEVEL	00-127	17
10	SBRT	BRIGHT	00-255	35
11	RON	R OUTPUT MUTE	00-01	1
12	GON	G OUTPUT MUTE	00-01	1
13	BON	B OUTPUT MUTE	00-01	1
14	BLLV	BLUE STRETCH(00:no <-> 11:deep)	00-03	1
15	MTRX	MATRIX RATIO SELECT	00-03	2
16	AXIS	R-Y PHASE OFFSET	00-63	48
17	SSHO	SHARPNESS GAIN(OVER)	00-63	17
18	SSHP	SHARPNESS GAIN(PRE)	00-63	26
19	SHPF	SHRPNESS fo(00:2 CLK <-> 11:5 CLK)	00-03	1

ADJUSTMENT ITEMS (2 OF 8)**DEVICE "VP1"**

Item#	OSD	DETAIL	Range (DEC)	Initial Data
20	SHCL	SHARPNESS CPRING LEVEL	00-15	0
21	SHMX	SHARPNESS LIMITTER LEVEL	00-15	15
22	ACLV	ACL VTH	00-03	0
23	ABLV	ABL VTH	00-63	0
24	AKBD	AKB Self Diagnostic Counter(@1sec)	00-07	7
25	AKBS	AKB H/W S/W Switch	00-02	1
26	REFP	AKB REFPLS timing	00-01	1
27	YNRC	YNR LIMITER LEVEL	00-15	15
28	BKON	BLACK STRETCH ON	00-01	1
29	BKTH	BLACK STRETCH DETECTOR TRESH LEVEL	00-255	22
30	BKAR	BLACK STRETCH DETECTOR TRESH AREA	00-03	1
31	BKSP	BLACK STRETCH START POINT	00-03	1

DEVICE "VP2"

Item#	OSD	DETAIL	Range (DEC)	Initial Data
1	VMLO	VM LEVEL at "Low" Setting	00-15	10
2	VMHI	VM LEVEL at "High" Setting	00-15	15
3	VMDL	VM DELAY	00-15	6
4	VMPL	VM PORALITY	00-01	0
5	VMWD	VM WIDTH	00-03	0
6	VMCL	VM CORING LEVEL	00-15	0
7	VMMX	VM LIMITER LEVEL	00-15	15
8	CKLV	COLOR KILLER VTH	00-127	1/YUV:0
9	CKON	FORCE KILLER	00-01	0
10	ALFA	ADAPTIVE DET SENSITIVITY	00-03	2
11	YCMD	YC SEPA FORCE SELECT(00:ADAPTIVE 01:H 10:V 11:HV)	00-03	0
12	VACL	V APERTURE CORING LEVEL	00-15	0
13	VAGA	V APERTURE GAIN LEVEL	00-15	Soft Cont'l
14	VAMX	V APERTURE LIMITER LEVEL	00-15	3
15	GAMM	GANMA(00:no <-->11:deep)	00-03	Soft Cont'l
16	YDLY	Y DELAY TIME	00-03	3/YUV:3
17	CDLY	C DELAY	00-03	2/YUV:2
18	YOFF	Y OUTPUT MUTE	00-01	0
19	CBPF	C BPF fo HI	00-01	0/YUV:0
20	CLIM	C OUTPUT LIMITTER	00-15	15
21	YFSL	Y BAND WIDTH	00-03	0
22	CFSL	C BAND WIDTH	00-03	0
23	BGPP	BGP(for C DECODER)TIMING	00-31	8
24	NRCH	NOISE DET TIME CONSTANT	00-03	0
25	NRCL	NOISE DET TIME CONSTANT	00-255	8
26	NRVL	NOISE DET VTH	00-255	16
27	NRVH	NOISE DET VTH	00-255	0
28	GDOF	G DRIVE	00-31	18
29	BDOF	B DRIVE	00-31	31
30	GCOF	G CUTOFF	00-31	02
31	BCOF	B CUTOFF	00-31	00
32	DCTV	DCTTRANSFER VTH	00-127	5
33	DCTG	DCTTRANSFER GAIN	00-31	Soft Cont'l

ADJUSTMENT ITEMS (3 OF 8)**DEVICE "VIVID"**

Item#	OSD	DETAIL	Range (DEC)	Initial Data
1	VPIC	Picture(VIVID)	00-63	63
2	VBRI	Brightness(VIVID)	00-63	31
3	VCOL	Color(VIVID)	00-63	37
4	VHUE	Hue(VIVID)	00-63	31
5	VSHA	Sharpness(VIVID)	00-63	31
6	VVM	VM(VIVID)	00-02	2
7	VTRI	Color Temp(VIVID)	00-02	0
8	VAPA	Aperture G(VIVID)	00-15	7
9	VGMA	Gamma(VIVID)	00-03	3
10	DCTG	DCT LV(VIVID)	00-03	16

DEVICE "STD"

Item#	OSD	DETAIL	Range (DEC)	Initial Data
1	VPIC	Picture(STANDARD)	00-63	50/FEFS:63
2	VBRI	Brightness(STANDARD)	00-63	37/FEFS:31
3	VCOL	Color(STANDARD)	00-63	31/FEFS:37
4	VHUE	Hue(STANDARD)	00-63	31/FEFS:31
5	VSHA	Sharpness(STANDARD)	00-63	31/FEFS:31
6	VVM	VM(STANDARD)	00-02	1/FEFS:2
7	VTRI	Color Temp(STANDARD)	00-02	1/FEFS:0
8	VAPA	Aperture G(STANDARD)	00-15	7/FEFS:7
9	VGMA	Gamma(STANDARD)	00-03	3/FEFS:3
10	DCTG	DCT LV(STANDARD)	00-03	16/FEFS:16

DEVICE "MOVIE"

Item#	OSD	DETAIL	Range (DEC)	Initial Data
1	VPIC	Picture(MOVIE)	00-63	31
2	VBRI	Brightness(MOVIE)	00-63	51
3	VCOL	Color(MOVIE)	00-63	25
4	VHUE	Hue(MOVIE)	00-63	31
5	VSHA	Sharpness(MOVIE)	00-63	31
6	VVM	VM(MOVIE)	00-02	0
7	VTRI	Color Temp(MOVIE)	00-02	2
8	VAPA	Aperture G(MOVIE)	00-15	7
9	VGMA	Gamma(MOVIE)	00-03	3
10	DCTG	DCT LV(MOVIE)	00-03	16

DEVICE "SPORTS"

Item#	OSD	DETAIL	Range (DEC)	Initial Data
1	VPIC	Picture(SPORTS)	00-63	63
2	VBRI	Brightness(SPORTS)	00-63	31
3	VCOL	Color(SPORTS)	00-63	40
4	VHUE	Hue(SPORTS)	00-63	31
5	VSHA	Sharpness(SPORTS)	00-63	31
6	VVM	VM(SPORTS)	00-02	2
7	VTRI	Color Temp(SPORTS)	00-02	0
8	VAPA	Aperture G(SPORTS)	00-15	7
9	VGMA	Gamma(SPORTS)	00-03	3
10	DCTG	DCT LV(SPORTS)	00-03	16

ADJUSTMENT ITEMS (4 OF 8)

DEVICE "Y"

Item#	OSD	DETAIL	Range (DEC)	Initial Data
1	COFI	0:4 Linedelaies 1:2 Linedelaies	00-01	0
2	YNRS	YNR ON	00-01	0
3	YTHR	Y SIGNAL GENERATE from 2DYCS	00-01	0
4	Y2D	Y SIGNAL GENERATE from 2DYCS	00-01	0
5	2DFX	C SIGNAL GENELATE from H/V BPF only	00-01	1
6	CLPS	Y CLAMP TIME CONSTANT	00-01	1
7	VLPF	Y_LPF(ANALOG) fo Ajust	00-03	3
8	CLPF	C_LPF(ANALOG) fo Ajust	00-03	3
9	BKHS	BLACK STRETCH HYSTERISYS	00-31	1
10	BPFB	YCS HBPF SELECT(BACK)	00-03	1
11	BPFF	YCS HBPF SELECT(FRONT)	00-01	1

DEVICE "C"

Item#	OSD	DETAIL	Range (DEC)	Initial Data
1	FORG	CHROMA DECODER PHASE SELECT	00-03	0
2	FSEL	CHROMA DECODER CLK SELECT	00-01	0/YUV:0
3	ACTL	ANALOG ACC AMP MAX GAIN	00-03	3
4	A1FL	ANALOG ACC hysteresis	00-255	34
5	A1FH		00-01	0
6	A1ON	ANALOG ACC AMP ON LEVEL	00-127	12
7	MV	MACROVISION(BURST) DET TRESH	00-15	0
8	MV1S	MACROVISION(BURST) DET ON	00-01	1
9	MV2S	MACROVISION(BURST) DET POSITION	00-01	1
10	ACCS	ACC ON/OFF	00-01	0/YUV:1
11	KILS	KILLER DET SELECT	00-01	0/YUV:1
12	AASL	C DECODER TIME CONSTANT(32,16,8,1H)	00-03	3
13	BASL	ACC TIME CONSTANT	00-03	0
14	ATIM	ANALOG ACC HISTERISYS SELECT	00-03	0
15	VMSK	ACC V BLK OFF WIDTH	00-07	0
16	A3ON	ACC MAX GAIN	00-01	0
17	INTE	C DECODER INTRGRATOR ENABLE	00-01	0
18	SIN	C DECODER PHASE V ENABLE	00-01	0
19	CKVT	PLL STOP BURST LEVEL	00-03	1
20	XFFR	VCXO FORCE FREERUN	00-01	0/YUV:1
21	ACCV	C DECODER PHASE V ENABLE	00-01	1
22	BWSL	KILLER DET SELECT	00-01	1/YUV:1
23	BWDT	PLL KILLER VTH	00-03	0/YUV:3
24	A23E	AMP2,3 ON/OFF ENABLE(0 FIX)	00-01	1
25	A2ON	ABL VTH	00-127	12
26	A3ON	ACL VTH	00-127	12
27	A2FL	AMP2 OFF LEVEL lower	00-255	34
28	A2FH	AMP2 OFF LEVEL upper	00-01	0
29	A3FL	AMP3 OFF LEVEL lower	00-255	34
30	A3FH	AMP3 OFF LEVEL upper	00-01	0
31	AXTH	AXS HYS	00-63	30
32	ACTH	ROM HYS	00-63	10
33	AVAV	AVE SEL AV	00-03	3
34	B2TH	B2COMP	00-127	0

ADJUSTMENT ITEMS (5 OF 8)

DEVICE "RGB"

Item#	OSD	DETAIL	Range (DEC)	Initial Data
1	AMUT	RGB POWER ON MUTE	00-01	0
2	PMUT	RGB MUTE(EXCEPT OSD)	00-01	1
3	VBLK		00-01	0
4	CORL	R CUTOFF lower	00-255	100
5	CORH	R CUTOFF upper	00-01	1
6	COGL	G CUTOFF lower when Color Temp. is "Cool" and "Neutral"	00-255	125
7	COGH	G CUTOFF upper when Color Temp. is "Cool" and "Neutral"	00-01	1
8	COBL	B CUTOFF lower when Color Temp. is "Cool" and "Neutral"	00-255	125
9	COBH	B CUTOFF upper when Color Temp. is "Cool" and "Neutral"	00-01	1
10	ABLS	ABL SELECT (ON:00, OFF:01)	00-01	0
11	ACLS	ACL ON (ON:00, OFF:01)	00-01	1
12	ALSP	ACL SPEED	00-03	1
13	ALRS	ACL RECOVER SPEED	00-15	2
14	ALAS	ACL ATACK SPEED	00-15	9
15	ABLG	ABL GAIN	00-15	15
16	ALS2	ACL ATACK SPEED(2)	00-03	2
17	AKBS	AKB MODE	00-01	1
18	AKBP	AKB PULSE HEIGHT	00-63	40
19	OSDL	OSD LIMMIT SELECT	00-01	0
20	MPXS	UV MULTIPLEX ON	00-01	0/YUV:0
21	CXUV	YC/YUV SELECT	00-01	0/YUV:1
22	UVIN	U/V INVERT	00-01	0/YUV:0
23	UVOS	UV OFFSET CANCELER ON	00-01	0/YUV:0
24	ACL	SOFT ACL CONTROLE	00-63	63
25	HBLS	H BLK OFF	00-01	0
26	VENS	V-latch OFF	00-01	0
27	UOFS	U IN OFFSET	00-15	4
28	VOFS	V IN OFFSET	00-15	9
29	AABL	ANALOG ABL THRESHOLD LEVEL CONTROL	00-15	0
30	AABG	ANALOG ABL GAIN CONTROL	00-01	0
31	AALG	ANALOG ACL GAIN CONTROL	00-01	0
32	AABS	ANALOG ABL ON/OFF CONTROL (ON:01, OFF:00)	00-01	0
33	AALS	ANALOG ACL ON/OFF CONTROL (ON:01, OFF:00)	00-01	1

ADJUSTMENT ITEMS (6 OF 8)

DEVICE "DEFD"

Item#	OSD	DETAIL	Range (DEC)	Initial Data
1	VSTP	V OUTPUT STOP	00-01	0
2	HFFR	AFC1 FORCE FREERUN	00-01	0
3	HFUP	H FREERUN FREQUENCY UP(700Hz)	00-01	0
4	VPHA	V PHASE(V POSITION ADJUST)	00-15	0
5	JSWW	Jump Pulse Width	00-01	0
6	EWG	EWV AD OUTPUT LEVEL(6db)	00-01	0
7	EWCL	EW/VRAMP DA CLOCK SELECT	00-03	2/YUV:2
8	EWDI	EW/VRAMP DA DITHER	00-01	0
9	XF0A	VCXO FREERUN ADJUST	00-15	0
10	BGST	BGP(for PLL) TIMING	00-63	17
11	SKWI	Skew correcter refernce phase	00-01	0/YUV:0
12	XPHA	VCXO PHASE ADJUST	00-15	10
13	SKEW	Skew correcterphase controle	00-07	0/YUV:3
14	HRMP	AFC2 TIME CONSTANT	00-03	0
15	RPLU	REF PLL TIME CONSTANT	00-07	3
16	RPLB	REF PLL TIME CONSTANT	00-01	1
17	XF0B	VCXO Fo ADJUST	00-03	0
18	RPLS	REF VCO FB LOOP SELECT	00-01	0
19	SSM	SyncSepaMasking CONTROL	00-01	0
20	VSAG	V-SAG prevent ON	00-01	0
21	AFC2	AFC2 GAIN CONTROL	00-03	0
22	VRFL	V RAMP FILTER SWITCHING OFF	00-01	0
23	SSLP	LPF pre SYNC SEPA ON/OFF	00-01	0
24	IMTS	I.M. TEST	00-01	0
25	XPLU	ACP TIME CONSTANT	00-01	0
26	8FSC	8fscCLK Skew OFF	00-01	1/YUV:1
27	4FS2	4fscCLK Skew OFF	00-01	1/YUV:1
28	EWVR	DSDAC V RESET Enable	00-01	0
29	VLOF	IIC V Latch OFF(for TEST)	00-01	0
30	1WIN	FORCE 1Window	00-01	1
31	BGPC	ANGLE Return current up	00-01	0
32	MHDL	ANGLE Return current up timing	00-01	1
33	BFRE	force V FREERUN	00-01	0
34	ANGG	ANGLE Retun current up	00-01	1
35	ANGT	ANGLE Retun current up timing	00-01	0
36	DOSD	Digital OSD ON	00-01	0
37	ANGS	AFC2 ANGLE/BOW INHIBIT	00-01	0
38	HRPP	FRAMP RRAMP H OUT CONTROL RANGE	00-15	8
39	VF50	FORCE V FREERUN 50Hz	00-01	0
40	CLKS	TBC clock system select	00-03	0
41	VBHK	V BLK HALF KILL	00-01	0
42	DSYC	CVBS INPUT CONTROL	00-01	0
43	VPW	V Pulse Wide	00-01	1
44	QSW	MODULATOR FEEDBACK GAIN CONTROL	00-01	0
45	ADTY	CLOCK DUTY CONTROL at IIC QSWITCH=ON	00-01	0
46	DTH	DITHER THRESHOLD LEVEL CONTROL at IIC AUTOD=ON	00-03	1
47	HBSW	HBLK REFERENCE AFC1/AFC2	00-01	0
48	DSCS	•DAC CLOCK ON/OFF CONTROL	00-01	0

ADJUSTMENT ITEMS (7 OF 8)

DEVICE "OTHER"

Item#	OSD	DETAIL	Range (DEC)	Initial Data
1	PCLP	SYNC TIP/PEDESTAL CLAMP SELECT	00-01	0
2	VRT	ADC REFERENCE (00:1.15Vpp 01:1.25Vpp 10:1.35Vpp 11:1.45Vpp)	00-03	1/YUV:1
3	AM	INTERIGENT MONITOR OUTPUT SELECT(analog)	00-15	0
4	DME	INTERIGENT MONITOR OUTPUT SELECT(degital)	00-01	0
5	DM	INTERIGENT MONITOR OUTPUT SELECT(degital)	00-31	0
6	14HI	4fsc(Skew)CLK POLARITY	00-01	0
7	14HD	4fscCLK(Skew)CLK DELAY ADJUST	00-03	1
8	28I	8fscCLK POLARITY	00-01	1
9	28D	8fscCLK DELAY ADJUST	00-03	1
10	ADCD	ADC CLK DELAY ADJUST	00-03	1/YUV:0
11	CLKS	AD/LOGIC CLK SWAP	00-01	0/YUV:0
12	HDSL	HD OUT(for MCU)SELECT	00-01	1
13	CPSL	PLL CP LATCH ON	00-01	0
14	CPCL	PLL CP LATCH CLOCK	00-01	0
15	CPCP	PLL CP LATCH POLARTY	00-01	0
16	DUMY	DUMMY	00-0F	1

DEVICE "OSD"

Item#	OSD	DETAIL	Range (DEC)	Initial Data
1	HT	HALF TONE LEVEL	00-03	0
2	OSLR	R OSD LEVEL	00-63	27
3	OSLG	G OSD LEVEL	00-63	27
4	OSDC		00-03	0
5	OSDB	B OSD LEVEL	00-63	27

DEVICE "S/W ADKB"

Item#	OSD	DETAIL	Range (DEC)	Initial Data
1	SRIL	S/W AKB RED OUTPUT Lower	00-255	Soft Cont'l
2	SRIH	S/W AKB RED OUTPUT Upper	00-01	Soft Cont'l
3	SGIL	S/W AKB GREEN OUTPUT Lower	00-255	Soft Cont'l
4	SGIH	S/W AKB GREEN OUTPUT Upper	00-01	Soft Cont'l
5	SBIL	S/W AKB BLUE OUTPUT Lower	00-255	Soft Cont'l
6	SBIH	S/W AKB BLUE OUTPUT Upper	00-01	Soft Cont'l
7	SLM1	S/W AKB LIMIT DATA 1	00-255	4
8	SLM2	S/W AKB LIMIT DATA 2	00-255	29
9	SLM3	S/W AKB LIMIT DATA 3	00-255	130
10	SAD1	S/W AKB ADD DATA 1	00-255	1
11	SAD2	S/W AKB ADD DATA 2	00-255	1
12	SBIT	S/W AKB BIT SHIFT DATA	00-05	0
13	SNOP	S/W AKB POWER ON NOP TIMER COUNTER DATA	00-FF	1
14	SERL	S/W AKB BIT ERROR JUDGE LEVEL	01-80	124
15	SPWC	S/W AKB ERROR JUDGE COUNTER DATA	01-FF	2
16	SLMC	S/W AKB LIM2/LIM3 JUDGE COUNTER DATA	01-FF	10
17	SPWL	S/W AKB POWER ON MUTE OFF JUDGE LEVEL	01-80	30
18	SPMT	S/W AKB POWER ON MUTE EXIT TIMER DATA(@100ms)	00-FF	120
19	SEEP	S/W AKB INITIAL DATA EEPROM WRITE TIMER(@1sec)	00-FF	20

ADJUSTMENT ITEMS (8 OF 8)

DEVICE "AUDIO PROCESSOR"

Item#	OSD	DETAIL	Range (DEC)	Initial Data
1	SBAL	Sub Balance	00-07	4
2	SBAS	Sub Bass	00-07	0
3	STRE	Sub Treble	00-07	0
4	SRL	Surround Level	00-01	0
5	BBOL	Surround Off-BBE Low	00-15	0
6	BBOH	Surround Off-BBE High	00-15	3
7	BBSL	Simulate BBE Low	00-15	0
8	BBSH	Simulate BBE High	00-15	0
9	BBGL	WOW Game BBE Low	00-15	7
10	BBGH	WOW Game BBE High	00-15	3
11	BBTL	SRS BBE Low	00-15	0
12	BBTH	SRS BBE High	00-15	2
13	VFIX	Audio output fix data	00-255	240
14	AGCL	AGC level	00-03	2

DEVICE "MICROPROCESSOR"

Item#	OSD	DETAIL	Range (DEC)	Initial Data
1	DISP	OSD horizontal offset	00-127	78
2	CCHP	Closed Caption Horizontal Position	00-7E	80
3	HRLW	Low limit of H-pulse counting window (RF)	00-255	16
4	HRHG	High limit of H-pulse counting window (RF)	00-255	64
5	HSLW	Low limit of H-pulse counting window (S-Video)	00-255	16
6	HSHG	High limit of H-pulse counting window (S-Video)	00-255	64
7	HSDT	H-pulse Detection(S-Video)	00-255	8

DEVICE "FEATURE"

Item#	OSD	DETAIL	Range (DEC)	Initial Data
	ID0	Language related	00-255	SEE ID MAP
	ID1	Video related	00-255	SEE ID MAP
	ID2	Audio related	00-255	SEE ID MAP
	ID3	Miscellaneous	00-255	SEE ID MAP
	ID4	Miscellaneous	00-255	SEE ID MAP
	ID5	Miscellaneous	00-255	SEE ID MAP
	ID6	Miscellaneous	00-255	SEE ID MAP
	ID7	Miscellaneous	00-255	SEE ID MAP

Notes:

Range (DEC) shows the range of possible setting for each Adjustment Mode.
Initial Data shows the standard settings for each Adjustment Mode.

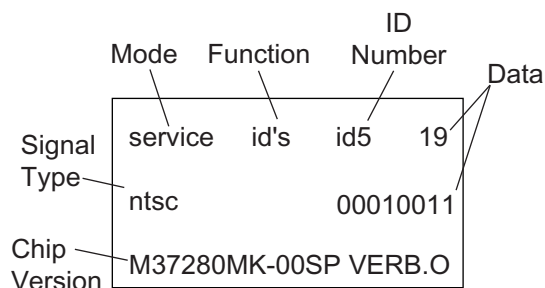

4-4. ID MAP TABLE

Model	Destination	ID-0	ID-1	ID-2	ID-3	ID-4	ID-5	ID-6	ID-7
KV-24FS100	US	89	23	65	33	128	48	0	150
KV-24FS100	CND	89	23	65	49	128	48	0	150
KV-25FS100	E	81	23	81	129	160	48	0	214

4-5. A BOARD ADJUSTMENTS

H. FREQUENCY (FREE RUN) CHECK

1. Input a TV mode (RF) with no signal.
2. Connect a frequency counter to base of Q502 (TP-25 H. DRIVE) on the A Board.
3. Check H. Frequency for 15735 ± 200 Hz.

V. FREQUENCY (FREE RUN) CHECK

1. Select video 1 with no signal input.
2. Set the conditions for a standard setting.
3. Connect the frequency counter to TP-27 (V OUT) or CN515 pin ⑥ (V DY+) and ground on the A Board .
4. Check that V. Frequency shows 60 ± 4 Hz.

DRIVE (SCON)

1. Input a color-bar signal and set the level to 75%.
2. Set in Standard mode.
3. Activate the Service Adjustment Mode.
4. Set AALS, ABLs, GON and BON items. Using **[3]** and **[6]** set each to the following values. Leave RON set to "1".

Signal Type	Mode	Category	Display Item	Item Data
	service	video	rdrv	26
	ntsc			
	vchp			00000000 00000000

AALS: OFF (0)
 ABLs: OFF (1)
 RON: ON (1)
 GON: OFF (0)
 BON: OFF (0)

5. Connect an oscilloscope probe to CV Board, J1751Pin 12 (KR) (Red Out) .
6. Select SCON with **[1]** and **[4]** .
7. Adjust the value of SCON with **[3]** and **[6]** for $96 \pm 3V_{pp}$.

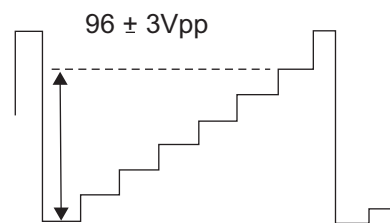

8. Reset AALS, ABLs, GON and BON values to "1".
 AALS: ON (1)
 ABLs: ON (0)
 RON: ON (1)
 GON: ON (1)
 BON: ON (1)
9. Press **[MUTING]** then **[ENTER]** to save into the memory.

DISPLAY POSITION ADJUSTMENT (DISP)

1. Input a color-bar signal.
2. Set to Service Adjustment Mode.
3. Select DISP with **[1]** and **[4]** .
4. Adjust values of DISP with **[3]** and **[6]** to adjust characters to the center.
5. Write to memory by pressing **[MUTING]** then **[ENTER]** .
6. Check to see if the text is displayed on the screen.

Signal Type	Mode	Category	Display Item	Item Data
	service	micro	disp	48
	ntsc			
	vchp			00000000 00000000

SUB BRIGHT ADJUSTMENT (SBRT)

1. Input a monoscope signal.
2. Activate the Service Adjustment Mode.
3. Set the PICTURE and BRIGHTNESS to minimum.
4. Select the SBRT item with **[1]** and **[4]** .
5. Adjust the values of SBRT with **[3]** and **[6]** to obtain a faintly visible crosshatch.
6. Press **[MUTING]** then **[ENTER]** to save into the memory.

SUB HUE, SUB COLOR ADJUSTMENT (SHUE, SCOL)

1. Input color-bar signal at 75%.
2. Activate the Service Adjustment Mode.
3. Set (PIC) to Max and (COL) to 50%.
4. Connect an oscilloscope probe to CV Board, CN301Pin ④ Blue Out.
5. Select the SHUE and SCOL item with **[1]** and **[4]** .
6. While showing the SHUE item, adjust the waveform with **[1]** and **[4]** until the second and third bars show the same level ($V_2 = V_3 < 0.15V_{p-p}$). Set Sub Hue -2 Step.

7. While showing the SCOL item, adjust the waveform with **3** and **6** until the first and fourth bars show the same level ($V1 = V4 < 0.15Vp-p$). Set Sub Col +3 Step.

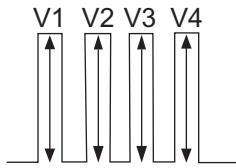

8. Press **MUTING** then **ENTER** to save into the memory.

V. SIZE ADJUSTMENT (VSIZ)

1. Input a crosshatch signal.
2. Activate the Service Adjustment Mode.
3. Select the VSIZ item with **1** and **4**.
4. Adjust value of VPOS with **1** and **4** for the best vertical center.
5. Press **MUTING** then **ENTER** to save into the memory.

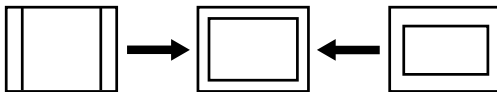

V. CENTER ADJUSTMENT (VPOS)

Perform this adjustment after performing H. Frequency (Free Run) Check.

1. Input a crosshatch signal.
2. Activate the Service Adjustment Mode.
3. Select the VPOS item with **1** and **4**.
4. Adjust value of VPOS with **3** and **6** for the best vertical center.
5. Press **MUTING** then **ENTER** to save into the memory.

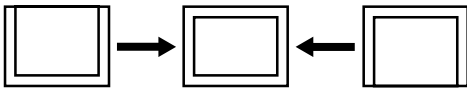

H. CENTER ADJUSTMENT (HPOS)

Perform this adjustment after performing H. Frequency (Free Run) Check.

1. Input a crosshatch signal.
2. Activate the Service Adjustment Mode.
3. Select the HPOS item with **1** and **4**.
4. Adjust the value of HPOS with **3** and **6** for the best horizontal center.
5. Press **MUTING** then **ENTER** to save into the memory.

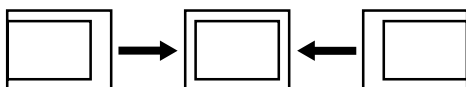

H. SIZE ADJUSTMENT (HSIZ)

1. Input a monoscope signal.
2. Activate the Service Adjustment Mode.
3. Select HSIZ with **1** and **4**.
4. Adjust with **3** and **6** for the best horizontal size.
5. Press **MUTING** then **ENTER** to save into the memory.

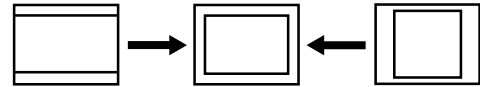

V. LINEARITY (VLIN), V. CORRECTION (SCOR), PIN AMP (PAMP), AND HORIZONTAL TRAPEZOID (HTRP) ADJUSTMENTS

1. Input a crosshatch signal.
2. Activate the Service Adjustment Mode.
3. Select VLIN, SCOR, PAMP, and HTRP with with **1** and **4**.
4. Adjust with **3** and **6** for the best horizontal size.
5. Press **MUTING** then **ENTER** to save into the memory.

V LINEARITY (VLIN)

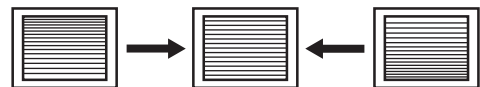

V CORRECTION (SCOR)

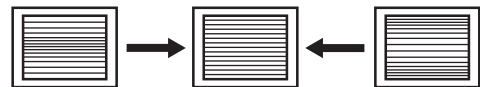

PIN AMP (PAMP)



HORIZONTAL TRAPEZOID (HTRP)

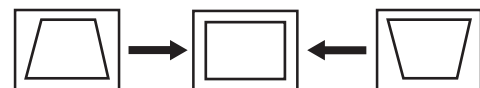

V. ANGLE (VANG), V. BOW (VBOW), UPPER PIN (UPIN) AND LOW PIN (LPIN) ADJUSTMENTS

1. Input a crosshatch signal.
2. Activate the Service Adjustment Mode.
3. Select VANG, VBOW, UPIN, and LPIN with **1** and **4**.
4. Adjust with **3** and **6** for the best picture.
5. Press **MUTING** then **ENTER** to save into the memory.

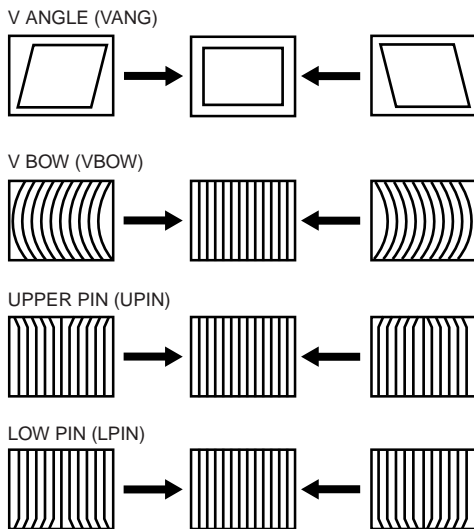

SERVICE ADJUSTMENT MODE MEMORY

1. After completing all adjustments, press **0** then **ENTER**.
Read From Memory

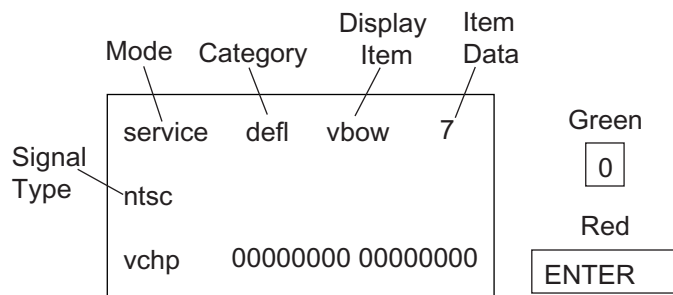



SECTION 5: DIAGRAMS

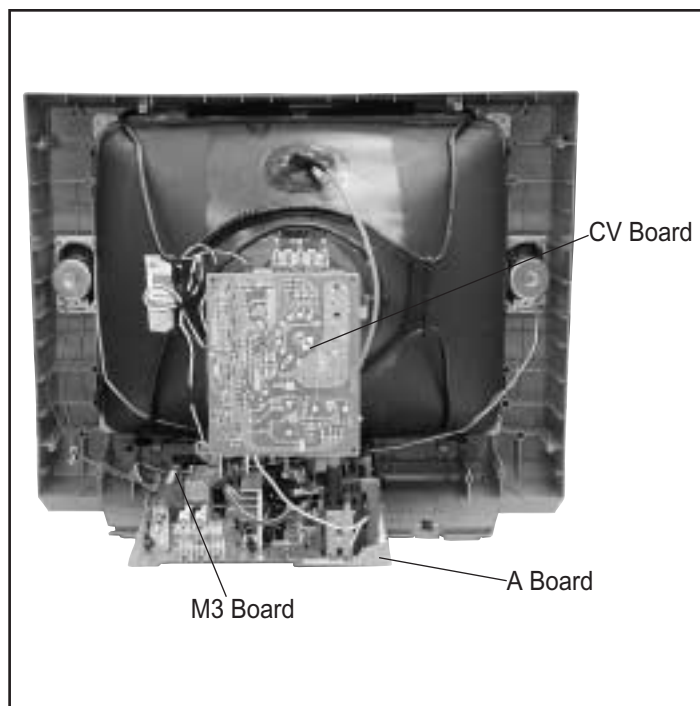

5-1. CIRCUIT BOARDS LOCATION



The components identified by  in this basic schematic diagram have been carefully factory-selected for each set in order to satisfy regulations regarding X-ray radiation. Should replacement be necessary, replace only with the value originally used.

When replacing components identified by , make the necessary adjustments as indicated. If the results do not meet the specified value, change the component identified by  and repeat the adjustment until the specified value is achieved. (Refer to Safety Related Adjustments on Page 15.)

When replacing the parts listed in the table below, it is important to perform the related adjustments.

Part Replaced ()	Adjustment ()
DY, T585, CRT, IC001, IC561, C507, C508, C506, T511, L510, C588, L588, C566, C561, C563, D567, D568, D566, R567, R568, R565, R566, R562, R563, R561, R528.....A Board	HV HOLD-DOWN R565

5-2. PRINTED WIRING BOARD AND SCHEMATIC DIAGRAM INFORMATION

All capacitors are in μF unless otherwise noted. pF : μF 50VV or less are not indicated except for electrolytics and tantalums.

All electrolytics are in 50V unless otherwise specified.

All resistors are in ohms. k=1000, M=1000k

Indication of resistance, which does not have one for rating electrical power, is as follows: Pitch : 5mm Rating electrical power :

$\frac{1}{4}$ W in resistance, $\frac{1}{10}$ W and $\frac{1}{8}$ W in chip resistance.

: nonflammable resistor.

: fusible resistor.

: internal component.

: panel designation and adjustment for repair.

All variable and adjustable resistors have characteristic curve B, unless otherwise noted.

Readings are taken with a color-bar signal input.

Readings are taken with a 10M digital multimeter.

Voltages are DC with respect to ground unless otherwise noted.

Voltage variations may be noted due to normal production tolerances.

All voltages are in V.

S : Measurement impossibility.

 : B-line. (Actual measured value may be different).

: signal path. (RF)

Circled numbers are waveform references.

REFERENCE INFORMATION

RESISTOR	: RN	METAL FILM
	: RC	SOLID
	: FPRD	NONFLAMMABLE CARBON
	: FUSE	NONFLAMMABLE FUSIBLE
	: RW	NONFLAMMABLE WIREWOUND
	: RS	NONFLAMMABLE METAL OXIDE
	: RB	NONFLAMMABLE CEMENT
	: 	ADJUSTMENT RESISTOR

COIL : LF-8L MICRO INDUCTOR

CAPACITOR	: TA	TANTALUM
	: PS	STYROL
	: PP	POLYPROPYLENE
	: PT	MYLAR
	: MPS	METALIZED POLYESTER
	: MPP	METALIZED POLYPROPYLENE
	: ALB	BIPOLAR
	: ALT	HIGH TEMPERATURE
	: ALR	HIGH RIPPLE

The components identified by shading and  symbol are critical for safety. Replace only with part number specified.

The symbol  indicates a fast operating fuse and is displayed on the component side of the board. Replace only with fuse of the same rating as marked.

Les composants identifiés par un trame et une marque  sont critiques pour la sécurité. Ne les remplacer que par une pièce portant le numéro spécifique.

Le symbole  indique une fusible à action rapide. Doit être remplacé par une fusible de même valeur, comme marqué.

BLOCK DIAGRAM

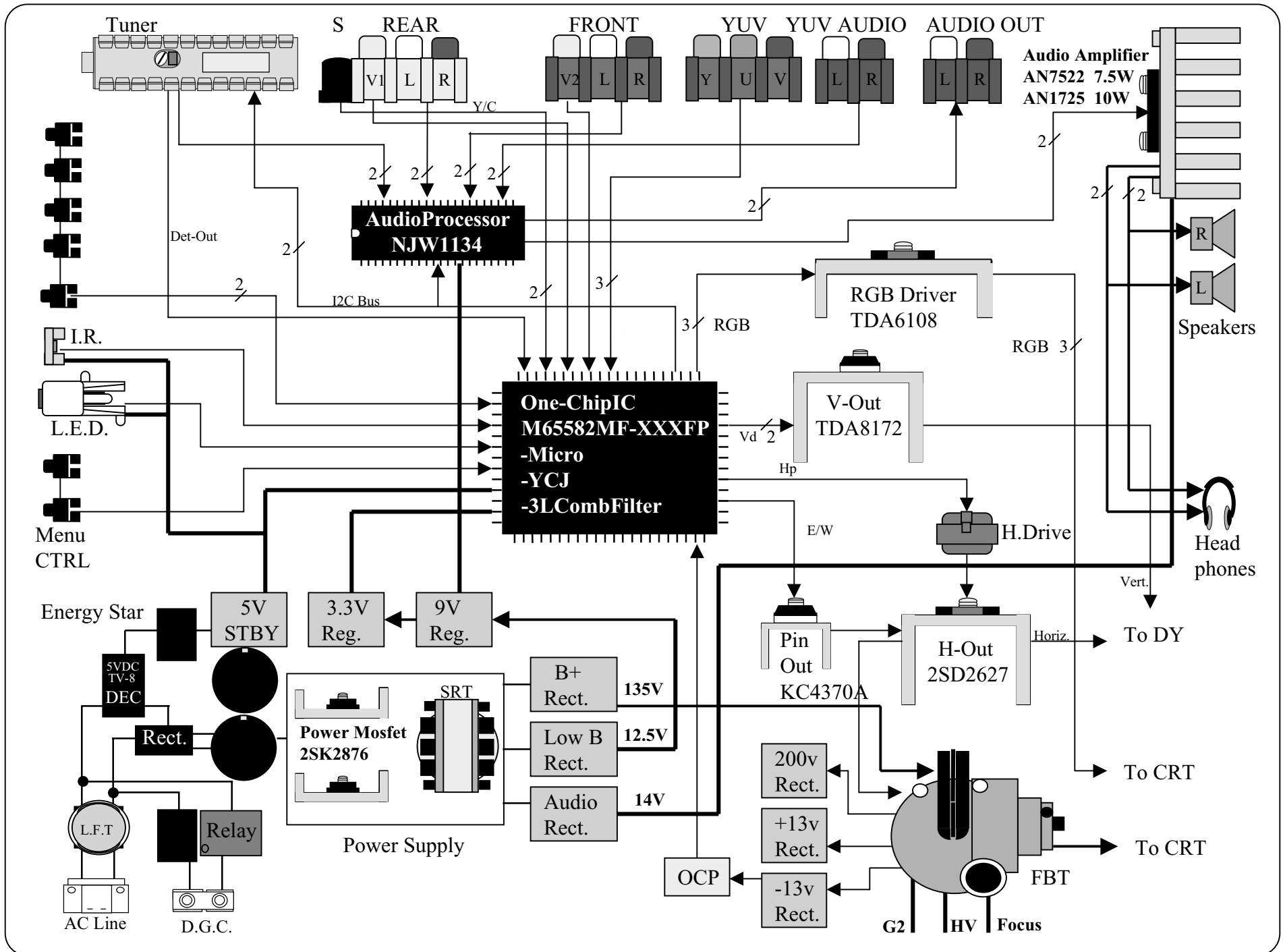

A [POWER SUPPLY, DEFLECTION, TUNER/IF, AUDIO, MTS, TUNING CONTROL, Y-C JUNGLE]

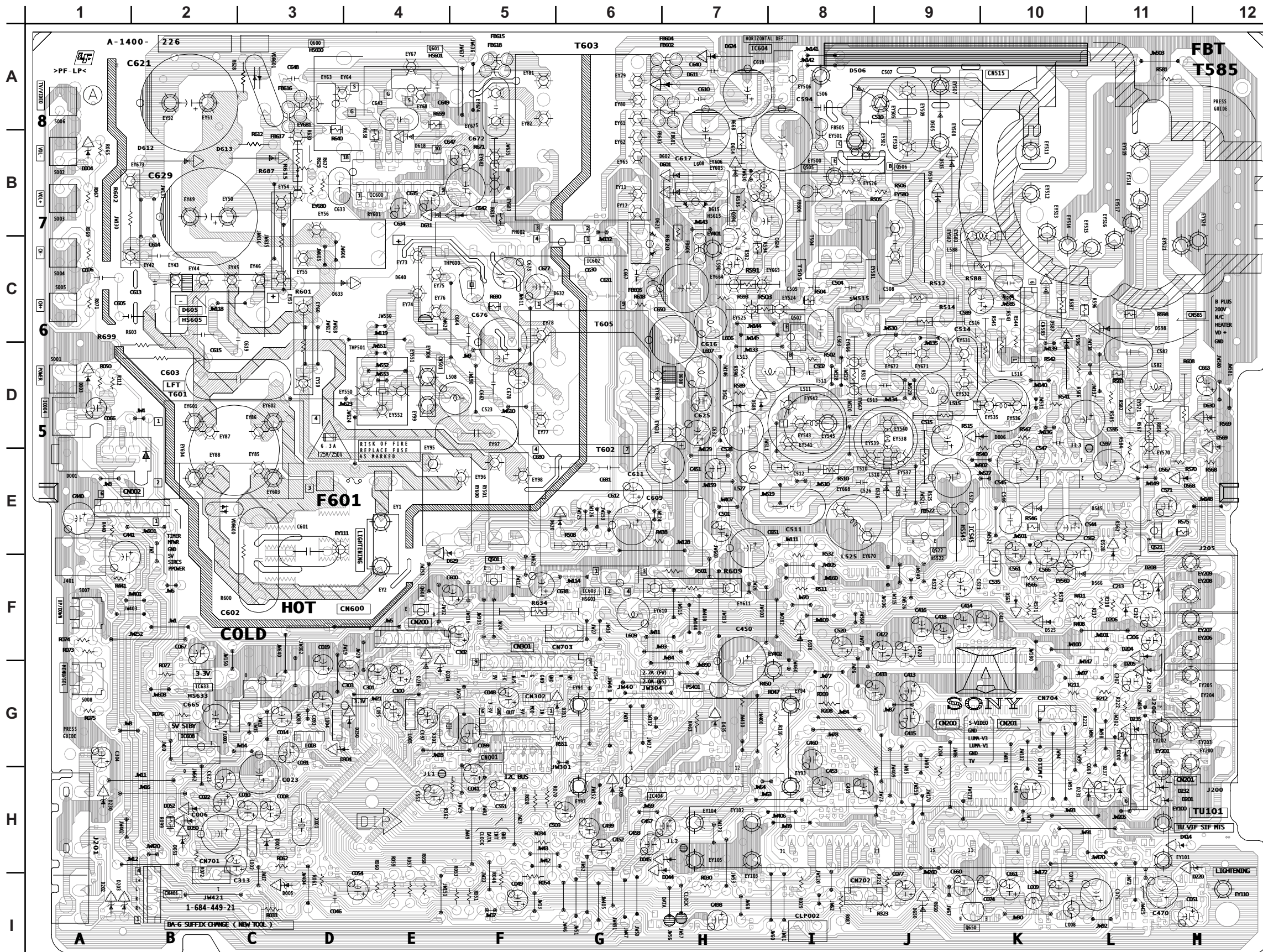

A BOARD LOCATOR TABLE

DIODE		D526	E-9	IC603	D-6
D001	E-2	D528	D-11	IC604	I-8
D002	B-3	D545	E-10	IC608	C-2
D003	F-1	D558	D-5	IC633	C-3
D004	H-1	D559	F-8	TRANSISTORS	
D005	A-3	D562	F-7	Q002	B-6
D006	F-10	D566	D-11	Q004	A-11
D044	A-6	D567	E-11	Q005	A-11
D045	B-7	D568	E-11	Q006	D-6
D050	B-2	D569	F-12	Q008	C-2
D051	B-2	D587	G-10	Q009	B-10
D052	B-2	D589	F-8	Q300	C-5
D200	B-11	D596	F-10	Q301	D-5
D201	B-11	D598	F-11	Q303	D-5
D202	A-1	D605	G-3	Q304	D-5
D203	A-1	D608	F-7	Q305	C-5
D204	C-11	D611	I-7	Q306	A-8
D205	C-11	D612	B-2	Q390	C-7
D230	B-1	D613	B-3	Q391	C-6
D231	B-11	D614	H-7	Q400	C-10
D232	B-11	D615	H-7	Q401	C-10
D234	C-5	D618	H-5	Q404	C-8
D235	C-11	D620	E-6	Q405	C-8
D236	C-4	D621	G-6	Q411	A-6
D237	B-11	D624	I-7	Q412	B-11
D351	C-6	D628	E-5	Q435	G-7
D390	C-7	D629	E-4	Q501	D-5
D410	B-5	D630	F-12	Q502	G-8
D412	B-11	D631	H-5	Q505	H-8
D413	A-11	D650	A-9	Q521	D-11
D414	B-11	IC		Q522	E-9
D435	G-7	IC001	B-4	Q572	D-6
D438	G-7	IC002	B-5	Q573	D-6
D501	E-5	IC003	B-3	Q578	D-10
D505	I-9	IC004	F-1	Q590	G-7
D506	I-8	IC401	B-9	Q600	I-3
D508	D-10	IC404	B-7	Q601	I-4
D509	C-6	IC545	E-10	Q604	E-7
D514	H-9	IC561	E-11	Q608	F-4
D515	H-10	IC565	D-8	Q650	A-9
D525	D-10	IC600	H-4		

A BOARD TRANSISTOR VOLTAGE LIST

	B	C	E		B	C	E
Q002	0.0	2.0	GND	Q405	0.0	0.0	GND
Q004	3.8	9.0	4.4	Q411	0.0	5.8	GND
Q005	5.1	0.8	5.0	Q412	0.1	0.1	GND
Q006	0.0	0.0	GND	Q435	0.0	GND	5.8
Q008	0.0	2.6	GND	Q501	0.0	14.3	GND
Q009	0.0	5.2	GND	Q502	0.0	74.1	GND
Q300	1.8	9.0	2.4	Q505	0.0	131.8	0.0
Q301	3.6	2.1	3.6	Q521	0.0	3.8	GND
Q303	3.6	GND	2.8	Q522	0.1	-2.1	0.0
Q304	3.6	GND	2.9	Q572	0.0	2.6	GND
Q305	3.6	GND	3.0	Q573	2.6	0.0	2.6
Q306	5.5	GND	4.9	Q578	0.0	0.5	GND
Q390	0.8	1.5	1.9	Q590	133.7	0.0	134.2
Q391	0.6	3.3	1.5	Q604	30.6	11.6	30.2
Q400	0.0	0.1	GND	Q608	0.0	6.7	GND
Q401	0.0	0.1	GND	Q650	5.8	9.0	5.0
Q404	0.0	0.0	GND				

All voltages are in V.

	D	G	S
Q600	157.8	0.0	-4.4
Q601	-4.4	-153.7	-158.4

A BOARD WAVEFORMS

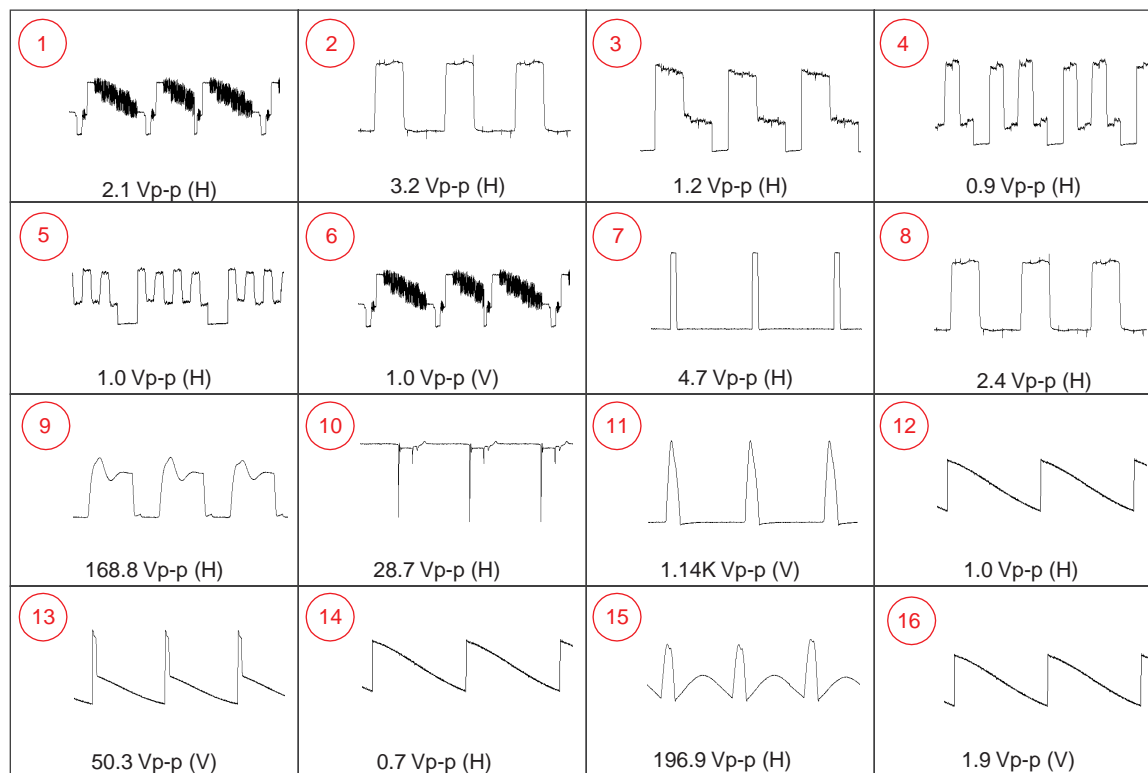

A BOARD IC VOLTAGE LIST

IC001		44	1.6	7	GND	12	7.0	8	-134.0
PIN	VOLT	45	1.6	8	5.0	IC545		9	-158.0
1	N/C	46	2.3	IC003		PIN	VOLT	10	-147.0
2	GND	47	1.0	PIN	VOLT	1	0.7	11	-158.0
3	2.2	48	N/C	1	N/C	2	13.5	12	-153.0
4	2.2	49	0.5	2	GND	3	-12.2	13	N/C
5	GND	50	1.2	3	GND	4	-13.3	14	6.0
6	5.0	51	2.0	4	5.0	5	0.2	15	-4.4
7	0.0	52	1.5	5	5.0	6	13.8	16	0.0
8	2.0	53	4.8	IC004		7	0.7	17	N/C
9	0.3	54	4.8	PIN	VOLT	IC561		18	158.0
10	2.1	55	4.8	1	5.0	PIN	VOLT	IC603	
11	5.0	56	4.8	2	5.0	1	0.1	PIN	VOLT
12	GND	57	N/C	3	GND	2	3.4	I	12.0
13	3.3	58	5.2	IC401		3	2.3	G	GND
14	3.1	59	0.0	PIN	VOLT	4	GND	O	9.0
15	1.0	60	0.0	1	4.5	5	9.2	IC604	
16	1.5	61	0.0	2	0.3	6	10.2	PIN	VOLT
17	3.3	62	0.0	3	4.5	7	0.1	1	133.7
18	0.5	63	1.4	4	0.3	8	13.5	2	N/C
19	1.1	64	4.9	5	4.5	IC565		3	2.5
20	GND	65	4.9	6	4.5	PIN	VOLT	4	11.3
21	0.5	66	0.0	7	0.0	1	3.4	5	GND
22	1.7	67	0.1	8	4.5	2	3.4	IC608	
23	0.5	68	0.1	9	4.5	3	2.1	PIN	VOLT
24	0.5	69	2.4	10	N/C	4	9.0	I	11.0
25	0.5	70	5.0	11	4.4	5	1.0	O	5.0
26	0.0	71	5.0	12	0.0	6	1.0	G	GND
27	0.0	72	0.1	13	4.5	7	1.0	IC633	
28	2.1	73	0.0	14	9.0	8	1.6	PIN	VOLT
29	2.7	74	5.0	15	4.4	9	1.6	I	9.0
30	3.3	75	5.0	16	GND	10	1.6	G	GND
31	2.9	76	5.0	IC404		11	GND	O	3.3
32	GND	77	0.1	PIN	VOLT	12	1.6	All voltages are in V.	
33	2.8	78	0.0	1	14.6	13	1.6		
34	3.3	79	4.9	2	7.0	14	1.6		
35	2.9	80	4.9	3	GND	IC600			
36	GND	IC002		4	7.0	PIN	VOLT		
37	1.8	PIN	VOLT	5	5.9	1	-155.0		
38	0.0	1	GND	6	0.0	2	-156.0		
39	0.1	2	GND	7	GND	3	-155.0		
40	2.0	3	GND	8	0.0	4	-155.0		
41	1.6	4	GND	9	0.5	5	-158.0		
42	3.3	5	4.8	10	7.2	6	-158.0		
43	N/C	6	4.8	11	GND	7	-151.0		

CV BOARD SCHEMATIC DIAGRAM

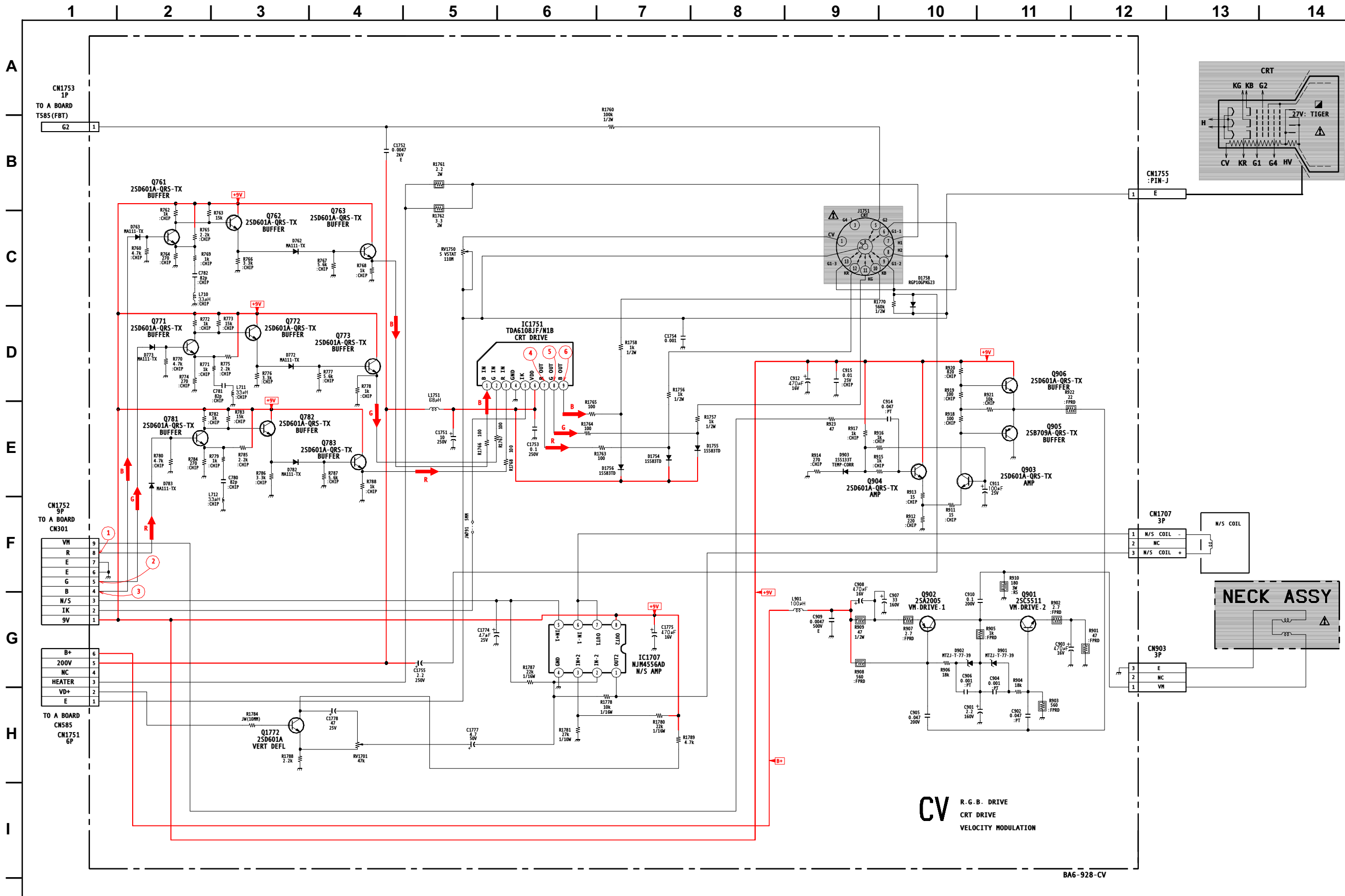

BA6-928-CV

CV BOARD WAVEFORMS

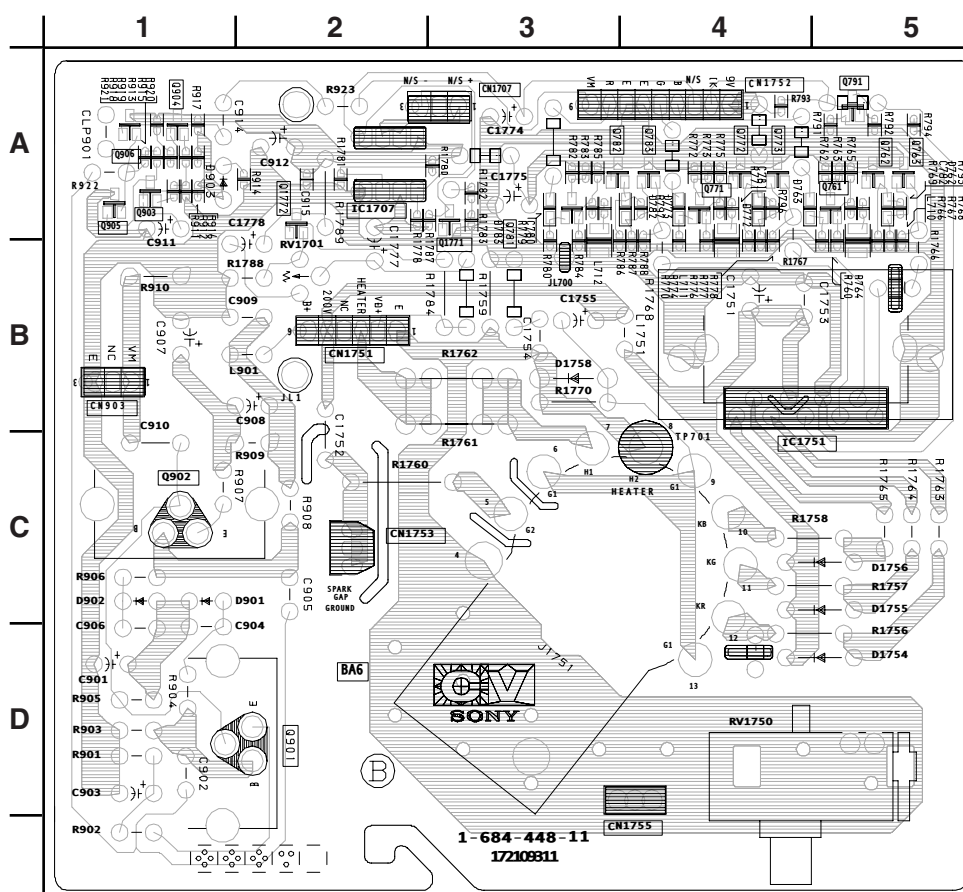
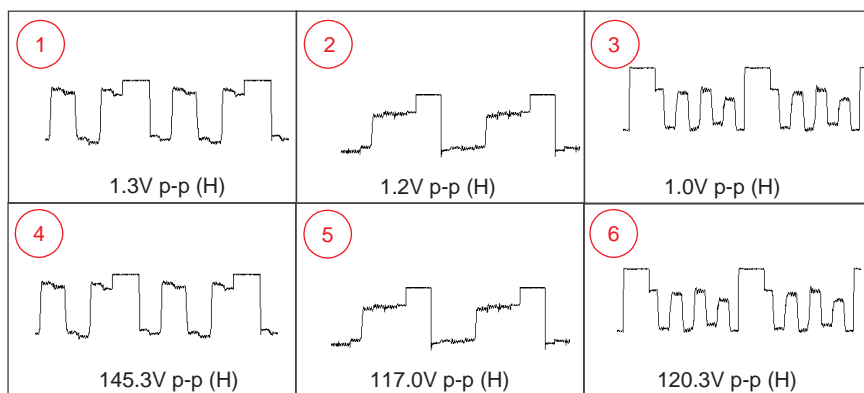

CV BOARD IC VOLTAGE TABLE

IC1707	
PIN	VOLT
1	1.8
2	2.8
3	4.4
4	GND
5	4.8
6	4.8
7	4.8
8	9.0
IC1751	
PIN	VOLT
1	2.0
2	2.0
3	2.4
4	GND
5	3.7
6	200.0
7	136.0
8	142.0
9	140.0

All voltages are in V.

CV BOARD TRANSISTOR TABLE

	B	C	E		B	C	E
Q761	2.2	3.8	2.9	Q783	2.1	9.0	2.7
Q762	3.1	9.0	3.8	Q901	0.9	67.0	0.4
Q763	2.0	9.0	2.6	Q902	134.0	67.0	134.0
Q771	2.2	3.8	2.9	Q903	1.8	5.4	2.4
Q772	3.2	9.0	3.8	Q904	1.8	9.0	2.4
Q773	2.0	9.0	2.6	Q905	5.7	GND	5.4
Q781	2.2	3.9	2.9	Q906	5.7	9.0	6.1
Q782	3.3	9.0	3.9	Q1772	0.0	0.0	0.0

All voltages are in V.

M3 BOARD SCHEMATIC DIAGRAM

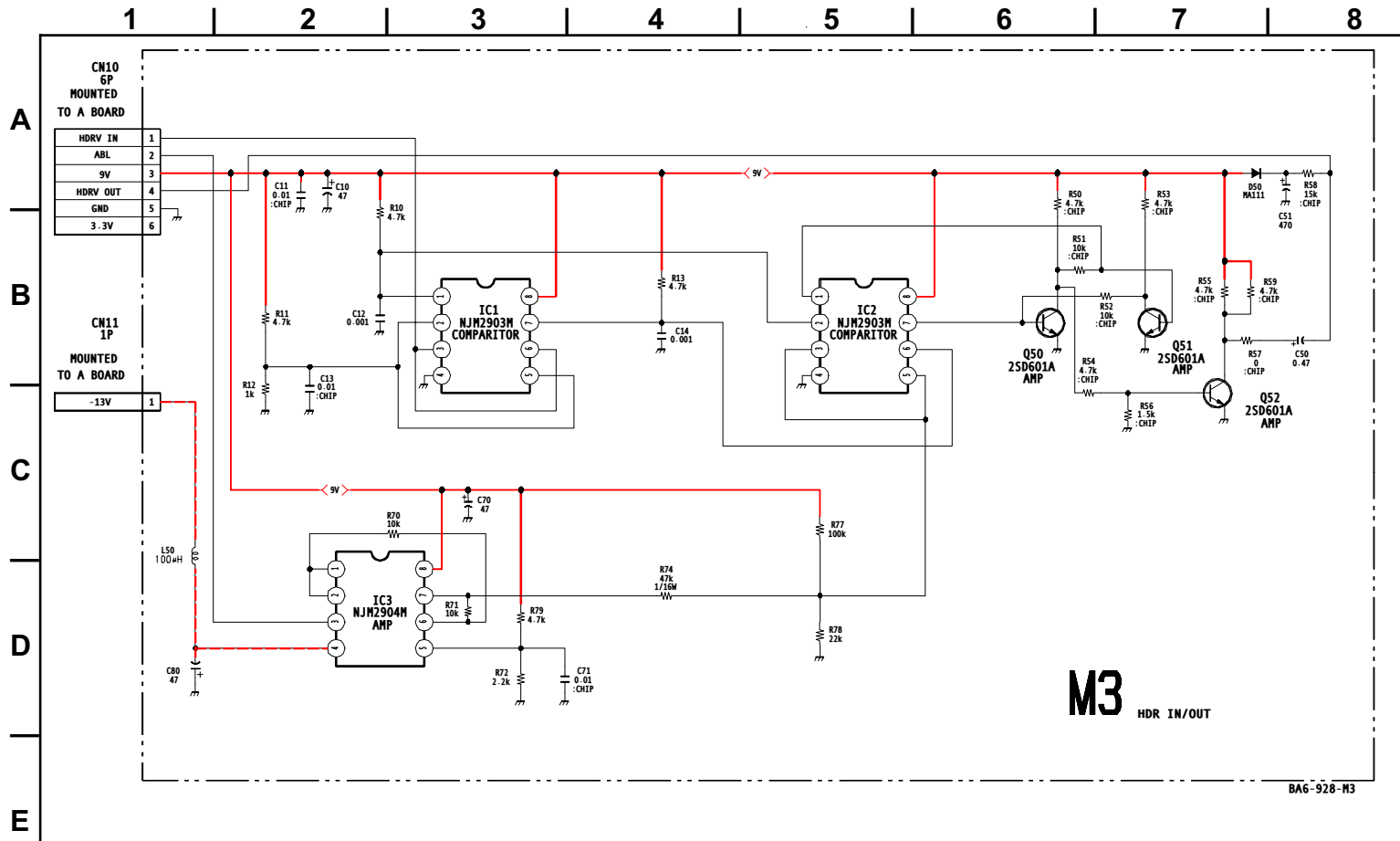

BAG-928-H3

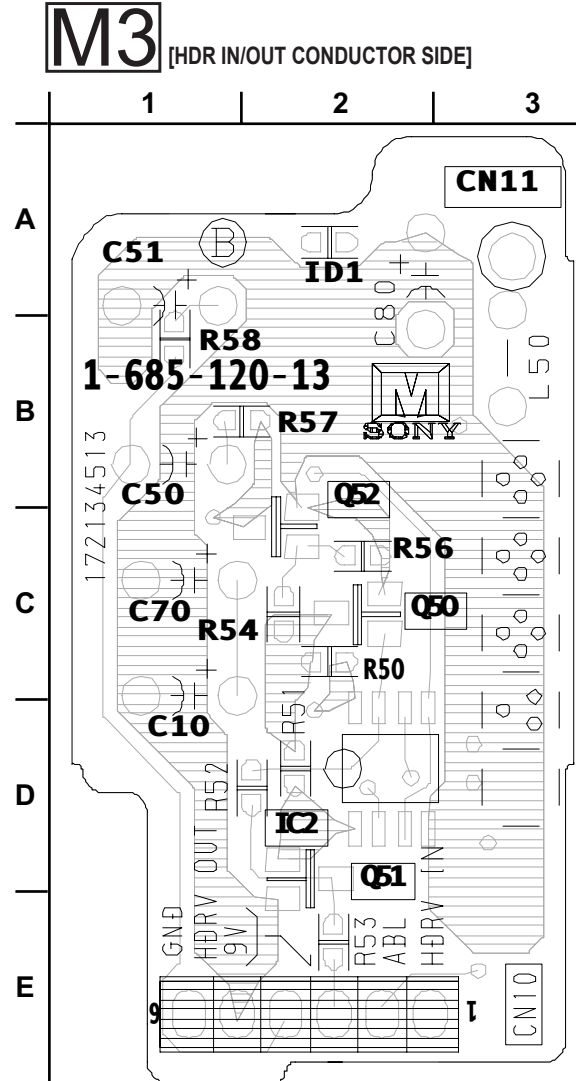
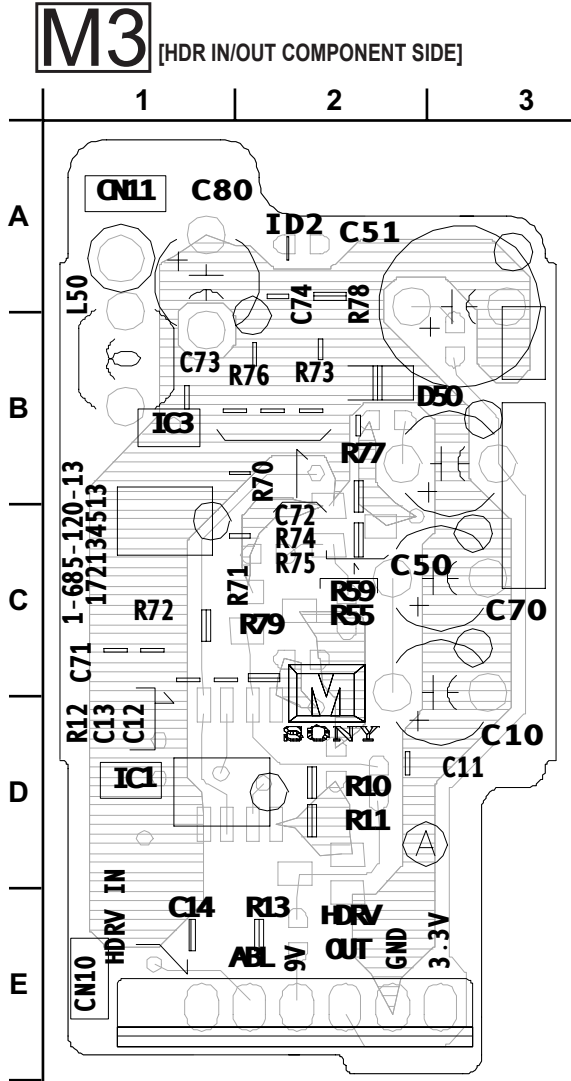

5-4. SEMICONDUCTORS

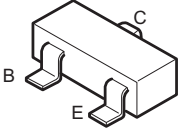
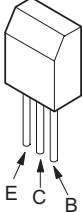
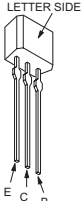
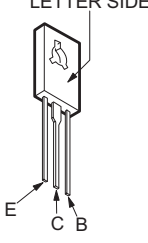
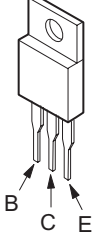
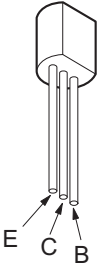
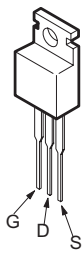
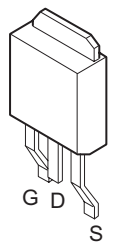
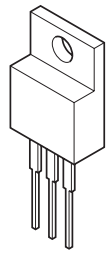
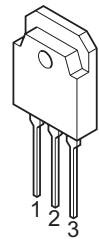
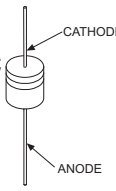
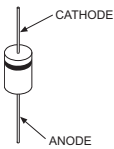
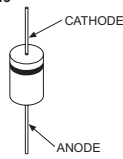
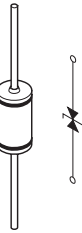
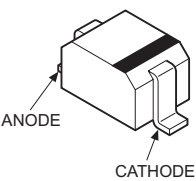
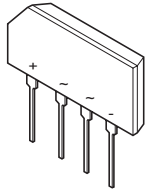
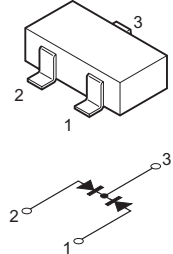
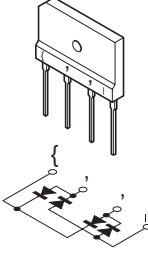
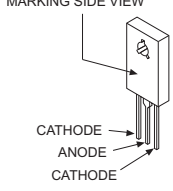
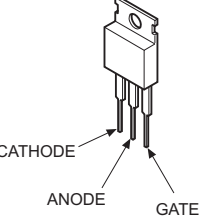
<p>2SB709A-QRS-TX 2SD601A-QRS-TX</p> 	<p>2SB734-T-34 2SC3209LK-TP</p> 	<p>2SA1309A-QRSTA 2SC3311A-QRSTA 2SD2144S-TP-UVV</p> 	<p>2SC3840K</p> 	<p>2SA1837</p> 
<p>2SA10910-TPE2</p> 	<p>IRF614</p> 	<p>2SK2663</p> 	<p>2SC4793</p> 	<p>2SD2578-YB</p> 
<p>ERA38-06TP1 ERA82-004TP5 1SS133T-77 D1NS0R-TA MTZJ-T-77-12C MTZJ-T-77-15B MTZJ-T-77-33B MTZJ-T-77-39</p> 	<p>RU-1P ERC06-15S EGP20DPKG23 MTZJ-T-77-5.1C MTZJ-T-77-5.6C MTZJ-T-77-7.5A MTZJ-T-77-10B MTZJ-T-77-30D RGP10-GPKG3 RGP02-17PKG23</p> 	<p>ERB44-06TP1 1SS83TD GP08DPKG23 RGP10GPKG23 RU4AM-T3</p> 	<p>RD9.1EW-T1</p> 	<p>MA111-TX UDZ-TE-17.5.1B UDZ-TE-17.91B</p> 
<p>D2SB60A-F04</p> 	<p>DAP202K-T-146</p> 	<p>D4SB60L-F</p> 		
<p>D5LC20U</p> 	<p>TF541M</p> 			

SECTION 6: EXPLODED VIEWS

Components not identified by a part number or description are not stocked because they are seldom required for routine service.

The component parts of an assembly are indicated by the reference numbers in the far right column of the parts list and within the dotted lines of the diagram.

* Items marked with an asterisk are not stocked since they are seldom required for routine service. Expect some delay when ordering these components.

NOTE: The components identified by shading and \triangle mark are critical for safety. Replace only with part number specified.

NOTE: Les composants identifiés par un trame et une marque \triangle sont critiques pour la sécurité. Ne les remplacer que par une pièce portant le numéro spécifié.

6-1. CHASSIS

- 4-388-477-02 SCREW 3X16 TAPPING, +BV
- 7-685-663-91 SCREW +BVTP 4X16 TYPE2 TT(B)
- ▲ 4-041-268-01 SCREW (7) TAPPING
- ★ 7-685-647-91 SCREW + BVTP 3X10 TYPE 2 TT(B)

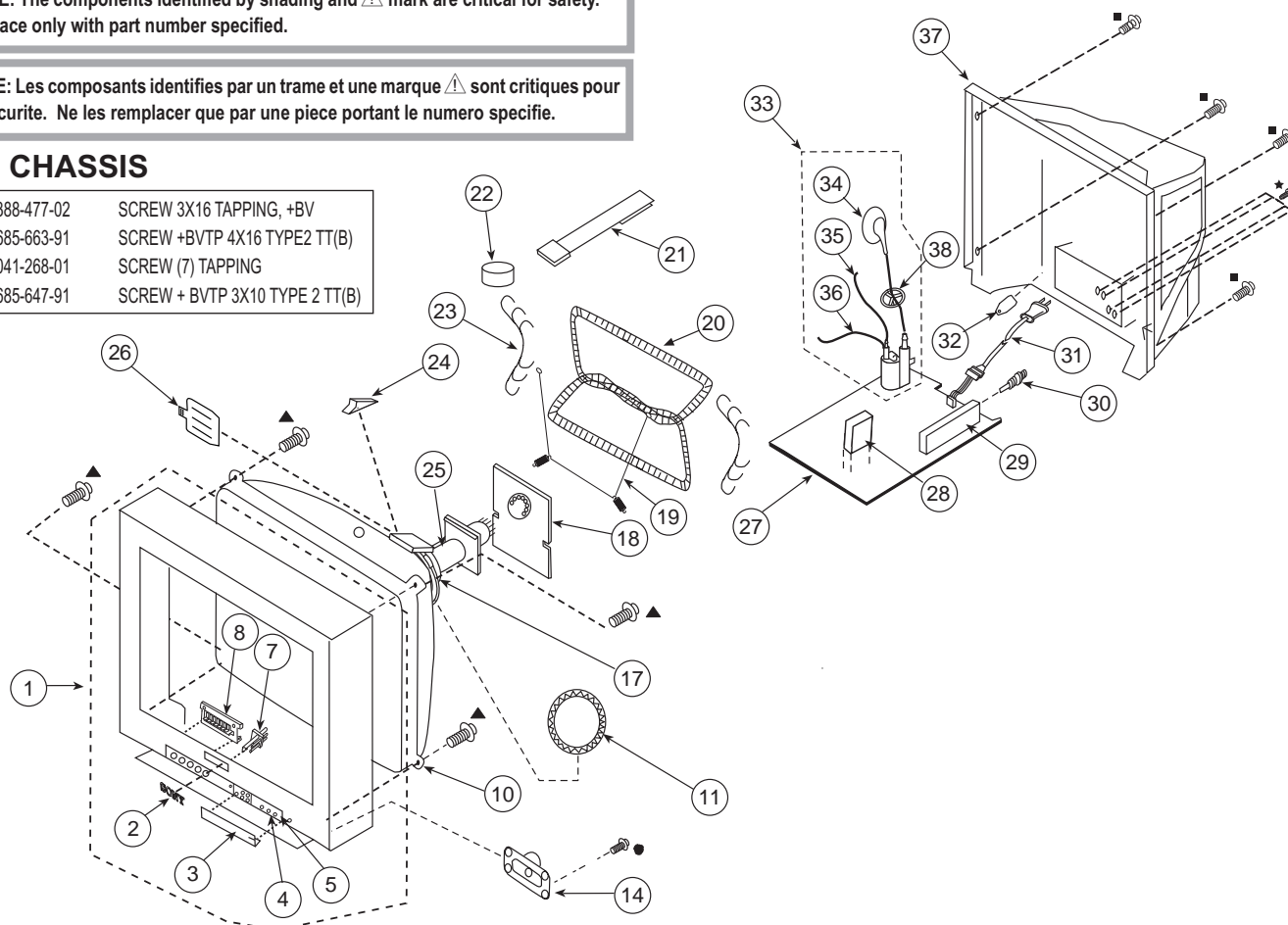

REF. NO.	PART NO.	DESCRIPTION	[Assembly Includes]	REF. NO.	PART NO.	DESCRIPTION	[Assembly Includes]
1	X-4040-306-1	BEZNET ASSY	[2-5, 7-8]	*	27	A-1300-477-A	A BOARD, COMPLETE 25FS100(S) (ONLY)
2	4-046-160-21	EMBLEM, SONY (NO.9)					The high-voltage leads associated with the FBT on this board are not included and must be ordered separately (SEE 34-36).
3	4-087-194-11	DOOR, CONTROL		*	27	A-1300-391-A	A BOARD, COMPLETE KV-24FS100/25FS100(N) (ONLY)
4	4-074-895-32	LABEL, FRONT TERMINAL					The high-voltage leads associated with the FBT on this board are not included and must be ordered separately (SEE 34-36).
5	4-087-195-01	SPRING, D00R		*	28	A-1400-739-A	M3 (VAR) BOARD, MOUNTED
7	4-068-308-01	GUIDE, LED		\triangle	29	8-598-593-30	TUNER, FSS BTF-WA421
\triangle 8	4-087-196-01	BUTTON, MULTI		\triangle	30	1-766-374-11	PLUG, F-PIN
\triangle 10	8-733-250-05	CRT 25RSN (A60LPN70X)		\triangle	31	1-757-840-12	CORD, POWER (WITH CONNECTOR) KV-25FS100(S) (ONLY)
\triangle 11	1-452-896-11	COIL, NA ROTATION (RT200)		\triangle	31	1-824-069-11	CORD, AC KV-24FS100/25FS100(N) (ONLY)
14	1-825-018-11	SPEAKER (6X12CM)					
\triangle 17	1-451-475-11	DY (Y25RSA)					
*	18	A-1400-341-A	CV (VAR) BOARD, MOUNTED				
*	19	4-036-329-01	SPRING (B), TENSION				
\triangle 20	1-419-509-21	COIL, DEGAUSSING					
21	4-083-414-01	PIECE A(110), CONV CORRECT					
22	1-452-032-00	MAGNET, DISC					
*	23	4-080-810-21	BAND, DEGAUSS COIL				
24	4-053-005-01	SPACER, DY		\triangle 32	4-081-980-01	HOLDER, AC CABLE	
\triangle 25	1-451-552-11	NECK ASSEMBLY		\triangle 33	1-453-336-11	FBT ASSY NX-4011//X4A4	[34-36]
26	4-057-714-01	PIECE, TLH CONVERGENCE		\triangle 34	1-251-642-52	CAP ASSY, HIGH-VOLTAGE	
				\triangle 35	1-900-800-65	CONNECTOR ASSY, FOCUS LEAD	
				\triangle 36	1-900-803-22	WIRE ASSY, G2 LEAD	
				37	4-087-192-01	COVER, REAR	
				38	3-704-372-71	HOLDER, HV CABLE	

SECTION 7: ELECTRICAL PARTS LIST

NOTE: The components identified by shading and  mark are critical for safety. Replace only with part number specified.

NOTE: Les composants identifiés par un trame et une marque  sont critiques pour la sécurité. Ne les remplacer que par une pièce portant le numéro spécifié.

The components in this manual identified by the following symbol:  indicate parts that have been carefully factory-selected to satisfy regulations regarding X-ray radiation for each set.

Should replacement be required for one of these components, replace only with the value originally used.

* Items marked with an asterisk are not stocked since they are seldom required for routine service. Expect some delay when ordering these components.

RESISTORS

- All resistors are in ohms
- F : nonflammable
- All variable and adjustable resistors have characteristic curve B, unless otherwise noted.



When ordering parts by reference number, please include the board name.

REF. NO.	PART NO.	DESCRIPTION	VALUES	REF. NO.	PART NO.	DESCRIPTION	VALUES
				C022	1-126-964-11	ELECT	10μF 20% 50V
				C023	1-126-935-11	ELECT	470μF 20% 16V
				C033	1-162-970-11	CERAMIC CHIP	0.01μF 10% 25V
				C041	1-126-964-11	ELECT	10μF 20% 50V
*	A-1300-391-A	A BOARD, COMPLETE (KV-24FS100/25FS100(N) ONLY)		C047	1-164-315-11	CERAMIC CHIP	470pF 5% 50V
*	A-1300-477-A	A BOARD, COMPLETE (KV-25FS100(S) ONLY)		C048	1-104-665-11	ELECT	100μF 20% 25V
	1-533-223-11	HOLDER, FUSE		C049	1-126-960-11	ELECT	1μF 20% 50V
*	4-374-846-11	COVER,CAPACITOR, CAP TYPE		C051	1-126-964-11	ELECT	10μF 20% 50V
	4-382-854-11	SCREW (M3X10), P, SW (+)		C052	1-164-230-11	CERAMIC CHIP	220pF 5% 50V
				C053	1-165-176-11	CERAMIC CHIP	0.047μF 10% 16V
				C054	1-126-960-11	ELECT	1μF 20% 50V
				C056	1-162-966-11	CERAMIC CHIP	0.0022μF 10% 50V
				C057	1-107-826-11	CERAMIC CHIP	0.1μF 10% 16V
				C064	1-165-176-11	CERAMIC CHIP	0.047μF 10% 16V
				C066	1-126-947-11	ELECT	47μF 20% 25V
				C074	1-126-964-11	ELECT	10μF 20% 50V
				C075	1-126-935-11	ELECT	470μF 20% 16V
				C076	1-104-665-11	ELECT	100μF 20% 25V
				C077	1-126-947-11	ELECT	47μF 20% 25V
				C079	1-162-968-11	CERAMIC CHIP	0.0047μF 10% 50V
				C080	1-128-934-91	CERAMIC CHIP	0.33μF 20% 10V
				C081	1-128-934-91	CERAMIC CHIP	0.33μF 20% 10V
				C090	1-162-970-11	CERAMIC CHIP	0.01μF 10% 25V
				C091	1-126-947-11	ELECT	47μF 20% 25V
				C092	1-126-947-11	ELECT	47μF 20% 25V
				C094	1-162-970-11	CERAMIC CHIP	0.01μF 10% 25V
				C095	1-126-947-11	ELECT	47μF 20% 25V
				C096	1-162-970-11	CERAMIC CHIP	0.01μF 10% 25V
				C097	1-126-947-11	ELECT	47μF 20% 25V
				C098	1-162-970-11	CERAMIC CHIP	0.01μF 10% 25V
				C099	1-126-947-11	ELECT	47μF 20% 25V
				C100	1-126-956-91	ELECT	0.1μF 20% 50V
				C115	1-164-739-11	CERAMIC CHIP	560pF 5% 50V
				C116	1-107-826-11	CERAMIC CHIP	0.1μF 10% 16V
				C200	1-107-826-11	CERAMIC CHIP	0.1μF 10% 16V
C001	1-164-230-11	CERAMIC CHIP	220pF 5% 50V				
C003	1-162-919-11	CERAMIC CHIP	22pF 5% 50V				
C004	1-162-923-11	CERAMIC CHIP	47pF 5% 50V				
C005	1-162-966-11	CERAMIC CHIP	0.0022μF 10% 50V				
C006	1-126-942-61	ELECT	1000μF 20% 25V				
C007	1-164-315-11	CERAMIC CHIP	470pF 5% 50V				
C008	1-126-956-91	ELECT	0.1μF 20% 50V				
C009	1-164-230-11	CERAMIC CHIP	220pF 5% 50V				
C010	1-126-960-11	ELECT	1μF 20% 50V				
C011	1-162-964-11	CERAMIC CHIP	0.001μF 10% 50V				
C012	1-162-968-11	CERAMIC CHIP	0.0047μF 10% 50V				
C014	1-126-960-11	ELECT	1μF 20% 50V				
C015	1-107-826-11	CERAMIC CHIP	0.1μF 10% 16V				
C019	1-126-956-91	ELECT	0.1μF 20% 50V				
C021	1-107-826-11	CERAMIC CHIP	0.1μF 10% 16V				

The high-voltage leads associated with the FBT on the A board are not included and must be ordered separately. Order the following leads when requesting this A board:

1-251-642-52 CAP ASSY, HIGH-VOLTAGE
 1-900-800-65 CONNECTOR ASSY, FOCUS LEAD
 1-900-803-22 WIRE ASSY, G2 LEAD

CAPACITOR

NOTE: The components identified by shading and \triangle mark are critical for safety. Replace only with part number specified.

NOTE: Les composants identifiés par un trame et une marque \triangle sont critiques pour la sécurité. Ne les remplacer que par une pièce portant le numéro spécifique.









REF. NO.	PART NO.	DESCRIPTION	VALUES			REF. NO.	PART NO.	DESCRIPTION	VALUES		
C202	1-107-826-11	CERAMIC CHIP	0.1 μ F	10%	16V	C498	1-126-960-11	ELECT	1 μ F	20%	50V
C203	1-107-826-11	CERAMIC CHIP	0.1 μ F	10%	16V	C499	1-126-965-91	ELECT	22 μ F	20%	50V
C204	1-107-826-11	CERAMIC CHIP	0.1 μ F	10%	16V	C502	1-102-112-00	CERAMIC	330pF	10%	50V
C205	1-107-826-11	CERAMIC CHIP	0.1 μ F	10%	16V	C503	1-106-383-00	MYLAR	0.047 μ F	10%	200V
C206	1-126-963-11	ELECT	4.7 μ F	20%	50V	C504	1-102-212-00	CERAMIC	820pF	10%	500V
C207	1-126-963-11	ELECT	4.7 μ F	20%	50V	C505	1-102-002-00	CERAMIC	680pF	10%	500V
C212	1-126-933-11	ELECT	100 μ F	20%	16V	\triangle C506	1-162-116-00	CERAMIC	680pF	10%	2KV
C213	1-126-933-11	ELECT	100 μ F	20%	16V	\triangle C507	1-127-717-21	FILM	19000pF	3%	1.2KV
C220	1-107-826-11	CERAMIC CHIP	0.1 μ F	10%	16V	\triangle C508	1-130-895-00	FILM	0.056 μ F	10%	400V
C301	1-126-956-91	ELECT	0.1 μ F	20%	50V	C509	1-128-551-11	ELECT	22 μ F	20%	25V
C302	1-126-956-91	ELECT	0.1 μ F	20%	50V	C510	1-117-214-11	CERAMIC	0.001 μ F	10%	2KV
C303	1-126-956-91	ELECT	0.1 μ F	20%	50V	C511	1-117-813-11	FILM	0.75 μ F	5%	250V
C304	1-126-956-91	ELECT	0.1 μ F	20%	50V	C512	1-104-987-11	MYLAR	0.001 μ F	10%	100V
C305	1-107-826-11	CERAMIC CHIP	0.1 μ F	10%	16V	C513	1-106-383-00	MYLAR	0.047 μ F	10%	200V
C306	1-107-826-11	CERAMIC CHIP	0.1 μ F	10%	16V	C514	1-115-521-11	FILM	0.82 μ F	5%	250V
C307	1-107-826-11	CERAMIC CHIP	0.1 μ F	10%	16V	C515	1-107-651-11	ELECT	4.7 μ F	20%	250V
C312	1-164-230-11	CERAMIC CHIP	220pF	5%	50V	C516	1-117-661-11	FILM	0.15 μ F	5%	250V
C313	1-126-956-91	ELECT	0.1 μ F	20%	50V	C520	1-126-965-91	ELECT	22 μ F	20%	50V
C325	1-162-967-11	CERAMIC CHIP	0.0033 μ F	10%	50V	C521	1-126-960-11	ELECT	1 μ F	20%	50V
C326	1-127-715-91	CERAMIC CHIP	0.22 μ F	10%	16V	C522	1-162-923-11	CERAMIC CHIP	47pF	5%	50V
C328	1-162-970-11	CERAMIC CHIP	0.01 μ F	10%	25V	C523	1-136-346-21	MYLAR	0.22 μ F	20%	125V
C330	1-162-970-11	CERAMIC CHIP	0.01 μ F	10%	25V	C525	1-164-646-11	CERAMIC	2200pF	10%	500V
C337	1-162-919-11	CERAMIC CHIP	22pF	5%	50V	C526	1-102-244-00	CERAMIC	220pF	10%	500V
C351	1-164-315-11	CERAMIC CHIP	470pF	5%	50V	C527	1-107-645-11	ELECT	22 μ F	20%	160V
C360	1-164-230-11	CERAMIC CHIP	220pF	5%	50V	C529	1-164-690-91	CERAMIC CHIP	0.0022 μ F	5%	50V
C361	1-164-230-11	CERAMIC CHIP	220pF	5%	50V	C534	1-162-966-11	CERAMIC CHIP	0.0022 μ F	10%	50V
C362	1-162-964-11	CERAMIC CHIP	0.001 μ F	10%	50V	C536	1-162-966-11	CERAMIC CHIP	0.0022 μ F	10%	50V
C363	1-162-964-11	CERAMIC CHIP	0.001 μ F	10%	50V	C537	1-162-964-11	CERAMIC CHIP	0.001 μ F	10%	50V
C370	1-162-970-11	CERAMIC CHIP	0.01 μ F	10%	25V	C539	1-162-970-11	CERAMIC CHIP	0.01 μ F	10%	25V
C390	1-162-970-11	CERAMIC CHIP	0.01 μ F	10%	25V	C542	1-162-966-11	CERAMIC CHIP	0.0022 μ F	10%	50V
C424	1-126-960-11	ELECT	1 μ F	20%	50V	C544	1-126-967-11	ELECT	47 μ F	20%	50V
C440	1-126-940-11	ELECT	330 μ F	20%	25V	C545	1-126-969-11	ELECT	220 μ F	20%	50V
C441	1-126-940-11	ELECT	330 μ F	20%	25V	C546	1-137-194-81	FILM	0.47 μ F	5%	50V
C450	1-126-943-11	ELECT	2200 μ F	20%	25V	C551	1-126-960-11	ELECT	1 μ F	20%	50V
C451	1-126-959-11	ELECT	0.47 μ F	20%	50V	C552	1-126-964-11	ELECT	10 μ F	20%	50V
C452	1-126-933-11	ELECT	100 μ F	20%	16V	C553	1-107-826-11	CERAMIC CHIP	0.1 μ F	10%	16V
C453	1-126-933-11	ELECT	100 μ F	20%	16V	C554	1-162-970-11	CERAMIC CHIP	0.01 μ F	10%	25V
C454	1-164-677-11	CERAMIC CHIP	0.033 μ F	10%	16V	\triangle C561	1-126-963-11	ELECT	4.7 μ F	20%	50V
C455	1-164-677-11	CERAMIC CHIP	0.033 μ F	10%	16V	\triangle C562	1-104-666-11	ELECT	220 μ F	20%	25V
C457	1-136-169-00	FILM	0.22 μ F	5%	50V	C563	1-162-970-11	CERAMIC CHIP	0.01 μ F	10%	25V
C458	1-136-169-00	FILM	0.22 μ F	5%	50V	\triangle C566	1-107-635-11	ELECT	4.7 μ F	20%	160V
C459	1-137-194-91	FILM	0.47 μ F	5%	50V	C571	1-104-665-11	ELECT	100 μ F	20%	25V
C460	1-137-194-91	FILM	0.47 μ F	5%	50V	C582	1-106-387-00	MYLAR	0.068 μ F	10%	200V
C470	1-126-935-11	ELECT	470 μ F	20%	16V	C588	1-137-417-11	MYLAR	0.0047 μ F	10%	200V

NOTE: The components identified by shading and  mark are critical for safety. Replace only with part number specified.

NOTE: Les composants identifiés par un trame et une  sont critiques pour la sécurité. Ne les remplacer que par une pièce portant le numéro spécifique.













REF. NO.	PART NO.	DESCRIPTION	VALUES	REF. NO.	PART NO.	DESCRIPTION	VALUES
C589	1-128-560-11	ELECT	22µF 20% 100V	C661	1-104-665-11	ELECT	100µF 20% 25V
 C590	1-126-964-11	ELECT	10µF 20% 50V	C663	1-126-963-11	ELECT	4.7µF 20% 50V
C594	1-123-024-21	ELECT	33µF 160V	C665	1-104-665-11	ELECT	100µF 20% 25V
C595	1-104-666-11	ELECT	220µF 20% 25V	C672	1-137-756-21	FILM	22000pF 3% 800V
C597	1-104-666-11	ELECT	220µF 20% 25V	C680	1-127-793-51	CERAMIC	2200pF 20% 250V
C600	1-126-964-11	ELECT	10µF 20% 50V	C681	1-127-793-51	CERAMIC	2200pF 20% 250V
 C602	1-136-311-11	MYLAR	0.47µF 20% 125V	C690	1-162-970-11	CERAMIC CHIP	0.01µF 10% 25V
 C603	1-136-311-11	MYLAR	0.47µF 20% 125V				
 C605	1-127-793-51	CERAMIC	2200pF 20% 250V	CONNECTOR			
 C606	1-127-793-51	CERAMIC	2200pF 20% 250V	* CN001	1-560-124-00	PLUG,CONNECTOR (2.5MM)	4P
C609	1-126-942-61	ELECT	1000µF 20% 25V	* CN401	1-564-507-11	PLUG,CONNECTOR	4P
C610	1-164-644-11	CERAMIC	330pF 10% 500V	* CN501	1-508-786-00	PIN,CONNECTOR (5MM PITCH)	2P
C611	1-126-971-11	ELECT	470µF 20% 50V	* CN515	1-580-798-11	CONNECTOR PIN (DY)	6P
C612	1-126-961-11	ELECT	2.2µF 20% 50V	* CN585	1-564-509-11	PLUG,CONNECTOR	6P
C613	1-161-964-91	CERAMIC	0.0047µF 250V	CN600	1-580-843-11	PIN,CONNECTOR (POWER)	
C614	1-161-964-91	CERAMIC	0.0047µF 250V	DIODE			
C615	1-161-964-91	CERAMIC	0.0047µF 250V	D001	8-719-074-84	DIODE LNK0120022G1	
C616	1-126-943-11	ELECT	2200µF 20% 25V	D002	8-719-109-89	DIODE MTZJ-T-77-5.6B	
C617	1-128-564-11	ELECT	220µF 20% 100V	D003	8-719-110-17	DIODE MTZJ-T-77-10B	
C618	1-128-564-11	ELECT	220µF 20% 100V	D004	8-719-110-17	DIODE MTZJ-T-77-10B	
C619	1-161-964-91	CERAMIC	0.0047µF 250V	D005	8-719-110-17	DIODE MTZJ-T-77-10B	
C620	1-162-970-11	CERAMIC CHIP	0.01µF 10% 25V	D006	8-719-921-44	DIODE MTZJ-T-77-5.1C	
C621	1-165-922-11	ELECT	470µF 20% 250V	D044	8-719-110-17	DIODE MTZJ-T-77-10B	
C624	1-107-636-11	ELECT	10µF 20% 160V	D045	8-719-110-17	DIODE MTZJ-T-77-10B	
C625	1-126-964-11	ELECT	10µF 20% 50V	D050	8-719-991-33	DIODE 1SS133T-77	
C629	1-165-922-11	ELECT	470µF 20% 250V	D051	8-719-991-33	DIODE 1SS133T-77	
C632	1-126-967-11	ELECT	47µF 20% 50V	D052	8-719-109-89	DIODE MTZJ-T-77-5.6B	
C633	1-136-479-11	FILM	0.001µF 2% 50V	D200	8-719-929-15	DIODE RD9.1ES-T1B2	
C634	1-126-947-11	ELECT	47µF 20% 25V	D201	8-719-929-15	DIODE MTZJ-T-77-9.1B	
C635	1-126-963-11	ELECT	4.7µF 20% 50V	D202	8-719-929-15	DIODE MTZJ-T-77-9.1B	
C636	1-127-715-91	CERAMIC CHIP	0.22µF 10% 16V	D203	8-719-929-15	DIODE MTZJ-T-77-9.1B	
C637	1-127-715-91	CERAMIC CHIP	0.22µF 10% 16V	D204	8-719-929-15	DIODE MTZJ-T-77-9.1B	
C638	1-104-665-11	ELECT	100µF 20% 25V	D205	8-719-929-15	DIODE MTZJ-T-77-9.1B	
C640	1-164-644-11	CERAMIC	330pF 10% 500V	D230	8-719-108-12	DIODE RD9.1EW-T1	
C642	1-126-969-11	ELECT	220µF 20% 50V	D231	8-719-108-12	DIODE RD9.1EW-T1	
C643	1-130-777-00	MYLAR	0.1µF 5% 100V	D232	8-719-108-12	DIODE RD9.1EW-T1	
C645	1-162-964-11	CERAMIC CHIP	0.001µF 10% 50V	D234	8-719-108-12	DIODE RD9.1EW-T1	
C647	1-126-947-11	ELECT	47µF 20% 25V	D235	8-719-108-12	DIODE RD9.1EW-T1	
C648	1-162-115-00	CERAMIC	330pF 10% 1KV	D236	8-719-108-12	DIODE RD9.1EW-T1	
C649	1-162-115-00	CERAMIC	330pF 10% 1KV	D237	8-719-108-12	DIODE RD9.1EW-T1	
C650	1-126-942-61	ELECT	1000µF 20% 25V	D351	8-719-109-66	DIODE MTZJ-T-77-3.3B	
C651	1-126-942-61	ELECT	1000µF 20% 25V	D390	8-719-404-50	DIODE MA111-TX	
C652	1-164-227-11	CERAMIC CHIP	0.022µF 10% 25V	D410	8-719-404-50	DIODE MA111-TX	
C660	1-126-947-11	ELECT	47µF 20% 25V				

NOTE: The components identified by shading and  mark are critical for safety. Replace only with part number specified.

NOTE: Les composants identifiés par un trame et une marque  sont critiques pour la sécurité. Ne les remplacer que par une pièce portant le numéro spécifique.





REF. NO.	PART NO.	DESCRIPTION	VALUES	REF. NO.	PART NO.	DESCRIPTION	VALUES
D412	1-216-864-11	SHORT CHIP		D650	8-719-109-89	DIODE MTZJ-T-77-5.6C	
D413	8-719-404-50	DIODE MA111-TX				FUSE	
D414	8-719-921-63	DIODE MTZJ-T-77-7.5B			F601	1-576-193-11	FUSE 6.3A/125V
D435	8-719-110-17	DIODE MTZJ-T-77-10B				(KV-24FS100/25FS100(N) ONLY)	
D438	8-719-404-50	DIODE MA111-TX			F601	1-532-506-51	FUSE 6.3A/250V
D501	8-719-404-50	DIODE MA111-TX				(KV-25FS100(S) ONLY)	
D505	8-719-081-00	DIODE BY228/A52A/				FERRITE BEAD	
D506	8-719-312-10	DIODE RU4AM-T3		FB505	1-410-397-21	FERRITE	1.1μH
D508	8-719-404-50	DIODE MA111-TX		FB522	1-410-397-21	FERRITE	1.1μH
D509	8-719-109-66	DIODE MTZJ-T-77-3.3B		FB601	1-412-911-11	FERRITE	0μH
D514	8-719-908-03	DIODE GP08DPKG23		FB602	1-412-911-11	FERRITE	0μH
D515	8-719-908-03	DIODE GP08DPKG23		FB603	1-412-911-11	FERRITE	0μH
D525	8-719-991-33	DIODE 1SS133T-77		FB604	1-412-911-11	FERRITE	0μH
D526	8-719-302-43	DIODE RGP10GPKG23		FB616	1-469-578-11	FERRITE	1.1μH
D528	8-719-991-33	DIODE 1SS133T-77		FB617	1-469-578-11	FERRITE	1.1μH
D545	8-719-908-03	DIODE GP08DPKG23				FILTER	
D558	8-719-404-50	DIODE MA111-TX		FL001	1-239-803-11	ENCAPSULATED COMPONENT	
D559	8-719-404-50	DIODE MA111-TX				IC	
 D562	8-719-991-33	DIODE 1SS133T-77			IC001	6-800-842-01	IC M65582μF-100FP
 D566	8-719-979-84	DIODE EGP20DPKG23		IC002	8-759-699-33	IC M24C16-MN6T(A)	
 D567	8-719-991-33	DIODE 1SS133T-77		IC003	8-759-352-91	IC PST9143NL	
D568	8-719-110-08	DIODE MTZJ-T-77-8.2B		IC004	8-742-212-20	HYB IC SBX3081-71	
 D569	8-719-921-44	DIODE MTZJ-T-77-5.1C		IC401	6-701-105-01	IC NJM2750M-TE2	
D587	8-719-302-43	DIODE RGP10GPKG23		IC404	6-701-104-01	IC AN17820A	
 D589	8-719-991-33	DIODE 1SS133T-77		IC545	8-759-980-58	IC TDA8172	
D596	8-719-979-85	DIODE RGP15GPKG23			IC561	8-759-700-07	IC NJM2903M-TE2
D598	8-719-979-85	DIODE RGP15GPKG23		IC565	8-759-700-44	IC NJM2902M-TE2	
D605	8-719-510-53	DIODE D4SB60L-F		IC600	8-759-670-30	IC MCZ3001D	
D608	8-719-077-76	DIODE D2SB60A-F04		IC603	8-759-833-71	IC NJM2395F09	
D611	8-719-302-43	DIODE EL1Z-V1			IC604	8-749-012-13	IC DM-58
D612	8-719-068-00	DIODE ERC04-06SE (KV-24FS100/25FS100(N) ONLY)		IC608	8-759-450-47	IC BA05T	
D613	8-719-068-00	DIODE ERC04-06SE (KV-24FS100/25FS100(N) ONLY)		IC633	8-759-445-59	IC BA033T	
D614	8-719-057-52	DIODE EZ0150AV1				JACK	
D615	6-500-177-01	DIODE MA7D50		J200	1-794-119-11	TERMINAL BLOCK, S	4P
D618	8-719-979-64	DIODE μF4005PKG23		J201	1-794-048-11	JACK, PIN	3P
D620	8-719-911-19	DIODE 1SS119-25TD		J202	1-794-116-11	JACK BLOCK, PIN	2P
D621	8-719-510-37	DIODE D5LC20U		J206	1-794-117-11	JACK BLOCK, PIN	3P
D624	8-719-302-43	DIODE EL1Z-V1		J401	1-568-267-21	JACK	
D628	8-719-404-50	DIODE MA111-TX					
D629	8-719-110-31	DIODE MTZJ-T-77-12B					
D630	8-719-982-22	DIODE MTZJ-T-77-30D					
D631	8-719-063-70	DIODE D1NL20U-TA2					

NOTE: The components identified by shading and  mark are critical for safety. Replace only with part number specified.

NOTE: Les composants identifiés par un trame et une marque  sont critiques pour la sécurité. Ne les remplacer que par une pièce portant le numéro spécifique.



REF. NO.	PART NO.	DESCRIPTION	VALUES	REF. NO.	PART NO.	DESCRIPTION	VALUES
CHIP CONDUCTOR				L525	1-409-955-11	INDUCTOR	8MH
JR102	1-216-864-11	SHORT CHIP		 L588	1-412-528-81	INDUCTOR	18μH
JR128	1-216-864-11	SHORT CHIP		L606	1-412-525-31	INDUCTOR	10μH
JR200	1-216-864-11	SHORT CHIP		L607	1-412-525-31	INDUCTOR	10μH
JR301	1-216-864-11	SHORT CHIP		L608	1-412-533-21	INDUCTOR	47μH
JR302	1-216-864-11	SHORT CHIP		L609	1-412-525-31	INDUCTOR	10μH
JR303	1-216-864-11	SHORT CHIP		PHOTO COUPLER			
JR304	1-216-864-11	SHORT CHIP		PH602	8-749-010-64	PHOTO COUPLER PC123FY2	
JR305	1-216-864-11	SHORT CHIP		IC LINK			
JR306	1-216-864-11	SHORT CHIP		PS401	1-576-336-21	LINK, IC	
JR307	1-216-864-11	SHORT CHIP		TRANSISTOR			
JR308	1-216-864-11	SHORT CHIP		Q002	8-729-422-27	TRANSISTOR 2SD601A-QRS-TX	
JR309	1-216-864-11	SHORT CHIP		Q004	8-729-422-27	TRANSISTOR 2SD601A-QRS-TX	
JR310	1-216-864-11	SHORT CHIP		Q005	8-729-424-02	TRANSISTOR 2SB709A-QRS-TX	
JR311	1-216-864-11	SHORT CHIP		Q006	8-729-422-27	TRANSISTOR 2SD601A-QRS-TX	
JR313	1-216-864-11	SHORT CHIP		Q008	8-729-422-27	TRANSISTOR 2SD601A-QRS-TX	
JR314	1-216-864-11	SHORT CHIP		Q009	8-729-422-27	TRANSISTOR 2SD601A-QRS-TX	
JR315	1-216-864-11	SHORT CHIP		Q300	8-729-422-27	TRANSISTOR 2SD601A-QRS-TX	
JR316	1-216-864-11	SHORT CHIP		Q301	8-729-424-02	TRANSISTOR 2SB709A-QRS-TX	
JR317	1-216-864-11	SHORT CHIP		Q303	8-729-424-02	TRANSISTOR 2SB709A-QRS-TX	
JR318	1-216-864-11	SHORT CHIP		Q304	8-729-424-02	TRANSISTOR 2SB709A-QRS-TX	
JR401	1-216-864-11	SHORT CHIP		Q305	8-729-424-02	TRANSISTOR 2SB709A-QRS-TX	
JR500	1-216-864-11	SHORT CHIP		Q306	8-729-424-02	TRANSISTOR 2SB709A-QRS-TX	
JR501	1-216-864-11	SHORT CHIP		Q390	8-729-422-27	TRANSISTOR 2SD601A-QRS-TX	
JR502	1-216-864-11	SHORT CHIP		Q391	8-729-422-27	TRANSISTOR 2SD601A-QRS-TX	
JR860	1-216-864-11	SHORT CHIP		Q400	8-729-422-27	TRANSISTOR 2SD601A-QRS-TX	
COIL				Q401	8-729-422-27	TRANSISTOR 2SD601A-QRS-TX	
L002	1-239-803-11	ENCAPSULATED COMPONENT		Q404	8-729-422-27	TRANSISTOR 2SD601A-QRS-TX	
L003	1-239-803-11	ENCAPSULATED COMPONENT		Q405	8-729-422-27	TRANSISTOR 2SD601A-QRS-TX	
L004	1-239-803-11	ENCAPSULATED COMPONENT		Q411	8-729-422-27	TRANSISTOR 2SD601A-QRS-TX	
L005	1-239-803-11	ENCAPSULATED COMPONENT		Q412	8-729-422-27	TRANSISTOR 2SD601A-QRS-TX	
L006	1-412-032-11	INDUCTOR	100μH	Q435	8-729-424-02	TRANSISTOR 2SB709A-QRS-TX	
L007	1-412-032-11	INDUCTOR	100μH	Q501	8-729-423-33	TRANSISTOR 2SC3311A-QRSTA	
L008	1-410-482-31	INDUCTOR	100μH	Q502	8-729-140-50	TRANSISTOR 2SC3209LK-TP	
L009	1-410-482-31	INDUCTOR	100μH	 Q505	6-550-041-01	TRANSISTOR 2SD2634-YB	
L010	1-412-029-11	INDUCTOR	10μH	Q521	8-729-423-33	TRANSISTOR 2SC3311A-QRSTA	
L101	1-414-229-11	FERRITE	0μH	Q522	8-729-053-87	TRANSISTOR KTC4370A	
L360	1-412-029-11	INDUCTOR	10μH	Q572	8-729-422-27	TRANSISTOR 2SD601A-QRS-TX	
L361	1-412-029-11	INDUCTOR	10μH	Q573	8-729-424-02	TRANSISTOR 2SB709A-QRS-TX	
L513	1-406-677-11	INDUCTOR	10MH	Q578	8-729-422-27	TRANSISTOR 2SD601A-QRS-TX	
L515	1-412-552-11	INDUCTOR	2.2MH	 Q590	8-729-200-17	TRANSISTOR 2SA10910-TPE2	
L516	1-406-978-11	INDUCTOR	150μH				



REF. NO.	PART NO.	DESCRIPTION	VALUES			REF. NO.	PART NO.	DESCRIPTION	VALUES		
Q600	8-729-053-36	TRANSISTOR 2SK2640-01MR-F122				R060	1-249-409-11	CARBON	220	5%	1/4W
Q601	8-729-053-36	TRANSISTOR 2SK2640-01MR-F122				R061	1-249-429-11	CARBON	10K	5%	1/4W
Q604	8-729-424-02	TRANSISTOR 2SB709A-QRS-TX				R062	1-249-413-11	CARBON	470	5%	1/4W
Q608	8-729-922-37	TRANSISTOR 2SD2144S-TP-UVW				R063	1-216-829-11	RES-CHIP	4.7K	5%	1/10W
Q650	8-729-926-14	TRANSISTOR 2SD1292				R065	1-249-415-11	CARBON	680	5%	1/4W
	RESISTOR					R067	1-249-416-11	CARBON	820	5%	1/4W
R001	1-216-813-11	RES-CHIP	220	5%	1/10W	R069	1-249-421-11	CARBON	2.2K	5%	1/4W
R002	1-216-864-11	SHORT CHIP				R070	1-249-409-11	CARBON	220	5%	1/4W
R003	1-216-821-11	RES-CHIP	1K	5%	1/10W	R071	1-249-427-11	CARBON	6.8K	5%	1/4W
R004	1-216-817-11	RES-CHIP	470	5%	1/10W	R072	1-249-425-11	CARBON	4.7K	5%	1/4W
R006	1-216-829-11	RES-CHIP	4.7K	5%	1/10W	R073	1-249-419-11	CARBON	1.5K	5%	1/4W
R015	1-216-833-11	RES-CHIP	10K	5%	1/10W	R074	1-249-421-11	CARBON	2.2K	5%	1/4W
R027	1-218-732-11	METAL CHIP	47K	0.50%	1/16W	R075	1-249-427-11	CARBON	6.8K	5%	1/4W
R028	1-249-409-11	CARBON	220	5%	1/4W	R076	1-247-807-31	CARBON	100	5%	1/4W
R029	1-249-409-11	CARBON	220	5%	1/4W	R080	1-216-833-11	RES-CHIP	10K	5%	1/10W
R030	1-249-409-11	CARBON	220	5%	1/4W	R081	1-216-841-11	RES-CHIP	47K	5%	1/10W
R031	1-216-813-11	RES-CHIP	220	5%	1/10W	R082	1-216-857-11	RES-CHIP	1M	5%	1/10W
R032	1-216-813-11	RES-CHIP	220	5%	1/10W	R083	1-216-847-11	RES-CHIP	150K	5%	1/10W
R033	1-249-409-11	CARBON	220	5%	1/4W	R084	1-216-819-11	RES-CHIP	680	5%	1/10W
R035	1-216-809-11	RES-CHIP	100	5%	1/10W	R085	1-216-864-11	SHORT CHIP			
R036	1-216-829-11	RES-CHIP	4.7K	5%	1/10W	R086	1-216-821-11	RES-CHIP	1K	5%	1/10W
R037	1-216-833-11	RES-CHIP	10K	5%	1/10W	R087	1-247-807-31	CARBON	100	5%	1/4W
R038	1-216-821-11	RES-CHIP	1K	5%	1/10W	R090	1-216-837-11	RES-CHIP	22K	5%	1/10W
R039	1-216-815-11	RES-CHIP	330	5%	1/10W	R091	1-216-841-11	RES-CHIP	47K	5%	1/10W
R040	1-216-829-11	RES-CHIP	4.7K	5%	1/10W	R092	1-216-825-11	RES-CHIP	2.2K	5%	1/10W
R041	1-216-829-11	RES-CHIP	4.7K	5%	1/10W	R093	1-216-841-11	RES-CHIP	47K	5%	1/10W
R042	1-216-813-11	RES-CHIP	220	5%	1/10W	R094	1-414-229-11	FERRITE	0μH		
R043	1-216-813-11	RES-CHIP	220	5%	1/10W	R095	1-414-229-11	FERRITE	0μH		
R044	1-216-829-11	RES-CHIP	4.7K	5%	1/10W	R096	1-216-829-11	RES-CHIP	4.7K	5%	1/10W
R045	1-216-829-11	RES-CHIP	4.7K	5%	1/10W	R098	1-216-839-11	RES-CHIP	33K	5%	1/10W
R047	1-249-409-11	CARBON	220	5%	1/4W	R101	1-216-829-11	RES-CHIP	4.7K	5%	1/10W
R048	1-216-829-11	RES-CHIP	4.7K	5%	1/10W	R102	1-216-837-11	RES-CHIP	22K	5%	1/10W
R049	1-216-829-11	RES-CHIP	4.7K	5%	1/10W	R103	1-216-833-11	RES-CHIP	10K	5%	1/10W
R050	1-249-425-11	CARBON	4.7K	5%	1/4W	R105	1-216-864-11	SHORT CHIP			
R051	1-249-417-11	CARBON	1K	5%	1/4W	R107	1-216-809-11	RES-CHIP	100	5%	1/10W
R052	1-216-813-11	RES-CHIP	220	5%	1/10W	R108	1-216-809-11	RES-CHIP	100	5%	1/10W
R053	1-249-433-11	CARBON	22K	5%	1/4W	R109	1-216-829-11	RES-CHIP	4.7K	5%	1/10W
R054	1-249-433-11	CARBON	22K	5%	1/4W	R110	1-249-409-11	CARBON	220	5%	1/4W
R055	1-216-829-11	RES-CHIP	4.7K	5%	1/10W	R111	1-216-829-11	RES-CHIP	4.7K	5%	1/10W
R056	1-216-833-11	RES-CHIP	10K	5%	1/10W	R112	1-249-425-11	CARBON	4.7K	5%	1/4W
R057	1-249-417-11	CARBON	1K	5%	1/4W	R115	1-216-817-11	RES-CHIP	470	5%	1/10W
R058	1-249-429-11	CARBON	10K	5%	1/4W	R116	1-216-853-11	RES-CHIP	470K	5%	1/10W
R059	1-249-417-11	CARBON	1K	5%	1/4W	R200	1-216-841-11	RES-CHIP	47K	5%	1/10W
						R202	1-216-845-11	RES-CHIP	100K	5%	1/10W



















REF. NO.	PART NO.	DESCRIPTION	VALUES			REF. NO.	PART NO.	DESCRIPTION	VALUES		
R203	1-216-845-11	RES-CHIP	100K	5%	1/10W	R371	1-216-857-11	RES-CHIP	1M	5%	1/10W
R204	1-249-437-11	CARBON	47K	5%	1/4W	R372	1-216-827-11	RES-CHIP	3.3K	5%	1/10W
R205	1-216-841-11	RES-CHIP	47K	5%	1/10W	R390	1-216-864-11	SHORT CHIP			
R206	1-216-845-11	RES-CHIP	100K	5%	1/10W	R391	1-216-829-11	RES-CHIP	4.7K	5%	1/10W
R207	1-216-845-11	RES-CHIP	100K	5%	1/10W	R392	1-216-818-11	RES-CHIP	560	5%	1/10W
R208	1-249-437-11	CARBON	47K	5%	1/4W	R393	1-216-825-11	RES-CHIP	2.2K	5%	1/10W
R209	1-249-437-11	CARBON	47K	5%	1/4W	R394	1-216-833-11	RES-CHIP	10K	5%	1/10W
R210	1-216-845-11	RES-CHIP	100K	5%	1/10W	R402	1-216-864-11	SHORT CHIP			
R211	1-249-437-11	CARBON	47K	5%	1/4W	R406	1-216-813-11	RES-CHIP	220	5%	1/10W
R212	1-249-437-11	CARBON	47K	5%	1/4W	R407	1-216-813-11	RES-CHIP	220	5%	1/10W
R213	1-216-845-11	RES-CHIP	100K	5%	1/10W	R410	1-216-864-11	SHORT CHIP			
R220	1-216-841-11	RES-CHIP	47K	5%	1/10W	R413	1-216-864-11	SHORT CHIP			
R226	1-218-285-11	RES-CHIP	75	5%	1/10W	R415	1-216-864-11	SHORT CHIP			
R227	1-218-285-11	RES-CHIP	75	5%	1/10W	R416	1-216-864-11	SHORT CHIP			
R250	1-216-864-11	SHORT CHIP				R435	1-216-833-11	RES-CHIP	10K	5%	1/10W
R251	1-216-864-11	SHORT CHIP				R436	1-216-864-11	SHORT CHIP			
R301	1-218-285-11	RES-CHIP	75	5%	1/10W	R437	1-216-829-11	RES-CHIP	4.7K	5%	1/10W
R303	1-218-285-11	RES-CHIP	75	5%	1/10W	R438	1-249-417-11	CARBON	1K	5%	1/4W
R305	1-218-285-11	RES-CHIP	75	5%	1/10W	R440	1-249-409-11	CARBON	220	5%	1/4W
R306	1-218-285-11	RES-CHIP	75	5%	1/10W	R441	1-249-409-11	CARBON	220	5%	1/4W
R307	1-218-285-11	RES-CHIP	75	5%	1/10W	R450	1-249-425-11	CARBON	4.7K	5%	1/4W
R308	1-216-821-11	RES-CHIP	1K	5%	1/10W	R455	1-216-821-11	RES-CHIP	1K	5%	1/10W
R309	1-216-833-11	RES-CHIP	10K	5%	1/10W	R456	1-216-821-11	RES-CHIP	1K	5%	1/10W
R310	1-216-821-11	RES-CHIP	1K	5%	1/10W	R457	1-216-821-11	RES-CHIP	1K	5%	1/10W
R311	1-216-813-11	RES-CHIP	220	5%	1/10W	R458	1-216-821-11	RES-CHIP	1K	5%	1/10W
R312	1-218-867-11	RES-CHIP	6.8K	5%	1/10W	R459	1-216-817-11	RES-CHIP	470	5%	1/10W
R313	1-216-864-11	SHORT CHIP				R460	1-216-817-11	RES-CHIP	470	5%	1/10W
R314	1-216-833-11	RES-CHIP	10K	5%	1/10W	R461	1-216-825-11	RES-CHIP	2.2K	5%	1/10W
R315	1-216-813-11	RES-CHIP	220	5%	1/10W	R462	1-216-825-11	RES-CHIP	2.2K	5%	1/10W
R316	1-216-825-11	RES-CHIP	2.2K	5%	1/10W	R463	1-249-437-11	CARBON	47K	5%	1/4W
R317	1-216-813-11	RES-CHIP	220	5%	1/10W	R464	1-216-841-11	RES-CHIP	47K	5%	1/10W
R318	1-216-825-11	RES-CHIP	2.2K	5%	1/10W	R477	1-216-819-11	RES-CHIP	680	5%	1/10W
R319	1-216-813-11	RES-CHIP	220	5%	1/10W	R478	1-216-833-11	RES-CHIP	10K	5%	1/10W
R320	1-216-825-11	RES-CHIP	2.2K	5%	1/10W	R479	1-216-821-11	RES-CHIP	1K	5%	1/10W
R321	1-247-807-31	CARBON	100	5%	1/4W	R484	1-216-809-11	RES-CHIP	100	5%	1/10W
R322	1-216-817-11	RES-CHIP	470	5%	1/10W	R485	1-216-809-11	RES-CHIP	100	5%	1/10W
R323	1-249-414-11	CARBON	560	5%	1/4W	R487	1-216-837-11	RES-CHIP	22K	5%	1/10W
R324	1-216-826-11	RES-CHIP	2.7K	5%	1/10W	R488	1-216-837-11	RES-CHIP	22K	5%	1/10W
R337	1-216-801-11	RES-CHIP	22	5%	1/10W	R489	1-216-805-11	RES-CHIP	47	5%	1/10W
R351	1-216-833-11	RES-CHIP	10K	5%	1/10W	R490	1-216-805-11	RES-CHIP	47	5%	1/10W
R352	1-216-853-11	RES-CHIP	470K	5%	1/10W	R494	1-216-833-11	RES-CHIP	10K	5%	1/10W
R360	1-216-809-11	RES-CHIP	100	5%	1/10W	R498	1-216-864-11	SHORT CHIP			
R361	1-216-809-11	RES-CHIP	100	5%	1/10W	R499	1-218-700-11	METAL CHIP	2.2K	0.50%	1/16W
R370	1-216-825-11	RES-CHIP	2.2K	5%	1/10W	R502	1-249-425-11	CARBON	4.7K	5%	1/4W

NOTE: The components identified by shading and  mark are critical for safety. Replace only with part number specified.

A component identified by this  symbol indicates that it has been carefully factory-selected to satisfy regulations regarding X-ray radiation. Should replacement be required, replace only with the value originally used.



REF. NO.	PART NO.	DESCRIPTION	VALUES			REF. NO.	PART NO.	DESCRIPTION	VALUES		
R503	1-215-919-11	METAL OXIDE	2.2K	5%	3W	 R568	1-215-416-00	METAL	620	1%	1/4W
R504	1-249-426-11	CARBON	5.6K	5%	1/4W	R569	1-249-429-11	CARBON	10K	5%	1/4W
R507	1-216-833-11	RES-CHIP	10K	5%	1/10W	R570	1-249-429-11	CARBON	10K	5%	1/4W
R510	1-260-328-11	CARBON	1K	5%	1/2W	R572	1-216-829-11	RES-CHIP	4.7K	5%	1/10W
R513	1-215-908-00	METAL OXIDE	33	5%	3W	R573	1-216-829-11	RES-CHIP	4.7K	5%	1/10W
R514	1-215-910-00	METAL OXIDE	68	5%	3W	R574	1-216-833-11	RES-CHIP	10K	5%	1/10W
R515	1-215-885-00	METAL OXIDE	68	5%	2W	R575	1-249-389-11	CARBON	4.7	5%	1/4W
R520	1-216-833-11	RES-CHIP	10K	5%	1/10W	R578	1-249-429-11	CARBON	10K	5%	1/4W
R521	1-216-819-11	RES-CHIP	680	5%	1/10W	R581	1-249-441-11	CARBON	100K	5%	1/4W
R522	1-249-411-11	CARBON	330	5%	1/4W	R583	1-249-377-11	CARBON	0.47	5%	1/4W
R524	1-218-867-11	RES-CHIP	6.8K	5%	1/10W	R584	1-215-453-00	METAL	22K	1%	1/4W
R525	1-215-861-00	METAL OXIDE	47	5%	1W	R585	1-215-449-00	METAL	15K	1%	1/4W
R526	1-216-837-11	RES-CHIP	22K	5%	1/10W	R586	1-215-429-00	METAL	2.2K	1%	1/4W
R527	1-216-825-11	RES-CHIP	2.2K	5%	1/10W	R587	1-249-401-11	CARBON	47	5%	1/4W
R528	1-216-816-11	RES-CHIP	390	5%	1/10W	R588	1-215-882-00	METAL OXIDE	22	5%	2W
R529	1-218-720-11	METAL CHIP	15K	0.50%	1/16W	 R589	1-247-895-91	CARBON	470K	5%	1/4W
R530	1-218-708-11	METAL CHIP	4.7K	0.50%	1/16W	 R590	1-249-429-11	CARBON	10K	5%	1/4W
R533	1-216-833-11	RES-CHIP	10K	5%	1/10W	 R591	1-216-365-00	METAL OXIDE	0.47	5%	2W
R534	1-218-720-11	METAL CHIP	15K	0.50%	1/16W	 R592	1-249-441-11	CARBON	100K	5%	1/4W
R535	1-216-830-11	RES-CHIP	5.6K	5%	1/10W	 R593	1-249-429-11	CARBON	10K	5%	1/4W
R536	1-216-833-11	RES-CHIP	10K	5%	1/10W	 R594	1-249-418-11	CARBON	1.2K	5%	1/4W
R537	1-216-848-11	RES-CHIP	180K	5%	1/10W	 R595	1-247-895-91	CARBON	470K	5%	1/4W
R539	1-216-864-11	SHORT CHIP				R596	1-249-377-11	CARBON	0.47	5%	1/4W
R540	1-249-429-11	CARBON	10K	5%	1/4W	R597	1-216-849-11	RES-CHIP	220K	5%	1/10W
R541	1-215-443-00	METAL	8.2K	1%	1/4W	R598	1-249-377-11	CARBON	0.47	5%	1/4W
R542	1-215-445-00	METAL	10K	1%	1/4W	R600	1-219-512-11	CARBON	2.2M	5%	1/2W
R543	1-216-351-00	METAL OXIDE	1.5	5%	1W	R601	1-205-998-11	CEMENTED	1	5%	10W
R545	1-215-890-11	METAL OXIDE	470	5%	2W			(KV-24FS100/25FS100(N) ONLY)			
R546	1-249-385-11	CARBON	2.2	5%	1/4W	R601	1-244-206-11	CEMENTED	2.2	5%	10W
R547	1-215-445-00	METAL	10K	1%	1/4W			(KV-25FS100(S) ONLY)			
R548	1-218-714-11	METAL CHIP	8.2K	0.50%	1/16W	R602	1-202-961-11	CEMENTED	1.8	5%	10W
R549	1-216-841-11	RES-CHIP	47K	5%	1/10W			(KV-24FS100/25FS100(N) ONLY)			
R550	1-216-817-11	RES-CHIP	470	5%	1/10W	R602	1-244-206-11	CEMENTED	2.2	5%	10W
R553	1-216-821-11	RES-CHIP	1K	5%	1/10W			(KV-25FS100(S) ONLY)			
R555	1-216-833-11	RES-CHIP	10K	5%	1/10W	 R603	1-219-513-11	CARBON	4.7M	5%	1/2W
R557	1-216-825-11	RES-CHIP	2.2K	5%	1/10W			(KV-24FS100/25FS100(N) ONLY)			
R560	1-216-821-11	RES-CHIP	1K	5%	1/10W	R604	1-216-821-11	RES-CHIP	1K	5%	1/10W
 R561	1-216-833-11	RES-CHIP	10K	5%	1/10W	R605	1-216-833-11	RES-CHIP	10K	5%	1/10W
 R562	1-249-429-11	CARBON	10K	5%	1/4W	R606	1-216-833-11	RES-CHIP	10K	5%	1/10W
 R563	1-216-833-11	RES-CHIP	10K	5%	1/10W	R607	1-216-857-11	RES-CHIP	1M	5%	1/10W
 R564	1-218-738-11	METAL CHIP	82K	0.50%	1/16W	R608	1-215-924-00	METAL OXIDE	15K	5%	3W
  R565	1-218-716-11	METAL CHIP	10K	0.50%	1/16W	R609	1-240-251-11	CEMENTED	6.8	5%	10W
 R566	1-215-469-00	METAL	100K	1%	1/4W	R612	1-260-131-11	CARBON	470K	5%	1/2W
 R567	1-215-879-11	METAL OXIDE	47K	5%	1W	R614	1-216-825-11	RES-CHIP	2.2K	5%	1/10W



NOTE: The components identified by shading and \triangle mark are critical for safety. Replace only with part number specified.

NOTE: Les composants identifiés par un trame et une marque \triangle sont critiques pour la sécurité. Ne les remplacer que par une pièce portant le numéro spécifique.

REF. NO.	PART NO.	DESCRIPTION	VALUES			REF. NO.	PART NO.	DESCRIPTION	VALUES		
R615	1-202-933-61	FUSIBLE	0.1	10%	1/2W						
R616	1-216-821-11	RES-CHIP	1K	5%	1/10W	S006	1-692-431-21	SWITCH TACTILE			
R617	1-216-821-11	RES-CHIP	1K	5%	1/10W	S007	1-762-816-11	SWITCH TACTILE			
R619	1-249-377-11	CARBON	0.47	5%	1/4W	S008	1-762-816-11	SWITCH TACTILE			
R620	1-216-353-00	METAL OXIDE	2.2	5%	1W						
R625	1-216-817-11	RES-CHIP	470	5%	1/10W			SWITCH			
R626	1-218-715-11	METAL CHIP	9.1K	0.50%	1/16W	SW515	1-572-707-11	SWITCH LEVER			
R627	1-215-481-00	METAL	330K	1%	1/4W			TRANSFORMER			
R628	1-260-131-11	CARBON	470K	5%	1/2W	T505	1-433-836-11	TRANSFORMER, HORIZONTAL DRIVE			
R629	1-215-481-00	METAL	330K	1%	1/4W	T510	1-437-610-11	TRANSFORMER, FERRITE (PMT)			
R630	1-215-481-00	METAL	330K	1%	1/4W	\triangle T511	1-433-850-11	TRANSFORMER, HORIZONTAL LINEAR			
R631	1-218-718-11	METAL CHIP	12K	0.50%	1/16W	\triangle T585	1-453-336-11	FBT ASSY NX-4011//X4A4			
R632	1-216-809-11	RES-CHIP	100	5%	1/10W						
R634	1-215-907-11	METAL OXIDE	22	5%	3W	\triangle T601	1-435-617-11	TRANSFORMER, LINE FILTER (KV-24FS100/25FS100(N) ONLY)			
R640	1-249-417-11	CARBON	1K	5%	1/4W	\triangle T601	1-426-717-11	TRANSFORMER, LINE FILTER (KV-25FS100(S) ONLY)			
R647	1-216-811-11	RES-CHIP	150	5%	1/10W						
R650	1-249-415-11	CARBON	680	5%	1/4W	\triangle T602	1-435-675-11	TRANSFORMER, STANDBY (KV-24FS100/25FS100(N) ONLY)			
R658	1-249-393-11	CARBON	10	5%	1/4W	\triangle T602	1-435-676-11	TRANSFORMER, STANDBY (KV-25FS100(S) ONLY)			
R659	1-249-393-11	CARBON	10	5%	1/4W	\triangle T603	1-437-611-11	TRANSFORMER, CONVERTER			
R660	1-216-833-11	RES-CHIP	10K	5%	1/10W			THERMISTOR			
R667	1-216-833-11	RES-CHIP	10K	5%	1/10W	THP501	1-809-539-11	THERMISTOR, POSITIVE (KV-24FS100/25FS100(N) ONLY)			
\triangle R668	1-249-418-11	CARBON	1.2K	5%	1/4W	THP501	1-803-540-11	THERMISTOR, POSITIVE (KV-25FS100(S) ONLY)			
R670	1-216-833-11	RES-CHIP	10K	5%	1/10W			TUNER			
R671	1-243-979-71	METAL OXIDE	0.1	5%	2W	\triangle TU101	8-598-593-30	TUNER, FSS BTF-WA421			
R680	1-216-864-11	SHORT CHIP						VARISTOR			
R687	1-202-961-11	CEMENTED (KV-24FS100/25FS100(N) ONLY)	1.8	5%	10W	VDR600	1-803-585-11	VARISTOR ENE271D-10A (KV-24FS100/25FS100(N) ONLY)			
R687	1-244-206-11	CEMENTED (KV-25FS100(S) ONLY)	2.2	5%	10W	VDR600	1-803-967-11	VARISTOR ENE271D-10A (KV-25FS100(S) ONLY)			
\triangle R699	1-218-265-11	RES, METAL FILM (KV-25FS100(S) ONLY)	8.2M	5%	1W			CRYSTAL			
R850	1-215-451-00	METAL	18K	1%	1/4W	X001	1-795-006-21	OSCILLATOR, CRYSTAL			
R851	1-216-821-11	RES-CHIP	1K	5%	1/10W	X301	1-781-377-11	VIBRATOR, CRYSTAL			
R862	1-216-813-11	RES-CHIP	220	5%	1/10W						
		RELAY									
RY501	1-755-198-11	RELAY									
\triangle RY600	1-755-395-11	RELAY (AC POWER)									
		SWITCH									
S001	1-692-431-21	SWITCH TACTILE									
S002	1-692-431-21	SWITCH TACTILE									
S003	1-692-431-21	SWITCH TACTILE									
S004	1-692-431-21	SWITCH TACTILE									
S005	1-692-431-21	SWITCH TACTILE									

M3 CV

REF. NO.	PART NO.	DESCRIPTION	VALUES	REF. NO.	PART NO.	DESCRIPTION	VALUES
M3				RESISTOR			
*	A-1400-739-A	M3 (VAR) BOARD, MOUNTED		R10	1-208-798-11	METAL CHIP	4.7K 0.50% 1/10W
	CAPACITOR			R11	1-208-798-11	METAL CHIP	4.7K 0.50% 1/10W
C10	1-126-947-11	ELECT	47μF 20% 25V	R12	1-218-692-11	METAL CHIP	1K 0.50% 1/16W
C11	1-162-970-11	CERAMIC CHIP	0.01μF 10% 25V	R13	1-208-798-11	METAL CHIP	4.7K 0.50% 1/10W
C12	1-163-275-11	CERAMIC CHIP	0.001μF 5% 50V	R50	1-216-829-11	RES-CHIP	4.7K 5% 1/10W
C13	1-162-970-11	CERAMIC CHIP	0.01μF 10% 25V	R51	1-216-833-11	RES-CHIP	10K 5% 1/10W
C14	1-163-275-11	CERAMIC CHIP	0.001μF 5% 50V	R52	1-216-833-11	RES-CHIP	10K 5% 1/10W
C50	1-126-959-11	ELECT	0.47μF 20% 50V	R53	1-216-829-11	RES-CHIP	4.7K 5% 1/10W
C51	1-126-935-11	ELECT	470μF 20% 16V	R54	1-216-829-11	RES-CHIP	4.7K 5% 1/10W
C70	1-126-947-11	ELECT	47μF 20% 25V	R55	1-216-065-91	RES-CHIP	4.7K 5% 1/10W
C71	1-162-970-11	CERAMIC CHIP	0.01μF 10% 25V	R56	1-216-823-11	RES-CHIP	1.5K 5% 1/10W
C80	1-126-947-11	ELECT	47μF 20% 25V	R57	1-216-864-11	SHORT CHIP	
	CONNECTOR			R58	1-216-835-11	RES-CHIP	15K 5% 1/10W
*	CN10	1-816-567-11	HEADER,CONNECTOR 6P	R59	1-216-065-91	RES-CHIP	4.7K 5% 1/10W
	DIODE			R70	1-218-716-11	METAL CHIP	10K 0.50% 1/16W
D50	8-719-404-50	DIODE MA111-TX		R71	1-218-716-11	METAL CHIP	10K 0.50% 1/16W
	IC			R72	1-218-700-11	METAL CHIP	2.2K 0.50% 1/16W
IC1	8-759-700-07	IC NJM2903M-TE2		R74	1-218-732-11	METAL CHIP	47K 0.50% 1/16W
IC2	8-759-700-07	IC NJM2903M-TE2		R77	1-218-740-11	METAL CHIP	100K 0.50% 1/16W
IC3	8-759-701-01	IC NJM2904M(T E2)		R78	1-208-814-91	METAL CHIP	22K 0.50% 1/10W
	CHIP CONDUCTOR			R79	1-208-798-11	METAL CHIP	4.7K 0.50% 1/10W
JR1	1-216-864-11	SHORT CHIP		CV			
JR2	1-216-864-11	SHORT CHIP		*	A-1400-341-A	CV (VAR) BOARD, MOUNTED	
JR6	1-216-864-11	SHORT CHIP		4-382-854-11	SCREW (M3X10), P, SW (+)		
JR7	1-216-864-11	SHORT CHIP			CAPACITOR		
JR12	1-216-864-11	SHORT CHIP		C780	1-162-926-11	CERAMIC CHIP	82pF 5% 50V
JR44	1-216-864-11	SHORT CHIP		C781	1-162-926-11	CERAMIC CHIP	82pF 5% 50V
	COIL			C782	1-162-926-11	CERAMIC CHIP	82pF 5% 50V
L50	1-408-615-31	INDUCTOR	100μH	C901	1-107-667-11	ELECT	2.2μF 20% 160V
	TRANSISTOR			C902	1-130-491-00	MYLAR	0.047μF 5% 50V
Q50	8-729-422-27	TRANSISTOR 2SD601A-QRS-TX		C903	1-126-935-11	ELECT	470μF 20% 16V
Q51	8-729-422-27	TRANSISTOR 2SD601A-QRS-TX		C904	1-130-471-00	MYLAR	0.001μF 5% 50V
Q52	8-729-422-27	TRANSISTOR 2SD601A-QRS-TX		C905	1-106-383-00	MYLAR	0.047μF 10% 200V
				C906	1-130-471-00	MYLAR	0.001μF 5% 50V
				C907	1-107-638-11	ELECT	33μF 20% 160V
				C908	1-126-935-11	ELECT	470μF 20% 16V
				C909	1-161-830-00	CERAMIC	0.0047μF 500V
				C910	1-104-999-11	MYLAR	0.1μF 10% 200V
				C911	1-104-665-11	ELECT	100μF 20% 25V
				C912	1-126-935-11	ELECT	470μF 20% 16V



REF. NO.	PART NO.	DESCRIPTION	VALUES	REF. NO.	PART NO.	DESCRIPTION	VALUES
C914	1-130-491-00	MYLAR	0.047μF 5% 50V				
C915	1-162-970-11	CERAMIC CHIP	0.01μF 10% 25V				
C1751	1-107-652-11	ELECT	10μF 20% 250V				
C1752	1-162-114-00	CERAMIC	0.0047μF 2KV				
C1753	1-137-528-11	MYLAR	0.1μF 10% 250V				
C1754	1-102-074-00	CERAMIC	0.001μF 10% 50V				
C1755	1-107-649-11	ELECT	2.2μF 20% 250V				
C1774	1-126-947-11	ELECT	47μF 20% 25V				
C1775	1-126-935-11	ELECT	470μF 20% 16V				
C1777	1-126-963-11	ELECT	4.7μF 20% 50V				
C1778	1-126-947-11	ELECT	47μF 20% 25V				
CONNECTOR							
CN903	1-564-506-11	PLUG,CONNECTOR	3P				
CN1707	1-564-506-11	PLUG,CONNECTOR	3P				
CN1751	1-564-509-11	PLUG,CONNECTOR	6P				
* CN1752	1-564-512-11	PLUG,CONNECTOR	9P				
CN1753	1-785-879-11	CONNECTOR, ONE TOUCH					
CN1755	1-695-915-11	TAB (CONTACT)					
DIODE							
D762	8-719-404-50	DIODE MA111-TX					
D763	8-719-404-50	DIODE MA111-TX					
D772	8-719-404-50	DIODE MA111-TX					
D773	8-719-404-50	DIODE MA111-TX					
D782	8-719-404-50	DIODE MA111-TX					
D783	8-719-404-50	DIODE MA111-TX					
D901	8-719-110-86	DIODE MTZJ-T-77-39					
D902	8-719-110-86	DIODE MTZJ-T-77-39					
D903	8-719-991-33	DIODE 1SS133T-77					
D1754	8-719-901-83	DIODE 1SS83TD					
D1755	8-719-901-83	DIODE 1SS83TD					
D1756	8-719-901-83	DIODE 1SS83TD					
D1758	8-719-302-43	DIODE RGP10GPKG23					
IC							
IC1707	8-759-356-16	IC NJM4556AD					
IC1751	8-759-562-43	IC TDA6108JF/N1B					
COIL							
L710	1-410-387-11	INDUCTOR	33μH				
L711	1-410-387-11	INDUCTOR	33μH				
L712	1-410-387-11	INDUCTOR	33μH				
L901	1-408-615-31	INDUCTOR	100μH				
L1751	1-408-613-31	INDUCTOR	68μH				
				TRANSISTOR			
				Q761	8-729-422-27	TRANSISTOR 2SD601A-QRS-TX	
				Q762	8-729-422-27	TRANSISTOR 2SD601A-QRS-TX	
				Q763	8-729-422-27	TRANSISTOR 2SD601A-QRS-TX	
				Q771	8-729-422-27	TRANSISTOR 2SD601A-QRS-TX	
				Q772	8-729-422-27	TRANSISTOR 2SD601A-QRS-TX	
				Q773	8-729-422-27	TRANSISTOR 2SD601A-QRS-TX	
				Q781	8-729-422-27	TRANSISTOR 2SD601A-QRS-TX	
				Q782	8-729-422-27	TRANSISTOR 2SD601A-QRS-TX	
				Q783	8-729-422-27	TRANSISTOR 2SD601A-QRS-TX	
				Q901	8-729-045-04	TRANSISTOR 2SC5511	
				Q902	8-729-045-05	TRANSISTOR 2SA2005	
				Q903	8-729-422-27	TRANSISTOR 2SD601A-QRS-TX	
				Q904	8-729-422-27	TRANSISTOR 2SD601A-QRS-TX	
				Q905	8-729-424-02	TRANSISTOR 2SB709A-QRS-TX	
				Q906	8-729-422-27	TRANSISTOR 2SD601A-QRS-TX	
				Q1772	8-729-422-27	TRANSISTOR 2SD601A-QRS-TX	
				RESISTOR			
				R760	1-216-829-11	RES-CHIP	4.7K 5% 1/10W
				R762	1-218-692-11	METAL CHIP	1K 0.50% 1/16W
				R763	1-216-835-11	RES-CHIP	15K 5% 1/10W
				R764	1-218-678-11	METAL CHIP	270 0.50% 1/16W
				R765	1-218-700-11	METAL CHIP	2.2K 0.50% 1/16W
				R766	1-216-827-11	RES-CHIP	3.3K 5% 1/10W
				R767	1-216-830-11	RES-CHIP	5.6K 5% 1/10W
				R768	1-216-821-11	RES-CHIP	1K 5% 1/10W
				R769	1-216-821-11	RES-CHIP	1K 5% 1/10W
				R770	1-216-829-11	RES-CHIP	4.7K 5% 1/10W
				R771	1-216-821-11	RES-CHIP	1K 5% 1/10W
				R772	1-218-692-11	METAL CHIP	1K 0.50% 1/16W
				R773	1-216-835-11	RES-CHIP	15K 5% 1/10W
				R774	1-218-678-11	METAL CHIP	270 0.50% 1/16W
				R775	1-218-700-11	METAL CHIP	2.2K 0.50% 1/16W
				R776	1-216-827-11	RES-CHIP	3.3K 5% 1/10W
				R777	1-216-830-11	RES-CHIP	5.6K 5% 1/10W
				R778	1-216-821-11	RES-CHIP	1K 5% 1/10W
				R779	1-216-821-11	RES-CHIP	1K 5% 1/10W
				R780	1-216-829-11	RES-CHIP	4.7K 5% 1/10W
				R782	1-218-692-11	METAL CHIP	1K 0.50% 1/16W
				R783	1-216-835-11	RES-CHIP	15K 5% 1/10W
				R784	1-218-678-11	METAL CHIP	270 0.50% 1/16W
				R785	1-218-700-11	METAL CHIP	2.2K 0.50% 1/16W
				R786	1-216-827-11	RES-CHIP	3.3K 5% 1/10W



REF. NO.	PART NO.	DESCRIPTION	VALUES			REF. NO.	PART NO.	DESCRIPTION	VALUES		
R787	1-216-830-11	RES-CHIP	5.6K	5%	1/10W	R1767	1-247-807-31	CARBON	100	5%	1/4W
R788	1-216-821-11	RES-CHIP	1K	5%	1/10W	R1768	1-247-807-31	CARBON	100	5%	1/4W
R901	1-249-401-11	CARBON	47	5%	1/4W	R1770	1-260-132-11	CARBON	560K	5%	1/2W
R902	1-249-386-11	CARBON	2.7	5%	1/4W	R1778	1-216-833-11	RES-CHIP	10K	5%	1/10W
R903	1-249-414-11	CARBON	560	5%	1/4W	R1780	1-216-837-11	RES-CHIP	22K	5%	1/10W
R904	1-249-432-11	CARBON	18K	5%	1/4W	R1781	1-216-838-11	RES-CHIP	27K	5%	1/10W
R905	1-249-417-11	CARBON	1K	5%	1/4W	R1787	1-216-837-11	RES-CHIP	22K	5%	1/10W
R906	1-249-432-11	CARBON	18K	5%	1/4W	R1788	1-249-421-11	CARBON	2.2K	5%	1/4W
R907	1-249-386-11	CARBON	2.7	5%	1/4W	R1789	1-249-425-11	CARBON	4.7K	5%	1/4W
R908	1-249-414-11	CARBON	560	5%	1/4W						
R909	1-260-312-11	CARBON	47	5%	1/2W			<u>VARIABLE RESISTOR</u>			
R910	1-216-476-11	METAL OXIDE	180	5%	3W	RV1701	1-238-019-11	RES, ADJ, CARBON	47K		
R911	1-216-799-11	RES-CHIP	15	5%	1/10W	RV1750	1-241-656-11	RES, ADJ, METAL FILM	110M		
R912	1-216-813-11	RES-CHIP	220	5%	1/10W			<u>ACCESSORIES AND PACKING</u>			
R913	1-216-799-11	RES-CHIP	15	5%	1/10W			1--501-730-41	ANTENNA, TELESCOPIC		
R914	1-216-814-11	RES-CHIP	270	5%	1/10W				(KV-25FS100 ONLY)		
R915	1-216-821-11	RES-CHIP	1K	5%	1/10W			1-417-182-11	CONVERTER (EAC-25)		
R916	1-216-821-11	RES-CHIP	1K	5%	1/10W				(KV-25FS100 ONLY)		
R917	1-216-821-11	RES-CHIP	1K	5%	1/10W			4-041-255-01	BAG, PROTECTION		
R918	1-216-809-11	RES-CHIP	100	5%	1/10W	*					
R919	1-216-809-11	RES-CHIP	100	5%	1/10W			4-086-340-22	MANUAL, INSTRUCTION		
R920	1-216-820-11	RES-CHIP	820	5%	1/10W				(KV-24FS100 ONLY)		
R921	1-216-833-11	RES-CHIP	10K	5%	1/10W			4-086-340-32	MANUAL, INSTRUCTION		
R922	1-249-397-11	CARBON	22	5%	1/4W				(KV-24FS100 (CND) ONLY)		
R923	1-249-401-11	CARBON	47	5%	1/4W			4-086-342-42	MANUAL, INSTRUCTION		
R1756	1-260-328-11	CARBON	1K	5%	1/2W				(KV-25FS100 ONLY)		
R1757	1-260-328-11	CARBON	1K	5%	1/2W	*		4-088-022-01	CARTON		
R1758	1-260-328-11	CARBON	1K	5%	1/2W	*		4-088-023-01	CUSHION, UPPER		
R1760	1-260-123-11	CARBON	100K	5%	1/2W	*		4-088-024-01	CUSHION, LOWER		
R1761	1-216-373-11	METAL OXIDE	2.2	5%	2W						
R1762	1-216-375-00	METAL OXIDE	3.3	5%	2W			<u>REMOTE COMMANDERS</u>			
R1763	1-247-807-31	CARBON	100	5%	1/4W			1-477-119-21	REMOTE COMMANDER (RM-Y173)		
R1764	1-247-807-31	CARBON	100	5%	1/4W			3-709-322-31	COVER, BATTERY (FOR RM-Y173)		
R1765	1-247-807-31	CARBON	100	5%	1/4W						
R1766	1-247-807-31	CARBON	100	5%	1/4W						

A BOARD SCHEMATIC DIAGRAM

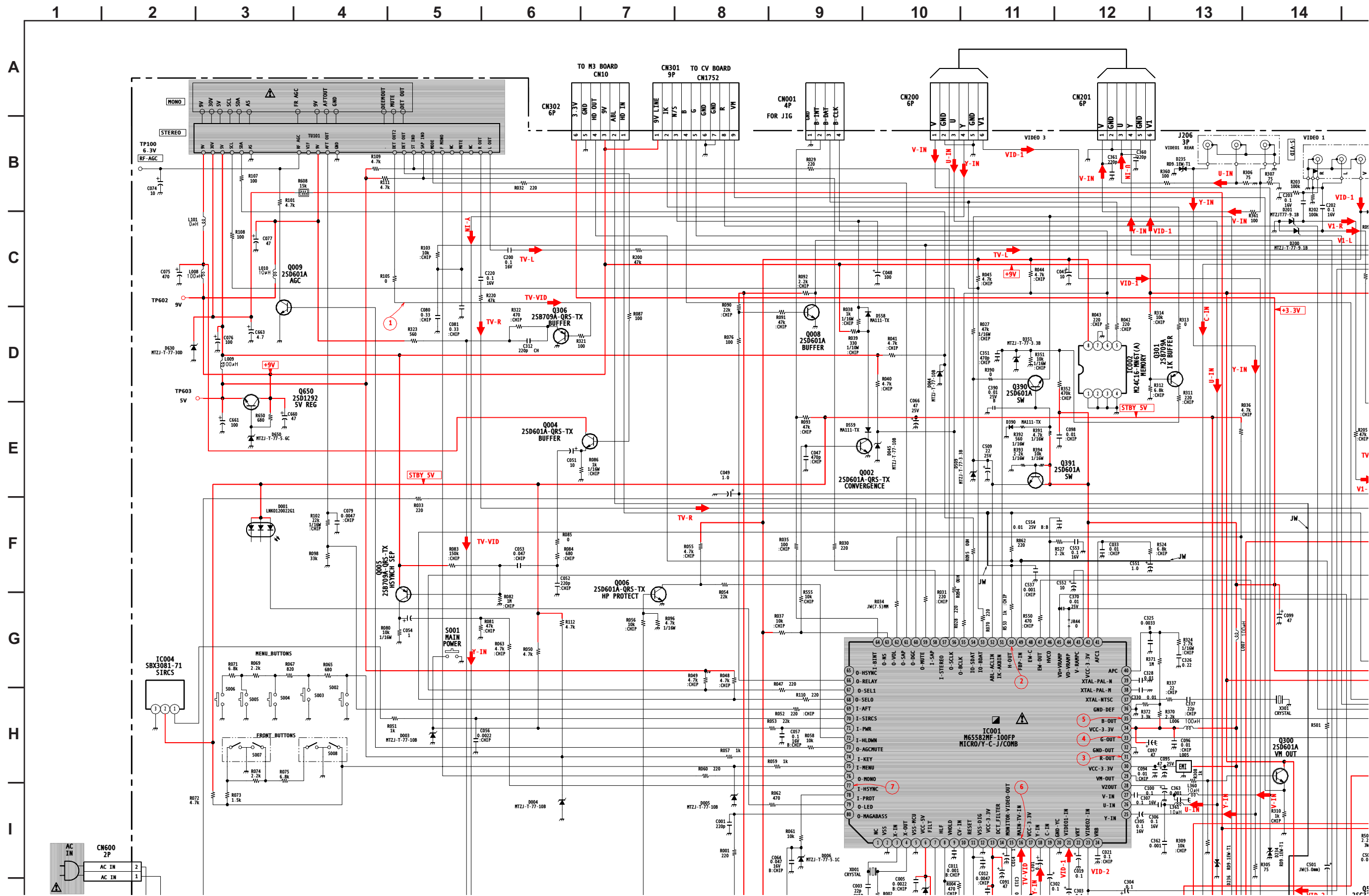

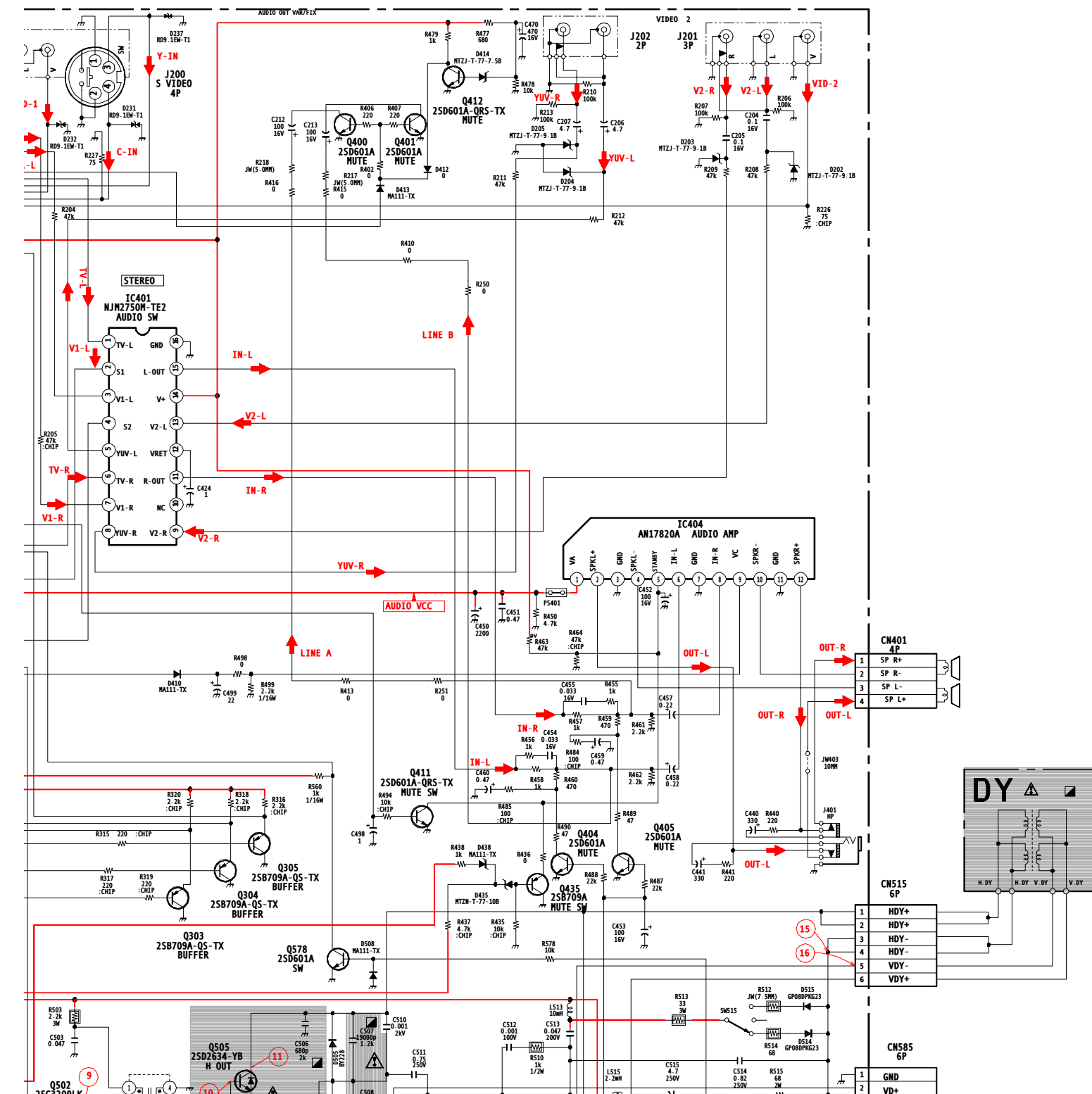

J
K
L
M
N
O

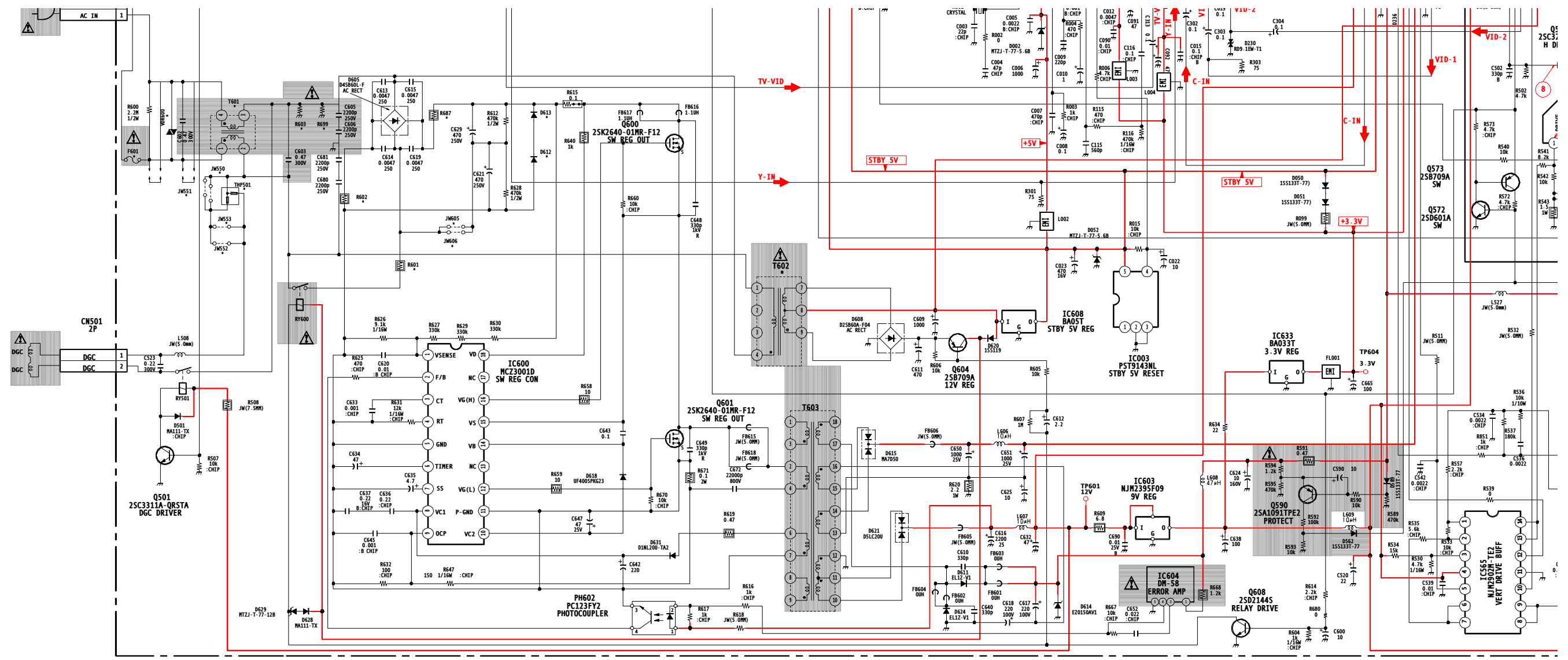

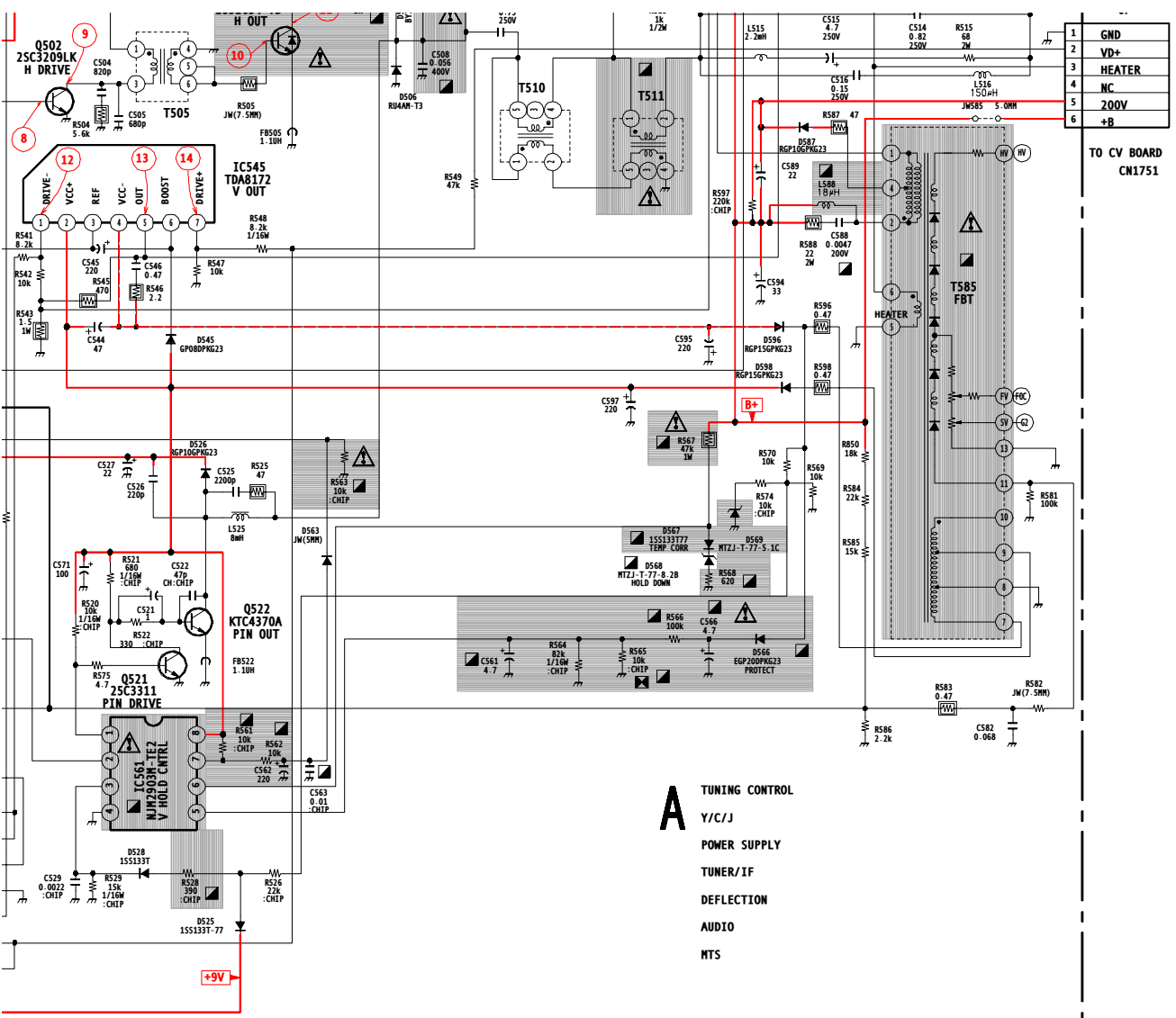

BA6-928-A



FD Trinitron
WEGA[®]

Operating Instructions

KV-13FS100
KV-13FS110
KV-20FS100
KV-24FS100

WARNING

To reduce the risk of fire or electric shock, do not expose the TV to rain or moisture.

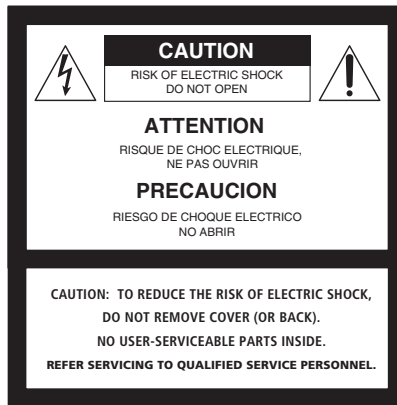

This symbol is intended to alert the user to the presence of uninsulated “dangerous voltage” within the product’s enclosure that may be of sufficient magnitude to constitute a risk of electric shock to persons.



This symbol is intended to alert the user to the presence of important operating and maintenance (servicing) instructions in the literature accompanying the appliance.

Note to the CATV Installer

This reminder is provided to call the CATV system installer’s attention to Article 820-40 of the NEC that provides guidelines for proper grounding and, in particular, specifies that the cable ground shall be connected to the grounding system of the building as close to the point of cable entry as practical.

SAFETY PRECAUTIONS

- Operate the TV only on 120 V AC.
- One blade of the power plug is wider than the other for safety purposes and will fit into the power outlet only one way. If you are unable to insert the plug fully into the outlet, contact your dealer.
- If any liquid or solid object falls into the TV, unplug it and have it checked by qualified personnel before operating it further.

CAUTION

When using TV games, computers, and similar products with your TV, keep the brightness and contrast functions at low settings. If a fixed (non-moving) pattern is left on the screen for long periods of time at a high brightness or contrast setting, the image can be permanently imprinted onto the screen. Continuously watching the same channel can cause the imprint of station logos onto the TV screen. These types of imprints are not covered by your warranty because they are the results of misuse.



To reduce the risk of electric shock, do not use this polarized plug with an extension cord, receptacle, or other outlet unless the blades can be fully inserted to prevent blade exposure.

 You are cautioned that any changes or modifications not expressly approved in this manual could void your authority to operate this equipment.

NOTIFICATION

This equipment has been tested and found to comply with the limits for a Class B digital device pursuant to Part 15 of the FCC Rules. These limits are designed to provide reasonable protection against harmful interference in a residential installation. This equipment generates, uses, and can radiate radio frequency energy and, if not installed and used in accordance with the instructions, may cause harmful interference with radio communications. However, there is no guarantee that interference will not occur in a particular installation. If this equipment does cause harmful interference to radio or television reception, which can be determined by turning the equipment off and on, the user is encouraged to try to correct the interference by one or more of the following measures:

- Reorient or relocate the receiving antennas.
- Increase the separation between the equipment and receiver.
- Connect the equipment into an outlet on a circuit different from that to which the receiver is connected.
- Consult the dealer or an experienced radio/TV technician for help.

Protecting the TV

- To prevent internal heat build-up, do not block the ventilation openings.
- Do not install the TV in a hot or humid place, or in a place subject to excessive dust or mechanical vibration.

Note on Caption Vision

This television receiver provides display of television closed captioning in accordance with § 15.119 of the FCC rules.

Use of this television for other than private viewing of programs broadcast on UHF or VHF or transmitted by cable companies for the use of the general public may require authorization from the broadcaster-cable company and/or program owner.

Owner's Record

The model and serial numbers are located on the front cover of this manual and at the rear of your TV.

Trademarks and Copyrights

ENERGY STAR[®] is a registered mark.



As an ENERGY STAR[®] Partner, Sony has determined that this product or product model meets the ENERGY STAR[®] guidelines for energy efficiency.

IMPORTANT SAFEGUARDS

For your protection, please read these instructions completely, and keep this manual for future reference. Carefully observe and comply with all warnings, cautions and instructions placed on the set, or described in the operating instructions or service manual.

WARNING

To guard against injury, the following basic safety precautions should be observed in the installation, use, and servicing of the set.

Use

Power Sources

This set should be operated only from the type of power source indicated on the serial/model plate. If you are not sure of the type of electrical power supplied to your home, consult your dealer or local power company. For those sets designed to operate from battery power, refer to the operating instructions.



Grounding or Polarization

This set is equipped with a polarized AC power cord plug (a plug having one blade wider than the other), or with a three-wire grounding type plug (a plug having a third pin for grounding).

Refer to the following instructions:

For the set with a polarized AC power cord plug

This plug will fit into the power outlet only one way. This is a safety feature. If you are unable to insert the plug fully into the outlet, try reversing the plug. If the plug still fails to fit, contact your electrician to have a suitable outlet installed. Do not defeat the safety purpose of the polarized plug by forcing it in.

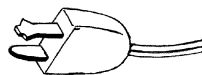

Alternate Warning

For the set with a three-wire grounding type AC plug

This plug will only fit into a grounding-type power outlet. This is a safety feature. If you are unable to insert the plug into the outlet, contact your electrician to have a suitable outlet installed. Do not defeat the safety purpose of the grounding plug.

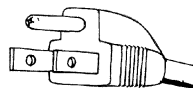

Overloading

Do not overload wall outlets, extension cords or convenience receptacles beyond their capacity, since this can result in fire or electric shock. Always turn the set off when it is not to be used. When the set is left unattended and unused for long periods of time, unplug it from the wall outlet as a precaution against the possibility of an internal malfunction that could create a fire hazard.



Do not disconnect the antenna or the power cord during a heavy storm. Lightning may strike while you are holding the cable or cord, causing serious injury. Turn off your TV and wait for the weather to improve.

Object and Liquid Entry

Never push objects of any kind into the set through the cabinet slots as they may touch dangerous voltage points or short out parts that could result in a fire or electric shock. Never spill liquid of any kind on the set.

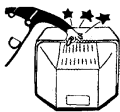

Attachments

Do not use attachments not recommended by the manufacturer, as they may cause hazards.

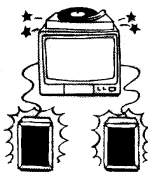

Do not place any objects, especially heavy objects, on top of the set. The object may fall from the set, causing injury.

Cleaning

Unplug the set from the wall outlet before cleaning or polishing it. Do not use liquid cleaners or aerosol cleaners. Use a cloth lightly dampened with water for cleaning the exterior of the set.



If a snapping or popping sound from a TV set is continuous or frequent while the TV is operating, unplug the TV and consult your dealer or service technician. It is normal for some TV sets to make occasional snapping or popping sounds, particularly when being turned on or off.



Installation

Always use two or more people to lift or move the set. The set is heavy and the bottom surface is flat. Serious injury can result from trying to move the set by yourself alone, or from unsteady handling. Install the set on a stable, level surface.

Water and Moisture

Do not use power-line operated sets near water — for example, near a bathtub, washbowl, kitchen sink, or laundry tub, in a wet basement, or near a swimming pool, etc.

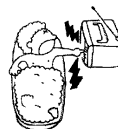

Accessories

Do not place the set on an unstable cart, stand, tripod, bracket, table, or shelf. The set may fall, causing serious injury to a child or an adult, and serious damage to the set. Use only a cart or stand recommended by the manufacturer for the specific model of TV. Any mounting of the product should follow the manufacturer's instructions, and should use a mounting accessory recommended by the manufacturer. An appliance and cart combination should be moved with care. Quick stops, excessive force, and uneven surfaces may cause the appliance and cart combination to overturn.

Disconnect all cables and cords from the set before attempting to move the set.



Do not allow children or pets to climb up onto, or push against, the set. The set may fall, causing serious injury.

Ventilation

The slots and openings in the cabinet and in the back or bottom are provided for necessary ventilation. To ensure reliable operation of the set, and to protect it from overheating, these slots and openings must never be blocked or covered.

- **Never cover the slots and openings with a cloth or other materials.**

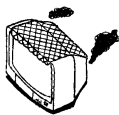

- **Never block the slots and openings by placing the set on a bed, sofa, rug or other similar surface.**

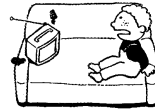

- **Never place the set in a confined space, such as a bookcase or built-in cabinet, unless proper ventilation is provided.**



- **Do not place the set near or over a radiator or heat register, or where it is exposed to direct sunlight.**



Power-Cord Protection

Do not allow anything to rest on or roll over the power cord, and do not place the set where the power cord is subject to wear or abuse.



Grounding or Polarization

This set may be equipped with a polarized alternating current line plug (a plug having one blade wider than other). This plug will fit into the power outlet only one way. This is a safety feature. If you are unable to insert the plug fully into the outlet, try reversing the plug. If the plug still fails to fit, contact your electrician to replace your obsolete outlet. Do not defeat the safety purpose of the polarized plug.

Antennas

Outdoor Antenna Grounding

If an outdoor antenna is installed, follow the precautions below. An outdoor antenna system should not be located in the vicinity of overhead power lines or other electric light or power circuits, or where it can come in contact with such power lines or circuits.

WHEN INSTALLING AN OUTDOOR ANTENNA SYSTEM, EXTREME CARE SHOULD BE TAKEN TO KEEP FROM CONTACTING SUCH POWER LINES OR CIRCUITS AS CONTACT WITH THEM IS ALMOST INVARIABLY FATAL.

Be sure the antenna system is grounded so as to provide some protection against voltage surges and built-up static charges. Section 810 of the National Electrical Code (NEC) in USA and Section 54 of the Canadian Electrical Code in Canada provides information with respect to proper grounding of the mast and supporting structure, grounding of the lead-in wire to an antenna discharge unit, size of grounding conductors, location of antenna discharge unit, connection to grounding electrodes, and requirements for the grounding electrode.

Antenna Grounding According to the NEC

Antenna Grounding According to the National Electrical Code, ANSI/NFPA 70.

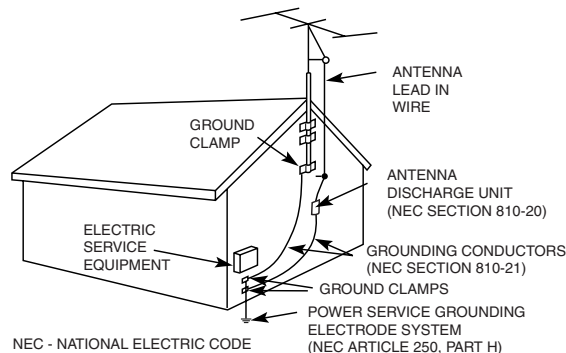

Lightning

For added protection for this television receiver during a lightning storm, or when it is left unattended and unused for long periods of time, unplug it from the wall outlet and disconnect the antenna. This will prevent damage to the receiver due to lightning and power-line surges.

Service Damage Requiring Service

Unplug the set from the wall outlet and refer servicing to qualified service personnel under the following conditions:

- When the power cord or plug is damaged or frayed.

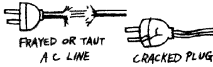

- If liquid has been spilled into the set or objects have fallen into the product.

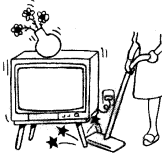

- If the set has been exposed to rain or water.



- If the set has been subject to excessive shock by being dropped, or the cabinet has been damaged.

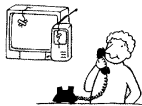

- If the set does not operate normally when following the operating instructions. Adjust only those controls that are specified in the operating instructions. Improper adjustment of other controls may result in damage and will often require extensive work by a qualified technician to restore the set to normal operation.



- When the set exhibits a distinct change in performance — this indicates a need for service.

Servicing

Do not attempt to service the set yourself since opening the cabinet may expose you to dangerous voltage or other hazards. Refer all servicing to qualified service personnel.



Replacement Parts

When replacement parts are required, be sure the service technician certifies in writing that he has used replacement parts specified by the manufacturer that have the same characteristics as the original parts. Unauthorized substitutions may result in fire, electric shock, or other hazards.



Safety Check

Upon completion of any service or repairs to the set, ask the service technician to perform routine safety checks (as specified by the manufacturer) to determine that the set is in safe operating condition, and to so certify. When the set reaches the end of its useful life, improper disposal could result in a picture tube implosion. Ask a qualified service technician to dispose of the set.



Contents

Introduction

Introducing the FD Trinitron WEGA® Features.....	1
Batteries for the Remote Control	2
About this Manual	2
Front Panel Menu Controls	2







Connecting Your TV

TV Rear Panel	3
Basic Connections	4
Connecting Additional Equipment	5

Using the Remote Control and Basic Functions

Using the Remote Control	12
Setting Up the TV Automatically	14
Quick Start to the Menus	15

Using the Menus

To Access a Menu.....	17
Using the Video  Menu	18
Using the Audio  Menu	19
Using the Channel Setup  Menu.....	20
Parental Control	22
Using the Parental Control  Menu	25
Using the Timer  Menu.....	28
Using the Setup  Menu.....	29

Other Information

Troubleshooting	31
Specifications	33

Index	35
--------------------	----

Introduction

Congratulations on your purchase of the Sony FD Trinitron WEGA[®]. Before you begin using this manual, please check the model number located on the rear of your TV or on the front cover of this manual.

Introducing the FD Trinitron WEGA[®] Features

Some of the features you will enjoy include:

- ❑ **FD Trinitron FLAT CRT** — Technologically advanced tube delivers a picture with uncompromising accuracy and outstanding image detail.
- ❑ **Y, P_B, P_R Inputs** — A component video input connection for a superior picture quality.
- ❑ **Parental Control (V-Chip)** — A tool to help parents monitor what their children watch on TV by establishing rating limits.
- ❑ **Favorite Channels** — Instant access to your favorite channels with the touch of a button.
- ❑ **Energy Star[®]** — A recognized symbol of energy efficiency.
- ❑ **Direct MTS** — Allows direct access for changing your Multi-Channel TV Sound: Stereo, Mono, or Auto SAP (Second Audio Program) with the touch of a button.
- ❑ **Trilingual Menus** — Choose between English, French, or Spanish menus.
- ❑ **Front Panel Controls** — Allows access to the on-screen menus without the use of a remote control.
- ❑ **Front A/V Inputs** — A quick connection for video games, camcorders, stereo/mono equipment, or headphones.
- ❑ **Auto Mute** — A friendly feature designed to automatically mute your TV when no signal is received.

Batteries for the Remote Control

Insert two AA (R6) batteries (supplied) into the remote control using the following illustration as a guide.

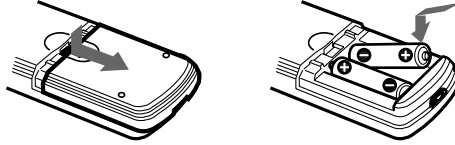

 Under normal conditions, batteries will last up to six months. If the remote control does not operate properly, the batteries might be worn out.

 If you will not be using the remote control for an extended period of time, remove the batteries to avoid possible damage from battery leakage.









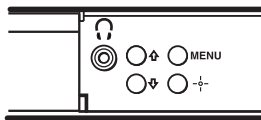

About this Manual

This manual provides instructions to help you enjoy your new TV. It shows you how to connect to an antenna or cable, cable box, VCR, DVD, satellite receiver, stereo system, or camcorder. Once you're connected, follow the instructions and use the remote control to access the on-screen menus.

 The TV front and rear panels illustrated in this manual are for KV-24FS100. The front and rear panels on your TV may not look exactly like those illustrated.

Front Panel Menu Controls



The front Audio/Video panel controls allows you to access the menu without the remote control. Press  to display the on-screen menu. Use the  and  buttons on the front Audio/Video panel instead of the  and  buttons on the remote control. Use the  button on the front Audio/Video panel instead of the , , and  buttons on the remote control. Press  again when the setting or adjustment is complete.

 To navigate the menus with your remote control, see "Using the Menus" on page 17.

Connecting Your TV

Read this section before setting up your TV for the first time. This section covers basic connections in addition to any optional equipment you may be connecting.

TV Rear Panel

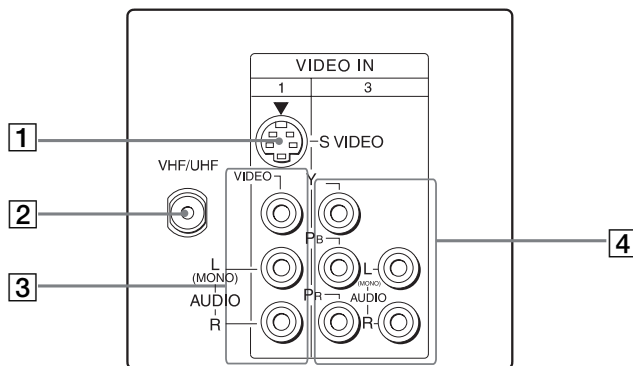

Jack	Description
1 S VIDEO	Connects to the S VIDEO OUT jack on your VCR or other video equipment that has S VIDEO. S VIDEO provides better picture quality than the VHF/UHF jacks or the video input jack. S VIDEO does not provide sound; the audio cables must still be connected.
2 VHF/UHF	Connects to your VHF/UHF antenna or cable.
3 VIDEO/ AUDIO (L/R)	Connects to the AUDIO and VIDEO output jacks on your VCR or other video equipment. A second video input jack (VIDEO 2) is located on the front panel of the TV. These AUDIO/VIDEO input jacks provide better picture quality than the VHF/UHF jack.
4 Y, PB, PR/ L, R	Connects to the component video Y, PB, PR to AUDIO L and R output jacks on your DVD player or Digital Set-top box.

 The rear panels illustrated in this manual are for KV-24FS100. The rear panels on your TV may not look exactly like those illustrated.

Basic Connections

TV with indoor or outdoor antenna, or CATV cable

Depending on the cable available in your home, choose one of the connections below:

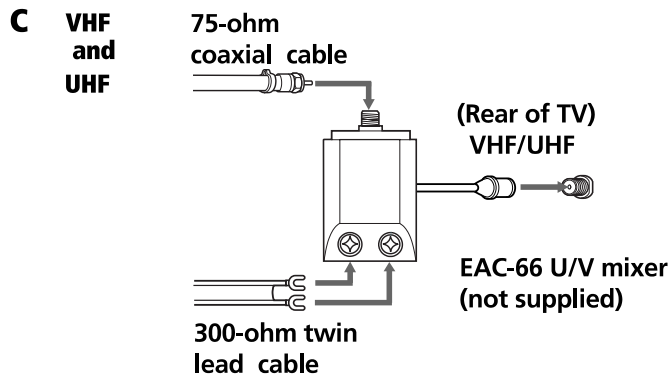
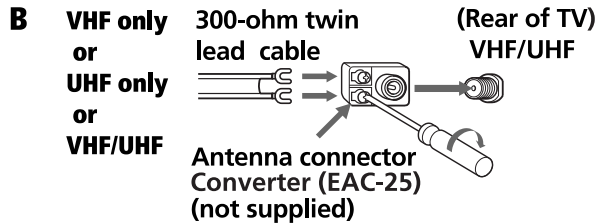
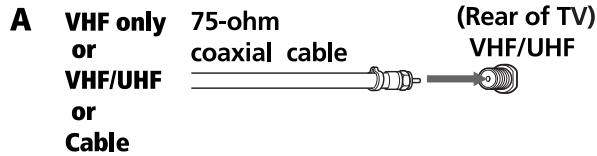

 If you are connecting to an indoor or outdoor antenna, you may need to adjust the orientation of the antenna for best reception.

Connecting Additional Equipment

TV and VCR

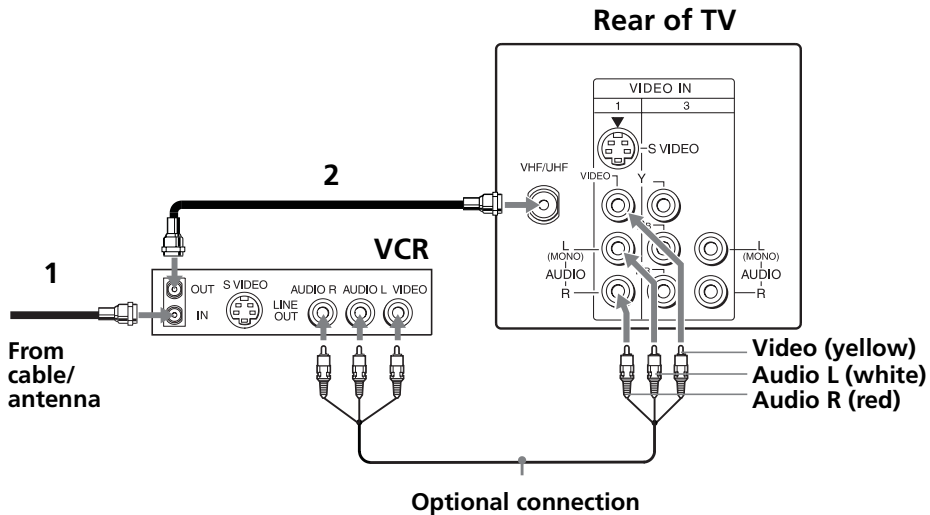

To watch video programs from your VCR, tune your TV to channel 3 or 4 (as set on the rear of your VCR).

- 1** Connect the coaxial cable from your TV antenna or cable service to the IN jack on your VCR.
- 2** Connect a coaxial cable (not supplied) from the OUT jack on your VCR to the VHF/UHF jack on the TV.

Optional connection

If your VCR is equipped with video outputs, you can get better picture quality by connecting Audio/Video cables (not supplied) from AUDIO and VIDEO OUT on your VCR to AUDIO/VIDEO IN on your TV.

You can use the button to switch between the VHF/UHF and VIDEO inputs.

For better picture quality, use S VIDEO instead of the yellow Audio/ Video cable. S VIDEO does not provide sound; the audio cables must still be connected.

TV and Cable Box

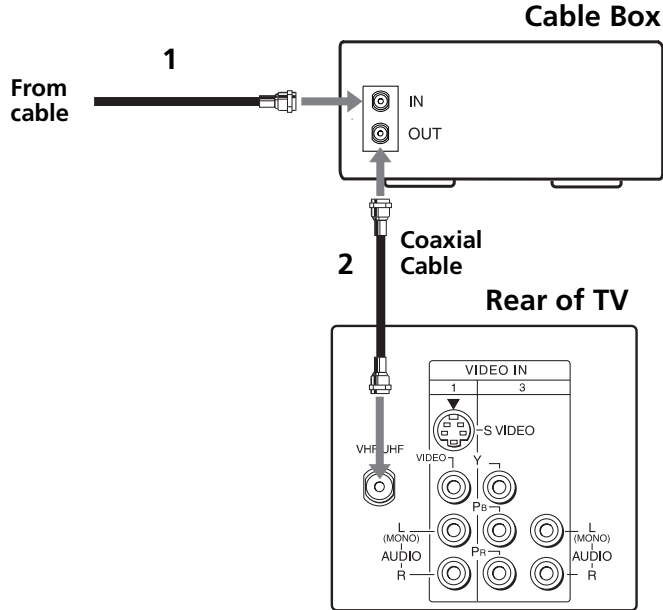

- 1** Connect the coaxial cable from your cable service to the IN jack on your cable box.
- 2** Connect a coaxial cable (not supplied) from the OUT jack on your cable box to the VHF/UHF jack on the TV.

 To view channels from your cable box, tune your TV to channel 3 or 4 (as set on the rear panel of your cable box) and use the cable box's remote control to change channels.

 If you will be controlling all channel selection through your cable box, you should consider using the Channel Fix feature by setting your TV to channel 3 or 4 (see page 20).

TV, VCR, and Cable Box

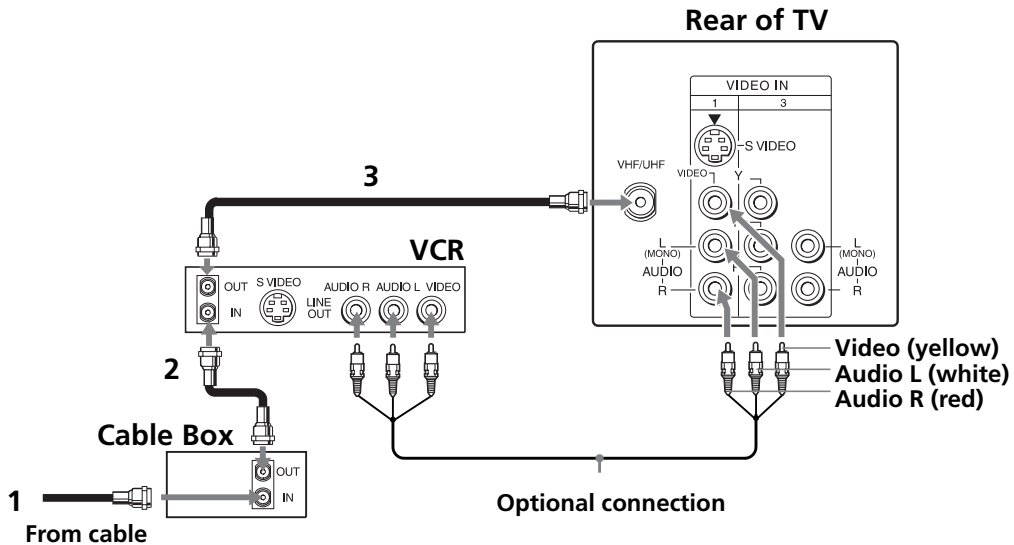

- 1** Connect the coaxial cable from your cable service to the IN jack on your cable box.
- 2** Connect a coaxial cable (not supplied) from the OUT jack on your cable box to the IN jack on your VCR.
- 3** Connect a coaxial cable (not supplied) from the OUT jack on your VCR to the VHF/UHF jack on the TV.

If you will be controlling all channel selection through your cable box, you should consider using the Channel Fix feature by setting your TV to channel 3 or 4 (see page 20).

Optional connection

If your VCR is equipped with video outputs, you can get better picture quality by connecting Audio/Video cables (not supplied) from AUDIO and VIDEO OUT on your VCR to AUDIO/VIDEO IN on your TV.

You can use the button to switch between the VHF/UHF and VIDEO inputs.

For better picture quality, use S VIDEO instead of the yellow Audio/ Video cable. S VIDEO does not provide sound; the audio cables must still be connected.

TV and Satellite Receiver

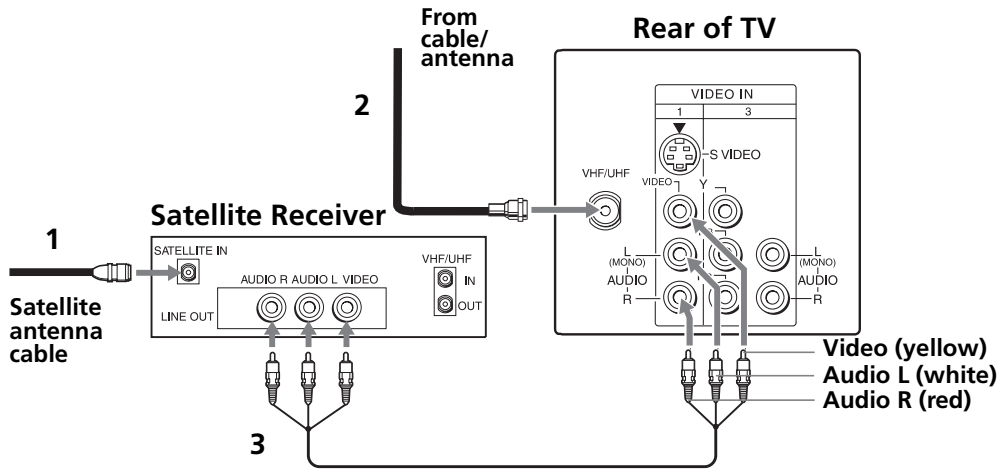

- 1 Connect the cable from your satellite antenna to SATELLITE IN on your satellite receiver.
- 2 Connect the coaxial cable from your cable service or antenna to the VHF/UHF jack on your TV.
- 3 Using Audio/Video cables (not supplied), connect AUDIO and VIDEO OUT on your satellite receiver to AUDIO and VIDEO IN on your TV.



 You can use the  button to switch between the VHF/UHF and VIDEO inputs.

 For better picture quality, use S VIDEO instead of the yellow Audio/ Video cable. S VIDEO does not provide sound; the audio cables must still be connected.

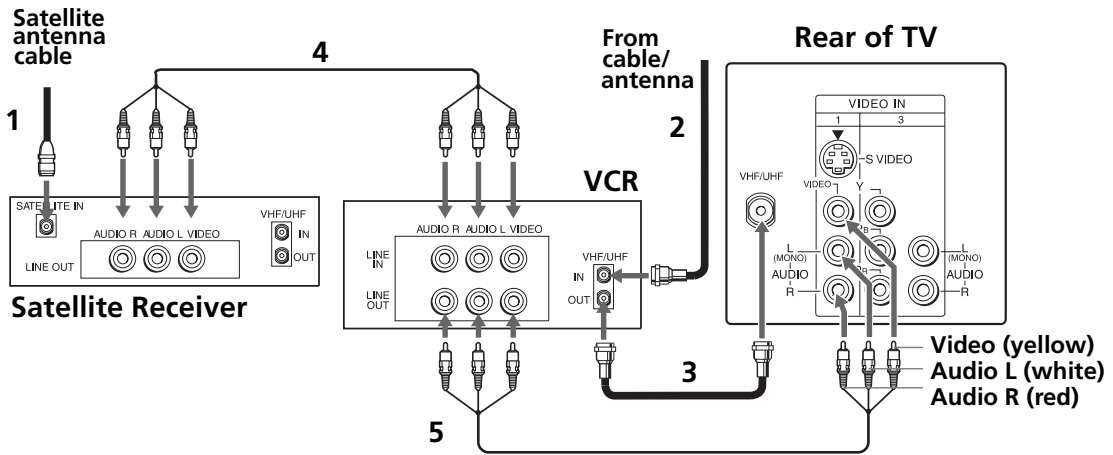
TV, Satellite Receiver, and VCR



- 1** Connect the cable from your satellite antenna to SATELLITE IN on the satellite receiver.
- 2** Connect the coaxial cable from your cable service or antenna to the IN jack on your VCR.
- 3** Using a coaxial cable (not supplied), connect the OUT jack on your VCR to the VHF/UHF jack on your TV.
- 4** Using Audio/Video cables (not supplied), connect AUDIO and VIDEO OUT on your satellite receiver to AUDIO and VIDEO IN on your VCR.
- 5** Using Audio/Video cables (not supplied), connect AUDIO and VIDEO OUT on your VCR to AUDIO and VIDEO IN on your TV.

 To view from the satellite receiver or VCR, select the video input to which your satellite receiver or VCR is connected by pressing  on the remote control.

Connecting a DVD Player

Using Audio/Video cables (not supplied), connect AUDIO and VIDEO OUT on your DVD player to AUDIO and VIDEO IN on your TV.

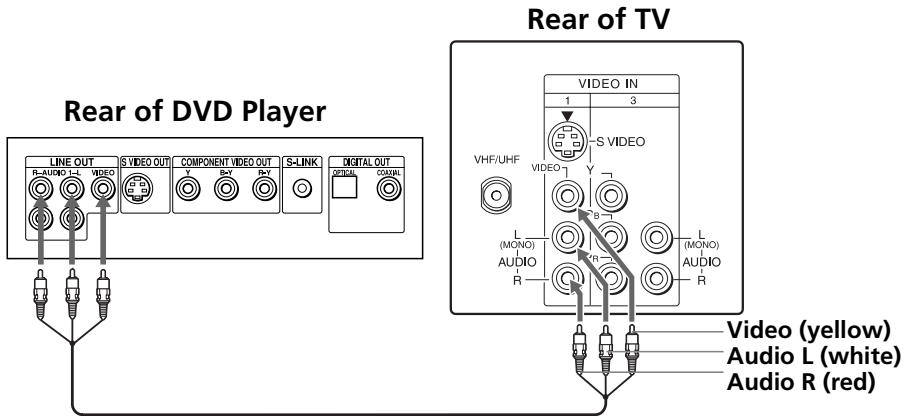

For better picture quality, use S VIDEO instead of the yellow Audio/ Video cable. S VIDEO does not provide sound; the audio cables must still be connected.

Optional connection

If your DVD player is equipped with component video outputs (Y, P_B, P_R), you can optimize the picture quality by using component video cables.

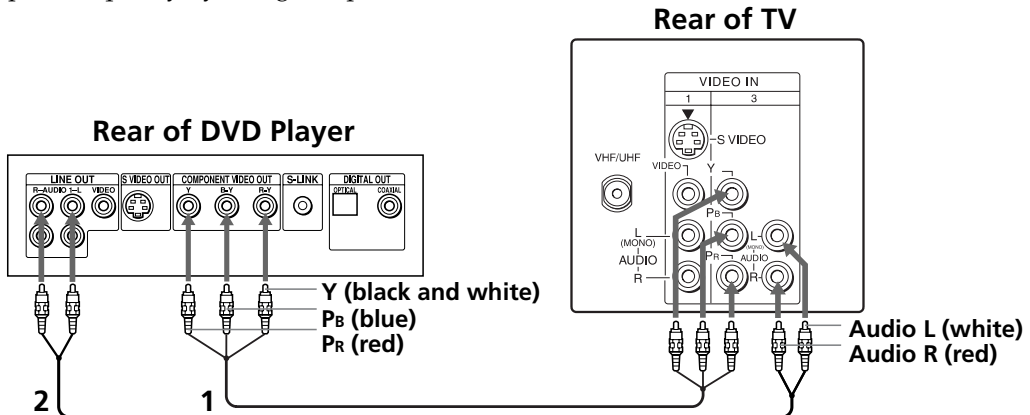

- 1 Using component video cables (not supplied), connect the Y, P_B, P_R OUT on your DVD player to Y, P_B, P_R IN on your TV.
- 2 Connect AUDIO OUT on your DVD player to AUDIO IN on your TV.

The Y, P_B, P_R outputs on your DVD player are sometimes labeled Y, C_B, and C_R or Y, B-Y, and R-Y. If so, connect the cables to like colors.

Connecting a Camcorder

Using Audio/Video cables (not supplied), connect AUDIO and VIDEO OUT on your camcorder to AUDIO and VIDEO IN on your TV.

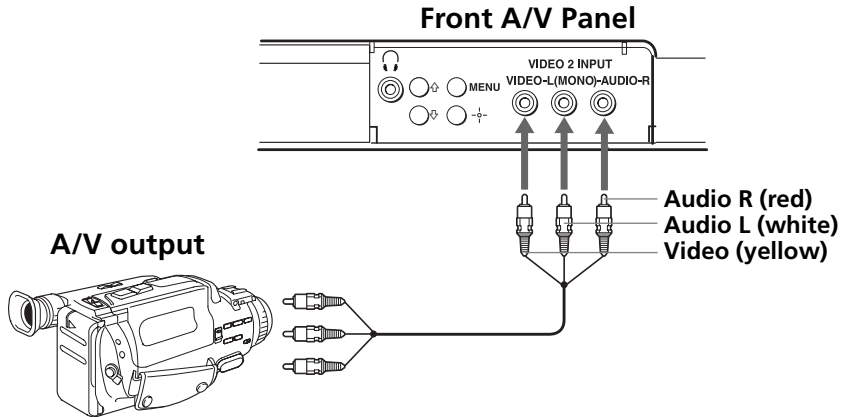

Connecting Headphones

Connect the headphones to the  jack on the front of your TV. Headphone jack is STEREO.

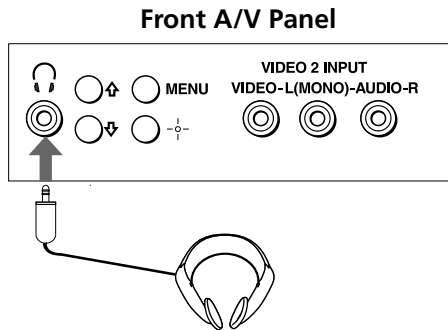

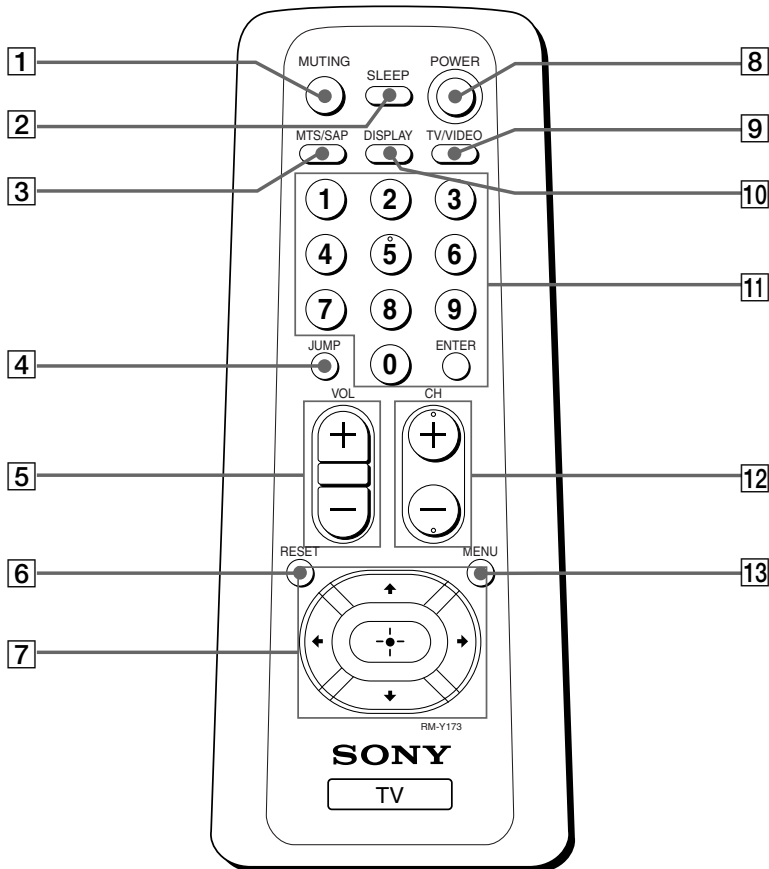

Using the Remote Control and Basic Functions

This section shows you how to use the buttons on the remote control and how to navigate the on-screen menus.

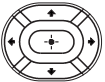

Using the Remote Control

Button	Description
1 MUTING	Instantly turns off the sound. Press again or press  to restore the sound.
2 SLEEP	Turns the TV off automatically in approximately 15, 30, 45, 60, or 90 minutes. Cancel by pressing until SLEEP OFF appears.
3 MTS/SAP	Cycles through the Multi-channel TV Sound (MTS) options: Stereo, Mono, and Auto SAP (Second Audio Program).
4 JUMP	Press to jump back and forth between two channels. The TV alternates between current channel and the last channel that was selected.
5 VOL (volume)	Press when you want to adjust the volume.
6 RESET	Press to return to factory settings while in an on-screen menu.
7 	Moves the cursor in the on-screen menus. Press the arrow buttons to move the cursor, then press the center button to select or access an option.
8 POWER	Press when you want to turn the TV on or off.
9 TV/VIDEO	Cycles through available video inputs.
10 DISPLAY	Press to display the current time (if set) and channel number. Press again to turn DISPLAY off.
11 0-9 and ENTER	Change the channels directly. Press 0-9 buttons to select a channel, then press ENTER.
12 CH (channel)	Press when you want to change channels.
13 MENU	Displays the on-screen menu. Press again to exit the menu at any time.



 If you lose your remote control, see page 32.

Setting Up the TV Automatically

After you have finished connecting your TV, you can perform Auto Program to set up your channels.











- 1 Press  to turn on the TV. The Initial Setup screen appears.





- 2 Press  on the remote control or on the TV front panel to perform Auto Program, or press  to exit.

 The Initial Setup screen appears each time you turn on the TV until you perform Auto Program.

To perform Auto Program again

- 1 Press .
- 2 Press  to highlight Channel Setup ().
- 3 Press  to highlight Cable. Press  to select.
- 4 Press  or  to select On or Off according to how you connected your TV. Press .
- 5 Press  to highlight Auto Program. Press  to search for channels.

 After performing Auto Program, press  to exit.

Quick Start to the Menus

The following settings are available in your on-screen menus:

Menu

Allows you to

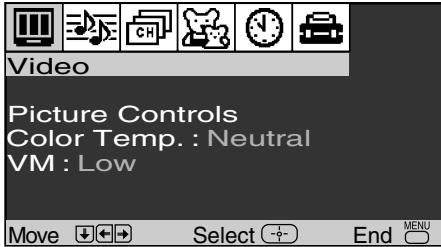

Make adjustments to your picture settings.



Change your audio settings.



Customize your channel settings.



Set rating limits on your TV based on a program's rating or content.

 The menus shown in this manual are for KV-24FS100. Your menus may not look like those illustrated.

Menu



Allows you to

Set the clock on your TV and program scheduled viewing using Timer 1 and Timer 2.













Select closed captioning options, label video inputs, adjust tilt correction, select menu languages, or run a demo of the menus.

Using the Menu

This section shows the options available for setting up and adjusting your TV.

To Access a Menu

- 1 Press  to display the on-screen menu.
- 2 Use the  or  buttons to highlight the desired menu, then press .
- 3 Use the  or  buttons to highlight the desired option, then press .
- 4 Press  to complete the adjustment or follow the instructions that will appear on your screen to activate the desired option.
- 5 Press  to exit the menu.

 Press  once to display the on-screen menu, and press again to return to normal viewing. If no buttons are pressed, the menu closes automatically after about 90 seconds.

Using the Video Menu

To access the Video menu, refer to the following steps:

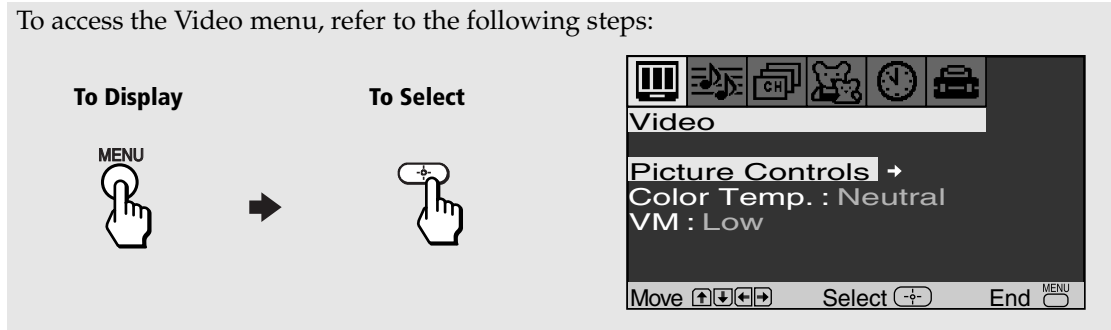

Picture Controls

Press ⇨ to open Picture Controls menu:

Picture:

Press ⇐ to decrease the contrast. Press ⇨ to increase contrast.

Brightness:

Press ⇐ to darken the picture. Press ⇨ to brighten the picture.

Color:

Press ⇐ to decrease color saturation. Press ⇨ to increase color saturation.

Hue:

Press ⇐ to increase the red tones. Press ⇨ to increase the green tones.

Sharpness:

Press ⇐ to soften the picture. Press ⇨ to sharpen the picture.

Color Temp.

White color tint adjustment

Use the ⬆ or ⬇ buttons to select from one of the following options:

Cool: Gives the white colors a blue tint.

Neutral: Gives the white colors a neutral tint.

Warm: Gives the white colors a red tint.

VM

Velocity Modulation

KV-20FS100 and KV-24FS100 only

Sharpens picture definition to give objects a sharp, clean edge. Use the ⬆ or ⬇ buttons to select from one of the following options: **Off, High,**

Low.

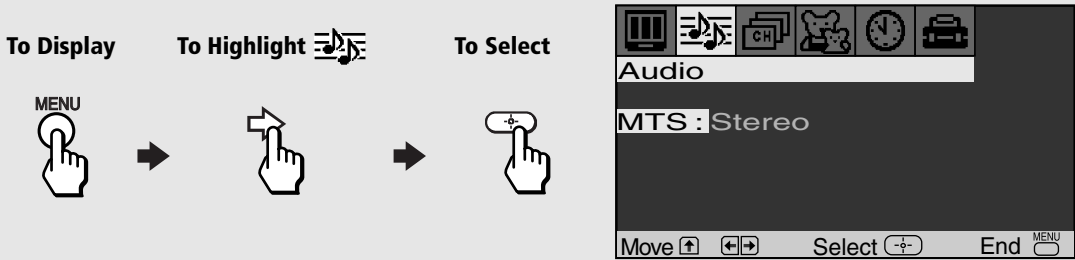

Using the Audio Menu

To access the Audio menu, refer to the following steps:



MTS



*Multi-Channel
TV Sound*

Press  or  to select one of the following options:

Stereo: Select when viewing a broadcast in stereo.

Mono: Select to reduce noise in areas of poor reception.





Auto SAP: Select to have the TV automatically switch to a Second Audio Program (SAP) when a signal is received.

 Press  to access MTS settings (Stereo, Mono, Auto SAP) directly.

 If your TV is set to Auto SAP, some programs may be muted or distorted. If your TV does not output sound, change your Audio setting to Stereo or Mono.

Using the Channel Setup Menu

To access the Channel Setup menu, refer to the following steps:

<p>To Display</p> 	→	<p>To Highlight </p> 	→	<p>To Select</p> 	
--	---	--	---	---	--

Favorite Channels

Quick access to favorite channels

Press ⇨ to open the Favorite Channels menu:

- 1 Use the ⇧ or ⇩ buttons to select the position (1-5) where you want to set a favorite channel, then press ⇨.
- 2 Using the ⇧ or ⇩ button, select the desired channel.
- 3 Press ⇨ to change to the channel selected.
- 4 Press ⇧ to return to the Channel Setup menu or press  to exit.

 To use Favorite Channels: Exit all menus and press ⇨. Press ⇧ or ⇩ to move the cursor to the desired channel number and press ⇨.

Cable

On: Select if you are receiving cable channels with a CATV cable.

Off: Select if you are using a TV antenna.

 After changing your cable settings, you will need to perform Auto Program. When Channel Fix is set, you will not be able to use your Cable settings.

Channel Fix

2-6: Select when you want to control all channel selection through a cable box or VCR. Select the appropriate channel (usually 3 or 4) and use the cable box's or VCR's remote control for channel selection.

Video 1: Select from available video inputs when you have connected video equipment (e.g. satellite receiver) and you want your TV fixed to it.

Off: Channel Fix is not set.

Auto Program

Press ⇨ to perform Auto Program.

The TV will scan through all available channels and program receivable channels.

Channel Skip/Add

Use this feature after you run Auto Program to skip unwanted channels or add new ones. Press to open the Channel Skip/Add menu:

- 1 Use the or buttons to select the position of the desired channel, then press .
- 2 Use the or buttons to select Skip or Add, then press .
- 3 Press to return to the Channel Setup menu or press to exit.

Pressing CH+ or CH- will skip over channels that have been skipped. You can still use the buttons to directly tune to skipped channels.

Channel Label

Label up to 40 channels with their call letters

Press to open the Channel Label menu:

- 1 Press , then press or until you reach the desired channel number. Press to activate the channel.
- 2 Press , then use the or button to display the first call letter or number of the caption, then press to select it. When finished, press to activate.

Favorite Channels, Cable, Channel Skip/Add, and Channel Label cannot be used when Channel Fix is set.

Parental Control

The Parental Control feature is designed to help parents monitor what their children watch on television. This section shows you the different rating systems available and how to set your TV's rating limit.

Overview of the Ratings

Once you have become familiar with these rating systems, you should be ready to set your TV's rating limit.

Movie Rating

(U.S. models only)

This system defines the rating levels of movies shown in theaters and on prime cable channels.

Rating	Defined as
G	General audience
PG	Parental Guidance suggested
PG-13	Parents strongly cautioned
R	Restricted
NC-17	No one 17 and under admitted
X	Adult audience only

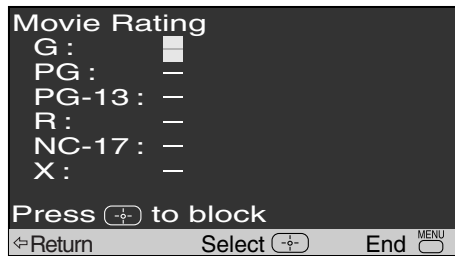

TV Rating

(U.S. models only)

The TV rating is divided into two groups: age-based and content-based.

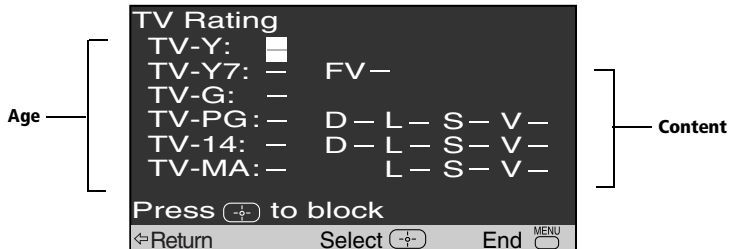

Age	Defined as
TV-Y	All children
TV-Y7	Directed to older children
TV-G	General audience
TV-PG	Parental Guidance suggested
TV-14	Parents strongly cautioned
TV-MA	Mature Audience only

Content	Defined as
FV	Fantasy Violence
D	Suggestive dialogue
L	Strong language
S	Sexual situations
V	Violence

The content ratings will increase depending on the level of the age-based rating. For example, a program with a TV-PG V (Violence) rating may contain moderate violence, while a TV-14 V (Violence) rating may contain intense violence.

Unrated

(U.S. models only)

You have the option of blocking TV programs or movies that are not rated.

Allow	Allows all unrated programs
Block	Blocks all unrated programs



If you choose to block unrated TV programs, please be aware that the following programs may be blocked: emergency broadcasts, political programs, sports, news, public service announcements, religious programs, and weather.

English Rating

(Canadian models only)

These ratings are for Canadian programs that are broadcast in English.

Rating	Defined as
C	Children
C8+	Children 8 years and older
G	General programming
PG	Parental Guidance
14+	Viewers 14 and older
18+	Adult programming

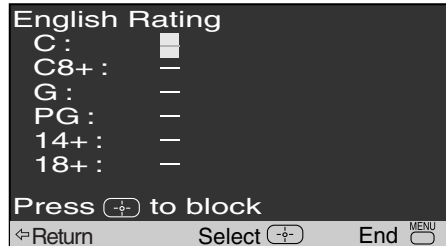

French Rating

(Canadian models only)

These ratings are for Canadian programs that are broadcast in French.

Rating	Defined as
G	General
8 ans+ :	Not recommended for younger children
13 ans+ :	Not recommended for children under age 13
16 ans+ :	Not recommended for ages under 16
18 ans+ :	This program is restricted to adults

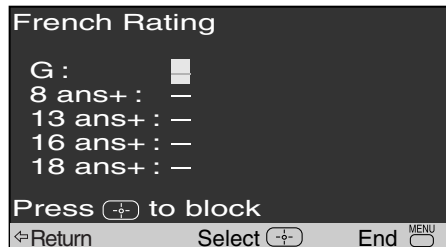





U.S.A. Rating

(Canadian models only)



For programs from the United States, please see “TV Rating” on page 23.

Using the Parental Control Menu

To access the Parental Control menu, refer to the following steps:

To Display	To Highlight 	To Select	
			

In the Parental Control  menu, you will be asked to set a 4-digit password for any further access into Parental Control.

- 1** Press , then use the  buttons to enter a 4-digit password.

 Keep this manual in a safe place. If you forget your password, see page 32.

- 2** Confirm your password by entering it again.

Once your password is set correctly, the next Parental Control menu appears. For future access to this menu, use your password. A password is needed every time you want to access Parental Control menu.

Setting the Rating

You can change the Rating by selecting one of the Lock options.



- 1 With Lock highlighted, press **+**.

If you are not familiar with the Parental Guidelines rating system, use one of the following preselected categories to simplify the rating selections: Child, Youth, Young Adult.

- 2 Use the **↑** or **↓** buttons to select the desired rating, then press **+**.

Rating	TV will allow a maximum rating of
Child	TV-Y, TV-G, G (U.S. models only), G (Canadian models only)
Youth	TV-PG, PG (U.S. models only), PG (Canadian models only)
Young Adult	TV-14, PG-13 (U.S. models only), 14+ (Canadian models only)
Custom	Select to set more restrictive ratings (see next section)
Off	No rating limit

Changing your Password

- 1 Use the **↑** or **↓** button to move the cursor to Change Password and press **+**.
- 2 Follow steps 1 and 2 for “Using the Parental Control Menu” on page 25.

Information for Parents

To view a program that exceeds the TV rating

- Press **ENTER**, then use the **0-9** buttons to enter your password.

 Entering your password to view a blocked program will temporarily turn Lock to Off. To reactivate your Lock settings, turn the TV off. When you turn the TV on, your Lock settings are restored.

Using the Custom Menu

Before setting Custom ratings, see pages 22-24, "Overview of the Ratings," for a description of the available rating systems.





Follow the instructions on the screen to make your custom settings. Select the country desired for your TV's rating limit. See page 23 for U.S. models and page 24 for Canadian models for more information.



Once you have blocked a rating or content, all higher ratings or content will be automatically blocked.

Using the Timer 🕒 Menu

To access the Timer menu, refer to the following steps:

<p>To Display</p> 	<p>To Highlight 🕒</p> 	<p>To Select</p> 	
--	--	---	--

- Current Time** Set your TV to the current day and time.
 Press ⇨ to open Current Time menu:
- 1 Use the ⬆ or ⬇ button to enter the day and time, then press ⇨.
 - 2 Press 🕒 to exit the menu.

 You must set the Current Time before you can use Timer 1 and Timer 2.

- Timer 1 and Timer 2** Use your timers settings to program your TV by day, time, duration and channel. The timer's duration is maximum of 6 hours. When the channel is fixed, it is not necessary to set the channel.
Scheduled viewing
- With the menu open, set cursor on Timer 1 or Timer 2:
- 1 Press ⬆ or ⬇ to select Timer 1 or Timer 2, then press ⇨.
 - 2 Press ⬆ or ⬇ to enter the desired day, time, duration and channel, then press ⇨. The Timer status should be On when the Timer has been set.
 - 3 Press 🕒 to exit the menu.

 You can set the Timer to On, Off, or Set. Once the timer is set, you can turn it On or Off without having to go through the settings. When you set Timer 1 or Timer 2, a red light on the front panel of your TV will turn on.

 When you perform Auto Program, Timer 1 and Timer 2 settings will be cleared. Also, in the event of any loss of power, Current Time and Timer 1 and Timer 2 settings will be cleared.

Using the Setup Menu

To access the Setup menu, refer to the following steps:

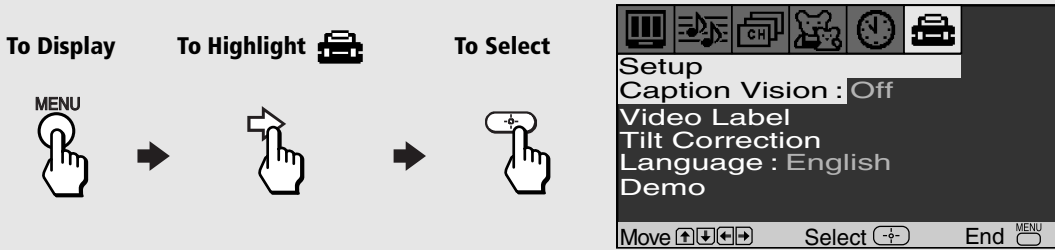

Caption Vision <i>Closed-Captioning</i>	<p>Allows you to select from three closed caption modes (for programs that are broadcast with closed caption).</p> <p>Press \uparrow or \downarrow to select one of the following options:</p> <p>CC1, 2, 3, 4: Displays printed dialogue and sound effects of a program.</p> <p>Text1, 2, 3, 4: Displays network/station information.</p> <p>XDS (Extended Data Services): Displays the name of the current program and its remaining time, if available.</p> <p>Off: Caption Vision is not activated.</p>
Video Label <i>Label connected equipment</i>	<p>Allows you to label the audio/video components you connected to the TV: VCR, DVD, etc. When you press TV/VIDEO to switch inputs, the Video Label will display on-screen.</p> <p>Press \Rightarrow to open the Video Label menu:</p> <ol style="list-style-type: none"> 1 Press \uparrow or \downarrow to access the input you want to label and press \odot. 2 Press \uparrow or \downarrow to choose a label and press \odot.
Tilt Correction	<p>Press \Rightarrow to open Tilt Correction:</p> <p>Press \uparrow or \downarrow to correct any tilt of the picture from -5 to +5, then press \odot to activate and return to the Setup menu.</p>
Language	<p>Display all menus in the language of your choice.</p> <p>Use the \uparrow or \downarrow buttons to select desired language and press \odot.</p>
Demo	<p>Press \odot to run a demonstration of the on-screen menus.</p>

 You can press any key to exit the Demo mode.

Other Information

Troubleshooting

If you are having a problem with your TV, try the suggestions below. If the problem persists, contact your nearest Sony Dealer.

No picture, no sound	<ul style="list-style-type: none"><input type="checkbox"/> Make sure the power cord is plugged in.<input type="checkbox"/> If a red light is flashing on the front of your TV for more than a few minutes, disconnect and reconnect the power cord to restore the TV. If the problem continues, call your local service center.<input type="checkbox"/> Check the TV/VIDEO settings: when watching TV, set to TV; when watching video equipment, set to VIDEO (page 13).<input type="checkbox"/> Make sure the batteries have been inserted correctly into the remote control (page 2).<input type="checkbox"/> Try another channel; it could be station trouble.
Poor or no picture, good sound	<ul style="list-style-type: none"><input type="checkbox"/> Adjust Picture in the Picture Controls menu under Video (page 18).<input type="checkbox"/> Adjust Brightness in the Picture Controls menu under Video (page 18).<input type="checkbox"/> Check the antenna and/or cable connections (page 4).
Good picture, no sound	<ul style="list-style-type: none"><input type="checkbox"/> Press  so that MUTING disappears from the screen (page 13).<input type="checkbox"/> Check your Audio settings. Your TV may be set to Auto SAP (page 19).
No color	<ul style="list-style-type: none"><input type="checkbox"/> Adjust Color in the Picture Controls menu under Video (page 18).
Only snow appears on the screen	<ul style="list-style-type: none"><input type="checkbox"/> Check the Cable setting in the Channel Setup menu (page 20).<input type="checkbox"/> Check the antenna and/or cable connections (page 4).<input type="checkbox"/> Make sure the channel selected is currently broadcasting.
Dotted lines or stripes	<ul style="list-style-type: none"><input type="checkbox"/> Adjust the antenna.<input type="checkbox"/> Move the TV away from other electronic equipment. Some electronic equipment can create electrical noise, which can interfere with TV reception.
Double images or ghosts	<ul style="list-style-type: none"><input type="checkbox"/> Check your outdoor antenna or call your cable service.

Operating Instructions

Cannot receive higher number channels (UHF) when using an antenna	<ul style="list-style-type: none"><input type="checkbox"/> Make sure Cable is set to Off in the Channel Setup menu (page 20).<input type="checkbox"/> Perform Auto Program to add channels that are not presently in the memory (page 14).
Cable stations don't seem to work	<ul style="list-style-type: none"><input type="checkbox"/> Make sure Cable is set to On in the Channel Setup menu (page 20).<input type="checkbox"/> Perform Auto Program to add channels that are not presently in the memory (page 14).
Remote control does not operate	<ul style="list-style-type: none"><input type="checkbox"/> Batteries could be weak. Replace them (page 2).<input type="checkbox"/> Move the TV 3-4 or more feet away from fluorescent lights.
The TV needs to be cleaned	<ul style="list-style-type: none"><input type="checkbox"/> Clean the TV with a soft dry cloth. Never use strong solvents such as thinner or benzine, which might damage the finish of the cabinet.
Lost password for Parental Control	<ul style="list-style-type: none"><input type="checkbox"/> In the password screen, enter the following master password: 4357. After using the master password, you must create a new password, it cannot be used to unlock currently blocked channels.
You lost your remote control	<ul style="list-style-type: none"><input type="checkbox"/> You can use the front Audio/Video panel controls to access the menu (page 2). Contact your nearest Sony Dealer to order a replacement.

If, after reading these Operating Instructions, you have additional questions related to the use of your Sony television, please call our Direct Response Center at 1-800-222-SONY (7669) (U.S. residents only) or (416) 499-SONY (7669) (Canadian residents only).

Specifications

For all models (except as noted)

Television system	American TV standard/NTSC
Channel coverage	VHF: 2-13/UHF: 14-69/CATV: 1-125
Antenna	75-ohm external antenna terminal for VHF/UHF
Picture tube	FD Trinitron® tube
Power requirements	120V, 60 Hz
Supplied Accessories	Size AA (R6) batteries (2) Remote Control RM-Y173 (1)
Optional Accessories	Connecting cables VMC-810S/820S, VMC-720M, YC-YC-15V/30V, RK74A EAC-66 U/V mixer

KV-13FS100, KV-13FS110

Screen size	Visible screen size: 13 inches (330 mm) measured diagonally Actual screen size: 14 inches (355.6 mm) measured diagonally
Inputs/outputs	2 video, 2 audio 1 Y, P _B , P _R , 1 audio 1 headphone jack
Speaker output	3 W x 2
Power Consumption	100 W in use 1 W in standby
Dimensions (W/H/D)	407 x 340 x 411 mm (16x 13 ³ / ₈ x 16 ¹ / ₈ in.)
Mass	12 kg (26 lbs. 7 oz.)

KV-20FS100

Screen size	Visible screen size: 20 inches (508 mm) measured diagonally Actual screen size: 21 inches (533.4 mm) measured diagonally
Inputs/outputs	2 video, 2 audio 1 Y, P _B , P _R , 1 audio 1 headphone jack
Speaker output	5 W x 2
Power Consumption	120 W in use 1 W in standby
Dimensions (W/H/D)	592 x 466 x 494 mm (23 ¹ / ₄ x 18 ³ / ₈ x 19 ¹ / ₂ in.)
Mass	24.8 kg (54 lbs. 10 oz.)

Operating Instructions

KV-24FS100

Screen size	Visible screen size: 24 inches (610 mm) measured diagonally Actual screen size: 25 inches (635 mm) measured diagonally
-------------	---

Inputs/outputs	2 video, 2 audio 1 S VIDEO 1 Y, P _B , P _R , 1 audio 1 headphone jack
----------------	---

Speaker output	7.5 W x 2
----------------	-----------

Power Consumption	145 W in use 1 W in standby
-------------------	--------------------------------

Dimensions (W/H/D)	704 x 524 x 472 mm (27 ³ / ₄ x 20 ⁵ / ₈ x 18 ¹ / ₂ in.)
--------------------	---

Mass	35 kg (77 lbs. 1oz.)
------	----------------------

Design and specifications are subject to change without notice.

Index

A

- Audio  Menu 19
- Auto Program 14, 20
- Auto SAP 19

B

- Battery Installation 2
- Brightness 18

C

- Cable 20
- Caption Vision 29
- Channel Fix 20
- Channel Label 21
- Channel Setup  Menu 20
- Channel Skip/Add 21
- Color 18
- Connections
 - Cable and Antenna 4
 - Connecting a Camcorder 11
 - Connecting a DVD Player 10
 - Connecting Headphones 11
 - TV and Cable Box 6
 - TV and VCR 5
 - TV and Satellite Receiver 8
 - TV, Satellite Receiver, and VCR 9
 - TV, VCR, and Cable Box 7
- Current Time 28

D

- Demo 29
- DISPLAY 13

F

- Favorite Channels 20
- Front A/V Panel (*see TV Front Panel*) 2





H

- Hue 18

L

- Language 29

M

- Menus
 - Audio  19
 - Channel Setup  20
 - Parental Control  25
 - Setup  29
 - Timer  28

- Video  18

- Mono 19

MTS

- Auto SAP 19
- Mono 19
- Stereo 19

P

- Parental Control 22
- Parental Control  menu 25
- Picture 18
- Picture Controls 18
 - Brightness 18
 - Color 18
 - Hue 18
 - Picture 18
 - Sharpness 18

R

- Ratings
 - English Rating 24
 - French Rating 24
 - Movie Rating 22
 - TV Rating 23
 - Unrated 23
 - U.S.A. Rating 24
- Remote Control 12

S

- Setup  menu 29
- Sharpness 18
- SLEEP 13
- Specifications 33
- Stereo 19

T

- Tilt Correction 29
- Timer  Menu 28
- Timer 1 and Timer 2 28
- Troubleshooting 31
- TV Features 1
- TV Front Panel 2
- TV Rear Panel 3

V

- Video  Menu 18
- Video Label 29
- VM 18



FD Trinitron
WEGA[®]

Manual de Instrucciones

KV-21FS100
KV-25FS100

Lea este manual antes de operar el producto.

ADVERTENCIA

Para disminuir el riesgo de incendio o descarga eléctrica, no exponga el televisor a lluvia o humedad.



Este símbolo tiene por objeto advertir al usuario de la presencia de “voltaje peligroso” desprovisto de aislamiento en el interior del producto que puede ser de suficiente magnitud como para presentar un riesgo de descarga eléctrica para las personas.



Este símbolo tiene por objeto advertir al usuario de la presencia de instrucciones importantes de uso y mantenimiento (servicio) en la documentación que acompaña a este aparato.

Nota para el instalador de CATV

Esta nota pretende llamar la atención del instalador del sistema CATV en relación con el artículo 820-40 de la NEC que proporciona las pautas para una adecuada conexión a tierra y, en particular, especifica que el cable de conexión a tierra debe estar conectado al sistema de toma de tierra del edificio lo más cerca posible de la entrada del cable.

PRECAUCIONES DE SEGURIDAD

- ❑ Utilice el televisor con ca (corriente alterna) como se indica a continuación:
ca 120 V 60 Hz
ca 220 V 50/60 Hz (Chile, Perú, Bolivia)
ca 120 - 220 V 50/60 Hz (Argentina)
- ❑ Una terminal del enchufe es más ancha que la otra para garantizar la seguridad y solo se podrá introducir en la toma de corriente de una manera (sólo los modelos con ca 120 V). Si no puede insertar completamente el enchufe en la toma, póngase en contacto con su proveedor.
- ❑ Si se introduce algún objeto sólido o líquido en el televisor, desconéctelo y haga que sea revisado por personal especializado antes de volver a utilizarlo.

PRECAUCIÓN

Si utiliza juegos de televisión, ordenadores y productos similares con el televisor, mantenga las funciones de brillo y contraste a una configuración baja. Si una imagen fija (sin movimiento) permanece en pantalla durante un tiempo prolongado con una configuración alta del brillo y el contraste, dicha imagen podría permanecer indefinidamente en la pantalla. Si mira continuamente el mismo canal, los logotipos del mismo podrían quedar impresos en la pantalla del televisor. La garantía no cubre este tipo de marcas porque son el resultado de un uso inadecuado.



Para reducir el riesgo de descarga eléctrica, no utilice el enchufe polarizado con un cable de extensión, un receptáculo ni otras tomas, a menos que las terminales estén bien insertadas y no queden expuestas.

 Se advierte que cualquier cambio o modificación que no se apruebe de modo explícito en este manual podría anular su autorización para utilizar este equipo.

NOTIFICACIÓN

Este equipo se ha probado y cumple con las restricciones de los aparatos digitales de clase B de acuerdo con la sección 15 del reglamento de FCC. Estas restricciones se han diseñado para proporcionar protección contra interferencias nocivas en instalaciones domésticas. Este equipo genera, utiliza y puede irradiar energía de radio frecuencia y si no se instala y utiliza siguiendo las instrucciones, puede provocar interferencias en las radiocomunicaciones. Sin embargo, no se garantiza que no se produzcan interferencias en una instalación determinada. Si el equipo produce interferencias en la recepción de radio y televisión que se pueden determinar conectando y desconectando el equipo, el usuario debería intentar corregir la interferencia siguiendo una o varias de las siguientes medidas:

- Reorientar o cambiar de lugar las antenas receptoras.
- Aumentar la separación entre el equipo y el receptor.
- Conectar el equipo a una toma o a un circuito distinto al que está conectado el receptor.
- Ponerse en contacto con el proveedor o con un técnico con experiencia en radio y televisión para obtener asistencia.

Protección del televisor

- Para evitar el sobrecalentamiento interno, no obstruya los orificios de ventilación.
- No instale el televisor en un lugar con temperatura elevada, humedad, exceso de polvo o donde puedan producirse vibraciones.

Nota sobre Caption Vision

Este receptor de televisión proporciona pantalla de televisión con visualización de subtítulos de acuerdo con el punto § 15.119 del reglamento de la FCC.

El uso del televisor con finalidades distintas a la visualización privada de emisiones de programas en UHF o VHF o transmisiones vía cable dirigidas al público en general puede requerir la autorización de la compañía de emisión por cable y/o del propietario del programa.

Información para el propietario

Los números de serie y modelo están situados en la portada de este manual y en la parte posterior del televisor.

Marcas comerciales y derechos de autor

ENERGY STAR® es una marca registrada.



En calidad de compañía asociada a ENERGY STAR®, Sony ha determinado que este producto o modelo de producto cumple con las directrices de uso eficiente de energía de ENERGY STAR®.

Normas importantes sobre seguridad

Para su protección lea completamente las instrucciones y conserve este manual para consultarlo en el futuro. Tenga en cuenta y siga todas las advertencias, precauciones e instrucciones que aparecen en pantalla o que se describen en el manual de instrucciones o de asistencia técnica.

ADVERTENCIA

Para prevenir daños personales, se aconseja seguir las siguientes precauciones básicas de seguridad durante la instalación, el uso y la reparación del aparato.

Uso

Fuentes de alimentación

Este aparato sólo debe utilizarse con la fuente de alimentación que se indica en la placa del número de serie/ modelo. Si no está seguro del tipo de alimentación eléctrica que se utiliza en su domicilio, consulte con su proveedor o con la compañía eléctrica local. Para los aparatos alimentados mediante una batería, consulte el manual de instrucciones.

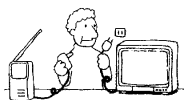

Conexión a tierra o polarización

Este aparato está equipado con un enchufe de cable de alimentación de ca polarizado (con una terminal más ancha que la otra) o con un enchufe de tres cables de conexión a tierra (con una tercera terminal para la conexión a tierra).

Consulte las siguientes instrucciones .

Para los equipos con un enchufe de cable de alimentación de ca polarizado

El enchufe se introduce en la toma de corriente en una única dirección. Se trata de una característica de seguridad. Si no puede insertar completamente el enchufe en la toma, intente girar el enchufe. Si sigue teniendo problemas para insertar el enchufe, póngase en contacto con su electricista para que le instale una toma adecuada. No ponga a prueba la finalidad de seguridad del enchufe polarizado forzándolo.



Advertencia alternativa

Para los equipos con un enchufe de ca con tres cables de conexión de tierra

Este enchufe únicamente se acoplará a una toma de corriente de conexión a tierra. Se trata de una característica de seguridad. Si no puede insertar el enchufe en la toma, póngase en contacto con su electricista para que le instale una toma adecuada. No ponga a prueba la seguridad del enchufe de conexión a tierra.

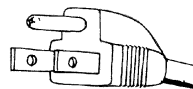

Sobrecarga

No sobrecargue las tomas de pared, los cables de extensión ni los receptáculos más allá de su capacidad, puesto que podría producirse un incendio o una descarga eléctrica. Apague siempre el televisor cuando no lo utilice. Si no va a utilizar el aparato durante un tiempo prolongado, desconéctelo de la toma de pared como precaución ante la posibilidad de que se produzca un mal funcionamiento interno que pueda provocar un incendio.

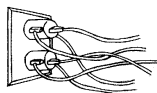

No desconecte la antena ni el cable de alimentación en caso de tormenta. Los relámpagos podrían descargar mientras sujeta el cable y provocarle lesiones graves. Apague el televisor y espere que el tiempo mejore.

Introducción de objetos y líquidos

No introduzca nunca objetos extraños en el aparato a través de las ranuras de la unidad, puesto que podrían entrar en contacto con puntos de voltaje peligrosos o provocar cortocircuitos de piezas y originar un incendio o descarga eléctrica. Nunca vierta líquidos de ningún tipo en el aparato.



Accesorios

No utilice accesorios no recomendados por el fabricante ya que podrían ser peligrosos.

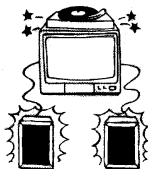

No coloque ningún tipo de objetos, especialmente objetos pesados, encima del aparato. Podrían caerse del aparato y causar lesiones.

Limpieza

Desconecte el aparato de la toma de pared antes de limpiarlo. No utilice detergentes líquidos ni aerosoles. Utilice un paño ligeramente humedecido con agua para limpiar el exterior del aparato.



Si se produce un ruido continuo o intermitente en el interior del aparato de televisión mientras está en funcionamiento, desconecte el televisor y póngase en contacto con el proveedor o con el servicio de asistencia técnica. Es normal que algunos aparatos de televisión produzcan ocasionalmente este tipo de ruidos, especialmente cuando se conectan y desconectan.

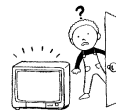

Instalación

Para levantar o mover el aparato siempre se deberá hacer entre dos o más personas. El aparato es pesado y la superficie inferior es plana. Si intenta mover el aparato sin ayuda o lo manipula de forma insegura, puede producirse lesiones graves. Instale el aparato sobre una superficie plana y estable.

Agua y humedad

No utilice aparatos de conexión eléctrica cerca de agua, por ejemplo: cerca de la bañera, el lavabo, el fregadero, el lavadero, en un sótano con humedad o cerca de una piscina, etc.

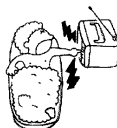

Colocación

No sitúe el aparato sobre un carro, una mesa pequeña, un tripie, un soporte, una mesa o una estantería inestables. El aparato podría caer y dañarse o bien provocar lesiones graves a niños o adultos. Utilice únicamente carros o mesas recomendados por el fabricante para el modelo específico de televisor. Para el montaje del producto deberán seguirse las instrucciones del fabricante y utilizar los accesorios de montaje recomendados por el mismo. Si se desea mover un aparato colocado encima de un carro, deberá hacerse con cuidado. Las paradas bruscas, la fuerza excesiva y las superficies inestables pueden causar que el aparato y el carro volqueen.

Desconecte todos los cables del aparato antes de intentar moverlo.



No permita que niños o animales se suban encima del aparato o lo empujen. El aparato podría caerse y causar lesiones graves.

Ventilación

Las ranuras y aperturas en la unidad y en la parte posterior o inferior son para obtener la ventilación necesaria. Para garantizar el buen funcionamiento del aparato y protegerlo de un sobrecalentamiento, estas ranuras y aperturas nunca se deberán obstruir ni cubrir.

- No cubra nunca las ranuras y aperturas con un paño ni otros tejidos.



- No bloquee nunca las ranuras y aperturas situando el aparato encima de una cama, un sofá, una alfombra o superficies similares.

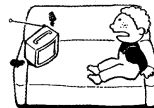

- No sitúe nunca el aparato en un espacio cerrado, como una biblioteca o un armario empotrado, a menos que exista la ventilación adecuada.



- No sitúe el aparato cerca o encima de un radiador o fuente de calor ni lo exponga a luz solar directa.



Protección del cable

No coloque ningún objeto encima del cable de alimentación ni alrededor del mismo, ni sitúe el aparato en un lugar donde el cable de alimentación pueda estar sometido a desgastes o usos no adecuados.



Conexión a tierra o polarización

Este aparato puede estar equipado con un enchufe de línea de corriente alterna polarizado (con una terminal más ancha que la otra). El enchufe sólo se puede introducir en la toma de corriente en una dirección. Se trata de una característica de seguridad. Si no puede insertar completamente el enchufe en la toma, intente girarlo. Si sigue teniendo problemas para introducir el enchufe, póngase en contacto con su electricista para que sustituya la toma obsoleta. No ponga a prueba la seguridad del enchufe polarizado.

Antenas

Conexión a tierra de una antena exterior

Para instalar una antena exterior, siga los procedimientos que se indican a continuación. Los sistemas de antenas exteriores no deben situarse cerca de líneas eléctricas o circuitos de alimentación o luz eléctrica, o bien donde pueda entrar en contacto con dichas líneas eléctricas o circuitos.

CUANDO INSTALE UN SISTEMA DE ANTENA EXTERIOR, EXTREME LAS PRECAUCIONES Y MANTÉNGALO ALEJADO DE DICHAS LINEAS ELECTRICAS O CIRCUITOS, DADO QUE EL CONTACTO PUEDE RESULTAR FATAL.

Asegúrese de que el sistema de antena tiene conexión a tierra para proporcionar protección contra los incrementos de voltaje y el aumento de las cargas estáticas. El apartado 810 del Código Eléctrico Nacional (NEC) en EE.UU. y el apartado 54 del Código eléctrico de Canadá proporcionan información relativa a la conexión a tierra adecuada del mástil y de la estructura de soporte, la conexión a tierra del cable de conexión a la unidad de descarga de la antena, el tamaño de los conductores de la conexión a tierra, la ubicación de la unidad de descarga de la antena, la conexión de los electrodos de conexión a tierra y los requisitos de los electrodos de conexión a tierra.

Conexión a tierra de la antena de acuerdo con la NEC

Conexión a tierra de la antena de acuerdo con el Código Eléctrico Nacional, ANSI/NFPA 70.

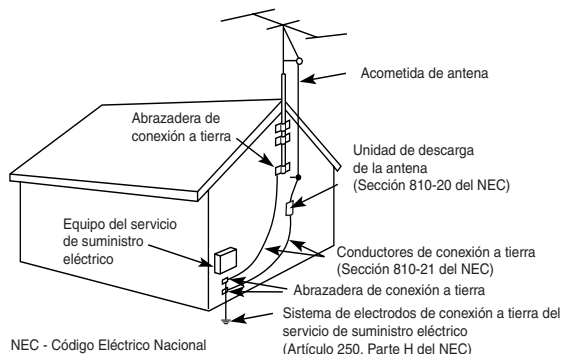

Rayos

Para mayor protección del receptor de televisión durante una tormenta con rayos o cuando no se utiliza durante largos periodos de tiempo, desconéctelo de la toma de pared y desconecte la antena. Con ello evitará que los rayos y los incrementos de voltaje dañen el receptor.

Reparación

Daños que requieren reparación

Desconecte el aparato de la toma de pared y haga que sea revisado por personal calificado cuando se produzcan las siguientes condiciones:

- Si el cable de alimentación o el enchufe están dañados o deshilachados.

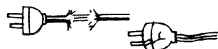

- Si se ha vertido líquido en el interior del aparato o si se han caído objetos en el interior del producto.



- Si el aparato se ha expuesto a lluvia o agua.



- Si el aparato se ha caído y ha sufrido golpes excesivos o si se ha dañado la unidad.

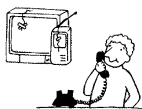

- Si el aparato no funciona con normalidad al seguir las instrucciones del manual. Ajuste solamente los controles que se especifican en el manual de instrucciones. El ajuste inadecuado de otros controles puede provocar daños y a menudo requerirá mucho trabajo por parte de un técnico calificado para restablecer el funcionamiento normal del aparato.



- Si el aparato muestra un cambio de rendimiento significativo, debe repararse.

Asistencia técnica

No intente reparar usted mismo el aparato, puesto que si abre la unidad puede exponerse a voltajes peligrosos u otros peligros. Ponga cualquier tipo de reparación en manos de personal de asistencia técnica calificado.



Piezas de reemplazo

Si necesita piezas de reemplazo, asegúrese de que el técnico certifique por escrito que ha utilizado piezas de reemplazo especificadas por el fabricante con las mismas características que las piezas originales. El uso de piezas no autorizadas puede provocar incendios, descargas eléctricas y otros peligros.



Comprobación de seguridad

Después de realizar cualquier reparación del aparato, solicite al técnico de la reparación que realice comprobaciones rutinarias de seguridad (como especifica el fabricante) para determinar si el aparato se encuentra en condiciones seguras de funcionamiento y certificarlo. Cuando el aparato llega al final de su vida útil, debe desecharse adecuadamente para evitar una implosión del tubo de la imagen. Consulte a un técnico de reparación calificado para depositar el aparato.



Contenido

Introducción

Características del televisor FD Trinitron WEGA®	1
Baterías para el control remoto	2
Acerca de este manual.....	2
Uso del interruptor MAIN POWER (alimentación principal) del televisor (solamente los modelos KV-21FS100 y KV-25FS100 con destino a Argentina) 2	
Controles del menú del panel frontal	2







Conexión del televisor

Panel posterior del televisor	3
Conexiones básicas	4
Conexión de equipo adicional.....	5

Uso del control remoto y funciones básicas

Uso del control remoto.....	14
Programación automática del televisor	15
Acceso rápido a los menús	16

Uso de los menús

Para acceder a un menú.....	19
Uso del menú de Video 	20
Uso del menú Audio 	21
Uso del menú Ajuste de Canal 	22
Uso del menú Bloqueo de Canal 	24
Uso del menú Timer (Reloj) 	25
Uso del menú Ajustes 	26

Información adicional

Solución de problemas	27
Especificaciones.....	29

Índice alfabético.....	31
------------------------	----

Introducción

Gracias por la compra del televisor FD Trinitron WEGA® a color de Sony. Antes de utilizar este manual, verifique el número de modelo situado en la parte posterior del televisor o en la portada de este manual.

Características del televisor FD Trinitron WEGA®

Algunas de las características de las cuales disfrutará incluyen:

- ❑ **FD Trinitron CRT PLANO** — Nueva pantalla tecnológicamente avanzada para una calidad de imagen óptima.
- ❑ **Entradas Y, P_B, P_R** — Conexión de entrada de video para una calidad de imagen superior.
- ❑ **Bloqueo de canales** — Herramienta que permite a los padres bloquear los canales del televisor para controlar los programas que ven sus hijos.
- ❑ **Canales favoritos** — Acceso instantáneo a los canales favoritos con sólo oprimir un botón.
- ❑ **Energy Star®** — Símbolo reconocido de eficacia energética.
- ❑ **S VIDEO** — Entrada de video que ofrece calidad de imagen mejorada.
- ❑ **MTS Directo** — Permite el acceso directo para cambiar el sonido multicanal del televisor: Estéreo, Mono, o Auto SAP (Segundo Programa de Audio) con sólo oprimir un botón.
- ❑ **Realce de graves** — Nueva característica que proporciona tonos graves más profundos y de mejor calidad.
- ❑ **Menús trilingües** — Elección de menús en inglés, francés o español (KV-21FS100 y KV-25FS100 con destino a Argentina, no tienen menús en francés).
- ❑ **Controles del panel frontal** — Permiten el acceso a los menús de pantalla sin utilizar el control remoto.
- ❑ **Entradas de A/V frontales** — Conexión rápida para videojuegos, cámaras de video, equipos estéreo/mono o audífonos.
- ❑ **Silenciamiento automático** — Función diseñada para silenciar automáticamente el televisor cuando no se reciben señales.

Baterías para el control remoto

Inserte dos baterías de tipo AA (R6) (incluidas) en el control remoto utilizando como ejemplo la siguiente ilustración.

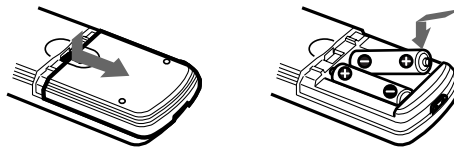

En condiciones de uso normales, las baterías tienen una duración máxima de seis meses. Si el control remoto no funciona correctamente, es posible que las baterías estén gastadas.

Si no va a utilizar el control remoto durante un largo tiempo, extraiga las baterías para evitar posibles daños por fugas de las mismas.

Acerca de este manual

Este manual proporciona instrucciones para ayudarle a disfrutar de su nuevo televisor. Muestra como conectarlo a la antena o cable, a la caja de cable, a la videograbadora, al DVD, al receptor de satélite o a la cámara de video. Una vez conectado, siga las instrucciones y utilice el control remoto para acceder a los menús de pantalla.







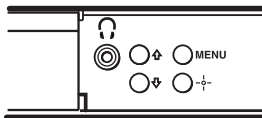

Los paneles frontales y posteriores del televisor que se ilustran en este manual corresponden a los modelos KV-25FS100. Es posible que los paneles frontales y posteriores del televisor no sean exactamente igual que los ilustrados.

Uso del interruptor MAIN POWER (alimentación principal) del televisor (solamente los modelos KV-21FS100 y KV-25FS100 con destino a Argentina)

Antes de encender el televisor utilizando el control remoto suministrado, oprima , situado en la parte frontal de televisor.

Controles del menú del panel frontal



Los controles del panel de audio/video frontal le permiten acceder al menú sin control remoto. Oprima  para que aparezca el menú de pantalla. Utilice los botones  y  del panel de audio/video frontal en lugar de los botones  y  del control remoto. Utilice el botón  del panel de audio/video frontal en lugar de los botones  y  del control remoto. Oprima de nuevo  cuando haya completado el ajuste o configuración.

Para navegar por los menús con el control remoto, consulte "Uso de los menús" en la página 19.

Conexión del televisor

Lea este capítulo antes de instalar el televisor por primera vez. Este capítulo hace referencia a las conexiones básicas, así como a cualquier otro equipo opcional que conecte.

Panel posterior del televisor

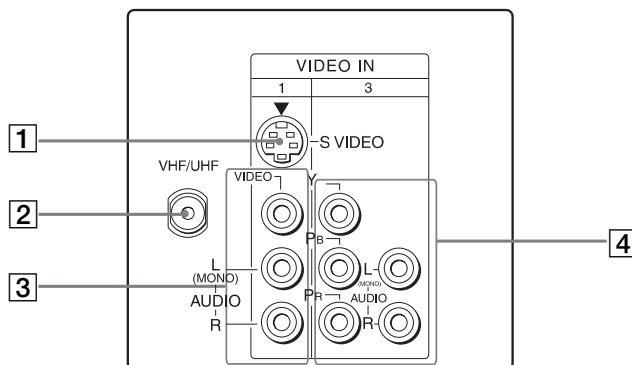

Toma	Descripción
1 S VIDEO	Establece una conexión con la toma S VIDEO OUT (salida de S video) de la videgrabadora o de otro equipo de video con S VIDEO. S VIDEO proporciona una mejor calidad de imagen que las tomas VHF/UHF o la toma de entrada de video. S VIDEO no proporciona sonido; los cables de audio deben estar conectados.
2 VHF/UHF	Establece una conexión con el cable o la antena de VHF/UHF.
3 VIDEO/AUDIO (L/R)	Establece una conexión con las tomas de salida de AUDIO y VIDEO de la videgrabadora o de otro equipo de video. En el panel frontal del televisor existe una segunda toma de entrada de video (VIDEO 2). Estas tomas de entrada de AUDIO/VIDEO proporcionan una mejor calidad de imagen que la toma VHF/UHF.
4 Y, P_B, P_R/L, R	Se conectan con las salidas de video (Y, P _B , P _R) y de audio (L/R) de su reproductor de videodiscos o de su caja digital.

Los paneles frontales y posteriores del televisor que se ilustran en este manual corresponden a los modelos KV-25FS100.

Conexiones básicas

Televisor con antena interior o exterior o cable CATV

Dependiendo del cable de que disponga, elija una de las siguientes conexiones:

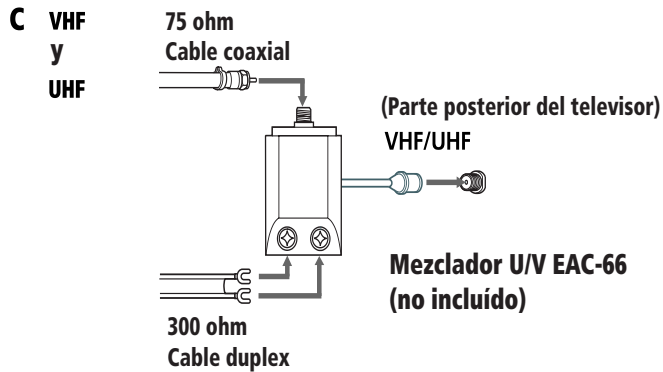
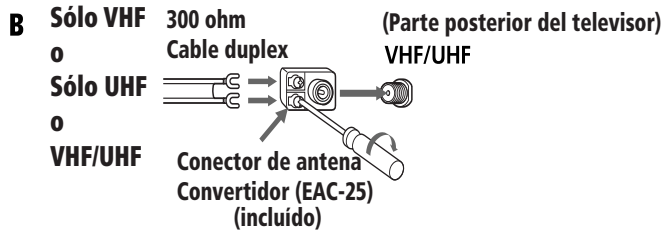
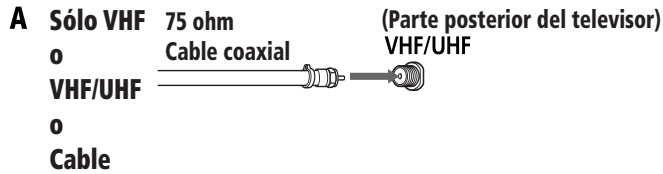

 Si conecta el televisor a una antena interior o exterior, es posible que deba ajustar la orientación de la antena para obtener una mejor recepción.

Conexión de equipo adicional

Televisor y videgrabadora

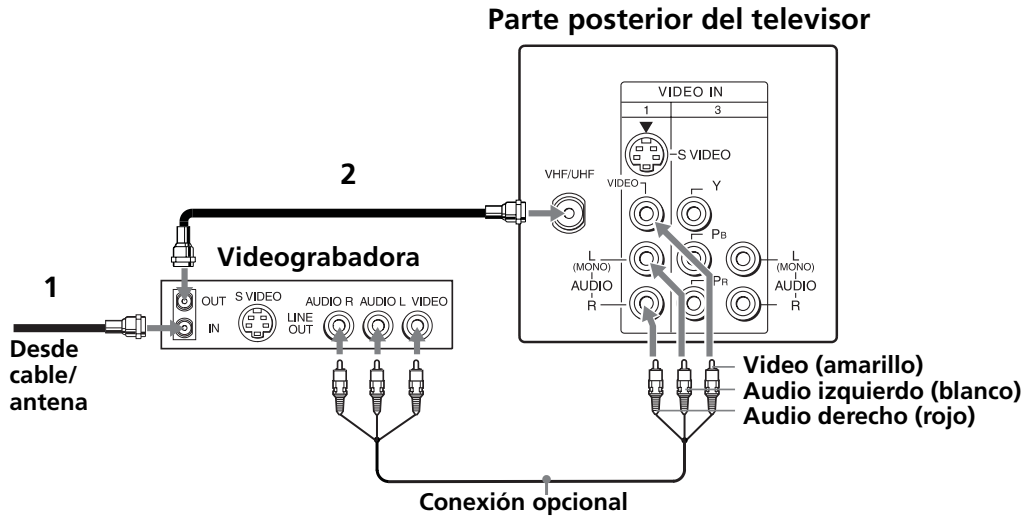

🔧 Para ver programas de video desde la videogradora, sintonice el televisor en los canales 3 ó 4 (como se indica en la parte posterior de la videogradora).

- 1** Conecte el cable coaxial de la antena del televisor o del servicio de cable a la toma IN de la videogradora.
- 2** Conecte el cable coaxial (no incluido) de la toma OUT de la videogradora a la toma VHF/UHF del televisor.

Conexión opcional

Si la videogradora dispone de salidas de video, podrá obtener una mejor calidad de imagen conectando los cables de Audio/Video (no incluidos) de las salidas AUDIO y VIDEO OUT de la videogradora a la entrada AUDIO/VIDEO IN del televisor.

🔧 Puede utilizar el botón  para cambiar entre las entradas VHF/UHF y VIDEO.

🔧 Para obtener una mejor calidad de imagen, utilice S VIDEO en lugar del cable amarillo de audio/video. S VIDEO no proporciona sonido; los cables de audio deben permanecer conectados para obtener sonido.

Televisor y caja de cable

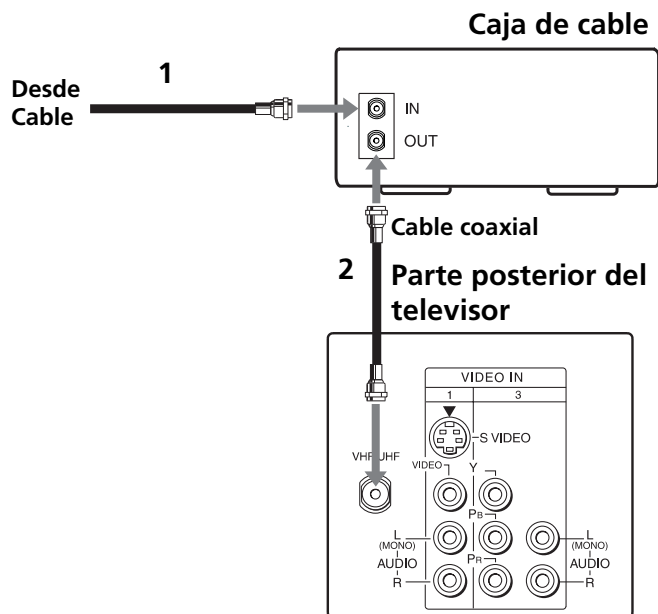

- 1** Conecte el cable coaxial del servicio de cable a la toma IN de la caja de cable.
- 2** Conecte un cable coaxial (no incluido) de la toma OUT de la caja de cable a la toma VHF/UHF del televisor.

Para ver los canales desde la caja de cable, sintonice el televisor en los canales 3 ó 4 (como se indica en el panel posterior de la caja de cable) y utilice el control remoto de la caja de cable para cambiar los canales.

Si desea controlar la selección de todos los canales a través de la caja de cable, es aconsejable utilizar la función Fijar Canal ajustando el televisor en el canal 3 ó 4 (consulte la página 22).

Televisor, videograbadora y caja de cable

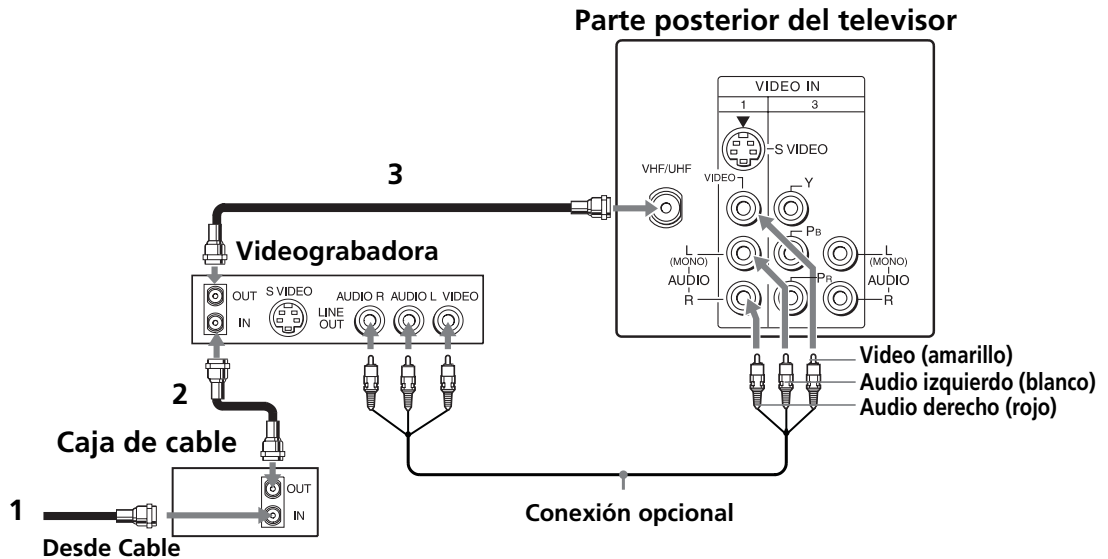

- 1** Conecte el cable coaxial del servicio de cable a la toma IN de la caja de cable.
- 2** Conecte un cable coaxial (no incluido) desde la toma OUT de la caja de cable a la toma IN de la videograbadora.
- 3** Conecte un cable coaxial (no incluido) desde la toma OUT de la videograbadora a la toma VHF/UHF del televisor.

Si desea controlar la selección de todos los canales a través de la caja de cable, es aconsejable utilizar la función Fijar Canal ajustando el televisor en el canal 3 ó 4 (consulte la página 22).

Conexión opcional

Si la videograbadora dispone de salidas de video, podrá obtener una mejor calidad de imagen conectando los cables de Audio/Video (no incluidos) desde la salida AUDIO y VIDEO OUT de la videograbadora a la toma de entrada AUDIO/VIDEO IN del televisor.

Puede utilizar el botón para cambiar las entradas VHF/UHF y VIDEO.

Para obtener una mejor calidad de imagen, utilice S VIDEO en lugar del cable amarillo de audio/video. S VIDEO no proporciona sonido; los cables de audio deben permanecer conectados para obtener sonido.

Televisor y receptor de satélite

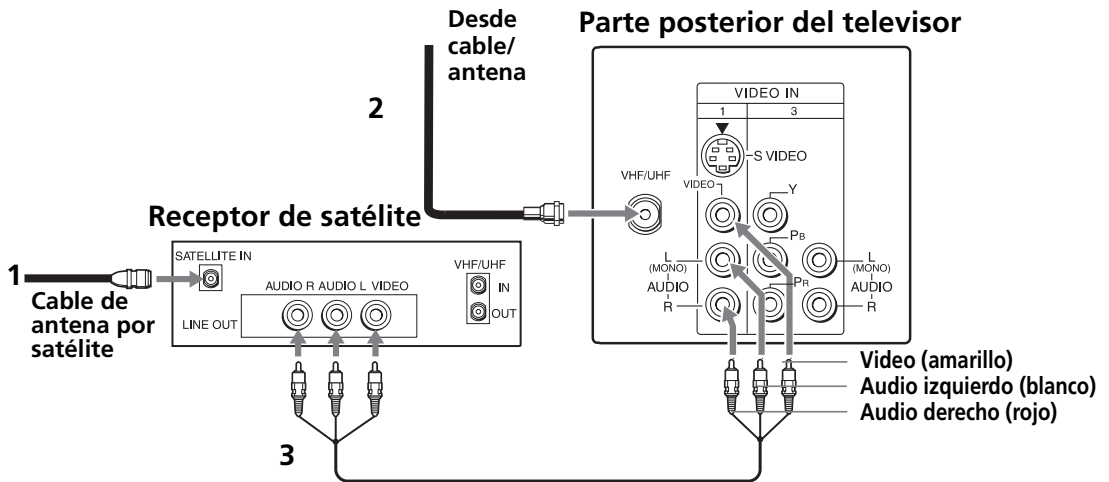

- 1 Conecte el cable de la antena por satélite a la entrada SATELLITE IN del receptor de satélite.
- 2 Conecte el cable coaxial del servicio de cable o antena a la toma VHF/UHF del televisor.
- 3 Utilizar cables de Audio/Video (no incluidos), conecte AUDIO y VIDEO OUT del receptor de satélite a AUDIO y VIDEO IN del televisor.

Puede utilizar el botón para cambiar las entradas VHF/UHF y VIDEO.

Para obtener una mejor calidad de imagen, utilice S VIDEO en lugar del cable amarillo de audio/video. S VIDEO no proporciona sonido; los cables de audio deben permanecer conectados para obtener sonido.

Televisor, receptor de satélite y videograbadora

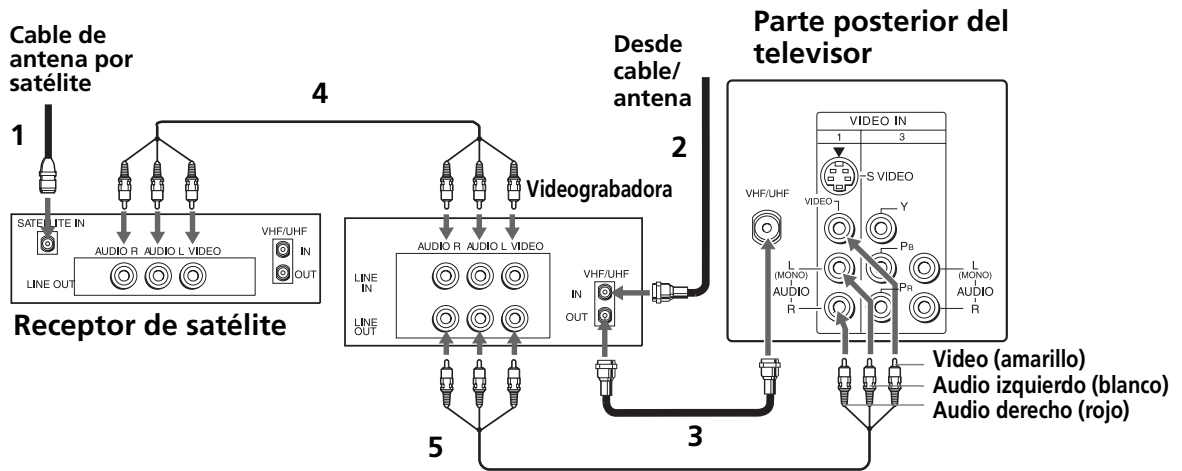

- 1** Conecte el cable de la antena por satélite a la entrada SATELLITE IN del receptor de satélite.
- 2** Conecte el cable coaxial del servicio de cable o antena a la toma IN de la videograbadora.
- 3** Conecte la toma OUT de la videograbadora a la toma VHF/UHF del televisor mediante un cable coaxial (no incluido).
- 4** Conecte las tomas AUDIO y VIDEO OUT del receptor de satélite a las tomas AUDIO y VIDEO IN de la videograbadora mediante los cables de Audio/Video (no incluidos).
- 5** Conecte las tomas AUDIO y VIDEO OUT de la videograbadora a las tomas AUDIO y VIDEO IN del televisor mediante los cables de Audio/Video (no incluidos).

Para visualizar las imágenes desde el receptor del satélite o la videograbadora, seleccione la entrada de video a la que está conectado el receptor de satélite o la videograbadora oprimiendo en el control remoto.

Conexión de un reproductor de DVD

Conecte las salidas AUDIO y VIDEO OUT del reproductor DVD a las entradas AUDIO y VIDEO IN del televisor mediante los cables de Audio/Video (no incluidos).

Parte posterior del televisor

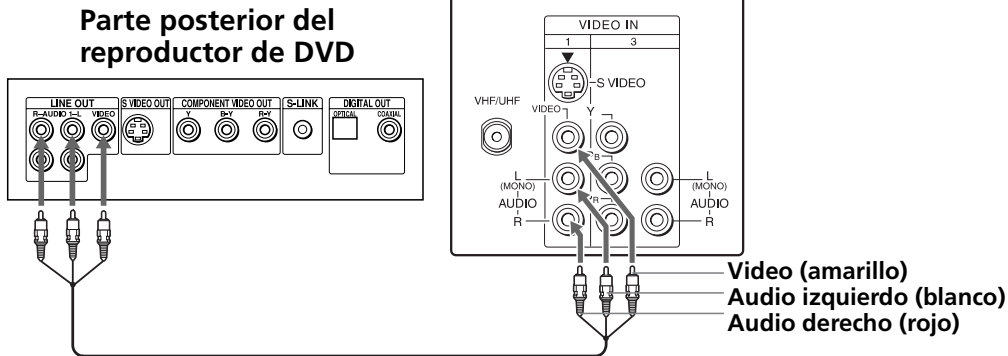

Para obtener una mejor calidad de imagen, utilice S VIDEO en lugar del cable amarillo de audio/video. S VIDEO no proporciona sonido; los cables de audio deben permanecer conectados para obtener sonido.

Conexión opcional

Si el reproductor de DVD dispone de salidas de video para componentes (Y, P_B, P_R), podrá optimizar la calidad de imagen utilizando cables de video para componentes.

Parte posterior del televisor

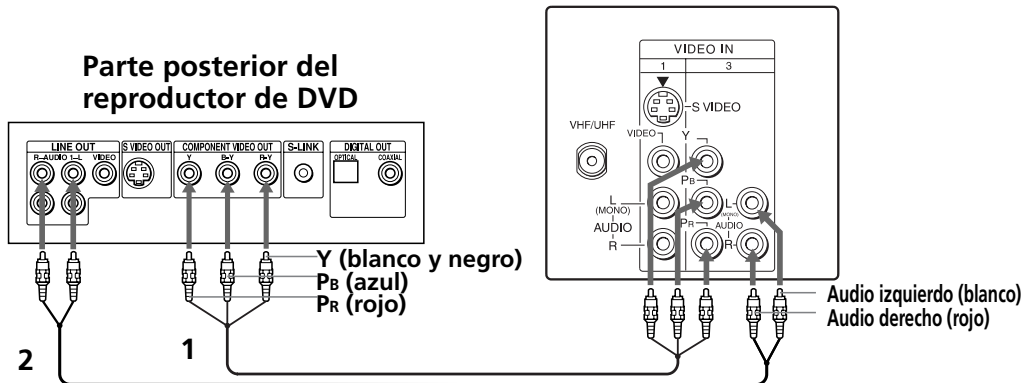

- 1 Conecte las tomas Y, P_B, P_R OUT del reproductor de DVD a las tomas Y, P_B, P_R IN del televisor mediante los cables de video para componentes.
- 2 Conecte la toma AUDIO OUT del reproductor de DVD a la toma AUDIO IN del televisor.

Las salidas Y, P_B, P_R del reproductor de DVD algunas veces están etiquetadas como Y, C_B, y C_R o Y, B-Y y R-Y. Si es así, conecte los cables rigiéndose por los colores.

Conexión de una cámara de video

Conecte las salidas AUDIO y VIDEO OUT de la cámara de video a las entradas AUDIO y VIDEO INPUT del televisor mediante los cables de Audio/Video (no incluidos).

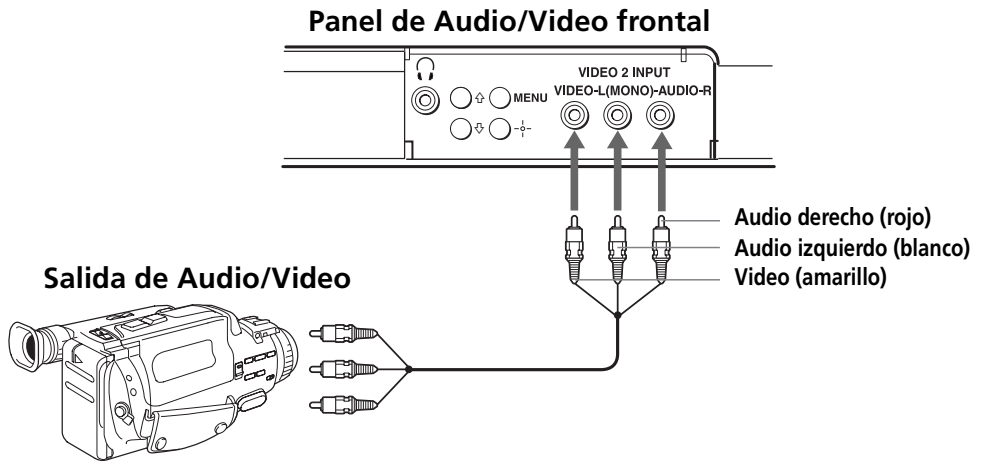

Conexión de audífonos

Conecte los audífonos a la toma  situada en la parte frontal del televisor.

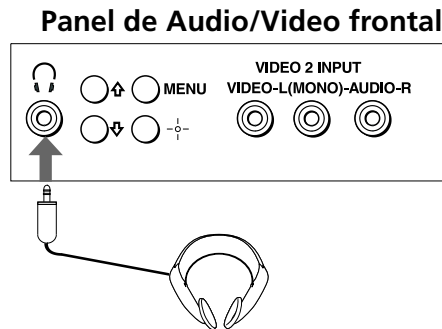

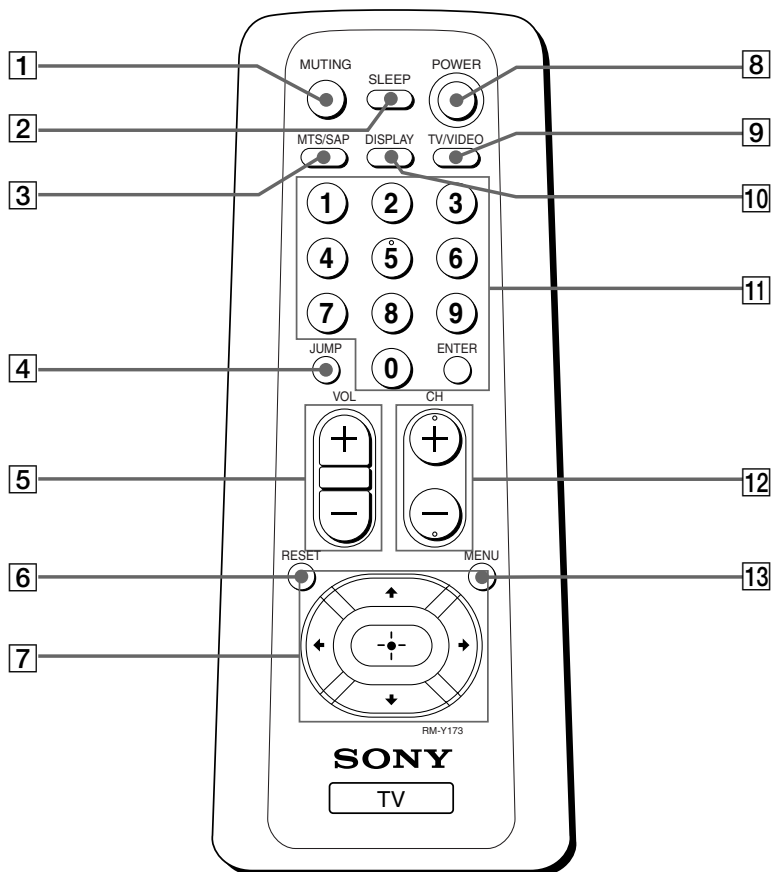

Uso del control remoto y funciones básicas

Este capítulo muestra cómo utilizar todos los botones del control remoto y los menús de pantalla.



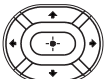

Uso del control remoto

Botón	Descripción
1 MUTING	Desactiva el sonido de forma instantánea. Oprímalo de nuevo u oprima  para restaurar el sonido.
2 SLEEP	Apaga automáticamente el televisor en aproximadamente 15, 30, 45, 60 ó 90 minutos. Para cancelar, oprima hasta que aparezca SLEEP OFF.
3 MTS/SAP	Muestra las distintas opciones de sonido multicanal del televisor (MTS): Estéreo, Mono, y Auto SAP (Segundo Programa de Audio).
4 JUMP	Oprima para alternar entre dos canales. El televisor cambia del canal actual al canal anterior seleccionado.
5 VOL (volumen)	Oprímalo cuando desee ajustar el volumen.
6 RESET	Oprímalo para volver a la configuración de fábrica desde un menú de pantalla.
7 	Mueve el cursor en los menús de pantalla. Oprima los botones de flecha para mover el cursor y a continuación oprima el botón central para seleccionar o acceder a una opción.
8 POWER	Oprímalo cuando desee encender ó apagar el televisor.
9 TV/VIDEO	Alterna las entradas de video disponibles.
10 DISPLAY	Oprímalo para mostrar la hora actual (si está ajustada) y el número de canal. Oprímalo de nuevo para desactivar DISPLAY.
11 0-9 y ENTER	Oprima los botones 0-9 para seleccionar un canal después oprima ENTER para que cambie de inmediato.
12 CH (canal)	Oprímalo cuando desee cambiar canales.
13 MENU	Muestra el menú de pantalla. Oprímalo de nuevo para salir del menú en cualquier momento.



 Si pierde el control remoto, consulte la página 28.

Programación automática del televisor

Cuando haya terminado de conectar el televisor, puede ajustar los canales mediante Autoprogramación.

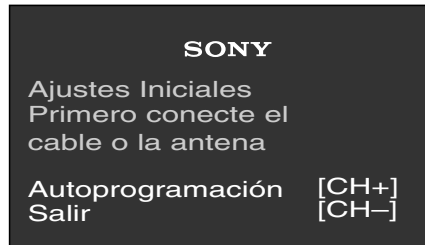









- 1 Oprima  para encender el televisor. Aparecerá la pantalla de Ajustes Iniciales. Para KV-21FS100 y KV-25FS100 con destino a Argentina: Oprima  antes de oprimir  para encender el televisor.



- 2 Oprima  en el control remoto o en el panel frontal del televisor para activar Autoprogramación u oprima  para salir.

 La pantalla de Ajustes Iniciales aparecerá cada vez que encienda el televisor hasta que realice Autoprogramación.

Para volver a activar Autoprogramación

- 1 Oprima .
- 2 Oprima  para seleccionar Ajuste de Canal ().
- 3 Oprima  para seleccionar Cable. Oprima  para seleccionar.
- 4 Oprima  o  para seleccionar Si o No según el estado del televisor. Oprima .
- 5 Oprima  para seleccionar Autoprogramación. Oprima  para buscar los canales.

 Una vez finalizada la función Autoprogramación, oprima  para salir.

Acceso rápido a los menús

Los ajustes siguientes están disponibles en los menús de pantalla.

Menú	Permite
 <p>The screenshot shows the 'Video' menu with options: 'Control de Imagen', 'Temp. del Color : Neutro', and 'VM : Bajo'. At the bottom, there are navigation controls: 'Mover' with left and right arrows, 'Seleccionar' with a plus sign, and 'Salir' with a MENU button icon.</p>	Modificar los ajustes de la imagen.
 <p>The screenshot shows the 'Audio' menu with options: 'MTS : Estéreo' and 'Realce de graves : Sí'. At the bottom, there are navigation controls: 'Mover' with left and right arrows, 'Seleccionar' with a plus sign, and 'Salir' with a MENU button icon.</p>	Cambiar el ajuste de audio.
 <p>The screenshot shows the 'Ajuste de Canal' menu with options: 'Canales Favoritos', 'Cable : No', 'Fijar Canal : No', 'Autoprogramación', 'Omitir/Añadir Canal', and 'Nombre del Canal'. At the bottom, there are navigation controls: 'Mover' with left and right arrows, 'Seleccionar' with a plus sign, and 'Salir' with a MENU button icon.</p>	Personalizar el ajuste de los canales.
 <p>The screenshot shows the 'Bloqueo de Canal' menu with options: '5 : Permitir', '6 : Permitir', '7 : Permitir', '8 : Permitir', and '9 : Permitir'. At the bottom, there are navigation controls: 'Mover' with left and right arrows, 'Seleccionar' with a plus sign, and 'Salir' with a MENU button icon.</p>	Bloquear los canales no deseados.

Menú



Permite

Ajustar el reloj del televisor y programar el encendido y apagado automático del televisor en un canal establecido mediante Timer 1 y Timer 2 (Reloj 1 y Reloj 2).













Seleccionar los modos de subtítulos, etiquetar las entradas de video, corregir la inclinación de la imagen, seleccionar el idioma de los menús o ejecutar una demostración de los menús.

Uso de los menús

Este capítulo muestra las opciones disponibles para configurar y ajustar el televisor.

Para acceder a un menú

- 1 Oprima  para que aparezca el menú de pantalla.
- 2 Utilice los botones  o  para seleccionar el menú deseado y después oprima .
- 3 Utilice los botones  o  para seleccionar la opción deseada y después oprima .
- 4 Siga las indicaciones que aparecen en pantalla para activar las opciones deseadas. Oprima  para terminar el ajuste.
- 5 Oprima  para salir del menú.

 Oprima  una vez para que aparezca el menú en pantalla y oprímalo de nuevo para que desaparezca. Si no se oprime ningún botón, el menú se cierra automáticamente transcurridos 90 segundos aproximadamente.

Uso del menú de Video

Para acceder al menú Video, siga los siguientes pasos:



Control de Imagen

Oprima ⇨ para abrir el menú Control de Imagen:

Contraste:

Oprima ⇐ para disminuir el contraste. Oprima ⇨ para aumentar el contraste.

Brillo:

Oprima ⇐ para oscurecer la imagen. Oprima ⇨ para aumentar el brillo de la imagen.

Color:

Oprima ⇐ para disminuir la intensidad de color. Oprima ⇨ para aumentar la intensidad de color.

Tinte:

Oprima ⇐ para aumentar los tonos rojos. Oprima ⇨ para aumentar los tonos verdes.

Nitidez:

Oprima ⇐ para suavizar la imagen Oprima ⇨ para aumentar la nitidez de la imagen.

Temperatura del Color

Ajuste de la tonalidad del blanco

Oprima ⇕ o ⇩ para seleccionar una de las opciones siguientes:

Frío: Proporciona a los colores blancos una tonalidad azulada.

Neutro: Proporciona a los colores blancos una tonalidad neutra.

Cálido: Proporciona a los colores blancos una tonalidad rojiza.

VM

Modulación de velocidad

Aumenta la nitidez de la definición de la imagen y proporciona a los objetos un contorno más nítido y limpio. Oprima ⇕ o ⇩ para seleccionar una de las opciones siguientes: **No**, **Alto**, **Bajo**.



Uso del menú Audio

Para acceder al menú Audio, siga los siguientes pasos :

Para mostrar Para seleccionar  Para seleccionar





MTS
*Sonido
multicanal
del televisor*

Oprima  o  para seleccionar una de las siguientes opciones:

Estéreo: Seleccione esta opción cuando visualice una emisión en estéreo.

Mono: Seleccione esta opción para reducir el ruido en zonas de difícil recepción.

Auto SAP: Seleccione esta opción para que el televisor cambie automáticamente a Segundo Programa de Audio (SAP) cuando reciba la señal.

 Oprima  para acceder directamente a los ajustes de MTS (Estéreo, Mono, Auto SAP)



**Realce de
graves**

Proporciona tonos graves más profundos e intensos. Oprima  o  para seleccionar Si o No.

 Si el televisor está en modo Auto SAP, algunos programas se silenciarán o se distorsionarán. Si el televisor no emite sonido, cambie el ajuste de audio a Estéreo o Mono.

Uso del menú Ajuste de Canal

Para acceder al menú Ajuste de Canal, siga los siguientes pasos:

Para mostrar  → Para seleccionar   Para seleccionar 











The screenshot shows a menu with the following items: Ajuste de Canal, Canales Favoritos (with a right arrow), Cable : No, Fijar Canal : No, Autoprogramación, Omitir/Añadir Canal, and Nombre del Canal. At the bottom, there are navigation controls: Mover (up, down, left, right arrows), Seleccionar (plus and minus buttons), and Salir (MENU button).





Canales

Favoritos

Acceso rápido a los canales favoritos

Oprima  para abrir el menú Canales Favoritos:

- 1 Utilice el botón  o  para seleccionar la posición (1-5) donde desea ajustar un canal favorito. A continuación oprima .
- 2 Utilice el botón  o  para seleccionar el canal deseado.
- 3 Oprima  para cambiar al canal seleccionado.
- 4 Oprima  para volver al menú Ajuste de Canal u oprima  para salir.

 Para utilizar Canales Favoritos: Salga de todos los menús y oprima . Oprima  o  para desplazar el cursor al número de canal deseado y oprima .

Cable

Si: Selecciónelo si recibe canales vía cable con un cable CATV.

No: Selecciónelo si utiliza una antena de televisión.

 Después de cambiar los ajustes del cable, deberá realizar la función Autoprogramación.

Fijar Canal

2-6: Seleccione esta opción cuando desee controlar la selección de todos los canales a través de la caja de cable o de la videograbadora. Seleccione el canal adecuado (normalmente el 3 ó 4) y utilice el control remoto de la caja de cable o de la videograbadora para seleccionar los canales.

Video 1: Seleccione esta opción desde las entradas de video disponibles cuando haya conectado el equipo de video (por ejemplo, el receptor de satélite) y desee que quede fijado en el televisor.

No: Fijar Canal no está activado.

Autoprogramación

Realice la función Autoprogramación siempre que ajuste el televisor. Recorrerá todos los canales disponibles y programará los que se reciben.

Omitir/Añadir Canal Utilice esta función después de ejecutar Autoprogramación para omitir los canales no deseados o para añadir nuevos canales. Oprima ⇨ para abrir el menú Omitir/Añadir Canal:

- 1 Utilice los botones ↑ o ↓ para seleccionar la posición del canal deseado y a continuación oprima ⏪.
- 2 Oprima el botón ↑ o ↓ para omitir o añadir canales y a continuación oprima ⏪.
- 3 Oprima ⇐ para volver al menú Ajuste de Canal u oprima  para salir.

 Cuando oprima CH+ o CH- no tendrá acceso a los canales omitidos, sólo a través de los botones ①-⑨ podrá accederlos.

Nombre del Canal Oprima ⇨ para abrir el menú Nombre del Canal:

Etiqueta hasta 40 canales con sus letras de llamada

- 1 Oprima ⏪ y a continuación oprima ↑ o ↓ hasta que localice el número de canal deseado.
- 2 Oprima ⏪ para activar el canal.
- 3 Oprima ⏪ y a continuación oprima el botón ↑ o ↓ para mostrar la primera letra de llamada o número de captura y a continuación oprima ⏪ para seleccionarlo. Cuando termine, oprima ⏪ para activar el canal.

 Los modos Canales Favoritos, Omitir/Añadir Canal, Nombre del Canal, Cable y Bloqueo de Canal no se pueden utilizar cuando Fijar Canal está activado, o la televisión se encuentra en los modos de video.

Uso del menú Bloqueo de Canal

Para acceder al menú Bloqueo de Canal, siga los siguientes pasos:

Para mostrar Para seleccionar  Para seleccionar



MENU → → → +

Bloqueo de Canal

5 : Permitir
6 : Permitir
7 : Permitir
8 : Permitir
9 : Permitir

Seleccione el canal

Mover ↑↓←→ Seleccionar + Salir MENU

 Cuando entre al menú Bloqueo de Canal, el canal seleccionado es el canal que está visualizando.

Con el menú Bloqueo de Canal abierto:

Bloquear o Desbloquear

- 1 Utilice los botones ↑ o ↓ para elegir el canal deseado y a continuación oprima + para seleccionarlo.
- 2 Utilice los botones ↑ o ↓ para bloquear o desbloquear el canal seleccionado y a continuación oprima +.
- 3 Oprima MENU para salir.

 Si un canal está bloqueado, se mostrará una pantalla negra con la palabra "Programa Bloqueado" (solamente para el uso habitual del televisor). La función Bloqueo de Canal se desactiva en los modos de Video.

Uso del menú Timer (Reloj) 🕒

Para acceder al menú Timer (Reloj), siga los siguientes pasos:

Para mostrar Para seleccionar 🕒 Para seleccionar



Hora Actual

Muestra el día y la hora actual. Oprima ⇨ para abrir el menú de Hora Actual.

- 1 Utilice los botones ⬆ o ⬇ para introducir el día y la hora correcta y a continuación oprima ⇨.
- 2 Oprima para salir del menú.

Debe ajustar la hora actual antes de poder utilizar Timer 1 y Timer 2 (Reloj 1 y Reloj 2).

Timer 1 y Timer 2 (Reloj 1 y Reloj 2)

*Visualización
programada*

Programa su televisor al día, hora, duración y canal deseado. La programación máxima es de 6 horas. Cuando el canal esté fijado no será necesario introducirlo. Oprima ⇨ para abrir el menú de Timer 1 o Timer 2.

- 1 Oprima ⬆ o ⬇ para seleccionar Timer 1 o Timer 2 (Reloj 1 y Reloj 2) y a continuación oprima ⇨.
- 2 Oprima ⬆ o ⬇ para introducir el día, hora, duración y el canal deseado y a continuación oprima ⇨.
- 3 Oprima para salir del menú.

Puede fijar Timer en las posiciones Si, No o Ajustar. Cuando Timer 1 y Timer 2 (Reloj 1 y Reloj 2) esté ajustado podrá activarlo y desactivarlo sin tener que revisar los ajustes.

















Al ejecutar Autoprogramación, los ajustes de Timer 1 y Timer 2 (Reloj 1 y Reloj 2) se borrarán. Así mismo, en caso de producirse una pérdida de electricidad, los ajustes de Hora Actual, Timer 1 y Timer 2 (Reloj 1 y Reloj 2) se borrarán.

Uso del menú Ajustes

Para acceder al menú Ajustes, siga los siguientes pasos:

Para mostrar Para seleccionar  Para seleccionar





Caption Vision <i>Subtítulos</i>	<p>Permite seleccionar tres modos de subtítulos (para programas que se emiten con subtítulos).</p> <p>Oprima  o  para seleccionar una de las siguientes opciones:</p> <p>CC1, 2, 3, 4: Muestra el diálogo impreso y los efectos de sonido de un programa.</p> <p>Text1, 2, 3, 4: Muestra información sobre la red/emisora.</p> <p>XDS: Muestra el nombre del programa actual y el tiempo restante, si está disponible.</p> <p>No: Los subtítulos no están activados.</p>
Etiqueta de Video <i>Etiqueta el equipo conectado</i>	<p>Permite etiquetar los componentes de audio/video que tiene conectado a su televisor: VCR, DVD, etc.</p> <p>Con la ventana Etiqueta de Video abierta:</p> <p>1 Oprima  o  para acceder a la entrada que desea etiquetar y oprima .</p> <p>2 Oprima  o  para elegir una etiqueta y oprima .</p>
Rotación	<p>Oprima  o  para corregir la inclinación de la imagen entre -5 y +5 y a continuación oprima  para activarla.</p>
Idioma	<p>Muestra todos los menús en el idioma elegido.</p> <p>Oprima  o  para seleccionar el idioma deseado (Español, Inglés, Francés) y oprima .</p>
Demo (Demostración)	<p>Oprima  para ejecutar una demostración de los menús de pantalla.</p>
<p> Puede oprimir cualquier tecla para salir del modo Demo (Demostración).</p>	
Sistema de Color	<p>Sólo en los modelos KV-21FS100 y KV-25FS100 con destino a Argentina</p> <p>Seleccione las configuraciones siguientes para las entradas TV, Video 1 y Video 2: AUTO, NTSC, PAL-M, PAL-N.</p>

Información adicional

Solución de problemas

Si tiene problemas con el televisor, intente seguir las indicaciones que se sugieren a continuación. Si el problema persiste, consulte con su proveedor Sony más cercano.

No hay imagen ni sonido	<ul style="list-style-type: none"><input type="checkbox"/> Asegúrese que el cable de alimentación esté conectado.<input type="checkbox"/> Si hay una luz roja que parpadea en la parte frontal del televisor durante algunos minutos, desconecte y vuelva a conectar el cable de alimentación para restaurar el televisor. Si el problema persiste, llame al servicio técnico local.<input type="checkbox"/> Compruebe los ajustes TV/VIDEO: cuando utilice el televisor, ajústelos en TV; cuando utilice el equipo de video, ajústelo en VIDEO (página 14).<input type="checkbox"/> Asegúrese de que las baterías están insertadas correctamente en el control remoto (página 2).<input type="checkbox"/> Inténtelo con otro canal; podría ser problema de la emisora.
Imagen de baja calidad o sin imagen, buen sonido	<ul style="list-style-type: none"><input type="checkbox"/> Ajuste Contraste en la opción Video del menú Control de Imagen (página 20).<input type="checkbox"/> Ajuste Brillo en la opción Video del menú Control de Imagen (página 20).<input type="checkbox"/> Compruebe las conexiones de la antena y/o del cable (página 4).
Buena Imagen, sin sonido	<ul style="list-style-type: none"><input type="checkbox"/> Oprima  para que desaparezca MUTING de la pantalla (página 14).<input type="checkbox"/> Compruebe los ajustes de Audio. Es posible que el televisor esté en modo Auto SAP (página 21).
Sin color	<ul style="list-style-type: none"><input type="checkbox"/> Ajuste Color en la opción Video del menú Control de Imagen (página 20).
Sin señal	<ul style="list-style-type: none"><input type="checkbox"/> Compruebe el ajuste del cable en el menú Ajuste de Canal (página 22).<input type="checkbox"/> Compruebe las conexiones de la antena y/o del cable (página 4).<input type="checkbox"/> Asegúrese de que el canal seleccionado esté emitiendo.
Líneas de puntos o rayas	<ul style="list-style-type: none"><input type="checkbox"/> Ajuste la antena.<input type="checkbox"/> Aparte el televisor de cualquier otro equipo electrónico. Algunos equipos electrónicos pueden crear ruidos eléctricos que interfieran con la recepción del televisor.
Imágenes dobles o fantasmas	<ul style="list-style-type: none"><input type="checkbox"/> Revise la antena exterior o llame al servicio técnico del cable.

No se reciben canales con un número alto (UHF) cuando se utiliza una antena	<ul style="list-style-type: none"><input type="checkbox"/> Asegúrese de que Cable esta en la posición No en el menú Ajuste de Canal (página 22).<input type="checkbox"/> Ejecute Autoprogramación para añadir canales que actualmente no estén en la memoria (página 15).
Las emisoras del cable parece que no funcionan	<ul style="list-style-type: none"><input type="checkbox"/> Asegúrese de que Cable esta en la posición Sí en el menú Ajuste de Canal (página 22).<input type="checkbox"/> Ejecute Autoprogramación para añadir canales que actualmente no estén en la memoria (página 15).
El control remoto no funciona	<ul style="list-style-type: none"><input type="checkbox"/> Las baterías podrían estar bajas. Sustitúyalas (página 2).<input type="checkbox"/> Coloque el televisor a unos 90-120 cm o más de las luces fluorescentes.
El televisor está sucio	<ul style="list-style-type: none"><input type="checkbox"/> Limpie el televisor con un paño suave y seco. No utilice nunca disolventes fuertes como diluyentes o bencina, puesto que podría dañar el acabado de la unidad.
Ha perdido el control remoto	<ul style="list-style-type: none"><input type="checkbox"/> Puede utilizar los controles del panel de audio/video frontal para acceder al menú (página 2). Póngase en contacto con su proveedor Sony más cercano para solicitar un control remoto de repuesto.

Si después de leer este manual de instrucciones, tiene más preguntas relacionadas con la utilización del televisor Sony, póngase en contacto con su proveedor Sony más cercano para recibir asistencia técnica.

Especificaciones

Para todos los modelos (excepto los indicados)

Sistema de televisión	Estándar de televisión americana/NTSC (KV-21FS100, KV-25FS100) PAL-M/PAL-N/NTSC (KV-21FS100, KV-25FS100, con destino a Argentina)
Cobertura de canales	VHF: 2-13/UHF: 14-69/CATV: 1-125
Antena	Terminal de antena externa para VHF/UHF de 75 ohm
Tubo de imagen	Tubo FD Trinitron®
Requisitos de alimentación para todos los países excepto en donde se indique:	ca 120 V 60 Hz ca 220 V 50/60 Hz (Chile, Perú, Bolivia) ca 120 - 220 V 50/60 Hz (Argentina)
Accesorios incluidos	Baterías de tamaño AA (R6) (2) Control remoto RM-Y173 (1) Antena dipolo (1) Convertidor (EAC-25) (1)
Accesorios opcionales	Cables de conexión VMC-810S/820S, VMC-720M, YC-YC-15V/30V, RK74A Mezclador EAC-66 U/V

KV-21FS100







Tamaño de la pantalla	Tamaño de pantalla visible: 508 mm (20 pulgadas) medido en diagonal Tamaño de pantalla real: 533,4 mm (21 pulgadas) medido en diagonal
Entradas/salidas	2 de video, 2 de audio 1 Y, PB, PR, 1 audio 1 conector para audífonos
Salida de la bocina	5 W x 2
Consumo de energía para todos los países excepto en donde se indique:	120 W 115 W (Chile, Perú, Bolivia) 1 W en espera
Dimensiones (An./Al./Prof.):	592 x 466 x 494 mm (23 ¹ / ₄ x 18 ³ / ₈ x 19 ¹ / ₂ pulgadas)
Peso	24,8 kg (54 lbs. 10 oz.)

KV-25FS100

Tamaño de la pantalla	Tamaño de pantalla visible: 610 mm (24 pulgadas) medido en diagonal Tamaño de pantalla real: 635 mm (25 pulgadas) medido en diagonal
Entradas/salidas	2 de video, 2 de audio, 1 S VIDEO 1 Y, PB, PR, 1 audio 1 conector para audífonos
Salida de la bocina	7.5 W x 2
Consumo de energía para todos los países excepto en donde se indique:	145 W 140 W (Chile, Perú, Bolivia) 1 W en espera
Dimensiones (An./Al./Prof.):	704 x 524 x 472 mm (27 ³ / ₄ x 20 ⁵ / ₈ x 18 ¹ / ₂ pulgadas)
Peso	35 kg (77 lbs. 1 oz.)

El diseño y las especificaciones están sujetos a cambios sin previo aviso.

Índice alfabético

- A**
 - Autoprogramación 15, 22
 - Auto SAP 21
- B**
 - Bloquear o desbloquear 24
 - Brillo 20
- C**
 - Cable 22
 - Canales Favoritos 22
 - Caption Vision 26
 - Características del televisor 1
 - Color 20
 - Conexiones
 - Cable y antena 4
 - Conexión de audífonos 11
 - Conexión de una cámara de video 11
 - Conexión de un reproductor de DVD 10
 - Televisor y caja de cable 6
 - Televisor y receptor de satélite 8
 - Televisor, receptor de satélite y videograbadora 9
 - Televisor y videograbadora 5
 - Televisor, videograbadora y caja de cable 7
 - Contraste 20
 - Control remoto 13
- D**
 - Demo (Demostración) 26
 - DISPLAY (Despligue) 14
- E**
 - Especificaciones 29
 - Etiqueta de Video 26
- F**
 - Fijar Canal 22
- H**
 - Hora Actual 25
- I**
 - Idioma 26
- Instalación de baterías 2**
- Interruptor MAIN POWER (Alimentación principal)2**
- M**
 - Menús
 - Ajuste de Canal  22
 - Ajustes  26
 - Audio  21
 - Bloqueo de Canal  24
 - Timer (Reloj)  25
 - Video  20
 - MTS
 - Auto SAP 21
 - Estéreo 21
 - Mono 21
- N**
 - Nitidez 20
 - Nombre del Canal 23
- O**
 - Omitir/Añadir Canal 23
- P**
 - Panel frontal del televisor 2
 - Panel posterior del televisor 3
- R**
 - Realce de graves 21
 - Rotación 26
- S**
 - Sistema de Color 26
 - SLEEP (Apagado automático)14
 - Solución de problemas 27
- T**
 - Temperatura del Color 20
 - Timer 1 y Timer 2 (Reloj1 y Reloj2) 25
 - Tinte 20
- V**
 - VM 20

PRINTING THE SERVICE MANUAL

The PDF of this service manual is not designed to be printed from cover to cover. The pages vary in size, and must therefore be printed in sections based on page dimensions.

NON-SCHEMATIC PAGES

Data that does NOT INCLUDE schematic diagrams are formatted to 8.5 x 11 inches and can be printed on standard letter-size and/or A4-sized paper.

SCHEMATIC DIAGRAMS

The schematic diagram pages are provided in two ways, full size and tiled. The full-sized schematic diagrams are formatted on paper sizes between 8.5" x 11" and 18" x 30" depending upon each individual diagram size. Those diagrams that are LARGER than 11" x 17" in full-size mode have been tiled for your convenience and can be printed on standard 11" x 17" (tabloid-size) paper, and reassembled.

TO PRINT FULL SIZE SCHEMATIC DIAGRAMS

If you have access to a large paper plotter or printer capable of outputting the full-sized diagrams, output as follows:

- 1) Note the page size(s) of the schematics you want to output as indicated in the middle window at the bottom of the viewing screen.
- 2) Go to the File menu and select Print Set-up. Choose the printer name and driver for your large format printer. Confirm that the printer settings are set to output the indicated page size or larger.
- 3) Close the Print Set Up screen and return to the File menu. Select "Print..." Input the page number of the schematic(s) you want to print in the print range window. Choose OK.

TO PRINT TILED VERSION OF SCHEMATICS



Schematic pages that are larger than 11" x 17" full-size are provided in a 11" x 17" printable tiled format near the end of the document. These can be printed to tabloid-sized paper and assembled to full-size for easy viewing.

If you have access to a printer capable of outputting the tabloid size (11" x 17") paper, then output the tiled version of the diagram as follows:

- 1) Note the page number(s) of the schematics you want to output as indicated in the middle window at the bottom of the viewing screen.
- 2) Go to the File menu and select Print Set-up. Choose the printer name and driver for your printer. Confirm that the plotter settings are set to output 11" x 17", or tabloid size paper in landscape () mode.
- 3) Close the Print Set Up screen and return to the File menu. Select "Print..." Input the page number of the schematic(s) you want to print in the print range window. Choose OK.

TO PRINT SPECIFIC SECTIONS OF A SCHEMATIC

To print just a particular section of a PDF, rather than a full page, access the Graphics Select tool in the Acrobat Reader tool bar.

- 1) To view the Graphics Select Tool, press and HOLD the mouse button over the Text Select Tool which looks like: . This tool will expand to reveal additional tools. Choose the Graphics Select tool by placing the cursor over the button on of the far right that looks like: 
- 2) After selecting the Graphics Select Tool, place your cursor in the document window and the cursor will change to a plus (+) symbol. Click and drag the cursor over the area you want to print. When you release the mouse button, a marquee (or dotted lined box) will be displayed outlining the area you selected.
- 3) With the marquee in place, go to the file menu and select the "Print..." option. When the print window appears, choose the option under the section called "Print Range" which says "Selected Graphic".

Select OK and the output will print only the area that you outlined with the marquee. 

(continued >)

ON-SCREEN SEARCH OPTION

All of the text within the service manual PDF is content searchable. This means that you can enter any text, word, phrase or reference number that appears in the manual, and the PDF software will search, find and move the cursor to the location where you requested text first appears. This feature can be particularly useful in locating components on a specific schematic or printed wire circuit board (PWB) diagrams.

Follow these steps to effectively locate a component on a schematic diagram:

- 1) Locate the schematic you want to search by clicking on the corresponding bookmark on the left side of the screen. The view on the right of the screen will then jump to the desired schematic page.
- 2) Magnify the diagram to at least 400% before conducting a component search. This will enable you to easily view the reference number when it is highlighted on screen. To do this, click on the magnifying glass button on the tool bar at the top of the screen. Move the cursor over the diagram and RIGHT click you mouse. Select the 400% magnification option on the pop-up menu. Click on the button with the icon of the open hand to deactivate the magnification tool
- 3) Search the diagram (or the entire manual) by clicking on the binocular button tool at the top of the screen. The "Find" window will appear and allow you to type in your desired text. Type in a reference designator, such as R502, and click on the "Find" button. If the component is not on the diagram, but is listed anywhere else in the manual, the cursor will jump to the first location the text is found in the file. To find another instance of that same text, click on the binocular button again and select "Find Again."

<u>MODEL NAME</u>	<u>REMOTE COMMANDER</u>	<u>DESTINATION</u>	<u>CHASSIS NO.</u>
KV-24FS100	RM-Y173	US	SCC-S61D-A
KV-24FS100	RM-Y173	CND	SCC-S59D-A
KV-25FS100	RM-Y173	LATIN NORTH	SCC-S60J-A
KV-25FS100	RM-Y173	LATIN SOUTH	SCC-S60K-A

CORRECTION- 1

SUBJECT: SCREEN (G2) INSTRUCTIONS
A BOARD IC VOLTAGE LIST

Correct the service manual as shown.
File this Correction with the service manual.

 : Corrected Item

Section 2: Set-Up Adjustments (Page 13)

2-4. Screen (G2) added Step #4 to instructions

Section 5: Diagrams (Page 34)

Replaced A Board IC Voltage List

DYNAMIC CONVERGENCE ADJUSTMENT

Before performing this adjustment, perform Horizontal and Vertical Static Convergence Adjustment.

1. Slightly loosen deflection yoke screw.
2. Remove deflection yoke spacers.
3. Move the deflection yoke for best convergence as shown below:

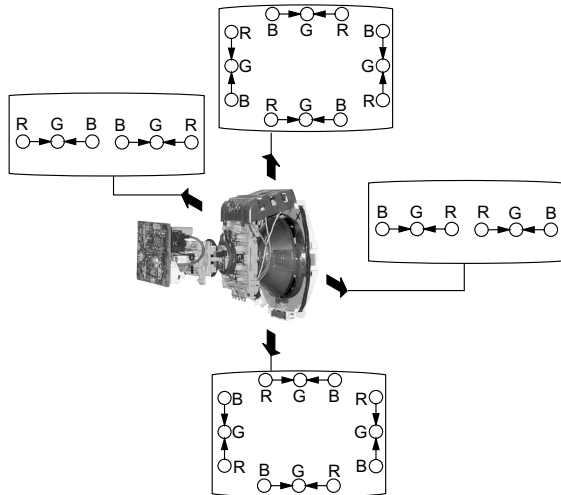

4. Tighten the deflection yoke screw.
5. Install the deflection yoke spacers.

TLH PLATE ADJUSTMENT

1. Input crosshatch pattern.
2. Adjust PICTURE QUALITY to standard, PICTURE and BRIGHTNESS to 50%, and OTHER to standard.
3. Adjust the Horizontal Convergence of red and blue dots by tilting the TLH plate on the deflection yoke.

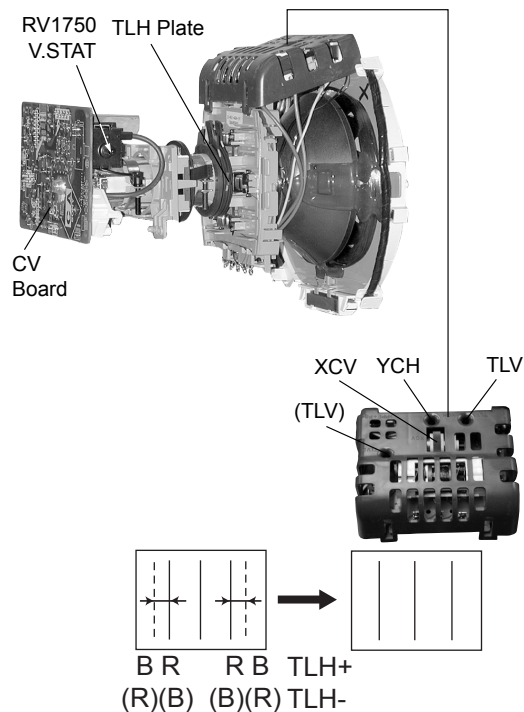

4. Adjust XCV core to balance X axis.
 5. Adjust YCH VR to balance Y axis.
 6. Adjust vertical red and blue convergence with V.TILT (TLV VR.)
- Note: Perform adjustment 3-6 while tracking items 1 and 2.

SCREEN-CORNER CONVERGENCE

1. Affix a permalloy assembly corresponding to the misconverged areas:

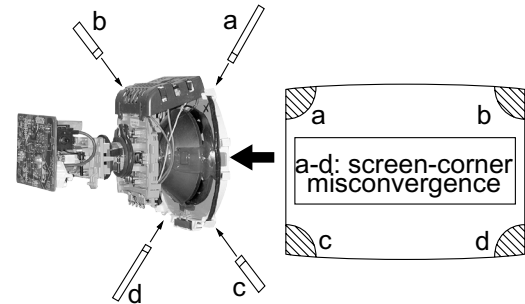

2-3. FOCUS

1. Adjust FOCUS control for best pictures.

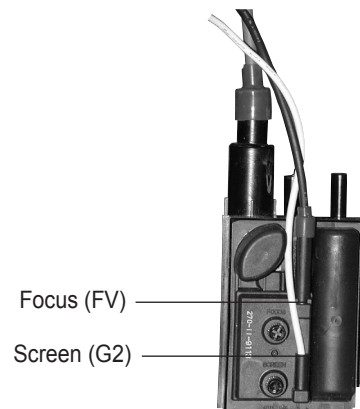

2-4. SCREEN (G2)

1. Input a dot pattern.
2. Set the PICTURE and BRIGHTNESS controls at minimum and COLOR control at normal.
3. Adjust SBRT, GCUT, BCUT in service mode with an oscilloscope as shown below so that voltages on the red, green, and blue cathodes are $160 \pm 2\text{VDC}$.

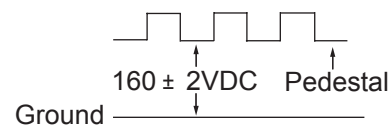

4. Observe the screen and adjust SCREEN (G2) VR in FBT to obtain the faintly visible background of dot signal.

A BOARD IC VOLTAGE LIST

IC001		44	1.6	7	GND	12	7.0	8	17.2
PIN	VOLT	45	1.6	8	5.0	IC545		9	GND
1	N/C	46	2.3	IC003		PIN	VOLT	10	10.4
2	GND	47	1.0	PIN	VOLT	1	0.7	11	0.0
3	2.2	48	N/C	1	N/C	2	13.5	12	4.6
4	2.2	49	0.5	2	GND	3	-12.2	13	N/C
5	GND	50	1.2	3	GND	4	-13.3	14	163.6
6	5.0	51	2.0	4	5.0	5	0.2	15	153.5
7	0.0	52	1.5	5	5.0	6	13.8	16	157.6
8	2.0	53	4.8	IC004		7	0.7	17	N/C
9	0.3	54	4.8	PIN	VOLT	IC561		18	1.7
10	2.1	55	4.8	1	5.0	PIN	VOLT	IC603	
11	5.0	56	4.8	2	5.0	1	0.1	PIN	VOLT
12	GND	57	N/C	3	GND	2	3.4	I	12.0
13	3.3	58	5.2	IC401		3	2.3	G	GND
14	3.1	59	0.0	PIN	VOLT	4	GND	O	9.0
15	1.0	60	0.0	1	4.5	5	9.2	IC604	
16	1.5	61	0.0	2	0.3	6	10.2	PIN	VOLT
17	3.3	62	0.0	3	4.5	7	0.1	1	133.7
18	0.5	63	1.4	4	0.3	8	13.5	2	N/C
19	1.1	64	4.9	5	4.5	IC565		3	2.5
20	GND	65	4.9	6	4.5	PIN	VOLT	4	11.3
21	0.5	66	0.0	7	0.0	1	3.4	5	GND
22	1.7	67	0.1	8	4.5	2	3.4	IC608	
23	0.5	68	0.1	9	4.5	3	2.1	PIN	VOLT
24	0.5	69	2.4	10	N/C	4	9.0	I	11.0
25	0.5	70	5.0	11	4.4	5	1.0	O	5.0
26	0.0	71	5.0	12	0.0	6	1.0	G	GND
27	0.0	72	0.1	13	4.5	7	1.0	IC633	
28	2.1	73	0.0	14	9.0	8	1.6	PIN	VOLT
29	2.7	74	5.0	15	4.4	9	1.6	I	9.0
30	3.3	75	5.0	16	GND	10	1.6	G	GND
31	2.9	76	5.0	IC404		11	GND	O	3.3
32	GND	77	0.1	PIN	VOLT	12	1.6	All voltages are in V.	
33	2.8	78	0.0	1	14.6	13	1.6		
34	3.3	79	4.9	2	7.0	14	1.6		
35	2.9	80	4.9	3	GND	IC600			
36	GND	IC002		4	7.0	PIN	VOLT		
37	1.8	PIN	VOLT	5	5.9	1	2.5		
38	0.0	1	GND	6	0.0	2	1.8		
39	0.1	2	GND	7	GND	3	2.2		
40	2.0	3	GND	8	0.0	4	2.5		
41	1.6	4	GND	9	0.5	5	GND		
42	3.3	5	4.8	10	7.2	6	0.0		
43	N/C	6	4.8	11	GND	7	4.0		

SERVICE MANUAL

BA-6 CHASSIS

<u>MODEL NAME</u>	<u>REMOTE COMMANDER</u>	<u>DESTINATION</u>	<u>CHASSIS NO.</u>
KV-24FS100	RM-Y173	US	SCC-S61D-A
KV-24FS100	RM-Y173	CND	SCC-S59D-A
KV-25FS100	RM-Y173	LATIN NORTH	SCC-S60J-A
KV-25FS100	RM-Y173	LATIN SOUTH	SCC-S60K-A

CORRECTION - 2

SUBJECT: REPLACED A BOARD TRANSISTOR VOLTAGE LIST (Q600, Q601)
REPLACED A BOARD IC VOLTAGE LIST (IC600)

Correct the service manual as shown.
File this Correction with the service manual.

 : Corrected Items

SECTION 5: DIAGRAMS

5-3. BLOCK DIAGRAM AND SCHEMATICS

A Board Transistor Voltage List (Page 33)

A Board IC Voltage List (Page 34)

TRINITRON® COLOR TELEVISION

SONY®

SECTION 5: DIAGRAMS

5-3. BLOCK DIAGRAM AND SCHEMATICS (Page 33)

A BOARD TRANSISTOR VOLTAGE LIST

	B	C	E		B	C	E
Q002	0.0	2.0	GND	Q405	0.0	0.0	GND
Q004	3.8	9.0	4.4	Q411	0.0	5.8	GND
Q005	5.1	0.8	5.0	Q412	0.1	0.1	GND
Q006	0.0	0.0	GND	Q435	0.0	GND	5.8
Q008	0.0	2.6	GND	Q501	0.0	14.3	GND
Q009	0.0	5.2	GND	Q502	0.0	74.1	GND
Q300	1.8	9.0	2.4	Q505	0.0	131.8	0.0
Q301	3.6	2.1	3.6	Q521	0.0	3.8	GND
Q303	3.6	GND	2.8	Q522	0.1	-2.1	0.0
Q304	3.6	GND	2.9	Q572	0.0	2.6	GND
Q305	3.6	GND	3.0	Q573	2.6	0.0	2.6
Q306	5.5	GND	4.9	Q578	0.0	0.5	GND
Q390	0.8	1.5	1.9	Q590	133.7	0.0	134.2
Q391	0.6	3.3	1.5	Q604	30.6	11.6	30.2
Q400	0.0	0.1	GND	Q608	0.0	6.7	GND
Q401	0.0	0.1	GND	Q650	5.8	9.0	5.0
Q404	0.0	0.0	GND				

All voltages are in V.

	D	G	S
Q600	340.0	160.0	156.0
Q601	155.0	4.9	0.0

SECTION 5: DIAGRAMS

5-3. BLOCK DIAGRAM AND SCHEMATICS (Page 34)

A BOARD IC VOLTAGE LIST

IC001		44	1.6	7	GND	12	7.0	8	17.5
PIN	VOLT	45	1.6	8	5.0	IC545		9	0.0
1	N/C	46	2.3	IC003		PIN	VOLT	10	10.6
2	GND	47	1.0	PIN	VOLT	1	0.7	11	0.0
3	2.2	48	N/C	1	N/C	2	13.5	12	4.9
4	2.2	49	0.5	2	GND	3	-12.2	13	NC
5	GND	50	1.2	3	GND	4	-13.3	14	163.9
6	5.0	51	2.0	4	5.0	5	0.2	15	153.8
7	0.0	52	1.5	5	5.0	6	13.8	16	158.2
8	2.0	53	4.8	IC004		7	0.7	17	NC
9	0.3	54	4.8	PIN	VOLT	IC561		18	340.0
10	2.1	55	4.8	1	5.0	PIN	VOLT	IC603	
11	5.0	56	4.8	2	5.0	1	0.1	PIN	VOLT
12	GND	57	N/C	3	GND	2	3.4	I	12.0
13	3.3	58	5.2	IC401		3	2.3	G	GND
14	3.1	59	0.0	PIN	VOLT	4	GND	O	9.0
15	1.0	60	0.0	1	4.5	5	9.2	IC604	
16	1.5	61	0.0	2	0.3	6	10.2	PIN	VOLT
17	3.3	62	0.0	3	4.5	7	0.1	1	133.7
18	0.5	63	1.4	4	0.3	8	13.5	2	N/C
19	1.1	64	4.9	5	4.5	IC565		3	2.5
20	GND	65	4.9	6	4.5	PIN	VOLT	4	11.3
21	0.5	66	0.0	7	0.0	1	3.4	5	GND
22	1.7	67	0.1	8	4.5	2	3.4	IC608	
23	0.5	68	0.1	9	4.5	3	2.1	PIN	VOLT
24	0.5	69	2.4	10	N/C	4	9.0	I	11.0
25	0.5	70	5.0	11	4.4	5	1.0	O	5.0
26	0.0	71	5.0	12	0.0	6	1.0	G	GND
27	0.0	72	0.1	13	4.5	7	1.0	IC633	
28	2.1	73	0.0	14	9.0	8	1.6	PIN	VOLT
29	2.7	74	5.0	15	4.4	9	1.6	I	9.0
30	3.3	75	5.0	16	GND	10	1.6	G	GND
31	2.9	76	5.0	IC404		11	GND	O	3.3
32	GND	77	0.1	PIN	VOLT	12	1.6	All voltages are in V.	
33	2.8	78	0.0	1	14.6	13	1.6		
34	3.3	79	4.9	2	7.0	14	1.6		
35	2.9	80	4.9	3	GND	IC600			
36	GND	IC002		4	7.0	PIN	VOLT		
37	1.8	PIN	VOLT	5	5.9	1	2.8		
38	0.0	1	GND	6	0.0	2	1.9		
39	0.1	2	GND	7	GND	3	2.3		
40	2.0	3	GND	8	0.0	4	2.6		
41	1.6	4	GND	9	0.5	5	GND		
42	3.3	5	4.8	10	7.2	6	0.0		
43	N/C	6	4.8	11	GND	7	4.6		

All voltages are in V.

