

SONY®

Digital Book Reader

User Guide

Click for instant access!

Table of Contents

This User Guide is for Russian and Ukrainian models only.

Reader™

4-470-508-41(1)
©2013 Sony Corporation

PRS-T3

Table of Contents

Getting started	5
Welcome!	5
Wireless Connectivity	12
Battery.....	32
Installing Reader application (Reader for PC/Mac)	40
Turning the Power On/Off	43
Parts and Controls.....	46
Basic Operations.....	57
[Home] Screen.....	57
Adding/Getting Content	75
Adding Content	75

Browsing Content Lists	78
Content Lists	78
Reading	94
Reading Books.....	94
Organizing	135
Organizing Your Content.....	135
Using Collections	142
Other Applications	152
All Notes	152
Web Browsing	157
Dictionary	177
Handwriting.....	182

Text Memo	189
Pictures	194
Evernote	204
Facebook.....	211
Settings	214
Changing the Settings	214
Other Information	224
Troubleshooting.....	224
Precautions.....	239
Legal Notice	255
Appendix.....	258

Welcome!

About your Reader™

Enjoy the most natural and intuitive reading experience Sony has to offer. This is e-reading.

- Unplug and unwind. Wi-Fi® functionality lets you download books directly via your Reader™.
- Superior touchscreen. Bookmark, highlight and take notes on the high-contrast e-paper screen. Read clearly under direct sunlight.
- Zoom. Easily adjust the font size, or zoom into images for a closer look.
- Dictionary and Wikipedia®. Simply tap and hold a word to look up its definition, translate it or learn more from the Wikipedia Web site.

You can also:

- Personalize the standby screen with either your favorite pictures or the cover of the last-read book.
- Create your own collections and organize your books by bestsellers, favorites, genre and more.

About this guide

Please read the Quick Start Guide and Important Product Information in this package to help you get started.

This User Guide describes key features of your Reader. You can also find this guide in [Books] on your Reader. You can find the User Guide in your language at the support PC Web site.

<http://support.sony-europe.com/eBook/PRS>

Note

- Screenshots in the User Guide may depict screens different from your Reader.

Searching for a specific topic in this User Guide

Use the [Table of Contents] feature of your Reader to search for topics, and then tap a topic to jump to it.

While viewing this User Guide on your Reader, press the ☰ (Menu) button ➔ tap [Navigate Page] ➔ [Table of Contents] to view the Table of Contents.

You can also tap the page number at the bottom of the screen ➔ tap [Table of Contents].

Jumping to a linked section in this User Guide

Tap the link to a chapter or section indicated with a highlight to open the page.

To return to the page you were previously viewing, while viewing a book, tap  after tapping a link.

To hide the /  icons, press the  (Back) button.

Changing the font size

You can adjust the font size to improve legibility. See Details.

Reader Features and Functions

Transferring content from your computer

To enjoy books and pictures on the Reader, download the Reader application to transfer them from your computer to the Reader. See Details. You can also use the Reader application to backup and manage the content on the the Reader.

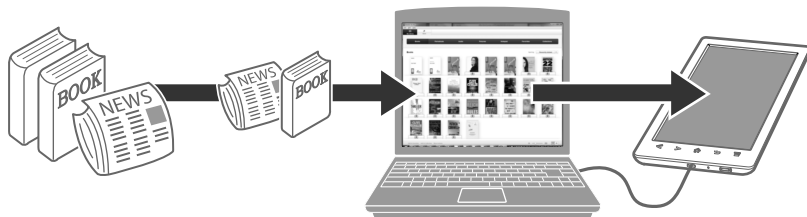

Useful features

Wi-Fi network access Details

- Wikipedia Details
- Use the Web browser for internet access Details
- Use Evernote Details
- Use Facebook Details

Annotation Details

- Add bookmarks Details
- Highlight words Details
- Handwrite notes on a page Details

Resize

- Adjust font size Details
- Change the page view mode Details

Zoom in Details

Adjust content view Details

Search

- Find notes Details
- Find pages with a keyword Details
- Search content via keyword Details

Jump to pages Details

Dictionary Details

- Look up words while reading Details
- Look up words in a dictionary Details
- List previously looked-up words Details

Collections Details

Supplementary applications

- Handwriting Details
- Text memo Details
- Picture viewer Details
- Evernote Details
- Facebook Details

Wireless Connectivity

Join a Wi-Fi® Network

To connect to the internet wirelessly, set up a wireless (Wi-Fi®) internet connection with the following steps.

Preparing to set up a Wi-Fi connection

Before connecting to an access point, turn on [Wi-Fi] on the Reader.

- 1 Press the **⬆** (Home) button ➔ tap [Applications] ➔ [Settings] ➔ [Wireless Network Settings].

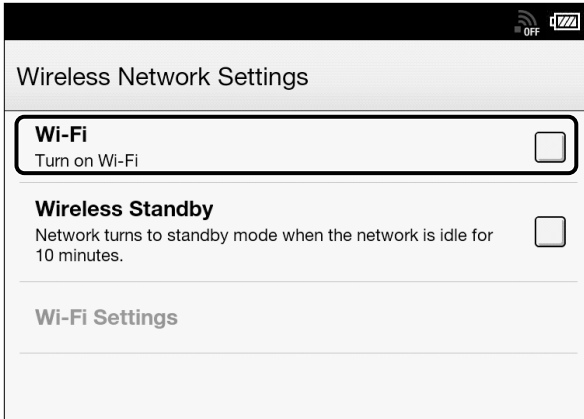

- 2 Check the check box to the right of [Wi-Fi] to turn on the Wi-Fi network.

A check indicates that [Wi-Fi] is turned on. Wi-Fi is turned off by default.





Alternatively, you can tap the status bar ➔ [Wi-Fi]. See Details.

Tip

- Turn off [Wi-Fi] when it is not in use in order to extend the battery life of the Reader.
- Turn on [Wireless Standby] when you want to extend the battery life. See Details.

Wi-Fi status icons

The following icons in the status bar indicate the status of the Wi-Fi connection.

Icon	Status
	Wi-Fi is activated. The number of bars indicates the Wi-Fi signal strength.
	The Wi-Fi network feature of the Reader is in standby mode. See Details.
	There is no Wi-Fi access point.
	The [Wi-Fi] setting is turned off.

Choosing a connection type

Depending on your Wi-Fi environment, connect to an access point via one of the following methods.

The following questions will determine the most suitable case for setting the Reader's Wi-Fi network connection.

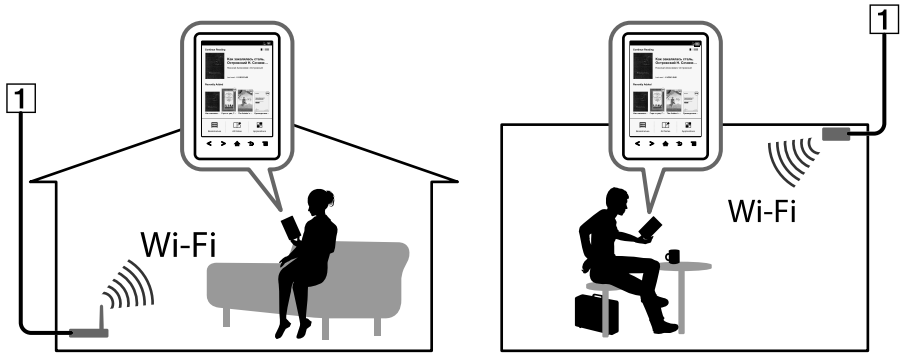

1 Internet

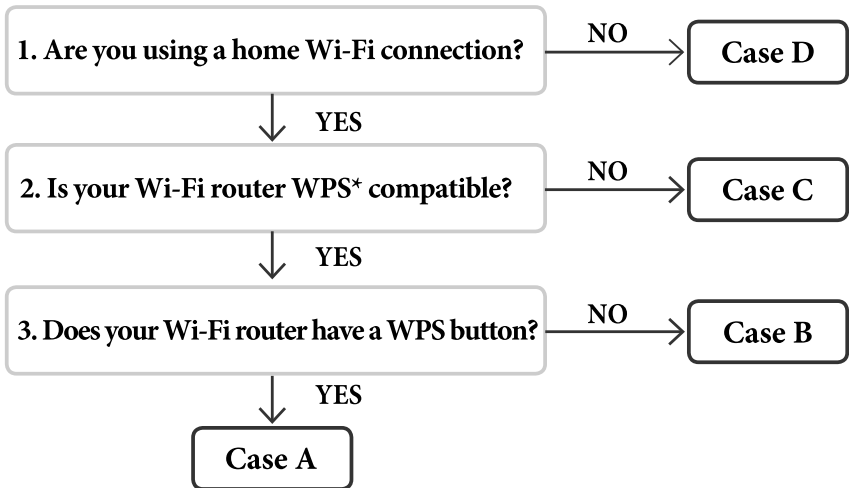

*WPS: Wi-Fi Protected Setup

Case A

A WPS-compatible Wi-Fi router with WPS button

Details

Case B

A WPS-compatible Wi-Fi router with PIN input

Details

Case C

Connecting to a Wi-Fi router without WPS support

Details

Case D

Connecting to an available Wi-Fi network

Details

Manual setup

Set up a Wi-Fi network connection manually; connect to an access point for which the SSID is set to be invisible. See Details.

Case A: A WPS-compatible Wi-Fi router with WPS button

The Reader is compatible with WPS (Wi-Fi Protected Setup), which lets you easily make a Wi-Fi connection using the “WPS” or “Connect” button on your WPS-compatible Wi-Fi router. Make sure to turn on [Wi-Fi] and tap [Wi-Fi Settings] on the [Wireless Network Settings] screen. Alternatively, you can turn on [Wi-Fi] by tapping the status bar and tapping [Wi-Fi Settings].

1 Tap [WPS Push-Button Configuration] → [Start].

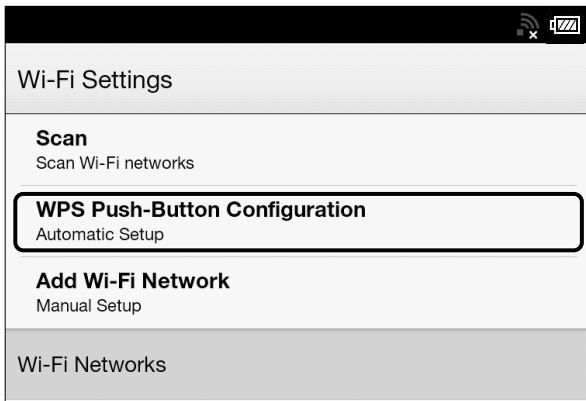

2 On your Wi-Fi router, press the “WPS” or “Connect” button within 2 minutes.*

The Reader automatically attempts to establish a

Wi-Fi connection.

* The name of the button on your Wi-Fi router may vary.

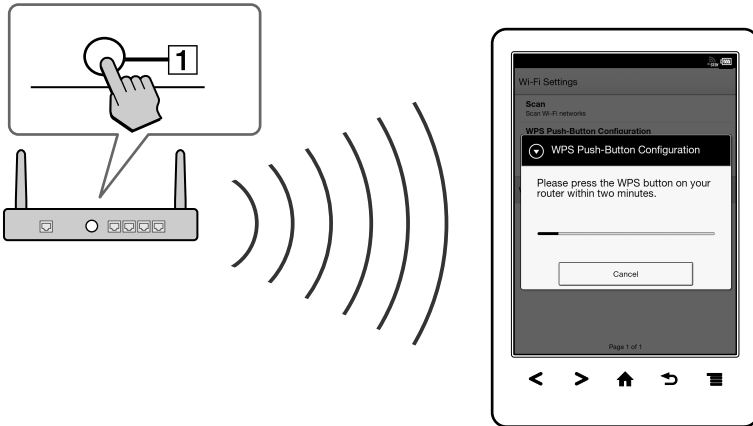

1 “WPS” or “Connect” button

3 After the Reader screen shows the setup completion, tap [OK].

The wireless connection status is displayed in the status bar. See Details.

For more technical notes, see Details.

Case B: A WPS-compatible Wi-Fi router with PIN input

If your WPS-compatible Wi-Fi router does not support push-button configuration, connect by using a PIN (Personal Identification Number). Make sure to turn on [Wi-Fi] and tap [Wi-Fi Settings] on the [Wireless Network Settings] screen. Alternatively, you can turn on [Wi-Fi] by tapping the status bar and tapping [Wi-Fi Settings].

- 1 Tap **[Add Wi-Fi Network]** → **[WPS PIN Method]** → **[Start]**.

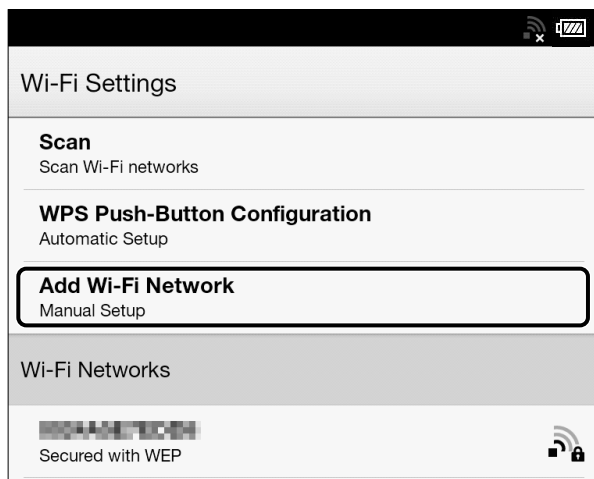

A PIN will be shown on the screen of the Reader. Enter the PIN into your Wi-Fi router.

Refer to your Wi-Fi router's instruction manual for further details.

- 2 After entering the PIN, tap [OK] on the Reader. After a moment, the Reader connects to the wireless network automatically.**

The wireless connection status is displayed in the status bar. See Details.

For more technical notes, see Details.

Case C: Connecting to a Wi-Fi router without WPS support

Make sure to turn on [Wi-Fi] and tap [Wi-Fi Settings] on the [Wireless Network Settings] screen. Alternatively, you can turn on [Wi-Fi] by tapping the status bar and tapping [Wi-Fi Settings].

1 Tap [Scan].

The available access points are listed under [Wi-Fi Networks].

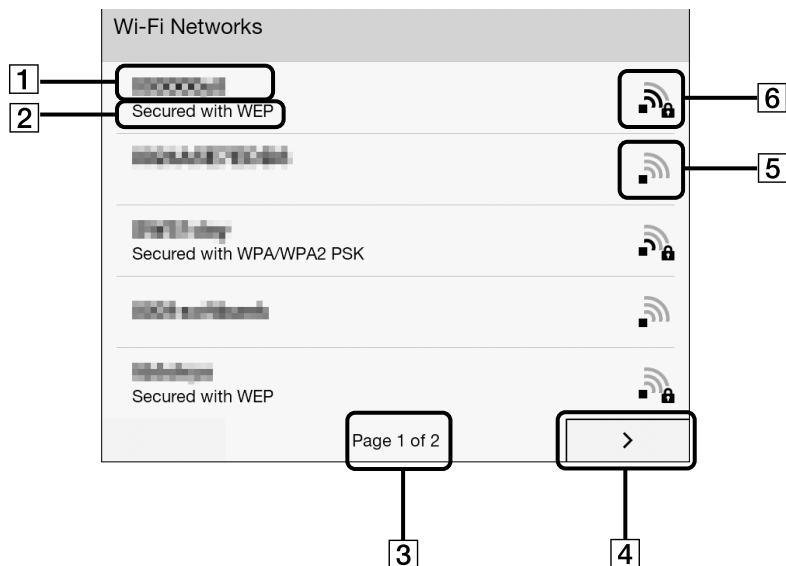

Item	Description
1	Network SSID
2	Security type
3	Page indicator
4	Page turn icon
5	Wi-Fi is activated and the Reader detects an unsecured network.
6	Wi-Fi is activated and the Reader detects a secured network. The Wi-Fi router to which you want to connect requires a password. A password may also be called a WEP key/WPA key/encryption key/network key, etc.

- 2 Tap your Wi-Fi router's SSID (Service Set Identifier) in the [Wi-Fi Networks] list. For details on determining your Wi-Fi router's SSID, refer to your Wi-Fi router's instruction manual.**
- 3 If prompted for a password, tap the input area and type in the password using the on-screen keyboard.**
- 4 Tap [Connect].**

The Reader connects to the Wi-Fi network.

The wireless connection status is displayed in the status bar. See Details.

For more technical notes, see Details.

Case D: Connecting to an available Wi-Fi network

Some public wireless access points, or “hotspots”, are open and you can simply connect to them. Make sure to turn on [Wi-Fi] and tap [Wi-Fi Settings] on the [Wireless Network Settings] screen. Alternatively, you can turn on [Wi-Fi] by tapping the status bar and tapping [Wi-Fi Settings].

1 Tap [Scan].

The available access points are listed under [Wi-Fi Networks].

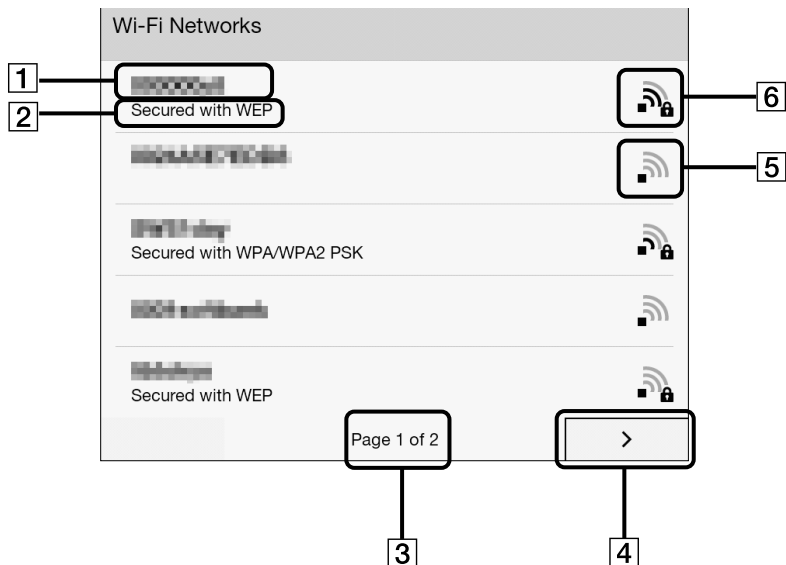

Item	Description
1	Network SSID
2	Security type
3	Page indicator
4	Page turn icon
5	Wi-Fi is activated and the Reader detects an unsecured network.

Item	Description
6	Wi-Fi is activated and the Reader detects a secured network. The Wi-Fi router to which you want to connect requires a password. A password may also be called a WEP key/WPA key/encryption key/network key, etc.

- 2 Tap your Wi-Fi router's SSID (Service Set Identifier) in the [Wi-Fi Networks] list.**
- 3 If prompted for a password, tap the input area and type in the password using the on-screen keyboard.**
- 4 Tap [Connect].**

The wireless connection status is displayed in the status bar.
- 5 The [Browser] application may start automatically to connect to a public access point. Otherwise, start the [Browser] application manually; press the **↑** (Home) button, tap [Applications] → [Browser].**

- 6 The browser screen may show further information about completing the connection. Follow any instruction(s) where applicable.**

For more technical notes, see Details.

Manually setting a Wi-Fi connection

You can set up a Wi-Fi network connection manually by inputting the required information for connection. Make sure to turn on [Wi-Fi] and tap [Wi-Fi Settings] on the [Wireless Network Settings] screen. Alternatively, you can turn on [Wi-Fi] by tapping the status bar and tapping [Wi-Fi Settings].

1 Tap [Add Wi-Fi Network].

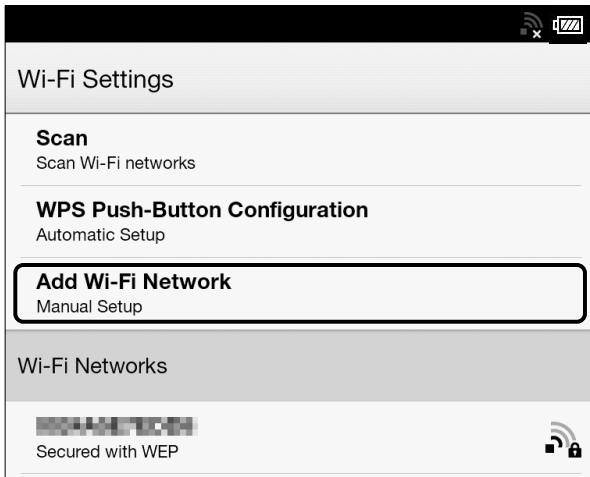

2 Tap [Manual Registration].

3 Tap the [SSID] input area and type in using the on-screen keyboard.

- 4 Tap the [Security Method] menu (the default value is [Open]), and then tap the supported security type.**
- 5 Tap the [Password] input area and type in your password using the on-screen keyboard, and then tap [Done] → [Save].**
- 6 Tap the saved network SSID in the [Wi-Fi Networks] list on the [Wi-Fi Settings] screen.**
- 7 If prompted for a password, tap the input area and type in the password using the on-screen keyboard.**
- 8 Tap [Connect].**

The Reader connects to the Wi-Fi network.

The Wi-Fi connection status is displayed in the status bar. See Details.

For more technical notes, see Details.

General notes on Wi-Fi connectivity

- Tap and hold a network SSID in the [Wi-Fi Networks] list to display the access point's status and related information.
- Before connecting to a wireless network, check all requirements, user name and/or password details with the internet/Wi-Fi service provider.
- You can configure up to 20 Wi-Fi network connections.
- The Reader does not support certain custom Wi-Fi network security systems. For details, contact the internet/Wi-Fi service provider.
- If you edit the password of a Wi-Fi network to which you are currently connected, the Reader will attempt to reconnect to the Wi-Fi network using the new password.
- To use a static IP address, press the ☰ (Menu) button ➔ tap [Advanced] in the [Wi-Fi Settings] ➔ tap [Use Static IP]. Do not change this setting unless instructed to by a network administrator, as the Wi-Fi network connection may not be established correctly.

- If an access point's SSID (Service Set Identifier) is private, enter Wi-Fi connection information manually.
- The access point may filter access by MAC address. Check the MAC address by pressing the 🏠 (Home) button → tap [Applications] → [Settings] → [About] → [Device Information], then register the MAC address with the access point to establish a Wi-Fi connection.
- When you are connected to a Wi-Fi network, you can also display speed, security and other Wi-Fi network details by pressing the ☰ (Menu) button and tapping [Connection Information] in the [Wi-Fi Settings] screen.
- An access point, once configured, can be connected to again simply by tapping it in the [Wi-Fi Networks] list and tapping [Connect].

Battery

Charging the Reader

The charge/battery status icon at the right side of the status bar shows the battery level. See Details. If it is low, choose one of the methods in the following sections to charge the Reader.

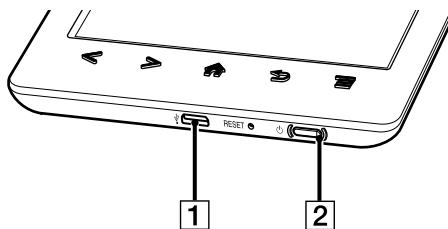





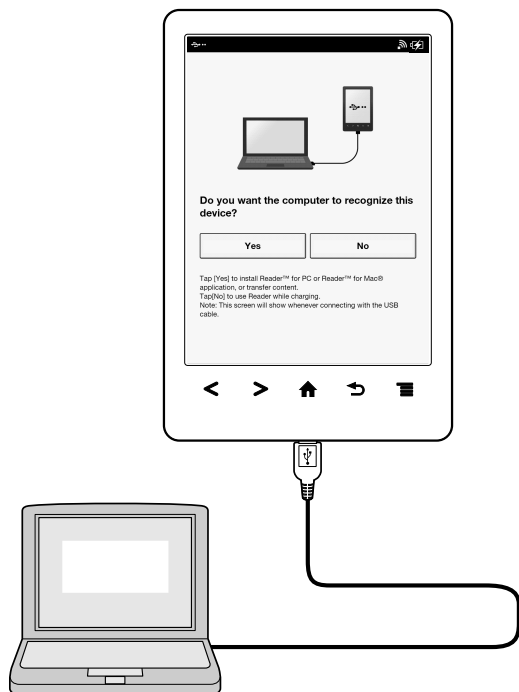

- 1** USB connector
- 2** Charge indicator

Charging via your computer

- 1 Power on your computer.**
- 2 Connect the Reader to your computer with the supplied USB cable.**

Wait until the below screen is displayed.



To	Description
Install the Reader application, or transfer files from your computer to the Reader while charging. The Reader cannot be operated during transfer.	<p>Tap [Yes] to install the Reader application, or transfer files from your computer to the Reader while charging. The Reader cannot be operated during transfer.</p> <p>After the USB storage screen is displayed on the Reader, it is detected on your computer, and the "READER" and "SETUP" drives appear on your computer.</p> <p>When the  icon* turns into the  icon, charging is complete.</p> <p>When charging is complete, disconnect the USB cable from the Reader and your computer. After a short time, the [Home] screen will appear.</p> <p>* This icon is only displayed when the Reader is in data transfer mode.</p>
Charge the Reader	<p>Tap [No], or press the  (Back) button, to return to the previous screen.</p> <p>Alternatively, press the  (Home) button. The [Home] screen appears. When the  icon turns into the  icon, charging is complete.</p> <p>In this mode, the Reader is not detected by your computer*. When charging is complete, disconnect the USB cable from the Reader and your computer.</p> <p>* This situation may vary, depending on the settings of your computer.</p>

Note

- Do not set the Reader to data transfer mode while downloading via a wireless connection.
- Your computer must be turned on to charge the Reader. The Reader will not be charged if your computer enters sleep mode or standby mode. Keep your computer turned on with a stable and continuous power supply while charging the Reader.
- The  (Power) button cannot be used when the Reader is connected to your computer and charging.
- If you turn off the Reader by tapping [Settings] → [Device Shutdown] while in charging mode, the Reader will stop charging.

Tip

- You can also charge the Reader using the AC Adapter (PRSA-AC10/PRSA-AC1A, sold separately). This method of charging will take approximately 2 hours to fully charge the battery.
- If the battery is depleted, charging the Reader with the AC adapter for 3 minutes will provide enough battery power to read up to approximately 600 pages.
- To change from charge mode to data transfer mode, tap the status bar to display the notification window → tap [USB connected] → [Yes].

Charge/Battery status icon

The charge/battery status icon shows the charging status or approximate remaining charge of the battery.

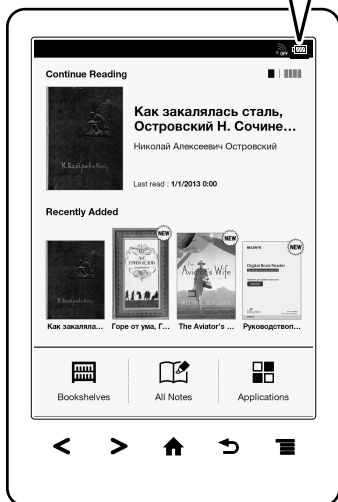
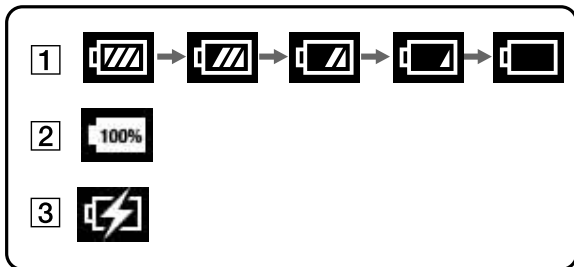

Icon	Description
1	Four bars indicate a fully charged or almost-fully charged battery. The number of bars decreases with the battery's charge. Zero bars indicate that the battery has almost no remaining charge.
2	The battery is fully charged.
3	The battery is charging.

Maximizing Battery Life

There are many ways to conserve battery power. To extend battery life:

- If you have no plans to use the Reader, completely power off the Reader.
- Do not leave the Reader with the battery depleted for a prolonged period of time. Battery capacity may be affected.
- Use and store the Reader at room temperature, or within the recommended temperature range of 5°C to 35°C (41°F to 95°F).
- Turn off Wi-Fi when no wireless communication is necessary.
- Turn on [Wireless Standby] when you want to extend the battery life.

Power-consuming operations

The following may require more power than normal reading operations.

- Wi-Fi communications
- Constantly updating the [Wi-Fi Networks] list
- Displaying graphic-intensive books, files or Web sites
- Displaying a slideshow with a short interval setting
- Using a microSD card
- Frequent insertion and removal of a microSD card
- Having a large volume of content stored on a microSD card
- Annotations, keyword searches and dictionary searches
- The Wi-Fi network feature of the Reader is not in standby mode.

Installing Reader application (Reader for PC/Mac)

Installing Reader application (Reader for PC/Mac)

- 1 Turn on your computer, connect your computer to the internet, and then connect the Reader to your computer using the supplied USB cable.**

Make sure you have administrator access to your computer.

- 2 When [Do you want the computer to recognize this device?] appears, tap [Yes]. See Details.**

- 3 To install on Windows computers:**

From your computer, click on the “Start” menu → “Computer” or “My Computer” → double-click the “SETUP” drive → double-click “Setup Reader for PC”.

To install on Mac computers:

When the Reader is connected to your Mac, the

“SETUP” and “READER” drives will appear on the desktop. Double-click the “SETUP” drive ➔ double-click “Setup Reader for Mac”.

4 Follow the on-screen instructions on computer to complete the installation of the Reader application.

For details on transferring content to the Reader and syncing, refer to the [Help] menu of the Reader application.

5 When transfer is complete, click “Disconnect” on the Reader application, and then disconnect the USB cable from the Reader. After a short time, the [Home] screen will appear.

Content will be sent to its corresponding application based on the file format of the content. Personal documents other than pictures files will be sent to the [Books] application.

Tip

- When you transfer data to the microSD card, insert the microSD card to the Reader in Step 2.
- For details on the system requirements for the Reader application, see Details.
- For details on supported file formats, see Details.

Turning the Power On/Off

Turning the Power On/Off

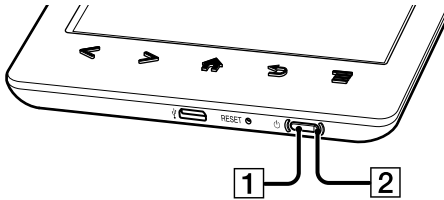

1 ⏻ (Power) button

2 Charge indicator

Turning on the power

1 Press the ⏻ (Power) button.

If the battery is completely depleted, power will not be supplied to the ⏻ (Power) button, and you may not be able to turn on the Reader. In this case, the Charge indicator may blink red 3 times. Connect the Reader to your computer via the supplied USB cable; the Reader will automatically turn on immediately. Wait until the Reader turns on before trying to operate it.

Shutting down/turning off the power completely

1 Press and hold the  (Power) button for about 3 seconds.

2 Tap [Yes] to turn off the Reader.

Completely turning off the Reader can preserve battery power longer than sleep mode when you are not using the Reader for a prolonged period of time.

The same operation can be done via [Settings].

1 Press the  (Home) button → tap [Applications] → [Settings] → [Device Shutdown] → [Yes].

Sleep mode

To save battery life and prevent unintentional operation of the touchscreen, set the Reader to sleep mode by pressing the ⏻ (Power) button. The standby screen appears. You can personalize the standby screen. See Details.

To wake the Reader, press the ⏻ (Power) button again.

Tip

- The Reader can also be set to sleep mode by closing the Standard Cover or Cover with Light (sold separately).

Automatic power-saving modes

The Reader will enter sleep mode after 10 minutes of inactivity. After 3 days in sleep mode, the Reader will shut down/power off automatically. The automatic power-saving modes cannot be turned off.

Parts and Controls

Overview

This section describes the features and controls of the Reader.

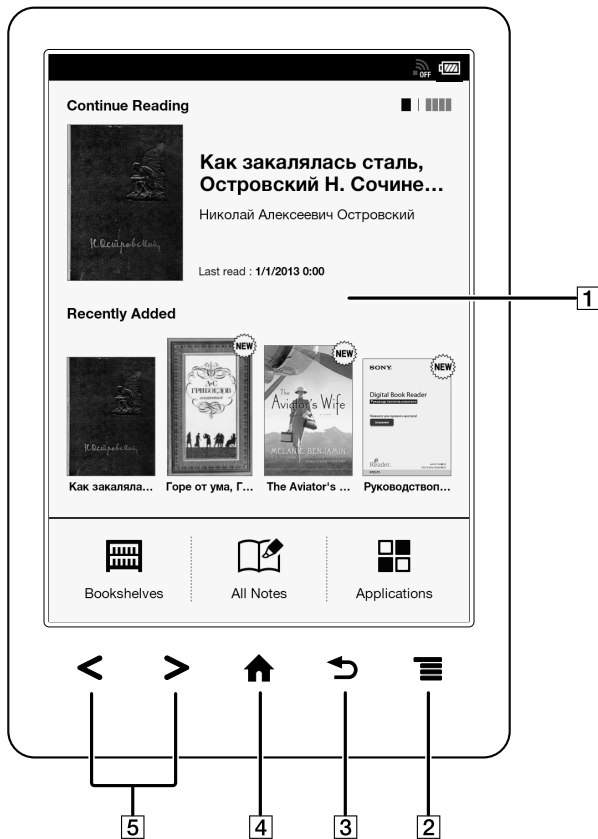

- 1** Touchscreen
- 2** ≡ (Menu) button
- 3** ↶ (Back) button
- 4** ⬆ (Home) button
- 5** < > (Page turn) buttons

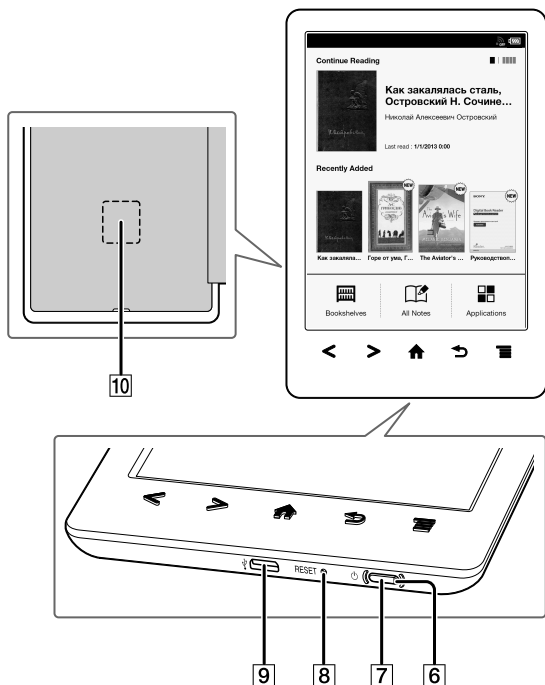

- 6** Charge indicator
- 7** ⏻ (Power) button
- 8** RESET button
- 9** ⚡ Micro USB connector
- 10** microSD card slot

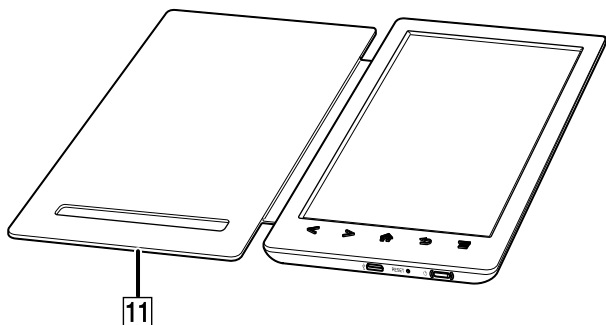

11 Standard Cover

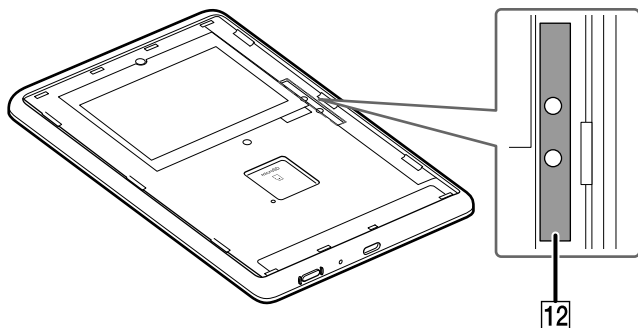

12 Power supply terminal

Note

- The power supply terminal can be used to supply power to the Cover with Light (PRSA-CL30, sold separately).

Supplied accessories

- USB cable × 1
- Standard Cover × 1

[Table of Contents](#)

Buttons

(Power)

Turns the Reader on/off, and sets it to sleep mode. See Details.

< > (Page turn)

When reading a book: Press either button to turn the page back or forward, respectively. Press and hold either button to turn pages continuously.

When using the Web browser: Press either button to scroll the page up or down, respectively.

(Home)

Displays the [Home] screen.

(Back)

Returns to the previous screen, or returns to the content list from a book. Also closes the on-screen keyboard or a dialog box/navigation bar/tool bar.

(Menu)

Displays the available option items.

Removing/attaching the Standard Cover

Removing the Standard Cover

- 1** Open the Standard Cover and turn over the Reader.
- 2** Hold the Reader firmly with one hand.
- 3** Place your fingernail or a pointed object into the slot on the bottom edge, then carefully lift and remove the Standard Cover.

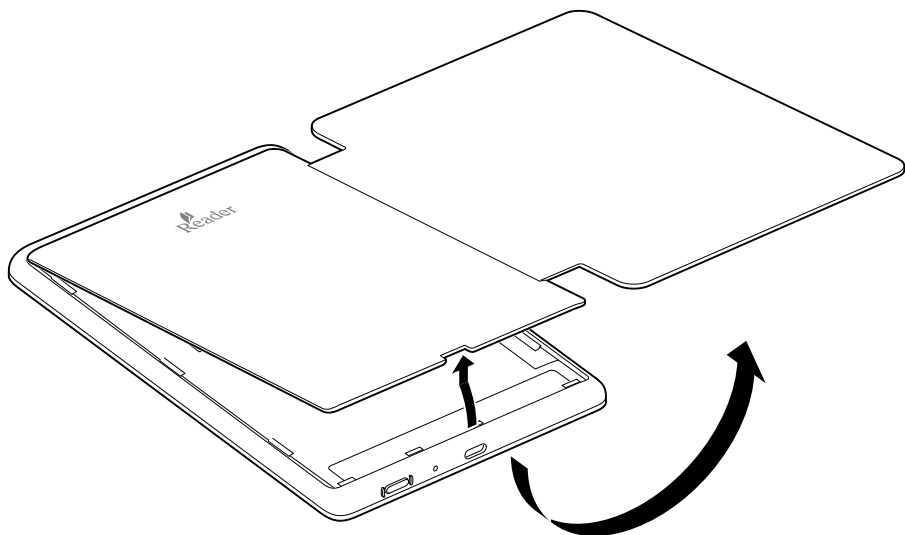

Attaching the Standard Cover

- 1** Insert the top four tabs of the Standard Cover into the upper holes of the Reader.
- 2** Insert all the tabs in their holes (indicated by arrows), and push down the Standard Cover firmly.

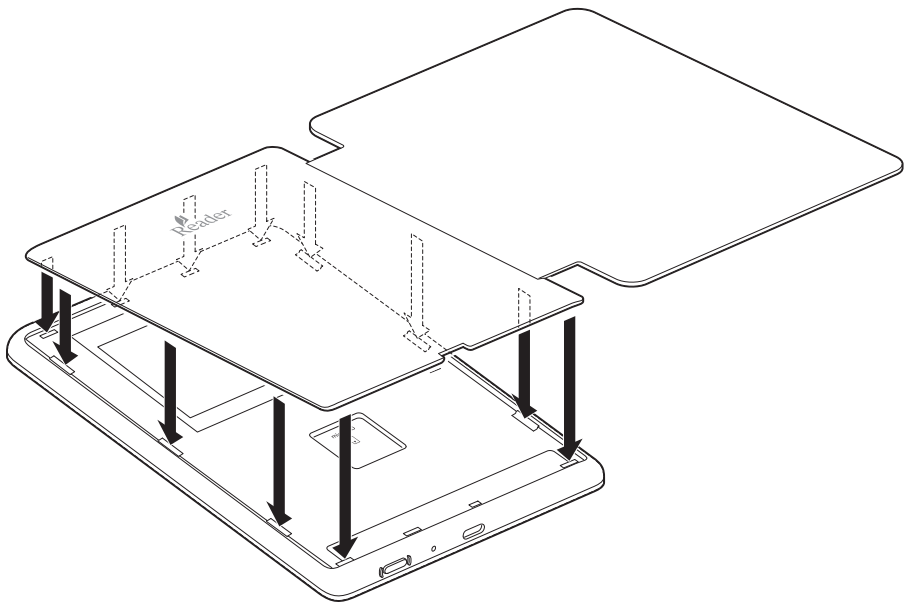

Note

- Do not remove the label on the battery.

Tip

- The Standard Cover and Cover with Light (sold separately) include a magnetically-activated wake/sleep feature, which automatically wakes/puts your Reader to sleep when you open/close the cover.

microSD Card Slot

The microSD card slot is located on the back of the Reader.

- 1 Remove the Standard Cover.**
- 2 Hold the microSD card with its contacts facing down and the arrow pointing toward the microSD card slot, then insert it until it clicks into place.**
The access indicator lights up in orange while the Reader is accessing the microSD card.

- 3 Attach the Standard Cover.**

You can format the microSD card if necessary. See Details.

Note

- Do not remove the microSD card while the access indicator is lit.
- Push in the microSD card once, carefully slide the card out with your fingertip, then release.

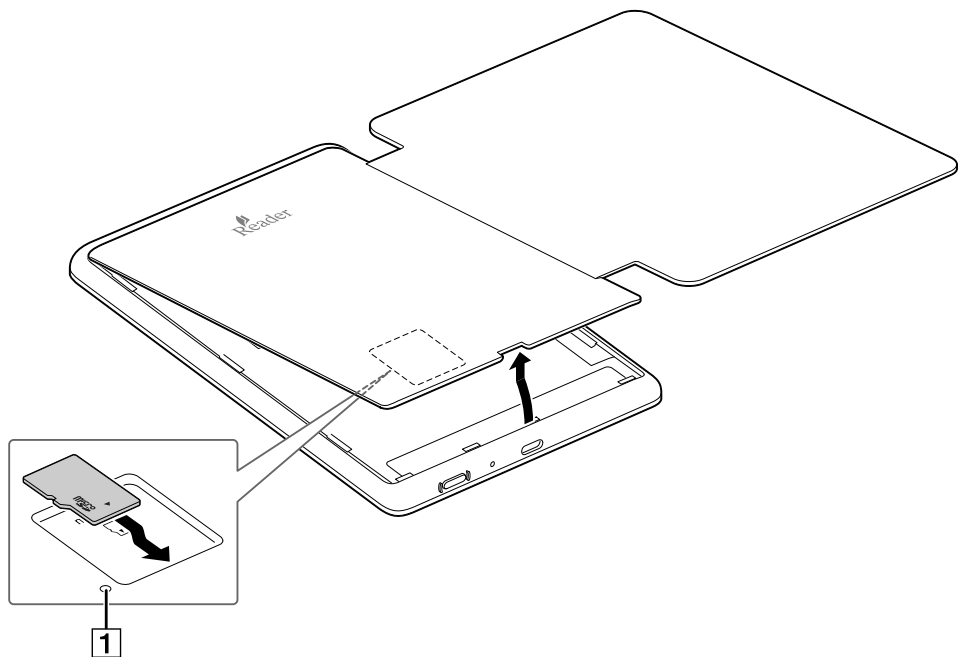

1 Access indicator

[Home] Screen

Applications and the [Home] Screen

Press the  (Home) button to display the [Home] screen. The [Home] screen has the following applications.

The displayed icons may vary depending on the country/region setting.



1 Status bar

2 Last read item

Tap ■■■■ to show the four most recently read books.

Tap ■ to show the previous screen.

3 Recently added books

4 Applications

The [Applications] screen appears when you tap [Applications] on the [Home] screen.

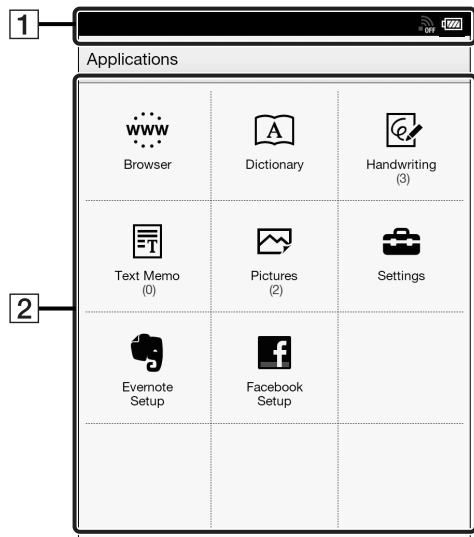

1 Status bar

2 Applications

Tip

- The most recent book that you opened is shown under

[Continue Reading] on the [Home] screen. Tap it to continue reading where you previously left off.

- The four most recently read books are shown by changing the [Continue Reading] on the [Home] screen.
- The four most recent books that have been added to the Reader are displayed under [Recently Added] on the [Home] screen. Tap one to start reading it.











Application	Description
[Bookshelves]	Tap [Bookshelves] to show the [Books] content list by factory default. Alternatively, tap the top-left corner of the screen or press ☰ (Menu) button → [Choose Bookshelf] to show the following pop-up menu. [Books] [Collections] [Evernote]
[All Notes]	Lists the bookmarks/annotations made on the books. See Details.
[Applications]	Lists the applications.



Application	Description
[Browser]	Launches the Web browser. See Details.
[Dictionary]	Allows you to look up a word in the dictionary. See Details.
[Handwriting]	Allows you to use a drawing pad for drawing. See Details
[Text Memo]	Allows you to use a notepad for typing memos. See Details.
[Pictures]	Shows pictures in the Reader and, if inserted, the microSD card. See Details.
[Settings]	Displays the items for setting the Reader. See Details.
[Evernote Setup]	Sign in to upload your highlights, pictures and handwritten notes to Evernote cloud. See Details.
[Facebook Setup]	Log in or Log out to post book information, favourite passages and collections with your comments to Facebook. See Details.

Status bar

The status bar shows the current status of the Reader, such as Wi-Fi status, the battery level and the status of downloading files.

The following items are displayed in the status bar.

Icon	Indication
	Connected via the USB cable.
	Connecting to a network.
	A download is in progress. When multiple downloads are in progress, the number of downloads is displayed next to this icon. This icon is also shown when downloading the firmware update.
	A download has completed. If downloading fails, the  (Fail) icon is displayed. The icon disappears when you open the notification window and tap [Clear], or when you tap the downloaded items in the [Notification] list. This icon is also shown when firmware download is complete.
	Evernote synchronizing in progress.
	Evernote synchronizing completed. If synchronizing fails, the  (Fail) icon will be displayed. The icon disappears when you open the notification window and tap [Clear], or when you tap a synchronized item in the [Notification] list.
	The icon appears when Evernote synchronizing stops.
	Updating database.

	Wi-Fi network signal strength. See Details.
	Current battery level. See Details.
	The icon appears when new firmware is found.

Note

- Depending on the situation, not all icons will be displayed at once.





Tip

- When you press the  (Menu) button from the [Home] screen, the time is displayed at the left side of the status bar for approximately 5 seconds.

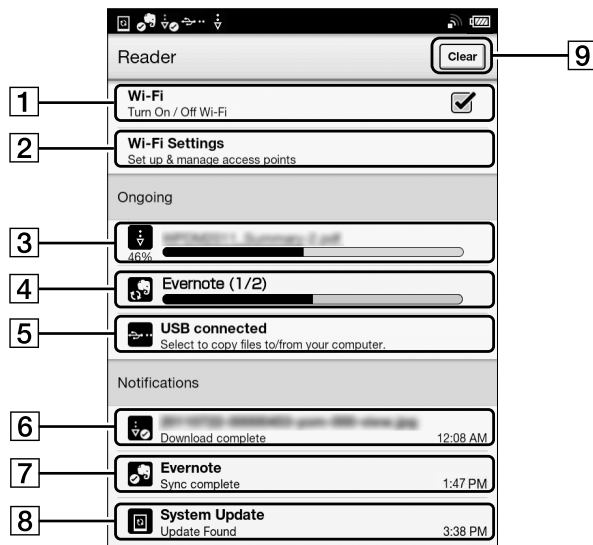
Notification window

Tapping on the status bar reveals the notification window, which contains network-related items and other current operations.



Item	Description
1	Turn [Wi-Fi] on/off. See Details.
2	Go to the [Wi-Fi Settings] screen. See Details.
3	Displays the status of items that are downloading from the Web. The progress bar indicates how long an item download will take from the Web.
4	Displayed when Evernote synchronizing is in progress.
5	Enter data transfer mode. See Details.
6	An item that has been downloaded. Tap to open the item.
7	Item with which Evernote synchronizing has completed. Tap to open.
8	Displayed when new firmware is found.
9	Displayed when notifications are displayed. Tap to clear the notification list. The  (Download complete) icon,  (Evernote sync complete) icon,  (Evernote sync failed) icon and  (New firmware is found) icon also disappear from the status bar.

Depending on the status of the Reader, other items may also appear in the notification window.

Press the ☰ (Menu) button to close the notification window

Touchscreen Operations

The touchscreen recognizes the following gestures.

Tap

Tap an icon, a button or a menu item and raise your finger quickly to select or perform an action.

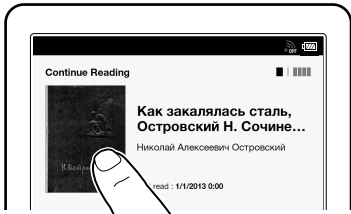

Tap and hold

Tap and hold your finger to select a word and display a pop-up menu for further operations.

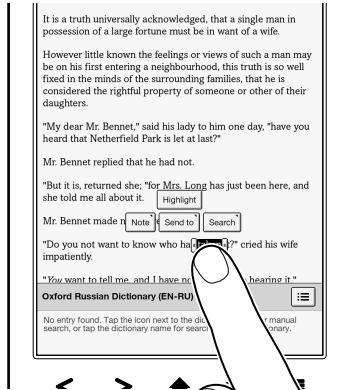

Tap, hold and drag

Touch and hold your finger to the display and drag your finger; you can select a group of text and display a pop-up menu for further operations.

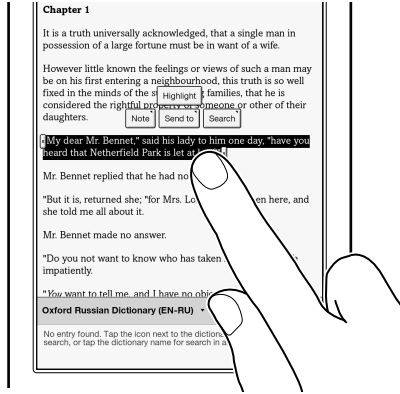

Swipe

Slide your finger gently and swiftly on the touchscreen to turn the page; you can turn the page forward by swiping to the left, or backward by swiping to the right. You can also navigate pages of content lists.

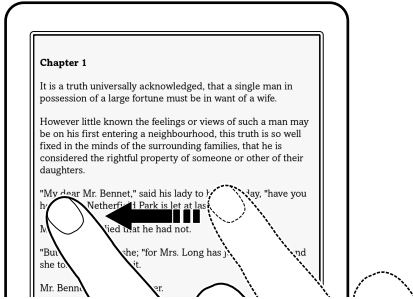

Swipe and hold

To turn multiple pages continuously, swipe and hold your finger on the screen. Release your finger to stop.

Pinch

Pinch your fingers in or out to zoom in or out of the current page or image.

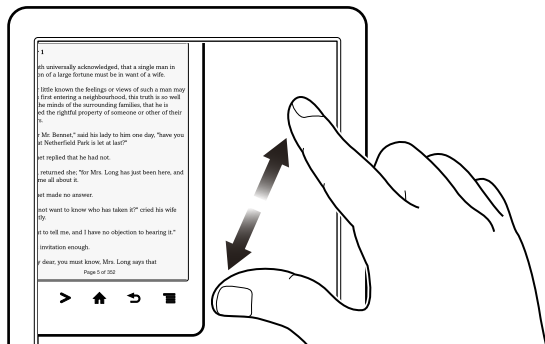

Note

- To exit zoom mode, press the ↶ (Back) button.

Drag

Touch and drag your finger to reposition a zoomed-in page or image. The page or image is repositioned after you release your finger.

On-Screen Keyboard

The on-screen keyboard is used when you need to type. If the keyboard does not automatically appear, tap the input area on the screen.

On-screen keyboard layout

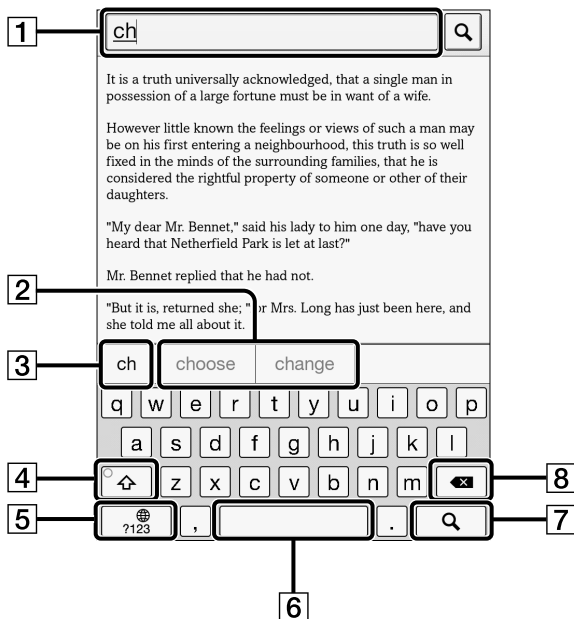



- 1 Input area
- 2 Keyboard history
- 3 Current word input box







4 Shift key/[ALT]

5 [?123]/[ABC]

6 Space

7  (Search icon)/ (Line feed icon)/[Go]

8 Backspace

To	Do this
Input text	Tap the input area.
Delete a character	Tap  .
Finish typing	Tap [Go]/[Done].
Insert line feed	Tap the  key. The  key is enabled only when multi-line input is available.
Switch the keyboard type	Tap [?123] to display the symbol keyboard. Tap [ALT] to switch to additional characters. Tap [ABC] to return to the alphabetical keys.
Switch between QWERTY input and Cyrillic character input	Tap and hold [?123]/[ABC].
Capitalize a single letter	Tap  . Tap and hold  to activate caps lock. To cancel, tap  again.
Enter a space	Tap the space key.

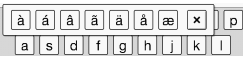
To	Do this
Enter a previously registered word	A list of words you registered to the keyboard history* displayed next to the current word input box. Tap the desired word to enter it. Tap and hold the current word input box to register the word in it to the keyboard history. (The word must consist of at least 3 letters.)
Move the cursor in the input area	Tap the location to which you want to move the cursor.
Type extended characters	Tap and hold a key and choose one from the keys. 

* To clear the keyboard history, press the  (Home) button → tap [Applications] → [Settings] → [Initialization] → [Clear Keyboard History].

Note

- The available types of keyboards and input methods differ depending on the application.

Adding Content

Adding Content

Transferring content via the Reader application (Reader for PC/Mac)

You can use the Reader application to transfer books and pictures to the Reader. You will need to install the Reader application and organize content on your computer in advance. You can also backup the contents on the Reader to the Reader application.

Transferring content via drag-and-drop

You can directly transfer content by drag-and-drop to your computer.

1 Connect the Reader to your computer using the supplied USB cable.

Make sure the Reader is in a state that can transfer data. See Details.

- 2 For Windows users, click on the “Start” menu → “Computer” or “My Computer” → double-click the “READER” drive, and then drag and drop your data onto the “READER” drive.**

For Mac users, double-click the “READER” drive, and then drag and drop your data onto the “READER” drive.

- 3 When transfer is complete, use the safely remove hardware function of your computer before disconnecting the USB cable from the Reader and your computer.**

Content will be sent to its corresponding application based on the file format of the content. Personal documents other than pictures files will be sent to the [Books] application.

Note

- Content transferred via drag-and-drop may not be displayable on the Reader, or thumbnails of the content may not be properly displayed on the Reader. Sony recommends that you transfer data via the Reader application.
- Do not delete any system default folders created by the Reader on the “READER” drive, the “SETUP” drive or the

microSD card.

- If you disconnect the USB cable while data is being transferred, data corruption may occur. To disconnect the Reader or the microSD card when the Reader is connected to your computer, make sure to use the safely remove hardware function of your computer, and then disconnect the USB cable.
- Do not format the Reader or your microSD card via your computer. If you have formatted the Reader or microSD card on your computer, the Reader may not be able to display transferred content. In this case, use the Reader's [Format Memory] function to reformat the Reader and your microSD card. See Details.

Tip

- When you transfer data to the microSD card, insert the microSD card to the Reader in Step 1, and drag-and-drop to the microSD (removable disk) drive in Step 2 above.
- For details on the system requirements for the Reader application, see Details.
- For details on supported file formats, see Details.

Content Lists

Browsing Content List Pages

The Reader organizes content by content type and file format using applications. For example, books or your personal documents (such as PDF files or text files) are stored in the [Books] application and pictures in the [Pictures] application, etc.

Content list pages allow you to sort content, as well as search content on the Reader.

The following instructions use the [Books] application as an example.

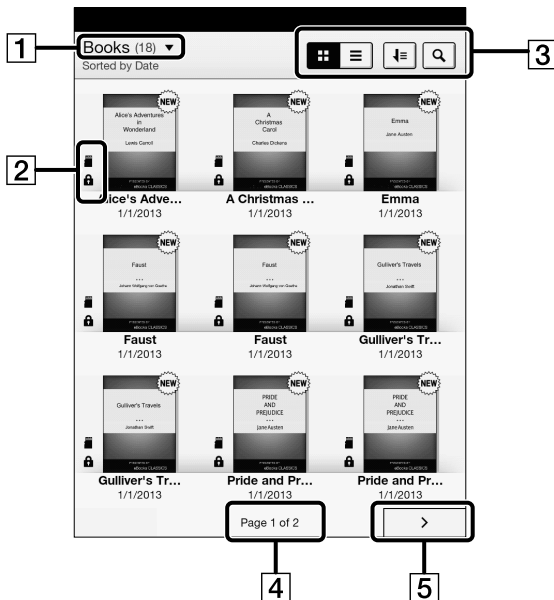

1 Tap to choose the bookshelf

2 Status icons

3 Tool icons Details



4 Page indicator

5 Page navigation icon

Tip

- Depending on the application, several tools are available for content list pages. See Details.

Status icons

Icon	Description
	The item is stored on the microSD card.
	The item is protected from deletion. See Details.
	The item has not been opened.*

* This icon is displayed for books only.

Navigation

Navigation method	Description
Page indicator	Display the page jump panel. See Details.
Page navigation icon or the < (Previous) button	View the previous page or item.
Page navigation icon or the > (Next) button	View the next page or item.

Browsing in Thumbnail View and List View

Content can be displayed as individual thumbnails or in a list.

The following instructions use the [Books] application as an example.

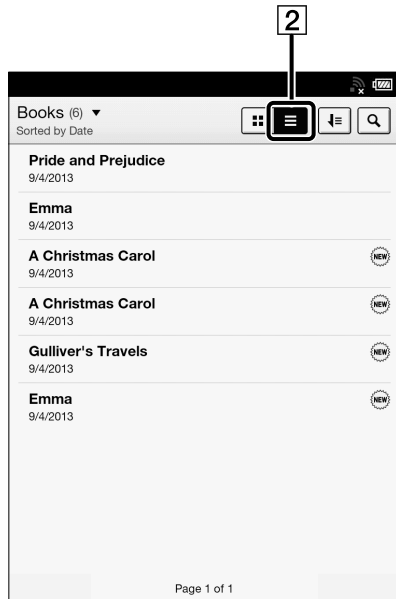
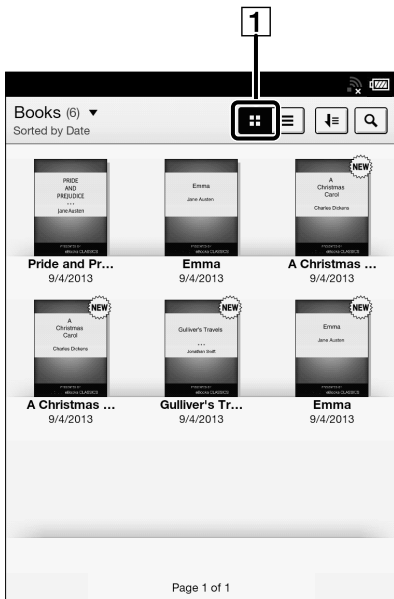

1 Thumbnail view icon

2 List view icon

1 Press the **⬆** (Home) button → tap **[Bookshelves]**
→ tap **[Books]**.

2 Tap  or .*

 displays thumbnails of content.

 displays a list of content.

* Some applications only allow list view.

Adjusting the title view

The titles of some books may be cut off if they are too long. To avoid this, you can set the Reader to display titles across two lines instead of one line.

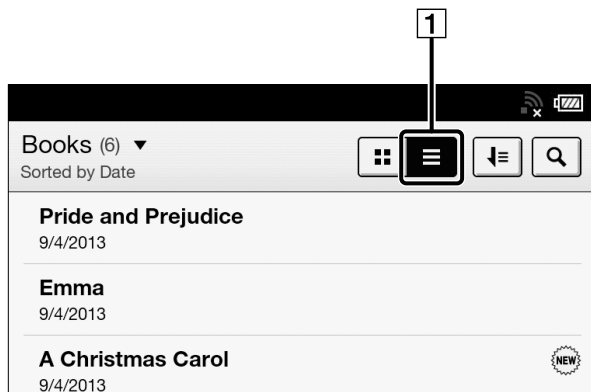

1 List view

- 1 Press the **⬆️ (Home) button** → tap **[Bookshelves]** → **[Books]** → **☰ (List view)** → **press the ☰ (Menu) button** → **tap [Title (2 Line View)]**.

Titles are displayed on two lines.

Tip

- When you tap [Bookshelves], any previously displayed content from [Books], [Collections] and [Evernote] will be shown.

Using the Page Jump Panel in Content List Pages

Content list pages can be turned conveniently via the page jump panel.

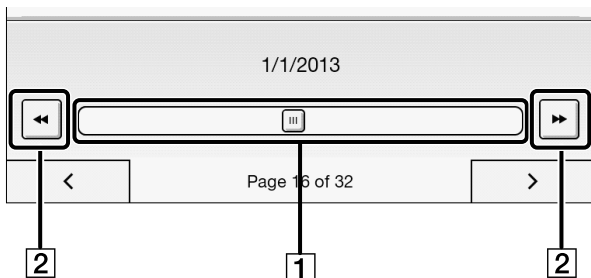

1 Page jump bar

2 Page skip icon

To use the page jump bar

- 1 When viewing a content list page, tap the page indicator at the bottom of the screen.**
- 2 Tap and slide the bar left or right to navigate back or forward.**

Press the ↶ (Back) button to hide the page jump panel.

Skipping 10 pages at a time

When the page jump bar is displayed, tap << or >> (Page skip) to skip back 10 pages or skip forward 10 pages at a time.

Finding Content with a Keyword

You can find a specific item quickly with a keyword search.

You can locate a book or author of a book on the Reader via the [Books] application, or search for annotations via the [All Notes] application, etc.

The following instructions use the [Books] application as an example.

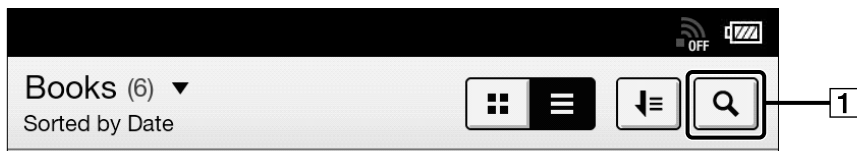

1 Search icon

1 Press the **↑** (Home) button → tap [Bookshelves].

2 Tap ; the keyword input area and the on-screen keyboard appear.

3 Input a search keyword and tap .

The view shows only the items that satisfy the search criteria.

To exit the search result view, press the ↶ (Back) button.

Note

- Some applications do not support keyword searching.
- The available search target varies among content types.

Posting Book information to Facebook

You can post the book title and author information to Facebook.

- 1. Press the  (Home) button → tap [Bookshelves] → tap and hold the book that you wish to post.**
- 2. Tap [Post to Facebook].**

The selected book information is posted to Facebook.









Note

- Before posting to Facebook, you need to log in. Press the  (Home) button → tap [Applications] → [Facebook Setup].

Tools

Below is a list of the tools available on each application's content list page.

Not all tools are available in each application.

Tool icon	Description
	Changes the view between the thumbnail view and the list view. See Details.
	Changes the sort order.
	Finds content with a keyword. See Details.
	Creates a new collection.
	Specifies the notes type to view in the list.
	Creates a new drawing.
	Creates a new memo.
	Synchronizing with Evernote. See Details. During synchronization, the icon will change to  (tap to stop synchronization).

Using ☰ (Menu) Items

Below is a list of option items available when you press the ☰ (Menu) button on each application's content list page.

Not all options are available in each application.

Option	Description
[Add to Collection]	Adds one or more books to a collection. See Details.
[Delete Books]	Deletes one or more books from the Reader. See Details.
[Protect Books]	Protects one or more books from deletion. See Details.
[Title (1 Line View)]/[Title (2 Line View)]	Displays the full title string without truncating it. See Details.
[Choose Bookshelf]	Open the pop-up menu and you can choose from following submenu. [Books] Displays the book. [Collections] Displays the collections. [Evernote] Displays items downloaded from Evernote.
[Move to Collection]	Moves one or more books to a collection.

Option	Description
[Remove Content]	Removes items from a collection that you have created. See Details.
[Rename Collection]	Renames a collection. See Details.
[Post to Facebook]	Posts a book collection information. See Details.
[Organize to Collection]	Moves one or more items of [Default Collection] to other collections created by the user. See Details.
[Sync]	Synchronizing with Evernote. See Details.
[Delete Notes]	Deletes one or more notes.
[Delete Memos]	Deletes one or more text memos. See Details.
[Protect Memos]	Protects one or more text memos. See Details.
[Delete Drawings]	Deletes one or more drawings. See Details.
[Protect Drawings]	Protects one or more text memos/drawings. See Details.
[Delete Pictures]	Deletes one or more pictures. See Details.

Option	Description
[Settings]	Changes the slideshow interval. See Details.

Reading Books

Opening a Book

- 1 Press the  (Home) button  tap [Bookshelves].**

The [Books] content list opens. See Details.



- 2 Tap a book.**

The book opens.

You can also open a book by tapping and holding the book you want to open.

To navigate within a book, see Details.

Tip

- When [Collections] or [Evernote] appears, tap the top-left corner of the screen to show [Books]. Alternatively, press the  (Menu) button  tap [Choose Bookshelf] to show [Books].

Page Navigation

There are several ways to navigate through books.

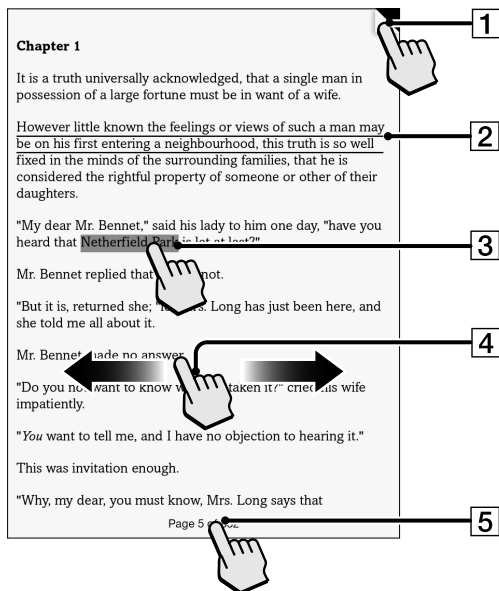

- 1** Tap to add a bookmark Details
Tap and hold to add a bookmark with note
- 2** Draw a handwritten note Details
- 3** Tap and hold to open option items Details
- 4** Swipe the screen to turn the page
- 5** Tap to open the page navigation panel.

Tip

- If you select the [Refresh Display] checkbox from [Application Preferences], the display refreshes at each page turn. See Details.

Using the page navigation panel

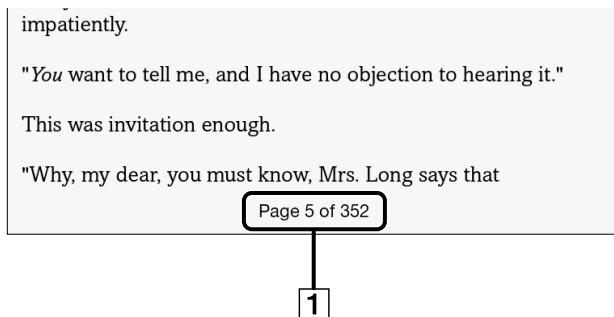

1 Page indicator

- 1 Tap the page indicator, or press the ≡ (Menu) button → tap [Navigate Page] to open the page navigation panel.

Using the paging bar

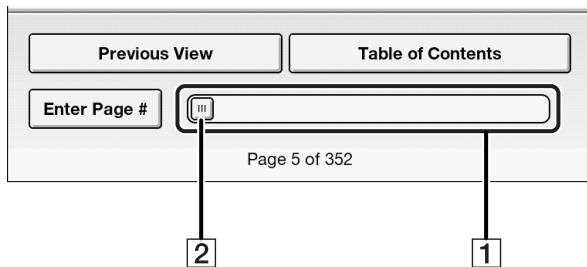

1 Paging bar

2 Slider

- Tap on a point on the paging bar to jump to a page that corresponds with that point.
- Tap and drag the slider.

To close the page navigation panel, press the ↶ (Back) button.

Using [Table of Contents]

1 Tap [Table of Contents].

To return to the book page, press the ↶ (Back) button.

2 Tap to open the selected chapter or section.

Using [Enter Page #]

- 1 Tap [Enter Page #] to enter the page number with the on-screen numeric keyboard, and tap [OK].

Jumping to viewed pages

- 1 Tap [Previous View].

The   (Page history) icons are displayed.

- 2 Tap  to go backward in the page display history. Tap  to go forward in the page display history.

To cancel page history, press the  (Back) button.

Tip

- This is the same operation for when you tap on a highlighted link.

Appearance

Changing the orientation

You can view books in either portrait or landscape mode.

1 When viewing a book, press the **☰ (Menu)** button → tap **[More]** → **[Orientation]**.

The screen orientation changes.

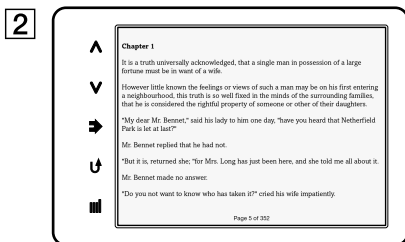
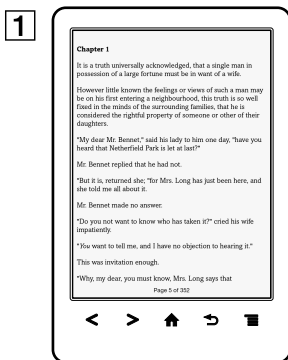

1 Portrait mode

2 Landscape mode

Note

- The orientation can be changed for the [Books], [Browser] and [Pictures] applications. Changing the orientation in one application does not affect the orientation setting of the other applications.

Changing the font and font size

You can change the font and font size to your preference.

- 1 When viewing a book, press the ☰ (Menu) button → tap [Font].**

The font bar is displayed.

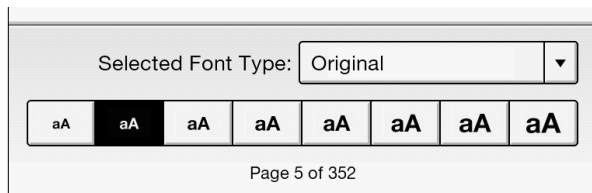

- 2 To change the font size, tap on one of the font size icons. The book will be updated to apply the specified font size.**

Press the ↶ (Back) button when done.

3 To change the font, tap [Original] and select from one of the fonts in the list.

Press the ↶ (Back) button when done.

The book will be updated to apply the specified font and font size.

Note

- The font size and font of some content with embedded fonts may not change.
- When you select other than the [Original] font, performance may be slightly lower when opening books or turning pages.
- When you select other than the [Original] font, boldface/italics/italicized boldface may not be displayed correctly.

Tip

- You can change the default font for all content in the [Books] application. See Details.

About PDF files

The Reader provides the ability to display most text-based PDF files in several font sizes. Documents are displayed in the default font position with their original layouts.

Due to the complex nature of PDF files, in certain situations when you change the font size, only text will appear. This is because some tables and graphics may be reformatted and altered during the reflow process. Also, in cases where PDF files are created using image data only, there is no text to reflow or resize. In these cases, if retaining the original layout of a PDF file is required, Sony recommends that you view the PDF file at its original font size.

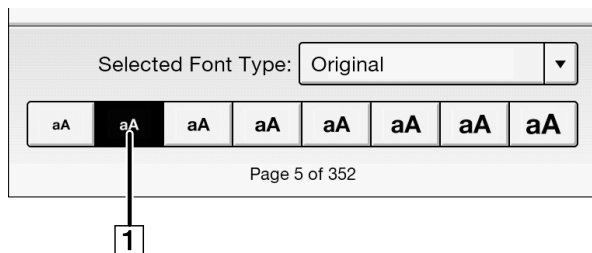

1 To display the original layout

Note

- If you modified the default font size with [Font Size Preference] under [Settings], return it to its original layout to view PDF files normally.
- To view the document in a different size, use the zoom in function.
- When you view PDF files in other than their original layout, some functions such as highlighting or searching may not work correctly.

Changing the page mode

You can change the page viewing style for PDF files. This is convenient for viewing pages with text arranged in columns.

This mode remains active as you continue reading. The setting applies only to the currently open book.

1 When viewing a book, press the ☰ (Menu) button → tap [Customize View] → [Page Mode].

The [Page Mode] screen appears.

2 Choose from one of the following options.

Option	Description
[Original]	Set to the default view.
[2-Column Split]	Splits the page into two columns and two rows.
[3-Column Split]	Splits the page into three columns and two rows.
[Fit Landscape Width]	Displays the page fit to landscape view.

Note

- In order to attach a handwritten note, the page mode needs to be restored to [Original].

Cropping a page

You can crop the page margins to create a wider viewing area. This is convenient for viewing pages that have large margins.

This mode remains active as you continue reading. The setting applies only to the currently open book.

- 1 When viewing a book, press the ☰ (Menu) button → tap [Customize View] → [Crop Page].**
- 2 Choose from one of the following options.**

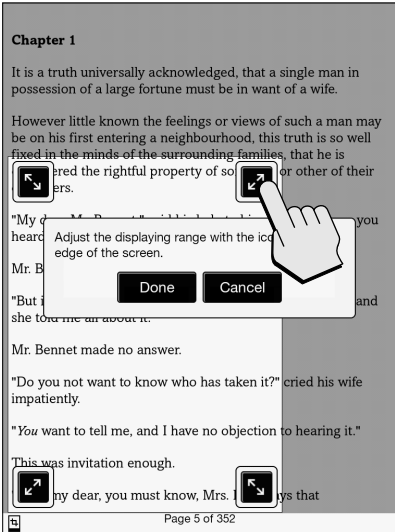



Option	Description
[Uncrop]	Disables cropping.
[Manual]	<p>Allows you to adjust the crop area manually by dragging arrows at the corners. Tap [Done] to set the area, or tap [Cancel] to cancel editing the crop area.</p> 
[Auto]	Automatically crops the margins of a document.

Adjusting the brightness and contrast

A page that is hard to read, such as a scanned or color-converted document, can be made more readable by adjusting the brightness and contrast. This mode remains active as you continue reading. The setting applies only to the currently open book.

- 1 When viewing a book, press the ☰ (Menu) button → tap [Customize View] → [Adjust View].**
- 2 Choose from one of the following options.**

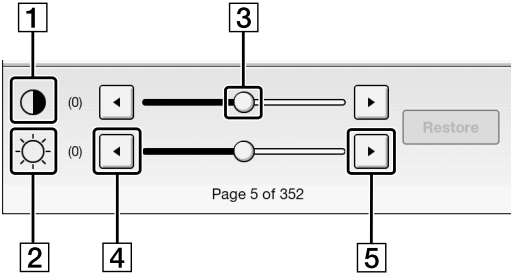
Option	Description
[Original]	Displays the page in the original quality.
[Saturated]	Improves readability by emphasizing contrast.
[Details]	Backlight compensation; brings up details in a dark area.
[Brighter]	Increases the brightness.
[Darker]	Decreases the brightness.

Option	Description
[Custom]	<p>Create a custom setting. Tap  (Settings) to adjust  (Contrast) and  (Brightness).</p>  <p>1 Contrast 2 Brightness 3 Slider 4 Lower 5 Higher</p> <p>Tap  (Lower) or  (Higher), or tap on the slider.</p> <p>Tap [Restore] to revert to the previously saved custom settings.</p>

- Press the  (Back) button when done.

Zooming in

Use the zoom function when you want to temporarily zoom in on part of a page.

The viewer shows the zoom bar and viewing position indicator while in zoom mode.

- Pinch out to zoom in.
- Pinch in to zoom out.

To exit zoom mode, press the ↶ (Back) button.

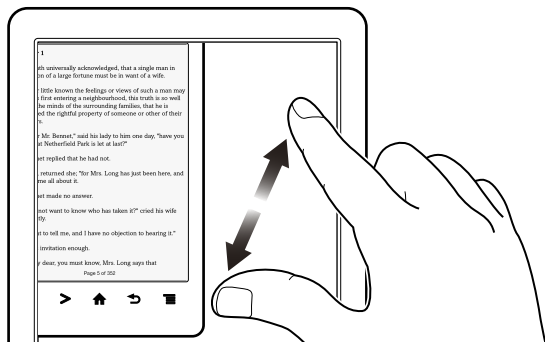

Annotations

Bookmarking a page

You can bookmark a page and take a note so that you will remember what the bookmark is for.

1 Tap the top right corner of the page.

Tip

- To search, sort and view all annotations across all books, use the [All Notes] application. See Details.
- To search annotations for the currently open book, press the ☰ (Menu) button ➔ tap [Notes].

Adding text notes

1 Tap and hold the bookmark.

2 Tap [by Keyboard].

3 Type the notes using the on-screen keyboard.

4 Tap [Save].

The 📌 icon appears on the bookmark, indicating that a note is attached.

Adding handwritten notes

1 Tap and hold the bookmark.

2 Tap [by Drawing].

3 Draw with your finger on the drawing pad.

To erase, tap  (Erase), and then tap the line(s) you want to erase.

4 Tap [Save].

The  icon appears on the bookmark, indicating that a note is attached.

Notes on handwriting

- While writing, make sure that you are not touching another area on the touchscreen; this could affect the notes that you write with your finger.
- To ensure that your notes are correctly saved, do not handwrite notes too close to the edge of the touchscreen.
- If you experience difficulties when handwriting or drawing on the Reader:
 - avoid applying excessive pressure to the touchscreen.
 - try not to handwrite or draw too quickly.
 - this functionality is not designed for very detailed drawings or for writing small characters.

Editing notes

1 Tap and hold on the bookmark.

The notepad or the drawing pad opens.

2 Tap [Edit].

The on-screen keyboard or the drawing pad opens.

3 Edit the note.



4 Tap [Save].

The notepad or the drawing pad closes, returning to the viewer.

Removing a bookmark

1 Tap the bookmark.

Tip

- This will remove the bookmark and any note attached to it. To delete only a note, tap and hold the  icon and tap [Delete] ➔ [Yes].
- To delete all bookmarks in the current book, press the  (Menu) button ➔ tap [Notes]. See Details.
- To delete annotations across all books, use the [All Notes] application. See Details.

Highlighting words on a page

You can highlight words and take notes.

1 Tap and hold the first word and drag across to the last word of the section you would like to highlight.

The pop-up menu appears.

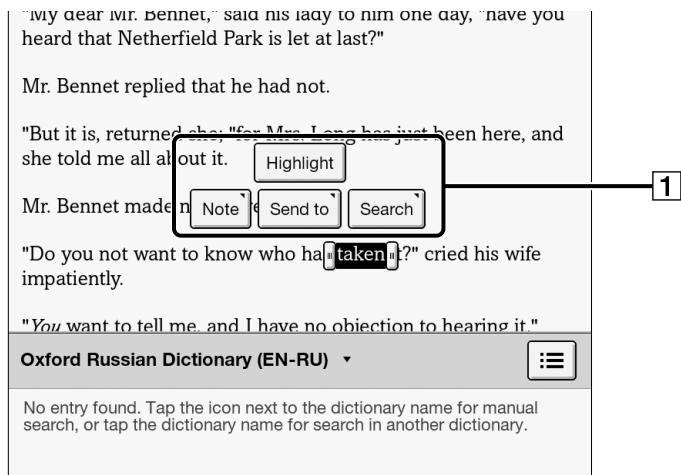

1 Pop-up menu

2 Tap [Highlight].

The selected words are now highlighted.

Tip

- To search, sort and view all annotations across all books, use the [All Notes] application. See Details.
- To search annotations for the currently open book, press the ☰ (Menu) button ➔ tap [Notes]. See Details.

Adding text notes or handwritten notes to a highlight**1 Tap and hold a highlighted word.**

The pop-up menu appears.

2 Select [Note].**3 Select from [by Keyboard] and [by Drawing].**

Create a note.

For a text note, see Details.

For a handwritten note, see Details.

4 Tap [Save].

The 📌 icon appears at the beginning of the highlight, indicating that a note is attached.

Editing notes on a highlight**1 Tap and hold 📌 at the beginning of the highlight.**

The pop-up menu appears.

2 Tap [Note] → [Edit].

The on-screen keyboard or the drawing pad opens.



3 Edit the note.**4 Tap [Save].**

The notepad or the drawing pad closes, returning to the viewer.

Removing highlights**1 Tap and hold  at the beginning of the highlight.**

The pop-up menu appears.

2 Tap [Remove Highlight].**3 Tap [Yes] when prompted.****Tip**

- This will remove the highlight and any note attached to it. To delete only a note, tap and hold the  icon, tap [Note] → [Edit] → [Delete] → [Yes].
- To delete all annotations in the current book, press the  (Menu) button → tap [Notes]. See Details.
- To delete annotations across all books, use the [All Notes] application. See Details.

Handwriting a note on a page

You can use your finger and draw directly on a page.

- 1 Press the ☰ (Menu) button.
- 2 Tap [Handwriting] and use your finger to draw a line.

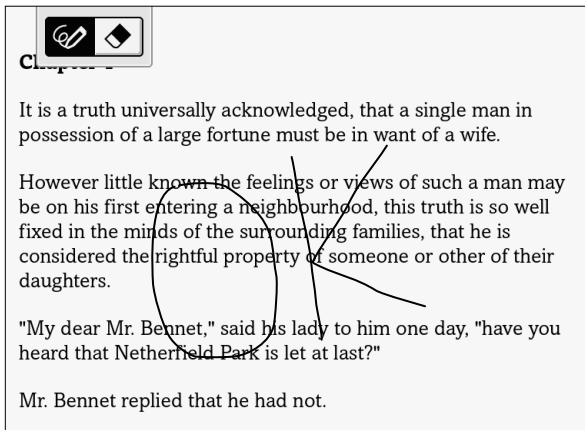



Note

- While writing, make sure that you are not touching another area on the touchscreen; this could affect the notes that you write with your finger.
- To ensure that your notes are correctly saved, do not handwrite notes too close to the edge of the touchscreen.

- If you experience difficulties when handwriting or drawing on the Reader:
 - avoid applying excessive pressure to the touchscreen.
 - try not to handwrite or draw too quickly.
 - this functionality is not designed for very detailed drawings or for writing small characters.

To delete a drawn line

Tap  (Erase) and drag across the drawn line.

Press the  (Back) button when you are done to continue reading.

Tip

- To delete all annotations in the current book, press the  (Menu) button ➔ tap [Notes]. See Details.
- To delete annotations across all books, use the [All Notes] application. See Details.

Hiding annotations

You can set the viewer to show or hide the annotations that you have made to the book. This is convenient for when a highlight overlaps with a link.

1 Press the ☰ (Menu) button.

The option items appear.

2 Tap [More].

3 Tap [Settings].

4 Tap [Show Notes].

- Check the checkbox to show annotations.
- Uncheck it to hide annotations.

5 Press the ↩ (Back) button when done.

Finding annotations within a book

You can search and view all annotations (bookmarks/highlights/handwritten notes) in the currently open book.

To search, sort and view all annotations across all books, use the [All Notes] application. See Details.

1 Press the ☰ (Menu) button → tap [Notes].

The annotations in the book are listed.

Press the ↶ (Back) button to return to the book.

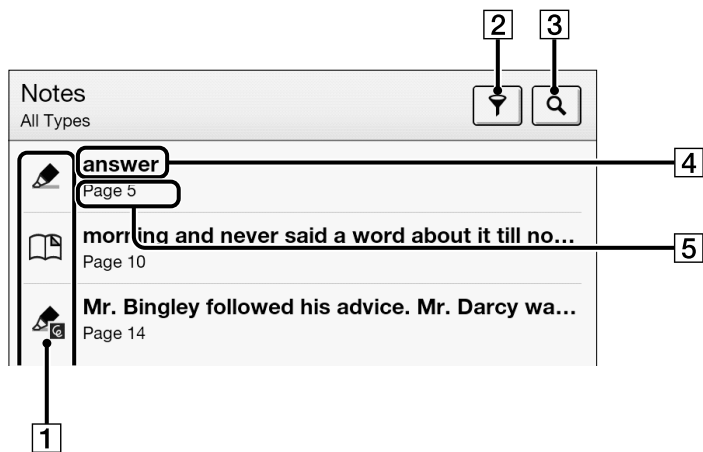







- 1 Note icons
- 2 Filter note type
- 3 Search icon

- 4** **Headline** (the highlighted text, the text note, the beginning text of the bookmarked page, or the beginning text of the page with the handwritten note)
- 5** **Page number of the note**
Press the ↶ (Back) button to return to the book.

2 Tap a note in the list.

The page containing the selected note is displayed.

Note icons

	Bookmark only
	Bookmark with text notes
	Bookmark with handwritten notes
	Handwritten note on a page
	Highlight only
	Highlight with text notes
	Highlight with handwritten notes

Filtering

1 Tap (Filter) → tap one of the annotation types.

Annotations of the type that you select are shown.

Searching for notes via keyword

You can perform a search for all or one of the specific note types.

The search target changes depending on the type of annotation that is being searched.

Item type	Target
For [Bookmark] items	<ul style="list-style-type: none"> • Bookmarks only: The first 100 characters of bookmarked pages are searched. • Bookmark text notes: Entire text notes are searched. • Bookmark handwritten notes: The first 100 characters of bookmarked pages are searched.
For [Handwriting] items	<ul style="list-style-type: none"> • The first 100 characters of pages with handwriting on them are searched.
For [Highlight] items	<ul style="list-style-type: none"> • Highlights only: The highlighted words are searched. • Highlight text notes: Entire text notes are searched. • Highlight handwritten notes: The highlighted words are searched.

1 Tap (Search).

2 Type a search keyword using the on-screen keyboard.

3 Tap  (Search) next to the search box.

The [Search Results] view is shown.

The view shows notes that satisfy the search criteria. Press the  (Back) button to return to the [Notes] list.



Note

- If you apply a filter before searching, the search will be performed only on the filtered items.

To delete annotations

1 Press the  (Menu) button → tap [Delete Notes]. See Details.

To delete all annotations

1 Press the  (Menu) button → tap [Delete Notes] → press the  (Menu) button → tap [Select All] → [Done] → [Yes].

Using ☰ (Menu) Items

Press the ☰ (Menu) button from the [Notes]/[All Notes] list to select an option.

Option	Description
[Delete Notes]	Deletes one or more notes from the Reader. See Details.

Uploading Highlighted Words on a Page to Evernote

You can upload highlighted words and take notes to Evernote.

1 Tap and hold the first word and drag to the last word of the section you would like to upload.

The pop-up menu appears.

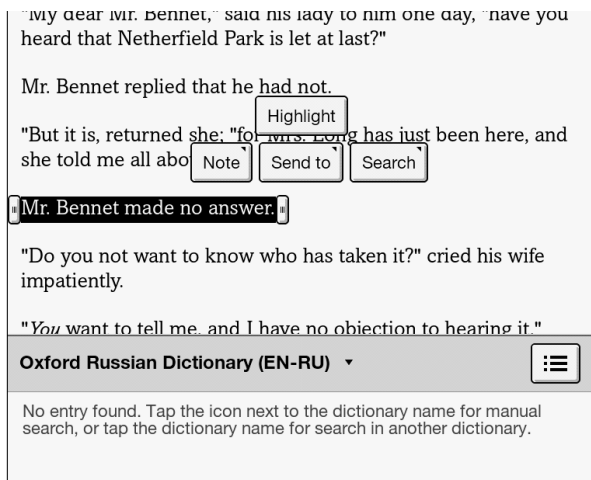

2 Tap [Send to] → [Evernote]

The selected words are now uploaded.

Note

- Before uploading to Evernote, you need to log in. Press the  (Home) button ➔ tap [Applications] ➔ [Evernote Setup].

Tip

- Before you upload the highlighted words, you can also upload with your memo in the preview screen.
- If the highlighted words are attached with text notes or handwritten notes, you can upload those, too.
- Highlighted words may be uploaded up to 140 characters.

Posting Highlighted Words on a Page to Facebook

You can post highlighted words to Facebook.

1. Tap and hold the first word and drag to the last word of the section you would like to post.

The pop-up menu appears.

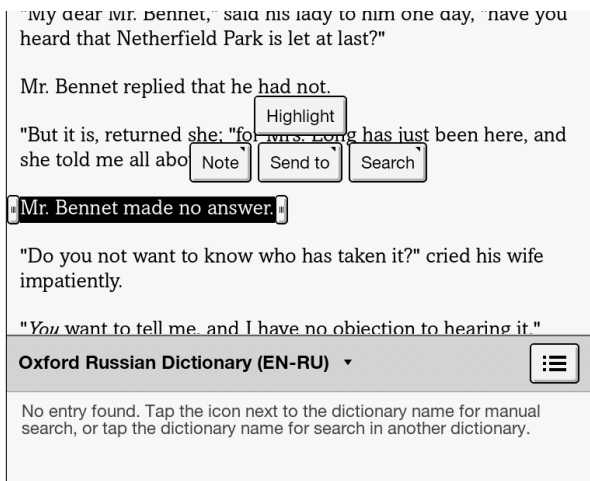

2. Tap [Send to] → [Facebook].

The dialog box appears.

You can confirm the highlighted words, and enter your comment in the preview screen before posting.

3. Tap [Post].

The selected words are now posted.

Note

- Selected items may not be posted where a limitation is applied.
- Before posting to Facebook, you need to log in. Press the  (Home) button → tap [Applications] → [Facebook Setup].
- If the highlighted words are attached with text notes, you can post these, too.
- Highlighted words may be posted up to 140 characters.
- Handwritten notes added to highlights may not appear with book information that you post to Facebook.

Using the Dictionary

The Reader has built-in dictionaries to assist you with looking up the definition of a word on a page. You can choose one of several bilingual dictionaries to use. See Details.

Only the dictionaries included on the Reader can be used. New dictionaries cannot be installed or added.

1 Tap and hold a word on a page.

The dictionary panel is displayed at the bottom.

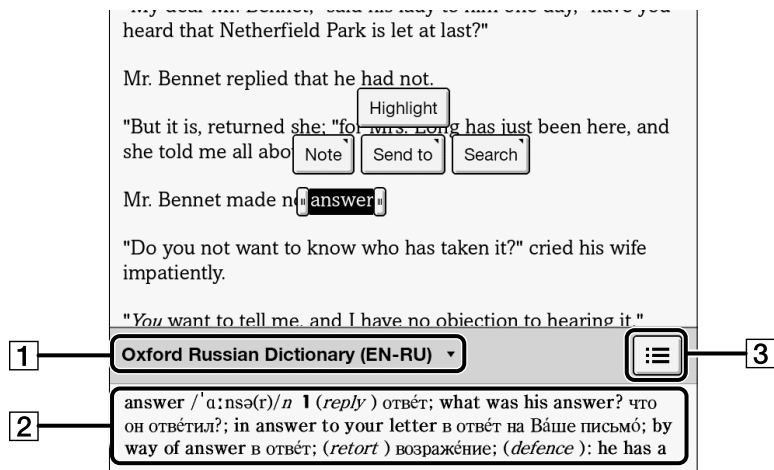

1 Title of the current dictionary. Tap to change the dictionary.

- 2 Definition area. Tap to open the dictionary viewer. See Details.
- 3 Tap to display a list of candidate words. See Details.

2 Tap the definition area. The definition is displayed in the dictionary viewer.

To go to the next page, either swipe or press the < or > (Page turn) buttons.

Press the ↩ (Back) button to return to the book page.



Finding Keywords in a Book

You can find pages that contain specific words using a keyword search.

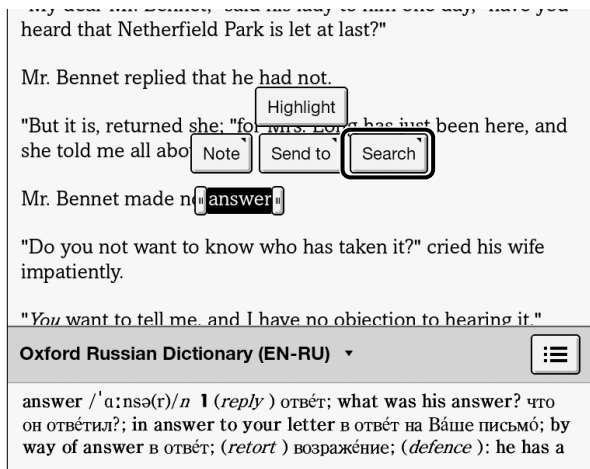
1 Tap and hold a word, and tap [Search] → [in This Book] in the pop-up menu.



2 A page that includes the keyword for which you searched is displayed.

Tap  or  to display to the previous/next page that contains the selected keyword.

To cancel, press the  (Back) button.

Tip

- You can find the definition of a word and more at the Wikipedia and Google Web sites. Tap and hold a word ➔ tap [Search] ➔ [Wikipedia] or [Google]. The [Browser] application will open to the Wikipedia or Google Web site and search for the word. (A Wi-Fi network connection is necessary. See Details.) To return to the book, press the ≡ (Menu) button ➔ tap [Continue Reading].

You can also directly enter the keyword for a search.

- 1 When viewing a book, press the ≡ (Menu) button ➔ tap [More] ➔ [Search], and enter the keyword using the on-screen keyboard.**

Note

- When using the Book Viewer's keyword search, Latin alphabet searches make no distinction between uppercase and lowercase letters, but Cyrillic alphabet searches make this distinction.
- Searches from other than the [Books] content list, such as from the [Collection] or [Notes]/[All Notes] lists, make no distinction between uppercase and lowercase letters, including when searching in Cyrillic.

Changing Book Page Settings

The following settings are available for the current book issue you are reading.

1 When viewing a book, press the ☰ (Menu) button → tap [More] → [Settings].

2 Choose from one of the following options.

Option	Description
[Show Notes]	This is convenient when notes are obscuring your view of the text. See Details.
[Info]	Information for the book that is currently open is displayed.

To return to the book, press the ↶ (Back) button.

Using ≡ (Menu) Items

Below is a list of option items available when you press the ≡ (Menu) button from the book viewer.

Option	Description
[Navigate Page]	Selects a method for navigating through a book. See Details.
[Notes]	Displays a list of annotations in the book. See Details.
[Font]	Changes the font and font size. See Details.
[Customize View]	Adjusts the page mode (see Details), crops the page margins (see Details) or adjusts the brightness (see Details).
[Handwriting]	Allows you to draw on a page. See Details.
[More]	Displays more option items.
[Search]	Finds pages with a keyword. See Details.
[Post to Facebook]	Post the highlighted text with your comments. See Details
[Orientation]	Changes to portrait or landscape mode. See Details.
[Settings]	Changes book settings. See Details.

Organizing Your Content

Deleting a Single Item

You can delete individual items.

The following instructions use the [Books] application as an example; this feature is also available in other applications.

1 Press the  (Home) button \rightarrow tap [Bookshelves].

2 Tap and hold an item.

The option items appear.

3 Tap [Delete].

4 Tap [Yes] when prompted.



The item is deleted from the Reader.

Note

- If [Books] is not shown, press the  (Menu) button \rightarrow tap [Choose Bookshelf] to show [Books].
- Depending on the application, it may not be possible to delete certain files.
- Sony recommends that you create a backup of the contents of the Reader using the Reader application before deleting an item.

Deleting Multiple Items at Once

You can delete multiple items at once. This is convenient for clearing up space on the Reader. The following instructions use the [Books] application as an example; this feature is also available in other applications.

- 1 Press the  (Home) button → tap [Bookshelves].**
- 2 Press the  (Menu) button.**

3 Tap [Delete Books].

Boxes appear next to the thumbnails or list entries.

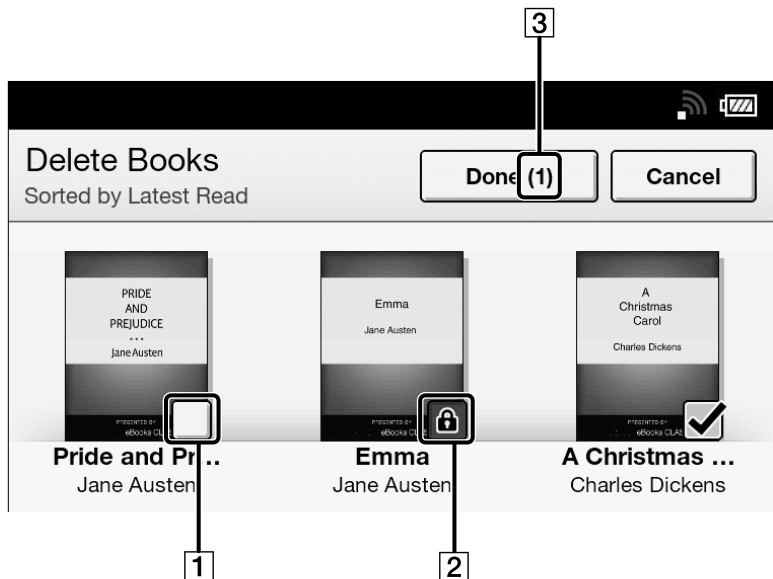

- 1** Box
- 2** Protect icon
- 3** Selected number of items

4 Tap to check the items to delete.

You can press the ☰ (Menu) button ➔ tap [Select All] if you wish to delete all items.

5 Tap [Done].

6 Tap [Yes] when prompted.

The selected items are deleted from the Reader.

Note

- If [Books] is not shown, press the ☰ (Menu) button ➔ tap [Choose Bookshelf] to show [Books].
- Depending on the application, it may not be possible to delete certain files.
- Sony recommends that you create a backup of your files using the Reader application.

Protecting a Single Item

You can protect an item so that you will not delete it accidentally.

The following instructions use the [Books] application as an example; this feature is also available in other applications.

1 Press the  (Home) button → tap [Bookshelves].

2 Tap and hold an item.

The option items appear.

3 Tap [Protect].

You can remove the protection from the item in the same manner. Tap [Unprotect] in Step 3 above.

Note

- If [Books] is not shown, press the  (Menu) button → tap [Choose Bookshelf] to show [Books].
- This protection feature works only on the Reader. Protected content may still be deleted via your computer.

Protecting Multiple Items at Once

You can protect one or more items at once.

The following instructions use the [Books] application as an example; this feature is also available in other applications.

- 1** Press the **⬆** (Home) button **➔** tap [Bookshelves].
- 2** Press the **☰** (Menu) button **➔** tap [Protect Books].

Boxes appear next to the thumbnails or list entries.

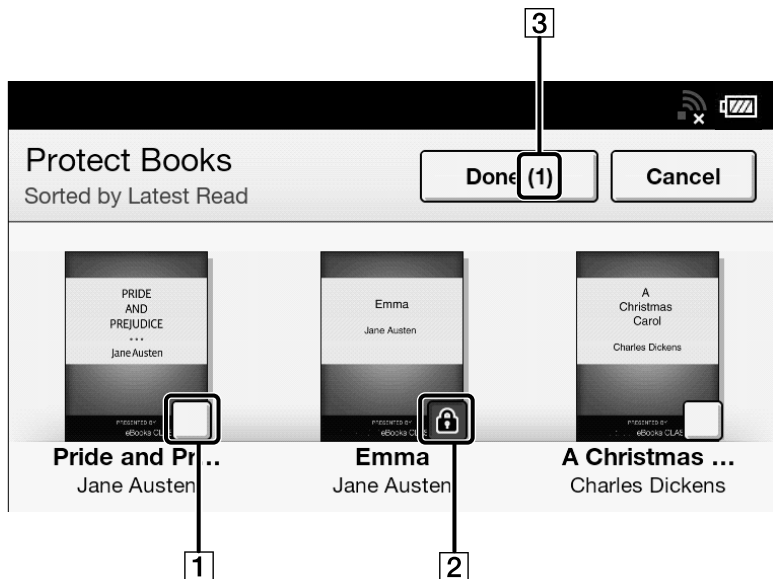

- 1 Box
- 2 Protect icon
- 3 Selected number of items

3 Tap the box of the item to be protected.

Selected items are indicated with a protect icon. You can press the ☰ (Menu) button and tap [Select All] if you wish to protect all items.

4 Tap [Done].

The protect icon appears next to the protected items. You can remove protection in Step 3 above by tapping items with the protect icon.

Note

- If [Books] is not shown, press the ☰ (Menu) button → tap [Choose Bookshelf] to show [Books].
- The protection feature works only on the Reader. Protected content may still be deleted via your computer.

Using Collections

Creating a Collection

A collection is a custom set of books and other items that you create from items on the Reader. It is a unique and convenient way to organize your items.

You can organize and personalize your content by creating collections by subject matter, date, genre or anything that best suits your purpose.

- 1 Press the **⬆** (Home) button **➔** tap [Bookshelves] **➔** [Collections].

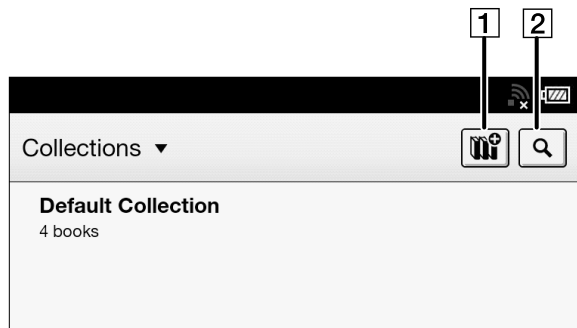

- 1 Create a new collection
- 2 Search by collection name

- 2 Tap .

- 3 Enter a collection name using the on-screen keyboard and tap [OK].

- 4 Select the location to store the collection.

A new collection is added to the [Collections] list.



Tip

- You can also create and sync collections with the Reader application. For details, refer to the [Help] menu of the Reader application.



Adding Items to a Collection

You can add items to existing collections.

From the [Collections] application

- 1** Press the  (Home) button → tap [Bookshelves].
- 2** Tap [Default Collection].
- 3** Press the  (Menu) button → tap [Organize to Collection].
- 4** Select the collection that you wish to move.
- 5** Select one or more books from the list.
Selected items are indicated with check marks.
- 6** Tap [Done].

From the [Books] application

- 1** Press the  (Home) button → tap [Bookshelves].
- 2** Press the  (Menu) button → tap [Add to Collection].

- 3 Tap a collection that you have created that appears in the list.**
- 4 Select one or more books that you wish to add.**
Selected items are indicated with a check.
- 5 Tap [Done].**

Note



- A collection and its items must be stored in the same location. For example, if the book is stored on the Reader's internal memory, you may not add items stored on a microSD card to the collection.

Tip

- Any books that have not been added to a collection are contained in [Default Collection].
- When you add a book to a collection, it is moved from [Default Collection].
- To add a book to a collection, at least one collection needs to be created.
- When moving an item from [Organize to Collection] or [Add to Collection], you can create a new collection to move the item to. To create a new collection, tap  in the upper-right corner of the screen.

Removing Items from a Collection

You can remove one or more items from a collection that you have created.

- 1 Press the  (Home) button → tap [Bookshelves] → tap a collection that you have created → press the  (Menu) button → tap [Remove Content].**

You can also tap and hold an item → tap [Remove].

- 2 Tap one or more items.**

Selected items are indicated with a check.

- 3 Tap [Done].**

- 4 Tap [Yes] when prompted.**

The selected item(s) will be removed from the collection.

Note



- If you have deleted an item from [Books], it will be automatically removed from all of the collections with which it was associated.
- Removing items from a collection does not delete them from the Reader or their stored locations.
- If you remove an item from a collection that does not exist in other collections, its original will be moved back to the [Default Collection] in the Reader. If you remove an item that exists in another collection(s), it will remain in the other collection(s), and not be moved back to the [Default Collection].

Tip

- You can remove all items at once. After completing Step 1 above, press the ☰ (Menu) button ➔ [Select All].

Renaming a Collection

You can change the name of a collection.



- 1 Press the  (Home) button → tap [Bookshelves] → tap a collection that you have created → press the  (Menu) button → tap [Rename Collection].**

You can also tap and hold a collection that you have created → tap [Rename].

- 2 Enter a new name for the collection using the on-screen keyboard.**
- 3 Tap [OK].**

Deleting a Collection

You can delete a collection that you have created.

- 1 Press the  (Home) button → tap [Bookshelves] → press the  (Menu) button → tap [Delete Collections].**

You can also tap and hold a collection that you have created → tap [Delete].

- 2 Tap the collection to be deleted.**

Selected items are indicated with a check.

- 3 Tap [Done].**

- 4 Tap [Yes] when prompted.**



The selected item(s) will be removed from the collection.

Note

- Deleting a collection does not delete content from the Reader or their stored locations.

Posting a Collection to Facebook

You can post your book collection information to Facebook.

- 1. Press the  (Home) button → tap [Bookshelves] → tap the collection that you have created → press the  (Menu) button → tap [Post to Facebook].**

The collection information is posted to Facebook.

Note

- Before posting to Facebook, you need to log in. Press the  (Home) button → tap [Applications] → [Facebook Setup].

Using ≡ (Menu) Items

Below is a list of option items available when you press the ≡ (Menu) button from a collection list.

Option	Description
[Delete Collections]	Deletes collections that you created. See Details.
[Choose Bookshelf]	Shows the following pop-up menu. Alternatively, tap the title or press ≡ (Menu) button → [Choose Bookshelf]. [Books] [Collections] [Evernote]

All Notes

Finding Annotations Across All Books

You can use [All Notes] to find annotations across all books. The application stores all annotations including bookmarks, highlights and drawings that you have added on pages. Tap an item in the list to jump to the page on which that annotation is located.

1 Press the **↑ (Home) button** → tap **[All Notes]**.

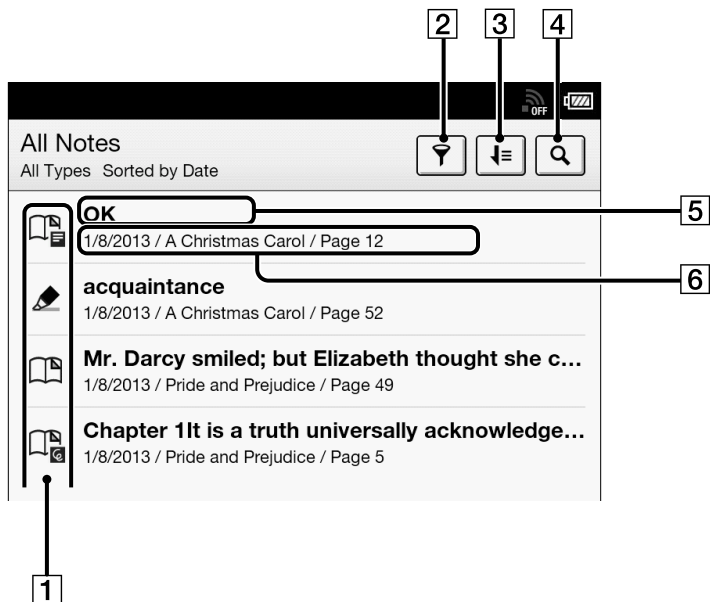



- 1 Note icons Details
- 2 Filter note type Details
- 3 Sort icon; sort by date, title or file name
- 4 Search icon Details
- 5 Headline (the highlighted text, the text note, the beginning text of the bookmarked page, or the beginning text of the page with the handwritten note)
- 6 Annotation creation date, book title, page number



2 Tap a note in the list.

The page containing the selected note is displayed.
To return to [All Notes], press the ↶ (Back) button.
To delete annotations, see Details.

Uploading Annotations Across All Books to Evernote

- 1 Press the  (Home) button  tap [All Notes]  tap and hold the note that you wish to upload in the list.**
- 2 Tap [Upload to Evernote].**
The note is uploaded to Evernote.

Note

- Before uploading to Evernote, you need to log in by [Home]  [Applications]  [Evernote Setup].

Posting Annotations Across All Books to Facebook

- 1 Press the  (Home) button → tap [All Notes] → tap and hold the note that you wish to post in the list.**
- 2 Tap [Post to Facebook].**
The note is posted to Facebook.







Note

Before posting to Facebook, you need to log in by [Home] → [Applications] → [Facebook Setup].

Web Browsing

Browsing the Web

The Reader has a Web browser that enables you to visit Web sites and download files and images directly to the Reader, saved under [Books] and [Pictures] applications.

- 1 Make sure that Wi-Fi is set up and turned on.**
- 2 Press the  (Home) button  tap [Applications]  [Browser].**
- 3 Navigate to a Web site.**
 - Tap  (Bookmarks)  tap one of the bookmarks.
 - Tap the URL box and type the URL address using the on-screen keyboard, and tap [Go].
- 4 Browse the Web site.**
 - Press the < (Previous) button to scroll up.
 - Press the > (Next) button to scroll down.
 - Tap and drag to move the view area.
 - Press the  (Back) button to go back to the previous Web page.

Note

- You must agree to the terms and conditions before using [Browser]. Please read the terms and conditions carefully. When you tap [Accept], [Browser] opens.

Tip

- You can press the ☰ (Menu) button ➔ tap [Continue Reading] to return to the last read page of your last read book.

Browsing Tools

Zooming in

While in zoom mode, the zoom bar is shown at the bottom-right of the screen.

- Pinch out to zoom in.
- Pinch in to zoom out.
- Double-tap to fit the page to the window size.

To exit zoom mode, press the ↶ (Back) button.

Capturing a screenshot

You can capture the current page as a screenshot.

- 1** When viewing a Web page, press the ☰ (Menu) button → tap [More] → [Capture Screenshot] → [OK].

Screenshots are stored in the [Pictures] application. See Details.

Downloads

When you click a download link, the item will be downloaded onto the Reader.*

You can view the download history by pressing the ☰ (Menu) button → tap [More] → [Downloads].

* Only supported file types can be downloaded. For supported file types, see Details.

Downloading a linked file

You can download a file behind a link without opening it in the browser window.

1 Tap and hold the link → tap [Save Link].

2 Tap [Yes] when prompted.

Depending on the Web site, a file may begin downloading once you tap the download icon. The downloaded file can be found in the [Books] application.

Downloading an image

You can download an image displayed in the browser window.

- 1 Tap and hold the image → tap [Save Image].**
- 2 Tap [Yes] when prompted.**

Viewing download progress

You can view items that you are currently downloading or have recently downloaded.

- 1 When an item is downloading, an icon indicating that the download is in progress appears in the status bar.**

Tap the status bar to open the notification window.
See Details.

Items that you are currently downloading are listed under [Ongoing].

Recent items that have been downloaded and recent items which were not downloaded successfully are listed under [Notification].

- 2 Press the ↶ (Back) button to return to the Web page.**

Canceling a download

You can cancel a download that is currently in progress.

- 1 When viewing a Web page, press the ☰ (Menu) button → tap [More] → [Downloads].**

You can also tap the status bar → tap the item currently downloading under [Ongoing].
The download history opens.

- 2 Tap and hold an item → tap [Cancel Download], or press the ☰ (Menu) button → tap [Cancel Download].**

To return to the Web page, press the ↶ (Back) button.

Opening a downloaded file/image

You can view the files downloaded from a Web site. Downloaded files are stored in [Books] or [Pictures], depending on the file type.

1 When viewing a Web page, press the ☰ (Menu) button → tap [More] → [Downloads].

You can also tap the status bar → tap the item currently downloading under [Notification].

2 Tap a downloaded file, or tap and hold an item → tap [Open].

The Reader opens the file in the appropriate application.

To return to the Web page, press the ↶ (Back) button.

Deleting a downloaded file

You can delete downloaded files.

- 1 When viewing a Web page, press the ☰ (Menu) button → tap [More] → [Downloads].**
- 2 Tap and hold an item → tap [Delete].**

The file is deleted from the Reader.

Depending on the file type, files can also be deleted from their respective applications.

Multiple Windows

Opening a new window

- 1 When viewing a Web page, press the ☰ (Menu) button → [More] → [Windows] → [New Window].**

A maximum of 3 windows can be open at one time. If [New Window] is not displayed, tap [Close] in the Window list.

Opening a link in a new window

Instead of the current window, you can open a link in a new window so that you can keep the current window open.

- 1 Tap and hold a link → tap [Open in New Window].**

The link opens in a new window.

A maximum of 3 windows can be open at one time. After the third window is opened, [Open in New Window] is not displayed.

Changing the browser window in view

When you have more than one browser window open, you can change the window in view.

- 1 When viewing a Web page, press the ☰ (Menu) button → tap [More] → [Windows].**
- 2 Select another browser window.**

Closing a browser window

You can close browser windows.

- 1 When viewing a Web page, press the ☰ (Menu) button → tap [More] → [Windows].**
- 2 Tap [Close].**
The window is closed.

Note

- If there is only one browser window open and you tap [Close], the browser home page is automatically opened.

Bookmarks and History

Bookmarking a Web site

You can bookmark your favorite Web sites so that you can return to them quickly.

- 1 Visit the Web site that you wish to bookmark.**
- 2 Add the current site to the bookmarks as follows:**
 - Tap  next to the URL box → tap [Add Bookmark...].
- 3 Optionally, edit the bookmark name by tapping the text input area under [Name] and using the on-screen keyboard. See Details.**
- 4 Tap [OK].**

The current Web page is now added to the bookmark list.

Opening a bookmarked Web site

You can quickly return to your favorite Web sites using bookmarks.

1 When viewing a Web page, tap  next to the URL box.

The bookmark list opens.

2 Tap the bookmark to open it.

Editing a bookmark

You can change a bookmark name or the address (URL) if necessary.

1 When viewing a Web page, tap  next to the URL box.

The bookmark list opens.

2 Tap and hold the bookmark that you wish to edit → tap [Edit Bookmark].

3 Edit the bookmark name/location by tapping the text input area under [Name]/[Location] and using the on-screen keyboard.

4 Tap [OK].

To return to the Web page you were browsing, press the  (Back) button.

Deleting bookmarks

You can remove bookmarks from the bookmark list to keep only the ones you need.

1 When viewing a Web page, tap ✎ next to the URL box.

The bookmark list opens.

2 Tap and hold the bookmark that you wish to remove from the list → tap [Delete Bookmark].

3 Tap [OK] when prompted.

The bookmark is removed from the list.

To return to the Web page you were browsing, press the ↶ (Back) button.



Opening a previously visited Web site

You can view a list of Web sites that you have previously visited.

- 1 When viewing a Web page, tap  next to the URL box.**
- 2 Tap [History].**
A list of sites that you have previously visited opens.
- 3 Tap an item to open it in the browser.**

Deleting browsing history items

You can remove entries from the browsing history.

- 1 When viewing a Web page, tap  next to the URL box.**
- 2 Tap [History].**
A list of sites that you have previously visited opens.
- 3 Tap and hold the entry that you wish to remove from the list  tap [Remove from History].**

4 Press the ↶ (Back) button to return to the Web page you were browsing.

Tip

- You can delete all browsing history items by pressing the ☰ (Menu) button ➔ tapping [Clear History] in Step 2.

Uploading an Address of a Website to Evernote

You can upload the address of your favorite Websites to Evernote.

- 1 Visit the Web site that you wish to upload the address of.**
- 2 Press the ☰ (Menu) button → tap [More] → [Upload to Evernote].**

The Website address is uploaded to Evernote.

Note

- Before uploading to Evernote, you need to log in. Press the 🏠 (Home) button → tap [Applications] → [Evernote Setup].

Browser Settings

You can change the following browser settings to your preference. When viewing a Web page, press the ☰ (Menu) button and tap [More] ➔ [Settings] to change the settings.

Setting	Description
[Default Zoom]	The default zoom ratio. Set to “Medium” by default.
[Open Pages in Overview]	Opens the page scaled to the window size. Enabled by default.
[Text Encoding]	Set to “Unicode (UTF-8)” by default. The browser supports the following encodings: <ul style="list-style-type: none"> • Latin-1 (ISO-8859-1) • Unicode (UTF-8)
[Block Pop-up Windows]	Blocks pop-up windows. Enabled by default.
[Load Images]	Loads images on a Web page. Enabled by default.
[Auto-fit Pages]	Formats Web pages to the window size. Enabled by default.
[Enable JavaScript]	Enables JavaScript. Enabled by default.

Setting	Description
[Set Home Page]	Sets the default Web page to display. You can set the currently opened Web page as your home page.
[Page Information]	Displays the details of a Web page.
[Clear Cache]	Empties the cache.
[Clear History]	Deletes the browsing history.
[Accept cookies]	Accepts cookies from Web sites. Enabled by default.
[Clear All Cookie Data]	Removes all cookies.
[Remember Form Data]	Allows the browser to remember the form history. Enabled by default.
[Clear Form Data]	Empties the search and form history.
[Remember Passwords]	Allows the browser to remember some entered passwords. Enabled by default.
[Clear Passwords]	Deletes the passwords saved by the browser.
[Reset to Default]	Restores the default settings, and deletes all browser data.
[Legal Information]	Displays the terms and conditions of use of the browser.

To return to the Web page you were browsing, press the ↶ (Back) button.

Using ≡ (Menu) Items

Below is a list of option items available when you press the ≡ (Menu) button from a browser window.

Option	Description
[Browse Home]	Displays the home page. See Details.
[Refresh]	Updates the content displayed on the Web page.
[Forward]	Advances to a previously viewed page.
[Orientation]	Changes to portrait or landscape mode.
[Continue Reading]	Closes the [Browser] application and returns to the last read page of your last read book.
[More]	Displays more option items.
[Windows]	Opens the window list. See Details.
[Upload to Evernote]	Uploads the addresses of your favourite websites.
[Capture Screenshot]	Captures a screenshot of the current Web page. See Details.
[Downloads]	Opens the download history. See Details.



Option	Description
[Settings]	Changes browser settings. See Details.

Dictionary

Using the Dictionary

You can choose one of several embedded dictionaries to use.

Only the dictionaries included on the Reader can be used. New dictionaries cannot be installed or added.

- 1 Press the  (Home) button  tap [Applications]  [Dictionary].**
- 2 Type a word that you wish to look up by using the on-screen keyboard.**
The list of candidate words is displayed.

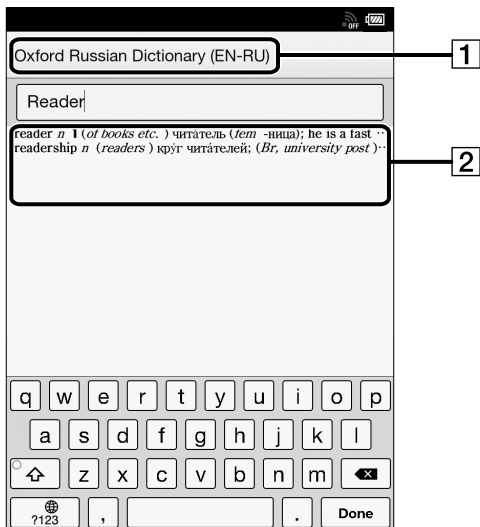

1 Title of the current dictionary

2 List of candidate words

3 Tap one of the candidate words.

The definition is displayed in the dictionary viewer. To look up another word, tap  (Search) in the dictionary viewer.

Tip

- In the dictionary viewer, tap and hold another word to look that word up in the dictionary.

Changing the Dictionary

You can choose a different dictionary.

The dictionary can also be changed as you look up a word.

- 1 Press the ☰ (Menu) button → tap [Change Dictionary].**
- 2 Tap one of the dictionaries.**
- 3 The dictionary is changed, and the list of candidate words or the dictionary viewer for the dictionary to which you changed is displayed.**

When you change the dictionary in the [Dictionary] application, the dictionary used when you look up a word in the [Books] application also changes.

Listing Previously Looked-up Words

You can view a list of words that you have previously looked up in the selected dictionary.

1 When a dictionary is open, press the ☰ (Menu) button → tap [Word Logs: Dictionary].

A list of words that you have previously looked up opens.

2 Tap a word to look it up in the dictionary.

Deleting items in the look-up history

You can delete words that you have previously looked up.

1 Press the ☰ (Menu) button → tap [Delete Word Logs].

2 Tap the items that you want to delete.

A check appears next to selected items.

3 Tap [Done] → [Yes].

To return to the dictionary viewer, press the ↶ (Back) button.

Using ≡ (Menu) Items

Below is a list of option items available when you press the ≡ (Menu) button from the dictionary viewer.

Option	Description
[Previous View]	Opens a previously looked-up word in the dictionary viewer after you have looked up another word from the dictionary viewer.
[Change Dictionary]	Changes to another dictionary and searches again.
[Font]	Changes the font size of the candidate words list and the definition viewer.
[Word Logs: Dictionary]	Displays a list of previously looked-up words. See Details.

Handwriting

Creating a Drawing

You can use the [Handwriting] application to create a drawing.

- 1 Press the **↑ (Home) button** → tap [Applications] → [Handwriting].



- 1 Create a new drawing.
- 2 Tap  at the upper-right corner of the screen. The canvas opens.
- 3 Draw in the drawing area with your finger.

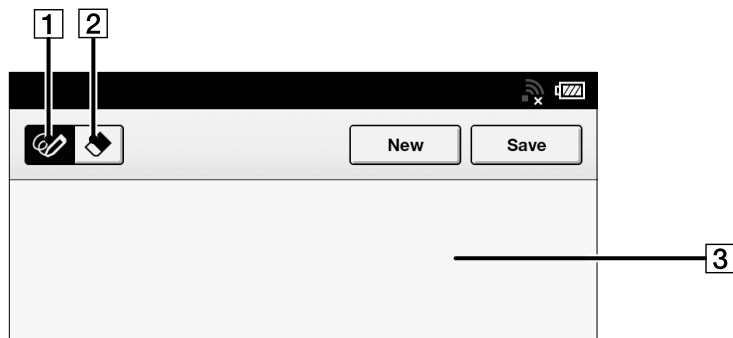

- 1 Pencil tool
- 2 Eraser tool
- 3 Drawing area

To erase a line, tap  → tap or stroke a part of the line.

4 Tap [Save].

Note

- While writing, make sure that you are not touching another area on the screen. This could affect the notes that you write.
- To ensure that your notes are correctly saved, do not draw too close to the edge of the canvas.

- If you experience difficulties when drawing on the Reader:
 - avoid applying excessive pressure to the screen.
 - try not to draw too quickly.
 - this functionality is not designed for very detailed drawings or for writing small characters.

Tip

- If you tap [New] while creating a drawing, the current drawing is saved, and a new canvas opens.
- These drawings will be saved only in the internal memory.

Editing an Existing Drawing

1 Press the **↑** (Home) button → tap [Applications] → [Handwriting] → tap the drawing that you wish to edit.

2 Edit the drawing.

You can use your finger.

To erase a line, tap  (Erase) → tap or stroke a part of the line.



3 Tap [Save].

Tip

- If you tap [New] while creating a drawing, the current drawing is saved, and a new canvas opens.
- These drawings will be saved only in the internal memory.
- To delete the currently viewed drawing, press the  (Menu) button → tap [Delete Drawing] → [Yes].

Deleting/Protecting a Drawing

You can delete or protect drawings.

- 1 Press the  (Home) button → tap [Applications] → [Handwriting].**
- 2 Press the  (Menu) button → tap [Delete Drawings] or [Protect Drawings].**

To delete drawings, see Details.



You can also delete a drawing after step 1 by tapping and holding it. See Details.

To protect drawings, see Details.

You can also protect a drawing after step 1 by tapping and holding it. See Details.

Capturing a Screenshot

The Reader allows you to capture a screenshot of a drawing and store the image as a picture file.

- 1 Press the  (Home) button → tap [Applications] → [Handwriting] → tap a drawing.**
- 2 Press the  (Menu) button → tap [Capture Screenshot] → [OK].**

You can view your captured screenshots by the [Pictures] application.

Using ≡ (Menu) Items

Below is a list of option items available when you press the ≡ (Menu) button from the [Handwriting] content list.

Option	Description
[Delete Drawings]	Deletes one or more drawings from the Reader. See Details.
[Protect Drawings]	Protects one or more drawings from deletion. See Details.

Text Memo

Creating a Text Memo

You can use the [Text Memo] application to create a memo.

- 1 Press the \uparrow (Home) button \rightarrow tap [Applications] \rightarrow [Text Memo].**

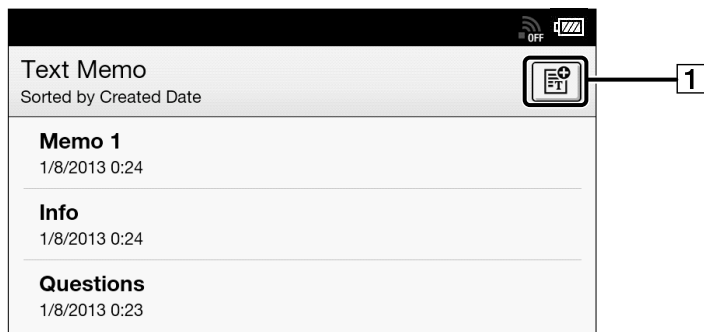

- 1 Create a new memo.**
- 2 Tap  at the upper-right corner of the screen. A notepad opens.**
- 3 Type a memo using the on-screen keyboard.**
- 4 Tap [Save].**

Tip

- If you tap [New] while creating a memo, the current memo is saved, and a new notepad opens.
- Newly created memos will be saved only in the internal memory.

Editing an Existing Memo

- 1 Press the  (Home) button → tap [Applications] → [Text Memo] → tap the memo that you wish to edit.**
- 2 Tap [Edit].**



The on-screen keyboard opens.
Edit the memo using the on-screen keyboard.
- 3 Tap [Save].**

Tip

- If you tap [New] while creating a memo, the current memo is saved, and a new notepad opens.
- Newly created memos will be saved only in the internal memory.
- To delete the currently viewed memo, press the  (Menu) button → tap [Delete Memo] → [Yes].

Deleting/Protecting a Memo

You can delete or protect one or more memos.

- 1 Press the  (Home) button → tap [Applications] → [Text Memo].**
- 2 Press the  (Menu) button → tap [Delete Memos] or [Protect Memos].**

To delete memos, see Details.

You can also delete a memo after step 1 by tapping and holding it. See Details.

To protect memos, see Details.

You can also protect a memo after step 1 by tapping and holding it. See Details.

Using ≡ (Menu) Items

Below is a list of option items available when you press the ≡ (Menu) button from the [Text Memo] content list.

Option	Description
[Delete Memos]	Deletes one or more text memos from the Reader. See Details.
[Protect Memos]	Protects one or more text memos from deletion. See Details.

Pictures

Viewing Pictures

You can use the [Pictures] application to view pictures one by one or as a slideshow. You can also select the picture of your choice for the Reader's standby screen. For details on setting pictures to the standby screen, see Details.

For details on transferring pictures to the Reader, see Details.

For details on supported file types, see Details.

- 1 Press the  (Home) button  tap [Applications]  [Pictures].**

To browse the pictures list, see Details.

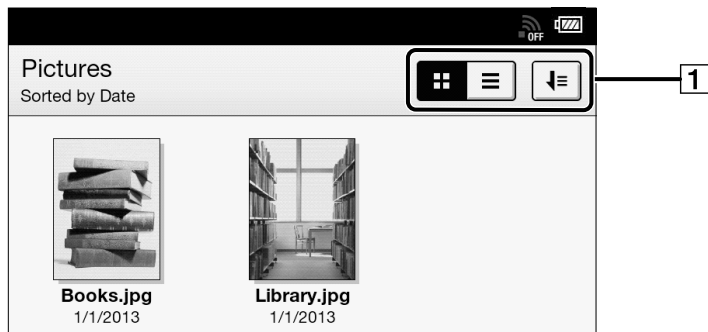

1 Tool icons Details

- 2 Tap a picture.**

The picture viewer opens.



Picture viewer navigation

Perform the following operations with a picture open.

To	Do this
Go to the next page	<ul style="list-style-type: none">• Press the > (Next) button.• Swipe left.
Go to the previous page	<ul style="list-style-type: none">• Press the < (Previous) button.• Swipe right.

Changing the Orientation

You can adjust the view to either portrait or landscape.

- 1 Press the  (Home) button → tap [Applications] → [Pictures].**
- 2 Tap a picture → press the  (Menu) button → tap [Orientation].**

The orientation switches between landscape and portrait mode.

Pictures are shown in the orientation that you have specified.

Zooming in on a Picture

You can zoom in on pictures for easier visibility. The viewer shows the zoom bar and viewing position indicator while in zoom mode.



- Pinch out to zoom in.
- Pinch in to zoom out.

You can drag on the screen to move the viewing position.

To exit zoom mode, press the ↶ (Back) button.

Viewing Pictures in a Slideshow

The slideshow displays pictures one by one in the current sort order. You can also specify the display interval.



- 1 Press the  (Home) button → tap [Applications] → [Pictures].**
- 2 Tap a picture → press the  (Menu) button → tap [Slideshow].**

The slideshow starts from the current picture.

To stop the slideshow and return to the viewer

- Press the  (Back) button.
- Tap on the picture.

To change the slideshow interval

- 1 Press the  (Home) button → tap [Applications] → [Pictures].**
- 2 Tap a picture → press the  (Menu) button → tap [Settings] → [Slide Duration]. Choose from one of the following displayed items.**

3 Press the ↶ (Back) button to return to the picture viewer.

The selected interval is now applied when you start a slideshow.

Tip

- You can also change the slideshow interval from the [Settings] application. See Details.

Uploading a Picture to Evernote

- 1 Press the  (Home) button → tap [Applications] → [Pictures].**
- 2 Tap and hold a picture.**
The pop-up menu appears.
- 3 Tap [Upload to Evernote].**
The picture is uploaded to Evernote.

Note



- Before uploading to Evernote, you need to log in by [Home] → [Applications] → [Evernote Setup].

Tip

- You can also upload the selected picture by pressing the  (Menu) button → tap [Upload to Evernote].

Deleting Pictures

You can delete one or more pictures.

- 1 Press the  (Home) button → tap [Applications] → tap [Pictures].**
- 2 Press the  (Menu) button → tap [Delete Pictures].**

To delete pictures, see Details.

You can also delete a picture by tapping and holding it. See Details.

Using ≡ (Menu) Items

Below is a list of option items available when you press the ≡ (Menu) button from the [Pictures] content list.

Option	Description
[Delete Pictures]	Deletes one or more pictures from the Reader. See Details.
[Settings]	Changes the slideshow interval. See Details.

Evernote

Using Evernote

You can download notes from a dedicated Evernote Notebook and view them in ePub format on the Reader. You can also upload highlighted words, pictures and written notes to Evernote.

- To upload highlighted words on a page, see Details.
- To upload a picture, see Details.
- To upload annotations for all books, see Details.
- To upload an address of a website, see Details.

Note

- You need to create an Evernote account in order to use Evernote. Refer to the Evernote website. Evernote account creation is also possible with the Reader when connected to a Wi-Fi network.
- Notes created by Evernote Clearly™ and mainly text based notes are best viewed. Some notes may not be displayed correctly due to ePub conversion.
- Any binary file(s) attached to an Evernote note will be excluded after ePub conversion.

- An Evernote note of a picture size no larger than 1200 × 1600 pixels (width × height) will be displayed correctly.
- Highlighted words may be uploaded up to 140 characters where a limitation is applied.

Creating a new account

If you have not created an Evernote account yet, you will need to, in order to get started.

- 1 Press the  (Home) button  tap [Applications]  [Evernote Setup].**

An Evernote settings screen for signing in appears.

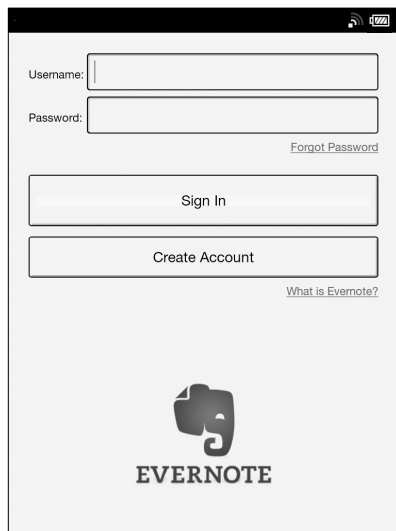

The screenshot shows the Evernote login screen. At the top, there are status icons for signal strength, Wi-Fi, and battery. Below these are two input fields: "Username:" and "Password:". To the right of the password field is a link that says "Forgot Password". Below the input fields are two buttons: "Sign In" and "Create Account". At the bottom of the screen, there is a link that says "What is Evernote?". The Evernote logo, which is a stylized elephant head, is centered at the bottom of the screen, with the word "EVERNOTE" written in all caps below it.

- 2 Tap [Create Account].**

- 3 Tap the input area and type the email address, username and password using the on-screen keyboard.

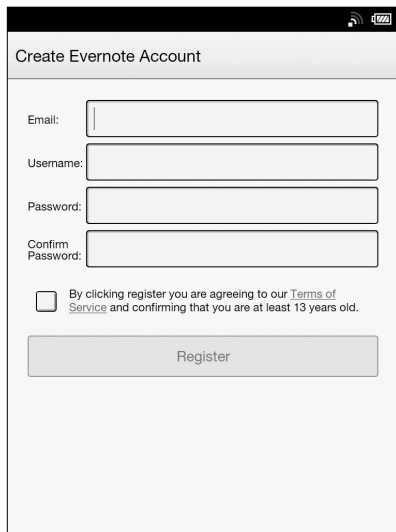

The screenshot shows a mobile application interface for creating an Evernote account. At the top, there is a title bar with the text "Create Evernote Account" and a status bar with signal strength, Wi-Fi, and battery icons. Below the title bar, there are four input fields stacked vertically, each with a label to its left: "Email:", "Username:", "Password:", and "Confirm Password:". Below these fields is a checkbox with the text "By clicking register you are agreeing to our [Terms of Service](#) and confirming that you are at least 13 years old." At the bottom of the form is a large, light gray button with the text "Register".

- 4 Tap [Register].

Sign in to Evernote

If you have an Evernote account, you can use it by typing your username and password.

- 1 Press the  (Home) button  tap [Applications]  [Evernote Setup].**

An Evernote settings screen for signing in appears.

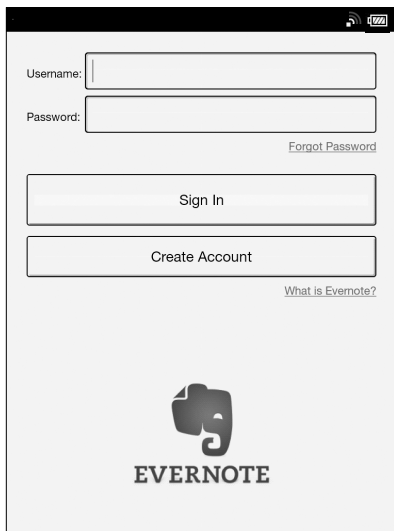

The screenshot shows the Evernote sign-in interface. At the top, there are status icons for signal strength, Wi-Fi, and battery. Below these are two input fields: 'Username:' and 'Password:'. To the right of the password field is a link that says 'Forgot Password'. Below the input fields are two large buttons: 'Sign In' and 'Create Account'. At the bottom of the form area is a link that says 'What is Evernote?'. The Evernote logo, featuring a stylized elephant head, is centered below the form, with the word 'EVERNOTE' in all caps underneath it.

- 2 Type your username and password using the on-screen keyboard.**
- 3 Tap [Sign In].**

An Evernote settings for configuration appears.

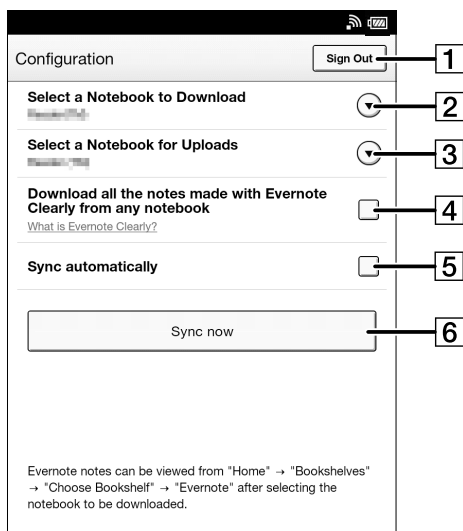

Evernote Settings



- 1** Sign out from Evernote.
- 2** Select the notebook to be downloaded from Evernote to the Reader.
- 3** Select the notebook to be uploaded from the Reader to Evernote.
- 4** Check this box to download notes created with Evernote Clearly to the Reader.
- 5** Check this box to synchronize notebooks on the Reader with Evernote automatically.
- 6** Synchronize notebooks and update.

Synchronizing in the Evernote list page

You can synchronize notebooks easily in the Evernote list page.

- 1 Make sure that Wi-Fi is set up and turned on.**
- 2 Press the  (Home) button → tap [Bookshelves] → [Evernote].**
- 3 Tap  at the top of the screen.**

Synchronization with Evernote starts.

Note

- If you delete Evernote cloud content that has been synchronized, the same content on the Reader is also deleted.

Tip

- When [Books] or [Collections] appears, tap the top-left corner of the screen to show [Evernote]. Alternatively, press the  (Menu) button, then tap [Choose Bookshelf] to show [Evernote].

Facebook

Using Facebook

You can post book information, such as title, author and publisher (when available) and your favourite passages with your comments to Facebook.

You can also post a list of your book collection with your comments .

These posted items can then be viewed on Facebook.

- To post highlighted words on a page, see Details.
- To post a book information, see Details.
- To post annotations for all books, see Details.
- To post a collection, see Details.

Note

- You need to create a Facebook account in order to use Facebook. Refer to the Facebook website.
- Highlighted words may be posted up to 140 characters.

Log In to Facebook

After you have created your account, type in your email address and Facebook password.

Note

- You must agree to the terms and conditions before using [Facebook Setup]. Please read the terms and conditions carefully. When you tap [Accept], [Facebook Setup] opens.

1. Press the **↑ (Home) button** → tap **[Applications]** → **[Facebook Setup]**.

The web browser opens.

facebook

Log in to use your Facebook account with "Reader" from Sony.

Already have an account?

Email or Phone

Password

Log In

New to Facebook?

Create New Account

Forgot password? · Help Center

Trouble logging in?

English (US) · 日本語 · Español · More...

Facebook ©2013

2. Type your email address and Facebook password using the on-screen keyboard.

If a screen for permission appears, confirm your acceptance.

3. Tap Log In button on the web page.

Note

- Before posting to Facebook, you need to log in by this screen.
- Actual screen images may vary.

Changing the Settings

Changing the Settings

The [Settings] application allows you to personalize the Reader, set the date and time, configure the Wi-Fi connection, and change the standby screen and other Reader settings.

General Settings

Setting	Description
[Page Turn Preference]	Sets the swipe direction for turning pages.
[Menu Language]	Sets the menu language.
[Keyboard]	Sets the on-screen keyboard layout.

Wireless Network Settings

Setting	Description
[Wi-Fi]	Turn Wi-Fi on/off. See Details.
[Wireless Standby]	<p>Wireless standby helps avoid unnecessary battery consumption caused by wireless communication. If you do not perform any wireless operations for more than 10 minutes, the wireless feature automatically enters standby mode.</p> <p>Note</p> <ul style="list-style-type: none"> • Accessing the [Browser] application from wireless standby mode takes more time than accessing when the Reader is connected to the wireless network. • If you deactivate wireless standby, the Reader retains a wireless connection at all times, resulting in higher battery consumption.
[Wi-Fi Settings]	Wi-Fi settings enable the Reader to use local Wi-Fi networks to connect to the Internet. See Details.

Application Preferences

Setting	Description
[Books]	Sets preferences for all books. You can adjust the default font size. [Refresh Display]: Refreshes the display at each page turn*. * Even if the [Refresh Display] check box is not selected, the screen may still flicker, to prevent after-image.
[Dictionary]	Specifies the default dictionary.
[Picture]	Sets the slideshow interval.
[Browser]	Sets the browser preferences.

Date and Time Settings

Setting	Description
[Date]	Sets the date.
[Time]	Sets the time.
[Date Format]	Sets the date format.
[24-Hour Format]	Check to display time in 24 hour-format.
[Time Zone]	Sets the time zone.

Tip

- When you start the Reader application and connect the Reader to your computer, the Reader's time setting is updated to match your computer's time.

System Management

Setting	Description
[Device Lock]	<p>Sets a 4-digit PIN for the Reader to prevent unauthorized use.</p> <p>To set [Device Lock] to [On], input your 4-digit PIN → tap [Continue] to enter it again → tap [OK]. When [Device Lock] is set to [On], you must unlock the Reader with the 4-digit PIN when waking up the Reader from sleep mode, or when turning on the power.</p> <p>To set [Device Lock] to [Off], input your 4-digit PIN and tap [Continue].</p> <p>Note</p> <ul style="list-style-type: none"> • Sony recommends that you make a note of your password and keep it in a safe place separate from the Reader. • If you forget your password, contact Sony Customer Support. Note that in unlocking your device, all content on it will be erased.

Setting	Description
[Standby Screen]	Sets standby screen preferences. [Type of Image]: You can select whether to display the cover of the last read book or pictures from the [Pictures] application. When you select [Selected Pictures], continue by tapping [Select Pictures] ➔ tap to add a check next to the pictures you want to display ➔ tap [Done]. [Show Message]: You can select whether to display a message about waking up the Reader from sleep mode on the standby screen.
[Download Destination]	Sets the destination for files downloaded from the browser. Select between [Internal Memory] and [SD Card].
[Check for Updates]	Check the update information.
[Demo Mode]	Sets the Reader to the Demo Mode. To enter the Demo Mode, check the checkbox next to [Demo Mode].

Initialization

Setting	Description
[Restore Defaults]	Restores the default Reader settings.
[Clear Keyboard History]	Deletes words registered to the on-screen keyboard history.
[Format Memory]	<p>Allows you to format the Reader's internal memory and the microSD card.</p> <p>Note</p> <ul style="list-style-type: none"> • If you have formatted the Reader or microSD card on your computer, the Reader may not be able to display transferred content. In this case, use the Reader's [Format Memory] function to reformat the Reader and your microSD card. • When either memory is formatted, content download stops. <p>Tip</p> <ul style="list-style-type: none"> • Before formatting, make sure to backup data you wish to keep to your computer via the Reader application. Note that protected content will also be deleted when you format it.

About

Setting	Description
[Device Information]	Displays the device details including the memory capacity, Adobe DRM authorization and MAC address in use.
[Legal Information]	Displays trademark and copyright information.
[End User License Agreement]	Displays the terms and conditions on use of the Reader.

Device Shutdown

Enables you to shut down (turn off) the Reader, instead of leaving it in sleep mode.

Troubleshooting

Troubleshooting Tips

Troubleshooting tips may help you quickly resolve technical issues.

1 Charge the Reader completely.

2 Reset the Reader.

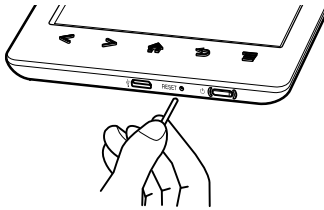

Press the RESET button with a small pin or clip. The screen will freeze; the Reader will not restart automatically.

Press the  (Power) button, and the startup screen appears.

Note

- The bookmarks, highlights, handwritten notes or the setting information may be deleted by resetting.
- Do not push the RESET button with a breakable point, such

as the graphite of a mechanical pencil. It can cause the RESET button to be blocked.

- 3 Comprehensive support and troubleshooting information is available at the support PC Web site. See Details.**

Support PC Web Site

For comprehensive support and troubleshooting information, visit the support PC Web site.

Support PC Web

<http://support.sony-europe.com/eBook/PRS>

Reader Device

Power On/Off

The Reader cannot turn on.

- The Reader cannot be operated if connected to your computer and set to data transfer mode. Use the safely remove hardware function of your computer, and then disconnect the USB cable from the Reader.
- Moisture condensation may have occurred. Wait for a few

hours and then turn on the Reader.

- If the battery is completely depleted, power will not be supplied to the ⏻ (Power) button, and you may not be able to turn on the Reader. In this case, connect the Reader to your computer via the supplied USB cable; the Reader will turn on immediately. If the Reader does not turn on, press the ⏻ (Power) button. If the Charge indicator blinks red 3 times, disconnect the USB cable from the Reader, then reconnect approximately 5 minutes later.

The Reader cannot turn off or enter sleep mode.

- If the Reader screen freezes and stops responding, the ⏻ (Power) button will also not work. In this case, reset the Reader. See Details.



The Reader automatically enters sleep mode or turns off.

- To conserve the battery's charge, the Reader includes automatic power saving modes. The Reader will enter sleep mode after 10 minutes of inactivity. After 3 days* in sleep mode, the Reader will shut down/power off automatically.

* If the battery's charge is low, the Reader may automatically turn off within 3 days. However, when viewing a slideshow, this feature does not work. The automatic power saving modes cannot be turned off.



Battery

Cannot charge the Reader.

- If you use other than the supplied USB cable to charge the Reader, it may not charge correctly. To charge the Reader, use only the supplied USB cable and, optionally, the AC Adapter (PRSA-AC10/PRSA-AC1A, sold separately). See Details.
- If you are charging from the USB port on your computer, make sure that the Reader is connected directly to the USB port with the supplied USB cable. Do not use a USB hub.
- The battery has not been given enough time to fully charge. Charge the Reader until the  icon changes to the  icon. (The charge icon does not indicate the remaining battery power while charging.)
- Your computer must be turned on to charge the Reader. The Reader will not be charged if your computer enters sleep mode or standby mode. Keep your computer turned on with a stable and continuous power supply while charging the Reader.
- If your computer enters sleep mode while the Reader is connected and charging, the Reader battery's charge will gradually drain, the Reader will shut down and the Reader's battery will not charge. In this case, disconnect the USB cable from the Reader, wake the computer from sleep mode, and then reconnect the USB cable to the Reader.

- Your computer may not be supplying sufficient power. If you connect the Reader to your laptop computer, maintain a stable and continuous power supply to the laptop computer while charging the Reader.
- If the ambient temperature is too cold or too hot for the Reader to charge, adjust the room temperature to between 5°C (41°F) and 35°C (95°F), disconnect and reconnect the USB cable.

Battery life seems short.

- The Reader may not have been charged fully. Make sure that you charge the Reader until  changes to .
- The operating temperature is below 5°C (41°F). This is due to the battery characteristics and not a malfunction.
- The Reader requires power while in sleep mode. If you are not planning to use the Reader, turn it off instead of leaving it in sleep mode.
- If you are not browsing on the Web, exit [Browser] by pressing the  (Home) button.
- The Reader battery gradually discharges when not in use for a prolonged period of time. Before turning on the Reader after a prolonged period of disuse, charge the Reader again.
- If you are not using wireless communications, turn off Wi-Fi. See Details.
- If you are charging the Reader by data transfer mode and

the computer enters sleep mode or standby mode, the Reader will be unable to charge, and the battery may drain. When charging the Reader, confirm that your computer is on, and completely charge the Reader before using it. See Details.

Touchscreen

The Reader does not wake up or start immediately.

- In cold temperatures, the touchscreen may respond slower than usual. This is due to the touchscreen characteristics and is not a malfunction.
- After resetting or turning off the Reader, it may take time for the startup screen to appear.

The screen does not respond.

- Reset the Reader. See Details.





The screen responds slowly.

- If the touchscreen becomes dirty, it may not function correctly. Clean the touchscreen with a soft cloth, such as a cleaning cloth for eyeglasses.
- In cold temperatures, the touchscreen may respond slower than usual. Turn off the Reader and leave it for a few hours until it adjusts to the ambient temperature.

Wireless Connectivity

Wi-Fi connection

The Reader does not connect to the Wi-Fi network.

- The network feature could not be turned on because the remaining battery power is too low. Charge the Reader for a few minutes, and then try again.
- Make sure that Wi-Fi is turned on and check the signal strength of the access point.
- Scan the available access points in the vicinity and select a new one.
- Make sure that the security method (WEP/WPA), the static IP address and the proxy settings are correct.
- The access point is using an unsupported security method or encryption key.
- Public Wi-Fi networks may require a user ID and password. In this case, you must enter a correct user ID and password to establish a network connection.
- The access point has the MAC address filter enabled. To check the MAC address, press the  (Home) button  tap [Applications]  [Settings]  [About]  [Device Information]. Make sure that this MAC address is accepted by the access point.
- The Wi-Fi network settings of the access point are not

correct. Adjust the settings as described in the manuals that came with the access point and in any information provided by the network administrator.

- The Reader is too far from the access point. Move the Reader closer to the access point and scan again.
- Obstacles such as walls, metal or concrete between the Reader and an access point may adversely affect the connection. Try moving the Reader to a different location and scan again.
- There is other equipment nearby using the 2.4 GHz frequency band (such as a cordless phone, a microwave oven, or Bluetooth computer equipment). Move the equipment away or turn it off.
- The Wi-Fi network service is temporarily not available or degraded. Check with the network administrator for the status.

Cannot find the access point in the Wi-Fi networks list.

- The access point you want to use is set to not broadcast its SSID to users. In this case, the access point may not be shown on the Wi-Fi network list. Tap [Add Wi-Fi Network] and enter the SSID manually. See Details.

Browser

The Web page is not displayed properly.

- The Wi-Fi network connection may have been interrupted. Make sure that Wi-Fi is turned on and set up correctly, check the signal strength of the access point, and then refresh the Web page.
- Due to the vast range of standards and technologies used to design Web pages, it is not possible to guarantee that all pages will be displayed correctly.
- When you pinch in/out to zoom in/out a web page, the screen may be too light to read. This is not a malfunction.

Cannot change the font size.

- The font size does not change if it is specified by the Web page. You can use the zoom feature to enlarge the page display.
- When you pinch in/out to zoom in/out a web page, the screen may be too light to read. This is not a malfunction.

Reading Books

Cannot open a book.

- You must be the account holder who purchased the book to read it.
- If there is an authentication code error, you can open the book/periodical by entering the Adobe ID/Password. (A maximum of ten IDs can be saved on the Reader.)
- The book may be in an unsupported file type. For details on supported file types, see Details.

“Continue Reading” does not work, or the bookmark is missing.

- If the file status has changed (such as in the following cases), data under [Continue Reading] or notes may be deleted.
 - A text/PDF file is edited.

Cannot find content on the Reader.

- If you have formatted the Reader on your computer, the Reader may not be able to display transferred content. In this case, use the Reader’s [Format Memory] function to reformat the Reader. See Details.
- Although protected on the Reader, books may be deleted if you sync the Reader after they have been deleted from the Reader application.

- If you delete or modify folders or files in the “database” folder on your computer, content or notes may be deleted.

Viewing Pictures

Cannot view a picture.

- The picture may be in an unsupported file type. For details on supported file types, see Details.
- If the size of a picture that you transferred with the Reader application is too large, a thumbnail may not be created on the Reader and the picture may not be displayed in the [Pictures] content list. In this case, delete the picture via the Reader application.

Connecting to your Computer

The computer does not detect the Reader.

- After connecting the Reader to your computer via the USB cable, you must set the Reader to data transfer mode. See Details.
- It may take a while for the computer to detect the Reader.
- Make sure that the Reader is connected directly to the USB port with the supplied USB cable. Do not use a USB hub.
- Try connecting to a different USB port on the computer.
- Try disconnecting the Reader and connecting it again.
- If none of the above solves the problem, reset the Reader. See Details.

Cannot sync content with the Reader.

- The Reader may not have been authorized. Authorize the Reader first. For details, refer to the [Help] menu of the Reader application.
- There may not be enough space on the Reader or the memory card. Check [About] for the amount of free space on internal memory. See Details. Delete some content, or copy it to the Reader application to make some space on the Reader or the memory card.

microSD Card

The Reader does not detect the microSD card, or cannot open an item stored on the microSD card.

- If you have formatted the microSD card on the computer, the Reader may not be able to display transferred content. Use the Reader to format the microSD card. See Details.
- It may take a while for the Reader to detect the microSD card and load all files stored on it. Wait a little longer after inserting the microSD card to the card slot.
- Make sure that the microSD card is supported by the Reader. See Details.
- Make sure that the microSD card is inserted properly. See Details.
- Make sure that the gold contact point of the microSD card and the card slot are clean. If dirty or dusty, clean them carefully.
- The Reader may not have been authorized. Authorize the Reader first. For details, refer to the [Help] menu of the Reader application.
- Data transferred via drag-and-drop may not be displayable on the Reader, or thumbnails of the data may not be properly displayed on the Reader. Sony recommends that you transfer data via the Reader application.

Cannot save the book or other items on the microSD card.

- The Reader does not offer a feature that enables you to move files to or from the microSD card. You need to use the Reader application to do so.

Cannot delete the book or other items from the microSD card.

- You cannot delete the file if it is read-only. You must use the computer and remove the read-only attribute from the file.

Precautions

Safety Information

Protected content

Protected content is limited to personal use only. Use of the content beyond this limit requires permission of the copyright holders.

Handling the Reader

- In order to comply with FCC radio-frequency radiation exposure guidelines for an uncontrolled exposure, this device and its antenna must not be co-located or operating in conjunction with any other antenna or transmitter.
- If the Reader causes interference to radio or television reception, turn the Reader off and move it away from the radio or television.
- Refrain from using the Reader according to the in-flight announcements during take off or landing in an aircraft.
- Do not drop, or put any heavy object on top of the Reader or apply a strong shock to the Reader. It may cause a malfunction or damage.

- Never subject the Reader to extremes of light, temperature, moisture or vibration.
- If part of the Reader that generates heat contacts your skin for a prolonged period, you may suffer from symptom of burn, such as redness, swelling, even if temperature is moderate. Avoid prolonged contact, especially if you have sensitive skin.
- Do not leave the Reader on an unstable surface.
- If any object is placed on the touchscreen, it may cause a malfunction. When not in use, leave the Reader in sleep mode, or turn it off.
- When using the Reader internationally, it is your responsibility to ensure that the Reader is used in compliance with the following specifications:
 - AC voltage
 - Wireless products regulations
 - Other safety regulations or requirements
- Do not touch the terminals of the Reader with a finger or metallic object, as it may cause malfunction.
- Never leave the Reader exposed to high temperature, such as in a car parked in the sun or under direct sunlight.

Avoiding water and moisture

- Note that condensation may form temporarily in cases such as when the player is moved quickly from a low-

temperature environment to a high temperature environment or used in a room that has a heater just turned on. Condensation creates a phenomenon where moisture in the air adheres to surfaces such as metal panels, etc., and then changes to liquid. If condensation forms in the Reader, leave it turned off until the condensation disappears. If you use the Reader with condensation present, a malfunction may result.

- The Reader is not waterproof. Remember to follow the precautions below.
- Be careful not to drop the Reader into a sink or other container filled with water.
- Do not use the Reader in humid locations or bad weather, such as in the rain or snow.
- Do not get the Reader wet.

If you touch the Reader with wet hands, or put the Reader in a damp article of clothing, the Reader may get wet and this may cause a malfunction.

Charging the Reader

- Heat may build up in the Reader while charging, or if it is used for an extended period of time.
- Use the supplied USB cable or the optional AC adapter (PRSA-AC10/PRSA-AC1A, sold separately) only. Do not use other USB cable and AC Adapter.

- Never wrap the Reader in anything when it is being charged. Heat build-up in the Reader may cause malfunction or damage.
- If the battery quickly runs out of power after being fully charged, it may be reaching the end of its life and should be replaced. Consult Sony Support Center.

Wi-Fi connectivity

The Wireless LAN functionality has passed Wi-Fi certification and complies with the interoperability specifications established by WFA (Wi-Fi Alliance).

Cleaning the Reader

- Clean the Reader with a soft cloth, such as a cleaning cloth for eyeglasses. Make sure that there is no dust or dirt on the soft cloth, as the Reader may be damaged.
- Do not use any type of abrasive pad, scouring powder or solvent, such as alcohol or benzene, as it may mar the finish of the case.
- Be sure to keep the Reader away from water or spills.

Touchscreen

- Do not apply excessive pressure to the touchscreen. The color or lighting may become blurred or uneven, and the Reader may become damaged.
- When using the Reader in a cold environment, thin lines may appear on the touchscreen. This is not a malfunction.
- The outside cover of the touchscreen is made of glass. This glass could break if the Reader is dropped on a hard surface or receives a substantial impact. It could also be damaged by scratching and abrasion while being carried in a bag. If you are concerned about damages to the touchscreen, you can use a protective case (sold separately).

Wireless feature

- Turn off the wireless feature when you are in a location in which radio communications are prohibited. When you are in such a location, you must obtain permission from the appropriate authorities before enabling the wireless feature of this device.
- Turn off the wireless feature in health care facilities where any regulations posted in such areas instruct you to do so. Hospitals or health care facilities may be using equipment that could be effected by radio frequency (RF) energy which is generated by wireless communication.
- Do not use your Reader near medical equipment without first obtaining permission to do so.
- General notes on using the Wi-Fi (Wireless LAN) function.
In some countries or regions, use of Wi-Fi products may be restricted by the local regulations (e.g. limited number of channels).

Applications on the Reader

Disclaimer: In no event will SONY be liable for any financial damage, or loss of profits, including claims made by third parties, arising out of the use of the software supplied with this Reader.

Sony is not responsible for incomplete recording/downloaded or damaged data due to problems of the Reader or computer.

- Copyright laws prohibit reproducing the software or the manual accompanying it in whole or in part, or renting the software without the permission of the copyright holder.
- The software provided with this Reader cannot be used with equipment other than that which is so designated.
- Due to continued efforts to improve quality, software specifications may be changed without notice.
- Please note that, due to continued efforts to improve quality, software specifications may be changed without notice.
- Operation of this Reader with software other than that provided is not covered by the warranty.
- By updating the Reader device software, you can ensure your Reader has the latest features. The latest software updates can be performed by going to the [Help] menu of the Reader application and clicking [Check for Updates].

- Depending on the types of the text and characters, the text shown on the Reader may not be displayed properly. This is due to:
 - The capacity of the Reader.
 - The Reader is not functioning normally.
 - Content information is written in the language or the character that is not supported by the Reader.
- The ability to display the languages on your Reader will depend on the OS installed on your computer. For better results, please ensure that the installed OS is compatible with the desired language you want to display.
 - We do not guarantee all the languages will be able to be displayed properly on your Reader.
 - User-created characters and some special characters may not be displayed.

About Pre-installed Sample Content

Sample content is pre-installed in the Reader so that you can try them out right away.

The pre-installed sample content is for the purpose of trial reading and viewing.

Note

- You will not be able to restore the pre-loaded samples once you delete them from the Reader. Sony does not supply any replacement samples.

Reader Disposal Reference

The built-in rechargeable battery of the Reader is recyclable. Do not remove the battery yourself; consult Sony Support Center.

Disposal of Old Electrical & Electronic Equipment (Applicable in the European Union and other European countries with separate collection systems)

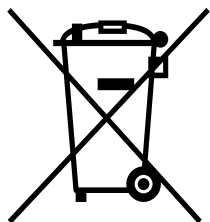

This symbol on the product or on its packaging indicates that this product shall not be treated as household waste. Instead it shall be handed over to the applicable collection point for the recycling of electrical and electronic equipment. By ensuring this product is disposed of correctly, you will help prevent potential negative consequences for the environment and human health, which could otherwise be caused

by inappropriate waste handling of this product. The recycling of materials will help to conserve natural resources. For more detailed information about recycling of this product, please contact your local Civic Office, your household waste disposal service or the shop where you purchased the product.

Disposal of waste batteries (applicable in the European Union and other European countries with separate collection systems)



This symbol on the battery or on the packaging indicates that the battery provided with this product shall not be treated as household waste.

On certain batteries this symbol might be used in combination with a chemical symbol. The chemical symbols for mercury (Hg) or lead (Pb) are added if the battery contains more than 0.0005% mercury or 0.004% lead.

By ensuring these batteries are disposed of correctly, you will help prevent potentially negative consequences for the environment and human health which could otherwise be caused by inappropriate waste handling of the battery. The recycling of the materials will help to conserve natural resources.

In case of products that for safety, performance or data integrity reasons require a permanent connection with an incorporated battery, this battery should be replaced by qualified service staff only.

To ensure that the battery will be treated properly, hand over the product at end-of-life to the applicable collection point for the recycling of electrical and electronic equipment.

For all other batteries, please view the section on how to remove the battery from the product safely. Hand the battery over to the applicable collection point for the recycling of waste batteries.

For more detailed information about recycling of this product or battery, please contact your local Civic Office, your household waste disposal service or the shop where you purchased the product.

Notes on microSD Cards

SD cards are made to standards and are commonly used as storage media for portable devices. microSD and microSDHC cards are members of the SD card family.

The Reader supports the following card types.

- microSD and microSDHC cards
 - Up to 32 GB

microSD cards of up to 32 GB has been tested to work with the Reader; however, not all microSD cards are guaranteed to work.

Precautions

- Insert into the correct slot with the card's label side up until it clicks into place.
- To avoid a choking hazard, keep the microSD card out of the reach of children.
- Do not touch the gold contact point of the microSD card.
- Do not disassemble or modify a memory card.
- Do not allow a memory card to get wet.
- Avoid the following to prevent data damage. Sony does not provide any guarantee for damaged data.
 - Remove a memory card or turn off the Reader while reading or writing data.

- Operate the Reader in the location where static charge or electrical noise is present.
- Do not strike, bend, drop, disassemble, open, crush, deform, puncture, shred, microwave, incinerate or paint the microSD card.
- Do not use force, a thin stick or tweezers to remove the microSD card. If you cannot remove the microSD card, contact customer support.
- Do not remove the microSD card or turn off the Reader while data on the memory card is being edited or accessed. Otherwise, edited data will not be saved.
- Do not insert a deformed microSD card into the Reader.
- If a memory card is formatted by your computer, it may become unusable on the Reader and “Reader for PC/Mac”. When formatting a memory card, format it using the Reader (see Details). If a format process is executed, all the files, even including write-protected image files, will be deleted.
- If you change or erase a folder name via computer, or move a file to a folder other than “database”, there is a possibility that data recorded in a memory card might be lost or become unreadable by this product.
- You can use a microSD card (less than 2 GB) and microSDHC card (less than 32 GB), but CPRM (Content Protection for Recordable Media) is not supported.

- microSDXC card is not supported.
- FAT (File Allocation Table) is supported.
- exFAT (Extended File Allocation Table) is not supported.

Formatting a microSD card

You can use the Reader to format a microSD card if necessary.

WARNING

Formatting the microSD card will delete all files stored on it. You can use the Reader application to backup files. Files that you have set protection for via the Reader's applications will also be deleted.

1 Press the  (Home) button → tap [Applications] → [Settings] → [Initialization] → [Format Memory] → [SD Card].

2 Tap [Yes] when prompted.

To cancel, tap [No].

It may take a few minutes to finish formatting the microSD card.

Legal Notice

Legal Notice

The contents of each book pre-loaded on this product are copyrighted works, edited with the cooperation of the publisher.

Copyright laws prohibit copying the data of this product or the contents of this manual (illustrations, related documents, etc.) in whole or in part without the permission of the copyright holder. Additionally, use of the data of this product or the contents of this manual is not allowed without Sony's permission except for personal use.

- Sony, the Sony logo, "Reader", "BBeB" and their logos are either trademarks or registered trademarks of Sony Corporation.
- EPUB is a registered trademark of the IDPF.
- Frutiger, Univers, Helvetica and Palatino are trademarks of Linotype Corp. registered in the United States Patent and Trademark Office and may be registered in certain jurisdictions in the name of Linotype Corp. or its licensee Linotype GmbH.
- Bitstream is a registered trademark, and Dutch, Font

- Fusion, and Swiss are trademarks, of Bitstream Inc.
- Microsoft, Windows, Windows Vista and Windows Media are trademarks or registered trademarks of Microsoft Corporation in the United States and / or other countries.
 - Macintosh and Mac OS are trademarks of Apple Inc., registered in the U.S. and other countries.
 - This PRS-T3 contains Adobe® Reader® Mobile software under license from Adobe Systems Incorporated, Copyright © 1995-2011 Adobe Systems Incorporated. All rights reserved. Adobe and Reader are trademarks of Adobe Systems Incorporated.
 - This product includes software developed by the OpenSSL Project for use in the OpenSSL Toolkit. (<http://www.openssl.org/>) Copyright© 1998-2011 The OpenSSL Project. All rights reserved. This product includes cryptographic software written by Eric Young (eay@cryptsoft.com). This product includes software written by Tim Hudson (tjh@cryptsoft.com). For details on OpenSSL License, refer to [End User License Agreement] in [About] at [Settings] on the Reader.
 - Wi-Fi, the Wi-Fi CERTIFIED logo, WPA, WPA2 and Wi-Fi Protected Setup are trademarks or registered trademarks of Wi-Fi Alliance.
 - Facebook is a trademark of Facebook, Inc.
 - EVERNOTE, Evernote Clearly, the Evernote elephant logo and REMEMBER EVERYTHING are trademarks of Evernote

Corporation, and used under licence.

- Contains Reader® Mobile technology by Adobe Systems Incorporated.
- Google is a trademark of Google Inc.

All other system names and product names appearing in this document are the registered trademarks or trademarks of their respective owners. Further, the trademark™ and registered trademark® symbols are not indicated throughout this document.

Documentation © 2013 Sony Corporation

Appendix

Specifications

Model name

PRS-T3

Power source

Built-in rechargeable battery: 3.7 V DC, 1000mAh
USB powered from a computer or the optional AC Adapter PRSA-AC10/PRSA-AC1A (sold separately) via the supplied USB cable.

Battery life (continuous page turn)

Maximum Battery: Approximately 30,000 continuous page turns when reading only.*

* Measured using a text based content in ePub format and a fully charged battery, consecutive page-turns at approximately one second per page under the recommended operating temperature. Actual battery life may vary based on usage patterns and individual device.

Charging time

Computer-based charging: Approximately 2.5 hours

AC Adapter PRSA-AC10/PRSA-AC1A(sold separately)-based charging: Approximately 2 hours

Internal memory capacity (for data storage)

Approximately 1.2 GB after initial setting.

Depending on size of pre-loaded excerpts, available memory capacity may vary.

Operating/Charging temperature

5°C to 35°C (41°F to 95°F)

Dimensions (w/h/d)

109 × 160 × 11.3 mm (4 3/8 × 6 3/8 × 15/32 inches)

Mass

200 g (7.1 oz.)

Display

152.4 mm (6 inch) diagonal electrophoretic display

758 × 1024 pixels, 16-level grayscale

Wi-Fi

Wireless standards: IEEE 802.11b/g/n compliant

Wireless security: WEP (Open System), WEP (Shared Key),

WPA-PSK (TKIP), WPA-PSK (AES), WPA2-PSK (TKIP), WPA2-PSK (AES)

Expansion slots

microSD card slot

See Details for supported card types and precautions.

Supplied items

This Reader × 1

USB cable × 1

Quick Start Guide × 2

Supported File Types

The following files can be managed on the Reader application and transferred to the Reader device. However, depending on the file size and format, it may not be possible to view/display/play some data.

Books

- EPUB files (.epub)
 - EPUB (OPS version 2.0) supported.
- PDF files (.pdf)
 - Support is based on the PDF 1.6 specification.
- Text files (.txt)
- FB2 files (.fb2)

Pictures

- JPEG files (.jpg, .jpeg)
- GIF files (.gif)
- PNG files (.png)
- BMP files (.bmp)

Note

- If the size of a picture that you transferred with the Reader application is too large, a thumbnail may not be created on the Reader and the picture may not be displayed in the [Pictures] content list. In this case, delete the picture via the Reader application.
- For an animated GIF file, only the first frame will be shown.

System Requirements

The Reader application will work with the following operating systems.

Operating System	Details
Microsoft Windows 8 (32/64-bit)	Windows 8 Windows 8 Pro

Operating System	Details
Microsoft Windows 7 (32/64-bit)	Windows 7 Starter with Service Pack 1 or later Windows 7 Home Basic with Service Pack 1 or later Windows 7 Home Premium with Service Pack 1 or later Windows 7 Professional with Service Pack 1 or later Windows 7 Ultimate with Service Pack 1 or later
Microsoft Windows Vista (32/64-bit)	Windows Vista Home Basic with Service Pack 2 or later Windows Vista Home Premium with Service Pack 2 or later Windows Vista Business with Service Pack 2 or later Windows Vista Ultimate with Service Pack 2 or later

Operating System	Details
Microsoft Windows XP (32-bit only)	Windows XP Home Edition with Service Pack 3 or later Windows XP Professional with Service Pack 3 or later Windows XP Media Center Edition 2004 & 2005 with Service Pack 3 or later
Mac OS X 10.8	Mac OS X version 10.8.1 or later
Mac OS X 10.7 (64-bit only)	Mac OS X version 10.7 or later
Mac OS X 10.6 (32/64-bit)	Mac OS X version 10.6.6 or later
Mac OS X 10.5 (32-bit only)	Mac OS X version 10.5.8

The Reader application also requires at minimum the following computing environment.

Requirement	Details
CPU	1 GHz Intel processor
RAM	512 MB
Free space on hard disc	250 MB or more*

Requirement	Details
Screen	1,024 x 768 display resolution with 24-bit color
Network	Broadband internet connection

* Depending on the content amount, more space may be required.

Note

- The Reader application is not supported with the following:
 - An operating system other than those listed above
 - A personally built computer or operating system
 - A multi-boot environment
 - A multi-monitor environment