

TC-150/B, BT-50

US Model
Canadian Model
E Model
AEP Model
UK Model



TC-150B: for AEP
BT-50: for US

CASSETTE-CORDER

SPECIFICATIONS

Power Requirements:	6 V dc, four batteries, size AA, (IEC Designation R-6), Rechargeable Battery Pack BP-28 (optional) or 12 V car battery with SONY Car Battery Cord DCC-127H (optional) 120 V ac, 60 Hz with SONY AC Power Adaptor AC-9W for USA Model with SONY AC Power Adaptor AC-9 for Canadian Model 220 ~ 240 V ac (100, 110 ~ 127 V adjustable), 50/60 Hz with SONY Power Adaptor AC-4W (optional) for E Model 110, 220 V ac adjustable, 50/60 Hz with SONY Power Pack AC-456C (optional) ... for AEP Model 240 V ac, 50 Hz with SONY AC Power Adaptor AC-15 (optional) for UK Model	Fast Winding Time:	Approx. 1 min. 50 sec. with SONY Cassette C-60
		Frequency Response:	90 ~ 10,000 Hz (USA, Canada, E, AEP Model) 150 ~ 8,000 Hz (UK Model)
		Input:	MIC 1 (mini jack) sensitivity 0.2 mV (-72 dB) for low impedance microphone
		Output:	EARPHONE 1 (mini jack) 8 Ω earphone or load impedance 10 k Ω or higher
		Other Jack:	REMOTE 1
		Battery Life:	Approx. 2.5 hours of continous recording from the built-in microphone with SONY Super Batteries, size AA (IEC Designation R-6)
Power Consumption:	6 W (with AC-9W or AC-9) 9 W (with AC-15) 9 VA (with AC-456C) 7.4 VA at 50 Hz (with AC-4W) 6.8 VA at 60 Hz (with AC-4W)	Dimensions:	Approx. 174(w) x 29.5(h) x 113(d) mm 6 $\frac{7}{8}$ (w) x 1 $\frac{1}{4}$ (h) x 4 $\frac{1}{2}$ (d) inches
		Weight:	Approx. 760 g (1 lb 11 oz)
Power Output:	360 mW (max.) (USA, Canada, E, AEP Model) 320 mW (max.) (UK Model)		
Speaker:	5 cm (2 inches) dia.		
Recording System:	2-track 1-channel monaural		
Tape Speed:	4.8 cm/sec (1 $\frac{7}{8}$ ips)		

0 dB = 0.775 V

SONY[®]

SERVICE MANUAL

SERVICING NOTE

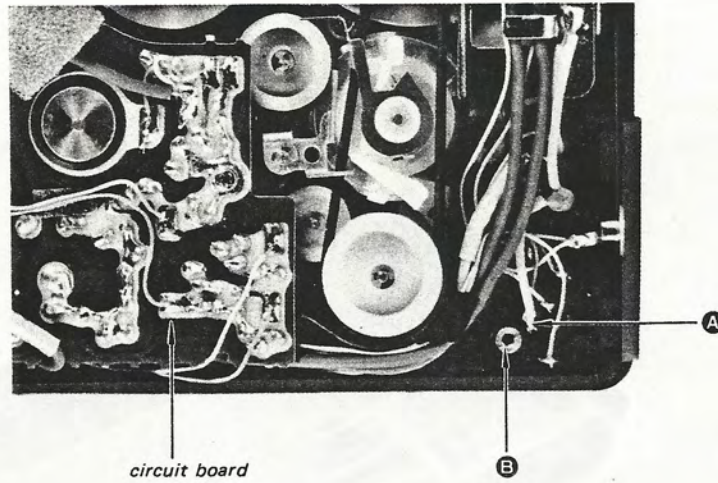

Before attaching the lower panel, confirm that portion **A** is detached from portion **B**

SECTION 1
OUTLINE

1-1. BLOCK DIAGRAM

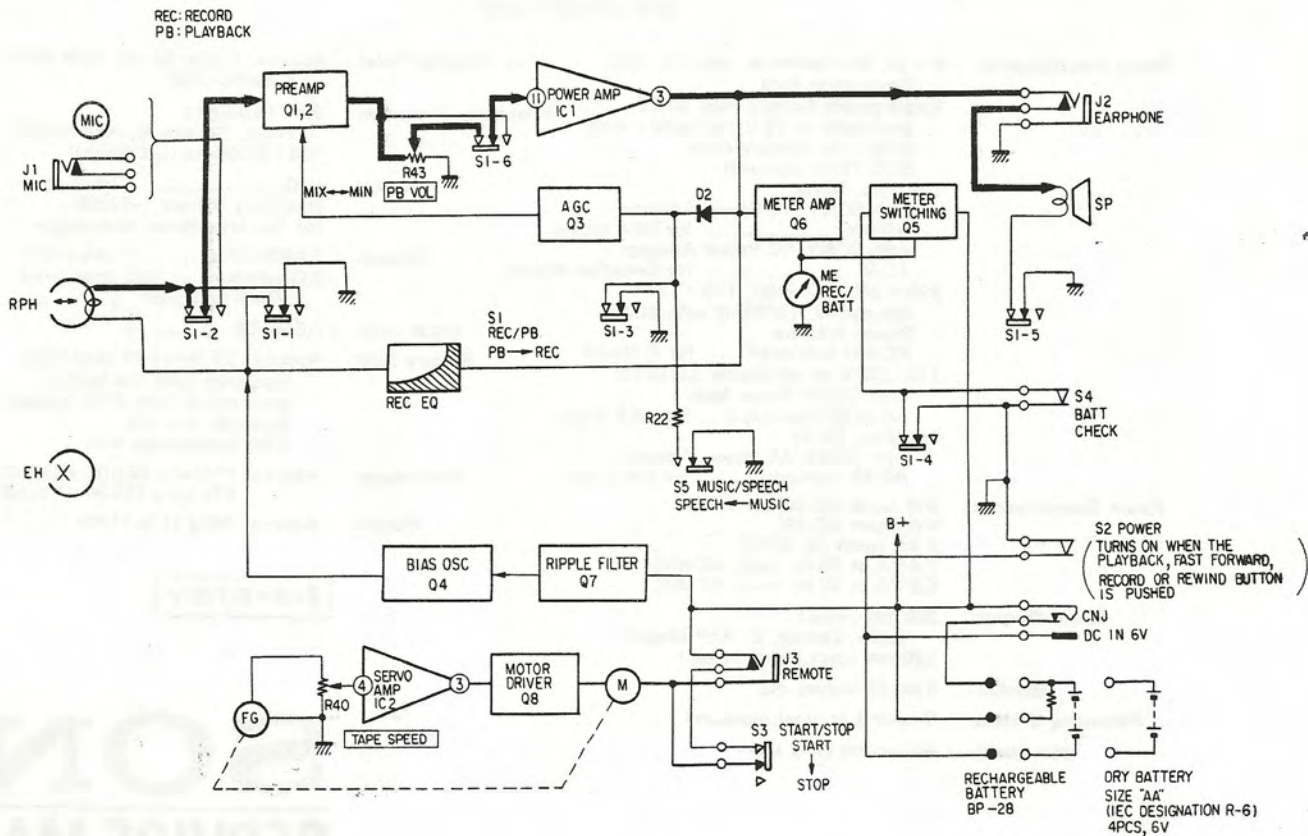

1-2. AUTOMATIC SHUT-OFF MECHANISM

TC-150 mechanism is so designed that it is automatically shuts tape transport off at tape end in record or playback mode. When the tape comes to the end, the tape tension stops the take-up reel spindle from rotating. This mechanism mechanically detects such

stop of the reel spindle rotation and returns tape transport to stop mode.

This operation in playback mode is described as follows. The operation in record mode is the same as in playback mode.

During tape travel: 1 ~ 5

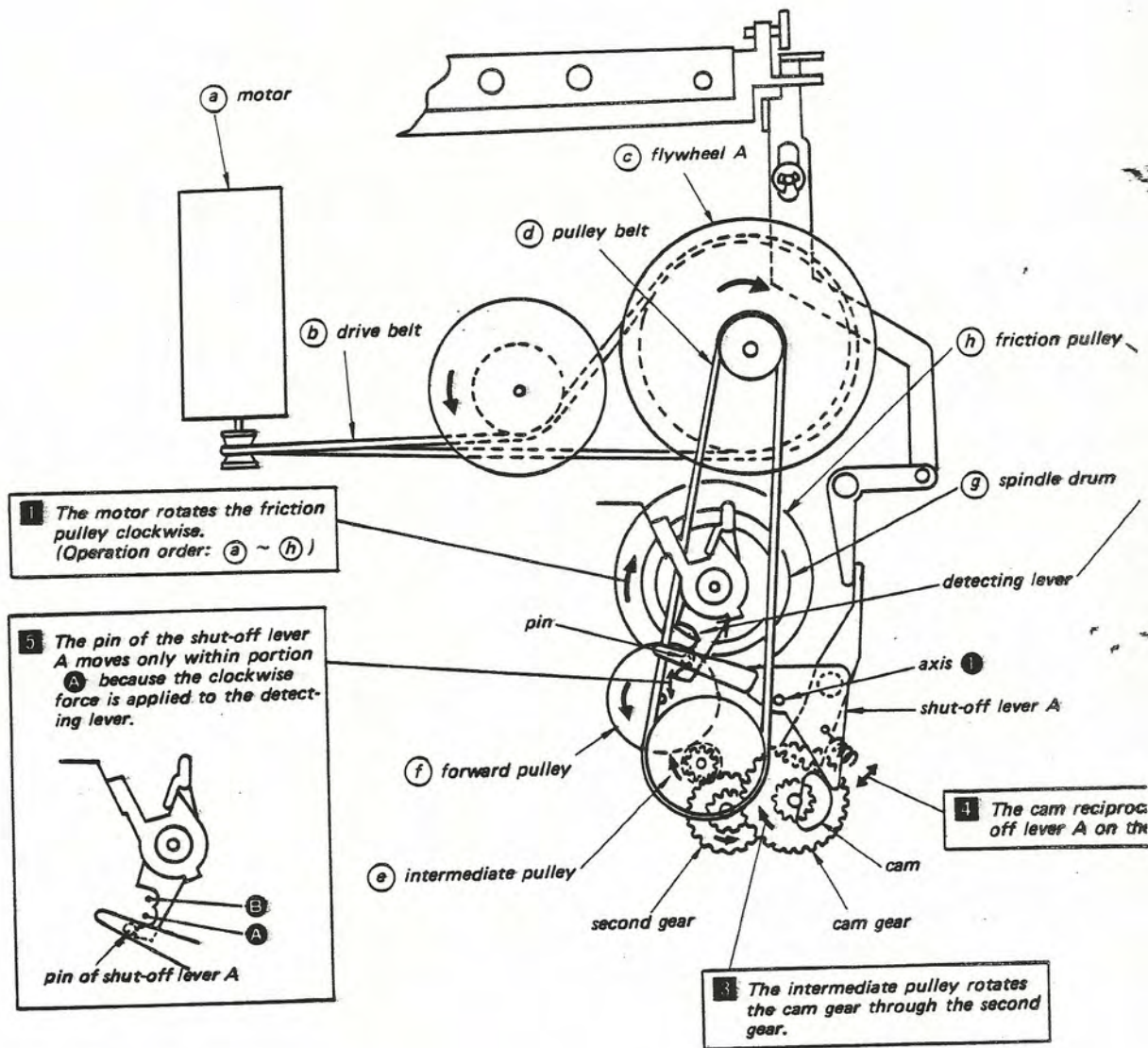

When tape stops traveling at tape end: **6 ~ 14**

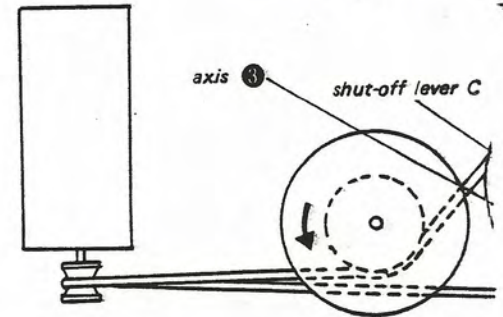
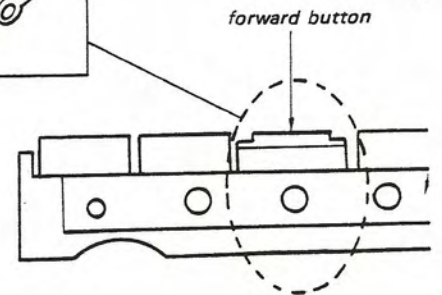
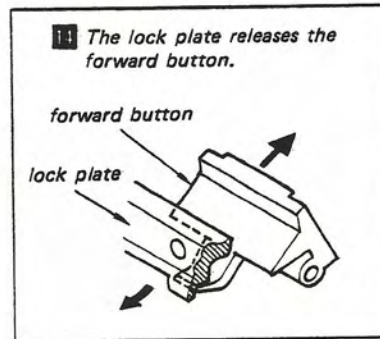

2 The friction pulley applies clockwise force to the detecting lever through coil spring.

6 When the tape stops traveling at tape end, the friction pulley directly connected with the take-up reel spindle stops moving. The friction pulley, therefore, stops to apply the clockwise force to the detecting lever.

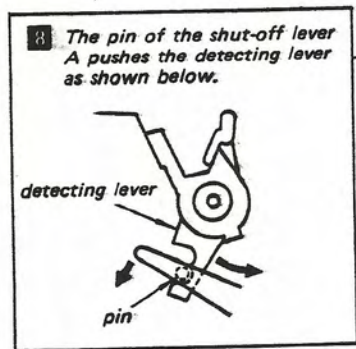
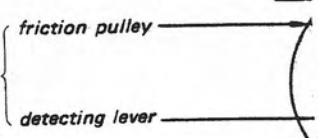

7 The shut-off lever continues to reciprocate.

indicates the shut-off axis **3**.

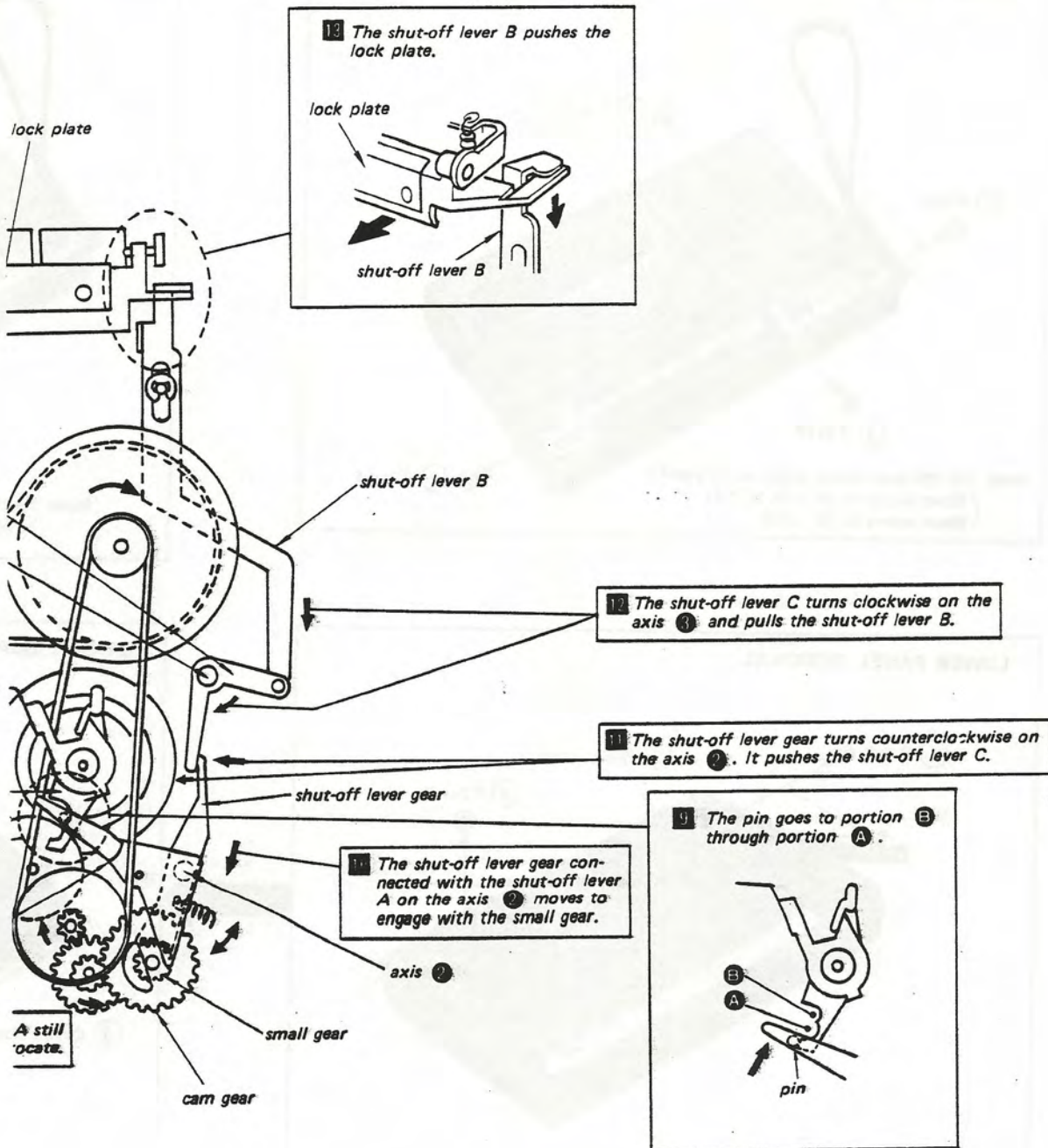

SECTION 2
DISASSEMBLY

UPPER PANEL REMOVAL



A top-down view of the Sony cassette player with the upper panel being removed. Four screws are indicated with callouts: 1 (P 2x4.5) at the top right, 2 (P 2x2) at the top left, 3 (P 2x10) at the bottom left, and 4 (P 2x4.5) at the bottom right. A black strap is attached to the top left.

Note: Use the same colour screws as the panel's.
(Silver screws for TC-150, BT-50)
(Black screws for TC-150B)

CASSETTE LID REMOVAL



A side view of the cassette player with the cassette lid open. A black strap is attached to the top left.

Note: To avoid losing, be sure to close

LOWER PANEL REMOVAL

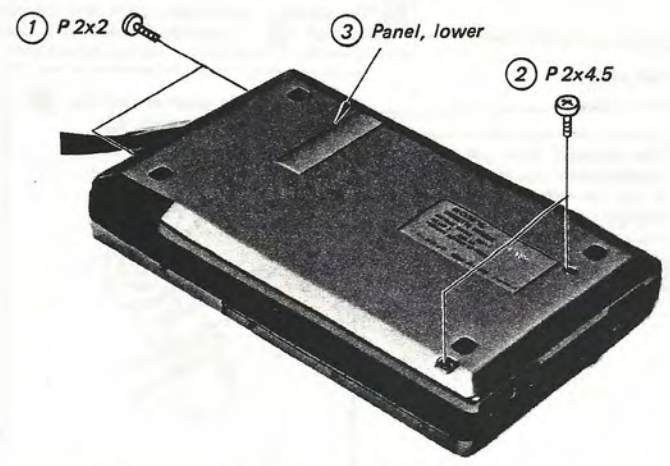

A bottom-up view of the cassette player with the lower panel being removed. Two screws are indicated with callouts: 1 (P 2x2) at the top left and 2 (P 2x4.5) at the top right. The lower panel is labeled as 3. A black strap is attached to the top left.

Be sure to use the screws specified above.

CIRCUIT BOARD REMOVAL



A close-up view of the circuit board being removed from the cassette player. The circuit board is labeled as 3.

REEL PANEL REMOVAL

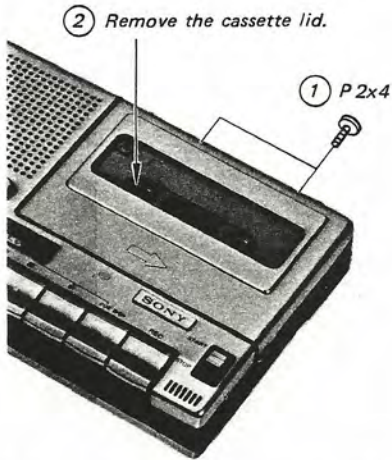

Remove the toggle springs attached to the cassette lid, then remove the cassette lid and then remove it.

REEL PANEL REMOVAL: (1) and (2)
MAIN CHASSIS REMOVAL (PART 1): (3)

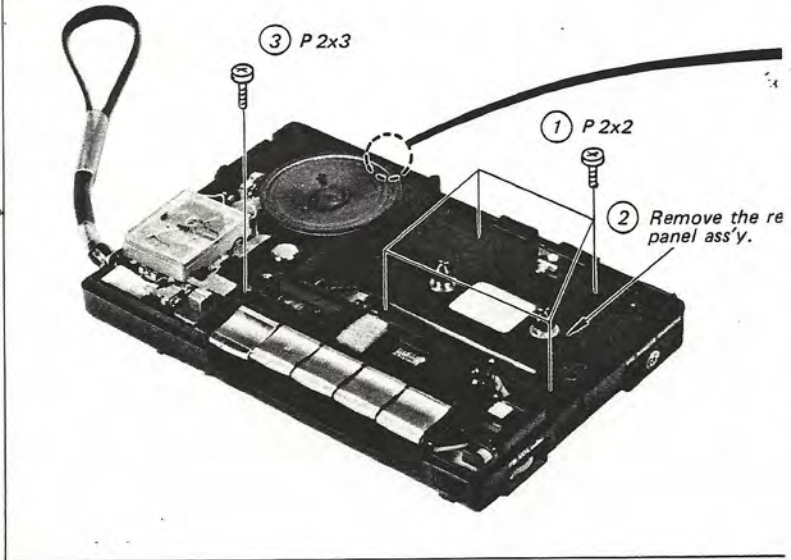

REEL PANEL REMOVAL

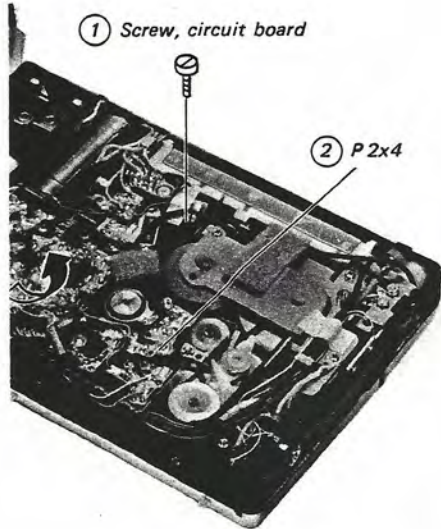

MAIN CHASSIS REMOVAL (PART 2)

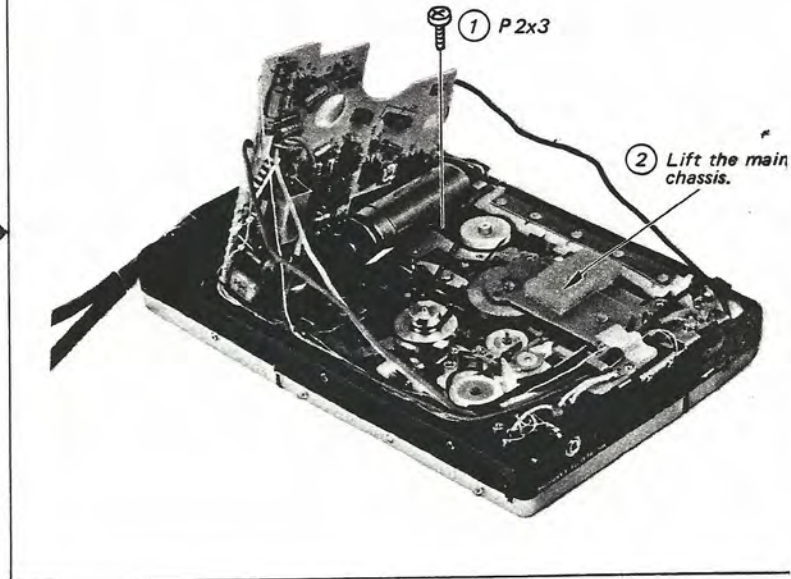

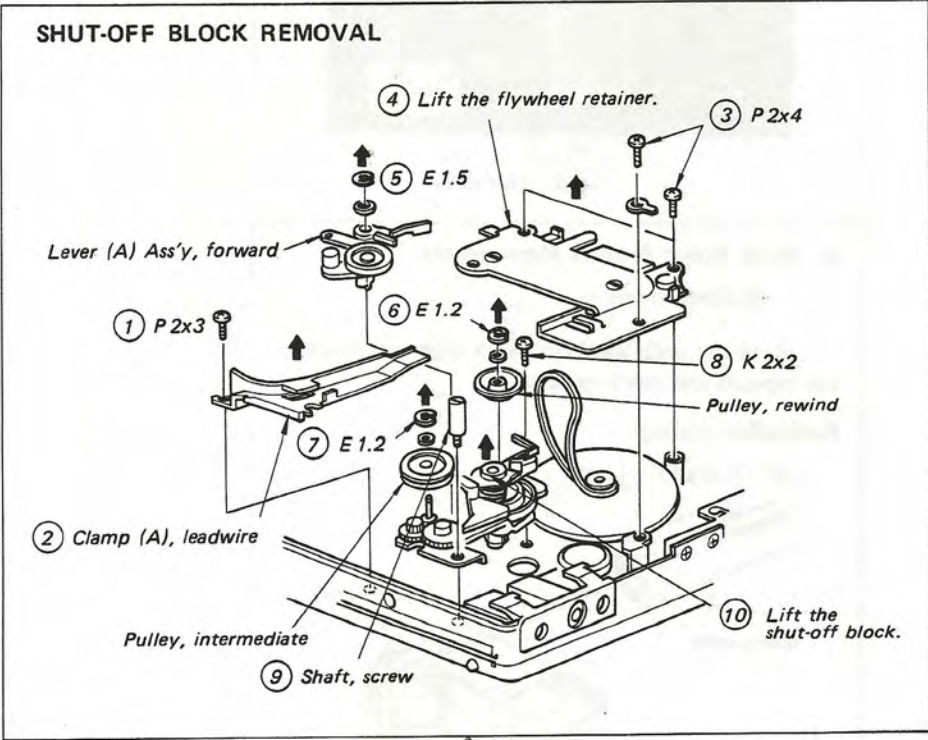
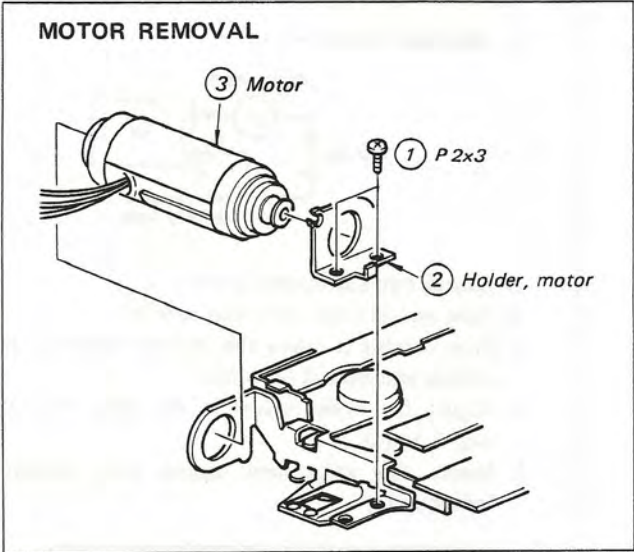

SECTION 3 ADJUSTMENTS AND MEASUREMENTS

3-1. MECHANICAL ADJUSTMENT AND MEASUREMENTS

1. Flywheel Thrust Play Adjustment

— playback mode —

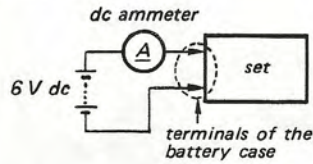

1. Loosen two adjustment screws.
2. Turn one of them clockwise carefully.
3. Stop turning it when the current suddenly increases and back it 1/4 turn.
4. Adjust the other screw in the same way as step 2 and 3.
5. Secure the adjustment screws with locking compound.

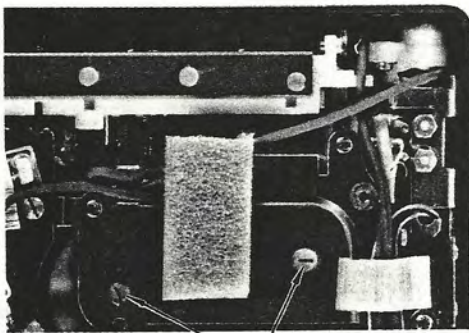

adjustment screws

2. Pinch Roller Pressure Measurement

— playback mode —

Read the scale when the pinch roller just touches the capstan and starts to turn.

Permissible reading:

200 ~ 300 g (7 ~ 11 oz)

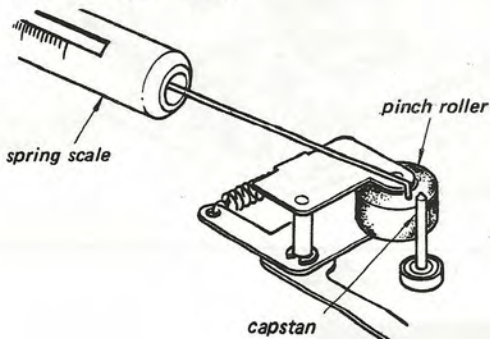

3. Torque Measurement

Keep the set horizontally and confirm that the B+ voltage is 5 Vdc.

Torque	SONY Torque Meter	Permissible Reading
Forward	CQ101A, CQ102A, CQ103A	25 ~ 45 g·cm (0.35 ~ 0.63 oz·inch)
Fast Forward and Rewind	CQ201A	over 55 g·cm (0.76 oz·inch)
Cue and Review	CQ201A	over 55 g·cm (0.76 oz·inch)

4. Wow and Flutter Measurement

Permissible value: within 0.38 %

3-2. ELECTRICAL ADJUSTMENTS

PRECAUTION

- Clean the following parts with alcohol moistened swab:

Record/Playback head	Pinch roller
Erase head	Rubber belts
Capstan	Idlers
- Demagnetize the record/playback head with a head demagnetizer.
(Do not bring the head demagnetizer close to the erase head, and do not use magnetized screwdriver for adjusting).
- After the adjustments, apply the locking compound to the adjusted parts.
- The adjustments should be performed in the order listed in this service manual.
- The adjustments should be performed with the rated power supply voltage unless otherwise specified.

1. Tape Speed Adjustment

Settings:

Power source 6 V dc

Procedure:

- Mode playback

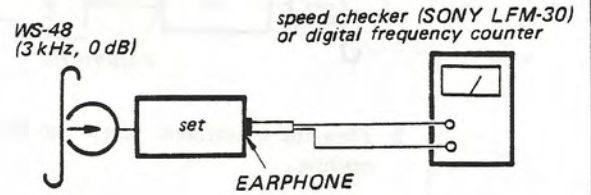

Specifications

- | Speed checker | Digital frequency counter |
|---------------|---------------------------|
| ±3 % | 2910 Hz ~ 3090 Hz |
 - Frequency difference between beginning and end of tape should be within 1 % (30 Hz).
2. If the above specification is not satisfied, adjust R40.

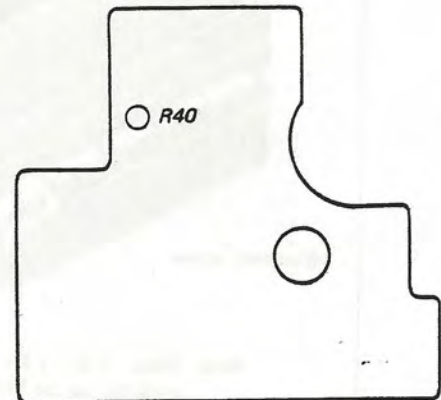

2. Record/Playback Head Azimuth Adjustment

Procedure:

1. Mode playback

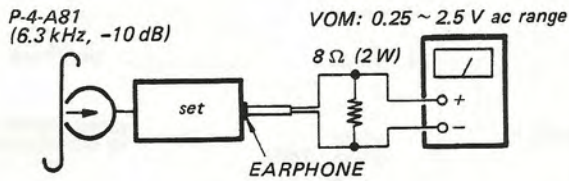

2. Turn the adjustment screw for the highest VOM reading.

Note: Several peaks may appear, take the highest.



Note: When 0.25 ~ 2.5 V ac range is not available on the VOM, use a network as shown below.

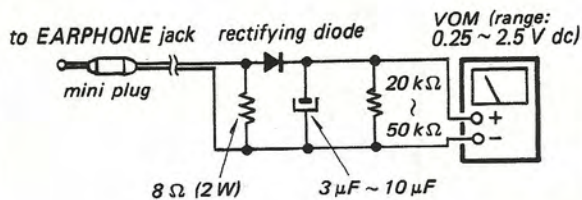

3. REC/BATT Meter Calibration

Setting:

Power source 3.6 V dc

Procedure:

1. Push forward button without cassette.
2. When power source is 3.6 V dc, the pointer should indicate as shown below.

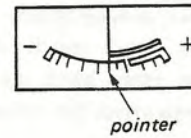

3. If necessary, solder ★ 1 and ★ 2.

Soldering Portion	Pointer
nothing	- mark
★ 1	↕
★ 1 and ★ 2	+ mark

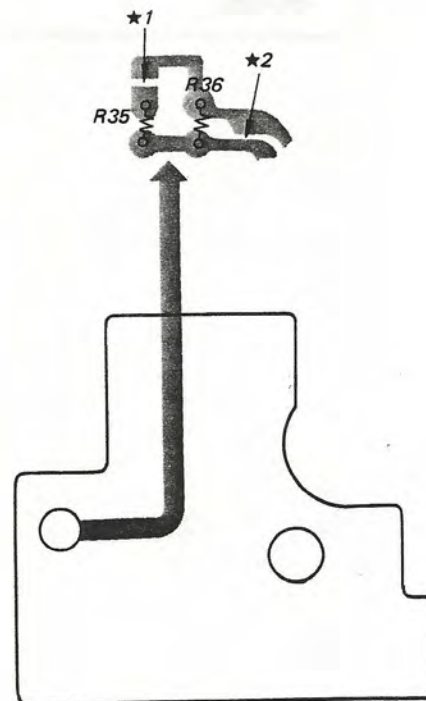

4. Record Bias Adjustment

Procedure:

1. Mode record

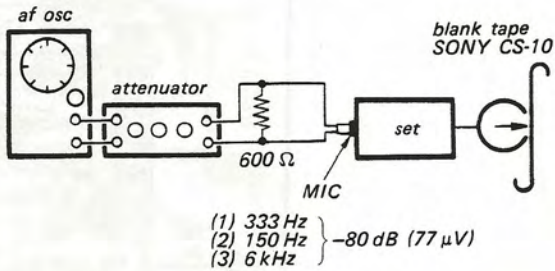

2. Mode playback

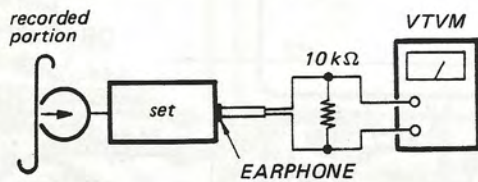

Recorded signal	VTVM reading
333 Hz	Adjust VOLUME control for -10 dB (0.25 V).
150 Hz	6 dB allowable range
6 kHz.	150 Hz 333 Hz 6 kHz

If necessary, adjust by changing the soldering portions (*1, *2 and *3).

Soldering Portion	6 kHz Level
*1	down ↑ up
*2	
*3	

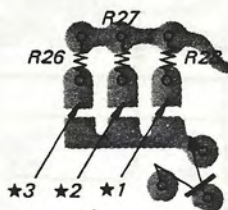

MEMO

.....

.....

.....

.....

.....

.....

.....

.....

.....

.....

.....

.....

.....

.....

.....

.....

.....

.....

.....

.....

.....

.....

.....

.....

.....

.....

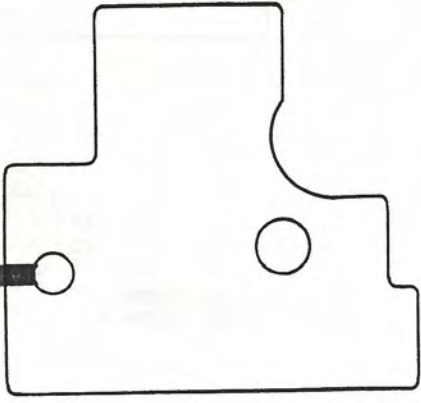

SECTION 4
DIAGRAMS

4-1. MOUNTING DIAGRAM

- Conductor Side -

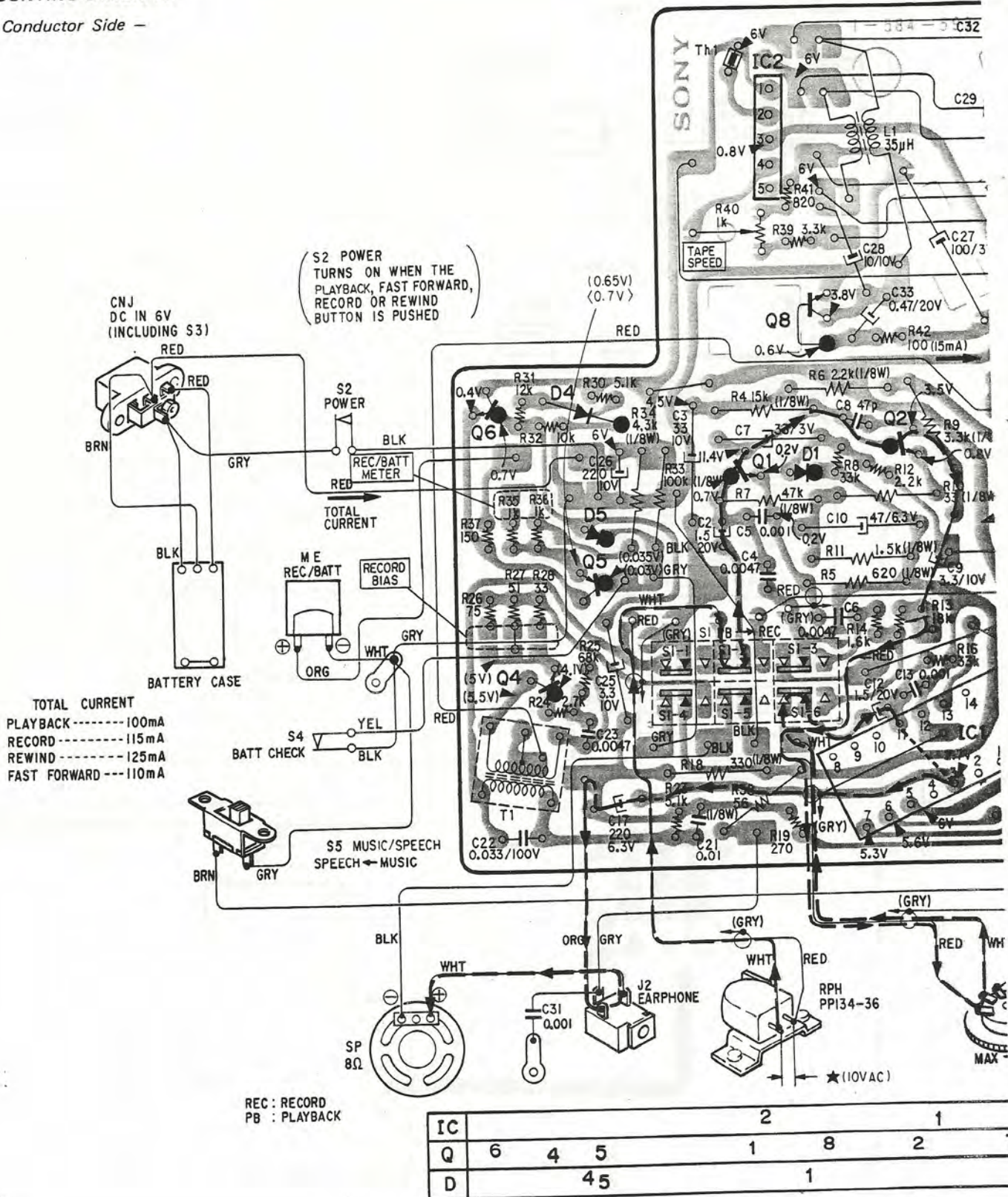

BT-50 TC-150/B.BT-50

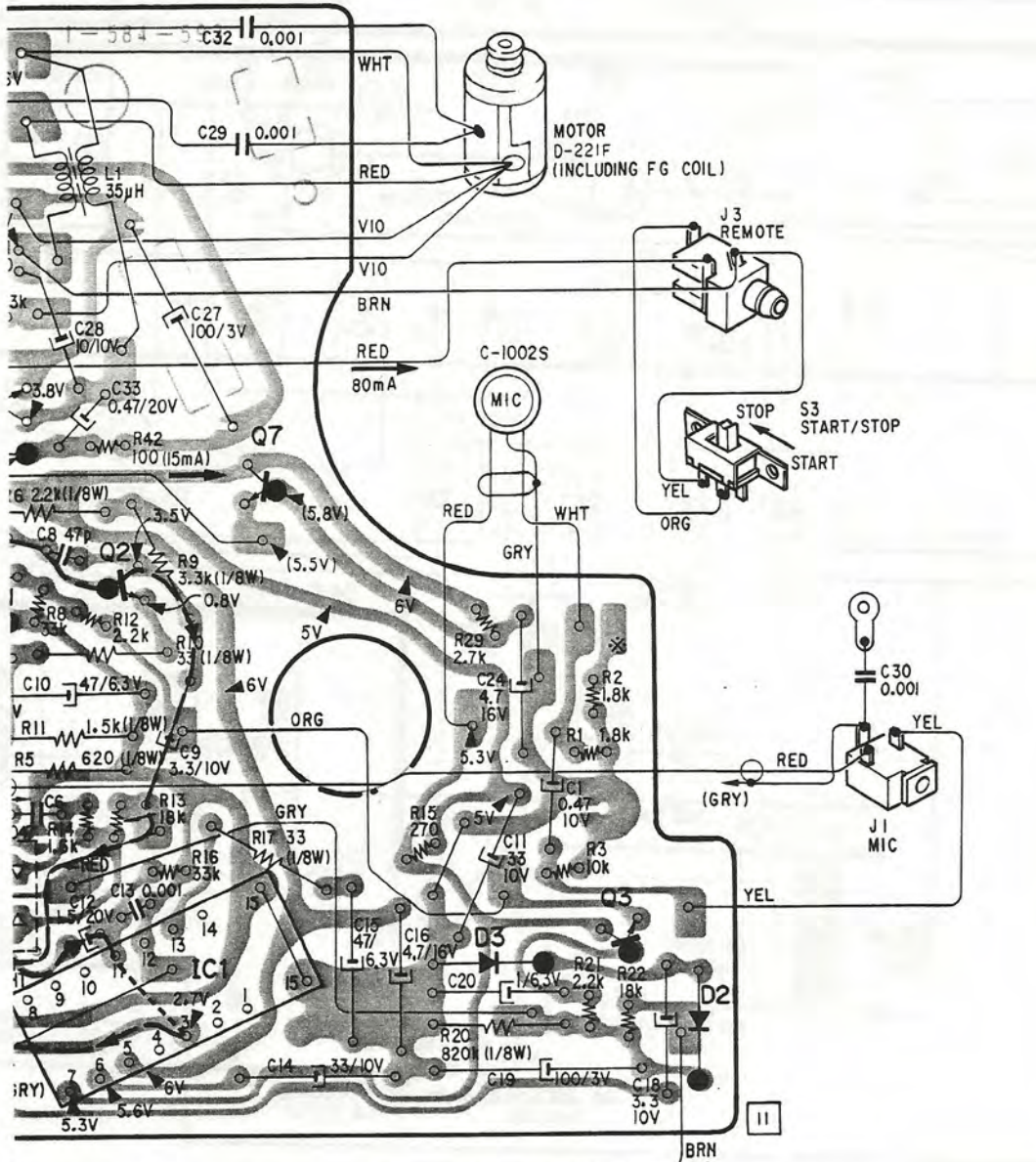

Q1, 2 2SC632A
Q3, 4, 6, 7 2SC634A

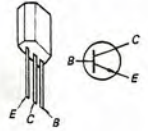

Q5 2SA678

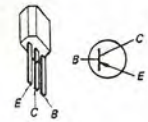

Q8 2SC1474

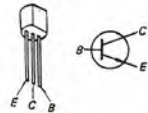

D1, 2, 3, 4, 5 1T40

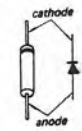

IC 1 CX-170

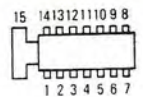

(Top view)

IC 2 BX-295



(Marking side view)

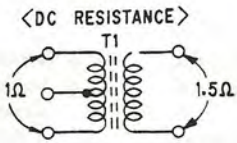
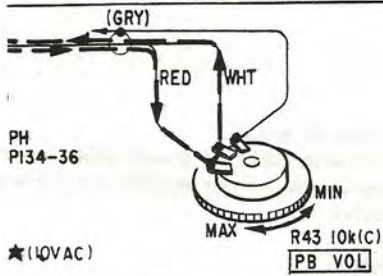

1	7	3
3	2	7
3	2	3

Note:

- : B+ pattern
- : signal path

4-2. SCHEMATIC DIAGRAM

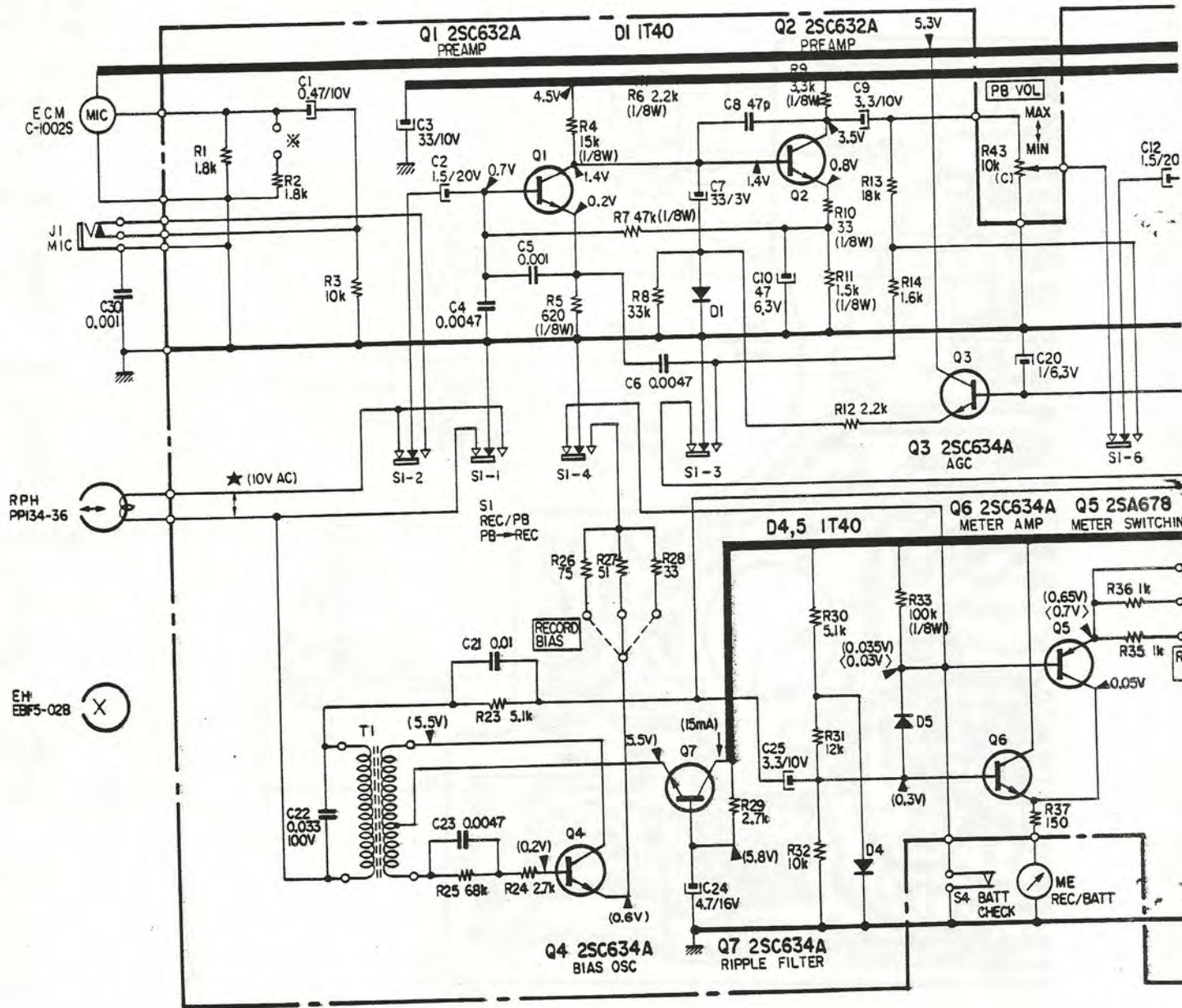

Note:

- All capacitors are in μF unless otherwise noted. 50 or less working volts are omitted except for electrolytic type. $p = \mu\text{F}$.
- All resistors are in Ω , $\frac{1}{16} W$, unless otherwise noted. $k = 1,000$ $M = 1,000k$
- Coil resistances are out-of-circuit values.
- In using electret condenser microphone with red mark on side of case, connect resistor R2 shown with * in parallel with R1.
- indicates chassis ground.

- indicates B+ circuit.
- Voltages are DC with respect to ground unless otherwise noted. Readings are taken under no-signal conditions with a VOM (20 k Ω/V).
(): record
< > : playback
no mark: common
- Voltage variations may be noted due to normal production tolerances.
- Readings indicated by * are taken on VTVM.

SECTION 5
EXPLODED VIEWS

5-1.

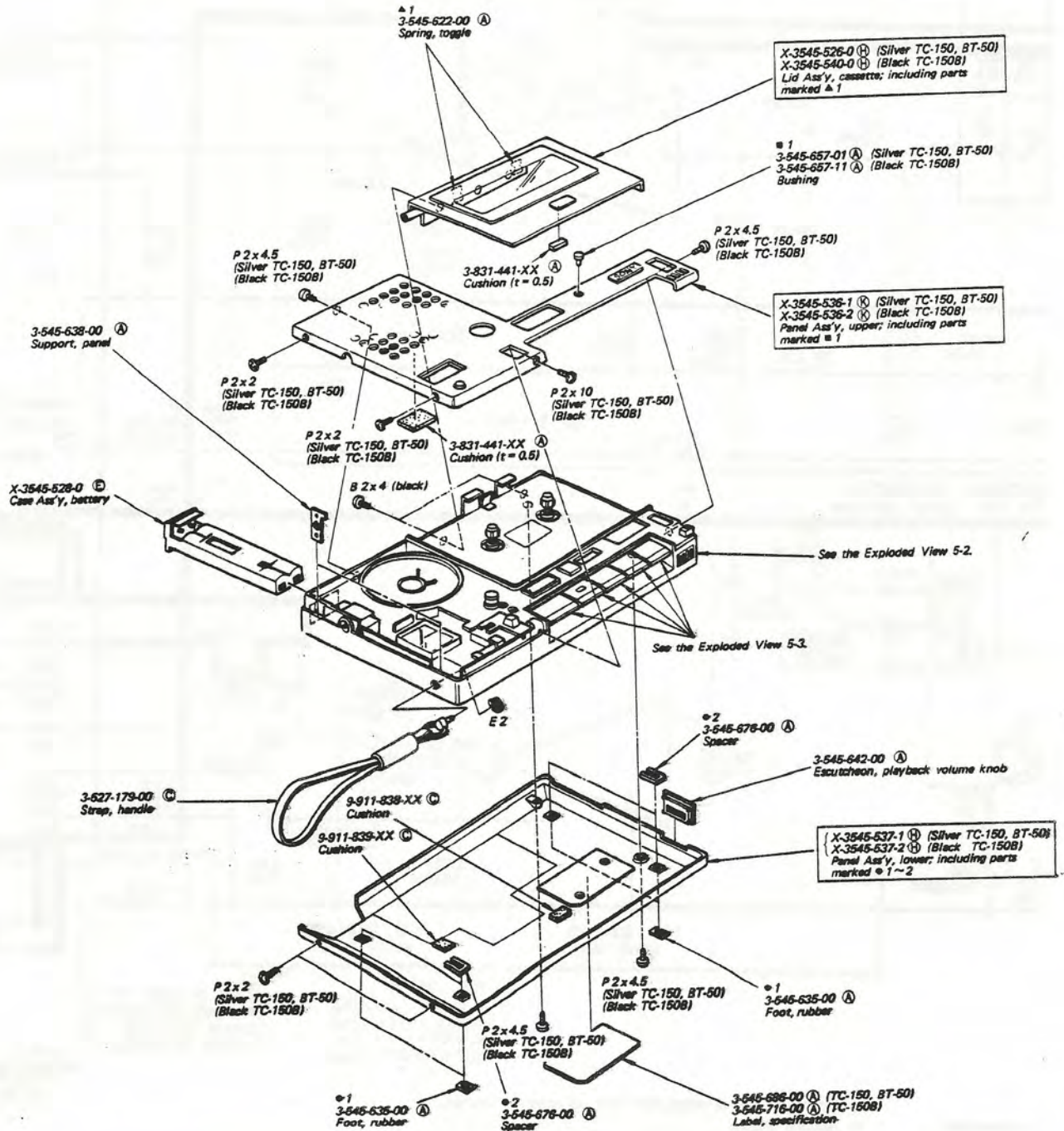

Note:

- Items with no part number and/or no description are not stocked because they are seldom required for routine service.
- All screws are Phillips (cross recess) type unless otherwise noted.
- (-) = slotted head
- (□□T) shows the number of coils in spring.

TC-150/B.BT-50

5-2.

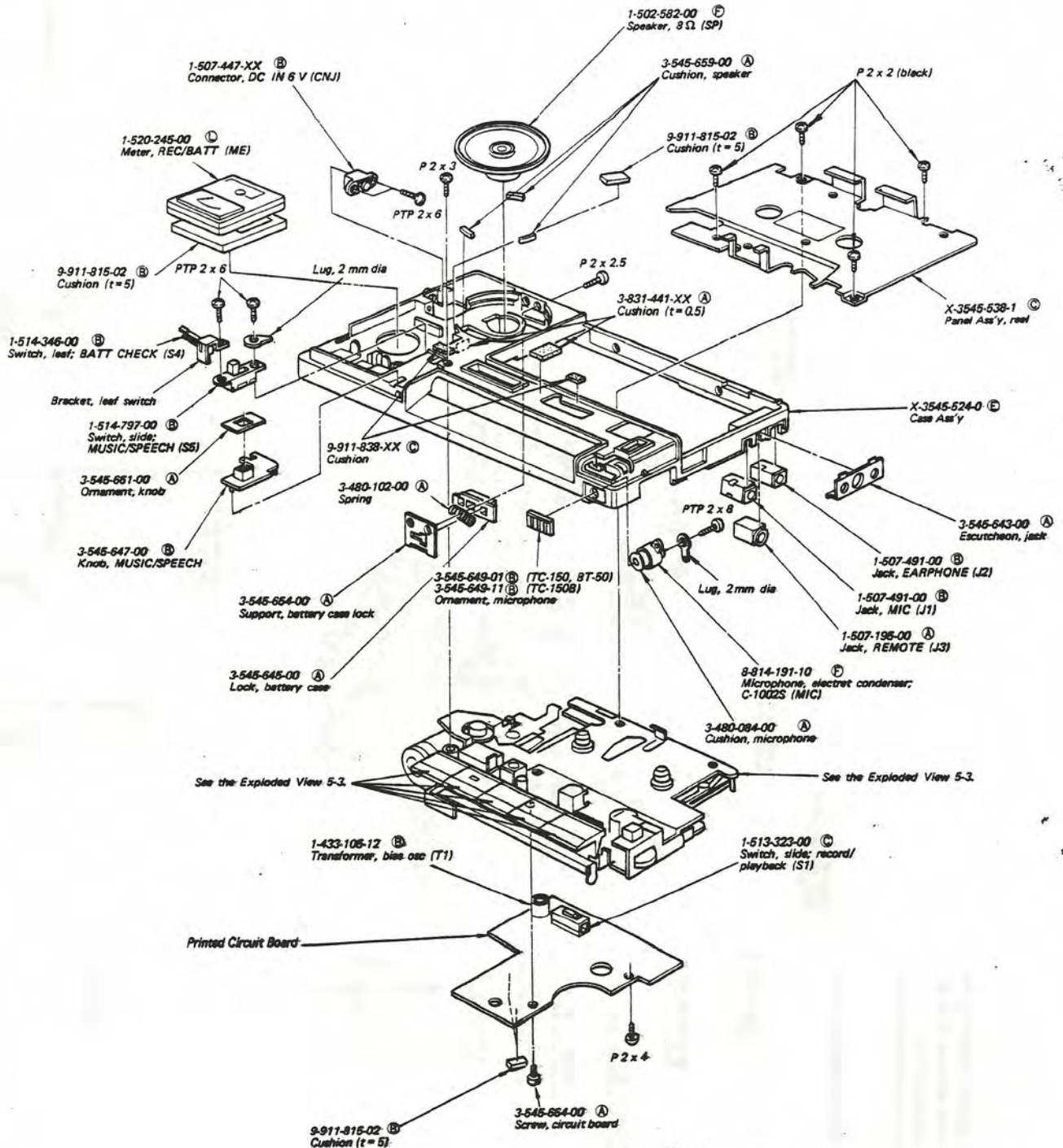

Note:

- Items with no part number and/or no description are not stocked because they are seldom required for routine service.
- All screws are Phillips (cross recess) type unless otherwise noted.
- (-) = slotted head
- (□□T) shows the number of coils in spring.

5-3.

- Note:**
- Items with no part number and/or no description are not stocked because they are seldom required for routine service.
 - All screws are Phillips (cross recess) type unless otherwise noted.
 - (-) = slotted head
 - (□ □ T) shows the number of coils in spring.

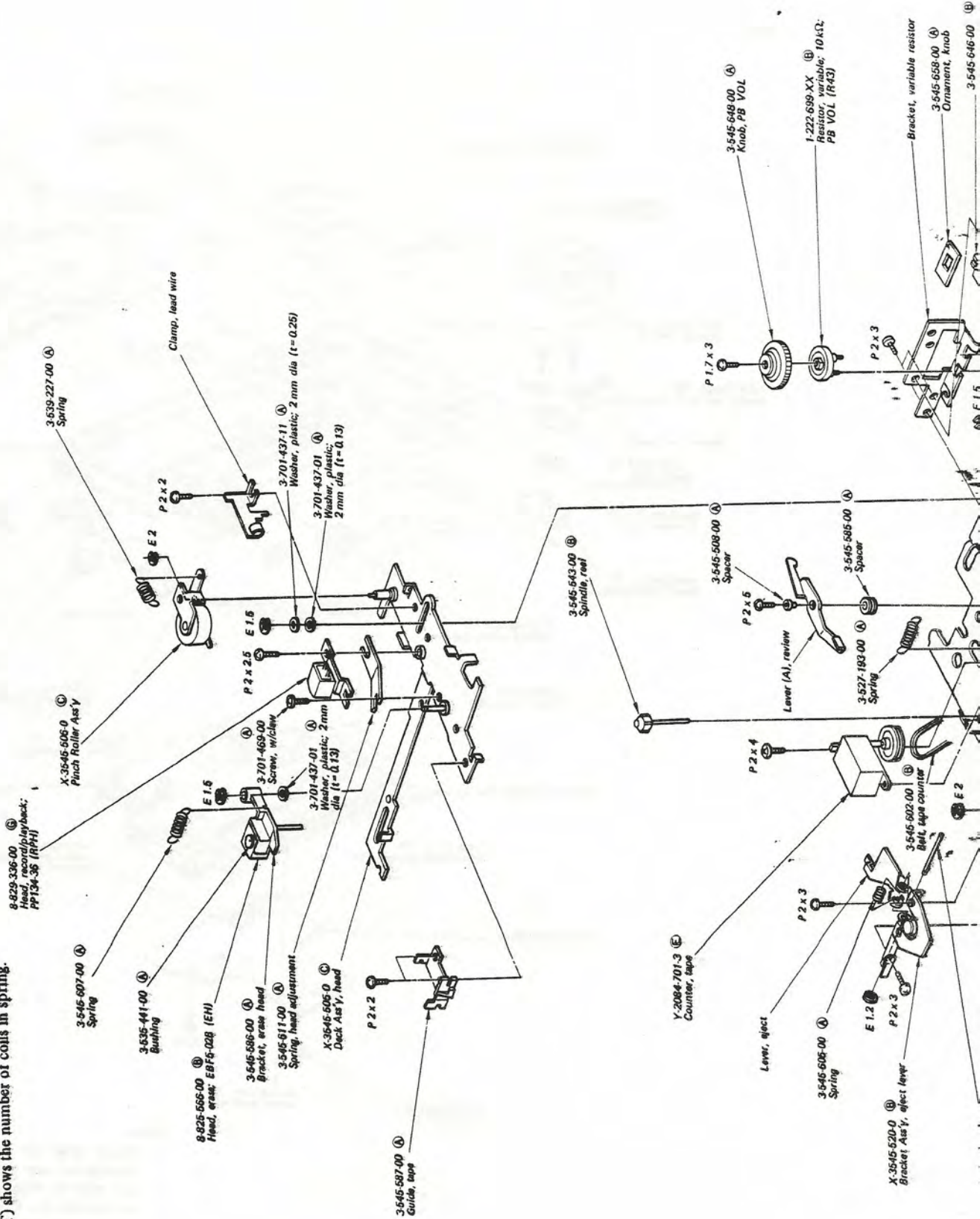

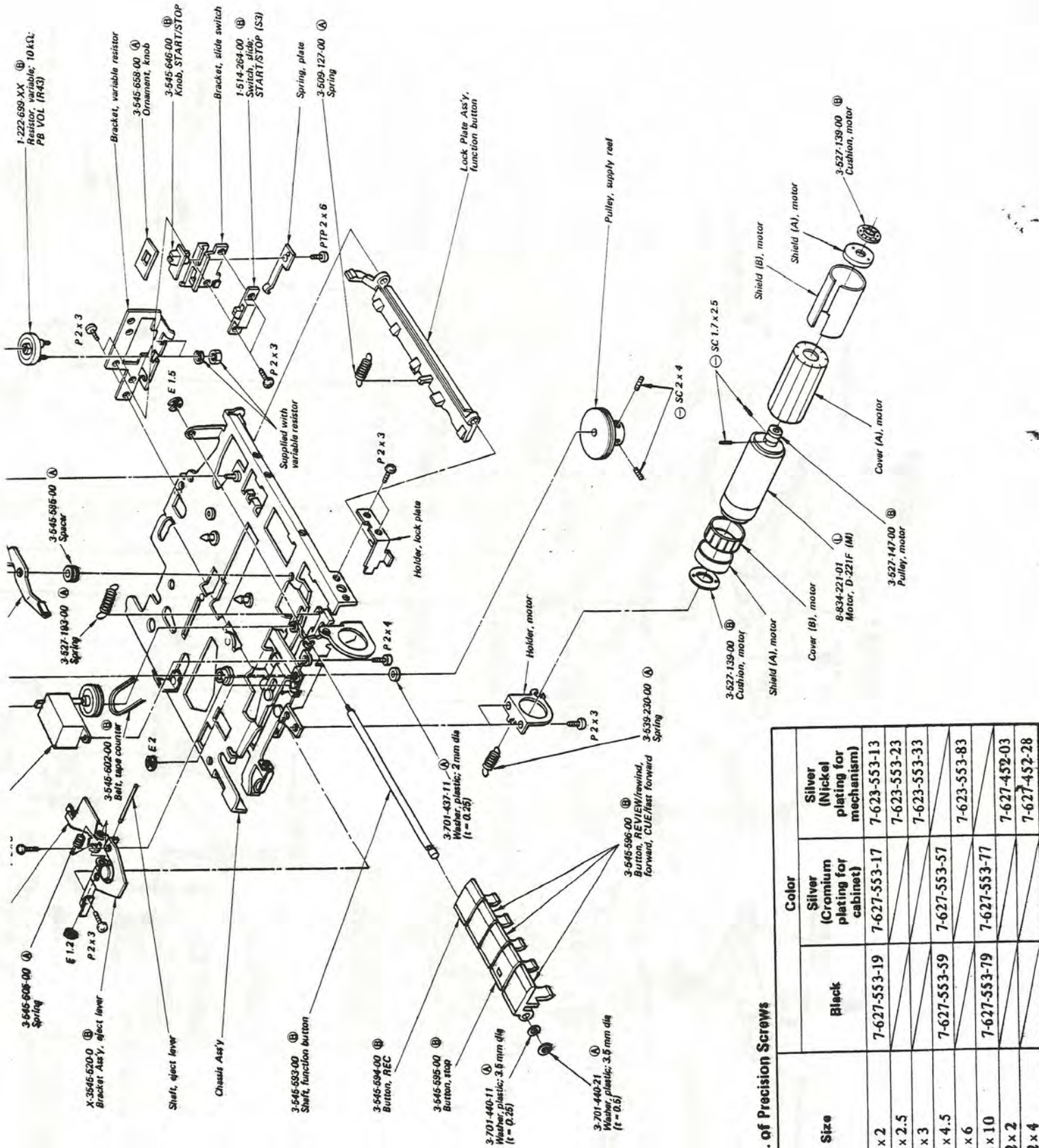

Part No. of Precision Screws

Size	Color	
	Black	Silver (Nickel plating for mechanism)
φ P 2 x 2	7-627-553-19	7-627-553-17
φ P 2 x 2.5	7-627-553-23	7-627-553-13
φ P 2 x 3	7-627-553-33	7-627-553-23
φ P 2 x 4.5	7-627-553-59	7-627-553-33
φ P 2 x 6	7-627-553-79	7-627-553-57
φ P 2 x 10	7-627-452-03	7-627-553-83
φ K 2 x 2	7-627-452-28	7-627-452-03
φ K 2 x 4	7-627-452-28	7-627-452-28

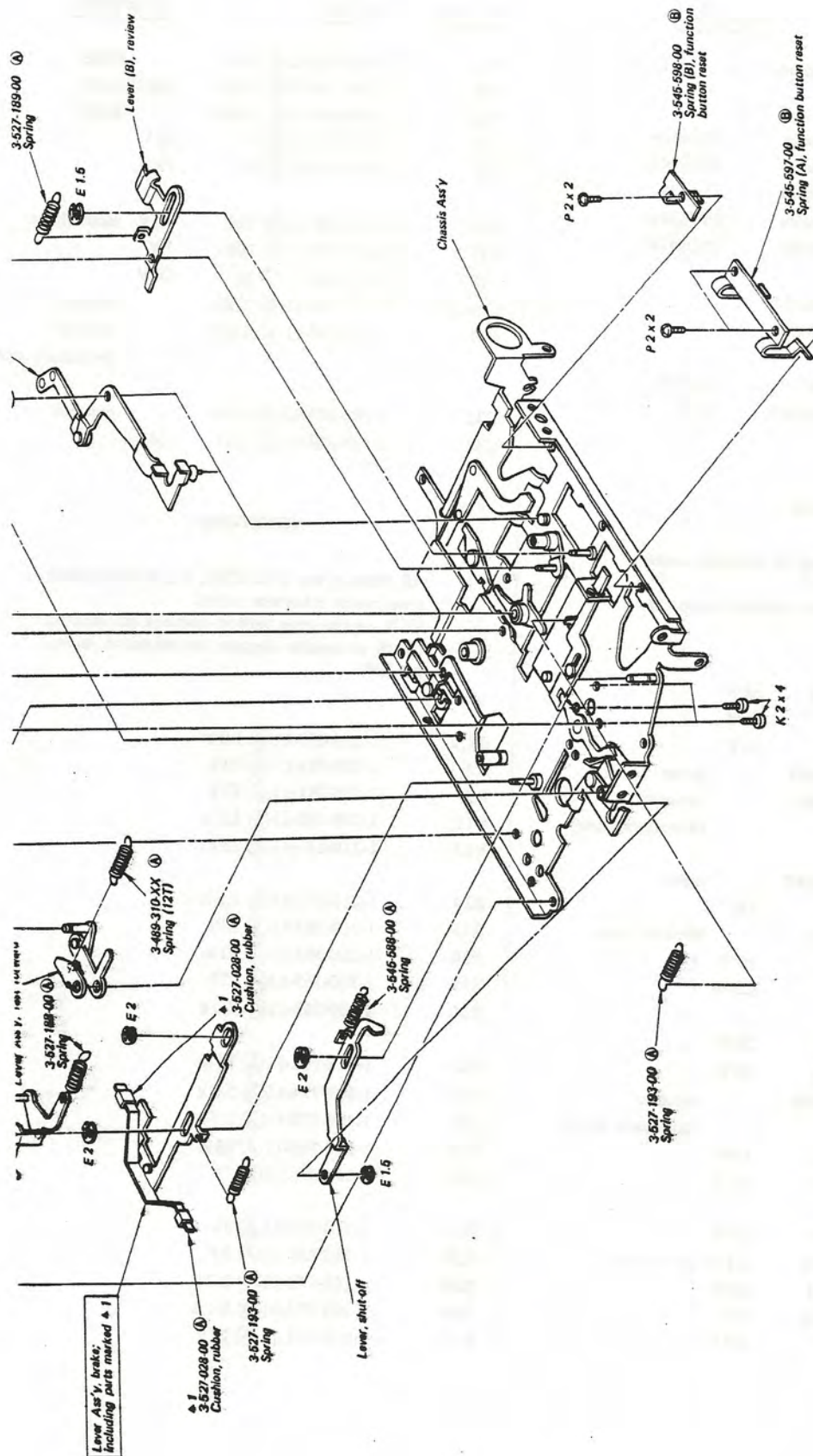

- Note:**
- o Items with no part number and/or no description are not stocked because they are seldom required for routine service.
 - o All screws are Phillips (cross recess) type unless otherwise noted.
 - o (-) = slotted head
 - o (□□T) shows the number of coils in spring.

**SECTION 6
ELECTRICAL PARTS LIST**

The mark of (A) to (Z) : for Europe

<u>Ref. No.</u>	<u>Part No.</u>	<u>Description</u>
SEMICONDUCTORS		
Q1,2	(B) Transistor	2SC632A
Q3,4	(B) Transistor	2SC634A
Q5	(C) Transistor	2SA678
Q6,7	(B) Transistor	2SC634A
Q8	(B) Transistor	2SC1474
IC1	(F) IC CX170	
IC2	(H) IC BX295	
D1~5	(B) Diode	1S1555
Th1	1-800-198-XX (A) Thermistor	S-1K

CAPACITORS

All capacitors are in μF and of tantalum unless otherwise noted. ($p = \mu\mu\text{F}$)
50 or less working volts are omitted except for electrolytic type.

C1	1-131-169-11 (B) 0.47	10 V
C2	1-131-202-11 (B) 1.5	20 V
C3	1-131-173-11 (C) 33	10 V
C4	1-105-669-12 (A) 0.0047	mylar
C5	1-161-190-11 (A) 0.001	ceramic (boundary layer)
C6	1-105-669-12 (A) 0.0047	mylar
C7	1-131-176-11 (B) 33	3 V
C8	1-107-123-11 (A) 47 p	silvered mica
C9	1-131-170-11 (B) 3.3	10 V
C10	1-131-174-11 (C) 47	6.3 V
C11	1-131-173-11 (C) 33	10 V
C12	1-131-202-11 (B) 1.5	20 V
C13	1-161-190-11 (C) 0.001	ceramic (boundary layer)
C14	1-131-173-11 (C) 33	10 V
C15	1-131-174-11 (B) 47	6.3 V
C16	1-131-171-11 (B) 4.7	16 V
C17	1-121-419-11 (B) 220	6.3 V electrolytic
C18	1-131-170-11 (B) 3.3	10 V
C19	1-131-177-11 (C) 100	3 V
C20	1-131-244-11 (B) 1	6.3 V

<u>Ref. No.</u>	<u>Part No.</u>	<u>Description</u>
C21	1-105-673-12 (A) 0.01	mylar
C22	1-105-719-12 (B) 0.033	100 V mylar
C23	1-105-669-12 (A) 0.0047	mylar
C24	1-131-171-11 (B) 4.7	16 V
C25	1-131-170-11 (B) 3.3	10 V
C26	1-121-420-11 (A) 220	10 V electrolytic
C27	1-131-177-11 (C) 100	3 V
C28	1-131-256-11 (C) 10	10 V
C29,30	1-102-074-11 (A) 0.001	ceramic
C31	1-161-190-11 (A) 0.001	ceramic (boundary layer)
C32	1-102-074-11 (A) 0.001	ceramic
C33	1-131-264-11 (C) 0.47	20 V

RESISTORS

All resistors are in Ω , $\pm 5\%$, $1/16$ W and carbon type unless otherwise noted.
 $1/8$ W regular-type carbon resistors are omitted.
Check schematic diagram for resistance values.
 $k = 1000$

R1,2	1-209-878-11 (A) 1.8 k
R3	1-209-781-11 (A) 10 k
R8	1-210-381-11 (A) 33 k
R12	1-209-768-11 (A) 2.2 k
R13	1-210-113-11 (A) 18 k
R14	1-210-371-11 (A) 1.6 k
R15	1-210-363-11 (A) 270
R16	1-210-381-11 (A) 33 k
R19	1-210-363-11 (A) 270
R21	1-209-768-11 (A) 2.2 k
R22	1-210-113-11 (A) 18 k
R23	1-209-774-11 (A) 5.1 k
R24	1-209-770-11 (A) 2.7 k
R25	1-210-388-11 (A) 68 k
R26	1-210-392-11 (A) 75
R27	1-210-101-11 (A) 51
R28	1-210-846-11 (A) 33
R29	1-209-770-11 (A) 2.7 k
R30	1-209-774-11 (A) 5.1 k
R31	1-210-111-11 (A) 12 k

TC-150/B.BT-50

<u>Ref. No.</u>	<u>Part No.</u>	<u>Description</u>
R32	1-209-781-11 (A)	10 k
R35,36	1-204-122-11 (A)	1 k
R37	1-210-102-11 (A)	150
R39	1-204-123-11 (A)	3.3 k
R40	1-224-726-00 (C)	1 k, adjustable
R41	1-210-108-11 (A)	820
R42	1-210-355-11 (A)	100
R43	1-222-699-XX (B)	10 k, variable; PB VOL

SWITCHES

S1	1-513-323-00 (C)	Slide, record/playback
S2	1-514-346-00 (B)	Leaf, power
S3	1-514-264-00 (B)	Slide, START/STOP
S4	1-514-346-00 (B)	Leaf, BATT CHECK
S5	1-514-797-00 (B)	Slide, MUSIC/SPEECH

<u>Ref. No.</u>	<u>Part No.</u>	<u>Description</u>
JACKS		
CNJ	1-507-447-XX (B)	Connector, DC IN 6 V
J1	1-507-491-00 (B)	MIC
J2	1-507-491-00 (B)	EARPHONE
J3	1-507-195-00 (A)	REMOTE

MISCELLANEOUS

EH	8-825-566-00 (B)	Head, erase; EBF5-02B
L1	1-407-847-00 (B)	Coil, microinductor; 35 μ H
M	8-834-221-01 (L)	Motor, D-221F
ME	1-520-245-00 (L)	Meter, REC/BATT
MIC	8-814-191-10 (F)	Microphone, electret condenser; C-1002S
RPH	8-829-336-00 (G)	Head, record/playback; PP134-36
SP	1-502-582-00 (F)	Speaker, 8 Ω
T1	1-433-105-12 (B)	Transformer, bias osc

ACCESSORIES AND PACKING MATERIALS								
Part No.	Description	TC-150					TC-150B	BT-50
		US	Canadian	E	AEP	UK	AEP	US
A-3003-001-A	Ⓜ Pack, battery; BP-28							○
X-3701-018-2	Ⓐ Tips Ass'y, head cleaning	○	○	○	○	○	○	
1-463-138-00	Ⓚ Adaptor, ac; AC-9W	○						○
1-463-806-00	Ⓝ Adaptor, ac; AC-9		○					
1-504-044-00	Ⓑ Earphone, ME-21	○	○	○	○	○	○	○
1-506-309-00	Ⓐ Plug, shorting; SP-100							○
1-520-027-11	Ⓑ Battery, long-life; size "AA" (4 PCS)		○	○				○
1-534-237-26	Ⓔ Cord, connection; RK-64H	○	○	○	○	○	○	
3-545-675-00	Ⓓ Cushion			○	○	○	○	○
3-545-700-00	Ⓓ Cushion	○						
3-545-685-00	Ⓛ Case, carrying	○	○	○	○	○	○	○
3-545-691-00	Ⓑ Carton	○	○	○	○	○		
3-545-718-00	Ⓑ Carton						○	
3-545-689-00	Ⓑ Carton (BT-50)							
3-545-698-00	Ⓑ Sleeve, carton	○						
3-545-693-00	Ⓐ Sheet (A), protection		○	○	○	○	○	
3-545-694-00	Ⓐ Sheet (B), protection		○	○	○	○	○	
3-545-707-00	Ⓑ Spacer	○						
X-3545-544-1	Ⓔ Manual, instruction						○	
3-780-914-11	Ⓓ Manual, instruction			○	○			
3-780-914-22	Manual, instruction	○	○					○
3-780-914-41	Ⓒ Manual, instruction					○		
3-793-973-31	Manual, instruction; French		○					
3-793-828-00	Ⓐ Card, caution; cassette	○	○	○	○	○	○	○
3-793-959-21	Ⓐ Supplement, instruction manual							○
8-890-036-11	Ⓕ Tape, DC-60S							○
8-893-512-00	Ⓕ Tape, demonstration; CD-807	○	○	○	○	○	○	

Note: The mark of Ⓐ to Ⓩ for Europe.

HARDWARE NOMENCLATURE

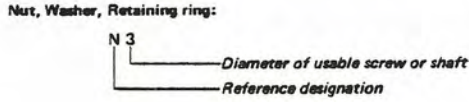
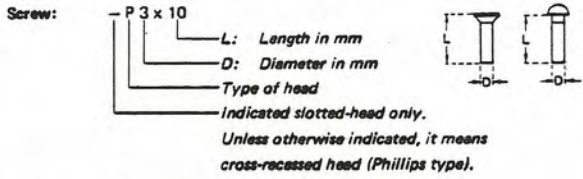

Reference Designation	Shape	Description	Remarks
SCREWS			
P		pan-head screw	binding-head (B) screw for replacement
PWH		pan-head screw with washer face	binding-head (B) screw and flat washer for replacement
PS PSP		pan-head screw with spring washer	binding-head (B) screw and spring washer for replacement
PSW PSPW		pan-head screw with spring and flat washers	binding-head (B) screw and spring and flat washers for replacement
R		round-head screw	binding-head (B) screw for replacement
K		flat-countersunk-head screw	
RK		oval-countersunk-head screw	
B		binding-head screw	
T		truss-head screw	binding-head (B) screw for replacement
F		flat-fillister-head screw	
RF		fillister-head screw	
BV		braizer-head screw	

Reference Designation	Shape	Description	Remarks
SELF-TAPPING SCREWS			
TA		self-tapping screw	ex: TA, P 3 x 10
PTP		pan-head self-tapping screw	binding-head self-tapping (TA, B) screw for replacement
PTPWH		pan-head self-tapping screw with washer face	binding-head self-tapping (TA, B) screw and flat washer for replacement
PTTWH		pan-head thread-rolling screw with washer face	binding-head (B) screw and flat washer for replacement
SET SCREWS			
SC		set screw	
SC		hexagon-socket set screw	ex: SC 2.6 x 4, hexagon socket
NUT			
N		nut	
WASHERS			
W		flat washer	
SW		spring washer	
LW		internal-tooth lock washer	ex: LW3, internal
LW		external-tooth lock washer	ex: LW3, external
RETAINING RINGS			
E		retaining ring	
G		grip-type retaining ring	

TC-150/B, BT-50

CASSETTE-CORDER

US Model
Canadian Model
E Model
AEP Model
UK Model

SUPPLEMENT

Subject: Changes of circuit board and pause switch

No. 1
November, 1976

This supplement updates the service manual to include production changes.
File this supplement with the service manual.

	Model	Applicable Serial No.
TC-150	US	16,001 and later
	Canadian	34,001 and later
	AEP	38,001 and later
	UK	41,601 and later
	E	42,601 and later
TC-150B	AEP	33,401 and later
BT-50	US	42,001 and later

● PAUSE SWITCH

Former Type
(Slide Switch Type)

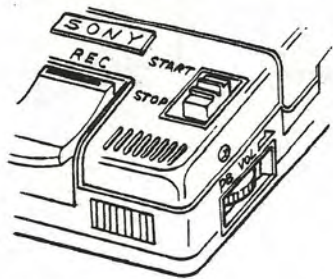

New Type
(Pushbutton Switch Type)

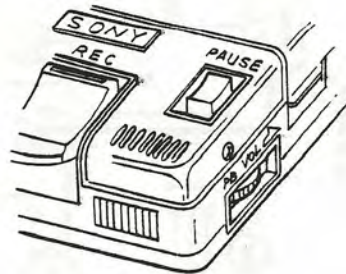

SONY
SERVICE MANUAL

TC-150/B.BT-50

1. BLOCK DIAGRAM

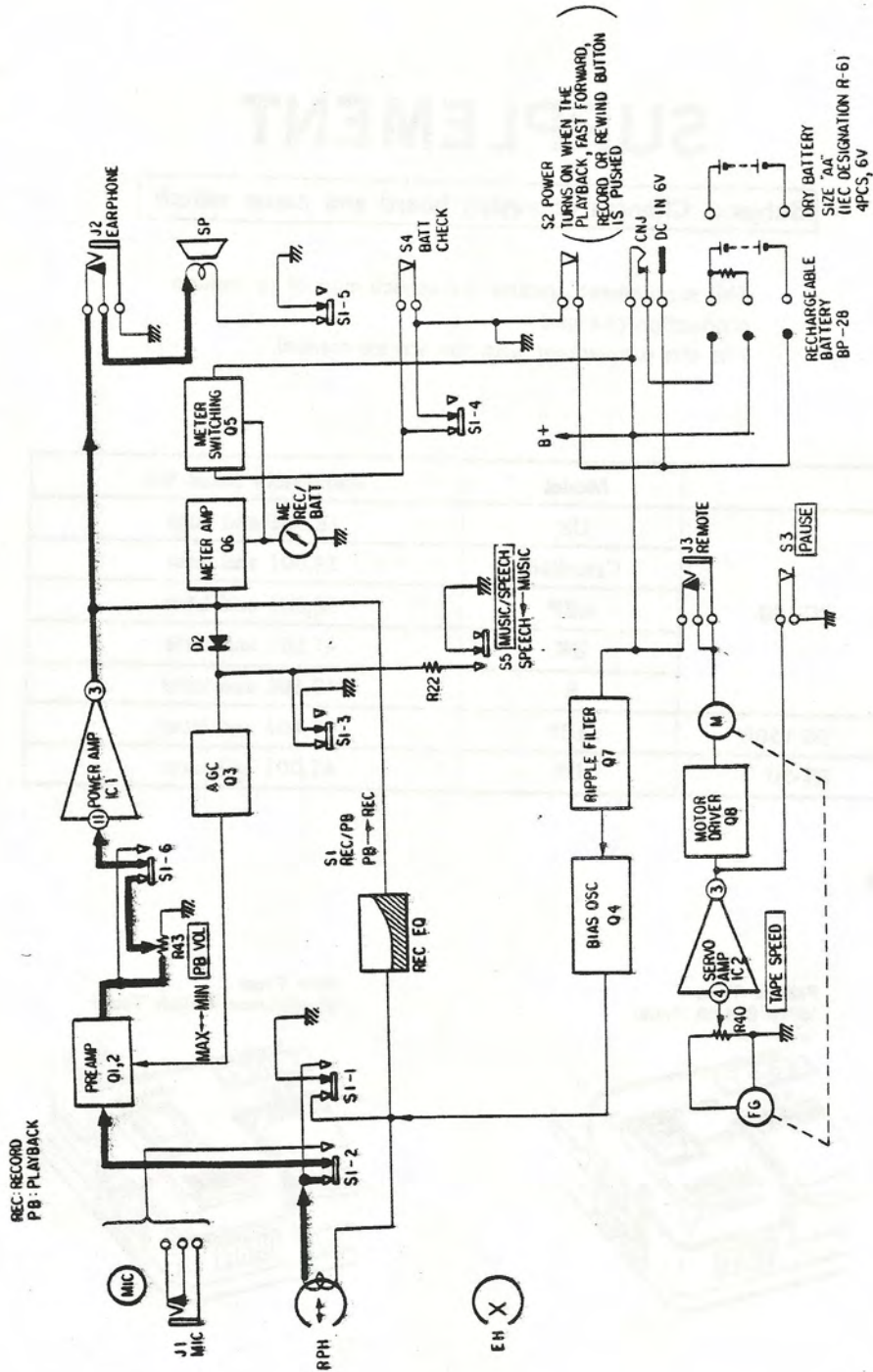

2-1. MOUNTING DIAGRAM

— Conductor Side —

• Semiconductor lead layouts

Q1, 2: 2SC632A
Q3, 4, 6, 7: 2SC634A

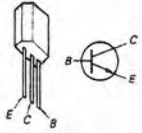

Q5: 2SA678

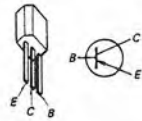

Q8: 2SC1474

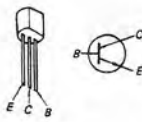

D1, 2, 3, 4, 5: 1S1555
1T40

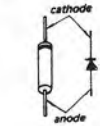

IC1: CX170

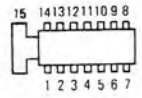

(Top view)

IC2: BX295



(Marking side view)

Notes:

- : B+ pattern
- : signal path
- Color code of sleeving over the end of the jacket.

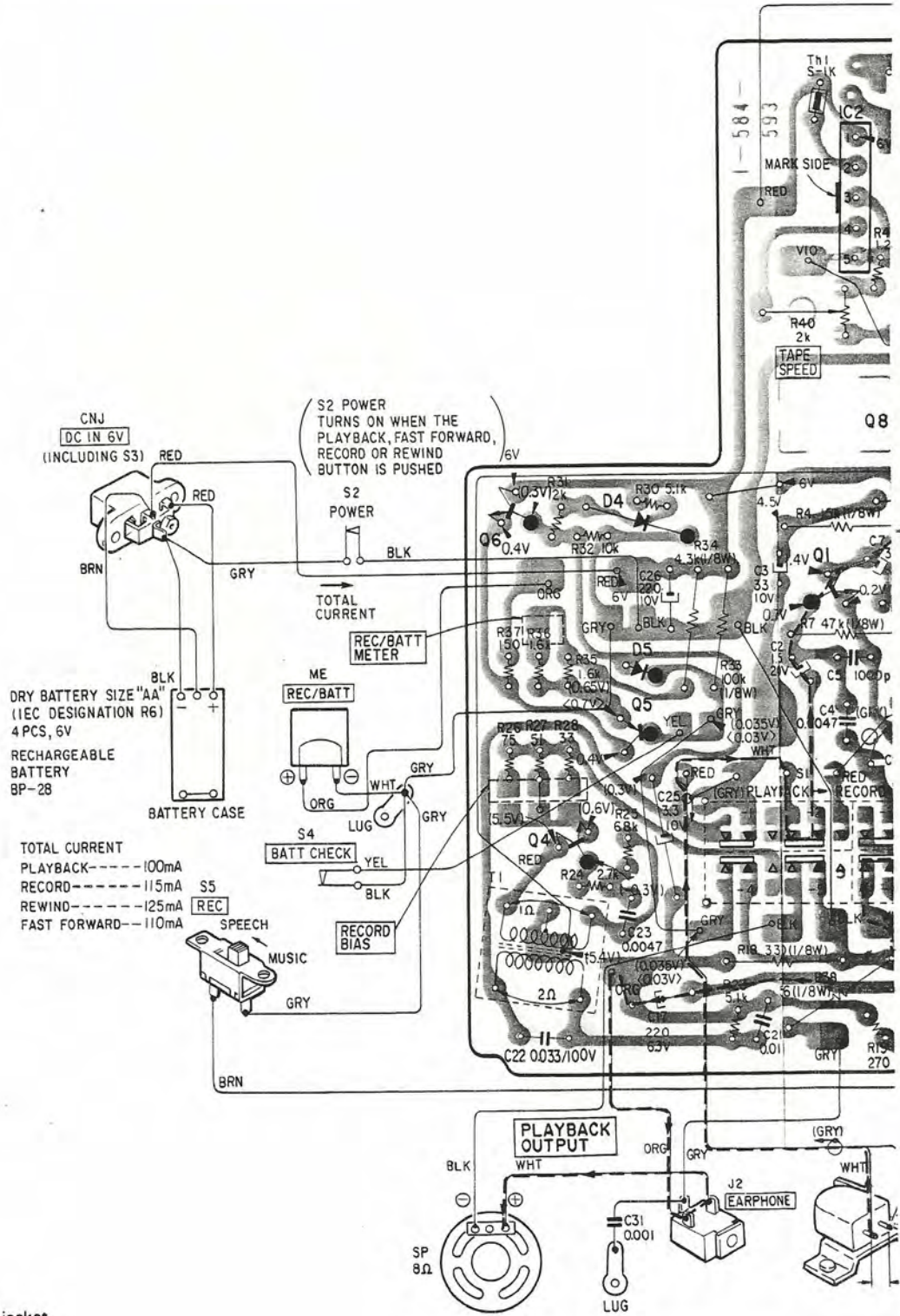
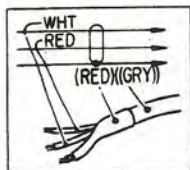

Q	6	4	5	IC2
I C			4	1
D			5	

B.BT-50 TC-150/B.BT-50

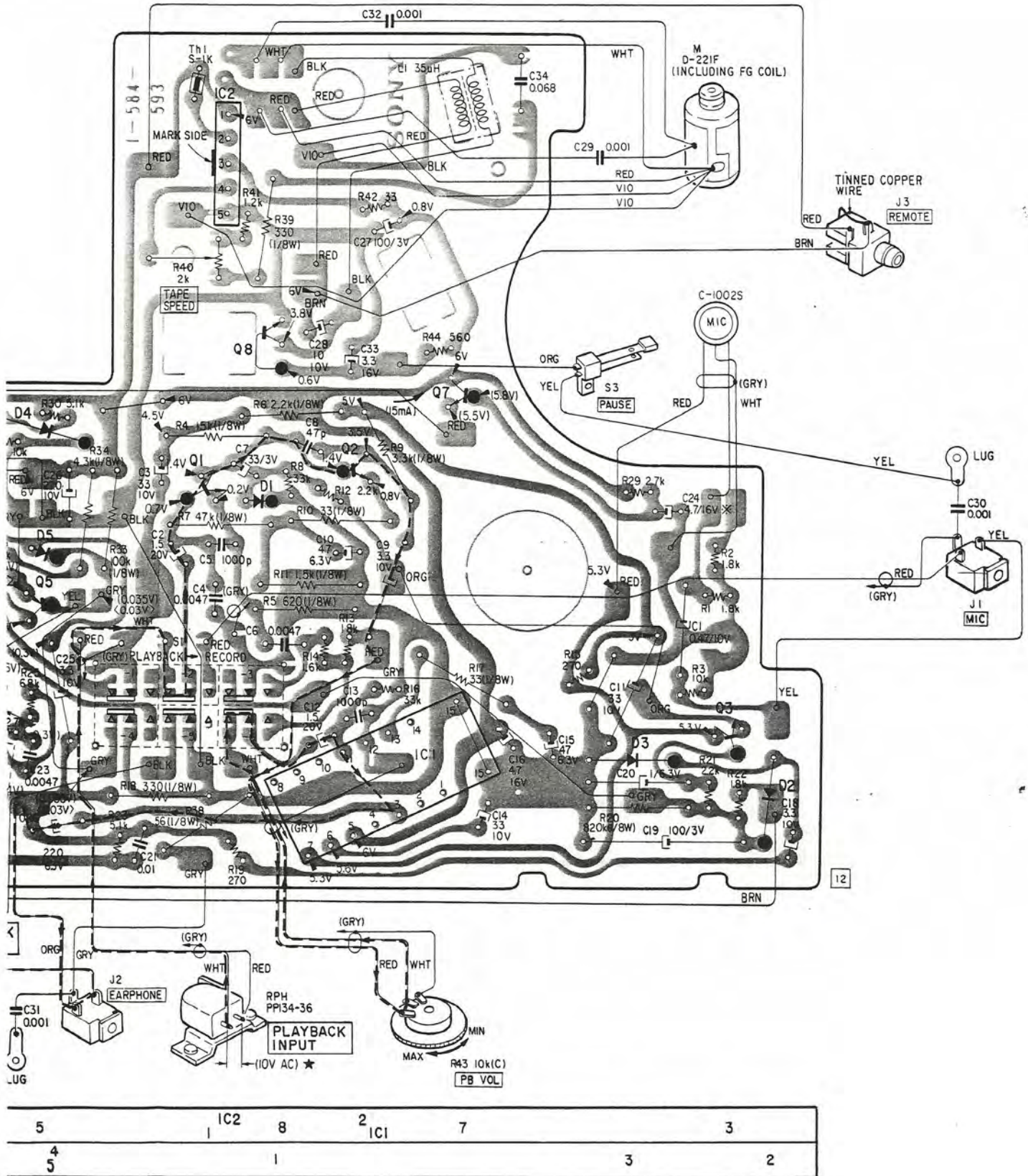

2-2. SCHEMATIC DIAGRAM

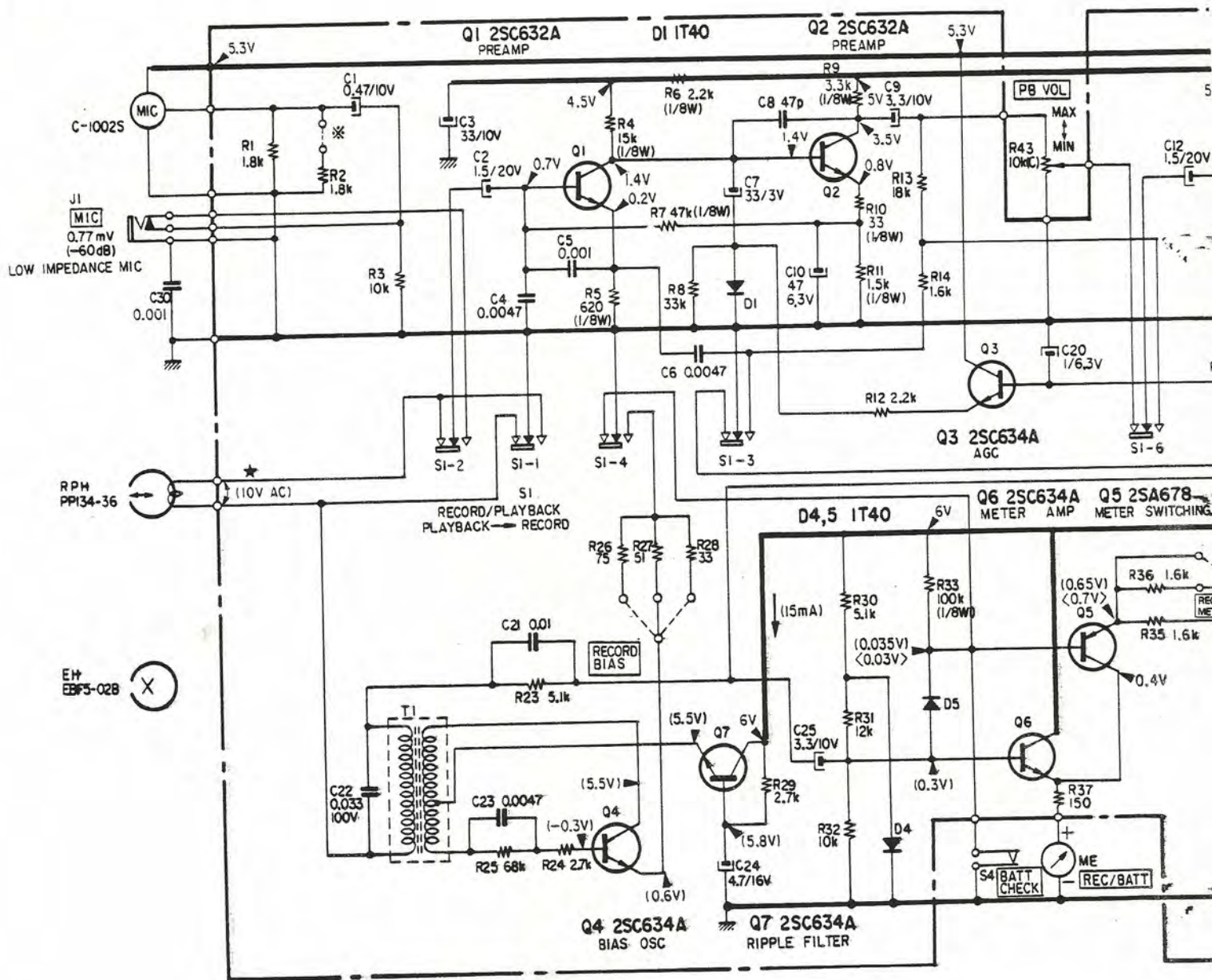

Notes:

- All capacitors are in μF unless otherwise noted. 50 or less working volts are omitted except for electrolytic type. $\mu = \mu\text{F}$.
- All resistors are in Ω , $\frac{1}{16} \text{W}$, unless otherwise noted. $k = 1,000$ $M = 1,000k$.
- Coil resistances are out-of-circuit values.
- In using electret condenser microphone with red mark on side of case, connect resistor R2 shown with \otimes in parallel with R1.
- --- indicates chassis ground.

- --- indicates B+ circuit.
- Voltages are DC with respect to ground unless otherwise noted. Readings are taken under no-signal conditions with a VOM (20 $k\Omega/V$).
- (): record
- < > : playback
- no mark: common
- Voltage variations may be noted due to normal production tolerances.
- Readings indicated by * are taken on VTVM.

.BT-50 TC-150/B.BT-50

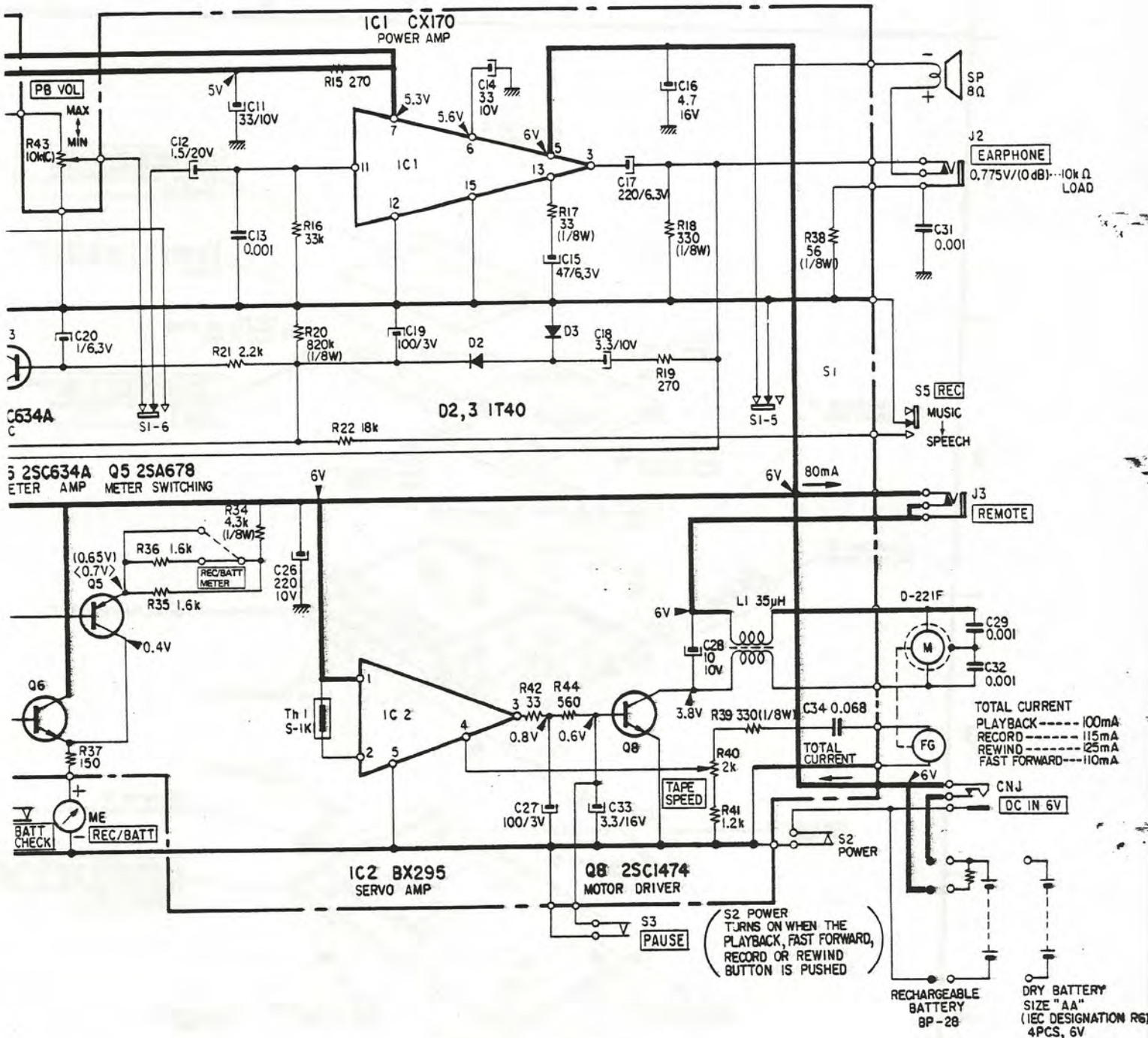

- Total current is measured with no cassette loaded.
- Switch Mode:

Ref. No.	Switch	Position
S1	REC/PB	PB
S2	POWER	OFF
S3	PAUSE	OFF
S4	BATT CHECK	OFF
S5	MUSIC/SPEECH	MUSIC

3. EXPLODED VIEWS

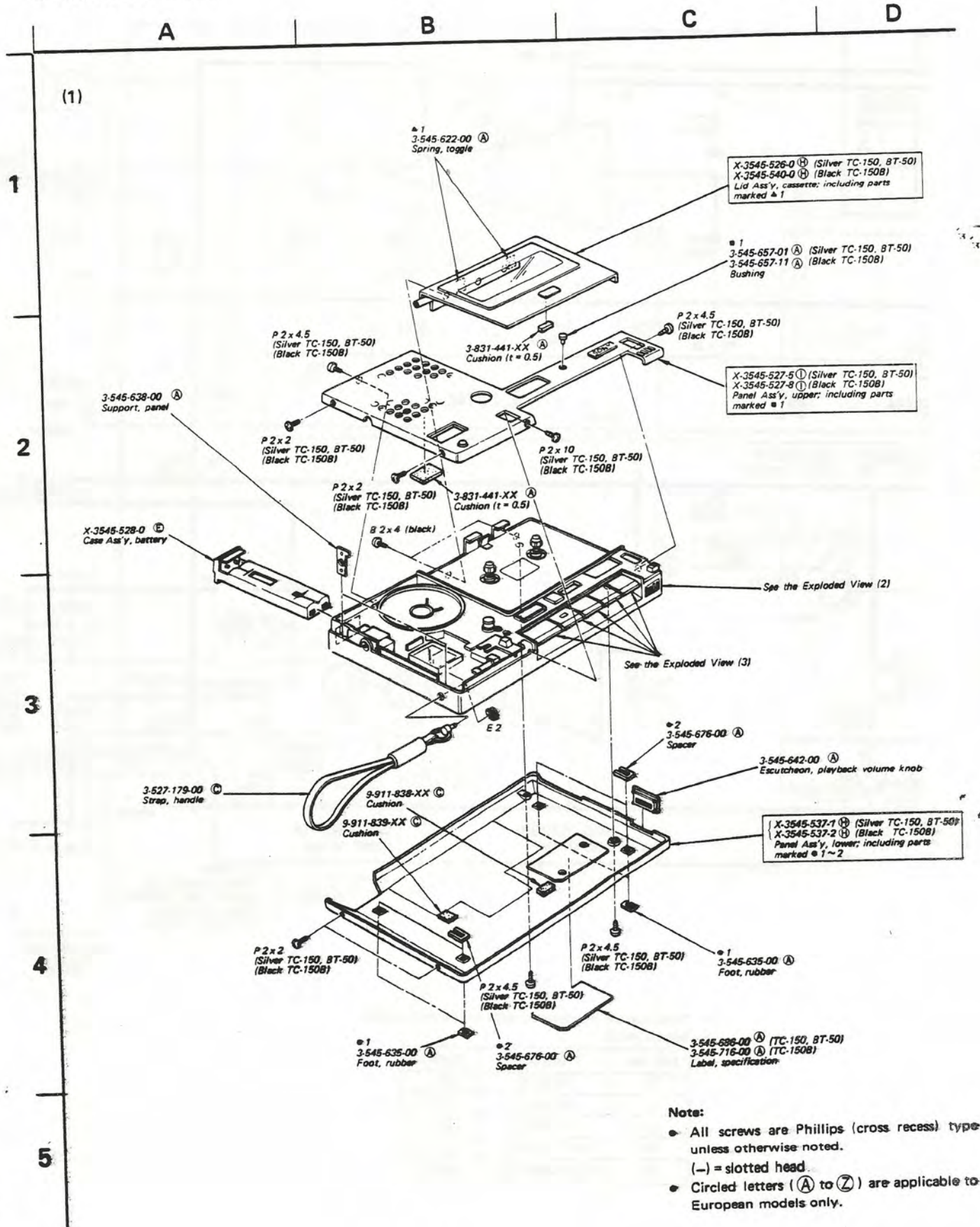

TC-150/B.BT-50

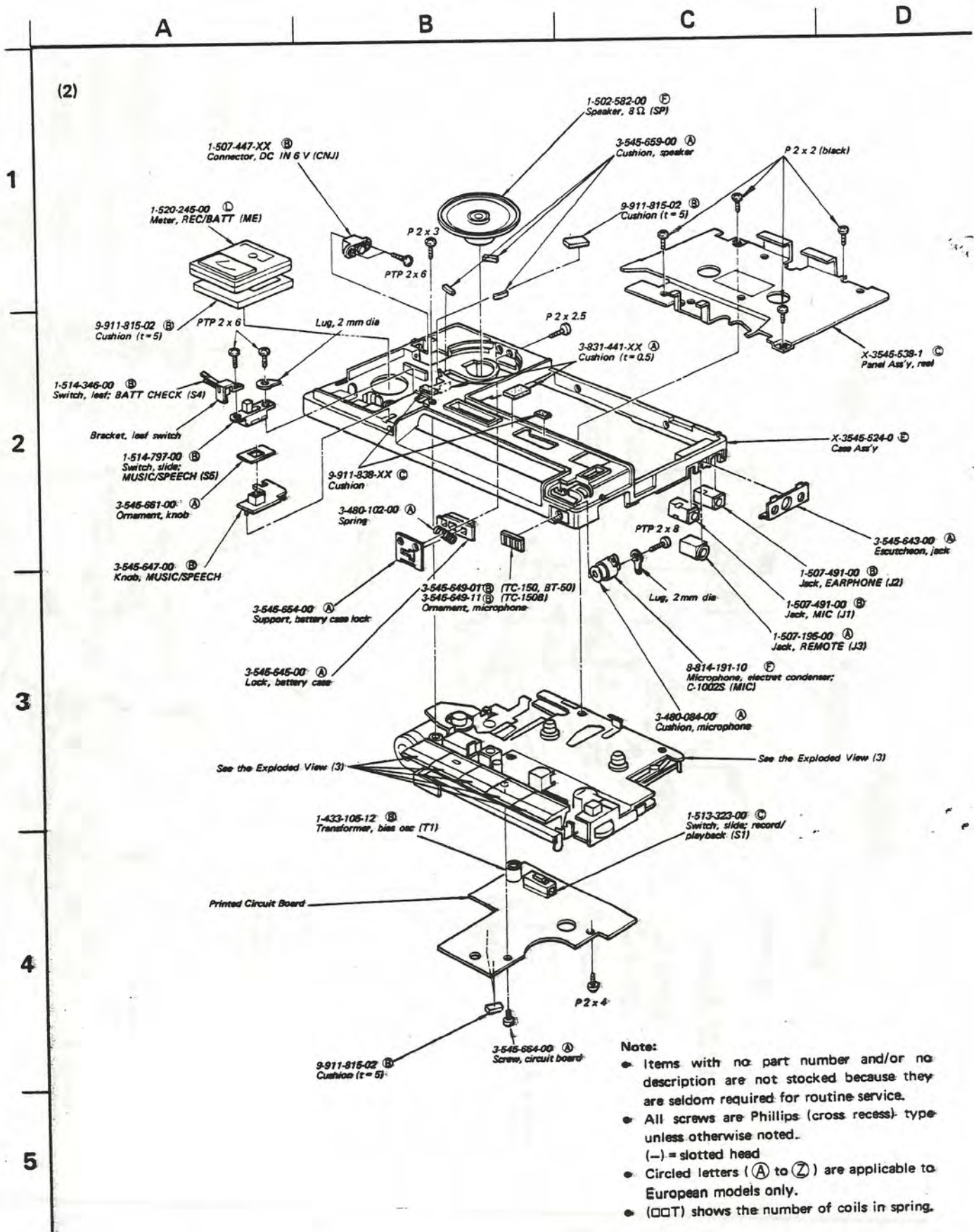

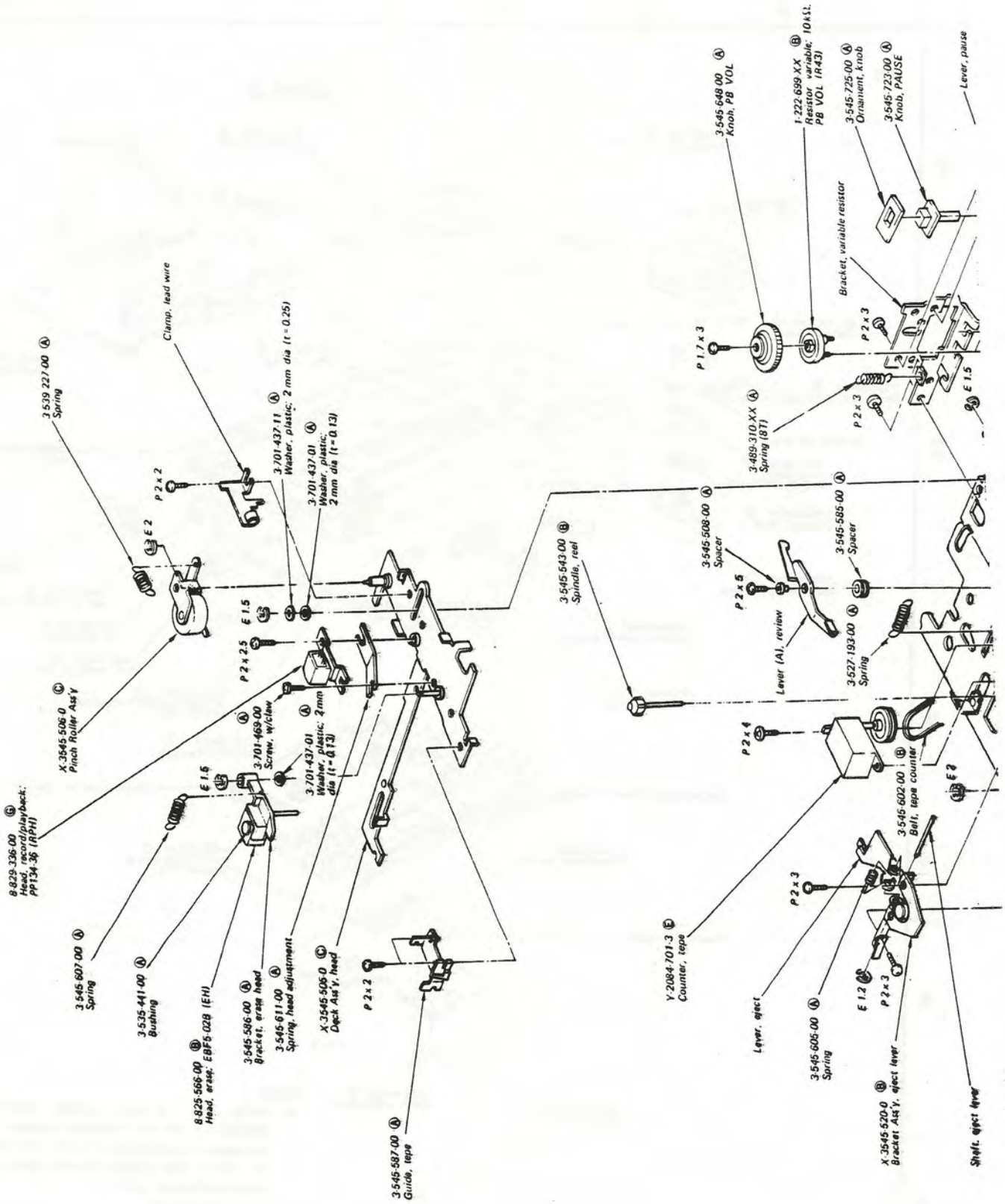

T-50 TC-150/B.BT-50

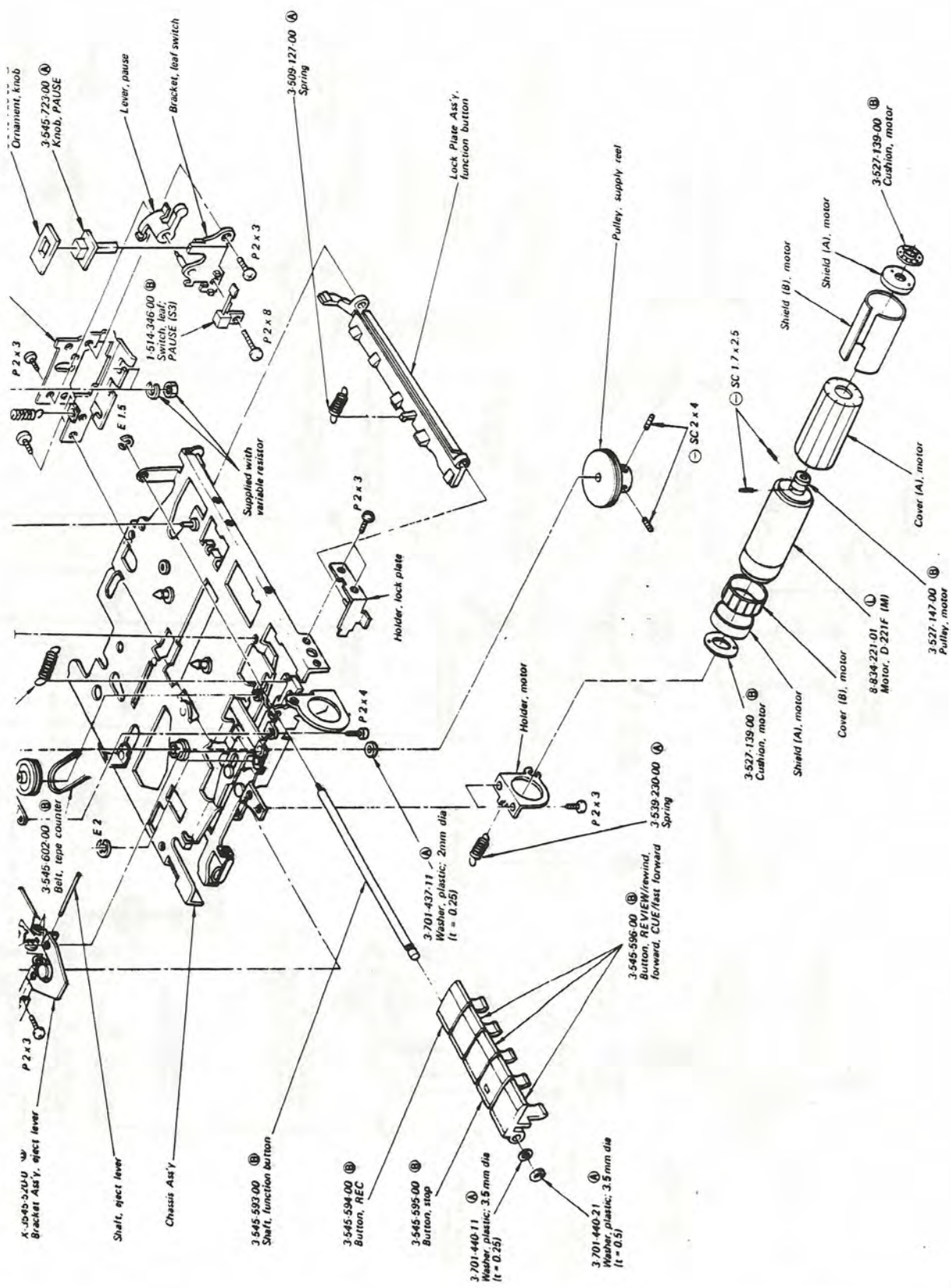

Note:

- Items with no part number and/or no description are not stocked because they are seldom required for routine service.
- All screws are Phillips (cross recess) type unless otherwise noted.
- (—) = slotted head
- Circled letters (A) to (Z) are applicable to European models only.
- (EJECT) shows the number of coils in spring.

4

5

6

7

E

D

C

B

A

(4)

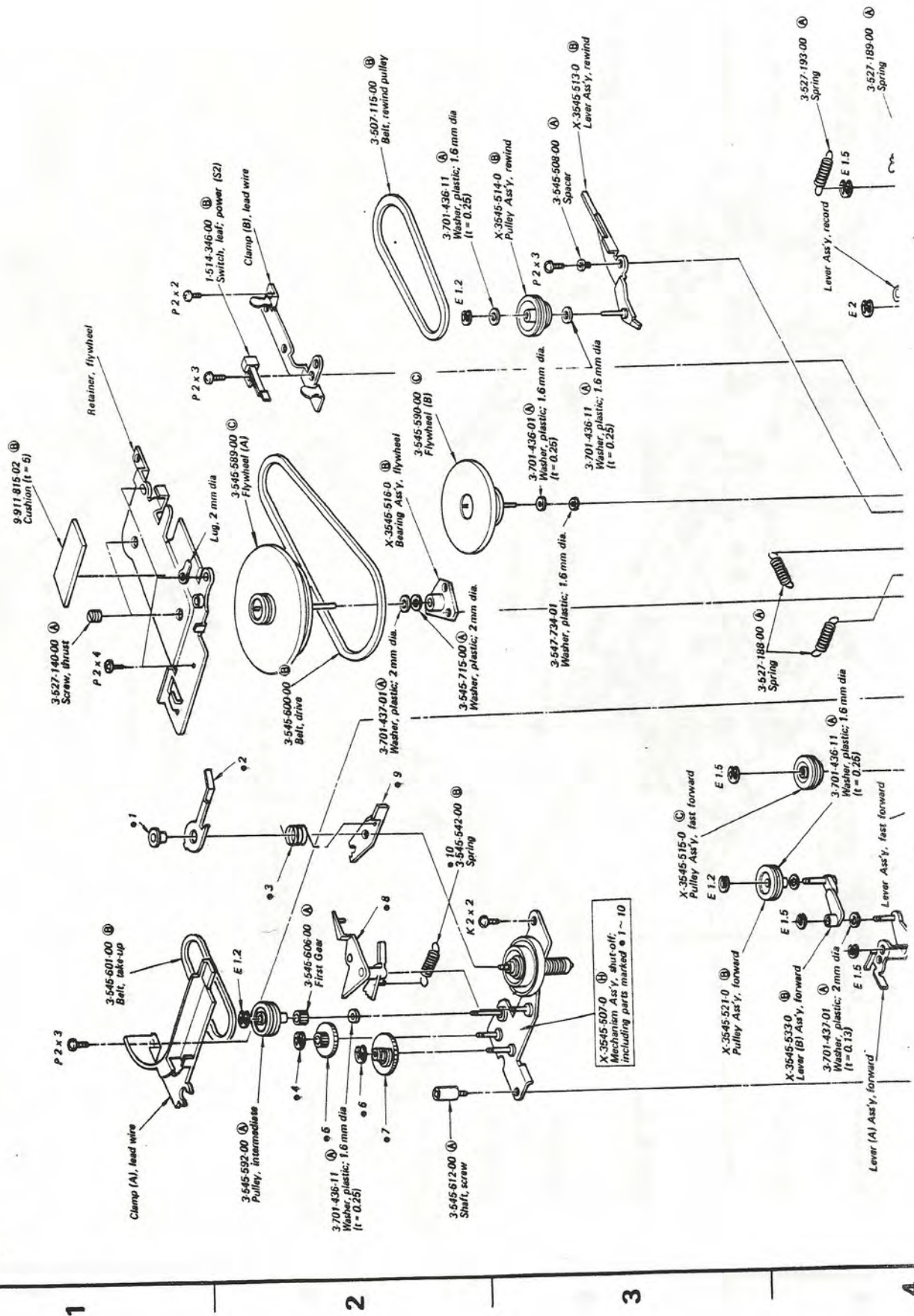

/B.BT-50 TC-150/B.BT-50

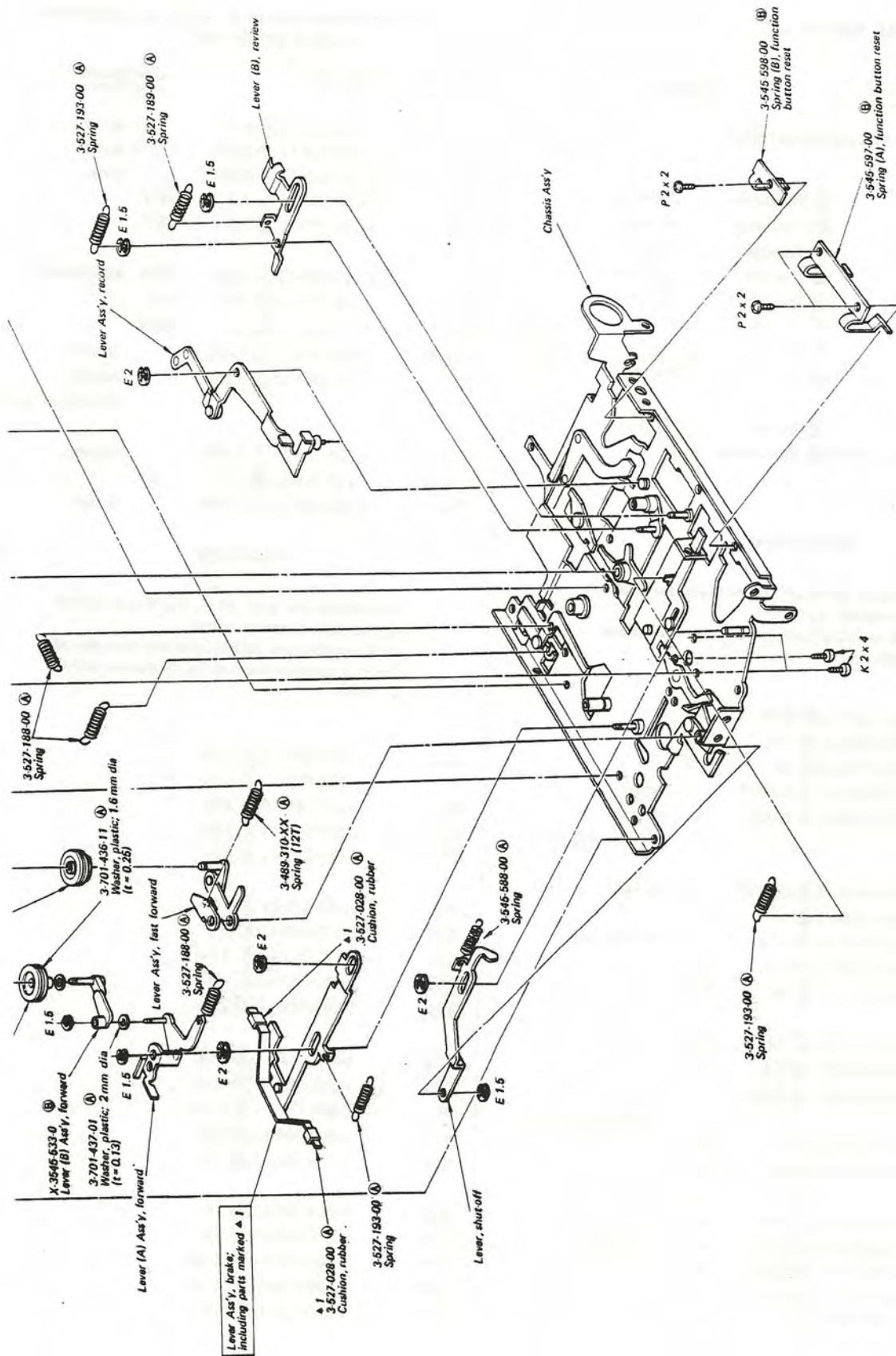

- Note:**
- Items with no part number and/or no description are not stocked because they are seldom required for routine service.
 - All screws are Phillips (cross recess) type unless otherwise noted.
 - (—) = slotted head
 - Circled letters (A to Z) are applicable to European models only.
 - (COT) shows the number of coils in spring.

4. ELECTRICAL PARTS LIST

Note: Circled letters (A to Z) are applicable to European models only.

Ref. No.	Part No.	Description
SEMICONDUCTORS		
Q1,2	(B) Transistor	2SC632A
Q3,4	(B) Transistor	2SC634A
Q5	(C) Transistor	2SA678
Q6,7	(B) Transistor	2SC634A
Q8	(B) Transistor	2SC1474
IC1	(F) IC	CX170
IC2	(H) IC	BX295
⇒ D1~5	(B) Diode	1S1555
Th1	1-800-198-XX (A) Thermistor	S-1K
CAPACITORS		
All capacitors are in μF and of tantalum unless otherwise noted. (p = $\mu\mu\text{F}$)		
50 or less working volts are omitted except for electrolytic type.		
C1	1-131-169-11 (B) 0.47	10 V
C2	1-131-202-11 (B) 1.5	20 V
C3	1-131-173-11 (C) 33	10 V
C4	1-105-669-12 (A) 0.0047	mylar
C5	1-161-190-11 (A) 0.001	ceramic (boundary layer)
C6	1-105-669-12 (A) 0.0047	mylar
C7	1-131-176-11 (B) 33	3 V
C8	1-107-123-11 (A) 47 p	silvered mica
C9	1-131-170-11 (B) 3.3	10 V
C10	1-131-174-11 (C) 47	6.3 V
C11	1-131-173-11 (C) 33	10 V
C12	1-131-202-11 (B) 1.5	20 V
C13	1-161-190-11 (C) 0.001	ceramic (boundary layer)
C14	1-131-173-11 (C) 33	10 V
C15	1-131-174-11 (B) 47	6.3 V
C16	1-131-171-11 (B) 4.7	16 V
C17	1-121-419-11 (B) 220	6.3 V electrolytic
C18	1-131-170-11 (B) 3.3	10 V
C19	1-131-177-11 (C) 100	3 V
C20	1-131-244-11 (B) 1	6.3 V

Ref. No.	Part No.	Description
C21	1-105-673-12 (A) 0.01	mylar
C22	1-105-719-12 (B) 0.033	100 V mylar
C23	1-105-669-12 (A) 0.0047	mylar
C24	1-131-171-11 (B) 4.7	16 V
C25	1-131-170-11 (B) 3.3	10 V
C26	1-121-420-11 (A) 220	10 V electrolytic
C27	1-131-177-11 (C) 100	3 V
C28	1-131-256-11 (C) 10	10 V
C29,30	1-102-074-11 (A) 0.001	ceramic
C31	1-161-190-11 (A) 0.001	ceramic (boundary layer)
C32	1-102-074-11 (A) 0.001	ceramic
C33	1-131-368-11 (B) 3.3	16 V
C34	1-108-249-12 (A) 0.068	mylar

RESISTORS

All resistors are in Ω , $\pm 5\%$, $1/16$ W and carbon type unless otherwise noted.
 $1/8$ W regular-type carbon resistors are omitted.
 Check schematic diagram for resistance values.
 k = 1000

R1,2	1-209-878-11 (A) 1.8 k
R3	1-209-781-11 (A) 10 k
R8	1-210-381-11 (A) 33 k
R12	1-209-768-11 (A) 2.2 k
R13	1-210-113-11 (A) 18 k
R14	1-210-371-11 (A) 1.6 k
R15	1-210-363-11 (A) 270
R16	1-210-381-11 (A) 33 k
R19	1-210-363-11 (A) 270
R21	1-209-768-11 (A) 2.2 k
R22	1-210-113-11 (A) 18 k
R23	1-209-774-11 (A) 5.1 k
R24	1-209-770-11 (A) 2.7 k
R25	1-210-388-11 (A) 68 k
R26	1-210-392-11 (A) 75
R27	1-210-101-11 (A) 51
R28	1-210-846-11 (A) 33
R29	1-209-770-11 (A) 2.7 k
R30	1-209-774-11 (A) 5.1 k
R31	1-210-111-11 (A) 12 k

⇒: Due to standardization, interchangeable replacements may be substituted for parts specified in the diagrams.

TC-150/B.BT-50

Note: Circled letters (A to Z) are applicable to European models only.

<u>Ref. No.</u>	<u>Part No.</u>	<u>Description</u>
R32	1-209-781-11 (A)	10 k
R35,36	1-210-371-11 (A)	1.6 k
R37	1-210-102-11 (A)	150
R40	1-224-727-00 (C)	2 k, adjustable
R41	1-209-765-11 (A)	1.2 k
R42	1-210-846-11 (A)	33
R43	1-222-699-XX (B)	10 k, variable; PB VOL
R44	1-210-105-11 (A)	560

SWITCHES

S1	1-513-323-00 (C)	Slide, record/playback
S2	1-514-346-00 (B)	Leaf, power
S3	1-514-346-00 (B)	Leaf, PAUSE
S4	1-514-346-00 (B)	Leaf, BATT CHECK
S5	1-514-797-00 (B)	Slide, MUSIC/SPEECH

<u>Ref. No.</u>	<u>Part No.</u>	<u>Description</u>
JACKS		
CNJ	1-507-447-XX (B)	Connector, DC IN 6 V
J1	1-507-491-00 (B)	MIC
J2	1-507-491-00 (B)	EARPHONE
J3	1-507-195-00 (A)	REMOTE

MISCELLANEOUS

EH	8-825-566-00 (B)	Head, erase; EBF5-02B
L1	1-407-847-00 (B)	Coil, microinductor; 35 μ H
M	8-834-221-01 (L)	Motor, D-221F
ME	1-520-245-00 (L)	Meter, REC/BATT
MIC	8-814-191-10 (F)	Microphone, electret condenser; C-1002S
RPH	8-829-336-00 (C)	Head, record/playback; PP134-36
SP	1-502-582-00 (F)	Speaker, 8 Ω
T1	1-433-105-12 (B)	Transformer, bias osc

Note: Circled letters (A) to (Z) are applicable to European models only.

ACCESSORIES AND PACKING MATERIALS								
Part No.	Description	TC-150					TC-150B	BT-50
		US	Canadian	E	AEP	UK	AEP	US
A-3003-001-A	(M) Pack, battery; BP-28							○
X-3545-541-0	Carton Ass'y	○						
X-3701-018-2	(A) Tips Ass'y, head cleaning	○	○	○	○	○	○	○
1-463-138-00	Adaptor, ac; AC-9W	○						○
1-463-806-00	Adaptor, ac; AC-9		○					
1-504-044-00	(B) Earphone, ME-21	○	○	○	○	○	○	○
1-506-309-00	Plug, shorting; SP-100							○
1-520-027-11	Battery, long-life; size "A" (4 PCS)		○	○				○
1-534-237-26	(E) Cord, connection; RK-64H	○	○	○	○	○	○	
3-545-675-00	(D) Cushion			○	○	○	○	○
3-545-700-00	Cushion	○						
3-545-685-00	(L) Case, carrying	○	○	○	○	○	○	○
3-545-691-00	(B) Carton		○	○	○	○		
3-545-718-00	(B) Carton						○	
3-545-689-00	Carton							○
3-545-698-00	Sleeve, carton	○						
3-545-693-00	(A) Sheet (A), protection		○	○	○	○	○	
3-545-694-00	(A) Sheet (B), protection		○	○	○	○	○	
3-545-707-00	Spacer	○						
X-3545-544-1	(E) Manual instruction						○	
3-780-914-11	(D) Manual, instruction			○	○			
3-780-914-21	Manual, instruction	○						○
3-780-914-41	(C) Manual, instruction					○		
3-780-914-21	Manual, instruction		○					
3-793-973-31	Manual, instruction; French							
3-793-828-00	(A) Card, caution; cassette	○	○	○	○	○	○	○
3-793-959-21	Supplement, instruction manual							○
8-890-036-11	Tape, DC-60S							○
8-893-506-00	(F) Tape, demonstration; CD-803	○	○	○	○	○	○	

TC-150/B BT-50

Sony Corporation

© 1976

- 16 -