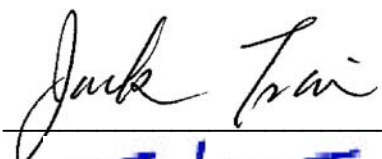
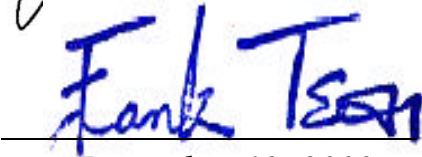

TRENDware
TEW-231BRP
EMC TEST REPORT

Report No: C51ET385

| | |
|---------------------------|--|
| Report No. | C51ET385 |
| Specifications | ETSI EN 301 489-1 V1.4.1 (August, 2002) ETSI EN 301 489-17 V1.2.1 (April, 2002) |
| Applicant | TRENDware International Inc. |
| Applicant address | 3135 Kashiwa Street Torrance, CA 90505, USA |
| Items tested Model No. | IEEE 802.11b Wireless LAN Broadband Router TEW-231BRP |
| Results | Compliance (As detailed within this report) |
| Date | 11/20/2003 (month / day / year) (Sample received) 11/24/2003 (month / day / year) (Test) |
| Prepared by |  Project Engineer (Jack Tsai) |
| Authorized by |  General Manager (Frank Tsai) |
| Issue date | December 10, 2003 (month / day / year) |
| Modifications | None |
| Tested by | Training Research Co., Ltd. |
| Office at | No. 255, Nan Yang Street, Shijr City, Taipei Hsien 221, Taiwan |
| Laboratory at | 1F, No. 255, Nan Yang Street, Shijr City, Taipei Hsien 221, Taiwan |
| Open site at | No. 15, Lane 530, Balian Rd., Sec. 1, Shijr City, Taipei Hsien 221, Taiwan |

Conditions of issue:

This test report shall not be reproduced except in full, without written approval of TRC. And the test result contained within this report only relate to the sample submitted for testing.

★ Aut. No. ELA 131

Generally Statement:

The results appear in the following order:

Electromagnetic compatibility and radio spectrum matters (ERM); Electro Magnetic Compatibility (EMC) standard for radio equipment and services;

Part 1: Common Technical requirements

Part 17: Specific conditions for Wideband data and HIPERLAN equipment.

The results exhibits below only apply to particular samples tested and to the specific tests carried out, as detailed in this Test Report. The issue of this Test Report does not indicate any measure of Approval, Certification, Supervision, Control or Surveillance by Training Research Co., Ltd. of any product. No extract, abridgement or abstraction from a Test Report may be published or used to advertise a product without the written consent of the Director, Training Research Co., Ltd. who reserves the absolute right to agree or reject all or any of the details of any item of publicity for which consent may be sought.

Contents

| | |
|------------------|---|
| CHAPTER 0 | EMISSION AND SUSCEPTIBILITY STANDARDS.....5 |
| | EMISSION STANDARDS..... 5 |
| | SUSCEPTIBILITY STANDARDS..... 5 |
| CHAPTER 1 | INTRODUCTION.....6 |
| | DESCRIPTION OF EUT 6 |
| | TEST METHOD 6 |
| | LIST OF SUPPORT EQUIPMENT..... 7 |
| CHAPTER 2 | EMISSION AND IMMUNITY REQUIREMENTS |
| | OVERVIEW.....10 |
| | EMISSION (ETSI EN 301 489-1)..... 10 |
| | IMMUNITY (ETSI EN 301 489-1)..... 11 |
| CHAPTER 3 | PERFORMANCE CRITERIA.....12 |
| | ETSI EN 301 489-17, SUBCLAUSE 6.2 12 |
| CHAPTER 4 | ELECTROSTATIC DISCHARGES IMMUNITY TEST 18 |
| | ESD TEST INFORMATION:..... 18 |
| | EN 61000-4-2 PHOTO OF TEST SET-UP 20 |
| CHAPTER 5 | RADIO FREQUENCY IMMUNITY TEST (RS).....21 |
| | RS TEST INFORMATION:..... 21 |
| | EN 61000-4-3 PHOTO OF TEST SET-UP 23 |
| CHAPTER 6 | ELECTRIC FAST TRANSIENT/ BURST REQUIREMENTS TEST24 |
| | EFT TEST INFORMATION: 24 |
| | EN 61000-4-4 PHOTO OF TEST SET-UP 26 |
| CHAPTER 7 | SURGE IMMUNITY TEST.....27 |
| | SURGE TEST INFORMATION:..... 27 |
| | EN 61000-4-5 PHOTO OF TEST SET-UP 29 |

| | | |
|-------------------|--|-----------|
| CHAPTER 8 | CONTINUOUS WAVE VOLTAGE IMMUNITY TEST | 30 |
| | CS TEST INFORMATION:..... | 30 |
| | TEST INSTRUMENTS: | 32 |
| | EN 61000-4-6 PHOTO OF TEST SET-UP | 33 |
| CHAPTER 9 | VOLTAGE DIP / INTERRUPTION TEST | 34 |
| | DIP TEST INFORMATION: | 34 |
| | EN 61000-4-11 PHOTO OF TEST SET-UP | 35 |
| CHAPTER 10 | HARMONICS TEST | 36 |
| CHAPTER 11 | VOLTAGE FLUCTUATION AND FLICKER TEST | 37 |
| CHAPTER 12 | CONDUCTED EMISSION TEST | 38 |
| | TEST CONDITION AND SETUP | 38 |
| | LIST OF TEST INSTRUMENT | 38 |
| | CONDUCTED TEST PLACEMENT (FRONT VIEW AND SIDE VIEW)..... | 39 |
| | TEST RESULT OF CONDUCTED EMISSIONS FOR MAINS POWER..... | 40 |
| CHAPTER 13 | RADIATED EMISSION TEST | 42 |
| | TEST CONDITION AND SETUP | 42 |
| | LIST OF TEST INSTRUMENT | 42 |
| | RADIATED TEST PLACEMENT (FRONT VIEW AND SIDE VIEW)..... | 43 |
| | TEST RESULT OF SPURIOUS RADIATED EMISSIONS | 44 |
| APPENDIX A | | 45 |
| | BRAND NAME AND MODEL NAME LIST | 45 |

Chapter 0 Emission and Susceptibility Standards

Emission Standards

| Emission Standard | European Standard | International Standard |
|-------------------|-------------------|--------------------------------|
| () | EN 61000-6-3/2001 | IEC 61000-6-3/1996 |
| () | EN 61000-6-4/2001 | IEC 61000-6-4/1997 |
| () | EN 50081-1/1992 | |
| () | EN 50081-1/8.93 | |
| () | EN 55014/4.93 | CISPR 14: 1993 |
| () | EN 55015/12.93 | CISPR 15: 1992 |
| () | EN 55011/91 | CISPR 11: 1990 |
| (X) | EN 55022/98 | CISPR 22: 1997 |
| (X) | EN 61000-3-2/2000 | IEC 61000-3-2: 2000 (Modified) |
| (X) | EN 61000-3-3/1995 | IEC 61000-3-3: 1994 + A1/2001 |

Susceptibility Standards

| Susceptibility Standard | European Standard | International Standard |
|-------------------------|--------------------|------------------------|
| () | EN 61000-6-1/2001 | IEC 61000-6-1/1997 |
| () | EN 61000-6-2/2001 | IEC 61000-6-2/1999 |
| () | EN 50082-1/1997 | |
| () | EN 50082-2/1994 | |
| () | EN 55024/1998 | CISPR 24/1997 |
| () | EN 55020/2002 | CISPR 20/2002 |
| (X) | EN 61000-4-2:1995 | IEC 61000-4-2:1995 |
| (X) | EN 61000-4-3:1996 | IEC 61000-4-3:1995 |
| (X) | EN 61000-4-4:1995 | IEC 61000-4-4:1995 |
| (X) | EN 61000-4-5:1995 | IEC 61000-4-5:1995 |
| (X) | EN 61000-4-6:1996 | IEC 61000-4-6:1996 |
| () | EN 61000-4-8:1993 | IEC 61000-4-8:1993 |
| (X) | EN 61000-4-11:1994 | IEC 61000-4-11:1994 |
| () | EN 55014-2:1993 | CISPR/F (Sec) 159 |

Chapter 1 Introduction

Description of EUT

| | | |
|----------------------------|---|---|
| Product Name | : | IEEE 802.11b Wireless LAN Broadband Router |
| Model | : | as Appendix A |
| Frequency Range | : | 2.400GHz ~ 2.4835GHz |
| Operating Frequency | : | 2.412GHz ~ 2.472GHz |
| Support Channel | : | 13 Channels |
| Modulation Skill | : | DBPSK, DQPSK, CCK |
| Power Type | : | Power adapter Model: 48075100-C5 I/P: 230VAC, 50Hz, 90mA O/P: 7.5 VDC, 1000mA Power cable 184cm length, non-shielded, no ferrite core |
| Data Cable | : | RJ45*1, 30m length, non-shielded, no ferrite core RJ45*3, 2m length, non-shielded, no ferrite core RJ45*1, 1.2m length, non-shielded, no ferrite core |

Test Method

1. Using the computer and software provided by the manufacturer to control EUT.
2. During test, making EUT to the following mode.
 - (a) EMI testing: Making EUT to the linking mode with support equipments
 - (b) EMS testing: Making EUT to the linking mode with support equipments

List of Support Equipment

In order to construct the minimum testing, following equipment were used as the support units.

- Notebook** : **IBM Think Pad X20**
Model No. : 2662-11T
Serial No. : FX-1192200/09
FCC ID : N/A, DoC Approved (Declaration of Confirmation) Approved
檢磁 : 3892B565
- Adaptor** : **IBM**
Model No. : PA2450U
Serial No. : 02K6654
FCC ID : N/A, DoC Approved
Power type : I/P: 100 ~ 240vac, 50 ~ 60 Hz, 0.5A ~ 1.2A; O/P: 16Vdc, 4.5A
Power cord : Non-shielded, 1.80m long, Plastic, with ferrite core
- PC** : **IBM 6840; HP Pavilion**
Model No. : 6840MJV; P8574A
Serial No. : 96CC 0C1; TW21920435
FCC ID : N/A, DoC
檢磁 : 3892I279; 3902H097
Power type : 100 ~ 127VAC / 4A, 200 ~ 240VAC/2A, 50 ~ 60Hz, 5A, Switching
Power cord : Non-shielded, 2.33 m length, Plastic hood, No ferrite core
- Printer** : **HP**
Model No. : C6464A, C2642A
Serial No. : TH16LEB5PK, SG69A196GV
FCC ID : None (DoC Approved), B94C2642X
檢磁 : 3892H381, None
Power type : Switching adaptor
Power cord : Non-shielded, 173cm length, No ferrite core
(between adaptor and AC source)
Non-shielded, 180cm length, with ferrite core
(between printer and adaptor)
Data cable : Shielded, 1.70m length, No ferrite core

Monitor : **HP 15' Color Monitor, HP pavilion mx70**
Model No. : D2827A, P1283A
Serial No. : KR91379759, TWTBQ00397
FCC ID : C5F7NFCMC1518X
檢磁 : 3872B039
Power type : 110 ~ 240 VAC / 50 ~ 60 Hz, Switching
Power cord : Shielded, 1.83m length, No ferrite core
Data cable : Shielded, 1.46m length, with two ferrite cores

Modem : **ACEEX**
Model No. : XDM-56V14
FCC ID : IFAXDM-56V14
Power type : Linear
Power cord : Non-shielded, 1.9m length, No ferrite cord
Data cable : RS232, Shielded, 1.2m length, No ferrite core
RJ11C x 2, 7' length non-shielded, No ferrite core

Mouse : **HP**
Model No. : M-S34
Serial No. : LZB90714106, LZC84446151
FCC ID : DZL211029
檢磁 : 4862A011
Power type : By PC
Power cord : Non-shielded, 1.88m length, No ferrite core

Keyboard : **HP**
Model No. : 5187-0343, SK-2501K
Serial No. : BE21700404, M981216213
FCC ID : DoC Approved, GYUR38SK
檢磁 : 3892C981, 3862A621
Power type : By PC
Data cable : Shielded, 1.73m length, Plastic hood, No ferrite core

USB Gamepad : Rockfire
Model No. : QF-337uv
Serial No. : 10600545, KR91379759
FCC ID : None (CE approval)
檢磁 : 3862A574
Power type : By computer
Data Cable : Shielded, 1.81m long, Plastic, with ferrite core

Notebook : ASUSTek Computer
Model No. : AB00F
Serial No. : 24NP016361
FCC ID : DoC Approved
BSMI : 41016012
Power type : 100 ~ 240VAC, 1A 50/60 Hz, Switching

Adaptor of PC : LITE-ON Electronics, Inc.
Model No. : PA-1530-01
Serial No. : 00151184
FCC ID : DoC Approved
檢磁 : 3882B259
Power cable : Non-shielded, 1.72m length, Plastic hood, No ferrite core
(Between power adaptor and AC power source)
Power cable : Shielded, 1.48m length, Plastic hood, with ferrite core
(Between power adaptor and notebook)

WLAN Card : Gemtek Technology Co., Ltd.
Model No. : C911003
FCC ID : MXF-C911003

LAN Card : D-Link
Model No. : DFE-530TX
Serial No. : 0050BAE32FF3, 0050BAE3158B
FCC ID : N/A, DoC Approved
Power type : Powered by PC

Chapter 2 Emission and Immunity Requirements Overview

Emission (ETSI EN 301 489-1)

| Phenomenon | Application | Equipment test requirement | | | Reference Subclause in the present document |
|----------------------------------|----------------------------------|--|--|---|---|
| | | Radio and ancillary equipment for fixed use (base station equipment) | Radio and ancillary equipment for vehicular use (mobile equipment) | Radio and ancillary equipment for portable use (portable equipment) | |
| Radiated emission | Enclosure of ancillary equipment | Applicable for stand alone testing | Applicable for stand alone testing | Applicable for stand alone testing | 8.2 |
| Conducted emission | DC power input/output port | Applicable | Applicable | Not applicable | 8.3 |
| Conducted emission | AC mains input/output port | Applicable | Not applicable | Not applicable | 8.4 |
| Harmonic current emissions | AC mains input port | Applicable | Not applicable | Not applicable | 8.5 |
| Voltage fluctuations and flicker | AC mains input port | Applicable | Not applicable | Not applicable | 8.6 |

Immunity (ETSI EN 301 489-1)

| Phenomenon | Application | Equipment test requirement | | | Reference Subclause in the present document |
|---|--|--|--|---|---|
| | | Radio and ancillary equipment for fixed use (base station equipment) | Radio and ancillary equipment for vehicular use (mobile equipment) | Radio and ancillary equipment for portable use (portable equipment) | |
| RF electromagnetic field (80MHz to 1GHz) | Enclosure | Applicable | Applicable | Applicable | 9.2 |
| Electrostatic discharge | Enclosure | Applicable | Applicable | Applicable | 9.3 |
| Fast transients common mode | Signal, telecommunication and control ports, DC and AC power ports | Applicable | Not applicable | Not applicable | 9.4 |
| RF common mode 0.15 MHz to 80MHz | Signal, telecommunication and control ports, DC and AC power ports | Applicable | Applicable | Not applicable | 9.5 |
| Transients and surges | DC power input ports | Not applicable | Applicable | Not applicable | 9.6 |
| Voltage dips and interruptions | AC mains power input ports | Applicable | Not applicable | Not applicable | 9.7 |
| Surges, line to line and line ground | AC mains power input ports, telecommunication ports | Applicable | Not applicable | Not applicable | 9.8 |

Chapter 3 Performance Criteria

ETSI EN 301 489-17, Subclause 6.2

| Table 1 Performance criteria | | |
|-------------------------------------|---|--|
| Criteria | During test | After test |
| A | Shall operate as intended May show degradation of performance (NOTE 1) Shall be no loss of function Shall be no unintentional transmissions | Shall operate as intended Shall be no degradation of performance (NOTE 2) Shall be no loss of function Shall be no loss of stored data or user programmable functions |
| B | May show loss of function (one or more) May show degradation of performance (NOTE 1) No unintentional transmissions | Function shall be self-recoverable Shall operate as intended after recovering Shall be no degradation of performance (NOTE 2) Shall be no loss of stored data or user programmable functions |
| C | May be loss of function (one or more) | Functions shall be recoverable by the operator Shall operate as intended after recovering Shall be no degradation of performance (NOTE 2) |

NOTE 1:

Degradation of performance during the test is understood as a degradation to a level not below a minimum performance level specified by the manufacturer for the use of the apparatus as intended. In some cases the specified minimum performance level may be replaced by a permissible degradation of performance.

If the minimum performance level or the permissible performance degradation is not specified by the manufacturer then either of these may be derived from the product description and documentation (including leaflets and advertising) and what the user may reasonably expect from the apparatus if used as intended.

NOTE 2:

No degradation of performance after the test is understood as no degradation below a minimum performance level specified by the manufacturer for the use of the apparatus as intended. In some cases the specified minimum performance level may be replaced by a permissible degradation of performance. After the test no change of actual operating data or user retrievable data is allowed.

If the minimum performance level or the permissible performance degradation is not specified by the manufacturer then either of these may be derived from the product description and documentation (including leaflets and advertising) and what the user may reasonably expect from the apparatus if used as intended.

ETSI EN 301 489-1

Performance criteria for Continuous phenomena applied Transmitters (CT)

If no further details are given in the relevant part of the present document dealing with the particular type of radio equipment, the following *general performance criteria for continuous phenomena* shall apply.

During and after the test:

The apparatus shall continue to operate as intended. No *degradation of performance* or *loss of function* is allowed below a permissible performance level specified by the manufacturer when the apparatus is used as intends. In some cases this permissible performance level may be replaced by a permissible loss of performance.

During the test:

The EUT shall not unintentionally transmit or change its actual operating state and stored data. If the *minimum performance level* or the *permissible loss* is not specified by the manufacturer, then either of these may be deduced from the product description and documentation and what the user may reasonably expect form the apparatus if used as intended.

For ancillary equipment the pass/failure criteria supplied by the manufacturer (see subclause 6.4) shall apply, unless the ancillary equipment is tested in connection with a receiver or transmitter in which case the corresponding performance criteria above shall apply.

Performance criteria for Transient phenomena applied Transmitters (TT)

If no further details are given in the relevant part of the present document dealing with the particular type of radio equipment, the following *general performance* criteria for transient phenomena shall apply.

After the test:

The apparatus shall continue to operate as intended. No *degradation of performance* or *loss of function* is allowed below a permissible performance level specified by the manufacturer when the apparatus is used as intends. In some cases this permissible performance level may be replaced by a permissible loss of performance.

During the test:

The EMC exposure to an electromagnetic phenomenon, a *degradation of performance* is, however, allowed. No change of the actual mode of operation (e.g. unintended transmission) or stored data is allowed.

If the minimum performance level or the permissible loss is not specified by the manufacturer, Then either of these may be deduced from the product description and documentation and what the user may reasonably expect form the apparatus if used as intended.

For ancillary equipment the pass/failure criteria supplied by the manufacturer (see subclause 6.4) shall apply, unless the ancillary equipment is tested in connection with a receiver or transmitter in which case the corresponding performance criteria above shall apply.

Performance criteria for Continuous phenomena applied Receivers (CR)

If no further details are given in the relevant part of the present document dealing with the particular type of radio equipment, the following *general performance* criteria for continuous phenomena shall apply.

During and after the test:

The apparatus shall continue to operate as intended. No *degradation of performance* or *loss of function* is allowed below a permissible performance level specified by the manufacturer when the apparatus is used as intends. In some cases this permissible performance level may be replaced by a permissible loss of performance.

During the test:

The EUT shall not unintentionally transmit or change its actual operating state and stored data. If the minimum performance level or the permissible loss is not specified by the manufacturer, then either of these may be deduced from the product description and documentation and what the user may reasonably expect form the apparatus if used as intended.

For ancillary equipment the pass/failure criteria supplied by the manufacturer (see subclause 6.4) shall apply, unless the ancillary equipment is tested in connection with a receiver or transmitter in which case the corresponding performance criteria above shall apply.

Performance criteria for Transient phenomena applied Receivers (TR)

If no further details are given in the relevant part of the present document dealing with the particular type of radio equipment, the following *general performance* criteria for transient phenomena shall apply.

After the test:

The apparatus shall continue to operate as intended. No *degradation of performance or loss of function* is allowed below a permissible performance level specified by the manufacturer when the apparatus is used as intends. In some cases this permissible performance level may be replaced by a permissible loss of performance.

During the test:

The EMC exposure to an electromagnetic phenomenon, a degradation of performance is, however, allowed. No change of the actual mode of operation (e.g. unintended transmission) or stored data is allowed.

If the minimum performance level or the permissible loss is not specified by the manufacturer, then either of these may be deduced from the product description and documentation and what the user may reasonably expect form the apparatus if used as intended.

For ancillary equipment the pass/failure criteria supplied by the manufacturer (see subclause 6.4) shall apply, unless the ancillary equipment is tested in connection with a receiver or transmitter in which case the corresponding performance criteria above shall apply.

ETSI EN 301 489-17

Performance criteria for Continuous phenomena applied Transmitters (CT)

The performance criteria A shall apply.

Tests shall be repeated with the EUT in standby mode (if applicable) to ensure that unintentional transmission does not occur. In systems using acknowledgement signals, it is recognized that an ACKnowledgement (ACK) or Not ACKnowledgement (NACK) transmission may occur, and steps should be taken to ensure that any transmission resulting from the application of the test is correctly interpreted.

Performance criteria for Transient phenomena applied Transmitters (TT)

The performance criteria B shall apply, except for voltage dips of 100ms and voltage interruptions of 5000 ms duration, for which performance criteria C shall apply.

Tests shall be repeated with the EUT in standby mode (if applicable) to ensure that unintentional transmission does not occur. In system using acknowledgement signals, it is recognized that an acknowledgement (ACK) or not-acknowledgement (NACK) transmission may occur, and steps should be taken to ensure that any transmission resulting from the application of the test is correctly interpreted.

Performance criteria for Continuous phenomena applied Receivers (CR)

The performance criteria A shall apply.

Where the EUT is a *transceiver*, under no circumstances, shall the transmitter operate unintentionally during the test. In systems using acknowledgement signals, it is recognized that an ACK or NACK transmission may occur, and steps should be taken to ensure that any transmission resulting from the application of test is correctly interpreted.

Performance criteria for Transient phenomena applied Receivers (TR)

The performance criteria B shall apply, except for voltage dips of 100ms and voltage interruptions of 5000 ms duration, for which performance criteria C shall apply.

Where the EUT is a *transceiver*, under no circumstances, shall the transmitter operate unintentionally during the test. In systems using acknowledgement signals, it is recognized that an ACK or NACK transmission may occur, and steps should be taken to ensure that any transmission resulting from the application of test is correctly interpreted.

Chapter 4 Electrostatic Discharges Immunity Test

ESD Test information:

Test setup: Shielded room, According to EN 61000-4-2

Test setup for table-top equipment at laboratory tests:

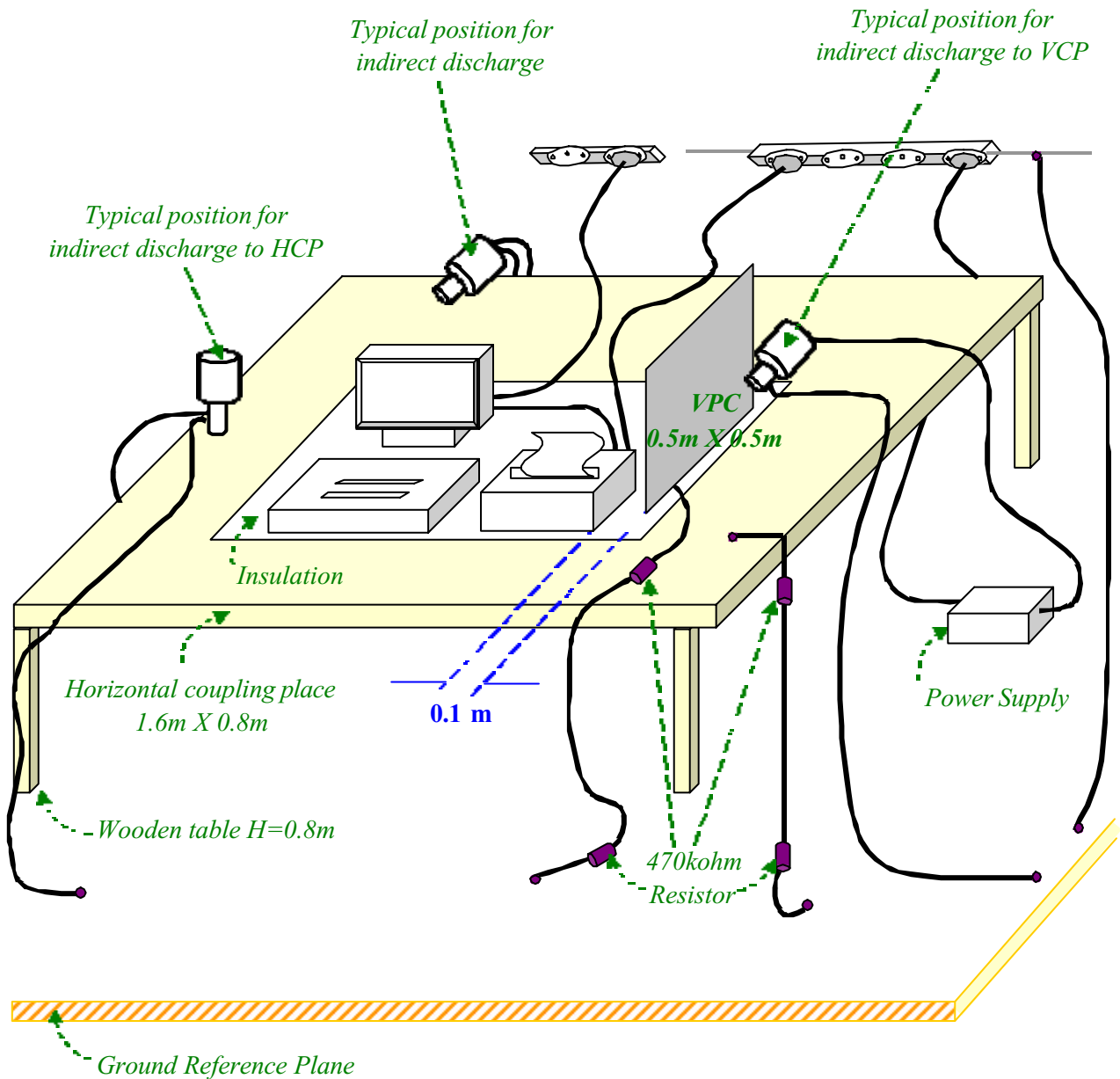

Test levels: (Apply Level 2 and Level 3)

| 1a —Contact discharge | | 1b —Air discharge | |
|-----------------------|-------------------|-------------------|-------------------|
| Level | Test voltage (kV) | Level | Test voltage (kV) |
| 1 | 2 | 1 | 2 |
| 2 | 4 | 2 | 4 |
| 3 | 6 | 3 | 8 |
| 4 | 8 | 4 | 15 |
| X | Special | X | Special |

NOTE: “X” is an open level. The level has to be specified in the dedicated equipment specification. If higher voltages than those shown are specified, special test equipment may be needed.

Test Voltage: (X) 4KV contact discharge (X) 8KV air discharge

Indirect Discharges: (X) HCP (X) VCP

Polarity: (X) Positive (X) Negative

Test mode: Ref. Test method of Chapter 1

Test points: enclosure and connectors of EUT.

Test instruments:

| Name | Model Number | Serial Number | Selected |
|--|------------------------|------------------------------------|----------|
| Best Plus BURST ESD SURGE TRANSIENTS | Best Plus V6.2 | 199749-019SC | |
| BEST EMC Test Instrument | BEST EMC V2.3 (-8, -9) | 199918-006SC | |
| KeyTek Instrument ESD Test system | Series 2000 | 9204303/9204310 9209226/9301395 | X |
| NoiseKen Electrostatic Discharge Simulator | ESS-100L(A) | 2100C03605 | |
| NoiseKen Electrostatic Discharge Gun | TC-815P | 2100C03566 | |

Comment:

Performance Criteria: (According to ETSI EN 301 489-1)

| | | | | |
|--------------------------------|--------|----------|--------|----------|
| (X) Enclosure | () CT | (X) TT | () CR | (X) TR |
| (X) Signal and control ports | () CT | (X) TT | () CR | (X) TR |

EN 61000-4-2 PHOTO OF TEST SET-UP



Chapter 5 Radio Frequency Immunity Test (RS)

RS Test information:

Test setup: GTEM cell

Radiated Immunity Test Setup

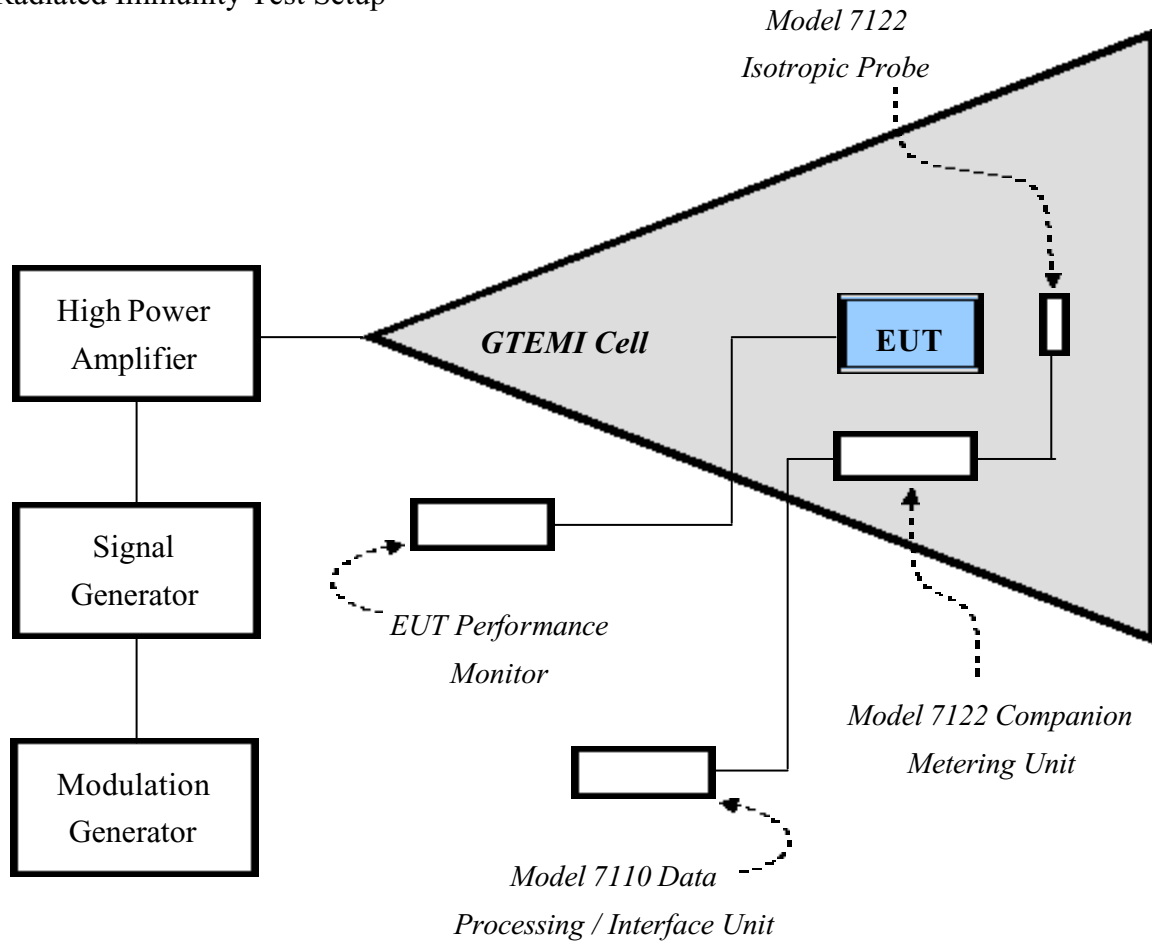

Test levels: **(Apply Level 2)**

| Level | Test Field Strength (V/m) |
|--|------------------------------|
| 1 | 1 |
| 2 | 3 |
| 3 | 10 |
| X | Special |
| NOTE: the "X" is an open test level. This level may be given in the product specification. | |

Field strength: 3V/m at 80 ~ 1000 MHz
 3 V/m at 1400 ~ 2000 MHz

Modulation: FM %
 80% AM Modulation with 1KHz
 80% AM Modulation with 400Hz when signal is modulated at 1kHz
 900 KHz± 5 KHz with PM 200 Hz and 100% depth

Step size: 1% step size

Sweep time: 2.5 Second

Test mode: Ref. Test method of Chapter 1

Test instruments:

| Name | Model Number | Serial Number | Selected |
|-----------------------------------|--------------|---------------|----------|
| EMCO GTEM | 5317 | 9411-1123 | X |
| EMCO Probe | 7122 | 9406-1194 | X |
| EMCO METERING UNIT | 7122 | 9406-1194 | X |
| EMCO data interface | 7110 | 9410-1273 | X |
| HP Personal Computer | D3178A | 3438S00486 | X |
| HP Signal Generator | 8657B | 2928U00286 | X |
| HP Signal Generator | 83711A | 3429A00434 | X |
| IFI Wideband Amplifier | SMX50 | 467-0795 | X |
| Min-circuit Amplifier | GFL-2500VH | N/A | X |
| WG radiation meters | EMC-20 | BN2244129 | X |
| WG E-filed | 2244 / 90.20 | Z-0001 | X |
| HP Transmission Test Set | 4935A | 3115A24046 | X |
| B & K Precision Sound Level Meter | Type 2232 | 1810564 | X |

Comment:

Performance Criteria: **(According to ETSI EN 301 489-1)**

Enclosure CT TT CR TR

EN 61000-4-3 PHOTO OF TEST SET-UP



Chapter 6 Electric Fast Transient/Burst Requirements Test

EFT Test information:

General test set-up for laboratory type tests:

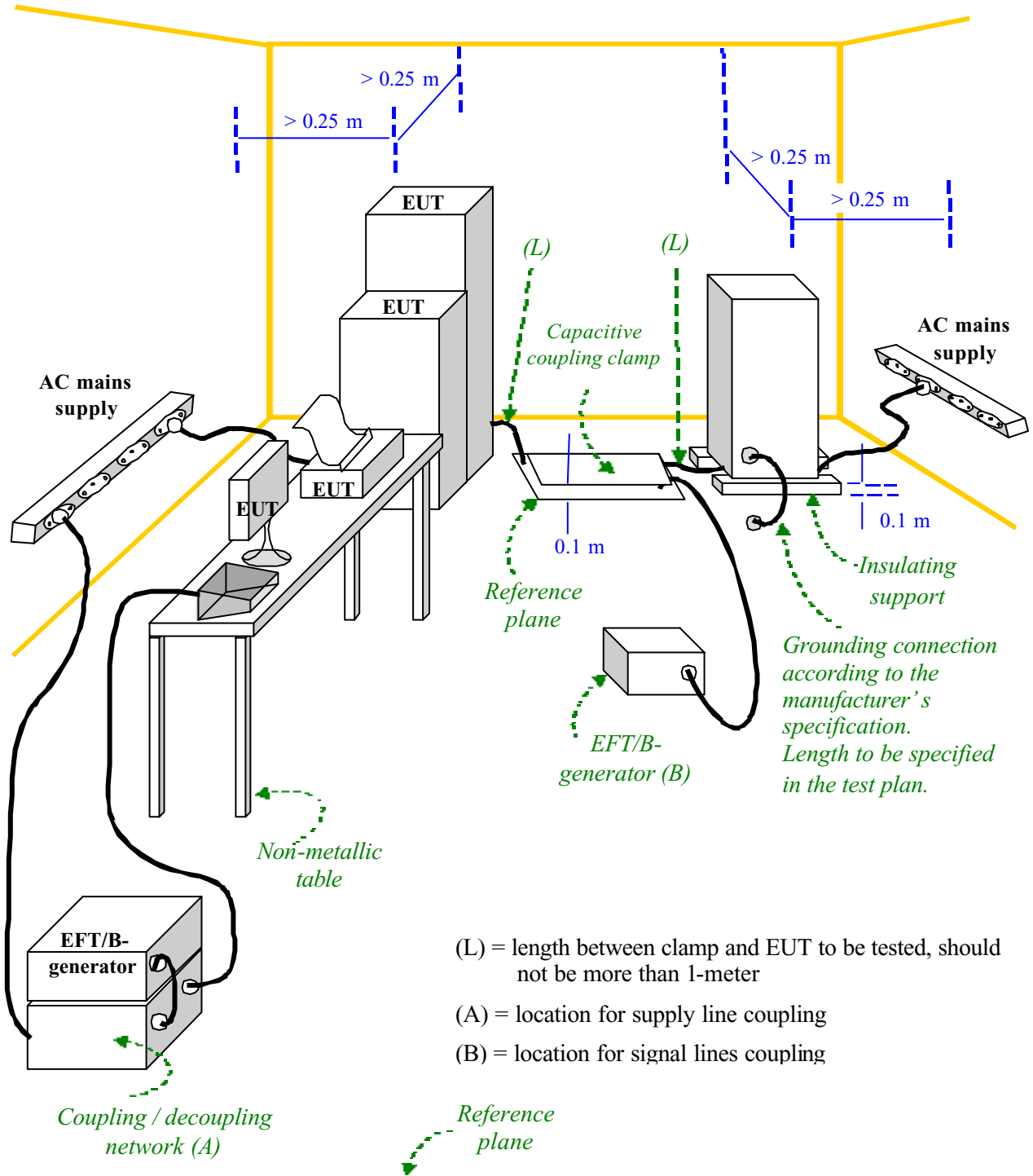

Test levels: (Apply Level 2)

| Open-circuit output test voltage ($\pm 10\%$) and repetition rate of the impulses ($\pm 20\%$) | | | | |
|--|--------------------------|------------------------|--|------------------------|
| Level | On power supply port, PE | | On input/output signal, data and control ports | |
| | Voltage peak kV | Repetition rate kHz | Voltage peak kV | Repetition rate kHz |
| 1 | 0.5 | 5 | 0.25 | 5 |
| 2 | 1 | 5 | 0.5 | 5 |
| 3 | 2 | 5 | 1 | 5 |
| 4 | 4 | 2.5 | 2 | 5 |
| X | Special | Special | Special | Special |

NOTE: the "X" is an open level. The level has to be specified in the dedicated equipment specification

Test setup: According to EN 61000-4-4

Test Voltage: DC Power line () 0.5 KV, 5 KH
 AC Power line (X) 1 KV, 5 KHz
 Signal & Control line (X) 0.5 KV, 5 KHz; () 1 KV, 5 KHz

Polarity: (X) Positive (X) Negative

Test Duration: (X) 1 minute () 3 minutes

Connected lines: () Power line shielded (X) Power line non-shielded
 (X) Signal & Control line non-shielded () Signal & Control line shielded

Test mode: Ref. Test method of Chapter 1.

Test instrument:

| Name | Model Number | Serial Number | Selected |
|--------------------------------------|------------------------|----------------|----------|
| Best Plus BURST ESD SURGE TRANSIENTS | Best Plus V6.2 | 199749-019SC | |
| BEST EMC Test Instrument | BEST EMC V2.3 (-8, -9) | 199918-006SC | |
| KeyTek Instrument EFT Test system | E412 | 9505206/505207 | X |

Comment:

Performance Criteria: (According to ETSI EN 301 489-1)

| | | | | |
|------------------------------|-------|-------|-------|-------|
| (X) Signal and control ports | ()CT | (X)TT | ()CR | (X)TR |
| () DC power input ports | ()CT | ()TT | ()CR | ()TR |
| (X) AC mains input ports | ()CT | (X)TT | ()CR | (X)TR |

EN 61000-4-4 PHOTO OF TEST SET-UP



Chapter 7 Surge Immunity Test

Surge Test information:

Test setup: According to EN 61000-4-5

Test levels: (Apply Level 2 and Level 3)

| Level | Test Field Strength (kV) |
|---|-----------------------------|
| 1 | 0.5 |
| 2 | 1.0 |
| 3 | 2.0 |
| 4 | 4.0 |
| X | Special |
| NOTE: the "X" is an open class. This level may be specified in the product specification. | |

Test Voltage:

- DC Power line () 0.5 KV
- AC Power line () Line – Line: 1KV
- () Line – Ground: 2KV
- (X) Line – Line: 0.5KV
- (X) Line – Ground: 1KV
- Control line () 0.5 KV
- Signal () 1 KV, (X) 0.5KV

Time: (X) 1.2/50µs (8/20µs)

Polarity: (X) Positive (X) Negative

Connected lines:

- () Power line shielded
- (X) Power line non-shielded
- (X) Signal & Control line non-shielded
- () Signal & Control line shielded

Test mode: Ref. Test method of Chapter 1.

Test instrument:

| Name | Model Number | Serial Number | Selected |
|--------------------------------------|--|---------------------------|----------|
| Best Plus BURST ESD SURGE TRANSIENTS | Best Plus V6.2 | 199749-019SC | |
| BEST EMC Test Instrument | BEST EMC V2.3 (-8, -9) | 199918-006SC | |
| KeyTek Pulsed-EMI Test System | E103, 501B, E502B, E503, E505A, E4552A | 0008260 ~0008264, 0008254 | X |

Comment:

Performance Criteria: **(According to ETSI EN 301 489-1)**

| | | | | |
|--------------------------------|--------|----------|--------|----------|
| (X) AC mains input ports | () CT | (X) TT | () CR | (X) TR |
| (X) Signal and control ports | () CT | (X) TT | () CR | (X) TR |

EN 61000-4-5 PHOTO OF TEST SET-UP



Chapter 8 Continuous Wave Voltage Immunity Test

CS Test information:

Test setup: According to EN 61000-4-6

Immunity test to RF conducted disturbances:

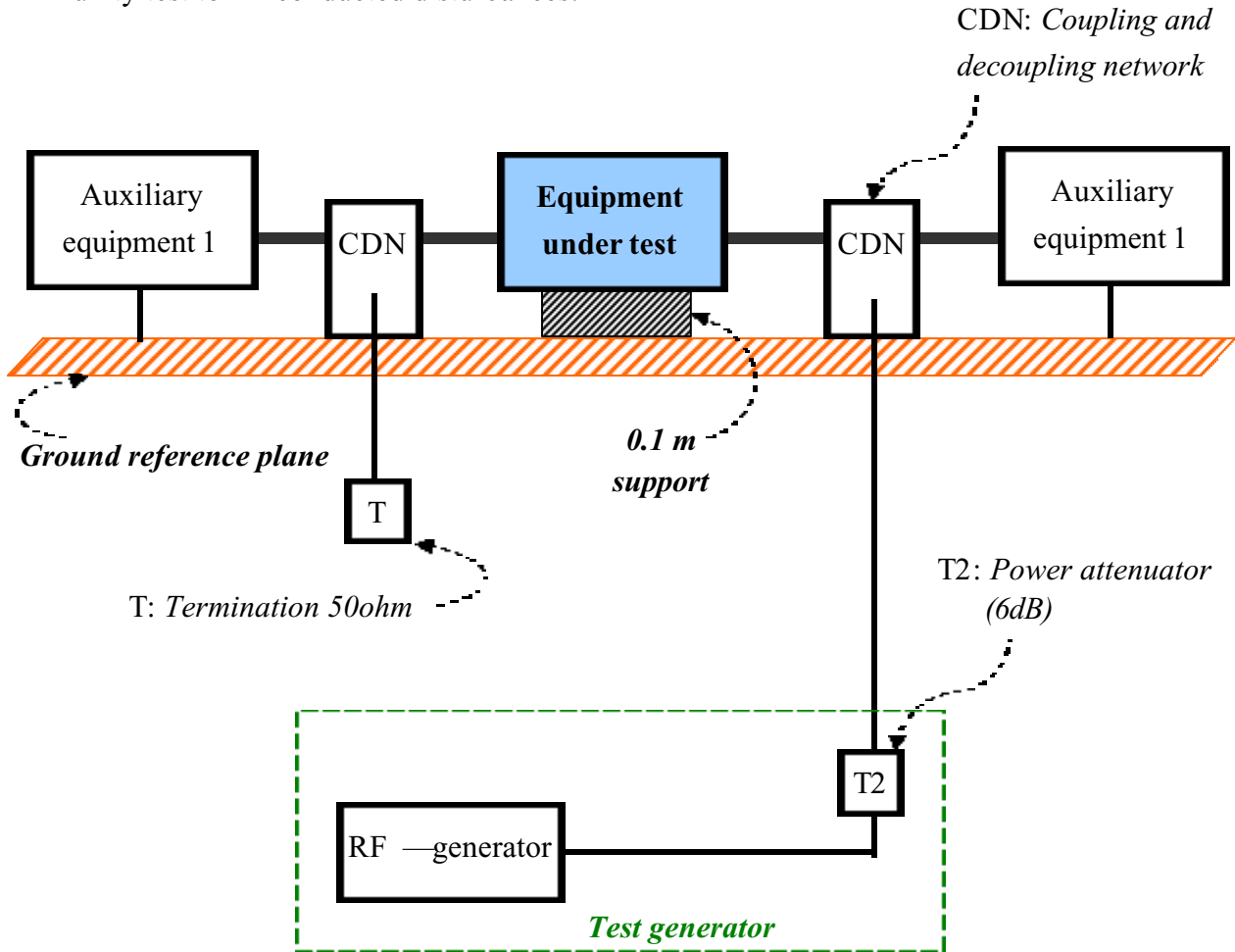

Test levels: (Apply Level 2)

| Frequency range 150kHz to 80MHz | | |
|---------------------------------|------------------------|-----------|
| Level | Voltage level (e.m.f.) | |
| | U_o [dB(μ v)] | U_o [V] |
| 1 | 120 | 1 |
| 2 | 130 | 3 |
| 3 | 140 | 10 |
| X | Special | |

NOTE: the "X" is an open test level.

Test Frequency: (X) 0.15 ~ 80MHz

Modulation: () FM %
(X) 80% AM Modulation with 1kHz
() 80% AM Modulation with 400Hz when signal is modulated at 1kHz
() 900 MHz \pm 5 MHz with PM 200 Hz and 50% duty cycle

Step size: () Performed over the frequency range 150kHz to 80MHz with the exception of an exclusion band for transmitters, and for receivers and duplex transceivers
(X) For receivers and transmitters the stepped frequency increments shall be 1% frequency increment of the momentary frequency in the frequency range 150kHz to 80MHz, unless specified otherwise in the part of EN 301 489 dealing with the particular type of radio equipment

Field strength: () 1Vrms (X) 3Vrms () 10Vrms

Connected lines: () Power line shielded
(X) Power line non-shielded
(X) Signal & Control line non-shielded
() Signal & Control line shielded

Test mode: Ref. Test method of Chapter 1

Test instruments:

| Name | Model Number | Serial Number | Selected |
|------------------------------------|--------------|---------------|----------|
| FRANKONIA EMV-Mess-System | CIT-10 | 103A3113 | X |
| FRANKONIA CDN | M2+M3 | A3011015 | X |
| FRANKONIA CDN | T2-801 | A3010002 | |
| FRANKONIA CDN | T4-801 | A3015004 | X |
| FRANKONIA CDN | S1-801 | A3005002 | |
| SCHAFFNER FM-Koppelzange | KEMZ 801 | 17045 | |
| SCHAFFNER RF-SYNTHESIZERIAMP21FIER | NSG 2070-1 | 1020 | |
| SCHAFFNER CDN | M325 | 13773 | |
| SCHAFFNER CDN | M216 | 15604 | |
| SCHAFFNER CDN | T004 | 15230 | |
| SCHAFFNER CDN | S501 | 15167 | |
| SCHAFFNER FM-Koppelzange | KEMZ 801 | 14301 | |
| HP Transmission Test Set | 4935A | 3115A24046 | |
| B & K Precision Sound Level Meter | Type 2232 | 1810564 | |

Comment:

Performance Criteria: (According to ETSI EN 301 489-1)

| | | | | |
|--------------------------------|---------|-------|----------|-------|
| () Antenna port | ()CT | ()TT | () CR | ()TR |
| (X) Signal and control ports | (X)CT | ()TT | (X) CR | ()TR |
| () DC power input ports | ()CT | ()TT | () CR | ()TR |
| (X) AC mains input ports | (X)CT | ()TT | (X) CR | ()TR |

EN 61000-4-6 PHOTO OF TEST SET-UP



Chapter 9 Voltage DIP / Interruption Test

DIP Test information:

Test setup: According to EN 61000-4-11

Voltage dips: (X) 30%, 0.01 Second
 (X) 60%, 0.1 Second

Voltage interruptions: (X) > 95%, 5 Seconds

Test mode: Ref. Test method of Chapter 1

Test instruments:

| Name | Model Number | Serial Number | Selected |
|--------------------------------------|------------------------|---------------|----------|
| Best Plus BURST ESD SURGE TRANSIENTS | Best Plus V6.2 | 199749-019SC | |
| BEST EMC Test Instrument | BEST EMC V2.3 (-8, -9) | 199918-006SC | |
| Partner EMS Tester | Transienter-1000 | PIO | X |

Comment:

Performance Criteria: (According to ETSI EN 301 489-1)

Dips 30%: (X) CT () TT (X) CR () TR
 Dips 60%: () CT () TT () CR () TR
 Interruptions >95%: () CT () TT () CR () TR

No unintentional responses shall occur at the end of the test;

() Event of loss of function(s) () Event of loss of user stored data

Performance Criteria: (According to ETSI EN 301 489-17)

Dips 60%, 100 ms : () A () B (X) C
 Interruptions >95%, 5 000 ms: () A () B (X) C

EN 61000-4-11 PHOTO OF TEST SET-UP



Chapter 10 Harmonics Test

Test information:

Test setup: According to EN 61000-3-2

Test item: Quasi – stationary & Fluctuating Current Harmonics Test.

Test mode: Ref. Test method of Chapter 1

Test instrument:

| Name | Model Number | Serial Number | Selected |
|------------------------------|--------------|---------------|----------|
| Harmonic/Flicker Test System | HP 6842A | 3531A-00102 | X |

| | | |
|---------------------------|---|------------------------------------|
| Test Equipment Settings: | Quasi-stationary Current Harmonics Test | Fluctuating Current Harmonics Test |
| Line Voltage | 230VAC | 230VAC |
| Line Frequency | 50Hz | 50Hz |
| Device Class | A | A |
| Test Limit Overrides | None | None |
| | | |
| Total Number of Failures: | None | None |
| | | |
| Total Number of Errors: | None | None |

Test Result: Pass

Chapter 11 Voltage Fluctuation and Flicker Test

Test information:

Test setup: According to *EN 61000-3-3*

Test mode: Ref. Test method of Chapter 1

Test instrument:

| Name | Model Number | Serial Number | Selected |
|------------------------------|--------------|---------------|----------|
| Harmonic/Flicker Test System | HP 6842A | 3531A-00102 | X |

Test Equipment Settings:

| | |
|---------------------------|---------------------------|
| Line Voltage | 230VAC |
| Line Frequency | 50Hz |
| Test Limit Overrides | None |
| Total Number of Failures: | Pst: (0), Plt: (0) |
| | Dc: (0), Dmax (0), Dt (0) |
| Total Number of Errors: | None |

Test Result: Pass

Chapter 12 Conducted Emission Test

Test condition and setup

All the equipment is placed and setup according to *EN 55022*.

Mains power:

The EUT is assembled on a wooden table, which is 80 cm high and placed 40 cm from the back-wall, which is a vertical conducting plane. One LISN is for EUT, the other LISN is for support equipment. They are all placed on the conductive ground. The EUT's LISN connect a line switch box for selecting L1 or L2, then connect to a preamplifier and spectrum.

The spectrum scans from 150KHz to 30MHz. Conducted emission levels are detected at *maximum peak mode*. But if the maximum peak mode failed or over *average limit*, it will be measured by *average detection mode*.

While testing the worst-emission plot printed in the *peak detection mode*, and there are up to 6 highest emissions to be recorded. The plot is kept as the original data and not included in the test report.

List of test Instrument

| Instrument Name | Model No. | Brand | Serial No. | Calibration Date | |
|------------------------------|-----------|-------|------------|------------------|-----------|
| | | | | Last time | Next time |
| EMI Receiver | 8546A | HP | 3520A00242 | 07/28/03 | 07/28/04 |
| RF Filter Section | 85460A | HP | 3448A00217 | 07/28/03 | 07/28/04 |
| LISN (EUT) | LISN-01 | TRC | 9912-03,04 | 07/21/03 | 07/21/04 |
| LISN (Support E.) | LISN-01 | TRC | 9912-05 | 06/21/03 | 06/21/04 |
| Auto Switch Box (< 30MHz) | ASB-01 | TRC | 9904-01 | 11/20/02 | 11/20/03 |

The level of confidence of 95%, the uncertainty of measurement of conducted emission is +2.43dB / -2.53dB.

Conducted Test Placement (Front view and Side view)

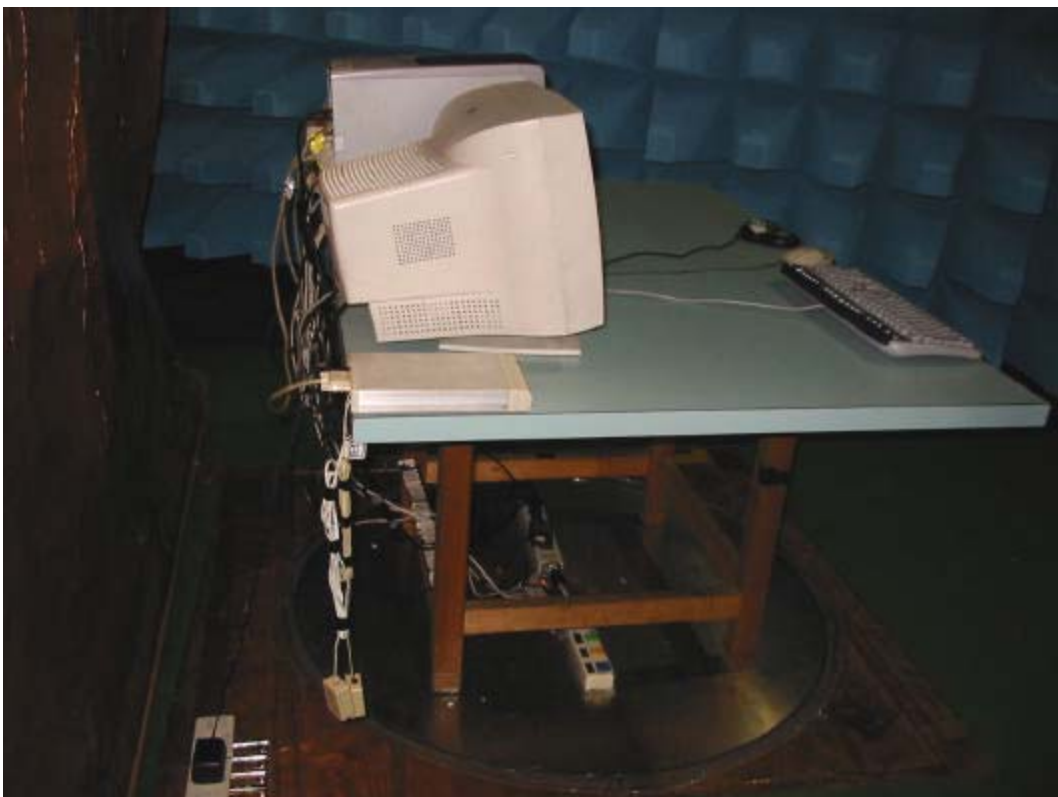

Test Result of Conducted Emissions for Mains power

Test Conditions: Temperature : 25 °C Humidity : 73 % RH

Test Mode: Standby mode

| <i>Power Connected Emissions</i> | | | | | <i>Class B</i> | | |
|----------------------------------|------------------------|--------------------|------------------|-----------------------|------------------------|-------------------------|--------------------|
| <i>Conductor</i> | <i>Frequency (KHz)</i> | <i>Peak (dBµV)</i> | <i>QP (dBµV)</i> | <i>Average (dBµV)</i> | <i>QP-limit (dBµV)</i> | <i>AVG-limit (dBµV)</i> | <i>Margin (dB)</i> |
| Line 1 | 159.000 | 48.70 | --- | --- | 65.74 | 55.74 | -7.04 |
| | 201.000 | 45.90 | --- | --- | 64.54 | 54.54 | -8.64 |
| | 257.000 | 43.12 | --- | --- | 62.94 | 52.94 | -9.82 |
| | 355.000 | 43.26 | --- | --- | 60.14 | 50.14 | -6.88 |
| | 485.000 | 40.52 | --- | --- | 56.43 | 46.43 | -5.91 |
| | 668.000 | 39.73 | --- | --- | 56.00 | 46.00 | -6.27 |
| | 16230.000 | 43.39 | --- | --- | 60.00 | 50.00 | -6.61 |
| | 17710.000 | 42.66 | --- | --- | 60.00 | 50.00 | -7.34 |
| | 20200.000 | 41.89 | --- | --- | 60.00 | 50.00 | -8.11 |
| | 23120.000 | 40.41 | --- | --- | 60.00 | 50.00 | -9.59 |
| Line 2 | 118.640 | 52.90 | 49.17 | 25.26 | 65.86 | 55.86 | -16.69 |
| | 180.000 | 50.79 | --- | --- | 65.14 | 55.14 | -4.35 |
| | 229.000 | 48.66 | --- | --- | 63.74 | 53.74 | -5.08 |
| | 373.710 | 47.06 | 40.17 | 24.80 | 59.91 | 49.91 | -19.74 |
| | 401.390 | 45.83 | 39.63 | 23.87 | 57.37 | 47.37 | -17.74 |
| | 507.550 | 44.79 | 38.15 | 22.42 | 56.00 | 46.00 | -17.85 |
| | 603.500 | 44.50 | 37.43 | 20.44 | 56.00 | 46.00 | -18.57 |
| | 767.000 | 42.96 | --- | --- | 56.00 | 46.00 | -3.04 |
| | 16160.000 | 43.00 | --- | --- | 60.00 | 50.00 | -7.00 |
| | 17710.000 | 43.13 | --- | --- | 60.00 | 50.00 | -6.87 |

***The reading amplitudes are all under limit.**

Test Conditions: Temperature : 25 °C Humidity : 73 % RH

Test Mode: Linking mode

| <i>Power Connected Emissions</i> | | | | | <i>Class B</i> | | |
|----------------------------------|------------------------|--------------------|------------------|-----------------------|------------------------|-------------------------|--------------------|
| <i>Conductor</i> | <i>Frequency (KHz)</i> | <i>Peak (dBμV)</i> | <i>QP (dBμV)</i> | <i>Average (dBμV)</i> | <i>QP-limit (dBμV)</i> | <i>AVG-limit (dBμV)</i> | <i>Margin (dB)</i> |
| Line 1 | 118.340 | 52.87 | 44.56 | 10.90 | 65.63 | 55.63 | -21.07 |
| | 212.000 | 49.75 | --- | --- | 64.23 | 54.23 | -4.48 |
| | 271.000 | 46.99 | --- | --- | 62.54 | 52.54 | -5.55 |
| | 365.810 | 47.38 | 38.21 | 24.84 | 60.03 | 50.03 | -21.82 |
| | 368.790 | 46.53 | 38.33 | 23.92 | 58.11 | 48.11 | -19.78 |
| | 421.680 | 46.14 | 36.56 | 23.92 | 56.83 | 46.83 | -20.27 |
| | 617.050 | 44.59 | 33.08 | 23.45 | 56.00 | 46.00 | -22.92 |
| | 802.000 | 42.16 | --- | --- | 56.00 | 46.00 | -3.84 |
| | 18240.000 | 35.05 | --- | --- | 56.00 | 46.00 | -10.95 |
| | 23120.000 | 39.82 | --- | --- | 60.00 | 50.00 | -10.18 |
| Line 2 | 163.000 | 48.58 | --- | --- | 65.63 | 55.63 | -7.05 |
| | 197.000 | 46.18 | --- | --- | 64.66 | 54.66 | -8.48 |
| | 231.000 | 44.61 | --- | --- | 63.69 | 53.69 | -9.08 |
| | 267.000 | 42.81 | --- | --- | 62.66 | 52.66 | -9.85 |
| | 366.000 | 43.83 | --- | --- | 59.83 | 49.83 | -6.00 |
| | 426.000 | 41.67 | --- | --- | 58.11 | 48.11 | -6.44 |
| | 490.000 | 40.93 | --- | --- | 56.29 | 46.29 | -5.36 |
| | 731.000 | 39.65 | --- | --- | 56.00 | 46.00 | -6.35 |
| | 19620.000 | 35.84 | --- | --- | 60.00 | 50.00 | -14.16 |
| | 26540.000 | 39.35 | --- | --- | 60.00 | 50.00 | -10.65 |

***The reading amplitudes are all under limit.**

Chapter 13 Radiated Emission Test

Test condition and setup

Pretest: Prior to the final test (OATS test), the EUT is placed in a shielded enclosure, and scan from 30MHz to 1GHz. This is done to ensure the radiation is exactly emitted from the EUT. **Final test:** Final radiation measurements are made on a **10 – meter, open-field** test site. The EUT is placed on a nonconductive table, which is 0.8m height, the top surface is 1.0 x 1.5 meter. The entire placement is according to EN 55022.

The whole range antenna is used to measure frequency from 30 MHz to 1GHz. The final test is used the spectrum analyzer (EMI Receiver). Measure more than six top marked frequencies generated form pretest by computer step by step at each frequency.

The EUT is rotated 360 degrees, and antenna is raised and lowered from 1 to 4 meters to find the maximum emission levels. The antenna is used with both horizontal and vertical polarization. Appropriated preamplifier which is made by TRC is used for improving sensitivity and precautions is taken to avoid overloading .The spectrum analyzer’s 6dB bandwidth is set to 120 kHz, and the EUT is measured at quasi-peak (below 1GHz) mode.

If the emission is close to the frequency band of ambient, the tester will recheck the data and the corrected data will be written in the test data sheet. If the emission is just within the ambient, the data from shielded room will be taken as the final data.

List of test Instrument

| Instrument Name | Model No. | Brand | Serial No. | Calibration Date | |
|--|--------------|-----------|------------|------------------|-----------|
| | | | | Last time | Next time |
| Receiver | SCR3102 | SCHAFFNER | 021 | 04/22/03 | 04/22/04 |
| Control box | TWR95-4 | TRC | C9001-2 | None | None |
| Antenna | CBL6141A | SCHAFFNER | 4206 | 05/27/03 | 05/27/04 |
| Pre-amplifier | TRC-CB-2 | TRC | CB-002 | 05/29/03 | 05/29/04 |
| Coixal cable (20m) | RG-214/U | Jyebao | CL-002 | 05/29/03 | 05/29/04 |
| Coixal cable (50cm) | BNC31VB-0316 | Jyebao | CL-002 | 05/29/03 | 05/29/04 |
| Coixal cable (20cm) | BNC31VB-0318 | Jyebao | CL-007 | 05/29/03 | 05/29/04 |
| Coixal cable (55cm) | BNC31VB-0316 | Jyebao | CL-006 | 05/29/03 | 05/29/04 |
| Coixal cable (55cm) | BNC31VB-0316 | Jyebao | CL-005 | 05/29/03 | 05/29/04 |
| Open test side (Antenna, Amplify, cable calibrated together) | | | | 05/15/03 | 05/15/04 |

The level of confidence of 95% , the uncertainty of measurement of radiated emission is +2.85dB / -2.77dB.

Radiated Test Placement (Front view and Side view)

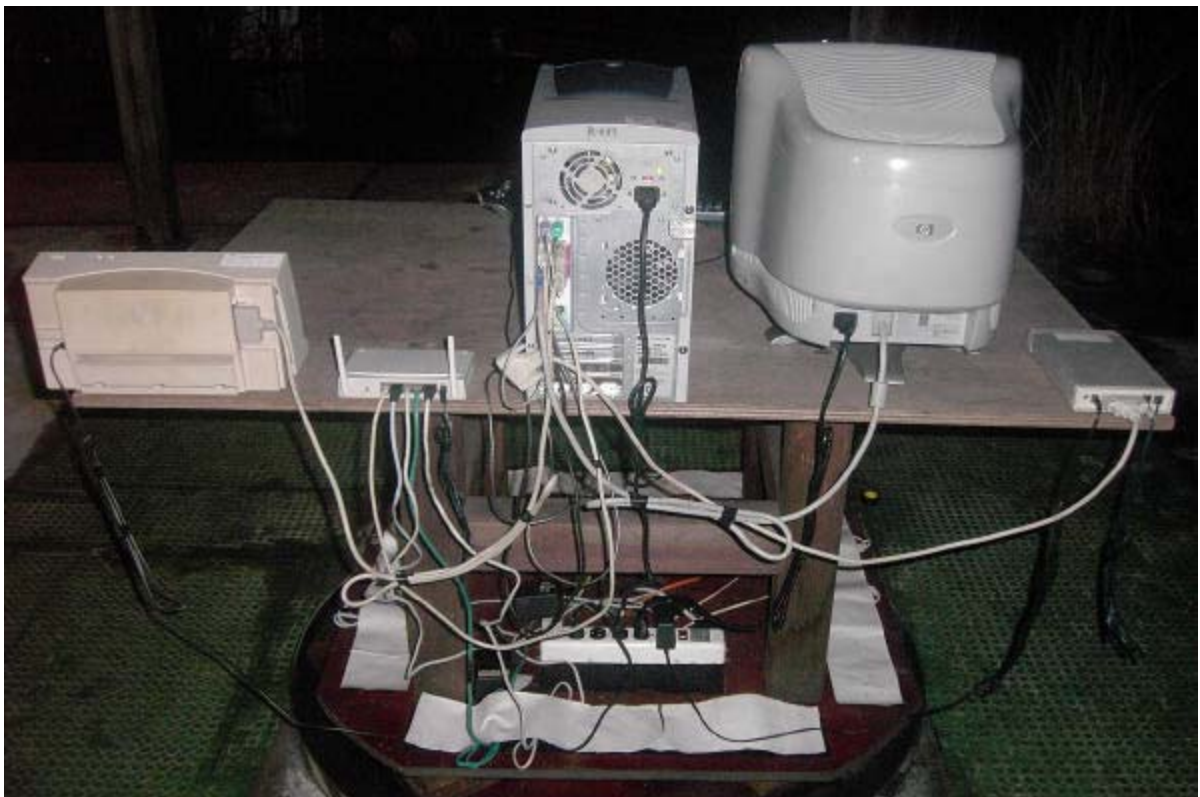

Test Result of Spurious Radiated Emissions

Test Conditions: Temperature : 25 ° C Humidity : 73 % RH

Test Mode: Linking mode, Horizontal

| <i>Radiated Emission</i> | | | | <i>Correction Factors</i> | <i>Corrected Amplitude</i> | <i>Class B (10 m)</i> | |
|--------------------------|-------------------------|--------------------|--------------------|---------------------------|----------------------------|-----------------------|--------------------|
| <i>Frequency (MHz)</i> | <i>Amplitude (dBµV)</i> | <i>Ant. H. (m)</i> | <i>Table (°)</i> | | | <i>Limit (dBµV/m)</i> | <i>Margin (dB)</i> |
| 205.3338 | 29.17 | 2.50 | 326 | -3.85 | 25.32 | 30.00 | -4.68 |
| 250.0163 | 33.50 | 2.50 | 359 | -1.80 | 31.70 | 37.00 | -5.30 |
| 308.0000 | 32.20 | 2.50 | 308 | -0.99 | 31.21 | 37.00 | -5.79 |
| 425.0288 | 28.46 | 2.50 | 218 | 5.10 | 33.56 | 37.00 | -3.44 |
| 475.0275 | 24.22 | 2.50 | 18 | 6.20 | 30.42 | 37.00 | -6.58 |

Test Mode: Linking mode, Vertical

| <i>Radiated Emission</i> | | | | <i>Correction Factors</i> | <i>Corrected Amplitude</i> | <i>Class B (10 m)</i> | |
|--------------------------|-------------------------|--------------------|--------------------|---------------------------|----------------------------|-----------------------|--------------------|
| <i>Frequency (MHz)</i> | <i>Amplitude (dBµV)</i> | <i>Ant. H. (m)</i> | <i>Table (°)</i> | | | <i>Limit (dBµV/m)</i> | <i>Margin (dB)</i> |
| 30.2700 | 19.57 | 1.00 | 118 | 4.79 | 24.36 | 30.00 | -5.64 |
| 124.4638 | 30.95 | 2.51 | 359 | -4.73 | 26.22 | 30.00 | -3.78 |
| 205.5685 | 27.62 | 2.51 | 324 | -3.84 | 23.78 | 30.00 | -6.22 |
| 250.0163 | 37.66 | 1.00 | 170 | -1.80 | 35.86 | 37.00 | -1.14 |
| 410.6675 | 28.53 | 2.51 | 105 | 4.81 | 33.34 | 37.00 | -3.66 |

Note:

1. Margin = Amplitude – limit, if margin is minus means under limit.
2. Corrected Amplitude = Reading Amplitude + Correction Factors
3. Correction factor = Antenna factor + (Cable Loss – Amplitude gain)

Appendix A

Brand name and Model name List

| Brand Name | Model Name |
|-------------------|-------------------|
| TRENDware | TEW-231BRP |