

# TELGUARD®

## Cellular Alarm Transmission System Using Microburst™ Control Channel Technology

MODELS TG-200; TG-300



### INSTALLATION AND OPERATING INSTRUCTIONS

#### COMPANY CONFIDENTIAL

For use by **TELGUARD®** customers only.  
Distribution to others strictly prohibited.

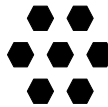

**TELULAR®**  
CORPORATION

Corporate Headquarters  
647 North Lakeview Parkway  
Vernon Hills, Illinois 60061  
847-247-9400 Fax: 847-247-0021

**May 24, 2000**

**TELGUARD®** is a registered trademark of Telular Corporation. Products are protected under one or more of the following U.S. patents:  
4,658,096    4,737,975    4,775,997    4,868,519    4,922,517  
© 2000 Telular Corporation

## FOREWORD

A word about the significance of our UL Listings: These UL Listings allow the Telguard® models to meet certain requirements of insurance companies, fire marshals, building inspectors and other regulatory authorities in burglary and fire alarm service as follows:

1. **In Burglary Alarm Service:** When used in conjunction with a Listed central station burglary alarm control unit with integral or Listed DACT that is connected to a Listed Grade A bell and bell housing, the combined control/communicator and Telguard TG-300 is suitable for Grade A central station service. This is one grade higher than a Listed control/communicator can obtain on its own without some type of external line supervision, such as is involved in UL AA service.

A UL Grade A Listing is available in installations where the host Listed burglary alarm control/communicator transmits through the TG-300 solely on cellular ("Cellular only": No Telco; Cellular primary). Also, where the control/communicator is switched to transmit over cellular when it can not reach the central station over telco ("Cellular backup for Telco": Telco primary; Cellular secondary).

The specific UL Listings for the TG-300 with respect to burglary alarm service are Residential Burglary, UL1023. Central Station Burglar Alarm Systems, UL1610; Police Station Connected Alarm Systems, UL365; and Digital Alarm Communicators, UL1635.

2. **In Fire Alarm Service:** When used in conjunction with a Listed central station fire alarm control unit with a two-telco line integral or Listed DACT, the combined control/communicator and Telguard TG-200 meet the requirements for commercial fire alarm usage under UL 864 and NFPA. This enables the TG-200 to be the second "phone line" in commercial fire installations.

In UL/NFPA Listed fire alarm installations, the Listed two-line fire alarm control communicator must always use telco as the primary transmission path, switching to cellular only when and if it can not reach the central station over telco. Also, the TG-200 may be employed in residential fire, UL985 applications.

Appendices A3.1 through A3.3.1 (burglary alarm service) and A3.4 through A3.5.1 (fire alarm service) show the installation configurations and the connections that must be made to meet various UL Listing requirements.

## NOTICES

### ABOUT THIS MANUAL

This manual assumes that you have basic security system installation skills such as measuring voltages, stripping wire, properly connecting wires together, connecting wires to terminals, and checking phone lines. It also assumes that you have a familiarity with the proper installation and programming tasks related to various Control/Communicator panels.

The material and instructions covered in this manual have been carefully checked for accuracy and are presumed to be reliable. However, Telular assumes no responsibility for inaccuracies and reserves the right to modify and revise this manual without notice.

It is our goal at Telular to always supply accurate and reliable documentation. If a discrepancy is found in this documentation, please mail or fax a photocopy of the corrected material to:

Telular Security Products  
Technical Services Department  
420 Thornton Road, Suite 109  
Lithia Springs, GA 30122  
Fax: 678-945-1651

© 2000 Telular Corporation. Lithia Springs, GA U.S.A. All rights reserved.

### FCC NOTICES

#### *Part 15*

This equipment generates and uses radio frequency energy. If not installed and used in accordance with the manufacturer's instructions, it may cause interference to radio and television reception. It has been tested and found to comply with the specifications in Part 15 of FCC rules for Class computing devices.

If this equipment causes interference to radio or television reception — which can be determined by turning the equipment on and off — the installer is encouraged to correct the interference by one or more of the following measures: 1) Reorient the antenna of the radio/television. 2) Connect the AC transformer to a different outlet so the Telguard and radio/television are on different branch circuits. 3) Relocate the Telguard with respect to the radio/television.

If necessary, the installer should consult an experienced radio/television technician for additional suggestions, or send for the "Interference Handbook" prepared by the Federal Communications Commission. This booklet is available from the U.S. Government Printing Office, Washington D.C. 20402, stock number 004-000-00450-7.

#### *Part 68*

This equipment complies with Part 68 of the FCC Rules. Located on the inside of the hinged door of *Telguard*<sup>®</sup> models TG-200 and TG-300 is a label that contains, among other information, the FCC Registration Number and Ringer Equivalence Number (REN) for this equipment. If requested, this information must be provided to the Telephone Company.

The *Telguard*<sup>®</sup> Cellular Alarm Transmission System is registered for connection to the public telephone network using an RJ38X or RJ31X jack.

The ringer equivalence number (REN) is used to determine the quantity of devices which may be connected to the telephone line. Excessive REN's on the telephone line

may result in the devices not ringing in response to an incoming call. In most, but not all areas, the sum of the REN's should not exceed five (5.0). To be certain of the number of devices that may be connected to the line, as determined by the total number of REN's, contact the telephone company to determine the maximum of REN for the calling area.

If the *Telguard<sup>®</sup> Cellular Alarm Transmission System* caused harm to the telephone network, the Telephone Company will notify you in advance that temporary discontinuance of the service may be required. But if advance notice is not practical, the Telephone Company will notify the customer as soon as possible. Also, you will be advised of your rights to file a complaint with the FCC if you believe it is necessary.

The telephone company may make changes in its facilities, equipment, operation, or procedures that could affect the operation of the equipment. If this happens, the Telephone Company will provide advance notice in order for you to make the necessary modifications in order to maintain uninterrupted service. If trouble is experienced with the *Telguard<sup>®</sup> Cellular Alarm Transmission System* please contact Telular Technical Service in the U.S.A. for repair and (or) warranty information.

Telular Security Products

**TECHNICAL SERVICES DEPARTMENT**  
420 Thornton Road, Suite 109  
Lithia Springs, GA 30122  
Phone: (800) 229-2326

If the trouble is causing harm to the telephone network, the Telephone Company may request that you remove the equipment from the network until the problem is resolved.

The customer (user) should not attempt any repair to the *Telguard<sup>®</sup> Cellular Alarm Transmission System*. Repair of this equipment should be referred to only qualified technical personnel.

Note that this equipment cannot be used on the public coin service provided by the Telephone Company. Connection to Party Line Service is subject to state tariffs. ***(Contact the state public utility commission or corporation commission for information).***

## **FUTURE TESTING AND LIMITATIONS ON USE**

Telguard<sup>®</sup> is part of an advanced design alarm-communication system. It does not offer guaranteed protection against burglary and fire. Any alarm communication system is subject to compromise or failure.

The Telguard<sup>®</sup> will not work without power. Devices powered by AC will not work if the AC power supply is off for any reason, however briefly, and at the same time, the backup battery is missing, dead or not properly installed.

The cellular radio network, needed to transmit alarm signals from a protected premises to a central monitoring station, may be inoperable or temporarily out of service. Cellular radio networks are also subject to compromise by sophisticated methods of attack.

This equipment, like any other electrical device is subject to component failure. Although this equipment is designed to be long lasting, the electrical components could fail at any time.

Due to these limitations, we recommend that if the automatic self-test feature is not enabled, other arrangements be made with the user to test the system at least once every three months. Moreover, arrangements should also be made for on site inspection/test by a licensed alarm installer at least once each year.

# TABLE OF CONTENTS

<b>FOREWORD</b> .....	<b>I</b>
<b>NOTICES</b> .....	<b>II</b>
ABOUT THIS MANUAL.....	II
FCC NOTICES.....	II
<i>Part 15</i> .....	<i>ii</i>
<i>Part 68</i> .....	<i>ii</i>
TECHNICAL SERVICES DEPARTMENT .....	III
FUTURE TESTING AND LIMITATIONS ON USE.....	III
<b>1.0 GENERAL DESCRIPTION AND OPERATION</b> .....	<b>1</b>
<b>2.0 FEATURES</b> .....	<b>1</b>
2.1 OPERATING MODE.....	1
2.2 C/C COMPATIBLE COMMUNICATION FORMATS .....	2
2.3 COMPLETE SUPERVISION OF COMMUNICATION PATHS.....	2
2.3.1 <i>Line Fault Condition (LFC)</i> .....	2
2.3.2 <i>Telco Communications Failure Condition (CFC)</i> .....	2
2.3.3 <i>No Service Condition (NSC)</i> .....	2
2.3.4 <i>Radio Communications Failure Condition (RFC)</i> .....	3
2.4 COMPLETE POWER SUPERVISION .....	3
2.4.1 <i>Low/Missing Battery Condition (LBC)</i> .....	3
2.4.2 <i>AC Failure Condition (ACFC)</i> .....	3
2.4.3 <i>Watchdog Monitor/Reset (WR)</i> .....	3
2.4.4 <i>Catastrophic Failure (CF)</i> .....	3
2.5 TELGUARD AUTOMATIC SELF-TEST REPORT .....	4
2.5.1 <i>Telguard Remote Query Capability</i> .....	4
2.6 TELGUARD TERMINAL STRIP CONNECTIONS .....	4
2.6.1 <i>Programmable Supervisory Trip Output (STC) Relay</i> .....	4
2.7 DIAGNOSTIC AND STATUS LEADS.....	5
2.7.1 <i>LED Signal Strength Indication</i> .....	5
2.8 TELGUARD SETUP PROGRAMMING PARAMETERS .....	6
2.9 UL LISTINGS BY MODEL .....	6
2.9.1 <i>Model TG-200</i> .....	6
2.9.2 <i>Model TG-300</i> .....	6
<b>3.0 REQUEST TELGUARD ACTIVATION FOR CELLULAR SERVICE FROM TELULAR</b> .....	<b>7</b>
3.1 GETTING READY .....	7
<b>4.0 INSTALLATION SUMMARY</b> .....	<b>7</b>
4.1 TRANSMIT C/C ALARMS OVER THE TELCO CONNECTION .....	8
4.2 PROGRAM TELGUARD AND CONFIRM COMMUNICATIONS INTEGRITY .....	8
4.3 TRANSMIT C/C ALARMS OVER THE CELLULAR RADIO NETWORK .....	8
4.4 CONNECT TELCO LINE AND SUPERVISORY TRIP OUTPUT.....	8
4.5 COMPLETE THE INSTALLATION .....	8
<b>5.0 INSTALLATION STEPS</b> .....	<b>8</b>
5.1 <i>STEP 1: TRANSMIT C/C ALARMS OVER THE TELCO CONNECTION</i> .....	9
5.2 <i>STEP 2: PROGRAM TELGUARD AND CONFIRM COMMUNICATIONS INTEGRITY</i> .....	10
5.2.1 <i>Locate Unit</i> .....	10

5.2.2	Connect Backup Battery and AC Power Transformer .....	11
5.2.3	Decide on a STC Trip Output Strategy .....	11
5.2.4	Default Programming.....	12
5.2.5	Complete the Telguard Programming Data Sheet.....	12
5.2.7	Connect Antenna and Temporarily Place Unit .....	14
5.2.8	Measure Received Signal Strength (RSSI) for Best Antenna Placement .....	14
5.2.9	Request Telguard Activation "PING" from Telular's IVR.....	15
5.3	STEP 3: TRANSMIT C/C ALARMS OVER THE CELLULAR RADIO NETWORK .....	16
5.3.1	Connect C/C to Telguard Jack 2 .....	16
5.3.2	Verify Alarm Signal Transmissions over Cellular .....	17
5.4	STEP 4: CONNECT TELCO LINE AND SUPERVISORY TRIP OUTPUT.....	18
5.4.1	Be sure the Telguard is the first device on incoming phone line .....	18
5.4.2	Connect RJ31X to Telguard Jack 1 and Check LFC.....	19
5.4.3	Connect STC Trip Output.....	19
5.4.4	Check Telguard Supervisory Trip to C/C.....	20
5.5	STEP 5: COMPLETE THE TELGUARD INSTALLATION.....	21
5.5.1	Check Settings.....	21
5.5.2	Permanently Mount and Properly Ground the Telguard Chassis .....	21
<b>A1.0</b>	<b>APPENDICES.....</b>	<b>21</b>
A1.1	WIRING DIAGRAM.....	22
A1.2	JACK AND PIN ASSIGNMENTS .....	23
A1.3	TERMINAL STRIP PIN ASSIGNMENTS.....	24
A1.4	LED MODES AND FUNCTIONS .....	25
A1.5	JUMPERS .....	26
<b>A2.0</b>	<b>OPERATIONAL QUICK REFERENCE TABLE .....</b>	<b>27</b>
<b>A2.1</b>	<b>SETUP PROGRAMMING PARAMETERS .....</b>	<b>28</b>
<b>A2.2</b>	<b>TELGUARD COMMUNICATION FORMATS .....</b>	<b>29</b>
<b>A2.3</b>	<b>COMPATIBLE CONTROL COMMUNICATORS.....</b>	<b>29</b>
<b>A2.4</b>	<b>COMPATIBLE RECEIVERS.....</b>	<b>29</b>
<b>A2.5</b>	<b>ACTIVATION FORM .....</b>	<b>30</b>
<b>A3.0</b>	<b>COMPLIANCE FOR UL LISTED INSTALLATIONS.....</b>	<b>31</b>
A3.1	UL GRADE A CENTRAL STATION SERVICE.....	31
A3.2	UL GRADE A POLICE STATION CONNECT SERVICE.....	32
A3.3	NOTES TO INSTALLATION/WIRING REQUIREMENTS ON APPENDICES A3.1 AND A3.2.....	33
A3.3.1	Supervisory Requirements for Listed Burglary Configurations .....	34
A3.4	UL864/NFPA FIRE ALARM CENTRAL STATION SERVICE .....	35
A3.5	NOTES TO INSTALLATION/WIRING REQUIREMENTS ON APPENDIX A3.4.....	37
A3.5.1	Supervisory Requirements for Listed Fire Configurations .....	37
<b>A4.0</b>	<b>UL INSTALLATION REQUIREMENTS SUMMARY TABLE.....</b>	<b>38</b>
<b>A5.0</b>	<b>DETAILED SPECIFICATIONS.....</b>	<b>39</b>
A5.1	DIALER TO INTERFACE ELECTRONICS.....	39
A5.2	POWER .....	39
A5.3	RADIO .....	39
A5.4	PHYSICAL .....	39
A5.5	WARRANTY .....	39

**A6.0 PARTS LIST..... 40**  
**INDEX..... 41**



## 1.0 GENERAL DESCRIPTION AND OPERATION

The Telguard® is a cellular radio alarm transmission device, which is used to provide a backup transmission path (cellular) for control communicators (C/Cs) in case the primary transmission path (telco) is not available. When transmitting over cellular, Telguard obtains its data from the C/C by way of a telco interface. The device transmits a Link Request to the Telular operated Communication Center and when a link acknowledgement is received, the Telguard handshakes with the C/C and causes the C/C to transmit the alarm data. Telguard encodes the alarm data into digital packet data protocol and transmits on one of twenty-one available control channels used by the local AMPS cellular network provider. The signal is routed from the network provider through the Aeris virtual network system to the decoding (message) center. The Communication Center performs like a central station receiver and issues the transmission kiss-off when the last message in the transmission is received. After decoding and reformatting, the alarm signal is routed over telco to the appropriate alarm company central station for action.

Telguard is compatible with most control/communicators and no special equipment is needed at the premises or in the alarm monitoring station. All Telguard programming is done with a standard touch-tone telephone or lineman's buttset and Telguard can be installed wherever cellular service is available. Different dialing patterns between telco and cellular, cellular area code changes and PBX access numbers are not a problem for installers. Fraud and cloning problems are eliminated since all transmissions occur over the cellular control channels in packet-type data format and never over any voice channels.

In a typical alarm installation, Telguard is installed in the same area as the host alarm system. The incoming telco line is connected from the RJ31X to Telguard and then to the host control/communicator's digital dialer in the normal fashion. A programmable supervisory trip (STC) output is available for connection to the host control/communicator's trip zone input terminals in order to provide a Telguard trouble signal to the C/C. Additionally, automatic self-test and status-on-demand report signals are transmitted exclusively over the cellular network to the Communication Center. All models are capable of transmitting an automatic self-test signal to the central station on a daily, weekly, or monthly schedule. Telguard has its own internal power supply/battery charger. All telco line and cellular monitoring, switching and supervisory functions are built in--no extra modules are required.

All Telguard models come with a special Microburst™ compatible 3-watt cellular transceiver (without handset), antenna, interface with integrated control and power module, connecting cable, and plug-in transformer. The installer to provide backup times that range from twenty-four to seventy-two hours must supply a rechargeable 12V battery, 7.0AH or 21.0AH. Model TG-200, UL Listed for residential and commercial fire, as well as residential burglary, comes in a standard metal enclosure (12in.x12in.x3½in.) with keylock and magnetic mount antenna with 12ft. of cable. Model TG-300, UL Listed for all residential burglary and fire, commercial burglary and fire, and bank applications comes in an attack-resistant enclosure with keylock, tamper switch, and magnetic mount antenna.

The Listed equipment at the Telular operated Communication Center (TCC) plays a key role in the operation of every Telguard. All Telguard units are required to use the Communication Center because of the C/C alarm signal format encoding and decoding requirements used in packet-data transmissions over the cellular network control channels. The Communication Center also manages the real-time databases for cellular activation, airtime, billing, installation site location, and a complete history of every Telguard's operating conditions. These conditions include programming setup information, cellular alarm transmission information, supervisory trouble information, status-on-demand information, and automatic self-test information. This information is made available to authorized personnel through Telular's Interactive Voice Response System (IVR), Telular's computer access Communication Center Intranet System, or through Telular's Customer Service Center.

## 2.0 FEATURES

This section summarizes the key features of the Telguard. Actual installation instructions begin in Section 5.0.

### 2.1 OPERATING MODE

The Telguard is a cellular radio packet transmission device that is installed at the protected premises to provide alarm transmission integrity for security systems. It is used to provide a backup transmission path (cellular) for control communicators (C/Cs) in case the primary transmission path (telco) is not available.

If the telco line is cut or the C/C is unable to communicate with the central station receiver due to busy telephone line circuits then Telguard transmits the alarm message over the cellular network.

## **2.2 C/C COMPATIBLE COMMUNICATION FORMATS**

The Telguard reads the C/C's alarm messages and converts the C/C's digital data format into Microburst packet data protocol for transmission over the cellular radio network. In order for the C/C to be compatible with the Telguard, the C/C must be programmed to transmit alarm messages to the central station using one of the following non-extended formats:

- 3+1 pulse; 10pps, Double Round, 1400Hz ack
- 3+1 pulse; 20pps, Double Round, 2300Hz ack
- 3+1 pulse; 40pps, Double Round, 2300Hz ack
- 4+2 pulse; 20pps, Double Round, 1400Hz ack
- 4+2 pulse; 20pps, Double Round, 2300Hz ack
- 4+2 pulse; 40pps, Double Round, 2300Hz ack
- Ademco Contact ID

Hexadecimal account numbers (001-FFF or 0001-FFFF) can be used with 3+1 or 4+2 formats, but Contact ID requires a four digit account number using digits 0-9 (0001-9999).

## **2.3 COMPLETE SUPERVISION OF COMMUNICATION PATHS**

The Telguard continuously supervises both the primary (telco) and the secondary (cellular) communication paths. If either path becomes inoperative, the Telguard generates a relay trip output that can be connected to a zone input of the host control communicator and/or used to activate remote sounding devices.

### ***2.3.1 Line Fault Condition (LFC)***

The Telguard monitors voltage on the incoming telco line. If an inoperative telco line is identified, a telco line fault condition (LFC) is declared and Telguard switches to the cellular path. Once the telco line restores to normal, Telguard checks the radio link and switches back to the telco path after any communications on the radio link are completed.

LFC is programmable to trip the supervisory relay output (STC) after a 30 or 60 second delay. When the STC trips, the STC LED indicates 3 flashes at a time and the C/C zone trip message is transmitted to the alarm company central station indicating system trouble. Upon telco restoral, the STC relay and LFC LED are returned to normal and a STC restoral message is transmitted if the C/C is programmed to transmit restorals.

#### ***2.3.1.1 PBX Installations***

PBX's and other proprietary phone systems sometimes operate at lower voltages than the standard telco line. Telguard works equally well on PBX lines or telco lines.

**Note:** PBX connections are not allowed in any UL Listed installations.

### ***2.3.2 Telco Communications Failure Condition (CFC)***

Telco communications failure condition (CFC) is declared when the C/C fails to deliver the alarm message to the central station receiver after a selected number (1-5) of attempts over an operative telco line. Immediately upon CFC, Telguard switches to cellular mode and allows the C/C to attempt five transmissions over the cellular network. If the call is not acknowledged after the fifth attempt, Telguard switches the C/C back to telco and "disarms" the CFC detection. The CFC detection is re-armed when the C/C has been on-hook continuously for ten-minutes.

### ***2.3.3 No Service Condition (NSC)***

Telguard declares a no service condition (NSC) when the measured "receive" cellular radio signal strength at the protected premises drops to -114 dBm or less.

NSC is programmable to trip the supervisory relay output (STC) after a 30 or 60 second delay. When the STC trips, the STC LED indicates 4 flashes at a time and the C/C zone trip message is transmitted to the central station indicating system trouble. Restoral of this condition occurs

when a measurable signal strength greater than -114 dBm is maintained for the trip period of 30 or 60 seconds.

### **2.3.4 Radio Communications Failure Condition (RFC)**

Radio communications failure condition (RFC) is declared when Telguard is unable to transmit over the cellular network even with acceptable signal strength. Two conditions can cause an RFC to occur, Link Request failure (RFC1) or Link Termination failure (RFC2).

#### **2.3.4.1 RFC1 (Link Request Failure)**

When a LFC or CFC has been declared and there is an alarm signal to communicate, the Telguard attempts to transmit its message via radio. When the C/C goes off-hook, the Telguard transmits a Link Request to the TCC and waits for a Link Request ACK. If the Telguard does not receive an ACK for the transmission before the C/C hangs up, it will retransmit the Link Request again when the C/C goes off-hook for a redial attempt.

If the Telguard does not receive an ACK after three attempts, then an RFC will be declared which trips the STC relay, causes the STC LED to flash five times and switches the Telguard to Telco. Restoral of RFC occurs when the communication cycle is completed.

#### **2.3.4.2 RFC2 (Link Termination Failure)**

After the Telguard receives a Link Request ACK from the TCC, the Telguard communicates with the C/C to acquire the alarm message and transmits the message via radio. If the Telguard does not receive a link termination ACK (where the TCC acknowledges receiving the transmission) within 150 seconds, it will retry sending the entire transmission. Upon failing two attempts, the Telguard switches to Telco and allows the C/C to communicate directly with the Central Station. An RFC is declared causing the STC relay to trip and the STC LED to flash five times. Restoral of RFC occurs when the communication cycle is completed.

## **2.4 COMPLETE POWER SUPERVISION**

Telguard monitors its backup battery as well as its AC power source and reports low or missing power conditions from either. Telguard's integrated control and power module, protected by a 3 amp 3AG fuse, incorporates battery charger circuitry that is jumper selectable for high or low battery capacities. The high battery capacity selection is used for 12V 7Ah, or 12V 21Ah batteries.

### **2.4.1 Low/Missing Battery Condition (LBC)**

The Telguard checks the backup battery voltage on initial power-up and every minute thereafter. Additionally, a battery voltage test is performed by the Telguard every 24-hours while operating on AC power in order to measure the loaded battery voltage. Battery charging voltage is lowered to 10.0 volts and the Telguard is forced to operate entirely from the battery supply. If the battery voltage is less than 11.6 volts, a LBC is declared whereby the STC LED blinks twice (½ sec ON, ½ sec OFF, ½ sec ON, ½ sec OFF every 5 seconds) and the STC relay trips. When the battery voltage increases to 12.1 volts, the STC LED and STC relay restore.

### **2.4.2 AC Failure Condition (ACFC)**

AC failure condition (ACFC) occurs when AC power is lost or less than 102 VAC for 6 continuous hours. The AC Power LED goes out immediately, the STC LED blinks once and the STC trip output is activated after 6 hours. When AC power returns too normal ( $\geq 106$  VAC for 60 seconds), the AC Power LED turns on immediately and the STC trip output restores after 60 seconds.

### **2.4.3 Watchdog Monitor/Reset (WR)**

A watchdog monitor/reset (WR) circuit continuously monitors the Telguard's internal operating microprocessor functions.

### **2.4.4 Catastrophic Failure (CF)**

Catastrophic Failure (CF) is any condition that causes the Telguard to stop functioning at all levels. Most commonly because of AC power failure followed by a complete discharge of the

backup battery. The STC trip output is activated and visible indication is loss of all LED activity. Total loss of power to Telguard does not prevent transmission of alarm messages from the host C/C "through" the Telguard and out over an operative phone line in the normal fashion.

## **2.5 TELGUARD AUTOMATIC SELF-TEST REPORT**

The Telguard automatic self-test signal is originated by the Communication Center on a daily, weekly, or monthly schedule (note: UL Listed installations require a daily self-test). When the time for an automatic self-test occurs, the Communication Center transmits a radio signal to the Telguard and the Telguard responds with a self-test radio signal that is received by the Communication Center and processed on to the central station, just as normal alarm signals are processed. The central station receives the automatic self-test report in the same format that the C/C normally uses for communication over the telco line. The central station provides the Telguard self-test code along with the time and frequency of transmission when the Telguard is initially activated. However, an automatic self-test report can be initiated later, after the Telguard is installed, as well as modifying the time or frequency of reporting.

The Communication Center captures all current and historical data pertaining to the operation of the Telguard when it processes the automatic self-test signal on to the central station. This data contains current operational status (C.O.S.) of the Telguard such as "All OK", "AC fail condition", "low/missing battery condition", "line fault condition", or any combination of these as well as the current signal strength and mode of operation. In addition, the data also contains historical data for supervisory events that occurred since the last self-test signal was transmitted. This data includes the number of occurrences of AC fail conditions, low battery conditions, line fault conditions, communications failure conditions and no cellular service conditions. This self-test data is available for review at any time by authorized personnel such as installers, dealers, central station operators, or technical service personnel. Methods used to review this data include Telular's Interactive Voice Response System (IVR), Telular's computer access Communication Center Intranet System, or simply calling Telular Customer Service who can review the data using the "Back Office" program.

### ***2.5.1 Telguard Remote Query Capability***

Although Telguard has the capability for a daily, weekly, or monthly automatic self-test, a separate feature is provided for determining the current operational status of every Telguard. This feature is called Remote Query and is used to provide real-time operational status for Telguard on-demand. It is useful in resolving STC events that are reported by the C/C to the central station. Authorized personnel can initiate the Remote Query at any time by accessing the IVR, Intranet, or calling Customer Service. The Remote Query causes Telguard to upload current operational status data and historical data, just as the automatic self-test described above, except that the query signal is controlled by the one who initiates it. The query signal is held in the Telguard database at the Communication Center for review and is not forwarded on to the central station.

## **2.6 TELGUARD TERMINAL STRIP CONNECTIONS**

The conveniently located terminal strip provides wiring connections for the Telguard supervisory trip output (STC-pins 1&2, N.O.), battery leads for connecting to a 12 volt 7.0Ah, or 21.0AH rechargeable battery (BAT-pin 3 neg., pin 4 pos.), and AC power (16.5VAC 40VA, pins 6&7). If using a 12V 0.8Ah battery, a separate plug (J6) is provided that is located next to the terminal strip. The removable terminal strip can accommodate solid or stranded wire sizes from 14 gauge to 30 gauge.

### ***2.6.1 Programmable Supervisory Trip Output (STC) Relay***

The Telguard has one supervisory relay trip output (STC), a single pole single throw (SPST, form C) with contacts rated at 1.0A 30VDC, and is energized normally open (N.O.) in a powered up state when no system troubles exist. It enables a supervisory trouble code (zone shorted) to be transmitted to the central station when connected to a C/C's 24-hour instant input zone. The STC relay is programmable, using a standard touch-tone telephone or buttset, to meet virtually any installation requirement.

The following supervisory features or combination of features are programmable to trip the STC relay in order to meet a variety of installation requirements:

- Always Off.
- Trips on *AC fail condition* (ACFC)
- Trips on *low or missing battery condition* (LBC).
- Trips on *line fault condition* (LFC).
- Trips on *no service condition* (NSC).
- Trips on *radio communication failure condition* (RFC).

**NOTE:** For UL installations, all the above features **must** be enabled.

The following system trouble features are embedded in the Telguard for tripping the STC relay and cannot be changed:

- Trips on *catastrophic failure* (CF) if all power is lost.
- Trips on *transmit-disable command* from the Communication Center. This radio command disables only the Telguard transmitter and would be used, for example, to shut down the Telguard due to a runaway dialer. The Telguard receiver function stays active so that a *transmit-enable command* can be received by radio to put the Telguard back into normal service.

## 2.7 DIAGNOSTIC AND STATUS LEDs

Four LEDs are provided as a useful aid during installation and give installers an immediate visual indication of system status. These LEDs include an *AC Power LED* indicator that is green when AC power is normal and off when AC power is low or missing. The red *STC LED* provides system trouble information for low/missing AC power-ACFC (1 flash), low/missing battery-LBC (2 flashes), telco line fault-LFC (3 flashes), no cellular service-NSC (4 flashes), radio communication failure-RFC (5 flashes) and loss of dial-tone voltage-DTF (6 flashes). An *Operating Mode LED* indicates solid yellow for normal operating mode or slow flash for C/C off-hook when communicating over cellular. A short (1 second) solid green *Radio TX LED* indicates it is in a Microburst communication cycle. Separately, these LED's can be converted into a bar graph during installation to indicate radio signal strength by using a single jumper (J5) to select normal LED mode (off) or signal strength mode (on).

### 2.7.1 LED Signal Strength Indication

The Telguard provides the installer with an easy to use LED radio signal strength indicator (RSSI) for positioning the unit or remote antenna to obtain the strongest RF signal possible. A signal strength reading can be obtained at any time there is power applied to the Telguard without affecting the operation of the unit. When the **RSSI** jumper J5 is "IN", the Telguard displays the current received signal strength within 5 seconds and should the jumper be inadvertently left "IN"; the Telguard will revert to normal display operation after 10 minutes. The signal strength is read from bottom to top using the four sequential LEDs located on the top right side of the printed circuit board with the **Radio TX LED = 1** and the **AC POWER LED = 4**.

RSSI Value	LED's Lighted	RF dBm
NO SVC	LED 1* = on, LED 2-4 = off	≤ -116 dBm
0	LED 1 = on, LED 2-4 = off	≤ -111 dBm
1	LED 1 = on, LED 2 = slow flash LED 3-4 = off	≥ -110 dBm
2	LED 1-2 = on, LED 3-4 = off	≥ -100 dBm
3	LED 1-2 = on, LED 3 = slow flash LED 4 = off	≥ -90 dBm ( <b>Minimum signal strength required</b> )
4	LED 1-3 = on, LED 4 = off	≥ -80 dBm
5	LED 1-3 = on, LED 4 = slow flash	≥ -70 dBm
6	LED 1-4 = on	≥ -60 dBm
*Note: LED 1 = Radio TX; LED 2 = Mode; LED 3 = STC; LED 4 = AC Power.		

## 2.8 TELGUARD SETUP PROGRAMMING PARAMETERS

*The Telguard will not operate until the unit is activated from the Communication Center.* There are no radio NAM programming requirements since the radios have been preprogrammed at the factory. However, certain Telguard operating parameters may need to be changed from the factory default programming by the installer during installation in order to have the Communication Center process alarm signals to the central station. These are setup parameters and are used to tell the Communication Center how to encode alarm messages to the appropriate alarm monitoring station. Included in the setup parameters are the C/C reporting format and cellular operating system A or B. Also included are the STC supervisory trip input settings, CFC settings, NFC/LFC trip delay time, and standby battery size. If operating parameters are not uploaded to the Communication Center, a "missing parameters (MP) condition" exists and the Telguard will not operate. When an MP condition exists, the Telguard causes the STC LED to light and the STC (System Trouble) trip output to occur.

If default programming is correct or operating parameters are re-programmed into the Telguard, the installer calls the Telular IVR and follows the activation procedure to request an activation "ping". The Communication Center responds with a radio acknowledgement to the Telguard clearing the STC condition and allowing the Telguard to operate over the cellular radio network. The programmed parameters are transmitted automatically to the TCC when the Telguard is activated. The installer must perform any changes to the Telguard programming data since the Communication Center cannot download data to the unit.

## 2.9 UL LISTINGS BY MODEL

There is a Telguard model designed to meet UL requirements for virtually any residential and commercial burglary/fire installation. All models contain the same circuitry and perform the same functions. The difference between models is simply the type of enclosure and type of antenna that is shipped with the unit.

### 2.9.1 Model TG-200

Model TG-200 meets the requirements for Household Burglary, Household Fire, and Commercial Fire installations. TG-200 has a standard metal enclosure, keylock, and magnetic mount antenna with 12ft.cable. TG-200 is UL Listed for the following:

- ◆ **UL Household Burglary**
- ◆ **UL Household Fire**
- ◆ **UL Household Burg/Fire Combination**
- ◆ **UL Commercial Fire**

### 2.9.2 Model TG-300

Model TG-300 meets the requirements for all Household Burglary, Commercial Burglary, Household Fire, and Commercial Fire installations. TG-300 has an attack-resistant enclosure, keylock, tamper switch, and a magnetic mount antenna with 12ft.cable. Model TG-300 is UL Listed for the following and UL Listed for Grade A Burglary Certificate installations:

- ◆ **UL Household Burglary**
- ◆ **UL Household Fire**
- ◆ **UL Household Burg/Fire Combination**
- ◆ **UL Central Station Burglary**
  - Grade A
  - Grade B
- ◆ **UL Police Connect Burglary**
  - Grade A
- ◆ **UL Commercial Fire**
- ◆ **UL Commercial Fire and Central Station Burglary Grade A**
- ◆ **UL Bank, Safe and Vault**
  - Grade A

### 3.0 Request Telguard Activation for Cellular Service from Telular

There are two ways that you may activate cellular service for a Telguard. Both methods require the activation information to be completed and approved prior to installing the Telguard. The Telguard can only be activated when all the necessary accounting information has been entered into the customer database located at the Telular Communication Center. The database includes information about the customer account, unit location, and central station information.

1. **FAX Cellular Service Activation Form**: Complete the Cellular Service Activation Form that is shipped with each Telguard and fax it to Telular Customer Service, 678-945-1651. Within 24-hours, you will be notified of service activation.
2. **Computer access via Telular's Intranet**: Dealers may access their Telguard customer database via Telular's Intranet. The pertinent customer account information and serial number can be completed and submitted on-line. After an approval acknowledgement is issued, usually within 10-minutes, the Telguard is ready to install.

#### 3.1 GETTING READY

Before attempting to connect Telguard to the host C/C, please note the following:

1. Be sure your unit has cellular service activated. (See Section 3.0)
2. Be sure you have all the proper parts before you go to the job site. The following items are shipped with each Telguard unit:

- ✓ Basic Telguard unit (Model TG-200 in standard metal enclosure, or Model TG-300 in attack enclosure with tamper switch).
- ✓ 16.5 VAC, 40 VA UL Listed plug-in transformer (Revere, P/N: RT-1640).  
**Note: The 40 VA transformer is required for proper operation since the Telguard is capable of transmitting at 3 watts of output power. Do not use the C/C power transformer to provide AC power to the Telguard.**
- ✓ Antenna: Magnetic-mount 3dB-gain antenna with 12ft. cable for TG-200 or TG-300.
- ✓ 3-foot modular plug-to-plug cord for connecting Telguard to RJ31X jack.
- ✓ Telguard Installation and Operating Instructions Manual, P/N: 56018802
- ✓ Account Activation and Programming form documenting the unit's electronic serial number, cellular telephone number, etc.

**NOTE**: Backup batteries are not supplied with any models. You must source backup batteries separately. The TG-200 and TG-300 have flying leads with terminals for convenient plug-in connections to the larger capacity batteries.

All Telguard Models	Approx. Standby Time	12V. Battery Capacity	Manufacturer/model
TG-200/TG-300	35-Hours	7.0 Ah	Technacell EP 1270
	72-Hours	21.0 Ah (3 ea. 7.0 Ah)	Technacell EP 1270

3. You must also have certain installation test tools.
  - A standard telephone or lineman's buttset is required at the job site for use in programming the unit.
  - Optimal signal strength is determined by placing the unit where the most LEDs (up to four) are lighted when using Telguard's on-board Signal Strength Indicator feature so that the unit can be easily placed during installation where signal strength is greatest.

**NOTE**: Your unit may be subject to airtime charges for unintended use. Telular offers several cellular service rate plans. Check the Activation and Programming form that was shipped with your unit or call us to determine what rate plan each unit is operating under.

### 4.0 INSTALLATION SUMMARY

There are five steps in installing Telguard properly. **IF YOU DO NOT PROCEED IN THE ORDER AND MANNER PRESCRIBED, YOU MAY NOT COMPLETE THE INSTALLATION IN THE TIME ALLOCATED.** These five steps are summarized below and then explained in detail in the remainder of this manual.

#### **4.1 TRANSMIT C/C ALARMS OVER THE TELCO CONNECTION**

First, make sure you can transmit alarm signals from the C/C host to the central monitoring station **over the telco line without any connection to Telguard.**

#### **4.2 PROGRAM TELGUARD AND CONFIRM COMMUNICATIONS INTEGRITY**

Next, you will be confirming that Telguard's programming parameters are correctly entered into the unit and cellular service is activated. **This is the most important step in the installation, since the programming parameters contain all the necessary information for successful communications.** Also, you will confirm that Telguard has adequate cellular signal strength.

#### **4.3 TRANSMIT C/C ALARMS OVER THE CELLULAR RADIO NETWORK**

Next, you will be connecting the C/C's digital dialer output to Telguard and verifying that alarm signals can be reliably sent through Telguard over cellular to the central station digital receiver. The incoming Telco line is not connected to Telguard during this step.

#### **4.4 CONNECT TELCO LINE AND SUPERVISORY TRIP OUTPUT**

Once alarms are being successfully transmitted over cellular by the C/C, you will be ready to connect Telguard to the incoming phone line at the RJ31X and check that it properly switches to and from cellular upon telco restoral and telco line fault. Telguard's supervisory trip output (normally open) is connected to a 24-hour zone of the C/C and then tested.

**When backing up the host C/C's phone line, Telguard must be the first device on the incoming phone line in order to prevent Telguard from going into Telco Line Fault Condition when a phone device in front of it goes off-hook. This is the step where this is checked.**

#### **4.5 COMPLETE THE INSTALLATION**

Your last step will be to check the jumper setting of J5 (LED mode, out = normal), J7 (battery capacity selection- Jumper across pins 2 and 3 for 7Ah or 21 Ah batteries), attach earth ground, and permanently mount the unit.

\* \* \* \*

With this overview of the installation in mind, you should now proceed with the actual installation, following the steps described in the remainder of this manual. Experienced installers following these steps can usually install Telguard in new installations with good signal strength in a maximum of 30 minutes and in retrofit/existing installations in a maximum of one hour. However, you must first get the host C/C working correctly when transmitting over the incoming telco line.

If you come to a road block at any step during the installation of Telguard, call Telular Technical Support Department immediately before going on to the next step, so that we can help you complete each step in the proper order.

### **5.0 INSTALLATION STEPS**

This five-step installation approach (5.1 through 5.5) provides the alarm installer with the easiest and fastest method of properly installing Telguard. Please follow the instructions carefully and if you should need assistance or have any questions, call for

**TECHNICAL SUPPORT: 1-800-229-2326 / 678-945-7770    FAX: 678-945-1651**

**TELULAR IVR (Interactive Voice Response): 678-945-0228 (Local-Area: Atlanta, Ga.)  
1-888-TELULAR (Toll-Free: 1-888-835-8527)**

**TELULAR INTRANET (Computer Dial-up Connection): 678-945-1993**



### 5.1 STEP 1: TRANSMIT C/C ALARMS OVER THE TELCO CONNECTION

Be sure the C/C is powered up and programmed so that it will transmit a simple alarm signal over the telco line through the RJ31X to the central station when not connected to the Telguard. In checking this, do not connect the host C/C or incoming telco line to the Telguard.

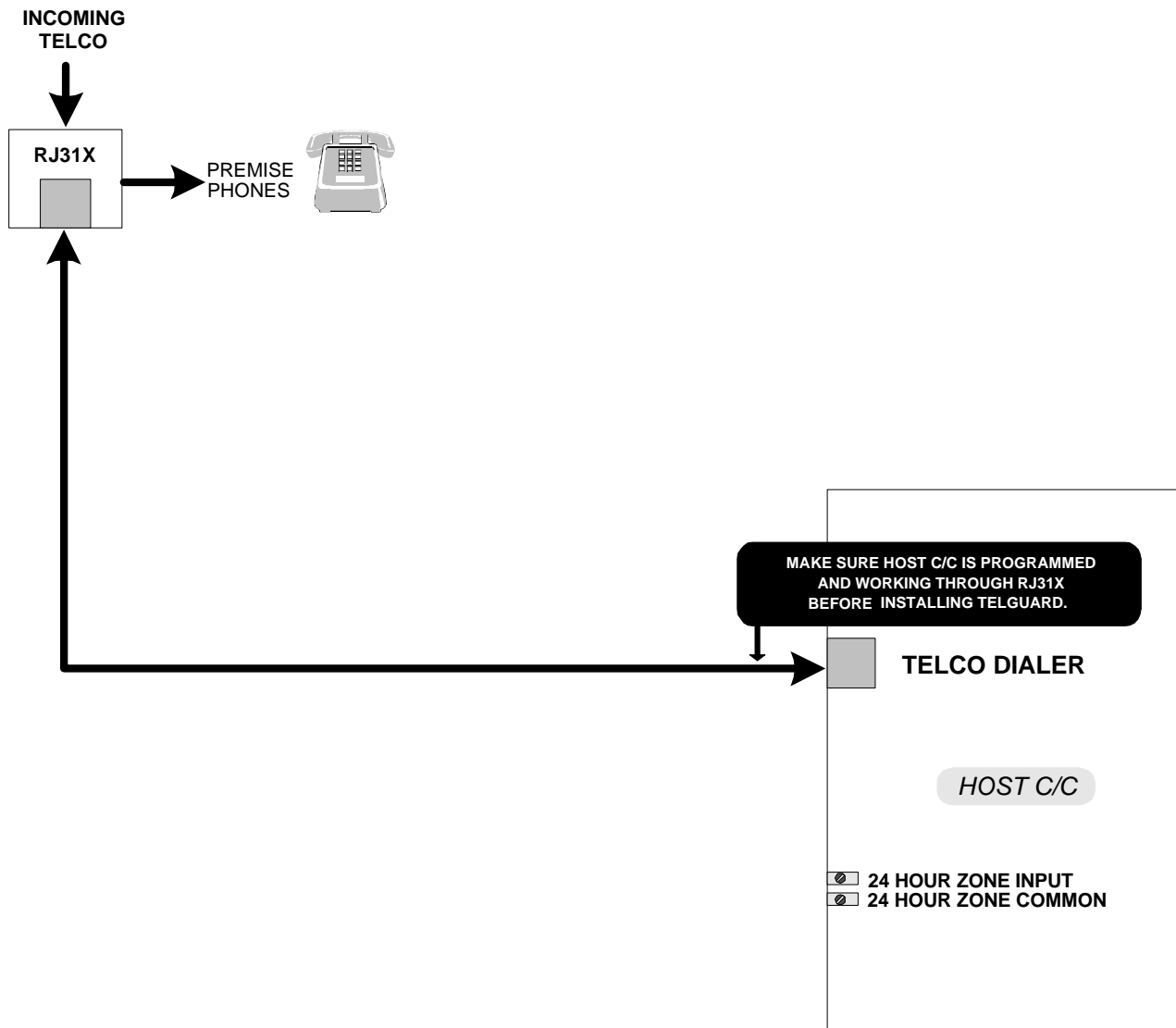

TG2 Step 1.VSD

## 5.2 STEP 2: PROGRAM TELGUARD AND CONFIRM COMMUNICATIONS INTEGRITY

Confirm that Telguard's programming parameters are correctly entered into the unit, cellular service is activated, and Telguard has adequate cellular signal-strength. **This is the most important step in the installation, since the programming parameters contain all the necessary information for successful communications and good signal-strength insures performance reliability.**

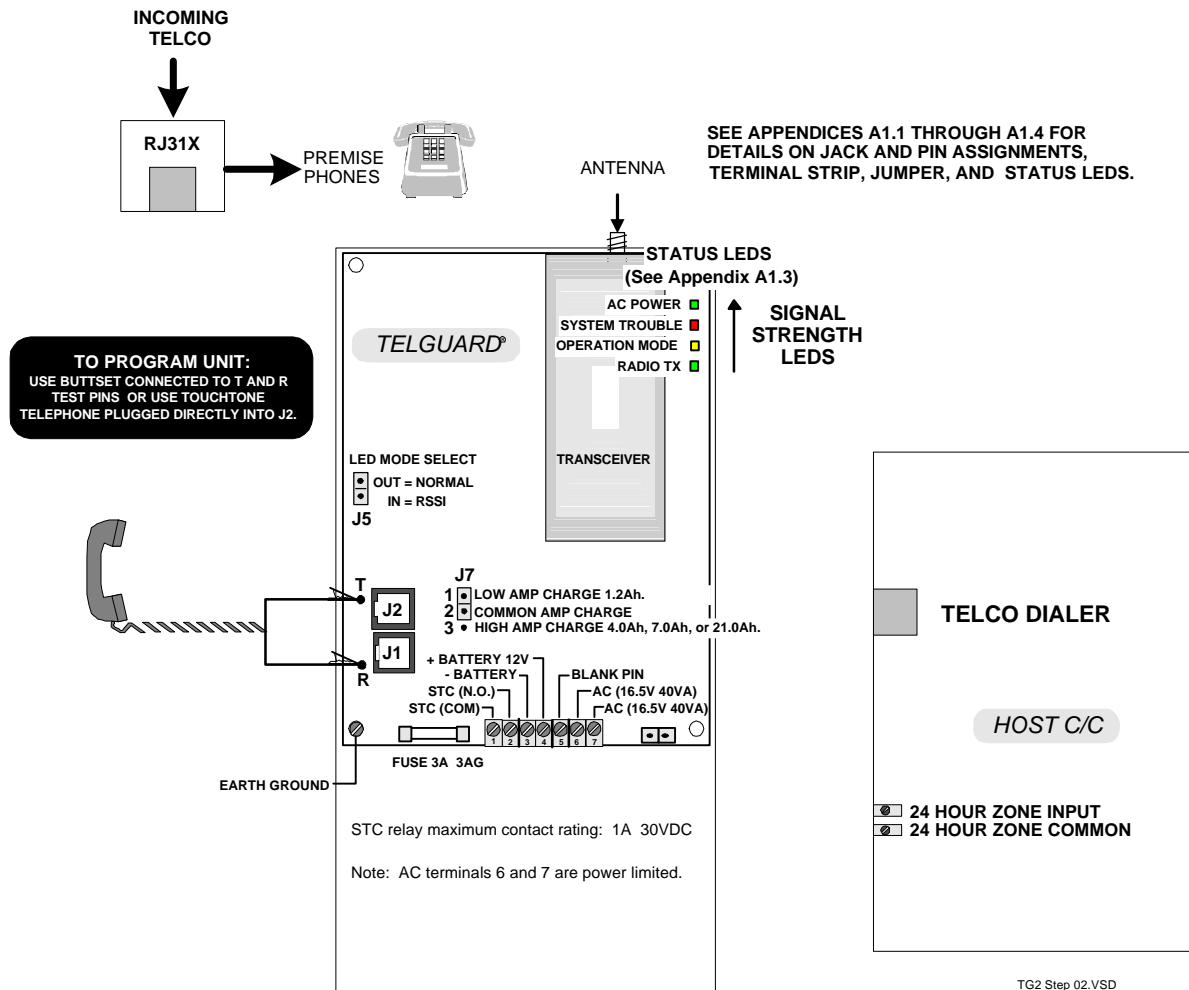

### 5.2.1 Locate Unit

Pick a spot next to the C/C where you think the Telguard will be mounted and place the unit down temporarily in that spot. **Do not mount it permanently now**, since it may need to be moved to receive a better cellular radio signal or a remote high-gain antenna may be necessary.

### 5.2.2 Connect Backup Battery and AC Power Transformer

To apply power on models TG-200 or TG-300 attach battery leads to terminals **3 (-)** and **4 (+)** noting polarity and set Jumper J7 for the proper battery capacity.

Use this default setting for  
1.2Ah batteries.  
Jumper across pins 1 & 2.

Use this setting for 7.0Ah, or  
21.0Ah batteries.  
Jumper across pins 2 & 3.

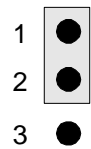

**J7**

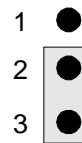

**J7**

Connect the Telguard AC power transformer to terminals **6** and **7** marked "AC 16.5V 40VA" using stranded copper insulated wire following wire gauge and length recommendations below:

<u>Recommended Wire Size</u>	<u>Length Not to Exceed</u>
18 ga	20 ft
16 ga	40 ft
14 ga	60 ft

### 5.2.3 Decide on a STC Trip Output Strategy

The Telguard provides the host C/C with one supervisory trip output for reporting a Telguard system trouble code to the central station. The supervisory trip output (terminals 1 & 2, N.O.) is programmable via a touch-tone telephone or buttset to suit various installation requirements. The programming options for this supervisory trip output can be any combination of the following (except Always off):

- Always Off:** Disables all relay supervisory functions with relay in N.C. condition.
- ACFC:** Trips 6-hours after loss of AC power. Restores 60 seconds after AC power is restored.
- LBC:** Trips within 60 seconds on low battery condition. Restores when battery voltage  $\geq 12.1$  vdc.
- LFC:** Trips 30/60-sec. on Telco line fault condition. Restores 30/60 seconds after Telco line restores.
- NSC:** Trips 30/60-sec. on no service condition due to loss of RF signal strength. Restores 30/60 seconds after RF signal strength is available.
- RFC:** Trips on radio failure to communicate with the Telular Communication Center due to either of the following:
  - Failing to receive a Link Request acknowledgement from the Communication Center after 3 Link Request transmissions. A Link Request transmission is generated each time the C/C goes off-hook to dial when the Telguard is in radio mode. The Link Request acknowledgement from the Communication Center allows the Telguard to begin accepting and transmitting alarm data from the C/C.
  - Failing to receive a Link Termination acknowledgement from the Communication Center after 2 complete transmission retries. A Link Termination acknowledgement is generated by the Communication Center only when all messages in an alarm transmission have been received successfully.

Refer to Appendix A3.3.1 for UL supervisory requirements for Listed burglary configurations and Appendix A3.5.1 for Listed fire configurations.

### 5.2.4 Default Programming

The Telguard default setup is pre-programmed at the factory. Default setup values are listed in **Section 5.2.5 (Telguard Programming Data Sheet)** and highlighted in "bold" type. Setup parameters are stored in non-volatile memory and retain their settings when power is removed from the unit. Review the default settings and record on the data sheet all changes that you make. Typically, the only critical programming entries are:

Memory Location	Field
32 *	Cellular System A or B
33 **	Enter the 1-digit C/C Reporting Format

\* **Note:** The Cellular carrier is factory defaulted to the "B" carrier. If the cellular carrier in your area providing Microburst™ service is an "A" carrier, then memory location 32 must be reprogrammed to 1. (Refer to the following Telguard Programming Data Sheet, location 32).

\*\***Note:** The C/C Reporting Format is already factory defaulted to Ademco Contact ID. Refer to Telguard Programming Data Sheet, location 33.

### 5.2.5 Complete the Telguard Programming Data Sheet

Fill out the following **Telguard Programming Data Sheet**. The completed data sheet enables you to properly install and test the Telguard as well as provide a valuable aid to future troubleshooting if it becomes necessary. Detach and retain this data sheet in your customer account file for future reference.

<b>Customer Name:</b>	<b>Dealer No:</b>	<b>Telguard Serial No:</b>
<b>Installation Location:</b>	<b>Date Installed:</b>	<b>Installed By:</b>

MEM LOC.	FIELD	DEFAULT VALUE	NEW PROGRAM VALUE	SETTING
<b>32</b>	Cellular System A or B	<b>2</b>		1=System A <b>2=System B</b>
<b>33</b>	C/C Reporting Format	<b>8</b>		1=4 x 2 Pulse 40 PPS    2300 Ack (Double Round) Non-Extended 2=4 x 2 Pulse 20 PPS    2300 Ack (Double Round) Non-Extended 3=4 x 2 Pulse 20 PPS    1400 Ack (Double Round) Non-Extended 4=3 x 1 Pulse 40 PPS    2300 Ack (Double Round) Non-Extended 5=3 x 1 Pulse 20 PPS    2300 Ack (Double Round) Non-Extended 6=3 x 1 Pulse 10 PPS    1400 Ack (Double Round) Non-Extended 7=Not Used <b>8=Contact ID (Ademco) 1400/2300 Ack</b>
<b>51</b>	STC Trip Output Reporting	<b>31</b>		Enter the <b>SUM TOTAL</b> of the events that you wish to trip the STC relay by <b>ADDING</b> the corresponding values: (ex: 01+02+08+16=27) Note that a LFC will not trip the STC relay. Program 31 (27+04) for all supervised features to trip the STC relay. 00 = STC Trip Input Not Used <b>01 = AC Failure    04 = LFC    16 = RFC</b> <b>02 = Low Battery    08 = NSC</b>
<b>52</b>	STC Trip Delay for LFC and NSC	<b>2</b>		1=30 Seconds <b>2=60 Seconds</b>
<b>61</b>	CFC Number of Attempts	<b>2</b>		<b>0=Disabled</b> 2=4 Attempts 1=2 Attempts    3=8 Attempts
<b>62</b>	CFC Between Events	<b>1</b>		<b>1=30 Seconds</b> 2=60 Seconds
<b>67</b>	Standby Battery Size (standard lead-acid battery)	<b>4</b>		<b>4=7 Amp Hour</b> 5=21 Amp Hour
<b>99</b>	Factory Default Values	<b>12345</b>		Returns EEPROM to original factory settings.

### 5.2.6 Setup & Programming

When the Telguard is received from the factory and is powered up for the first time, it is immediately ready for activation after a 10-second delay, provided the default settings are what you want. The STC LED turns on steady and the STC relay is tripped. If changes to the default values are required, then the Telguard is re-programmed with a plain old telephone set (POTS) connected to J2 where the C/C is usually connected. A standard lineman's buttset (set to TALK and TONE modes) can also be used when connected to the tip (T) and ring (R) test pins on the printed circuit board (PCB) adjacent to J1 and J2. Put jumper J5 "IN" and power up the Telguard. The Telguard Programming Data Sheet explains the programming options and memory locations.

**NOTE:** *The telephone line input to J1 must be disconnected prior to programming and the antenna must be connected. The Telguard will transmit the programming setup data to the communication center automatically when you activate the Telguard using the Telular IVR.*

#### 5.2.6.1 Command Key Sequences For POTS Re-Programming

Key Sequence	Description
memorylocation, value	Selects memory-location and stores data.
*	Exits and stores programming.

The syntax for programming a specific memory location is as follows:

#### **Memorylocation (2 digits), value.**

For example, to re-program the Telguard to transmit over the "A" carrier, the installer would power down the Telguard; put jumper J5 "IN", connect the buttset to T and R test pins, and then power up the unit. After approximately 10 seconds, four tones will be sounded on the buttset indicating entry into programming mode. After entering **32**, two tones will be sounded on the buttset indicating entry into a valid memory location (in this case, location 32). After the digit **1** is entered, four tones will be sounded on the buttset indicating a valid entry has been selected. If an invalid memory location or data value is entered, a long low tone will be sounded before the normal tones. **To re-enter a correct value, the memory location must be entered again and then a correct value for that memory location.**

**NOTE:** **To reset Telguard programming to factory default values, program memory location 99 with 12345 and the Telguard will reload factory default data to the EEPROM (This takes about 10 seconds!). The Telguard will now be ready to activate with factory default values or to re-program again, just as it was received from the factory.**

To exit programming mode, press \*. Two tones will be sounded on the buttset. Remove jumper J5 and disconnect the buttset. The Telguard does not need to power down and back up again unless you changed from B to A carrier or from A to B carrier. The red STC LED will remain on and the STC relay will remain tripped. Call the Telular IVR (888-TELULAR) and follow the "new activation or re-programming" menu. When the Telguard transmits the setup programming information to the Communication Center successfully, the red STC LED will begin flashing a Telco line fault trouble (LFC=3 flashes), the yellow Mode LED will turn on, and the AC power LED will turn on if AC is connected. This indicates the unit is in normal operating mode and is ready to transmit alarm signals.

### 5.2.7 Connect Antenna and Temporarily Place Unit

Pick a high, visually secure spot, using the guidelines below.

#### 5.2.7.1 Tips for Improved Radio Signal Reception

- The higher the antenna the better. So, start in the drop ceiling above the unit and proceed up from there, to the roof if necessary.
- Remember, the antenna should be as inconspicuous as possible for greatest visual security. If on the roof, plan to place the antenna in PVC tubing or in a custom wooden structure.
- Try to keep the antenna away from sources of RF interference, including pumps, compressors, ovens, etc., or where metal objects can shield it or otherwise block the cellular radio RF signal.
- Place the antenna perpendicular to the ground, either right side up or upside down. Do not mount the antenna horizontally.

### 5.2.8 Measure Received Signal Strength (RSSI) for Best Antenna Placement

Measure the received signal strength by putting jumper J5 "IN". This switches the LEDs to signal strength mode. Now, slowly move the unit or remote antenna to achieve maximum signal strength. Pick the place where the most LEDs (up to four) are lighted. The LEDs are located on the top-right side of the PCB and are read from bottom to top with the *Radio TX LED = 1* and the *AC Power LED = 4*. **At least two lighted LEDs with the third LED flashing are necessary to assure continuous, trouble free operation.** Move antenna slowly and check often. Only a few inches can make a great difference in signal strength.

**LED Function Table –View RSSI Mode**

RSSI Value	LED's Lighted	RF dBm
NO SVC	LED 1* = on, 2-4 = off	≤ -116 dBm
0	LED 1 = on, 2-4 = off	≤ -111 dBm
1	LED 1 = on, 2 = slow flash LED 3-4 = off	≥ -110 dBm
2	LED 1-2 = on, LED 3-4 = off	≥ -100 dBm
<b>3</b>	<b>LED 1-2 =ON, 3 =SLOW FLASH LED 4 = off</b>	<b>≥ -90 dBm (Minimum signal strength required)</b>
4	LED 1-3 = on, LED 4 = off	≥ -80 dBm
5	LED 1-3 = on , 4 = slow flash	≥ -70 dBm
6	LED 1-4 = on	≥ -60 dBm

**\*Note: LED 1 = Radio TX; LED 2 = Mode; LED 3 = STC; LED 4 = AC Power.**

**NOTE:** If you can not obtain a signal strength reading of TWO LEDS ON SOLID AND THE THIRD LED ON SLOW FLASH, you will probably need to move the unit and/or remote antenna higher, or switch to a special antenna, as described below.

#### 5.2.8.1 Antenna Options

Antenna problems are unlikely unless the premises are located in a fringe network coverage area, in a building below ground level, or in a metal structure. However, here are your options:

**Magnetic Mount 3-dB gain Antenna with 12ft. Cable:** The magnetic mount antenna comes with 12 feet of cable (Telular P/N: MMA-1).

**Magnetic Mount Antenna with Longer Cable:** If the MMA-1 does not have enough cable to allow for optimal antenna location, longer cables can be special ordered from Telular. These come in 35-foot (Telular P/N MMA-35M) and 50-foot lengths (Telular P/N MMA-50M), and include another antenna with the necessary connectors. It is not possible to splice cable to the existing antenna in the field. The extension cable is a special, low loss type.

**High Gain Antennas (Directional):** High Gain Antennas (HGA's) are also available from Telular. These boost signal strength (9-dB gain) by concentrating power in a single direction, toward the nearest cellular tower. HGA's come with 35 feet (Telular P/N HGA-35M) or 50 feet (Telular P/N HGA-50M) of cable.

**NOTE:** After determining the best signal strength location for the antenna, set the RSSI jumper J5 "OUT" to return to normal operating mode. If the "RSSI" jumper is inadvertently left "IN", Telguard will automatically cancel the RSSI LED mode after 10 minutes and return the LEDs to normal operation. During the 10-minute interval, Telguard will still operate normally.

### **5.2.9 Request Telguard Activation "PING" from Telular's IVR**

When you are ready to install and test the Telguard, call Telular's IVR (Interactive Voice Response) number, 1-888-TELULAR (1-888-835-8527). The automated system will ask you for the following information: (*All information must be supplied correctly*)

**Reminder!!!** The Activation form must be faxed to the Telular Communication Center (fax: 678-945-1651) and entered into the database before this step can occur.

- a) Dealer number?
- b) Tech number?
- c) Telguard Serial Number? Or, Confirmation Number if the Serial Number has not been previously submitted on the Activation Form.
- d) New Telguard programming/reprogramming or Requesting Status Report? (Select the programming menu.)

After you have programmed the Telguard, entered the correct Dealer, Tech, Telguard Serial number (or Confirmation Number), and selected "yes" for new install or reprogram on the menu, a radio "activation ping" will be generated from the Communication Center to the Telguard. This activates the Telguard and allows the Telguard to communicate over the cellular network. A successful "ping" causes the red *STC* LED to turn off. Additionally, if the Telguard is programmed to monitor LFC, then the *STC* LED will begin to flash 3 times indicating a telco line fault condition since there is no telco line connected to J1 at this time. Also, the yellow Mode LED will turn on and if AC power is connected, the green AC power LED will turn on.

Now, combined with other data previously submitted with the activation information such as automatic self-test data, the communication center is able to process alarm signals from the host C/C to the alarm monitoring station.

**Note to Installers:** The Telguard must be powered-up with antenna connected in order to receive the "activation ping". Also, the Telular IVR system will allow you to enter a TEST menu to access the Telguard's operational history (e.g., number of occurrences of ACFC, LBC, LFC, and NSC since the last self-test transmission to the communication center). Only the Dealer number, Tech number, and serial number are required to enter the TEST menu if the unit has already been activated. This feature is extremely helpful when troubleshooting intermittent problems such as NSC or LFC.

### **MOVE ON**

Once you have completed the Telguard Programming Data Sheet, confirmed Telguard programming, received the "activation ping" from the Communication Center and have good signal-strength, move on to Step 3.

### 5.3 STEP 3: TRANSMIT C/C ALARMS OVER THE CELLULAR RADIO NETWORK

Confirm that the Telguard enables the host C/C to transmit alarm signals over the cellular radio network. In checking this, do not connect the incoming telco line to the Telguard or connect the supervisory trip output (STC) to the C/C zone input.

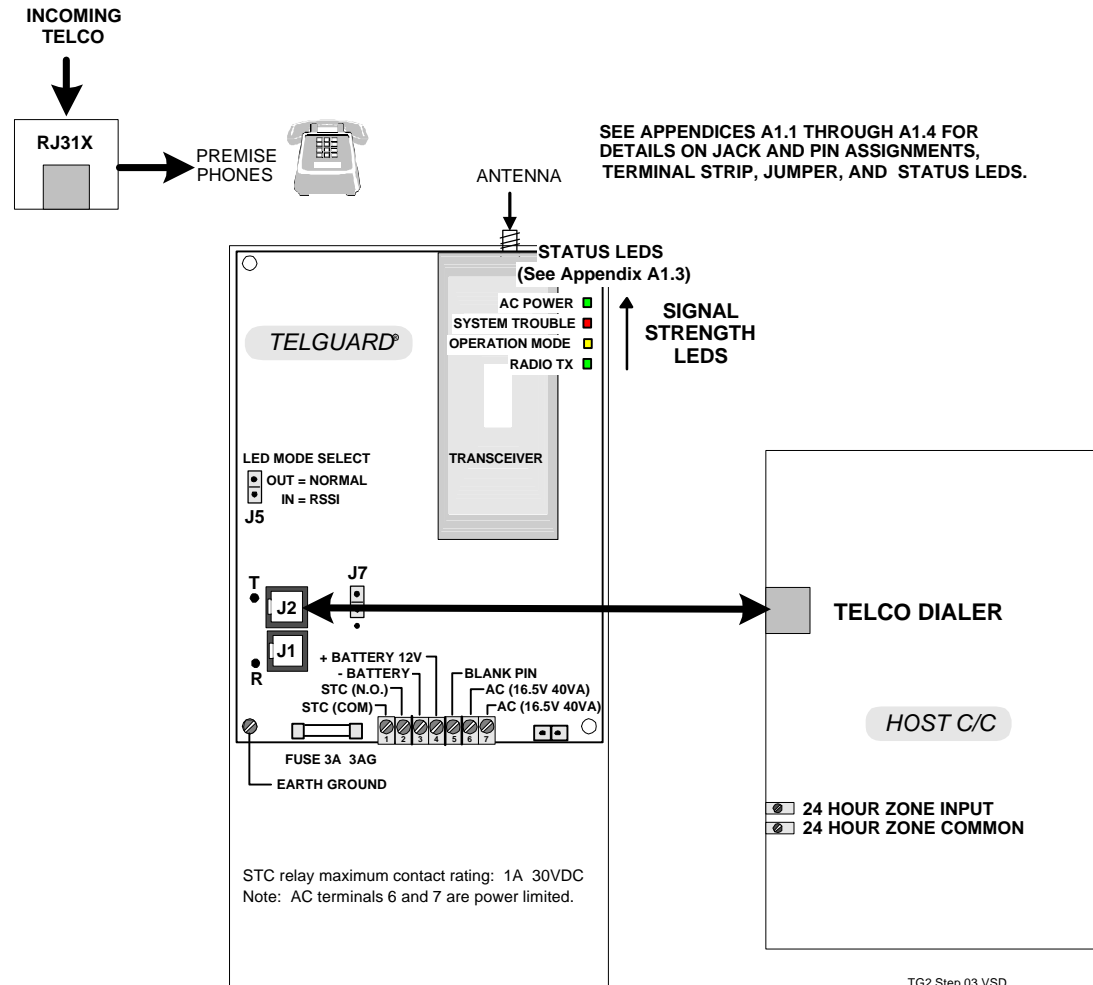

#### 5.3.1 Connect C/C to Telguard Jack 2

Unplug the modular jack of the C/C-to-RJ31X cable (not supplied) from the RJ31X and plug it into J2 on the Telguard.

**NOTE:** Since no RJ31X telco cable is connected to J1 at this point in the installation, the Telguard is detecting a telco line fault condition (LFC). The Telguard is forced to switch transmission paths from telco to cellular causing all C/C alarm signals to be transmitted over the cellular radio network during testing in this step.



### 5.3.2 Verify Alarm Signal Transmissions over Cellular

Trip several alarms on the C/C and verify that the central station received them by calling the central station operator. Use a lineman's buttset in **MONITOR MODE** and connected to Telguard's "T" and "R" test pins to "listen" to communications between the C/C and Telguard. The *Radio TX* LED flashes quickly when the Telguard microprocessor is communicating with the radio and provides a long flash (approximately 1 second) when the radio is in communication with the cellular network.

If you are having problems getting reliable alarm signal transmissions, additional adjustments may be necessary.

- ◆ Recheck signal strength. You need **TWO LEDS ON SOLID AND THE THIRD LED FLASHING** for adequate signal strength. Also, check antenna connector and make sure it is seated correctly.
- ◆ Try resetting the Telguard by powering the unit down then back up again.
- ◆ Call Telular Technical Service, 800-229-2326, and request the Communication Center operator to check the Telguard programming configuration for proper operation on "A" carrier or "B" carrier and *proper communications format*. The Telguard **MUST** be programmed to use the **SAME FORMAT** that the C/C is using (e.g. 3+1, 4+2, etc.,) to report alarm signals.

#### **MOVE ON**

Once you have determined that the C/C can reliably transmit alarm signals over the cellular network, proceed to Step 4.

## 5.4 STEP 4: CONNECT TELCO LINE AND SUPERVISORY TRIP OUTPUT

Now, you are ready to connect and test the incoming telco line and the supervisory trip output to the C/C. Also, you must check to be sure that *there are no other phone devices connected in front, or in parallel, of the RJ31X*.

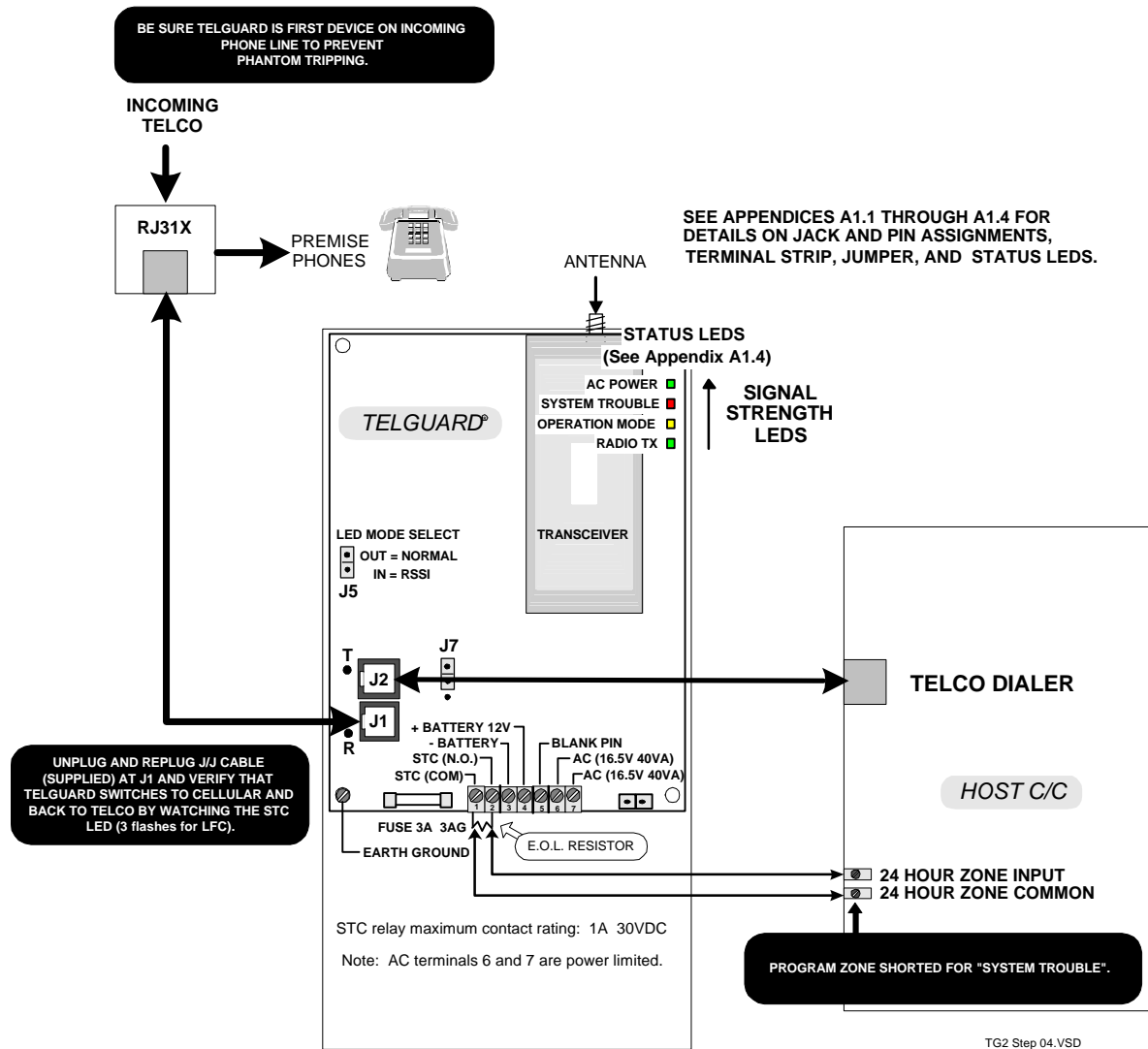

### 5.4.1 Be sure the Telguard is the first device on incoming phone line

The Telguard monitors voltage on the incoming phone line to decide when to switch transmission paths. This requires that the Telguard *must be the first device on the telco line*. If not, a line fault condition will be created (we call this a "phantom trip") each time the improperly connected device goes off-hook. This happens because the Telguard's line fault monitor detects the parallel "taps" to the street side of the RJ31X.

A phantom trip causes the Telguard to switch to cellular and if the STC trip-out is connected and programmed to trip the C/C, the C/C will call the central station over the cellular network to report the "Line Fault" (phantom trip). The result is a phone line trouble report although the incoming line measurements are good at the RJ31X. Therefore, look over **Exhibit I** (next page) carefully and be sure that there are no other phone devices connected to Tip and Ring on the incoming phone line.

**Exhibit 1. Telco Signal Path through Telguard**

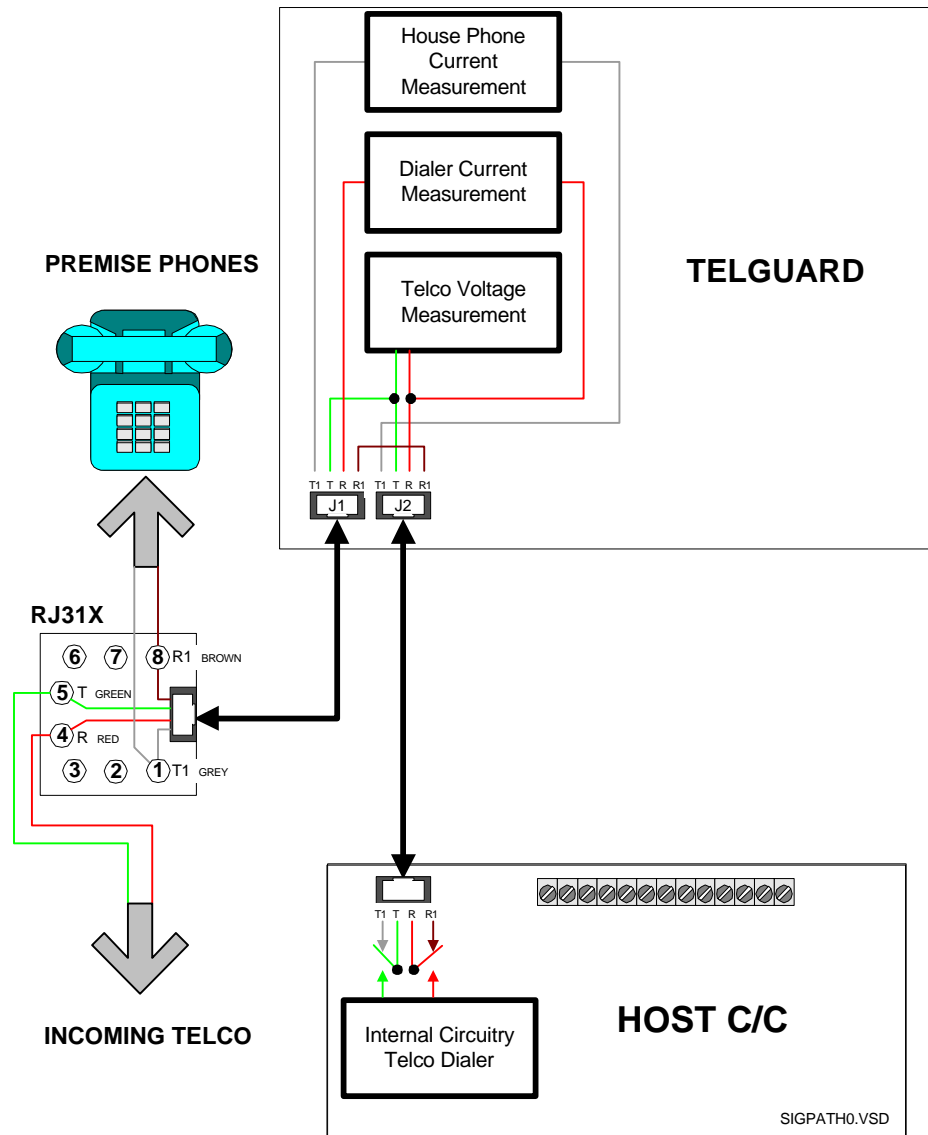

**5.4.2 Connect RJ31X to Telguard Jack 1 and Check LFC**

Find the modular Jack-to-Jack (J/J) cable supplied and connect one end to Telguard Jack 1 and other end to the RJ31X. Note that the STC LED goes out and the STC relay returns to normal due to telco line restoral.

**5.4.3 Connect STC Trip Output**

Connect the STC trip output (terminals 1 & 2, N.O.) to the 24-hour zone input of C/C.

**NOTE:** Activation of a local alarm or strobe light may be desirable when a trip is declared. The STC trip output can be used directly to activate a local signaling device, provided that the trip output is not needed to trip the host control/communicator at the same time. If both a local signal and a control trip input is required, then external relays are needed to provide additional uncommitted contacts.

#### 5.4.4 Check Telguard Supervisory Trip to C/C

After you have connected the STC trip output, check to be sure that it operates correctly.

##### 5.4.4.1 Reprogram C/C to Send Proper Code

Reprogram C/C to send proper alarm code when tripped by the Telguard's supervisory output. Program zone restoral as desired.

##### 5.4.4.2 Check Proper Operation of Telguard Supervisory Output

Check for proper operation of each programmed supervisory output by causing it to trip the C/C and be sure the proper LED illuminates and that the proper trouble code is reported to the central station. Skip the testing of any supervisory functions that have not been enabled. Note that the yellow mode LED starts to flash when the C/C goes off-hook to report the alarm signal over cellular. The yellow mode LED stays on solid when the C/C goes off-hook to report the alarm signal over Telco.

- **Low Battery Condition (LBC):** Disconnect the battery and during the next 60 seconds check to see that the STC LED flashes 2 times indicating that the battery is missing. Check to see that the C/C transmits the STC trouble code (over Telco) to the central station. Reconnect the battery and check during the next 60 seconds to see that the STC LED goes off, indicating the missing battery condition has been restored. If the C/C is programmed for transmitting restorals, another transmission will be sent (over Telco) to the central station.
- **Line Fault Condition (LFC):** Disconnect J/J cable at RJ31X. Check to see that the STC LED flashes 3 times in 30/60 seconds and the C/C transmits the STC trouble code (over radio) to the central station indicating the incoming telco line is disconnected. Reconnect J/J cable and check to see that the STC LED goes off in 30/60-seconds indicating telco line restoral. If the C/C is programmed for transmitting restorals, another transmission will be sent to the central station (over Telco) after the 30/60-second delay.
- **No Service Condition (NSC):** Disconnect the antenna from the Telguard. Check to see that the STC LED flashes 4 times in 30/60 seconds and the C/C transmits the STC trouble code over the telco line indicating loss of RF signal strength. Reconnect the antenna and check to see that the STC LED goes off in 30/60-seconds indicating RF signal strength restoral. If the C/C is programmed for transmitting restorals, another transmission will be sent to the central station (over Telco) after the 30/60-second delay.  
**Note:** The Received Signal Strength (RSSI) must be less than -114 dBm in order to cause a NSC condition. If the Telguard is located in a high signal strength area (close to a cellular tower), it is possible for the signal strength to be greater than -114 dBm even with the antenna disconnected.
- **AC Fail Condition (ACFC):** Disconnect the 40VA AC transformer and check to see that the AC POWER LED goes out and the STC LED flashes once indicating that AC power is missing. Reconnect the AC transformer and check to see that the AC POWER LED goes on and the STC LED goes off indicating that AC power has been restored. No transmissions will be sent to the central station. The AC power must be off, continuously, for 6-hours before the STC relay causes the C/C to send a trouble code. If the AC power is restored for 60 seconds or more, then the 6-hour timer restarts.

#### MOVE ON

When you are sure that the Telguard is monitoring the telco path and cellular path correctly and the C/C is correctly reporting the STC supervisory trip output, move on to Step 5.

## 5.5 STEP 5: COMPLETE THE TELGUARD INSTALLATION

Last step is to handle loose ends.

### 5.5.1 Check Settings

Check the jumper settings of J5 (LED mode, out = normal) and J7 (battery capacity selection).

### 5.5.2 Permanently Mount and Properly Ground the Telguard Chassis

Attach earth ground to the green grounding screw located on lower left-hand corner of printed circuit board assembly and permanently mount the Telguard chassis.

## A1.0 APPENDICES

A1.1	WIRING DIAGRAM.....	22
A1.2	JACK AND PIN ASSIGNMENTS .....	23
A1.3	TERMINAL STRIP PIN ASSIGNMENTS.....	24
A1.4	LED MODES AND FUNCTIONS .....	25
A1.5	JUMPERS .....	26
<b>A2.0</b>	<b>OPERATIONAL QUICK REFERENCE TABLE .....</b>	<b>27</b>
<b>A2.1</b>	<b>SETUP PROGRAMMING PARAMETERS .....</b>	<b>28</b>
<b>A2.2</b>	<b>TELGUARD COMMUNICATION FORMATS .....</b>	<b>29</b>
<b>A2.3</b>	<b>COMPATIBLE CONTROL COMMUNICATORS.....</b>	<b>29</b>
<b>A2.4</b>	<b>COMPATIBLE RECEIVERS.....</b>	<b>29</b>
<b>A2.5</b>	<b>ACTIVATION FORM .....</b>	<b>30</b>
<b>A3.0</b>	<b>COMPLIANCE FOR UL LISTED INSTALLATIONS .....</b>	<b>31</b>
A3.1	UL GRADE A CENTRAL STATION SERVICE.....	31
A3.2	UL GRADE A POLICE STATION CONNECT SERVICE.....	32
A3.3	NOTES TO INSTALLATION/WIRING REQUIREMENTS ON APPENDICES A3.1 AND A3.2.....	33
A3.3.1	<i>Supervisory Requirements for Listed Burglary Configurations</i> .....	34
A3.4	UL864/NFPA FIRE ALARM CENTRAL STATION SERVICE .....	35
A3.5	NOTES TO INSTALLATION/WIRING REQUIREMENTS ON APPENDIX A3.4.....	37
A3.5.1	<i>Supervisory Requirements for Listed Fire Configurations</i> .....	37
<b>A4.0</b>	<b>UL INSTALLATION REQUIREMENTS SUMMARY TABLE.....</b>	<b>38</b>
<b>A5.0</b>	<b>DETAILED SPECIFICATIONS.....</b>	<b>39</b>
A5.1	DIALER TO INTERFACE ELECTRONICS .....	39
A5.2	POWER .....	39
A5.3	RADIO .....	39
A5.4	PHYSICAL .....	39
A5.5	WARRANTY .....	39
<b>A6.0</b>	<b>PARTS LIST.....</b>	<b>40</b>
<b>INDEX.....</b>		<b>41</b>

## A1.1 WIRING DIAGRAM

**WARNING: HIGH VOLTAGE PRESENT ON PHONE LINES. DISCONNECT PRIOR TO SERVICING.**

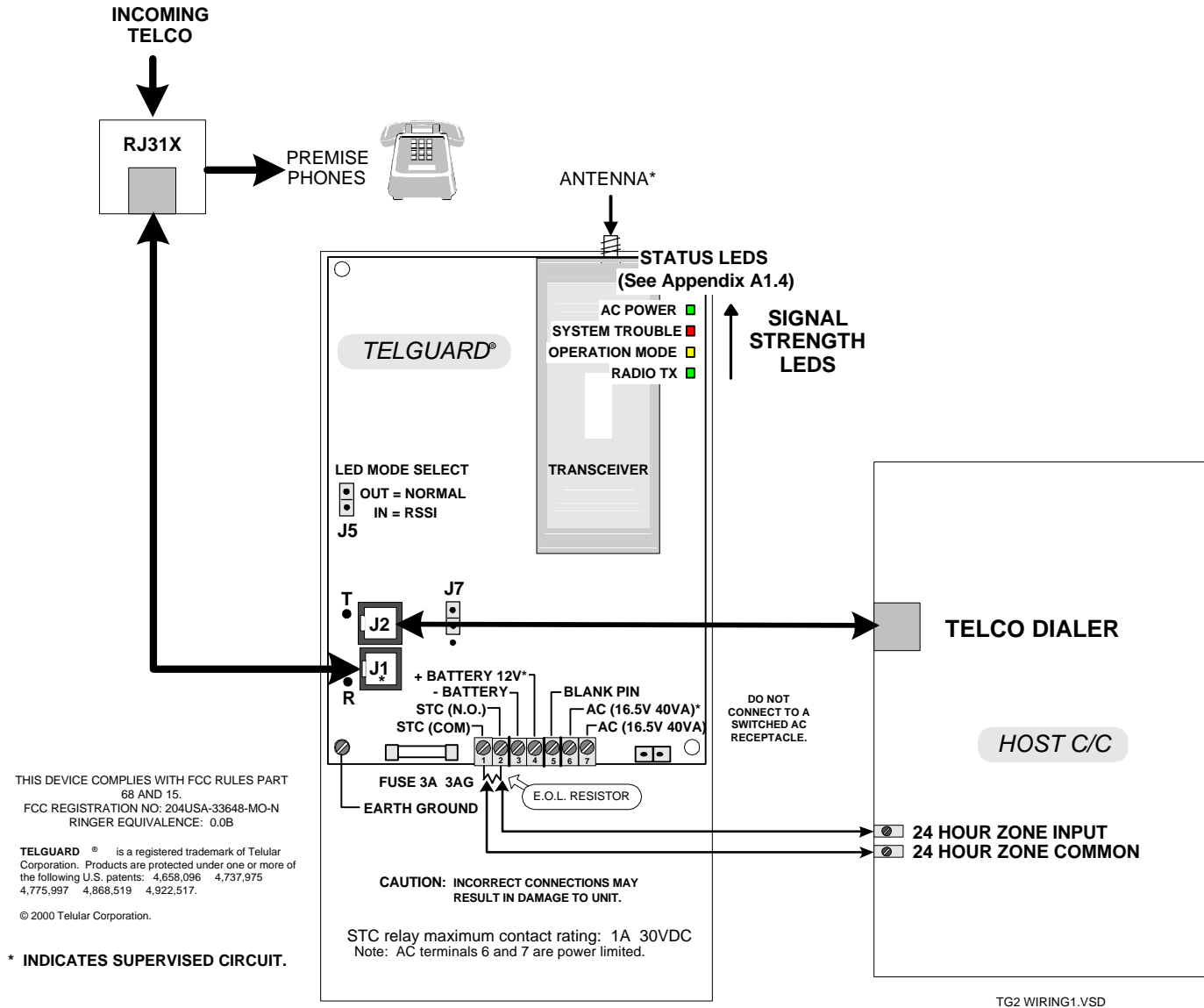

## A1.2 JACK AND PIN ASSIGNMENTS

Jack Designation	Connects To	Pin Assignment	Function	Status LED Reference
<b>J1</b> Telco RJ31X.	Incoming Telco RJ31X Jack.	1 Gray R1 4 Red R(Ring) 5 Green T(Tip) 8 Brown T1	Connects telco line to Telguard and provides output for premises phone connection at RJ31X.	<b>STC LED Flash 3 times</b> when telco voltage is lost.
<b>J2</b> C/C Digital Dialer	Digital Dialer input/output of host C/C.	1 Gray R1 4 Red R(Ring) 5 Green T(Tip) 8 Brown T1	Connects C/C digital dialer input/output through unit.	None.
<b>J4</b> Radio Interface.	Radio	1 VCC 2 SVC 3 GND 4 Rsvd 5 RXD 6 Rsvd 7 TXD 8 P-IN 9 RSSI 10 N/C 11 IN-A 12 IN-B 13 OUT-A 14 OUT-B	+12V DC supply input Service available flag Primary Ground Reserved Control serial data RX Reserved Control serial data TX Pulse Input Rx signal strength indication Pulse Ground Auxiliary input A Auxiliary input B Auxiliary output A Auxiliary output B	<b>STC LED Flash 4 times for NSC or Flash 5 times for RFC</b> when Radio is unable to communicate.  Or  <b>Radio Tx LED Fast Flash</b> when microprocessor is communicating with radio and <b>1 sec Flash</b> when Radio is transmitting over the cellular network.

### A1.3 TERMINAL STRIP PIN ASSIGNMENTS

Terminal Strip Pin	Definition	Connects To	Function	Status LED Reference
1 STC 2 STC	Supervisory Relay Trip output for programmable trouble conditions. (N.O.)	24-hour trip zone input on host C/C.	Enables transmission of programmed supervisory trouble code:  <ul style="list-style-type: none"> <li>◆ <b>AC Power Fail (ACFC).</b> - AC failure detected at 102 VAC.</li>   <li>◆ <b>Low/Missing Battery Condition (LBC)</b> due to: - Low Battery detected at 11.6 VDC.</li>   <li>◆ <b>Line Fault Condition (LFC)</b> due to: - Improper Telco voltage (LFC) ≤ 18 VDC.</li>   <li>◆ <b>No Service Condition (NSC)</b> due to: - Received Signal Strength ≤ -114 dBm.</li>   <li>◆ <b>Radio Communications Failure (RFC)</b> due to: - <i>RFC1</i>- Failure to receive Link Request Ack after 3 attempts.  <i>OR</i> - <i>RFC2</i>- Failure to receive Link Termination Ack after 2 attempts.</li>   <li>◆ <b>Loss of Telguard Dial Tone Voltage (DTF)</b> due to: Improper dial tone voltage. ≤ 35 VDC.</li> </ul>	When fault condition occurs:  <b>AC Power LED OFF</b> <b>STC LED Flashes 1 time.</b>  <b>STC LED Flashes 2 times.</b>  <b>STC LED Flashes 3 times.</b>  <b>STC LED Flashes 4 times.</b>  <b>STC LED Flashes 5 times.</b>  <b>STC LED Flashes 6 times.</b>
2 - BATT 3 + BATT (12 V)	Telguard Battery negative terminal.  Telguard Battery positive terminal.	Telguard backup battery	Provides 24 to 72 hour battery stand-by for Telguard depending on battery capacity provided.	<b>STC LED Flashes 2 times</b> when battery is low or missing.
5 BLANK	Not Used	N/A	Not Used	None
6 AC 7 AC	AC power input. 16.5 VAC 40 VA.	120 VAC 60Hz unswitched circuit.	Provides primary operational power to Telguard and battery charging circuit.	<b>AC Power LED ON</b> when AC is normal. <i>OR</i> <b>AC power LED OFF</b> <b>And</b> <b>STC LED Flashes 1 time</b> when AC is low or missing.



## A1.4 LED MODES AND FUNCTIONS

As shown below, J5 is a two-pin jumper used to select the LED Mode. Refer to the LED Function Tables for a description of each LED in "Normal Operating Mode" and "Received Signal Strength Mode".

### LED Mode Selection

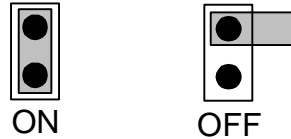

OFF = NORMAL MODE

ON = VIEW RSSI MODE OR ENTER PROGRAMMING MODE

**LED Function Table – Normal Operating Mode (J5 = OUT)**

LED Symbol	Color	Duty Cycle	Indication
AC POWER – LED 4	Green	Solid ON	AC Power is good
		OFF	AC Failure (<102 VAC, restores at 106 VAC)
STC - LED 3	RED	1 Flash*	System Trouble Condition – Low/Missing AC Power
		2 Flashes*	System Trouble Condition – Low/Missing Battery Condition
		3 Flashes*	System Trouble Condition – LFC
		4 Flashes*	System Trouble Condition – NSC
		5 Flashes*	System Trouble Condition – RFC
		6 Flashes*	System Trouble Condition – DTF
MODE – LED 2	Yellow	Solid ON	Telguard operating in Mode 1
		Fast Flash	C/C off-hook to transmit signals over cellular.
Radio TX – LED 1	Green	Solid ON (1 sec)	Telguard in Microburst transmission.
		Fast Flash	Microprocessor communicating with Radio.
		OFF	No Activity

\* - Note: One flash = ½ sec On and ½ second OFF. In order to diagnose multiple problems on STC LED, each condition will display for 5 seconds and then cycle to the next condition

**LED Function Table – View RSSI Mode (J5 = IN)**

RSSI Value	LED's Lighted	RF Signal (dBm)
NO SVC	LED 1* = on, 2-4 = off	≤ -114 dBm (Lowest)
0	LED 1 = on, 2-4 = off	≤ -111 dBm
1	LED 1 = on, 2 = slow flash LED 3-4 = off	≥ -110 dBm
2	LED 1-2 = on, LED 3-4 = off	≥ -100 dBm
3	<b>LED 1-2 = ON, 3 = SLOW FLASH LED 4 = off</b>	<b>≥ -90 dBm (Minimum signal strength required)</b>
4	LED 1-3 = on, LED 4 = off	≥ -80 dBm
5	LED 1-3 = on, 4 = slow flash	≥ -70 dBm
6	LED 1-4 = on	≥ -60 dBm (Highest)

**\*Note: LED 1 = Radio TX; LED 2 = Mode; LED 3 = STC; LED 4 = AC Power.**

## A1.5 JUMPERS

Jumper	Feature	Function	Jumper Position	
			In	Out
<b>J5</b>	Normal Operating Mode, RSSI or Programming Mode.	Used as LED Mode selector to indicate operating conditions of Telguard, used to view Received Signal Strength or enter Programming Mode. Refer to A1.4.	View Received Signal Strength or Enter Programming Mode.	<b>Normal*</b>
<b>J7</b>	Backup battery capacity selection.	Used to select proper charging current for backup battery.	See below.	

Use this default setting for 1.2Ah batteries.  
Jumper across pins 1 & 2.

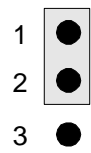

**J7**

Use this setting for 7.0Ah or 21.0Ah batteries.  
Jumper across pins 2 & 3.

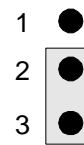

**J7**

## A2.0 Operational Quick Reference Table

Telguard Event		LED Response	Relay Output	Radio Message	Internal Action
Typical C/C Alarm Cycle over Telco		None	None	None	Monitors Telco line voltage and C/C attempts
Telguard System Trouble Conditions	ACFC – AC Fail Condition	Yes AC Power off and STC flashes 1 time.	If Selected	None	Switch to standby battery if present, monitor battery, monitor AC for restoral.
	LBC - Low Battery Condition	Yes STC flashes 2 times.	If Selected	None	Wait for LBC restoral, charge battery.
	LFC – Telco Line Fault Condition	Yes STC flashes 3 times.	If Selected	None	Switch to Radio, wait for C/C to go off hook, transmit alarm via radio if necessary, switch back to Telco when restored, remove LFC condition
	NSC – No Service Condition (Low Signal Strength)	Yes STC flashes 4 times.	If Selected	None	Continue to validate signal strength, remove NSC when signal returns
	RFC – Radio Failure to Communicate due to: <i>RFC1</i> : No Link Request ACK.  OR <i>RFC2</i> : No Link Termination ACK.	Yes STC flashes 5 times.	If Selected	None	Switch back to Telco so that C/C can communicate directly with Central Station.
	DTF - Dial Tone Failure	Yes STC flashes 6 times.	Yes	Yes	Internal 50V supply circuit failure. Return unit for repair on RMA.
	MP - Missing Programming parameters.	Yes STC on steady.	Yes	None	Telguard will not function until operating parameters are programmed and unit receives activation ping from Communication Center. Telguard remains in Telco only mode.
CF - Catastrophic Failure	None	Yes	None	Telguard not working. Remains in Telco only mode.	
CFC – C/C communication failure over good Telco line.		None	None	Yes (Alarm data)	Switch to Radio, transmit alarm via radio, switch back to Telco
Automatic Self-Test - Communication Center Activated.		Yes Radio TX When transmitting	None	Yes (Self-test))	Send Self-test information to central station via Communication Center, return to ready state
Telguard Remote Query - Communication Center Activated by IVR, Intranet, or Customer Service.		Yes Radio TX When transmitting	None	Yes (Status data)	Send Status data to Communication Center for review by IVR or Intranet.
Telguard Enable and Configuration Upload – Communication Center Activated.		Yes Radio TX When transmitting	None	Configuration Data (Setup data)	Telguard sends setup configuration to the Communication Center and switches to READY state to begin operation. Mode LED turns on and STC LED turns off.
Disable TX – Communication Center Activated.		Yes Radio TX When transmitting.	Yes	Yes (Status data)	TX capability is disabled until further notice. Telguard can still receive radio signals from Communication Center.

## A2.1 Setup Programming Parameters

Parameter	Description
Cellular System A or B Program Location 32	The cellular network system through which the Telguard radio is authorized to place calls to the central station. System B is the wireline system (usually operated by the local telephone company) and System A is the non-wireline system (usually operated by the telephone company's competitor). 1=A, 2=B.
C/C Reporting Format Program Location 33	<p>This format must be the same format that the C/C is programmed to use when communicating with the central station over Telco. The programmed selection tells the Telguard how to digitally encode alarm messages from the C/C to the central station over the cellular network control channels.</p> <p>1=4 + 2 Pulse 40 PPS 2300 Ack (Double Round) Non-Extended            2=4 + 2 Pulse 20 PPS 2300 Ack (Double Round) Non-Extended            3=4 + 2 Pulse 20 PPS 1400 Ack (Double Round) Non-Extended            4=3 + 1 Pulse 40 PPS 2300 Ack (Double Round) Non-Extended            5=3 + 1 Pulse 20 PPS 2300 Ack (Double Round) Non-Extended            6=3 + 1 Pulse 10 PPS 1400 Ack (Double Round) Non-Extended            8=Contact ID (Ademco)</p>
STC Trip Output Reporting Program Location 51	<p>Telguard has the capability to supervise proper operation of both power supplies (AC &amp; DC) and proper operation of both paths of communication (Telco and Cellular) to the central station. Should a condition occur that prevents Telguard from operating properly, the condition if programmed, will cause the supervisory trip output (STC) to trip the C/C's 24-hour zone forcing the C/C to communicate the "Telguard <u>S</u>ystem <u>T</u>rouble <u>C</u>ondition" to the central station.</p> <p>Enter the <b>Sum Total</b> of STC events that you wish to report by adding the corresponding values:            Example: <b>01</b> (AC Failure) + <b>02</b> (Low Battery) + <b>08</b> (NSC) + <b>16</b> (RFC) = <b>27</b>.</p> <p>A failure of any individual or combination of these five programmable supervised conditions will cause the STC relay to trip. Notice that since LFC is not selected, a Telco line fault will not cause the STC relay to trip and therefore, no STC trouble report will be sent to the central station by the C/C.</p> <p>00 = STC Relay Trip Not Used            01 = AC Failure            02 = Low Battery            04 = LFC            08 = NSC            16 = RFC</p>
STC Trip Output Delay for LFC and/or NSC Program Location 52	The amount of time (30 or 60 seconds) after a LFC or NSC fault condition occurs that the STC relay will trip. This trip delay also applies to a LFC or NSC restoral.
CFC Number of Attempts Program Location 61	<p>The number of attempts that the C/C will try to communicate with the central station over a good Telco line before Telguard switches the C/C to the cellular path.</p> <p>0=Disabled            1=2 Attempts            2=4 Attempts            3=8 Attempts</p>
CFC Between Events Program Location 62	<p>The amount of time that the C/C is allowed to go off-hook, on-hook, then off-hook again to qualify as a communications failure over Telco.</p> <p>1=30 Seconds            2=60 Seconds</p>
Standby Battery Size (standard lead-acid battery) Program Location 67	<p>This information is provided as historical data for the Telguard database.</p> <p>0=No Battery Installed      3=4 Amp/Hour            1=0.8 Amp/Hour              4=7 Amp/Hour            2=1.4 Amp/Hour              5=21 Amp/Hour</p>

## A2.2 Telguard Communication Formats

Telguard Standard Communication Formats							
NAME	HANDSHAKE FREQUENCY	DATA FREQUENCY	BAUD RATE	FORMAT	EXTENDED	KISS OFF FREQUENCY	Telguard CODE
RADIONICS (Double Round)	2300Hz	1800Hz	40 PPS	4-2	NO	2300Hz	1
FRANKLIN (Double Round)	2300Hz	1800Hz	20 PPS	4-2	NO	2300Hz	2
SIA P3 (Double Round)	1400Hz	1900Hz	20 PPS	4-2	NO	1400Hz	3
RADIONICS (Double Round)	2300Hz	1800Hz	40 PPS	3-1	NO	2300Hz	4
FRANKLIN (Double Round)	2300Hz	1800Hz	20 PPS	3-1	NO	2300Hz	5
SIA P1 (Double Round)	1400Hz	1900Hz	10 PPS	3-1	NO	1400Hz	6
ADEMCO CONTACT ID	DUAL TONE 1400Hz / 2300Hz	DTMF	DTMF	4-2-1-3-2-3	NO	1400Hz	8

## A2.3 Compatible Control Communicators

For UL Listed Commercial Burglary and Fire, and Residential Burglary and Fire (Combination Listed)

C/C Model  UL LISTED	Compatible Data Formats						
	1 Radionics	2 Franklin	3 SIA P3	4 Radionics	5 Franklin	6 SIA P1	8 Ademco
	4+2 40pps 2300Hz ACK	4+2 20pps 2300Hz ACK	4+2 20pps 1400Hz ACK	3+1 40pps 2300Hz ACK	3+1 20pps 2300Hz ACK	3+1 10pps 1400Hz ACK	Ademco Contact ID (DTMF)
DS7400Xi	X	X	X	X	X	X	X
NAPCO MA3000	X	X	X	X	X	X	X

## A2.4 Compatible Receivers

Receiver Model	Compatible Data Formats						
	1 Radionics	2 Franklin	3 SIA P3	4 Radionics	5 Franklin	6 SIA P1	8 Ademco
	4+2 40pps 2300Hz ACK	4+2 20pps 2300Hz ACK	4+2 20pps 1400Hz ACK	3+1 40pps 2300Hz ACK	3+1 20pps 2300Hz ACK	3+1 10pps 1400Hz ACK	Ademco Contact ID (DTMF)
FBI CP220	X	X	X	X	X	X	X
Radionics 6500	X	X	X	X	X	X	
Osborne-Hoffman Quickalert	X	X	X	X	X	X	X
Silent Knight 9000	X	X	X	X	X	X	X
SUR-GARD DRL2A	X	X	X	X	X	X	X
Ademco 685	X	X	X	X	X	X	X

## A2.5 Activation Form

<p><b><u>Subscriber Information</u></b></p> <p>This data is pertinent to the installation and location of the Telguard DataBurst system.</p> <p>Subscriber Name: _____          Subscriber Address: _____          City, ST, Zip: _____          Contact Name: _____          Contact Phone: _____</p> <p><b><u>Billing Information</u></b></p> <p>In order to activate Telguard DataBurst systems on the cellular network, you must be a registered Telguard DataBurst Dealer. Enter your Dealer information below. If you are not registered as a dealer and would like more information, contact Telular Sales at (800) 229-2326.</p> <p>Dealer Company Name: _____          Dealer Account Number: _____          Contact Name: _____          Contact Phone: _____</p> <p><b><u>Installer Information</u></b></p> <p>In order to activate the Telguard DataBurst from the toll free IVR, your installer must be registered under your Dealer Account.</p> <p>Installer Name: _____          Installer Number: _____</p>	<p><b><u>Telguard DataBurst Information</u></b></p> <p>The following data must be entered into the Telular Communication Center computers <i>prior</i> to activation on the cellular network.</p> <p>Telguard Serial Number: _____          C/C Account Number: _____          C/C Reporting Format: _____          Primary C/C Phone Number: _____          Secondary C/C Phone Number: _____</p> <p><b><u>Central Station Information</u></b></p> <p>Name of Central Station: _____          Contact Name: _____          Contact Phone: _____</p> <p><b><u>Telguard Automatic Self-Test</u></b></p> <p>Most rate plans include options for a Telguard Automatic Self-Test signal to be sent to your Central Station. This test signal verifies the integrity of the DataBurst system to your central station, and logs status information for that system on the Telular Communication Center. Please select the Test Code, which is transmitted to your central station, and the time of day the Test signal should be transmitted. The frequency of the Automatic Self-Test is selected when you choose a Cellular Service Rate Plan (Monthly Test, Weekly Test, or Daily Test).</p> <p>Telguard Automatic Self-Test Code: _____          Telguard Automatic Self-Test Time: _____ AM / PM</p>
--	---

**NOTE: When activating the Telguard DataBurst unit using the Interactive Voice Recognition (IVR) system, you will be required to enter your Dealer number, Installer number, and the unit's Serial number or Confirmation number.**

Select a Customer Code: \_\_\_\_\_

**Financial**

B1 Banks  
 B2 Credit Unions  
 B3 Other Financial Locations  
 B4 Check Cashing Locations  
 B5 ATMs

**Business Facilities**

C1 Office Locations  
 C2 Manufacturing/Industrial  
 C3 Utilities/Cable Sites  
 C4 Warehouse/Storage

**Other Facilities**

D1 Fleet/Distribution Hubs  
 D2 Media/Research Labs  
 D3 Schools  
 D4 Other Facilities

**Miscellaneous**

E1 Entertainment (Museums/Parks)  
 F1 Restaurants  
 H1 Residential/Private Homes

**Government**

G1 Federal/Military Locations  
 G2 State Locations  
 G3 Local/County Locations  
 G4 Other Government Locations

**Retail General**

R1 Drug/Pharmacies  
 R2 Supermarket/Convenient Stores  
 R4 Department/Chain Stores/Malls

**Retail Specialty**

R3 Office Equipment Stores  
 R3A Jewelry Stores  
 R5 Home Related Stores  
 R6 Other Retail Stores  
 R7 Electronic/Cellular/Entertainment  
 R8 Pawn Shops  
 R9 Clothing/Shoe Stores

**01 No Category Fit**

Select a Monthly Rate Plan

<p><b><u>Monthly Test (Please enter Day that test is scheduled)</u></b>                  This rate plan includes 1 automatic self-test to allow for monthly testing of the Telguard unit over the cellular network. This plan also includes 2 free monthly alarm signals.</p>	<p>Select <input type="checkbox"/></p>	<p>Day of Month 1 to 28</p>
<p><b><u>Weekly Test (Please enter Day that test is scheduled)</u></b>                  This rate plan includes 5 automatic self-tests to allow for weekly testing of the Telguard unit over the cellular network. This plan also includes 2 free monthly alarm signals.</p>	<p>Select <input type="checkbox"/></p>	<p>Day of Week Mon. to Sun.</p>
<p><b><u>Daily Test</u></b>                  This rate plan includes 31 automatic self-tests to allow for daily testing of the Telguard unit over the cellular network. This plan also includes 2 free monthly alarm signals.</p>	<p>Select <input type="checkbox"/></p>	
<p><b><u>Hi-Volume</u></b>                  This rate plan is flexible to meet your self-testing and alarm signaling needs. Call a Telular Sales Representative to create a rate plan that works for you.</p>	<p>Select <input type="checkbox"/></p>	

## A3.0 Compliance for UL Listed Installations

### A3.1 UL GRADE A CENTRAL STATION SERVICE

Installation and wiring requirements for UL commercial burglary and residential burglary usage to achieve **UL Grade A Central Station Service** using Telguard model **TG-300**. *Refer to Appendix A3.3 for NOTE explanations.* If installing for UL Bank Safe and Vault Service refer to additional requirements in Appendix A3.3 Note "J".

#### Telco Primary/Radio Secondary (Grade A)

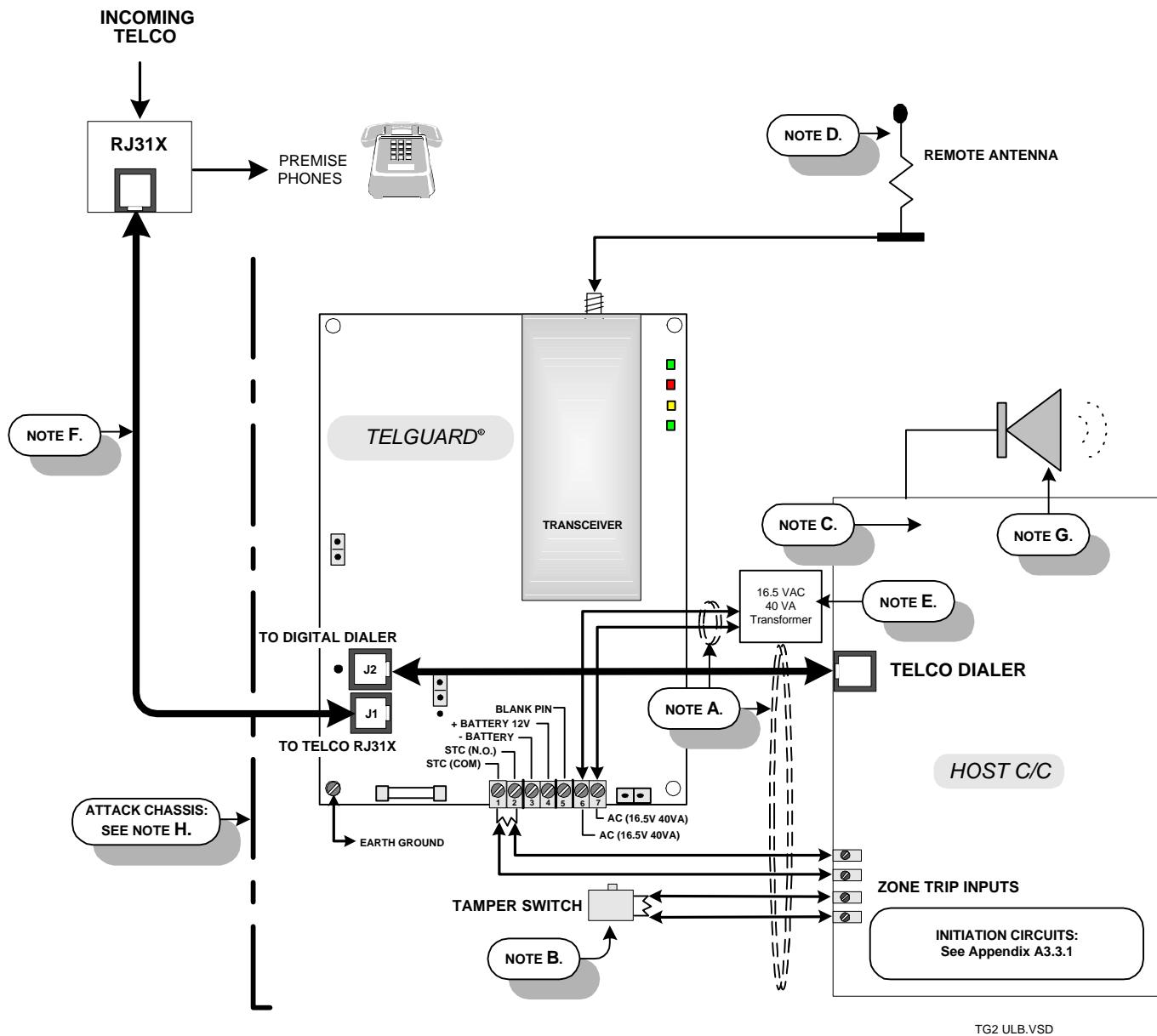

### A3.2 UL GRADE A POLICE STATION CONNECT SERVICE

Installation and wiring requirements for UL commercial burglary and residential burglary usage to achieve **UL Grade A Police Station Connect Service** using Telguard model **TG-300**. Refer to Appendix A3.3 for "NOTE" explanations.

#### Radio Only Mode

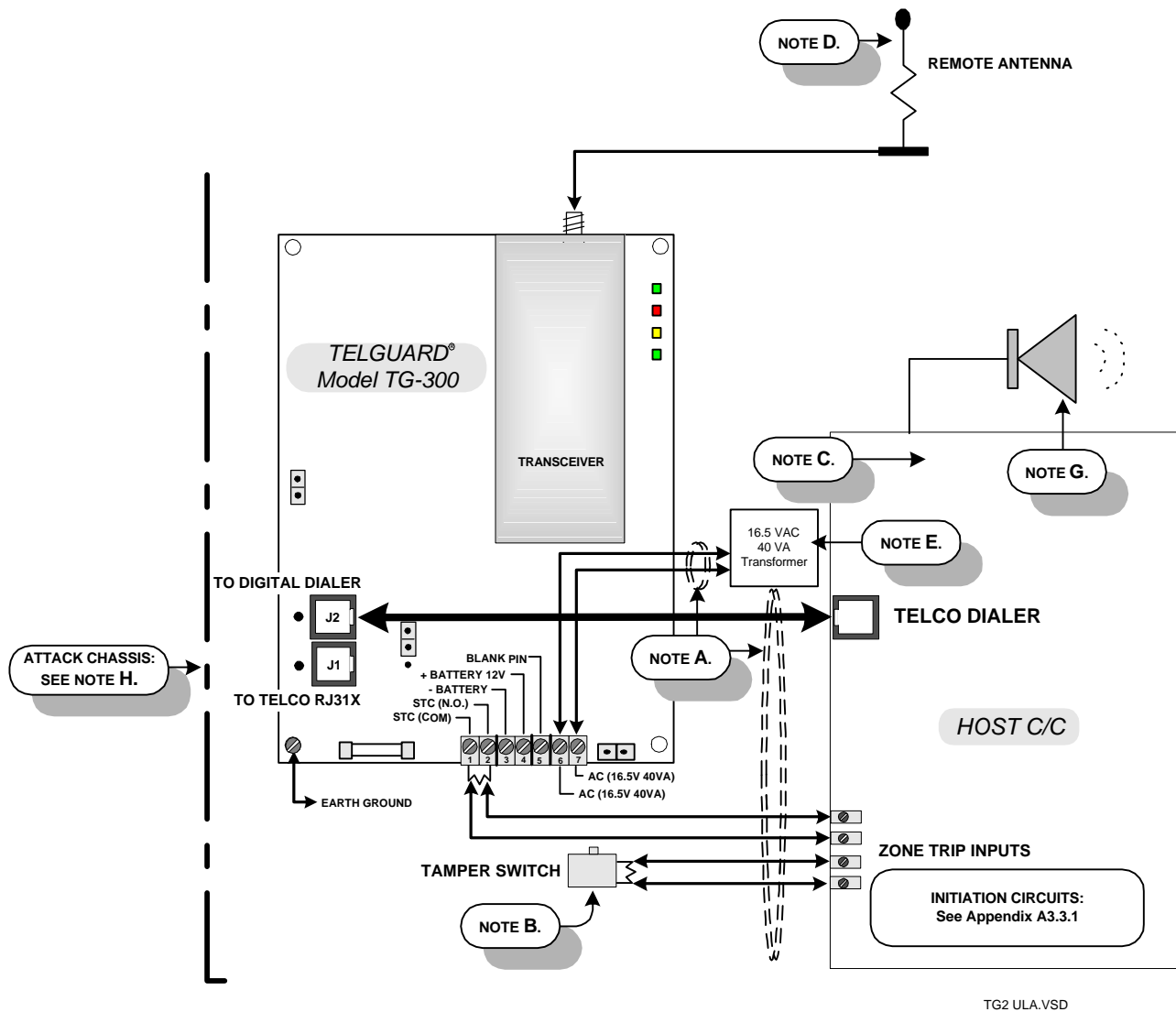



### **A3.3 NOTES TO INSTALLATION/WIRING REQUIREMENTS ON APPENDICES A3.1 AND A3.2**

*(Must use Telguard Model TG-300 for Commercial Burglary applications. Telguard Model TG-200 is acceptable for Residential Burglary applications.)*

- A.** All cables between the host burglary alarm control communicator (C/C) and Telguard model TG-300 must be enclosed in rigid conduit. Antenna cable may be enclosed in flexible conduit concealed within building structure or in field of vision of motion detector (if commercial burglary, UL1610, see Note **D**).
  - Host burglary alarm C/C and Telguard must be within 3 feet of each other.
- B.** Tamper switch on door of Telguard must be connected to instant 24 hour initiating circuit of host burglary alarm C/C.
- C.** Must use Listed burglary alarm central station control with integral or Listed remote DACT installed according to manufacturer's instructions. (For central station use only).
- D.** The Telguard antenna must be installed indoors in an area concealed from field of vision and in an area where access is protected by Listed motion detector. The motion detector must be connected to an instant-armed initiating circuit of host burglary alarm C/C\*. Example: If the antenna is placed above a drop ceiling, the motion detector must protect the room below the antenna. (Not required for residential use).
- E.** Transformer must be connected to unswitched AC outlet.
- F.** Incoming Telco is connected to J1. Direct Telco line connection required. No PBX.
  - Ring-back opening and closing is done over the DACT and the 24-hour check-in is done over both lines.
- G.** In "TELCO PRIMARY/RADIO SECONDARY" or "RADIO ONLY" configurations, use a Listed bell and bell housing (for example, Ademco AB-12, etc.) installed according to manufacturers instructions in order to maintain Grade A. Grade B available without bell and bell housing.
- H.** Tamper resistant housing supplied with model TG-300 is required for commercial burglary UL1635, but not required for residential burglary, residential fire, or commercial fire UL864. Use model TG-200 with standard metal enclosure for residential burglary, residential fire, or commercial fire UL864.
- J.** Additional requirements for UL Bank Safe and Vault Service:
  - Three 7Ah batteries and harnesses must be used to meet the minimum UL required 72-hour standby time in case of power failure.
  - The unit must be mounted inside of the bank safe or vault. If mounted outside the safe, the enclosure shall be lined or used in conjunction with a Listed compatible shock sensor.
  - The unit must be connected to a Control Unit that is UL Listed for Bank Safe and Vault Service.

---

\* - Motion detector required for commercial burglary UL1610, but not for residential burglary, residential fire, or commercial fire UL864.

**A3.3.1 Supervisory Requirements for Listed Burglary Configurations**

Listed Burglary Configuration	Telguard Supervisory Trip Output	Trip to Host C/C*	Telguard Programming		Host C/C Programming	
			Supervised Condition	Setup Requirement	Transmission to Central Station**	Local Annunciation
<b>Telco Primary/Radio Secondary - Grade A Central Station Service.</b>	STC	Yes	LBC	Enabled	Yes	Yes
			LFC	Enabled with 30 or 60-sec. delay.	Yes	Yes
			NSC	Enabled with 30 or 60-sec. delay.	Yes	Yes
			AC Failure	Enabled	Yes	Yes
	RFC	4 Attempts	Yes	Yes		
CFC	4 Attempts	Yes	Yes			
DTF (Self-Test)	None	Yes	Yes			
	Daily	Yes	No			
	Tamper Switch	Yes	N/A	N/A	Yes	Yes
<b>Radio Only Mode - Grade A Police Station Connect Service.</b>	STC	Yes	LBC	Enabled	Yes	Yes
			LFC	Disabled	N/A	N/A
			NSC	Enabled with 30 or 60-sec. delay.	N/A	Yes
			AC Failure	Enabled	Yes	Yes
	RFC	4 Attempts	N/A	Yes		
CFC	Off	N/A	N/A			
DTF (Self-Test)	None	N/A	N/A			
	Monthly	Yes	No			
	Tamper Switch	Yes	N/A	N/A	Yes	Yes
* - Trips must be 24-hour initiating circuits						
** - Use trouble code with restoral.						

### A3.4 UL864/NFPA FIRE ALARM CENTRAL STATION SERVICE

Installation and Wiring Requirements for UL commercial and residential fire usage to achieve UL864/NFPA Fire Alarm Central Station Service using Telguard model TG-200. Refer to Appendix A3.5 for Note explanations.

#### Telco Primary/Radio Secondary - Host C/C switches communication paths

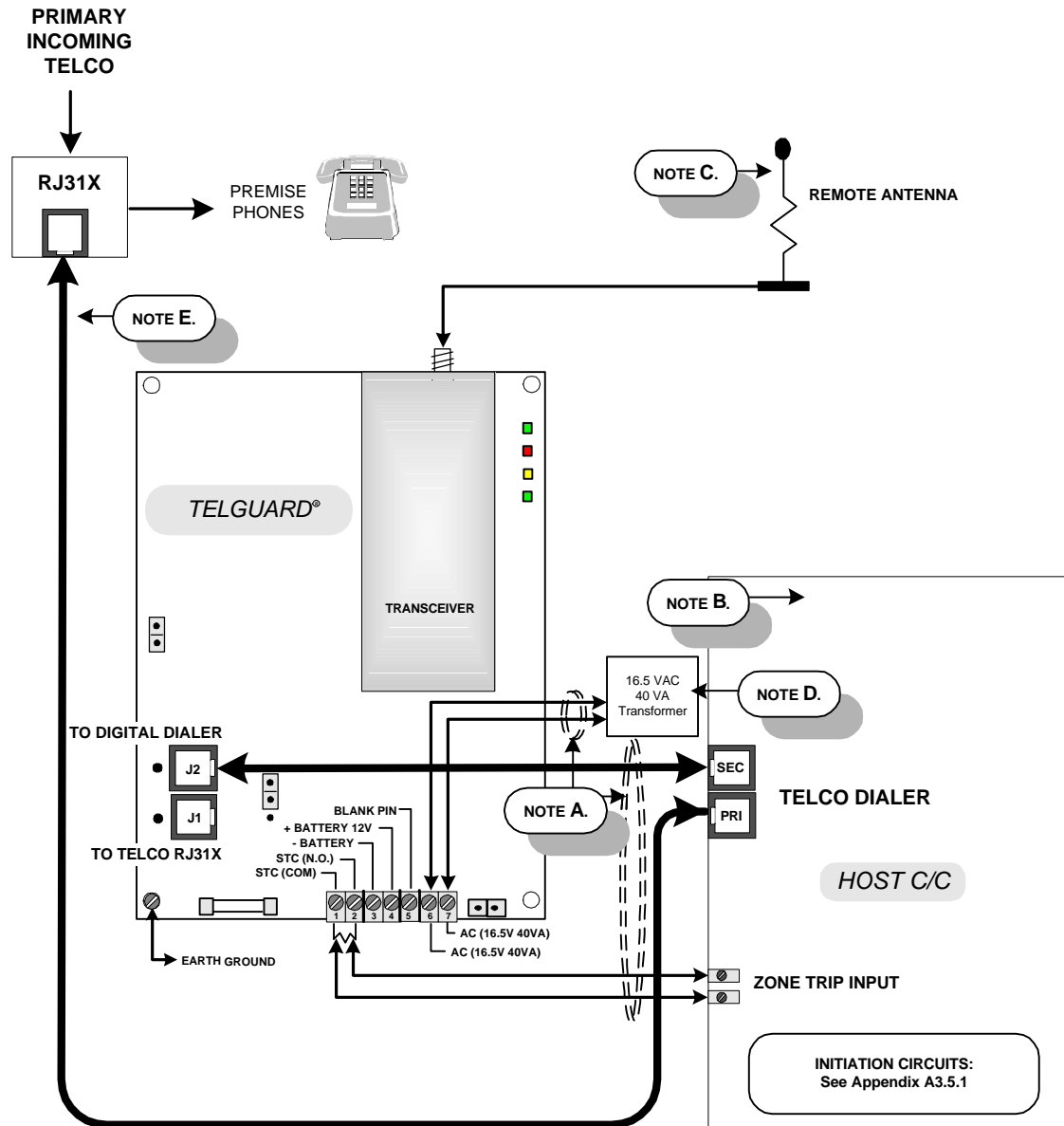

TG2 ULE.VSD

## Telco Primary/Radio Secondary - Telguard switches communication paths

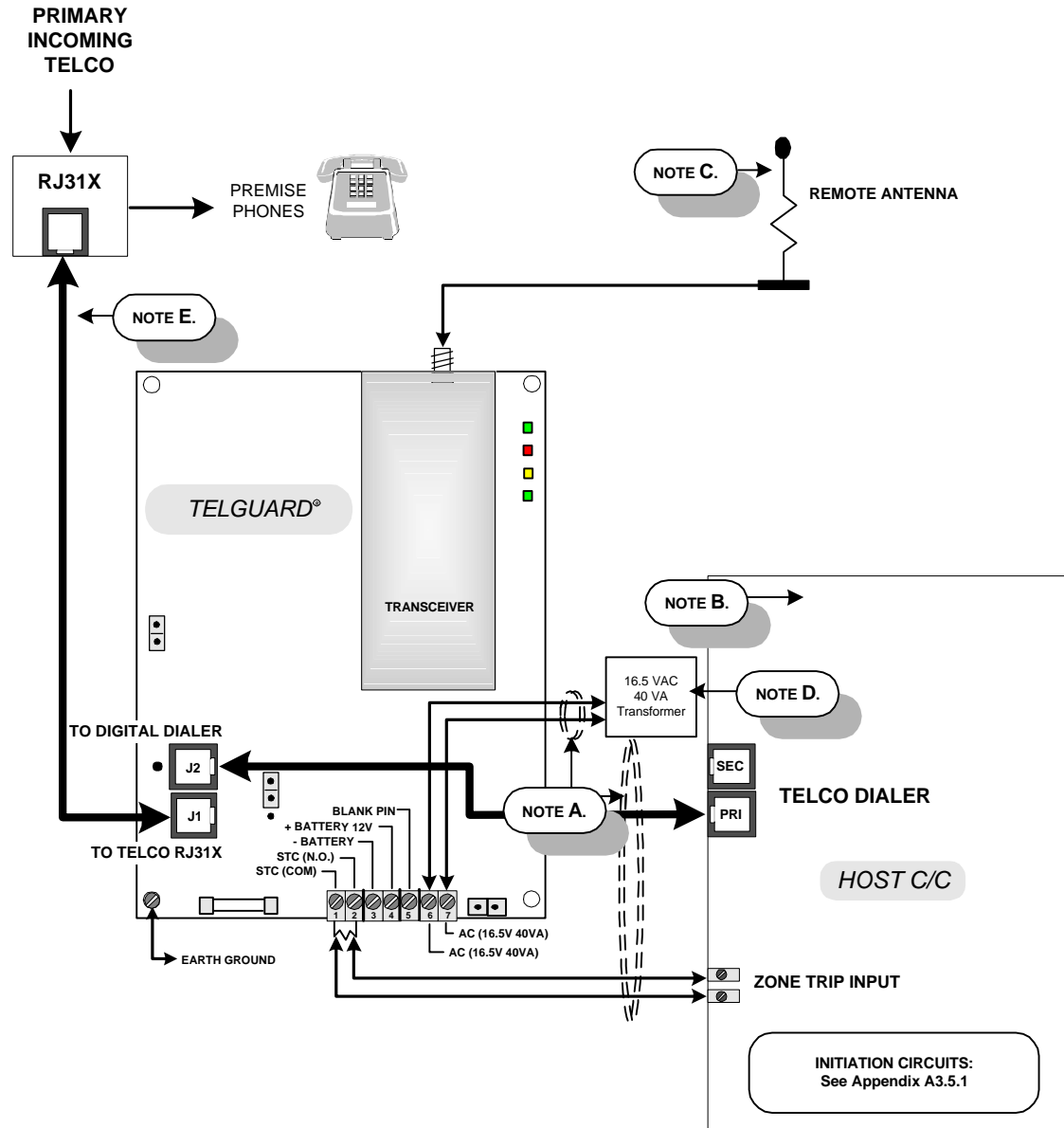

TG2 ULF.VSD

### A3.5 NOTES TO INSTALLATION/WIRING REQUIREMENTS ON APPENDIX A3.4

(Must use Telguard Model TG-200 or Model TG-300 for Commercial Fire or Residential Fire applications.)

- A. All cables between the host fire alarm control communicator and the Telguard must be enclosed in rigid conduit and Host fire alarm C/C and Telguard must be within 3 feet of each other.
- B. Must be Listed fire alarm central station control or Listed combination fire/burglar alarm control unit with two-line integral or Listed remote DACT installed according to manufacturer's instructions.
- C. Antenna must be installed indoors in an area concealed from field of vision.
- D. Installations using conduit: (conduit only required for commercial fire applications)
  1. Mount a Listed pull box (e.g., Notifier Integrated System, Model:NISCAB-4) as close to the Telguard as possible. The pull box dimensions should not be less than 8"W x 8"H x 6"D.
  2. Interconnect the pull box and Telguard with conduit and wire the Listed transformer (e.g., Revere, P/N: RT-1640) to the Telguard in accordance with local wiring codes.
  3. Plug the transformer into the 120 VAC receptacle and secure the transformer.
  4. Secure the pull box cover.
  5. AC power cable between the pull box housing and Telguard and between the host fire alarm control communicator must be enclosed in rigid conduit.
- E. Direct Telco line connection required. No PBX.

#### A3.5.1 Supervisory Requirements for Listed Fire Configurations

Listed Fire Configuration	Telguard Supervisory Trip Output	Trip to Host C/C*	Telguard Programming		Host C/C Programming	
			Supervised Condition	Setup Requirement	Transmission to Central Station**	Local Annunciation
Telco Primary/ Radio Secondary  UL864/NFPA Fire Alarm Central Station Service. (Telguard switches)	STC	Yes	LBC	Enabled	Yes	Optional
			LFC	Enabled with 30 or 60-sec. delay.	Yes	Yes***
			NSC	Enabled with 30 or 60-sec. delay.	Yes	Yes***
			AC Failure	Enabled	Yes	Yes
			RFC	4 Attempts	Yes	Yes
CFC	4 Attempts	Yes	Yes			
DTF	None	Yes	Yes			
(Self-Test)	Monthly	Yes	Yes***			

\* Trips must be 24-hour initiating circuits  
 \*\* Use trouble code with restoral.  
 \*\*\* Must activate a trouble buzzer in the host C/C chassis and not the local bell/given.

## A4.0UL Installation Requirements Summary Table

Household Burglary	Household Fire	Household Burg/Fire Combination	Central Station Burg Grade B	Central Station Burg Grade A	Police Connect Burg Grade A	Bank, Safe and Vault Grade A	Commercial Fire	Commercial Fire & Central Station Burg Grade A	
TG-200	TG-200	TG-200	TG-300	TG-300	TG-300	TG-300	TG-200	TG-300	Telguard Model Required.
O	O	O	Y	Y	Y	Y*	O	Y	UL Listed Bell and Bell Housing **
O	O	O	O	O	O	Y	Y	Y	AC transformer lines in rigid conduit.
Y	Y	Y	Y	Y	Y	Y	Y	Y	AC transformer plugged into unswitched outlet.
O	O	O	O	O	O	Y	Y	Y	AC transformer plugged into dedicated branch circuit.
O	O	O	O	O	O	Y	Y	Y	AC transformer enclosed in Listed pull box (example: Hoffman A-SG8x8x6).
-	-	-	N	N	N	N	N	N	PBX connection to RJ31X jack.
O	O	O	Y	Y	Y	Y	O	Y	Enclosure Tamper Switch connected to 24-hour circuit.
O	O	O	O	Y	Y	Y	Y	Y	Antenna cable in flexible conduit concealed or covered by motion detector.
O	O	O	Y	Y	Y	Y	O	Y	Attack resistant enclosure (APC-32S).
24 hrs. Use 7Ah.	24 hrs. Use 7Ah.	24 hrs. Use 7Ah.	24 hrs. Use 7Ah.	24 hrs. Use 7Ah.	24 hrs. Use 7Ah.	72 hrs. Use 21Ah.	24 hrs. Use 7Ah.	24 hrs. Use 7Ah.	12V. Battery backup requirement.
* Must be connected to C/C UL Listed for Bank and Vault									
** Use Mercantile Listed bell and bell housing									

**O=Optional (Not Required)    Y=Yes (Required)    N=No (Not Allowed)**

## A5.0 Detailed Specifications

### A5.1 DIALER TO INTERFACE ELECTRONICS

The patented integrated interface by Telular, Inc. allows digital dialers to dial into the cellular radio network.

- Line voltage: 48 vdc into standard telephone device when on-hook.
- Dial tone: Precision 400 Hz @-13 dBm +/- 2 dBm. 16 digits dial out capability.
- Ringer equivalent: 0.0B.
- Mode: Loop start only. 25mA +/- 5% off-hook.
- Protected by U.S. Patents: 4,658,096; 4,775,997; 4,922,517; 4,737,975; 4,868,519; 5,134,644.

### A5.2 POWER

- Power Input Rating: 120 VAC, 0.48A.
- Power Supply: Max full charge DC voltage = 13.8V +/- .01V. Max ripple = 30 mV.  
Low capacity charge for 1.2 Ah = Max. charging current of 200ma.  
High capacity charge for 7.0 Ah or 21.0 Ah = Max. charging current of 1.2A.  
Max voltage drop at max current = 1%.
- Transformer Supplied: 16.5 VAC, 40 VA, UL, plug-in.

### A5.3 RADIO

The Standard radio module, CMM8600, provides RF control channel data communication facilities for the Telguard. It provides real-time wireless access to the AMPS cellular network.

- Number of Control Channels: 42.
- Frequency range = 824.030 - 848.980 MHz Tx; 869.030 - 893.980 MHz Rx.
- Channel Spacing = 30 kHz.
- RF Communications: asynchronous, full duplex.
- Protocol: Standard Communications Serial Control Protocol.
- Data Rate: 9600 baud.
- Data bits, parity, stop bits: 8, N, 1.
- Antenna Port: Mini-UHF jack connector.
- Data Port: 14-pin header.
- Receiver Sensitivity: -114 dBm (SCR = 80%)
- Transmit Power: 3.0 W into 50-ohm load @ 25.0°C. (max allowable)
- Standard Antenna: TG-200/300: Magnetic mount, 5/8 wave. 825-896 MHz. Gain: 3 dB. One section 14-1/2" tall mast with 12 feet of cable terminated with mini-UHF plug connector. Optional cable lengths of 35 ft. or 50 ft. are also available.
- Optional Antenna: High Gain Directional Antenna (Gain: 9dB) with 35 or 50 feet of cable. Mini-UHF plug to N type adapter is included.

### A5.4 PHYSICAL

- Size: TG-200/300 12.0"H x 12.0"W x 3.5"D.
- Shipping weight: TG-200/300 16 lbs. with transformer only.
- FCC Registration: 204USA-33648-MO-N. Ringer equivalence 0.0B.
- Operating Environment: -10.0°C to +50°C; 0 - 90% humidity (non-condensing).

### A5.5 WARRANTY

Telular will repair or replace (our option) inoperative units for up to two years from date of shipment. Excludes damage due to lightning or installer error. Unauthorized modifications void this warranty. Not responsible for incidental or consequential damages. Liability limited to price of unit. This is the exclusive warranty and no other warranties will be honored, whether expressed or implied.

## A6.0 Parts List

Part No.	Description
----------	-------------

### *Basic Hardware:*

<b>Model TG-200</b>	Model TG-200 meets the requirements for Household Burglary, Household Fire, and Commercial Fire installations. TG-200 has a standard metal enclosure, keylock, and magnetic mount antenna with 12ft. cable. TG-200 is UL Listed for the following: <ul style="list-style-type: none"><li><input type="checkbox"/> <b>UL Household Burglary</b></li><li><input type="checkbox"/> <b>UL Household Fire</b></li><li><input type="checkbox"/> <b>UL Household Burg/Fire Combination</b></li><li><input type="checkbox"/> <b>UL Commercial Fire</b></li></ul>
<b>Model TG-300</b>	Model TG-300 meets the requirements for all Household Burglary, Commercial Burglary, Household Fire, and Commercial Fire installations. TG-300 has an attack-resistant enclosure, keylock, tamper switch, and a magnetic mount antenna with 12ft. cable. Model TG-300 is UL Listed for the following and UL Listed for Grade A Burglary Certificate installations: <ul style="list-style-type: none"><li><input type="checkbox"/> <b>UL Household Burglary</b></li><li><input type="checkbox"/> <b>UL Household Fire</b></li><li><input type="checkbox"/> <b>UL Household Burg/Fire Combination</b></li><li><input type="checkbox"/> <b>UL Central Station Burglary</b><ul style="list-style-type: none"><li><input type="checkbox"/> Grade A</li><li><input type="checkbox"/> Grade B</li></ul></li><li><input type="checkbox"/> <b>UL Police Connect Burglary</b><ul style="list-style-type: none"><li><input type="checkbox"/> Grade A</li></ul></li><li><input type="checkbox"/> <b>UL Commercial Fire</b></li><li><input type="checkbox"/> <b>UL Commercial Fire and Central Station Burglary Grade A</b></li><li><input type="checkbox"/> <b>UL Bank, Safe and Vault</b><ul style="list-style-type: none"><li><input type="checkbox"/> Grade A</li></ul></li></ul>

### **General Accessories:**

<b>BMR-1250</b>	Battery, 12V, 7.0 AH.
<b>TMR-1250</b>	Transformer, 16.5V, 40VA (Revere RT-1640 or RT1640SL). Supplied with all models.
<b>MMA-1</b>	Standard magnetic mount antenna. Supplied with models TG-200 and TG-300.
<b>MMA-35M</b>	Magnetic mount antenna with 35 feet of low loss cable.
<b>MMA-50M</b>	Magnetic mount antenna with 50 feet of low loss cable.
<b>HGA-35M</b>	High Gain Directional Antenna Kit with 35 feet of low loss cable.
<b>HGA-50M</b>	High Gain Directional Antenna Kit with 50 feet of low loss cable.
<b>APC-32S</b>	Attack resistant, heavy-duty enclosure. Supplied with model TG-300. Required for UL1635 (commercial burglary) Listing. Priced when purchased separately.



## Index

<i>AC Failure Condition (ACFC)</i> .....	3
Aeris.....	1
AMPS.....	1
<i>Antenna Options</i> .....	14
automatic self-test.....	1
<b>Automatic Self-test Report</b> .....	4
Backup batteries.....	7
Burglary Alarm Service.....	i
<b>C/C Compatible Communication Formats</b> .....	2
<i>Catastrophic Failure (CF)</i> .....	3
Cellular Service Activation Form.....	7
central station.....	1
<i>Communications Failure Condition (CFC)</i> .....	2
Compatible Control Communicators.....	29
Compliance for UL Listed Installations.....	31
<b>Contents</b> .....	v
control channels.....	1
current operational status (C.O.S.).....	4
Customer Service Center.....	1
<i>Default Programming</i> .....	12
<b>Detailed Specifications</b> .....	39
<b>Diagnostic and Status LEDs</b> .....	5
<i>Dialer to Interface Electronics</i> .....	39
Directional Antennas.....	15
FCC Notices.....	ii
Fire Alarm Service.....	i
<b>General Description</b> .....	1
<i>Ground</i> .....	21
<b>Installation Summary</b> .....	7
Intranet System.....	1
IVR.....	1
<i>Jack and Pin Assignments</i> .....	23
<i>Jumpers</i> .....	26
LED Function Table.....	14
LED Function Table – Normal Operating Mode.....	25
LED Function Table – View RSSI Mode.....	25
<b>LED Modes and Functions</b> .....	25
<i>LED Signal Strength Indication</i> .....	5
limitations on use.....	iii
<i>Line Fault Condition (LFC)</i> .....	2
<i>Low/Missing Battery Condition (LBC)</i> .....	3
message center.....	1
Microburst™.....	1
<i>Model TG-200</i> .....	6
<i>Model TG-300</i> .....	6
NAM programming.....	6
<i>No Service Condition (NSC)</i> .....	2
<b>Operating Modes</b> .....	1
<b>Parts List</b> .....	40
<i>PBX Installations</i> .....	2
<i>Physical</i> .....	39
<i>POTS Programming</i> .....	13
<i>Power</i> .....	39
<b>Power Supervision</b> .....	3
<b>Primary Modes of Operation</b> .....	27
Programming Data Sheet.....	13
<b>Quick Reference Tables</b> .....	27
<i>Radio</i> .....	39
<i>Radio Communications Failure Condition (RFC)</i> .....	3
<i>Remote Query</i> .....	4
<b>Request for Cellular Service</b> .....	7
<i>RF Signal Strength</i> .....	14
<i>RFC1 (Link Request Failure)</i> .....	3
<i>RFC2 (Link Termination Failure)</i> .....	3
RJ31X.....	1
RSSI jumper.....	5
<b>Setup Programming Parameters</b> .....	6, 28
<i>STC Trip Output Strategy</i> .....	11
<i>Supervisory Trip Output (STC) Relay</i> .....	4
<i>Telco Signal Path through Telguard</i> .....	19
<i>Telguard Communication Formats</i> .....	29
<b>Terminal Strip Connections</b> .....	4
<i>Terminal Strip Pin Assignments</i> .....	24
<i>UL Grade A Central Station Service</i> .....	31
<i>UL Grade A Police Station Connect Service</i> .....	32
UL Installation Summary Table.....	38
<b>UL Listings by Model</b> .....	6
UL/NFPA.....	i
<b>Warranty</b> .....	39
<i>Watchdog Monitor/Reset (WR)</i> .....	3
<i>Wiring Diagram</i> .....	22