



TRACER 4205 System Manual

12804205L1A TRACER 4205 System (Plan A)

12804205L1B TRACER 4205 System (Plan B)

Trademarks

Any brand names and product names included in this manual are trademarks, registered trademarks, or trade names of their respective holders.

To the Holder of the Manual

The contents of this manual are current as of the date of publication. ADTRAN reserves the right to change the contents without prior notice.

In no event will ADTRAN be liable for any special, incidental, or consequential damages or for commercial losses even if ADTRAN has been advised thereof as a result of issue of this publication.



901 Explorer Boulevard
P.O. Box 140000
Huntsville, AL 35814-4000
Phone: (256) 963-8000

©2002 ADTRAN, Inc.
All Rights Reserved.
Printed in U.S.A.

About this Manual

This manual provides a complete description of the TRACER 4205 system and system software. The purpose of this manual is to provide the technician, system administrator, and manager with general and specific information related to the planning, installation, operation, and maintenance of the TRACER 4205. This manual is arranged so that needed information can be quickly and easily found. The following is an overview of the contents.

Section 1 4205 System Description

Provides managers with an overview of the TRACER 4205 system.

Section 2 Microwave Path Engineering Basics

Explains the basics of analyzing a wireless microwave link, or path. The significant parameters are defined, and several recommendations are offered.

Section 3 Engineering Guidelines

Provides information to assist network designers with incorporating the TRACER 4205 system into their networks.

Section 4 Network Turnup Procedure

Provides step-by-step instructions on how to install the TRACER 4205 unit, determine the parameters for the system, install the network and option modules, and power up the system.

Section 5 User Interface Guide

Explains the terminal interface and provides a description for each of the menus available for the TRACER 4205 system.

Section 6 Troubleshooting Guide

Provides helpful information for troubleshooting common configuration problems for the TRACER 4205 system.

Revision History

This is the first issue of this manual.



Notes provide additional useful information.



Cautions signify information that could prevent service interruption.



Warnings provide information that could prevent damage to the equipment or endangerment to human life.

Safety Instructions

When using your telephone equipment, please follow these basic safety precautions to reduce the risk of fire, electrical shock, or personal injury:

1. Do not use this product near water, such as a bathtub, wash bowl, kitchen sink, laundry tub, in a wet basement, or near a swimming pool.
2. Avoid using a telephone (other than a cordless-type) during an electrical storm. There is a remote risk of shock from lightning.
3. Do not use the telephone to report a gas leak in the vicinity of the leak.
4. Use only the power cord, power supply, and/or batteries indicated in the manual. Do not dispose of batteries in a fire. They may explode. Check with local codes for special disposal instructions.

Save These Important Safety Instructions

Federal Communications Commission Radio Frequency Interference Statement

This equipment has been tested and found to comply with the limits for a Class A digital device, pursuant to Part 15 of the FCC Rules. These limits are designed to provide reasonable protection against harmful interference when the equipment is operated in a commercial environment. This equipment generates, uses, and can radiate radio frequency energy and, if not installed and used in accordance with the instruction manual, may cause harmful interference to radio frequencies. Operation of this equipment in a residential area is likely to cause harmful interference in which case the user will be required to correct the interference at his own expense.



Shielded cables must be used with this unit to ensure compliance with Class A FCC limits.

WARNING

Changes or modifications to this unit not expressly approved by the party responsible for compliance could void the user's authority to operate the equipment.

Warranty and Customer Service

ADTRAN will repair and return this product within five years from the date of shipment if it does not meet its published specifications or fails while in service. For detailed warranty, repair, and return information refer to the ADTRAN Equipment Warranty and Repair and Return Policy Procedure.

Return Material Authorization (RMA) is required prior to returning equipment to ADTRAN.

For service, RMA requests, or further information, contact one of the numbers listed at the end of this section.

LIMITED PRODUCT WARRANTY

ADTRAN warrants that for five years from the date of shipment to Customer, all products manufactured by ADTRAN will be free from defects in materials and workmanship. ADTRAN also warrants that products will conform to the applicable specifications and drawings for such products, as contained in the Product Manual or in ADTRAN's internal specifications and drawings for such products (which may or may not be reflected in the Product Manual). This warranty only applies if Customer gives ADTRAN written notice of defects during the warranty period. Upon such notice, ADTRAN will, at its option, either repair or replace the defective item. If ADTRAN is unable, in a reasonable time, to repair or replace any equipment to a condition as warranted, Customer is entitled to a full refund of the purchase price upon return of the equipment to ADTRAN. This warranty applies only to the original purchaser and is not transferable without ADTRAN's express written permission. This warranty becomes null and void if Customer modifies or alters the equipment in any way, other than as specifically authorized by ADTRAN.

EXCEPT FOR THE LIMITED WARRANTY DESCRIBED ABOVE, THE FOREGOING CONSTITUTES THE SOLE AND EXCLUSIVE REMEDY OF THE CUSTOMER AND THE EXCLUSIVE LIABILITY OF ADTRAN AND IS IN LIEU OF ANY AND ALL OTHER WARRANTIES (EXPRESSED OR IMPLIED). ADTRAN SPECIFICALLY DISCLAIMS ALL OTHER WARRANTIES, INCLUDING (WITHOUT LIMITATION), ALL WARRANTIES OF MERCHANTABILITY AND FITNESS FOR A PARTICULAR PURPOSE. SOME STATES DO NOT ALLOW THE EXCLUSION OF IMPLIED WARRANTIES, SO THIS EXCLUSION MAY NOT APPLY TO CUSTOMER.

In no event will ADTRAN or its suppliers be liable to the Customer for any incidental, special, punitive, exemplary or consequential damages experienced by either the Customer or a third party (including, but not limited to, loss of data or information, loss of profits, or loss of use). ADTRAN is not liable for damages for any cause whatsoever (whether based in contract, tort, or otherwise) in excess of the amount paid for the item. Some states do not allow the limitation or exclusion of liability for incidental or consequential damages, so the above limitation or exclusion may not apply to the Customer.

Customer Service, Product Support Information, and Training

ADTRAN will repair and return this product if within five years from the date of shipment the product does not meet its published specification or the product fails while in service.

A return material authorization (RMA) is required prior to returning equipment to ADTRAN. For service, RMA requests, training, or more information, use the contact information given below.

Repair and Return

If you determine that a repair is needed, please contact our Customer and Product Service (CAPS) department to have an RMA number issued. CAPS should also be contacted to obtain information regarding equipment currently in house or possible fees associated with repair.

CAPS Department (256) 963-8722

Identify the RMA number clearly on the package (below address), and return to the following address:

ADTRAN Customer and Product Service
901 Explorer Blvd. (East Tower)
Huntsville, Alabama 35806

RMA # _____

Pre-Sales Inquiries and Applications Support

Your reseller should serve as the first point of contact for support. If additional pre-sales support is needed, the ADTRAN Support web site provides a variety of support services such as a searchable knowledge base, latest product documentation, application briefs, case studies, and a link to submit a question to an Applications Engineer. All of this, and more, is available at:

<http://support.adtran.com>

When needed, further pre-sales assistance is available by calling our Applications Engineering Department.

Applications Engineering (800) 615-1176

Post-Sale Support

Your reseller should serve as the first point of contact for support. If additional support is needed, the ADTRAN Support web site provides a variety of support services such as a searchable knowledge base, updated firmware releases, latest product documentation, service request ticket generation and trouble-shooting tools. All of this, and more, is available at:

<http://support.adtran.com>

When needed, further post-sales assistance is available by calling our Technical Support Center. Please have your unit serial number available when you call.

Technical Support (888) 4ADTRAN

Installation and Maintenance Support

The ADTRAN Custom Extended Services (ACES) program offers multiple types and levels of installation and maintenance services which allow you to choose the kind of assistance you need. This support is available at:

<http://www.adtran.com/aces>

For questions, call the ACES Help Desk.

ACES Help Desk (888) 874-ACES (2237)

Training

The Enterprise Network (EN) Technical Training Department offers training on our most popular products. These courses include overviews on product features and functions while covering applications of ADTRAN's product lines. ADTRAN provides a variety of training options, including customized training and courses taught at our facilities or at your site. For more information about training, please contact your Territory Manager or the Enterprise Training Coordinator.

Training Phone (800) 615-1176, ext. 7500
Training Fax (256) 963-6700
Training Email training@adtran.com

Radio Frequency Interface Statement

This equipment has been tested and found to comply with the limits for an intentional radiator, pursuant to Part 15, Subpart C of the FCC Rules. This equipment generates, uses, and can radiate radio frequency energy. If not installed and used in accordance with the instructions, it may cause interference to radio communications.

The limits are designed to provide reasonable protection against such interference in a residential situation. However, there is no guarantee that interference will not occur in a particular installation. If this equipment does cause interference to radio or television reception, which can be determined by turning the equipment on and off, the user is encouraged to try to correct the interference by one or more of the following measures:

- Reorient or relocate the receiving antenna of the affected radio or television.
- Increase the separation between the equipment and the affected receiver.
- Connect the equipment and the affected receiver to power outlets on separate circuits.
- Consult the dealer or an experienced radio/TV technician for help.

WARNING

Changes or modifications not expressly approved by ADTRAN could void the user's authority to operate the equipment.

FCC Output Power Restrictions

The FCC does not require licensing to implement this device. It is the responsibility of the individuals designing and implementing the radio system to assure compliance with these and any other pertinent FCC Rules and Regulations. **This device must be professionally installed.**

Exposure to Radio Frequency Fields

The TRACER 4205 is designed to operate at 5.725 to 5.850 GHz with 100 mW maximum transmit power.

This level of RF energy is below the Maximum Permissible Exposure (MPE) levels specified in FCC OET 65:97-01. The installation of high gain antenna equipment in the system configuration may create the opportunity for exposure to levels higher than recommended for the general population at a distance less than 15 feet (4.6 meter) from the center of the antenna. **The following precautions must be taken during installation of this equipment:**

- The installed antenna must not be located in a manner that allows exposure of the general population to the direct beam path of the antenna at a distance less than 15 feet (4.6 meters). Installation on towers, masts, or rooftops not accessible to the general population is recommended; or
- Mount the antenna in a manner that prevents any personnel from entering the area within 15 feet (4.6 meter) from the front of the antenna.
- It is recommended that the installer place radio frequency hazard warnings signs on the barrier that prevents access to the antenna.
- Prior to installing the antenna to the TRACER 4205 output, make sure the power is adjusted to the settings specified in section 2 of this manual.
- During antenna installation, be sure that power to the TRACER equipment is turned off in order to prevent any energy presence on the coaxial connector.
- During installation and alignment of the antenna, do not stand in front of the antenna assembly.
- During installation and alignment of the antenna, do not handle or touch the front of the antenna.

These simple precautions must be taken to prevent general population and installation personnel from exposure to RF energy in excess of specified MPE levels.

4205 SYSTEM DESCRIPTION

This section of ADTRAN's TRACER 4205 System manual is designed for use by network engineers, planners, and designers for overview information about the TRACER 4205.

It contains general information and describes physical and operational concepts, network relationships, provisioning, testing, alarm status, and system monitoring. This section should be used in conjunction with Section 2, *Engineering Guidelines*, of the system manual.

CONTENTS

System Overview	12
Features and Benefits	12
Configuration and Management	12
Operational	12

1. SYSTEM OVERVIEW

The ADTRAN TRACER® 4205 wireless data system provides transparent extension of DS3 circuits over wireless links for up to 25 miles (line-of-sight path required). As authorized under Part 15.247 of the FCC Rules, the TRACER 4205 operates license-free in the 5.8 GHz industrial, scientific, and medical (ISM) band requiring no FCC licensing of end users.

For configuration and testing, the TRACER 4205 provides the capability to control the remote TRACER 4205 through a separate maintenance channel. The TRACER 4205 has several built-in test capabilities including remote loopback. Complete configuration and performance data is available through menus accessed using a standard RS-232 terminal interface.

2. FEATURES AND BENEFITS

The following is a brief list of TRACER 4205 features and benefits:

Configuration and Management

- Easy to use VT100 control port (RS-232 interface) for configuration and monitoring
- Remote configuration

Operational

- Transparent DS3 transmission over digital microwave link
- No license required per FCC Rules Part 15.247
- Frequency: 5.725 to 5.850 GHz
- Point-to-point, up to 25 miles
- 1-U high unit for easy rack-mounting

MICROWAVE PATH ENGINEERING BASICS

CONTENTS

Line-of-site	14
Decibels	14
Receiver Power	14
Antenna Gain	15
Path Loss	16
Antenna Alignment	18
Antenna Beam Patterns	19
Fresnel Zones, Earth Curvature, & Antenna Heights	19
Coaxial Cable	20
Receiver Sensitivity	21
Fade Margin	21
Path Availability	21

FIGURES

Figure 1. Example Microwave Path with Parameters	18
Figure 2. Typical Antenna Beam Pattern	19

TABLES

Table 1. Antenna Gain for Given Dish Diameters	15
Table 2. Path Loss for Given Path Lengths	16
Table 3. Minimum Antenna Height for Given Path Lengths	20
Table 4. Typical Coaxial Loss for Common Cable Types, per 100ft	20

1. LINE-OF-SITE

The TRACER 4205 system is designed for operation in the 5725 MHz to 5850 MHz license-free industrial, scientific and medical (ISM) band. Radio wave propagation in this band exhibits microwave characteristics, which are ideally suited for point-to-point, line-of-sight communications. Line-of-sight essentially requires that the transmitting antenna and receiving antenna are able to “see” each other, and that the straight-line path between the two antennas is free of any obstructions, such as buildings, trees, mountains, and, in longer paths, even the curvature of the earth.

Point-to-Point	Wireless communication from a single site to another individual site. Contrast with point-to-multipoint
Line-of-Sight	An unobstructed, direct path exists between the transmitting and the receiving antennas.

2. DECIBELS

The received signal power equation is often expressed in a decibel (dB) format, which turns the power multiplication and division operations into addition and subtraction operations. In general, any quantity can be expressed in decibels. If the quantity (x) is a power level, the decibel equivalent is defined as

$$x_{dB} = 10 \cdot \log_{10}(x) \quad (\text{dB})$$

If the quantity x is referenced to a milliwatt (mW), then the decibel-milliwatt (dBm) is used instead of a generic decibel.

$$x_{dBm} = 10 \cdot \log_{10}\left(\frac{x}{1\text{mW}}\right) \quad (\text{dBm})$$

3. RECEIVER POWER

The radio frequency (RF) signal power that is available at the input to the receiving TRACER 4205 system is the next parameter of interest in analyzing a wireless path. The TRACER 4205 has a maximum output power level of 100 mW, which is equivalent to 20 dBm. This output signal will be attenuated and distorted by various factors, all of which will degrade the original signal and affect the signal strength and quality as sensed by the receiving unit. A simplified power budget analysis is beneficial to perform after verifying a suitable line-of-sight path to determine if the microwave path is suitable, even for ideal, non-distorted signals.

The equation relating received signal power to the other microwave parameters is

$$P_R = \frac{P_T G_T G_R \lambda^2}{(4\pi)^2 d^2 L} \quad (\text{watts, W})$$

where the variables in the equation are defined as

P_R	received power (Watts)
P_T	transmitted power (100 mW (max) for TRACER 4205 - adjustable)
G_T	transmit antenna gain
G_R	receive antenna gain
λ	carrier wavelength (c / f) (meters)
d	path distance (meters)
L	other losses (RF coaxial cable, etc.)

The actual transmit and receive antenna gain values are strictly dependent upon the physical characteristics of the antennas installed for each link. Typical gains are between 20 and 40 dB. For example, a 4 foot diameter Parabolic dish has 34.2 dB of gain at 5.8 GHz. The carrier wavelength is the physical wavelength of the main RF carrier being used for communication, and is usually approximated at the center frequency of the band, which is 5787.5 MHz. This gives a wavelength of 5.18 cm.

The path distance is simply the physical distance between the transmit and receive antennas. For the TRACER 4205 these distances can range up to 25 miles. The final parameter L incorporates all other signal power losses in the microwave link, most of which are caused by antenna feed.

4. ANTENNA GAIN

Best performance will result from the use of a parabolic dish antenna. Antenna gain is determined by the size of the dish, with typical features detailed below. Dish manufactureres will be able to supply gains for other types of antennas.

Table 1. Antenna Gain for Given Dish Diameters

Dish Diameter (in feet)	Gain (in dBi)
2	28.5
4	34.2
6	37.5
8	40.7
10	42.5
12	44.2

5. PATH LOSS

The expression

$$L_P = \left(\frac{4\pi d}{\lambda}\right)^2 = \left(\frac{4\pi df}{c}\right)^2 \quad (\text{dB})$$

where

- f carrier frequency (Hz)
- λ carrier wavelength (c / f) (meters)
- d path distance (meters)
- c speed of light, free-space (meters)

is called the path loss, and increases rapidly as either path length increases or carrier wavelength decreases (which happens as the carrier frequency increases). So, longer microwave paths will naturally experience more path loss than shorter paths. Likewise, higher frequency microwave communication will experience more path loss than lower frequency microwave communication.

Table 1 tabulates path loss values for various path lengths for the TRACER 4205 system. Values not listed in the table can be interpolated from those listed.

Table 2. Path Loss for Given Path Lengths

Path Length (miles)	Path Loss (dB)
1	112
2	118
3	121
4	124
5	126
6	127
7	129
8	130
9	131
10	132
11	133
12	133
13	134
14	135
15	135
16	136
17	136
18	137
19	137

Table 2. Path Loss for Given Path Lengths

Path Length (miles)	Path Loss (dB)
20	138
21	138
22	139
23	139
24	139
25	140

When using decibel notation, the received power equation becomes

$$P_R = P_T + G_T + G_R - L - 20 \cdot \log_{10} \left(\frac{4\pi df}{c} \right) \quad (\text{dBm})$$

or

$$P_R = P_T + G_T + G_R - L - L_P \quad (\text{dBm})$$

Where, in the second equation the path loss has been lumped into a single quantity, L_P , as discussed previously. When using decibel notation, it is necessary that all quantities are individually converted to decibels prior to performing addition and subtraction.

When d is expressed in miles and f in GHz, the path loss expression in decibels becomes

$$L_P = 96.6 + 20 \cdot \log_{10}(d) + 20 \cdot \log_{10}(f) \quad (\text{dB})$$

Figure 1 illustrates a wireless link containing all of the parameters previously discussed.

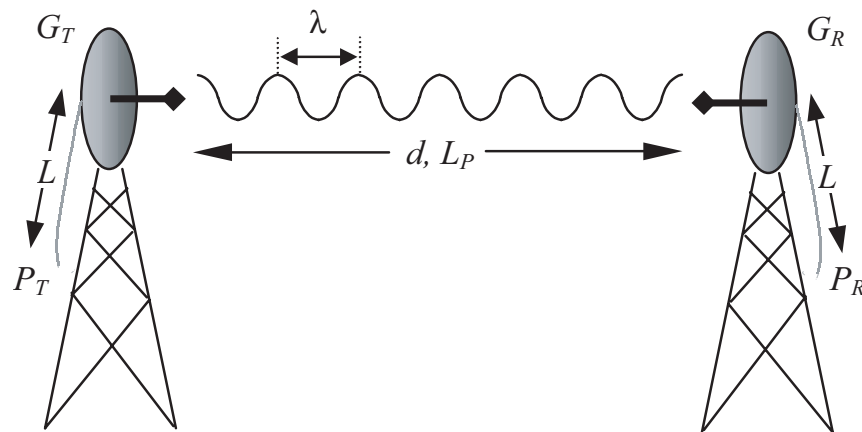

Figure 1. Example Microwave Path with Parameters

6. ANTENNA ALIGNMENT

With line-of-sight microwave communications, optimum system performance requires that the transmitting and receiving antennas are properly aligned. This will ensure maximum received signal power at each receiver. Antenna alignment must be achieved in both azimuth (along a horizontal plane) and elevation (along a vertical plane). A received signal strength indicator (RSSI) is used to aid the equipment installer in determining when alignment is maximized, by simply ensuring maximum RSSI. The RSSI indicator for the TRACER 4205 system is provided through the VT100 terminal menus accessed through the RS-232 interface, and is presented as a series of bars indicating signal strength. More bars means more RSSI, which ensures more received signal strength and better link performance.

If the remote system has acquired a useful signal from the remote system, then the remote TRACER 4205 RSSI can also be viewed from the local TRACER 4205 VT100 terminal menu interface.

An RSSI Test point is also provided on the front panel. The voltage (relative to the gnd test point) present on this test point represents a relative signal level of receive strength from the far end. The voltage at this test point can vary from approximately 0 to greater than 4 Volts DC, with 0 Volts corresponding to no signal and 4 Volts or better to full signal strength.

Antenna Beam Patterns

Directly related to the subject of antenna alignment is the topic of antenna beam patterns. Antennas being used with the TRACER 4205 system will have a particular beam shape determined in part by the physical construction and geometry of the antenna. The antenna beam patterns are characterized by a dominant main lobe, which is the preferred lobe to use for point-to-point communications, and several side lobes, as shown in Figure 2 on page 19. The antenna alignment step to setting up a microwave link is in fact steering the main lobes of both antennas until the main lobe of one transmitter is centered on the receiving element of the receiving antenna.

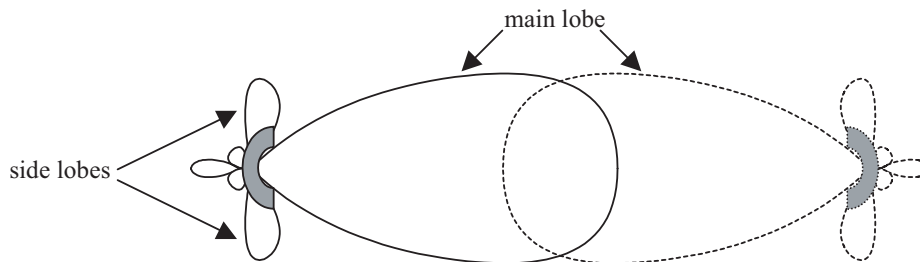

Figure 2. Typical Antenna Beam Pattern

Antennas are also designed to radiate RF energy efficiently for a specific range of frequencies. Please consult the data sheet for your particular antenna make and model to ensure that it is specified to operate in the 5725 MHz to 5850 MHz frequency band.

Fresnel Zones, Earth Curvature, & Antenna Heights

The Fresnel zones correspond to regions in the microwave path where reflections of the intended signal occur and combine in both constructive and destructive manners with the main signal, thereby either enhancing or reducing the net power at the receiver.

In general, the odd numbered Fresnel zones (1, 3, 5, ...) add constructively at the receiver, while the even numbered Fresnel zones (2, 4, 6, ...) add destructively at the receiver.

The first Fresnel zone corresponds to the main lobe, and must be at least 60% free of physical obstructions for the path calculations to be valid. Since the main lobe contains the vast majority of the microwave energy, this zone is typically used to determine proper antenna heights when placing antennas on towers or buildings.

The curvature of the Earth becomes a legitimate obstruction for path lengths of 7 miles or greater, and must also be accounted for when determining minimum antenna heights.

The aggregate expression for minimum antenna height that incorporates both the 60% first Fresnel zone and the Earth curvature is given by

$$h = 72.1 \sqrt{\frac{d}{4f}} + 0.125d^2 \quad (\text{feet})$$

where f is in GHz and d is in miles.

Table 3 tabulates minimum antenna heights for given path lengths.

Table 3. Minimum Antenna Height for Given Path Lengths

Path Length (miles)	Min. Antenna Height (ft)
2	22
4	32
6	41
8	50
10	60
15	86
20	117
25	153

7. COAXIAL CABLE

Coaxial cable will be required to attach the TRACER 4205 to the antenna. The length of the cable will vary from a few feet to several feet, depending upon your application and the proximity of the TRACER 4205 to the antenna.

Various grades of coaxial cable will work sufficiently well for connecting the TRACER 4205 unit to the antenna. A low-loss coaxial cable is suggested to minimize cable losses. One end of the cable will require an N-type male connector (plug) to mate with the TRACER 4205 unit. The other end of the coax will require a connector compatible with the antenna chosen for the installation, which is usually also an N-type male connector (plug). Additionally, it is recommended that both connectors on the coaxial cable be weatherproofed from the elements to prevent corrosion and electrical shorting.

Table 3 gives typical loss figures for some of the more common coaxial cable types, per 100 feet

Table 4. Typical Coaxial Loss for Common Cable Types, per 100ft

Cable Type	Cable Loss (dB/ft)
RG-213, RG-214, RG-293	20
1/4" Coax	11.36
3/8" Coax	9.65
1/2" Coax	6.49
5/8" Coax	4.90
RG-58, RG-8 (air, foam)	Not Recommended
7/8", 1 1/4", 1 5/8" Coax	Not Recommended
5.8 GHz Elliptical Waveguide	1.23

In certain areas where lightning strikes are frequent, a lightning arrestor should be installed directly on the antenna coax. This will help protect the RF electronics in the downstream path from damaging voltages and currents, including the TRACER 4205 unit.

8. RECEIVER SENSITIVITY

Receiver sensitivity is a value expressed in decibels referenced to one milliwatt (dBm) that corresponds to the minimum amount of signal power needed at the receiver to achieve a given bit error rate (BER).

Receiver sensitivity is usually a negative number of decibels, and as such smaller receiver sensitivity is better for a given BER. Several factors affect receiver sensitivity, including the data bandwidth of the wireless link, and the amount of additional signal degradation introduced in the receiver electronics. The receiver sensitivity of the TRACER 4205 is -78 dBm at 10^{-6} BER.

9. FADE MARGIN

Fade margin is a value indicating the amount of extra signal power available to the receiver to operate at a maximum bit error rate (BER). Higher levels of fade margin are better, and will protect the viability of the microwave link against signal fading. For most applications, 20 to 30 dB of fade margin should ensure a reliable link. Fade margin is simply the difference between the available signal power at the receiver and the receiver sensitivity, discussed previously:

$$F = P_R - P_{sens} = P_R + G_T + G_R - L - L_P - P_{sens} \quad (\text{dB})$$

10. PATH AVAILABILITY

The path availability of a wireless link is a metric that expresses the fractional amount of time a link is available over some fixed amount of time, and depends on several factors. Path availability is expressed as

$$A = [1 - (2.5 \times 10^{-6})abfd^3(10^{-F/10})] \times 100\% \quad (\text{dB})$$

where the parameters are

- a terrain factor
- b climate factor
- f carrier frequency (GHz)
- d path length (miles)
- F fade margin (dB)

The terrain factor is a quantity that compensates the link availability for different types of terrain. Generally speaking, the more smooth an area's terrain is, the less availability a wireless link running over that terrain will have, primarily due to multipath reflections. In contrast, secondary microwave signals will be randomly dispersed over rough terrain, and will not interfere with the main signal lobe as badly as in the smooth terrain case. The terrain factor values normally used are listed below:

Terrain	Terrain Factor	Description
Smooth	4	water, flat desert
Average	1	moderate roughness
Mountainous	1/4	very rough, mountainous

The climate factor is a quantity that compensates the link availability for different types of climates (weather). In general, microwave links operating in areas with high humidity will have less availability than those in arid areas, primarily because water is a dispersive mechanism to microwave energy, and causes the main signal lobe to refract and disperse away from the receiver location. The climate factor values normally used are listed below.

Climate	Climate Factor	Description
Very Dry	1/8	desert regions
Temperate	1/4	mainland, interior region
Humid	1/2	humid and coastal regions

ENGINEERING GUIDELINES

CONTENTS

Equipment Dimensions	24
Power Requirements	24
Reviewing the Front Panel Design	24
RSSI Monitoring Interface	24
TX PWR Monitoring Interface	25
Front Panel LEDs	25
Reviewing the TRACER 4205 Rear Panel Design	26
Antenna Interface	27
Fuse	27
DC Power Connection	27
Alarm Contacts	28
DS3 (In and Out) Connection	28
RS-232 Connection (Terminal Use)	28
RS-232 Connection (Modem Use)	30
At-A-Glance Specifications	31

FIGURES

Figure 1. TRACER 4205 Front Panel Layout	24
Figure 2. TRACER 4205 Rear Panel Layout	27

TABLES

Table 1. TRACER 4205 Front Panel Description	25
Table 2. TRACER 4205 LEDs	25
Table 3. DC Power Connector Pinout	27
Table 4. Alarm Contact Connector Pinout	28
Table 5. RS-232 Connection Pinout	29
Table 6. TRACER 4205 (DCE) to Terminal (DTE) Diagram (DB-25)	29
Table 7. TRACER 4205 (DCE) to Personal Computer (DB-9)	29
Table 8. TRACER 4205 (DCE) to Modem (DCE)	30

1. EQUIPMENT DIMENSIONS

The TRACER 4205 unit is 19" W, 10.5" D, and 1.75" H, weighs 7 lbs, and can be used in rack-mount configurations.

2. POWER REQUIREMENTS

The TRACER 4205 system has a maximum power consumption of 25W and a maximum current draw of 1.2A (at 21 VDC).

3. REVIEWING THE FRONT PANEL DESIGN

The front panel contains a single control switch for activating a DS3 line loopback, RSSI and TX PWR monitoring interfaces, a GND interface for reference with the monitoring interfaces, and status LEDs to provide visual information about the TRACER 4205 system. Figure 1 identifies the DS3 loopback switch, the various bantam interfaces, and the LEDs.

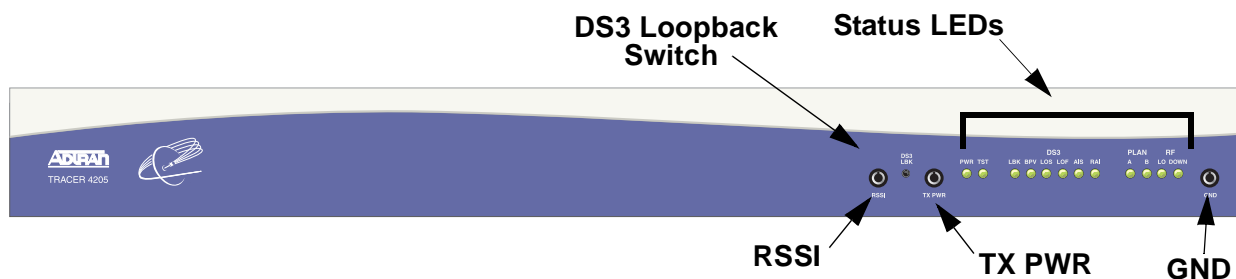

Figure 1. TRACER 4205 Front Panel Layout

RSSI Monitoring Interface

The RSSI voltage is a function of the signal strength at the receiver and is used to measure the received signal strength. RSSI varies approximately from 0 to greater than 4 Volts (V), with 0V corresponding to a weaker received signal and 4V or better corresponding to a stronger received signal.



The voltage level present at the RSSI test point represents only a relative signal level of receive strength from the far end. No direct correlation can be made between RSSI voltage levels and actual receive levels in dBm. This test point is provided to assess relative signal level for alignment of antennas.

TX PWR Monitoring Interface

The TX PWR voltage is a function of the selected transmit power level. This voltage ranges approximately from 0 to 5V, with 0V corresponding to +5 dBm (3 milliwatts) and 5V corresponding to +20 dBm (100 milliwatts).

Front Panel LEDs

With the TRACER 4205 powered-on, the front panel LEDs provide visual information about the status of the TRACER 4205 system. Table 1 provides a brief description of the front panel features, and Table 2 (continued on page 27) provides detailed information about the LEDs.

Table 1. TRACER 4205 Front Panel Description

Feature	Description
DS3 Loopback Switch	Allows quick activation/deactivation of DS3 line loopbacks
RSSI Interface	DC voltage indicating strength of the received signal at the antenna
TX PWR Interface	DC voltage indicating strength of transmitted signal
GND Interface	Ground reference for RSSI and TX PWR Interfaces
Status LEDs	Provides status information about the system

Table 2. TRACER 4205 LEDs

For these LEDs...	This color light...	Indicates that...
PWR	Green (solid)	the TRACER 4205 is connected to a power source.
	Off	the TRACER 4205 is not currently powered up.
PLAN A	Green (solid)	the TRACER 4205 is transmitting on Frequency Plan A.
	Off	the TRACER 4205 is not transmitting on Frequency Plan A.
PLAN B	Green (solid)	the TRACER 4205 is transmitting on Frequency Plan B.
	Off	the TRACER 4205 is not transmitting on Frequency Plan B.
RF DOWN	Red (solid)	there is a communication problem between the local and remote TRACER 4205 systems.
RF LOW	Red (solid)	the RSSI level is below suggested minimum threshold.
TST	Amber (solid)	unit is performing power-on self-test.
RAI	Red (solid)	the TRACER 4205 received a remote alarm in the DS3 EOC channel (bits X1 and X2 are both set to zero).

Table 2. TRACER 4205 LEDs (Continued)

For these LEDs...	This color light...	Indicates that...
AIS	Red (solid)	the TRACER 4205 received a remote alarm from a connected DS3 device (properly aligned and framed alternating one-zero pattern).
LOF	Red (solid)	the TRACER 4205 DS3 framer has lost alignment (due to receiving too many F or M bits in error).
LOS	Red (solid)	the TRACER 4205 does not detect a DS3 from the connected DS3 device signal (indicated by receiving 192 consecutive zeros).
BPV	Red (solid)	the TRACER 4205 detects Bipolar Violations on the received signal from the connected DS3 device (receiving two consecutive "one" bits with the same polarity).
LBK	Amber (solid)	the TRACER 4205 is currently in DS3 line loopback.
	Amber (flashing)	the TRACER 4205 is currently in DS3 link loopback.

4. REVIEWING THE TRACER 4205 REAR PANEL DESIGN

The TRACER 4205 rear panel contains the following interfaces:

- **ALARM** interface (terminal block) for connecting to an external alarm monitoring system
- **DC POWER** (terminal block) for connecting to a proper 21-63 VDC power source
- **DS3 IN** and **OUT** (BNC interfaces) for connecting to a DS3 device
- Antenna (N-Type connector) for the antenna feedline cable
- Ground lug for connecting to earth ground
- **RS-232** (DB-25 female) for connecting to a VT100 terminal or PC with terminal emulation software

Figure 2 on page 27 identifies the various features of the TRACER 4205 rear panel. A detailed discussion of all interfaces (including pinouts, where applicable) follows the figure.

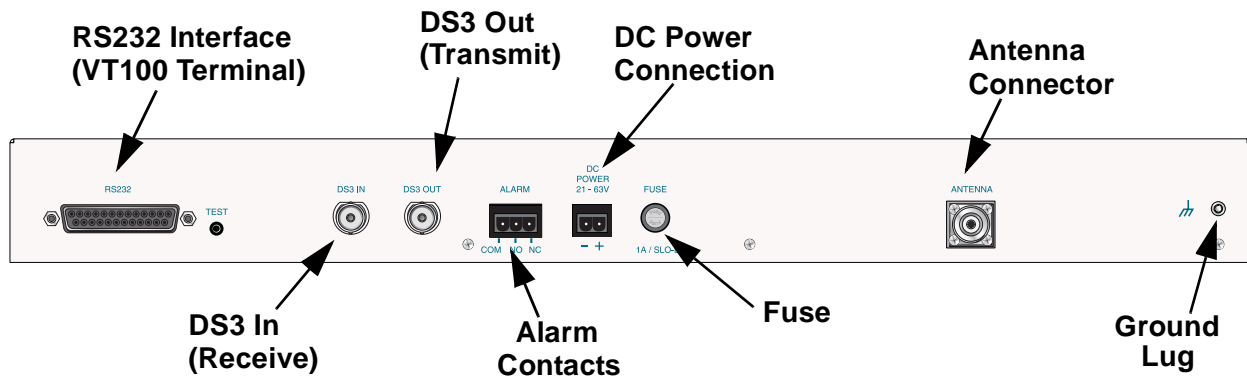

Figure 2. TRACER 4205 Rear Panel Layout

Antenna Interface

The **ANTENNA** interface (N-Type connector) connects to the antenna (customer supplied) using standard antenna feedline cable. When determining the cable specifications for your application, refer to Section 2, *Microwave Path Engineering Basics (Coaxial Cable* on page 20) for a discussion on cable length and loss factors.

Fuse

The fuse holder, accessible from the rear panel of the TRACER 4205, accepts a generic 1 Amp, 2-inch slow-blo fuse.

DC Power Connection

The TRACER 4205 can operate from a supply between 21 and 63 VDC, with either polarity referenced to ground, and consumes less than 25 Watts (W). Power supplies should be able to provide up to 30 W at the selected voltage. Current required (in amps) is determined by dividing the power consumed (in watts) by the applied voltage (in volts). For example, at 48 V, TRACER 4205 would draw approximately 0.52 A (25 W/48 V).

Connector type Terminal Block

Table 3. DC Power Connector Pinout

PIN	NAME	DESCRIPTION
1	+	POSITIVE LEAD (referenced to ground)
2	-	NEGATIVE LEAD (referenced to ground)

Alarm Contacts

Normally open (NO) and normally closed (NC) alarm contacts are provided on the rear panel of the TRACER 4205 system. In normal operation, the NC contact is electrically connected to the common contact (COM) and the NO contact is isolated. During an alarm condition, the NC contact becomes isolated and the NO is electrically connected to COM. This allows alarm conditions to be reported to external alarm monitoring systems.

Connector type Terminal Block

Table 4. Alarm Contact Connector Pinout

PIN	NAME	DESCRIPTION
1	COM	COMMON CONTACT
2	NO	NORMALLY-OPEN CONTACT
3	NC	NORMALLY-CLOSED CONTACT

DS3 (In and Out) Connection

The physical DS3 interface is provided by a pair of 75 Ω BNC connectors for transmit and receive.



The shielding on both BNC connectors are grounded per ANSI T1.404.

RS-232 Connection (Terminal Use)

The RS-232 connector provides a female DB-25 terminal connection (wired as a DCE interface), which is used for terminal access to the TRACER 4205 system. The RS-232 port provides the following functions:

- Accepts EIA-232 input from a PC or terminal for controlling the TRACER 4205 system
- Operates at 9600 bps

Table 5 on page 29 shows the pinout. Wiring diagrams for connecting to the RS-232 connector (for various applications) are provided following the pinout.

Connector type (USOC) DB-25

Table 5. RS-232 Connection Pinout

PIN	NAME	DESCRIPTION
1, 7	GND	GROUND
2	TX	TRANSMIT
3	RX	RECEIVE
4	RTS	REQUEST TO SEND
5	CTS	CLEAR TO SEND
6	DSR	DATA SET READY (MODEM CONTROL ONLY)
8	CD	CARRIER DETECT
9-19	—	UNUSED
20	DTR	DATA TERMINAL READY (MODEM CONTROL ONLY)
21	—	UNUSED
22	RI	RING INDICATOR
23-25	—	UNUSED

Table 6. TRACER 4205 (DCE) to Terminal (DTE) Diagram (DB-25)

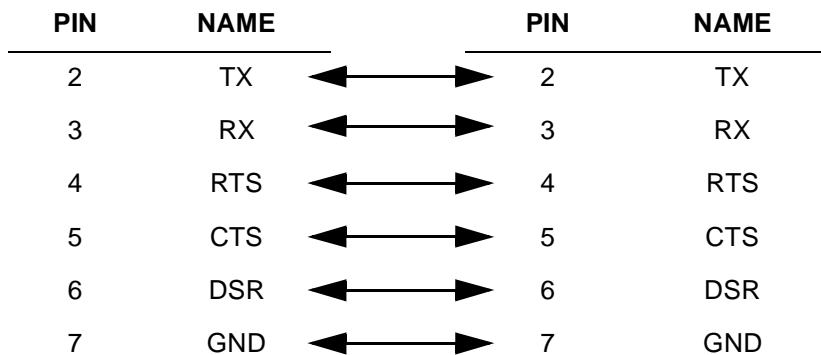
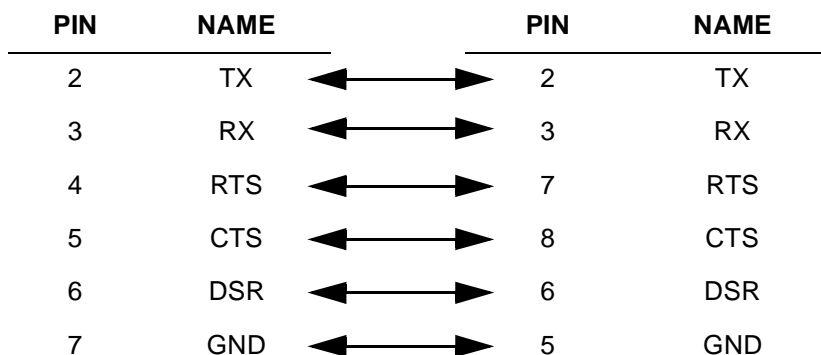

Table 7. TRACER 4205 (DCE) to Personal Computer (DB-9)



RS-232 Connection (Modem Use)

Modem controls, discussed in Section 5, *User Interface Guide*, of this manual, will enable or disable modem control through the RS-232 interface. When this option is enabled from a standard terminal connection, all RS-232 communications will cease until a modem is attached with a null modem adapter between the TRACER 4205 and the data modem. The data modem should be configured for AUTO ANSWER and 9600 bps. When the user connects via modem to the TRACER 4205 unit, communications via the RS-232 port will resume. If a user accidentally enables modem control from a terminal and disrupts the RS-232 communication, pressing <Ctrl + Z> three times will temporarily disable the modem control option (until the system is reset) and access the system configuration to disable modem control.

The TRACER 4205 must be interfaced to a modem via an RS-232 null modem adapter or cable. The null modem will convert Clear To Send (CTS) and Data Set Ready (DSR) into Ready To Send (RTS) and Data Terminal Ready (DTR), respectively. These signals will indicate (to most modems) that a valid DTE terminal device is present. The null modem interface must route Carrier Detect (CD) on pin 8 directly from the modem, and the modem must source CD only when actually connected to a carrier when using the RS-232 interface for modem control.

When **MODEM CONNECTION** is selected in the menu system, the TRACER 4205 will de-assert DTR and DSR for a time greater than 20 ms. The null modem will consequently drop DTR and RTS at the modem interface, signaling the modem to hang up the line. If password functionality is enabled in the TRACER 4205, selecting **MODEM CONNECTION** (logout) will reset the TRACER 4205 to the password entry screen.



Hangup-on-DTR-drop may need to be explicitly enabled on some modems.

Table 8 contains the wiring diagram needed for connecting the TRACER 4205 RS-232 interface to a modem using the null modem adapter.

Table 8. TRACER 4205 (DCE) to Modem (DCE)

PIN	NAME		PIN	NAME
2	TX	←→	3	RX
3	RX	←→	2	TX
4	RTS	←→	5	CTS
5	CTS	←→	4	RTS
6	DSR	←→	20	DTR
7	GND	←→	7	GND
8	CD	←→	8	CD

5. AT-A-GLANCE SPECIFICATIONS

The following is a list of specifications for the TRACER 4205 system.

Hardware	Description	Specification
Transmitter		
	Output Power	+20 dBm, max
	Frequency Range	5725 to 5850 MHz
Receiver		
	Receive Level, Range	-30 to -78 dBm
	Receive Level, Maximum	-30 dBm
	Receive Level, Nominal	-50 dBm
Frequency Plan		
	Plan A	Tx 5.750 GHz, Rx 5.800 GHz
	Plan B	Tx 5.800 GHz, Rx 5.750 GHz
DS3 Interface		
	Capacity	44.736 Mbps
	Connection	dual 75 Ω BNC connectors (Tx and Rx)
	Line Code	B3ZS
	Framing	M13, C-Bit Parity
	Alarms	AIS, Red, Yellow, BPVs
	Loopbacks	Local and remote (line and link)
User Interface		
	Diagnostics	DS3 Line and Link Loopbacks
	Test Points	RSSI, Tx PWR
VT100 Terminal Interface		
	Data Rate	9600 bps
	Data Bits	8
	Parity	None
	Stop Bits	1
	Terminal Emulation	VT100

Hardware	Description	Specification
Mechanical and Environmental		
	Operating Temperature	-25°C to 65°C
	Size	19" W x 10.5" D x 1.75" H
	Humidity	95%, Non-condensing
	Weight	7 lbs
Power		
	Input Voltage	21 to 63 VDC, either polarity referenced to ground
	Power Consumption	≤ 25 Watts
	Connector	2 pin terminal block (DC)
	Fuse	1 amp, 250 Volt slow-blo fuse (2-inch)

NETWORK TURNUP PROCEDURE

CONTENTS

Introduction	34
Tools Required	34
Unpack and Inspect the System	34
Contents of ADTRAN Shipment	34
Customer Provides	34
Channel Selection	35
Grounding Instructions	35
Supplying Power to the Unit	36
Mounting Options	36
Connecting the DS3 Interface	36

FIGURES

Figure 1. Bandwidth Division.....	35
-----------------------------------	----

1. INTRODUCTION

This section discusses the installation process of the TRACER 4205 system.

WARNING

Changes or modifications not expressly approved by ADTRAN could void the user's authority to operate the equipment.

2. TOOLS REQUIRED

The tools required for the installation of the TRACER 4205 are:

- VT100 terminal or PC with terminal emulation software
- RS-232 (DB-25 male for TRACER 4205 end) cable for connecting to terminal



To prevent electrical shock, do not install equipment in a wet location or during a lightning storm.

3. UNPACK AND INSPECT THE SYSTEM

Each TRACER 4205 is shipped in its own cardboard shipping carton. Open each carton carefully and avoid deep penetration into the carton with sharp objects.

After unpacking the unit, inspect it for possible shipping damage. If the equipment has been damaged in transit, immediately file a claim with the carrier, then contact ADTRAN Customer Service (see *Warranty and Customer Service* information in the front of this manual).

Contents of ADTRAN Shipment

Your ADTRAN shipment includes the following items:

- TRACER 4205 unit
- TRACER 4205 Documentation CD

Customer Provides

The following items are necessary for the installation of the TRACER 4205 system and are not provided by ADTRAN:

- 21 to 63 VDC power source (or AC adapter available from ADTRAN P/N 1280650L1), either polarity referenced to ground
- Antenna and mounting hardware
- Antenna feedline cable
- DS3 cables (BNC for TRACER 4205 end) for connecting to DS3 equipment

4. CHANNEL SELECTION

The FCC has allocated 100 MHz of spectrum in the band in which the TRACER 4205 operates. Figure 1 illustrates the bandwidth division.

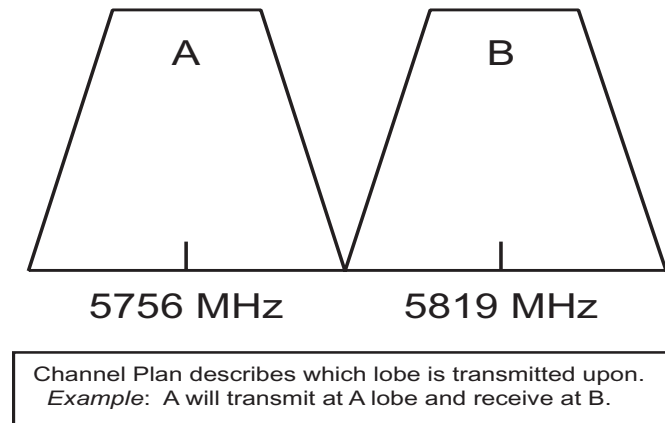

Figure 1. Bandwidth Division

To designate the utilization of the ISM bandwidth, there are two different channel plans, labeled A and B. The letter of each channel plan setting is preset by the factory and refers to the physical configuration of the diplexer filter inside the environmental housing. The transmitter at one end of the link will transmit in the lower portion of the spectrum and receive in the upper portion. Consequently, the receiver at the other end should receive in the lower portion and transmit in the upper portion. There is one rule for successful TRACER 4205 configuration.

1. The letter of the channel plan must be different on both ends. Shipment of a link will consist of one Plan A and Plan B unit.

5. GROUNDING INSTRUCTIONS

The following provides grounding instruction information from the Underwriters' Laboratory UL 60950 Standard for Safety of Information Technology Equipment Including Electrical Business Equipment, of December, 2000.

An equipment grounding conductor that is not smaller in size than the ungrounded branch-circuit supply conductors is to be installed as part of the circuit that supplies the product or system. Bare, covered, or insulated grounding conductors are acceptable. Individually covered or insulated equipment grounding conductors shall have a continuous outer finish that is either green, or green with one or more yellow stripes. The equipment grounding conductor is to be connected to ground at the service equipment.

The attachment-plug receptacles in the vicinity of the product or system are all to be of a grounding type, and the equipment grounding conductors serving these receptacles are to be connected to earth ground at the service equipment.

A supplementary equipment grounding conductor shall be installed between the product or system and ground that is in addition to the equipment grounding conductor in the power supply cord.

The supplementary equipment grounding conductor shall not be smaller in size than the ungrounded branch-circuit supply conductors. The supplementary equipment grounding conductor shall be connected to the product at the terminal provided, and shall be connected to ground in a manner that will retain the ground connection when the product is unplugged from the receptacle. The connection to ground of the supplementary equipment grounding conductor shall be in compliance with the rules for terminating bonding jumpers at Part K or Article 250 of the National Electrical Code, ANSI/NFPA 70. Termination of the supplementary equipment grounding conductor is permitted to be made to building steel, to a metal electrical raceway system, or to any grounded item that is permanently and reliably connected to the electrical service equipment ground.

The supplemental grounding conductor shall be connected to the equipment using a number 8 ring terminal and should be fastened to the grounding lug provided on the rear panel of the equipment. The ring terminal should be installed using the appropriate crimping tool (AMP P/N 59250 T-EAD Crimping Tool or equivalent.)



The supplemental equipment grounding terminal is located on the rear panel of the TRACER 4205.

6. SUPPLYING POWER TO THE UNIT

The TRACER 4205 can operate from a supply between 21 and 63 VDC, with either polarity referenced to ground. Power supplies should be able to provide up to 30 watts at the selected voltage. A dual pin terminal plug accepts power at the rear panel of the unit, providing a + and - polarity reference point. Adapters for this plug are available (P/N 1175043L2) and are furnished with the unit and optional power supply (P/N 1280650L1).

7. MOUNTING OPTIONS

Install the TRACER 4205 in a location that requires minimal antenna feedline length (the loss in this cable directly affects overall system performance). The TRACER 4205 is designed to be mounted in a rack. If multiple units are installed in one location, one half inch of spacing is recommended above and below the unit.

8. CONNECTING THE DS3 INTERFACE

The physical DS3 interface is provided using a pair of 75 Ω BNC connectors for transmit and receive. Using standard coaxial cable, connect the **DS3 OUT** interface of the TRACER 4205 to the receive data interface of the DS3 equipment. Connect the **DS3 IN** interface of the TRACER 4205 to the transmit data interface of the DS3 equipment.

USER INTERFACE GUIDE

CONTENTS

Navigating the Terminal Menu	38
Terminal Menu Window	38
Navigating using the Keyboard Keys	39
Terminal Menu and System Control	39
Password Protection	39
Menu Descriptions	40
>TRACER System Status	40
>Main Menu	42
>TRACER System Configuration	43
>TRACER Link Performance History	45
>DS3 Status/Configuration/Loopback	46
>DS3 Performance History	48

FIGURES

Figure 1. Main Menu Screen	38
Figure 2. TRACER System Status	40
Figure 3. Main Menu	42
Figure 4. TRACER System Configuration	43
Figure 5. TRACER Link Performance History	45
Figure 6. DS3 Status/Configuration/Loopback	46
Figure 7. DS3 Link Loopback	47
Figure 8. DS3 Line Loopback	48
Figure 9. DS3 Link Performance History	48

TABLES

Table 1. DS3 Interface Alarms	46
-------------------------------------	----

1. NAVIGATING THE TERMINAL MENU

The TRACER 4205 menu system can be accessed with a VT100 compatible terminal set to 9600 bits per second, 8 data bits, 1 stop bit, and no parity, connected to the RS-232 port located on the back of the unit. Flow control on the serial interface should be configured to None for proper operation. Once a terminal is connected, pressing <Ctrl + L> will refresh the current screen. If password access has been enabled, the **ENTER PASSWORD** message will be displayed at the bottom of the TRACER 4205 system status menu.



All TRACER 4205 systems are shipped factory default with password protection disabled.

Terminal Menu Window

The TRACER 4205 uses five menu pages and a single main menu page to access its many features. The main menu page (see Figure 1) provides a link to all available configuration/status pages.



After connecting a VT100 terminal to the TRACER 4205, press <Ctrl + L> to redraw the current screen. VT100 access will not be possible until this step is performed.

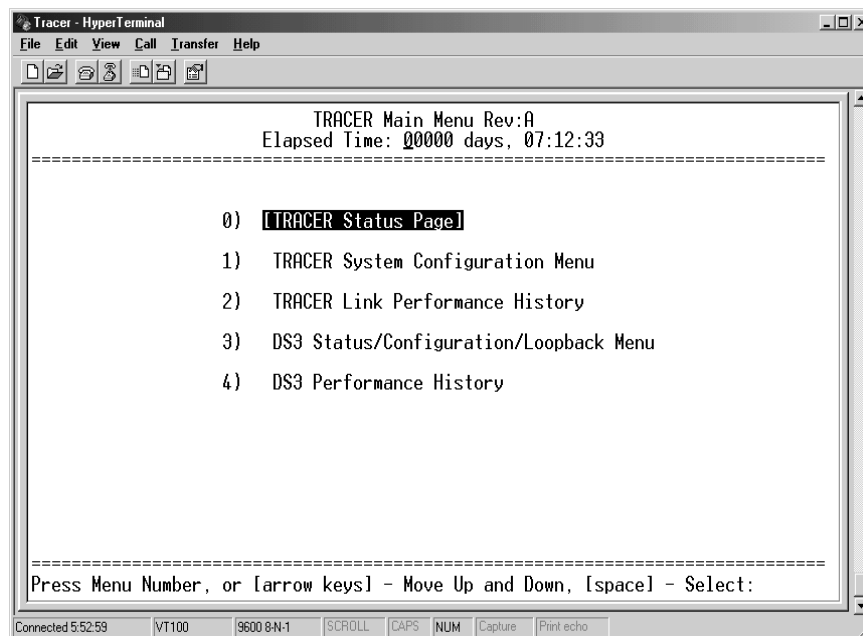

Figure 1. Main Menu Screen

Navigating using the Keyboard Keys

You can use various keystrokes to move through the terminal menu, to manage a terminal menu session, and to configure the system.

Moving through the Menus

To do this...	Press this key...
Move up to select items	Up Arrow
Move down to select items	Down Arrow
Edit a selected menu item	Enter
Scroll through configuration parameters for a menu item	Spacebar Left/Right Arrows P or N (Prev/Next)
Cancel an edit	Escape
Return to Main Menu page	M

Session Management Keystrokes

To do this...	Press this key...
Log into a session	Spacebar
Refresh the screen To save time, only the portion of the screen that has changed is refreshed. This option should only be necessary if the display picks up incorrect characters	<Ctrl + L>

2. TERMINAL MENU AND SYSTEM CONTROL

Password Protection

The TRACER 4205 provides optional password protection of the terminal interface. If enabled, a password prompt is presented at power-up, reboot, modem logout, or after ten minutes of inactivity on the terminal. Password protection is enabled and a password is defined via the system configuration menu.



All TRACER 4205 systems are shipped factory default with password protection disabled.

If the password is forgotten, physical access to the TRACER 4205 unit is required to access the terminal interface. The password may be bypassed by pressing the **DS3 LBK** button while the system is rebooted. This disabled the password and will initialize the TRACER 4205 system status menu to allow the password to be changed (via the configuration screen).



Rebooting the unit to bypass password protection and redefine the installed password is service affecting.

3. MENU DESCRIPTIONS

The remainder of this section describes the TRACER 4205 menus and submenus.

NOTE

The menu structure of the TRACER 4205 system is depicted below as follows:

- > **MENU PAGE**
- > **MENU PAGE > MENU SELECTION**
- > **MENU PAGE > MENU SELECTION > SUB-MENU**

>TRACER SYSTEM STATUS

Figure 2 shows the TRACER System Status menu page. Status of major system components for both sides of the TRACER link are displayed, but no configuration can be performed from this view.

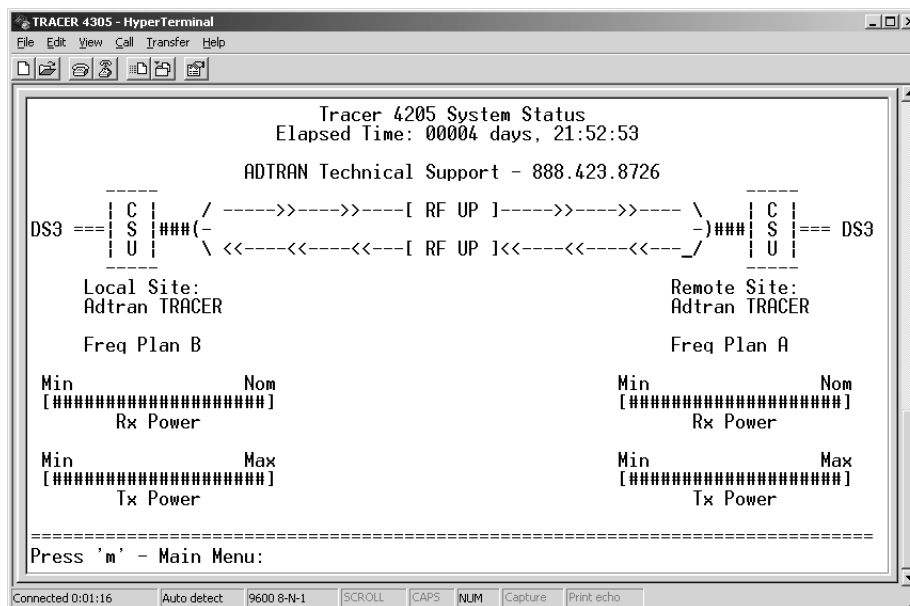

Figure 2. TRACER System Status

The top of the TRACER System Status menu page displays the elapsed time the TRACER 4205 system has been operational since the last power reset. Located directly beneath the ADTRAN Technical Support phone number is a graphical indicator of the status of the TRACER 4205 DS3 and RF links (as reported by both the local and remote units). The **DS3** labels will be reverse highlighted if any error conditions exist on that DS3 interface.

The status of the received radio link is indicated as **RF UP** or **RF DOWN** for each direction. The left portion of the menu page reports the status of the local TRACER 4205 (the system where the active terminal is attached). The right portion of the screen reports the status of the remote system. If the RF link is down from the remote unit to the local unit, **LOCAL RX LINK ERROR** will be displayed. If the RF link is down from the local unit to the remote unit, or if the RF link status cannot be determined, **REMOTE RX LINK ERROR** will be displayed.



Press <0> from any menu in the TRACER 4205 VT100 menu structure to access the TRACER System Status page.

>TRACER SYSTEM STATUS > FREQUENCY PLAN

Displays the frequency plan (A or B) for the TRACER 4205 unit. For an operational TRACER 4205 system, the local and remote units should display opposite frequency plans.

>TRACER SYSTEM STATUS > SITE

Displays the site name configured from the TRACER System Configuration page.

>TRACER SYSTEM STATUS > RX POWER

Displays the approximate receiver levels (for both the local and remote units) using a series of symbols (#). The more symbols (#) displayed, the stronger the signal. If the link is down and remote end data is unavailable, **DATA NOT AVAILABLE** is displayed in place of the symbols (#).

>TRACER SYSTEM STATUS > TX POWER

Displays the approximate transmitter levels (for both the local and remote units) using a series of symbols (#). The more symbols (#) displayed, the stronger the signal. If the link is down and remote end data is unavailable, **DATA NOT AVAILABLE** is displayed in place of the symbols (#).

>MAIN MENU

The TRACER 4205 Main Menu page provides access to all other configuration/status pages. Figure 3 shows the TRACER Main Menu page.

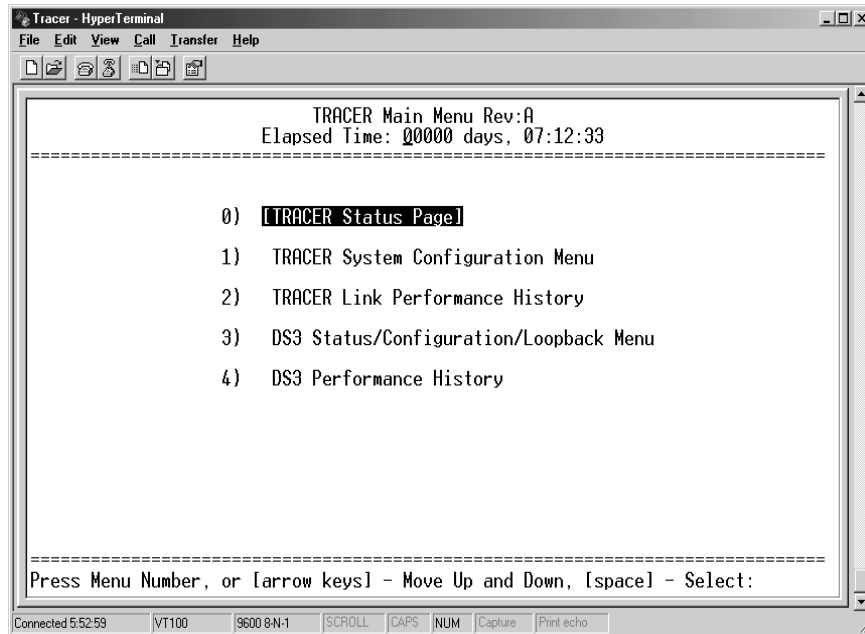

Figure 3. Main Menu

Use the up and down arrow keys to scroll through the available pages, or enter the number of the selected page (to highlight the menu page) and press <Enter>.



Press <M> from any menu in the TRACER 4205 VT100 menu structure to access the TRACER Main Menu page.

>TRACER SYSTEM CONFIGURATION

Figure 4 shows the TRACER System Configuration menu page. System configuration parameters for both the local and remote TRACER 4205 units are available through this menu page.

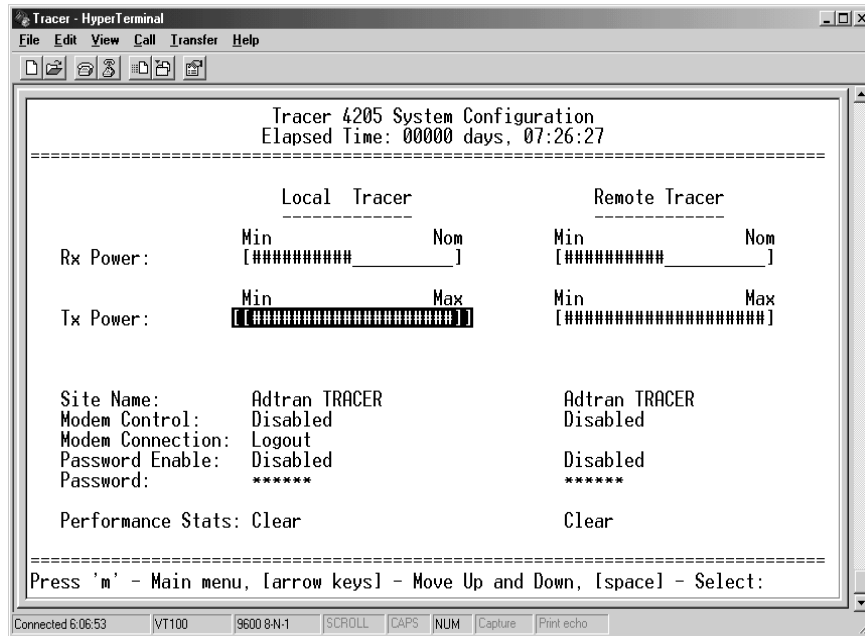

Figure 4. TRACER System Configuration

NOTE *Press <I> from any menu in the TRACER 4205 VT100 menu structure to access the TRACER System Configuration menu page.*

>TRACER SYSTEM CONFIGURATION > RX POWER

Displays the approximate receiver levels (for both the local and remote units) using a series of symbols (#). The more symbols (#) displayed, the stronger the signal. If the link is down and remote end data is unavailable, **DATA NOT AVAILABLE** is displayed in place of the symbols (#). This parameter is display only.

>TRACER SYSTEM CONFIGURATION > TX POWER

Allows the transmitter levels (for both the local and remote units) to be adjusted. The current transmitter level is displayed using a series of symbols (#). The more symbols (#) displayed, the stronger the signal. If the link is down and remote end data is unavailable, **DATA NOT AVAILABLE** is displayed in place of the symbols (#).

CAUTION *Reducing the transmitter power of the remote TRACER 4205 could negatively impact the TRACER RF link.*

>TRACER SYSTEM CONFIGURATION > SITE NAME

Enter up to 32 alphanumeric characters to be displayed for identification of the TRACER 4205 system.

>TRACER SYSTEM CONFIGURATION > MODEM CONTROL

Configures the modem control leads on the RS-232 port (terminal interface located on the rear panel of the unit). Set **MODEM CONTROL** to **ENABLED** when connecting the unit to a modem (using a null modem adapter). Setting **MODEM CONTROL** to **DISABLED** prevents the TRACER 4205 from monitoring DCD and enables data to be sent to the VT 100 continuously. **MODEM CONTROL** must be set to **DISABLED** when the VT100 terminal is in use. The TRACER 4205 comes factory programmed with **MODEM CONTROL** set to **DISABLED**.



*Press <Ctrl+Z> three times from the terminal interface to temporarily disable **MODEM CONTROL** when the modem control leads are active.*

>TRACER SYSTEM CONFIGURATION > MODEM CONNECTION (LOGOUT)

Activator to cause the TRACER 4205 to de-assert Clear To Send (CTS) and DSR for a time greater than 20 milliseconds. This signals the modem to disconnect the analog connection. Hangup-On-DTR-Drop may need to be explicitly enabled on some modems. If **PASSWORD PROTECTION** is **ENABLED**, this menu also causes the unit to close the current session and return to the TRACER System Status menu page and wait for password input.

>TRACER SYSTEM CONFIGURATION > PASSWORD ENABLE

Configures password protection for the VT100 terminal interface. Password protection for the TRACER 4205 requires password input from the TRACER System Status menu page when connecting to the unit. When configured for Password protection, the TRACER 4205 closes any terminal session that remains inactive for more than 10 minutes. The TRACER 4205 comes factory programmed with **PASSWORD ENABLE** set to **DISABLED**.

>TRACER SYSTEM CONFIGURATION > PASSWORD

Sets the password for password protection of the TRACER 4205 VT100 terminal interface. Enter up to 8 alphanumeric characters. The system password is case sensitive.



*The default password for the TRACER 4205 is **tracer**.*

>TRACER SYSTEM CONFIGURATION > PERFORMANCE STATS (CLEAR)

Activator to reset all system error counters for the TRACER 4205.

>TRACER LINK PERFORMANCE HISTORY

Figure 5 shows the TRACER Link Performance History menu page. The TRACER Link Performance History menu page displays detailed error statistics for the RF link (from both the local and remote TRACER 4205 units) in 15-minute increments.

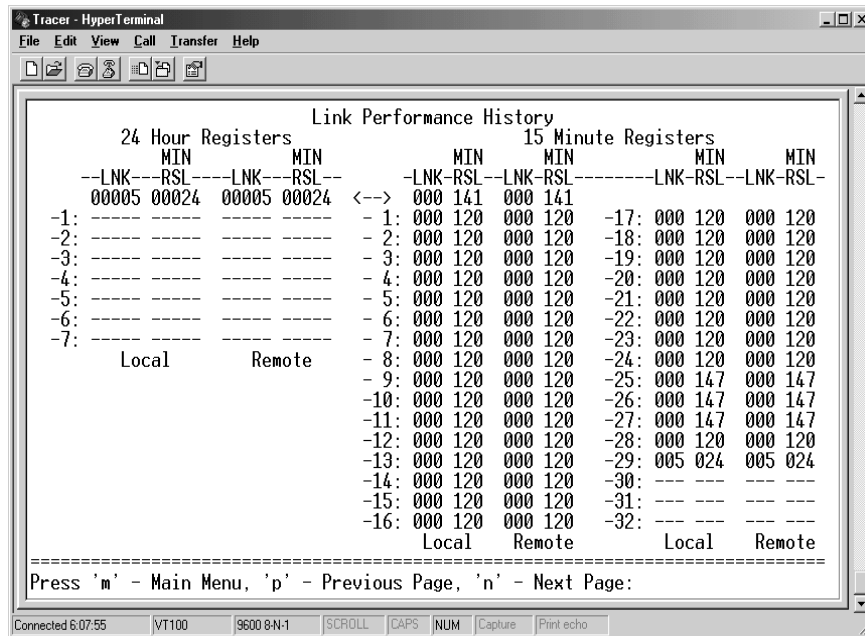

Figure 5. TRACER Link Performance History

RF performance data is presented as link (LNK) errors which represent errored seconds received on the wireless link. This is generally an indication of path or interference problems.

The minimum received signal level (MIN RSL) is represented as a numerical value from 0 to 255 with 0 corresponding to no receive power and 255 corresponding to an extremely hot signal. The minimum received signal level is directly related to RSSI.

The error count for the most recent 24 hours are recorded and displayed on the right side of the page. The left side of the page displays the 24 hour totals for the most recent 7 days.

NOTE Press <N> to view the next 8 hours worth of 15-minute totals and <P> to view the previous 8 hours.

NOTE Press <2> from any menu in the TRACER 4205 VT100 menu structure to access the TRACER Link Performance History menu page.

>DS3 STATUS/CONFIGURATION/LOOPBACK

Figure 6 shows the DS3 Status/Configuration/Loopback menu page. Real-time graphical representation for the DS3 link (using data from both the local and remote TRACER 4205 units) is displayed on this page. DS3 operational configuration parameters and testing functions are configured from this menu.

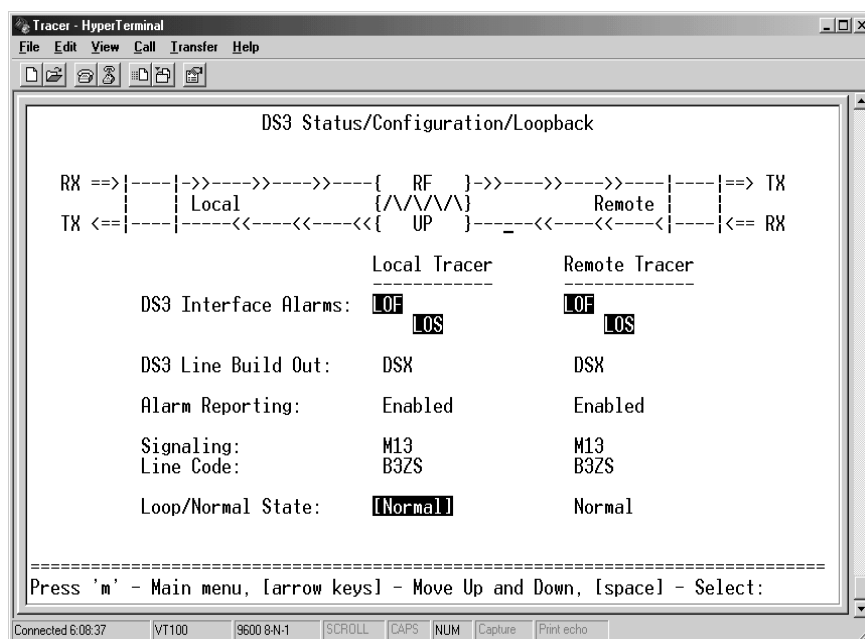

Figure 6. DS3 Status/Configuration/Loopback



Press <3> from any menu in the TRACER 4205 VT100 menu structure to access the DS3 Status/Configuration/Loopback menu page.

>DS3 STATUS/CONFIGURATION/LOOPBACK > DS3 INTERFACE ALARMS

Displays any active alarms on the DS3 link (reported from both the local and remote TRACER 4205 units). These alarms include Red, Blue, Yellow, AIS, and bipolar violations (**BPV**). See Section 6, *Troubleshooting Guide*, for more information on these alarms.

Table 1. DS3 Interface Alarms

BPV	Activates when the incoming DS3 stream presents bipolar violations (BPVs). BPVs are received when two consecutive "one" bits are the same polarity.
AIS	An AIS signal is a properly aligned and framed alternating one-zero pattern. The TRACER 4205 will transmit a blue alarm (RMT) to the remote equipment when an incoming alarm is received from a connected DS3 device. The remote equipment should transmit the AIS yellow alarm which will be passed by the TRACER 4205 to the connected DS3 device.
RMT	Activates when an incoming remote alarm is received (from the DS3 equipment) in the DS3 EOC channel (bits X1 and X2 are both set to zero).

Table 1. DS3 Interface Alarms (Continued)

LOS	Activates when no DS3 signal is present from the connected DS3 equipment. LOS is activated after receiving 192 consecutive zeros.
LOF	Activates when the DS3 framer loses alignment due to too many F bits or M bits in error.
IDLE	Connected DS3 equipment is indicating that the line is not in use by transmitting a properly aligned and frame 1100... pattern.

>DS3 STATUS/CONFIGURATION/LOOPBACK > DS3 LINE BUILD OUT

Configures the DS3 for the appropriate line buildout, based on the distance to the DS3 equipment. Use **DSX** for 0-255 feet and **HIGH** for distances greater than 255 feet.

>DS3 STATUS/CONFIGURATION/LOOPBACK > ALARM REPORTING

Determines whether the TRACER 4205 unit will report active alarms. If **DISABLED**, no alarms will be displayed on this menu page. The **ALARM REPORTING** parameter is independently configured for the local and remote TRACER 4205 units. When disabled, the front panel LED alarms will also be disabled (OFF).

>DS3 STATUS/CONFIGURATION/LOOPBACK > SIGNALING

Configures the framing format for the DS3 link for both the local and remote TRACER 4205 units. The TRACER 4205 transparently transports DS3 data across the link (as long as the DS3 signal is properly timed). Configure the framing format (using the **SIGNALING** menu) to enable the TRACER 4205 to monitor incoming framing error events and indicate problems with the attached metallic service. The TRACER 4205 supports both **M13** and **C-BIT** parity modes.

>DS3 STATUS/CONFIGURATION/LOOPBACK > LINE CODE

Sets the line coding for the DS3 link. The TRACER 4205 supports only **B3ZS** line coding.

>DS3 STATUS/CONFIGURATION/LOOPBACK > LOOP/NORMAL STATE

Controls the loop status of the DS3 link. Activates/deactivates loopback conditions for testing purposes.

>DS3 STATUS/CONFIGURATION/LOOPBACK > LOOP/NORMAL STATE > NORMAL

The DS3 link is in normal data transport mode - there are no active loopbacks.

>DS3 STATUS/CONFIGURATION/LOOPBACK > LOOP/NORMAL STATE > LINK

Activates a loopback at the TRACER 4205 DS3 framer towards the wireless link (see Figure 7). Use the **LINK** loopback to test data path integrity from one unit across the wireless link.



Figure 7. DS3 Link Loopback

>DS3 STATUS/CONFIGURATION/LOOPBACK > LOOP/NORMAL STATE > LINE

Activates a loopback at the TRACER 4205 DS3 framer towards the locally connected DS3 equipment (see Figure 8). Use the **LINE** loopback to test data path integrity from the TRACER 4205 unit to the DS3 equipment.

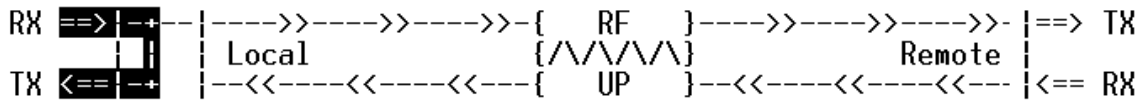

Figure 8. DS3 Line Loopback

>DS3 PERFORMANCE HISTORY

Figure 5 shows the DS3 Performance History menu page. The DS3 Performance History menu page displays detailed error statistics for the DS3 link (from both the local and remote TRACER 4205 units) in 15-minute increments.

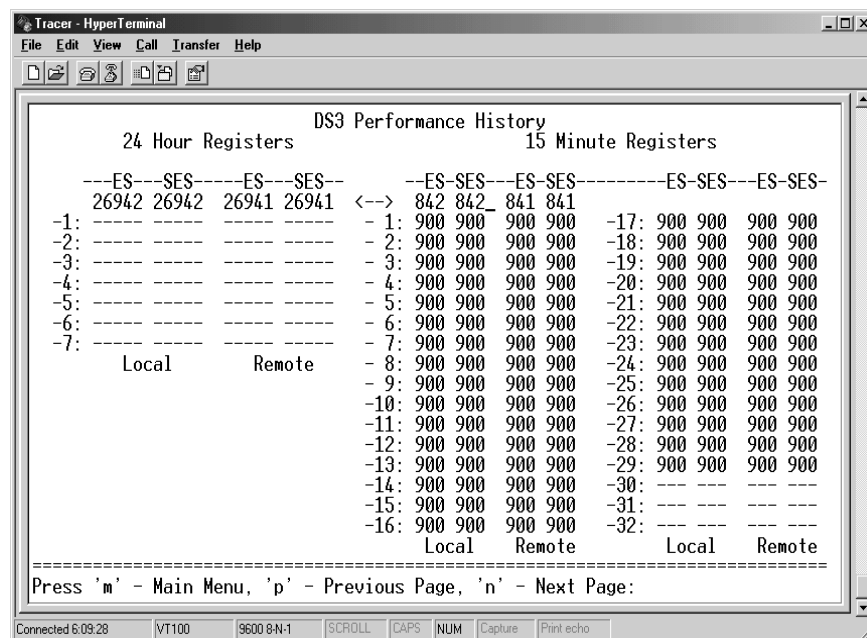

Figure 9. DS3 Link Performance History

DS3 performance data is presented as Errored Seconds (ES) and Severely Errored Seconds (SES) on the DS3 link. The following events qualify as an ES—AIS, LOS or LOF Alarm Second, a single BPV or excessive zero event, or a single parity bit. An SES is caused by an AIS, LOS or LOF Alarm Second, or excessive Bipolar Violations (BPVs) or framed Parity Bit errors causing a line Bit Error Rate (BER) of 10^{-6} .

The error count for the most recent 24 hours are recorded and displayed on the right side of the page. The left side of the page displays the 24 hour totals for the most recent 7 days.



Press <N> to view the next 8 hours worth of 15-minute totals and <P> to view the previous 8 hours.



Press <4> from any menu in the TRACER 4205 VT100 menu structure to access the DS3 Link Performance History menu page.

TROUBLESHOOTING GUIDE

CONTENTS

Overview	52
LED Indicators	52
PWR LED	52
TST LED	52
RF DOWN LED	52
RF LOW LED	53
LOS LED	53
LOF LED	53
AIS LED	54
RAI LED	54
BPV LED	54
RF Errors	54
Step-by-Step Troubleshooting	54
Installing/Troubleshooting the TRACER Hardware	55
Installing/Configuring DS3 Hardware	56

1. OVERVIEW

This troubleshooting guide provides recommended actions for various conditions of the TRACER 4205 system. The status LEDs (located on the front panel of the unit) provide information to help determine the necessary troubleshooting action. Recommended actions for resolving possible status LED indicators are contained in this guide.

2. LED INDICATORS

PWR LED

If the **PWR LED** is not **ON** and solid green, it is an indicator that the TRACER 4205 is not receiving adequate DC power.

Recommended Actions:

1. Verify that the power source is delivering between 21 and 63 VDC.
2. Check the polarity of the power connection (referenced to ground) of both the TRACER 4205 unit and the power source.
3. Check the internal fuse. The fuse is accessed from the rear panel of the unit. If this fuse is open, replace with a 1Amp, 250 Volt (2-inch) slow-blo fuse.

TST LED

The **TST** will remain **ON** (solid Amber) during power-up to indicate a self-test is in progress. If the **TST LED** is blinking or remains **ON** after 10 seconds, this indicates that the TRACER 4205 unit has failed self-test. This is an internal failure, and ADTRAN technical support should be contacted.

RF DOWN LED

If the **RF DOWN LED** is **ON** (solid Red), it is an indicator that there is a problem with the RF link to the TRACER 4205.

Recommended Actions:

1. Check the RF coaxial cable connection.
2. Measure the RSSI voltage. If the signal is acceptable (≥ 2.0 VDC at RSSI test point), go to Step 6.
3. Verify that one end of the link is configured as Plan A and the other end is Plan B.
4. Verify that the antenna polarization is the same at both ends of the RF signal transmit and receive path.
5. Verify the RF signal path is clear.
6. Check for possible interference at both ends of the link. If necessary, change polarization and/or Band Plans at both ends.
7. Check the integrity of lightning arrestors.

RF LOW LED

If the **RF LOW LED** is **ON** (solid Red), it is an indicator that the received signal is within 10 dB (approximately) of the minimum operable signal. This condition is typically indicative of a path problem.

Recommended Actions:

1. Verify the far-end transmitter power setting is the value that the link planning budget allows.
2. Check all coaxial cable connectors for solid connections. Check for water and corrosion around any of the connectors.
3. Verify the RF signal path by verifying the antenna alignment.
4. Check the integrity of the cable plant.
5. Check the integrity of lightning arrestors.

LOS LED

If the **LOS LED** is **ON** (solid Red), it is an indicator that the TRACER 4205 is unable to detect a viable DS3 received signal from the connected DS3 equipment. This error may be due to a degraded signal or no signal, or is may be caused by improper framing.

Recommended Actions:

1. Verify that the DS3 Coaxial cable is connected to the DS3 interface on the TRACER 4205.
2. Verify that the DS3 Out interface on the TRACER 4205 is connected to the transmit interface of the DS3 equipment.
3. Verify that the DS3 In interface on the TRACER 4205 is connected to the receive interface of the DS3 equipment.
4. Verify the connections at the opposite end of the DS3 cable.
5. Verify that the framing mode (C-Bit or M13 parity) is the same for both the TRACER 4205 and the DS3 equipment.

LOF LED

If the **LOF LED** is **ON** (solid Red), it is an indicator that the TRACER 4205 is unable to detect a viable framing pattern from the connected DS3 equipment. This error may be due to a degraded incoming signal or improper framing coming from the attached equipment.

Recommended Actions:

1. Verify that the DS3 Coaxial cable is connected to the DS3 interface on the TRACER 4205.
2. Verify that the DS3 Out interface on the TRACER 4205 is connected to the transmit interface of the DS3 equipment.
3. Verify that the DS3 In interface on the TRACER 4205 is connected to the receive interface of the DS3 equipment.
4. Verify the connections at the opposite end of the DS3 cable.
5. Verify that the framing mode (C-Bit or M13 parity) is the same for both the TRACER 4205 and the DS3 equipment.

AIS LED

An **AIS** Alarm, when indicated at the TRACER 4205 by a solid red **AIS LED**, is generated by the attached equipment in response to an error condition. The root cause must be determined at the attached equipment. A typical cause of an AIS alarm is a lack of input to a CSU.

Recommended Actions:

1. Verify the input to any attached data equipment.

RAI LED

A Remote Alarm, when indicated at the TRACER 4205 by a solid Red **RAI LED**, is generated by the attached equipment. When the 4205's DS3 interface experiences a LOF or LOS error, the TRACER 4205 will transmit an AIS Alarm to the remote equipment. The remote equipment should respond with a Remote alarm.

Recommended Actions:

1. Follow the troubleshooting steps for the LOS Alarm, but do so at the attached equipment.

BPV LED

If the **BPV LED** is **ON** (solid Red at time of incident), a Bipolar Violation (BPV) has occurred. BPVs indicate an improper configuration or faulty wiring.

Recommended Actions:

1. Verify the TRACER 4205 unit and the attached equipment are configured for the same line coding (B3ZS).
2. Verify the cable connections for the DS3 interface are solid.

3. RF ERRORS

RF errors can range anywhere from a non-viable microwave path to loose RF connectors.

Non-viable path conditions could be caused by physical obstructions such as buildings, mountainous terrain, trees, etc., as well as other physical limitations such as excessive path distances and in-band RF interference. These types of errors are remedied by performing a detailed line-of-sight microwave path study to determine whether or not a microwave link is feasible for the terrain and environment under consideration.

If after performing a microwave path study the system is still not operational, ensure that the antennas are properly aligned. Note that alignment must be achieved in both elevation and azimuth for optimal link performance. The TRACER 4205 can be used to aid in antenna alignment by looking at the RSSI submenu. Optimal antenna alignment will correspond to the maximum number of RSSI bars on the TRACER 4205 terminal display.

4. STEP-BY-STEP TROUBLESHOOTING

The logical troubleshooting flow presented in this section can be used to set up your TRACER 4205

system, and also to diagnose a previously installed system. Please contact Adtran Technical support at any stage during installation and/or troubleshooting if you require assistance.

5. INSTALLING/TROUBLESHOOTING THE TRACER HARDWARE

1. Perform a detailed path profile for each TRACER 4205 microwave link. A thorough path study can be used to estimate signal power budgets, fade margins at each receiver, identify potential line-of-site obstacles, properly size antenna dishes, and determine minimum antenna dish heights above the earth.
2. Setup all of the TRACER hardware on a work bench. It is also recommended that the actual cables to be used in the permanent installation be used in the work bench setup. A rigorous work bench "simulation" of the link will help you alleviate and avoid time-consuming errors.
3. Examine the PLAN A and PLAN B lights on the front panel of each unit. These LEDs indicate the frequency plan for each TRACER 4205 unit. The frequency plan (PLAN A, PLAN B) LED should be the opposite on both TRACER 4205 units.
4. Attach the RF coaxial cables to be used in the permanent installation to the N-type connectors on the base of the TRACER 4205 unit. Attach the other end of the coaxial cable(s) to an RF power meter or spectrum analyzer if either is available. The power measured by the meter/analyzer will be the RF power available at the input of the antenna. The TRACER 4205 unit is programmed at the factory to output approximately 100 mW (20 dBm) of 5.8 GHz RF power. The actual power level measured by the meter/analyzer will be less than 100 mW due to RF losses through the coaxial cable, and is a function of cable type and length of cable being used. In any event, the power level at the output of the coaxial cable should be a significant fraction of 100 mW. A power meter/analyzer reading that is not on the order of at least tens-of-milliwatts could be an indication of any combination of either unsuitable RF, faulty, or unreasonably long coaxial cable.
5. Resolve all RF coaxial cabling errors before proceeding.
6. Attach the RF coaxial cables to a 5.8 GHz attenuator, if possible. If you do not have an attenuator, attach the coaxial cables to the antennas to be used in the permanent installation. If the installation antennas are not available, small, inexpensive dipole or patch antennas can be used for verification purposes. If an adjustable attenuator is being used, dial in the amount of attenuation that corresponds to the path loss value expected for the microwave link in which the TRACER hardware will be installed. The path loss value can be calculated from a knowledge of the path length, or provided by a path study. Remember to subtract both antenna gain values from the attenuator level if these values have not already be accounted for.
7. After setting up the RF pieces, examine the **RF DOWN** LED on the front panel of each TRACER 4205 unit. If the **RF DOWN** LED is illuminated (red), the corresponding TRACER 4205 is not receiving a suitable RF signal from the other TRACER 4205 unit. In this case, the receiving TRACER 4205 is either receiving a very weak signal, or no signal at all. If the **RF DOWN** LED is not illuminated, then the TRACER 4205 units are receiving a suitable RF signal. Suitable RF power levels for low error rate communication will range from -30 dBm to -78 dBm measured at the N-type connector input on the TRACER 4205 unit.
8. Resolve any signal level issues before proceeding.

9. Examine the **RF LOW** LED on the front panel of each TRACER 4205. If this LED is illuminated, then the TRACER 4205 is receiving a relatively weak signal, however if the **RF DOWN** LED is not illuminated, the received signal is being suitably processed by the TRACER system. If you are receiving a weak signal (**RF LOW** is **ON**), please verify that the weak signal is not being caused by a faulty cable, an insufficiently tightened cable, or some other installation-related problem. Also, make sure an unreasonably large attenuation value has not been selected if you are using an attenuator on a work bench setup.

Use the tables in Section 2, *Microwave Path Engineering Basics*, of this manual to select the proper free-space attenuation value (in dB) based on the estimated length of the microwave path. Remember to subtract out both antenna gains (local and remote) from the attenuator setting.

10. Command a link loopback in one TRACER 4205 unit and run pattern from the connected DS3 equipment. This will verify data path between the DS3 equipment and the TRACER 4205 unit.



External pattern generators are required to test data path integrity. A DS3 BERT tester is suggested.

Installing/Configuring DS3 Hardware

1. If possible, attach any or all of the intended DS3 hardware to the TRACER 4205 units using the same work bench setup. This step offers the perfect opportunity to configure your DS3 hardware for proper functioning with the TRACER hardware.
2. Resolve any remaining DS3 equipment-to-TRACER 4205 configuration issues before field installation, if possible. This will significantly reduce the probability of unsuccessful field installation.