



EMC COMPLIANCE TEST REPORT

For

Firewall Router

Trade Name : TRENDnet
Model Number : TW100-BRF114
Report Number : 03E00023
Date : December11, 2003
Regulations : See below

Standards	Results (Pass/Fail)
EN 55022 CLASS B: 1998+A1: 2001	PASS
EN 61000-3-2: 1995 + A1: 1998 + A2: 1998 + A14: 2000	PASS
EN 61000-3-3: 1995+A1: 2001	PASS
EN 55024: 1998+A1: 2001	PASS
--EN 61000-4-2:2001/ IEC 61000-4-2	PASS
--EN 61000-4-3:2002 / IEC 61000-4-3	PASS
--EN 61000-4-4:1995+A1:2000+A2:2001/ IEC 61000-4-4	PASS
--EN 61000-4-5:2001/ IEC 61000-4-5	PASS
--EN 61000-4-6:2001 / IEC 61000-4-6	PASS
--EN 61000-4-8:2001 / IEC 61000-4-8	N/A
--EN 61000-4-11:2001 / IEC 61000-4-11	PASS

Prepared for:

TRENDware International. Inc.

3135 Kashiwa Street, Torrance, CA90505 U.S.A..

Prepared by:

COMPLIANCE CERTIFICATION SERVICES (KUNSHAN) INC.

10#Weiye Rd, Innovation Park

Eco. & Tec. Development Zone

Kunshan city JiangSu, (215300) CHINA



Lab. Code: 200581-0

TEL: 86-512-57355888

FAX: 86-512-57370818

*This report shall not be reproduced except in full, without the written approval of
COMPLIANCE CERTIFICATION SERVICES (KUNSHAN) INC.*

*The report must not be used by the client to claim product certification, approval, or
endorsement by NVLAP, NIST or any agency of the federal government.*

TABLE OF CONTENTS

VERIFICATION OF COMPLIANCE	3
PRODUCT INFORMATION	4
GENERAL INFORMATION	5
Test Facility.....	5
Test Equipment List.....	6
Block Diagram of Test Setup.....	9
Support Equipment.....	10
System Description.....	11
SECTION 1 - EMISSION MEASUREMENT	12
Procedure & Limit (Line Conducted Emission).....	13
Procedure & Limit (Common Mode Conducted).....	15
Procedure & Limit (Radiated Emission).....	17
SUMMARY DATA.....	19
EN 61000-3-2 & EN 61000-3-3	25
SECTION 2 – IMMUNITY TESTS (EN 55024)	29
IEC 61000-4-2	30
IEC 61000-4-3	35
IEC 61000-4-4	38
IEC 61000-4-5	40
IEC 61000-4-6	42
IEC 61000-4-8	45
IEC 61000-4-11.....	48
APPENDIX 1 Photographs of Test Setup	50
APPENDIX 2 Photographs (EUT)	62
APPENDIX 3 Certifications for CES	68

VERIFICATION OF COMPLIANCE

Equipment Under Test: Firewall Router
Trade Name: TRENDnet
Model Number: TW100-BRF114
Applicant: TRENDware International. Inc
Manufacturer: TRENDware International. Inc
Type of Test: EMC Directive 89/336/EEC for CE Marking
 EN 55022 CLASS B: 1998+A1: 2001
 EN 61000-3-2: 1995 + A1: 1998 + A2: 1998 + A14: 2000
 EN 61000-3-3: 1995+A1: 2001
Measurement Procedure: EN 55024: 1998+A1: 2001
 ---EN 61000-4-2:2001/ IEC 61000-4-2; EN 61000-4-3:2002 / IEC 61000-4-3;
 EN 61000-4-4:1995+A1:2000+A2:2001/ IEC 61000-4-4; EN 61000-4-5:2001/ IEC 61000-4-5
 EN 61000-4-6:2001 / IEC 61000-4-6; EN 61000-4-8:2001 / IEC 61000-4-8
 EN 61000-4-11:2001 / IEC 61000-4-11
File Number: 03E00016
Date of test: From November 21 to December 10, 2003
Condition of Test Sample: Normal
Test Site: COMPLIANCE CERTIFICATION SERVICES (KUNSHAN) INC.
 10#Weiye Rd, Innovation Park, Eco. & Tec. Development Zone, Kunshan city
 JiangSu, (215300) CHINA.
Final Result: Pass
Worst data: See below

Test Item	Freq.(MHz)	Measured data	Margin (M μ C)	Remark
Conducted Emission	0.29088	40.81(dB μ V/m)	-11.16 dB(\pm 2.15 dB)	Avg/L1
ISN 10base	10.008016	73.92(dB μ V/m)	9.92 dB (\pm 2.15 dB)	Avg
ISN 100base	23.12224	54.44(dB μ V/m)	-9.56 dB (\pm 2.15 dB)	Avg
Radiated Emission	30.00	25.55(dB μ V/m)	-4.45 dB (\pm 2.50 dB)	Peak/Vertical
<ul style="list-style-type: none"> ● The negative sign in Margin cell means under the specific limit. ● This test result traceable to national or international standards 				

The above equipment was tested by COMPLIANCE CERTIFICATION SERVICES (KUNSHAN) INC. for compliance with the requirements set forth in EMC Directive 89/336/EEC, Amended by 92/31/EEC & 93/68/EEC & 98/13/EC and the Technical Standards mentioned above. This said equipment in the configuration described in this report shows the maximum emission levels emanating from equipment and the level of the immunity endurance of the equipment are within the compliance requirements. The test results of this report relate only to the tested sample identified in this report.

Approved by Authorized Signatory:

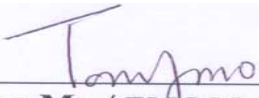

Tony Mo / EMC Manager

PRODUCT INFORMATION

Housing type: Metal case
EUT Power Rating: 9VDC /700mA
AC Power during test: 230VAC/50Hz
DC Power Cord Type: Non-Shielded, 1.8m (Non -Detachable)

I/O PORT OF EUT:

I/O PORT TYPES	Q'TY	TESTED WITH
1.) WAN Port	1	1
2.) LAN Port	4	4
3.) POWER Port	1	1

Note: Only two I/O ports were tested on the condition of data transmission; the others were tested by without data transmission and connection to load.

GENERAL INFORMATION

Test Facility

- Location:** 10#Weiye Rd, Innovation Park, Eco. & Tec. Development Zone, Kunshan city
JiangSu, (215300) CHINA.
- Description:** There are one 3/10m semi-anechoic chamber, one 3m semi-anechoic chamber and one conducted test site on the internal shield room for final test.
The semi-anechoic chamber and the Line Conducted labs are constructed and calibrated to meet the FCC requirements in documents ANSI C63.4: 2001 and CISPR16 requirements.
- Site Filing:** A site description is on file with the Federal Communications Commission, 7435 Oakland Mills Road, Columbia, MD 21046.

Registration also was made with Voluntary Control Council for Interference (VCCI).
- Site Accreditation:** Accredited by NVLAP (Lab code: 200581-0)

Accredited by NEMKO (Authorization No.: ELA 105) for Emission.

Accredited by VCCI (Member No. 1938 and Registration No.: C-1707) for Emission.
- Instrument Tolerance:** All measuring equipment is in accord with ANSI C63.4 and CISPR 22 requirements that meet industry regulatory agency and accreditation agency requirement.
- Ground Plane:** Two conductive reference ground planes were used during the Line Conducted Emission, one in vertical and the other in horizontal. The dimensions of these ground planes are as below. The vertical ground plane was placed distancing 40 cm to the rear of the wooden test table on where the EUT and the support equipment were placed during test. The horizontal ground plane projected 50 cm beyond the footprint of the EUT system and distanced 80 cm to the wooden test table. For Radiated Emission Test, one horizontal conductive ground plane extended at least 1m beyond the periphery of the EUT and the largest measuring antenna, and covered the entire area between the EUT and the antenna. It has no holes or gaps having longitudinal dimensions larger than one-tenth of a wavelength at the highest frequency of measurement up to 1GHz.

Test Equipment List

Instrumentation: The following list contains equipment used at COMPLIANCE CERTIFICATION SERVICES (KUNSHAN) INC. for testing. The equipment conforms to the CISPR 16-1 / ANSI C63.2 Specifications for Electromagnetic Interference and Field Strength Instrumentation from 9kHz to 1.0 / 2.0 GHz.

Equipment used during the tests:

3/10m semi-anechoic chamber:

Site A (10m Chamber) for Radiated					
EQUIPMENT TYPE	MFR	MODEL NUMBER	SERIAL NUMBER	LAST CAL.	CAL. DUE
EMI Test Receiver	R&S	ESI26	100068	11/14/2003	11/13/2004
EMC Analyzer	Agilent	E7402A	US41160329	12/30/2002	12/30/2003
Bilog Antenna	Schaffner	CBL 6143	5063	11/16/2003	11/15/2004
Coaxial Cable	N/A	N-type F1	N/A	05/26/2003	05/25/2004
Coaxial Cable	N/A	N-type C1	N/A	05/26/2003	05/25/2004
System Controller	Sunol	SC99V	121501-1	N/A	N/A
Turn Table	Sunol	FM3022HS	N/A	N/A	N/A
Antenna Mast	Sunol	TWR 99-4	121501-3	N/A	N/A
Coax Switch	Anitsu	MP 598	M 80094	N/A	N/A

Site A (10m Chamber) for Conducted					
EQUIPMENT TYPE	MFR	MODEL NUMBER	SERIAL NUMBER	LAST CAL.	CAL. DUE
EMI Test Receiver	R&S	ESI26	100068	11/14/2003	11/13/2004
EMC Analyzer	Agilent	E7402A	US41160329	12/30/2003	12/30/2004
LISN	FCC	FCC-LISN-50-50-2-M	01067	11/30/2003	11/30/2004
LISN(EUT)	FCC	FCC-LISN-50-50-2-M	01068	11/30/2003	11/30/2004
4-WIRE ISN	R&S	ENY41	830663/024	04/10/2003	04/09/2004
Double 2-Wire Isn	R&S	ENY22	830661/027	04/10/2003	04/09/2004
Coaxial Cable	N/A	N-type 01	N/A	05/26/2003	05/25/2004
EMI Monitor control box	FCC	0-SVDC	N/A	N/A	N/A

The calibrations of the measuring instruments, including any accessories that may effect such calibration, are checked frequently to assure their accuracy. Adjustments are made and correction factors applied in accordance with instructions contained in the manual for the measuring instrument.

Power Harmonic & Voltage Fluctuation/Flicker Measurement (61000-3-2&-3-3)					
EQUIPMENT TYPE	MFR	MODEL NUMBER	SERIAL NUMBER	LAST CAL.	CAL DUE.
Harmonic & Flicker Tester	Schaffner	CCN 1000-1	72045	1/25/2003	1/25/2004
AC Power Source	Schaffner	NSG 1007-5-400	54788	1/25/2003	1/25/2004

ESD test (61000-4-2)					
EQUIPMENT TYPE	MFR	MODEL NUMBER	SERIAL NUMBER	LAST CAL.	CAL DUE.
ESD-Gun	Schaffner	NSG 432	2021	12/30/2002	12/30/2003
ESD-Simulator	Schaffner	402-579	5015/4950	No Calibration Required	No Calibration Required

Radiated Electromagnetic Field immunity Measurement (61000-4-3)					
EQUIPMENT TYPE	MFR	MODEL NUMBER	SERIAL NUMBER	LAST CAL.	CAL DUE.
Signal Generator	R&S	SML 3	100564	05/21/2003	05/20/2004
Power Meter	Schaffner	CPW 9670	7004	01/10/2003	01/09/2004
E-Field Sensor	Schaffner	EMC-20 TYP-8	AI-0057 AM-0032	12/19/2002	12/19/2003
Bilog Antenna	Schaffner	CBL 6144	1006	No Calibration Required	No Calibration Required
Antenna Tower	HD GmbH	MM240	240/629 BJ01	No Calibration Required	No Calibration Required
Amplifier Research	Schaffner	60S1G3	302728	No Calibration Required	No Calibration Required
Amplifier Power unit	Schaffner	CBA9433	3007	No Calibration Required	No Calibration Required
CCD	GmbH Hmerau	CE-SYS	19709529	No Calibration Required	No Calibration Required

Fast Transients/Burst test (61000-4-4)/Surge(61000-4-5)/Voltage Dips(61000-4-11)					
EQUIPMENT TYPE	MFR	MODEL NUMBER	SERIAL NUMBER	LAST CAL.	CAL DUE.
Transients/Burst/Surge Test system	Schaffner	BEST EMC V2.7	200132-001SC	12/30/2002	12/30/2003
Clamp Meter	Fluke	36	78210055	07/09/2003	07/08/2004
Clamp	Schaffner	N/A	N/A	No Calibration Required	No Calibration Required
Signal Line Coupling Network	Schaffner	CDN-117	17396	No Calibration Required	No Calibration Required
Signal Line Coupling Network	Schaffner	CDN-118	SL 400-187	No Calibration Required	No Calibration Required

CS test (61000-4-6)					
EQUIPMENT TYPE	MFR	MODEL NUMBER	SERIAL NUMBER	LAST CAL.	CAL DUE.
Transients/Burst/Surge Test system	Schaffner	BEST EMC V2.7	200132-001SC	No Calibration Required	No Calibration Required
EM-Koppelzange	Schaffner	KEMZ 801	17629	03/05/2003	03/04/2004
CDN	Schaffner	CDN A800	17890	No Calibration Required	No Calibration Required
CDN	Schaffner	CDN T002	19000	No Calibration Required	No Calibration Required
CDN	Schaffner	CDN T400	16918	No Calibration Required	No Calibration Required
CDN	Schaffner	CDN M216	16399	No Calibration Required	No Calibration Required
CDN	Schaffner	CDN M316	16939	No Calibration Required	No Calibration Required
CDN	Schaffner	CDN M316	16940	No Calibration Required	No Calibration Required
CDN	Schaffner	CDN M316	16935	No Calibration Required	No Calibration Required
Attenuator	Schaffner	INA 2070-1	2042	No Calibration Required	No Calibration Required

Power Frequency Magnetic Field Immunity test (61000-4-8)					
EQUIPMENT TYPE	MFR	MODEL NUMBER	SERIAL NUMBER	LAST CAL.	CAL DUE.
Induction Coil Interface	Schaffner	INA2141 INA702	6004 200149-078SC	No Calibration Required	No Calibration Required
AC Power Source	Schaffner	NSG 1007-5-400	54788	No Calibration Required	No Calibration Required
EMF TESTER	TES	TES-1390	010800365	No Calibration Required	No Calibration Required

Block Diagram of Test Setup

System Diagram of Connections between EUT and Simulators

EUT: Firewall Router

Trade Name: TRENDnet

Model Number: TW100-BRF114

DC Power Cable: Non-shielded, 1.8 m (Non-Detachable)

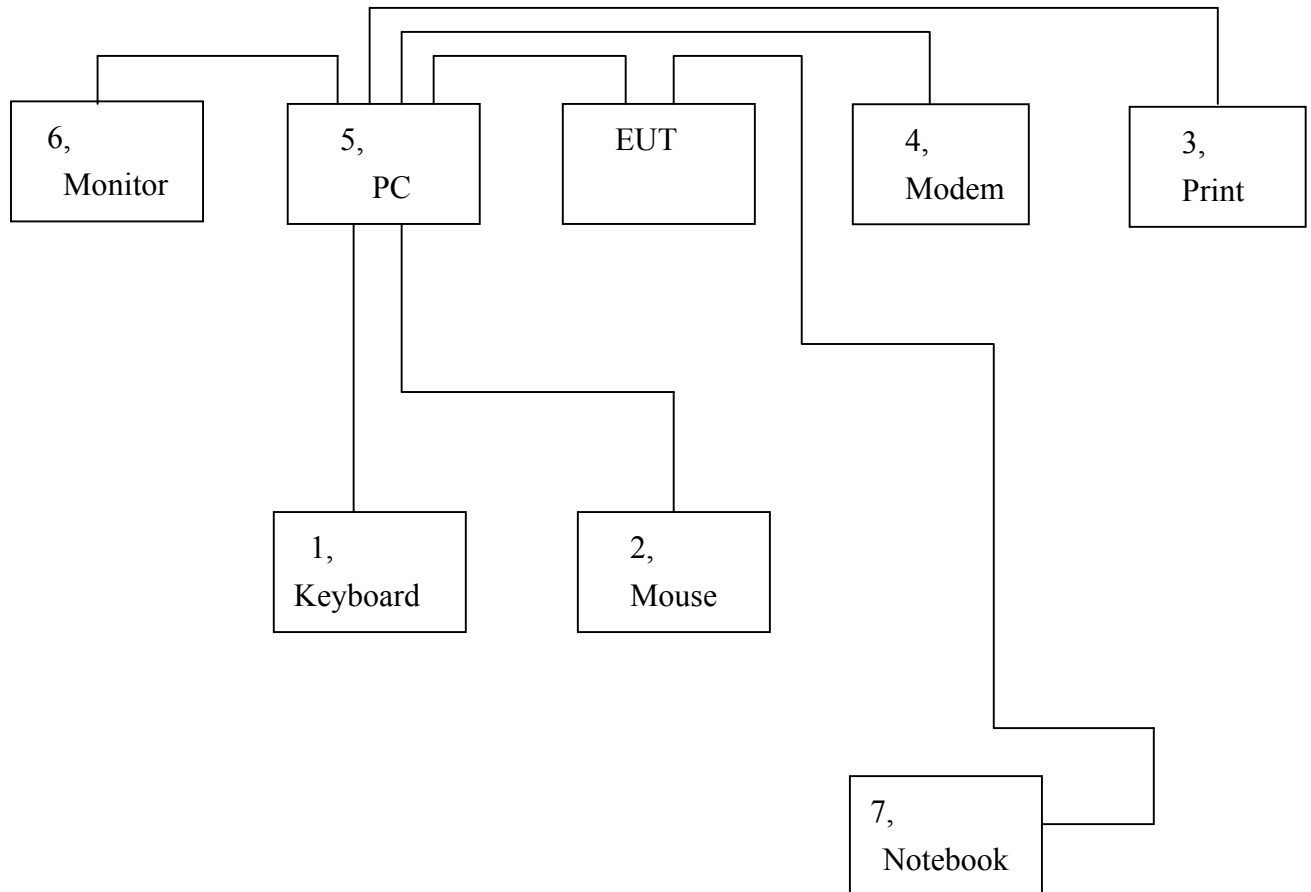

Support Equipment

	Equipment	Model #	Serial #	FCC ID	Trade Name	Data Cable	Power Cord
1	(PS/2)Keyboard	KB-9910	0081856	DoC	IBM	Shielded, 2m	N/A
2	MOUSE (PS/2)	MUS9JN	F13640M67G9D9F	EMJMUSJR	COMPAQ	Shielded, 1.8m	N/A
3	PRINT	B162a	EK6Y026422	DOC	EPSON stylus C61	Shielded, 1.8m with two Core	Un-Shielded, 1.8m
4	PRINT	P310B	C11344000HJ02	DOC	EPSON	Shielded, 1.8m with two Core	Un-Shielded, 1.8m
5	MODEM	2400SE	044-502501-000 94-364-176269	DK467GSM24	COMPUTER PERIPHERAL S	Shielded, 1.8m with one Core	Un-Shielded, 1.0m
6	PC	DPS-250GB-2D	DP4	DoC	DELTA	Shielded, 1.2m	Shielded, 1.2m
7	Monitor	CPD-G420	2404608	DoC	SONY	Shielded 1.8m with a Core	Un-Shielded, 1.5m
8	Notebook	M285	1824064-1B	DoC	LEO	N/A	Shielded, 1.8m
9	Notebook	PP01L	CN-04P240-4864 3-318-3259	DoC	DELL	N/A	Shielded, 1.8m

Note: All the above equipment/cables were placed in worse case positions to maximize emission signals during emission test.

Grounding: Grounding was in accordance with the manufacturer's requirements and conditions for the intended use.

System Description

EUT Test Program:

1. A STP Cable connects the LAN port on EUT (mode:IP505LA) with a PC outside chamber. Using DHCP options to provide the IP address of the PC, and then Running the order: ping 192.168.1.2 -t under command pattern, the PC will have response to the LAN Port.
2. A STP Cable connects the LAN port on IP505LA with a PC inside chamber. The IP address and gateway is settled separately to 192.168.1.2 and 192.168.1.0. The PC will have response by running the order: ping 192.168.1.2 -t under command pattern.
3. When tested ISN, we used the 30 meters Non-shielded Twisted Pair Cable connected the EUT and ISN.
4. A scroll 'H' test program was loaded and executed in Windows mode.

SECTION 1 - EMISSION MEASUREMENT

Conducted Emission Measurement

Radiated Emission Measurement

Power Harmonics Measurement (EN 61000-3-2)

Power Flicker Measurement (EN 61000-3-3)

Procedure & Limit (Line Conducted Emission) Preliminary Line Conducted Emission Test

- 1) The equipment was set up as per the test configuration to simulate typical actual usage per the user's manual. When the EUT is a tabletop system, a wooden table with a height of 0.8 meters is used and is placed on the ground plane as per EN 55022 (see Test Facility for the dimensions of the ground plane used). When the EUT is a floor-standing equipment, it is placed on the ground plane which has a 3-12 mm non-conductive covering to insulate the EUT from the ground plane.
- 2) Support equipment, if needed, was placed as per EN 55022.
- 3) All I/O cables were positioned to simulate typical actual usage as per EN 55022.
- 4) The EUT received power source from the Power Supply, The Power Supply received AC power (230V/50Hz) through a Line Impedance Stabilization Network (LISN) which supplied power source and was grounded to the ground plane.
- 5) All support equipment received power from a second LISN supplying power of 220VAC/50Hz, if any.
- 6) The EUT test program was started. Emissions were measured on each current carrying line of the EUT using a spectrum analyzer / Receiver connected to the LISN powering the EUT. The LISN has two monitoring points: Line 1 (Hot Side) and Line 2 (Neutral Side). Two scans were taken: one with Line 1 connected to Analyzer / Receiver and Line 2 connected to a 50 ohm load; the second scan had Line 1 connected to a 50 ohm load and Line 2 connected to the Analyzer / Receiver.
- 7) Analyzer / Receiver scanned from 150kHz to 30MHz for emissions in each of the test modes.
- 8) During the above scans, the emissions were maximized by cable manipulation.
- 9) The following test mode(s) were scanned during the preliminary test:

Mode(s):

run EMC test & ping WAN Port + LAN Port 1

run EMC test & ping WAN Port + LAN Port 1+LAN Port 2

run EMC test & ping WAN Port + LAN Port 1+LAN Port 2+LAN Port 3

run EMC test & ping WAN Port + LAN Port 1+LAN Port 2+LAN Port 3+LAN Port 4

- 10) After the preliminary scan, we found the following test mode(s) producing the highest emission level.

Mode(s): run EMC test & ping WAN Port +LAN Port 1

(Temperature: 20°C / Humidity: 68%)

Then, the EUT configuration and cable configuration of the above highest emission level were recorded for reference of final testing.

Final Line Conducted Emission Test

- 1) EUT and support equipment was set up on the test bench as per step 10 of the preliminary test.
- 2) A scan was taken on both power lines, Line 1 and Line 2, recording at least the six highest emissions. Emission frequency and amplitude were recorded into a computer in which correction factors were used to calculate the emission level and compare reading to the applicable limit. If EUT emission level was less -2dB to the A.V. limit in Q.P. mode, then the emission signal was re-checked using an A.V. detector.
- 3) The test data of the worst case condition(s) was reported on the Summary Data page.

Data Sample:

Freq (KHz)	Peak Amptd (dBuV)	QP Amptd (dBuV)	Avg Amptd (dBuV)	QP Limit (dBuV)	Avg Limit (dBuV)	Margin (dB)	Factor (dB)
281.70	38.04	37.74	37.18	62.17	52.17	-14.13	-1.61

Factor=Insertion Loss W/ Cable Loss
 Amptd = Metering Reading + Factor
 Margin=Amptd (Max. for Peak/QP/Avg) - Limits
 QP=Quasi-peak
 AVG=Average
 L1=Hot
 L2=Neutral

Line Conducted Emission Limit

Frequency	Maximum RF Line Voltage			
	Q.P.(dBuV)		AVERAGE(dBuV)	
	Class A	Class B	Class A	Class B
150kHz-500kHz	79	66-56	66	56-46
500kHz-5MHz	73	56	60	46
5MHz-30MHz	73	60	60	50

Note: The lower limit shall apply at the transition frequency.

Procedure & Limit (Common Mode Conducted)

- 1) Selecting ISN for unscreened cable or a current probe for screened cable to take measurement.
- 2) The port of the EUT was connected to the remote side support equipment through the ISN/Current Probe and communication in normal condition.
- 3) Making an overall range scan by using the test receiver controlled by controller and record at least six highest emissions for showing in the test report.
- 4) Emission frequency and amplitude were recorded into a computer in which correction factors were used to calculate the emission level and compare reading to the applicable limit.
- 5) In case of measuring on the screened cable, the current limit shall be applied, otherwise the voltage limit should be applied.
- 6) The following test mode(s) were scanned during the preliminary test:

Mode(s):

- run EMC test & ping WAN Port + LAN Port 1**
- run EMC test & ping WAN Port + LAN Port 1+LAN Port 2**
- run EMC test & ping WAN Port + LAN Port 1+LAN Port 2+LAN Port 3**
- run EMC test & ping WAN Port + LAN Port 1+LAN Port 2+LAN Port 3+LAN Port 4**

- 7) After the preliminary scan, we found the worst mode producing the highest emission level.

Mode(s): run EMC test & ping WAN Port +LAN Port 1
(Temperature: 20°C / Humidity: 55%)

Data Sample:

Freq (KHz)	Peak Amptd (dBuV)	QP Amptd (dBuV)	Avg Amptd (dBuV)	QP Limit (dBuV)	Avg Limit (dBuV)	Margin (dB)	Factor (dB)
3500.00	61.72	61.14	60.12	74.00	64.00	-2.28	10.76

Factor=Insertion Loss W/ Cable Loss

Amptd = Metering Reading + Factor

Margin=Amptd (Max. for Peak/QP/Avg) - Limits

QP=Quasi-peak

AVG=Average

L1=Hot

L2=Neutral

**Common Mode Conducted Emission Limit
At Telecommunication Ports**

Measuring Band	Voltage limit dB(uV)				Current limit dB(uA)			
	Q.P.		AV		Q.P.		AV	
	Class A	Class B	Class A	Class B	Class A	Class B	Class A	Class B
150k-500kHz	97-87	84-74	87-74	74-64	53-43	40-30	40-30	30-20
500k-30MHz	87	74	74	64	43	30	30	20

Note 1: The lower limit shall apply at the transition frequency.

***Note 2*:** Provisionally, a relaxation of 10dB over the frequency range of 6Mhz to 30Mhz is allowed for high-speed services having significant spectral density in this band. However, this relaxation is restricted to the common mode disturbance converted by the cable from the wanted signal. The provisional relaxation of 10dB will be reviewed no later than three years after the date of withdrawal based on the results and interference cases in this period.

Procedure & Limit (Radiated Emission)

Preliminary Radiated Emission Test

- 1) The equipment was set up as per the test configuration to simulate typical actual usage per the user's manual. When the EUT is a tabletop system, a wooden turntable with a height of 0.8 meters is used which is placed on the ground plane as per EN 55022 (see Test Facility for the dimensions of the ground plane used). When the EUT is a floor-standing equipment, it is placed on the ground plane which has a 3-12 mm non-conductive covering to insulate the EUT from the ground plane.
- 2) Support equipment, if needed, was placed as per EN 55022.
- 3) All I/O cables were positioned to simulate typical actual usage as per EN 55022.
- 4) The EUT received power source from the Power Supply. The Power Supply received AC power source (230V/50Hz) from the outlet socket under the turntable. All support equipment received 220VAC/50Hz power from another socket under the turntable, if any.
- 5) The antenna was placed at 10 meter away from the EUT as stated in EN 55022. The antenna connected to the Analyzer via a cable and at times a pre-amplifier would be used.
- 6) The Analyzer / Receiver quickly scanned from 30MHz to 1000MHz. The EUT test program was started. Emissions were scanned and measured rotating the EUT to 360 degrees and positioning the antenna 1 to 4 meters above the ground plane, in both the vertical and the horizontal polarization, to maximize the emission reading level.
- 7) The following test mode(s) were scanned during the preliminary test:
Mode(s):
 - run EMC test & ping WAN Port + LAN Port 1**
 - run EMC test & ping WAN Port + LAN Port 1+LAN Port 2**
 - run EMC test & ping WAN Port + LAN Port 1+LAN Port 2+LAN Port 3**
 - run EMC test & ping WAN Port + LAN Port 1+LAN Port 2+LAN Port 3+LAN Port 4**
- 8) After the preliminary scan, we found the following test mode(s) producing the highest emission level.
Mode(s): **run EMC test & ping WAN Port +LAN Port 1**
(Temperature: 20°C / Humidity: 73%)

Then, the EUT and cable configuration, antenna position, polarization and turntable position of the above highest emission level were recorded for final testing.

Final Radiated Emission Test

- 1) EUT and support equipment were set up on the turntable as per step 8 of the preliminary test.
- 2) The Analyzer / Receiver scanned from 30MHz to 1000MHz. Emissions were scanned and measured rotating the EUT to 360 degrees, varying cable placement and positioning the antenna 1 to 4 meters above the ground plane, in both the vertical and the horizontal polarization, to maximize the emission reading level.
- 3) Recorded at least the six highest emissions. Emission frequency, amplitude, antenna position, polarization and turntable position were recorded into a computer in which correction factors were used to calculate the emission level and compare reading to the applicable limit and only Q.P. reading is presented.
- 4) The test data of the worst case condition(s) was reported on the Summary Data page.

Data Sample:

Freq (MHz)	Peak (dBuV/m)	QP (dBuV/m)	Margin (dB)	Limits (dBuV/m)	Reading (dBuV)	Factor (dB)	Height (cm)	Degree (o)
92.10	28.69	25.02	-4.98	30.00	16.48	8.54	100	0

Factor=Antenna Factor + Cable Loss

Reading=Uncorrected Analyzer / Receiver Reading

Peak · QP (Corrected Reading) = Reading + Factor

Margin=Corrected Reading – Limits

QP=Quasi-peak

Radiated Emission Limit

Frequency (MHz)	Distance (m)	Maximum Field Strength Limit (dBu V/m/ Q.P.)	
		Class A	Class B
30-230	10	40	30
230-1000	10	47	37

Note: The lower limit shall apply at the transition frequency.

SUMMARY DATA (Line Conducted)

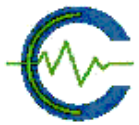

程智電子科技(昆山)有限公司
CES ELECTRONICS TECHNOLOGY(KUNSHAN)CO., LTD.

Tel: 86-512-57355888
Fax: 86-512-57370818

Site A

Custom Name: TRENDnet
Model Name: TW100-BRF114
Test Mode: 20C 68% 1023mbar

Project No.: 03E00023
Engineer Name: steven

Index: 1

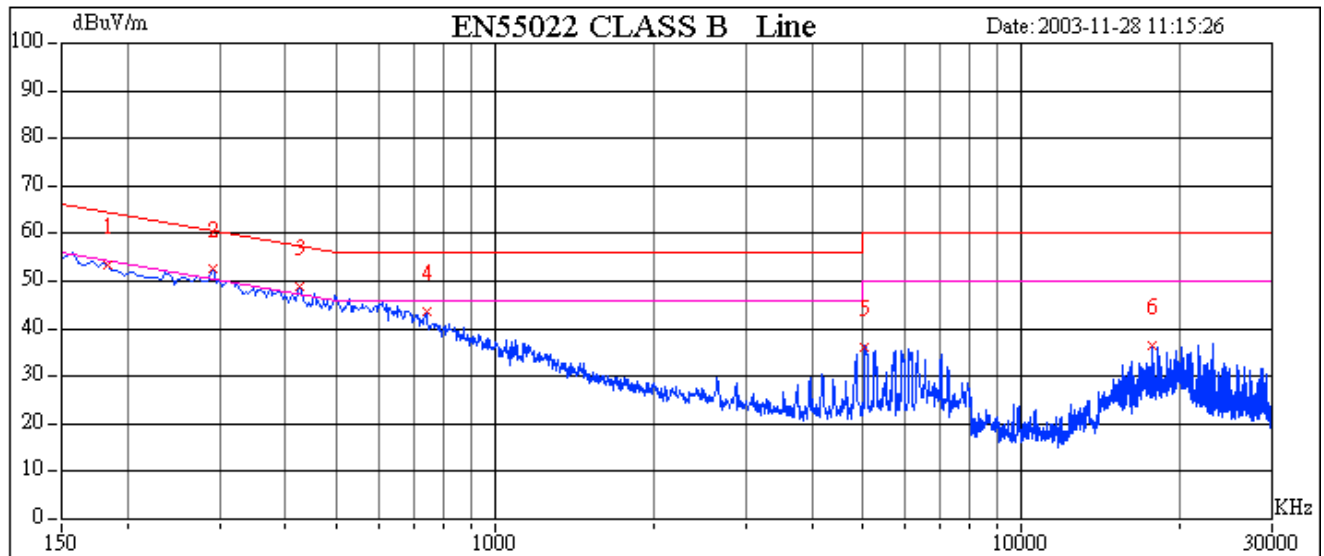

	Freq(KHz)	Peak Amptd(dBuV)	QP Amptd(dBuV)	Avg Amptd(dBuV)	QP Limit(dBuV)	Avg Limit(dBuV)	Margin(dB)	Factor(dB)
1	183.3667	53.52	49.36	42.99	65.05	55.05	-12.06	10.11
2	290.8818	52.62	46.88	40.81	61.97	51.97	-11.16	10.12
3	424.3487	48.80	42.36	35.89	58.16	48.16	-12.27	10.15
4	739.4790	43.69	36.46	30.27	56.00	46.00	-15.73	10.16
5	5046.0922	36.11	34.45	24.02	60.00	50.00	-25.55	10.53
6	17687.3747	36.47	35.21	28.49	60.00	50.00	-21.51	11.53

Comments: N/A



Custom Name: TRENDnet
Model Name: TW100-BRF114
Test Mode: 20C 68% 1023mbar

Project No.: 03E00023
Engineer Name: steven

Index: 1

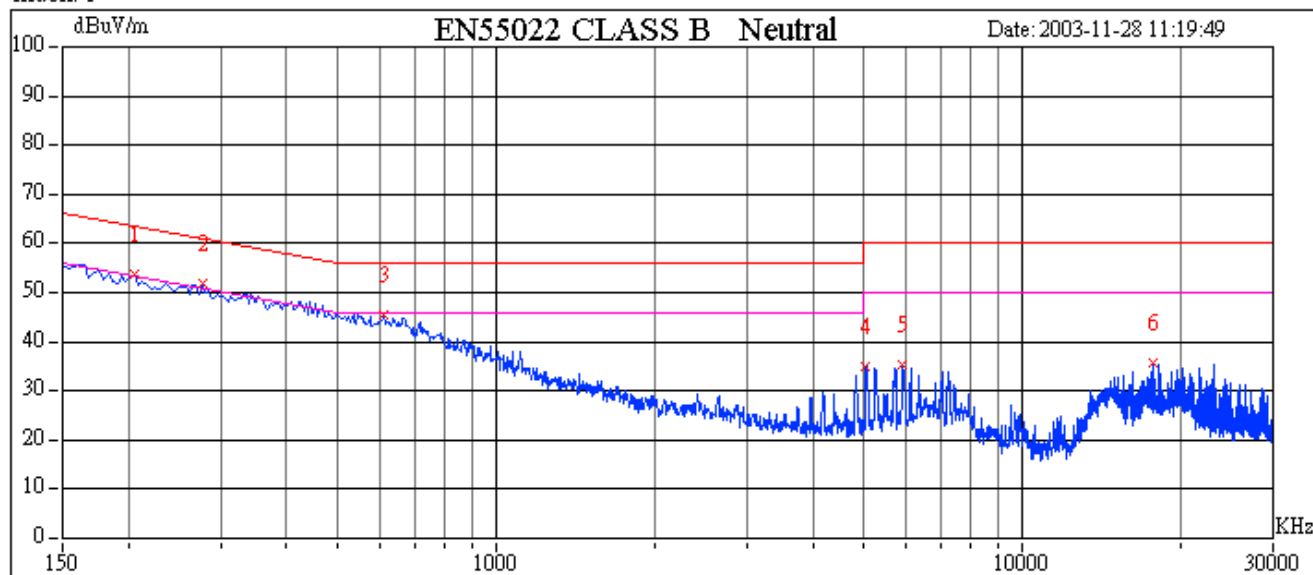

	Freq(KHz)	Peak Amptd(dBuV)	QP Amptd(dBuV)	Avg Amptd(dBuV)	QP Limit(dBuV)	Avg Limit(dBuV)	Margin(dB)	Factor(dB)
1	205.6112	53.61	48.03	41.69	64.41	54.41	-12.72	10.11
2	276.0521	51.98	45.51	39.11	62.40	52.40	-13.29	10.12
3	613.4269	45.41	39.47	33.21	56.00	46.00	-12.79	10.13
4	5038.0762	34.88	33.98	22.59	60.00	50.00	-26.02	10.51
5	5919.8397	35.50	31.14	20.92	60.00	50.00	-28.86	10.60
6	17703.4068	35.71	34.47	28.21	60.00	50.00	-21.79	11.84

Comments: N/A

Common Mode Conducted

ISN 10BASE



程智電子科技(昆山)有限公司
CES ELECTRONICS TECHNOLOGY(KUNSHAN)CO., LTD.

Tel: 86-512-57355888
Fax: 86-512-57370818

Site A

Custom Name: TRENDnet
Model Name: TW100-BRF114
Test Mode: TRANSFER RATE 10base 20c 55% 1025mbar

Project No.: 03E00023
Engineer Name: johnson-song

Index: 2

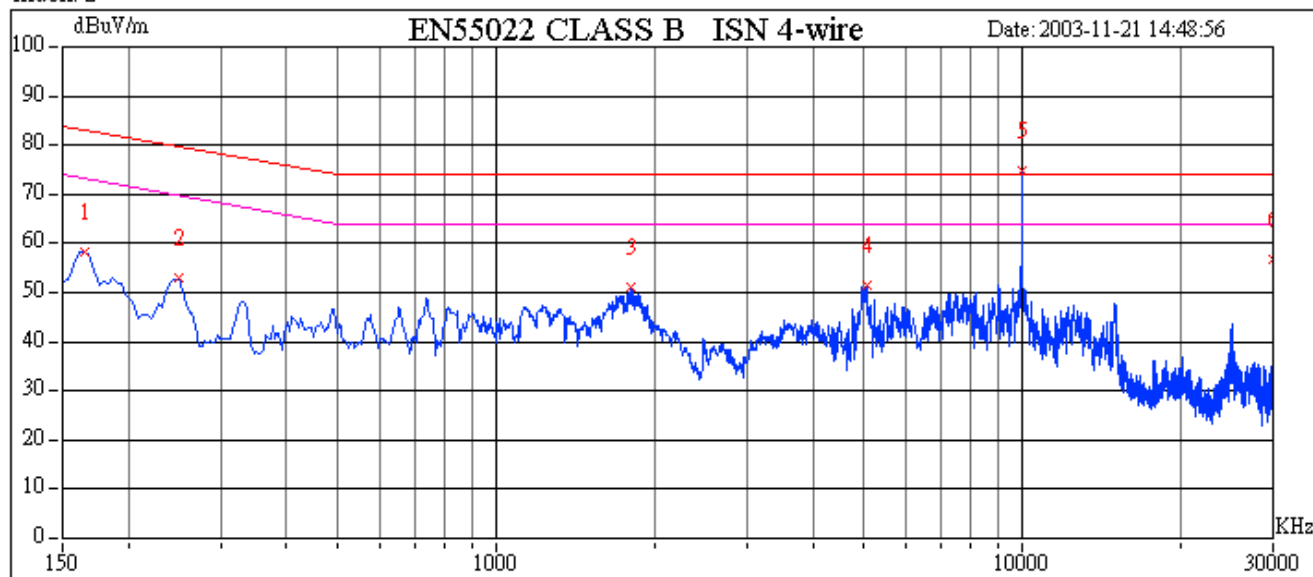

	Freq(KHz)	Peak Amptd(dBuV)	QP Amptd(dBuV)	Avg Amptd(dBuV)	QP Limit(dBuV)	Avg Limit(dBuV)	Margin(dB)	Factor(dB)	
	1	164.8297	58.10	46.18	42.56	83.58	73.58	-31.02	10.87
	2	250.1002	53.00	42.28	37.50	81.14	71.14	-33.64	10.86
	3	1810.9218	51.28	47.86	43.03	74.00	64.00	-20.97	10.83
	4	5062.1242	51.47	43.29	30.67	74.00	64.00	-30.71	10.78
❑	5	10008.0160	74.73	75.01	73.92	74.00	64.00	9.92	10.91
	6	30000.0000	56.85	58.45	57.64	74.00	64.00	-6.36	10.98

Comments: reading page 16 *Note 2*.

ISN 100BASE

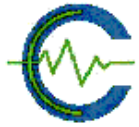

程智電子科技(昆山)有限公司
CES ELECTRONICS TECHNOLOGY(KUNSHAN)CO., LTD.

Tel: 86-512-57355888
Fax: 86-512-57370818

Site A

Custom Name: TRENDnet
Model Name: TW100-BRF114
Test Mode: TRANSFER RATE 100base 20c 55% 1025mbar

Project No.: 03E00023
Engineer Name: johnson-song

Index:

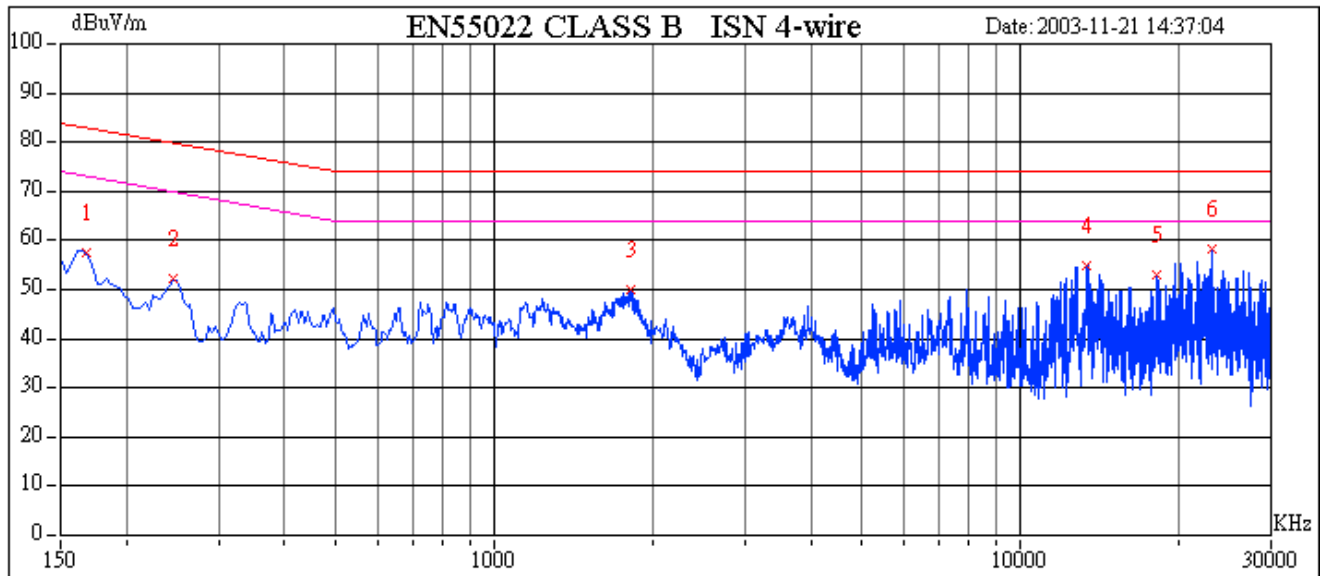

	Freq(KHz)	Peak Amptd(dBuV)	QP Amptd(dBuV)	Avg Amptd(dBuV)	QP Limit(dBuV)	Avg Limit(dBuV)	Margin(dB)	Factor(dB)
1	168.5371	57.58	45.45	40.72	83.47	73.47	-32.75	10.87
2	246.3928	52.28	41.80	36.21	81.25	71.25	-35.04	10.86
3	1814.6293	49.87	47.33	41.73	74.00	64.00	-22.27	10.83
4	13374.7495	54.85	54.82	49.71	74.00	64.00	-14.29	10.92
5	18248.4970	53.17	53.36	47.81	74.00	64.00	-16.19	10.97
6	23122.2445	58.17	58.68	54.44	74.00	64.00	-9.56	10.96

Comments: N/A

(Radiated Emission Test)



程智電子科技(昆山)有限公司
CES ELECTRONICS TECHNOLOGY(KUNSHAN)CO., LTD.

Tel: 86-512-57355888
Fax: 86-512-57370818

Page 1
Site A

Customer Name: TRENDnet
Model Name: TW100-BRF114
Project No.: 03E00023
Engineer Name: johnson song

Test Mode: 20C 73% 1024mbar

Index:

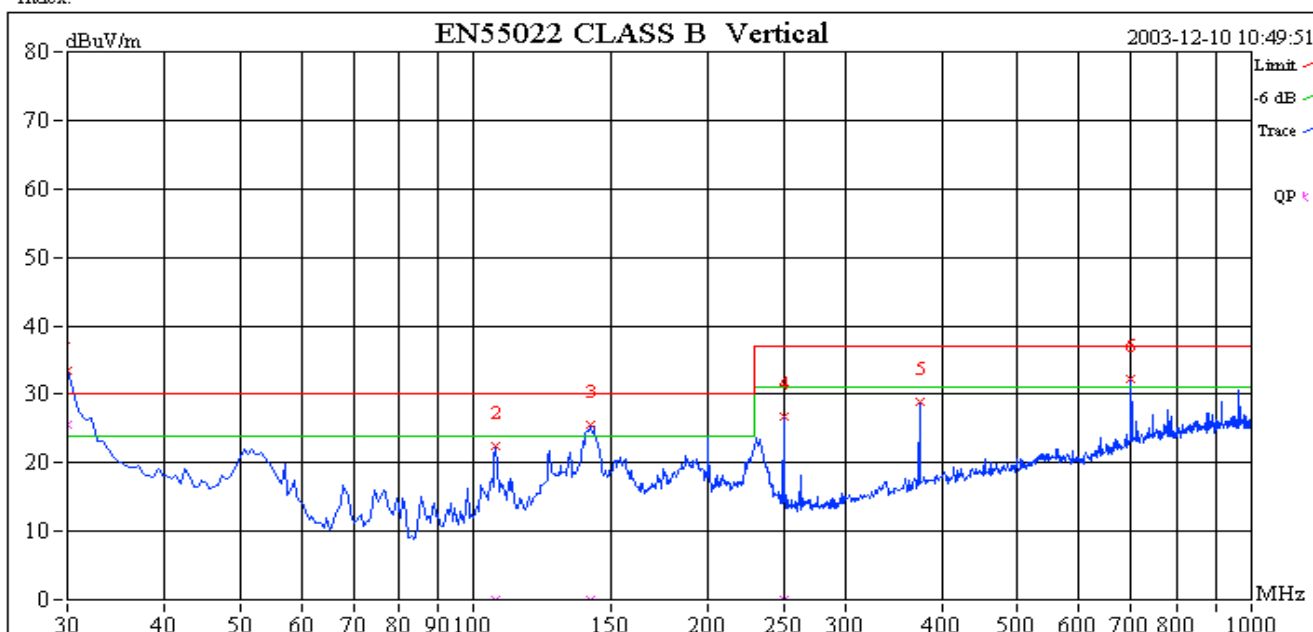

	Freq(MHz)	Pk(dBuV/m)	QP(dBuV/m)	Pk Margin(dB)	QP Margin(dB)	Limit(dBuV/m)	Read(dBuV)	C.F(dB)	Height	Deg	Remark
1	30.0000	33.55	25.55	3.55	-4.45	30.00	25.16	0.39	251	0	
2	106.8337	22.44		-7.56		30.00	32.80	-10.36	100	0	
3	140.9218	25.46		-4.54		30.00	35.16	-9.70	100	0	
4	250.2204	26.66		-10.34		37.00	35.39	-8.73	100	0	
5	374.3487	29.01		-7.99		37.00	34.53	-5.52	100	0	
6	699.7996	32.20		-4.80		37.00	31.98	0.22	100	0	

Comments: N/A

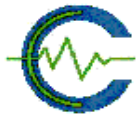

Customer Name: TRENDnet
Model Name: TW100-BRF114
Project No.: 03E00023
Engineer Name: johnson song

Test Mode: 20C 73% 1024mbar

Index:

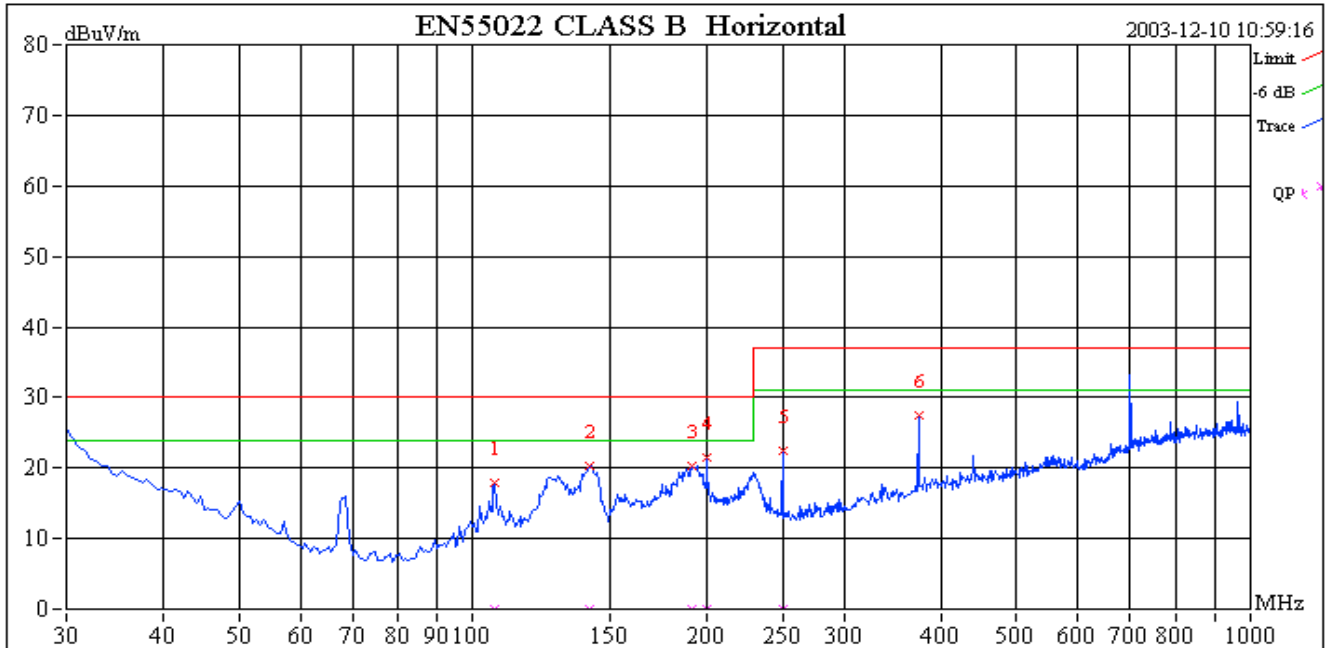

	Freq(MHz)	Pk(dBuV/m)	QP(dBuV/m)	Pk Margin(dB)	QP Margin(dB)	Limit(dBuV/m)	Read(dBuV)	C.F(dB)	Height	Deg	Remark
1	106.8337	17.86		-12.14		30.00	28.22	-10.36	100	0	
2	140.9218	20.34		-9.66		30.00	30.04	-9.70	100	0	
3	191.2425	20.23		-9.77		30.00	31.10	-10.87	100	0	
4	199.8998	21.37		-8.63		30.00	31.78	-10.41	100	0	
5	250.2204	22.56		-14.44		37.00	31.29	-8.73	100	0	
6	374.3487	27.58		-9.42		37.00	33.10	-5.52	100	0	

Comments: N/A

EN 61000-3-2 & EN 61000-3-3 (Power Harmonics & Voltage Fluctuation /Flicker)

POWER HARMONICS MEASUREMENT

Port : AC mains
Basic Standard : EN 61000-3-2: 1995 + A1: 1998 + A2: 1998 + A14: 2000
Limits : CLASS D
Tester : Ken
Temperature : 20°C
Humidity : 55%
Atmospheric Pressure : 1022mbar

VOLTAGE FLUCTUATION/FLICKER MEASUREMENT

Port : AC mains
Basic Standard : EN 61000-3-3:1995+A1:2001
Limits : Section 5 of EN 61000-3-3
Tester : Ken
Temperature : 20°C
Humidity : 55%
Atmospheric Pressure : 1022mbar

Block Diagram of Test Setup:

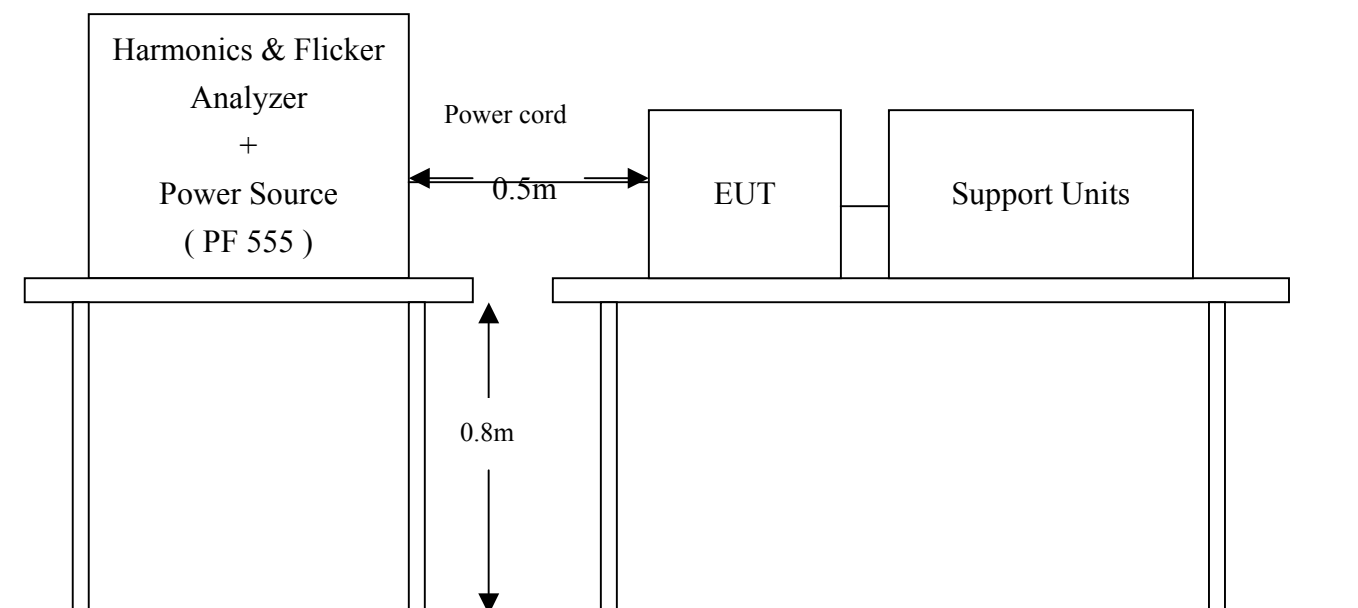

Result:

Please see the attached test data.

Harmonics-Class-A per A-14 (Run time)

Test Result: Pass

Source qualification: Normal

Current & voltage waveforms

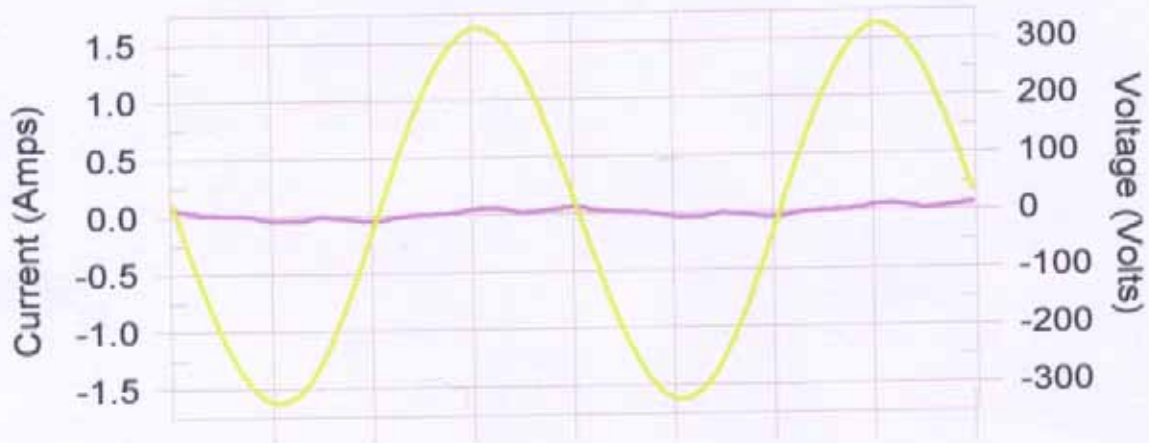

Harmonics and Class A limit line

European Limits

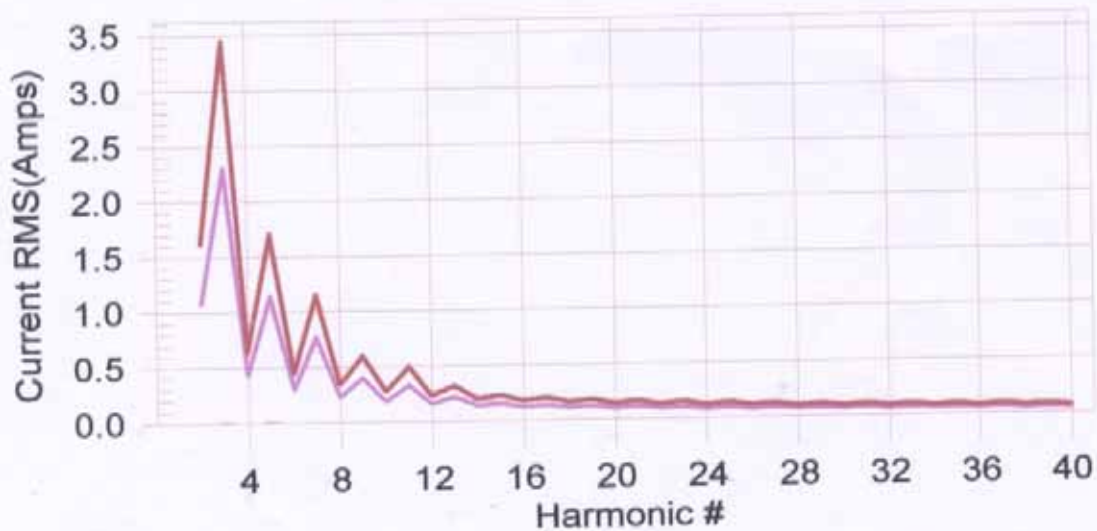

Test result: Pass

Worst harmonic was #5 with 0.59 % of the limit.

Current TEST Result Summary (Run time)

Test Result: Pass

Source qualification: Normal

Highest parameter values during test:

V_RMS (Volts): 230.34

I_Peak (Amps): 0.066

I_Fund (Amps): 0.030

Power (Watts): 5

I_RMS (Amps): 0.033

Crest Factor: 2.070

Power Factor: 0.649

Harm#	Harms(avg)	100%Limit	%of Limit	Harms(max)	150%Limit	%of Limit	Status
2	0.001	1.080	0.1	0.001	1.620	0.07	Pass
3	0.010	2.300	0.4	0.011	3.450	0.32	Pass
4	0.001	0.430	0.2	0.001	0.645	0.12	Pass
5	0.010	1.140	0.9	0.010	1.710	0.59	Pass
6	0.000	0.300	0.1	0.000	0.450	0.08	Pass
7	0.000	0.770	0.1	0.001	1.155	0.06	Pass
8	0.000	0.230	0.0	0.000	0.345	0.03	Pass
9	0.001	0.400	0.2	0.001	0.600	0.14	Pass
10	0.000	0.184	0.1	0.000	0.276	0.08	Pass
11	0.001	0.330	0.4	0.001	0.495	0.25	Pass
12	0.000	0.153	0.1	0.000	0.230	0.07	Pass
13	0.000	0.210	0.2	0.000	0.315	0.12	Pass
14	0.000	0.131	0.0	0.000	0.197	0.04	Pass
15	0.000	0.150	0.3	0.000	0.225	0.22	Pass
16	0.000	0.115	0.0	0.000	0.173	0.04	Pass
17	0.000	0.132	0.2	0.000	0.199	0.17	Pass
18	0.000	0.102	0.1	0.000	0.153	0.07	Pass
19	0.000	0.118	0.2	0.000	0.178	0.13	Pass
20	0.000	0.092	0.1	0.000	0.138	0.07	Pass
21	0.000	0.107	0.2	0.000	0.161	0.15	Pass
22	0.000	0.084	0.0	0.000	0.125	0.03	Pass
23	0.000	0.098	0.1	0.000	0.147	0.11	Pass
24	0.000	0.077	0.1	0.000	0.115	0.06	Pass
25	0.000	0.090	0.1	0.000	0.135	0.11	Pass
26	0.000	0.071	0.1	0.000	0.106	0.05	Pass
27	0.000	0.083	0.1	0.000	0.125	0.12	Pass
28	0.000	0.066	0.1	0.000	0.099	0.05	Pass
29	0.000	0.078	0.1	0.000	0.116	0.10	Pass
30	0.000	0.061	0.0	0.000	0.092	0.04	Pass
31	0.000	0.073	0.1	0.000	0.109	0.10	Pass
32	0.000	0.058	0.1	0.000	0.086	0.05	Pass
33	0.000	0.068	0.1	0.000	0.102	0.12	Pass
34	0.000	0.054	0.1	0.000	0.081	0.08	Pass
35	0.000	0.064	0.1	0.000	0.096	0.10	Pass
36	0.000	0.051	0.0	0.000	0.077	0.04	Pass
37	0.000	0.061	0.1	0.000	0.091	0.08	Pass
38	0.000	0.048	0.1	0.000	0.073	0.06	Pass
39	0.000	0.058	0.1	0.000	0.087	0.09	Pass
40	0.000	0.046	0.1	0.000	0.069	0.07	Pass

Flicker Test Summary (Run time)

Test Result: Pass

Status: Test Completed

Pst_t and limit line

European Limits



Time is too short for PIt plot

Parameter values recorded during the test:

Vrms at the end of test (Volt):	230.23	Test limit (%):	3.30	Pass
Highest dt (%):	0.00	Test limit (%):	3.30	Pass
Highest dc (%):	0.00	Test limit (%):	4.00	Pass
Highest dmax (%):	0.00	Test limit:	1.000	Pass
Highest Pst (10 min. period):	0.001	Test limit:	0.000	Pass
Highest PIt (2 hr. period):	0.001			

SECTION 2 – IMMUNITY TESTS (EN 55024)

Electrostatic discharge (ESD) immunity test (IEC 61000-4-2)

Radiated electromagnetic field (RS) immunity test (IEC 61000-4-3)

Fast transient / burst (EFT) immunity test (IEC 61000-4-4)

Surge immunity test (IEC 61000-4-5)

**Conducted disturbances inducted by radio-frequency fields, (CS)
immunity test (IEC 61000-4-6)**

Power Frequency Magnetic Field Immunity Test (IEC 61000-4-8)

**Voltage dips, short interruption and voltage variation
immunity test (IEC 61000-4-11)**

IEC 61000-4-2

ELECTROSTATIC DISCHARGE (ESD) IMMUNITY TEST

Port	: Enclosure
Basic Standard	: IEC 61000-4-2
Requirements	: +/- 8 kV (Air Discharge) +/- 4 kV (Contact Discharge) +/- 4 kV (Indirect Discharge)
Performance Criteria	: B (Standard require)
Tester	: Hadiif
Temperature/Humidity	: 22 °C / 55%
Atmospheric Pressure	: 1028mbar

Block Diagram of Test Setup:

(The 470 k ohm resistors are installed per standard requirement)

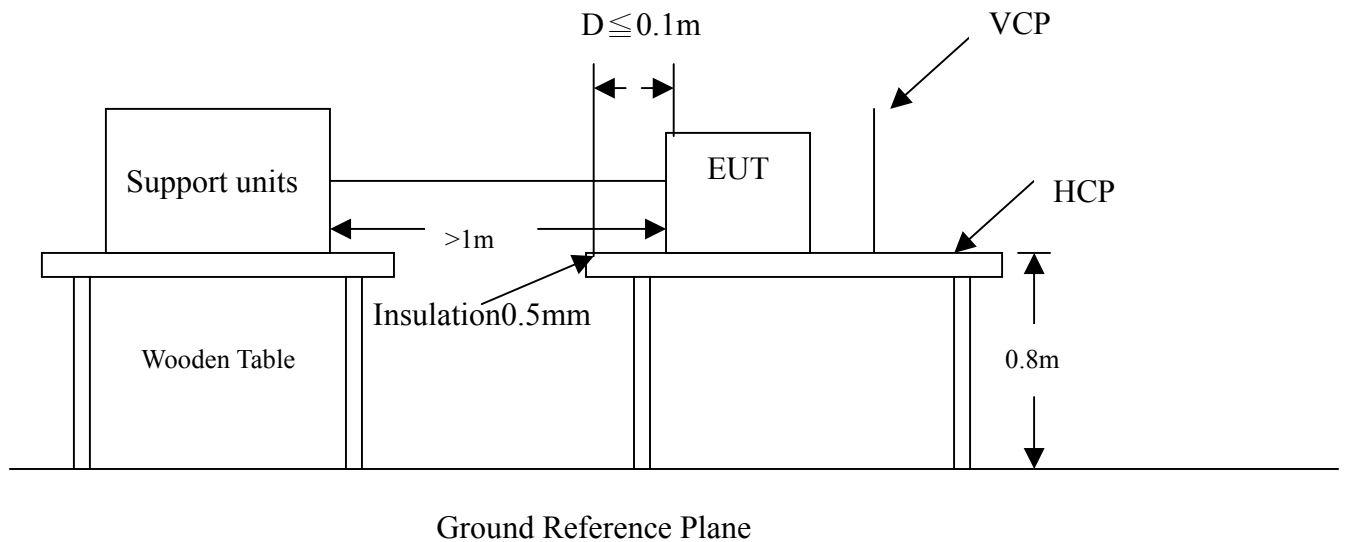

Test Procedure:

1. The EUT was located 0.1 m minimum from all side of the HCP.
2. The support units were located 1 m minimum away from the EUT.
3. Active the communication function if the EUT with such port(s).
4. As per the requirement of EN 55024; applying direct contact discharge at the sides other than front of EUT at minimum 50 discharges (25 positive and 25 negative) if applicable, discharge time for each point is 5 seconds. can't be applied direct contact discharge side of EUT then the indirect discharge shall be applied. One of the test points shall be subjected to at least 50 indirect discharge (contact) to the front edge of horizontal coupling plane.
5. Other parts of EUT where it is not possible to perform contact discharge then selecting appropriate points of EUT for air discharge, a minimum of 10 single air discharges shall be applied.
6. The application of ESD to the contact of open connectors is not required.
7. Putting a mark on EUT to show tested points. The following test condition was followed during the tests.

Note: As per the A2 to IEC 61000-4-2, a bleed resistor(470k Ω cable is connected between the EUT and HCP during the test.

The electrostatic discharges were applied as follows:

Amount of Discharges	Voltage	Coupling	Result (Pass/Fail)
Mini 25 /Point	$\pm 4\text{kV}$	Contact Discharge	Pass
Mini 25 /Point	$\pm 4\text{kV}$	Indirect Discharge HCP (Front)	Pass
Mini 25 /Point	$\pm 4\text{kV}$	Indirect Discharge VCP (Left)	Pass
Mini 25 /Point	$\pm 4\text{kV}$	Indirect Discharge VCP (Back)	Pass
Mini 25 /Point	$\pm 4\text{kV}$	Indirect Discharge VCP (Right)	Pass
Mini 10 /Point	$\pm 8\text{kV}$	Air Discharge	Pass

**** The tested points to EUT, please refer to attached pages.
(Blue arrow mark for contact discharge, red arrow mark for air discharge.)**

Performance & Result:

- Criteria A:** The apparatus continues to operate as intended. No degradation of performance or loss of function is allowed below a performance level specified by the manufacturer, when the apparatus is used as intended. In some cases the performance level may be replaced by a permissible loss of performance.
- Criteria B:** The apparatus continues to operate as intended after the test. No degradation of performance or loss of function is allowed below a performance level specified by the manufacturer, when the apparatus is used as intended. In some cases the performance level may be replaced by a permissible loss of performance. During the test, degradation of performance is however allowed.
- Criteria C:** Temporary loss of function is allowed, provided the functions self recoverable or can be restored by the operation of controls.

PASS

FAILED

Observation: No any function degraded during the tests.

The Tested Points of EUT

Front view of EUT

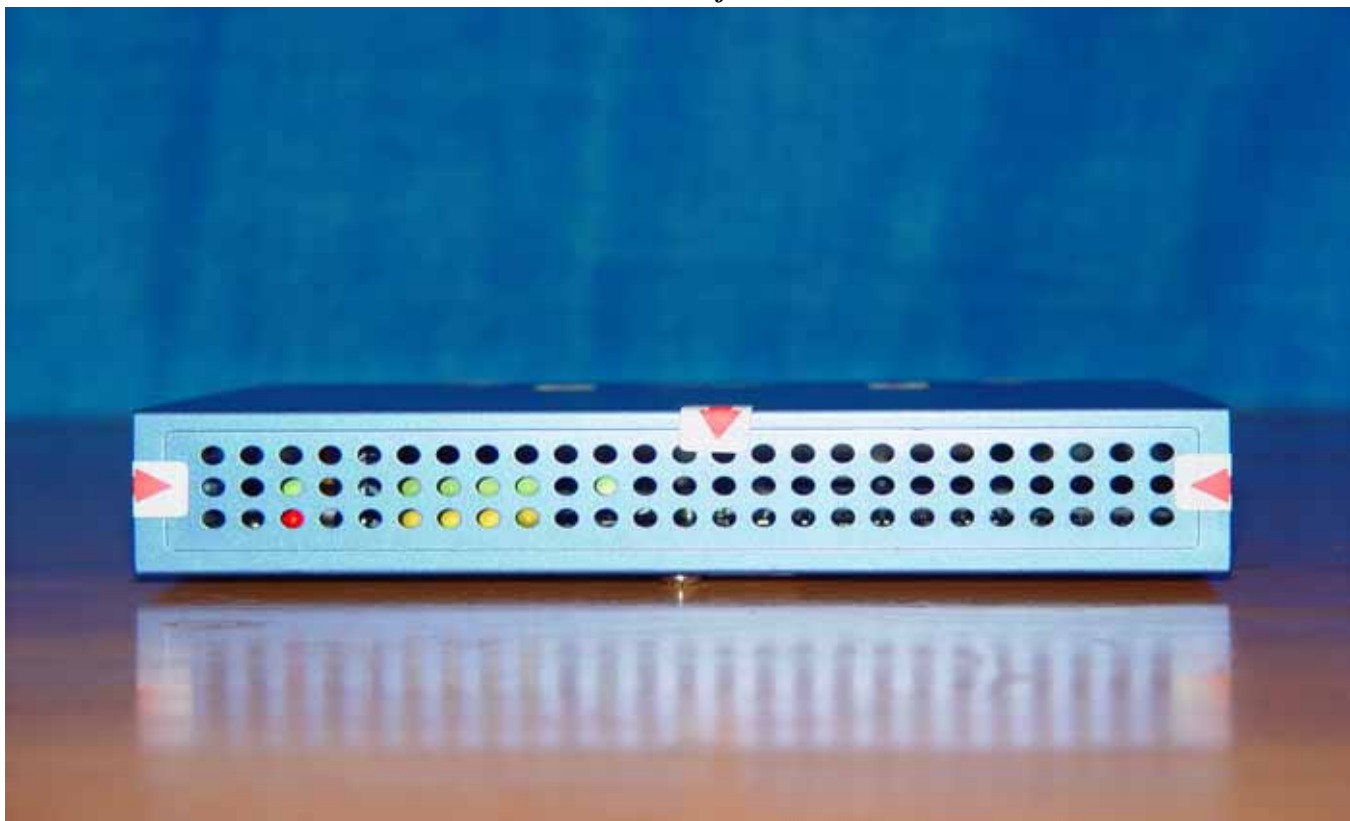

Back view of EUT



left view of EUT

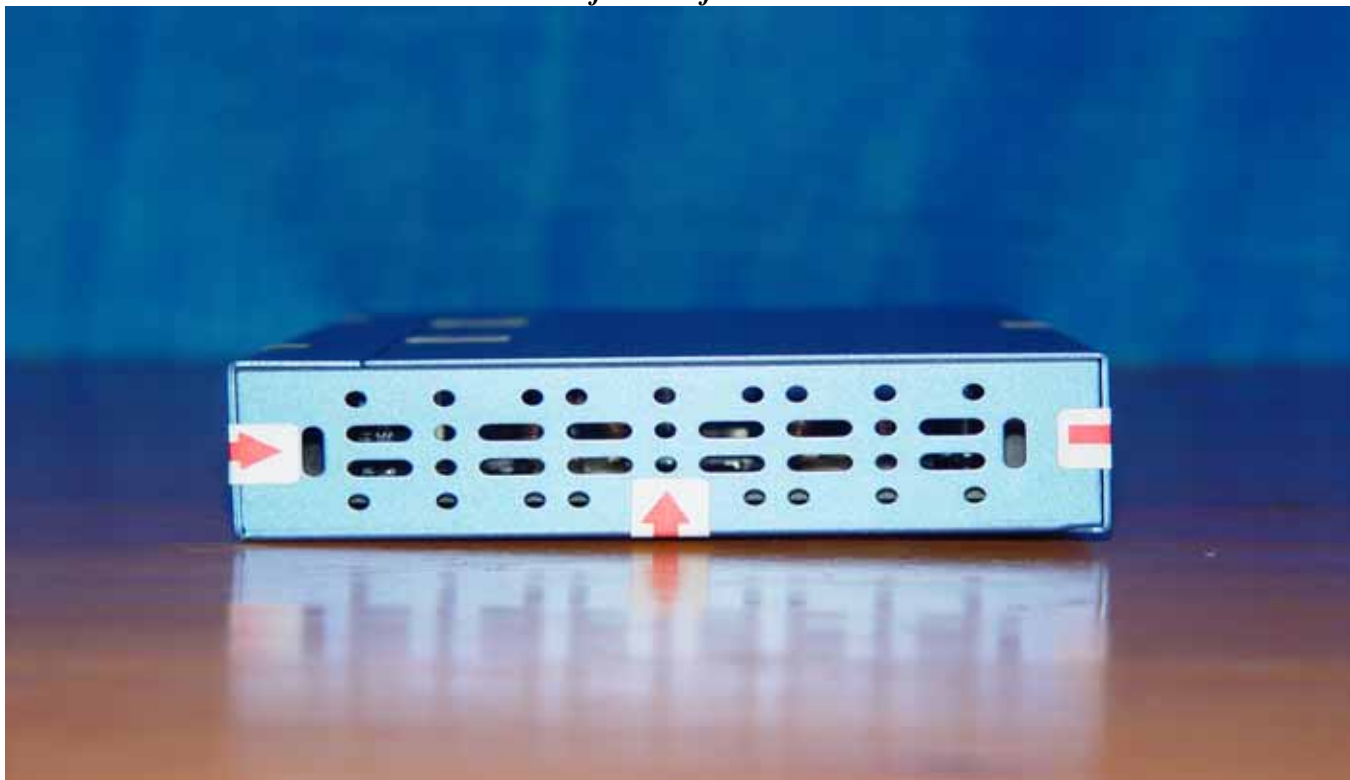

Right view of EUT



Top view of EUT

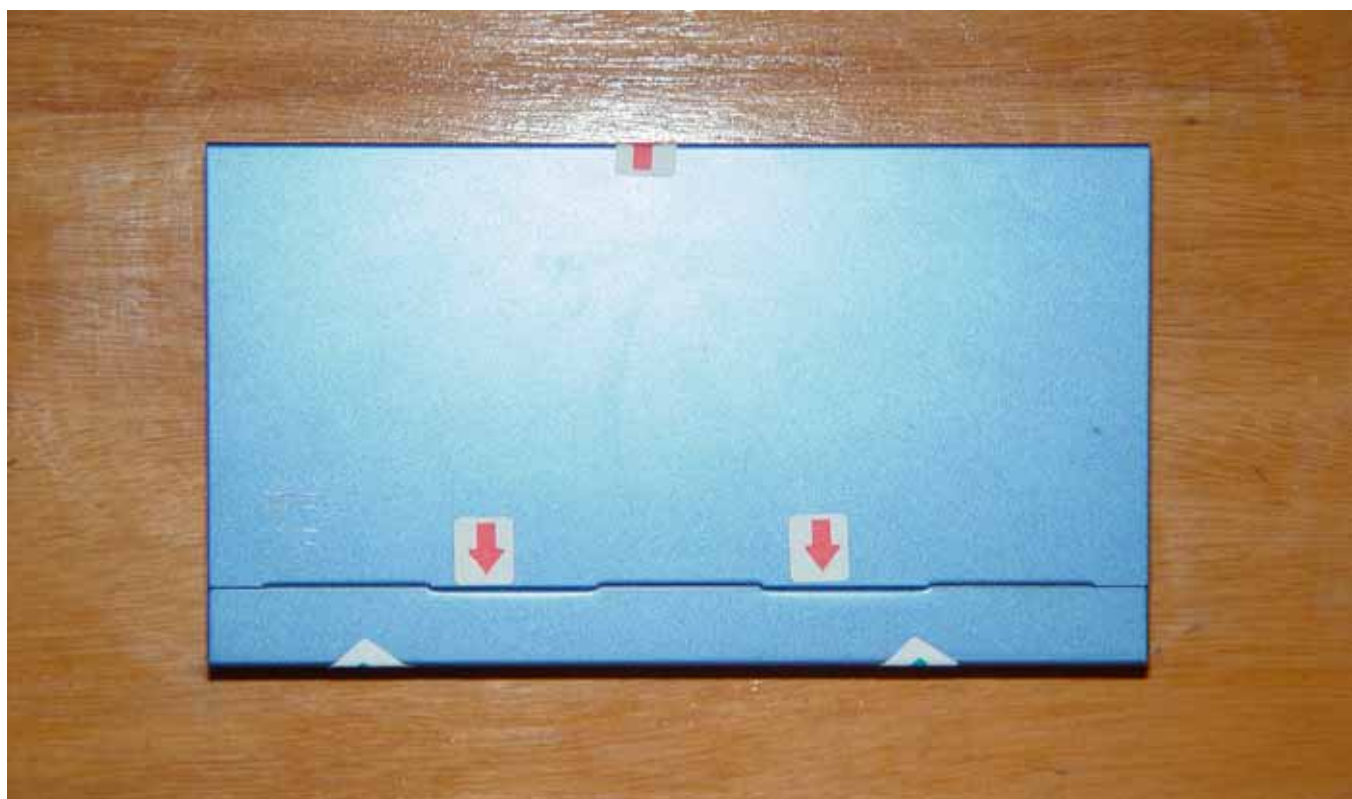

Bottom view of EUT

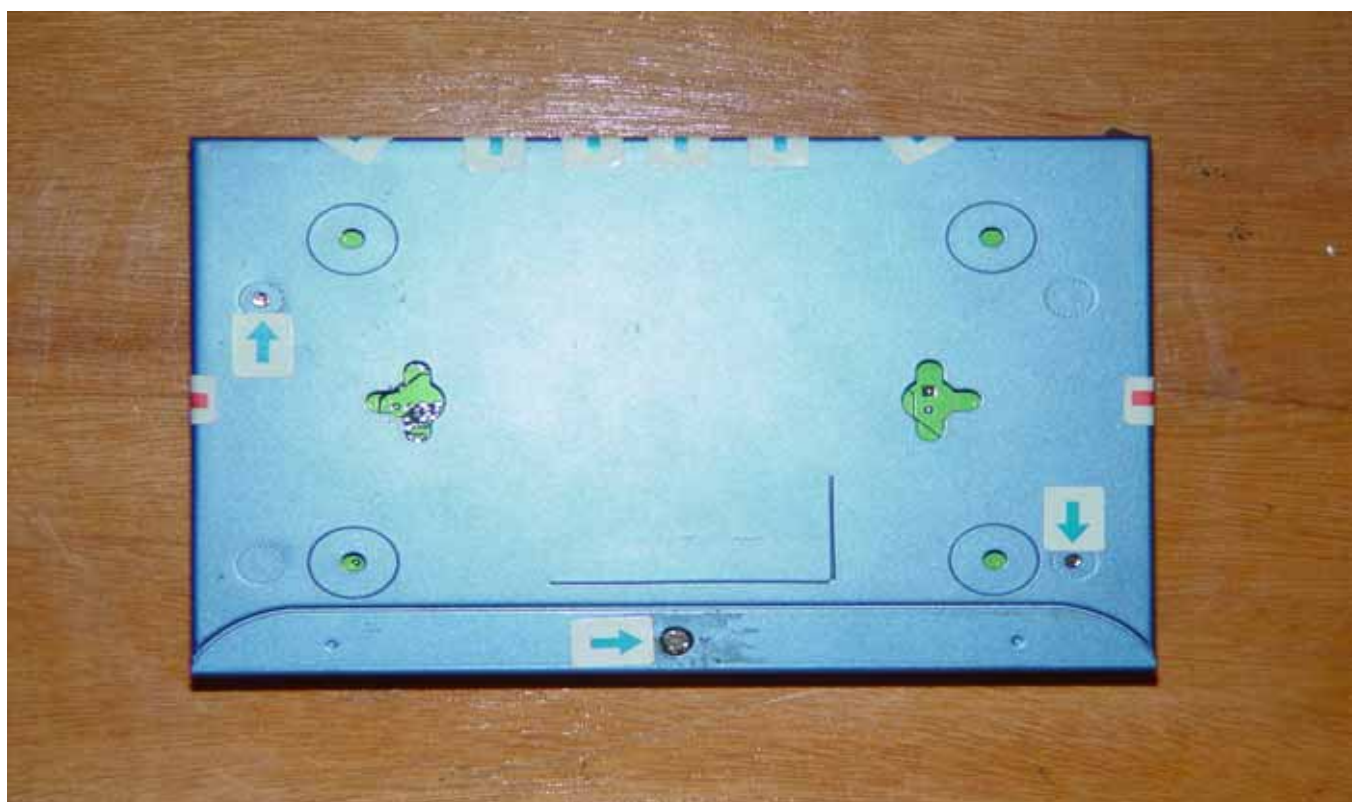

IEC 61000-4-3

RADIATED ELECTROMAGNETIC FIELD IMMUNITY TEST

Port	: Enclosure
Basic Standard	: IEC 61000-4-3
Requirements	: 3 V/m / with 80% AM. 1kHz Modulation.
Performance Criteria	: A (Standard require)
Tester	: Hadiif
Temperature	: 22°C
Humidity	: 55%
Atmospheric Pressure	: 1028mbar

Block Diagram of Test Setup:

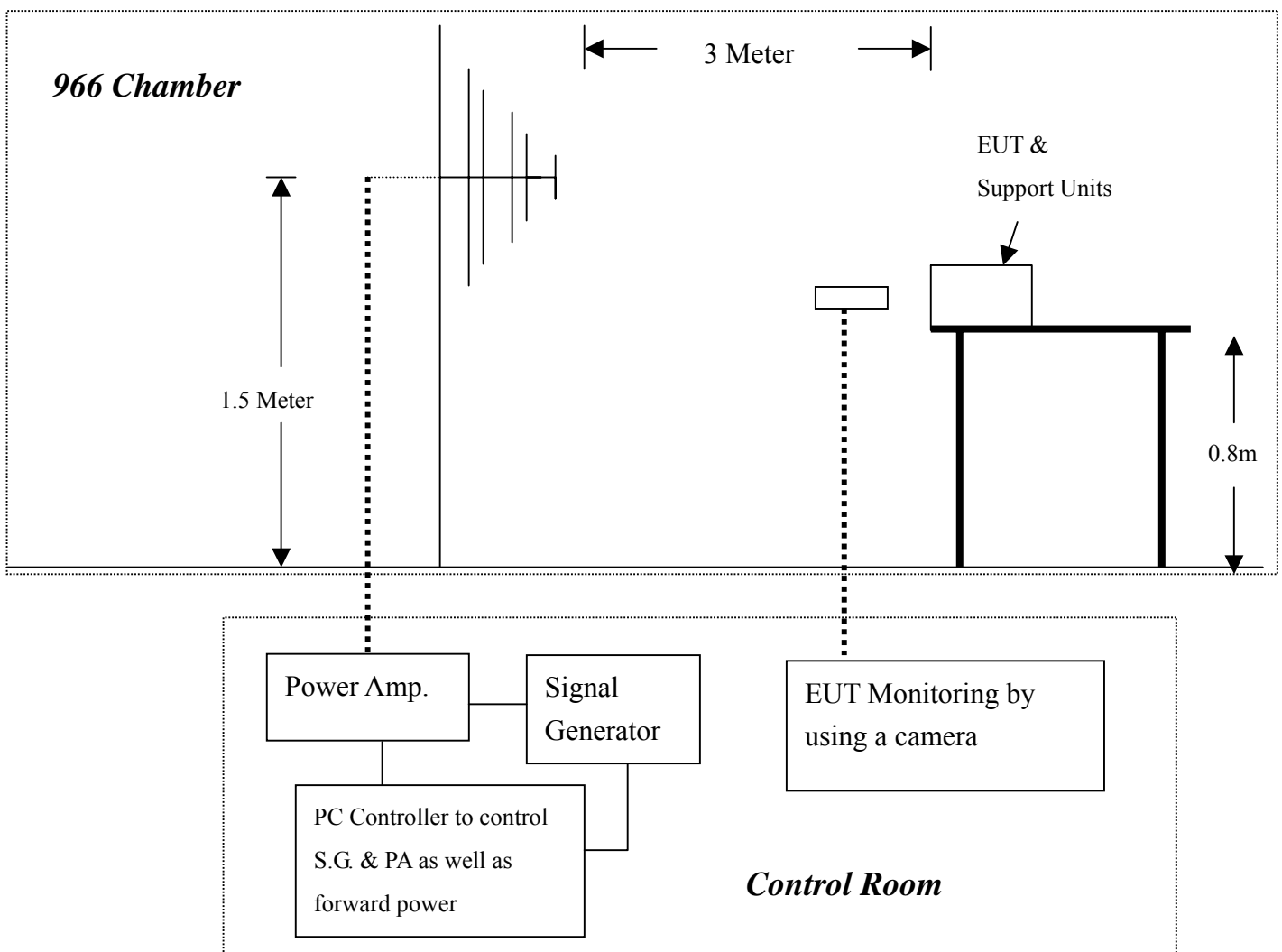

Test Procedure:

1. The EUT was located at the edge of supporting table keep 3 meter away from transmitting antenna, it just the calibrated square area of field uniformity. The support units were located outside of the uniformity area, but the cable(s) connected with EUT were exposed to the calibrated field as per IEC 61000-4-3.
2. Active the communication function if the EUT with such port(s).
2. Setting the testing parameters of RS test software per IEC 61000-4-3.
3. Performing the pre-test at each side of with double specified level (6V/m) at 4% steps.
4. From the result of pre-test in step 5, choice the worst side of EUT for final test from 80 MHz to 1000 MHz at 1% steps.
5. Recording the test result in following table.
6. It is not necessary to perform test as per annex A of EN 55024 if the EUT doesn't belong to ITE product.

IEC 61000-4-3 Preliminary test conditions:

Test level : 6V/m
Steps : 4 % of fundamental
Dwell Time : 3 sec

Range (MHz)	Field	Modulation	Polarity	Position (°)	Result (Pass/Fail)
80-1000	6V	Yes	H	Front	Pass
80-1000	6V	Yes	V	Front	Pass
80-1000	6V	Yes	H	Right	Pass
80-1000	6V	Yes	V	Right	Pass
80-1000	6V	Yes	H	Back	Pass
80-1000	6V	Yes	V	Back	Pass
80-1000	6V	Yes	H	Left	Pass
80-1000	6V	Yes	V	Left	Pass

IEC 61000-4-3 Final test conditions:

Test level : 3V/m
Steps : 1 % of fundamental
Dwell Time : 3 sec

Range (MHz)	Field	Modulation	Polarity	Position (°)	Result (Pass/Fail)
80-1000	3V	Yes	H	Back	Pass
80-1000	3V	Yes	V	Back	Pass

Performance & Result:

- Criteria A:** The apparatus continues to operate as intended. No degradation of performance or loss of function is allowed below a performance level specified by the manufacturer, when the apparatus is used as intended. In some cases the performance level may be replaced by a permissible loss of performance.
- Criteria B:** The apparatus continues to operate as intended after the test. No degradation of performance or loss of function is allowed below a performance level specified by the manufacturer, when the apparatus is used as intended. In some cases the performance level may be replaced by a permissible loss of performance. During the test, degradation of performance is however allowed.
- Criteria C:** Temporary loss of function is allowed, provided the functions self-recoverable or can be restored by the operation of controls.

PASS

FAILED

Observation: No any function degraded during the tests.

IEC 61000-4-4

FAST TRANSIENTS/BURST IMMUNITY TEST

Port	: On Power Lines and Data Cable
Basic Standard	: IEC 61000-4-4
Requirements	: +/- 1kV for Power Supply Lines +/- 0.5kV to Data Cable
Performance Criteria	: B (Standard require)
Tester	: Ken
Temperature	: 20 °C
Humidity	: 55%
Atmospheric Pressure	: 1022mbar

Block Diagram of Test Setup:

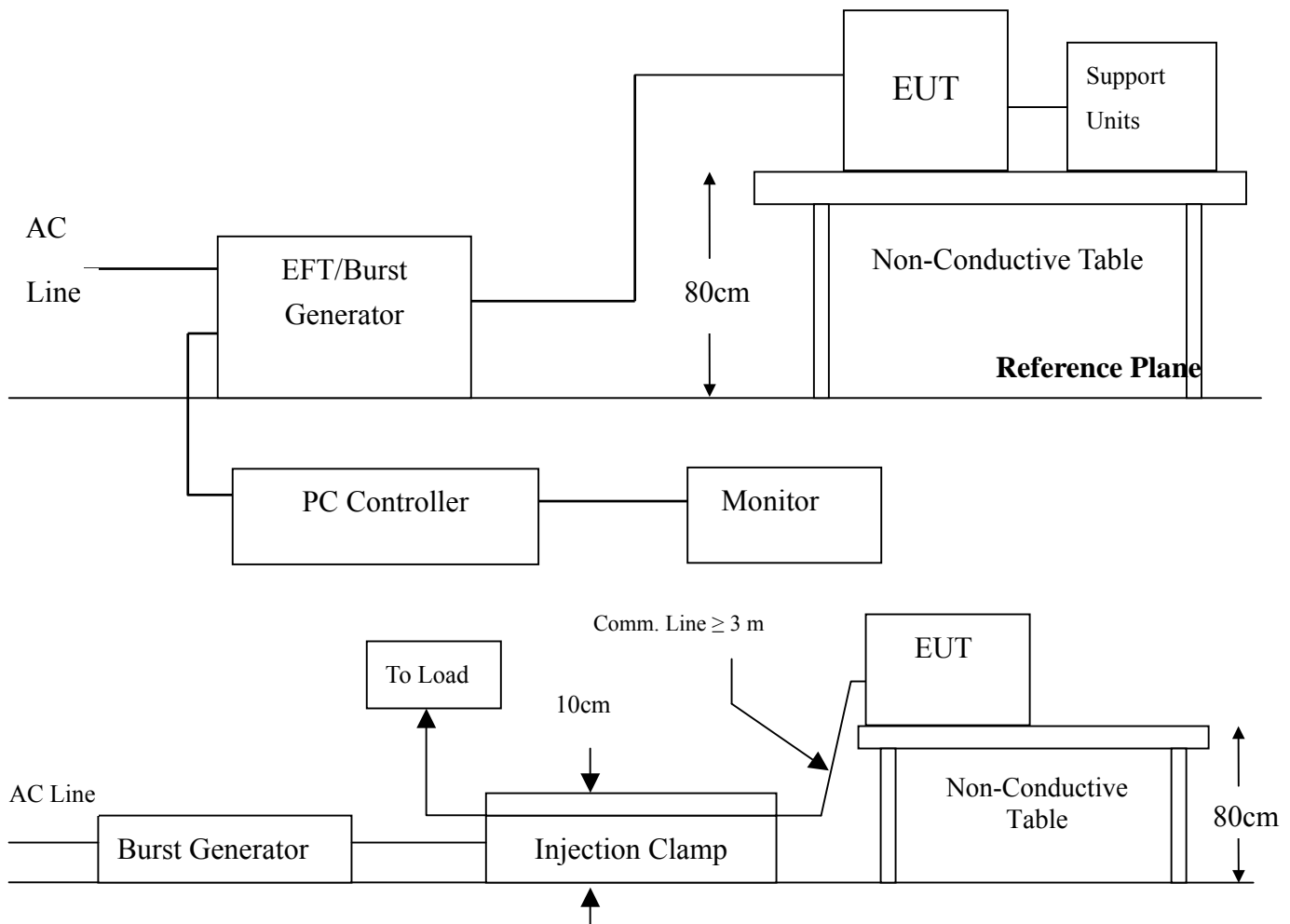

Test Procedure:

1. The EUT and support units were located on a wooden table 0.8 m away from ground reference plane.
2. A 1.0 meter long power cord was attached to EUT during the test.
3. The length of communication cable between communication port and clamp was keeping within 1 meter.
4. A scroll 'H' test program was loaded and executed in Windows mode.
5. Active the communication function if the EUT with such port(s).
6. The test program exercised related support units sequentially.
7. Repeating step 3 to 5 through the test.
8. Recording the test result as shown in following table.

Test conditions:

Impulse Frequency: 5kHz

Tr/Th: 5/50ns

Burst Duration: 15ms

Burst Period: 300mS

Inject Line	Voltage kV	Inject Method	Result (Pass/Fail)
L	+/- 1	Direct	Pass
N	+/- 1	Direct	Pass
L + N	+/- 1	Direct	Pass
RJ45 PORT	+/- 0.5	Clamp	Pass

Performance & Result:

- Criteria A:** The apparatus continues to operate as intended. No degradation of performance or loss of function is allowed below a performance level specified by the manufacturer, when the apparatus is used as intended. In some cases the performance level may be replaced by a permissible loss of performance.
- Criteria B:** The apparatus continues to operate as intended after the test. No degradation of performance or loss of function is allowed below a performance level specified by the manufacturer, when the apparatus is used as intended. In some cases the performance level may be replaced by a permissible loss of performance. During the test, degradation of performance is however allowed.
- Criteria C:** Temporary loss of function is allowed, provided the functions self recoverable or can be restored by the operation of controls.

PASS

FAILED

Observation: No any function degraded during the tests.

IEC 61000-4-5

SURGE IMMUNITY TEST

Port : AC Power cord
Basic Standard : IEC 61000-4-5
Requirements : +/- 1kV (Line to Line of AC Power Port)

Performance Criteria : B (Standard require)

Tester : Ken

Temperature : 22 °C

Humidity : 55%

Atmospheric Pressure : 1028mbar

Block Diagram of Test Setup:

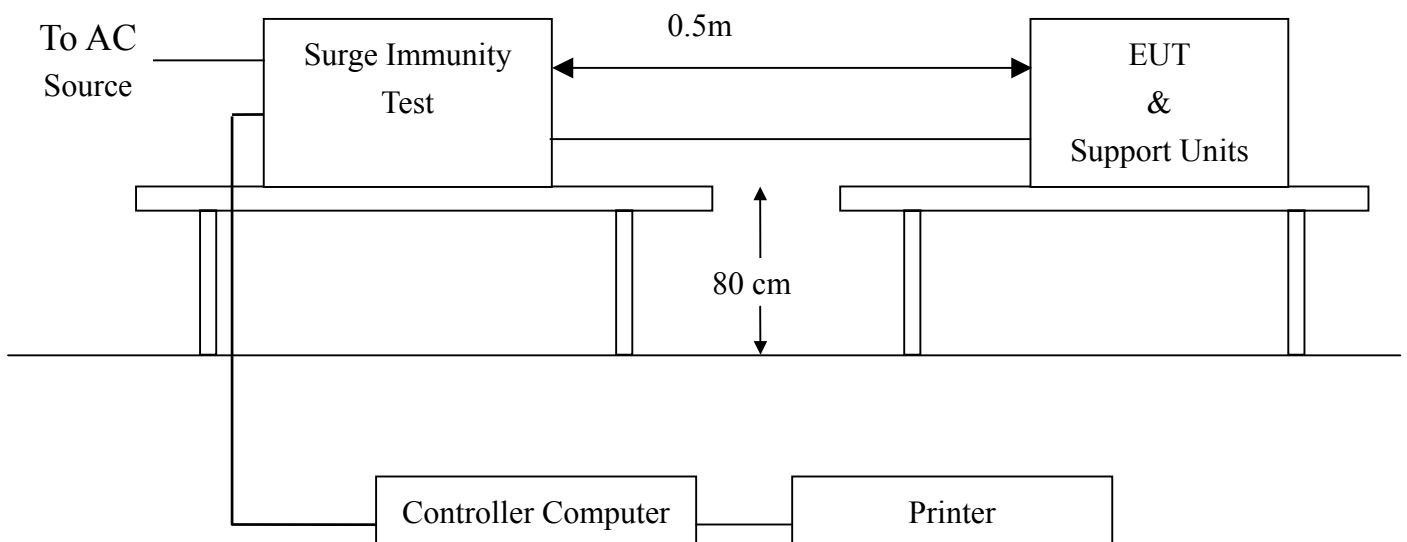

Test Procedure:

1. The EUT and support units were located on a wooden table 0.8 m away from ground floor.
2. A test program was loaded and executed in Windows mode.
3. Active the communication function if the EUT with such port(s).
4. The test program exercised related support units sequentially.
5. Repeating step 4 through the test.
6. Recording the test result as shown in following table.

Test conditions:

Voltage Waveform : 1.2/50 us
 Current Waveform : 8/20 us
 Polarity : Positive/Negative
 Phase angle : 0°, 90°, 270°
 Number of Test : 5

Coupling Line	Voltage (kV)	Polarity	Coupling Method	Result (Pass/Fail)
L1-L2	1	Positive	Capacitive	Pass
L1-L2	1	Negative	Capacitive	Pass

Performance & Result:

- Criteria A:** The apparatus continues to operate as intended. No degradation of performance or loss of function is allowed below a performance level specified by the manufacturer, when the apparatus is used as intended. In some cases the performance level may be replaced by a permissible loss of performance.
- Criteria B:** The apparatus continues to operate as intended after the test. No degradation of performance or loss of function is allowed below a performance level specified by the manufacturer, when the apparatus is used as intended. In some cases the performance level may be replaced by a permissible loss of performance. During the test, degradation of performance is however allowed.
- Criteria C:** Temporary loss of function is allowed, provided the functions self-recoverable or can be restored by the operation of controls.

<input checked="" type="checkbox"/> PASS <input type="checkbox"/> FAILED
Observation: No any function degraded during the tests.

IEC 61000-4-6

CONDUCTED DISTURBANCE /INDUCED BY RADIO-FREQUENCY FIELD

Port	: AC Port; Signal lines (Applicable only to ports which according to manufacturer's specification supports communication on cable lengths greater than 3m.)
Base Standard	: IEC 61000-4-6
Requirements	: 3 V with 80% AM. Modulation
Injection Method	: CDN-M316 for Power Cord EM-Clamp for LAN Cable
Performance Criteria	: A (Standard require)
Tester	: Ken
Temperature	: 20 °C
Humidity	: 55%
Atmospheric Pressure	: 1024mbar
Note	: The EUT doesn't belong to TTE product, the tests at limited number of frequencies not required

Block Diagram of Test Setup:

Side view:

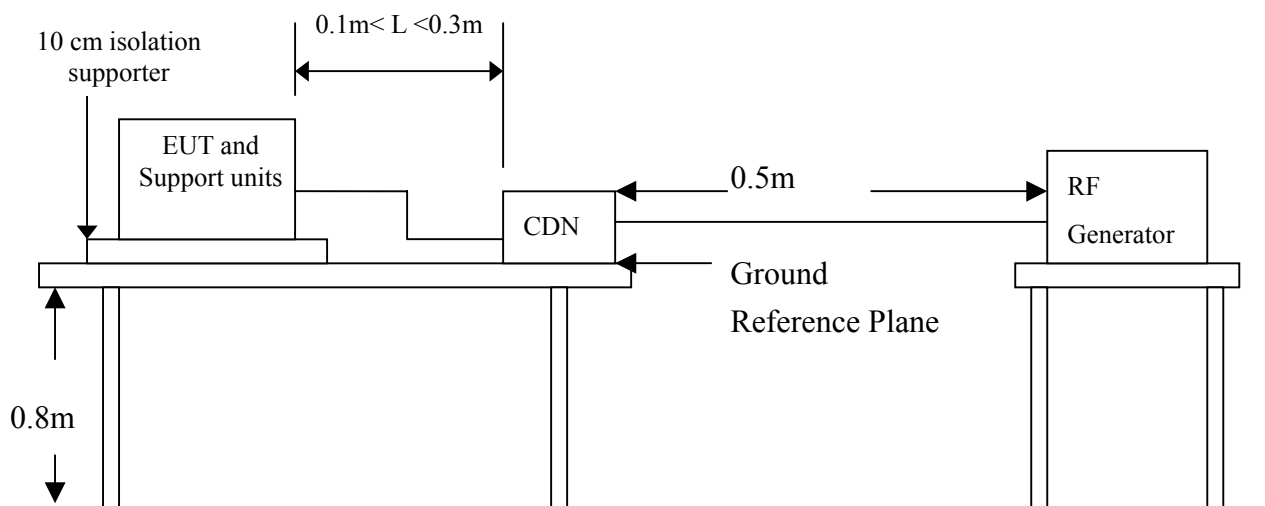

Top view:

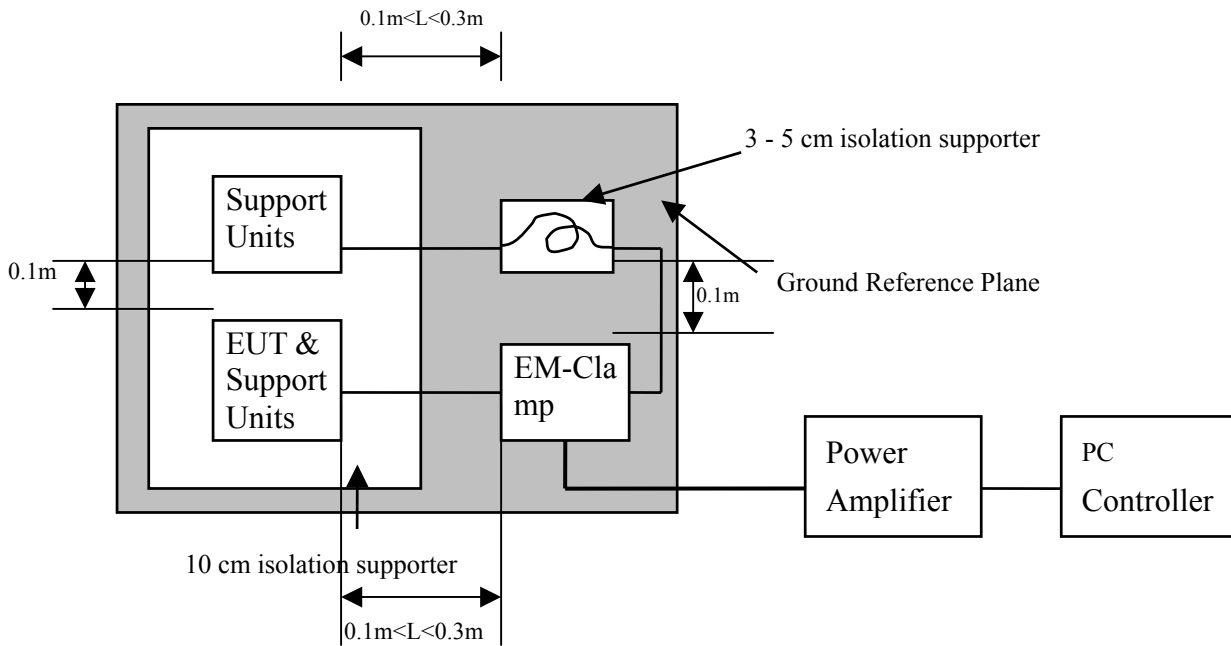

Test Procedure:

1. The EUT and support units were located at a ground reference plane with the interposition of a 0.1 m thickness insulating supporter and the CDN was located on GRP directly
2. Active the communication function if the EUT with such port(s).
3. Setting the testing parameters of CS test software per EN 61000-4-6.
4. Recording the test result in following table.

Test conditions:

Frequency Range : 0.15MHz-80MHz

Frequency Step : 1% of fundamental

Dwell Time : 3 sec

Range (MHz)	Field	Modulation	Result (Pass/Fail)
0.15-80	3V	Yes	Pass

Performance & Result:

- Criteria A:** The apparatus continues to operate as intended. No degradation of performance or loss of function is allowed below a performance level specified by the manufacturer, when the apparatus is used as intended. In some cases the performance level may be replaced by a permissible loss of performance.
- Criteria B:** The apparatus continues to operate as intended after the test. No degradation of performance or loss of function is allowed below a performance level specified by the manufacturer, when the apparatus is used as intended. In some cases the performance level may be replaced by a permissible loss of performance. During the test, degradation of performance is however allowed.
- Criteria C:** Temporary loss of function is allowed, provided the functions self-recoverable or can be restored by the operation of controls.

PASS

FAILED

Observation: No any function degraded during the tests.

IEC 61000-4-8

POWER FREQUENCY MAGNETIC FIELD IMMUNITY TEST

Port	: Enclosure
Basic Standard	: IEC 61000-4-8
Requirements	: 1 A/m
Performance Criteria	: A (Standard Required)
Tester	: N/A
Temperature	: N/A
Humidity	: N/A
Atmospheric Pressure	: N/A

Block Diagram of Test setup:

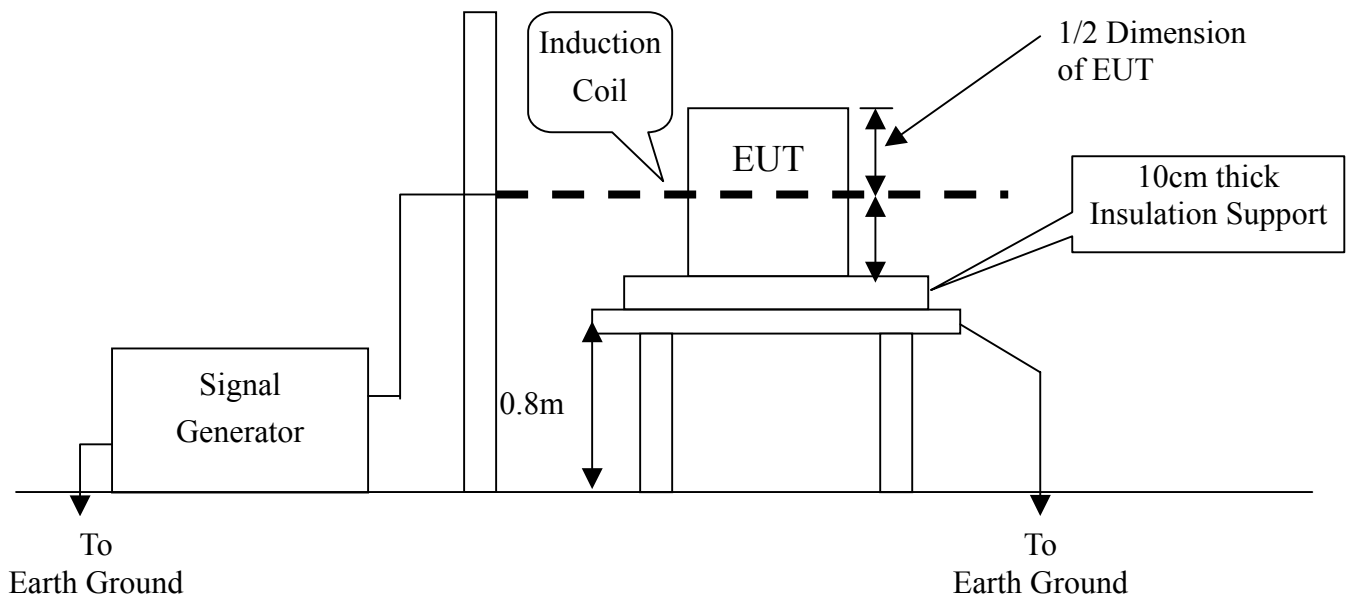

Test Procedure:

1. The EUT and support units were located on Ground Reference Plane with the interposition of a 0.1 m thickness insulation support.
2. Putting the induction coil on horizontal direction.(X direction)
3. A test program was loaded and executed in Windows mode.
4. Active the communication function if the EUT with such port(s).
5. The test program exercised related support units sequentially.
6. Repeating step 3 to 5 through the test.
7. Recording the test result as shown in following table.
8. Rotating the induction coil by 90° (Y direction) then repeat step 3 to 7.
9. Rotating the EUT by 90° horizontally again(Z direction) then repeat step 3 to 7.

*. Test conditions:

Field Strength: 1A/m
Power Freq.: 50Hz
Orientation: X, Y, Z

Orientation	Field	Result (Pass/Fail)	Remark
X axis	1A/m	Pass	N/A
Y axis	1A/m	Pass	N/A
Z axis	1A/m	Pass	N/A

Performance & Result:

- Criteria A:** The apparatus continues to operate as intended. No degradation of performance or loss of function is allowed below a performance level specified by the manufacturer, when the apparatus is used as intended. In some cases the performance level may be replaced by a permissible loss of performance.
- Criteria B:** The apparatus continues to operate as intended after the test. No degradation of performance or loss of function is allowed below a performance level specified by the manufacturer, when the apparatus is used as intended. In some cases the performance level may be replaced by a permissible loss of performance. During the test, degradation of performance is however allowed.
- Criteria C:** Temporary loss of function is allowed, provided the functions self recoverable or can be restored by the operation of controls.

PASS **FAILED**

Observation: No any function degraded during the tests.

IEC 61000-4-11

Voltage Dips, Short Interruptions and Voltage Variations

Port : AC mains
Basic Standard : IEC 61000-4-11 (1994)
Requirement : Phase angles 0 degrees.

Voltage Dips	Test Level % U_T	Reduction (%)	Duration (periods)	Performance Criteria
	<5	>95	0.5	B
70	30	25	C	

Voltage Interruptions	Test Level % U_T	Reduction (%)	Duration (periods)	Performance Criteria
	<5	>95	250	C

Test Interval : Min. 60 sec.
Tester : Ken
Temperature : 20°C
Humidity : 55%
Atmospheric Pressure : 1022mbar

Block Diagram of Test Setup:

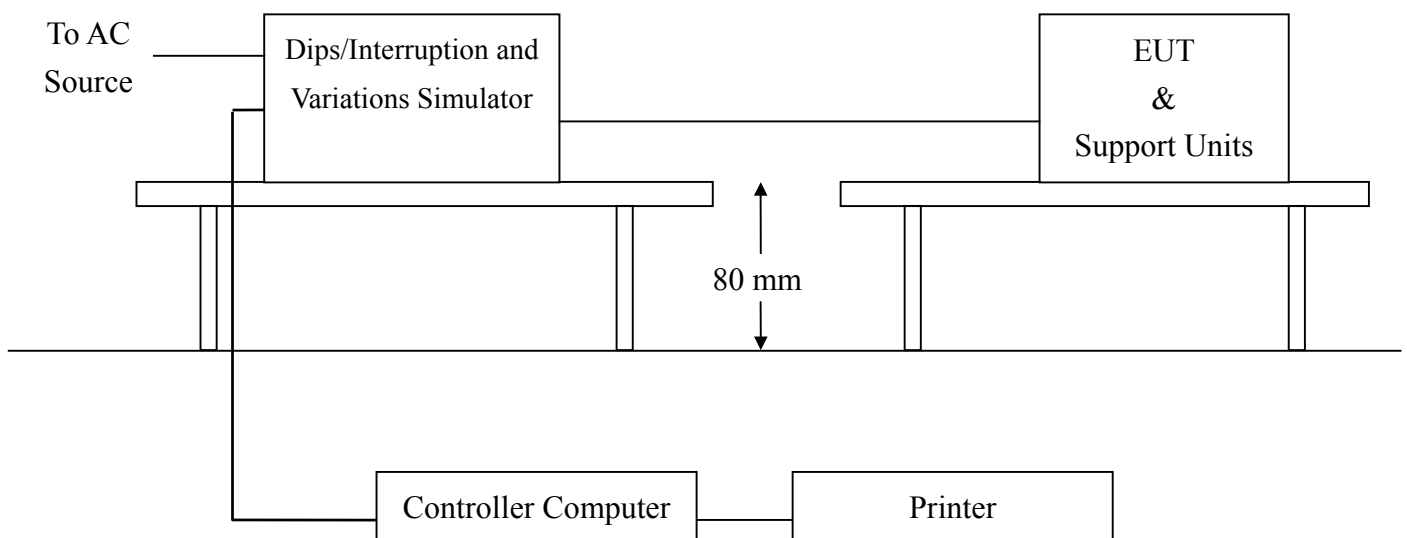

Test Procedure:

1. The EUT and support units were located on a wooden table, 0.8 m away from ground floor.
2. A test program was loaded and executed in Windows mode
3. Active the communication function if the EUT with such port(s).
4. The test program exercised related support units sequentially.
5. Setting the parameter of tests and then Perform the test software of test simulator.
6. Conditions changes to occur at 0 degree crossover point of the voltage waveform.
7. Repeating step 3 to 4 through the test.
8. Recording the test result in test record form.

Test conditions:

The duration with a sequence of three dips/interruptions with interval of 10s minimum (between each test events)

Voltage Dips:

Test Level % U _T	Reduction (%)	Duration (periods)	Observation	Meet Performance Criteria
0	100	0.5	Normal	B
70	30	25	Normal	B

Voltage Interruptions:

Test Level % U _T	Reduction (%)	Duration (periods)	Observation	Meet Performance Criteria
0	100	250	EUT shut down but can be recovered by manual, as the events disappears	C

Normal: No any functions degrade during and after the test.

Performance & Result:

Criteria A: The apparatus continues to operate as intended. No degradation of performance or loss of function is allowed below a performance level specified by the manufacturer, when the apparatus is used as intended. In some cases the performance level may be replaced by a permissible loss of performance.

Criteria B: The apparatus continues to operate as intended after the test. No degradation of performance or loss of function is allowed below a performance level specified by the manufacturer, when the apparatus is used as intended. In some cases the performance level may be replaced by a permissible loss of performance. During the test, degradation of performance is however allowed.

Criteria C: Temporary loss of function is allowed, provided the functions self recoverable or can be restored by the operation of controls.

<input checked="" type="checkbox"/> PASS	<input type="checkbox"/> FAILED
---	--

APPENDIX 1

Photographs of Test Setup

LINE CONDUCTED EMISSION TEST (EN 55022)
Front



BACK

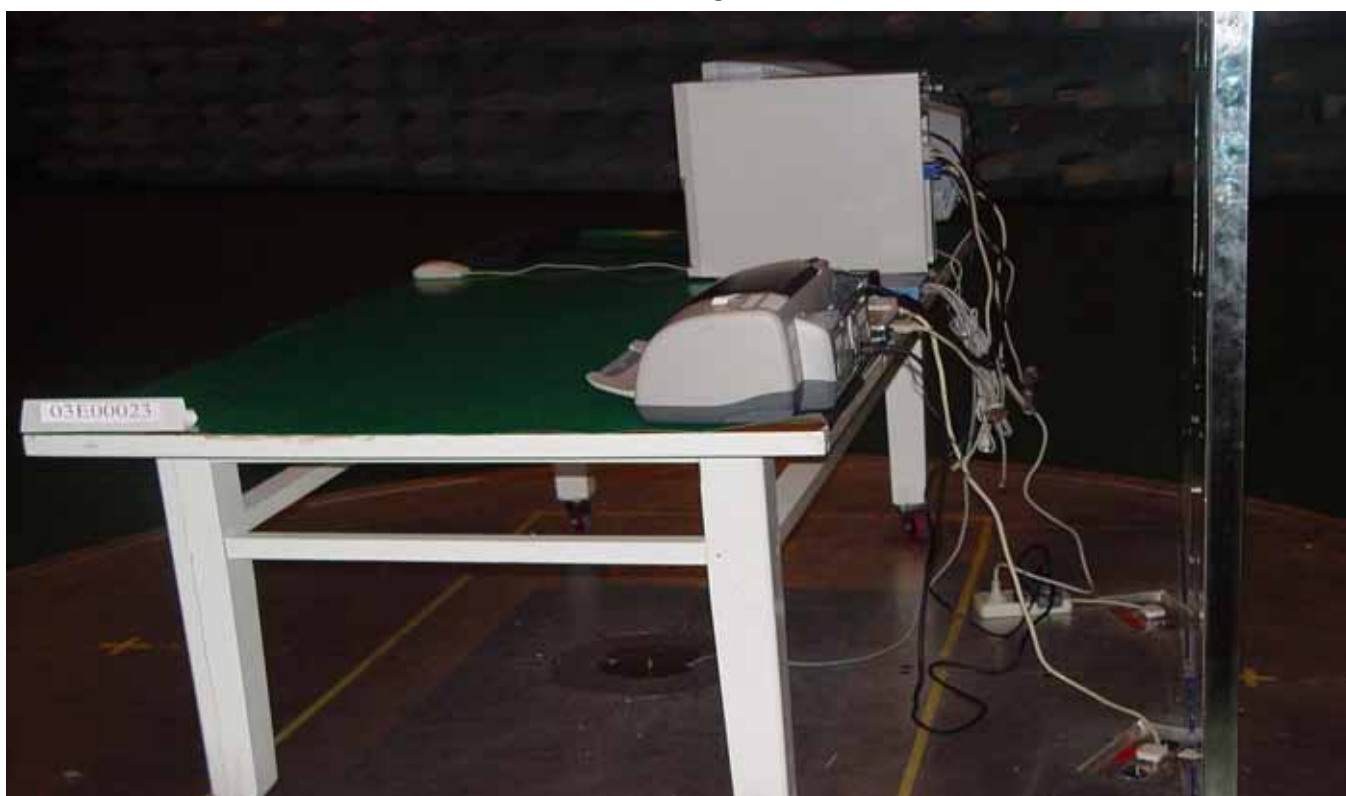

Common Mode Conducted (EN 55022) ISN



RADIATED EMISSION TEST (EN 55022)

Front



Back

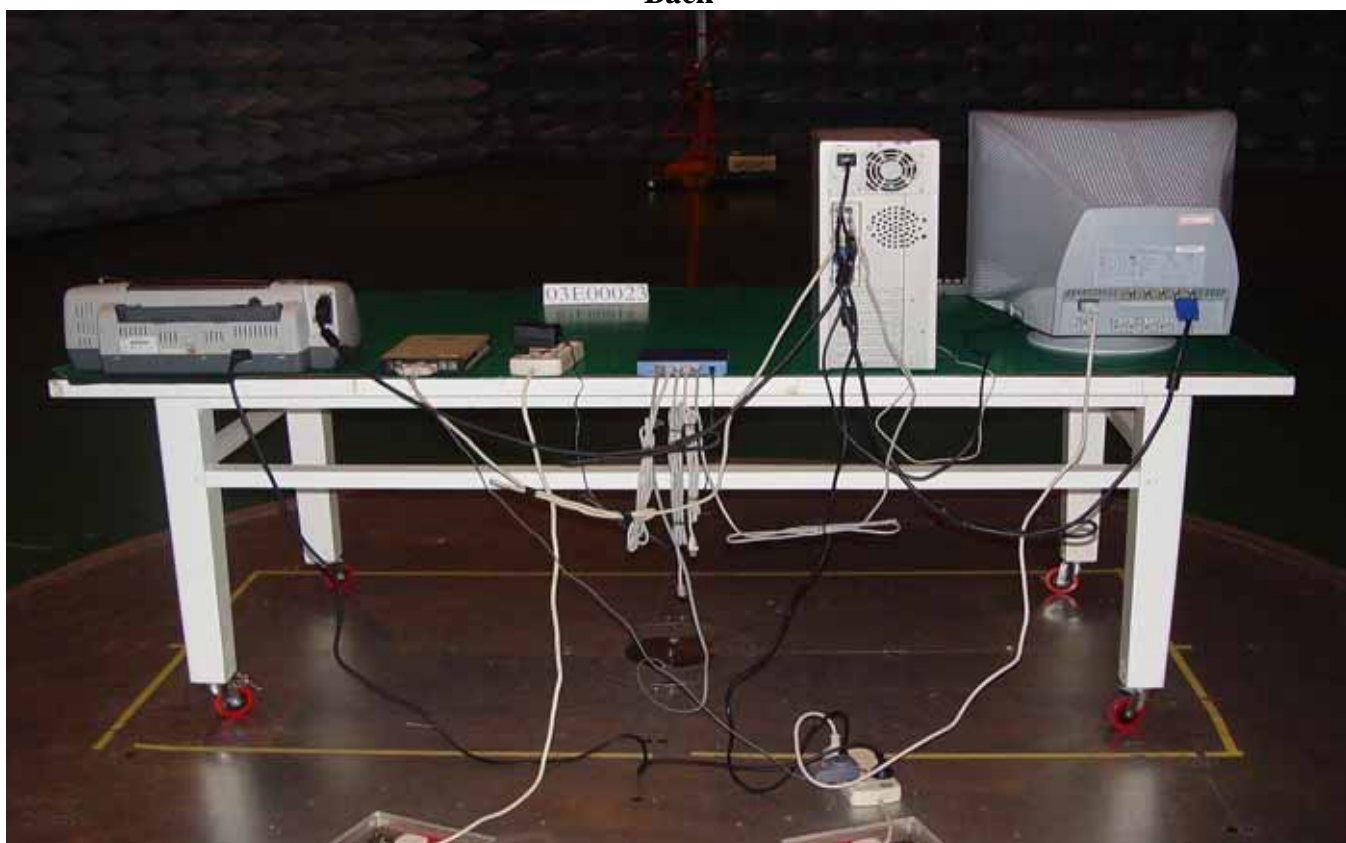

POWER HARMONIC & VOLTAGE FLUCTUATION / FLICKER TEST (EN 61000-3-2, EN 61000-3-3)



ELECTROSTATIC DISCHARGE TEST (IEC 61000-4-2) ESD AIR



ESD CONTACT



ESD VCP



RADIATED ELECTROMAGNETIC FIELD (IEC 61000-4-3)



FAST TRANSIENTS/BURST TEST (IEC 61000-4-4) *For power*



For I/O



SURGE IMMUNITY TEST (IEC 61000-4-5)



CONDUCTED DISTURBANCE, INDUCED BY RADIO-FREQUENCY FIELDS TEST (IEC 61000-4-6) CDN-M316 for Power Cord



EM-Clamp for LAN Cable

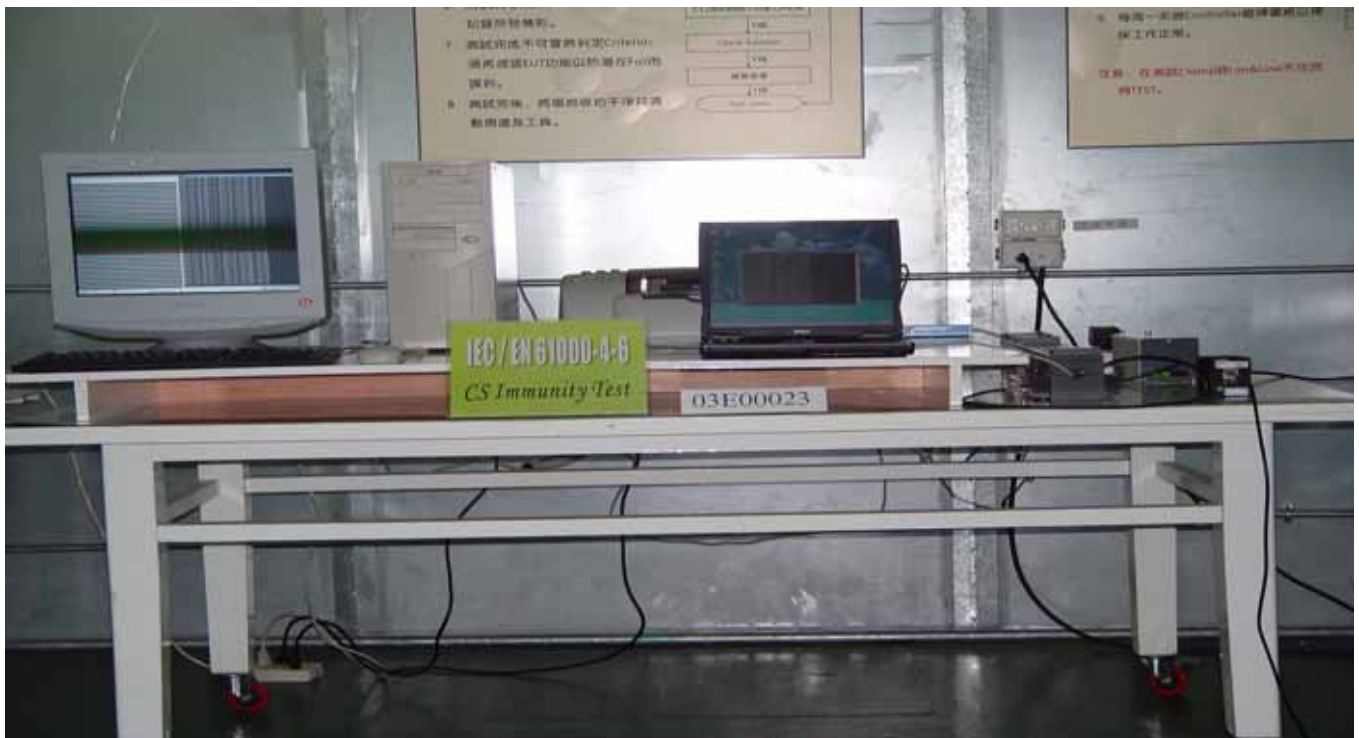

VOLTAGE DIPS / INTERRUPTION TEST (IEC 61000-4-11)



APPENDIX 2

Photographs (EUT)

Front view of EUT



Back view of EUT



Left view of EUT



Right view of EUT



Top view of EUT

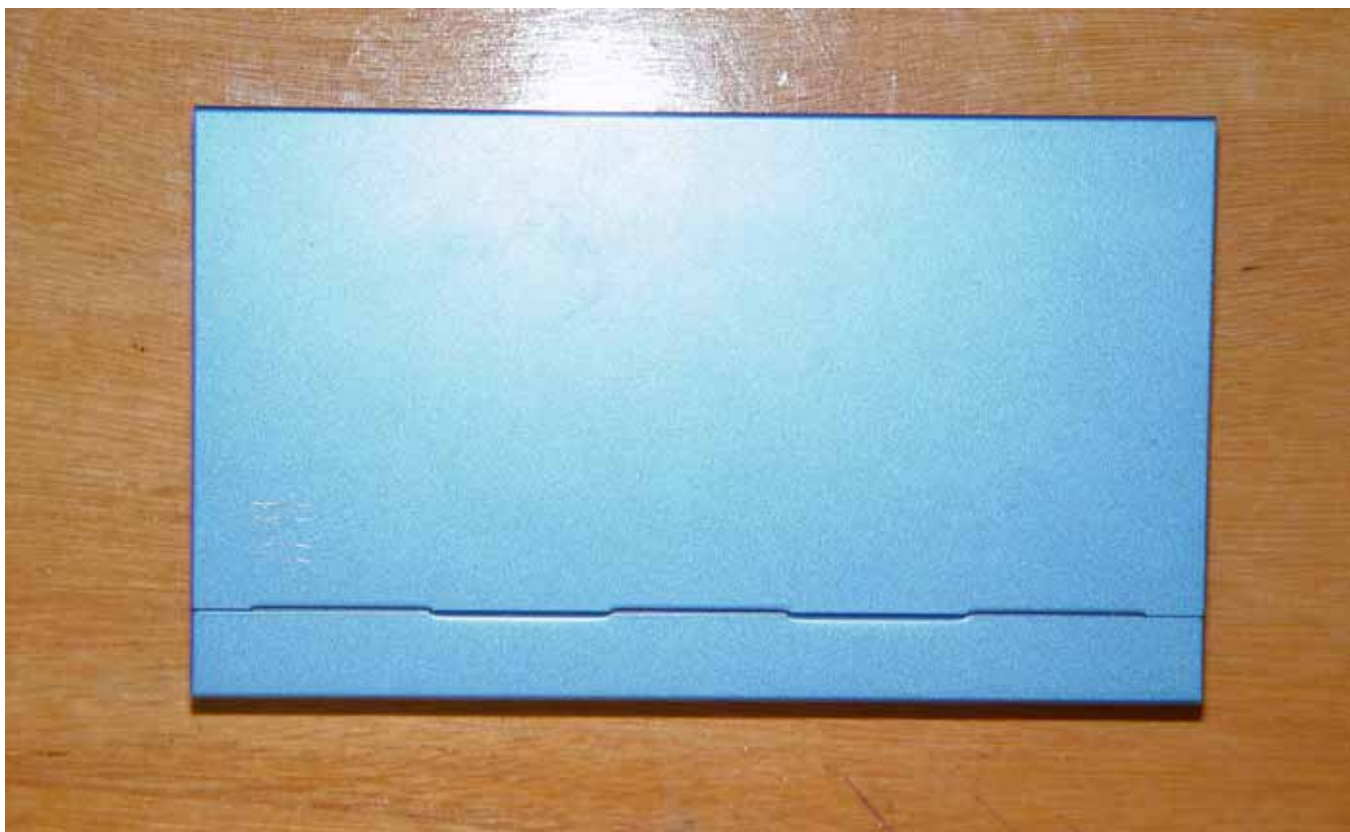

Bottom view of EUT

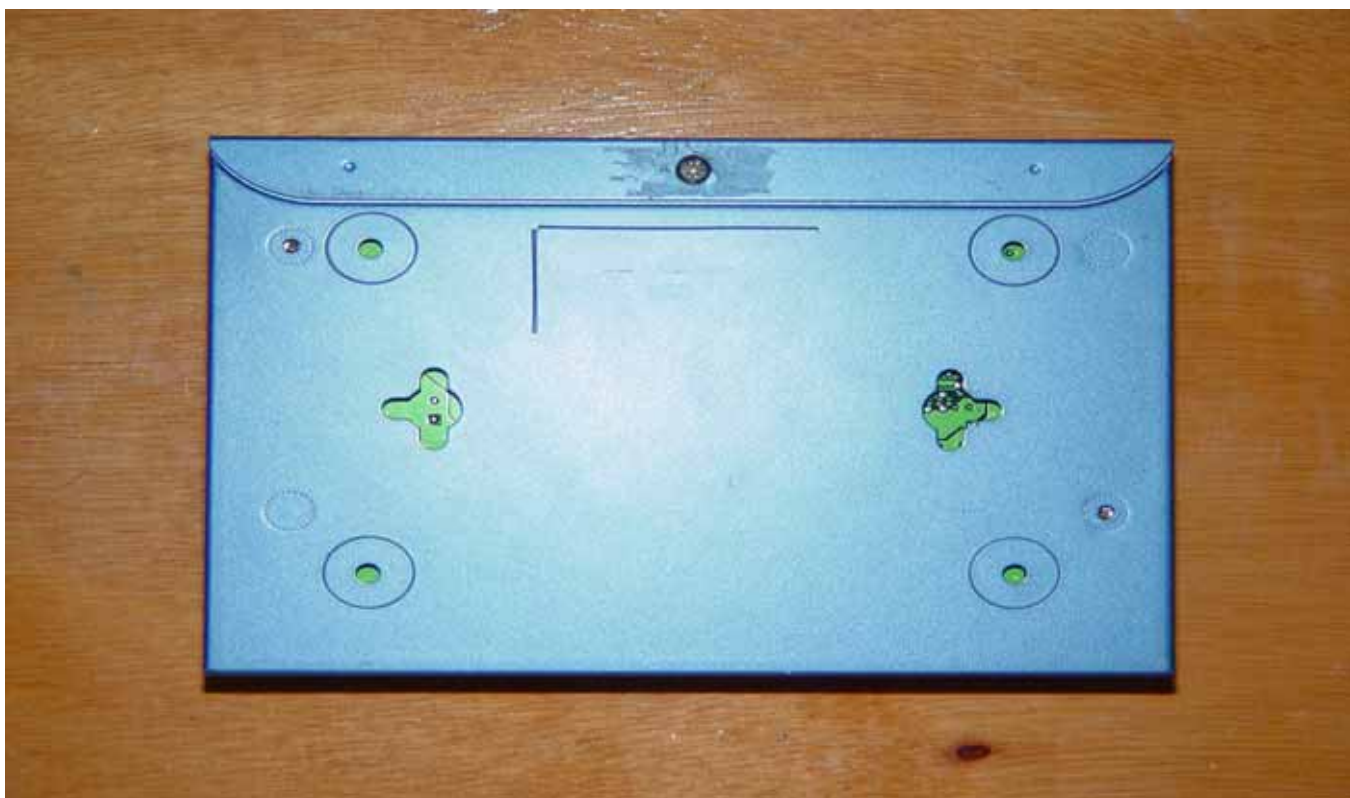

ADAPTER

Top view of EUT



Bottom view of EUT



APPENDIX 3

Sample of EC-Declaration of Conformity



EC-Declaration of Conformity

For the following equipment:

Firewall Router

(Product Name)

TRENDnet

(Model Designation / Trade name)

TRENDware International. Inc

(Manufacturer Name)

3135 Kashiwa Street, Torrance, CA90505 U.S.A.

(Manufacturer Address)

is herewith confirmed to comply with the requirements set out in the Council Directive on the Approximation of the Laws of the Member States relating to Electromagnetic Compatibility Directive (89/336/EEC, Amended by 92/31/EEC, 93/68/EEC & 98/13/EC), For the evaluation regarding the Electromagnetic Compatibility (89/336/EEC, Amended by 92/31/EEC, 93/68/EEC & 98/13/EC), the following standards are applied:

- EN 55022: 1998+A1: 2001
- EN 61000-3-2: 1995 + A1: 1998 + A2: 1998 + A14: 2000
- EN 61000-3-3:1995+A1: 2001
- EN 55024: 1998+A1: 2001

EN 61000-4-2:2001/ IEC 61000-4-2;EN 61000-4-3:2002 / IEC 61000-4-3;

EN 61000-4-4:1995+A1: 2000+A2:2001/ IEC 61000-4-4;EN 61000-4-5 :2001/ IEC 61000-4-5

EN 61000-4-6:2001 / IEC 61000-4-6;EN 61000-4-8:2001 / IEC 61000-4-8;

EN 61000-4-11:2001 / IEC 61000-4-11

The following manufacturer / importer or authorized representative established within the EUT is responsible for this declaration:

(Company Name)

(Company Address)

Person responsible for making this declaration:

(Name, Surname)

(Position / Title)

(Place)

(Date)

(Legal Signature)