

<b>Introduction</b> .....	<b>4</b>
Manual Overview .....	4
System Overview .....	4
Accessories Precautions.....	5
Important Safety Information .....	5
Map Overview .....	6
Current Street .....	6
Verified/Unverified Street.....	6
<b>User Agreement</b> .....	<b>8</b>
<b>Getting Started</b> .....	<b>10</b>
System Controls.....	10
Voice Control Basics .....	13
Using the Voice Control System.....	14
Improving Voice Recognition.....	14
Selecting an Item (Button) on the Screen .....	15
Selecting an Item in a List .....	15
Entering Information .....	16
System Start-up.....	18
System Language Selection.....	18
Bluetooth® HandsFreeLink® .....	19
Map Screen Legend .....	20
Map Screen Description .....	21
Zoom In/Out.....	21
Map Scrolling .....	21
Displaying Current Location .....	21
Traffic Display Legend.....	22

AcuraLink Real-Time Traffic™.....	23
Traffic Status Indicator.....	23
Viewing Flow Data.....	24
Viewing Incident Reports .....	25
System Function Diagram .....	27
<b>Entering a Destination</b> .....	<b>28</b>
By Address .....	29
Selecting the State or Province.....	29
Selecting the ZIP Code .....	30
Selecting the City.....	30
Selecting the Street .....	32
Entering the Street Number.....	34
By Address Book.....	34
Adding Addresses to the Personal Address Book .....	35
By Previous Destination .....	35
By Place Name .....	36
By Place Category .....	37
Subcategories .....	38
Place Name.....	41
City Vicinity.....	41
Sort by Distance to Travel.....	41
Search by Keyword.....	42
By Place Phone Number.....	43
By ZAGAT® 2012.....	43
By Coordinate.....	44
By Intersection.....	46
By Map Input.....	46

Showing the Map of Current Position .....	47
Showing the Map of City .....	48
Showing the Map of State.....	49
Showing the Map of Continental USA and Canada.....	50
By Go Home 1 or 2 .....	51
<b>Driving to Your Destination</b> .....	<b>52</b>
Driving to Your Destination.....	52
Calculate Route to Screen .....	52
Changing the Route Preference.....	53
Viewing the Routes .....	53
Viewing the Destination Map.....	54
Map Screen.....	54
Route Line.....	54
Voice Guidance Prompts.....	55
Map Screen Legend.....	56
Guidance Screen.....	57
Guidance Screen Legend.....	57
Distance and Time to Destination ...	58
Map Menu .....	58
Guidance Menu .....	59
Directions .....	59
Exit Info. (Freeway Exit Information) .....	60
Guidance Mode .....	61
Map Information.....	61
Showing Icons on the Map .....	62

- Map Orientation* ..... 63
- Current Location* ..... 64
- Map Legend* ..... 65
- Map Scale ..... 66
- Destination Icon ..... 67
- Various Other Icons ..... 67
  - Landmark Icons* ..... 67
  - Incident Icons* ..... 68
  - Weather Icons* ..... 68
- Going Off the Route ..... 71
- Off-road Tracking ..... 71
- Pop-ups and Disclaimers ..... 72
- Traffic Rerouting ..... 73
- Changing the Route ..... 74
- MENU Screen (Route) ..... 75
  - Cancel Route* ..... 75
  - Detour* ..... 75
  - Avoid Streets* ..... 75
  - Change Route Preference* ..... 75
  - Waypoint* ..... 76
  - Destination List* ..... 77
- Changing Your Destination ..... 78
  - Find Nearest (Voice command)* ..... 78
  - Go Home (Voice command)* ..... 78
  - Using Interface Dial to Change Destination* ..... 78
  - Entering a Destination from the Menu Screen (while en route)* ..... 79

- Continue Trip to Screen ..... 79
- AcuraLink Messages ..... 80
- Information Features** ..... **81**
- INFO Screen (Main Info.) ..... 81
  - Cellular Phone* ..... 81
  - Traffic Incidents* ..... 82
  - AcuraLink Weather Messages* ..... 86
  - Voice Help* ..... 86
  - Setup* ..... 87
- INFO Screen (Other) ..... 88
  - Calendar* ..... 88
  - Scenic Road Information* ..... 90
  - Calculator* ..... 90
  - System/Device Information* ..... 91
  - Map Data Update Status* ..... 92
  - Roadside Assistance* ..... 92
  - Key to ZAGAT Ratings* ..... 92
  - Show Wallpaper* ..... 93
- System Setup** ..... **94**
- SETUP Mode ..... 94
- SETUP Screen (Main Setup) ..... 94
  - Brightness* ..... 94
  - Contrast* ..... 94
  - Black Level* ..... 94
  - Volume* ..... 95
  - Interface Dial Feedback* ..... 95
- Personal Information ..... 95

- Address Book* ..... 95
- Home Address* ..... 99
- PIN Number* ..... 100
- Previous Destinations* ..... 101
- SETUP Screen (Other) ..... 102
- Music Search ..... 102
  - Song By Voice™ (SBV)* ..... 102
  - Phonetic Modification* ..... 103
- Basic Settings ..... 104
  - Units (mile or km)* ..... 104
  - Voice Recognition Feedback* ..... 104
- Routing & Guidance ..... 105
  - Rerouting* ..... 105
  - Unverified Area Routing* ..... 106
  - Traffic Rerouting* ..... 110
  - Edit Avoid Area* ..... 110
  - Edit Waypoint Search Area* ..... 112
  - Guidance Mode* ..... 113
  - Street Name Guidance* ..... 113
  - Guidance Screen Interruption* ..... 114
- Clock Adjustment ..... 114
  - Auto Daylight* ..... 114
  - Auto Time Zone* ..... 115
  - Time Adjustment* ..... 115
  - Resetting the Clock Settings* ..... 115
- Vehicle ..... 115
  - Off-road Tracking* ..... 115
  - Correct Vehicle Position* ..... 116



Color ..... 117  
*Map Color*.....117  
*Menu Color*.....118  
*Switching Display Mode Manually*...118  
*Switching Display Mode*  
*Automatically*.....119  
AcuraLink/Messages ..... 120  
Language..... 120  
Wallpaper..... 121  
*Selecting Wallpaper Pictures* .....121  
*Delete Pictures on HDD*.....121  
*Importing Pictures from USB*.....122  
Reset Factory Default Settings ..... 123  
Clear Personal Data ..... 123  
Traffic & Weather Status..... 124  
Multi-view Rear Camera ..... 125  
*Visible Range of the Rearview*  
*Image*.....125  
*Three-way Rearview Modes* .....126  
*Multi-view Rear Camera Brightness*  
*Adjustment*.....126  
**System Initialization .....127**  
System Initialization ..... 127  
Entering the Security Code..... 127  
GPS Initialization..... 127  
Map Matching..... 128  
**System Limitations.....129**  
*GPS Reception Issues* .....129

**Database Limitations ..... 130**  
**Client Assistance.....132**  
Reporting Errors ..... 132  
Acura Client Relations..... 132  
Visiting Your Dealer ..... 133  
Obtaining a Navigation Update .... 133  
**Coverage Areas..... 134**  
Map Coverage..... 134  
*U.S. Detailed Coverage Areas*.....134  
*Canada Detailed Coverage Areas*....139  
Operation in Alaska, Hawaii,  
Canada, and Puerto Rico ..... 149  
*Alaska, Hawaii, Canada, and Puerto*  
*Rico* .....149  
*INFO Screen Differences*.....150  
*Shipping a Vehicle*.....150  
**Frequently Asked Questions .... 151**  
**Troubleshooting..... 159**  
**Glossary.....160**  
Glossary ..... 160  
**Voice Command Index..... 163**  
Global Commands ..... 163  
Navigation Commands ..... 163  
*General Commands* .....163  
*Map Display Commands* .....164  
*Map Scale Commands* .....164  
*Find Place Commands* .....165

*Route Commands*.....166  
Climate Control Commands .....166  
Audio Commands .....167  
*Radio Commands*.....167  
*Disc Commands*.....168  
*HDD Commands* .....168  
*USB Commands*.....169  
*iPod Commands*.....169  
*Bluetooth® Audio Commands*.....170  
*AUX Commands* .....170  
*Song By Voice™ Commands*.....170  
*Rear Radio Commands*.....170  
*Rear CD Commands*.....171  
*Rear DVD Commands* .....171  
*Rear HDD Commands*.....172  
*Rear iPod Commands*.....173  
*Rear AUX Commands*.....173  
Cellular Phone Commands .....173  
SETUP Screen (Main Setup)  
Commands.....173  
On-Screen Commands .....174  
On-Screen Spelling Assist.....174  
**Index ..... 178**



## Manual Overview

**The manual is divided into the following sections:**

- Getting Started - A basic introduction that discusses the controls and how to communicate with the system.
- Entering a Destination - How to enter an address or locate a point of interest (POI).
- Driving to Your Destination - An explanation of the map features, guidance, and cautions.
- Information Features - An explanation of the information features, voice command help, and other accessories.
- System Setup - How to set up and tailor the system for your personal use and use the Address Book.

**The back of this manual contains:**

- Map Coverage (page [134](#))
- Cities with Traffic Coverage (page [148](#))
- Frequently Asked Questions (FAQs) (page [151](#))
- Troubleshooting Guide (page [159](#))
- Glossary of Terms (page [160](#))
- Voice Command List (page [163](#))
- Operation Specific to Alaska, Hawaii, Canada, and Puerto Rico (page [149](#))

## System Overview

Your navigation system is a highly sophisticated location system with voice control that uses satellites and a map database to show you where you are and to help guide you to a desired destination.

The navigation system receives signals from the global positioning system (GPS), a network of 24 satellites in orbit around the earth. By receiving signals from several of these satellites, the navigation system can determine the latitude, longitude, and elevation of your vehicle. In addition, a gyroscopic yaw sensor and a vehicle speed sensor in your vehicle keep track of the direction and speed of travel at all times.

The navigation system applies location, direction, and speed information to the maps and calculates a route to the destination you enter. As you drive to that destination, the system provides map and voice guidance.

The navigation system is easy to use. The locations of many places of business and entertainment are already entered in the system. You can select any of them as a destination by using the Interface Dial or voice control.

There are several ways to enter a destination, such as by point of interest (POI), by address, by phone number, and by selecting it from the map. The last 50 destinations are saved for reuse at a later date. The system also allows you to store a home address to simplify returning home from your destination.

### Accessories Precautions

If you have front or side window tinting installed, be aware that if the tint has metallic properties, it can seriously degrade or prevent GPS reception. This is because the GPS antenna is located behind the navigation display in the center of the dashboard.

If you plan to install electronic components such as radar detectors, vehicle tracking devices, remote starters, additional amplifiers, or other audio components, ensure that they are not located near the navigation display in the center of the dashboard, or near the GPS antenna behind the navigation display. Signal noise emanating from these devices can cause intermittent disruption of the navigation system.

### Important Safety Information

The navigation system can distract your attention from the road if you focus on the screen or operate the system's controls while driving.

Enter as much information as possible into the system before you begin driving, or when the vehicle is stopped. Then, as you drive, listen to the audio instructions and use voice commands when possible.

## **WARNING**

Using the navigation system while driving can take your attention away from the road, causing a crash in which you could be seriously injured or killed.

Follow all operating instructions and safety information in this manual.

While driving, do not look at the screen or operate the system controls for more than a second or so at a time, and only after deciding you can do so safely. Pull to the side of the road if you need more time to look at the screen or operate the controls.

The navigation system is designed to provide route information to help you reach your destination. However, this route guidance may sometimes conflict with current road conditions such as street closures, road construction, detours, and out-of-date map data.

Additionally, the system itself has certain limitations (see page 129). Therefore, you must verify the audio and visual route information provided by the system by carefully observing the roadway, signs and signals, etc. If you are unsure, proceed with caution. Always use your own good judgment, and obey traffic laws while driving.

## Map Overview

### **Current Street**

The current street on which your vehicle is located appears at the bottom of the map screen (see page 20). A message saying “Not on a digitized road” may appear instead when you drive half a mile away from a mapped road. For more details, see *Off-road Tracking* on page 71.

### **Verified/Unverified Street**

Your navigation system has two kinds of streets: verified (red, gray, and pink) and unverified (purple). The differences between the two types of streets are contrasted in the chart on page 7.



	Verified streets	Unverified streets
<b>When displayed</b>	These roads are found within metropolitan areas, and include interstate freeways and major roads connecting cities.	These roads are found in rural areas, and typically include residential streets away from the center of a town.
<b>Street color</b>	Shown as red (freeways), pink (state routes), or gray (verified streets) on the daytime map screen.	Shown on the daytime map screen as purple.
<b>Map quality</b>	The database vendor has verified these streets. Information like turn restrictions, average speed, and whether it is a one-way street have been gathered and used when creating your route to a destination.	These streets have not been verified by the database vendor. The system does not contain information on one-way streets, turn restrictions, or the road's average speed. They are shown on the map for reference and may have errors in map location, naming, and address range.
<b>Routing differences</b>	While driving to your destination, the displayed route line is solid blue. The system provides voice and map guidance to your destination.	Your route line is either a purple dotted "vector line," or a dashed pink/blue line. For information on selecting this option, and the routing differences, see <i>Unverified Area Routing</i> on page 106.
<b>Cautions</b>	There are no pop-up boxes urging extra caution during a route. However, because roads constantly change, you are urged to use common sense, and always obey posted traffic restrictions.	Regardless of whether the user chooses route guidance, there are cautionary screens before and during the route urging the user to be extra cautious, and obey all traffic restrictions. See <i>Unverified Area Routing</i> on page 106.
<b>Guidance voice</b>	Voice guidance issues instructions such as "In a half-mile, make a right turn."	The phrase "if possible" is added to each guidance instruction. For example: "In a half-mile, make a right turn, if possible."
<b>Time and distance "to go"</b>	The time and distance "to go," displayed while en route to a destination, is based on the average speed and distance for the roads used for your route.	The time and distance "to go," displayed while en route to a destination, is based on the average speed and distance for the roads used for your route.

In using this HDD “Satellite Linked Navigation System” (the “HDD”), which includes HONDA MOTOR CO., LTD. software, ALPINE ELECTRONICS, INC. software, and NAVTEQ database contents (hereinafter referred to as “Licensors”), you are bound by the terms and conditions set forth below. By using your copy of the HDD, you have expressed your Agreement to the terms and conditions of this Agreement. You should, therefore, make sure that you read and understand the following provisions. If for any reason you do not wish to be bound by the terms of this Agreement, please return the HDD to your dealer.

- The HDD may not be copied, duplicated, or otherwise modified, in whole or in part, without the express written permission of the Licensors.
- The HDD may not be transferred or sublicensed to any third party for profit, rent or loan, or licensed for reuse in any manner.
- The HDD may not be decompiled, reverse engineered or otherwise disassembled, in whole or in part.
- The HDD may not be used in a network or by any other manner of simultaneous use in multiple systems.
- The HDD is intended solely for personal use (or internal use where the end-user is a business) by the consumer. The HDD is not to be used for commercial purposes.
- The Licensors do not guarantee to the client that the functions included in the HDD meet the specific objectives of the user.
- Licensor shall not be responsible for any damages caused by the use of the HDD to the actual user or to any third party.
- The warranty on the HDD shall not extend to an exchange or refund due to misspelling, omission of letters, or any other cosmetic discrepancy in the contents of the HDD.
- The right to use the HDD shall expire either when the user destroys the HDD or software, or when any of the terms of this Agreement are violated and the Licensors exercise the option to revoke the license to use the HDD or software.



- The terms and conditions hereof apply to all subsequent users and owners as well as to the original purchaser.
- The logos of oil companies, hotels, convenience stores, and other businesses are displayed for your information and convenience, and in no way imply any sponsorship, approval or endorsement of these companies, or their products. The logos are trademarks of their respective owners.

The user shall indemnify and save harmless the Licensors, and their officers, employees and agents, from and against any claim, demand or action, irrespective of the nature of the cause of the claim, demand or action, alleging loss, costs, expense, damages or injuries (including injuries resulting in death) arising out of the use or possession of the HDD or software.

Use, duplication, or disclosure of this HDD by or on behalf of the United States government is subject to “Restricted Rights” as set forth at FAR 52.227-14, -19 or DFARS 252.227-7013, as applicable. Manufacturers are the Licensors, including HONDA MOTOR CO., LTD., 2-1-1 Minami Aoyama Minato-Ku Tokyo 107-8556 JAPAN., Alpine Electronics, Inc., 20-1 Yoshima Kogyodanchi, Iwaki, Fukushima 970-1192 JAPAN., NAVTEQ Corporation, 425 W Randolph St. Chicago, IL 60606, USA.

## System Controls

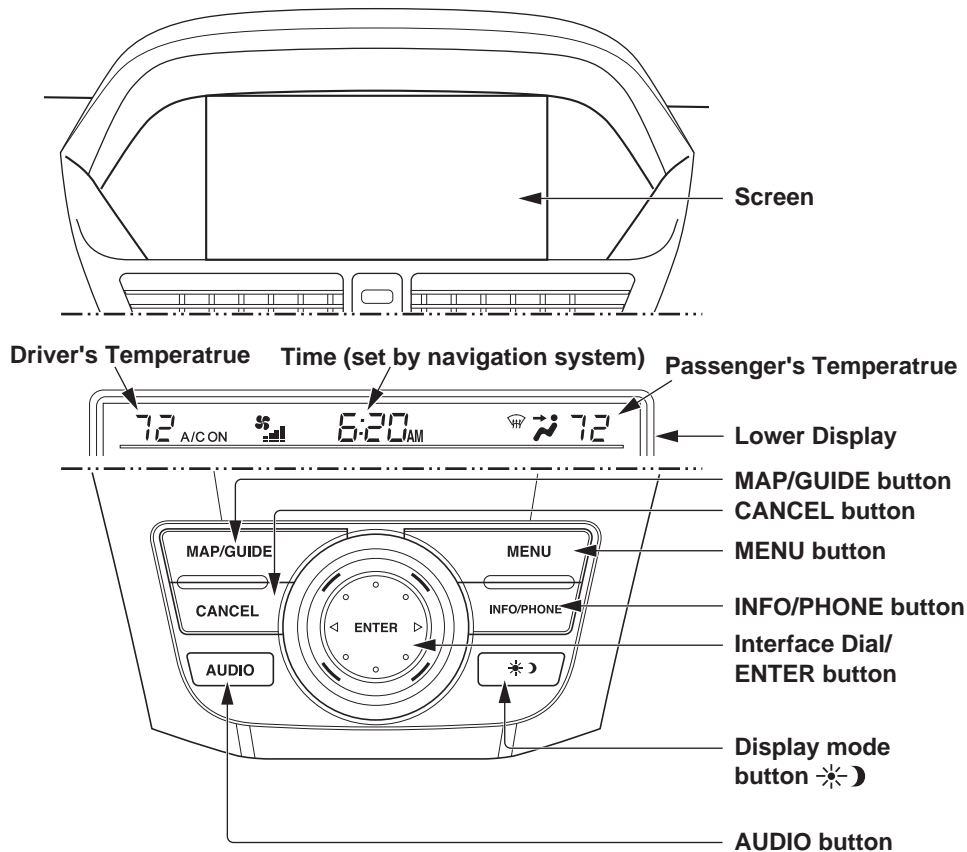

### MAP/GUIDE button

Displays the map. When en route, switches between the map and guidance screens. See page 20 or 56.

### CANCEL button

Cancels the current screen and returns to the previous screen display.

### NOTE:

The **BACK** button on the steering wheel performs the same basic function. See page 13.

### MENU button

Displays the “Dest. MENU 1” options on the MENU screen. When en route, displays the “Route” options on the MENU screen. See page 28 or 74.

### INFO/PHONE button

Displays the “Main Info.” options (including the Cellular Phone option) on the INFO screen. When selecting the “Other” tab, displays the “Other” options on the INFO screen. See page 81.



### Display Mode button

Adjusts the screen brightness for Day or Night mode, or turns the screen OFF. See page 118.

### AUDIO button

Press to display the audio screen. For more information on audio system features, see the *Audio* section of your Owner's Manual.

### Other buttons

See your Owner's Manual.

### Interface Dial/ENTER button

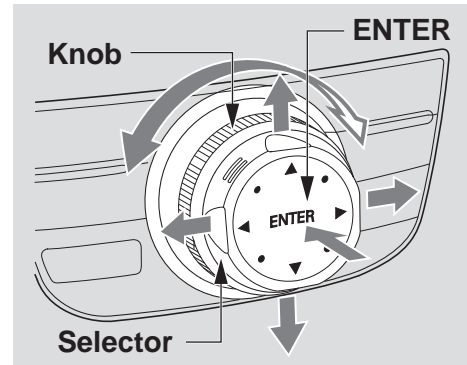

To see areas beyond the map that is displayed, you can move the **Interface Dial** left, right, up, or down. Rotating the **Interface Dial knob** allows you to change the scale. Rotating it clockwise reduces the scale, showing less area with greater detail. Rotating it counterclockwise increases the scale, showing more area with less detail.

You can also rotate the **Interface Dial knob** to scroll through a list or highlight items in a list to select. After making a selection in a menu or list, push in on the **Interface Dial (ENTER button)** to enter the selection into the system.

In almost all cases, you can enter a selection into the system by pushing in on the **Interface Dial**.

## Screen

All selections and instructions are displayed on the screen. The display is not a “touch screen” - you can enter information into the system either by voice or by using the **Interface Dial**.

Clean the screen with a soft, damp cloth. You may use a mild cleaner intended for use on computer screens.

### **NOTE:**

*Whenever you shift to R (Reverse), the rear view behind the vehicle is shown on the navigation system screen. See page 125.*

## Lower Display

Shows a summary of the audio and climate control information, as well as the time. This summary is helpful as a confirmation when adjusting audio or climate by voice.

The audio summary consists of the radio band, frequency, and volume. For XM radio, a brief description of the station and current music is displayed.

The climate status consists of the driver’s and passenger’s temperature, fan speed, ON/OFF (A/C), and vent setting. The time is automatically set by the navigation system. Settings can be adjusted in SETUP (see *Time Adjustment* on page 115).

### Voice Control Basics

Your vehicle has a voice control system that allows hands-free operation of most of the navigation system functions. You can also control the audio and climate control system. The voice control system uses the **TALK** and **BACK** buttons on the steering wheel and a microphone near the map lights on the ceiling.

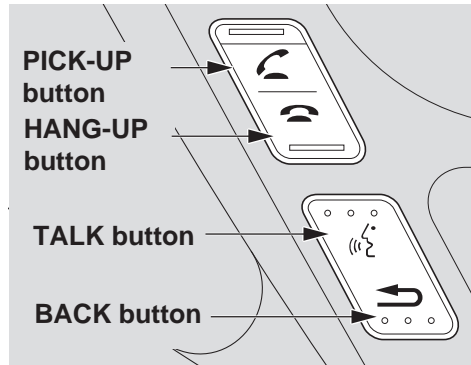

**NOTE:**

While using the voice control system, the audio system is muted.

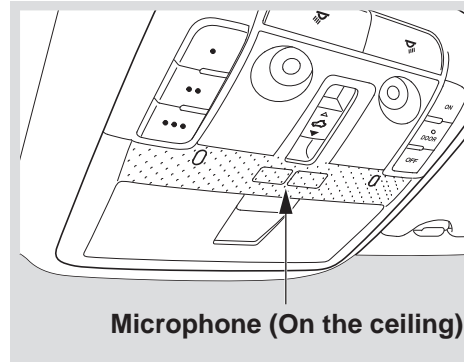

### TALK button

This button activates the voice control system. Press and release it when you want to give a voice command. See *Voice Command Index* on page 163 for a list of voice commands.

### BACK button

This button has the same function as the **CANCEL** button. When you press and release it, the display returns to the previous screen. When the previous screen appears, the system replays the last prompt.

When you press this button during voice recognition, voice recognition is ended. (The display does not return to the previous screen.)

## Using the Voice Control System

You should use the voice control system as much as possible, and consider manual entry using the **Interface Dial** as a backup method.

Most of the system's functions can be controlled by voice commands activated with the **TALK** button. To control the navigation system by voice:

- Press and release the **TALK** button. A pop-up voice icon () will appear in the upper left corner of the screen.
- Wait for the beep.
- Give a voice command. (Voice commands that the system recognizes are highlighted.)

Once the microphone picks up your command, the system changes the display in response to the command and prompts you for the next command. Using the **TALK** button, answer the prompts as required.

If the system does not understand a command or you wait too long to give a command, it responds with “Pardon,” “Please repeat,” or “Would you say again.” If the system cannot perform a command or the command is not appropriate for the screen you are on, a beep will sound.

You can find out which voice commands are available for a particular screen by saying “Help.” The system will display and read the list of available commands to you. (When **Help** is grayed out, this feature cannot be used.)

When you give a command, the system generally either repeats the command as a confirmation or asks you for further information. If you do not wish to hear this feedback, you can turn it off. However, hearing the feedback will familiarize you with the way the system expects commands to be phrased. See the **Voice Recognition Feedback** setting in **SETUP**.

If you hear a prompt such as “Please use the **Interface Dial** to...” or “Please choose an area with the **Interface Dial**,” the system is asking for input that cannot be performed using the voice control system.



## Improving Voice Recognition

To achieve optimum voice recognition when using either the navigation or **Bluetooth®** **HandsFreeLink®** voice control system, the following guidelines should be followed:

### **NOTE:**

*Make sure the correct screen is displayed for the voice command that you are using. See **Voice Command Index** on page 163.*

- It is best if the windows and moonroof are closed. If they are open, speak a little louder to overcome the wind noises.

- Adjust the dashboard and side vents so air does not blow against the microphone on the ceiling.
- If more than one person is speaking at the same time, the system may misinterpret your command.
- After pressing and releasing the **TALK** button, wait for the beep, then give a voice command while the  icon is displayed on the top left of the screen.
- Give a voice command in a clear, natural speaking voice without pausing between words.
- Try to reduce any background noise.
- If you are still having trouble with the voice control system, refer to **Voice Help** on the **INFO** screen (Main Info.) or say “Help” while the  icon is displayed on the top left of the screen.

### NOTE:

*The voice control system can only be used in the driver’s seat because the microphone unit removes noises from the front passenger’s side.*

## Selecting an Item (Button) on the Screen

On most screens, there are items that can be selected (like buttons with titles such as **OK** or **Return**). To select an item on any screen, do one of the following:

- Use the voice control system and say the name of the desired item. Almost all selectable items on the screen, including some listed items, are recognized by the voice control system.
- Move the highlighting to the desired item with the **Interface Dial** or its **knob**, then push in on the **Interface Dial**.

### Tip:

*If items are grayed out, this means that they cannot be selected.*

## Selecting an Item in a List

To scroll through a list, do one of the following:

- Rotate the **Interface Dial knob** to scroll one item at a time.
- Use the voice control system to scroll page by page. For example, to scroll up, say “Up” or “Previous.” To scroll down, say “Next” or “Down.”

If you cannot find the desired name, or have made an error, return to the previous screen by pressing the **CANCEL** or the **BACK** button on the steering wheel.

To select the desired item in the list, do one of the following:

- Use the voice control system, and say the item number of the desired item.
- Rotate the **Interface Dial knob** to move the highlighting to the item, then push in on the **Interface Dial**.

## Entering Information

When the system needs input from you, the display changes to a screen similar to the one on the next page. You can then use the displayed letters, numbers, or symbols to enter information. You can enter your keyboard input in either of the following ways:

- Say the desired letter, number, or symbol on the screen if you are entering a city or street name.
- Move the highlighting to the desired letter, number, or symbol by rotating the **Interface Dial knob**, then push in on the **Interface Dial**.

Each entered letter will appear at the top of the display. To enter a space between words, say “Space” or move the **Interface Dial** to the right. To delete an entry, say “Delete” or move the **Interface Dial** to the left.

If a letter has options (such as accent marks or symbols), they will appear in gray next to the selected letter on the upper row. Move the **Interface Dial** up to select **OPTION**, and use the **Interface Dial knob** to select the letter.

To enter symbols, rotate the **Interface Dial Knob** and select # or @, then move the **Interface Dial** up to select **OPTION**.

When entering an address, the system searches the database for words that match the letters you are entering. As a result, you will notice that some letters are no longer available.

When the system finds only one entry that matches, it completes the name entry for you. If the system finds more than one entry that matches your input, a list of these matches is displayed.

### *Tip:*

*When entering a name of a city, street, or place, or if you are unsure of the spelling of the name, enter the letters that you are sure of, then move the **Interface Dial** down to select **LIST**. The system will display a list of names that most closely match your input. For each letter that is entered, the number of corresponding choices is displayed on the right-hand side.*



**NOTE:**

The voice command names that can be used for each letter are shown below. For additional keyboard symbols, see page 176.

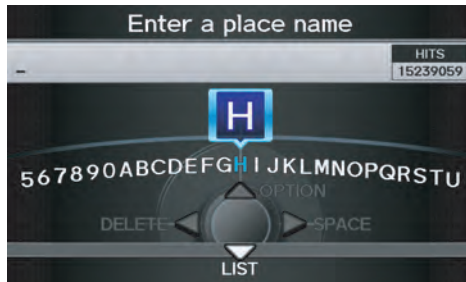

Say	Or say "..."	Say	Or say "..."	Say	Or say "..."	Say	Or say "..."
<b>A</b>	Alpha/Apple	<b>H</b>	Hotel/Henry	<b>O</b>	Oscar	<b>V</b>	Victor
<b>B</b>	Bravo/Boy	<b>I</b>	India/Igloo	<b>P</b>	Papa/Paul	<b>W</b>	Whiskey/William
<b>C</b>	Charlie	<b>J</b>	Juliet/John	<b>Q</b>	Quebec/Queen	<b>X</b>	X-ray
<b>D</b>	Delta/Dog	<b>K</b>	Kilo/King	<b>R</b>	Romeo/Robert	<b>Y</b>	Yankee/Yellow
<b>E</b>	Echo/Edward	<b>L</b>	Lima/Larry	<b>S</b>	Sierra/Sam	<b>Z</b>	Zulu/Zebra
<b>F</b>	Foxtrot/Frank	<b>M</b>	Mike/Mary	<b>T</b>	Tango/Tom		
<b>G</b>	Golf/George	<b>N</b>	November/Nancy	<b>U</b>	Uniform/Uncle		

## System Start-up

When you turn the ignition to ON (II), it takes about 10 seconds for the navigation system to boot up.

The first screen to appear is the navigation system globe screen. The screen then changes to the Disclaimer screen:

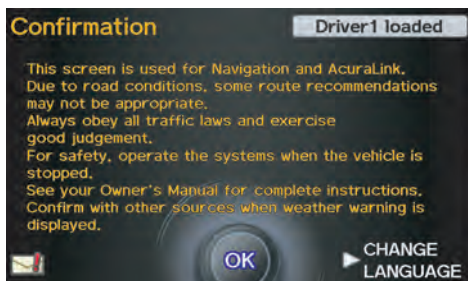

### NOTE:

Driver information will display on the upper right side of the screen. If there are any unread messages, the Message icon will display on the bottom left side of the screen. See page 20.

## System Language Selection

Move the **Interface Dial** to the right to select **CHANGE LANGUAGE**. On the **Select a language** screen, you can select the language to be used by the entire system by choosing from the language choices that are displayed. After you have changed the language settings, you will be returned to the Disclaimer screen.



Read this disclaimer carefully so you understand it before continuing. Push in on the **Interface Dial** to select **OK**, and the map screen will appear on the display. The “OK” cannot be activated by voice.

If you do not push in on the **Interface Dial**, the screen will go dark after 30 seconds. (You can also display the Wallpaper screen. See page 121.) To return to the Disclaimer screen, press any navigation or voice control button.

### NOTE:

Voice commands will not function if **OK** is not selected.

If you have entered any Calendar reminders, they are displayed after you select **OK**. See *Calendar* on page 88.

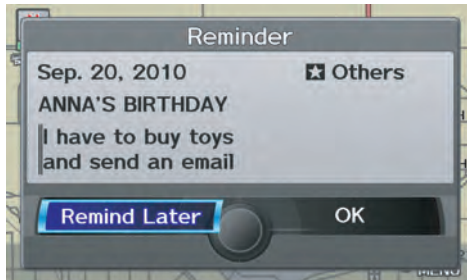

The Calendar reminder screen remains displayed until you select **OK** or **Remind Later** by rotating the **Interface Dial knob** and pushing in on the **Interface Dial**, or press the **CANCEL** button.

If you select **OK** and push in on the **Interface Dial**, the reminder will not show up again. (It will be deleted from the Calendar.)

If you select **Remind Later** and push in on the **Interface Dial**, the reminder will show up again the next time you start the vehicle. If there are several reminders, the next reminder will be displayed.

If you press the **CANCEL** button, the system will skip all the reminders. The reminders will show up again the next time you start the vehicle.

**NOTE:**

*The system will display the current message and any older or previously unread messages, with the newest message appearing first and the remaining messages appearing in date order.*

If you turn off the engine during route guidance and then restart the vehicle, the **Continue trip to screen** will be displayed. For more information, see *Continue Trip to Screen* on page 79.

### Bluetooth® HandsFreeLink®

If you have a Bluetooth-compatible cell phone that is paired with the system, then **Call** on the Calculate route to screen will be enabled.

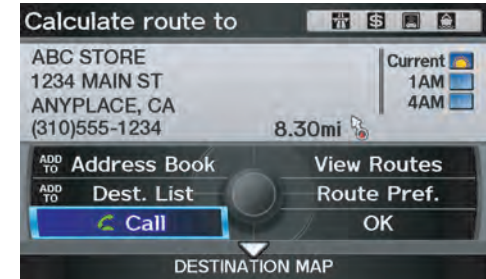

When you select **Call**, the system dials the number shown on the screen.

For more information on *Bluetooth® HandsFreeLink®*, see your Owner's Manual and the official website ([www.acura.com/handsfreelink](http://www.acura.com/handsfreelink)).

## Map Screen Legend

### GPS Signal Strength

- : Best Reception
- : Good Reception
- (Missing) : Poor/No Reception

### Traffic Status Indicator

(see page 23.)

### Vehicle Position (see page 64)

(Use voice command "Display current location" or use the **Interface Dial** to show current location.)

### Current Street (see page 6)

(see page 6)

### Current Map Scale (see page 66)

(see page 66)

### Message Icon (see page 80)

Indicates that you have an AcuraLink message.

### Warning Icon

Indicates that there are weather warnings. To check the warning list, see page 85.

### Map Scale Adjustment

(Mile or km per half-inch appears only when you zoom in or out by rotating the **Interface Dial knob**.)

### NOTE:

See *Map Legend in the Map Information* on the **Map menu** for further explanation.

### Map Orientation (see page 63)

(see page 63)

- North-up
- Heading-up

### Breadcrumbs (see Off-road Tracking on page 71)

(see *Off-road Tracking* on page 71)



### No Entry Icon

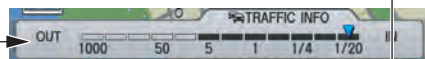
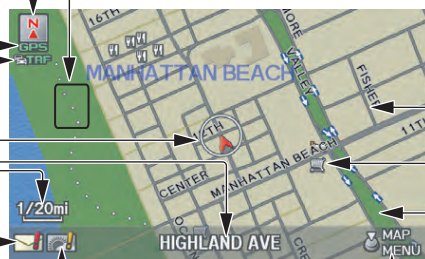

### Map Menu (see page 58)

(Push in on the **Interface Dial** to view.)

### Streets (see *Map Overview* on page 6)

- : Freeways
- : State Routes
- : Verified Streets
- : Unverified Streets
- : One-way Streets (see page 67) (1/20 mile scale only)

### Landmark Icon - Generic (see page 67)

- |                          |               |
|--------------------------|---------------|
| Acura Dealer             | Grocery Store |
| Honda Dealer             | Hotel/Lodging |
| ATM                      | Gas Station   |
| School                   | Hospital      |
| Parking Lot              | Post Office   |
| Parking Garage           | Restaurant    |
| Freeway Exit Information |               |

### Map Features

- |                 |                    |
|-----------------|--------------------|
| : Park          | : Airport/Business |
| : Hospital      | : Water Area       |
| : Shopping Mall | : Cemetery         |
| : Golf Course   | : University       |

### NOTE:

If you move the **Interface Dial** over an area (map features shown above), the name is displayed at the top of the screen.

### Map Screen Description

#### Zoom In/Out

Rotate the **Interface Dial knob** to change the map scale. Zooming in increases the detail, while zooming out gives you a wide area view. After changing the scale, give the system a few moments to update the display.

#### Map Scrolling

To view other map areas, move the **Interface Dial** left, right, up, or down. The map will shift in that direction. To return the map to your current location, press either the **MAP/GUIDE**, **CANCEL**, or **BACK** button on the steering wheel.

### Displaying Current Location

You can see the current address, latitude, longitude, and elevation at any time by doing one of the following:

- Use the voice control system and say “Display the current location.”
- Push in on the **Interface Dial** while displaying the map of the current location, and select **Map Information**. Rotate the **Interface Dial knob** to select **Current Location**.

The **Current location** screen will appear on the display.



#### NOTE:

*The elevation will not appear when the system is temporarily lacking proper GPS information. The system elevation may not agree with elevations shown on roadside elevation signs, and may fluctuate plus or minus 100 feet or more.*

You can save the current location in your Address Book by doing one of the following (if an Address Book PIN has been set, you need to enter your PIN.):

- Use the voice control system and say “Save.”
- Select **Save** by rotating the **Interface Dial knob** and push in on the **Interface Dial**.

Say “Register the current location” on the map screen, and you can register the current location without displaying the **Current location** screen.

Select **Return** to return to the previous screen.

## Traffic Display Legend

### Viewing Incident Details:

To view incident details, use the **Interface Dial** to position the cursor (round red circle) over an incident icon and push in.

### Incident Icons

- Accident/Incident (other)
- Congestion
- Weather
- Construction
- Road Closed

### Incident Icon Update Details:

- Typically M-F, 5:00 AM – 7:00 PM (varies by metropolitan area)
- Continuously updated

### Map Scale

Traffic flow and incident icons are displayed on the 5 mile (8 km) or less map scale

### NOTE:

When driving to a destination on freeways that have traffic flow data, the route line is used to display moderate and heavy traffic flow status instead of the colored bands on the side of the road. The route line color indicates the following conditions:

- Free Flow Traffic** - A section of the blue route line will be bordered with a light green line (this may be difficult to see).
- Moderate Traffic Flow** - A section of the route line will change from green to orange.
- Heavy Traffic Flow** - A section of the route line will change from green to red.
- Unknown Traffic Flow** - A section of the route will not be bordered with traffic flow

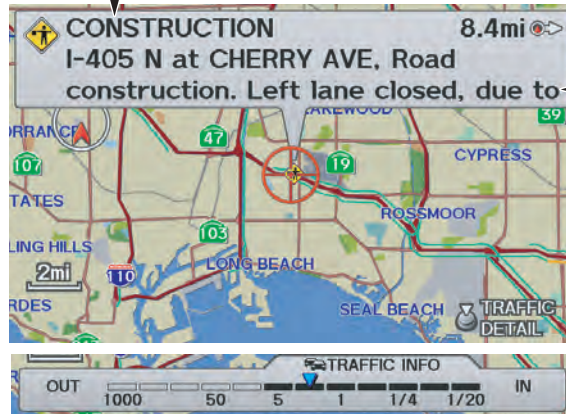

### Hearing Incident Details:

If this screen is displayed, the system will start reading incident details. To view the message on the screen, push in on the **Interface Dial**.



To return to current position, say or select **Return**.

### Traffic Flow Data (colored lines parallel to road)

- Heavy traffic: 0 – 27 mph (approx.)
- Moderate traffic: 27 – 52 mph (approx.)
- Free flow traffic: 52+ mph (approx.)

(shown for both sides of the freeway where available)

### Traffic Flow Data Update Details:

- Available 24 hours a day, 7 days a week
- Continuously updated



### AcuraLink Real-Time Traffic™

The navigation screen can display up-to-the-minute traffic information when available, including flow (traffic speed), accidents, and construction on freeways in major metro areas.

The display of traffic flow and incidents on the map screen is optional and can be turned On/Off by selecting the “Traffic” icon on the Icon bar (see *Showing Icons on the Map* on page 62).

The current metropolitan areas that have traffic coverage can be seen on page 148. For more current metro coverage information, go to [www.acura.com/realtimetraffic](http://www.acura.com/realtimetraffic). This link offers the following:





- The latest list of metro areas that have AcuraLink Real-Time Traffic coverage
- Detailed coverage information for each metro area showing what roads have traffic speed, traffic icons, or both
- An AcuraLink Real-Time Traffic demonstration
- Frequently asked questions (FAQs)

#### NOTE:

- *AcuraLink Real-Time Traffic relies on a satellite signal. It will not work in Hawaii, Alaska, Canada, and Puerto Rico.*
- *AcuraLink Real-Time Traffic is only available if you have a current traffic subscription with XM®. See page 124.*

### Traffic Status Indicator

You can confirm the reception status of traffic information (traffic flow and incidents). The “TRF” icon indicates the following status:

Icon	Status
	Traffic information is available.
	Flow or Incident data is not available.
	Traffic information is not available.
	<ul style="list-style-type: none"> <li>• Traffic display is turned off.</li> <li>• Traffic information cannot be displayed on the current map scale.</li> </ul>
Missing	No traffic information available (Out of coverage area).

#### NOTE:

- *Traffic information can be turned on or off. See Showing Icons on the Map on page 62.*
- *Traffic information can be displayed on the 5 miles (8 km) or less map scale.*

## Viewing Flow Data

Traffic flow data is displayed as colored bands on either side of the freeway (see *Traffic Display Legend* on page 22). The different colored bands represent the average road speeds as determined by under-road sensors and other probes.

While driving to your destination on a road that has traffic flow data, your route line color is used to display the traffic flow data. This means that when the map scale is set to one of the traffic scales (1/20 through 5 mile scale), your blue route line may appear as alternating orange, red, or green segments (see *Traffic Display Legend* on page 22).

### NOTE:

*A blue route line segment on a freeway can mean one of two things:*

- Under-road sensors, GPS probes, cell phone probes, and other methods used to collect traffic speed information indicate free-flow traffic.
- The road has no sensors, and traffic conditions are unknown (they could be congested).

Naturally, only roads with these sensors will show traffic information. The amount of flow data varies considerably from one city to another. This map display is refreshed continuously. You can only view traffic information in the city where you are located.

### NOTE:

- *Traffic flow and incident icons are displayed on the 5 miles (8 km) or less map scale.*
- *Not all freeways within a metropolitan area have traffic flow data (colored bands on the side of the freeways) - this is normal, and you cannot assume that a lack of data implies no traffic.*
- *Not all cities have traffic flow information. See cities listed on page 148.*
- *Due to freeway maintenance and construction, traffic flow may be available only for one side of a road, or be missing entirely for some portion of the freeway.*

- *The displayed traffic flow may conflict with other audio- or Internet-based traffic information.*
- *If traffic flow is not showing, verify that the “TRAFFIC” selection for the Icon Bar is ON, and that the icon options for traffic are both ON (see page 62).*



### Viewing Incident Reports

Incident reports appear as small diamond- or circle-shaped icons (see *Traffic Display Legend* on page 22 for examples). There are four ways to view traffic incidents:

- By voice control, say “Display traffic incidents.”
- Select **Traffic Incidents** from the Map menu.
- Select **Traffic Incidents** on the INFO screen (Main Info.).
- Select an incident icon from the map screen.

#### **NOTE:**

*The first method is recommended because it works on any scale and requires the minimum input.*

### Listing Traffic Incidents by Voice Control

From the map screen (any scale), say “Display traffic incidents” or “Display traffic list.” The Traffic list screen will be displayed, which includes the “All” and “On Route” tabs.

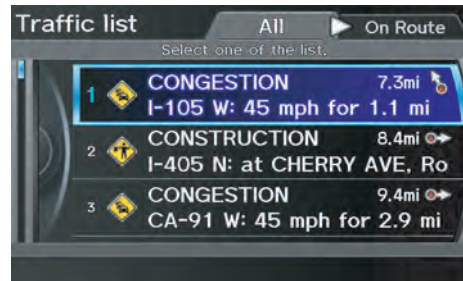

When you select the “All” tab, a list of all incidents within the metro traffic area will be displayed. When you select the “On Route” tab, a list of all incidents on the current route will be displayed.

Incidents are listed by distance from your current position outward in all directions.

To view incident details, say the number of the incident you want to select. A map showing the location of the incident will be displayed, and the message will be read to you.

#### **NOTE:**

*The “On Route” tab can be selected only when you are en route.*

### Listing Traffic Incidents from the INFO Screen or Map Menu

Select **Traffic Incidents** from the INFO screen (Main Info.) or Map menu. The Traffic list screen will be displayed.

## No Traffic Incidents

If you say “Display traffic incidents” or select **Traffic Incidents**, but there are no incidents, the following screen will be displayed.

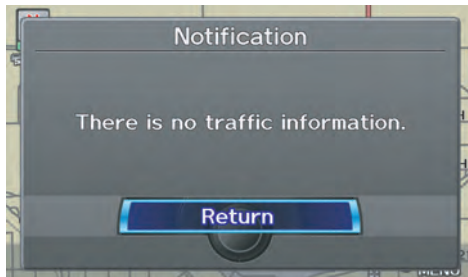

## Selecting an Incident Icon from the Map Screen

Zoom in or out so that you are between the 1/20 and 5 mile scales. (The map must be on the 1/20 to 5 mile scales to view the incident icons). To view the details of a specific incident, use the **Interface Dial** to position the cursor (round red circle) over the incident icon you are interested in. Push in on the **Interface Dial** and select **Traffic** to view a pop-up box summary describing the incident.

To see the incident details, push in on the **Interface Dial**. To return to your current position map screen, say or select **Return**. To continue viewing incidents in your “scrolled to” location, press the **CANCEL** button.

## NOTE:

- *Incident reports may be displayed on roads that have no traffic flow data available.*
- *Freeway incident reports can lag behind the actual incident, or remain displayed after an incident has cleared. This is normal, and is dependent on the reporting agency and the speed at which the data is updated.*
- *The displayed incidents may conflict with other audio- or Internet-based traffic information.*

## System Function Diagram

This diagram shows the navigation system features, starting at the center and working outward in layers. The navigation program starts at “Key ON,” and then displays the navigation system globe screen (blue). If **OK** is selected on the Disclaimer screen, the functions in the yellow segments of the diagram become available in the **SETUP** and **INFO** screens.

The items above the map screen show various methods to begin driving to your destination (orange). You are provided with map/voice guidance, routing cautions, and a direction list. While driving to your destination, use the voice control system as much as possible to interact with the navigation, audio, and climate control systems (green).

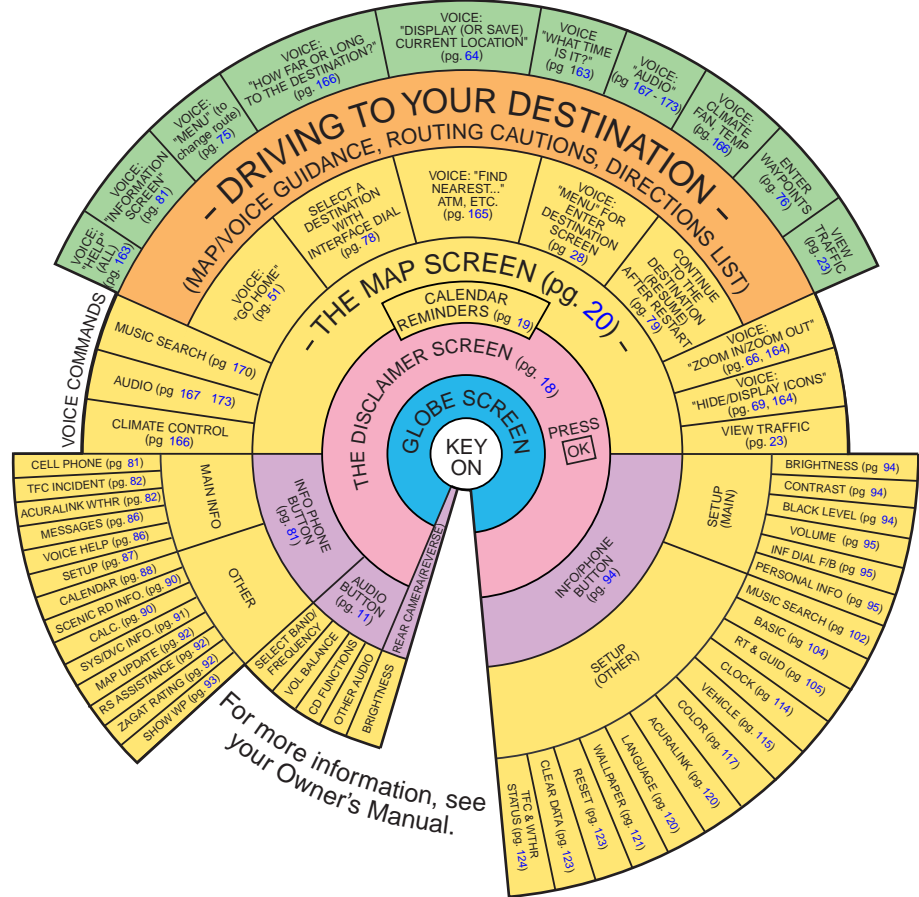

For more information, see your Owner's Manual.

## Entering a Destination

Intro

SEC

When you press the **MENU** button, the display changes to:



To display the “Dest. MENU 1” tab or the “Dest. MENU 2” tab, move the **Interface Dial** to the left or right.

### NOTE:

*If you press the **MENU** button while en route, the **MENU** screen (Route) will be displayed. To enter destinations, select the “Dest. MENU 1” tab by moving the **Interface Dial** to the right.*

### Address (see page 29)

You can enter the street, city, state, or ZIP code to search for your destination.

### Address Book (see page 34)

You can select locations stored in the **Address Book** as destinations. The addresses of these locations can also be saved. The system can store up to a combined total of 200 DRIVER 1 and DRIVER 2 addresses.

### Previous Destination (see page 35)

When you enter a destination with any of the available selections (except **Address Book**, **Go Home 1** and **Go Home 2**), the last 50 destinations are saved by the system. Use this selection to choose a destination again.

### NOTE:

*If **Previous Destination** is grayed out, there are no Previous Destinations entered.*

### Place Name (see page 36)

You can input the names of places to search for your destination.

### Place Category (see page 37)

The system has been programmed with the locations of many businesses, parks, hospitals, etc. This selection lets you search these by category, name, or Zagat 2012 (for restaurant information).

### Go Home 1 (see page 51)

This selection allows you to select Home Address 1 as a destination.

### NOTE:

*If you have no home address entered, the system prompts you for one.*

### Place Phone No. (see page 43)

You can search for the destination by inputting a place’s phone number.

### ZAGAT 2012 (see page 43)

This selection allows you to find a restaurant by the ZAGAT Rating information.



### Coordinate (see page 44)

You can search for the destination by inputting the latitude and longitude for the destination.

### Intersection (see page 46)

This selection allows you to enter the names of two intersecting streets in a city. This is useful if you know the general location of your destination, but not the exact address.

### Map Input (see page 46)

You can select a destination from the map screen.

### Go Home 2 (see page 51)

If you select this feature, you can select Home Address 2 as a destination.

#### **NOTE:**

*If you have no home address entered, the system prompts you for one.*

### By Address

After you select **Address** from the MENU screen (Dest. MENU 1), the display changes to:



#### **Tip:**

- *When entering an address by voice, it is more efficient to say the city name first, then the street name.*
- *When entering an address by the **Interface Dial**, it is usually easier to enter the street first. A city or cities that the street appears in will be displayed. For your convenience, you do not have to enter both city and street.*

#### **NOTE:**

- *If you find that your city is not listed, it may be part of a larger metropolitan area. Try entering the street first.*
- *Prior to departure, you can set areas to avoid. The system then includes them in its calculations for the destination you have entered. See Edit Avoid Area on page 110.*

### Selecting the State or Province

The state you are in is displayed at the top of the screen. If your desired destination is in another state, select **CHANGE STATE** by moving the **Interface Dial** up.

The display then changes to the **Select a state** screen. Use the voice control system and say the name or corresponding number of the state, or rotate the **Interface Dial knob** to select the state.

You can select the “USA” or “Canada/AK.” If you select **Canada/AK**, Canada and Alaska will be displayed. If you choose **USA**, the American mainland, Hawaii, and Puerto Rico will be displayed.

## Entering a Destination

### Selecting the ZIP Code

If you move the **Interface Dial** to the right to select **ZIP CODE** while on the Find address by screen, the Enter ZIP code screen will display.

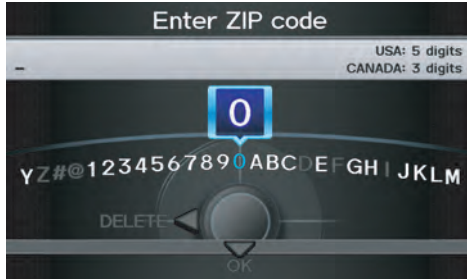

When you input the ZIP code and select **OK** by moving the **Interface Dial** down, the **Select a city** screen will appear, listing all cities with that ZIP code.

#### Tip:

*This system is enabled for both American and Canadian ZIP codes.*

### Selecting the City

This is helpful if the street runs through several cities, and you know what city includes the street. The city you are in is displayed on the screen.

#### By Voice Control:

Say “City” on the Find address by screen, and the display changes to the Say city name screen. Say the city name and the searching will begin.

If the city you want is displayed on the screen, say “Select current city.” If your desired destination is in another city, say or enter that city.



#### NOTE:

*To improve voice recognition when saying the city name, pronounce the syllables as clearly as possible.*

The Say city name screen will not display when a language other than English has been selected. You will have to enter the city name using the **Interface Dial**.

To enter the city name by voice spelling, say **CHANGE TO SPELL MODE** on the Say city name screen, and the display will change to the Enter city name screen.

Say the city name by saying individual letters, or words that represent the letters, one at a time.





The system has a talk back function. If your spoken letter is not recognized, the system will talk back to you. For example, if you say “E” but the system does not recognize the command, it will ask you, “Please select the number of the input letter from the list,” and the following pop-up box will appear:

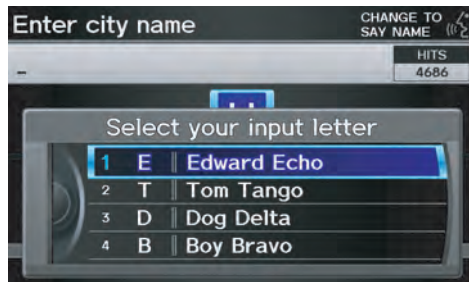

You should select a letter by saying the number.

Alternatively, to improve voice recognition, you can say “Echo” or “Edward” instead of “E.” See page 17 for a list of available words for each letter.

### By Interface Dial:

Select **City**, and the display then changes to the Enter city name screen.

### Tip:

*After the display has been changed to the Enter city name screen, the name of the city where your vehicle is currently located will be displayed. Vehicle position may not be displayed when the automobile is traveling off road or when vehicle position data cannot be updated. In these situations, you can select the **City** that is currently displayed and conduct a Street search by moving the **Interface Dial** down.*

Use the **Interface Dial** to enter the name of the city.

The system will display a list of city names, with the closest match to the name you entered at the top of the list. Select the number (1-6) of the desired city from the list.

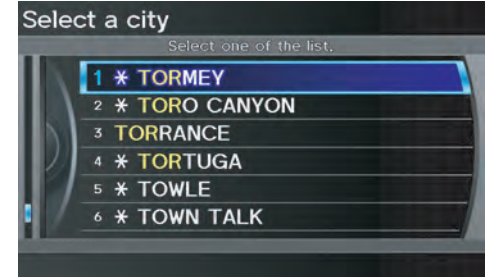

You can also enter part of the name and look for the name you want from the list that appears.

### Tip:

*For name input, you don't need to enter spaces and symbols (&, -, %, etc.). The system is also enabled for partial match searches. For example, when you search “LOS ANGELES,” it is on the list of search results if you input “LOS” or “ANGELES.”*

## Entering a Destination

If the system does not find an exact match, select **LIST** when you finish entering the name of the city. Most of the cities and towns for that state are listed.

Listings of cities and towns in the non-detailed coverage area may have an asterisk "\*" next to their names. If you select one, a pop-up box is displayed saying, "No detailed street data...", and a street address cannot be entered (See *Map Coverage* on page 134). Try entering the street first, and then select the city if available.

Select **DESTINATION MAP** and use the **Interface Dial** to select an icon, approximate area, or street you wish to choose as your destination. Otherwise, a central location of the city will be selected. If you select a point of interest (POI) or road in an unverified area, you may or may not have routing in these areas. See *Map Overview* on page 6.

### Selecting the Street

#### By Voice Control

After you have selected the city, or if you say "Street" on the Find address by screen, the display changes to the Say street name screen. Say the street name and the searching will begin.

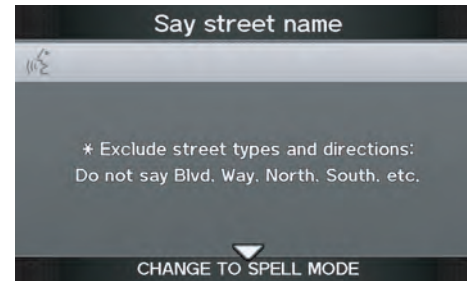

To enter the street name by voice spelling, say or select **CHANGE TO SPELL MODE** on the Say street name screen, and the display will change to the Enter street name screen.

Say the street name by saying individual letters or numbers, or words that represent the letters, one at a time.



The system has a talk back function. If your spoken letter is not recognized, the system will talk back to you. For example, if you say "E" but the system does not recognize the command, it will ask you, "Please select the number of the input letter from the list," and the following pop-up box will appear:



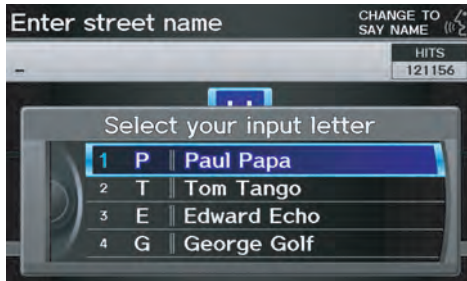

You should select a letter by saying the number.

Alternatively, to improve voice recognition, you can say “Echo” or “Edward” instead of “E.” See page 17 for a list of available words for each letter.

### By Interface Dial:

After you have selected the city, or if you selected **Street** in the beginning, the display changes to the **Enter street name** screen. Use the **Interface Dial** to enter the name of the street (e.g., ELM or 42ND) that is your destination.

When entering the names of major freeways, it is possible to use the following abbreviations. For interstates, use an “I” (I-10). For U.S. freeways, use “US” (US-18). For state freeways, use the two character state designation (CA-101). For county roads, use the appropriate designation (G-2, for example).

### Tip:

*When entering a street, you do not need to enter the direction (N, S, E, W) or the type (St, Ave, etc.). The system will automatically determine that for you, based on your entered city and street number.*

The system will display a list of street names, with the closest match to the name you entered at the top of the list. Select the number (1-6) of the desired street from the list.



## Entering a Destination

### Entering the Street Number

After you have completed the street name, the display changes to the **Enter street number** screen. Use the voice control system and say the address number as a continuous string of numbers. For example, the address 1527 should be spoken as “One, five, two, seven.” You can also use the **Interface Dial** to enter the street number.

Some address numbers may not be available on the selected street. For example, let’s say the individual address ranges for a selected street name are 1 - 20 and 9,000 - 10,000, with an overall range shown on the display of 1 to 10,000. If you try to enter a number outside the individual address ranges such as 500, the system will show this number as unavailable (grayed out).

- When using the **Interface Dial**, the system only allows you to choose available address numbers.
- When using voice control, the system beeps if you try to select an unavailable (grayed out) address number.

If you did not select a city in the beginning, the street name you selected might appear in more than one city. The system will give you a list of cities that the street appears in. Select the desired city from the list. The system then displays the **Calculate route to** screen (see *Driving to Your Destination* on page 52).

#### Tip:

*If the particular address you want cannot be found, select **Map Input** on the MENU screen (Dest. MENU 2) and use the **Interface Dial** to select the appropriate location on the map (see *By Map Input* on page 46).*

Select **DESTINATION MAP** and use the **Interface Dial** to select an icon, approximate area, or street you wish to choose as your destination. Otherwise, a central location of the street will be selected. If you select a point of interest (POI) or road in an unverified area, you may or may not have routing in these areas. See *Map Overview* on page 6.

### By Address Book

This selection allows you to choose a personal address entry for a destination. After you select **Address Book** from the MENU screen (Dest. MENU 1), the display changes to:

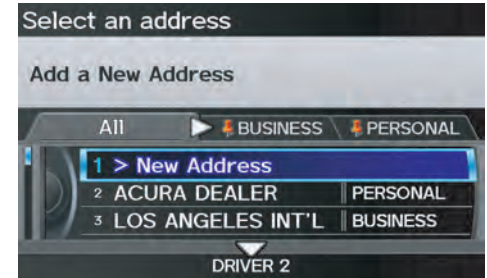

If an **Address Book PIN** has been set in SETUP, the system prompts you to enter your PIN. Say or enter your PIN.

If the PIN has not been entered, the system displays the list.

To switch the list between **Driver 1** or **Driver 2**, move the **Interface Dial** down.

#### NOTE:

*For information on the PIN setting, see page 100.*

The system then displays a list of the places entered in your personal Address Book. By using the **Interface Dial**, you can sort the displayed addresses by **All**, **BUSINESS**, **PERSONAL**, or by other categories you may create.

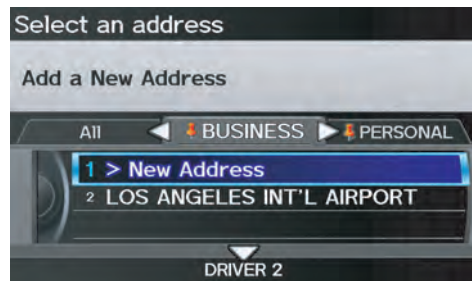

Scroll through the list to find your desired destination. After you select it, the system then displays the **Calculate route to** screen (see *Driving to Your Destination* on page 52).

### Tip:

If you select **New Address** in the list, you can store a new address in the personal Address Book. For information on storing New Address, see Address Book on page 95.

### Adding Addresses to the Personal Address Book

There are three ways to enter addresses to the personal Address Book:

- Selecting **New Address** on the **Select an address** screen (see page 96).
- Entering them to the personal Address Book feature in **SETUP** (see page 96).
- Adding them to the Address Book directly from the **Calculate route to** screen (see page 52).

### NOTE:

- *Destinations chosen from the Address Book do not show up in Previous Destinations.*
- *Prior to departure, you can set areas to avoid. The system then includes them in its calculations for the destination you have entered. See Edit Avoid Area on page 110.*
- *For information on the available Voice Command Index, see on page 163.*

### By Previous Destination

Every time you route to a destination, that destination is saved by the system. Up to 50 destinations can be stored. Select **Previous Destination** from the **MENU** screen (**Dest. MENU 1**) to choose one of those destinations.

After you select **Previous Destination**, the display lists the last 50 destinations entered, with the most recent appearing first.

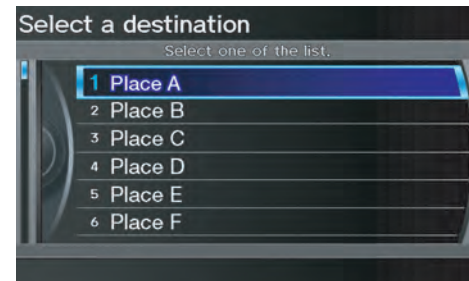

### NOTE:

- *If Previous Destination is grayed out, there are no Previous Destinations entered.*
- *Neither your home address nor the personal Address Book is displayed on the Previous Destinations list.*

## Entering a Destination

Scroll through the list and say the line number (1-6) of the destination, or select the desired destination you want.

Once you select the desired destination, the system then displays the **Calculate route to** screen (see *Driving to Your Destination* on page 52).

### NOTE:

- Prior to departure, you can set areas to avoid. The system then includes them in its calculations for the destination you have entered. See *Edit Avoid Area* on page 110.
- For information on the available voice commands, see *Voice Command Index* on page 163.

## By Place Name

If you select **Place Name** from the MENU screen (Dest. MENU 1), the display will switch to the Enter a place name screen. Use the **Interface Dial** to input the location name. You can input this place name by spelling out the word one letter at a time.



Well-known facilities and other businesses known by more than one name can be searched for by multiple name queries.

If you select a restaurant name with the **Z** icon next to it, move the **Interface Dial** to the right to view the Zagat information.

### NOTE:

*Prior to departure, you can set areas to avoid. The system then includes them in its calculations for the destination you have entered. See *Edit Avoid Area* on page 110.*

The place name closest to what you input will be displayed at the top of the list. If the place falls into multiple categories, the categories are listed after making a selection. If you move the **Interface Dial** down while the list is displayed, the display will switch to **SORT BY DISTANCE** or **SORT BY NAME**.

### NOTE:

When there are more than 2,000 destinations, the ordering of the items in the list cannot be sorted by distance or name.

When you select a location, the system displays the Calculate route to screen. (See *Driving to Your Destination* on page 52.)

### By Place Category

After you select **Place Category** from the MENU screen (Dest. MENU 1), the display changes to:

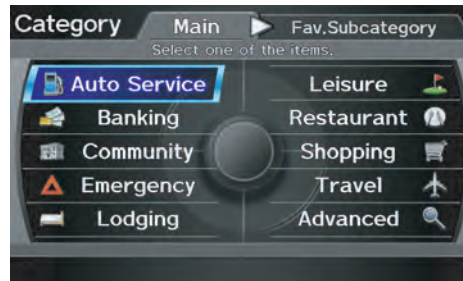

If you select a category from the list, you can select even more detailed subcategories.

Let's assume you want to find a coffee shop (restaurant) called "Bucks."

- If you know the phone number of the coffee shop, select **Place Phone No.**, then enter the 10-digit number with area code. This is the quickest way to find it. See *By Place Phone Number* on page 43.

- The second best method is to select **Place Category**, then **Restaurant**, then **CAFÉ/COFFEE SHOP**, and then enter the keyword "Bucks." The list will include all restaurants that have the letters "bucks" anywhere in the name.
- You can try to enter "Bucks" using **Place Name**, but you may have to search through a list that might include Bucks Welding, Bucks Surplus, etc.

### NOTE:

- Prior to departure, you can set areas to avoid. The system then includes them in its calculations for the destination you have entered. See *Edit Avoid Area* on page 110.
- You can enter the desired destination using the voice control system. For information on the available voice commands, see *Voice Command Index* on page 163.

## Entering a Destination

Intro

### Subcategories

If you select a category, the Subcategory screen will appear.

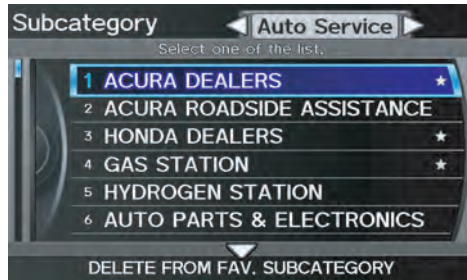

When you move the **Interface Dial** to the left or right, other subcategories can be displayed. Select your desired subcategory.

A subcategory stored in **Fav. Subcategory** has a star at the end of the line. When you move the **Interface Dial** down, you can add your desired subcategory as your favorite or delete it.

### Tip:

*If you are not sure of the spelling of a place, the best way to find it is to use the keyword search. Select **Place Category**, choose a category and subcategory from the menus, then select **Search by Keyword**, and enter the partial name.*

### Favorite Subcategory

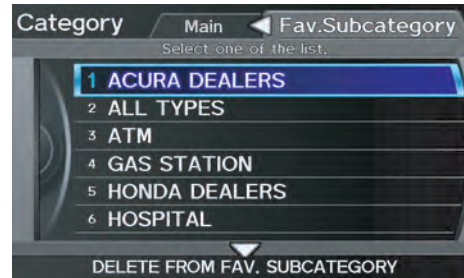

When you select the “Fav. Subcategory” tab on the Category screen, you can choose directly from previously stored subcategories. A maximum of 30 favorite subcategories can be stored.

To delete a category from the favorites, move the **Interface Dial** down. Select categories you want to delete and select **OK** by moving the **Interface Dial** down.





Auto Service		Lodging		Shopping	
Acura Dealers*1	Auto Repair & Maintenance	Bed & Breakfast	Resort	All Shopping*3	Office Supplies/Electronics
Acura Roadside Assistance	Car Wash & Detailing	Hotel/Motel		Accessories/Jewelry	Pharmacy/Drug Store
Honda Dealers*1	Motorcycle Dealers	Leisure		Auto Parts & Electronics	Pet Food/Supplies
Gas Station*1	Other Car Dealers	Amusement Park	Museum	Books/Music/Video	Sewing/Linen
Hydrogen Station	Roadside Assistance	Golf Course	Park/Recreation Area	Clothing	Shoes/Bags
Auto Parts & Electronics		Historical Monument	Performing Arts	Groceries	Sporting Goods
Banking		Marina	Sports Complex	Home Improvement	Toys/Arts/Crafts
ATM*1	Check Cashing/Money Transfer	Movie Theater	Tourist Attraction	Mall/Department Store	
Bank	Currency Exchange	Restaurant		Travel	
Community		All Types*1*2	Indian	Airport	Parking Lot
Business	Higher Education	All Types (Zagat Only)	Italian	Automobile Club	Rental Car Agency
City Hall	Library	American	Japanese	Bed & Breakfast	Resort
Civic/Community Center	Post Office	Californian	Korean	Bus Station	Rest Area
Convention/Exhibition Center	School	Chinese	Mexican	Camping	Ski Area
Court House		Café/Coffee Shop	Pizza	Commuter Rail Station	Tourist Attraction
Emergency		Continental	Seafood	Ferry Terminal	Tourist Information
Acura Roadside Assistance	Roadside Assistance	Fast Food	Thai	Hotel/Motel	Train Station
Hospital*1	Veterinarian	French	Vegetarian	Named Place	Travel Agency
Police Station		German	Vietnamese	Park & Ride	Truck Stop/Plaza
		Greek	Other	Parking Garage/House	
				Advanced	
				If the category you want is not listed, you can try to find it with a keyword. When you select this option, the display changes to the Enter keyword for category screen. If the system finds any categories with the keyword you entered, the display changes to the Select a category screen. Select the desired category.	

\*1 Factory default subcategories stored in **Fav. Subcategory**.

\*2 When trying to find a specific restaurant, select the category **ALL TYPES**. Some restaurants may be miscategorized.

\*3 When trying to find a specific store, select the category **ALL SHOPPING**. Some stores may be miscategorized.

## Finding a restaurant

The ZAGAT SURVEY for some restaurants is available in the system. See the INFO screen (Other), “Key to ZAGAT Rating” for an explanation of these ratings (see page 92).



On the Select a place screen, restaurants with a Zagat Rating have a **Z** icon at the end of the line. To list only restaurants with Zagat Reviews, say “Zagat” or select **ZAGAT 2012**. You can view the complete Zagat Review for a selected restaurant by selecting the **Z** tab.

By voice, select the **Z** tab by saying “Zagat list number X” (where X is the line number 1-3). Alternatively, use the **Interface Dial** to first select the line item, and move the **Interface Dial** to the right to view the survey.

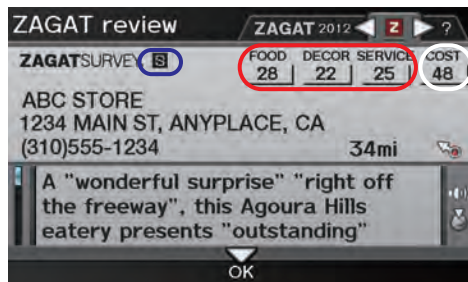

Say “Read List” or push in on the **Interface Dial**, and the review will be read to you. Move the **Interface Dial** down to display the Calculate route to screen.

### NOTE:

*Scrolling through the Zagat Review is disabled when the vehicle is moving.*

“Food,” “Decor,” and “Service” categories (red frame) are rated using numbered values (e.g., 22, 21, 20 etc.)

“Cost” (white frame) is the average cost of a meal (including drink and tip). If unavailable then estimated cost symbols are shown:

- “VE”: Very Expensive
- “E”: Expensive
- “M”: Moderate
- “T”: Inexpensive

The symbols, if displayed (blue frame), indicate the following information:

- S** open on Sunday
- M** open on Monday
- L** open for lunch
- serving after 11 PM
- no credit card accepted



After selecting a category and subcategory, the system will give you the options of **Place Name**, **Sort by Distance to Travel**, **City Vicinity**, or **Search by Keyword** with the following screen:

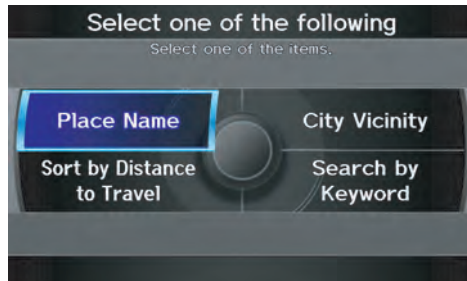

### Place Name

When you select this option, the display changes to the **Enter a place name** screen. Enter the place name, using the **Interface Dial**.

Once you select a place, the system then displays the **Calculate route to** screen (see *Driving to Your Destination* on page 52).

### City Vicinity

The system allows you to find points of interest in the vicinity of the city you entered. When you select this option, the display changes to the **Enter city name** screen. Enter the name of the city using the **Interface Dial**. If the system does not find an exact match, select **LIST** when you finish entering the name of the city. Select a desired city from the list.

Once you have selected the city, the display changes to the **Enter a place name** screen. Enter the name of the place using the **Interface Dial**.

The system searches within a 20-mile radius of the city center. If more than 1,000 POIs are located, only the first 1,000 are displayed.

Once you select a place, the system then displays the **Calculate route to** screen (see *Driving to Your Destination* on page 52).

### Sort by Distance to Travel

When you select this option, the system gives you a list of all the places in the subcategory. This list is arranged by distance from your current location, with the closest at the top of the list.



The distance and direction to the destination at the cursor position in the list are shown on the screen. The distance shown is straight line distance (as the crow flies), not driving distance. Say or select the number (1-4) of the desired destination from the list.

Once you select a place, the system then displays the **Calculate route to** screen (see *Driving to Your Destination* on page 52).

## Entering a Destination

Intro

### Search by Keyword

If you do not know the exact name of the destination, you can find the place with a keyword. When you select this option, the display changes to:

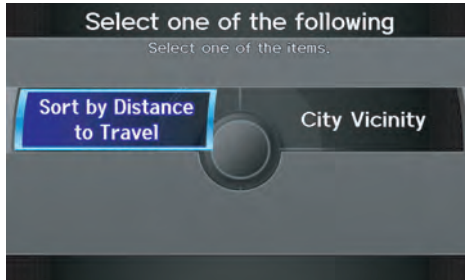

You can find your destination with a keyword using the **Sort by Distance to Travel** option or **City Vicinity** option.

If you select the **Sort by Distance to Travel** option, the Enter keyword for place screen appears. Enter the keyword using the **Interface Dial**. If the system does not find an exact match, select **LIST** when you finish entering the keyword. The system starts searching for places that match the entered keyword. If you see your desired place, select it from the list. If not, scroll through the list to find the desired place.

If you move the **Interface Dial** down to select **MORE**, the scope of the search can be increased.

When there are a large number of search results, the number of locations will increase to 100, 200, and up to 1,000 locations. When the number of locations is 100 or less, you can increase the scope to 500 miles, 1000 miles, or entire U.S.

If you select the **City Vicinity** option, the Enter city name screen appears. Enter the name of the city using the **Interface Dial**. The system will display a list of city names, with the closest match to the name you entered at the top of the list. Select your desired city name from the list. Once you have selected your desired city name, the Enter keyword for place screen appears.

Enter the keyword using the **Interface Dial** to specify the desired place. Once you select a place, the system then displays the Calculate route to screen (see *Driving to Your Destination* on page 52).



### By Place Phone Number

You can select a destination by phone number. Only phone numbers saved in the system are recognized. The phone numbers of private residences and numbers entered in your private address book are not in the system. If you select **Place Phone No.** on the MENU screen (Dest. MENU 2), the display will switch to the Enter phone number screen. Use the **Interface Dial** to enter the phone number.



#### **NOTE:**

Prior to departure, you can set areas to avoid. The system then includes them in its calculations for the destination you have entered. See Edit Avoid Area on page 110.

After entering the number, move the **Interface Dial** down and select **OK**. Multiple listings for the same phone number may be shown.

#### **NOTE:**

All 10 digits must be entered.

#### **Tip:**

When using the voice control system, the entry should be spoken as a continuous string of numbers. For example, the telephone number (310) 555-4000 should be spoken as “Three, one, zero, five, five, five, four, zero, zero, zero.”

### By ZAGAT® 2012

The **ZAGAT 2012** option allows you to find a restaurant by the ZAGAT Rating information. When you select **ZAGAT 2012** on the MENU screen (Dest. MENU 2), the system lets you select the metro area, neighborhood, and food type to search the restaurant you like. After you select the food type, the following display appears:



**Food, Decor, Service** - When you select **Food, Decor, or Service**, the restaurant will be listed by rating value.

**Cost** - When you select **Cost**, the restaurant will be listed by the average cost of a meal (including drink and tip).

## Entering a Destination

Intro  
SEC

When you select a sorting method, the list of restaurants will appear.



You can see the survey for a listed item by selecting the **Z** tab, or by saying “Zagat list number X” (where X is the number 1-3).

Once you select a restaurant, the system then displays the Calculate route to screen (see *Driving to Your Destination* on page 52).

### NOTE:

- *Selecting this sorting method will show you Zagat’s highest-rated restaurants by the options, and not necessarily by distance from your current location.*
- *For details on the ratings and symbols, say “Key to Zagat rating” or select the “?” tab using the Interface Dial.*

### By Coordinate

If you select **Coordinate** from the MENU screen (Dest. MENU 2), the display will change to the Enter latitude screen. Use the **Interface Dial** to input the latitude.

### NOTE:

*Latitude and longitude must be entered up to the seconds’ value.*



### NOTE:

*Prior to departure, you can set areas to avoid. The system then includes them in its calculations for the destination you have entered. See Edit Avoid Area on page 110.*



After entering the latitude, move the **Interface Dial** down and select **OK**. The display will change as follows.

On the Enter longitude screen, use the **Interface Dial** to input the longitude.

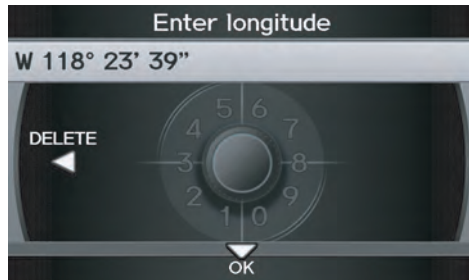

With the selection of **Coordinate**, it is assumed that you are searching for the destination within the area that is in the closest proximity. The display will change as follows.

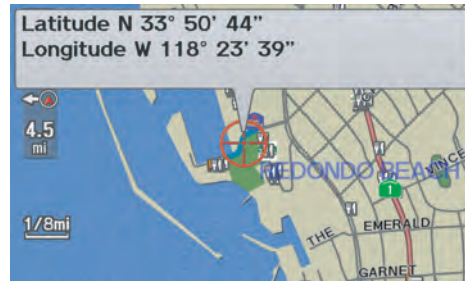

Move the **Interface Dial** to find the desired destination. The map and crosshairs move in the same direction.

If so desired, you can also rotate the **Interface Dial knob** and change the scale of the map. When the crosshairs are on the desired icon, map location, or road, push in on the **Interface Dial**. The address for this location will be displayed at the very top of the screen.

The yellow box (shown in scales above 1/4 mile) denotes the area that can be viewed with the **Interface Dial** when the current map is clicked.

### NOTE:

Information icons are displayed at scales from 1 mile to 1/4 mile, POI icons are displayed at 1/8 mile or less, and roads are displayed at 1/4 mile or less.

When you find the desired address, press on the **Interface Dial** again. If it is not the desired address, change the location of the crosshairs with the **Interface Dial**. Push in on the **Interface Dial** again to display a new address.

If you select a section of road within the crosshairs, the following screen appears. Select **Set as Dest.** and calculate the route for the destination that you selected.

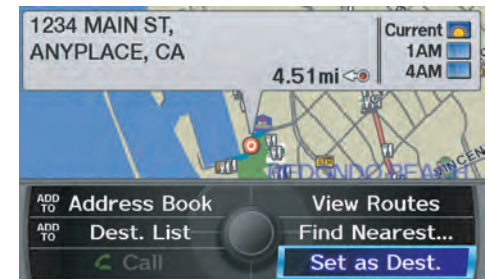

## Entering a Destination

### By Intersection

After you select **Intersection** from the MENU screen (Dest. MENU 2), the display changes to:



To select an intersection outside the state you are currently in, select the state. For details of how to select a state, see *Selecting the State or Province* on page 29.

Next, select the city where the intersection is located. For details of how to select a city, see *Selecting the City* on page 30.

Last, select the two streets which intersect. For details of how to select a street, see *Selecting the Street* on page 32.

If the two streets that you have selected do not intersect, no intersection will appear.

#### Tip:

*When entering an address, it is usually easier to enter the street first. A city or cities that the street appears in will be displayed. For your convenience, you do not have to enter both city and street.*

#### NOTE:

- If you find that your city is not listed, it may be part of a larger metropolitan area. Try entering the street first.
- Prior to departure, you can set areas to avoid. The system then includes them in its calculations for the destination you have entered. See *Edit Avoid Area* on page 110.

### By Map Input

After you select **Map Input** from the MENU screen (Dest. MENU 2), the display changes to:



Select **Current Position**, **City**, **State**, or **USA and Canada** to display the map.

#### NOTE:

- Prior to departure, you can set areas to avoid. The system then includes them in its calculations for the destination you have entered. See *Edit Avoid Area* on page 110.
- For information on the available voice commands, see *Voice Command Index* on page 163.



### Showing the Map of Current Position

The **Current Position** selection assumes that you are looking for a destination in the immediate area. The display changes to:

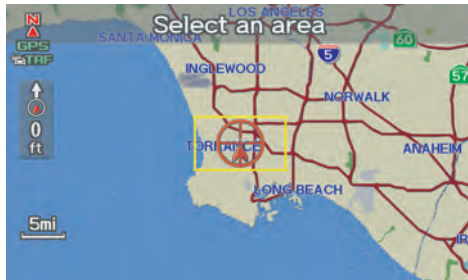

The red arrow indicates your vehicle position. Find your desired destination by moving the **Interface Dial** up and down and to the left and right. The map and crosshairs will move in the same direction.

The yellow box indicates the area you will see when you click on the current map with the **Interface Dial**. The scale will decrease each time you push in the **Interface Dial**.

If desired, rotate the **Interface Dial knob** to change the map scale. When you have the crosshairs on the desired icon, polygon, or road, push in on the **Interface Dial**. The address of the location will appear at the top of the screen (at scales less than 1 mile).

### NOTE:

*Information icons are displayed at scales from 1 mile to 1/4 mile, POI icons are displayed at 1/8 mile or less, and roads are displayed at 1/4 mile or less.*

If this is the desired address, push in on the **Interface Dial** again. If not, use the **Interface Dial** to reposition the crosshairs, then push in on the **Interface Dial** again to display the new address.

If you select a single icon or road segment within the target mark, the following screen appears. Select **Set as Dest.** to calculate a route to the selected destination.

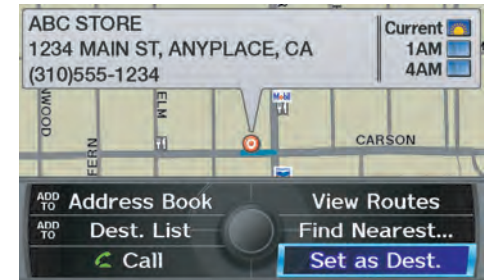

If you select multiple icons within the cursor radius, the following screen appears.

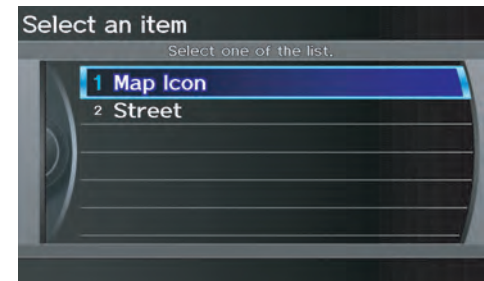

Select **Map Icon** or **Street** to find the desired destination.





Select an item from the list. Then select **Set as Dest.** to calculate a route to the selected destination.

## Showing the Map of City

You can search for a city name in all coverage areas.

### By Voice Control:

Say “City” on the Show map of screen, and the display changes to the Say city name screen. Say the city name and the searching will begin.

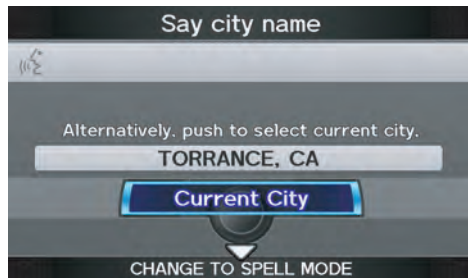

### NOTE:

*To improve voice recognition when saying the city name, pronounce the syllables as clearly as possible.*

The Say city name screen will not display when a language other than English has been selected.

To enter the city name by voice spelling, say **CHANGE TO SPELL MODE** on the Say city name screen, and the display will change to the Enter city name screen.



Say the city name by saying individual letters, or words that represent the letters, one at a time.

The system has a talk back function. If your spoken letter is not recognized, the system will talk back to you. For example, if you say “E” but the system does not recognize the command, it will ask you “Please select the number of the input letter from the list” and the following pop-up box will appear:

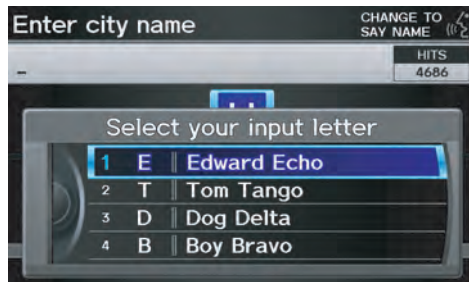

You should select a letter by saying the number.

Alternatively, to improve voice recognition, you can say “Echo” or “Edward” instead of “E.” See page 17 for a list of available words for each letter.

### By Interface Dial:

With the **City** selection, the display changes to the Enter city name screen. For instructions on entering the city name, see *Selecting the City* on page 30.

When you have entered the desired city, the display changes to a map. The starting location will be the central position in the selected city.

See *Showing the Map of Current Position* on page 47 for instructions on finding and entering your desired destination.

### Showing the Map of State

#### By Voice Control:

Say “State” on the Show map of screen, and the display changes to the **Select a state** screen. Say the state name (e.g., California or CA) or the state number (1-7).



You can select the “USA” or “Canada/AK” tab by moving the **Interface Dial** to the left and right.

If you select **Canada/AK**, Canada and Alaska will be displayed. If you choose **USA**, the American mainland, Hawaii, and Puerto Rico will be displayed.

Say the state name by saying individual letters, or words that represent the letters, one at a time.

## Entering a Destination

Intro

### By Interface Dial:

With the **State** selection, the display changes to the **Select a state** screen.

After you select the desired state, the display changes to a map of the state, with the crosshairs located near the middle.

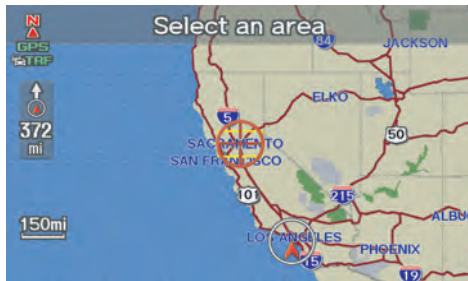

The yellow box indicates the area you will see when you click on the current map with the **Interface Dial**. The scale will decrease each time you push in on the **Interface Dial**.

Use the **Interface Dial** to move the crosshairs to the area of the state close to your intended destination. If desired, rotate the **Interface Dial knob** to change the map scale. When you have the crosshairs in the desired area, push

in on the **Interface Dial**. The address of the location you have selected will appear at the top of the screen.

### NOTE:

*Information icons are displayed at scales from 1 mile to 1/4 mile, POI icons are displayed at 1/8 mile or less, and roads are displayed at 1/4 mile or less.*

If this is the desired address, push in on the **Interface Dial** again. If not, use the **Interface Dial** to reposition the crosshairs, then push in on the **Interface Dial** again to display the new address.

If you selected a single icon or road segment, select **Set as Dest.** to calculate a route to the selected destination. If you selected multiple icons within the cursor radius, select an item from the list. Then select **OK** to calculate a route to the selected destination.

### Showing the Map of Continental USA and Canada

With the **USA and Canada** selection, the display changes to:

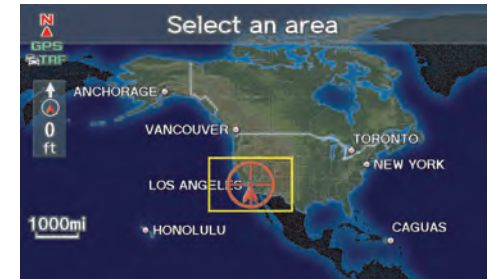

The yellow box indicates the area you will see when you click on the current map with the **Interface Dial**. The scale will decrease each time you push in on the **Interface Dial**.

Use the **Interface Dial** to move the crosshairs to the area of the country close to your intended destination. Then push in on the **Interface Dial**.

SEC

i

Home

If desired, rotate the **Interface Dial knob** to change the map scale. When you have the crosshairs on the desired icon, polygon, or road, push in on the **Interface Dial**. The address of the location you have selected will appear at the top of the screen.

### **NOTE:**

*Information icons are displayed at scales from 1 mile to 1/4 mile, POI icons are displayed at 1/8 mile or less, and roads are displayed at 1/4 mile or less.*

If this is the desired address, push in on the **Interface Dial** again. If not, use the **Interface Dial** to reposition the crosshairs, then push in on the **Interface Dial** again to display the new address.

If you selected a single icon or road segment, select **Set as Dest.** to calculate a route to the selected destination. If you selected multiple icons within the cursor radius, select an item from the list. Then select **OK** to calculate a route to the selected destination.

### **By Go Home 1 or 2**

Selecting **Go Home 1** or **2** from the MENU screen (Dest. MENU 1 or 2) takes you to the address you have set as “home.”

If a **Go Home 1** or **2 PIN** has been set, the system prompts you to enter your PIN.

Say or enter your PIN. The system will then display the **Calculate route** to screen (see *Driving to Your Destination* on page 52).

If a **Go Home 1** or **2 PIN** has not been set, the system displays the **Calculate route** to screen after you select **Go Home 1** or **2** (see *Driving to Your Destination* on page 52).

### **NOTE:**

- *To edit Home Address, see Home Address on page 99.*
- *When no Home Address 1 or 2 has been set, the SETUP screen will be displayed. For details, see Home Address on page 99.*
- *Prior to departure, you can set areas to avoid. The system then includes them in its calculations for the destination you have entered. See Edit Avoid Area on page 110.*
- *PINs are optional. If you choose to use a PIN, make sure you remember it. If you forget your PIN, your dealer will have to reset it for you, and all PINs will be cleared.*
- *If a PIN is desired, enter it using the Personal preference PIN number feature in SETUP. See page 100 for information on entering your PIN number.*

## Driving to Your Destination

A route typically has three phases.

- Initial route calculation (the Calculate route to screen) (see page 52)
- Change the route while en route (see page 74).
- Resume the route when restarting the engine (see *Continue Trip to Screen* on page 79).

## Calculate Route to Screen

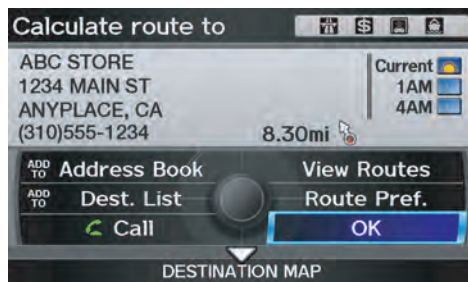

Say or select **OK**. The system calculates the route (see *Map Screen* on page 54).

### NOTE:

- *Prior to departure, you can set areas to avoid. The system then includes them in its calculations for the destination you have entered. See *Edit Avoid Area* on page 110.*
- *For information on the available voice commands, see *Voice Command Index* on page 163.*

Further selections from the Calculate route to screen include:

## ADD TO Address Book

Allows you to add the destination to your Address Book. See *By Address Book* on page 34.

### NOTE:

*When you select a destination from your Address Book, **EDIT Address Book** will be displayed. You can edit the address by selecting this button. For information on editing your Address Book, see *Address Book* on page 95.*

## ADD TO Dest. List

Allows you to add a location to the **Destination List** as a destination or waypoint. While on the Calculate route to screen, rotate the **Interface Dial knob** and select **ADD to Dest. List**. The Add to dest. list screen appears and the destination is added. See *Destination List* on page 77.

## Call

Dials the number on the screen when available. See *Bluetooth® HandsFreeLink®* on page 19.

### Changing the Route Preference

The system lets you select the way you want to drive to your destination. Select **Route Pref.** on the Calculate route to screen by rotating the **Interface Dial knob**.



- You can choose **MAX** or **MIN** for four settings: **Freeways**, **Toll Roads**, **ETC Roads**, and **Ferries**. The route calculations for the current selection will be displayed in the upper right-hand corner of the screen.

#### NOTE:

If you select **MIN** or **MAX** of **ETC Roads** as your route preference, the system finds the route with as few electronic toll collection (ETC) gates as possible in **MIN** or as many ETC gates as possible in **MAX**.

The generated route may not be the route you would choose. For safety reasons, the system generally applies the following rules to your route:

- Shortcuts through residential areas are avoided.
- Right turns are favored over left turns or U-turns.
- Restricted turns (turns that cannot be made during or at certain times of the day) are not used.

### Viewing the Routes

If you select **View Routes** on the Calculate route to screen, you can view three possible routes to your destination. You can also use the **Interface Dial** to verify the areas peripheral to the map. If you select **View Routes**, the display changes to:



These different routes are shown and calculated based on the setup options in **Route Pref.**

You can select one of the three routes (1-3) by rotating the **Interface Dial knob**. The system will calculate the selected route and display the map screen.

#### NOTE:

- The driving distance and time estimated for the various routes is displayed.
- It is not unusual for the different methods to pick the same route. Voice commands cannot be used while the system is calculating.



- Zoom IN/OUT to view route details or traffic conditions is not available on the View routes screen. After moving the **Interface Dial** and scrolling through the map, you can then zoom in or out on the map screen to view your route in details.

Based on the route data, you can change the routing method by rotating the **Interface Dial knob**.

Once you confirm your selection, say the number of the desired routing method or push in on the **Interface Dial**.

The calculated route will be highlighted as a blue line, and a voice prompt will tell you how to proceed along the highlighted route.

Push in on the **Interface Dial** and select **Voice** to have the guidance repeated.



## Viewing the Destination Map

If you move the **Interface Dial** down and select **DESTINATION MAP** on the Calculate route to screen, a map of the destination vicinity is displayed. Press the **CANCEL** or **BACK** button, or select **Return** to return to the previous screen. You can view the destination map anytime while en route by saying “Display destination map.”

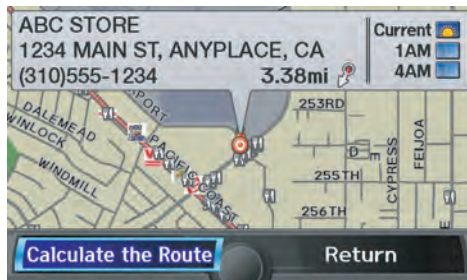

## Map Screen

When you select **OK** on the Calculate route to screen, the map screen appears, showing your highlighted route (blue line) in real time.

## Route Line

When driving on unverified streets (purple), the route line changes to either a purple dotted “vector line” pointing to your destination, or a blue-pink line. See *Unverified Area Routing* on page 106 for a detailed explanation of how to enable unverified routing, and the related cautions and disclaimers.

### NOTE:

- You can always view the entire route by simply saying, “Display entire route.”
- When your route line uses streets that display traffic information, the route line may consist of orange or red segments. This is normal. See *Traffic Display Legend* on page 22, and *Viewing Flow Data* on page 24.



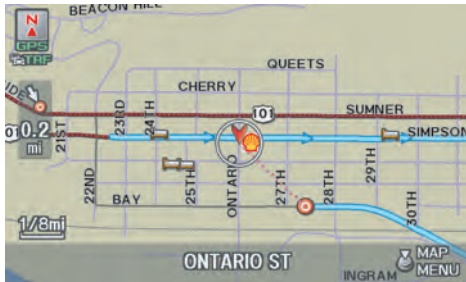

“Vector line” (unverified routing off)

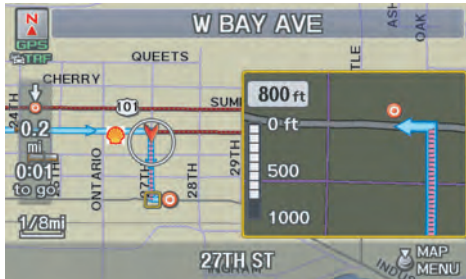

Blue-pink unverified route line  
(unverified routing on)

### Voice Guidance Prompts

As you get near the guidance point, you will hear a voice reminder and see a pop-up window showing you the guidance point. You will typically hear three prompts:

- The first is about 1/2 mile from the guidance point.
- The next is about 1/4 mile from the guidance point.
- The final prompt is close to your actual turn.

If the distance between the next two guidance points is very small, both of them are displayed on the screen in a single window, and the voice will remind you of them at the same time.

### NOTE:

- You can say “Voice” at any time, or select **Voice** after pushing in on the **Interface Dial** to be reminded of the next guidance point.
- Typically, a pop-up guidance window shows your next turn, and a voice guidance is heard. The timing of guidance varies depending on the type of road you are on and the distance to the next guidance point.



When the guidance in unverified areas, the phrase “if possible” is inserted before each guidance prompts. See Unverified Area Routing on page 10<sup>6</sup> for more detailed information on the unverified routing.

Intro  
SEC

## Map Screen Legend

- Breadcrumbs**  
(see *Off-road Tracking* on page 71)
- No Entry Icon** 
- Direction of Destination**  
(when en route)
- Distance to Destination**  
(see page 58)
- Time to Destination** (see page 58)
- Vehicle Position** (see page 64)
- Current Map Scale**  
(see page 66)
- Current Street**  
(see page 64)
- Message Icon** (see page 80)  
Indicates that you have an AcuraLink message.
- Warning Icon**  
Indicates that there are weather warnings.  
To check the warning list, see page 85.
- Map Scale Adjustment**  
(Mile or km per half-inch appears only when you zoom in or out by rotating the **Interface Dial knob.**) (see page 66)

**Map Orientation**  
(see page 63)

North-up  Heading-up 

**Blue Line** Calculated route  
(see page 54)





**Next Guidance**  
(when en route)



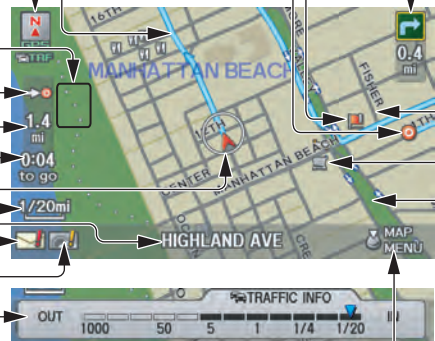









**Waypoint** (see page 76)









**Destination Icon**  
(see page 67)

**Map Menu**  
(see page 58)  
(Push in on the **Interface Dial** to view.)



- Streets** (see *Map Overview* on page 6)
  -  : Freeways
  -  : State Routes
  -  : Verified Streets
  -  : Unverified Streets
  -  : One-way Streets (see page 67)  
(1/20 mile scale only)
- Landmark Icon - Generic** (see page 67)
 

 Acura Dealer	 Grocery Store
 Honda Dealer	 Hotel/Lodging
 ATM	 Gas Station
 School	 Hospital
 Parking Lot	 Post Office
 Parking Garage	 Restaurant
 Freeway Exit Information	

- Map Features**
- |   |  |
|---|--|
|  Park          |  Airport/Business |
|  Hospital      |  Water Area       |
|  Shopping Mall |  Cemetery         |
|  Golf Course   |  University       |

**NOTE:**  
If you move the **Interface Dial** over an area (map features shown above), the name is displayed at the top of the screen.

**NOTE:**  
See *Map Legend* in the **Map Information** on the **Map menu** for further explanation.

Home

### Guidance Screen

The guidance screen offers an alternative way to view your route information. Many of the icons and screen features are similar to those on the map screen. While driving to your destination, press the **MAP/GUIDE** button to switch between the map and guidance screens. The guidance screen shows you:

**Milestone to Destination** - The position of the small circular icon shows your trip progress. As you get closer to your destination, the indicator will approach .

#### NOTE:

- The map and voice guidance in unverified areas differ from those in verified areas.
- Current guidance points and those within 1000 feet will show on the Countdown bar, indicating the distance until the next guidance point.

### Guidance Screen Legend

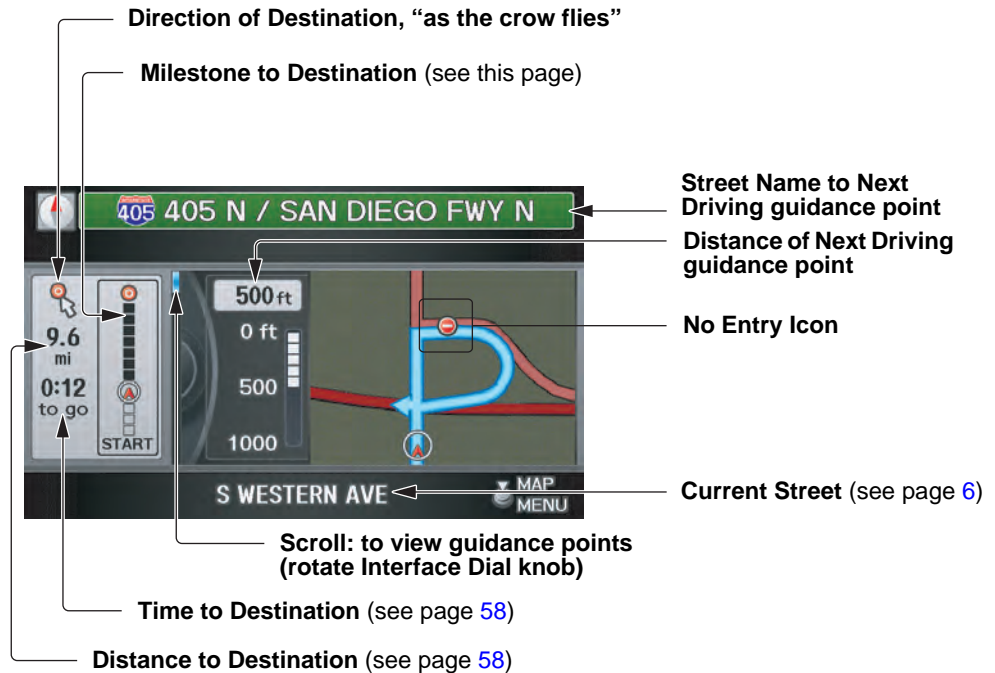

## Distance and Time to Destination

When you select a destination, the distance to the destination is the actual road distance of the calculated route, and not “as the crow flies.” When viewing a list of destinations (points of interest), such as restaurants, the distance is “as the crow flies” (see *Sort by Distance to Travel* on page 41).

The displayed time to the destination may differ from the actual travel time because the time is calculated based on the posted road speed data and your current speed.

### NOTE:

*If you are en route and the **Interface Dial** is moved, the “Time to Destination” and “Distance to Destination” indications are replaced with an indicator showing distance from the current vehicle location.*

## Map Menu

When the map screen is displayed, pressing in on the **Interface Dial** displays the Map menu. If the map is scrolled, the Map menu will not appear. Press the **MAP/GUIDE** button, the **BACK** button, or the **CANCEL** button to return to the basic map screen.

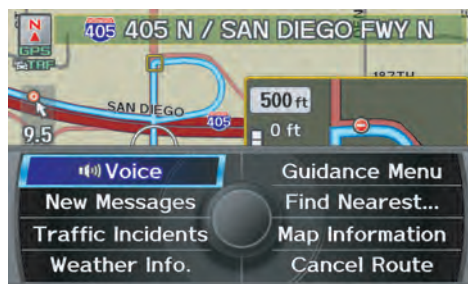

**Voice** - Button shown if currently en route. Select to hear the next voice guidance.

**New Messages** - Indicates that there are AcuraLink messages for you to read. These messages consist of quick tips and other information communicated to you by Acura. If the button is grayed out, you have no messages. For detailed information on this feature, see page 80.

**Traffic Incidents** - Displays a list of the traffic incidents around your current position or on your current route. You can view this same list by saying “Display traffic incidents.” For detailed information on this feature, see page 25.

**Weather Info.** - Allows you to view the weather forecast, warning list, warning map, and radar map. See *AcuraLink Weather* on page 82.

**Guidance Menu** - Button shown if currently en route. This button allows you to set or confirm the guidance features. For detailed information, see *Guidance Menu* on page 59.

**Find Nearest ...** - Selects a subcategory from the list to search the nearest POI from your current location. For detailed information on this feature, see *Subcategories* on page 38.

**Map Information** - Allows you to confirm information on the map or change the settings of displaying a map. For detailed information on this feature, see *Map Information* on page 61.

**Cancel Route** - Cancels your current route. The map screen will display your current position.

### Guidance Menu

When you select **Guidance Menu** from the Map menu, the Guidance menu screen appears.

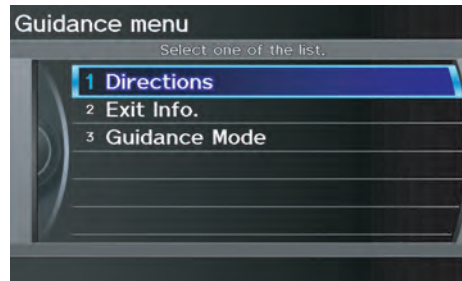

**Directions** - Select to confirm the directions (guidance points) to your destination (see page this page).

**Exit Info.** - Allows you to set a new destination or waypoint located near a freeway exit when you are en route (see page 60).

**Guidance Mode** - Allows you to select the guidance mode (single screen or split screen) (see page 61).

### Directions

You can display a list of the guidance points on your route and confirm the distance between them.

Select **Directions** on the Guidance menu screen, the display changes to:

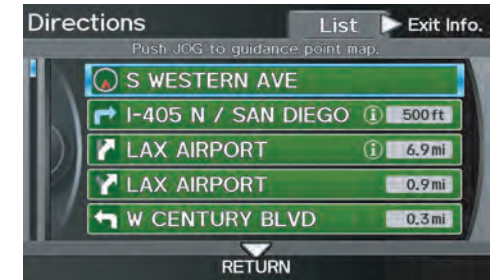

#### NOTE:

- When you select a guidance point from the list, a map of the guidance point is shown.
- Guidances that occur at freeway exits or contain freeway exit information will show the exit info icon (i).

When you select **Exit Info.** by moving the **Interface Dial** to the right, you can display a list of the freeway exits en route (see this page).

Press the **CANCEL** button or the **BACK** button, or move the **Interface Dial** down to return to the previous screen.

You can scroll one guidance point at a time by rotating the **Interface Dial knob**.

The route guidance display disappears and guidance ends when you reach your destination. Press the **MENU** button to return to the MENU screen (Dest. MENU 1 or 2).

### **Exit Info. (Freeway Exit Information)**

You can search freeway exit information (gas stations, restaurants, ATMs, etc.) and add new destinations or waypoints to the calculated route. Select **Exit Info.** on the **Guidance** menu screen, and a list of freeway exits for the route is displayed.

If you select the freeway exit you plan on taking, a list of businesses in the area will be displayed. You can choose a listing to set as a new destination or waypoint, and say or select **OK**.

On the map screen, you can display Freeway Exit information using the **Interface Dial**. The Exit Info icon will only be displayed on the map screen if there is any freeway exit information available. Choose the 1/4, 1/2, or 1 mile scale, then move the crosshairs to the desired Exit Info icon and push in on the **Interface Dial**. Choose a place from the list and set it as a new destination or waypoint.

#### **NOTE:**

*To turn on “Freeway exit information” on the map screen, display the icon bar and select the  icon (see page 62).*



### Guidance Mode

When en route to a destination, you have two display options: single-screen mode (the factory default) or split-screen mode.

If you select **Guidance Mode** on the Guidance menu screen, the Select a guidance mode screen will appear.

**Single-screen mode** - While the map screen is displayed, only the map is shown with occasional guidance pop-up windows as you approach a guidance point. When you press the **MAP/GUIDE** button and switch to the guidance screen, only the guidance screen is displayed.

**Split-screen mode** - While the map screen is displayed, the map is on the left of the screen, and the next guidance point is on the right side of the screen. You will see the same screen setup when you press the **MAP/GUIDE** button.

Guidance mode can be changed in **SETUP** (see *Guidance Mode* on page 113).

When you get near the guidance point, the map screen changes to:



On the map screen, the location of the guidance point is marked with a small yellow square. The guidance window is simply an enlargement of the next guidance point. After you get through the guidance point, the display returns to a full map screen when single-screen mode is set, or to a map and direction list screen when split-screen mode is set.

### Map Information

When you select **Map Information** from the Map menu, the Map information screen appears.

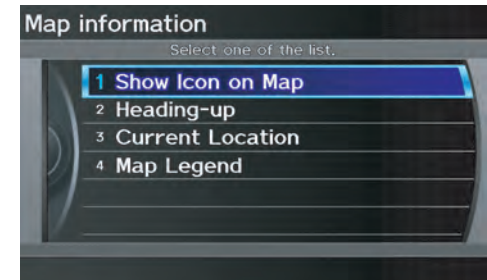

**Show Icon on Map** - Allows you to select the icons displayed on the map (see page 62).

**North-up/Heading-up** - Select **North-up** or **Heading-up** to change map orientation (see page 63). On scales greater than 1 mile, this button is grayed out (North-up only mode).

**Current Location** - Allows you to display and/or save your current location (see page 64).

**Map Legend** - Allows you to learn the meaning of map features (see page 65).



## Showing Icons on the Map

Selecting **Show Icon on Map** on the Map information screen displays the following screen:



The screen consists of the following items:

### Icon Bar

The icon bar allows you to manually select the icons that are displayed on the map (see page 69 for a list of these icons).

In the screen shown, traffic, gas stations, and restaurants are selected. Rotate the **Interface Dial knob** and push in to select (blue with box checked) or remove them (black with box unchecked). You can also display or hide the same icons by using the “Display” or “Hide” voice commands on the map screen (see page 164).

### ICON OPTION

This feature allows you to “fine tune” some of the icons on the Icon bar. If you move the **Interface Dial** down and select **ICON OPTION**, the following screen will be displayed:

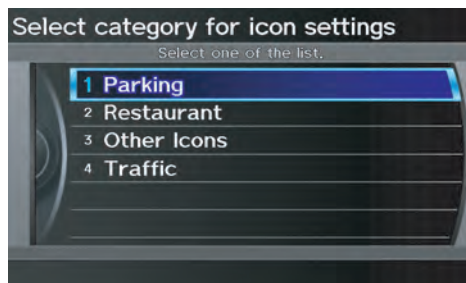

The four icon choices – **Parking**, **Restaurant**, **Other Icons**, and **Traffic** – can each be tailored to your needs.

For instance, let’s assume that hospital icons are not displayed on the map, and you want to make sure that your settings are correct. You would do the following:

- First, ensure that **OTHER ICON** on the Icon Bar is selected.
- Second, select **Other Icons** from **ICON OPTION** and verify that the hospital option is on (blue with box checked). This procedure is explained below.

If you select **Other Icons** from the **Select category for icon settings** screen, the other icon options are displayed:

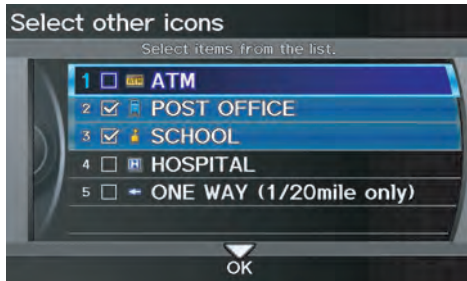

In the previous example, only **POST OFFICE** and **SCHOOL** are selected and will show up on the map. To also see **HOSPITAL** on the map, this would need to be turned on by first selecting it and then pushing in on the **Interface Dial** to select it so it appears as below.

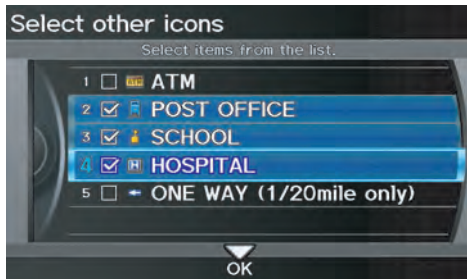

Exit, and save your settings by moving the **Interface Dial** down to select **OK**.

### **NOTE:**

*When viewing the map screen, you can turn some icons on using voice control. See the Voice Command Index on page 164 for the available “Display” and “Hide” icon commands.*

### **Map Orientation**

The map can be orientated two ways:

- North-up: North pointing up as you would normally view a paper map.
- Heading-up: The map constantly rotates so the road you are driving on always points up (as you see the road through your front windshield).



“North Up”



“Heading Up”

### **NOTE:**

*The red arrow in both heading symbols always shows the direction north.*

Select **North-up** or **Heading-up** on the Map information screen, or say “Display heading up” or “Display north up.”

In the larger map scales (above 2 mile), the map is always oriented with north facing upward. You cannot change the orientation.

**NOTE:**

For information on the available voice commands, see Voice Command Index on page 163.

### Current Location

Whenever you are on a map screen, you can always obtain your current location either by pushing in on the **Interface Dial**, selecting **Current Location** from **Map Information**, or by using the voice control system and saying “Display current location.” A screen pops up which shows the address of your current location, as well as the latitude, longitude, and elevation.

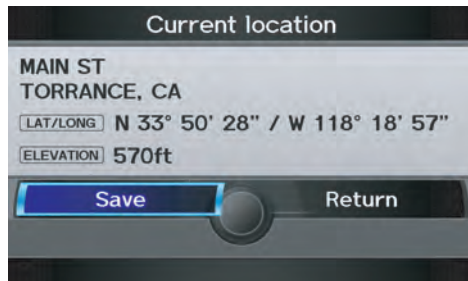

**NOTE:**

The elevation will not appear when the system is temporarily lacking proper GPS information. The system elevation may not agree with elevations shown on roadside elevation signs, and may fluctuate plus or minus 100 feet or more.

You can store the current location for later use. It does not change or cancel your current route.

For example, you are following the system's directions to get to a destination. While sitting at a stoplight you notice a store on the corner, but do not have time to visit it right now. You can save the location to select as a destination at a later date.

To save the location, say “Save current location” or select **Save** on the **Current location** screen. The **Edit address** screen with the current location data will appear. You can edit the name, phone number, or category name to be saved in your personal **Address Book**.

Select **Return** and you will be returned to the **Map information** screen. You can then use **Address Book** from the **MENU** screen (**Dest. MENU 1**) to select the saved location, and return to the same spot.

### Map Legend

You can use the **Map legend** screens to learn the meaning of map features, icons, colors, etc. used in this system.

When you select **Map Legend** on the **Map information** screen, the **Map legend** screen appears.

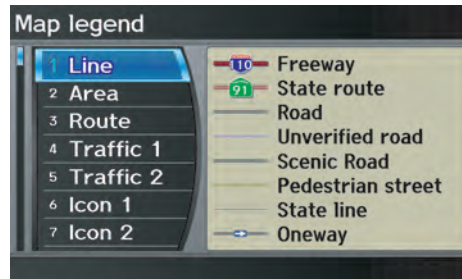

Say or select the desired item or item number to view each section of the map legend.

## Map Scale

Rotate the **Interface Dial knob** or a voice command such as “Display 1/2 mile scale” (see page 164) to change the scale of the map. Zooming in increases the detail, while zooming out gives you a view of a wider area. After changing the scale, give the system a few moments to update the display.

### Functions available at various map scales

Map Scale (English and Metric) For selecting units, see page 104.		1/20 mi.	1/8 mi.	1/4 mi.	1/2 mi.	1 mi.	2 mi.	5 mi.	15 mi.	50 mi.	150 mi.	350 mi.	1000 mi.
		80 m	200 m	400 m	800 m	1.6 km	3 km	8 km	24 km	80 km	240 km	560 km	1600 km
POI icon symbols (like ATM)	page 67	X	X										
Breadcrumbs (off-road tracking dots)	page 71	X	X	X	X								
Freeway exit information icons	page 67			X	X	X							
One-way traffic icon	page 67	X											
Unverified road display (purple)	page 6	X	X	X									
Map orientation “Heading-up”	page 63	X	X	X	X	X							
Map orientation “North-up”	page 63	X	X	X	X	X	X	X	X	X	X	X	X
Map features (park, golf course, etc.)	page 56	X	X	X	X	X	X	X	X	X	X	X	
Avoid area shown on map	page 110	X	X	X									
Avoid area scales (when creating)	page 110	X	X	X									
Waypoint “flag” icons	page 76	X	X	X	X	X	X	X	X	X	X	X	X
Traffic speed / incident	page 22	X	X	X	X	X	X	X					
Weather Information	page 68	X	X	X	X	X	X	X	X	X	X	X	X

### NOTE:

- You can change between miles or kilometers in **SETUP** (see Units on page 104).
- For information on the available voice commands, see Voice Command Index on page 163.

### Destination Icon

The destination icon only shows the approximate location of the destination. This occurs because a city block can have as many as 100 possible addresses (for example, the 1400 block is followed by the 1500 block.) Since most cities use only a portion of the 100 possible addresses (for example, in the 1400 block, the addresses may only go up to 1425 before the 1500 block starts). Therefore, the address 1425 will be shown a quarter of the way down the block by the system instead of near the end of the block where the destination is actually located.

#### Tip:

When en route, you can view a map showing your destination. Using voice control, say “Display destination map.”

### Various Other Icons

#### Landmark Icons

Landmark icons are shown in the map screen on 1/20 and 1/8 mile scales. The Freeway exit information is displayed on the 1/4, 1/2, and 1 mile scales. The icons are:

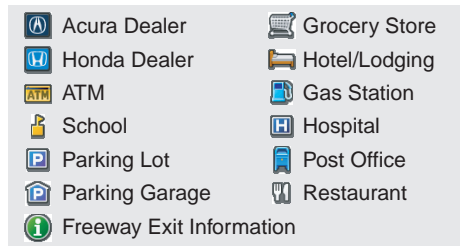

#### One-Way Traffic Icon

The one-way traffic icons (see *Map Screen Legend* on page 56) are only shown on the 1/20 mile scale.

Some icons can be turned on or off. To hide or display icons, use the **Interface Dial** to select **Map Information** from the Map menu, and select **Show Icon on Map** (see page 62). You can also hide or display icons by using voice commands (see page 164).

You can select most landmark, traffic, or weather icons with the **Interface Dial** to display the icon's information. See the table on page 69 for exceptions.

#### NOTE:

- The same icon list can be viewed on the screen by selecting **Map Legend** from the Map information screen in the Map menu.
- When there are overlapping landmark icons, a list of the points of interest (POIs) is displayed when selected.
- For information on the available voice commands, see Voice Command Index on page 163.

## Incident Icons

Incident icons are displayed on the 1/20 through 5 mile scales. The icons are:



## Weather Icons

Weather icons are displayed on all map scales. The icons are:

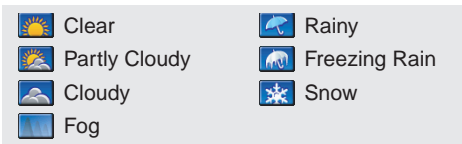

### Daytime mode



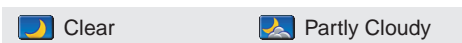

### Night mode



Icons with  indicate a possibility for lightning. For example:

-  Rain
-  Rain with lightning

Icons with  indicate a possibility for high wind. For example:

-  Rain
-  Rain with high wind

## NOTE:

*Weather icons are only visible if you have a current traffic/weather subscription with XM. See page [124](#).*



For some icons, you can choose to show or hide them on the map, while others like Acura Dealers are always shown. The table below shows the features for each icon type. Some Points of Interest (POIs) like Police Stations are not shown as an icon, but you can still locate the nearest one with the voice command, “Find nearest Police station.” See *Find Place Commands* on page 165.

### Landmark icon

POI type	Icon can be manually displayed	Icon can be manually hidden	Icon selection by voice	Icon can be selected as a destination on the map screen with the Interface Dial	POI can be found on the map screen using voice command “Find...”
Honda/Acura dealer	Yes, always	No	No	Yes	Yes
Hospital	Yes	Yes	Yes	Yes	Yes
School	Yes	Yes	Yes	Yes	Yes
ATM	Yes	Yes	Yes	Yes	Yes
Gas station*1	Yes	Yes	Yes	Yes	Yes
Restaurants*1*2	Yes	Yes	Yes	Yes	Yes
Post office	Yes	Yes	Yes	Yes	Yes
Grocery store*1	Yes	Yes	Yes	Yes	Yes
Hotel*1/ Lodging	Yes	Yes	Yes	Yes	Yes
Police station	No icon	No icon	No	No	Yes
Shopping, Tourist attraction, Bank	No icon	No icon	No	No	Yes
Parking garage	Yes	Yes	Yes	Yes	Yes
Parking lot	Yes	Yes	Yes	Yes	Yes
Freeway exit information	Yes	Yes	Yes	Yes (choose POI)	No
One-way traffic icon	Yes	Yes	Yes	No	No

\*1. When these types are selected for view on the map, some icons are shown as “brand icons.”

\*2. When selecting **Restaurant** on the Select category for icon settings screen (see *ICON OPTION* on page 62), specialty types of restaurants, like Chinese or Italian, can be individually displayed or hidden. See *Showing Icons on the Map* on page 62. Also see the *Voice Command Index* on page 164 for the “Display,” “Hide,” and “Find” commands.

## Incident icon

POI type	Icon can be manually displayed	Icon can be manually hidden	Icon selection by voice	Icon can be selected as a destination on the map screen with the Interface Dial	POI can be found on the map screen using voice command "Find..."
Traffic speed	Yes	Yes	Yes	No	No
Traffic incident	Yes	Yes	Yes	No	Yes *1

\*1. You can display the nearest traffic incidents by saying, "Display traffic incidents."

## Weather icon

POI type	Icon can be manually displayed	Icon can be manually hidden	Icon selection by voice	Icon can be selected as a destination on the map screen with the Interface Dial	POI can be found on the map screen using voice command "Find..."
Weather information	Yes	Yes	Yes	No	No

### Going Off the Route

If you leave the calculated route, “Recalculating...” is displayed at the top of the screen. The system will recalculate the route from your current location and direction to the desired destination then give you a new route instruction. This is done automatically if you have set **Rerouting to AUTOMATIC** on the **SETUP** screen (Other) (see page 105).

If the **Rerouting** option in **SETUP** is set to **MANUAL**, “Off route” appears at the top of the screen when you leave the calculated route. Say “Recalculate,” or select **Recalculation** whenever you want the system to perform a recalculation.



### Off-road Tracking

If you drive away from a mapped road, “Not on a digitized road” appears at the bottom of the screen.

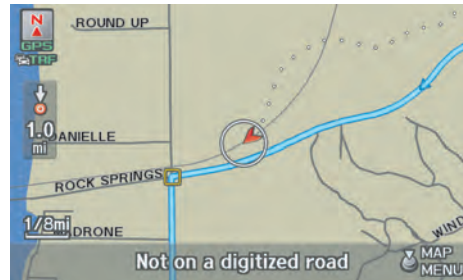

The map screen starts displaying a series of dots (breadcrumbs) to show the path you have taken if **Off-road Tracking** on the **SETUP** screen (Other) is set to **ON** (see page 115).

By following the dots, you can backtrack to the mapped road you originally left. “Breadcrumbs” may occasionally be displayed in urban areas, such as large parking lots in shopping malls, or in new subdivisions where the roads are not yet in the database. In other cases, you may see dots if the system temporarily goes off route, like in a parking garage where the GPS signal is unavailable. These dots appear only in the 1/20, 1/8, 1/4, and 1/2 mile map scales. Rotate the **Interface Dial knob** to change scales if necessary.

Off-road Tracking continues for approximately 150 miles; dots at the beginning of the trail will start disappearing when you exceed that distance. When you reach a mapped road, the system stops displaying dots.

## Pop-ups and Disclaimers

When you say “OK” in the Calculate route to screen, or if you change your route, the system checks your route and provides you with pop-up messages for the following situations:

- Your route takes you into an area that you previously set as an “Avoid Area” (see *Edit Avoid Area* on page 110).

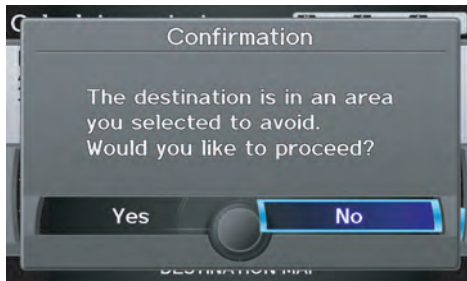

- Your route includes traffic restrictions in the vicinity of the departure point or destination.

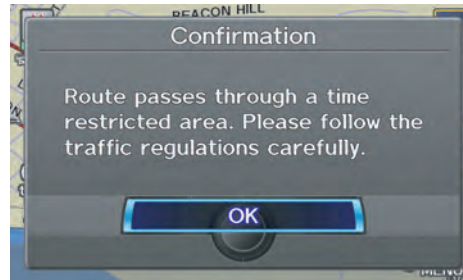

- Your route passes through unverified areas (see *Unverified Area Routing* on page 106).

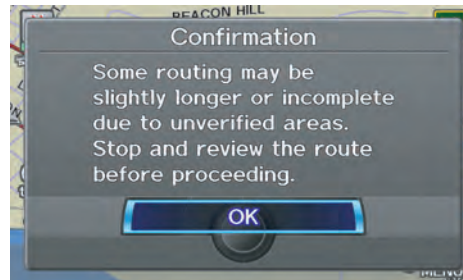

- Your route includes unverified areas (see *Unverified Area Routing* on page 106).

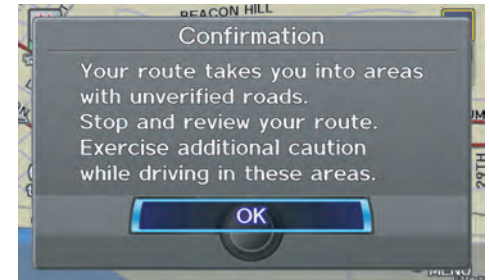

- You are about to enter an unverified area (see *Unverified Area Routing* on page 106).

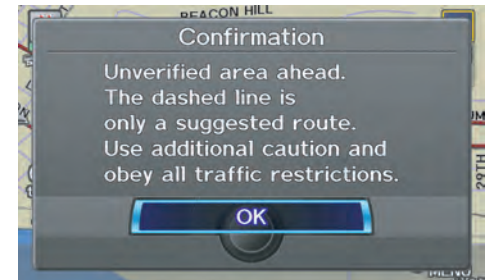

- You actually entered an unverified area (see *Unverified Area Routing* on page 106).



## Traffic Rerouting

When driving en route to your destination with **Traffic Rerouting** is **ON**, the system can find a faster route based on traffic flow information or detect a Road Closed incident and find a detour route. In either case, the system automatically recalculates and displays a pop-up box to signify that the route has changed.

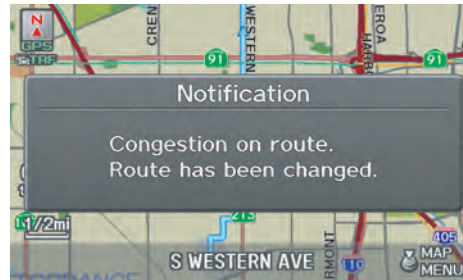

You can also calculate the detour route manually by choosing to avoid specific incidents and/or congestion on your route. Say "Display traffic incidents" or "Display traffic list," and select the "On Route" tab on the Traffic list screen.



Select an incident from the list, and push in on the **Interface Dial** twice. The system will display the confirmation screen:

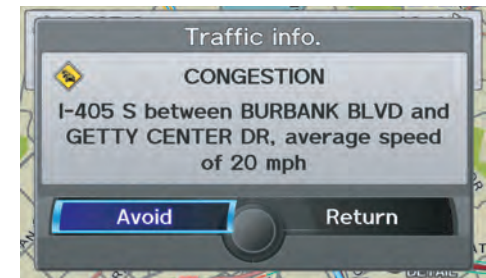

When you say or select **Return**, the display returns to the list screen. When you select **Avoid**, the system recalculates a detour route avoiding the road. You can choose to avoid up to 10 traffic incidents.

### NOTE:

- When you select the “All” tab, **Avoid** is not displayed.
- To activate this function, you need to set **Traffic Rerouting** to **ON** in the **Routing & Guidance** settings (see page 110).
- Because the criterion for whether the traffic event is to be detoured or not is included in the traffic event data itself, the traffic rerouting is not performed for all the traffic incidents ahead on the route.
- Even when the route recalculation is performed for a traffic event, if the system cannot find any detour route or a quicker detour route, the event location is not always avoided.
- Traffic rerouting is available only if you have a current traffic/weather subscription with XM. See page 124.

## Changing the Route

While en route, you may wish to alter your route, add an interim “Waypoint” (pit stop), choose a different destination, or cancel your current destination. To change your present route, you can do any of the following:

Say “Menu,” or press the **MENU** button to view the MENU screen (Route):

- Cancel Route (page 75)
- Detour (page 75)
- Avoid Streets (page 75)
- Change Route Preference (page 75)
- Waypoint (page 76)

Choose a different destination (other methods) by:

- Saying, “Find nearest...” to find a POI (page 78).
- Saying, “Go home” (page 78).
- Using the **Interface Dial** to select a different POI or address on the map (page 78).
- Pressing the **MENU** button and selecting the “Dest. MENU 1 or 2” tab on the MENU screen (page 79).



### MENU Screen (Route)

Pressing the **MENU** button displays the MENU screen (Route):



#### NOTE:

The “Route” tab can be selected only when you are en route.

### Cancel Route

Cancels the current route (and any waypoints) and returns you to the map screen.

### Detour

Calculates a detour route for you if you encounter an unexpected obstacle such as a closed road or extremely heavy traffic congestion. If a detour is selected, the system will attempt to recalculate a new route, avoiding the next 5 miles (while on a freeway) or 1 mile (while on a surface street).

### Avoid Streets

From the MENU screen (Route), if you say or select **Avoid Streets**, the system displays a list of streets that will get you to your destination. This feature allows you to avoid a street or streets along your route. This is helpful if you know of road construction, closures, or excessive traffic along the route.

Simply select the street or streets you wish to avoid. You can store up to 10 streets to be avoided. You cannot avoid your current street or the streets of your waypoint(s) or destination (system beeps if selected).

#### NOTE:

Although you can choose streets to avoid, you cannot choose specific streets you want to use.

### Change Route Preference

From the MENU screen (Route), if you say or select **Change Route Preference**, then the Route preference screen is displayed. See *Changing the Route Preference* on page 53 for details.



Intro

SEC

## Waypoint

Waypoints allow you to add an interim “pit stop” while traveling to a destination. For instance, you may want to stop for gas or food, and then continue on to your destination. Although you can enter up to five places including the destination at a time, typically you may never use more than one at a time.

Waypoints are routed in the order they were entered (number 1 first, etc.), with your final destination routed to last.

When you enter waypoints, they appear on the map screen as small red flags numbered 1-4.



## Adding Waypoint

From the MENU screen (Route), if you say or select **Waypoint**, the Add waypoint screen is displayed. Select either **SEARCH AROUND** or **SEARCH ALONG** by rotating Interface Dial knob.

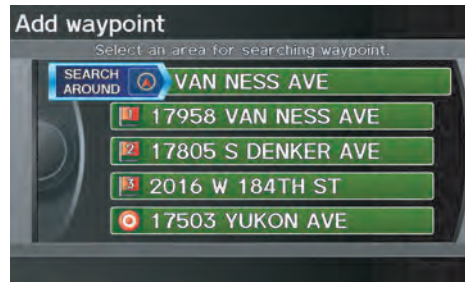

Next, select the category from the “Main” or “Fav. Subcategory” tab on the Category screen, then follow the menu prompts to select a destination.

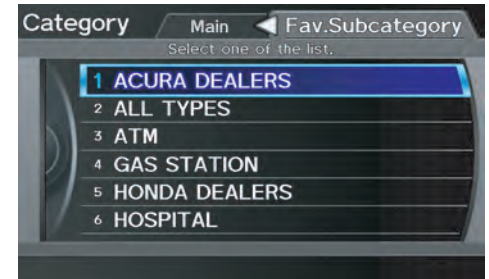

When the system performs a search from **SEARCH ALONG**, it displays matches that lie within a corridor on either side and in front of your route.

From **SEARCH AROUND**, the system displays matches that are a uniform distance from the departure point/waypoint/destination.

The search “corridor” distance value can be changed in **Edit Waypoint Search Area** in SETUP (see page 112).

i

Home

If you add a waypoint, the Add to dest. list screen will be displayed. If you push in on the **Interface Dial** and select **OK**, the addition is completed and rerouting begins. Press the **MAP/GUIDE** button to return to the map screen without adding the waypoint.

To add another waypoint, press the **MENU** button and repeat the procedure.

To delete waypoints or edit the order of waypoints, select **Edit** on the Dest. list screen. See *Editing Destination Lists* on this page.

### NOTE:

- The maximum of five places (including the destination) can be entered.
- The system does not allow you to select the roads you want to use to get to a destination. However, after you enter a destination, you can select intersections or POI waypoints that the system will use to tailor your route.

### Destination List

If you select **Destination List** from the MENU screen (Route), you can store four waypoints and one destination simultaneously. If you cancel the route, everything will be deleted.

### Verifying Destination List

If you select **Destination List** from the MENU screen (Route), the display will change to the Dest. list screen.



If you move the **Interface Dial** to the left to select **Map**, you will be able to see all the destinations on the map.

### NOTE:

Prior to departure, you can set areas to avoid. The system then includes them in its calculations for the destination you have entered. See *Edit Avoid Area* on page 110.

### Editing Destination Lists

If you move the **Interface Dial** to the right to select **Edit** on the Dest. list screen, the Select an edit menu screen will appear. If you select **Delete**, you can select which items to delete. If you select **Edit Order**, you can change the order of items in the list.

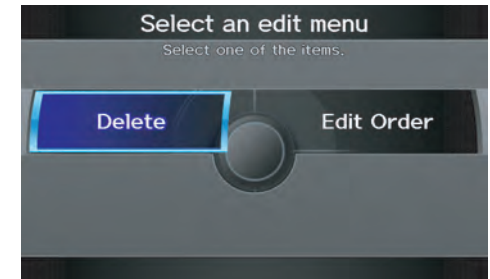

## Changing Your Destination

There are four methods by which you can change or add a waypoint to your route. These are:

### *Find Nearest (Voice command)*

From the map screen, say one of the “Find Nearest...” voice commands to locate the nearest gas station, ATM, restaurant or other point of interest. See the “Find Nearest” voice commands listing on page 165.

### *Go Home (Voice command)*

From the map screen, say “Go Home 1” or “Go Home 2.” If an address has been entered in both **Home Address 1** and **Home Address 2**, say “Go Home” and the system will give preference to **Home Address 1** and display the confirmation screen.

## *Using Interface Dial to Change Destination*

While following a calculated route, you can select a new destination with the map screen and the **Interface Dial**.

With the map screen displayed, use the **Interface Dial** to move the cursor. It will change to crosshairs.

Use the **Interface Dial** to position the crosshairs on your desired new destination, street, or icon, then push in on the **Interface Dial**. The **Select an item** screen or a pop-up menu may be displayed if there are multiple POIs in the vicinity.

### **NOTE:**

*The Select an item screen will be displayed when the crosshairs are positioned near multiple icons or locations. A pop-up menu will be displayed when the crosshairs are positioned on a particular street.*

If this is not your desired new destination, press the **CANCEL** button or the **BACK** button on the steering wheel to return to the map screen. Reposition the crosshairs with the **Interface Dial**, then push in on the **Interface Dial** again to see the new address.

When the **Select an item** screen is displayed, select an item from the list, and the **Calculate route to** screen is displayed. Then select **OK** and push in on the **Interface Dial**.

When the pop-up menu is displayed, select **Set as New Destination** to set your location as a replacement destination, or **Add to Dest. List** to set as a waypoint.

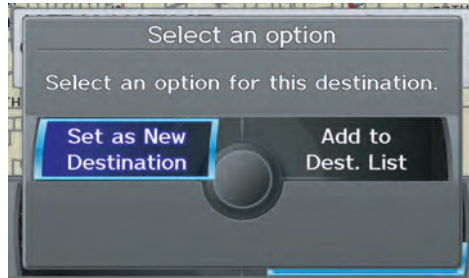

The system will return to the map screen and recalculate the route to your new destination or waypoint.

### **Entering a Destination from the Menu Screen (while en route)**

If you say “Menu”, or press the **MENU** button and select the “Dest. MENU 1” or “Dest. MENU 2” tab, the system displays the MENU screen. Follow the procedure described in Entering a Destination, which begins on page 28.

When the Calculate route to screen is displayed, select **OK** and push in on the **Interface Dial**.

When the pop-up menu is displayed, select **Set as New Destination** to set your location as a replacement destination, or **Add to Dest. List** to set as a waypoint.

The system will return to the map screen and recalculate the route to your specified new destination or waypoint.

### **Continue Trip to Screen**

If you restart the vehicle without having completed your prior trip, you will see the following screen:

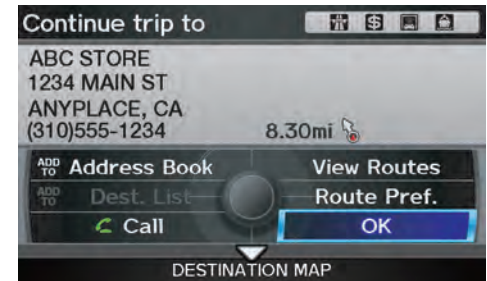

- To continue to your destination or other waypoints, say or select **OK**.
- To cancel your destination, press the **CANCEL** button or the **BACK** button on the steering wheel, or using the voice control system, say “Cancel” or “Back.”
- If you wish to change the routing method, select **Route Pref.** by using the **Interface Dial**.
- For additional information on changing the route preference, see *Changing the Route Preference* on page 53.



## AcuraLink Messages

AcuraLink enhances your ownership experience by providing a direct communication link between you and Acura. AcuraLink messages are displayed on the navigation screen. Working through XM® Satellite Radio, AcuraLink works in conjunction with your vehicle's navigation, *Bluetooth®* HandsFreeLink®, and audio systems to send and receive several kinds of message. These include:

- Operating tips and information on your vehicle's features.
- Important recall and safety information.
- Maintenance information to keep your vehicle in top condition.
- Diagnostic information to provide information about any problems with your vehicle.
- Planned appointments with your Acura dealer.

### NOTE:

*See your Owner's Manual for more details on this feature.*

When service information is received from your vehicle or AcuraLink, an envelope icon is displayed in the bottom left corner of the navigation screen.

To view messages, press the **INFO/PHONE** button and Say or select **Messages**. You can also push in on the **Interface Dial** on the map screen to get to the Map menu, and select **New Messages**.

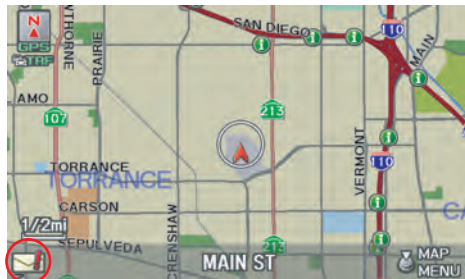

The **Interface Dial** controls most AcuraLink functions. For more information on AcuraLink, refer to:

- The Advanced Technology Guide for features and a function overview.
- Your Owner's Manual for a detailed explanation of the system.



The INFO function consists of two main screens. To display the INFO screen (Main Info.), say “Information” or press the **INFO/PHONE** button. To change it to the INFO screen (Other), select the “Other” tab. You can switch screens by selecting the tab.

You can use the voice control system to select any item on the INFO screen.

**NOTE:**

For information on the available voice commands, see Voice Command Index on page 163.

### INFO Screen (Main Info.)

When you say “Information” or press the **INFO/PHONE** button, the display changes to:



Move the **Interface Dial** to the left and right to display **Main Info.** or **Other**.

**NOTE:**

For more information on the INFO screen (Other), see page 88.

### Cellular Phone

The **Cellular Phone** option (available on some phones) allows you to import up to 1,000 entries to the phonebook of *Bluetooth® HandsFreeLink®* from your cellular phonebook.

Up to six phones can have their phonebooks imported. With HFL, you can then automatically dial any name or number in the phonebook.

Say or select **Cellular Phone** from the INFO screen (Main Info.), and the display changes to:



**NOTE:**

- For more information on this feature, see your Owner’s Manual.

- For questions about the HFL Cellular Phonebook, call HandsFreeLink customer support at (888) 528-7876, or (888) 9-ACURA-9 in Canada, or visit [www.acura.com/handsfreelink](http://www.acura.com/handsfreelink).

## Traffic Incidents

When you say or select **Traffic Incidents**, you can view a list of the traffic incidents near your current position or along your calculated route. See *Viewing Incident Reports* on page 25 and *Traffic Rerouting* on page 73.

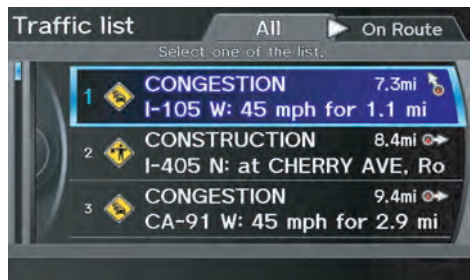

**NOTE:**  
To receive traffic information, your XM traffic/weather subscription must be paid. See page 124 for details.

If you select an incident from the list and push in on the **Interface Dial**, the detailed information and the map of the surrounding area will appear.

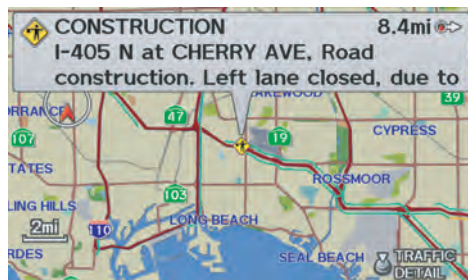

**NOTE:**  
When you cannot receive **Traffic Incidents** information and select this feature, the message “Traffic information could not be received” will be displayed. The traffic information will be automatically updated every 20 minutes. For an explanation regarding the verification of reception status, please see *Traffic & Weather Status* on page 124.

## AcuraLink Weather

The **Weather Info.** option allows you to view the weather forecast, warning list, warning map, and radar map.

When you say or select **Weather Info.** on the Map menu or INFO screen, the following screen appears:

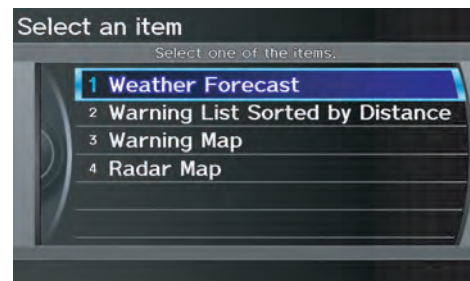

**NOTE:**

- You can view the same screen by selecting **Weather Info.** from the Map menu (see page 58).
- To receive weather information, your XM traffic/weather subscription must be paid. See page 124 for details.

- When you cannot receive **Weather Info.** and select this feature, the message “Weather information could not be received” will be displayed. The weather information will be automatically updated every 20 minutes. For information regarding the verification of reception status, please see *Traffic & Weather Status* on page 124.

### Weather Forecast

You can view the weather forecast for the current position or the city you selected. Say or select **Weather Forecast**, and the display changes to:



When you select **Current Position**, the Forecast screen will be displayed.

When you select **City Vicinity**, the Enter city name screen will be displayed. Enter the name of the city using the **Interface Dial**. If the system does not find an exact match, select **LIST** when you finish entering the name of the city. Select a desired city from the list. The Forecast screen will be displayed.



When you select the “1 day” tab, you can view the one-day forecast and get information about the current weather, forecast, and temperature. When you select the “3 day” tab, you can view the three-day forecast (day/night).

### NOTE:

- When the GPS signal or weather information cannot be received, “NA” or “No Data” will be displayed.
- You can view the same information by selecting the weather icon for a city on the map screen.

### Warning List

You can view a list of all weather warnings in the United States. Say or select **Warning List Sorted by Distance**, and the display changes to:



Intro  
SEC

You can view three types of lists by selecting a sorting method from “All US,” “Within 500mi,” or “On Route.” A warning icon in the list indicates that your vehicle is in the warning area, or the calculated route runs through the area. When you select a listed item by pushing in on the **Interface Dial**, the detailed information will be displayed.



Say “Read List” or push in on the **Interface Dial**, and the information will be read to you.

**NOTE:**

The “On Route” tab can be selected only when en route.

## Warning Map

You can view the warning map, which contains different colors according to the type of warning. Say or select **Warning Map**, and the display changes to:

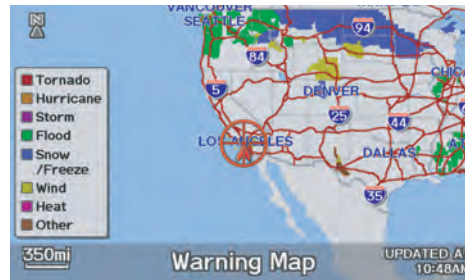

Select the colored area by moving the **Interface Dial**. If desired, rotate the **Interface Dial knob** to change the map scale (50, 150, or 350 miles). When you have the crosshairs in the desired area, push in on the **Interface Dial**. The Weather Warning screen will be displayed.

## Radar Map

To view a radar map displaying rain or other weather systems, say or select **Radar Map**. The display changes to:

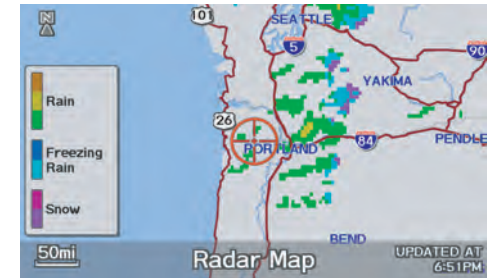

- Heavy rain
- Moderate rain
- Light rain
- Heavy freezing rain
- Light freezing rain
- Heavy snow
- Light snow

Move the **Interface Dial** to scroll the map. To change the scale (50, 150, or 350 miles), turn the **Interface Dial knob**.

Home



### NOTE:

- Moving the cursor does not display the detailed information.
- Changes to the scale of the Radar Map are not reflected on the original map screen.

## Weather Information on Map

### Weather Icons

Weather icons can be displayed on the map screen when turned on (see page 68). They appear next to the city names on all map scales.

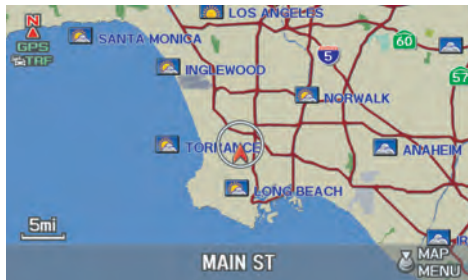

When you scroll through the map using the **Interface Dial**, the weather icon is displayed at the top right of the screen. This shows you the weather at the cursor position.

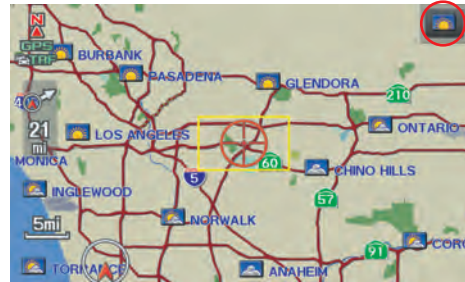

When you select the weather icon next to a city name and push in the **Interface Dial**, the Forecast screen will be displayed. To return to the map screen, press the **CANCEL** button.

### Warning Icon

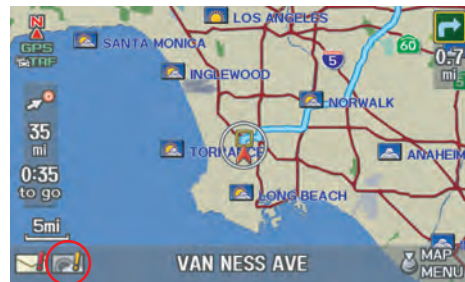

The warning icon indicates that a weather warning area exists near your current location or along your calculated

route. To check the weather warnings, see *Warning List* on page 83.

## Weather Information for Destination

When you select a destination, weather icons for the destination will display on the right side of the screen.



You can also view the weather information for your destination when you select the destination directly from the map screen (use the **Interface Dial** to position the target mark on your desired destination, and then push in on the **Interface Dial**).

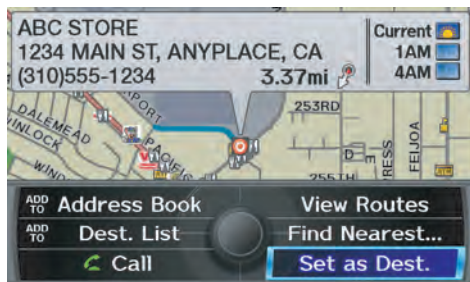

### NOTE:

When the GPS signal or weather information cannot be received, “NA” will be displayed.

When the system calculates a route and there is a warning on the route, the following screen will be displayed:

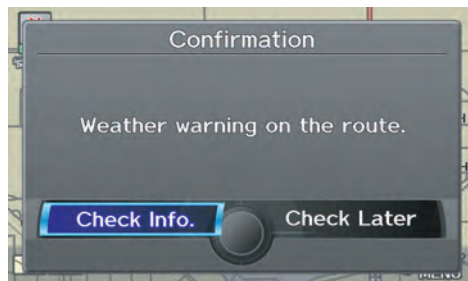

Select **Check Info.**, and the warning list will be displayed (see page 83).

## Messages

See *AcuraLink Messages* on page 80.

## Voice Help

When you say or select **Voice Help** on the INFO screen (Main Info.), you will see the following screen:

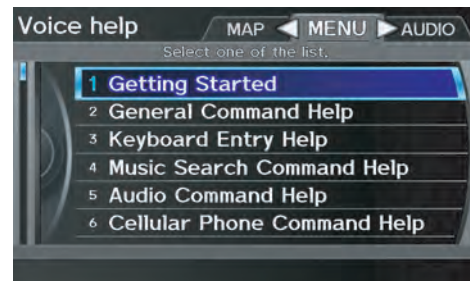

You can select the “MAP,” “MENU,” or “AUDIO” tab by moving the **Interface Dial** to the left or right.

### NOTE:

You can select an item by saying either the line number or the item name.



There is a tutorial available for the voice command help. Say or select **Getting started**, and the display changes to:

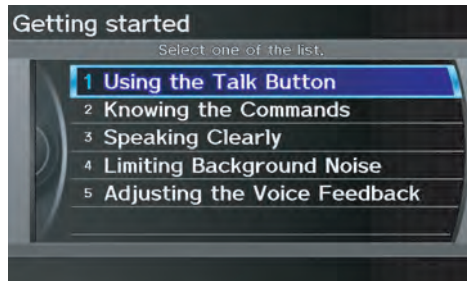

Select the line number of the desired tutorial you want to view, and the tutorial will automatically be read. To stop the reading, push in on the **Interface Dial**. To resume the reading, push in on the **Interface Dial** again.

When you make a command help selection under any of the help screens, you will see the help commands that can be used with voice control. You can say “Read List” or push in on the **Interface Dial** to select **Using the talk button**, and the system will read the list to you.

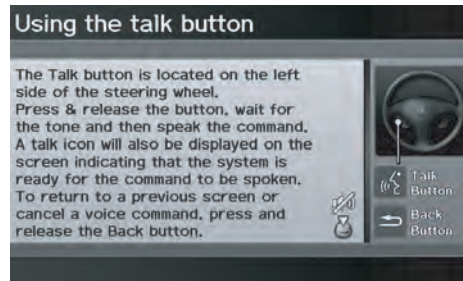

For a listing of all voice commands, see *Voice Command Index* on page 163.

### Setup

When you select **Setup**, you will see the following screen:



For detailed information on the **SETUP** screen, see *System Setup* on page 94.

## INFO Screen (Other)

Select the “Other” tab to view additional information, and the following screen appears:

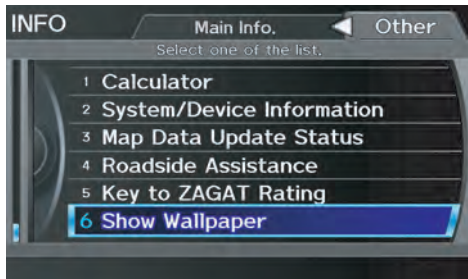
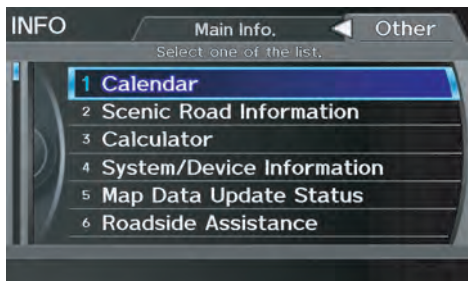

**NOTE:**

**Map Data Update Status** can be selected only during the update of map data.

## Calendar

The Calendar option allows you to enter events and be reminded of them in the future. When you say or select **Calendar** from the INFO screen (Other), the system shows the calendar with the current calendar day highlighted.

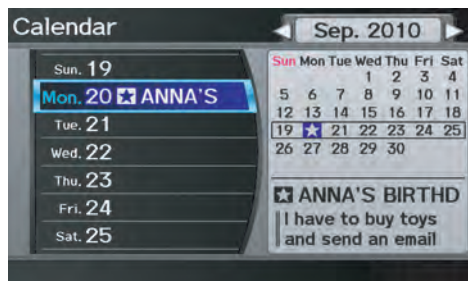

Dates with an icon indicate there is a scheduled entry for that date.

**NOTE:**

*Entries may be stored in the calendar for 10 years.*

You can scroll through the calendar day by day by rotating the **Interface Dial knob**, or select the day by voice. When you move the **Interface Dial** up or down, you can also scroll through the calendar week by week. To change the month, say “Next month” or “Previous month,” or move the **Interface Dial** right or left.

### Entering Your Schedule

Set your schedule by selecting the day on the calendar, and the display changes to:

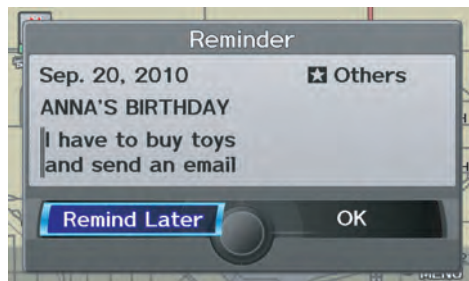
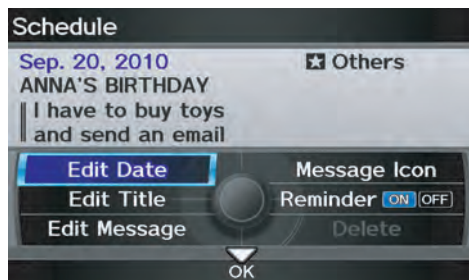

### Reminder

The default for Reminder is **ON**. This allows the system to remind you of the calendar item the next time you start the vehicle. See *System Start-up* on page 18.

### Edit Date

This allows you to move your calendar entry to a different date. If you say or select **Edit Date**, the Edit date screen is displayed with existing entries grayed out. When you select a new date, the display will return to the Schedule screen.

### Edit Title

Say or select **Edit Title**, then enter the name of your title using the **Interface Dial**. Once you have entered the title, say or select **OK**. The title will be displayed on the specified date on the Calendar screen and the display will return to the Schedule screen.

### Edit Message

Say or select **Edit Message**, and the system will show the Edit message screen. You can enter a message on two lines. Use **↵** to change the line.

Once you have entered the message, say or select **OK**. The message will be displayed on the specified date on the Calendar screen and the display will return to the Schedule screen.

### Message Icon

Say or select **Message Icon**, and the system displays a list of icons you can select to help identify the type of message you entered. The message icon you choose will be displayed alongside the specified date on the Calendar screen.

### Delete

Say or select **Delete** to display the confirmation screen. If you select **Yes**, the entry that is displayed will be deleted.

**NOTE:**

- Only one entry can be stored for each calendar day.
- A maximum of 50 entries can be stored in the calendar. After you reach 50 entries, a warning message will appear telling you that the limit has been reached. You can clear any older entries as needed.
- The system displays active calendar entries only after you answer **OK** on the Disclaimer screen.
- For more information, see System Start-up on page 18.

## Scenic Road Information

Say or select **Scenic Road Information** while on the INFO screen (Other), and the display will change as indicated below.

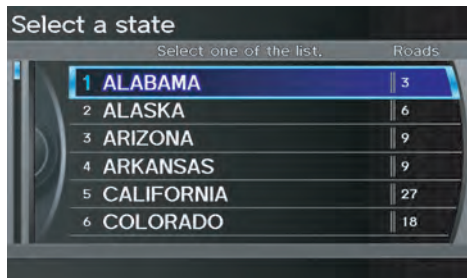

The number of scenic roads for each state will be listed.

Select a state and a list of the scenic roads in that state will be displayed. After making a selection, the scenic road will display on the screen at a scale, where its main portion is the focal point of the map. You can then set this as a destination or waypoint.

If you select a scenic road that runs through multiple states, only the portion of the road in the selected state will be displayed.

## Calculator

When you say or select **Calculator** on the INFO screen (Other), the display changes to:

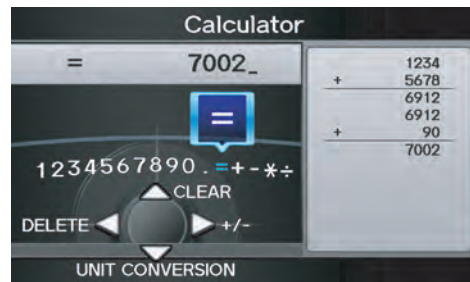

Use the **Interface Dial** and **Knob** to use the following features:

### Calculator

The calculator function operates like a standard handheld calculator.

### Unit Conversion

Values entered on the calculator can be converted from one unit to another (e.g., inches to millimeters).

To perform a conversion:

1. Enter a numeric value to be converted (for example, 1000).
2. Move the **Interface Dial** down to select **UNIT CONVERSION**. The screen changes to:

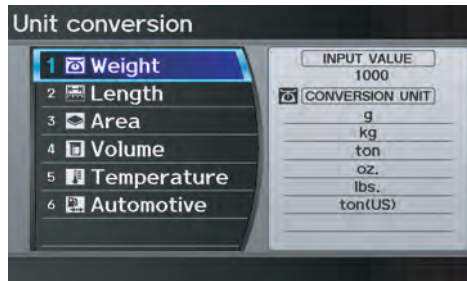

3. Rotate the **Interface Dial knob** to select the type of unit you want to convert (for example, Length) and push in on the **Interface Dial** to select. The screen for that conversion type appears (see illustration in step 4).

4. Select the base unit (e.g., mm) that you wish to convert to some other unit. All other units will change automatically depending on the base unit value. In the example below, 1000 mm converts to 100 cm, 1 m, etc.

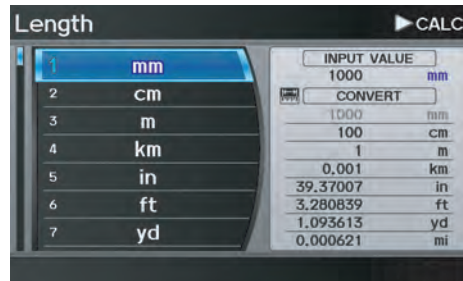

### NOTE:

- *If you do not enter a value to be converted, only “Temperature” units are selectable.*
- *Conversions using negative values may produce meaningless or physically impossible values.*
- *To return the Calculator screen, select **CALC.** by moving the **Interface Dial** to the right.*

### System/Device Information

Say or select **System/Device Information** while on the INFO screen (Other), and the display will change as indicated below.



You will need this information when ordering an update. See page 133 for more information.



## Map Data Update Status

During data updates, you can check the update status for map data.

During the update of map data, say or select **Map Data Update Status** while on the INFO screen (Other), and the display will change as indicated below.

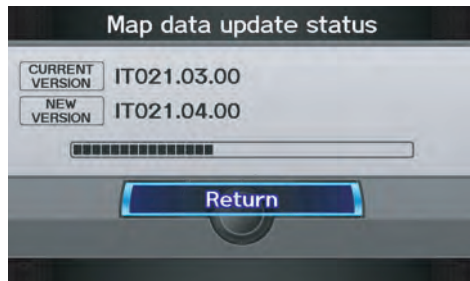

**NOTE:**

*This operation can only be carried out during a disc update.*

## Roadside Assistance

Acura Roadside Assistance is provided as a service to Acura clients. When paired with a Bluetooth-enabled cell phone, the system can call for assistance as long as the setting is switched **ON**.

Say or select **Roadside Assistance** while on the INFO screen (Other), and the display will change as indicated below.



When you select the country, the phone number for Roadside Assistance and vehicle position information will be displayed.

Say “Call” or select **Call** with the **Interface Dial**, and then select **Yes** from the confirmation screen.

## Key to ZAGAT Ratings

By saying or selecting **Key to ZAGAT Ratings** on the INFO screen (Other), you can see the explanation of the data displayed for the Zagat-surveyed restaurants.

- “Food,” “Decor,” and “Service” categories are rated using numbered values (e.g., 0-9, 10-15, etc.)
- “Cost” is the average cost of a meal (including drink and tip). If unavailable then estimated cost symbols are shown:
  - “VE”: Very Expensive
  - “E”: Expensive
  - “M”: Moderate
  - “T”: Inexpensive
- The symbols, if displayed, indicate the following information:
  - S** open on Sunday
  - M** open on Monday
  - L** open for lunch
  - ☉** serving after 11 PM
  - ✂** no credit card accepted



Use the **Interface Dial** to scroll through the Key to ZAGAT ratings screens.

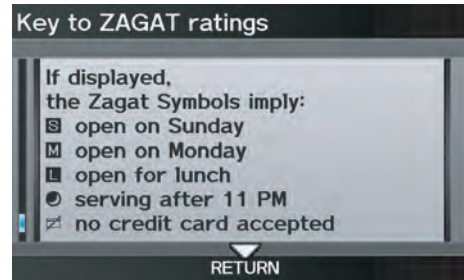
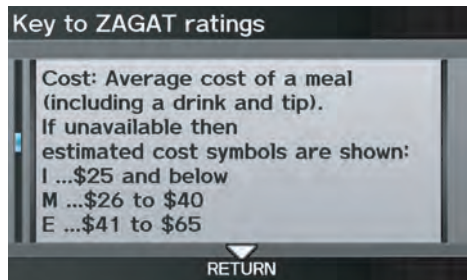

### Show Wallpaper

If you say or select **Show Wallpaper** from the INFO screen (Other), the wallpaper that is currently selected will be displayed on the screen. If you push in on the **Interface Dial**, the original screen will return. For instructions on changing wallpapers, see page [121](#).

## SETUP Mode

The SETUP function consists of two main screens that allow you to change and update information in the system.

### NOTE:

For information on the available voice commands, see page 173.

## SETUP Screen (Main Setup)

Select **Setup** from the INFO screen (Main info.), and the following screen will display.



### Brightness

The screen brightness has 11 settings. To change the brightness, use the voice control system and say “Brightness up” or “Brightness down.” You can also select **Brightness** and change the setting by rotating the **Interface Dial knob**.

### Tip:

If you are having trouble viewing the screen in bright lighting conditions, try increasing the brightness.

### Contrast

The screen contrast has 11 settings. To adjust the contrast, use the voice control system and say “Contrast up” or “Contrast down.” You can also select **Contrast** and change the setting by rotating the **Interface Dial knob**.

### Black Level

The screen black level has 11 settings. To change the black level, use the voice control system and say “Black level up” or “Black level down.” You can also select **Black Level** and change the setting by rotating the **Interface Dial knob**.

### NOTE:

You can have separate daytime and nighttime settings for **Brightness**, **Contrast**, and **Black Level**. Adjust each setting when the display is in either daytime or nighttime mode. Use the **Display Mode** button (page 11 and 118) to select Daytime or Nighttime mode.

### Volume

The navigation voice volume has 11 settings and can be adjusted by:

- Using the voice control system and saying “Volume up” or “Volume down”.
- Selecting **Volume** and changing the setting by rotating the **Interface Dial knob**.
- Saying “Volume Off,” or selecting **Volume** and then **OFF**.

#### NOTE:

*If you turn the volume off, you will not hear route guidance or voice command confirmations.*

If you then select **Voice** in the Map menu, you will hear route guidance at the default volume.

### Interface Dial Feedback

This setting allows you to control when (and if) the system will read the current selection you choose with the **Interface Dial**. The purpose of this feature is to minimize the need to look at the screen while operating the dial. You can set the one of the three settings explained in the following table. The factory default is **AUTO**.

Setting	Degree of assistance
<b>ON</b>	When selection is made, the system always reads what is selected.
<b>AUTO</b> (factory default)	The system reads selection only when moving
<b>OFF</b>	No voice assistance when selecting.

### Personal Information

From the SETUP screen (Main Setup), say or select **Personal Information** and the following screen appears:

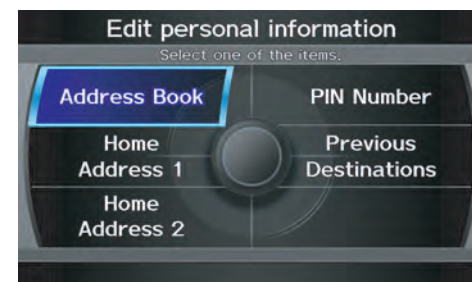

#### Address Book

The Address Book allows up to a total of 200 address entries. After 200 entries, no more entries can be added. The 200 addresses are shared between DRIVER 1 and DRIVER 2. For example, if DRIVER 1 has 150 addresses, DRIVER 2 can only have 50. You can add, modify, and delete information in the personal Address Book list.

You may choose to use a Personal Identification Number (PIN) to protect your privacy. However, PINs are optional, and if you decide to use one, record it in case you forget the number (see page 100).

**NOTE:**

*If you forget your PIN, your dealer will have to reset it for you, and all of your stored information will be cleared.*

You can do the following functions in the address book:

- Enter an address (see this page)
- Edit an existing address (see page 97)
- Delete an existing address (see page 99)

## Accessing the Address Book List

After selecting the **Address Book**, move the **Interface Dial** down while on the **Select an address** screen to change to **DRIVER 1** or **DRIVER 2**.

If an Address Book PIN has been set, the system prompts you to enter your PIN. Verify that the correct user is displayed, then enter your PIN. After entering your PIN correctly by voice or by using the **Interface Dial**, the system displays your Address Book.

If no Address Book PIN has been set, the system displays your Address Book.

**NOTE:**

*Personal information cannot be backed up or moved to another navigation system.*

## Entering an Address

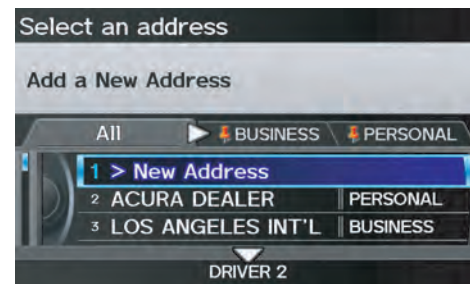

Select **New Address** by pushing in on the **Interface Dial** when beginning to build your Address Book list.

If you move the **Interface Dial** down, you can change to **DRIVER 1** or **DRIVER 2**.

### Edit Name

You may use the “Name” field to give the entry a name or title that you will recognize later, such as “Doctor Smith” or “Broadway Theatre.” If you do not give the address a name, the system will assign one (Address 001, etc.).

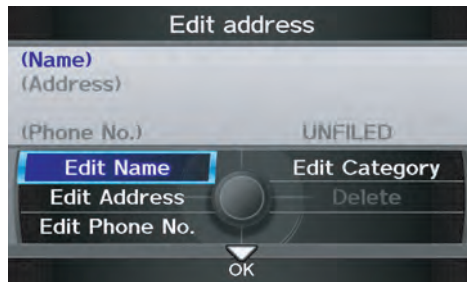

Say or select **Edit Name**. Then use the **Interface Dial** to enter the name. Select **OK** when finished.

#### NOTE:

*You can always re-enter, edit, or make changes to any entry. “Address” is the only required field.*

### Edit Address

When you say or select **Edit Address**, the display changes to:

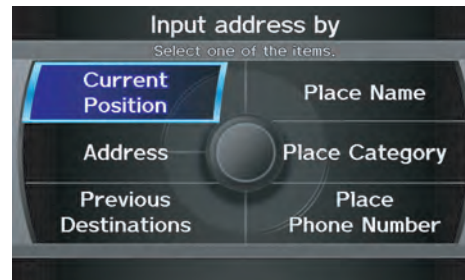

**Current Position** - Allows you to use your current position as the address.

**Address** - Requires you to enter the city and address you wish to store. The operation is the same as selecting **Address** from the MENU screen (Dest. MENU 1). See page 29.

**Previous Destinations** - Allows you to choose one of the locations in the Previous Destination list for your Address Book list. This operation is the same as selecting **Previous Destinations** from the MENU screen (Dest. MENU 1). See page 35.

**Place Name** - Allows you to select one of the Point of Interest (POI) locations already stored in the system as one of your personal addresses. This is the same as selecting **Place Name** from the MENU screen (Dest. MENU 1). See page 36.

**Place Category** - Allows you to select a point of interest (POI) that has been saved in the system as one individual address. This is the same as selecting **Place Category** from the MENU screen (Dest. MENU 1). See page 37.

**Place Phone Number** - This feature is very convenient when you know the phone number of a place or business that you want to save. This is the same as selecting **Place Phone No.** from the MENU screen (Dest. MENU 1). See page 43.

After you have used one of these six options to enter the address, the initial screen for entering the personal address is redisplayed, with the address shown in the “Address” field. If you have entered the address using **Place Name**, **Place Category**, or **Place Phone Number**, the phone number corresponding to the address also appears in the “Phone No.” field.

### Edit Phone Number

You can enter the phone number of the address. If the address was chosen with **Place Name**, **Place Category**, or **Place Phone Number**, and it has a phone number, that number is entered automatically.

Say or select **Edit Phone No.** to display the Enter phone number screen. Enter the phone number, including the area code, by using the voice control system (say the entire phone number one digit at a time) or by using the **Interface Dial**. Say or select **OK** when finished.

### Edit Category

If desired, you can specify the category of the address or the icon. Say or select **Edit Category** to display the Select a category screen.



Scroll the screen and select a category by saying the number next to your choice, or by pushing in on the **Interface Dial**.

To add a new category, select **New Category** from the list. To edit or delete a category, select **Edit** by moving the **Interface Dial** to the right. The system will display the Select an edit menu screen. Follow the on-screen prompts to edit, or delete a category. If you delete a category that was used to categorize addresses, the category for those addresses becomes “UNFILED.”

### NOTE:

*You can have 100 categories (including UNFILED). These are shared between DRIVER 1 and DRIVER 2.*



The system will then display everything that you have entered. If all the information is correct, say or select **OK**. This will return you to the Address Book list.

If you want to enter another address, select **New Address** in the list, then repeat the procedures above. If not, press the **CANCEL** button.

### Delete an Address

This feature allows you to select an address to delete. Once an address is selected, say “Delete” or push in on the **Interface Dial** to select **Delete**.



### Home Address

This feature lets you return “Home” from any location simply by saying “Go home 1” or “Go home 2” at the map screen.

Alternatively, you can select **Go home 1** or **Go home 2** on the MENU screen (Dest. MENU 1 or 2). See *By Go Home 1 or 2* on page 51.

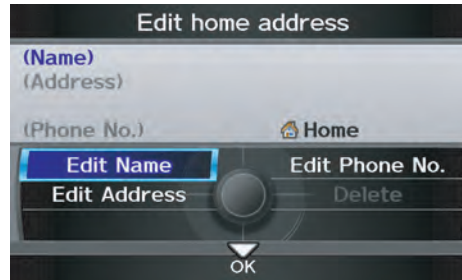

Select **Home Address 1** or **Home Address 2**.

Enter the name, address, and phone number in the same way as entering a personal address, then say or select **OK**. To leave the screen, press the **CANCEL** button.

### NOTE:

- If your Home Address cannot be found in the system, then while located on the street close to your home, select **Current Position** when entering the “Address” field.
- The home icon is shown on the map screen in the 1/20 and 1/8 mile scales.

## PIN Number

You can set a four-digit PIN (Personal Identification Number) for accessing and changing personal addresses and your home address if desired. Once you set the PIN on this screen, the system asks you to enter the PIN when you access a personal address or your home address.

### NOTE:

*PINs are optional. If you choose to use a PIN, make sure you remember it. If you forget your PIN, the dealer will have to reset it for you, and all of your stored information will be cleared.*

When you select **PIN Number**, the display changes to:

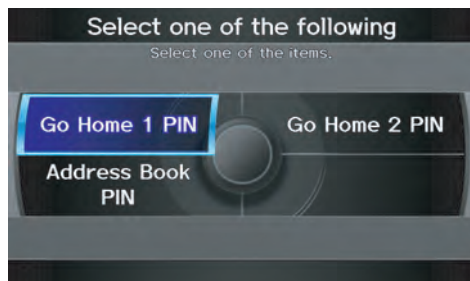

## Address Book PIN

If you choose to enter a PIN for the personal Address Book, you will have to enter it when you edit your Address Book (see page 95) or select **Address Book** on the MENU screen (Dest. MENU 1) (see page 34).

1. Select **Address Book PIN**.
2. The display changes to:



3. Enter your new four-digit PIN. If you do not wish to use a PIN, select **DO NOT USE PIN**.

### NOTE:

*The factory default is no PIN.*

4. When you have entered your PIN, the display changes to the **Re-enter new PIN** screen. Enter the same number to validate the number you have selected.
5. If you have entered the same number both times, the display returns to the **Select one of the following** screen. If not, "INCORRECT PIN" appears. Enter your PIN again.

### NOTE:

- *Once you enter your PIN to access your Address Book or select **Address Book** on the MENU screen (Dest. MENU 1), you will not need to enter your PIN until the ignition key is cycled again.*
- *If you wish to remove your PIN, return to the same screen and, after entering your PIN correctly, select **DO NOT USE PIN**.*
- *PINs are optional. If you choose to use a PIN, make sure you remember it. If you forget your PIN, your dealer will have to reset it for you.*

### Go home 1 or 2 PIN

1. Select **Go home 1 PIN** or **Go home 2 PIN**, and the system displays the Enter your new PIN screen.
2. Enter your PIN in the same way as entering the Address Book PIN.

#### NOTE:

- The factory default is no PIN. If you choose to use a PIN, you will have to enter it whenever you say “Go home 1” or “Go home 2” at the map screen or select **Go home 1** or **Go home 2** on the MENU screen (Dest. MENU 1 or 2).
- PINs are optional. If you choose to use a PIN, make sure you remember it. If you forget your PIN, your dealer will have to reset it for you, and all stored information will be cleared.

### Previous Destinations

Allows you to delete some or all of your previous destinations.

1. Select this option, and the display changes to:

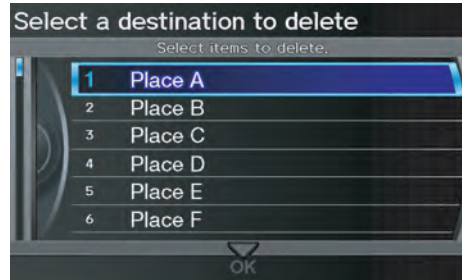

2. Scroll through the list and find the address you want to delete.
3. Select the address to delete by saying the line number, or by using the **Interface Dial**.

#### NOTE:

To cancel the deletion of Previous Destinations, select the address that was to have been deleted and push in on the **Interface Dial** before performing step 4.

4. Say or select **OK** to perform the deletion, and the display returns to the previous screen.

## SETUP Screen (Other)

Select the “Other” tab by moving the **Interface Dial** to the right to view additional SETUP functions and the following screen appears:

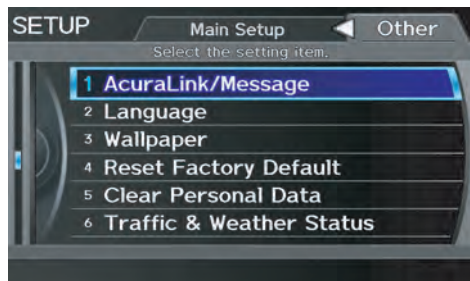

## Music Search

From the SETUP screen (Other), say or select **Music Search** and the Music search setup screen appears.

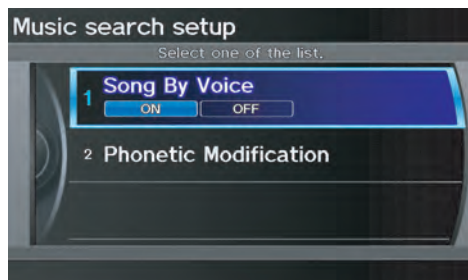

### Song By Voice™ (SBV)

Song By Voice™ allows you to search for and play music from your HDD or iPod device using voice commands.

To activate this mode, press the **TALK** button on the steering wheel and say “Hard Disc Drive Search” or “iPod Search” depending on the media that you would like to access. From this mode, you can use the following voice commands to select songs or display a song list.

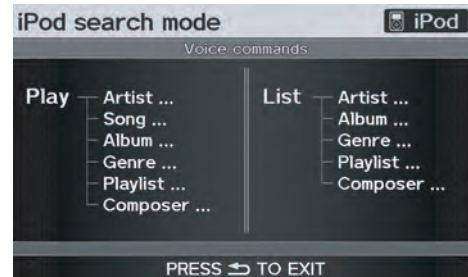

Say the desired voice command followed by the artist, song title, album, genre, playlist, or composer you wish to select. For example, when you say “Play artist ‘Artist A’”, the system will provide voice feedback and start playing all songs of Artist A.

#### NOTE:

- For information on the available voice commands in the Song By Voice™ mode, see Song By Voice™ Commands on page 170.
- Languages other than English may not be available for artist name, song title, album title, etc.
- You can turn this feature **ON** or **OFF**.

When you say “List artist ‘Artist A’”, the system will provide the following song list of Artist A.

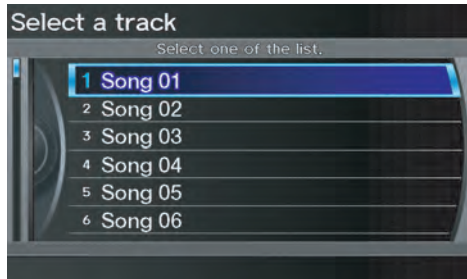

Select the desired song. The system will start playing the selected song and return back to the main Song By Voice™ screen.

To cancel the Song By Voice™ mode, press the **BACK** button on the steering wheel or any button on the navi interface.

**NOTE:**

*Once you have canceled this mode, you will need to say “Hard Disc Drive Search” or “iPod Search” again to re-activate this mode.*

### Phonetic Modification

You can modify the phonetics for all artists, songs, albums, and composers on the HDD and connected iPod. The modified phonetics can be used for the voice commands in the Song By Voice™ mode.

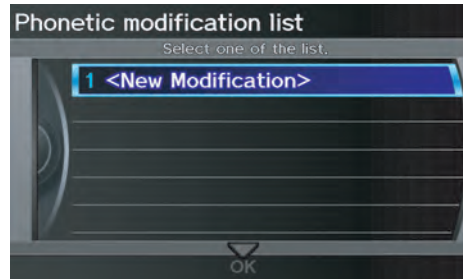

When you select **New Modification**, the following screen appears:

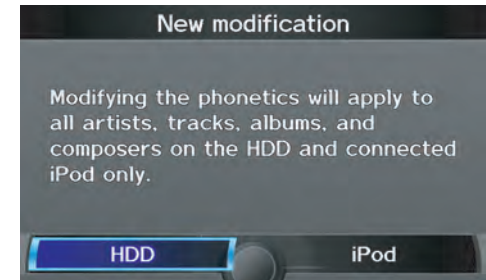

Select **HDD** or **iPod** depending on the media that you would like to access.

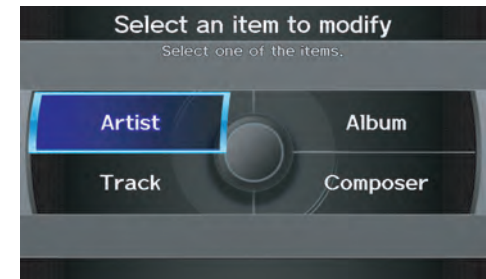



Select **Artist, Track, Album,** or **Composer** and then select an item to modify.

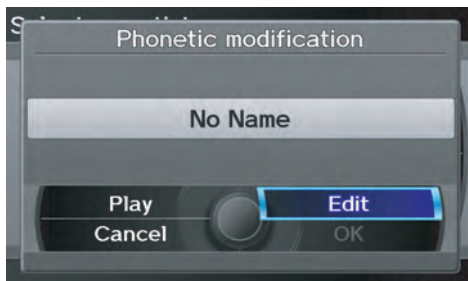

As in the example above, select the artist name stored as “No Name.” To play back the phonetic modification and check that it sounds right, select **Play**. Select **Edit** and enter the desired phonetic (e.g., “Artist A”), and then select **OK**.

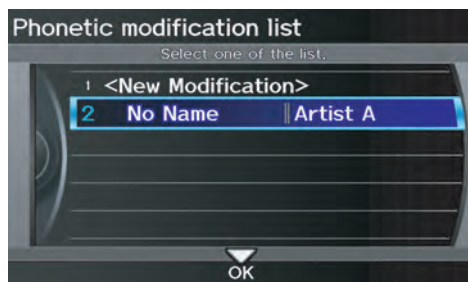

The artist “No Name” is modified to “Artist A” and you can use the voice command “Play artist ‘Artist A’” in the Song By Voice™ mode (see page 102).

If you add some other phonetics, repeat the procedure. When you finish modification, select **OK**.

**NOTE:**

- When **Song By Voice** is set to **OFF**, **Phonetic Modification** will be grayed out.
- Up to 2,000 phonetic modification items can be stored.

## Basic Settings

From the **SETUP** screen (Other), say or select **Basic Settings** and the following screen appears:



### Units (mile or km)

Allows you to select the units for the entire system (**mile** or **km**).

### Voice Recognition Feedback

Allows you to turn voice control system prompts **ON** or **OFF**. When **OFF**, you will not hear the voice control system confirmations or prompts.



### Routing & Guidance

From the SETUP screen (Other), say or select **Routing & Guidance** and the following screen appears:

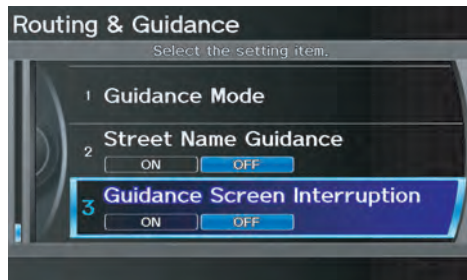
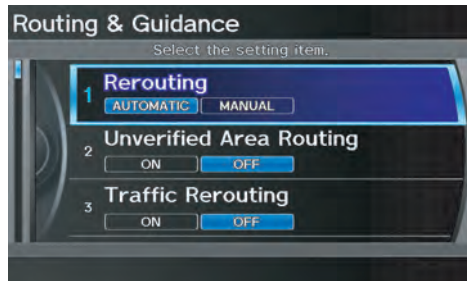

### Rerouting

If **Rerouting** is set to **AUTOMATIC** and you deviate from the route, you will see “Recalculating...” at the top of the screen for several seconds as the system calculates a new route. This is followed by new routing instructions.

If **Rerouting** is set to **MANUAL**, you will hear a tone when the “Off route” message is displayed. Say “Recalculation” or select **Recalculation** on the screen to make the system recalculate your new route.

#### NOTE:

- *It is strongly recommended that you leave the system set to the factory default (Automatic).*
- *If you live in an area with poor mapping, you may wish to set **Rerouting** to **MANUAL** to avoid constant recalculation. However, you will have to manually select **Recalculation** on the screen to have the system plot a new route.*

**Unverified Area Routing**

Allows you to receive turn-by-turn map and voice guidance in unverified areas when en route to a destination (see *Map Overview* on page 6). The chart below illustrates the routing differences with this setting **ON** or **OFF**.

	<b>Unverified Area Routing: OFF</b> (factory default)	<b>Unverified Area Routing: ON</b>
<b>Decision: Why choose ON or OFF?</b>	The driver wishes to navigate manually by using the navigation map and choosing the streets that lead to the destination. The driver understands that unverified roads may not be accurate, and can contain errors in location, naming, and address range.	The driver chooses to let the navigation system suggest possible routing. The driver understands that in some cases, guidance may not be appropriate. Unverified roads may not be accurate, and can contain errors in location, naming, and address range.
<b>What you will see...</b>	A blue dotted vector line is displayed on the map that continually points to your destination. The driver should stop and then use the map to select streets that lead to the destination.	A blue-pink dashed route line highlights suggested unverified streets on the map while traveling to your destination. This is in sharp contrast to the normal blue route line displayed in verified areas.
<b>Cautionary messages</b>	There are cautionary pop-up screens and voice announcements, before and during the route. These serve as reminders that you should obey all traffic restrictions.	There are cautionary pop-up screens and voice announcements, before and during the route. These serve as reminders that you should exercise additional caution, and obey all traffic restrictions.
<b>Guidance (map/voice)</b>	There is no turn-by-turn map or voice guidance.	Voice guidance commands end with the phrase “if possible.” This is to remind the driver to verify all traffic restrictions before getting near the guidance point.
<b>Directions list</b>	A direction list is typically not available. However, depending on your route, directions are provided to help you reach the first available verified road.	A direction list is provided showing street names and turn symbols in pink.

### Unverified Area Routing

When driving to your destination, you have the choice of using or not using “unverified” roads. You make this choice in the **SETUP** screen. The next few pages contain an example of a route to a destination in an unverified area explaining the routing differences found in unverified areas.

With **Unverified Area Routing OFF**, the system tries to use verified roads whenever possible. In this example, since only verified streets are used, it created a longer route than necessary.

With **Unverified Area Routing ON**, the route is shorter, but consists of unverified (purple) streets that may not be accurate. Because the streets are unverified, there may be errors in street location, name, or address range. Additional caution is recommended in these areas. Always obey posted traffic restrictions.

Because both routes bypass or use unverified streets, it is recommended that you stop and review the map.

### Unverified Area Routing “OFF”

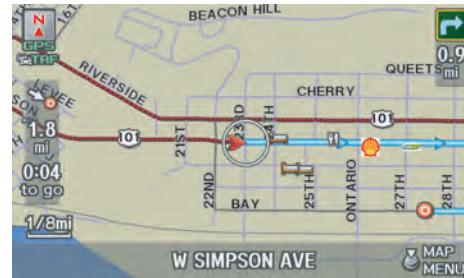
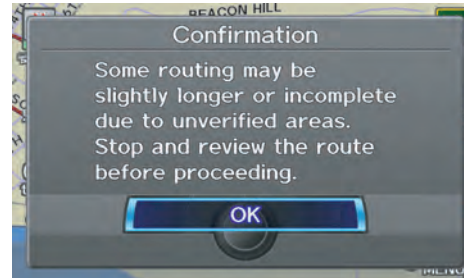

### Unverified Area Routing “ON”

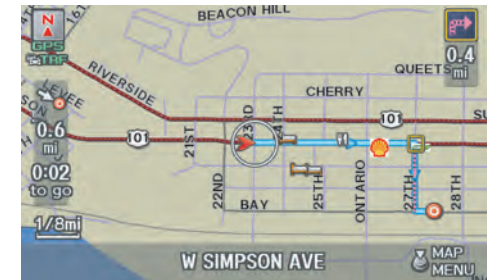
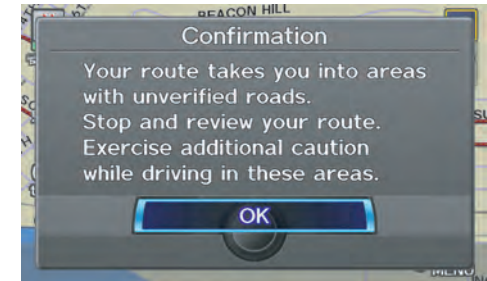

### NOTE:

Unverified roads are shown only when viewing the map in the 1/20, 1/8, 1/4 mile map scales.

With **Unverified Area Routing OFF**, before you enter an unverified street, a caution box appears on the screen and a voice message is given. This lets you know that you are about to enter an unverified area and that you will be following a dotted “vector line” that points to your destination.

With **Unverified Area Routing ON**, a caution box appears on the screen and is read by the voice. In this case, you will be presented with a dashed blue/pink line instead of the regular blue route line. This is your signal to pay attention to posted traffic restrictions. You cannot assume that all guidance is appropriate.

In both cases, when you actually enter the unverified street, a short caution will remind you. You will see and hear this short caution message whenever you enter unverified areas.

If you regularly enter and leave unverified roads for short amounts of time, there may be cases where no guidance is provided.

## Unverified Area Routing “OFF”

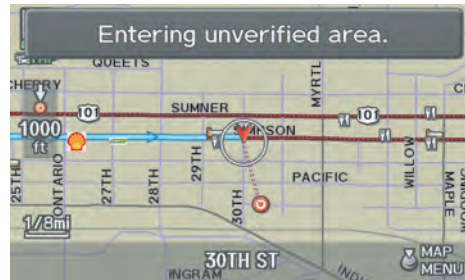
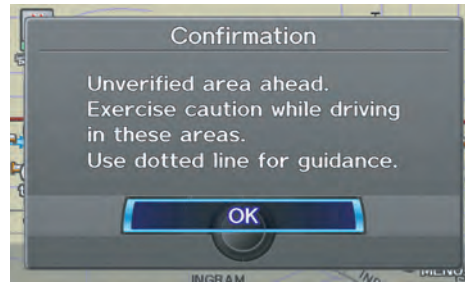

## Unverified Area Routing “ON”

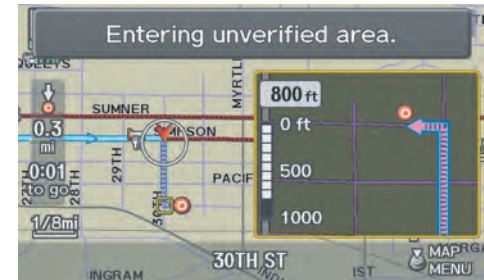
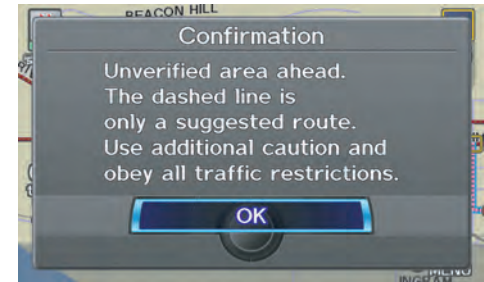

With **Unverified Area Routing OFF**, you are presented with a blue “vector line” that always points to the destination. You must manually choose streets from the map that will lead to your destination. No guidance is provided, and there are no directions to the destination.

With **Unverified Area Routing ON**, a blue/pink route line is shown for unverified segments. Voice guidance commands in unverified areas always end with “if possible.” This is your signal that you should use additional caution, and obey all traffic restrictions. The guidance window “arrow” shows any portions of unverified turns in blue/pink dashes.

These guidances are only a suggestion. You should always confirm that the guidance is possible.

A directions list is also provided that shows any unverified roads in a blue color, with pink arrows pointing to the next guidance point.

### Unverified Area Routing “OFF”

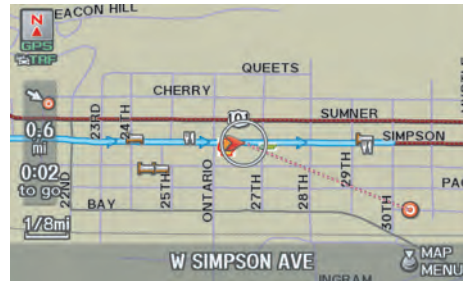

#### NOTE:

*For the pop-up menu displayed when pushing in on the **Interface Dial** from the map screen, **Voice** is grayed out. With **Unverified Area Routing OFF**, no **Direction List** is provided.*

### Unverified Area Routing “ON”

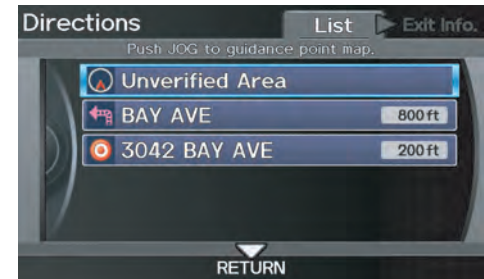
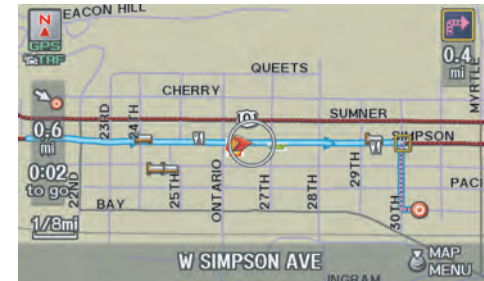



## Traffic Rerouting

This feature considers traffic information when carrying out automatic rerouting. Select either **ON** or **OFF** for this function. See *Traffic Rerouting* on page 73.

To access the guidance mode from the SETUP screen, select the “Other” tab, **Routing & Guidance**, and **Traffic Rerouting**. See *Traffic & Weather Status* on page 124 regarding verifying reception status.

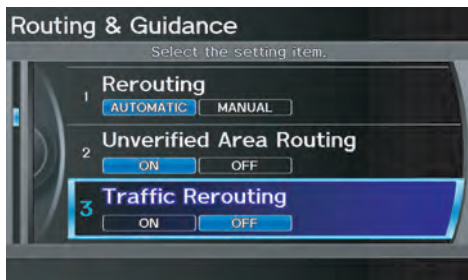

This is set to **OFF** as factory default.

**NOTE:**

*Automatic traffic rerouting may give inappropriate guidance in metro areas with limited or incomplete traffic flow data.*

## Edit Avoid Area

This function allows you to select areas you wish to avoid when calculating a route to your destination. You can select up to five areas to avoid. You may wish to set up an “avoid area” to route around long-term road construction, closures, or any area you wish to avoid. If you enter a route that takes you through or into an “avoid area,” a pop-up box will warn you that your route takes you into one of these areas. However, you can still choose destinations in an avoided area.

When you select **Edit Avoid Area**, the following list screen is displayed.

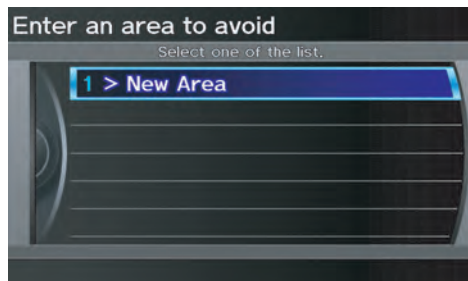

You can select **New Area**, or select one of your existing areas to modify. If you choose **New Area**, the following screen is displayed:

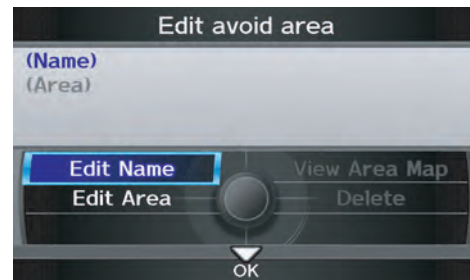

Say or select **Edit Name**, and use the **Interface Dial** to enter the name on the Enter avoid area name screen (25 characters max). Say or select **OK** to return to the previous screen.



Say or select **Edit Area** to create the area to be avoided. The following screen appears:

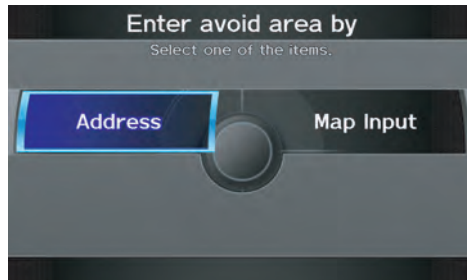

Either select **Address** or **Map Input** on the **Enter avoid area by** screen. Each choice provides a slightly different way to locate the approximate map display for drawing the area you wish to avoid.

After selecting the choice, a map screen will be displayed.

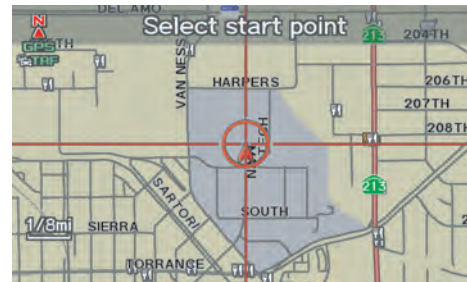

Rotate the **Interface Dial knob** to select the map scale. Use the **Interface Dial** to move the crosshairs (red circle) to the desired start point and push in on the **Interface Dial** to “set” the start point. Then move the **Interface Dial** in a straight or diagonal direction to encompass the area to be avoided.

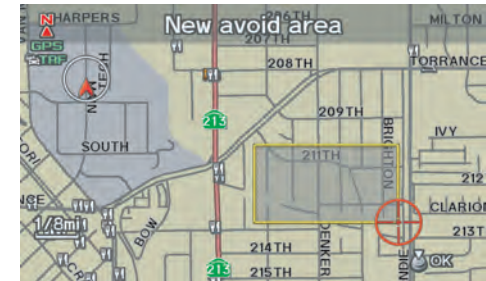

### **NOTE:**

*The maximum size of the “Avoid area” is 1/2 mile in length or width.*

The selected area will be displayed as a shaded box with a yellow border. Push in on the **Interface Dial** to set the end point of the avoided area. To “redraw” the area, select **CANCEL** and repeat the area selection process.

Say or select **OK** to return to the Edit avoid area screen.

If your selected area contains a freeway, the system will prompt you with a pop-up box saying “Do you want to avoid freeways?” Answering “No” allows you to enter a route through an avoided area on a freeway and skip the “Avoid area caution box” (see *Pop-ups and Disclaimers* on page 72).

When you return to the Edit avoid area screen, the “Area” field is automatically filled in by the system. Re-edit the area “Name” if desired. Select **OK** on the Edit avoid area screen to finish editing. Your new avoided area will now appear on the “Avoid area” list and be viewable on the map screen.

**NOTE:**

*You can select areas to avoid, however you cannot select roads or areas that you want the system to use for routing.*

## Edit Waypoint Search Area

When driving en route to your destination, you can select a temporary destination waypoint (marked with a small flag on the map) along your route for gas, a restaurant, or other POI. When you resume your trip from the waypoint, the system continues the trip to your original destination. To use this feature, see *Waypoint* on page 76.

This SETUP item allows you to select the distance from your highlighted route line (on either side of your route) that the system will search for a waypoint.

From the Routing & Guidance screen, select **Edit Waypoint Search Area**, and then choose the desired search distance for either “On Freeways” or “On Surface Street.”

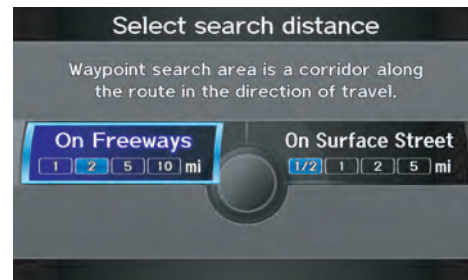

The diagram below shows how the system handles the search for “SEARCH ALONG” or “SEARCH AROUND the Destination” (see *Waypoint* on page 76).

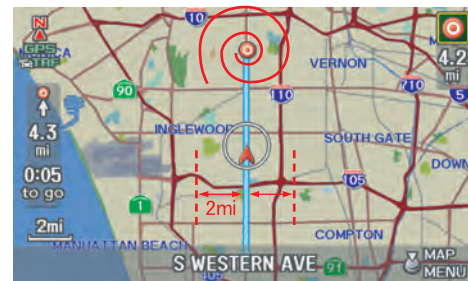

For “SEARCH ALONG,” the system looks in front of you within a corridor width specified by your values for “On Freeways” or “On Surface Street.” The system checks the upcoming area, based on your input.

For “SEARCH AROUND,” the system searches outwards in a spiral from the destination. In this case, specific search values are not needed; the matches are displayed in order of distance from destination.

**NOTE:**

*These settings do not affect the search range used for the voice commands like “Find nearest gas station” that are also available when viewing the map screen.*

### Guidance Mode

Allows you to select the guidance display mode: **Single Screen** or **Split Screen**.

To get to Guidance Mode from the **SETUP** screen, select the “Other” tab, **Routing & Guidance**, and **Guidance Mode**.

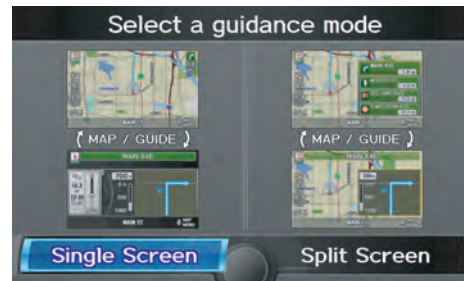

The factory default is **Single Screen**.

**NOTE:**

**Guidance Mode** can also be selected on the **Guidance** menu screen. See **Guidance Menu** on page 59.

### Street Name Guidance

Allows voice guidance to include the street names (for example, “Turn right on Main Street”). You can choose to turn this feature **ON** or **OFF**.

To access this feature from the **SETUP** screen, select the “Other” tab, **Routing & Guidance**, and **Street Name Guidance**.

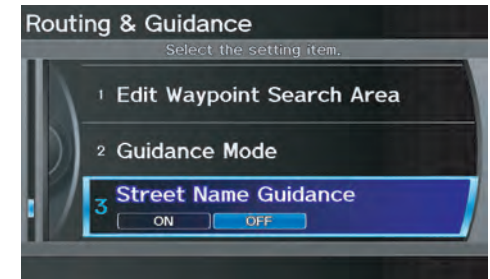

This feature is set to **OFF** as a factory default.

**NOTE:**

*If the system language selection is not English, **Street Name Guidance** will be grayed out, making its selection impossible.*

## Guidance Screen Interruption

When the audio screen is displayed and you get near the guidance point, the display will automatically switch to the navigation screen with the guidance window. After you get through the guidance point, the display will automatically return to the audio screen. You can choose to turn this feature **ON** or **OFF**.

To access this feature from the SETUP screen, select the “Other” tab, **Routing & Guidance**, and **Guidance Screen Interruption**.

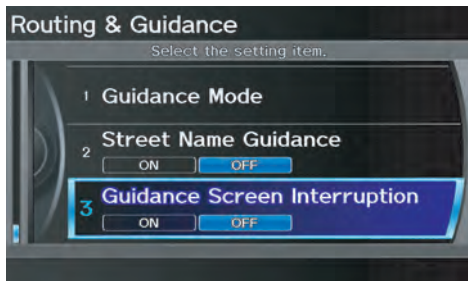

This feature is set to **OFF** as a factory default.

## Clock Adjustment

From the SETUP screen (Other), say or select **Clock Adjustment** and the following screen appears:



This screen allows you to set or adjust the following:

- Auto Daylight (Default = ON)
- Auto Time Zone (Default = ON)
- Adjust Time (adjust your clock)
- Reset (resets this screen’s settings to factory defaults)

## Auto Daylight

Sets automatic daylight saving time **ON** or **OFF**. If set to **ON**, the clock will automatically “spring ahead” or “fall back” by one hour when a daylight saving time change occurs.

### NOTE:

*Even if you have set Auto Daylight to **ON**, this function is not activated in areas that do not adopt daylight saving time.*

### Auto Time Zone

Sets automatic time zone selection by GPS to **ON** or **OFF**. If you are driving across the country and passing through time zones, then this feature will automatically set the time to the time zone you are traveling through. However, if you live and work in two different time zones, you may want to turn this feature off.

#### **NOTE:**

*When driving near a time zone boundary, the displayed time zone may fluctuate between the two zone times.*

### Time Adjustment

Adjusts the current time in hours and minutes. Select **ADJUST TIME** by moving the **Interface Dial** up, and then switch **HOUR** and **MINUTE** by moving the **Interface Dial** to the left and right and changing the value by rotating the **Interface Dial knob**. Selecting **OK** returns you to the previous screen.

### Resetting the Clock Settings

*Selecting **Reset** clears any changes you made to “Auto Daylight,” “Auto Time Zone” settings, or time adjustment. Depending on your location, you may need to adjust these settings.*

### Vehicle

From the **SETUP** screen (Other), say or select **Vehicle** and the following screen appears:



### Off-road Tracking

With this **ON**, the system will provide white off-road tracking dots (“breadcrumbs”) on the map screen whenever you drive into an area where the map does not show any roads. See *Map Screen Legend* on page 20.

After you have traveled approximately 1/2 mile away from a mapped road, the system will display a series of white dots on the map screen to show the path you have traveled. This is provided so you can follow the dots to backtrack to the mapped road you originally left. Tracking continues until you reach a mapped road. See *Off-road Tracking* on page 71.

Tracking is shown only in the 1/20, 1/8, 1/4, and 1/2 mile scales. Rotate the **Interface Dial knob** to change the scale if necessary.

**NOTE:**

To clear existing dots, turn this feature **OFF** and exit **SETUP**. To re-enable this feature, return to **SETUP** and turn it on again.

## Correct Vehicle Position

The system relies on satellites for positioning information. Buildings, tunnels, and other objects can block or reflect these signals, requiring the system to use “dead reckoning” to determine your location and direction. This can sometimes lead to small errors in positioning, such as showing you on an adjacent street.

**NOTE:**

*Using this function to adjust vehicle position is not recommended. When the system acquires a GPS signal, it will automatically place the vehicle in the correct location.*

If you choose to do this, follow these steps:

1. Stop the vehicle.
2. Select **Correct Vehicle Position**, and the system will display the Correct vehicle position screen.



3. Use the **Interface Dial** to move the vehicle position arrowhead to the correct location, and push in on the **Interface Dial**. The display will change to:

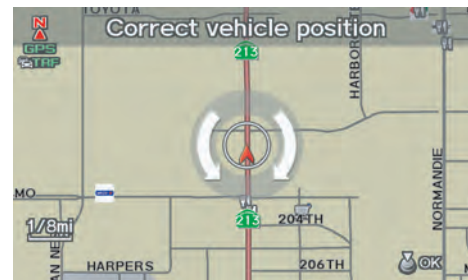



4. Rotate the **Interface Dial knob** so the vehicle position arrowhead is pointing in the correct direction, and push in on the **Interface Dial**. The display will return to the previous screen.

**NOTE:**

*If you continually have to do this, there are either problems in the database or GPS reception problems. See Accessories Precautions on page 5.*

5. As you drive, the current road will be displayed at the bottom of the screen.

### Color

From the **SETUP** screen (**Other**), say or select **Color** and the following screen appears:

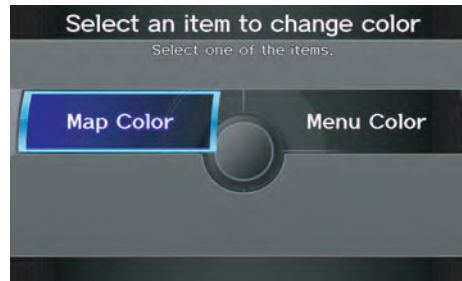

### Map Color

Allows you to choose the map color from one of five colors for the Day and Night modes.

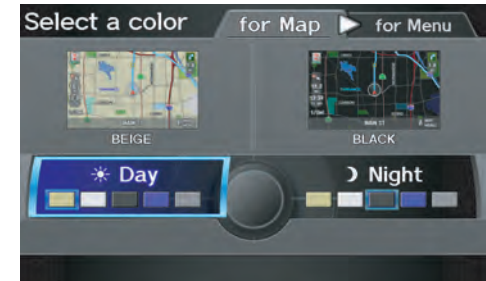

Press the **CANCEL** button to return to the previous screen.

**NOTE:**

- Choose “White” (factory default is Beige) as the Day color to obtain the best daytime display contrast.
- Choose “Black” (factory default) as the Night color to obtain the best nighttime display contrast.
- When you select the “for Menu” tab, you can change the menu color setting.

## Menu Color

Allows you to choose the menu color from one of five colors for the Day and Night modes.



Press the **CANCEL** button to return to the previous screen.

### NOTE:

- Choose “White” (factory default) as the Day color to obtain the best daytime display contrast.
- Choose “Black” (factory default) as the Night color to obtain the best nighttime display contrast.
- When you select the “for Map” tab, you can change the map color setting.

## Switching Display

### Mode Manually

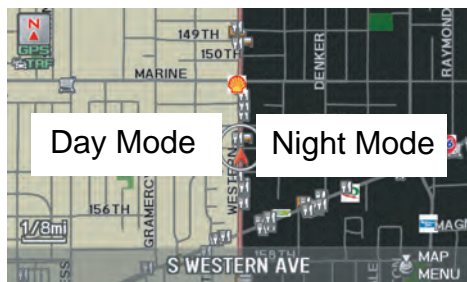

Pressing the **Display Mode** button ☼ ☾ allows you to toggle through the screen display modes: **Day**, **Night**, or **Off**. When selecting **Day** or **Night**, the Brightness bar will be displayed; rotate the **Interface Dial knob** and adjust the Brightness value. This button is the overriding control for the day/night display mode, and is the simplest way to control the display mode.

See the chart on page 119 for an explanation of other day/night display mode adjustments and how they interact with each other.



(Example of Day/Night Mode)

### Switching Display Mode Automatically

Illumination control	Priority	Operation	But remember
<b>Display Mode</b> button  (see page 11)	1	Allows selection of <b>Day</b> , <b>Night</b> , or <b>Off</b> display mode. This button has the highest priority and overrides all other display control adjustments listed below.	Once you press this button, you assume full manual control of the display mode until the ignition key is cycled again.
Sunlight sensor (middle of dash near the windshield, see your Owner's Manual for location)	2	If the sunlight sensor detects daylight and the headlights are turned on, the system automatically overrides (cancels) the <b>Night</b> display and displays the <b>Day</b> display mode.	If desired, use the <b>Display Mode</b> button  to override this automatic choice.
Dash illumination adjustment buttons (see the vehicle Owner's manual for location)	3	When headlights are turned on, and you wish to have the <b>Day</b> display mode, then adjust the illumination to the full bright setting (beeps).	Adjust the dash brightness back to mid-range to allow auto switching by sensing the headlights are on or off.
Headlights (Auto/On/Off)	4	When turned on, the display changes to <b>Night</b> display mode. The previous three controls listed above can "cancel" this function.	Use the <b>Display Mode</b> button  , or adjust the dash illumination to full bright to set the display to your desired choice.
Map <b>Day/Night</b> screen color choice (see page 118 for the <b>Day</b> and <b>Night</b> color choices)	N/A	The user can select the color of the screen that will be displayed for the <b>Day</b> and <b>Night</b> display modes described above.	For best contrast, ensure that the map color is white for <b>Day</b> and black for <b>Night</b> .

### Recommended Display Mode Day/Night Settings:

- With the headlights on, select mid-range for the dash illumination (see your Owner's Manual for location of buttons).
- With the headlights off, select mid-range for the dash illumination (see your Owner's Manual for location of buttons).
- On the SETUP Color adjustment screen, choose white for the map **Day** display and black for the map **Night** display (see page 117). Inappropriate adjustment of these colors can cause the **Day/Night** modes to appear inoperative.

## AcuraLink/Messages

For complete details on setting up your AcuraLink messaging, refer to the AcuraLink section in your Owner's Manual, or visit [www.myacura.com](http://www.myacura.com).

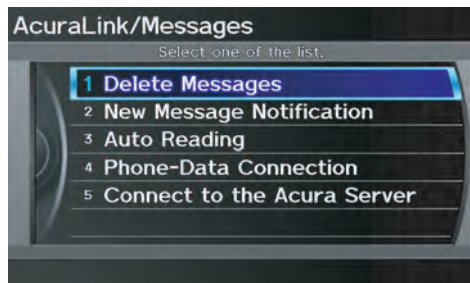

### NOTE:

*AcuraLink relies on a satellite signal. It will not work in Alaska, Hawaii, Canada, and Puerto Rico.*

## Language

Selects the language to be used on each screen that the system displays. From the SETUP screen (Other), say or select **Language** and the following screen will be displayed.



You can choose from three languages: **English**, **Français**, or **Español**.

### NOTE:

- *Voice confirmation of cities and streets only occurs when English has been selected.*
- *When Français or Español is selected, some messages will continue to be displayed in English.*

### Wallpaper

From the SETUP screen (Other), say or select **Wallpaper** and the following screen will be displayed.



With the factory default, two images are provided for the HDD.

### Selecting Wallpaper Pictures

If you say or select **Select a Picture for Wallpaper**, a list of the images on the HDD will appear.

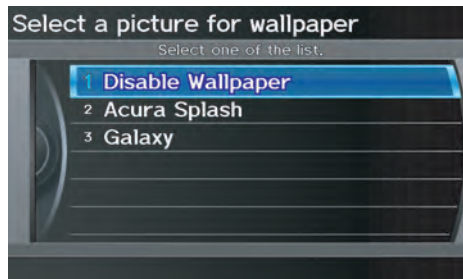

#### **NOTE:**

*If Wallpaper has not been set up, "Disable Wallpaper" will be selected.*

If you select an image, the image will appear in a pop-up screen. Select **OK** to complete the setup. The selected image will be highlighted on the list screen.

### Delete Pictures on HDD

If you say or select **Delete Pictures on HDD**, a list of the images on the HDD will appear.

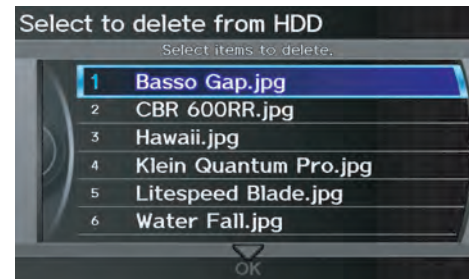

To delete the image, use the **Interface Dial** to select it, and the image will display. Select **OK** if you want to continue to delete the image, and the list of images will be displayed with your selected image highlighted. Move the **Interface Dial** down to select **OK** to delete. A confirmation message will appear.

### NOTE:

- If there are no images on the HDD, “No Entries Exist” will appear.
- You cannot delete images while driving.

Images that have not yet completed uploading from a USB thumb drive cannot be deleted.

### Importing Pictures from USB

To use a wallpaper image other than the factory defaults, you can import pictures from a USB thumb drive or similar device.

If you say or select **Import Pictures from USB** and a USB thumb drive is properly connected, the following screen will display.

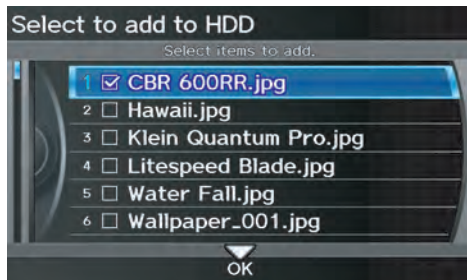

Rotate the **Interface Dial** knob and select the images to be uploaded to the HDD. Move the **Interface Dial** down and select **OK**.

### NOTE:

- You can only import images from the root directory. Images in the folders cannot be imported.
- The display size is 800 x 480 pixels. Smaller images are displayed with the extra area appearing in black. Larger images are reduced to a displayable size without changing the aspect ratio.
- Ten uploaded images (in BMP or JPEG format) can be saved to the HDD for Driver 1 and Driver 2 each.
- Incompatible data formats or images greater than 6 MB cannot be saved.
- When the file name is longer than 211 characters, the image cannot be uploaded.
- If you attempt to upload an image with the same name as an existing image, a pop-up screen will appear, asking if you want to overwrite the existing image file.
- You cannot import images while driving.



### Reset Factory Default Settings

The **Setup** settings and Multi-view rear camera brightness value settings can be returned to the factory default settings.

If you say or select **Reset Factory Default** from the **SETUP** screen (Other), the following screen will display.

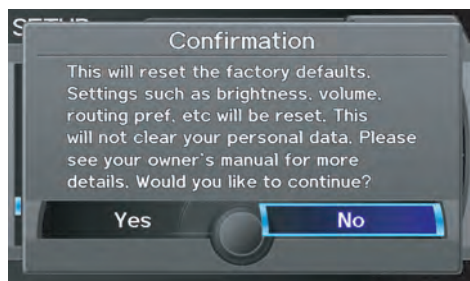

If you select **Yes**, the following Setup settings return to the factory default settings. If you select **No**, these settings will remain as they are currently set.

- Brightness, Contrast, Black Level, Volume, Interface Dial Feedback, Brightness (Multi-view rear camera)

- Basic Settings: Units, Voice Recognition Feedback
- Routing & Guidance: Rerouting, Unverified Area Rerouting, Traffic Rerouting, Edit Waypoint Search Area, Guidance Mode, Street Name Guidance, Guidance Screen Interruption
- Clock Adjustment: Auto Daylight, Auto Time Zone, Time
- Vehicle: Off-road Tracking
- Color: Map Color, Menu Color

#### **NOTE:**

*Messages are not deleted. AcuraLink/Messages settings do not return to the factory default settings.*

### Clear Personal Data

Any uploaded data, calendar entries, address books, stored destinations, or other settings can be cleared or returned to factory defaults. If you say or select **Clear Personal Data** from the **SETUP** screen (Other), the **Select** items to clear screen will display.

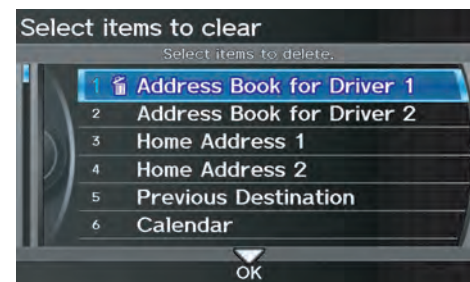

Rotate the **Interface Dial knob** and select the data to be deleted.

If a PIN number is set, the screen for entering the PIN code will be displayed. A pop-up screen verifying whether deletion is to be continued or not will be displayed, and then another deletion verification message will appear. Select **Yes** to commence the deletion; select **No** to suspend it.

**NOTE:**

- When the **Address Book** is deleted, all contents (except the Categories) will be deleted.
- When **Cellular Phone Information** is selected, the imported phonebooks, speed dials, and voicetags will be deleted. For information on deleting the paired phones, see your Owner's Manual.

## Traffic & Weather Status

You can confirm the reception status of XM signal, traffic information data, or weather information data.



The following messages will be displayed:

Message	Status
Receiving	The system is receiving XM signal, traffic data, or weather data.
No signal	<ul style="list-style-type: none"> <li>• The system cannot receive XM signal.</li> <li>• XM signal is received, but the system cannot receive traffic data or weather data.</li> </ul>
Expired	Activation is expired. Call XM at (800) 852-9696 to reactivate your traffic/weather subscription.
Loading	The system is searching for the signal or updating the data.
Check Antenna	Antenna error
---	The system cannot receive traffic data or weather data because XM Signal Reception status is "No signal" or "Check Antenna."

### Multi-view Rear Camera

Your vehicle is equipped with a Multi-view rear camera as shown in the illustration.

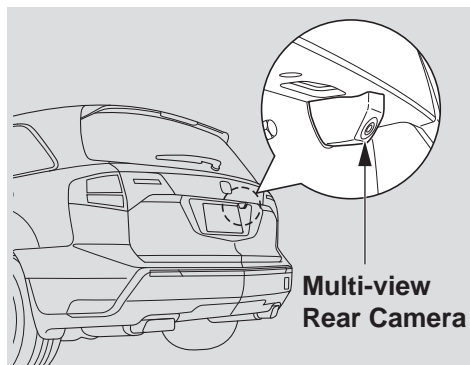

When you shift to R (Reverse) with the ignition switch in the ON (II) position, the rear view is shown on the navigation screen. Parking guide lines appear in the rear view. For the best image, always keep the camera lens clean, and be sure it is not covered.

Since the camera display area is limited, you should always back up slowly and carefully, and look behind you for obstacles.

### Visible Range of the Rearview Image

The rearview image is displayed within approximately three meters of the vehicle.

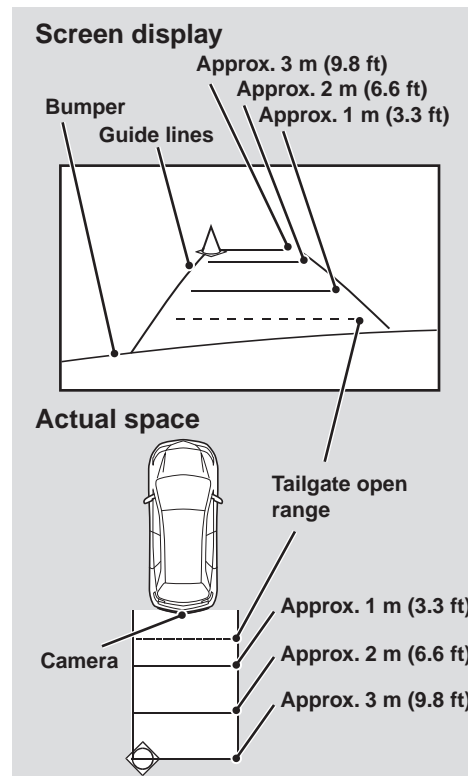

### NOTE:

- The Multi-view rear camera has a special lens that makes distances appear different than they actually are.
- The Multi-view rear camera display has a limited range, and the size and position of objects around the area may appear different from reality. Make sure to check the surrounding area carefully.

### Tip:

To turn the guide lines on or off, press and hold the **CANCEL** button for three seconds.

## Three-way Rearview Modes

The rearview image can be easily switched between Wide, Normal, and Top view modes by pushing in on the **Interface Dial**.

When you select the Wide or Normal view mode and turn the ignition off, the last mode will be selected next time the camera is used.

### Tip:

*Only use Top view when objects are close (less than one meter) to your vehicle.*

### NOTE:

*If the last mode is Top view, the Normal view mode will be selected after boot up.*

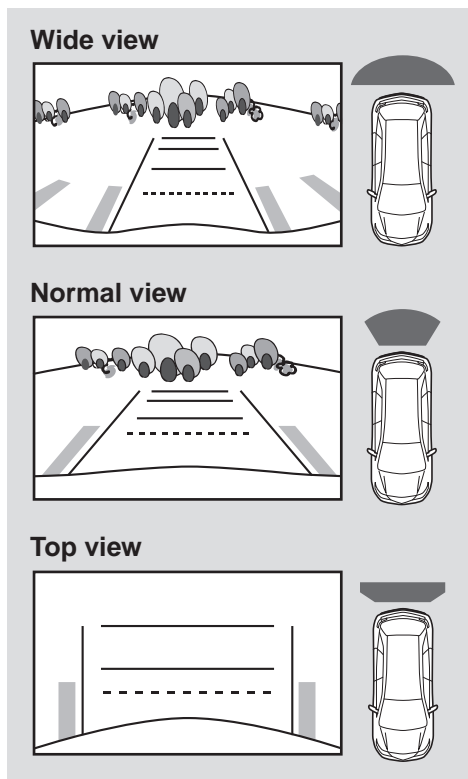

## Multi-view Rear Camera Brightness Adjustment

When in reverse, the navigation buttons are locked out, except the rotating portion of the **Interface Dial knob**. Rotate the **Interface Dial knob** clockwise to make the camera image brighter, and counterclockwise to darken the image.

This brightness adjustment is independent of the screen brightness adjustment in SETUP.

### NOTE:

- *The camera brightness cannot be adjusted by voice control.*
- *Slight delays can occur when switching to the camera image (especially when first starting your vehicle), or switching back to the map/menu screen. This is normal.*

### System Initialization

If for any reason you lose power to the navigation system (e.g., the battery was disconnected), the navigation system will require initialization. Once completed, your system will be ready to use.

This initialization requires the following:

- Entry of the 5-digit anti-theft security code to “unlock” the audio and navigation system.
- GPS initialization (may not be needed depending on the length of time the system was without power). (See *GPS Initialization* on this page.)
- Map matching to align the GPS coordinates to a place on the map (displays current street at the bottom of the map). (See *Map Matching* on page 128.)

### Entering the Security Code

If the battery goes dead or is disconnected for any reason, you will have to enter a security code for the audio and navigation system before you can use it again.

When you purchased the vehicle, you should have received one card containing the navigation system’s security code and serial number. Keep this card in a safe place in case you need the code. If you lose the card, you must obtain the security code from your dealer.

Enter the 5-digit security code in accordance with the owner’s manual for your vehicle. If you do not enter the security code, the navigation and audio voice will not function.

#### **NOTE:**

*The anti-theft security code is unrelated to your optional navigation system PIN (for Address Book or Home Address).*

### GPS Initialization

Depending on the length of time the battery was disconnected, your system may require GPS initialization. If it does, the following screen appears:

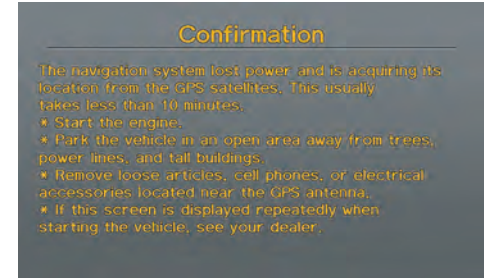

If this procedure is not necessary, the system proceeds directly to the Disclaimer screen (see page 18). During initialization, the system searches for all available GPS satellites and obtains their orbital information. During this procedure, the vehicle should be out in the open with a clear view of the sky.

If the navigation system finds the satellites properly, this box clears and the Disclaimer screen is shown. If within 10 minutes the system fails to locate a sufficient number of satellites to locate your position, the following screen appears:

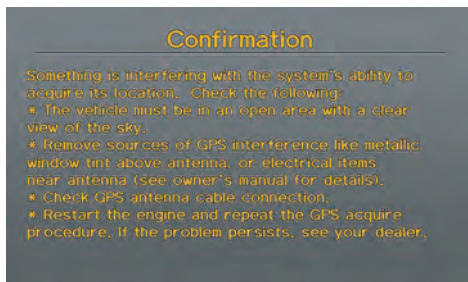

If the system is still unable to acquire a signal, follow the instructions on the screen, or contact your local dealer for assistance.

**NOTE:**

*The average acquiring time is less than 10 minutes.*

## Map Matching

This part of the initialization matches the GPS coordinates found above with a road on the map screen. To perform this part of the procedure, ensure that the navigation system is displaying a map, and drive the vehicle on a mapped road (a road shown on the map screen). Do not enter a destination at this time.

When the name of the current road you are driving on appears at the bottom of the screen, the entire procedure is complete. Your system is now ready to use.

Although your navigation system is one of the most highly sophisticated pieces of equipment you will find in a modern automobile, you may find during its use that it has certain limitations.

The system uses GPS signals to aid in determining its current location. The GPS is operated by the U.S. Department of Defense. For security reasons, there are certain inaccuracies built into the GPS that the navigation system must constantly compensate for. This can cause occasional positioning errors of up to several hundred feet.

For example, in urban areas where streets are close together, this could cause the system to show that you are traveling on a street that parallels the street you are actually on. The system will, under most circumstances, correct itself while you drive.



Also, depending on your current view of the sky and the position of the satellites, the elevation may be shown incorrectly. You may also notice some delay of the vehicle position icon at intersections; this is normal.

### GPS Reception Issues

The signals received from the GPS satellites are extremely weak (less than a millionth of the strength of a local FM station) and require an unobstructed view of sky. The signal can easily be interrupted or interfered with by the following:

- Aftermarket metallic window tint above or to the sides of the GPS antenna (located on the back of the navigation display)
- Cell phones, PDAs, or other electronic devices docked in a cradle or lying loose on the dashboard
- Remote starters or “hidden” vehicle tracking systems mounted near the navigation unit

- Other aftermarket audio electronic devices mounted near the navigation unit
- Trees, tall buildings, freeway overpasses, tunnels, or overhead electrical power wires

Although the system will direct you to your desired destination, it may not always generate what you consider to be the most direct route. Try changing the method of routing. See *Changing the Route Preference* on page 53. You may also have Unverified Area Routing set to OFF. See *Unverified Area Routing* on page 106.

Additionally, the mapping database contains verified and unverified maps. See *Map Overview* on page 6. A **Disclaimer** screen will warn you if your route includes unverified streets. Unverified streets may be missing from the map, in the wrong location, or have an incorrect name or address range. Exercise additional caution when driving in these unverified areas.

The destination icon shows the approximate location of the destination. This occurs because a city block can have as many as 100 possible addresses (for example, the 1400 block is followed by the 1500 block) Since most cities use only a portion of the 100 possible addresses (for example, in the 1400 block, the addresses may only go up to 1425 before the 1500 block starts), the address 1425 will be shown a quarter of the way down the block by the system instead of at the end of the block where the destination is actually located.

You may find that the system occasionally reboots. This is indicated by the display returning to the **navigation system globe** screen. A reboot can be caused by a number of things, such as extreme temperatures or shock from bumpy roads. It does not necessarily indicate a problem that requires service. If this happens frequently, please see your dealer.

You will find that some points of interest (POI) may be missing when you search the database. This can be caused if at the time the database was gathered, the name was misspelled, the place was improperly categorized, or the POI change is not yet in the database. This means you may not find places listed that you know exist. This is also true for police agencies and hospitals. In outlying areas, facilities listed may not be the closest. Always check with local information sources if you need law enforcement or hospital services.

Every effort has been made to verify that the system's database was accurate at the time it was created. However, businesses do close or relocate, and new businesses start in the old locations. For this reason, you may occasionally find inaccurate information when you select and drive to a point of interest (for example, a restaurant is now a jewelry store). The number of these inaccuracies increases the longer you go without an update.

The digitized map database reflects conditions as they existed at various points in time before production. Accordingly, your database may contain inaccurate or incomplete data or information due to the passage of time, road construction, changing conditions, or other causes.

Due to ongoing software and database improvements, navigation software and mapping versions may change in the middle of a production year. The version shipped with your vehicle was the most recent available at the time of production and is considered standard equipment for that vehicle. There is no free program to retrofit early production vehicles with the latest software and mapping versions. For update ordering information, see page [133](#).

In addition, this database does not include, analyze, process, consider, or reflect any of the following categories of information:

- Neighborhood quality or safety
- Population density
- Availability or proximity of law enforcement
- Emergency, rescue, medical, or other assistance
- Construction work, zones, or hazards
- Road and lane closures
- Legal restrictions (such as vehicular type, weight, load, height, and speed restrictions)
- Road slope or grade
- Bridge height, width, weight, or other limits

- Traffic facilities safety
- Special events
- Pavement characteristics or conditions

We assume no liability for any incident that may result from an error in the program, or from changed conditions not noted above.

### Copyrights

- infoUSA-Data: Certain business data provided by infoUSA, Inc., Omaha, NE, Copyright © 2010, All Rights Reserved.
- EXIT-Data: © ZENRIN CO., LTD. 2010. All Rights Reserved.
- Building foot print: © ZENRIN CO., LTD. 2010. All Rights Reserved.
- Junction View Data: © ZENRIN USA, INC. 2010. All rights reserved.
- ZAGAT SURVEY: © 2012 Zagat Survey, LLC. Zagat Survey is a registered trademark of Zagat Survey, LLC.
- Brand icon: The marks of companies displayed by this product to indicate business locations are the marks of their respective owners. The use of such marks in this product does not imply any sponsorship, approval, or endorsement by such companies of this product.

### Reporting Errors

Occasionally, you may encounter database errors.

- If the error pertains to freeways and main “verified” roads shown in black on the map, then report it online at <http://mapreporter.navteq.com/dur-web-external/>.
- If the error involves a purple “unverified” road, then do not report it. These areas have not been verified and are provided for reference only (see *Map Overview* on page 6).
- For errors in points of interest (POI), like a business that has changed its name, do not report them. Keep in mind that depending on when the data was collected, the database can be out of date. The business may have not reported the change(s), or not be in the database at all. Updates are available for purchase, usually in the fall of each year. See *Obtaining a Navigation Update* on page 133 regarding updates to the navigation system.

- If the error does not involve the database, such as vehicle position icon error, screen error messages, or other GPS related errors, see *Frequently Asked Questions* on page 151, *System Limitations* on page 129, or *Troubleshooting* on page 159.

### Acura Client Relations

Telephone: (800) 382-2238

Fax: (310) 783-3535

Mail:

**Acura Navi**

America Honda Motor Co., Inc.

Acura Client Relations

MS 500-2N-7E

1919 Torrance Blvd.

Torrance, CA 90501-2746

### Visiting Your Dealer

We strive to make this manual as complete as possible and to answer all questions regarding operation of the system. Occasionally, you may run into a specific issue that you cannot find in the book. You may save yourself a trip to the dealer by first consulting the following resources:

- The Troubleshooting section (see page 159)
- The Frequently Asked Questions (FAQs) section (see page 151)
- The FAQs found on the online update order site (see “Obtaining a Navigation Update”)
- For detailed questions regarding HFL, audio, or other systems that interact with the navigation system, see your Owner’s Manual, or the Advanced Technology Guide.
- For traffic-related issues, see the “AcuraLink Real-Time Traffic” section (on page 23) and FAQs (on page 151).

- Call Acura Client Relations (see *Acura Client Relations* on page 132).
- For database or POI issues, follow the guidelines in the “Reporting Errors” section (see page 132).

If your question is still unanswered and you wish to visit the dealer, please be prepared to demonstrate the issue to the service consultant. That way, the service consultant can document the issue for the factory to allow more efficient troubleshooting.

Some issues may at first seem random, but you may notice a pattern, like they only occur when you enter a specific address, when driving on a certain road, or just when it’s cold. This information is very useful to the service consultant. Be patient, the service consultant may be unfamiliar with your specific issue.

### Obtaining a Navigation Update

Acura is continually expanding the scope of the navigation system. Upgraded software may be made available to navigation system owners periodically, usually in the fall of each year.

To purchase an updated, you will need your vehicle’s VIN number and the System/Device Information from the INFO screen (Other). Call the Acura Navigation Center at (888) 549-3798, or order online by going to [www.acuranavi.com](http://www.acuranavi.com).

#### **NOTE:**

- *Updates are not available at your dealer. However, the dealer may order an update for you out of courtesy. There is no program for free updates.*
- *The update order line staff cannot answer technical questions regarding navigation operation, coverage, or POIs.*

Intro

SEC

## Map Coverage

The system provides map coverage for the United States, as well as for Canada and Puerto Rico. The map coverage consists of accurately mapped (verified) metropolitan areas (in the following list) and a less accurate (unverified) rural database. See *Map Overview* on page 6 for a discussion of map coverage.

The cities and metropolitan areas in the following list are fully mapped. Only major streets, roads, and freeways have been verified outside these areas. If your route passes through these areas, routing may be limited, depending on your routing choices. See *Unverified Area Routing* on page 106.

If you desire additional map coverage information, contact Acura Client Relations or go to [www.acuranavi.com](http://www.acuranavi.com). Enter your vehicle model and model year, and then select the state for which you want to verify map coverage.

## U.S. Detailed Coverage Areas

### Alabama

Auburn-Opelika  
Birmingham/Tuscaloosa  
Huntsville  
Mobile  
Montgomery

### Arizona

Phoenix Metro  
Prescott  
Sedona  
Tucson  
Yuma

### Arkansas

Fayetteville  
Fort Smith  
Hot Springs  
Little Rock  
Pine Bluff

### California

Central Valley - including Fresno,  
Merced, Modesto, and Stockton  
Humboldt  
Los Angeles/San Diego Metro  
Mammoth Lakes  
Sacramento Metro

San Francisco Bay (*approximately Monterey to Sonoma*) – including Monterey County and Hollister  
Southern California Area - including Bakersfield and San Luis Obispo  
Yuba

### Colorado

Denver/Boulder/Colorado Springs/  
Ski Resorts Metro area – including Ft. Collins  
Grand Junction

### Connecticut

Bridgeport  
Danbury  
Hartford Metro  
New Haven Metro  
Norwalk  
Stamford

### Delaware

Entire state – including Dover,  
Wilmington Metro area, New Castle County

### Florida

Cape Canaveral/Cocoa Beach/  
Titusville  
Dixie County  
Florida Keys





Fort Myers Metro area – including  
*Naples*

Fort Pierce

Gainesville

Jacksonville Metro – including *St.  
Johns County*

Miami/Fort Lauderdale/West Palm  
Beach Metro

Orlando/Daytona Beach/Melbourne  
area – including *Osceola County*

Panama City

Pensacola

Tallahassee

Tampa Bay/St. Petersburg Metro –  
including *Pasco and Manatee  
Counties*

Vero Beach

### **Georgia**

Athens

Atlanta Metro

Augusta/Aiken Metro

Columbus

Macon

Rome

Valdosta

Warner Robbins

### **Hawaii (all cities for the following islands)**

Hawaii

Kauai

Lanai

Maui

Molokai

Oahu

### **Idaho**

Boise

Idaho Falls

Pocatello

Sun Valley Ski Resorts

### **Illinois**

Bloomington-Normal

Carbondale

Champaign

Charleston

Chicago Metro (to Wisconsin border)  
– including *Lake County, IN, and  
DeKalb County, IL*

East St. Louis Metro

Galesburg

Moline

Peoria

Quincy

Rock Island

Rockford

Springfield

Urbana-Danville

### **Indiana**

Bloomington

Evansville

Fort Wayne

Gary/Hammond Metro

Indianapolis Metro

Kokomo Metro

Lafayette

Muncie

Northwest Indiana

South Bend/Elkhart/Goshen

Terre Haute

### **Iowa**

Ames

Cedar Rapids

Davenport

Des Moines

Iowa City

Waterloo-Cedar Falls

### **Kansas**

Kansas City/Leavenworth Metro

Topeka

Wichita

### **Kentucky**

Lexington

Louisville

## **Louisiana**

Baton Rouge  
Lafayette  
New Orleans Metro  
Shreveport

## **Maine**

Bangor  
Bar Harbor/Acadia National Park  
Portland/Lewiston/Auburn

## **Maryland**

State of (partial) - Baltimore/  
Washington D.C. Metro – including  
Charles and Carroll Counties  
Cumberland  
Ocean City

## **Massachusetts**

Boston/Cape Cod Metro  
Cape Cod  
Springfield Metro area  
*Complete coverage of all cities in  
Barnstable, Berkshire, Bristol,  
Essex, Hampshire, Hampden,  
Middlesex, Norfolk, Plymouth,  
Suffolk, and Worcester Counties*

## **Michigan**

Detroit Metro area – including Ann  
Arbor, Pontiac, Flint, Clinton,  
Eaton, and Monroe Counties  
Kalamazoo  
Northern Michigan Resort Area –  
including Traverse City, Elk  
Rapids, Petoskey, Charlevoix,  
Boyne City, and Harbor Springs  
Saginaw-Midland  
Southeast Michigan – including  
Detroit - Grand Rapids - Lansing  
Southern Michigan

## **Minnesota**

Duluth  
Minneapolis/St. Paul Metro –  
including cities in Anoka Scott and  
Carver Counties  
Moorhead  
Rochester

## **Mississippi**

Biloxi/Gulfport  
Jackson  
Memphis  
Tupelo

## **Missouri**

Branson  
Columbia  
Jefferson City  
Joplin  
Kansas City (KS-MO) Metro –  
including Platte County  
Lake of the Ozarks  
Springfield  
St. Louis Metro (IL-MO) – including  
additional cities in Jefferson  
County

## **Montana**

Billings  
Helena  
Missoula

## **Nebraska**

Lincoln (Lancaster County)  
Omaha

## **Nevada**

Las Vegas Metro  
Reno/Lake Tahoe

## **New Hampshire**

Lebanon  
Manchester  
Nashua

### ***New Jersey***

Camden Metro  
Newark Metro  
Southern New Jersey – *including Atlantic City/Cape May/Cumberland Metro*  
Trenton Metro – *including Ocean and Hunterdon Counties*

### ***New Mexico***

Albuquerque  
Las Cruces  
Santa Fe  
Taos Ski Resorts

### ***New York***

Binghamton  
Buffalo – *including Erie and Niagara Counties*  
Eastern New York – *including the Adirondack, Oneonta - Cooperstown, New York City Metro, Albany, Glen Falls, Schenectady, Troy*  
Elmira  
Ithaca  
Lake Placid  
Rochester – *including cities in Monroe County*  
Syracuse  
Utica  
Watertown

### ***North Carolina***

Asheville  
Charlotte Metro  
Fayetteville  
Hickory  
Jacksonville  
Morgantown  
Outer Banks  
Raleigh-Durham Metro  
Wilmington  
Winston-Salem/Greensboro Metro

### ***North Dakota***

Fargo Metro  
Grand Forks

### ***Ohio***

Akron  
Columbus/Marysville Metro  
Cincinnati Metro – *including Butler County*  
Cleveland Metro – *including Geauga County*  
Dayton  
Lima  
Mansfield  
Springfield  
Toledo (*Lucas County*)  
Youngstown

### ***Oklahoma***

Oklahoma City  
Tulsa

### ***Oregon***

Bend  
Corvallis  
Eugene  
Medford  
Portland/Salem Metro  
Seaside/Astoria/Cannon Beach

### ***Pennsylvania***

Allentown  
Erie  
Gettysburg  
Harrisburg  
Lancaster  
Philadelphia Metro  
Reading  
Southeastern Pennsylvania  
Southwest Pennsylvania - *including Pittsburgh and Washington County*  
State College/University Park  
Wilkes-Barre/Scranton  
Williamsport  
York

### ***Rhode Island***

Newport  
Providence Metro

## **South Carolina**

Beaufort  
Charleston  
Columbia  
Greenville/Spartanburg – *including additional cities in Greenville and Spartanburg Counties*  
Myrtle Beach Metro  
Rock Hill Metro  
Sumter/Florence

## **South Dakota**

Rapid City  
Sioux Falls

## **Tennessee**

Chattanooga  
Chester County  
Franklin County  
Johnson City/Kingsport/Bristol  
Knoxville/Farragut Metro  
Memphis Metro – *including Desoto and Tunica Counties*  
Nashville

## **Texas**

Abilene  
Amarillo  
Austin Metro  
Beaumont  
Big Bend  
Brownsville

Bryan/College Station  
Corpus Christi  
Dallas/Fort Worth Metro – *including additional cities in Grayson County*  
El Paso  
Houston Metro – *including additional cities in Galveston County*  
Laredo  
Longview  
Lubbock  
McAllen  
Midland/Odessa Metro  
Nacogdoches-Lufkin  
San Antonio Metro  
South Padre Island  
Texarkana  
Wichita Falls

## **Utah**

Moab  
Ogden  
Park City  
Salt Lake City Metro  
St. George

## **Vermont**

Rutland  
State of (partial) - *including Burlington, Montpelier*

## **Virginia**

Washington D.C. detailed area – *including Alexandria, Arlington, Fairfax, Falls Church, Fauquier County, Fredericksburg City, Manassas, and additional cities in Loudon and Prince William Counties*  
Bristol  
Charlottesville  
Danville  
Emporia  
Lynchburg  
Richmond Metro  
Roanoke  
Shenandoah National Park  
Staunton-Waynesboro-Harrisonburg  
Williamsburg/Norfolk/Virginia Beach Metro – *including Charles City, Hopewell, Kent, and Prince George Counties*  
Winchester

## **Washington**

Bellingham  
Seattle/Tacoma/Olympia Metro – *including Island County*  
Spokane  
Tri-Cities  
Whatcom  
*Point Roberts (community)*  
Yakima

### **West Virginia**

Charleston  
Harper's Ferry Metro  
Huntington  
Morgantown  
Parkersburg

### **Wisconsin**

Appleton  
Beloit  
Eau Claire  
Green Bay  
Janesville  
Kenosha County  
La Crosse  
Madison  
Lake Geneva  
Milwaukee Metro – *including  
Milwaukee, Ozaukee, Washington,  
and Waukesha Counties*  
Neenah  
Oshkosh  
Racine  
Sheboygan  
Wausau

### **Wyoming**

Cheyenne  
Jackson Ski Resorts

### **Canada Detailed Coverage Areas**

#### **ALBERTA**

Airdrie  
Banff  
Beaumont  
Calgary  
Calmar  
Canmore  
Chestermere  
Cochrane  
Crossfield  
Devon  
Edmonton  
Fort Saskatchewan  
Leduc  
Lethbridge  
Medicine Hat  
Spruce Grove  
St. Albert  
Stony Plain  
Strathcona County

#### **BRITISH COLUMBIA**

##### **Greater Vancouver**

Anmore  
Belcarra  
Bowen Island  
Burnaby  
Coquitlam  
Delta  
Langley  
Langley Twp  
Lions Bay  
Maple Ridge  
New Westminster  
North Vancouver  
North Vancouver District  
Pitt Meadows  
Port Coquitlam  
Port Moody  
Richmond  
Surrey  
Squamish  
Vancouver  
West Vancouver  
White Rock

##### **Whatcom, WA**

Point Roberts (Community) *also  
listed in USA Washington St Cities*

## **Fraser Valley**

Abbotsford  
Chilliwack  
Mission

## **Squamish-Lillooet**

Lillooet  
Pemberton  
Squamish  
Whistler

## **Thompson-Nicola**

Kamloops

## **Central Okanagan**

Kelowna  
Peachland

## **Okanagan-Similkamen**

Penticton  
Summerland

## **Victoria**

### **Capital**

Central Saanich  
Colwood  
Esquimalt  
Highlands  
Langford  
Metchosin  
North Saanich  
Oak Bay

Saanich  
Sidney  
Sooke  
Victoria  
View Royal

## **MANITOBA**

East St Paul  
Headingley  
West St Paul  
Winnipeg

## **NOVA SCOTIA**

Halifax (*partial*)

## **ONTARIO**

### **Brant**

Brant  
Brantford

### **Chatham-Kent**

Chatham-Kent

### **Dufferin**

Amaranth  
East Garafraxa  
East Luther Grand Valley  
Melancthon  
Mono  
Mulmur  
Orangeville  
Shelburne

## **Durham**

Ajax  
Brock  
Clarington  
Oshawa  
Pickering  
Scugog  
Uxbridge  
Whitby

## **Elgin**

Aylmer  
Bayham  
Central Elgin  
Dutton/Dunwich  
Malahide  
Southwold  
St. Thomas  
West Elgin

## **Frontenac**

Central Frontenac  
Frontenac Islands  
Kingston  
North Frontenac  
South Frontenac

## **Gatineau**

Gatineau



### ***Grey***

Blue Mountains  
Chatsworth  
Georgian Bluffs  
Meaford  
Grey Highlands  
Hanover  
Owen Sound  
Southgate  
West Grey

### ***Haldimand***

Haldimand

### ***Halton***

Burlington  
Halton Mills  
Milton  
Oakville

### ***Hamilton***

Hamilton

### ***Kawartha Lakes***

Kawartha Lakes

### ***Lambton***

Brooke-Alvinston  
Dawn-Euphemia  
Enniskillen  
Lambton Shores  
Oil Springs

Petrolia  
Plympton-Wyoming  
Point Edward  
Sarnia  
St Clair  
Warwick

### ***Lanark***

Beckwith  
Carleton Place  
Drummond/North Elmsley  
Lanark Highlands  
Mississippi Mills  
Montague  
Perth  
Smiths Falls  
Tay Valley

### ***Leeds and Grenville***

Athens  
Augusta  
Brockville  
Edwardsburgh/Cardinal  
Elizabethtown-Kitley  
Front of Yonge  
Gananoque  
Leeds and the Thousand Islands  
Merrickville-Wolford  
North Grenville  
Prescott  
Rideau Lakes  
Westport

### ***Muskoka***

Bracebridge  
Georgian Bay  
Gravenhurst  
Huntsville  
Lake of Bays  
Muskoka Lakes

### ***Middlesex***

Adelaide Metcalfe  
London  
Lucan Biddulph  
Middlesex Centre  
Newbury  
North Middlesex  
Southwest Middlesex  
Strathroy-Caradoc  
Thames Centre

### ***Niagara***

Fort Erie  
Grimsby  
Lincoln  
Niagara-on-the-Lake  
Niagara Falls  
Pelham  
Port Colborne  
St Catharines  
Thorold  
Wainfleet  
Welland  
West Lincoln

## *Norfolk*

Norfolk

## *Northumberland*

Alnwick/Halldimand  
Brighton  
Cobourg  
Cramahe  
Hamilton Twp  
Port Hope  
Trent Hills

## *Ottawa*

Ottawa

## *Oxford*

Blandford-Blenheim  
East Zorra-Tavistock  
Ingersoll  
Norwich  
South-West Oxford  
Tillsonburg  
Woodstock  
Zorra

## *Peel*

Brampton  
Caledon  
Mississauga

## *Perth*

North Perth  
Perth East  
Perth South  
St. Mary's  
Stratford  
West Perth

## *Prescott and Russell*

Alfred and Plantagenet  
Casselman  
Champlain  
Clarence-Rockland  
East Hawkesbury  
Hawkesbury  
Russell  
The Nation

## *Simcoe*

Adjala-Tosorontio  
Barrie  
Bradford West Gwillimbury  
Clearview  
Collingwood  
Essa  
Innisfil  
Midland  
New Tecumseth  
Orillia  
Oro-Medonte  
Penetanguishene

Ramara  
Severn  
Springwater  
Tay  
Tiny  
Wasaga Beach

## *Stormont, Dundas, and Glengarry*

Cornwall  
North Dundas  
North Glengarry  
North Stormont  
South Dundas  
South Glengarry  
South Stormont

## *Toronto*

Toronto

## *Waterloo*

Cambridge  
Kitchener  
North Dumfries  
Waterloo  
Wellesley  
Wilmot  
Woolwich

### **Wellington**

Centre Wellington  
Erin  
Guelph  
Guelph/Eramosa  
Mapleton  
Minto  
Puslinch  
Wellington North

### **York**

Aurora  
East Gwillimbury  
Georgina  
King  
Markham  
Newmarket  
Richmond Hill  
Vaughan  
Whitchurch-Stouffville

### **Windsor**

#### ***Essex***

Amherstburg  
Essex  
Kingsville  
Lakeshore  
Lasalle  
Leamington  
Pelee  
Tecumseh  
Windsor

#### **Inter-Town (partial) Coverage**

#### ***Counties/Districts/Regional***

#### ***Municipalities***

Brant  
Bruce  
Chatham-Kent  
Dufferin  
Elgin  
Essex  
Frontenac  
Gray  
Haldimand-Norfolk  
Haliburton  
Hastings  
Huron  
Kawartha Lakes  
Lambton  
Lanark

Leeds and Granville

Lennox and Addington

Middlesex

Muskoka

Northumberland

Oxford

Perth

Peterborough

Prescott and Russell

Prince Edward

Simcoe

Stormont, Dundas, and Glengarry

Waterloo

Wellington

## QUÉBEC

### **Montreal-Laurentians**

#### *Beauharnois-Salaberry*

Beauharnois  
Salaberry-de-Valleyfield  
St-Martine  
St-Étienne-de-Beauharnois  
St-Louis-de-Gonzague  
St-Stanislas-de-Kostka  
St-Urbain-Premier

#### *Deux-Montagnes*

Deux-Montagnes  
Oka  
Pointe-Calumet  
St-Eustache  
St-Joseph-du-Lac  
Ste-Marthe-sur-le-Lac  
St-Placide

#### *L'Assomption*

Charlemagne  
L'Assomption  
L'Épiphanie  
L'Épiphanie Paroisse  
Repentigny  
St-Sulpice

#### *La Rivière-du-Nord*

Prévost  
St-Colomban  
St-Hippolyte  
St-Jérôme  
Ste-Sophie

#### *La Vallée-du-Richelieu*

Beloeil  
Caringnan  
Chambly  
McMasterville  
Mont-St-Hilaire  
Otterburn Park  
St-Antoine-sur-Richelieu  
St-Basile-le-Grand  
St-Charles-sur-Richelieu  
St-Denis-sur-Richelieu  
St-Jean-Baptiste  
St-Marc-sur-Richelieu  
St-Mathieu-de-Beloeil

#### *LaJemmerais*

Calixa-Lavallée  
Contrecoeur  
St-Amable  
Ste-Julie  
Varennes  
Verchères

#### *Laval*

Laval

#### *Le-Haut-Richelieu*

Henryville  
Lacolle  
Mont-St-Grégoire  
Noyan  
St-Alexandre  
St-Blaise-sur-Richelieu  
St-Georges-de-Clarenceville  
St-Jean-sur-Richelieu  
St-Paul-de-L'Île-aux-Noix  
St-Sébastien  
St-Valentin  
Ste-Anne-de-Sabreviois  
Ste-Brigide-D'Iberville  
Venise-en-Québec

#### *Le Haut-St-Laurent*

Dundee  
Elgin  
Franklin  
Godmanchester  
Havelock  
Hinchinbrooke  
Howick  
Huntingdon  
Ormstown  
St-Anicet  
St-Chrysostome  
Ste-Barbe  
Très-St-Sacrement

### *Les-Jardins-De-Napierville*

Hemmingford  
Hemmingford Village  
Napierville  
St-Bernard-de-Lacolle  
St-Cyprien-de-Châteauguay  
St-Édouard  
St-Jacques-le-Mineur  
St-Michel  
St-Patrice-de-Sherrington  
St-Rémi

### *Les Laurentides*

Amherst  
Arundel  
Barkmere  
Brèbeuf  
Huberdeau  
La Conception  
La Minerve  
Labelle  
Lac-Supérieur  
Lantier  
Mont-Tremblant  
Montcalm  
St-Faustin-Lac-Carré  
Ste-Agathe-des-Monts  
Ste-Lucie-des-Laurentides  
Val-David  
Val-des-Lacs  
Val-Morin

### *Les Moulins*

Mascouche  
Terrebonne

### *Les Pays-D'en-Haut*

Lac-des-Seize-Îles  
Morin-Heights  
Piedmont  
Ste-Adolphe-d'Howard  
St-Sauveur  
Ste-Adèle  
Ste-Anne-des-Lacs  
Ste-Marguerite-Estèrel  
Wentworth-Nord

### *Longueuil*

Boucherville  
Brossard  
Longueuil  
St-Bruno-de-Montarville  
St-Lambert

### *Mirabel*

Mirabel

### *Montcalm*

St-Alexis  
St-Alexis Paroisse  
St-Calixte  
Ste-Julienne  
Ste-Marie-Salomé  
St-Esprit

St-Jacques  
St-Liguori  
St-Lin -- Laurentides  
St-Roch-de-l'Achigan  
St-Roch-Ouest

### *Montreal*

Baie-D'Urfé  
Beaconsfield  
Côte-St-Luc  
Dollard-des-Ormeaux  
Dorval  
Hampstead  
Kirkland  
L'Île -Dorval  
Montréal  
Montréal-Est  
Montréal-Ouest  
Mont-Royal  
Pointe-Claire  
Senneville  
Ste-Anne-de-Bellevue  
Westmount

### *Roussillon*

Candiac  
Châteauguay  
Delson  
La Prairie  
Lery  
Mercier

Intro

SEC

Ste-Catherine  
St-Constant  
St-Isidore  
St-Mathieu  
St-Philippe

### ***Sherbrooke***

Sherbrooke

### ***Therese-de-Blainville***

Blainville  
Boisbriand  
Bois-des-Filion  
Lorraine  
Rosemere  
Ste-Therese

### ***Vaudreuil-Soulanges***

Coteau-du-Lac  
Hudson  
Les Cèdres  
Les Coteaux  
L'Île-Cadieux  
L'Île-Perrot  
Notre-Dame-de-l'Île-Perrot  
Pincourt  
Pointe-des-Cascades  
Pointe-Fortune  
Rigaud  
Riviere-Beaudette  
St-Clet  
Ste-Justine-de-Newton

St-Lazare  
Ste-Marthe  
St-Polycarpe  
St-Telephore  
St-Zotique  
Terrasse-Vaudreuil  
Tres-St-Redempteur  
Vaudreuil-Dorion  
Vaudreuil-sur-le-Lac

### **Quebec**

#### ***La Cote-de-Beaupré***

Beaupré  
Boischatel  
Château-Richer  
L'Ange-Gardien  
St-Ferréol-les-Neiges  
St-Joachim  
St-Louis-de-Gonzague-du-Cap-  
Tourmente  
Ste-Anne-de-Beaupré

#### ***La Jacques-Cartier***

Fossambault-sur-le-Lac  
Lac-Beauport  
Lac-Delage  
Lac-St-Joseph  
Ste-Brigitte-de-Laval  
Ste-Catherine-de-la-Jacques-Cartier  
Shannon

### ***L'Île-d'Orléans***

St-François- L'Île-d'Orléans  
St-Jean  
St-Laurent-de- L'Île-d'Orléans  
St-Pierre-de- L'Île-d'Orléans  
Ste-Famille  
Ste-Pétronille

### ***Lévis***

Lévis

### ***Québec***

L'Ancienne-Lorette  
Notre-Dame-des-Anges  
Québec  
St-Augustin-de-Desmaures



Home



### **CANADA CONNECTOR ROADS**

The Cross-Canada Connector Road allows for travel between the provinces of British Columbia and Quebec in DCA 11. Major metropolitan city Points of Interest are also included.

#### **Road Inclusion**

##### ***Roads in the province of British Columbia***

- Hwy-1/Trans Canada Hwy from Alberta/BC boundary to Vancouver detailed city
- Hwy-3/Crowsnest Hwy from Hwy-1/Trans Canada Hwy (Hope) to Hwy-5/Coquihalla Hwy (Hope)
- Hwy-5/Coquihalla Hwy (in Hope) to Hwy-1/Trans Canada Hwy (in Kamloops)
- Hwy-99 between Vancouver and Whistler

##### ***Roads in the province of Alberta***

- Hwy-1/Trans Canada Hwy across whole province
- Hwy-1A from Cochrane to Canmore
- Hwy-1X from Hwy-1A to Hwy-1/Trans Canada Hwy
- Morley Road from Hwy-1/Trans Canada Hwy
- Hwy-3/Crowsnest Hwy (at Medicine Hat) to Lethbridge
- Hwy-4 (at Lethbridge) to 1-15 (U.S. border)
- Hwy-36 between Hwy-3 (in Taber) and Hwy-4 (in Warner)
- Hwy-3/Crowsnest Hwy (in Lethbridge) to Hwy-2 (in Fort Macleod)
- Hwy-2 (in Fort Macleod) to Hwy-1/Trans Canada Hwy (in Calgary)

##### ***Roads in the province of Saskatchewan***

- Hwy-1/Trans Canada Hwy across whole province

##### ***Roads in the province of Manitoba***

- Hwy-1/Trans Canada Hwy across whole province
- Hwy-100/Trans Canada Hwy in Winnipeg (partial beltway)
- Hwy-75 from Hwy-100/Trans Canada Hwy (Winnipeg) south to link with 1-29 (U.S. border)

##### ***Roads in the province of Ontario***

- Hwy-69/Trans Canada Hwy from Muskoka district to Sudbury
- Hwy-17/Trans Canada Hwy from Ottawa Detailed Area Coverage to Manitoba border
- Hwy-17B at Sault Ste Marie to link with 1-75 (U.S. border)
- Hwy-61 from Hwy-17 at Thunder Bay to link with US-61 (U.S. border)
- Hwy-11 from Muskoka district to North Bay
- Hwy-60 and Hwy-127 in Nipissing County

## Cities with available real-time in-car traffic information

The following cities currently have available real-time traffic information.

### In the U.S.

- Albany-Schenectady-Troy, NY
- Albuquerque, NM
- Allentown-Bethlehem, PA
- Atlanta, GA
- Austin, TX
- Baltimore, MD
- Birmingham, AL
- Boston, MA
- Buffalo-Niagara Falls, NY
- Charlotte-Gastonia-Rock Hill, NC
- Chicago, IL
- Cincinnati, OH
- Cleveland, OH
- Colorado Springs, CO
- Columbus, OH
- Dallas-Ft. Worth, TX
- Dayton, OH
- Denver-Boulder, CO
- Detroit, MI
- Fresno, CA
- Grand Rapids, MI
- Greensboro-Winston Salem-High Point, NC
- Greenville-Spartanburg, SC
- Harrisburg-Lebanon-Carlisle, PA
- Hartford-New Britain-Middletown, CT
- Houston-Galveston, TX
- Indianapolis, IN
- Jacksonville, FL
- Kansas City, KS

- Lancaster-York, PA
- Las Vegas, NV
- Lincoln, NE
- Little Rock, AR
- Los Angeles, CA
- Louisville, KY
- Memphis, TN
- Miami-Ft. Lauderdale-Hollywood, FL
- Milwaukee-Racine, WI
- Minneapolis-St. Paul, MN
- Mobile, AL
- Naples-Ft. Myers, FL
- Nashville, TN
- New Orleans, LA
- New York, NY
- Norfolk-Virginia Beach-Newport News, VA
- Oklahoma City, OK
- Omaha-Council Bluffs, NE
- Orlando, FL
- Philadelphia, PA
- Phoenix, AZ
- Pittsburgh, PA
- Portland, OR
- Portsmouth-Manchester, NH
- Providence-Warwick-Pawtucket, RI
- Raleigh-Durham, NC
- Richmond, VA
- Rochester, NY
- Sacramento, CA
- Salt Lake City, UT
- San Antonio, TX
- San Diego, CA
- San Francisco-Oakland, CA
- San Jose, CA
- Sarasota-Bradenton, FL
- Seattle-Tacoma, WA
- Spokane, WA

- St. Louis, MO
- Syracuse, NY
- Tampa-St. Petersburg-Clearwater, FL
- Toledo, OH
- Tucson, AZ
- Tulsa, OK
- Washington, DC
- West Palm Beach-Boca Raton, FL
- Wilkes Barre-Scranton, PA
- Wilmington, DE

### In Canada

- Toronto, ON
- Montreal, QB
- Vancouver, BC

Coverage may expand to other cities as traffic information in those cities becomes available. For the latest traffic coverage details for each metropolitan area, check:

[www.acura.com/realtimetraffic](http://www.acura.com/realtimetraffic).

This site provides traffic coverage for each city, a demonstration video, and FAQs.

### Operation in Alaska, Hawaii, Canada, and Puerto Rico

Certain functions that rely on a satellite signal will not work correctly. These functions include but are not limited to AcuraLink, and traffic- and weather-related services.

#### XM Radio

Navigation-equipped vehicles delivered to Alaska, Hawaii, Canada, and Puerto Rico are equipped with XM hardware, but XM broadcasting is not available; therefore sections of the manual that mention XM audio, traffic displays, weather information, and AcuraLink features do not apply.

Vehicles originally delivered to the U.S. mainland and shipped to Hawaii also have XM, but will not function because the XM satellites (aimed toward the U.S. mainland) are too far away to obtain reception.

### Alaska, Hawaii, Canada, and Puerto Rico

This section describes the differences in navigation system operation for vehicles delivered in Alaska, Hawaii, Canada, and Puerto Rico.

#### Map Coverage

All roads displayed on the map screens are detailed coverage roads. Text related to “unverified” roads or areas are not applicable. The following topics do not apply:

- Unverified road descriptions (see page [6, 106](#))
- Cautions and pop-up windows related to unverified roads (see page [72](#))
- Setup entries that relate to turning on or off unverified routing (see page [106](#))
- See the coverage section for a list of islands with coverage (see page [134](#))

#### Address and POI Entry Screens

The following differences occur for map, address, and POI selection:

- Entry of a destination address or POI on an island other than your current island may result in a screen caution message. This is normal because there are no “ferry” routes between islands available in the database.

#### Setup Screen Differences

The SETUP screen differences are minor and are listed below. See the Setup section (page [94](#)) for additional information.

#### AcuraLink/Messages

This item is grayed out on the SETUP screen (Other) because XM is not available.

#### Traffic & Weather Status

This item is grayed out on the SETUP screen (Other) because XM is not available.

### **Puerto Rico**

If **Street Name Guidance** is set to **ON**, the street names will not be read out by voice guidance. This may change with future data updates.

### **INFO Screen Differences**

#### **Messages**

The INFO screen **Messages** feature utilizes XM. Because XM is not available, it is not displayed on the INFO screen except messages such as the diagnosis information for the trouble of the car. In addition, the “Map menu” item **New Messages** will appear grayed out except messages such as the diagnosis information for the trouble of the car. This is normal.

#### **Traffic Incidents**

This item is grayed out on the INFO screen because XM is not available.

### **Weather Info.**

This item is grayed out on the INFO screen because XM is not available.

### **Map Legend**

The map legend “Traffic” and “Weather” descriptions may be available, but do not apply.

### **Shipping a Vehicle**

#### **Shipping a vehicle from Alaska, Hawaii, Canada, and Puerto Rico to the U.S. mainland**

- If you wish to receive XM audio, traffic, or weather, you must call XM and set up an account at (800) 852-9696.
- To begin receiving AcuraLink quick tips, contact Acura Client Relations at (800) 382-2238, and ask them to activate your AcuraLink unit.

### **Shipping a vehicle from the U.S. mainland to Alaska, Hawaii, Canada, and Puerto Rico**

- If a U.S. mainland-delivered vehicle is shipped to Alaska, Hawaii, Canada, and Puerto Rico, there is no XM reception.
- The issues under “Operation in Alaska, Hawaii, Canada, and Puerto Rico” apply.

### Map and Features, Voice Operation, Entering Addresses

Problem	Solution
Why does the Disclaimer screen need to be displayed every time I start the car? I am the only driver.	The Disclaimer screen reminds you and your guest drivers to always operate the navigation system in a safe manner.
I tried entering an address, but the city or street could not be found. Is there any other way to route to the location?	Some cities are lumped in with a major metro area. Try entering the street first. In rural “unverified” areas or new subdivisions, streets may be missing, or only partially numbered. Try selecting the destination directly from the map. See <i>By Map Input</i> on page 46.
When I enter an address, some letters become grayed out. Is this normal?	Yes. As you enter each letter in an address or a point of interest (POI), the system looks in the database to see what letters are possible and “grays out” letters that do not apply.
How do I delete Personal Addresses, Previous Destinations, or the Home Address?	This is done in the SETUP screen (Main Setup), under “Personal Information.” See page 95.
I cannot hear the navigation system voice.	1) Ensure that <b>Volume</b> in the SETUP screen (Main Setup) is not <b>OFF</b> . See page 95. 2) Go to “Basic Settings” in the SETUP screen (Other), and set <b>Voice Recognition Feedback</b> to <b>ON</b> . See page 104.
The voice control system is having difficulty recognizing my voice commands.	Ensure that the vents are not blowing on the microphone on the ceiling, the vehicle is as quiet as possible, and you are using the correct command when speaking (see <i>Improving Voice Recognition</i> on page 14). Say “Help” at any screen to see a list of the applicable voice commands. If the system cannot recognize your command because of background noise, speak louder.
When the system pronounces the street name in the guidance command or reads the destination address, it sounds strange. What causes this?	The basic guidance phrase uses a studio-recorded voice, but the street name is pronounced by the system using a machine-generated voice. Consequently, the name may be mispronounced or sound strange at times.
When I drive at night, the screen is bright and will not switch to the night display mode. Why?	Verify the following: The nighttime dash brightness control is not set to maximum, and <b>Map Color</b> in SETUP is set to <b>Black</b> for Night. See <i>Switching Display Mode Manually</i> on page 118.

Problem	Solution
The daytime map screen is dark like the night display mode, and it is hard to see. Why?	Verify the following: The <b>Map Color</b> in SETUP is set to <b>White</b> for Day. See <i>Switching Display Mode Manually</i> on page 118.
How do I change or remove my PIN?	Go to “Personal Information” in the SETUP screen (Main Setup), and select <b>PIN Number</b> . Select <b>GO Home 1 PIN</b> or <b>GO Home 2 PIN</b> or <b>Address Book PIN</b> and enter your existing PIN. You then have the choice to change or remove the PIN. See page 100.
I forgot the PIN for Home, or the PIN for personal addresses (DRIVER 1 or DRIVER 2). How do I reset it?	PINs are optional. See information regarding PINs on page 100. Your dealer can reset the PIN for you.
<b>CALL</b> is not available on the Calculate route to screen. Why?	Your phone is not paired to HFL, or if your phone is paired, it is in use; press the <b>HANG-UP</b> button.



### Traffic

Problem	Solution
My AcuraLink Real-Time Traffic is missing and is not displaying properly. What is wrong?	<p>Verify the following:</p> <ul style="list-style-type: none"> <li>• Check the traffic icon on the icon bar, and the icon options for traffic. Page 62 walks you through the verification steps.</li> <li>• Your XM traffic subscription may have expired. Call XM at (800) 852-9696 and verify your account status. If your subscription has lapsed, you may need to request a “rapid refresh.” After XM refreshes your account status, leave the vehicle running outside for 30 minutes to receive the refresh. See page 124 for the status of your subscription.</li> <li>• It is possible that there is a temporary technical problem with your metropolitan area traffic. You can call Acura Client Relations to see if there is an outage (page 132).</li> <li>• If the situation persists, see your Acura dealer for assistance.</li> <li>• AcuraLink relies on a satellite signal. It will not work in Alaska, Hawaii, Canada, and Puerto Rico.</li> </ul>
When I am driving a route on the freeway and Traffic Rerouting is <b>ON</b> , sometimes the system provides a detour route. Why is this?	The system will provide a detour route to your destination only if it can find a considerably faster route than the original one.
While traveling on my route on the freeway, the system has me exit and take an alternate freeway with unknown flow speeds or surface streets. Why is this?	Based on freeway congestion along your route, the system predicted that taking an alternate freeway or surface streets would be faster. Use your own experience to determine whether the alternate route would be faster.
How can I ignore the detour route and return to the original route?	Turn <b>Traffic Rerouting</b> to <b>OFF</b> in <b>SETUP</b> , under <b>Routing &amp; Guidance</b> (page 110).

## Guidance, Routing

Problem	Solution
The navigation system does not route me the same way I would go, or the way some other mapping program displays. Why is this?	The navigation system attempts to generate the optimum route. See <i>Changing the Route Preference</i> on page 53.
The navigation wants to route me around potential traffic problems. How do I stop these pop-up messages?	This feature can be turned off. See <i>Traffic Rerouting</i> on page 110.
Why is the street I'm on not shown on the map? It has been here for more than a year.	The mapping database is constantly undergoing revision. See page 134 for ways to obtain the latest detailed coverage information.
The vehicle position icon is not following the road and the "GPS icon" text in the upper left hand corner of the screen is white or missing.	<ul style="list-style-type: none"> <li>• The GPS antenna (located on the back of the navigation display) may be blocked by personal items. For best reception, remove items from the dashboard, such as radar detectors, cell phones, or loose articles.</li> <li>• Metallic tinting or other aftermarket devices can interfere with the GPS reception. Please see your dealer. Also see <i>System Limitations</i> on page 129.</li> </ul>
I entered a destination, but the blue highlighted route and voice guidance stopped, or turned into a blue/pink dashed line before I got to my destination. Why is this?	Your route has entered an unverified area. See <i>Unverified Area Routing</i> on page 106.
The map rotates while I make turns. How can I stop this?	Select the North-up map orientation by voice, or by selecting <b>North-up</b> from the <b>Map</b> menu. See <i>Map Orientation</i> on page 63.
Sometimes, I cannot select between the North-up and Heading-up map orientations. Why is this?	The Heading-up map orientation can only be shown in the lower scales (1/20 - 1 mile scales). See <i>Map Scale</i> on page 66.
While driving to my destination, the "time to go" display sometimes increases, even though I am getting closer.	The "Time to go" is based on actual road speeds. However if your speed slows down when you encounter slower traffic, the system updates the "Time to go" based on your actual speed to give you a better estimate of arrival time.

Problem	Solution
The vehicle position icon on the map “lags” a short distance behind, especially when I arrive at an intersection. Is there anything wrong?	No. When at an intersection, the system is unaware of the width of the intersecting road. Large differences in vehicle position can indicate a temporary loss of the GPS signal. See <i>GPS Reception Issues</i> on page 129.
While I drive, my screen shows white dots (“breadcrumbs”) on it. What do they mean?	These are called “breadcrumbs.” If you drive more than 1/2 mile from mapped roads, the off-road tracking feature begins to function. See <i>Off-road Tracking</i> on page 71 and 115.
How can I get rid of the white dots (“breadcrumbs”) from my screen?	Go to “Vehicle” in the <b>SETUP</b> screen ( <b>Other</b> ), and set <b>Off-road Tracking</b> to OFF, then return to the map. See page 115.
A road that I selected to avoid is being used when routing. What is wrong?	When you “draw” your area to avoid, make sure to select sections of roads that include at least one intersection. See page 110.
My elevation (shown when I display the current position) seems to fluctuate even though my elevation has not changed.	This is normal and due to errors in satellite position. The elevation can vary +/- 100 feet. See <i>System Initialization</i> on page 127.
My elevation is missing on the “current position” screen. Why?	If the GPS antenna cannot receive signals from at least four satellites, the elevation is not displayed. Try moving the vehicle into an open area. If the elevation is zero, or below sea level, the elevation is also not displayed.

## Updates, Coverage, Map Errors, Limitations

Problem	Solution
When is my city going to become part of a fully verified detailed coverage area?	The mapping database vendor is constantly revising map coverage. See page <a href="#">134</a> for ways to obtain the latest detailed coverage information.
Will the navigation system work outside North America?	The system contains maps for the 50 U.S. states, as well as for Canada and Puerto Rico. The system will not work in Mexico or overseas. See <i>Map Coverage</i> on page <a href="#">134</a> .
Can I play video DVDs in my navigation system?	No. The navigation system is designed only to read music discs. The system cannot read other mapping databases or video DVDs. If you experience any problems that you cannot resolve, please contact your dealer.
I found some errors in the database. How do I report them?	Minor errors are bound to occur in a large database. If you encounter major errors, you can report them following the instructions on page <a href="#">132</a> .



### Display, Accessories

Problem	Solution
The display appears dim when starting the car in really cold weather. Is there a problem?	No. This is normal, and it will become brighter after a few minutes.

### Rear Camera

Problem	Solution
When I shift gears, the rear camera image is delayed.	When shifting into or out of reverse, you may experience delays when the screen image switches between the navigation screen and the rear camera image. This is normal.
The rear camera image is too dark or too bright. How do I adjust the brightness?	While the camera image is displayed, use the rotating portion of the <b>Interface Dial (knob)</b> to adjust the brightness. This adjustment does not affect the <b>SETUP</b> screen brightness adjustments.

### Miscellaneous Other Questions

Problem	Solution
My clock frequently changes forward and backward by one hour. Why is this?	The clock is being automatically set based on your GPS location. If you live and work on the boundary between two time zones, you can turn off this feature. See page <a href="#">115</a> (Auto Time Zone).
When driving near a time zone border, the time changes even though I am not near the time zone. Why is this?	The time zone borders are only approximated in the system. Depending on the geography of the time zone boundary, the switch to a different zone can be erratic. See page <a href="#">115</a> (Auto Time Zone).
My state does not observe daylight saving time. How do I turn off this feature?	You can turn off this feature. See page <a href="#">114</a> (Auto Daylight).

Problem	Solution
Daylight saving time occurred, but the navigation system did not change time even though SETUP shows <b>Auto Daylight</b> is <b>ON</b> .	The automatic daylight saving time feature does not work in regions where the daylight saving time system is not adopted.
The navigation system automatic daylight time feature is not switching the navigation system clock on the correct dates. Why is this?	<ol style="list-style-type: none"> <li>1) Go to the <b>Clock adjustment</b> screen in SETUP and ensure that <b>Auto Daylight</b> is <b>ON</b>.</li> <li>2) The automatic daylight saving time feature does not work in regions where the daylight saving time system is not adopted. For more information, see page 114.</li> </ol>
The navigation system clock switched by one hour for no apparent reason. What can cause this?	You may be driving near a time zone boundary (see <i>Auto Daylight</i> on page 114). See page 115 (Auto Time Zone) for more information.
My battery was disconnected or went dead, and the navigation system is asking for a code. Where do I find this code?	There should be a card in the glove box with the anti-theft code for the navigation/audio system. This card contains the 5-digit security code and serial number. If you cannot find it, your dealer can help you out.
I speak a language other than English. Are there any other languages available for the system?	Besides English, you may select Français or Español for your language setting.



Screen Error Message	Solution
Display temp is too high. System will shut down until display cools down.	This message will appear briefly when the display temperature is too high, and then the display will turn off until the temperature cools down. The system will turn back on when the display cools down.
HDD access error. System reset...	The temperature is below -22°F (-30°C) and the navigation system has difficulty reading the HDD. The system will start up when the temperature warms up.
Route has not been completed. Please try again from a different location.	This message will appear when you are routing to or from a place (new area) that is not in the database. Try planning a different route to or from a different location.*
Destination is not in this database version. Please set from map.	The destination was not found in the database. Try another destination nearby, or select the destination with the <b>Interface Dial</b> .*

\* If the error persists, or is shown for a wide area, see your dealer.

## Glossary

The following is a glossary of terms pertaining to the voice recognition navigation system.

**Avoid Area** - Areas you wish to avoid can be entered into the system, and will be avoided while routing.

**Breadcrumbs** - Off-road tracking dots that can be followed on the map to retrace your route back to a mapped (digitized) road. This function can be turned on/off in the **SETUP** screen (Other).

**Database** - This consists of the map data, and the POI (Points of Interest) data stored on the HDD.

**DCA** - Detailed Coverage Area. United States, Canada, and Puerto Rico are mapped. See page [130](#) for a list of these areas.

**Digitized Road** - A road that appears on the navigation screen. The road name will appear at the bottom of the navigation screen. If the user drives “off road,” the navigation system will display “breadcrumbs,” depending on how far you drive from a mapped road.

**Disclaimer Screen** - Screen containing cautionary information. It is meant to be read carefully and acknowledged by the client when using the navigation system.

**FAQ** - Frequently Asked Questions. See page [151](#) for a list of the client FAQs and troubleshooting information.

**GPS** - Global Positioning System. A network of 24 satellites in orbit around the earth. The navigation system can simultaneously receive signals from up to 12 satellites to accurately position the vehicle on the map.

**GPS Antenna** - Located on the back of the navigation display, which is in the center of the dashboard. Electronic items operating in this general location can interfere with the GPS signal.

**HDD** - Hard Disk Drive. The primary data storage device containing your vehicle’s navigation and map software and uploaded wallpaper images. The HDD can also store audio files. See the Audio section of your Owner’s Manual for more information.

**HFL** - *Bluetooth*® HandsFreeLink®. Your vehicle is equipped with this feature, which uses Bluetooth technology as a wireless link between the vehicle and your Bluetooth-compatible cell phone.

**Icon** - Symbol representing Points of Interest (POI) that can be displayed on the map.

**Initialization** - This refers to the period needed to reacquire the GPS satellite orbital information whenever the navigation system power has been disconnected. This can take 10 to 45 minutes with the vehicle out in an open area.

**LCD** - Liquid Crystal Display. The navigation screen.

**Map Matching** - The received GPS information allows the navigation system to position the vehicle on the map. Map matching has occurred if the map screen is displaying the current street name in the bottom shaded area.

**Mic** - Abbreviation for the microphone used for receiving voice commands. It is located near the map lights in the ceiling.

**MW** - Maneuver Window. While en route to a destination, this window displays information about the next guidance point.

**Navi** - Abbreviation for the navigation system.

**North Pointer** - The map symbol showing the map orientation. See page 63.

**Off road** - This occurs when the user leaves mapped roads. Off-road tracking dots (“breadcrumbs”) are displayed if the option is enabled in the **SETUP** screen. The user can use them to return to a mapped road. The bottom of the navigation screen will say, “Not on a digitized road.”

**Outlying Areas** - These are rural areas that typically have only their main roads mapped. All other roads are shown in purple for reference only, since they have not been verified.

**PIN** - Personal Identification Number. A 4-digit number created by the client to protect personal information.

**POI** - Point of Interest. These are the businesses, schools, etc. found under **Place category** or **Place Name** on the MENU screen (Dest. MENU 1). See page 56.

**Polygon** - Colored areas on the map screen denoting parks, schools, etc. See Map Screen “features” for a list of the assigned colors. See page 56.

**Reminder** - Automatic pop-up Calendar message. See *Calendar* on page 88.

**Security Code** - Code needed to activate the navigation system or audio system. See *Entering the Security Code* on page 127.

**Unverified Streets** - These streets have not been verified for turn restrictions, one-way, etc. They are shown in purple on the map. Unverified streets may be missing from the map, shown in the wrong location, or have an incorrect name or address range.

**USB** - Universal Serial Bus. A computer hardware interface used to store and play audio files from USB devices, such as thumb drives or iPods. Image files can also be stored to USB devices and uploaded to the HDD. See the *Audio* section in your Owner's Manual for more information.

**Vehicle Speed Sensor** - Provides speed signal to the navigation system for moving the VP icon on the map.

**Verified Streets** - These streets consist of the detailed metropolitan coverage areas and all other inter-town connection roads. These roads are shown in black, red, or pink on the map.

**Voice Control** - See VR.

**VP** - Vehicle Position. When in map mode, this circular icon shows the vehicle position on the map. Push in on the **Interface Dial**, select **Map Information** on the Map menu, and then rotate the **Interface Dial Knob** to select **Current Location**. It shows the latitude, longitude, and elevation of your current position.

**VR** - Voice Recognition. This allows voice control of many of the navigation functions. The hardware consists of the microphone, voice control switch (**TALK/BACK** buttons), and the front speakers.

**Waypoint** - A temporary destination you may enter while en route (e.g., a gas station, ATM, etc.). See page 76.

**Yaw Rate Sensor** - Senses when the vehicle makes a turn, which makes the VP change direction on the map as you turn.

**Zagat Ratings** - Restaurant ratings information provided by Zagat Survey. See the INFO screen on page 92 for an explanation of the ratings.

### Global Commands

The system accepts these commands on any screen.

*Help* (displays the list of commands for current displayed screen)

*Display map* (displays the map screen)

*Display menu* (displays the MENU screen (Dest. MENU 1 or 2))

*Display information* (displays the INFO screen)

*Display audio screen* (displays the audio screen)

*Back* (to previous screen, same as **CANCEL** or **BACK** button)

*Cancel* (cancels current activity)

*What is today's date?* (reads the current date)

*What time is it?*

The “Voice Help” option on the INFO screen (Main Info.) lists many of the following controls. To avoid distraction while you are driving, the system can read the commands for you.

The commands are accessible at any time while driving and can be read to you so that you do not need to memorize all of them.

### Navigation Commands

#### General Commands

The system accepts these commands on a map/guidance screen.

*Display menu* (if en route, displays the MENU screen (Route))

*Display navigation* (if en route, displays the MENU screen (Route))

*Display map*

*Display map guide* (when en route, shows the next guidance point)

*Display information* (or just Information)

*Display audio screen*

*Cancel*

*Backward* (or just Back)

*What time is it?*

*What is today's date?* (reads the current date)

*Repeat voice* (repeats the screen prompt)

*Help* (reads list of Navigation General and Navigation Display Commands at any screen)

**Map Display Commands**

The system accepts these commands on a map/guidance screen.

*Display current location* (shows current latitude, longitude, and elevation)

*Display:* (display the selected icon on the screen)

*ATM*

*gas station*

*restaurant*

*post office*

*grocery store*

*lodging* (hotel, motel)

*parking garage*

*parking lot*

*school*

*hospital*

*one way*

*freeway exit information*

*traffic*

*traffic speeds*

*traffic icons*

*traffic incidents*

*weather*

*weather icons*

*Hide:* (hide the selected icon from the screen)

*ATM*

*gas station*

*restaurant*

*post office*

*grocery store*

*lodging* (hotel, motel)

*parking garage*

*parking lot*

*school*

*hospital*

*one way*

*freeway exit information*

*traffic*

*traffic speeds*

*traffic icons*

*weather*

*weather icons*

*Go home 1*

*Go home 2*

*Messages*

*Register the current location* (puts current location in the personal Address Book)

**Map Scale Commands**

*The system accepts these commands on a map/guidance screen.*

*Display north up*

*Display heading up*

*Display zoom in*

*Display zoom out*

*Display:* (the selected scale)

*1/20 mile (80 m) scale*

*1/8 mile (200 m) scale*

*1/4 mile (400 m) scale*

*1/2 mile (800 m) scale*

*1 mile (1600 m) scale*

*2 mile (3 km) scale*

*5 mile (8 km) scale*

*15 mile (24 km) scale*

*50 mile (80 km) scale*

*150 mile (240 km) scale*

*350 mile (560 km) scale*

*1000 mile (1600 km) scale*

*Max zoom in*

*Max zoom out*

### Find Place Commands

The system accepts these commands on a map/guidance screen.

*Find nearest:* (find the nearest selection)

*ACURA dealers*

*HONDA dealers*

*Gas station*

*Hydrogen station*

*Auto parts & electronics shop*

*Auto repair & maintenance shop*

*Car wash & detailing shop*

*Motorcycle dealers*

*Other car dealers*

*Roadside assistance*

*ATM*

*Bank*

*Check cashing*

*Currency exchange*

*Business*

*City hall*

*Civic center*

*Convention center*

*Court house*

*Higher education*

*Library*

*Post office*

*School*

*Hospital*

*Police station*

*Veterinarian*

*Bed & breakfast*

*Hotel*

*Resort*

*Amusement park*

*Golf course*

*Historical monument*

*Marina*

*Movie theater*

*Museum*

*Park*

*Performing arts*

*Sports complex*

*Tourist attraction*

*Restaurant*

*Zagat restaurant*

*American restaurant*

*Californian restaurant*

*Chinese restaurant*

*Café/Coffee shop*

*Continental restaurant*

*Fast food restaurant*

*French restaurant*

*German restaurant*

*Greek restaurant*

*Indian restaurant*

*Italian restaurant*

*Japanese restaurant*

*Korean restaurant*

*Mexican restaurant*

*Pizza*

*Seafood restaurant*

*Thai restaurant*

*Vegetarian restaurant*

*Vietnamese restaurant*

*Other restaurant*

*Shopping*

*Accessory store*

*Book store*

*Clothing store*

*Grocery store*

*Home improvement store*

*Mall*

*Office supply store*

*Pharmacy*

*Pet food store*

*Sewing store*

*Shoe store*

*Sporting goods store*

*Toy store*

*Airport*

*Automobile club*

*Bus station*

*Camping*



*Commuter rail station*  
*Ferry terminal*  
*Named place*  
*Park & ride*  
*Parking garage*  
*Parking lot*  
*Rental car agency*  
*Rest area*  
*Ski area*  
*Tourist information*  
*Train station*  
*Travel agency*  
*Truck stop*

### Route Commands

The system accepts these commands on a **map/guidance** screen when en route.

*How long to the destination?* (tells the time to destination)\*

*How far to the destination?* (tells the distance to destination)\*

*Display destination map* (shows the map of the destination)

*Display entire route* (adjusts the map scale so that the entire route is displayed)

\* These commands are not available if you scroll through the map while en route to a destination.

### Climate Control Commands

The system accepts these commands on most screens.

*Climate control automatic* (controls temperature to your selection)

*Climate control off*

*Air conditioner on\**

*Air conditioner off\**

*Climate control defrost on\**

*Climate control defrost off\**

*Rear defrost on\**

*Rear defrost off\**

*Climate control fresh air*

*Climate control recirculate*

*Climate control vent*

*Climate control bi-level* (vent and floor)

*Climate control floor*

*Climate control floor and defrost*

*Fan speed up*

*Fan speed down*

*Fan speed #* (#: 1-7) (for best voice control, lower the fan speed)

\* Repeating these commands switches (toggles) the function between On and Off, so the action that occurs may not match the command you speak.

*Temperature # degrees*  
(#: 57 - 87 degrees F)  
*Driver temperature # degrees*  
(#: 57 - 87 degrees F)  
*Passenger temperature # degrees*  
(#: 57 - 87 degrees F)  
*Temperature up*  
*Temperature down*  
*Driver temperature up*  
*Driver temperature down*  
*Passenger temperature up*  
*Passenger temperature down*  
*Temperature max hot*  
*Temperature max cold*  
*Driver temperature max hot*  
*Driver temperature max cold*  
*Passenger temperature max hot*  
*Passenger temperature max cold*  
*Temperature balance*  
*Temperature dual mode on*  
*Temperature dual mode off*  
*Front climate control automatic*  
*Front climate control off*

*Rear climate control automatic*  
*Rear climate control off*  
*Rear climate control vent*  
*Rear climate control floor*  
*Rear fan speed up*  
*Rear fan speed down*  
*Rear fan speed #* (#: 1-5)

\* Repeating these commands switches (toggles) the function between On and Off, so the action that occurs may not match the command you speak.

## Audio Commands

### Radio Commands

The system accepts these commands on most screens.

*Audio on*\*

*Audio off*\*

*Radio on*\*

*Radio off*\*

*Radio select FM1*

*Radio select FM2*

*Radio select AM*

*Radio tune to # FM* (#: frequency.  
Example Radio 95.5 FM)

*Radio tune to # AM* (#: frequency.  
Example Radio 1020 AM)

*Radio seek up*

*Radio seek down*

*Radio next station*

*Radio preset #* (#: 1-6)

*Radio FM preset #* (#: 1-6)

*Radio FM1 preset #* (#: 1-6)

*Radio FM2 preset #* (#: 1-6)

*Radio AM preset #* (#: 1-6)

\* Repeating these commands switches (toggles) the function between On and Off, so the action that occurs may not match the command you speak.

- Radio auto select\**
- Radio scan\**
- Radio select XM1*
- Radio select XM2*
- XM channel # (#: 1-255)*
- XM channel up*
- XM channel down*
- XM category up*
- XM category down*
- XM preset # (#: 1-6)*
- XM1 preset # (#: 1-6)*
- XM2 preset # (#: 1-6)*
- XM scan\**
- XM category scan\**
- XM channel scan\**
- XM category mode*
- XM channel mode*

\* Repeating these commands switches (toggles) the function between On and Off, so the action that occurs may not match the command you speak.

**NOTE:**

*Radio volume levels cannot be controlled using voice control. Use the buttons on your steering wheel. See your Owner's Manual for more information.*

## Disc Commands

The system accepts these commands on most screens.

- DISC play*
- DISC play track # (#: 1-30)*
- DISC skip forward*
- DISC skip back*
- DISC track random\**
- DISC track repeat\**
- DISC track scan\**
- DISC folder up*
- DISC folder down*
- DISC folder random\**
- DISC folder repeat\**
- DISC folder scan\**
- DISC normal play* (resumes “Play” from the random-, repeat-, or scan-play)

\* Repeating these commands switches (toggles) the function between On and Off, so the action that occurs may not match the command you speak.

## HDD Commands

The system accepts these commands on most screens.

- HDD play*
- HDD search* (activates Song By Voice™)
- HDD skip forward*
- HDD skip back*
- HDD album up\**
- HDD album down\**
- HDD genre up\**
- HDD genre down\**
- HDD artist up\**
- HDD artist down\**
- HDD track up*
- HDD track down*
- HDD playlist up\**
- HDD playlist down\**

\* These commands will be available in the corresponding playback mode. For example, the command “HDD artist up/down” works in the “artist” playback mode. For more information on the playback mode, see your Owner's Manual.

*HDD track random\**

*HDD track repeat\**

*HDD track scan\**

*HDD normal play* (resumes “Play from the random-, repeat-, or scan play)

*What/Who am I listening to?*

*Who is this?*

*What’s playing?*

*Who’s playing?*

*What album is this?*

- \* Repeating these commands switches (toggles) the function between On and Off, so the action that occurs may not match the command you speak.

## USB Commands

The system accepts these commands on most screens.

*USB play*

*USB play track #* (#:1-30)

*USB skip forward*

*USB skip back*

*USB track random\**

*USB track repeat\**

*USB track scan\**

*USB folder up*

*USB folder down*

*USB folder random\**

*USB folder repeat\**

*USB folder scan\**

*USB normal play* (resumes “Play” from the random-, repeat-, or scan-play)

- \* Repeating these commands switches (toggles) the function between On and Off so the action that occurs may not match the command you speak.

## iPod Commands

The system accepts these commands on most screens.

*iPod play*

*iPod search* (activates Song By Voice™)

*iPod skip forward*

*iPod skip back*

*iPod track shuffle\**

*iPod album shuffle\**

*iPod track repeat\**

*iPod normal play* (resumes “Play” from the shuffle- or repeat-play)

*What/Who am I listening to?*

*Who is this?*

*What’s playing?*

*Who’s playing?*

*What album is this?*

- \* Repeating these commands switches (toggles) the function between On and Off so the action that occurs may not match the command you speak.

## Bluetooth® Audio Commands

The system accepts these commands on most screens.

- Bluetooth Audio play*
- Bluetooth Audio skip forward*
- Bluetooth Audio skip back*
- Bluetooth Audio pause*
- Bluetooth Audio resume*

### NOTE:

*Bluetooth® audio commands may not work on some phones or Bluetooth® audio devices.*

## AUX Commands

The system accepts these commands on most screens.

- AUX play (or Auxiliary play)*

## Song By Voice™ Commands

The system accepts these commands on most screens.

- iPod Search (activates Song By Voice™)*
- HDD Search (activates Song By Voice™)*
- What/Who am I listening to?*
- Who is this?*
- What's playing?*
- Who's playing?*
- What album is this?*
- List album (specify album)*
- List artist (specify artist)*
- List composer (specify composer)*
- List genre (specify genre)*
- List playlist (specify playlist)*
- Play album (specify album)*
- Play artist (specify artist)*
- Play composer (specify composer)*
- Play genre (specify genre)*
- Play playlist (specify playlist)*
- Play song (specify song)*

### NOTE:

*Song By Voice™ commands are available for tracks stored in the HDD or iPod.*

## Rear Radio Commands

The system accepts these commands on most screens.

- Rear audio on\**
- Rear audio off\**
- Rear radio on\**
- Rear radio off\**
- Rear radio select FM1*
- Rear radio select FM2*
- Rear radio select AM*
- Rear radio tune to # FM*  
(#: frequency. Example Radio 95.5 FM)
- Rear radio tune to # AM*  
(#: frequency. Example Radio 1020 AM)
- Rear radio seek up*
- Rear radio seek down*
- Rear radio next station*
- Rear radio preset # (#: 1-6)*
- Rear radio FM preset # (#: 1-6)*
- Rear radio FM1 preset # (#: 1-6)*
- Rear radio FM2 preset # (#: 1-6)*
- Rear radio AM preset # (#: 1-6)*
- Rear radio auto select\**

\* Repeating these commands switches (toggles) the function between On and Off so the action that occurs may not match the command you speak.

*Rear radio scan\**

*Rear radio select XM1*

*Rear radio select XM2*

*Rear XM channel # (#: 1-255)*

*Rear XM channel up*

*Rear XM channel down*

*Rear XM category up*

*Rear XM category down*

*Rear XM preset # (#: 1-6)*

*Rear XM1 preset # (#: 1-6)*

*Rear XM2 preset # (#: 1-6)*

*Rear XM scan\**

*Rear XM category scan\**

*Rear XM channel scan\**

*Rear XM category mode*

*Rear XM channel mode*

- \* Repeating these commands switches (toggles) the function between On and Off so the action that occurs may not match the command you speak.

## **NOTE:**

*Radio volume levels cannot be controlled using voice control. Use the buttons on your steering wheel. See your Owner's Manual for more information.*

## **Rear CD Commands**

The system accepts these commands on most screens.

*Rear CD play*

*Rear CD play track # (#: 1-30)*

*Rear CD skip forward*

*Rear CD skip back*

*Rear CD track random\**

*Rear CD track repeat\**

*Rear CD track scan\**

*Rear CD normal play* (resumes “Play” from the random-, repeat-, or scan-play)

*Rear CD folder up*

*Rear CD folder down*

*Rear CD folder random\**

*Rear CD folder repeat\**

*Rear CD folder scan\**

- \* Repeating these commands switches (toggles) the function between On and Off so the action that occurs may not match the command you speak.

## **Rear DVD Commands**

The system accepts these commands on most screens.

*Rear DVD play*

*Rear DVD pause*

*Rear DVD title up*

*Rear DVD title down*

*Rear DVD chapter up*

*Rear DVD chapter down*

*Rear DVD title # (#: 1-30)*

*Rear DVD chapter # (#: 1-30)*

*Rear DVD title #1 chap. #2 (#1, #2: 1-30)*

*Rear DVD play track # (#: 1-30)*

*Rear DVD skip forward*

*Rear DVD skip back*

*Rear DVD track random\**

*Rear DVD track repeat\**

*Rear DVD track scan\**

*Rear DVD normal play* (resumes “Play” from the random-, repeat-, or scan-play)

- \* Repeating these commands switches (toggles) the function between On and Off so the action that occurs may not match the command you speak

*Rear DVD folder random\**

*Rear DVD folder repeat\**

*Rear DVD folder scan\**

- \* Repeating these commands switches (toggles) the function between On and Off so the action that occurs may not match command you speak.

## **Rear HDD Commands**

The system accepts these commands on most screens.

*Rear HDD play*

*Rear HDD skip forward*

*Rear HDD skip back*

*Rear HDD album up*

*Rear HDD album down*

*Rear HDD genre up*

*Rear HDD genre down*

*Rear HDD artist up*

*Rear HDD artist down*

*Rear HDD track up*

*Rear HDD track down*

*Rear HDD playlist up*

*Rear HDD playlist down*

*Rear HDD track random\**

*Rear HDD track repeat\**

*Rear HDD track scan\**

*Rear HDD normal play* (resumes “Play” from the random-, repeat-, or scan-play)

- \* Repeating these commands switches (toggles) the function between On and Off so the action that occurs may not match command you speak.

## **Rear iPod Commands**

The system accepts these commands on most screens.

*Rear iPod play*

*Rear iPod skip forward*

*Rear iPod skip back*

*Rear iPod track shuffle\**

*Rear iPod album shuffle\**

*Rear iPod track repeat\**

*Rear iPod normal play* (resumes “Play” from the shuffle- or repeat-play)

- \* Repeating these commands switches (toggles) the function between On and Off so the action that occurs may not match command you speak.



### **Rear AUX Commands**

The system accepts these commands on most screens.

*Rear AUX play (or Auxiliary play)*

### **Cellular Phone Commands**

The system accepts these commands only on the Cellular phone screens.

*Call # or “name” (voice tag)*

### **SETUP Screen (Main Setup) Commands**

The system accepts these commands on the SETUP screen (Main Setup). (For the SETUP screen (Other), simply say what is written on the screen, and follow the voice prompts)

*Brightness up*

*Brightness down*

*Brightness minimum/min.*

*Brightness maximum/max.*

*Contrast up*

*Contrast down*

*Contrast minimum/min.*

*Contrast maximum/max.*

*Black level up*

*Black level down*

*Black level minimum/min.*

*Black level maximum/max.*

*Volume up*

*Volume down*

*Volume minimum/min.*

*Volume maximum/max.*

*Volume off*

*Interface dial feedback off*

*Interface dial feedback auto*

*Interface dial feedback on*

## On-Screen Commands

The system accepts these commands on any screen. There are over 100 on-screen commands. Just say what is written on the screen (this excludes listed items).

*Next* (or “Down”)

*Previous* (or “Up”)

*Return*

*OK* (except at the Disclaimer screen)

*Delete*

## On-Screen Spelling Assist

When speaking the letters or using “spell mode,” you can substitute the name that represents each letter or symbol. This improves recognition. For example:

- To select the letter “A”:  
Say “**A**,” “**Alpha**,” or “**Apple**.”
- To select the letter “M”:  
Say “**M**,” “**Mary**,” or “**Mike**.”

The system will respond to the names shown in the following tables.

### NOTE:

- *The system will only respond to the names shown in the following tables.*
- *To select the letter “A,” you can also; select the “A” by using the **Interface Dial**.*
- *To select the number “1,” say “One” or “Number One,” or select the “1” by using the **Interface Dial**.*
- *To select the symbol “- (hyphen),” say “Hyphen” or “Symbol Hyphen,” or select the “-” by using the **Interface Dial**.*
- *When selecting letters using the voice control system, a confirmation box may pop up to confirm the letter.*

## Letters Assist Definitions:

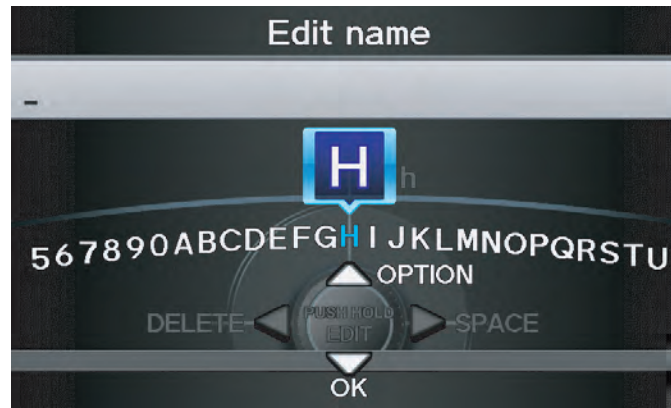

Say	Or say "..."	Say	Or say "..."	Say	Or say "..."	Say	Or say "..."
<b>A</b>	Alpha/Apple	<b>H</b>	Hotel/Henry	<b>O</b>	Oscar	<b>V</b>	Victor
<b>B</b>	Bravo/Boy	<b>I</b>	India/Igloo	<b>P</b>	Papa/Paul	<b>W</b>	Whiskey/William
<b>C</b>	Charlie	<b>J</b>	Juliet/John	<b>Q</b>	Quebec/Queen	<b>X</b>	X-ray
<b>D</b>	Delta/Dog	<b>K</b>	Kilo/King	<b>R</b>	Romeo/Robert	<b>Y</b>	Yankee/Yellow
<b>E</b>	Echo/Edward	<b>L</b>	Lima/Larry	<b>S</b>	Sierra/Sam	<b>Z</b>	Zulu/Zebra
<b>F</b>	Foxtrot/Frank	<b>M</b>	Mike/Mary	<b>T</b>	Tango/Tom		
<b>G</b>	Golf/George	<b>N</b>	November/Nancy	<b>U</b>	Uniform/Uncle		

## Symbol Assist Definitions:

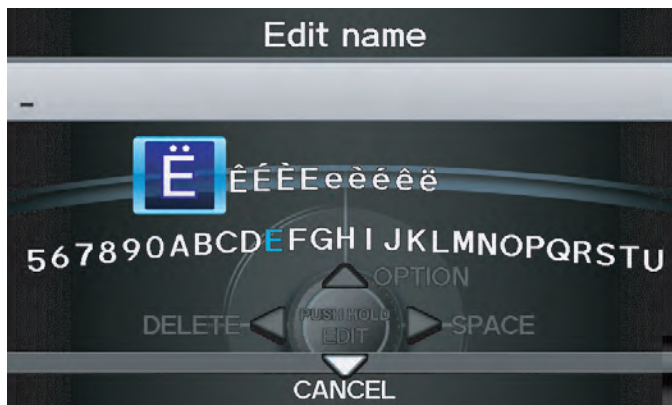

Symbols	Say "...” or “Symbol ...”	Symbols	Say "...” or “Symbol ...”	Symbols	Say "...” or “Symbol ...”
À	A grave	î	I circumflex	_	Underscore
Â	A circumflex	ï	I umlaut	`	Back quote
Ä	A umlaut	ô	O circumflex	,	Comma
Ç	C cedilla	ù	U grave	.	Dot
È	E grave	û	U circumflex	?	Question mark
É	E acute	ü	U umlaut	:	Colon
Ê	E circumflex	@	At sign	;	Semicolon
Ë	E umlaut	^	Caret	+	Plus
ì	I grave	*	Asterisk		

### NOTE:

The term “grave” (used for symbols À, È, ì, and Ù) is pronounced like “save.”

## Numbers and Additional Symbol Assist Definitions:



Numbers	Say "...” or “Number ...”	Symbols	Say "...” or “Symbol ...”	Symbols	Say "...” or “Symbol ...”
1	One	-	Hyphen	~	Tilde
2	Two	!	Exclamation point	/	Slash
3	Three	”	Double quote	<	Less than
4	Four	#	Pound	>	Greater than
5	Five	\$	Dollar	{	Open brace
6	Six	%	Percent	}	Close brace
7	Seven	&	Ampersand	↵	Enter
8	Eight	'	Apostrophe		
9	Nine	(	Open parenthesis		
0	Zero	)	Close parenthesis		

**A**

Accessing the Address Book List .....96  
 Acura Automobile Client Service .....132  
 AcuraLink Messages .....80  
 AcuraLink Real-Time Traffic .....23  
 AcuraLink Weather.....82  
 AcuraLink/Messages.....120  
 Add to Address Book .....52  
 Add to Dest. List.....52  
 Adding Waypoint.....76  
 Address .....28, 29, 97  
 Address Book .....28, 34, 95  
 Address Book PIN .....100  
 Advanced .....39  
 AUDIO button .....11  
 Auto Daylight.....114  
 Auto Service.....39  
 Auto Time Zone.....115  
 AUX Commands .....170  
 Avoid Streets .....75

**B**

BACK button.....13  
 Banking.....39  
 Basic Settings .....104  
 Black Level .....94

Bluetooth® Audio Commands ..... 170  
 Bluetooth® HandsFreeLink®..... 19  
 Breadcrumbs..... 20, 56, 71  
 Brightness ..... 94  
 By Address ..... 29  
 By Address Book ..... 34  
 By Coordinate..... 44  
 By Go Home 1 or 2 ..... 51  
 By Intersection..... 46  
 By Map Input..... 46  
 By Place Category..... 37  
 By Place Name ..... 36  
 By Place Phone Number ..... 43  
 By Previous Destination ..... 35  
 By ZAGAT® 2012 ..... 43

**C**

Calculator..... 90  
 Calendar..... 19, 88  
 Call ..... 19, 52  
 CANCEL button ..... 10  
 Cancel Route ..... 59, 75  
 Category..... 28, 37, 98  
 Cellular Phone ..... 81  
 Cellular Phone Commands..... 173  
 Change Route Preference..... 53, 75  
 Change State..... 29, 46  
 Changing the Route..... 74

Changing Your Destination..... 78  
 City ..... 30, 48  
 City Vicinity ..... 41  
 Clear Personal Data ..... 123  
 Client Assistance..... 132  
 Climate Control Commands ..... 166  
 Clock Adjustment ..... 114  
 Color ..... 117  
 Community..... 39  
 Continental USA ..... 50  
 Contrast..... 94  
 Convert (Unit)..... 90  
 Correct Vehicle Position ..... 116  
 Coverage Areas..... 134  
 Current Location ..... 21, 64  
 Current Position ..... 47, 97  
 Current Street..... 6

**D**

Database Limitations ..... 130  
 Delete Previous Destinations..... 101  
 Delete Waypoints ..... 77  
 Destination ..... 28, 52, 78  
 Destination Icon ..... 67  
 Destination List..... 77  
 Destination Map..... 54  
 Detailed Coverage Areas ..... 134, 139  
 Detour ..... 75



Directions .....59  
 Disc Commands.....168  
 Display Mode button.....11  
 Driving to Your Destination.....52

**E**

Edit Avoid Area.....110  
 Edit Waypoint Search Area.....112  
 Edit/Delete Address .....97, 99  
 Emergency .....39  
 Entering a Destination .....28  
 Entering an Address .....96  
 Entering Security Code.....127  
 Entering the Street Number.....34  
 Entering Your Schedule.....89  
 Error Message.....159  
 Exit Info.....60

**F**

Fav. Subcategory .....38  
 Find Nearest .....59  
 Find Place Commands.....165  
 Frequently Asked Questions .....151

**G**

General Commands.....163

Getting Started..... 10  
 Global Commands..... 163  
 Glossary ..... 160  
 Go Home 1 or 2 ..... 28, 51  
 Go Home 1 PIN ..... 101  
 Go Home 2 PIN ..... 101  
 Going Off the Route ..... 71  
 GPS Initialization..... 127  
 Guidance Menu..... 58, 59  
 Guidance Mode..... 113  
 Guidance Screen ..... 57  
 Guidance Screen Interruption..... 114

**H**

HDD Commands..... 168  
 Home Address ..... 99  
 Hotel/Motel (Lodging) ..... 39

**I**

Icon Bar ..... 62  
 Incident Icons ..... 68  
 INFO button ..... 10, 81  
 INFO Screen (Main Info.)..... 81  
 INFO Screen (Other)..... 88  
 Interface Dial..... 11  
 Interface Dial Feedback..... 95  
 Interface Dial knob..... 11

Intersection ..... 29, 46  
 iPod Commands ..... 169

**K**

Key to ZAGAT Ratings ..... 92

**L**

Landmark Icons ..... 67  
 Language..... 120  
 Leisure ..... 39  
 Lodging (Hotel/Motel)..... 39  
 Lower Display ..... 12

**M**

Map Color ..... 117  
 Map Coverage..... 134  
 Map Data Update Status ..... 92  
 Map Display Commands..... 164  
 Map Information ..... 59, 61  
 Map Input ..... 29, 46  
 Map Legend..... 65  
 Map Matching..... 128  
 Map Menu ..... 58  
 Map Orientation ..... 63  
 Map Scale..... 66  
 Map Scale Commands ..... 164



Map Screen .....20, 56  
 MAP/GUIDE button .....10, 57  
 MENU button .....10  
 Menu Color .....118  
 Messages .....80  
 Microphone .....13  
 Multi-view Rear Camera .....125  
 Music Search .....102

**N**

Name .....28, 36  
 Navigation Commands .....163  
 New Messages .....58

**O**

Off-road Tracking .....71, 115  
 On-Screen Commands .....174  
 On-Screen Spelling Assist .....174

**P**

Personal Information .....95  
 Phone Number .....28, 43  
 Phonetic Modification .....103  
 PIN Number .....100  
 Place Name .....28, 36, 41, 97

Previous  
 Destination ..... 28, 35, 97, 101

**R**

Radar Map ..... 84  
 Radio Commands ..... 167  
 Read List ..... 40, 84  
 Rear CD Commands ..... 171  
 Rear DVD Commands ..... 171  
 Rear HDD Commands ..... 172  
 Rear iPod Commands ..... 173  
 Rear Radio Commands ..... 170  
 Recalculation ..... 71, 105  
 Reporting Errors ..... 132  
 Rerouting ..... 105  
 Reset Factory Default ..... 123  
 Restaurant ..... 39, 40  
 Roadside Assistance ..... 92  
 Route ..... 52, 54, 71, 74  
 Route Commands ..... 166  
 Route Preference ..... 53  
 Routing & Guidance ..... 105

**S**

Save Current Location ..... 64  
 Scenic Road Information ..... 90  
 Schedule ..... 89

Screen ..... 12  
 Search by Keyword ..... 42  
 Security Code ..... 127  
 Selecting the City ..... 30, 48  
 Selecting the State ..... 29, 46  
 Selecting the Street ..... 32, 46  
 SETUP Screen (Main Setup) ..... 94  
 SETUP Screen (Main Setup)  
 Commands ..... 173  
 SETUP Screen (Other) ..... 102  
 Shopping ..... 39  
 Show Icon on Map ..... 62  
 Show Wallpaper ..... 93  
 Single-screen Mode ..... 61  
 Song By Voice™ ..... 102  
 Song By Voice™ Commands ..... 170  
 Sort by Distance to Travel ..... 41  
 Split-screen Mode ..... 61  
 State ..... 29, 46, 49  
 Street ..... 32, 46  
 Street Name Guidance ..... 113  
 Switching Display Mode ..... 118, 119  
 System Controls ..... 10  
 System Function Diagram ..... 27  
 System Information ..... 91  
 System Initialization ..... 127  
 System Limitations ..... 129  
 System Setup ..... 94



System Start-up.....18  
 System/Device Information .....91

**T**

TALK button .....13  
 Time Adjustment .....115  
 Traffic .....22, 23  
 Traffic & Weather Status.....124  
 Traffic Display Legend.....22  
 Traffic Incidents.....25, 58, 82  
 Traffic Rerouting .....73, 110  
 Travel .....39  
 Troubleshooting.....159

**U**

Unit Conversion.....90  
 Units (mile or km).....104  
 Unverified Area Routing .....107  
 Unverified Street.....6  
 Update .....133  
 Using the Voice Control System .....14

**V**

Vehicle.....115  
 Verified Street .....6  
 View Routes .....53

Visiting Your Dealer ..... 133  
 Voice ..... 58  
 Voice Command Index ..... 163  
 Voice Control Basics..... 13  
 Voice Guidance ..... 55  
 Voice Help ..... 86  
 Voice Recognition Feedback..... 104  
 Voice Recognition, Improving ..... 14  
 Volume ..... 95

**W**

Wallpaper..... 121  
 Warning Icon..... 85  
 Warning List..... 83  
 Warning Map..... 84  
 Waypoints ..... 76  
 Weather..... 68, 82  
 Weather Forecast ..... 83  
 Weather Icons ..... 68, 85  
 Weather Info..... 58, 82

**Z**

ZAGAT® 2012..... 43



## END USER LICENSE AGREEMENT

You have acquired a device (“DEVICE”) that includes software licensed by Alpine Electronics, Inc. (collectively “ALPINE”) from an affiliate of Microsoft Corporation (collectively “MS”). Those installed software products of MS origin, as well as associated media, printed materials, and “online” or electronic documentation (“SOFTWARE”) are protected by international intellectual property laws and treaties. The SOFTWARE is licensed, not sold. All rights reserved.

IF YOU DO NOT AGREE TO THIS END USER LICENSE AGREEMENT (“EULA”), DO NOT USE THE DEVICE OR COPY THE SOFTWARE INSTEAD. PROMPTLY CONTACT ALPINE FOR INSTRUCTIONS ON RETURN OF THE UNUSED DEVICE(S) FOR A REFUND. ANY USE OF THE SOFTWARE, INCLUDING BUT NOT LIMITED TO USE ON THE DEVICE, WILL CONSTITUTE YOUR AGREEMENT TO THIS EULA (OR RATIFICATION OF ANY PREVIOUS CONSENT).

- GRANT OF SOFTWARE LICENSE,  
This EULA grants you the following license:  
You may use the SOFTWARE only on the DEVICE.
- NOT FAULT TOLERANT.  
THE SOFTWARE IS NOT FAULT TOLERANT. ALPINE HAS INDEPENDENTLY DETERMINED HOW TO USE THE SOFTWARE IN THE DEVEICE, AND MS HAS RELIED UPON

ALPINE TO CONDUCT SUFFICIENT TESTING TO DETERMINE THAT THE SOFTWARE IS SUITABLE FOR SUCH USE.

- NO WARRANTIES FOR THE SOFTWARE,  
THE SOFTWARE is provided “AS IS” and with all faults. THE ENTIRE RISK AS TO SATISFACTORY QUALITY, PERFORMANCE, ACCURACY, AND EFFORT (INCLUDING LACK OF NEGLIGENCE) IS WITH YOU. ALSO, THERE IS NO WARRANTY AGAINST INTERFERENCE WITH YOUR ENJOYMENT OF THE SOFTWARE OR AGAINST INFRINGEMENT. IF YOU HAVE RECEIVED ANY WARRANTIES REGARDING THE DEVICE OR SOFTWARE THOSE WARRANTIES DO NOT ORIGINATE FROM, AND ARE NOT BINDING ON, MS.
- NO LIABILITY FOR CERTAIN DAMAGES.  
EXCEPT AS PROHIBITED BY LAW, MS SHALL HAVE NO LIABILITY FOR ANY INDIRECT, SPECIAL, CONSEQUENTIAL OR THE SOFTWARE. THIS LIMITATION SHALL APPLY EVEN IF ANY REMEDY FAILS OF ITS ESSENTIAL PURPOSE. IN NO EVENT SHALL MS BE LIABLE FOR ANY AMOUNT IN EXCESS OF U.S. TWO HUNDRED FIFTY DOLLARS (U.S. \$250.00).
- SPEECH RECOGNITION.  
If the SOFTWARE includes speech recognition component(s), you should understand that speech recognition is an

inherently statistical process and that recognition errors are inherent in the process. Neither ALPINE nor its suppliers shall be liable for any damages arising out of errors in the speech recognition process.

- LIMITATIONS ON REVERSE ENGINEERING, DECOMPILATION, AND DISASSEMBLY  
You may not reverse engineer, decompile, or disassemble the SOFTWARE, except and only to the extent that such activity is expressly permitted by applicable law notwithstanding this limitation.
- ADDITIONAL SOFTWARE/SERVICES.  
The SOFTWARE may permit ALPINE, MS, Microsoft Corporation or their affiliates to provide or make available to you SOFTWARE updates, supplements, add-on components, or Internet-base service components of the SOFTWARE after the date you obtain your initial copy of the SOFTWARE (“Supplemental Components”).
  - If ALPINE provides or makes available to you Supplemental Components and no other EULA terms are provided along with the Supplemental Components, then the terms of this EULA shall apply.
  - If MS, Microsoft Corporation or their affiliates make available Supplemental Components, and no other EULA terms are provided, then the terms of this EULA shall apply, except that MS, Microsoft Corporation or affiliate entity providing the Supplemental Component(s) shall be licensor of the Supplemental Component(s).

- ALPINE, MS, Microsoft Corporation and their affiliates reserve the right to discontinue any Internet-based services provided to you or made available to you through the use of the SOFTWARE.
- **RECOVERY MEDIA.**  
If SOFTWARE is provided by ALPINE on separate media and labeled “Recovery Media” you may use the Recovery Media solely to restore or reinstall the SOFTWARE originally installed on the DEVICE.
- **UPGRADES.**  
If the SOFTWARE is provided by ALPINE separate from the DEVICE on separate media or via web download or other means, and is labeled “For Upgrade Purposes Only” you may install one (1) copy of such SOFTWARE onto the DEVICE as a replacement copy for the existing SOFTWARE, and use it in accordance with this EULA, including any additional EULA terms accompanying the upgrade SOFTWARE.
- **TERMINATION.**  
Without prejudice to any other rights, ALPINE or MS may terminate this EULA if you fail to comply with the terms and conditions of this EULA. In such event, you must destroy all copies of the SOFTWARE and all of its component parts.
- **INTELLECTUAL PROPERTY RIGHTS.**  
All title and intellectual property rights in and to the SOFTWARE (including but not limited to any images, photographs, animations, video, audio, music, text and “applets,” incorporated into the SOFTWARE), the accompanying printed materials, and any copies of the

- SOFTWARE, are owned by MS, Microsoft Corporation, their affiliates or suppliers. The SOFTWARE is licensed, not sold.
- You may not copy the printed materials accompanying the SOFTWARE. All title and intellectual property rights in and to the content which may be accessed through use of the SOFTWARE is the property of the respective content owner and may be protected by applicable copyright or other intellectual property laws and treaties. This EULA grants you no rights to use such content. All rights not specifically granted under this EULA are reserved by MS, Microsoft Corporation, their affiliates and suppliers. Use of any on-line services which may be accessed through the SOFTWARE may be governed by the respective terms of use relating to such services. If this SOFTWARE contains documentation that is provided only in electronic form, you may print one copy of such electronic documentation.
- **TRADEMARKS.**  
This EULA does not grant you any rights in connection with any trademarks or service marks of ALPINE MS, Microsoft Corporation, their affiliates or suppliers.
- **PRODUCT SUPPORT.**  
Product support for the SOFTWARE is not provided by MS, its parent corporation Microsoft Corporation, or their affiliates or subsidiaries. For product support, please refer to ALPINE support number provided in the documentation for the DEVICE.  
Should you have any questions concerning this EULA, or if you desire to contact ALPINE for

any other reason, please refer to the address provided in the documentation for the DEVICE.

- **SOFTWARE TRANSFER ALLOWED BUT WITH RESTRICTIONS.**  
You may permanently transfer rights under this EULA only as part of a permanent sale or transfer of the Device, and only if the recipient agrees to this EULA. If the SOFTWARE is an upgrade, any transfer must also include all prior versions of the SOFTWARE.
- **EXPORT RESTRICTIONS.**  
You acknowledge that SOFTWARE is of US-origin. You agree to comply with all applicable international and national laws that apply to the SOFTWARE, including the U.S. Export Administration Regulations, as well as end-user, end-use and country destination restrictions issued by U.S. and other governments. For additional information on exporting the SOFTWARE, see <http://www.microsoft.com/exporting/>

*As required by the FCC:*

*1) This device complies with Part 15 of the FCC Rules and Canadian RSS-210/RSS-Gen. Operation is subject to the following two conditions: (1) this device may not cause harmful interference, and (2) this device must accept any interference received, including interference that may cause undesired operation.*

*2) The FCC requires the user to be notified that any changes or modifications made to this device that are not expressly approved by the party responsible for compliance may void the user's authority to operate the equipment.*

*3) This product emits radio frequency energy, but the radiated output power of this device is far below the FCC and IC radio frequency exposure limits. This equipment complies with FCC and IC RF radiation exposure limits forth for an uncontrolled environment. Nevertheless, the device should be used in such a manner that the potential for human contact with the antenna during normal operation is minimized.*

