

Bob Carver's
Sunfire
...from his mind & soul

*Theater Grand
Processor III*

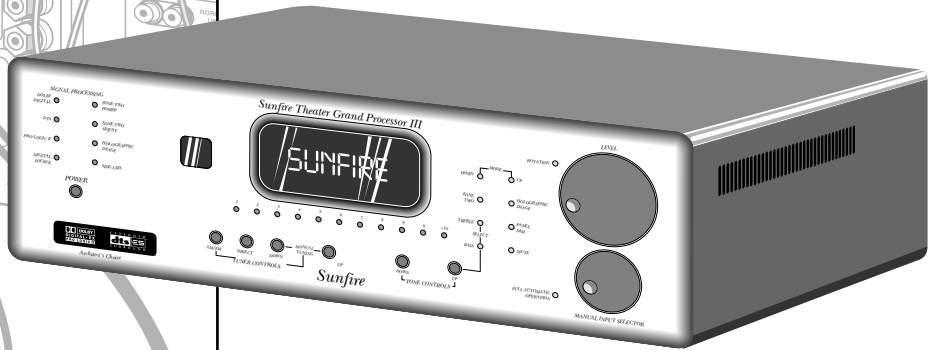

*Architect's Choice
and Standard Edition*

User's Manual

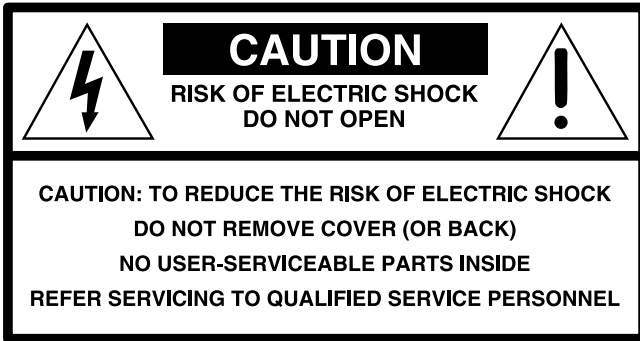

The lightning flash with arrowhead symbol within an equilateral triangle is intended to alert the user to the presence of uninsulated "dangerous voltage" within the product's enclosure, that may be of sufficient magnitude to constitute a risk of electric shock to persons.



The exclamation point within an equilateral triangle is intended to alert the user of the presence of important operating and maintenance (servicing) instructions in the literature accompanying the appliance.

Safety Instructions

- 1. Read Instructions** — All the safety and operation instructions should be read before the Sunfire Component is operated.
- 2. Retain Instructions** — The safety and operating instructions should be kept for future reference.
- 3. Heed Warnings** — All warnings on the Component and in these operating instructions should be followed.
- 4. Follow Instructions** — All operating and other instructions should be followed.
- 5. Water and Moisture** — The Component should not be used near water - for example, near a bathtub, washbowl, kitchen sink, laundry tub, in a wet basement, or near a swimming pool, etc.
- 6. Ventilation** — The Component should be situated so that its location or position does not interfere with its proper ventilation. For example, the Component should not be situated on a bed, sofa, rug, or similar surface that may block any ventilation openings; or placed in a built-in installation such as a bookcase, cabinet, or closed equipment rack that may impede the flow of air through ventilation openings.
- 7. Heat** — The Component should be situated away from heat sources such as radiators, or other devices which produce heat.
- 8. Power Sources** — The Component should be connected to a power supply only of the type described in these operation instructions or as marked on the Component.
- 9. Power Cord Protection** — Power-supply cords should be routed so that they are not likely to be walked upon or pinched by items placed upon or against them, paying particular attention to cords at plugs, convenience receptacles, and the point where they exit the Component.
- 10. Cleaning** — The Component should be cleaned only as recommended in this manual.
- 11. Non-use Periods**—The power cord of the Component should be unplugged from the outlet when unused for a long period of time.
- 12. Object and Liquid Entry** — Care should be taken so that objects do not fall into and liquids are not spilled into the inside of the Component.
- 13. Damage Requiring Service** — The Component should be serviced only by qualified service personnel when:
 - A.** The power-supply cord or the plug has been damaged; or
 - B.** Objects have fallen, or liquid has spilled into the Component; or
 - C.** The Component has been exposed to rain; or
 - D.** The Component does not appear to operate normally or exhibits a marked change in performance; or
 - E.** The Component has been dropped, or its cabinet damaged.
- 14. Servicing** — The user should not attempt to service the Component beyond those means described in this operating manual. All other servicing should be referred to qualified service personnel.

PORTABLE CART WARNING



Carts and stands - The Component should be used only with a cart or stand that is recommended by the manufacturer. A Component and cart combination should be moved with care. Quick stops, excessive force, and uneven surfaces may cause the Component and cart combination to overturn.



15. To prevent electric shock, do not use this polarized plug with an extension cord, receptacle or other outlet unless the blades can be fully inserted to prevent blade exposure.

Pour prévenir les chocs électriques ne pas utiliser cette fiche polarisée avec un prolongateur, un prise de courant ou une autre sortie de courant, sauf si les lames peuvent être insérées à fond sans laisser aucune partie à découvert.

16. Grounding or Polarization — Precautions should be taken so that the grounding or polarization means of the Component is not defeated.

This apparatus does not exceed the Class A/Class B (whichever is applicable) limits for radio noise emissions from digital apparatus as set out in the radio interference regulations of the Canadian Department of Communications.

ATTENTION — Le présent appareil numérique n'émet pas de bruits radioélectriques dépassant les limites applicables aux appareils numériques de class A/de class B (selon le cas) prescrites dans le règlement sur le brouillage radioélectrique édicté par les ministere des communications du Canada.

WARNING – TO REDUCE THE RISK OF FIRE OR ELECTRIC SHOCK, DO NOT EXPOSE THIS APPLIANCE TO RAIN OR MOISTURE.

CAUTION: TO PREVENT ELECTRIC SHOCK, MATCH WIDE BLADE OF PLUG TO WIDE SLOT, FULLY INSERT.

ATTENTION: POUR ÉVITER LES CHOCS ÉLECTRIQUES, INTRODUIRE LA LAME LA PLUS LARGE DE LA FICHE DANS LA BORNE CORRESPONDANTE DE LA PRISE ET POUSSER JUSQU'AU FOND.

EXAMPLE OF ANTENNA GROUNDING ACCORDING TO NATIONAL ELECTRICAL CODE INSTRUCTIONS CONTAINED IN ARTICLE 810—"RADIO AND TELEVISION EQUIPMENT"

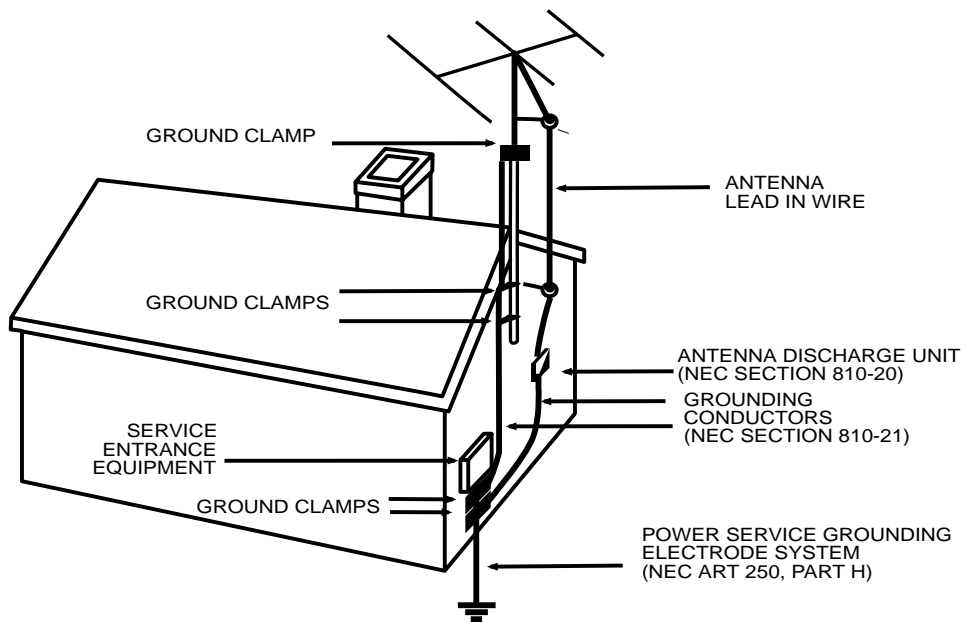

NEC NATIONAL ELECTRICAL CODE.

NOTE TO CATV INSTALLER







This reminder is to call the CATV system installer's attention to Article 820-40 of the NEC that provides guidelines for proper grounding and in particular, specifies that the cable ground shall be connected to the grounding system of the building as close to the point of cable entry as practical.

OUTSIDE ANTENNA GROUNDING

If an outside antenna is connected to the receiver, be sure the antenna system is grounded so as to provide some protection against voltage surges and built-up static charges. Article 810 of the National Electrical Code, ANSI/NFPA 70, provides information with regard to proper grounding of the lead-in wire to an antenna-discharge unit, connection to grounding electrodes, and requirements for the grounding electrode. See Figure above.



Contents

	Safety Instructions	2-3
	Chapter 1: Introduction	5
	Unpacking and Features	6
	Overview.....	7
	Quick Start Guide	8
	Front Panel Features.....	10
	Rear Panel Features	12
	Installation	14
	Chapter 2: System Configurations	15
	Chapter 3: Remote Control	25
	Chapter 4: On Screen Display	30
	Speaker Calibration	40
	Chapter 5: Using the Theater Grand III	42
	Bass Management.....	42
	Surround Modes	43
	Tuner Operation	45
	Recording	46
	Zone 2 Operation.....	47
	The Holographic Image	48
	CD Software Upgrade	48
	Appendix:	
	Speaker Placement	49
	The RS-232 Port.....	51
	Troubleshooting Guide	52
	Remote Control Codes.....	55
	Favorite Settings.....	57
	Specifications	58
	Limited Warranty	59
	Service Assistance	59

Read the **Safety Instructions** carefully before connecting and using your Sunfire Theater Grand Processor III (TGIII).

Chapter 1 is a general introduction to the features, details and installation of your TGIII.

Chapter 2 shows many options for connecting your source equipment and amplifiers to the TGIII.

Chapter 3 describes the details and operation of the advanced remote control.

Chapter 4 shows the various menus of the On Screen Display, and how to adjust and customize your TGIII.

Chapter 5 describes the available modes, options and operational details of the TGIII.

The Appendix shows some additional information, including a troubleshooting guide, the Warranty and service assistance details

To find out more about this and other Sunfire products, please visit our website: **www.sunfire.com**



Introduction

Bob Carver's
Sunfire
...from his mind & soul

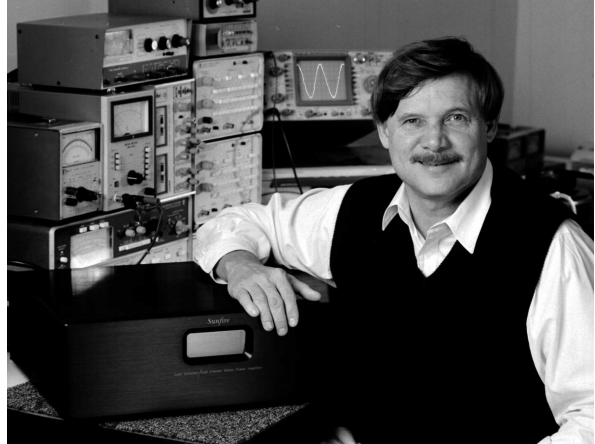

Bob Carver, Audio Designer, Physicist

Dear Friend,

Thank you for purchasing my Sunfire Theater Grand Processor III. I hope that you enjoy it and the music it makes as much as I have enjoyed creating it for you.

The Sunfire Theater Grand Processor III is unlike any home theater product on the market. For one thing, we have taken special pains to make it as easy to use as possible. We've designed it to virtually do the thinking for you, so you can quickly figure out how to listen to your favorite videotape, DVD or to bring in your favorite FM station.

When you use the "Full Automatic Operation" feature, the correct settings are made by its sophisticated microprocessors. So, when you turn on your video component, the processor will choose the proper input for you. All you have to do is adjust the volume the way you want, then sit back and enjoy. The same holds true if you wish to listen to a CD, watch a DVD and more. We've also made the Theater Grand Processor III highly flexible so you can easily adjust it to suit your taste.

As with our entire line of Sunfire products, the Theater Grand Processor III is brimming with exclusive, high-performance technology that will help you get the highest level of enjoyment from your home theater system. These include:

- High quality digital signal processor supports sampling rates up to 96 kHz
- Dolby Digital EX and Dolby Pro Logic II processing
- DTS ES and DTS Neo:6 processing
- FM/AM tuner with 40 station presets, and active dynamic FM noise reduction
- DSP Holographic Imaging, which gives a greatly enhanced soundstage
- Automatic 5.1 channel mode selection
- Balanced audio outputs
- Two Zone operation
- Pre-programmed and learning LCD remote control

The Theater Grand Processor III lets you run all of your audio and video components from a single easy-to-use control center. So you can experience the extraordinary, dynamic, full-range, multidimensional, wall-to-wall theater sound.

Bob Carver



Unpacking

Your Theater Grand Processor III should reach you in perfect condition. If you do notice any shipping damage, please contact your Sunfire Dealer immediately.

Gently lift out the unit and remove all the packing material and accessories. It is important to save all the packing materials and the box in case your Theater Grand Processor III ever needs to be moved or shipped for repair.

Make sure that you keep your sales receipt. It is the only way to establish the duration of your Limited Warranty and it may come in useful for insurance purposes.

Please take a moment to fill out and mail the Sunfire Customer Response card. Also read the serial number located on the rear panel and record it here:

Serial #:

Purchased at:

Date: _____

Features

- Fully automatic signal-sensing for audio and video input selection
- Dolby Digital EX[®], Dolby Pro Logic II[®], DTS ES[®] and DTS NEO:6[®] decoding modes
- Zone 2 can play sources independent of the Main Zone
- Six A/V inputs, each with audio, S-video and composite video
- Three A/V outputs, each with audio, S-video and composite video
- Three audio-only inputs, including MM Phono
- 8 channel analog input with separate RCA connectors
- On Screen Display (OSD)
- Two Tape record outputs
- Three component video inputs and two component video outputs
- Six coaxial and four optical digital inputs
- Coaxial and optical digital outputs (including from analog and down-mixed 5.1 sources)
- Flash memory upgradable through RS232 or CD
- IEEE 1394 port (FireWire[™]) for future expansion.
- Treble and Bass tone controls
- RS-232 control port with discrete codes
- Trigger outputs for both zones
- IR control of both zones, with rear IR ports and discrete codes.
- Supports all digital sampling rates to 96 kHz
- 24-bit Crystal Semiconductor[®] Analog to Digital converter
- 24-bit, 192 kHz Analog Devices[®] Digital to Analog converters
- 32-bit, 20 MHz control micro-processor and 24-bit, 150 MIPS Motorola Symphony[™] DSP processor
- DSP “simulated” surround mode for two channel sources
- Party mode allows two channel playback through all speakers
- DSP Holographic Imaging for unbelievable soundstage enhancement
- AM/FM tuner with 40 presets
- Gold plated inputs and outputs
- 7.1 channel outputs plus stereo side outputs for a total of 9.1 channels
- Record outputs are a downmixed 2 channel output from a 5.1 digital source
- Direct 2-channel analog bypass mode
- Balanced XLR outputs and unbalanced RCA outputs
- Four subwoofer outputs
- IEC removable power cord
- Steel chassis with thick, milled aluminum faceplate

Remote Features

- Fully backlit
- Pre-programmed for most brands of A/V equipment
- Learns commands from your other remote controls
- Macro feature lets you program a sequence of control steps
- Operates up to ten components
- Does not lose programming memory when changing batteries



Overview

Most features of the Theater Grand Processor III can be operated by the remote control's TGIII section.

For the best Home Theater performance, you should calibrate your speakers and customize the TGIII settings for your system. Press the MENU button on the remote control to activate the On Screen Display (OSD). This has several menus which will allow you to set up your speakers and calibrate your system correctly.

The remote can also be used to activate and control all features of the second zone.

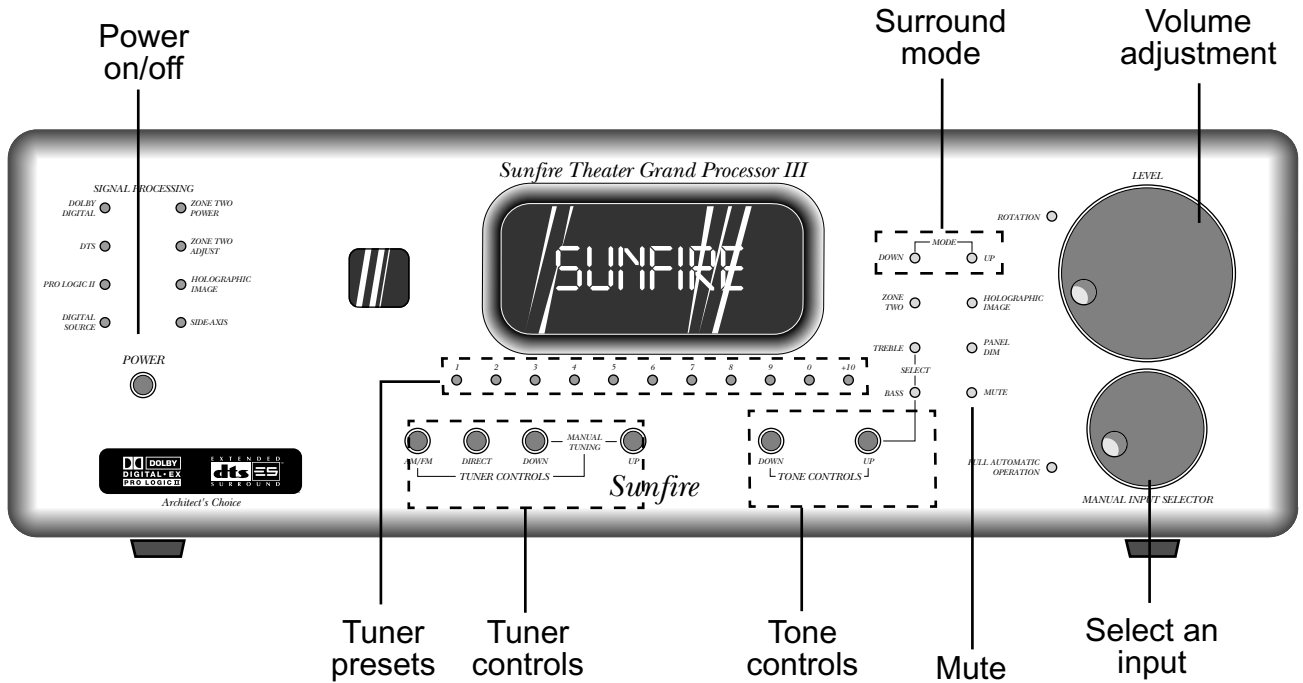
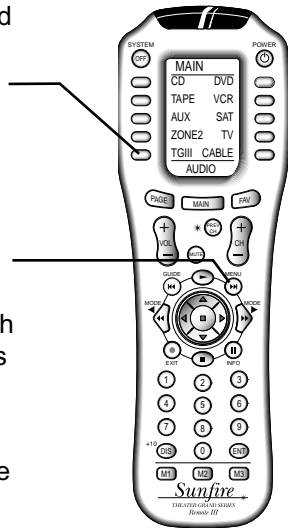

The Theater Grand Processor III is available in two versions:

- 17" wide chassis model, designed as part of the "Architect's Choice" line of preamplifiers and amplifiers. This series of 17" wide components makes an ideal choice for fitting into Home Theater entertainment centers and for specifying in custom installations.
- 19" wide chassis model, designed as an ideal match for the Sunfire range of two and five channel amplifiers.

The illustrations in this manual show the Architect's Choice model. Apart from the chassis, the two models are identical in all operational details, features and connections.

Please note that for the rest of this manual, "Theater Grand Processor III" is abbreviated to "TGIII."



Quick Start Guide

We hope that the following details will help you get started using your Theater Grand Processor III.

1. Take care to read and follow the safety instructions on pages 2-3. Also make sure that you read the notes and details throughout the manual, especially notes marked with a warning triangle (⚠).
2. Add batteries to the remote control.
3. Connect your source equipment and amplifiers to the TGIII. See the hookup diagrams on pages 15-24.

⚠ Make sure that all of your equipment remains unplugged from the AC mains until you have made all the connections.

4. Connect the speakers to your amplifiers.
5. In your DVD player's Audio setup menu, set the digital output to **BITSTREAM**. If this is not set correctly, the TGIII cannot decode the digital information for 5.1 surround sound playback.
6. The TGIII has a bass management system which allows the bass from each speaker to be redirected to a subwoofer. Larger speakers can play the full frequency range, and smaller speakers such as satellite types can have their bass redirected. See page 42 for more details.

Make a note of which speakers you would like to play the full frequency range (Large) and those which will have the bass redirected (Small). Also make a note of the approximate distance of each speaker from your listening position.

7. Turn on the TGIII, and then turn on your amplifiers, TV and other source equipment.

8. Press the remote MAIN button a few times to make sure you are on the Main Menu in the remote's display.
9. Set the remote to operate the TGIII by pressing the TGIII button.

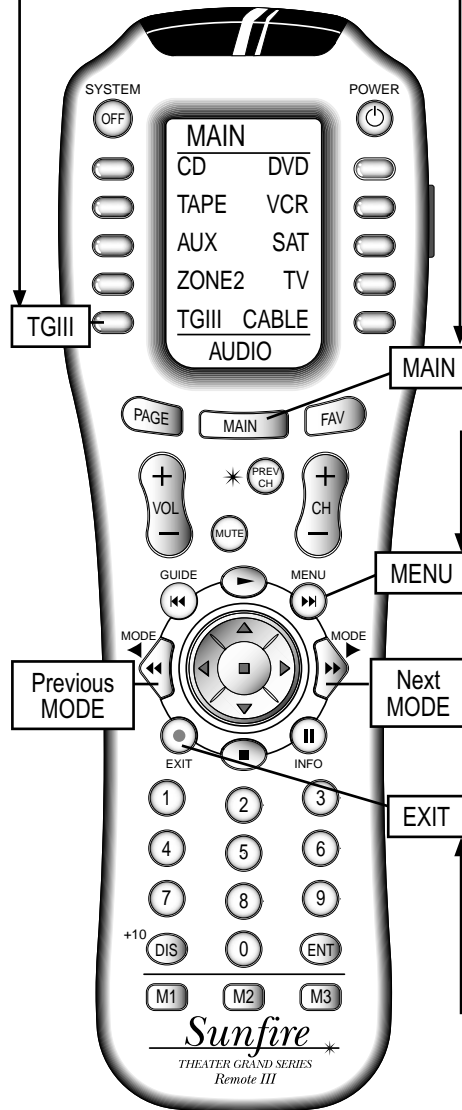

13. The TGIII now needs to be setup correctly to suit your speakers and system. The following On Screen Display (OSD) menus are used to enter and make three main adjustments:

- Speaker Size
- Speaker Calibration
- Speaker Position

This setup needs to be done when you use your system for the first time, or if you change anything such as the amplifiers or speakers, or the speaker position. The calibration is also a good way to check that your system is working correctly. These adjustments are made using the OSD as follows:

- 13.1 Press MENU on the remote to bring up the MAIN Menu of the OSD on your TV.

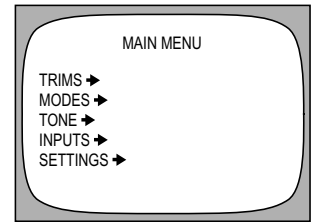

- 13.2 Use the joystick pad left, right, up and down buttons to navigate through the menus in the next steps.

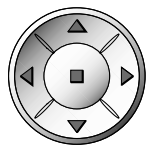

NOTE: you can quit the OSD at any time by pressing EXIT on the remote. Any changes you make will be saved. There is no need to navigate back through previous pages, unless you want to make more changes.

When the OSD is active, the TGIII front panel display shows an abbreviated message of where you currently are in the menus.

10. Turn down the TGIII volume and use the remote or front panel input selector to select a video source.
11. Play the source, and bring up the volume to suit your taste. Make sure the video can be seen in the TV monitor.
12. Stop or pause the source.



13.3 In the MAIN Menu, select the SETTINGS Menu, and then the SPEAKERS Menu.

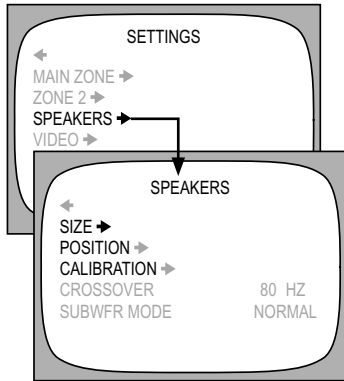

13.4 In the SPEAKERS Menu, select the SIZE Menu.

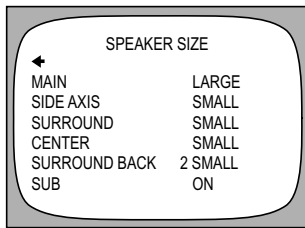

Use the joystick pad to set the size of each speaker to Small or Large, or set to OFF for those speakers which are not present. Return to the SPEAKERS Menu when you are finished.

13.5 In the SPEAKERS Menu, select the CALIBRATION Menu to adjust the output of each speaker. A test noise plays in each selected speaker, and you use the remote to adjust the volume of each speaker until they are all playing at the same level. Return to the SPEAKERS Menu when you are finished.

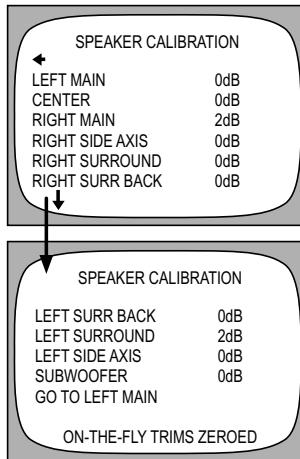

13.6 In the SPEAKERS Menu, select the SPEAKER POSITION Menu.

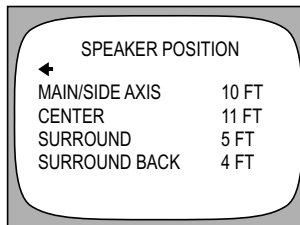

Enter how far each speaker is from your listening position. You can measure it with a tape, or do a visual estimation.

13.7 Press the remote's EXIT button to quit the On Screen Display. Now the TGIII is setup correctly and ready for action.

14. If you play a Dolby Digital or DTS encoded source, the TGIII will automatically select the correct surround mode. If it is a 2-channel source, you can select a surround mode using the remote's MODE buttons or from the front panel.

15. You might want to turn on the front panel "Fully Automatic" button near the Volume control. This will let the TGIII select an input source automatically, whenever the source starts to play.

16. The TGIII has many more options which are described in further detail in the OSD menu section on page 30. These options will help you customize the TGIII to suit your tastes. You can do this after you have used the TGIII for a while and have a better idea of how you would like to customize your system.

17. Enjoy your new Theater Grand Processor III. It will allow you to listen to many great and wonderful performances, from Big Band 78s in surround sound, to the latest space-action blockbuster with up to nine speakers and a subwoofer fully engaged.

Further Information

For more details, see the following pages of the manual:

- Remote Control: Page 25
- On Screen Display: Page 30
- Speaker Size: Page 38
- Speaker Position: Page 39
- Speaker Calibration: Page 40
- Bass Management: Page 42
- Surround Modes: Page 43



Front Panel Features

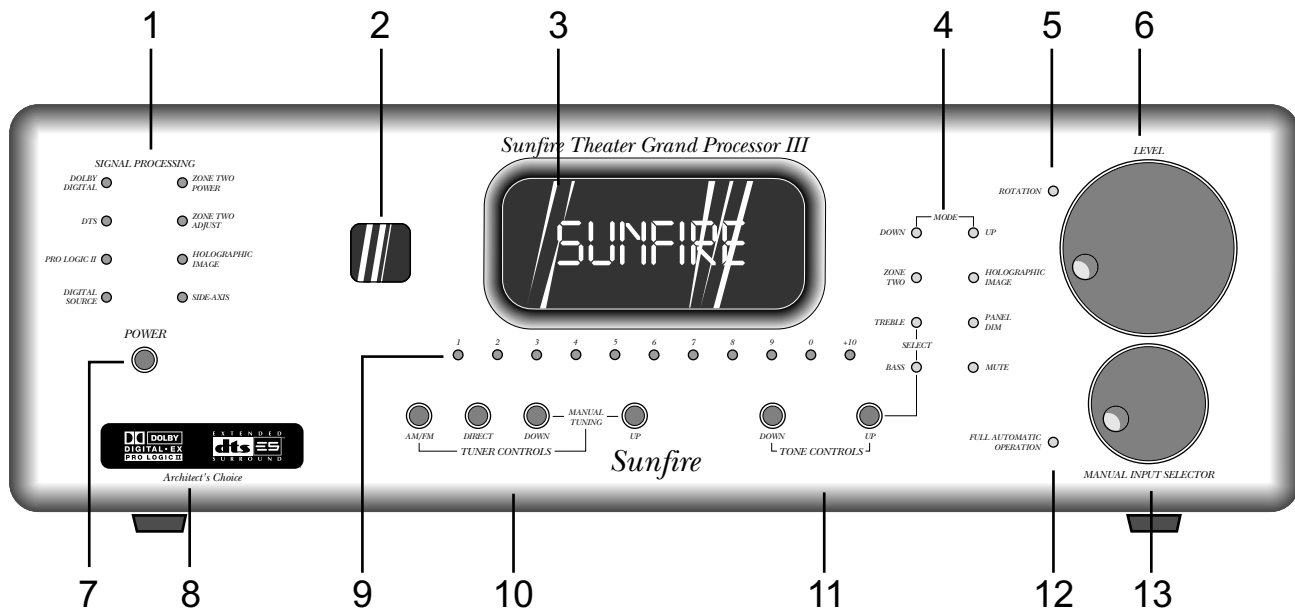

1. Signal Processing

DOLBY DIGITAL

This light is on when a Dolby Digital signal is being decoded.

DTS

This light is on when a DTS signal is being decoded.

DOLBY PRO LOGIC II

This light is on when the Dolby Pro Logic II mode is engaged.

DIGITAL SOURCE

This light is on when a Digital signal is being decoded.

ZONE TWO POWER

This light is on when Zone 2 is turned on.

ZONE TWO ADJUST

This light is on when Zone 2 is being adjusted.

HOLOGRAPHIC IMAGE

This light is on when the HOLOGRAPHIC IMAGE "circuit" is engaged. (This is actually modeled in DSP).

SIDE AXIS

This light is on when the side-axis outputs are enabled.

2. IR Receiver Window

This window should be clean and free from obstruction for the remote control to work correctly.

3. Processor Display

This soothing blue display shows which input is selected, the tuner frequency, volume level, and other useful features.

4. Mode Buttons

MODE UP/DOWN

These buttons allow you to step up or down through the various sound playback modes.

ZONE TWO

Note: If Zone 2 has not been enabled (see page 36) this button has no effect.

Any changes you make after pressing this, will affect Zone 2 and not the Main Zone. For example, press this and POWER to turn on Zone 2, then adjust the Volume and select an input. Press ZONE 2 again to revert back to Main Zone operation. It will also revert back after a short period of no activity.

TREBLE/BASS SELECT

Use these buttons to select either the Treble or Bass for adjustment using the UP/DOWN TONE controls (11).

HOLOGRAPHIC IMAGE

Engage this "circuit" to add a three dimensional effect, especially to stereo listening.

PANEL DIM

The front panel lights have four levels: bright, medium, low and off (low intensity display with amber LEDs off).

MUTE

This turns off the sound. Press it again, or adjust the volume control to return to the previous volume level.

5. Rotation

This light pulses when the front panel volume LEVEL or INPUT SELECTOR are being rotated, or when you are using the remote control.



Front Panel Features

6. Level

Rotate this manual control clockwise to increase the volume. The dB level will appear in the front panel display. Note that the control knob does not rotate when the remote is used. When turning on a new source, make sure the level is low, such as -80 dB and increase it slowly. The dB display becomes less negative as the volume increases.

Note: When the TGIII is turned on, it has a deliberately slow and smooth volume ramp from silence, up to the level that was set when the unit was last turned off. It can also be set to come up to a preset volume you can select, rather than the previous volume.

7. Power

This turns the TGIII on or off. It is a non-latching momentary button. If you press ZONE TWO first, it can turn on Zone 2 (even if the Main Zone is off).

8. Illuminated Logo Panel

This warmly lit panel is always on, and shows the fundamental technologies of the TGIII.

9. Tuner Presets

1-9, 0, +10

These buttons are used to select your favorite stations, previously stored as presets. For example:

Press	Result
3	Preset 3
+10,0	Preset 10
+10,3	Preset 13
+10,+10,3	Preset 23

See page 45 for more details of the Tuner operation.

10. Tuner Controls

AM/FM

This button toggles between the AM or FM band. Press and hold it to engage a scan of the station presets. Press it again or press a preset button to stop the scan.

DIRECT

Use this to enter a station's frequency directly using the 0 - 9 keys, such as 9, 5, 7 for 95.7 MHz.

UP/DOWN

Switch to stations above or below the frequency of the current station. If repeatedly pressed, the tuner will move up or down one frequency step each time. If held down for a second or more, the tuner will automatically keep tuning stations. Press UP or DOWN once again to stop when it reaches a station you like.

11. Tone

To change the tone, first press BASS or TREBLE and then press UP or DOWN to suit your taste. The display will show the change in dB level for reference. The range for both BASS and TREBLE is +/- 10 dB in steps of 1 dB.

Note: The Tone controls do not affect the LFE channel, or the 8-Channel analog input

The unit returns to its normal display after a few moments of inactivity, and any level changes are retained.

The BASS and TREBLE levels can also be adjusted using the OSD TONE Menu and the remote control.

12. Full Automatic Operation

When this is engaged, the TGIII will automatically switch to the next input which starts to play. For example, if you turn on your CD player and press Play, the TGIII will switch to CD. When you turn on your VCR and press Play, it will select the VCR input.

If the TGIII is turned off while the Auto mode is engaged, it will turn on and select an input whenever an input becomes active. For example, if you turn on your CD player and press Play, the TGIII will turn on and select the CD input.

We recommend that you turn off this feature if you are selecting the inputs manually, or recording.

Repeatedly pressing the Fully Automatic button will cycle through the active inputs.

Note: The automatic input switching will not occur unless the FULLY AUTOMATIC OPERATION button has been pressed (its light is on).

13. Manual Input Selector

Use this control to select the source you want to listen to.

Note: After you have selected an input, you should check that the TGIII is set to the desired surround mode (or the stereo mode).

Using the On Screen Display (OSD) INPUTS menu, each input can be adjusted in level so that all the inputs have similar volumes. Each input can also be set to enter a desired surround mode whenever that input is selected.



Rear Panel Features

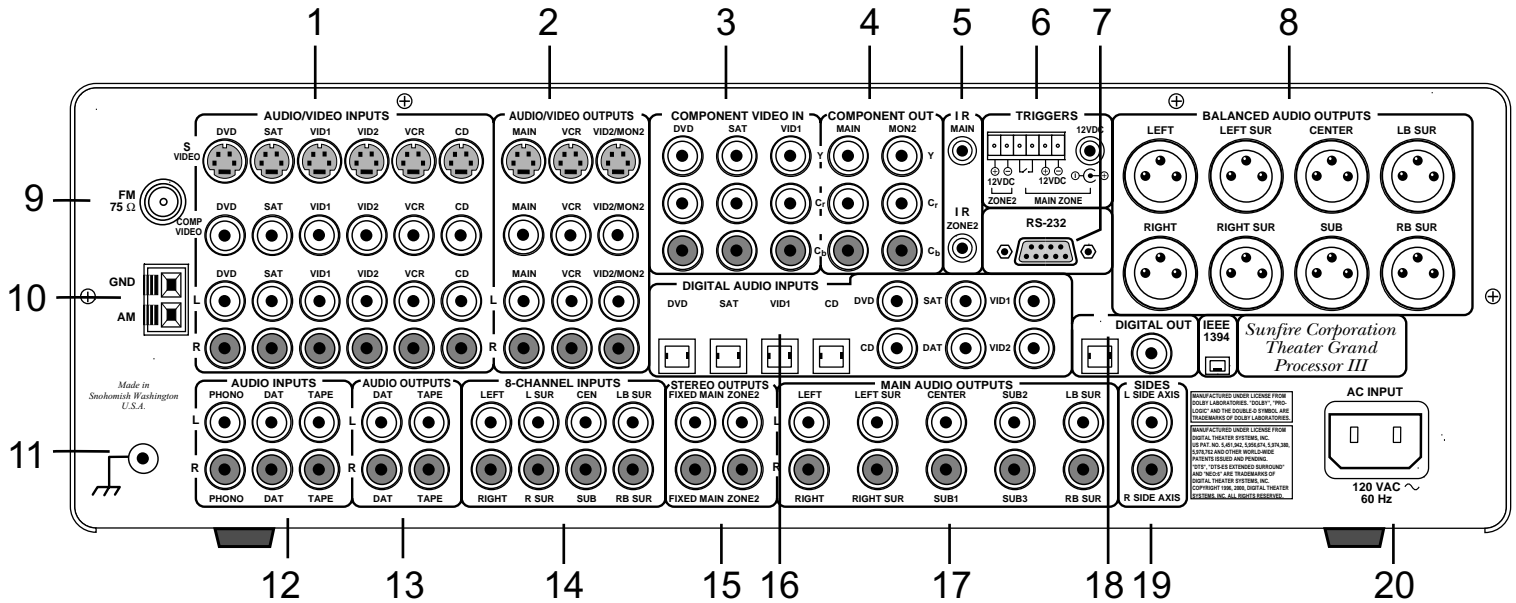

1. Audio/Video Inputs

These audio, composite-video and S-video inputs connect to the outputs of your audio video components. When these inputs are selected, the audio will be heard in your system and the video will be seen on the TV screen. VID2 can be used for a second VCR.

2. Audio/Video Outputs

MAIN: connects to the inputs of a TV monitor, where the video of any selected input and the On Screen Display (OSD) can be viewed. The audio connections allow you to listen to any selected audio source through your TV's speakers.

VCR: connects to the inputs of a VCR to allow recording.

VID2/MON2: connects to the input of a second VCR for recording, or to a second TV. When configured in the OSD for "VID2," this output is muted whenever the VID2 input is selected. This prevents feedback; also there is no OSD then on this output. When configured for "MON2," the output is always active, the same as the Main output.

Note: Analog audio signals are present at these L and R outputs even if a digital input has been selected. The output is a 2 channel downmix if the digital source is more than 2 channels.

3. Component Video In

These inputs connect to the component-video outputs of your DVD, SAT or other video source (VID1) if they have this advanced capability. When these inputs are selected, the Processor will automatically route any video signals going into these jacks to the component video outputs. Note that component video provides the best picture compared to composite or S-video. The TGIII can also switch HDTV signals.

4. Component Video Out

If your TV Monitor has component video inputs, connect them to these outputs. If you select DVD, SAT or VID1, then any video signals going to the component inputs, will pass through to your TV monitor. Note that the OSD is not available from the component video outputs.

5. Infrared (IR) Inputs

These are used in custom installations to control the Main Zone and Zone 2 from a remote location. The input accepts 1/8" mono mini-jacks from standard remote control IR equipment, such as those made by Xantech and other companies. The remote sensors can be in a different room, or in a preferred location in your main room.

6. Triggers and Relay

The relay switch is normally open, and it will close after a short delay, when selecting a source. This can be used in installations to trigger video screen deployment, or other custom purposes. The OSD INPUTS menu allows you to choose which inputs will activate the relay.

The +12 VDC outputs are on whenever their zone is enabled. Sunfire amplifiers have a +12 VDC input which allows them to be turned on automatically by the TGIII. The 1/8" mini-jack is wired in parallel with the terminals. Do not exceed a current draw of 500 mA total for both outputs.



Rear Panel Features

7. RS-232 Port

This connects to the serial port of a home computer, allowing the TGIII Flash memory software to be upgraded. Latest software can be downloaded from www.sunfire.com.

The port can also connect to the serial port of a Home Theater Controller, allowing the TGIII to be operated remotely.

8. XLR Audio Outputs

These line-level balanced XLR outputs connect to the XLR inputs of your amplifiers and powered subwoofer. The outputs are: front left, front right, center, left surround, left surround back, right surround back, right surround and one subwoofer (LFE) output.

If your amplifier has a choice of inputs, we recommend using the XLR balanced type. This gives better noise rejection, especially for longer cable runs.

9. FM Antenna

The supplied FM antenna fits this "F-type" screw-on connector. Other antennas can be fitted for improved reception.

10. AM Antenna

These connections are for the included AM loop antenna.

11. Ground Screw

This is commonly used for the ground connection wire of a turntable, to prevent any hum in your speakers. It is tied to the chassis ground, and may be used as needed.

Note: It is not necessary or desirable to connect this to an electrical ground.

12. Audio Inputs

These audio inputs connect to the outputs of your turntable, DAT or TAPE player. Any standard audio component with a line-level output can be connected to DAT or TAPE. Only a turntable with a moving-magnet, or high-output moving-coil cartridge can be connected to the PHONO input.

13. Audio Outputs

These audio outputs connect to the analog record inputs of your tape decks, such as DAT, cassette or reel to reel. These outputs allow you to record the selected audio program. Note that these also allow analog recording from digital audio sources.

14. 8-CH Input

These analog audio inputs can connect to the output of an external surround processor, or a source component such as DVD-Audio, SACD, or a DVD player with its own surround decoder. You can select this as an input from the front panel or remote control. The eight channels of analog audio will then pass into the TGIII.

Note: This is designed to be a very short analog-only signal path. DSP-based effects such as tone controls, bass management and DSP surround are bypassed. This input is not available in Zone 2.

15. Stereo Outputs

FIXED MAIN is a line level output, and the volume is not adjustable. This can be used as a record output, or to feed another audio system.

ZONE 2 connects to the inputs of a stereo amplifier to run Zone 2. The volume and source are adjustable, either from the front panel, or from a remote IR sensor.

16. Digital Inputs

These inputs connect to the digital outputs of your audio/video components. The DVD, SAT and VID1 and CD inputs have two options, optical or coaxial. The DAT and VID2 inputs are coaxial only.

Whenever one of these inputs is selected from the front panel or remote, the TGIII will automatically select the digital input if there is a signal present, otherwise it will select the corresponding analog input.

17. Main Audio Outputs

These line-level RCA outputs connect to the inputs of your amplifiers and powered subwoofer(s). There are outputs for front left, front right, center, left surround, left surround back, right surround back, right surround and three identical subwoofer (LFE) outputs.

18. Digital Output

This S/PDIF output is active for all sources except the 8-channel input. It allows you to record digital audio, for example to a DAT or CD-R.

19. Side-Axis Outputs

These outputs provide two optional front side channels to complement the left, center, right, surround and surround back channels. They can be turned on or off using the Speaker Size OSD menu (see page 38).

20. IEC Linecord Socket

The TGIII comes with a detachable linecord which connects here.

Plug the linecord into an AC wall socket or power strip which is correctly configured with the voltage specified for your model.



Installation

Observe the following precautions when choosing a location for your TGIII:

- Protect it from prolonged exposure to direct sunlight and other direct sources of heat, such as heating vents and radiators.
- Do not expose the unit to rain or moisture. If fluid or a foreign object should enter the unit, immediately turn off the power and contact your Sunfire Dealer.
- Avoid excessive exposure to extreme cold or dust.
- Do not place heavy objects on top of the unit.

AC Power Considerations

Ensure that the unit is plugged into an outlet capable of supplying the correct voltage specified for your model.

Care

If you need to clean the front surface, first turn off the power and then use a soft dry cloth, rubbing with the grain. Be careful not to scratch the display window.

Connection Tips

Before setting up your new system, please consider the following :



Always make sure that your components are all turned OFF, or unplugged before making or changing any connections.

- Whenever possible, route the power cords away from the signal cables or speaker wires to prevent any hum or interference heard in the speakers.
- Choose reliable hookup cables. They should be fully shielded and as short as possible.

- Use quality coaxial digital cables to connect the TGIII to any source equipment which has coaxial digital outputs.
- Some patch cords can be a very tight fit and there is usually a preferred method of getting them off. Some have to be removed with a twisting action. Be gentle or you may damage the jacks of your TGIII, or other components.
- Some audiophile cables should be hooked up in one direction, these are usually marked with arrows.
- It is usual for the right channel patch cord plugs to be red and the left channel connections to be white, grey or black. Composite video connections are usually yellow.
- If your amplifier has XLR inputs, use balanced connections as they provide superior rejection of hum and noise, especially if long cables are required.

Video Connections

The TGIII has three types of video connections: composite video, S-video, and component video. There are no internal connections between these three different types; if you put a composite video signal in, you will only get composite video out. Choose component or S-video if your video system supports it, this will give better picture quality than composite video.

When an audio/video component is selected, the audio will play in your system and the video will be switched to a video input of your TV monitor.

You must have the TV connected in order to see the On Screen Display (OSD). Note that the OSD is not available with component video, just composite or S-video.

Video Screen Trigger

The Main Zone and Zone 2 12 VDC terminals each supply 12 VDC whenever that zone is turned on. This can be used to turn on power amplifiers equipped with a 12 V trigger input.

The two middle terminals marked as relay contacts are connected together only when the Main Zone is on *and* an input is selected for which the trigger output is enabled. The OSD INPUTS Menu can be used to select which inputs have the trigger output enabled or disabled (see page 34).



Use all standard safety precautions and make sure all the equipment is disconnected before making any connections.

Here are two connection options:

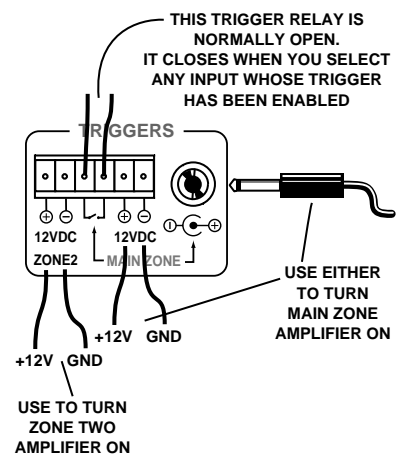

DO NOT use the relay contacts for 120 VAC or 240 VAC switching! They are only for low voltage AC/DC loads of 2 A maximum.

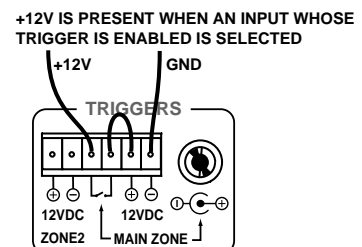

System Configurations

The following pages show some typical connections that you might make in your installation. They show how the inputs and outputs of the TGIII are connected to various audio and video components.

Analog audio and composite video

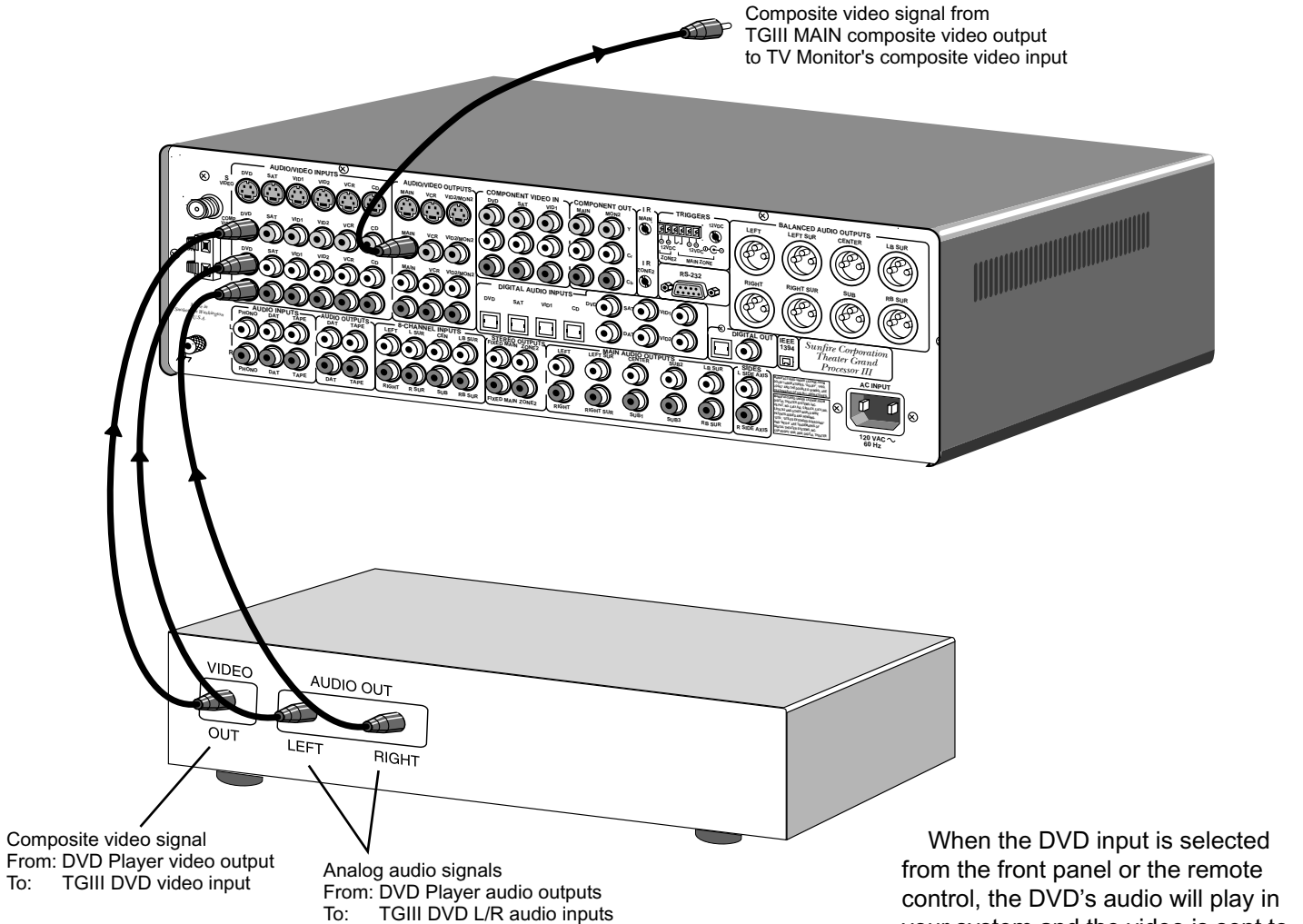



Digital audio and component video connections

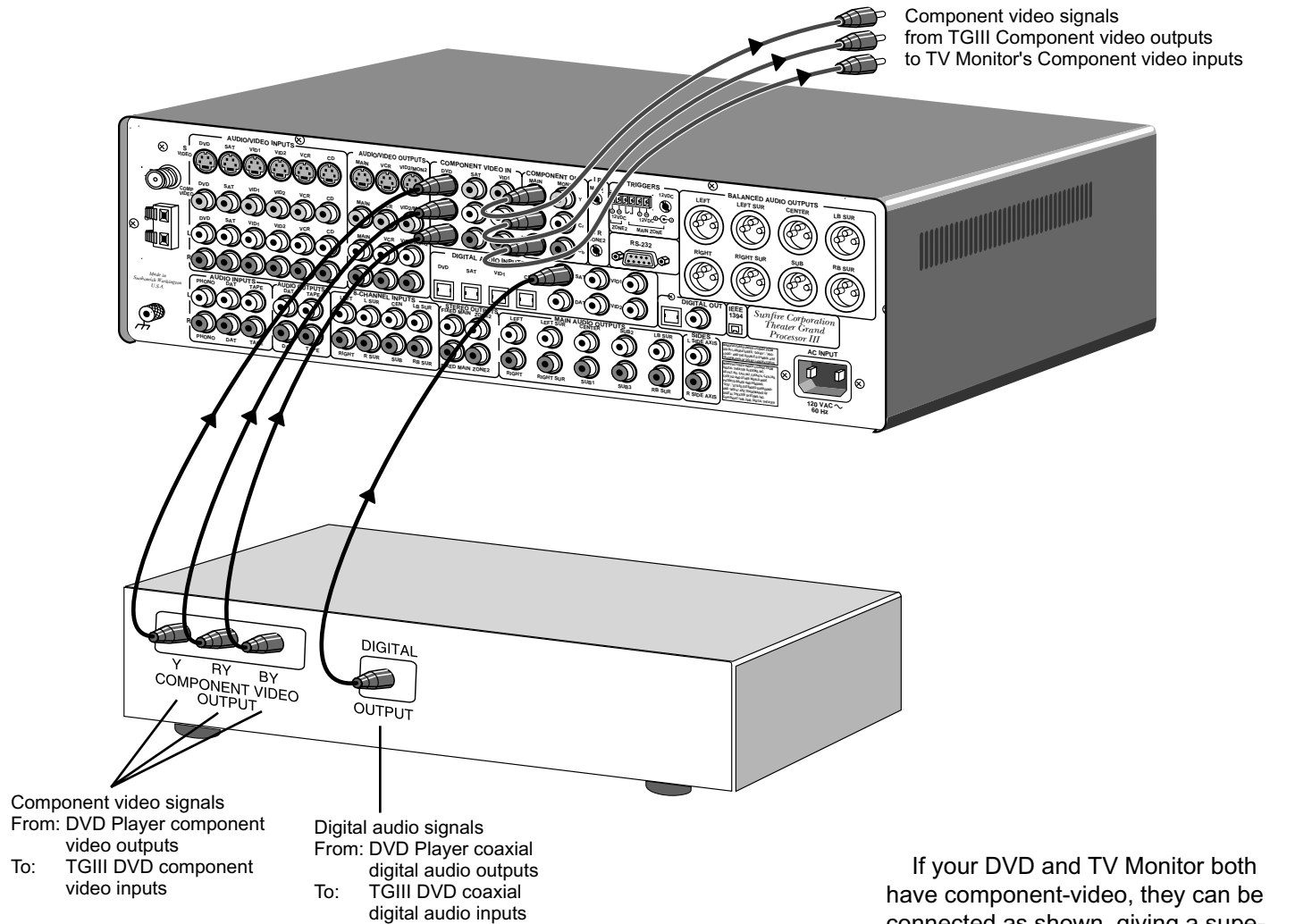

If your DVD and TV Monitor both have component-video, they can be connected as shown, giving a superior picture. Note that the OSD is not available with component video.

The digital output from the DVD player must be connected to the digital inputs of the TGIII. This is the only way the TGIII can receive and decode Dolby Digital or DTS signals. It is best to use a coaxial digital cable to make the connection to the TGIII, rather than a standard audio cable.

Note: you must also connect the player's two-channel audio outputs if you want it to play it in Zone 2 when the Main Zone is playing a different source.

LD connections: external RF Demodulator and S-Video

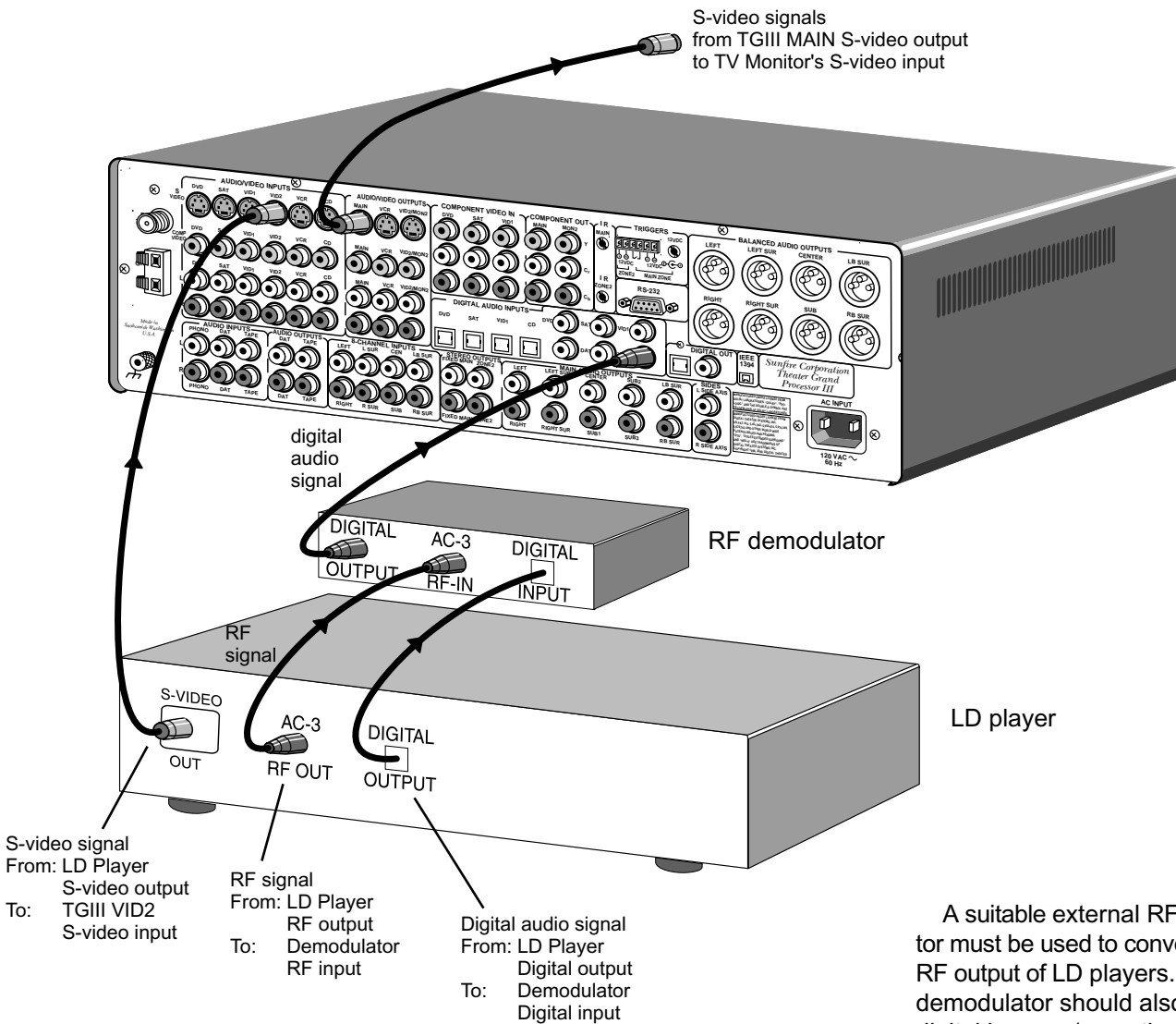

A suitable external RF demodulator must be used to convert the AC-3 RF output of LD players. Ideally, the demodulator should also have a digital bypass (pass-through) feature. Lexicon and B&K are among several companies making excellent demodulators with this feature.

If your LD and TV Monitor both have S-video, they can be connected as shown. This gives a better picture than composite video.

Note: you must also connect the player's two-channel audio outputs if you want to play it in Zone 2 when the Main Zone is playing a different source.



VCR connections: analog audio and composite video

Composite video signal from
TGIII MAIN composite video output
to TV Monitor's composite video input

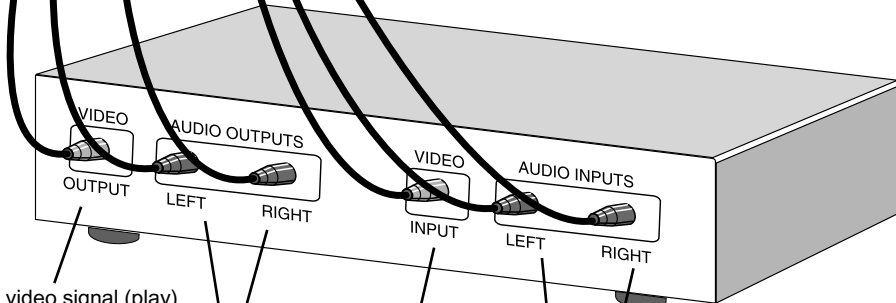
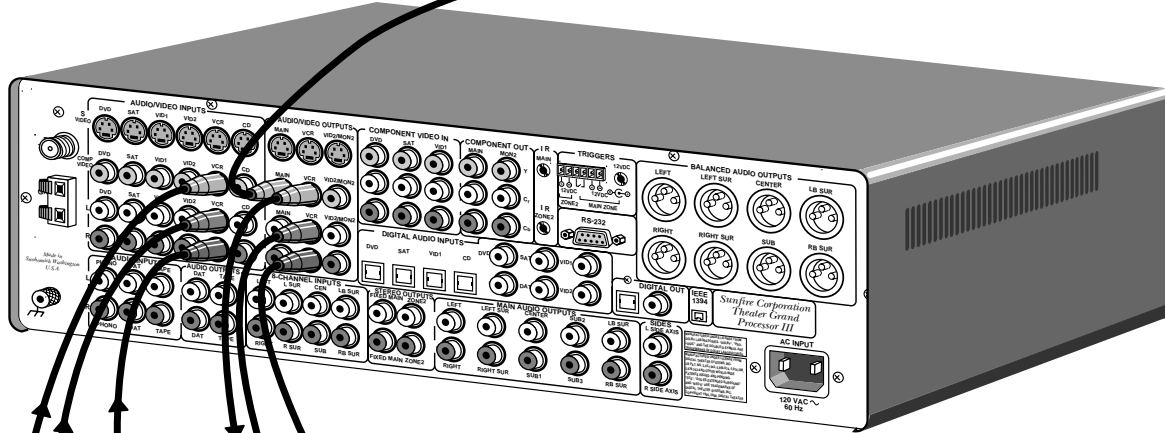

Composite video signal (play)
From: VCR video output
To: TGIII VCR video input

Analog audio signals (play)
From: VCR audio outputs
To: TGIII VCR L/R audio inputs

Composite video signal (record)
From: TGIII VCR video output
To: VCR video input

Analog audio signals (record)
From: TGIII VCR L/R audio
outputs
To: VCR L/R audio inputs

The VCR can record the analog audio and the video of whichever A/V input is selected.

NOTE: If your VCR has a digital output, connect it to the TGIII's digital VCR input. In this case, you must also connect the VCR's analog audio outputs (as shown) if you want to play in Zone 2 when the Main Zone is playing a different source.



CD and Antenna connections

AM Loop Antenna

Position this to get the best reception before fixing it in place. The supplied loop antenna has been carefully matched to the AM tuner. Larger Loop antennas may improve reception, provided that their inductive value is around 18 uH.



FM Antenna

This dipole antenna and its adaptor push onto the rear panel's F-type connector as shown. An outdoor antenna can be used for improved reception. Take care to observe all the safety instructions shown on page 3.

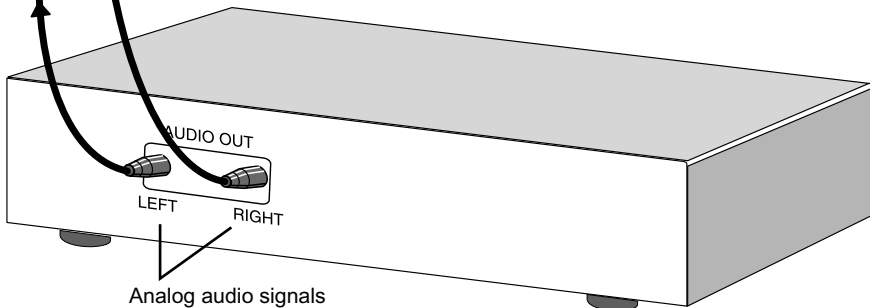
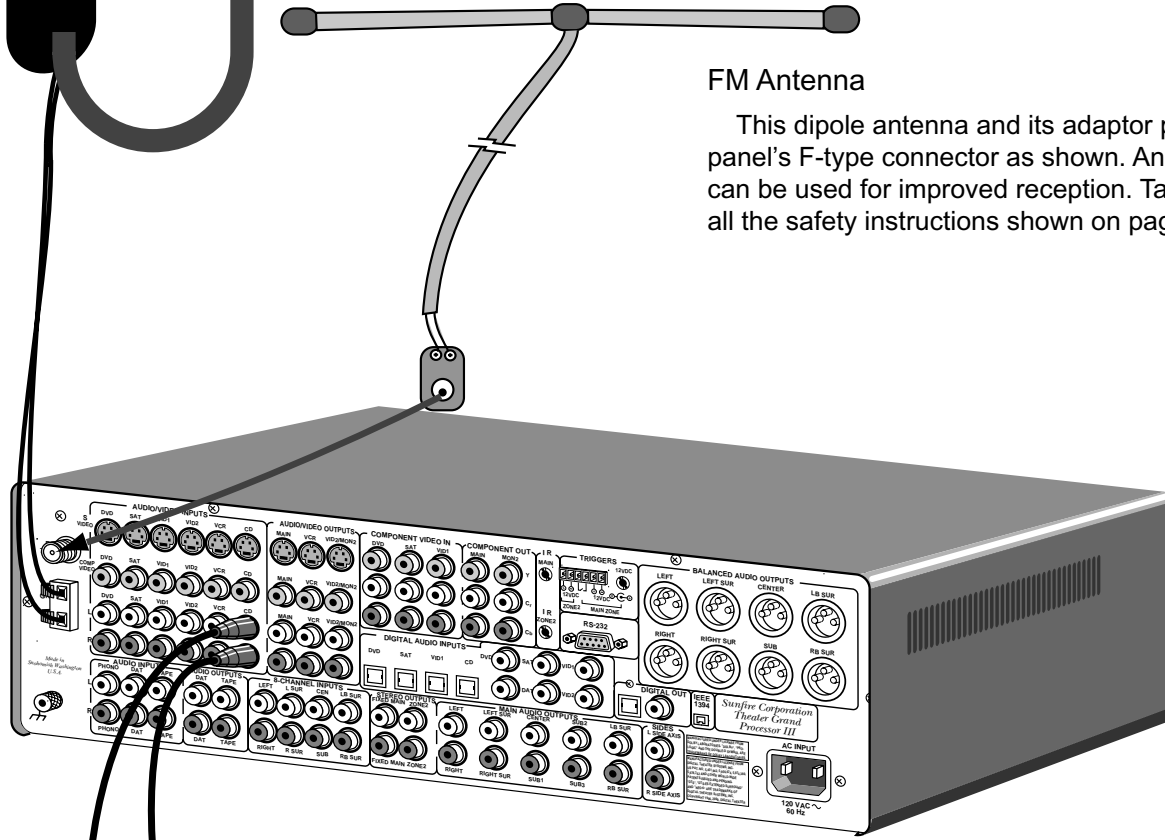

Analog audio signals
From: CD L/R audio outputs
To: TGIII CD L/R audio inputs

NOTE: If your CD has a digital output, connect it to the TGIII's digital CD input. Also connect the analog CD inputs (as shown) if you want this source available in Zone 2 when the Main Zone is playing a different source.

Some TGIII Tuners have connection terminals like this, with AM screw terminals above the FM connector. The specifications and operation is the same for both Tuners.





Turntable connections

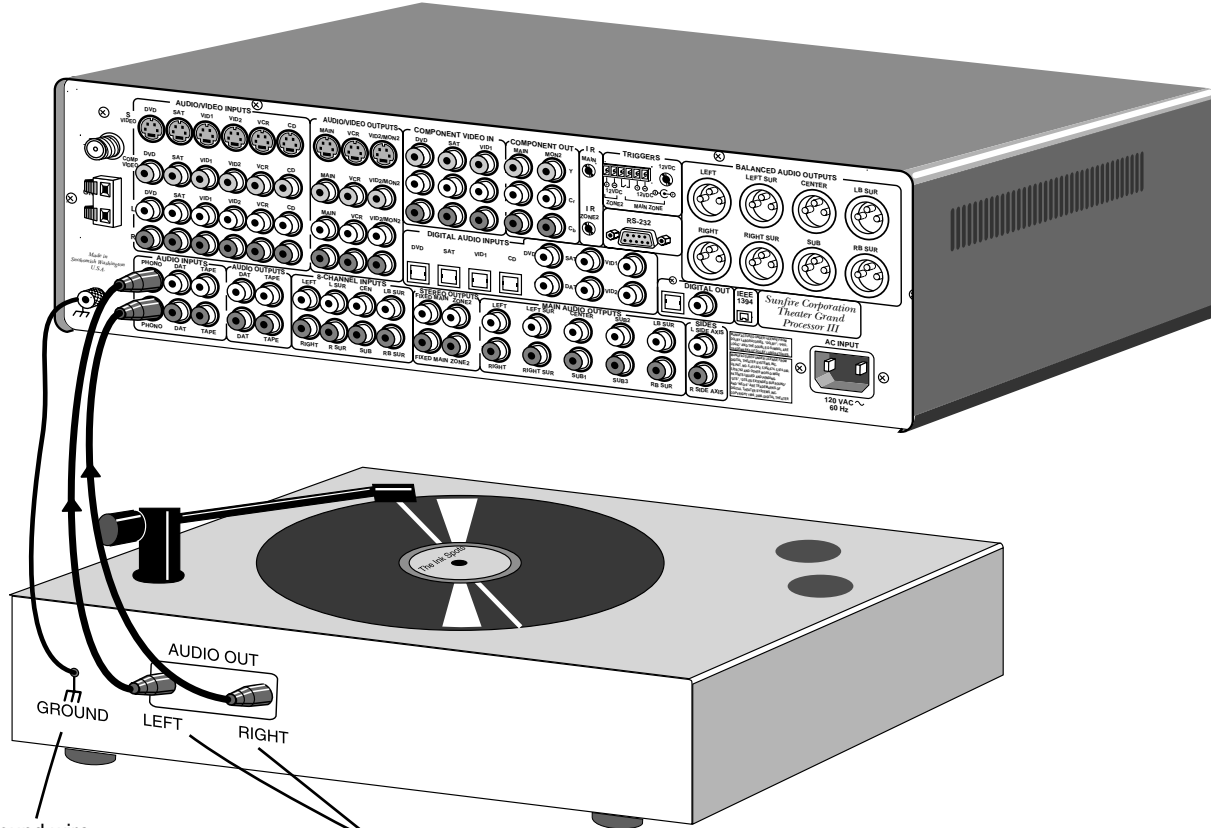

Ground wire
 From: Turntable chassis ground
 To: TGIII chassis ground connector

Phono-level audio signals
 From: Turntable L/R audio outputs
 To: TGIII Phono L/R audio inputs

Only connect a Turntable to the PHONO inputs. In most cases, you should also connect the ground wire to reduce any hum through the speakers.



The TGIII PHONO input is designed for moving magnet cartridges and high output moving coil cartridges. **DO NOT** connect CD players or other line-level sources to this input.



Tape Player connections

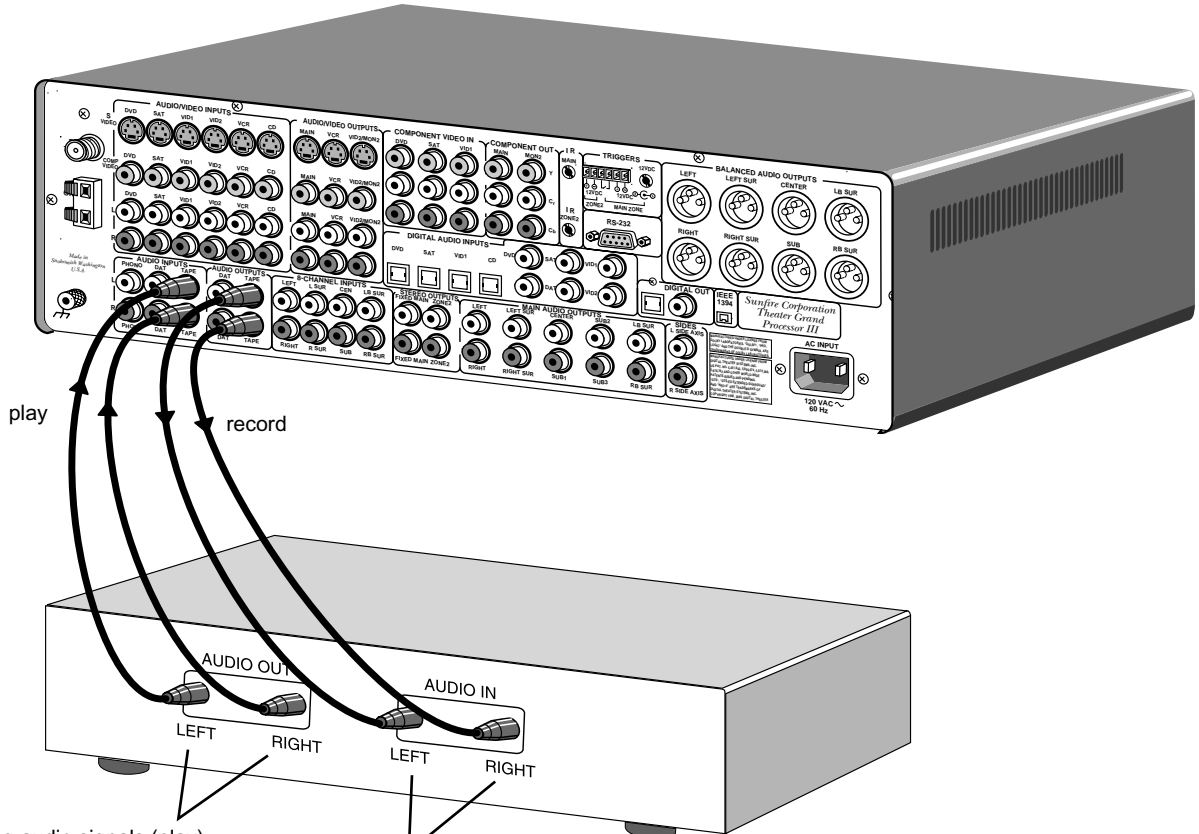

Analog audio signals (play)
 From: Tape player audio outputs
 To: TGIII Tape L/R audio inputs

Analog audio signals (record)
 From: TGIII Tape L/R audio output
 To: Tape Player L/R audio input

The tape player's output can be connected to the TAPE or DAT inputs. If you have two players, the TGIII will automatically select the input which has a signal present. The unused deck must be turned off when the other deck is playing.

The tape player can record the audio from whichever source is selected, but not from DAT to TAPE, or TAPE to DAT. Use an external switchbox to dub recordings.



8-Channel Input connections (analog audio)

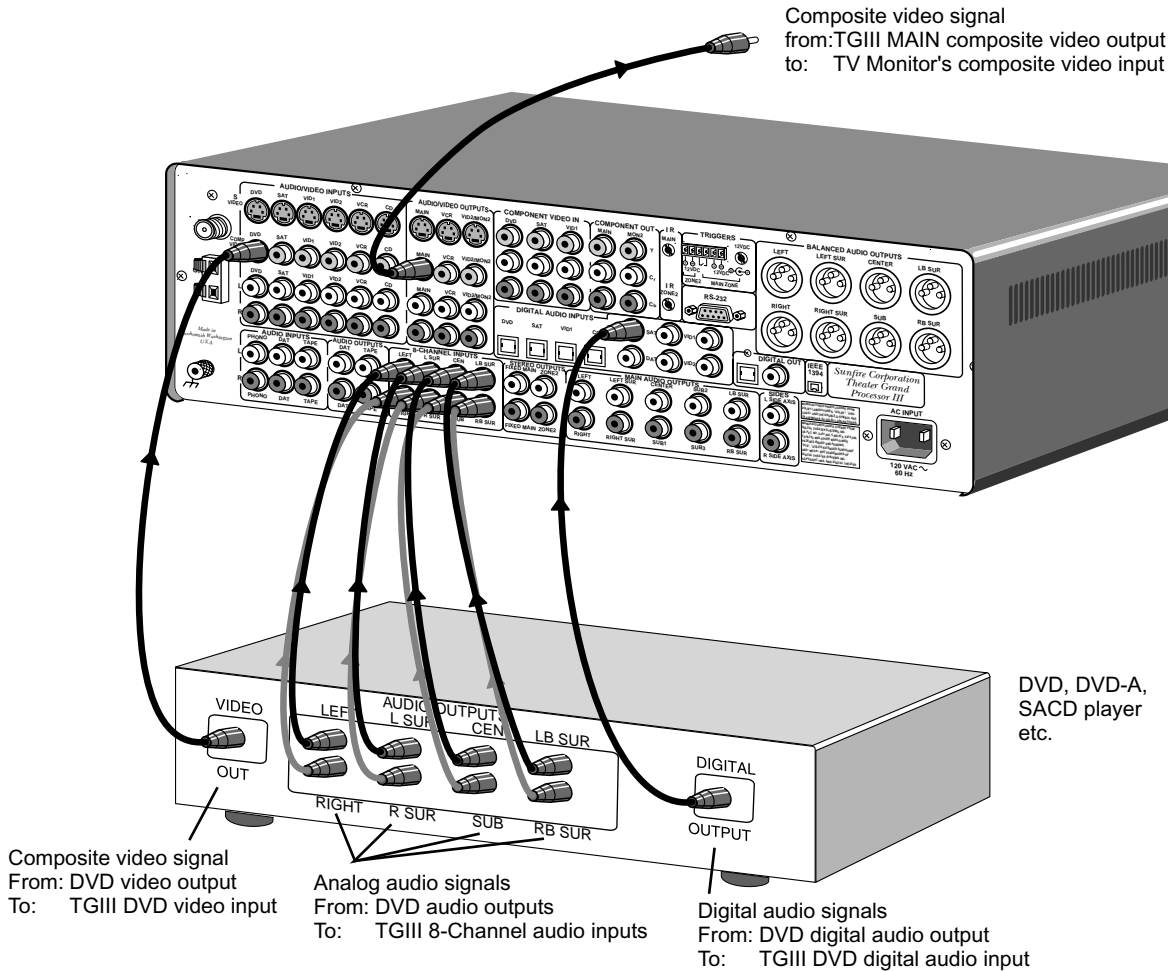

This input is really useful as an input for DVD A, SACD, etc., as a multichannel direct (DSP-bypass) input.

If your DVD player has its own surround processing circuits you can connect it as shown. The surround back inputs can be left disconnected if your player does not have these outputs.

An external surround processor can also be connected like this. You will have to connect some of your sources to the external processor, so it can process the original signals.

Note: The eight channels of audio from the DVD bypass the DSP circuits of the TGIII, so the tone controls, bass

management and surround mode selections will have no effect. This provides the highest fidelity signal path for SACD or DVD-Audio, free from any coloration or processor circuitry.

This input is only for the Main Zone, it is not selectable for Zone 2.

The video output in this example is connected to the TGIII DVD composite video input. Use the OSD 8-CH input configuration menu to lock the 8-channel input to DVD video (see page 34 for details). Whenever the 8-channel input is selected, the DVD video will also be selected.

In this diagram, the player's digital output is also connected. If you select the TGIII's DVD input, you will get DVD video and DVD digital audio. If you select the TGIII's 8-Channel input, you will get DVD video, and analog audio from the 8-channel input.



Amplifier connections

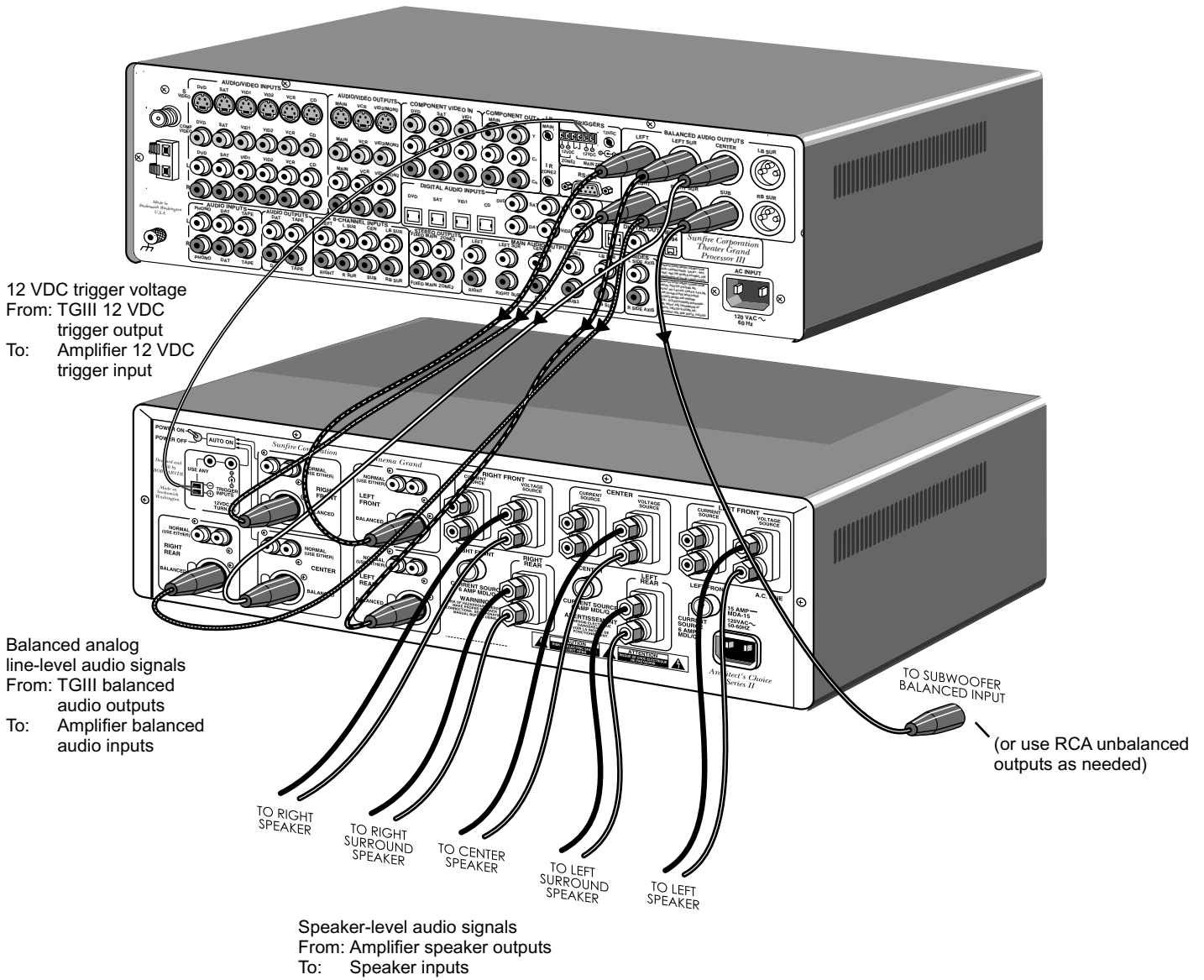

If your amplifier has XLR inputs, it can be connected to the balanced audio outputs as shown. It is preferable to use the XLR connections if you have this option, because they offer superior noise rejection compared to unbalanced (RCA) connections, especially for long cable runs.

This diagram shows a Sunfire five-channel amplifier. The left and right surround back outputs and the side-axis outputs can be connected to other amplifiers. The subwoofer output can connect to a powered subwoofer.

You can also use a Sunfire Cinema Seven amplifier, which has seven channels, or use separate amplifiers.

This diagram also shows the TGIII 12 VDC trigger output connected to the 12 VDC trigger input of the Sunfire amplifier. The amplifier automatically turns on whenever the TGIII main zone is turned on.



Zone 2 connections

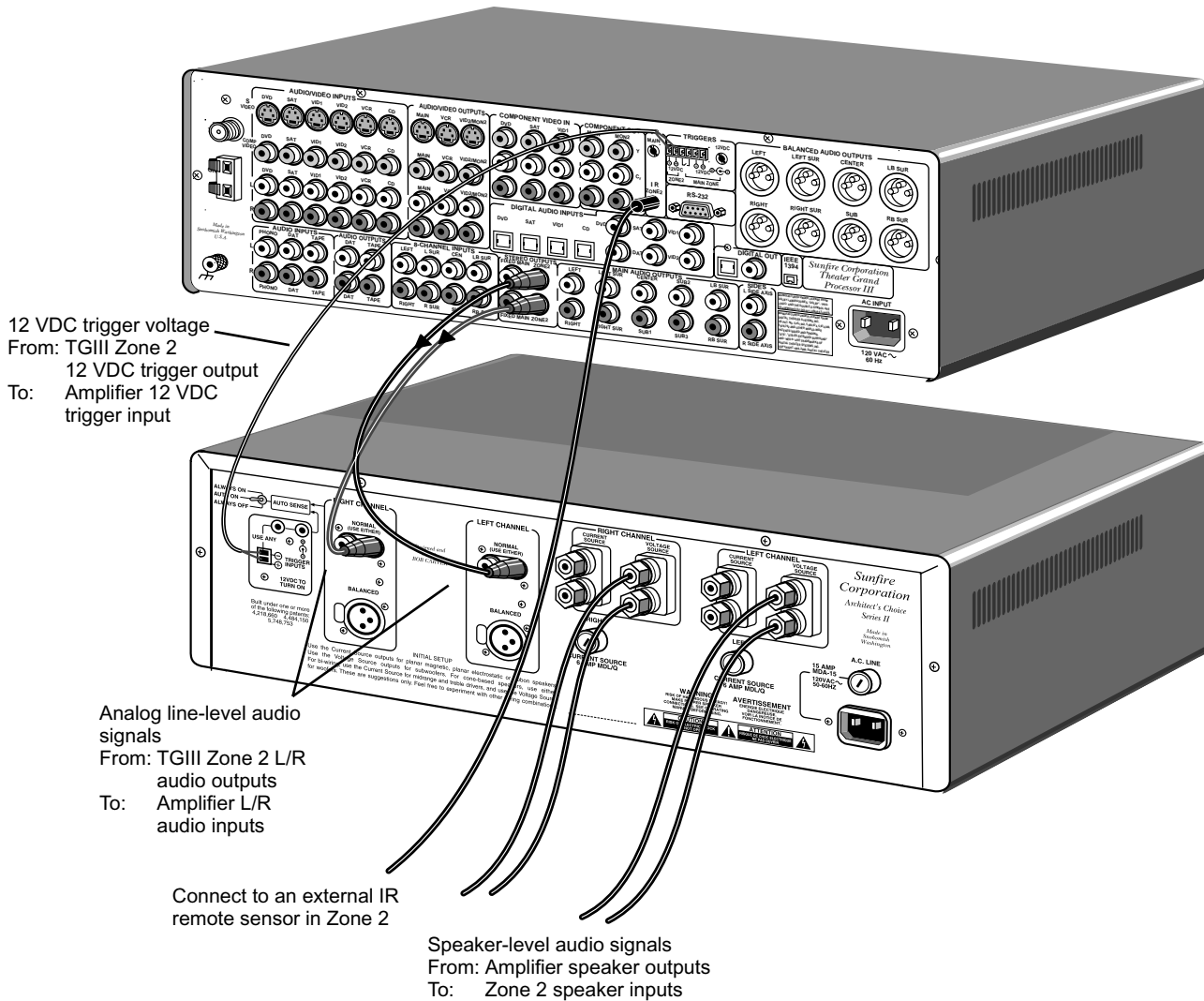

Zone 2 can play stereo analog sources independently of the main zone, or can play the same source. Zone 2 can only play a digital source if the main zone is playing the same source.

This example shows a Sunfire two-channel power amplifier fed from the TGIII Zone 2 stereo outputs.

The amplifier is located near the TGIII, and long speaker wires are run

out to your Zone 2 speakers. These are usually located in another room or area of your house.

The wire from an optional Infrared (IR) sensor is shown connected to the TGIII Zone 2 IR input. The TGIII is compatible with most makes of IR sensors and equipment.

The sensor can be located in a suitable area of Zone 2, allowing you complete control of the volume and

source selection. Zone 2 can also be controlled from the front panel, using the remote's Zone 2 buttons.

This diagram also shows the TGIII 12 VDC Zone 2 trigger output connected to the 12 VDC trigger input of the Sunfire amplifier. The amplifier automatically turns on whenever Zone 2 is turned on.

See page 47 for more details of Zone 2 operation.

Remote Control

Think of the TGIII remote control as ten remotes in one. There are ten DEVICE buttons, five on either side of the display, and each allows the remote to operate one piece of equipment.

From the factory, the device buttons are labeled: CD, TAPE, AUX, ZONE2, TGIII, DVD, VCR, SAT, TV and CABLE.

Only the TGIII and ZONE2 buttons are pre-programmed, and these allow the remote to operate your TGIII. The remote can be set to operate your other remote controlled equipment. This is done in three ways from the hidden SETUP menu:

1. Entering a code from the tables at the end of this manual
2. Stepping through the codes
3. Learning from your other remotes

See Remote Setup on page 27 for more details.

LCD Display

The top line shows the present device, mode or status, and it shows when a remote command is being transmitted. The bottom line shows the page number, status and basic instructions during programming.

The main part of the display shows the labels of the ten DEVICE buttons. You can change any label and customize the remote to fit your system. Note: this is not a touch-sensitive screen, just a way of labeling the device buttons on each side, and showing instructions and status.

Contrast

The contrast of the display can be changed by holding down the MAIN button and pressing the joystick pad UP or DOWN.

Light

The button on the right side of the remote briefly turns on the lights for the buttons and display. Pressing it again will turn it off. The number of seconds can be varied, or it can be disabled.

Device Buttons.

Once you press a device button, all the device buttons change label and function to become buttons to operate your device. There are two pages per device, and you can move between them using the PAGE button.

PAGE

Use this to jump to various display pages. For example, if you press the TGIII device button, the display changes to some show buttons which control your TGIII. If you press PAGE, the display will move to page 2, showing more functions for the TGIII.

MAIN

This button will return the remote display back to the Main menu. Depending on which mode you are in, it may take two or more presses. This will help you get back to the Main menu if you ever get lost in the menus.

FAV

This button allows you to step through five display pages of your favorite TV and radio stations. These can be set and re-labeled to suit.

Joystick Pad

This pad and surrounding buttons are used to operate standard DVD menus, and VCR and Tape transport controls. In TGIII mode, if you press MENU, the On Screen Display will appear and the joystick can be used to select and adjust the various items.

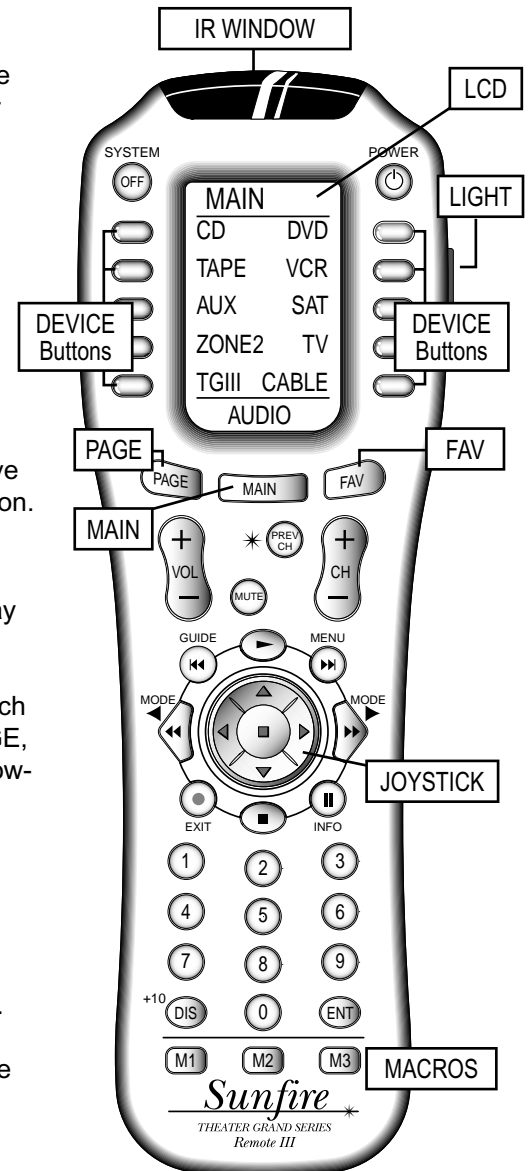

M1, M2 and M3 Macros

These MACRO buttons can be programmed to send out a sequence of commands with a single press.

Batteries

The remote takes four AAA batteries inside the rear compartment. These should last about six months in normal use, before a low-battery warning appears.



Operating the TGIII with the Remote

1. Press the remote's MAIN button to make sure the display is on the main display menu.

2. Press the TGIII device button to set the remote to operate your TGIII. The display changes to show the TGIII input selections:



3. Press PAGE to reach page 2, which shows the PRO LOGIC-II, PARTY, STEREO, HOLOGRAM, and the trims for center, surrounds, and sub. On the right is '+' (increase level) and on the left is '-' (decrease level).

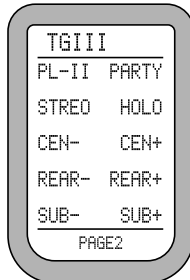

4. The following buttons with fixed labels are also programmed: Power, Volume up, down and Mute. The number pad accesses the tuner presets directly, and CH+/- steps through them. DIS is the +10 function, and ENT is station enter. The MODE buttons either side of the joystick, allow you to select the different surround modes.

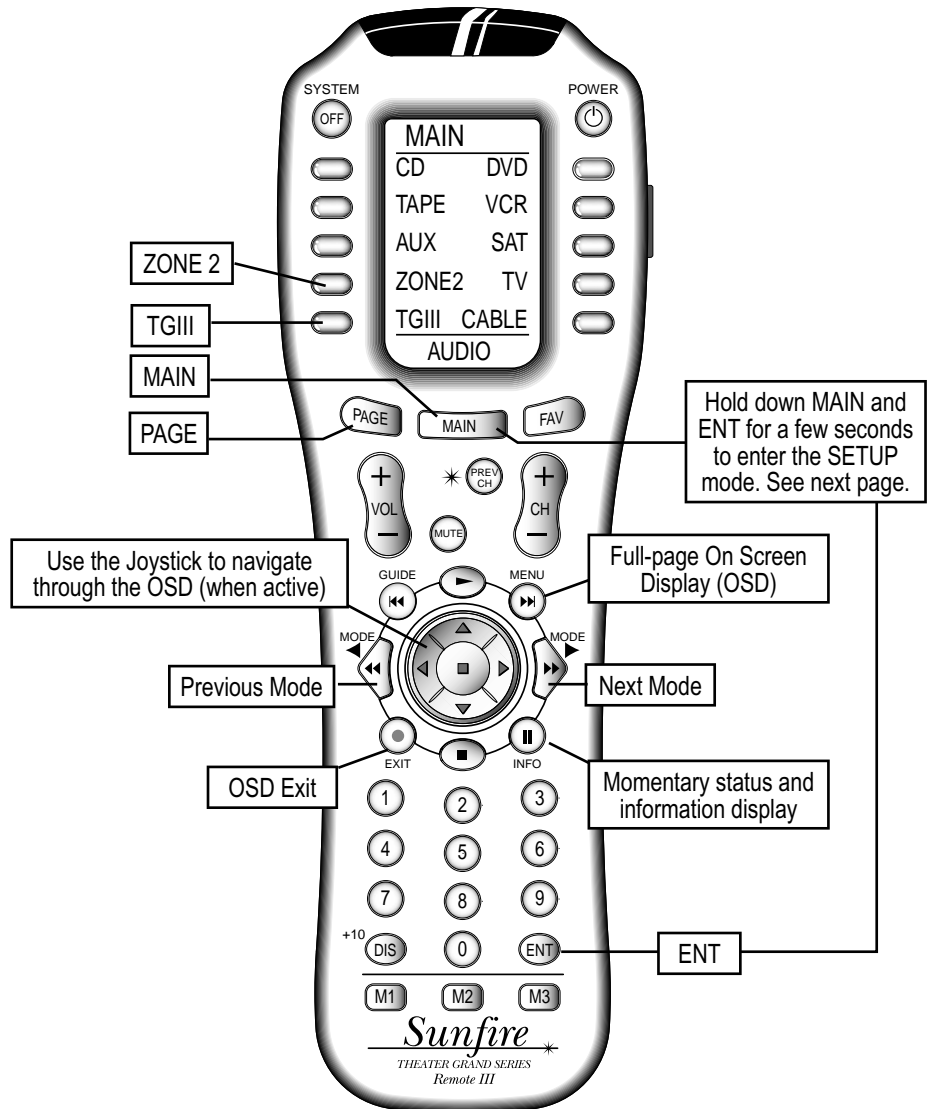

ZONE 2

1. From the main display menu, press the ZONE2 device button to access features of the second zone. Page 1 shows the input selections.

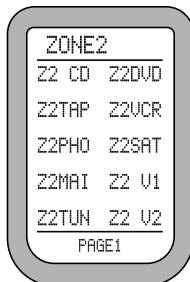

2. The hard buttons operate Zone 2, such as Power, Volume, Mute, and the Tuner controls and presets.

3. Page 2 shows Zone 2 on/off, Zone 1 on/off, and balance left/right.

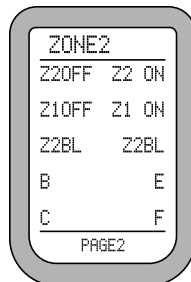

Note: Zone 2 must first be enabled using the OSD (see page 36), or these controls will have no effect. Zone 2 can be turned on even if the Main Zone is off.

See page 47 for more Zone 2 details.

Remote Setup

You must enter the SETUP mode to program the remote control for the other components in your system, and to customize it for your convenience. There is only one way to enter the SETUP mode:

Hold down both the MAIN and ENT buttons for a few seconds until SETUP appears in the display.

The SETUP display shows 10 options. These are described in more detail as follows:

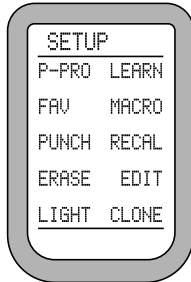

P-PRO

The remote is pre-programmed to operate many types of equipment. The P-PRO mode allows you to enter a 3-digit code to recall the commands for each of your system components.

1. Find the make of your TV, DVD, VCR, CD and other components, then look at the tables at the rear of this manual. Make a note of the various codes for each piece. Note that some TV/VCR combined units may use VCR codes, not TV.
2. Sit in a position in front of your equipment, and make sure that all components are turned off.
3. In the SETUP mode, press P-PRO and the device labels will appear.
4. Select the device button you want to program, then choose the device table you took the code from. For example, for a TV, press TV twice. If you want AUX to control a VCR, press AUX, then press VCR.
5. You can now enter a code using the remote's keypad, or UP or DOWN. After the third digit is entered, the remote transmits a power command. If the component turns on, press SAVE and then EXIT. Go to step 7.

6. If you could not find a code which works, hold the UP button to step through all the codes in the table for that device. Release UP when your equipment turns on. If you go past, press DOWN. Press SAVE and then EXIT.
7. The display will change to show the devices again, still in the P-PRO mode. Repeat steps 4 to 7 until all your equipment is working.
8. Press MAIN to return to the main menu from any setup mode.
9. Test the remote to see which buttons will operate your equipment. For example, if you were trying to control your TV, check the power, channel up and down, and volume up and down. If some of these buttons are not working correctly, choose another code for that manufacturer, or you can learn over those not working by using the LEARN mode.

 **NOTE:** If you accidentally "learn over" one or more of the buttons which operate the TGIII, fear not. You can use ERASE (see page 28) to reset either the individual buttons, or the whole TGIII bank. After erasing, the buttons will revert to their TGIII programming.

FAV

This mode allows you to enter your favorite TV and radio stations.

Note that the following procedure assumes you have already programmed your remote to operate your TV, radio tuner and other equipment. The keypad must already be able to select channels on your TV or SAT, and any TGIII tuner presets.

Before using FAV mode, use the EDIT mode to change the labels in the FAV display to show your station call signs or reminders. You can also delete the labels from unused buttons, or move all your most favorite FAV labels to page 1.

1. In the SETUP mode, select FAV.
2. Select the device, such as SAT, TV or TGIII, to learn station commands from.
3. The FAV display will appear, and you can step through five pages using PAGE or FAV.
4. Press a favorite channel button and the first character will blink. Use the keypad to enter the channel number. For channels below 10, you should enter a 0 (zero) first. If you want, you can enter a power button before entering the channel. Also, if your equipment needs it, you may have to enter the ENT button after the channel is entered. If you want to add a short delay, press PAUSE (|||).
5. When you have finished with one channel, press its button, and the label will reappear. Move on to the next favorite channel and program it in the same way. Repeat this for all the channels and devices. Press MAIN to return to the top menu.
6. Now, if you press the molded FAV button, the favorite channels appear in the display, and the ones you programmed will take you to your favorite channel or radio station. If you programmed in a power command, the TV or tuner will turn on first.
7. The commands are sent in sequence, for example for channel 13, first the 1 and then the 3 are sent. Wait a few seconds before switching between favorites, or your TV may receive for example, the 1 of one button and the 2 of the next.

continued..



Remote Setup continued

PUNCH

This mode allows you to set up the volume, channel up/down and transport buttons so they will work for your main devices, no matter which device the remote is set for. For example, the volume buttons can operate the TV, even if the remote is set to VCR. The channel buttons can operate the VCR, even if the remote is set to TV.

1. In SETUP, select PUNCH and the display changes to show VOL, CH, and PLAY. The PLAY selection will make the eight transport buttons around the joystick punch through.
2. Select one of these buttons, for example VOL.
3. Press a device button for the device you want the Volume commands to appear in (punch TO).
4. Press a device button for the device you want to learn from (punch FROM). These settings are saved.
5. Repeat steps 2 to 4 until you have punched to all devices you want.
6. Use MAIN to return to SETUP.

NOTE: To erase Punch commands from a device (return buttons to their previous programming): Repeat steps 1 and 2, then press the device button twice. Repeat for other devices, then press MAIN to return to SETUP.

ERASE

Use this mode to erase commands stored in the remote. This does not affect the labels, just the stored IR commands. The pre-programmed commands for the TGIII will not be lost, as they can be recalled.

1. In the SETUP mode, select ERASE and the display will show LEARN, FAV, MACRO and EXIT.
2. If you select LEARN, press ALL to erase all learned buttons, or KEY

to erase one device at a time. If you use KEY, press MAIN and EXIT when you have erased all the devices you want.

3. If you select FAV, press ALL to erase all favorites, or KEY to erase single favorites. Note that the labels are not erased.
4. If you select MACRO, press ALL to erase all macros, or KEY to erase macros, one device at a time.
5. Press EXIT to return to the SETUP menu, and press MAIN to return to the main device menu.

LIGHT

This mode allows you to either disable the light, or change the number of seconds it stays on. (The light is inactive while in the SETUP mode).

1. In the SETUP menu, select LIGHT and the display will show ON, time in seconds, SAVE and EXIT.
2. If you press ON, it changes to OFF and disables the light. This is useful if you want to save battery life, or if the kids like to use the remote as a flashlight or Light Saber®.
3. Use the keypad to enter the number of seconds you want the light to stay on. If you enter 00, it only stays on while the light button is held down.
4. Select SAVE, or press EXIT to make no change. Either of these will return you to the SETUP menu.

LEARN

The remote can learn commands from other remote controls. This is useful if the pre-programmed commands do not operate some of your equipment, or certain buttons do not work, or you want to customize key functions.

NOTE: PAGE, MAIN, FAV, M1, M2 and M3 cannot be learned over.

1. Find your original remote and make sure it has good batteries, and it operates your equipment perfectly. In the following example, the Sunfire remote will learn the PLAY command from a DVD remote.
2. Point the DVD remote into the Red IR top window of the Sunfire remote. Place them on a flat surface, about 1 to 2 inches apart, and avoid bright lighting or sunlight.
3. In the SETUP mode, press LEARN.
4. Select the DVD device button and the display will change to show some common DVD labels (remember there are two pages).
5. Select the PLAY button just above the joystick pad. The display will show "READY."
6. Press your DVD remote's PLAY button. The display will show "GOOD" if it has been accepted. If it shows "FAIL," press PLAY again.
7. Press another button on the Sunfire remote and repeat the procedure until all the DVD buttons you need are learned.
8. Press MAIN once to return to the LEARN mode, twice for SETUP and three times for the MAIN menu.
9. Try out the Sunfire remote and see if the learned buttons will successfully operate your equipment. You may find that some commands cannot be learned, because some are non-conventional, or too long or too short.
10. The EDIT command can be used to change the labels if some of the standard labels do not correspond to your original remote buttons.

continued..



Remote Setup continued

MACRO

The macro mode allows you to set up certain buttons to transmit up to 20 commands in sequence. For example, a single button press could turn on all of your home theater equipment, and set the TGIII to DVD, set the TV to channel 3, and set the DVD to play, make the tea and put the cat out.

The buttons which can be programmed as macros are: M1, M2 and M3 at the bottom of the remote, and Power and System at the top. The ten device buttons can also be programmed as macros, although these will only be activated if the device button is held down for a few seconds.

Note that the macro buttons are independent of which device the remote is set for. So there is only one M1 macro, only one power macro etc.

1. In the SETUP mode, press MACRO.
2. Press one of the buttons you wish to program as a macro, such as M3, Power, or a device button.
3. Press up to 20 buttons you would like the macro to store. Do this in the exact order you want them to be transmitted. Use the PAGE, FAV and the direct buttons to find buttons to use in the macro.
4. To add a delay between steps, you can add 0.2 seconds each time you press PAUSE (■). This does not take up a step.
5. Press the Channel UP button to save your macro.
6. Repeat this procedure to program more macros, and press MAIN to return to the main menu.
7. Try out the macros to see if they work OK. It may take some time to transmit all the commands in sequence, so keep the remote pointing at your equipment and do not move it during this time.

Note that the remote's Zone 2, Page 2 has discrete on and off codes for the Main Zone and Zone 2. You can use these within Macros instead of the main power button commands (which toggle on/off).

RECAL (Recall)

This mode lets you quickly see the three digit codes you have assigned to each device. This is useful if you want to check the tables and find other codes which may work better.

1. In the SETUP mode, select RECAL. The device labels and their codes will flash alternately, before returning to the SETUP menu. Make a note of the codes.
2. Press MAIN to return to the main device menu.

EDIT

This mode allows you to change the labels in the display to suit your system. You can change device labels, or the buttons on page 1 or page 2 of a device, or the FAV labels.

1. In the SETUP menu, press EDIT.
2. To edit a device label, press PAGE and then the device button. Go to step 5.
3. To edit a button on a device's page 1 or 2, press the device button and its page 1 will appear. Press PAGE to reach page 2 if required. Go to step 5.
4. To edit a FAV button, press FAV and select the button you want from the five pages. Use PAGE or FAV to change pages to find the one you want. Go to step 5.
5. Press the button you want to edit and the first character will flash.
6. Use the keypad to enter up to 5 characters. This is like using a telephone keypad to enter letters. For example, if you press 1 a few

times, it will step through A, B, C, 1. Press 2 for D, E, F and 2. The number 0 has a selection of special characters to choose from.

7. Press the joystick right to move on to the next character, or press it down to delete a character.
8. When finished, press the button next to the label you just edited. You can edit other buttons, or press MAIN a few times to return to the main menu.

CLONE

This feature allows you to easily copy all of the commands and labels from one Sunfire remote (of the same type) to another.

1. Set both remotes on a flat surface, with their IR windows pointing towards each other, about 1 or 2 inches apart.
2. In the SETUP menu for both remotes, press CLONE and the display will change to show SEND, RCV (receive) and EXIT.
3. Press SEND on the remote you want to copy from. Press DEVIC to only clone a single device, then press the device button. Press ALL to clone all programming.
4. Press RCV on the remote you want to copy to.
5. When you are ready, press START on both remotes. It may take up to 40 seconds, so do not move the remotes during this time. The remote will flash "GOOD" if it has successfully learned all the commands. If it flashes "FAIL," then repeat this procedure.
6. Press MAIN to return to the main menu.

On Screen Display (OSD)

Video Connections

The On Screen Display (OSD) is present at the composite video or S-video MAIN outputs. It is also present at the output labeled VID2/MON2, but only if it is set to MON2. Make sure that your TV monitor's video input is connected correctly to one of these outputs.

Note: The component video signal path uses broadcast-quality components with no OSD in the path. This assures no possibility of coloration of the video signal.

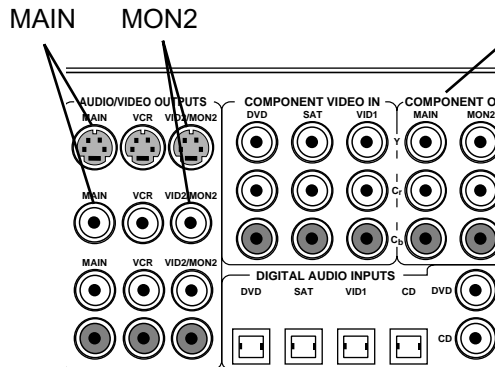

No OSD from:

- Component video outputs
- VCR outputs
- VID2/MON2 set to VID2

OSD Activation

The OSD is activated using the remote's MENU button (with the remote set to operate the TGIII).

The joystick pad and surrounding buttons allow you to navigate through the OSD menus to control and customize many features of the TGIII.

Press EXIT to quit the OSD at any time. Any changes you make will be saved.

Note that the TGIII front panel display shows abbreviated text when the OSD is activated.

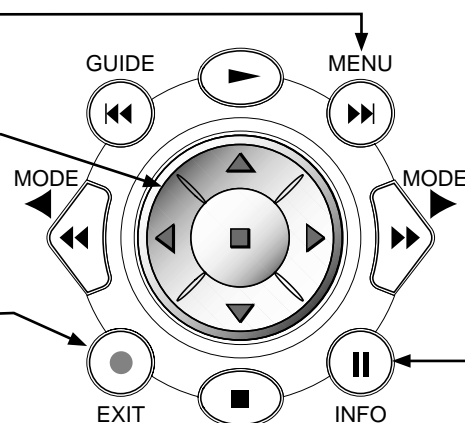

Quick Information

Pressing INFO at any time will bring up a short description of the source you are listening to. For example if you are listening to a DVD, the TV display might show:

DVD DIGITAL 48K
DOLBY EX 5.1 / 5.1

where:

DVD is the selected input,
DIGITAL is the signal type,
48K is the sample rate,
DOLBY EX is the mode,
5.1 is the input format,
5.1 is the output (i.e. five speakers and a subwoofer).

OSD Menus

Main Menu

The first menu of the TV On Screen Display looks like this

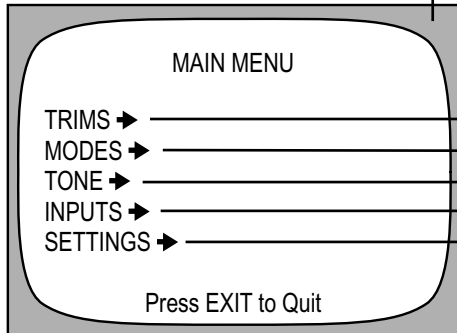

Navigation

Use the joystick pad left, right, up and down buttons to navigate through the menus.

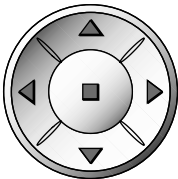

An arrow after text (➔) on the screen, shows there is more information on another page.

The back arrow (◀) shows that you can return to the previous page.

The down arrow (▼), such as at the bottom of the Inputs Menu, shows there is a second page of similar choices.

The up arrow (▲) shows the way back to the first page.

NOTE: you can quit the OSD at any time by pressing EXIT on the remote. Any changes you make will be saved. There is no need to navigate back through previous pages, unless you want to make more changes.

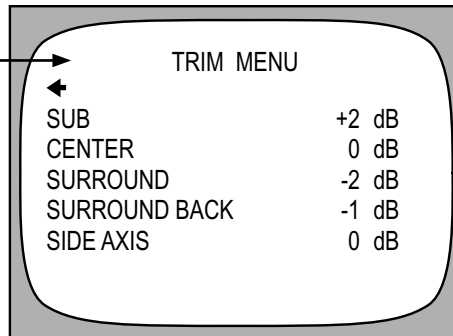

Trim (Page 32)

Adjust the volume of each speaker "on-the-fly."

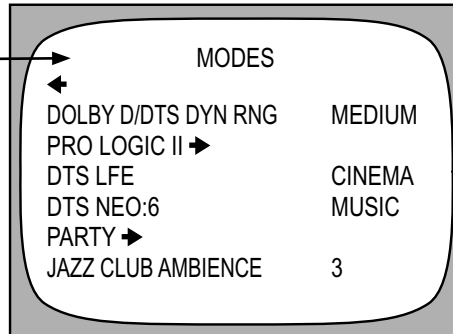

Modes (Page 33)

Adjust the settings of the surround modes.

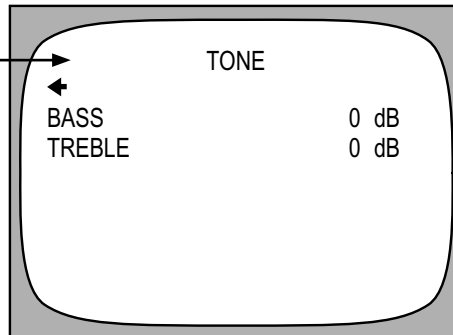

Tone (Page 32)

Treble and Bass adjustment.

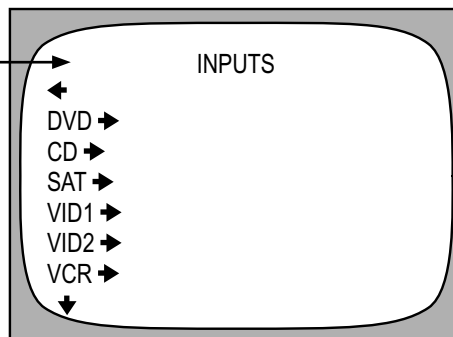

Inputs (Page 34)

Set up each input's trim level, default surround mode, enable/disable in main or zone 2, triggers.

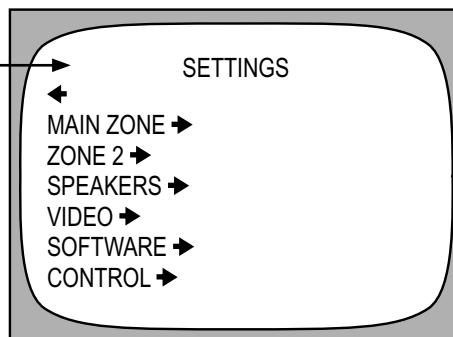

Settings (Page 36)

- Main Zone and Zone 2 volume and power-up setting
- Speakers size, position, calibration, and crossover
- Video and OSD settings
- Software settings
- IR and RS232 setup

Trim and Tone Menus

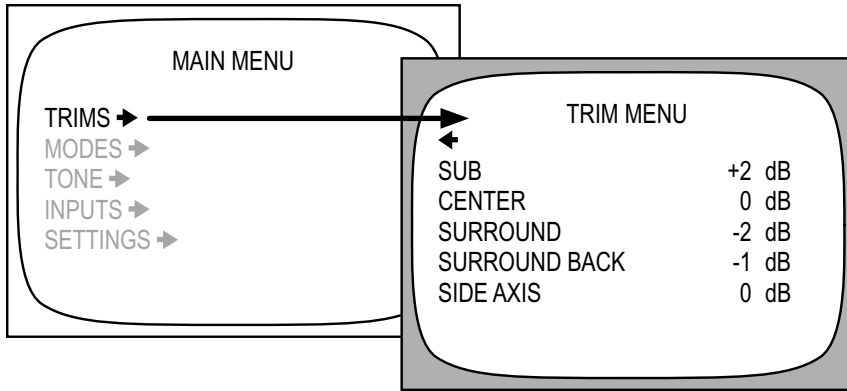

Trims Menu

This menu allows you to adjust the individual volume level of your speakers "on-the-fly." Although careful calibration is key to a good home theater, the Trims allow fine adjustment of the current program playing. The Trims add or subtract from the reference levels set during calibration using the Speaker Calibration menu. Recalibrating will reset these on-the-fly trims to zero.

Note: The Trim adjustments do not exceed +10 dB and are not less than -20 dB.

Step up and down through the menus

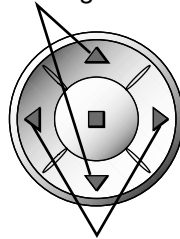

Step through any available options, and change dB levels

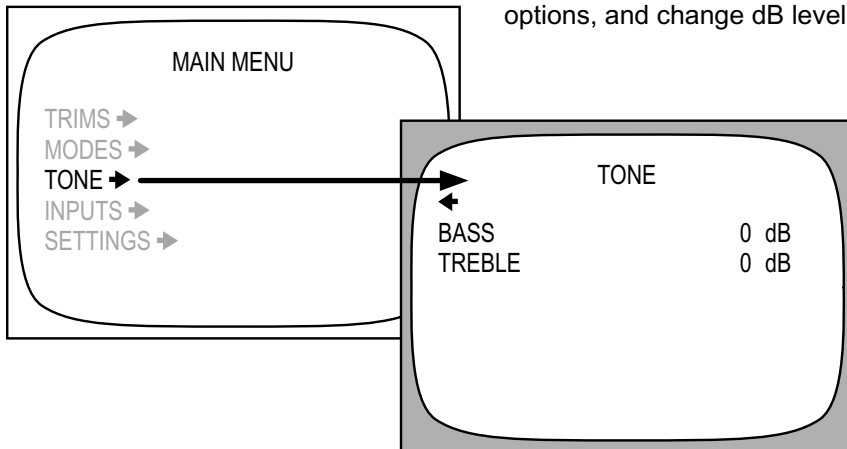

Tone Menu

The Bass and Treble can be boosted or cut by up to 10 dB.

Modes Menu

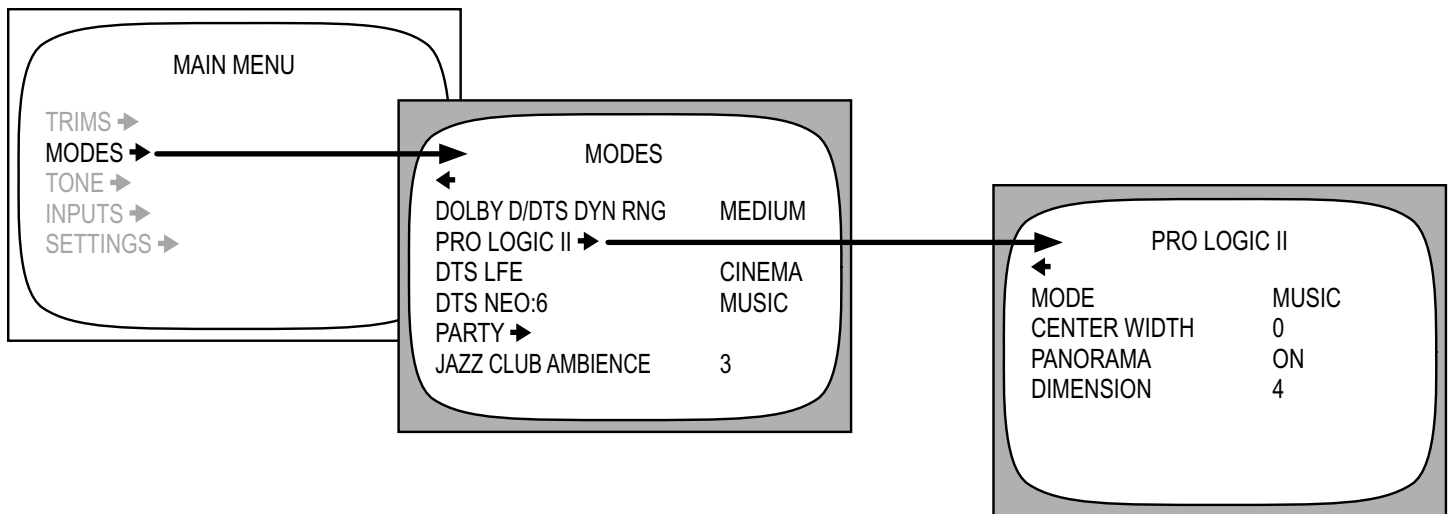

Modes Menu

Dynamic Range

This is the range in level between the loudest sound and quietest sound during Dolby Digital and DTS playback only. The options are Quiet (narrow range), Medium (average range) and Large (wide range). Select Quiet for late night listening if you do not want to disturb anyone. Select Loud for full dynamic range.

Pro Logic II

Select this for Dolby Surround playback, or to enhance any stereo program. A second menu will show the available options.

DTS LFE

Set your subwoofer (LFE) channel for either Cinema or Music during DTS playback. In the Cinema setting, there is no change to the DTS subwoofer level from that mastered on the DTS disk. For the Music setting, there is a 10 dB reduction, necessary to accurately match the levels on DTS music discs.

DTS Neo:6

This allows you to select either Cinema or Music for DTS Neo:6 playback. These two options are described in more detail on page 43.

Party

This mode allows you to play a stereo source with multiple speakers. A second menu allows you to select which speakers are present.

Jazz Club Ambience

This adjusts the ambience and effects of the Jazz Club mode, simulating various venue sizes and strength of the rear reflections.

Pro Logic II Menu

Modes

The available modes are : PLII Movie, Matrix, Dolby Pro Logic or Music. These are described in more detail on page 43.

PLII Music mode has three options which allow you to create a realistic and natural surround effect from 2 channel sources:

Center Width

This spreads the center channel between the front left and right channels.

Panorama

This wraps the front left and right channels around to the surround channels.

Dimension

This adjusts the balance between the front and surround speakers.

Input Menus

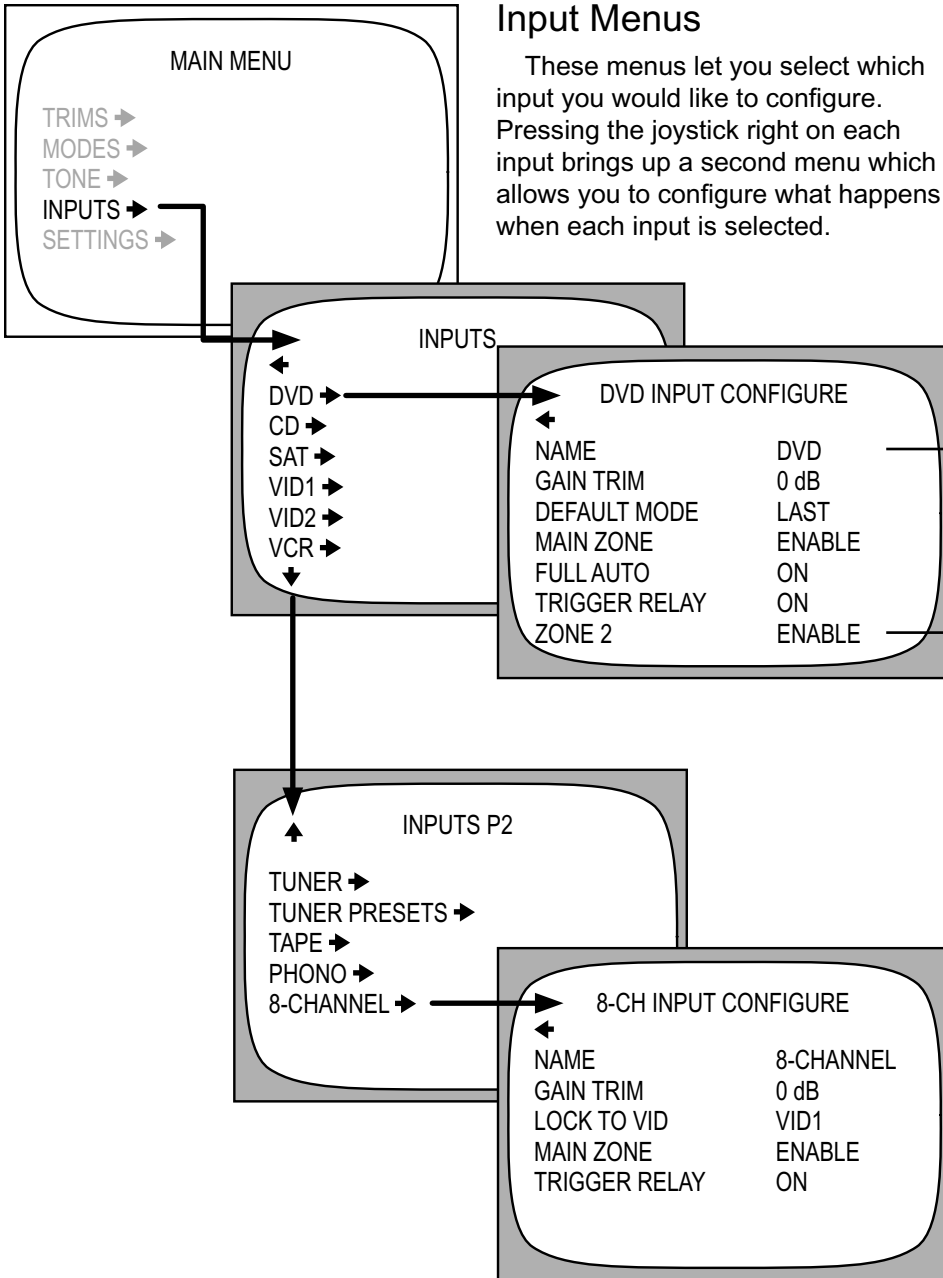

Input Menu

These menus let you select which input you would like to configure. Pressing the joystick right on each input brings up a second menu which allows you to configure what happens when each input is selected.

Input Configuration Menus

The example shows the DVD menu.

Name

Use the joystick up/down, and left/right to change the display name for any input, up to 9 characters. Move fully to the left after entering the name.

Gain Trim

Use this to adjust all of your sources to play at similar levels. To prevent overloading, the levels can only be adjusted downwards. You should try and trim all the inputs to be the same average level as your quietest source.

Default Mode

Set the input to a favorite surround mode or stereo.

Main Zone

Enable/disable the selected input in the Main Zone. You can set up your system so any unused inputs are not selectable. From the factory, the inputs are enabled. If you choose to disable an input, then it will not play in the Main Zone.

Full Auto

This turns on/off the fully automatic mode for this input. When this is on, the TGIII will turn on and select this input whenever this input starts to play. You can deselect any input which hinders full-auto operation.

Trigger Relay

The Trigger Relay can be set to turn on whenever the input is selected. This could be used to turn on an amplifier or a video screen for example.

Zone 2

Enable/disable the input in Zone 2. You can select the inputs you wish to play in Zone 2. For example, you might disable the Phono input if nobody in Zone 2 appreciates your vintage collection of 78s.

Note: the 8-Channel input menu is slightly different from the other menus:

It allows you to select a specific video input whenever the 8-Channel audio input is selected. Also, this input only works in the Main Zone, not Zone 2.

Tuner Preset Menus

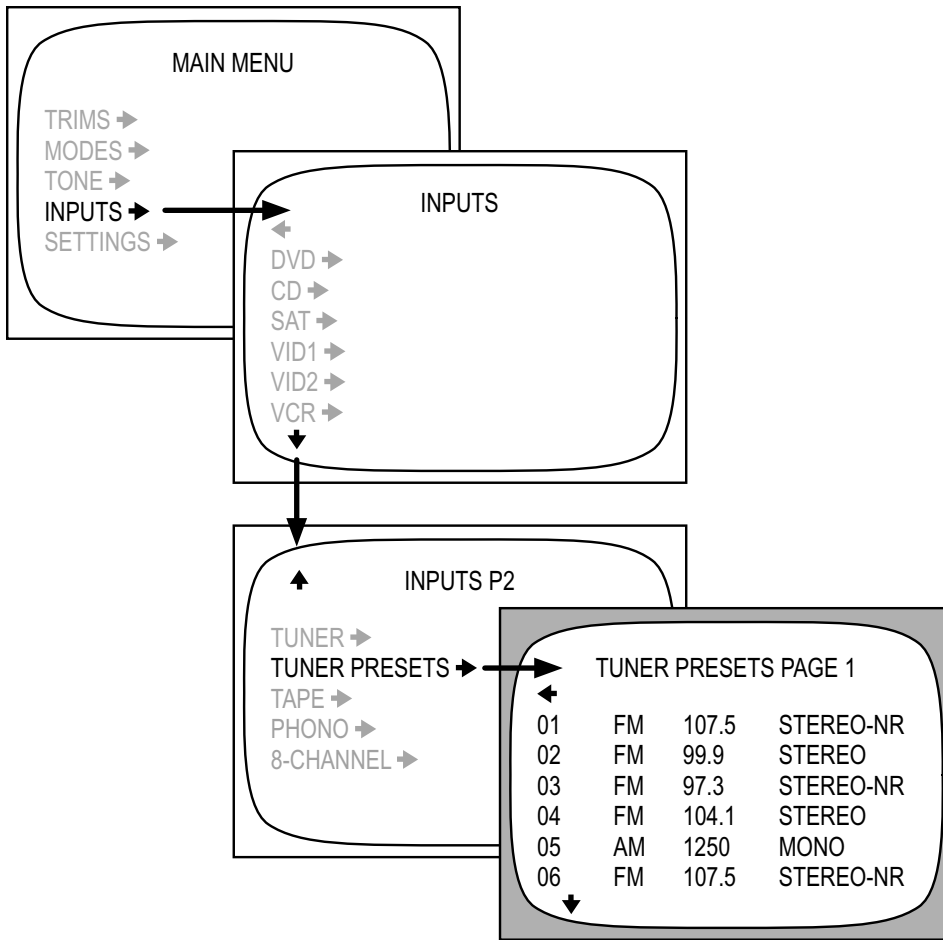

Tuner Preset Menu

This allows you to set the AM/FM band and frequency of up to 40 radio stations. They can be recalled quickly and set as favorite stations on the remote control. See page 45.

For FM stations, try to select the Stereo-NR (noise reduction) for the best reception.

Preset procedure

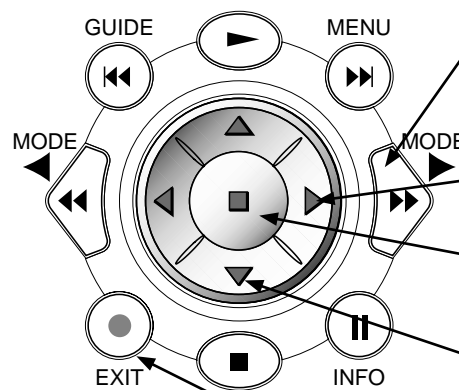

- 1/ Once you are on a preset in the OSD, press the MODE buttons on the remote control to select the band from Stereo FM, Stereo-NR or Mono AM.
- 2/ Then use joystick left and right to change the frequency.
- 3/ Press the joystick center to enter that frequency into preset memory and play that station.
- 4/ Use the joystick down button to move to the next preset down on the screen. The bottom arrow on each screen leads to the next page of presets.
- 5/ Repeat this for all the presets you want to set, then press EXIT when finished.

Main Zone and Zone 2 Menu

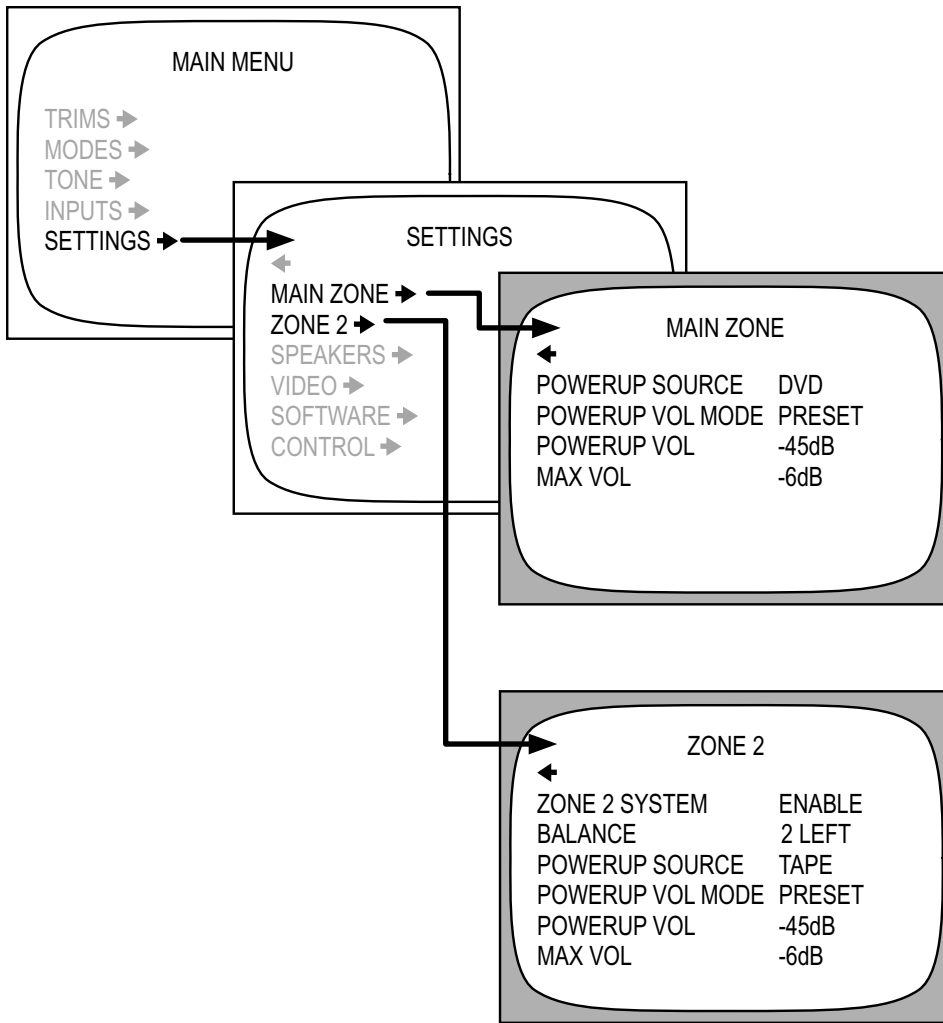

Main Zone Menu

PowerUp Source

This sets the input source which the TGIII will then always select whenever the TGIII is turned on.

Power Up Volume Mode

This lets you choose the volume level the TGIII reaches when it is turned on. You can select from a PRESET level, set below (the power-up volume), or it can play at the LAST level it was playing before it was turned off. The TGIII will always turn on at the level set here, but it can be adjusted to any level afterwards.

Power Up Volume

This allows you to set the PRESET volume level mentioned above. You might want to set it to a low level to avoid any surprises upon turn-on, especially if other users like loud music.

Max Volume

The volume can be set to not exceed a certain level. This is useful if you have sensitive speakers, sensitive neighbors, or you would rather not have others play your system too loud.

Zone 2 Menu

These settings are like those described for the Main Zone. In addition, the entire Zone 2 can be enabled or disabled, and the stereo balance adjusted with this menu.



Zone 2 is set "disabled" from the factory, so you should use this menu to enable Zone 2 when you are ready to use it.

The Power Up Volume has three options: PRESET, LAST and FIXED. The FIXED option allows you to set the Zone 2 to a fixed volume, not adjustable with the remote. PRESET and LAST are as described for the Main Zone.

Video, Software and Control Menus

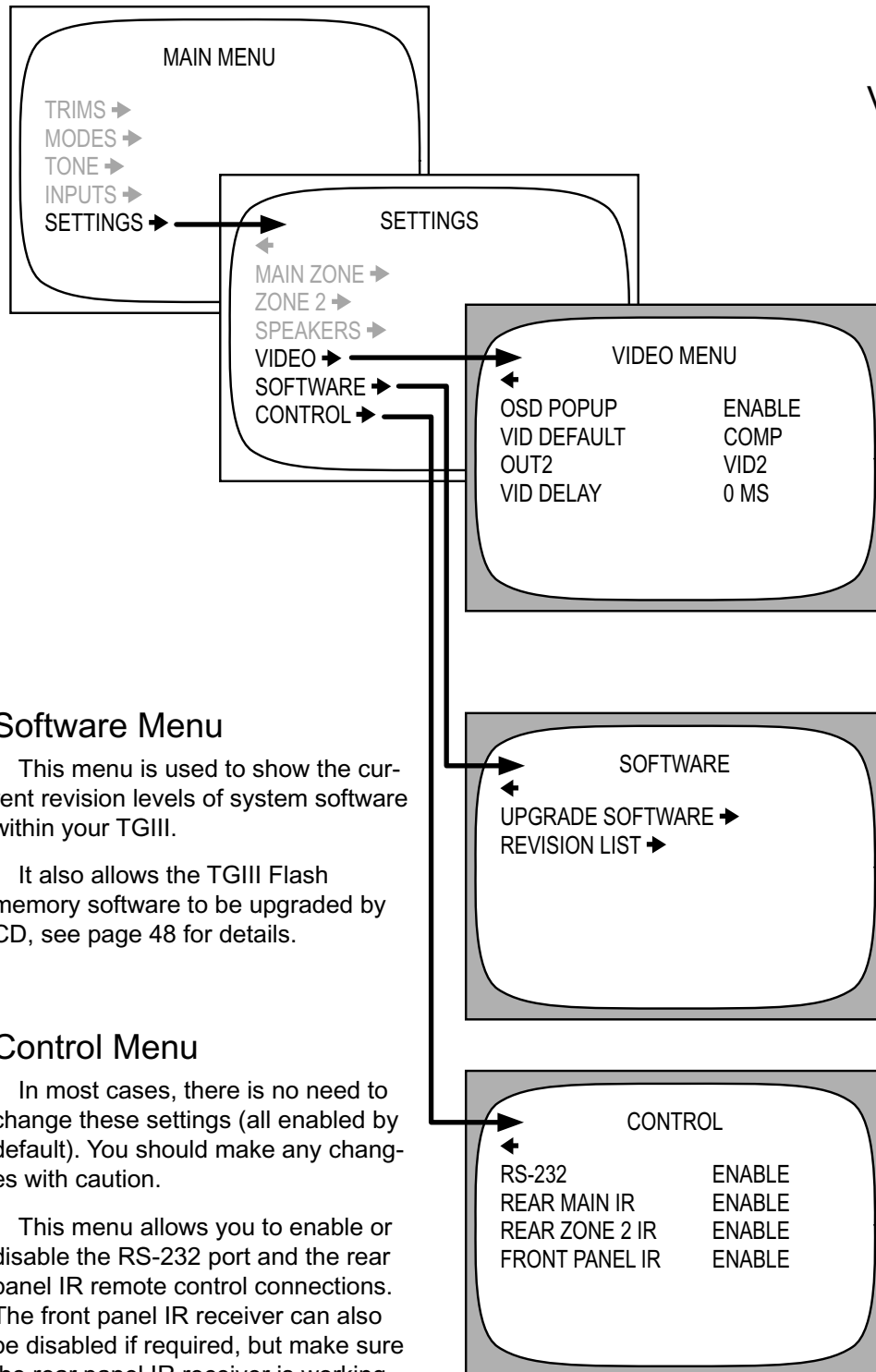

Video Menu

OSD POPUP

When enabled, a "pop-up" message appears on your TV any time a change is made, such as the input, mode, or volume.

VIDEO DEFAULT

Select the video output where the "pop-up" text appears, either S or composite video, but not both. The full OSD is not affected by this menu item, as it is available on both.

OUT2

VID2: the VCR2/MON2 outputs can be used for recording to a second VCR. There is no OSD, and the output is muted when VID2 is chosen as an input (to prevent feedback).

MON2: the VCR2/MON2 output becomes a second monitor output (with OSD) for another TV. It will not mute when VID2 is chosen.

VIDEO DELAY

This adjustment is useful if you have an external video processor in your system. Video signals may become delayed with respect to the audio signals. Although it is called Video Delay, it is actually a delay adjustment of the audio signals relative to the video signals.

Use the remote's joystick pad to adjust the delay in one millisecond steps. An equal amount of delay time is added to all audio channels.

Note: The speakers keep their relative time delay settings which the TGIII calculates from the Speaker Position Menu settings. The video delay is just added on top. Leave the video delay at zero if you do not have an external video processor.

Software Menu

This menu is used to show the current revision levels of system software within your TGIII.

It also allows the TGIII Flash memory software to be upgraded by CD, see page 48 for details.

Control Menu

In most cases, there is no need to change these settings (all enabled by default). You should make any changes with caution.

This menu allows you to enable or disable the RS-232 port and the rear panel IR remote control connections. The front panel IR receiver can also be disabled if required, but make sure the rear panel IR receiver is working correctly and is still active before doing this.

The front panel IR can be re-enabled by holding down the remote's MENU button for several seconds, while pointing it at the front IR window.

Speaker Size Menu

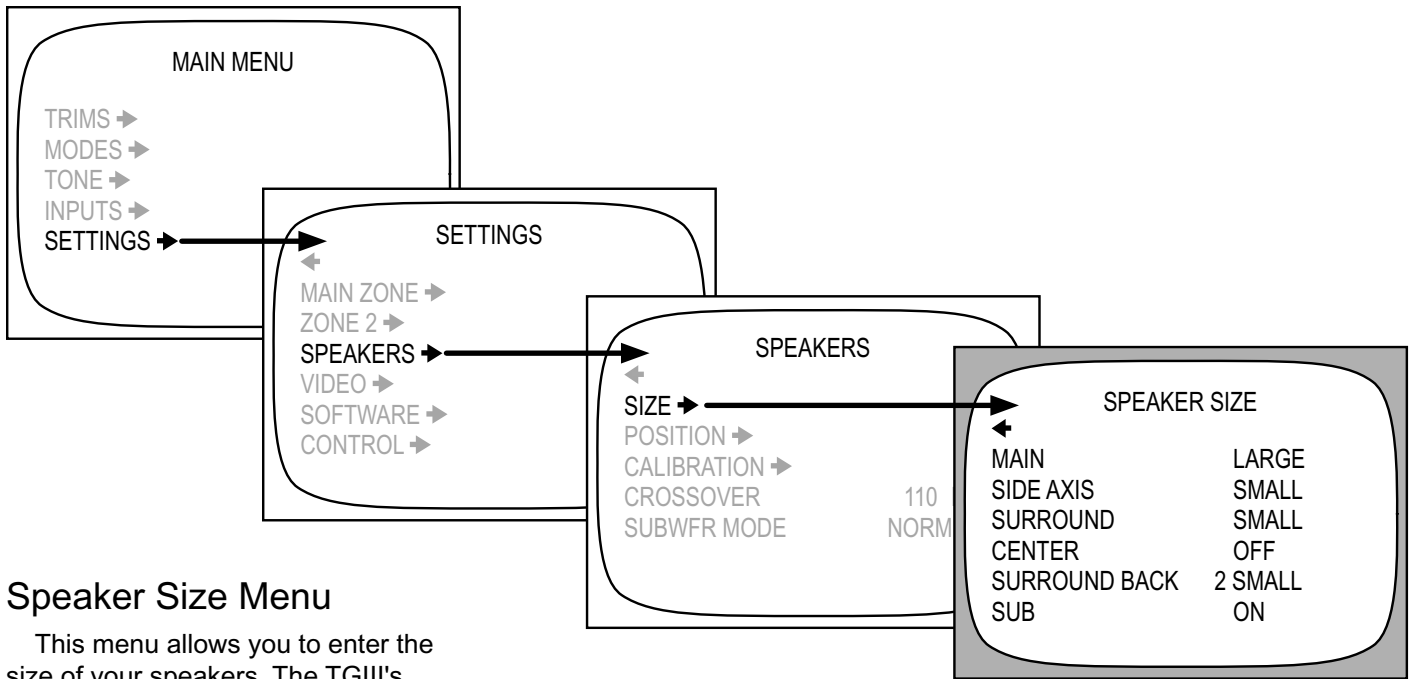

Speaker Size Menu

This menu allows you to enter the size of your speakers. The TGIII's bass management will then automatically assign each speaker a frequency range: either full range for large speakers or high-pass for small speakers. In the latter case, the low frequency range is sent to the subwoofer.

See page 42 for more details on bass management. See page 41 for information regarding the adjustment of the bass management crossover point.

LARGE or SMALL

With a few exceptions, this option can be applied independently to the main, center, surround and surround back speakers.

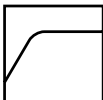
- Select **LARGE** for any speakers which are capable of good bass performance. They will then receive the full frequency range. 
- Select **SMALL** for any speakers such as satellites with 5 or 6 inch woofers. They will then receive the higher frequency range above 

the crossover point. Try using **SMALL** even if your speakers are large. This will protect your speakers from low frequency damage and conserve amplifier power.

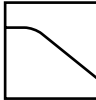
- The lower frequencies from all speakers set to **SMALL** will be redirected to the subwoofer, in addition to its own LFE channel. 

SIDE-AXIS

- Select **OFF** if you have no side-axis speakers. The size is always the same as the main speakers, so do not set the mains to **LARGE**, if the side-axis speakers are small and not capable of good bass performance.

SURROUND

- Select **OFF** if you have no surround speakers.

CENTER OFF

- In the **OFF** position, the center channel information is redirected to the fronts. This is sometimes known as a "PHANTOM" center channel.

SURROUND BACK

- Select **OFF** if you have no surround back speakers. The information will be shared among the other surround speakers, creating a phantom back channel.

SUBWOOFER ON/OFF

- Select **ON** if you have a subwoofer. It will then receive any LFE signals (from 5.1, 6.1 sources), and the bass from any channels set to **SMALL**

Note: the bass management does not work for the 8-Channel input, or for Zone 2. Therefore the speaker size settings will have no effect and these channels will always be full range.

Speaker Position Menu

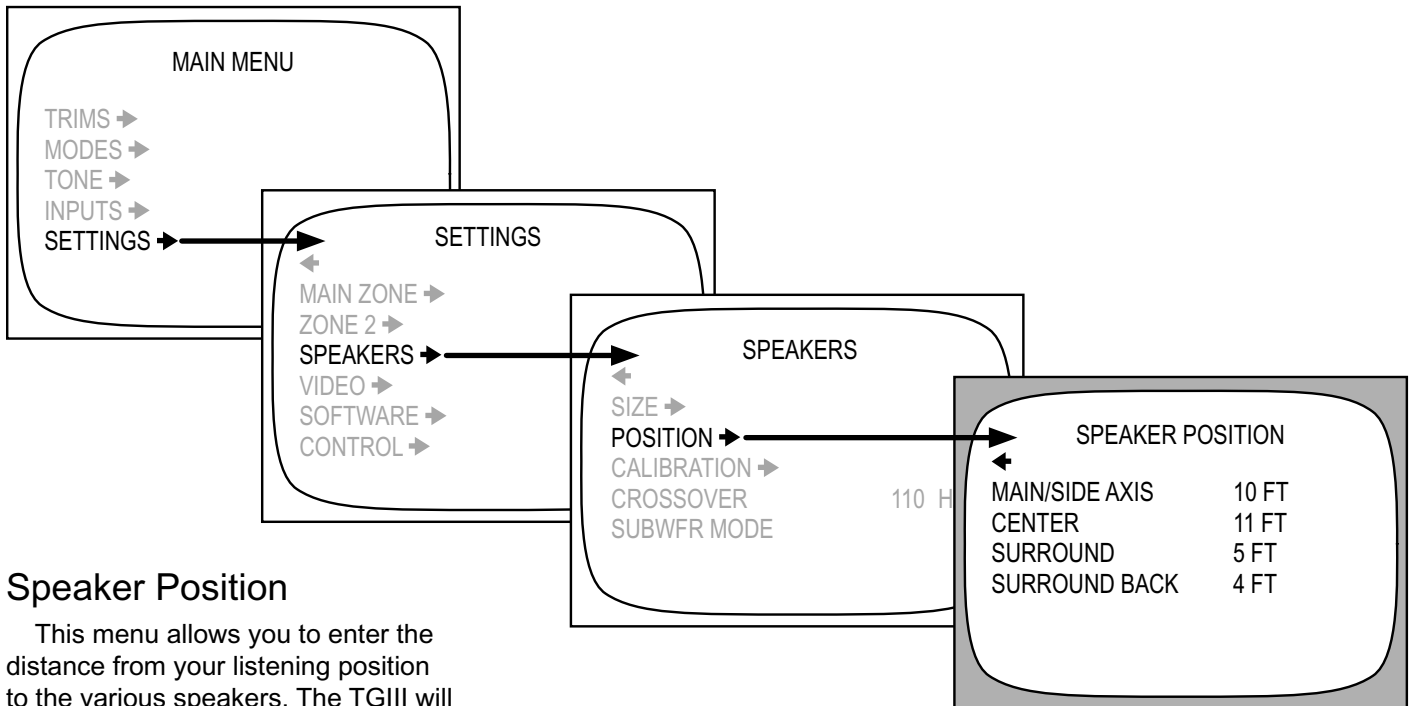

Speaker Position

This menu allows you to enter the distance from your listening position to the various speakers. The TGIII will then automatically adjust and correct the speaker delay times. The sound from each speaker should arrive at the listener at the correct time. The distance measurement is not critical, and a visual estimate is usually adequate.

The procedure is as follows:

1. Measure or visually estimate (in feet) how far each speaker is away from the center listening position of your home theater.
2. In the OSD menu, use the remote control joystick arrow buttons to enter the distance in feet for each speaker.
3. The TGIII automatically sets the appropriate delays for each speaker so the sounds arrive at the listening position at the correct time.
4. Use this table to record your speaker distance measurements.

SPEAKER	DISTANCE
MAIN	
CENTER	
SURROUND	
SURROUND BACK	

Speaker Calibration Menu

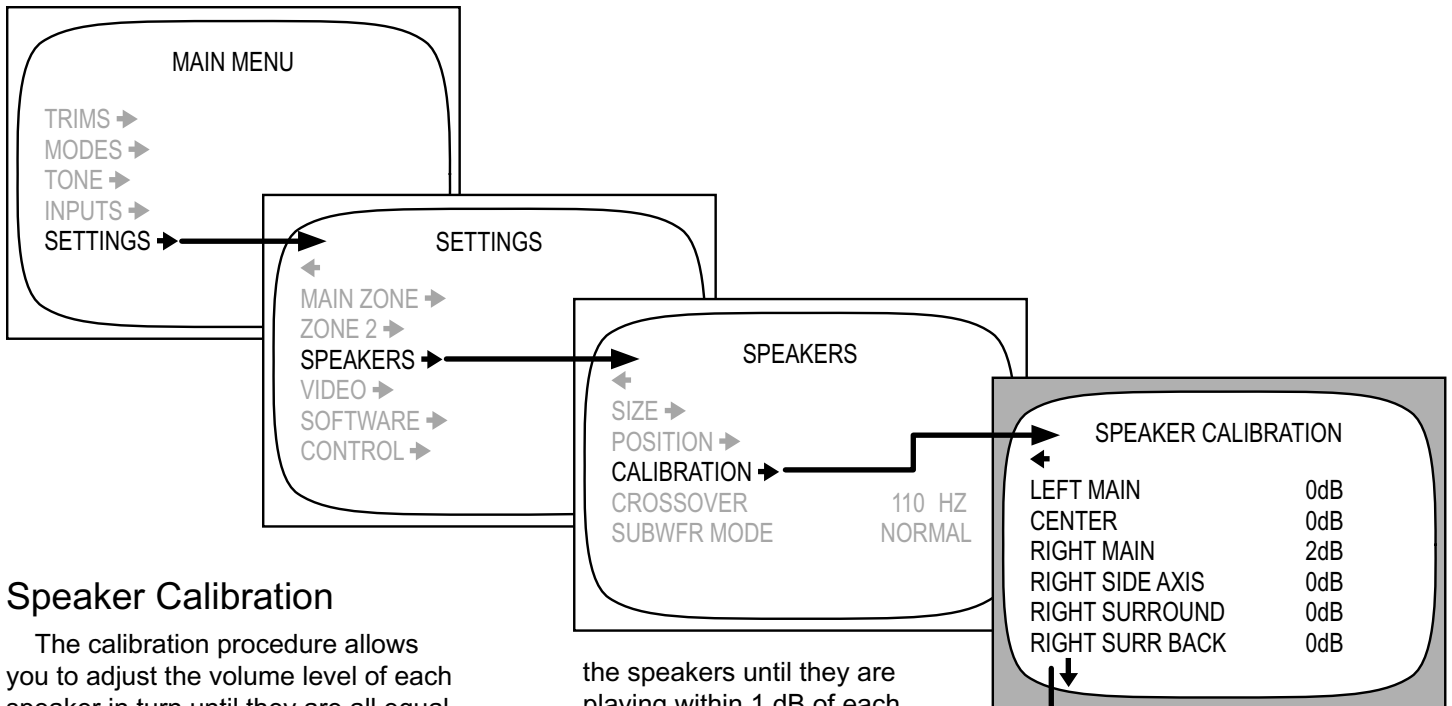

Speaker Calibration

The calibration procedure allows you to adjust the volume level of each speaker in turn until they are all equal. This will give you the best Home Theater performance. You should only do this calibration when you are sitting in your usual listening/viewing position.

Preliminary: Play a movie and adjust the volume for a comfortable listening level. The volume of the calibration test noise is linked to the setting of the main volume control, so if the test noise is too quiet, turn the main volume up a little and retry.

1. Use the OSD to navigate to the **SPEAKER CALIBRATION** menu.
2. Press the remote's joystick down to turn on the noise generator. While the test signal is playing in each speaker, its level can be adjusted using the joystick left/right buttons. Adjust each speaker in turn until they are all equal in volume.

The best results are obtained if you use a Sound Pressure Level (SPL) Meter. This is a hand held meter which will accurately measure and display the sound level. Adjust all of

the speakers until they are playing within 1 dB of each other. Without a meter, you can still obtain good results with careful listening.

3. Repeat the procedure several times for each speaker until you are satisfied they are playing at the same level.
4. Press the joystick-up to return to the top of the menu, and then press joystick-left to exit. The calibration noise generator will turn off.

The main volume control adjusts the volume of all of the speakers up and down at the same time. They keep the same relative levels you set here, that is, they will still be playing as loud or as quiet as each other.

The Dolby Digital, Dolby Pro Logic and DTS soundtracks are designed to be played back in a calibrated Home Theater. The sounds from each speaker will be at the correct relative levels, as the movie sound director designed them. Repeat the calibration if you change any external power amps or speakers, or if you move your couch relative to the speakers.

SPEAKER CALIBRATION

LEFT MAIN 0dB
 CENTER 0dB
 RIGHT MAIN 2dB
 RIGHT SIDE AXIS 0dB
 RIGHT SURROUND 0dB
 RIGHT SURR BACK 0dB

SPEAKER CALIBRATION

LEFT SURR BACK 0dB
 LEFT SURROUND 2dB
 LEFT SIDE AXIS 0dB
 SUBWOOFER 0dB
 GO TO LEFT MAIN

ON-THE-FLY TRIMS ZEROED

The range of adjustment is +/- 10 dB for each speaker.

Record your levels here:

SPEAKER	dB LEVEL
LEFT MAIN	
CENTER	
RIGHT MAIN	
RIGHT SIDE AXIS	
RIGHT SURROUND	
RIGHT SURR BACK	
LEFT SURR BACK	
LEFT SURROUND	
LEFT SIDE AXIS	
SUBWOOFER	

Speaker Crossover Menu

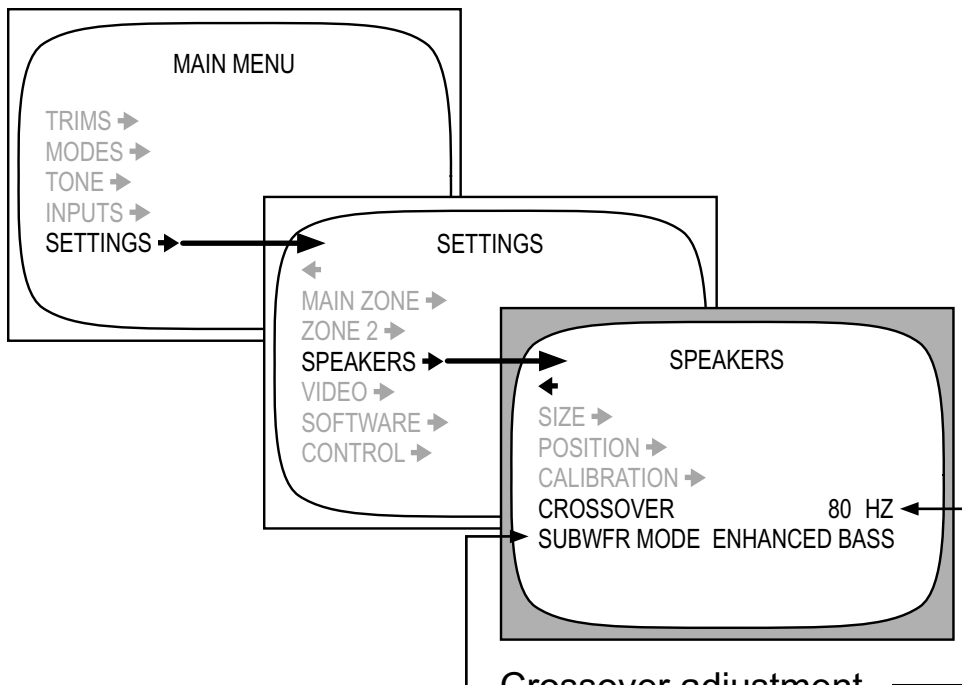

Crossover adjustment

The TGIII bass management system allows you to send the low frequencies of your speakers to a subwoofer. The crossover point can be selected from 40 Hz to 160 Hz.

For example, if you set the crossover to 80 Hz (a good starting point):

- The subwoofer receives frequencies below 80 Hz, from all speakers whose size is set to SMALL.
- All speakers set to SMALL, receive frequencies above 80 Hz.

Subwoofer Mode

The subwoofer output can be set to Normal, or to an Enhanced Bass mode.

The Enhanced Bass mode provides an output to your subwoofer even when you are listening to a stereo source with main speakers set to LARGE. In the Normal mode, there would be no subwoofer output in this case, and the bass would only come from the main speakers.

The Enhanced Bass mode has no effect if the main speakers are set to SMALL, as the subwoofer is automatically engaged. It also has no effect in 5.1 or greater surround modes.

Most manufacturers provide a -3 dB specification for their speakers. This is the frequency where the speaker's output has dropped by 3 dB. Set the TGIII's crossover to this frequency or above. If you cannot find this, set the crossover to 80 Hz (the default).

Set your subwoofer's own crossover control to maximum frequency or bypassed mode. If it is set lower than the TGIII, there would be a hole in the mid-bass, and bass information would be missing.

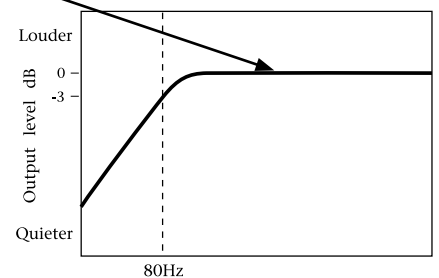
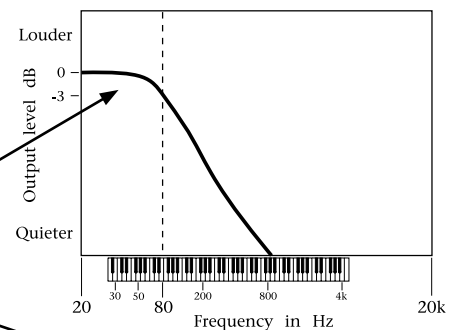



Using the TGIII

Bass Management

Unlike higher frequencies, it is difficult to discern exactly from which direction lower bass is coming from.

The TGIII has a bass management system which takes advantage of this effect. It allows you to choose whether your speakers will play the full frequency range, or if the bass will be redirected to the subwoofer.

The advantages of redirecting the bass to a subwoofer are :

- The overall bass of the system is improved as subwoofers, such as Sunfire's powered True Subwoofers are specially designed for this frequency range.
- The subwoofer can simultaneously play the bass from all of the speakers, in addition to it's own low frequency effects channel (LFE).
- There is no loss in perception of the position of movie or music sound effects, as the ear cannot easily locate the position of bass sound sources.
- Smaller speakers can be used for front, center and surrounds, as they do not have to reproduce the low frequency range. This leads to a saving in speaker expense and room space. Note that a subwoofer is required if the front speakers are set to SMALL.
- Your amplifiers do not waste power reproducing the low frequency range.

See the previous page for information regarding the adjustment of the bass management crossover point.

The SPEAKER SIZE menu is used to set the bass management correctly for your speaker system. See page 38.

NOTE: Dolby Digital and DTS modes are designed especially for complete systems with front, center, and surround speakers and subwoofers. You need all of the speakers to get the best performance from your Home Theater. If you do not have a subwoofer connected, then you should not use the bass management system (so set all the speakers to Large). Without a subwoofer, you will be missing the 5.1 LFE (low frequency effects) information.

Considering the advantages of the bass management system, you might try setting all of your speakers to Small, even if they are capable of good low-frequency performance.

Surround Modes for 2-Channel Sources

For 2 channel input sources, you can choose from the following modes:

STEREO
DOLBY PRO LOGIC II
PARTY
JAZZ CLUB
DTS Neo:6
SOURCE DIRECT

The mode selection can be made from the front panel MODE buttons, or from the remote control.

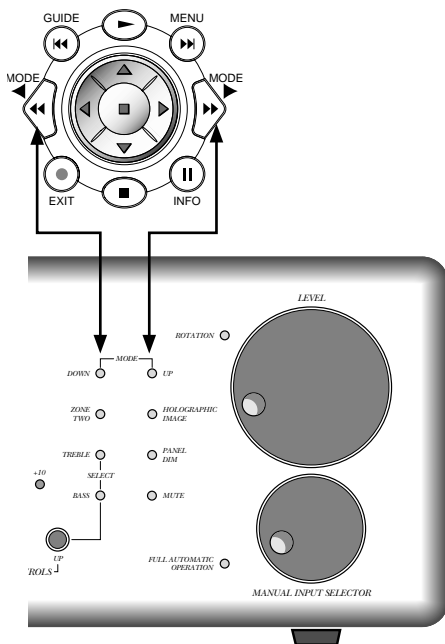

STEREO

This is the conventional two-channel stereo mode with sound from your left and right speakers. The TGIII bass management lets you use your subwoofer to handle the lower frequency range.

We recommend that you try the HOLOGRAPHIC IMAGE when using stereo sources.

DOLBY PRO LOGIC II

This mode allows you to enjoy many of the benefits of Dolby Digital from your stereo sources. This updated version of Dolby Pro Logic features enhanced realism from full range stereo surround channels.

Dolby Pro Logic II has several options which can be set using the On Screen Display (OSD) menus. These include:

MOVIE mode for Dolby Surround soundtracks. These are decoded by the TGIII into separate channels: left and right channels for off-screen imaging, a center channel for most on-screen dialog, and stereo surround channels for ambience and special effects.

MUSIC mode for listening to any stereo material. This mode also includes three options:

Center Width, which spreads the center channel across the front soundstage.

Panorama, which wraps the left and right channels around you.

Dimension, which adjusts the front/rear balance.

Try the **MUSIC** mode for all of your stereo programs, and adjust these extra options to suit your taste.

PRO LOGIC mode emulates the original standard surround mode. It can be used for source material which is not of optimum quality, or if you just feel nostalgic for the way things were.

MATRIX mode can be used for mono sources, or for FM programs with poor stereo reception.

PARTY

This extra stereo mode copies the front speaker signals to the other speakers in your system. This mode adds tremendous presence to your stereo sources and is great for parties and casual listening alike. The OSD menu can be used to select which speakers are active in this mode.

JAZZ CLUB

In this DSP mode, the surrounds simulate the ambience caused by rear reflections and effects of a small to medium sized venue. This is useful for adding surround sound effects to stereo sources. The ambience effect can be varied using the OSD MODES menu.

DTS Neo:6

The **CINEMA** option can produce up to six full range, separate channels and a subwoofer output from stereo matrix surround sources. This enhances the playback of sources such as surround sound video tapes, Laser Discs and broadcast TV programs.

The **MUSIC** option can expand normal stereo programs into six channels. It does so in a natural sounding way, which enhances the listening experience.

SOURCE DIRECT

This mode bypasses all DSP, Tone, and bass management circuits. It is stereo analog only, and offers the shortest signal path through the TGIII. Only the front left and right speakers are engaged. Do not use this mode for digital-only sources, as it only routes the analog audio. To prevent damage to your speakers, this mode only works if your front speakers are set to Large.

In addition to these modes, and those offered for multi-channel sources, the side-axis speakers will widen the front sound stage and fill in the sound field between the front speakers and the surrounds. Note that the side-axis speakers are active in stereo as well as multi-channel operation.

The **Holographic Image** can also be selected for any 2 channel or multi-channel source for enhanced realism and depth.



Surround Modes for Multi-Channel Sources

For multi-channel sources, the TGIII will automatically select the correct mode from one of the following:

DOLBY DIGITAL
DOLBY DIGITAL EX
DTS
DTS-ES MATRIX
DTS-ES DISCRETE

Dolby Digital and DTS are “5.1” surround systems with five main channels: left front, center, right front, left surround, and right surround. Each channel can play the full frequency range and is independent of the other channels. The “.1” denotes the subwoofer channel which plays the low frequency effects (LFE), also independent of the other channels.

Dolby Digital EX and DTS ES offer “Extended Surround.” Both systems offer a surround back channel which effectively fills in the otherwise empty soundspace behind you.

If you want to try one of the modes on the previous page, you should select a 2-channel output from your DVD player's options menu.

NOTE: In your DVD player's audio setup menu, set the digital output to **BITSTREAM**. If this is not set correctly, the TGIII cannot decode the digital information.

DOLBY DIGITAL (5.1)

This mode is available if the TGIII automatically detects a Dolby Digital encoded source on the currently selected input.

You should look for the Dolby Digital Logo on DVDs, LaserDiscs and other sources.

Many DVDs have the option of a Dolby Pro Logic, Dolby Digital or Stereo soundtrack. You may have to follow the instructions in your DVD player's instruction manual for your player to output Dolby Digital bitstreams. Dolby Digital must often be selected from the Disc's menu.

DOLBY DIGITAL EX (6.1)

Dolby Digital EX mode is primarily for playback of Dolby Digital Surround EX encoded soundtracks. One of its advantages over Dolby Digital playback is that it fills in the area behind the listener with a completely separate full-range channel.

The TGIII has the option of connecting one or two surround back speakers. The calibration and speaker size options allow a seamless surround field to be created.

If you do not have the surround back speakers connected, then the extra information is sent to the standard surrounds and no material is lost. (Set the surround back speakers to OFF in the SPEAKER SIZE menu).

The TGIII will also create the back surround channel if you are playing a 5.1 source.

DTS (5.1)

This mode is available if the TGIII automatically detects that a DTS encoded source is present at one of its digital inputs. Look for the DTS Logo on DVDs, LaserDiscs, CDs and other sources.

Make sure that you set your player to output DTS bitstreams. DTS must also be selected on the disc's menu.

DTS ES (6.1)

All DTS-ES sources have the surround back channel matrixed in the left and right surrounds. Newer DVD releases also have a discrete surround back channel, in addition to the same information matrixed.

DISCRETE ES sources: the TGIII DTS-ES discrete decoder will decode the discrete surround back channel. It also removes the surround back matrix from the left and right surrounds, and restores them to be fully independent channels.

MATRIX ES sources: If there is no discrete surround back channel, the TGIII decodes the matrixed surround back channel from the left and right surrounds, and restores them to be fully independent channels.

Tuner Operation

The Tuner is selected either by rotating the manual input selector on the front panel, or by touching the TUNER button in the remote's TGIII mode. The front panel display shows the frequency of the last station you were listening to.

The FM Tuner can tune stations from 87.5 MHz to 108.0 MHz in 0.2 MHz steps (.05 MHz steps for some international models). The AM Tuner range is 530 kHz to 1710 kHz in 10 kHz steps (531 kHz to 1710 kHz in 9 kHz steps for some international models).

Tuner and the OSD

Page 35 shows how to set up the Tuner using the on screen display.

Tuning Stations Manually

Use the front panel AM/FM button to select either the AM or FM band, and then use one of these three ways to tune stations manually:

1. Touch UP or DOWN momentarily to change the tuner by one frequency step.
2. Hold UP or DOWN for a second or so, then release to start the scanning feature. The TGIII will scan to the next station, pause on it for a few seconds to allow you to hear what is offered there, and then scan to the next, and so on. Pressing UP or DOWN stops the scanning process.
3. Hold UP or DOWN for an extended period to make the tuner speed across the band without stopping on a station. The tuner will begin scanning for stations when you release the button. Pressing UP or DOWN stops the scanning.
4. When a station is tuned, it can be set as a preset for easy recall, see "Setting the Presets" in the next column.

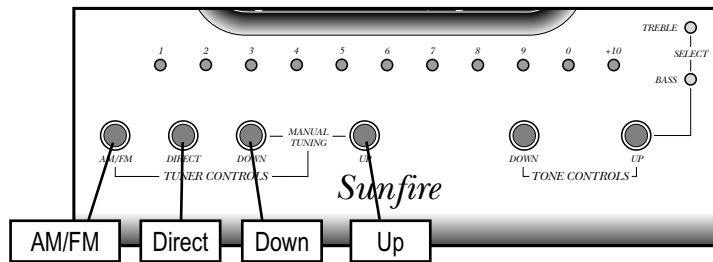

Tuning Stations Directly

Use the AM/FM button to select either the AM or FM band and then press the DIRECT button. Within a few seconds, enter the station's frequency by using the preset number buttons. For example, to tune to radio station 97.3, press DIRECT, then 9, then 7 and then 3.

Setting the Presets

Once you have tuned in a station, press and hold a preset button until the display flashes to show the memory has been set. Use the +10 button to add presets higher than 9, and hold the last button pressed for a few seconds.

Press	Result
5	Preset 5
+10, 0	Preset 10
+10,+10, 7	Preset 27
+10,+10, +10, 3	Preset 33

Recalling a Preset Station

Once you have selected the Tuner, you can quickly recall a station by pressing its preset number, either on the front panel or by using the remote's numeric keypad, FAV buttons, or the channel up and down buttons.

Scanning Presets

To scan through the presets, press and hold the FM/AM button. Touch it again to stop the scan.

Record your favorite stations here:

Preset	Station	AM	FM	NR
1				
2				
3				
4				
5				
6				
7				
8				
9				
10				
11				
12				
13				
14				
15				
16				
17				
18				
19				
20				
21				
22				
23				
24				
25				
26				
27				
28				
29				
30				
31				
32				
33				
34				
35				
36				
37				
38				
39				
40				



Recording

Recording to a Tape Player

Input signals from an audio source playing in the TGIII can be recorded using the left and right audio outputs. The tape player will receive a straight copy of the analog source signal going in, unaffected by the volume, tone or any surround modes. If you are playing a digital source, the tape player will receive a downmixed stereo analog signal for recording.

- Turn OFF the Fully Automatic mode. This is because some tape decks, such as three-head decks, will have an output signal going into the TGIII during recording. The DAT or TAPE inputs may be incorrectly selected as an input, rather than the source you are trying to record.
- Manually select the source such as CD and play it through your system.
- Set your tape player to record and adjust the input levels for the best performance. Once the levels are correct, you can reset your source to the beginning and make your recording.
- Do not select another Main Zone input while you are recording.

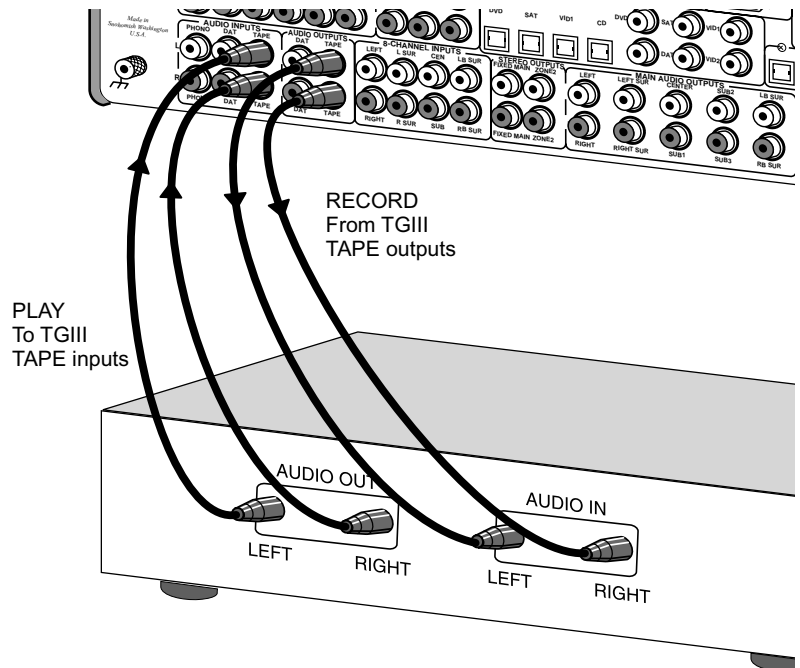

Recording to a VCR

Any video source playing in the TGIII can be recorded using the left and right audio and the video outputs. The VCR will receive a straight copy of the source signal going in, unaffected by the volume, tone or any surround modes.

- Select the video source and play it through your system.
- Set your VCR to record.
- Do not select another Main Zone source while you are recording.
- The VID2/MON2 output can also be used for recording, but first make sure that it is set to VID2 in the VIDEO menu of the OSD (see page 37). This output will then mute to prevent feedback whenever the VID2 input source is selected.
- Do not use the OSD while recording as the incoming video is shut off while the OSD is displayed

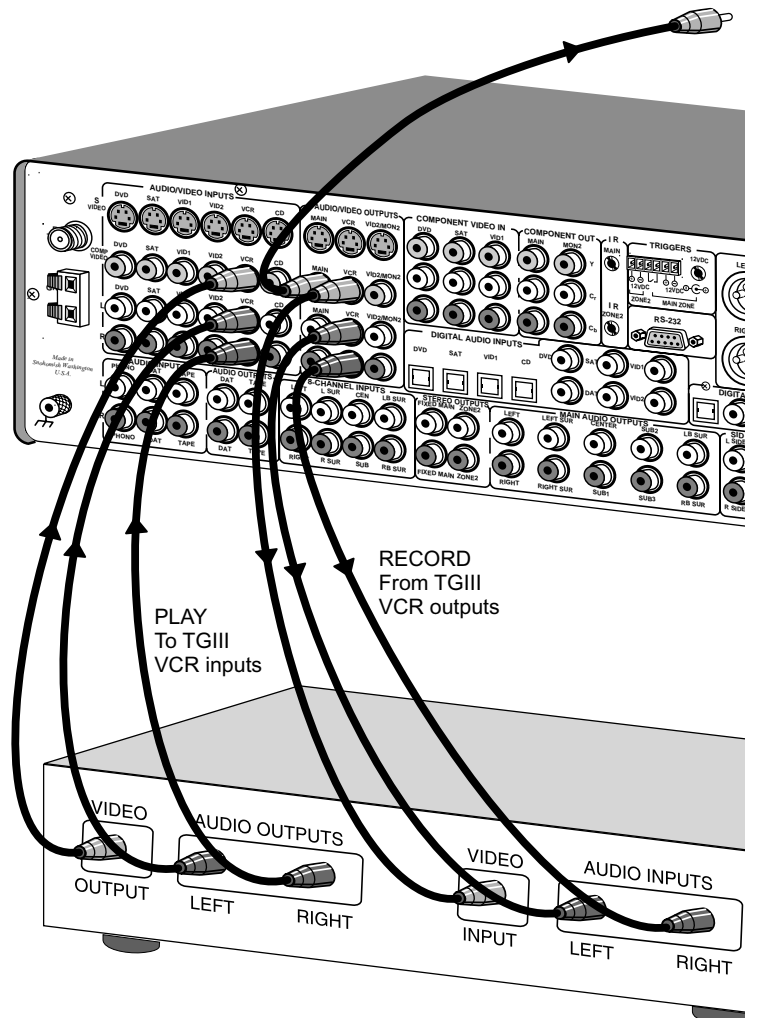

Zone 2 Operation

If you have an amplifier and a pair of speakers in a second room or area (Zone 2), they can play a stereo source independent of what is playing in the Home Theater room (Main Zone). You can also play the same source as selected in the Main Zone.

Zone 2 plays stereo sources, and is unaffected by the Tone controls, DSP, Holographic Image, surround modes or bass management.

Connections

The connections for Zone 2 are shown on page 24.

Note: Zone 2 can play analog sources independent of what is playing in the Main Zone. It **cannot** play from a digital-only source unless that input is selected and playing in the Main Zone. To play a source such as a DVD player in Zone 2 independent of the Main Zone, make sure you connect the player's L-R analog audio output to the TGIII.

Indicators

The front panel has two LEDs to show the Zone 2 status:

Zone 2 Power
This LED is always on when Zone 2 is on. If it is off, there will be no output to the Zone 2 amplifier.

Zone 2 Adjust

This turns on whenever the Zone 2 source or volume is being changed. Note: if this is on, then any adjustments you make of volume or input, will affect Zone 2, not the Main Zone.

In addition to these LEDs, the front panel display will show the input and volume adjustment.

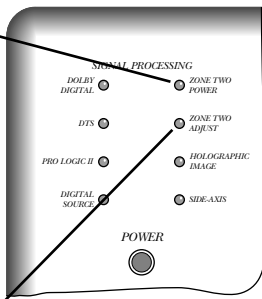

Turning on Zone 2

Use the On Screen Display in the Main Zone to check that Zone 2 is enabled. (See page 36, middle column for details). This enables the Zone 2 system, but it still has to be turned on.

Press the remote's ZONE 2 button. The remote's POWER, VOLUME and MUTE buttons then work for Zone 2. The remote display changes as follows:

PAGE 1

This allows you to select the inputs to play in Zone 2. Z2MAI (main) allows Zone 2 to play whatever is playing in the Main Zone.

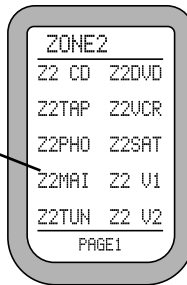

Press PAGE to show the next page:

PAGE 2

This has discrete codes which are useful if you want to program the remote control with Macros.

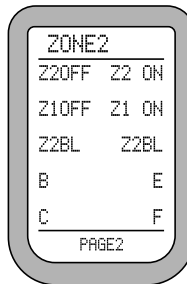

Z2 OFF, Z2 ON
Zone 2 on or off.

Z1 Off, Z1 ON
Main Zone on or off.

Z2 BL
Use these two buttons to adjust the left-right balance of Zone 2.

B, C, E, F
These are extra buttons you can Learn over and re-Label with your favorite Zone 2 commands.

Press MAIN to return to PAGE 1, and press it again to return to the Main Menu.

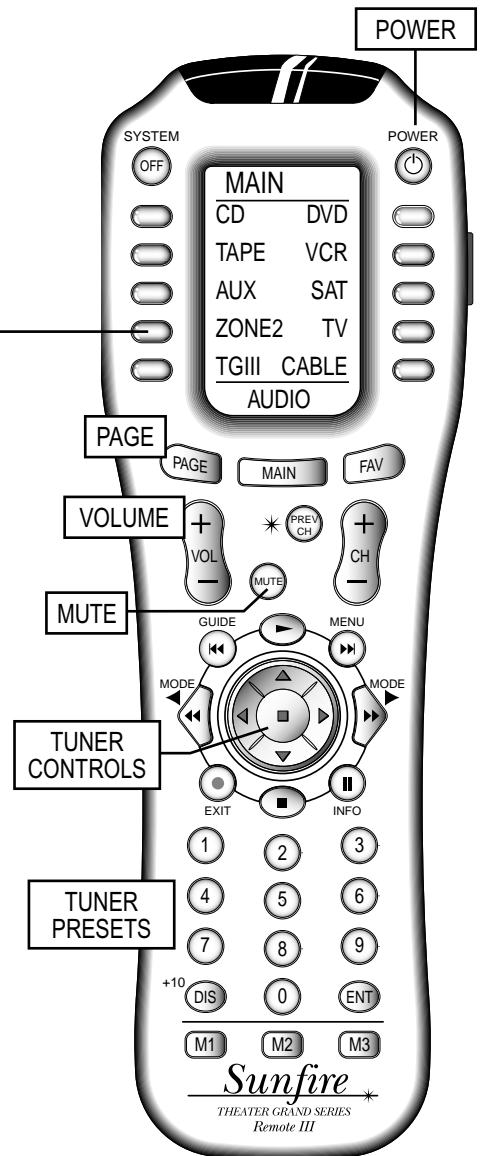

Note: Zone 2 can also be turned on and adjusted without using the remote. Press the Zone 2 button on the TGIII front panel, followed by Power, to turn it on (or off), or adjust the input source or volume.

Zone 2 operations will work even if the Main Zone is off.



Holographic Image

The Holographic Image is a unique process which enhances the three-dimensional effects and realism of stereo sound. This is modeled in DSP, from a design based on Bob's legendary (and much sought after) Carver C-9.

This circuit was designed to overcome a problem in obtaining accurate sound reproduction:

In a stereo system, both ears will hear the output from both speakers. The left ear hears sound from the left speaker and from the right speaker. To see a problem with this, compare what happens when listening to a live musical performance:

During a concert, each ear will receive one direct sound arrival. For example, a cymbal crashes, both your ears will hear it and the brain tells you accurately the position of the musician. In a stereo recording of the concert, this cymbal crash will be heard from both speakers. The left ear will hear the left speaker, which is fine, but it will also hear the crash from the right speaker. These extra sounds tend to confuse the sense of sound source location.

The stereo effect in a good pair of headphones is enhanced because the left ear only hears the left headphone, and the right ear hears only the right headphone. There are no extra sound arrivals.

To summarize :

1. A real musical event will create only two direct sound arrivals, one at the left ear and one at the right.
2. Stereo playback will give four arrivals, as both speakers are heard by each ear. These second sound arrivals reduce our naturally accurate sense of positioning.

The Holographic Image circuit was designed to cancel out the unwanted second arrivals. The left ear will mainly hear the left speaker and the right ear mainly hears the right speaker. This is accomplished by sending a complex crosstalk signal from the left and right speakers in addition to the normal program. These extra signals are virtually identical to the unwanted second sound arrivals but they are out-of-phase with them and they cancel each other out.

The result is a more three-dimensional and wider soundstage, where the positioning clues are restored. In a way, the musicians have been freed from the confines of the flat plane between the speakers. You will perceive them as playing forward or playing behind the speakers or to one side or the other, not just somewhere in between. We recommend that you experiment with its effect, remember that you are listening for a more accurate sense of the location of the different musicians.

Because the Holographic Image works by phase cancellation of the unwanted second sound arrivals, accurate speaker positioning is required. You must make sure that the left speaker is the same distance away from you as the right speaker. Follow the front speaker placement on the next page to get the best results. This is the same as any standard stereo system, only with more care taken to position the left and right speakers accurately.

The Hologram circuit can be engaged using the remote control or from the front panel. There is a short mute period until the circuit is fully engaged or disengaged.

Software CD

The TGIII Flash memory software can be upgraded by connecting your PC to the TGIII's RS-232 serial port, and downloading an update file from our website: www.sunfire.com. This is the preferred method, as the software can be updated fairly quickly. See page 51 for more details.

Alternatively, the TGIII software can be upgraded using a CD available from Sunfire Technical Support. This CD will be available periodically if there are major software changes since the initial release.

The following notes show the CD upgrade procedure. The CD or DVD player must be connected to the TGIII's digital audio inputs.

1. Turn on your TV, your CD player and the TGIII.
2. Use the TGIII remote to select the On Screen Display.
3. Go to the Settings Menu and then select the Software Menu.

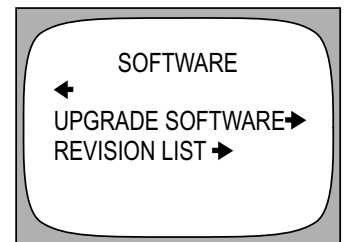

4. Select "Upgrade Software," which brings up a second OSD menu.
5. On the TGIII, select the digital input which will play the CD. Press ENT on the remote (bottom right).
6. Press 1,2 and 3 on the remote, then play the CD. The TGIII display will show the status as the CD data is transferred into the TGIII.
7. Turn off the TGIII when the software transfer is complete.



....Speaker Placement continued

In some systems, two center speakers are used; one on either side of the TV. As they are in mono, the result is a sound image that is positioned exactly at the screen center.

Side-Axis Speakers

The TGIII has two side-axis channels which are matrixed from the left and right front channels, so they are available in stereo as well as surround modes.

Use the OSD SPEAKER SIZE menu to turn the SIDE-AXIS channels ON or OFF (see page 38).

- D Shows the typical placement of the side-axis speakers. You can also angle them in towards your listening position. Place the speakers along the side walls, close to the fronts.

The Surround speakers

Place each surround speaker to be an equal distance away from your central listening position and keep them at least one or two feet above ear level.

- A The diagram shows the use of dipole surround speakers. These are usually positioned to the side of your listening position. They radiate forwards and backwards and have a quiet null zone which should point towards the listener. The overall effect is that you cannot hear the direct sound from the surround speakers, just the average soundfield.

Conventional surround speakers can be placed behind the listener, on the rear walls or the side walls. Adjust the angle so they do not point directly at the listener but cause reflections from the sidewalls or the ceiling. This will give the effect of broadening the rear soundstage so that you cannot distinguish the sound as coming from a small box on the wall but from a larger area behind you.

Surround Back Speakers

The TGIII has two extra outputs for surround back speakers. These create a wonderful sense of realism in surround effects during playback of Dolby Digital EX and DTS ES.

The TGIII can be configured for one or two surround back speakers. Ideally, all the surround speakers should be of the same make and model, and fitted at similar heights to produce a smooth continuous soundfield.

If you are connecting one surround back speaker, connect its amplifier input to the TGIII **left** surround back output. Place the speaker behind your listening position.

Subwoofer Location

The TGIII has identical output connections for up to three subwoofers, in addition to a fourth, balanced sub out.

The best location for a single subwoofer can be found by playing some heavy bass and proceeding as follows:

1. Place the subwoofer right on the seat of your couch or listening easy chair.
2. You can then either run the calibration (noise) signal through it, or simply plug the analog outputs of a CD player directly into your subwoofer's low-level inputs. Turn down the subwoofer's volume level before turning on the CD, then play some of your favorite music samples with heavy bass.
3. Walk around the room, standing in all the positions where you might be able to place the subwoofer. This is usually somewhere close to the corners of the room. Try locations fairly close to the front speakers.
4. Notice where in the room the bass output from the subwoofer sounds the loudest. Shut things down and install the subwoofer there.
5. This is the best position for the subwoofer. The bass will sound the best when you are sitting in your normal listening position.



The RS-232 Port

The TGIII has a rear panel RS-232 Serial communication port. This allows the FLASH memory to be upgraded to the latest software by connecting to a PC.

The TGIII software may be updated to refine operational details and to include new features. Downloadable updates will be posted on our website: www.sunfire.com.

Communications

Serial RS-232, 9600 Baud, 8-N-1

DB-9 Wiring

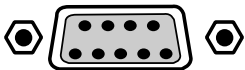

PINS 1, 6 and 4 are joined together internally

PINS 7 and 8 are joined together internally

PIN 2- Data from processor to controller (processor transmit)

PIN 3- Data from controller to processor (processor receive)

PIN 5- Ground/Common

PIN 9- No connection

The RS-232 connector is female.

Serial Cable

To connect the TGIII port to a computer, you will need a "straight-through" serial cable. This has connector pins at one end connected directly to the pins of the connector at the other end. For example, pin 1 at one end connects to pin 1 at the other end, pin 2 connects to pin 2, pin 3 to pin 3 and so on.

These common cables are available from most computer stores (or from Radio Shack as # 26-117). It should be 9-pin male at one end, to fit into the TGIII and normally 9-pin female at the other, to fit into your computer's serial port (COM1 or COM2).

Update Procedure

1. The current version level of the software running your TGIII can be found by looking at the Version Level OSD menu. This is under the Software OSD menu (see page 37).
2. If the website file is newer than your current version, follow the website directions and download the new file onto your computer's hard drive.
3. Record your calibration, preset stations or other settings on page 57. In most cases, the upgrade will not affect any of these settings, but it is good to record them just in case.
4. Turn off your computer and the TGIII. Position them close enough so that they can be easily connected using your serial cable. If you have a laptop computer, then it may be easier to bring that close to the TGIII. Otherwise, you need to disconnect the TGIII and move it close to your computer.
5. Connect the TGIII RS-232 port to the corresponding serial port on your computer.
6. Turn on the TGIII and your computer.
7. Find the file you downloaded in step 2, and run the program.
8. In AUTO mode, the software will look for an active serial connection and upload the new file. The TGIII display will show the status.
9. When the file transfer is complete, press the Power switch on the TGIII front panel. This completes the upgrade.
10. Turn off your computer and the TGIII and disconnect the serial cable.

External Control

The RS-232 port also allows the TGIII to be controlled externally by Home Theater controllers and computers.

The following information is for programmers and developers:

Partial Serial command set

Note that all standard commands and extended data are echoed back to the sender. When a change is made locally, the data is broadcast, except for the case of "Toggle" and volume commands. Here is a list of the most popular commands. (Contact Sunfire Technical Support, or our website www.sunfire.com for a more extensive list of commands).

COMMAND	ASCII DATA RECEIVED
POWER TOGGLE	*111
POWER ON	*112
POWER OFF	*113
CD	*114
TAPE	*115
SAT	*116
DVD	*117
PHONO	*118
TUNER	*119
VID1	*11A
VCR	*11B
VID2	*11C
DSP MODE UP	*11D
DSP MODE DOWN	*13W
STEREO	*11E
PRO LOGIC	*11F
PARTY	*134
NEO:6	13H
SOURCEDIRECT	13J
JAZZ-CLUB	*11K
HOLO TOGGLE	*11L
HOLO ON	*11M
HOLO OFF	*11N
MUTE TOGGLE	*11P
MUTE ON	*11Q
MUTE OFF	*11R
VOLUME UP	*11S
VOLUME DOWN	*11T
VOL ABSOLUTE	*11U + 2 EXT
	*11U00 = zero vol
	*11U99 = max vol
ZONE2 PWR TOGGLE	*13M
ZONE2 PWR ON	*13N
ZONE2 PWR OFF	*13P
ZONE2 MUTE TGGLE	*13Q
ZONE2 MUTE ON	*13R
ZONE2 MUTE OFF	*13S
ZONE2 VOL UP	*13T
ZONE2 VOL DOWN	*13U
ZONE2 CD	*138
ZONE2 TAPE	*139
ZONE2 SAT	*13A
ZONE2 DVD	*13B
ZONE2 PHONO	*13C
ZONE2 TUNER	*13D
ZONE2 VID1	*13E
ZONE2 VCR	*13F
ZONE2 VID2	*13G



Troubleshooting Guide

The Sunfire TGIII is expertly designed and built to provide years of trouble-free performance. Most problems that occur can usually be solved by checking your setup or making sure that the audio and video components connected to the processor are on and fully operational.

The following information will help you deal with common setup problems you may experience during normal use of your unit. If problems persist, contact your Sunfire Dealer for help.

No sound from one or more speakers

- Speaker cables may have come undone. Turn off your system and check the cables, and tighten the binding posts.
- An audio cable may have an internal break.
- The volume level is low for the channels concerned. Recheck the calibration procedure (page 40).
- The Mute switch is on.
- The channel has not been turned on in the Speaker Size Menu (page 38).
- The correct surround mode is not selected. (Some DVD discs are stereo only).
- Note: In Source Direct mode, only the front left and right speakers are engaged. They must also be set to Large.

No subwoofer or poor output

- The subwoofer's amplifier is off, or its controls are set low.
- Are all speakers set Large?
- SUB is not switched on in the Speaker Size Menu (page 38).
- Recheck the calibration procedure (page 40).
- Adjust the Crossover and check Bass Management (page 41-42).
- See page 50 to find the best location for your subwoofer.

- If the bass is weak during Dolby Digital or DTS playback, check the correct audio output is selected in your DVD menu, otherwise it may just play stereo into your TGIII and you won't get the true LFE signal to the subwoofer.

Poor Tuning of Stations

- The antenna may be incorrectly attached.
- Station not correctly tuned in, weak or off the air.
- You can improve reception by using external antennas. Some cable TV feeds also offer FM reception.

The same AM station can be heard at different frequencies

- One wire of the AM loop antenna may not be connected.
- A loop antenna is required for AM reception, as it forms part of the front-end tuned circuit.

Full Automatic does not work

- Make sure the Fully Automatic button is on (page 11).

In order to automatically choose the new input source, this mode senses the following active signals: Left audio signals, Video signals, Digital signals

Note that LD or DVD players sometimes put out digital signals even when the disc is paused or stopped. Make sure that any sources are turned off when not in use.

If a source is always active, the automatic operation may return to that input as the analog audio varies. In this case, you should try and turn off any unused sources, or turn off the automatic mode.

If you are listening to a mono source, make sure it connects to a left input, or use a "Y" cord to feed both left and right inputs.

There is no automatic selection of the Phono input, Tuner, or 8-CH.

Certain inputs cannot be selected

- Check the INPUTS menu of the OSD (page 34), and make sure that the input has not been disabled in that particular Zone.

No TV picture

- Make sure that the video input of your TV monitor is connected to the Main monitor output on the TGIII rear panel.
- Check that your Monitor is selecting it's correct video input.
- Check the video connection from your selected source component into the TGIII.
- Make sure that you are using the same video connections. For example, if your source is connected using S-video, then the TV monitor must also use S-video.
- If in doubt, try connecting the video output from your source directly to your TV monitor. This will help you narrow down the problem.
- Use only one type of S-video or composite connection. If both are present at the same time, the TGIII will choose S-video and the composite output will be off in this case.

No Holographic Image

- It is essential that your front speakers are positioned correctly. See pages 49-50.
- The Holographic Image is most effective in 2-channel operation. It gives a more accurate perception of the position of musicians and sound effects (page 48). The results may be masked if you are using it in a surround mode.

No Tone Controls

- They will not work if you are using the 8-CH input, Source Direct mode, or in Zone 2.



No Dolby Digital or DTS playback

- See page 44
- Make sure your player's digital output is set to BITSTREAM for Dolby Digital or DTS. This is often a player's setup menu item, not the disc's menu.
- Some discs are available with a number of different options, such as Dolby Digital or Dolby Pro Logic. Make sure that you have selected the correct mode from your player's menu.
- Only digital inputs will work for these modes. Check that your player's digital output is connected to the appropriate corresponding digital input on your TGIII.
- There is no AC-3 RF input connection for LaserDisc players. You will need an external RF demodulator.
- Look for the Dolby Digital or DTS Logo on the source program's box or sleeve.
- Check the calibration procedure from time to time. This is an excellent way of checking that all speakers are working correctly.

Noise bursts are heard when DTS encoded CDs or LDs are played

- Compressed DTS data uses the normal digital audio tracks of CDs and LDs. This analog noise may be heard in your system before the DTS digital signal is locked on, or it may appear as a background hiss.
- To reduce or prevent this noise, disconnect any analog connections to your CD or LD players. Just use the Digital connections.

No On Screen Display

- See page 30
- Press the remote's MENU button to activate the OSD. It should be present even when no video source has been selected.
- There is no OSD for component video connections.

Sound drops out with CD or DVD playback

- Make sure the disc is not dirty or scratched.
- Some inexpensive players and changers tend to mistrack more often, causing dropouts with an external DAC.

Remote won't Learn

- See page 28
- Make sure you are pointing the original remote into the receiving window of the Sunfire remote. This is located on the top edge of the remote.
- Try touching and holding the first button to be learned.
- Do not do the learn procedure in bright lighting or sunlight.
- Make sure the Sunfire remote is correctly in its LEARN mode.
- Try varying the distance between the remotes from 1 to 2 inches, and see if the learn procedure improves.

Remote will not work

- See pages 25-29
- Make sure the batteries are not dead, or installed incorrectly.
- Make sure the remote is set on the correct device display for the component you are trying to control.
- Make sure that the buttons have not been erased or learned over.
- Make sure that the TGIII front panel receiver window is not obstructed.
- Check that the front or rear IR receivers have not been turned off in the OSD CONTROL menu.

Zone 2 does not work

- See page 47
- Zone 2 is set "disabled" from the factory, so you must use the OSD Zone 2 menu on page 36 to enable it when you are ready to use it. This enables Zone 2, but it does not turn it on.

- Once Zone 2 is enabled, use the remote control's Zone 2 device button, followed by the Power button to turn Zone 2 on. Alternatively, press the front panel Zone 2 button, followed by the main Power button.
- The front panel (left hand side) Zone 2 Power light will be on when the zone is active (i.e. engaged and on). The Zone 2 Adjust light turns on when the zone is being adjusted. For example, if you turn Zone 2 on with the remote, and adjust the volume, Zone 2's volume changes, and the Zone 2 Adjust light will be on.

Zone 2 does not play digital inputs

Zone 2 can play analog sources independent of what is playing in the Main Zone. It **cannot** play from a digital-only source **unless** that input is selected and playing in the Main Zone. To play a source such as a DVD player in Zone 2 independent of the Main Zone, make sure you connect the player's L/R analog audio output to the TGIII.

TGIII does not respond to any controls

- Unplug AC power momentarily, and press Power to turn back on
- If this does not work, try the reset procedure on the next page.

Your amplifiers shut down often

Check the following:

- Make sure each speaker's average impedance is not less than your amplifiers can safely handle.
- The amplifiers have good ventilation, no vents are covered.
- Try setting all the speakers to Small, and let your subwoofers handle the heavy bass.
- Check that the amplifier power output is a good match for your speakers. If your speakers are inefficient, consider using larger power amplifiers.



Reset procedure

The TGIII is a microprocessor controlled device of great complexity. Occasional power fluctuations and spikes may cause the TGIII to "lock up" or act strangely. The TGIII can be reset as follows.



Warning: the TGIII will be reset to the factory defaults, and will clear all memory. All your stored OSD settings and Tuner presets will be erased.

- On page 57, write down your calibration settings, input settings, Tuner presets, and any other settings you have made.
- Press the power button to turn the unit off, or turn it off from the wall for a moment.
- Press and continue to hold down the front panel Power button and the Tone DOWN button at the same time.
- The TGIII will power on and cycle through the display. Keep holding the buttons down until "Resetting to Factory Defaults" appears in the front panel display
- When the TGIII has been reset, it will shut off.
- Turn the TGIII back on and it will go to the default screen. It has now been reset.
- If the TGIII has to be reset regularly, you should invest in a good quality AC line conditioner.

Updating firmware problems

- See page 51
- If you have a Palm Pilot™ or similar device with "HotSync™" or its equivalent, you may need to disable this software before proceeding. This software 'seizes' control of a serial port on your machine and prevents the Sunfire software from accessing that port. Use another port or disable HotSync.
- Check that the serial cable is connected correctly between the TGIII and your computer's serial port.

A Hum is heard in your speakers

This problem is more than likely caused by a "ground loop" in your system, rather than a fault in the TGIII. Follow these steps to isolate the main cause of the hum, there may even be more than one.

- Remember to turn off all components in your system, including the TGIII, before disconnecting or connecting any cables.
- Disconnect the following items in order, and check each time if the hum has gone away:
- Disconnect all cables which come from outside the room, such as cable TV, satellite TV, or roof top antennas. Make sure that they are disconnected where they first enter the room, so they are making no connection to the TGIII or the TV, or any other component. If the hum is caused by the cable TV line, then you will need a "ground loop isolator." This is an inexpensive device fitted in line with the coaxial cable feed. Contact your cable company or your Sunfire Dealer for assistance.
- Disconnect all connections from the TGIII to your TV.
- Disconnect any component which has a grounded power cord.
- If the hum persists, disconnect all the source components one at a time from the back of the TGIII, until you identify the problem.
- Ground loop isolators are available for audio lines and video. Ask your Sunfire Dealer for assistance.
- Try moving the speaker cables away from any power cords. Try just one speaker, connecting it to different channels and see if an amplifier channel is bad.
- If you are still having a problem, remember that Sunfire's dealers and technical support staff will assist you.

Other causes of noise

- Speaker noise may also be caused by interference or noise on your AC line. Make sure there are no large appliances sharing the line, or halogen lamps or light-dimming Triac devices.
- Try connecting your system to another AC socket on a separate line.
- If the hum is heard from within the TGIII and not through the speakers, this may also be caused by interference on the AC or DC lines. The power transformers may turn this interference into an audible noise. Internal hum can be made worse by a shelf or cabinet resonating, so try moving the TGIII to another shelf.
- Try moving your components further away from the TV, especially if you ever notice the screen has changed color in the area closest to the component.
- If you have very high efficiency speakers, these may show up noise which other speakers may not.



Remote Control Codes

Audio Components

ADC 007
 Adcom 082, 092, 225, 161, 269
 Aiwa 018, 104, 170, 202, 203, 213, 211, 188
 Akai 138, 189
 AMC 125, 126, 167, 128, 258, 281, 282
 Amend 054
 AMX 196
 Angstrom 142
 Arcam 141
 Audio Access 147
 Audio Alchemy 135
 Audio Design 194, 221, 011
 Audio Ease 021, 196, 207
 Audio File 071
 Audio Matrix 167
 Audio Source 273
 Audio Technica 134
 B&K 096, 097
 Bose 070, 170, 224
 Bryston 023
 Carver 006, 028, 061, 071, 201, 214, 226, 180, 185, 022, 029, 077, 284
 Casio 076
 Chiro 140
 Cinema Sound 034, 134
 Citation 148, 272
 Clarion 026
 Curtis Mathes 076
 Denon 002, 034, 109, 215, 229, 230, 027, 037, 234, 259
 Eiger 149
 Elan 057
 Enlightened Audio 099, 098
 Fisher 047, 214, 180, 182
 Fosgate 062, 231
 GE 056, 260
 Goldstar 008
 Hafler 174
 Harman/Kardon 231, 233, 254, 153, 154, 118, 121, 227, 277
 Hitachi 020
 Inkel 197
 JBL 263
 JC Penny
 Jeff Rowland 206
 Jensen 058
 JVC 240, 163, 191, 114, 266, 279
 Kenwood 026, 066, 145, 146, 181, 190, 197, 192, 182, 199, 151, 222, 180, 005, 280
 Kinergetics 220, 140
 Koss 216
 Krell 150, 072
 Kyocera 007
 Lexicon 120, 235, 236, 237
 Linn 124
 Luxman 137, 139, 052, 1654, 115, 004, 009
 LXI 076, 056
 Magnavox 086, 164, 152, 208
 Marantz 006, 028, 031, 040, 063, 185, 186, 251, 265
 McIntosh 238
 MCS 076
 Meridian 100, 012, 013
 Mitsubishi 242, 243, 204
 Mondial 157, 158, 042, 043, 081, 112
 Myryad 276
 NAD 186, 113, 283
 Nakamichi 111, 244, 245, 172, 183
 NEC 176
 Onkyo 017, 046, 064, 107, 108, 187, 079, 080, 090, 179, 209, 270, 275
 Optimus 026, 041, 138

Panasonic 032, 195, 219, 177
 Parasond 129, 130, 132, 261
 Phast 196
 Philips 249, 250, 251, 063
 Pioneer 014, 033, 039, 044, 045, 050, 069, 159, 168, 116, 035, 079, 198
 Proceed 144, 268
 RCA 010, 048, 117, 156, 067
 Realistic 019, 056, 073, 075, 095
 Revox 162
 Rotel 074, 083, 085
 Samsung 016
 Sansui 040, 048, 110, 119, 065, 228
 Sanyo 047, 059
 Scott 019, 091
 Sears 076
 Sharp 026, 094, 131, 175, 181
 Sherwood 024, 048, 055, 102, 103, 105, 106, 051, 030
 Sony 018, 093, 223, 247, 248, 160, 166, 015, 101, 184, 218, 271
 Soundesign 036
 Soundstream 084, 088
 SSI 068
 Sumo 171
 Sunfire TGI 329
Sunfire TGII or TGIII 001
 Taekwang 138
 Teac 005, 019, 049, 111, 212, 217
 Technics 122, 176, 193, 219, 178, 177, 200, 257, 262
 Theta Digital 136
 Toshiba 060, 087, 198, 278
 Wards 180
 Yamaha 026, 253, 169, 067, 173, 205, 264, 232, 089, 264, 274, 285
 Zenith 143, 210

Aux (Lighting, Switches, TiVo, Etc.)

3M 152
 Aiwa 164
 Archer 155
 Auton 191
 DMX 156
 Draper Screen 204
 Dwin 080
 Everquest 206
 Extron 151
 Faroudja 184
 Fuji 209
 Jerrold 153
 JVC 185
 Kenwood 185
 Lite-Touch 208
 Lutron 077, 158, 159
 Lutron 077, 158, 159
 Makita 186, 201
 Mindpath 205
 Niles 160, 187
 NSM 161
 Piano Disc Plus 085
 Philips 090
 Polk Audio 162
 Replay 075
 Russound 081
 Scientific Atlanta 156, 163
 Sima 082
 Solo Electronics 207
 Somfy 078, 079
 Sony 104, 164, 165, 166
 Starcom 153
 Turboscan 167
 Velodyne 203
 X-10 093, 183

Xantech 168, 169, 170, 171, 172, 188, 189

Cable Boxes

ABC 103, 003, 004, 039, 042, 046, 053
 Americast 099
 Antronix 014
 Archer 005, 007, 014
 Bell South 099
 Centurion 092
 Century 007
 Citizen 007
 Combano 080, 081
 Comsat 074
 Comtronics 030
 Digicable 101
 Eagle 020, 030, 040
 Eastern 057, 066
 Echostar 106
 Electricord 032
 Gemini 008, 054
 General Electric 072
 General Instruments 103, 074, 104
 GNC 099
 Golden Channel 030
 Hamlin 049, 050, 055
 Hitachi 103, 055
 Jerrold 013, 002, 003, 004, 008, 009, 010, 069, 074
 Magnavox 010, 012, 064, 079, 095, 094
 Media One 107
 Memorex 052
 Mitsubishi 102
 Lutron 077, 158, 159
 Makita 186, 201
 Mindpath 205
 Niles 160, 187
 NSM 161
 Piano Disc Plus 085
 Philips 090
 Polk Audio 162
 Replay 075
 Russound 081
 Scientific Atlanta 156, 163
 Sima 082
 Solo Electronics 207
 Somfy 078, 079
 Sony 104, 164, 165, 166
 Starcom 153
 Turboscan 167
 Velodyne 203
 X-10 093, 183
 Xantech 168, 169, 170, 171, 172, 188, 189

CD Players

Adcom 062, 042
 Aiwa 059, 065, 088, 089, 105, 122, 170, 187
 Akai 085, 195, 202
 AMC 231, 232
 Amend 118
 Arcam 238
 Audio Access 119, 147
 Audio Ease 165
 Audio Technica 046
 BSR 037, 057
 California Audio 103, 008
 Capetronic 063
 Carrera 057, 080
 Carver 185, 041, 044, 050, 086, 107, 130, 134, 135, 138, 139, 203, 204, 167
 Casio 111, 182
 Clarinette 182
 Creek 159
 Crown 035
 Denon 002, 123
 Emerson 042, 069, 102

Fisher 050, 185, 134, 008
 Fraba 111
 Genexxa 010, 069, 102
 Goldstar 010, 069, 102
 Haitai 093
 Harman/Kardon 018, 033, 047, 208
 Hitachi 042, 175
 Inkel 130, 143, 144
 JC Penny 014, 061, 092, 141
 Jensen 158
 JVC 004, 022, 136, 163, 213, 214, 242, 243
 Kenwood 185, 007, 023, 055, 071, 072, 142, 137
 Koss 061
 Krell 241
 Kyocera 005
 Lotte 102
 Luxman 011, 028, 070, 076
 LXI 059
 Magnavox 044, 107
 Marantz 027, 041, 044, 051, 077, 107, 209
 McIntosh 212
 MCS 014, 073, 092
 Memorex 010
 Mission 044, 107
 Mitsubishi 179
 Mitsumi 153
 Modulaire 182
 Mondial 147
 Myryad 244
 NAD 006, 005, 067, 178
 Nakamichi 217, 218, 219, 095
 NEC 014, 062
 Nikko 046
 NSM 044, 107
 Onkyo 030, 038, 039, 168, 169
 Optimus 010, 050, 057, 058, 081, 082, 083, 085, 093, 195
 Panasonic 103, 201, 172, 008, 068
 Parasond 233
 Philips 041, 044
 Pioneer 010, 020, 025, 056, 174, 175, 176
 Proceed 239
 Proton 044, 107, 228
 Quasar 103, 008
 Radio Shack 182
 RCA 017, 042, 150
 Realistic 042, 050, 051, 102, 181, 182, 187
 Rotel 044, 107, 161, 178, 250
 SAE 044, 107
 Sansui 044, 069, 107, 128, 171, 190, 125
 Sanyo 050
 Scott 069, 102
 Sharp 026, 031, 051, 066
 Sherwood 003, 019, 051, 096, 112, 115, 119, 166
 Signature 033
 Sony 048, 081, 097, 126, 133, 177, 225, 226, 164
 Soundesign 251
 Sumo 155
 Sylvania 044, 107
 Symphonic 052, 181
 Taekwang 195, 085
 Tandy 010
 Teac 015, 034, 036, 051, 052, 101, 131, 140, 079
 Technics 060, 103, 200, 172, 184, 008, 068
 Techwood 076
 Theta Digital 234, 235
 Toshiba 006, 067, 091, 160, 148
 Vector Research 080
 Victor 004, 022, 114, 124
 Wards 185, 033
 Yamaha 024, 046, 054, 186, 183, 245
 Yorx 182

DVD Players

Apex Digital 087
 Denon 007, 080
 GE 026, 027
 Harman/Kardon 084
 JVC 012
 LG 091, 057, 074
 Magnavox 066
 Marantz 083
 Mitsubishi 017
 NAD 088
 Onkyo 076, 035
 Panasonic 021, 042
 Philips 066
 Pioneer 023, 092
 Proceed 086
 Proscan 026, 027
 RCA 026, 027
 Samsung 056, 070
 Sharp 094
 Sony 033
 Theta Digital 032
 Thomson 026, 027
 Toshiba 035, 034
 Yamaha 042, 089
 Zenith 057, 074, 091

LaserDisc Players (Use with DVD)

Denon 206, 207
 Funai 120
 Kenwood 152, 013
 Magnavox 032, 121
 Marantz 211
 Mitsubishi 121
 NAD 121
 Optimus 049, 013
 Panasonic 113
 Philips 032
 Pioneer 106, 117, 121
 Radio Shack 120
 RCA 002
 Realistic 049
 Runco 127
 Sanyo 075
 Sharp 152, 013
 Sony 053, 110
 Technics 113
 Theta Digital 032
 Toshiba 152, 106
 Yamaha 043, 129

Satellite/DSS Receivers

Alphastar 123
 Amplica 050
 Birdview 129, 113, 051, 126
 BSR 053
 Capetronics 053
 Channel Master 013, 014, 015, 018, 036, 055
 Chaparral 008, 009, 012, 077
 Citoth 054
 Curtis Mathes 050
 Drake 005, 006, 007, 010, 011, 112, 116, 141, 052
 DX Antenna 024, 046, 056, 076
 Echostar 038, 040, 057, 058, 093, 094, 095, 096, 097, 098, 099, 100, 122
 Electrohme 089
 Eurosat 114
 Fujitsu 017, 021, 022, 027, 133, 134
 General Electric 151, 106, 150
 General Instruments 003, 004, 016, 029, 031, 059, 101, 148

**more Satellite/DSS receivers:**

Hitachi 139, 140
 Home Cable 080, 044, 029
 Houston Tracker 033, 037, 039, 104, 057, 051
 Hughes 068, 154
 Hytek 053
 Hyundai 149
 ICR 023
 Janiel 060, 147
 Kathrein 108
 Legend 057
 Lutron 132
 Luxor 144, 062
 Macom 010, 059, 063, 064, 065
 Memorex 057
 Nextwave 028, 124, 125
 Norsat 069, 070
 Pace 143
 Panasonic 142, 060
 Pansat 121
 Personal Cable 117
 Philips 071, 152, 153
 PL 023, 026
 President 019, 102
 Primestar 110, 030
 Prosat 072
 Proscan 151, 106, 150
 RCA 151, 106, 150
 Realistic 043, 074
 Samsung 123
 Satellite Service 028, 035, 047, 085
 Sony 103
 Starcast 041
 Superguide 020, 124, 125
 Teecom 023, 026, 075, 087, 088, 090, 107, 130, 137
 Toshiba 002, 127
 Town & Country 023, 026
 Uniden 016, 025, 042, 043, 044, 045, 048, 049, 078, 079, 080, 086, 101, 135, 136
 Viewstar 115
 Winegard 128, 146
 Zenith 081, 082, 083, 084, 091, 120

Tape Decks

Aiwa 015, 071, 100, 114
 Carver 006, 008, 027, 024, 036
 Denon 105, 227, 229
 Fisher 064
 Goldstar 011
 Harman/Kardon 233
 JVC 106, 116, 239, 240
 Kenwood 005, 013, 023, 026, 064, 145, 146, 181, 190
 Linn 124
 Luxman 035, 137, 139
 Magnavox 027
 Marantz 014, 027, 056, 065, 087
 McIntosh 238
 Mitsubishi 242, 243
 NAD 029, 048
 Nakamichi 244, 245, 025
 Onkyo 002, 012, 016, 017, 018, 019, 115
 Optimus 026, 054, 055
 Panasonic 007, 010, 032, 088, 195
 Philips 027, 087
 Pioneer 003, 039, 047, 050, 066, 098, 222
 Quasar 007, 088
 Sansui 027, 113, 119, 224
 Sharp 026, 057, 131, 175, 181
 Sherwood 038, 004, 028, 030, 033, 034
 Sony 020, 022, 052, 084, 089

Teac 009, 059, 212
 Technics 007, 010, 076, 088, 109, 122, 193
 Toshiba 112
 Victor 106
 Yamaha 021, 026, 031, 067, 040

Televisions

Admiral 072, 081, 161, 160
 Akai 197, 146
 Amark 112, 143
 Ampro 073, 167, 157, 183
 Amstrad 052
 Anam 043, 054, 056, 080, 112, 131
 AOC 197, 004, 112, 058
 Audiovox 076
 Blaupunkt 088
 Cairn 201
 Candle 197, 002, 003, 004
 Capehart 058
 Centronic 043
 Citizen 197, 002, 003, 004, 043, 101, 103, 143
 Classic 043
 Concerto 004
 Contec 043, 050, 051
 Coronado 143
 Craig 043, 054
 Crown 043, 143
 Curtis Mathes 197, 101, 004, 143
 CXC 043
 Daewoo 004, 016, 043, 004, 076, 103, 114, 125, 127, 143
 Daytron 004, 143
 Dwin 117
 Dynasty 043
 Dynatech 062
 Eiki 187
 Electrohome 024, 076, 143, 136
 Emerson 197, 004, 005, 028, 043, 047, 048, 050, 051, 076, 096, 143,
 151, 153, 154, 155
 Fisher 007, 057
 Fujitsu 198
 Funai 028, 043
 Futuretech 043
 GE 197, 008, 009, 034, 056, 073, 074, 130, 144, 155, 160, 161,
 165, 004, 091, 157, 183
 Goldstar 004, 102, 106, 112, 113, 116, 119, 127, 143
 Hall Mark 004
 Hitachi 004, 009, 010, 011, 012, 023, 075, 143, 158, 163, 166, 072
 Infinity 164
 JBL 164
 JC Penny 197, 004, 008, 009, 024, 030, 065, 101, 143, 156, 160
 Jensen 013
 JVC 034, 038, 070, 083, 154, 199
 KEC 043
 Kenwood 197, 070
 Kloss 002, 059
 KMC 143
 KTV 197, 043, 143, 154
 Lodgenet 072
 Logik 072
 Luxman 004
 LXI 166, 007, 015, 052, 081, 160, 164
 Magnavox 197, 003, 004, 022, 059, 060, 061, 063, 064, 127, 160, 164, 094

Marantz 197, 164
 Matsui 164
 Memorex 007, 072, 004
 Metz 088
 MGA 197, 004, 024, 028, 042
 Minerva 088
 Mitsubishi 004, 024, 028, 040, 042, 109, 124, 146, 191
 MTC 197, 004, 062, 101
 NAD 015, 025
 NEC 132, 130, 134, 197, 040, 016, 024, 056, 019
 Nikei 043
 Onking 043
 Onwa 043
 Optonica 019, 081
 Orion 096
 Panasonic 034, 056, 080, 092, 164
 Philco 197, 003, 024, 056, 059, 060, 063, 064, 164, 004
 Philips 197, 003, 004, 005, 038, 059, 093, 164, 127
 Pioneer 197, 018, 023, 025, 116, 135, 190
 Portland 004, 143
 Proscan 144, 160, 161, 165, 167
 Proton 004, 058, 131, 143, 171, 173, 193
 Quasar 034, 056, 092
 Radio Shack 019, 043, 143, 004, 127
 RCA 160, 161, 165, 065, 156, 144, 197, 004, 023, 024, 056, 074, 152
 Realistic 007, 019, 043, 047
 Roctec 186
 Runco 168, 169, 178, 179, 180, 181, 182, 183, 073, 157
 Sampo 197, 058, 004, 202
 Samsung 004, 050, 089, 101, 105, 127, 143, 160
 Sanyo 166, 007, 020, 053, 057, 082, 187
 Scott 004, 028, 043, 048, 143
 Sears 015, 030, 003, 007, 028, 057, 143, 094, 160, 080, 165, 166
 Seleco 189, 200
 Sharp 170, 081, 019, 028, 029, 014, 004, 022, 143, 175
 Siemens 088
 Signature 072
 Sony 070, 085, 139, 147, 126, 185, 194
 Soundesign 004, 028, 003, 043
 Spectricon 112
 SSS 004, 043
 Supre Macy 002
 Sylvania 197, 003, 059, 060, 063, 064, 164, 044, 160, 127
 Tandy 081
 Tatung 056, 062
 Technics 034, 080
 Techwood 004
 Teknika 002, 003, 004, 024, 028, 043, 072, 101, 143
 Telefunken 037, 046, 086, 087
 Telerent 072
 Tera 172
 TMK 004
 Toshiba 007, 015, 030, 040, 062, 101, 138
 Television 143
 Universal 008, 009
 Video Concepts 146
 Vidikron 174, 184, 188, 192
 Vidtech 994
 Wards 004, 008, 009, 019, 028, 060, 061, 063, 064, 072, 074, 143, 164, 034
 Westing House 076

Yamaha 197, 004
 York 004
 Yupiteru 043
 Zenith 072, 073, 095, 103, 157, 183
 Zonda 112

VCRs

Aiwa 034, 181
 Akai 016, 043, 046, 124, 125, 142, 146
 Ampro 072
 Anam 031
 Audio Dynamics 012, 023, 039, 043
 Brooksonic 035, 037, 129
 Canon 028, 031
 Capehart 108
 Craig 003, 040, 135
 Curtis Mathes 031, 041
 Daewoo 005, 007, 010, 065, 108, 110, 111, 112, 116, 117, 119
 Daytron 108
 DBX 012, 023, 039, 043
 Dynatech 034, 053
 Electrohome 059
 Emerson 006, 017, 025, 027, 029, 031, 034, 035, 036, 037, 046, 101, 129, 131, 138, 153, 162, 116
 Fisher 003, 008, 009, 010
 Funai 034
 GE 031, 063, 072, 107, 109, 144, 147
 Go Video 132, 136, 155, 040, 115
 Goldstar 012, 013, 020, 101, 106, 114, 123
 Harman/Kardon 014, 045
 Hitachi 004, 018, 026, 034, 043, 063, 137, 150, 160, 013
 InstantReplay 031
 JCL 031
 JC Penney 012, 013, 015, 040, 066, 101
 Jensen 043
 JVC 012, 031, 043, 048, 050, 055, 060, 130, 150, 152
 Kenwood 014, 048, 034, 106
 Lloyd 034
 LXI 003, 009, 017, 034, 106
 Magin 040
 Magnavox 031, 034, 041, 067, 068, 156, 164
 Marantz 012, 031, 067, 069
 Marta 101
 Matsui 027, 030
 MEI 031
 Memorex 003, 010, 014, 031, 034, 053, 072, 101, 102, 134, 139
 MGA 045, 046, 059
 Minolta 013, 020
 Mitsubishi 013, 020, 045, 046, 051, 059, 061, 142, 151, 049
 MTC 034, 040
 Multitech 024, 034
 NEC 012, 023, 039, 043, 048
 Nordmende 043
 Optonica 053, 054
 Orion 025
 Panasonic 066, 070, 083, 113, 140, 145, 157, 163, 074
 Pentax 013, 020, 031, 063
 Philco 031, 034, 067
 Philips 031, 034, 054, 067, 071, 101
 Pilot 101
 Pioneer 013, 021, 048
 Portland 108
 Pulsar 072
 Quartz 002, 014
 Quasar 066, 145, 075
 Radio Shack 123
 RCA 013, 020, 041, 107, 109, 140, 144, 145, 147, 034, 040, 158
 Realistic 003, 008, 010, 014, 031, 034, 040, 053, 054, 101
 Rico 058
 Runco 148
 Salora 014
 Samsung 032, 040, 066, 102, 104, 107, 109, 112, 113, 115, 120, 122, 125
 Sansui 022, 043, 048, 135
 Sanyo 003, 007, 010, 014, 134, 102
 Scott 017, 037, 112, 129, 131
 Sears 003, 008, 009, 010, 013, 014, 081, 101, 017, 073, 112
 Sharp 031, 054, 149, 159, 165
 Shintom 024
 Signature 034
 Sony 003, 031, 052, 056, 057, 058, 076, 077, 078, 149, 154
 Soundesign 034
 STS 013
 Sylvania 031, 034, 059, 067
 Symphonic 034
 Tandy 010, 034
 Tatung 039, 043
 Teac 034, 039, 043
 Technics 031, 070
 Teknika 019, 031, 034, 101
 Thomas 034
 TMK 006
 Toshiba 008, 013, 042, 047, 059, 079, 082, 112, 131, 081
 Totevision 040, 101
 Unitech 040
 Vector Research 012
 Victor 048
 Video Concepts 012, 034, 046, 141
 Videosonic 040
 Wards 003, 013, 017, 024, 031, 034, 040, 053, 054, 131
 Yamaha 012, 034, 039, 043
 Zenith 034, 048, 056, 058, 072, 080, 101



Favorite Settings

Use this page to record some of your favorite OSD settings and system details.

Tone Settings (page 32)

TONE	LEVEL dB
BASS	
TREBLE	

Zone Settings (page 36)

MAIN ZONE	SELECTION
POWERUP SOURCE	
POWERUP VOLUME MODE	
POWERUP VOLUME	
MAXIMUM VOLUME	

ZONE 2	SELECTION
ZONE 2 SYSTEM	
BALANCE	
POWERUP SOURCE	
POWERUP VOLUME MODE	
POWERUP VOLUME	
MAXIMUM VOLUME	

Mode Settings (page 33)

MODES	SELECTION
DOLBY/DTS DYNAMIC RANGE	
PRO LOGIC II MODE	
PRO LOGIC II CENTER WIDTH	
PRO LOGIC II PANORAMA	
PRO LOGIC II DIMENSION	
DTS LFE	
DTS NEO:6	
JAZZ CLUB AMBIANCE	

Video Settings (page 37)

VIDEO	SELECTION
OSD POP-UP	
VIDEO DEFAULT	
OUT 2	
VIDEO DELAY	

Control Settings (page 37)

CONTROL	ON / OFF
RS-232	
REAR MAIN IR	
REAR ZONE 2 IR	
FRONT PANEL IR	

Input Settings (page 34)

INPUT	NAME	GAIN TRIM dB	MAIN ZONE	FULL AUTO	TRIGGER RELAY	ZONE 2	MAKE/MODEL	REMOTE CODES	NORMAL VOLUME
DVD									
CD									
SAT									
VID1									
VID2									
VCR									
TUNER									
TAPE									
PHONO									
8 CH									

Speaker Settings (page 38-40)

SPEAKER	CALIBRATION LEVEL dB	TRIM LEVEL dB	DISTANCE (FEET)	SIZE (LARGE/SMALL/OFF)	MAKE/MODEL
LEFT MAIN					
CENTER					
RIGHT MAIN					
RIGHT SURROUND					
R SURROUND BACK					
L SURROUND BACK					
LEFT SURROUND					
SUBWOOFER					

CROSSOVER FREQUENCY	
---------------------	--



Specifications

Line Level Inputs

Sensitivity
(for 0.5 V output): 125 mV
Phono: 1.6 mV

Frequency response:
20 Hz-20 kHz +/- 0.5 dB

Signal to Noise
(relative to 2V out):
Analog 97 dB
Digital 105 dB

Distortion (THD): < 0.03%

Separation (at 1 kHz): 70 dB

Tone Control:
Bass: +/- 10 dB
Treble: +/- 10 dB

Audio Outputs

Frequency Response:
All but subwoofer:
(Large): 20 Hz-20 kHz
Sub: 20-160 Hz
(crossover set to 160 Hz)

(The Sub plays the bass from the other channels using Bass Management)

Delay adjustment
Center: 0-20 feet
Rear: 0-20 feet
(The TGIII calculates the delay time from the distance measurement of the speaker to the listening position)

Video Section

Video inputs/outputs: 1 Vp-p
75 ohms

Bandwidth

Component: 100 MHz, -1.5 dB

Composite: 6 MHz, -2 dB

S-video: 18 MHz, -1.5 dB

FM Tuner Section

FM range: 87.5-108 MHz
0.2 MHz steps
(0.05 MHz for some export models)

Usable sensitivity (Mono):
1.6 uV (75 ohms)
15.2 dBf (75 kHz DEV, 30 dB)

50dB quieting sensitivity (Stereo):
31.6 uV (75 ohms)
41.2 dBf

Audio output frequency range:
30 Hz to 15 kHz,
+5 dB, -3 dB

AM Tuner Section

AM range: 530-1710 kHz
10 kHz steps
(9 kHz for some export models)

Usable sensitivity: (30% mod.,
S/N 20 dB): 16 uV / (600 uV/m)
S/N (30% mod., 1 mV input): 48dB

Trigger Outputs

12 V Main and Zone 2 Trigger
current less than 500mA total

Main zone trigger relay contact
rating: 24 VDC 2A maximum

XLR Outputs

Pin 1 Ground
Pin 2 Positive
Pin 3 Negative

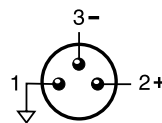

Rear Panel View

Infrared Inputs

Optically Isolated
Standard 1/8" mini jacks
Standard 12V signal level

Power Requirements

120 VAC 50-60 Hz: 40 W

Dimensions

Architect's Choice:
17" Wide x 5.75" High x 16.5" Deep

Standard Model:
19" Wide x 6.5" High x 15.5" Deep

Net Weight

Architect's Choice: 22 lbs

Standard Model: 24 lbs

Manufactured under license from Digital Theater Systems, Inc. US Pat. No. 5,451,942, 5,956,674, 5,974,380, 5,978,762 and other worldwide patents issued and pending. "DTS", "DTS-ES Extended Surround" and "Neo:6" are trademarks of Digital Theater Systems, Inc. Copyright 1996, 2000 Digital Theater Systems, Inc. All Rights Reserved.

Manufactured under license from Dolby Laboratories. "Dolby", "Pro Logic", and the double-D symbol are trademarks of Dolby Laboratories.

FireWire is a trademark of Apple Computer Inc.

© 2003 Sunfire Corporation. All rights reserved. Sunfire Corporation reserves the right to improve its products at any time. Therefore, specifications are subject to change without notice.

Manual part number:

913-010-00 Rev C



Limited Warranty

Sunfire Corporation is proud of its products which have been built with care using advanced technology and premium component parts. Your unit has been crafted to perform properly for many years. Sunfire Corporation offers the following Warranty to you, the owner of a new Sunfire product:

The Sunfire Corporation Warranty for the Theater Grand Processor III is in effect for TWO years from the date of original retail purchase. The Sunfire Corporation Warranty covers defects in materials and workmanship. The following, however, are excluded:

- a) Damage caused during shipment.
- b) Damage caused by accident, misuse, abuse of operation contrary to the instructions specified in the Sunfire Corporation user's manual.
- c) Units where the serial number has been defaced, modified or removed.
- d) Damage resulting from modification or attempted repair by any person not authorized in writing by Sunfire Corporation.
- e) Units purchased from unauthorized dealers.

The Sunfire Corporation Warranty extends to the original owner or subsequent owner(s) during the two year warranty period so long as the original dated purchase receipt is presented whenever warranty service is required.

All implied warranties, including warranties or merchantability and fitness for particular purposes, are limited in duration to the two year length of this Warranty, unless otherwise provided by state law.

Sunfire Corporation's liability is limited to the repair or replacement, at our option, of any defective product and shall not in any event include property or any other incidental or consequential damages which may result from the failure of this product.

Some states do not allow limitations on how long an implied warranty lasts and/or do not allow the exclusion or limitation of incidental or consequential damages, so the above limitations or exclusions may not apply to you.

This Warranty gives you specific legal rights, and you may also have other rights which vary from state to state. We suggest that you attach your purchase receipt to this Warranty and keep these in a safe place. Thank you for your choice of a Sunfire Corporation product.

Service Assistance

We suggest that you read the Limited Warranty completely to fully understand your Warranty/Service coverage.

If your Sunfire Corporation product ever requires service, write to us or call:

Sunfire Corporation
Technical Services Department
P.O. Box 1589
Snohomish, WA 98291
Tel (425) 335-4748
Fax (425) 335-4746

You will be directed to an authorized Sunfire Corporation Service Station or receive instructions to ship the unit to the factory. Please save the original shipping carton and packing materials in case shipping is required. Please do not ship Parcel Post.

NOTE: Before sending in your unit for repair, you must call Sunfire for return authorization.

Include a complete description of the problem, indicating how you have it connected, the associated equipment in your system and a copy of your purchase receipt. Initial shipping costs are not paid by Sunfire Corporation; return ground shipping costs will be prepaid if repairs were covered by the scope of this Warranty.

Bob Carver's
Sunfire
...from his mind & soul

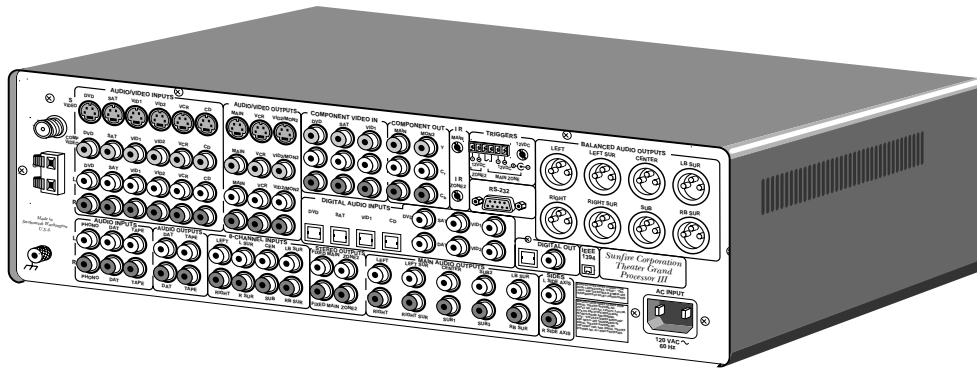

*Theater Grand
Processor III
Architect's Choice
and Standard Edition*

*Sunfire Corporation
P.O. Box 1589
Snohomish
WA 98291*

