



# Operation Manual (v1.2)

**MAGIC PLAY SP Z O.O.**

CHOCIMSKA 6, 62800 KALISZ, POLAND

Phone/Fax: +48 62 753 21 88

e-mail: [service@magicplay.pl](mailto:service@magicplay.pl)

website: [www.magicplay.pl](http://www.magicplay.pl)

# TABLE OF CONTENTS

## Important Safety Instructions

1. SPECIFICATIONS
2. PACKAGE CONTENTS
3. SET UP & INSTALATION
  - 3.1 DEVICE AND MOST IMPORTANT ELEMENTS
  - 3.2 MARQUEE ASSEMBLY
  - 3.3 LEVEL ADJUSTMENT
  - 3.4 TRANSPORTING THE GAME
  - 3.5 CONNECTING THE POWER
4. ACTIVATION, UPDATE AND GAMEPLAY
  - 4.1 ACTIVATION
  - 4.2 SOFTWARE UPDATE
  - 4.3 GAMEPLAY
5. GAME OPTIONS
  - 5.1. MENU ACCES AND NAVIGATION
  - 5.2. SERVICE MENU
  - 5.3. DEVICE SETTINGS
  - 5.4. GAME SETTINGS
  - 5.5. CREDITS SETTINGS
  - 5.6. TICKETS SETTINGS
  - 5.7. LEADERBOARDS
  - 5.8. COUNTERS
  - 5.9. LOGS AND STATS
  - 5.10. TESTS
6. RECOMMENDED TICKETS SETTINGS
7. MAINTENANCE, INSPECTION
  - 7.1 SAFETY CHECK
8. SPARE PARTS LIST
9. ELECTRICAL DIAGRAM
10. TROUBLESHOOTING
  - 8.1. SYSTEM MICROSD CARD LOCATION.
  - 8.2. „NO SIGNAL” ALERT ON SCREEN
  - 8.3. BLACK SCREEN WITHOUT COMMUNICATES
  - 8.4. PROBLEMS WITH TICKET DISPENSING, GAME CRASHING/FREEZING, SETTINGS ARE NOT SAVED
  - 8.5. PROBLEMS WITH COIN ACCEPTORS/BILL ACCEPTORS
  - 8.6. BUTTONS/COINS MECH NOT WORKING
  - 8.7. MICROSD card repair for Windows OS
  - 8.8. CPU BOARDS VERSIONS
11. TERMS OF WARRANTY

Thank You for purchasing TIMBERMAN . We hope you enjoy the product.

The manual contains valuable information about how to operate and maintain your game machine properly and safely. It is intended for the owner and/ or personnel in charge of product operation. Carefully read and understand the instructions.

If you need any help during instalation and setup please utilize this manual and troubleshooting guide. If the product fails to function properly, non-technical personnel should under no circumstance sttempt to service the machine. Contact your distributor or manufacturer for help.

### PLEASE READ BEFORE USE

## IMPORTANT SAFETY INSTRUCTIONS

**To ensure the safe usage of this product, carefully read and understand these instructions before operating your game.**

**Save these instructions for future reference.**

Use this product only as described in this manual. Other uses not recomended may cause fire, Electric shock or personal injury. Unplug the game from the outlet when not in use, when moving from one location to another, and before cleaning/servicing.

Explanations witch require special attention are indicated by signs of warning. Depending on the potential hazardous degree, the terms: **NOTE**, **NOTICE**, and **WARNING** are used.

**NOTE:** A NOTE indicates useful hints or information about product usage.

**NOTICE:** A NOTICE inticades potential damage to product and how to avoid the problem.

**WARNING:** A WARNING indicates a potential for product damage or serious personal injury.

I tis important to understand the meaning of the following HAZARD SIGNS befor contuning:

#### High Voltage and Shock Hazard:

High voltage can cause electric shock.  
Turn off/unplug power before servicing.



#### High temperature Hazard:

This part may cause scalding.  
Do not touch. Surface may be hot.



#### No Touching Hazard:

This may be hot or can cause electric shock.  
Do not touch.



Use the following safety guidelines to help ensure your own personal safety and to help protect your equipment and surrounding enviroment from potential damage.

# THIS PRODUCT IS AN INDOOR MACHINE ONLY! DO NOT INSTALL OUTDOOR!

Avoid installing in the following places to prevent fire, electric shock, injury and/ or machine malfunctioning:

- Places subject to rain/ moisture, or places subject to high humidity.
- Places subject to direct sunlight, or places subject to extremely hot or cold temperatures to ensure that it is used within the specified operating range.
- Places where inflammable gas may be present or in the vicinity of highly inflammable/ volatile chemicals or items that can easily catch fire
- On unstable or sloped surfaces. The machine may topple or cause unforeseen accidents.
- Vicinity of fire exist, fire extinguishers.

## WARNING!

Non-technical personnel who do not have technical knowledge and expertise should refrain from performing such work that this manual requires or performs tasks which are not explained in this manual. Failing to comply can cause severe accidents such as electric shock or other serious injuries.

**WARNING: To reduce the risk of fire, electric shock or personal injury, unplug or disconnect the machine from the power supply before servicing.**

**Note: The contents of this manual may be updated without notice.**

# 1. SPECIFICATIONS





Rated power supply: 110 - 240V  
 Dimensions: 115 x 68 x 294cm  
 Weight: 150Kg

**NOTICE: After turning off the game, please wait at least 1 minute before restarting again.**

# 2. PACKAGE CONTENTS

Open the package and make sure all the items are included:

- 1 x Body Assembly
- Following accessories

No.	Name	Qty.	Illustration	Note
1	Marquee	1		
2	Marquee mounting screws	4		
3	Keys	3 sets		
4	User's manual	1		
5	LED controler remote	1		
6	Bill acceptor cover	1		
7	Coin acceptor cover	1		

If any items are found missing, please contact your sales representative for help immediately.

**NOTE: Part models are subject to change without notice.**

### 3. SETUP & INSTALLATION

## WARNING!

**THIS PRODUCT IS AN INDOOR MACHINE ONLY!  
DO NOT INSTALL OUTDOOR!**

- Refer to IMPORTANT SAFETY INSTRUCTIONS (Pg. 3) for places to avoid
- Place the unit on dry level surface
- Ventilation openings in the back of the unit must not be obstructed by objects or by wall.

#### 3.1 DEVICE AND IMPORTANT ELEMENTS

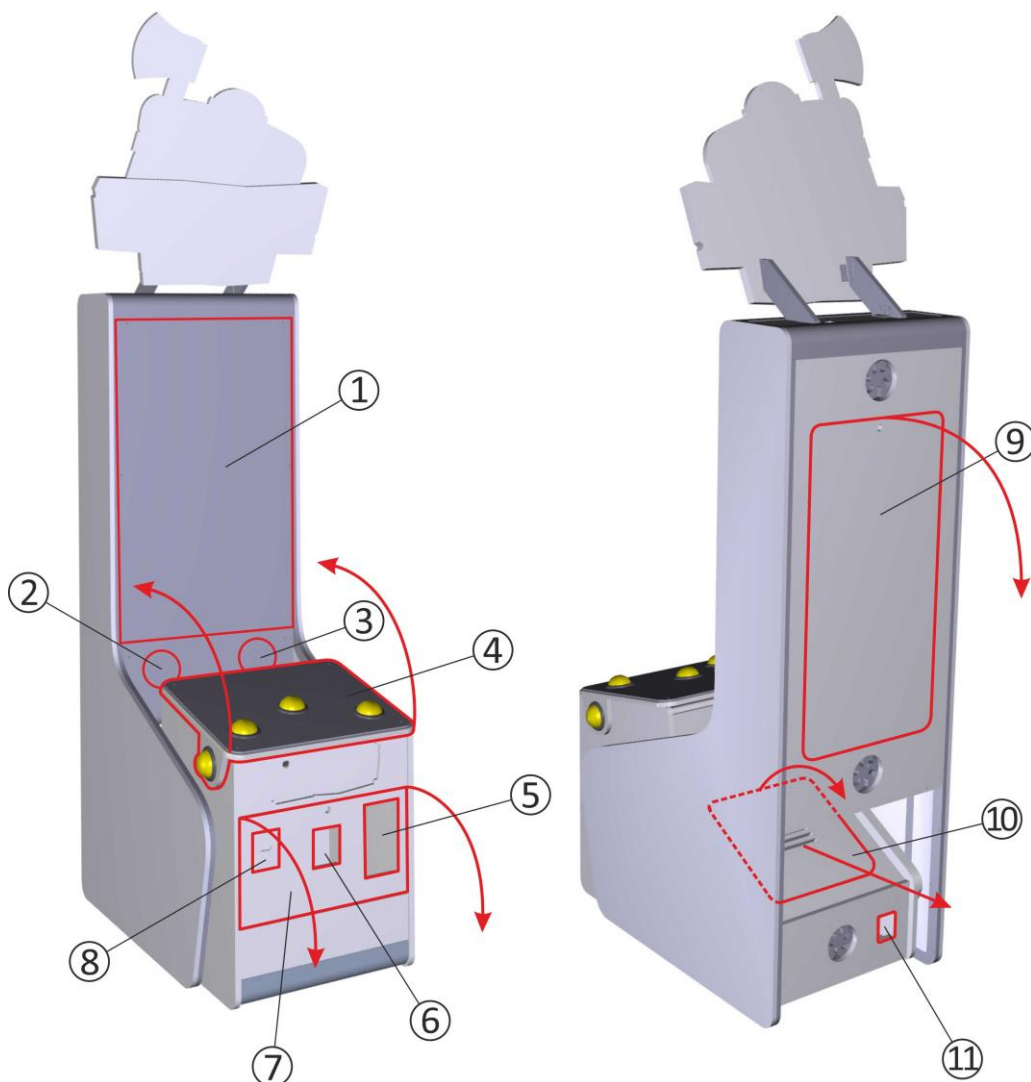

- 1. 42" LED display
- 2. left speaker
- 3. right speaker
- 4. game panel with control buttons – access to buttons switches – can be opened by unlocking clamps accessible through the front service door
- 5. coin acceptor
- 6. bill acceptor

- 7. front service door - access to coin and bill acceptors, tickets feeder, mechanical counters and service button
- 8. ticket dispenser
- 9. upper back service door – access to display, speakers and marquee assembly
- 10. lower back service door – access to main board, I/O board, power supply, LED controller and wiring
- 11. power socket

### 3.2 MARQUEE ASSEMBLY

Two persons may be required for marquee assembly. To install the marquee you first need to open the rear upper door. Set a ladder or other platform on the back of the unit.

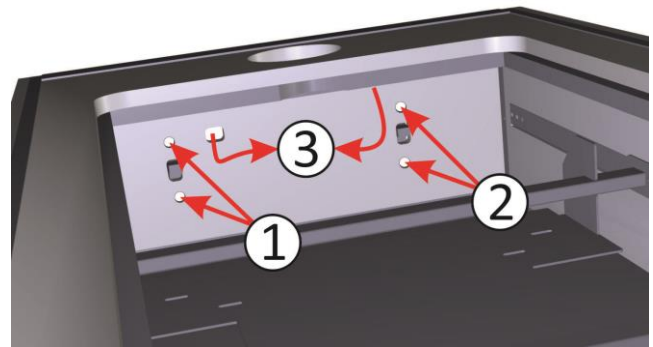
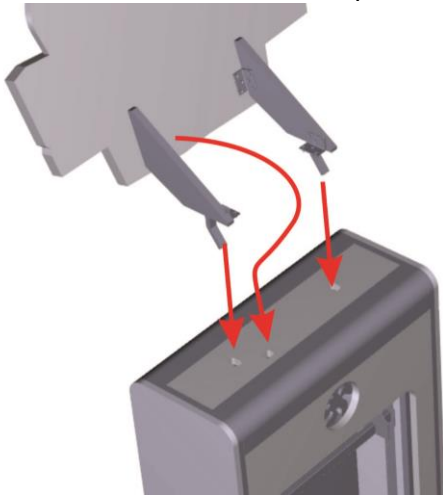

Raise the marquee up, climb onto the platform and place the marquee base brackets in the holes on top of the unit. Pass the backlight power cord through the hole.

Secure marquee by placing the screws in the holes (1 and 2). Tighten the screws. Connect the power cable connectors (3).

### 3.3 LEVEL ADJUSTMENT

Install this machine on flat surface. Adjust levers to lift casters off the ground to level the game. If the game is installed on an unstable floor, it could cause a malfunction.

To fix the game, adjust the leveler down until it touches the floor, lifting the casters off the ground by 5mm. Repeat the same for all levelers.

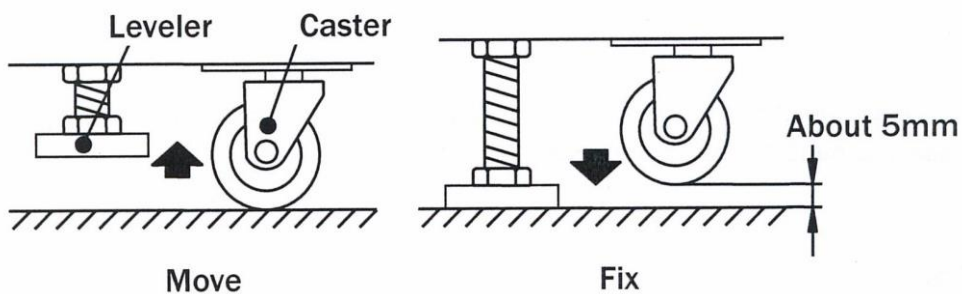

**NOTICE: Make sure the machine is level with the ground and all the adjustable legs should stick to floor closely.**

### 3.4 PLAY ZONE

This machine requires space for playing and for maintenance as shown below.

Leave space around the game upon installation:

Service area: 50cm

Play area: 100cm

### 3.5 TRANSPORTING THE GAME

If you need to move the game, adjust the levelers back to an „up“ position so the casters touch the ground.

#### NOTICE

- Be careful not to damage the machine during transport.
- The machine should be handled with care when bringing it down from a high level.
- Always unplug the game before moving.
- Keep the machine in upright position during transport.
- For longer distance transport, package the game properly to prevent damages

### 3.6 CONNECTING POWER

#### IMPORTANT: POWER SUPPLY ADJUSTS AUTOMATICALLY

- Machines electrical system (power supply and display) will adjust automatically to 230V or 115V voltage.
- Do not plug the equipment power cables into an electrical outlet if the power cable is damaged.
- Avoid putting many loads on one electrical outlet as it could generate heat the fire resulting from overload.
- Connect the grounding conductor to the earth terminal (GND):

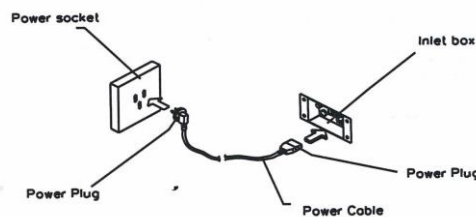

#### WARNING

Ensure no heavy objects rest on the power cord. Check to make sure the game cabinet does not sit on the power cord as this could damage the cord and become hazardous.



To disconnect the game, grip the plug and pull it from the wall outlet. Never pull by the cord.

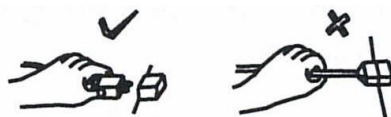

To prevent electric shock, do not touch the power plug when hand is wet.



Ensure that nothing rests on the power cord and that it is not located where it can be stepped on or tripped over.





## 4. ACTIVATION, UPDATE AND GAMEPLAY

# IMPORTANT!

DEVICE SOFTWARE IS COPYRIGHT PROTECTED. COPYING AND DISTRIBUTION IS STRICTLY PROHIBITED. IT IS ALSO FORBIDDEN TO INTERFERE IN THE INTEGRITY OF SOFTWARE THROUGH MODIFICATION OR IMPLEMENTATION OF ANY CHANGES WITHOUT APPROVAL OF THE MANUFACTURER. ANY ATTEMPTS OF SOFTWARE CHANGES, OTHER THAN THOSE SPECIFIED BY THE MANUFACTURER MAY RESULT IN WARRANTY LOSS.

### 4.1 ACTIVATION

**ACTIVATE YOUR VERSION**

RELEASE NUMBER: 20151119

**PRODUCT KEY**  
**FAFCFZ2HHL61**

**ACTIVATION KEY**

[Blue bar]

A	B	C	D	E	F	G	H
I	J	K	L	M	N	O	P
R	S	T	U	W	X	Y	Z
1	2	3	4	5	6	7	8
9	<-						

**APPLY**

The device is usually pre-activated, however, the activation process must be carried out, for example, in the case of replacement of some electronic components. To do this, turn on the device and copy version number displayed on the screen. Version number is a sequence of twelve digits and letters. Make sure that the code was rewritten correctly. The number should be sent to the address [timberman@magicplay.pl](mailto:timberman@magicplay.pl) in order to obtain the activation code. Activation code is a sequence of sixteen numbers and letters separated by dashes. Use RIGHT CUT BUTTON to select NEXT and LEFT CUT BUTTON to select PREVIOUS. Use START BUTTON to ENTER. Dashes are generated automatically.

## 4.2. SOFTWARE UPDATE

To carry out software upgrade memory stick and USB computer mouse is required.

1. Download the .apk file and save it to a memory stick.
2. Open the lower rear service door and locate the control processor (see picture)
3. Connect the memory stick and a computer mouse in free USB ports.
4. Leave the Timberman application by clicking the right mouse button.

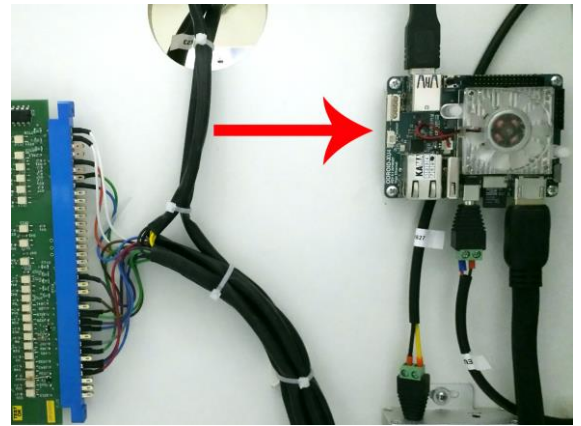

5. Go to application list in bottom center of the screen

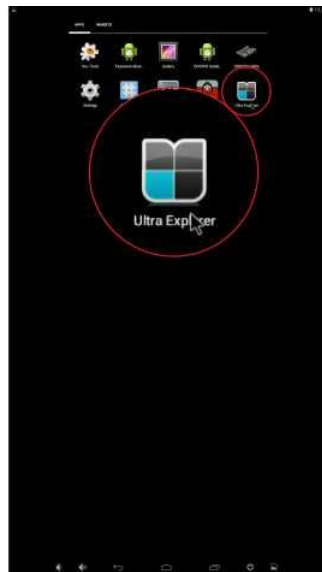

6. Click on ULTRA EXPLORER app icon



7. Select the source from which you want to install the update by clicking the "storage" in the upper left corner of the screen.



8. Select the memory stick on the list, described as usb2host, usb3host or similar

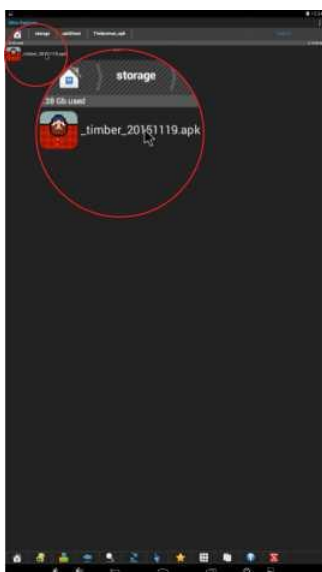

9. Locate and click the downloaded .apk file.

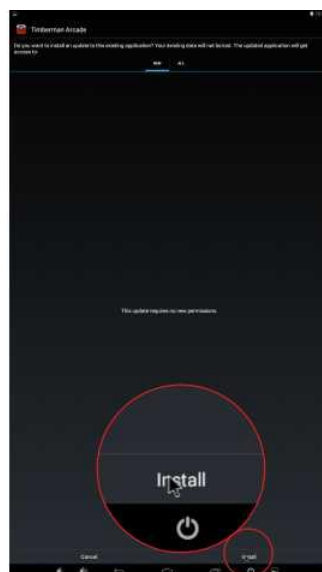

10. Click "Install" in the lower right corner of the screen.

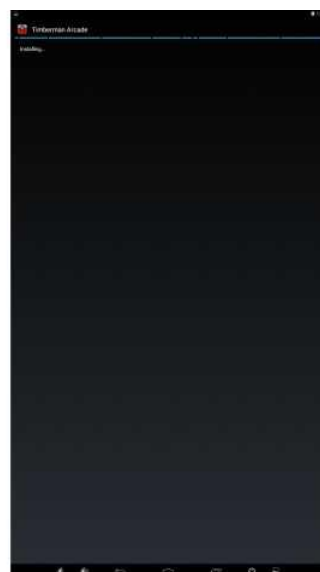

11. Wait for the installation to complete. It may take a while

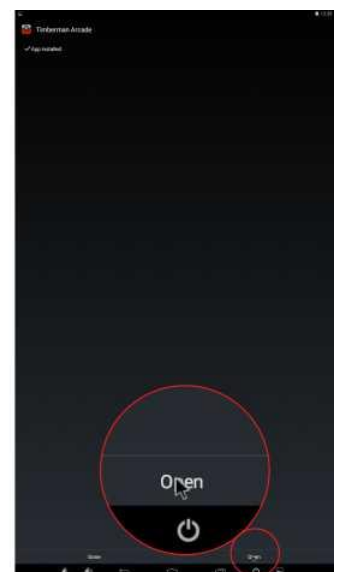

12. Click "Open" in the lower right corner of the screen

## 4.3 GAMEPLAY

To start the game insert coins in coin acceptor or banknote in bill validator. Press the START button to start the game. Instructions for players who are playing for the first time appears on the screen. You can skip this information by pressing the START button. After the countdown, you can start the game. Push CUT LEFT button to chop tree at the left side, push CUT RIGHT button to chop tree at the right side. You get a point for every cut. Each time for a given number of points you will get one ticket. Any contact of tree branches would result to game's over. The game will also end if the timer expires. However you can increase the timer by chopping the tree. If you cut fast enough, you can fill the time bar to the maximum level. Then, the time bar will change color from red to blue and you will receive bonus tickets.



## 5. GAME OPTIONS

### 5.1 MENU ACCES AND NAVIGATION

To access menu press SERVICE BUTTON located in service door, at the lower front of the machine, next to the coin and ticket counters. Use game panel buttons to navigate in the menu. Use RIGHT CUT BUTTON to select NEXT (down or right) and LEFT CUT BUTTON to select PREVIOUS (up or left). Use START BUTTON to ENTER or CHANGE the option value or selection.



Main Menu			Description	
Device settings	Sfx volume	0-100	setting sound volume from 0 to 100	
	Music volume	0-100	setting music volume from 0 to 100	
	Music 1, 2, 3	on/off		
	Lights	on/off	option is temporarily unavailable	
Game settings	Easy mode chops	0-100		
	Immortal chops	0-100		
	Difficulty / Timebar seed	0-10		
	Background settings	on/off	enable or disable the background of the game	
	free play	on/off		
Credits settings	default credits settings	DEFAULT USD	the preset settings credit for various currencies	
	default credits settings coin settings	DEFAULT EUR		
		DEFAULT PLN		
		channel mode	on/off	on/off - enable or disable channel mode to use electrical change giver
	coin settings bill settings	impulse mode	on/off	on/off - enable or disable pulse mode to use mechanical change giver
		channel settings		set the number of credits assigned to the change giver channel
		impulse settings		set the number credits corresponding to one pulse of the change giver
				set the number of credit to one pulse of the payout
	Tickets on/off	on/off	the possibility of enable or disable the issuance of tickets. Disable this option makes disappearance of any information and messages that are related with tickets	
	Tickets settings	Tickets for score	tickets for every score	on/off
Tickets for score		1 ticket for every points	0-100	the number of points needed to gain a single ticket
		tickets for score level	on/off	enable or disable the option to issue a given amount of tickets for exceeding a certain level of points
		tickets for levels table		identify specific limits / levels point and the amount of the ticket for exceeding it
		mercy tickets	0-100	determine the amount "consolation" tickets issued when a player wins nothing

<b>Tickets settings</b>	Tickets for specials	full stripe bonus	0-100	specify the number of tickets issued every second when the player manages to achieve and maintain a bonus for speed
		leaderboard tickets bonus		a table specifying the number of additional tickets for the player for entering the list of the best results between 1 and 8 place
	Divide by two	for tickets with double value		
<b>Leaderboards</b>	generate random table	generates a random scoreboard where the "base value" is the base number of points and the "spread" is the minimum and maximum "scatter" of the results		
	generate random table interval	specify the time when to generate a random list of results, value 0 is disabling the random list generation		
	results	a list of 8 the highest scores with the option of removing each of them		
<b>Counters</b>	Resetable	credit, won tickets, tickets issued, the number of games		Resettable counters of the device
	Non resetable	credit, won tickets, tickets issued, the number of games		Non resetable counters of the device
<b>Logs and stats</b>	avg. Tickets for play	the average number of winning tickets per game		
	avg. Score for play	the average number of winning tickets per game		
	avg. Time for play (seconds)	the average duration of the game in seconds		
	tickets for score	number of tickets earned for points		
	tickets for score levels	the number of tickets earned for crossing the the levels scoring		
	tickets for speed bonus	the number of tickets earned for keeping the "speed bonus"		
	tickets for leaderboard place	number of tickets earned for entered into the list of tickets		
<b>Tests</b>	input devices	validates input devices: coin acceptor, bill acceptor and push buttons		
	output devices	validates output devices: ticket dispenser		
	test audio	audio channels test		
	test video	display test		
<b>Exit</b>				

## 5.2 SERVICE MENU

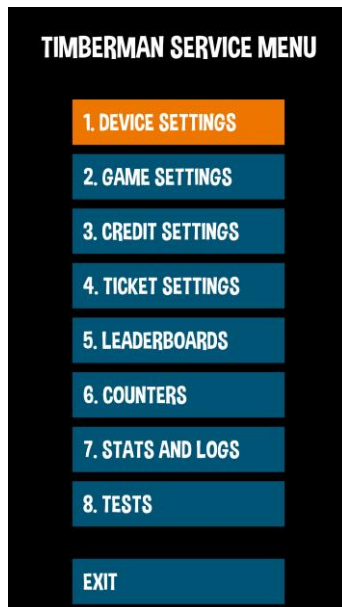

DEVICE SETTINGS	Sound effect, and music volume settings
GAME SETTINGS	Begginers settings and background images
CREDIT SETTINGS	Game prize, coin and bill acceptors settings
TICKET SETTINGS	Ticket for points, ticket for levels and special ticket settings
LEADERBOARDS	Random leader board and leaderboard reste time settings
COUNTERS	Credits and tickets resetable and non-resetable counters
STATS AND LOGS	Games, average tickets for game etc. statistics
TESTS	Machine components diagnostics

## 5.3 DEVICE SETTINGS

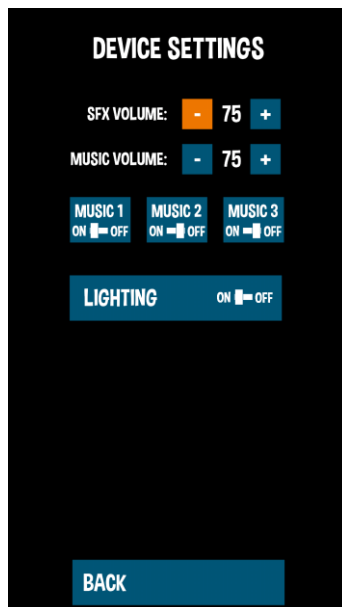

SFX VOLUME	Audio effects volume settings 0-100
MUSIC VOLUME	Music volume settings 0-100
MUSIC 1, 2, 3 – ON/OFF	Select a melody playing during the game
LIGHTNING	Option is temporarily unavailable

## 5.4 GAME SETTINGS

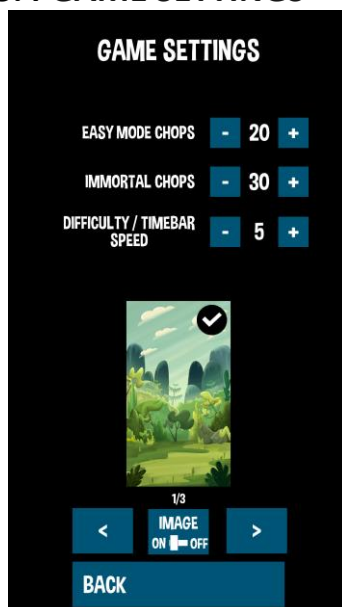

EASY MODE CHOPS	Set the number of cuts during which the player gets hints on avoiding branches and after which time bar begins to drop
IMMORTAL CHOPS	Set the number of cuts during which Timberman will be resistant to branches hits
DIFFICULTY / TIMEBAR SPEED	Set how fast timebar will decrease. Values from 1 to 10. 1 is very easy and 10 is very hard
BACKGROUND IMAGE	Enable or disable game background images

## 5.5 CREDITS SETTINGS

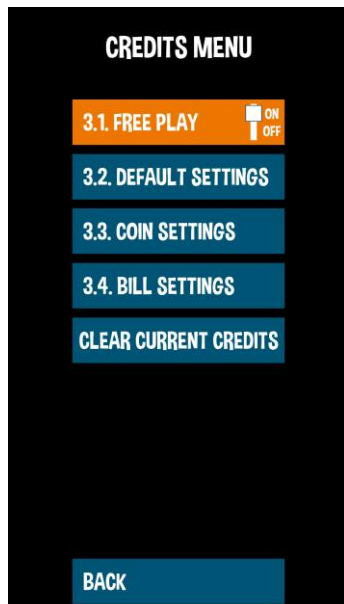

### FREE PLAY ON/OFF

Free play, no credits needed.

### DEFAULT SETTINGS

Predefined credits settings for various currencies

### COIN SETTINGS

Coin acceptor settings for impulse and channel modes

### BILL SETTINGS

Bill acceptor settings

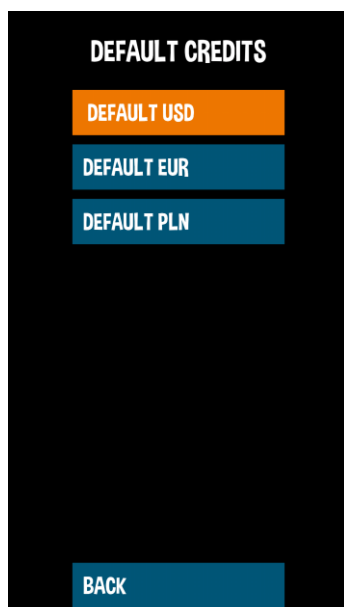

### DEFAULT USD

Predefined credit settings for US DOLLARS

### DEFAULT EUR

Predefined credit settings for EURO

### DEFAULT PLN

Predefined credit settings for POLISH ZLOTY

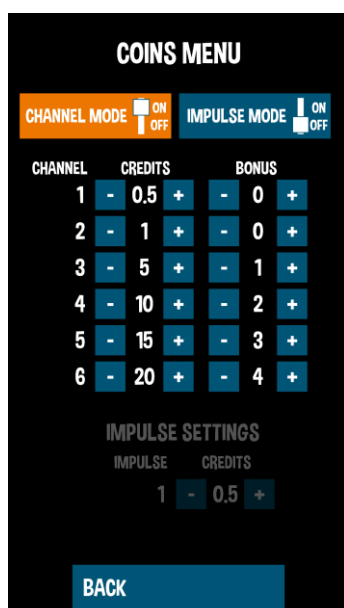

### CHANNEL MODE ON/OFF

CHANNEL MODE ON/OFF: for channel coin acceptors – can accept more than one type of coins/tokens. If channel mode is switched on, impulse mode turns off automatically.

### CHANNEL MODE SETTINGS

Set how many games/credits will be launched by single pulse from channel 1 to 6

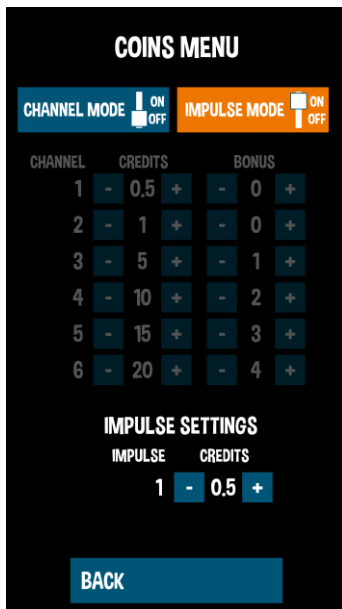

## IMPULSE MODE ON/OFF

IMPULSE MODE ON/OFF: for impulse or mechanical coin acceptors – accepts only one type of coins/tokens. If pulse mode is switched on, channel mode turns off automatically.

## IMPULSE MODE SETTINGS

Set how many games/credits will be launched by single pulse from coin acceptor

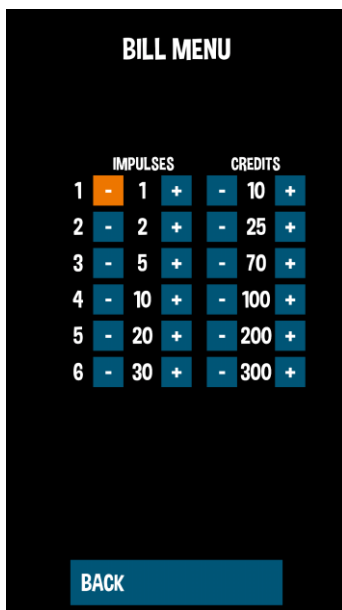

## BILL SETTINGS

Set how many games/credits will be launched by pulses from bill acceptor.

## 5.6 TICKETS SETTINGS

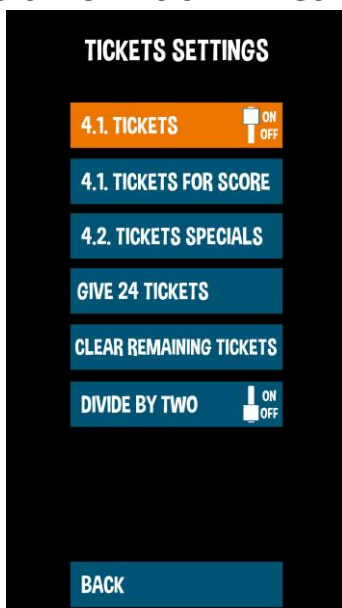

## TICKETS ON/OFF

Tickets support enabled or disabled. All in-game tickets information will be unavailable when OFF

## TICKETS FOR SCORE

Tickets ratio settings for points scored and number of tickets for score levels

## TICKETS SPECIALS

Tickets for speed bonus and leaderboard place

## GIVE ### TICKETS

Dispense outstanding tickets. NOTE: tickets will also dispense automatically when inserted into the ticket dispenser

## CLEAR REMANING TICKETS

Clear ticket due

## DIVIDE BY TWO ON/OFF

Turn on if you value each ticket as 2 tickets



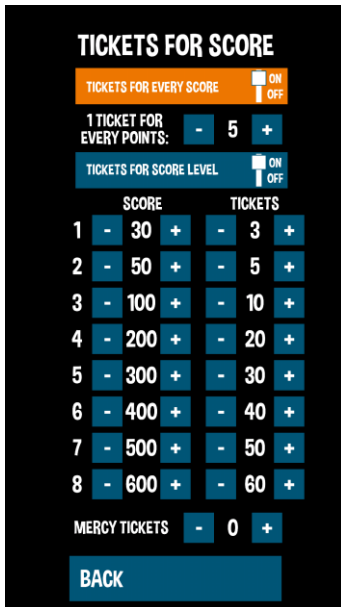

## TICKETS FOR SCORE ON/OFF

Enable or disable the option for the conversion number of points to a single ticket

Set how many points a player must earn to get a ticket

## TICKETS FOR SCORE LEVELS

Enable or disable the option to issue a given amount of tickets for exceeding a certain number of points

Set how many tickets player will receive for reaching this score

## MERCY TICKETS

Set how many "consolation" tickets will be given when the player wins nothing



## FULL STRIPE BONUS

Set how many tickets player will receive for achieving and maintaining the speed bonus bar

## LEADERBOARD TICKET BONUS

Table specifying number of bonus tickets for entering the best results list

## 5.7 LEADERBOARDS

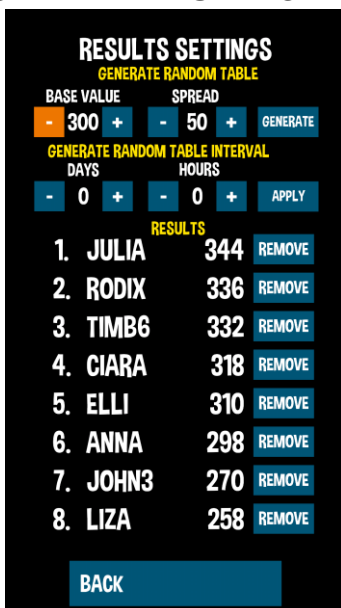

## RANDOM LEADERBOARD GENERATOR

Generates a random scoreboard where the "base value" is the base number of points and the "spread" is the minimum and maximum "scatter" of the results

## RANDOM LEADERBOARD GENERATOR INTERVAL

Specify the time when to generate a random list of results, value 0 is disabling the random list generation

## LEADERBOARD EDITOR

List of 8 the highest scores with the option of removing each of them

## 5.8 COUNTERS

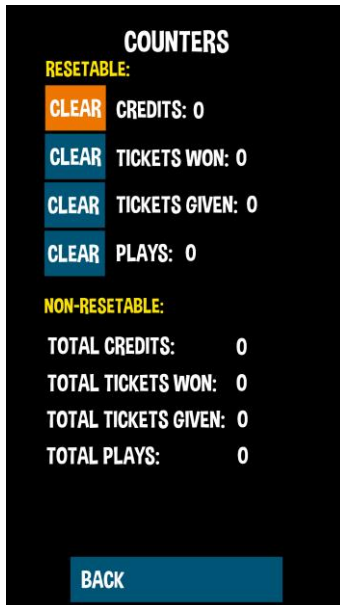

### RESETABLE COUNTERS

Credit, win tickets, tickets issued, the number of games

### NON-RESETABLE COUNTERS

Credit, win tickets, tickets issued, the number of games

## 5.9 LOGS AND STATS

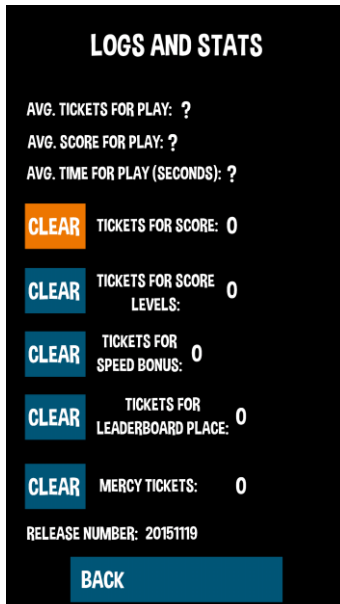

### AVG. TICKETS FOR PLAY

average number of tickets earned for points

### AVG. SCORE FOR PLAY

average number of tickets earned for score levels

### AVG. TIME FOR PLAY

average duration of the game

### TICKET FOR SCORE

number of tickets earned for points

### TICKETS FOR SCORE LEVELS

number of tickets earned for score levels

### TICKETS FOR SPEED BONUS

number of tickets earned for SPEED BONUS (full time bar)

### TICKETS FOR LEADERBOARD PLACE

number of tickets earned for leaderboard entry

### MERCY TICKETS

number of mercy tickets

## 5.10 TESTS

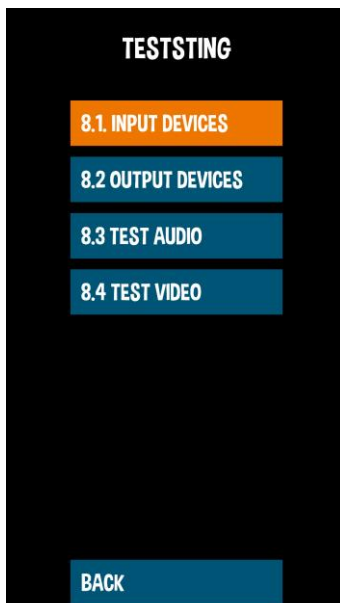

### INPUT DEVICES

Validates input devices: coin acceptor, bill acceptor and push buttons

### OUTPUT DEVICES

Validates output devices: ticket dispenser

### TEST AUDIO

Audio channels test

### TEST VIDEO

Display test



COIN ACCEPTOR

To check, insert a coin into the coin acceptor. The screen will display information about the channel on which the coin was accepted

BILL ACCEPTOR

To check, insert a bill into the bill acceptor.

BUTTON 1

Press START button to check

BUTTON 2

Press LEFT CUT button to check

BUTTON 3

Press RIGHT CUT button to check

BUTTON 4

Press SERVICE button to check

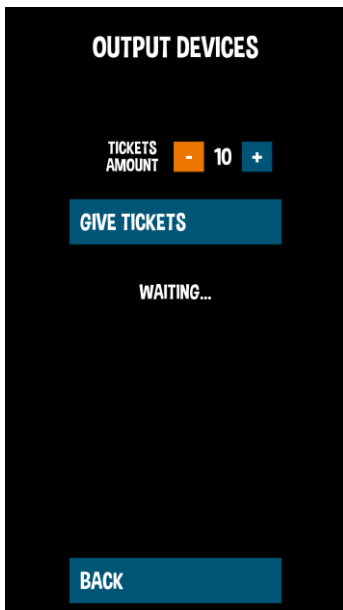

GIVE TICKETS

Dispense specified amount of tickets

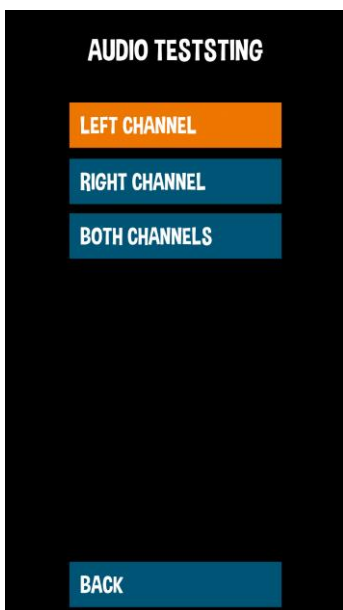

LEFT CHANNEL

Check left audio channel

RIGHT CHANNEL

Check right audio channel

BOTH CHANNELS

Check both channels simultaneously



RED

Display red color

GREEN

Display green color

BLUE

Display blue color

WHITE

Display white color

## 6. RECOMMENDED TICKETS SETTINGS

MENU		
<b>GAME SETTINGS</b>		
EASY MODE CHOPS		30
IMMORTAL CHOPS		60
DIFFICULTY/TIMBER SPEED		5
IMAGE		ON
<b>TICKET FOR SCORE</b>		
TICKETS FOR EVERY SCORE		YES
ONE TICKET FOR EVERY POINTS		10
TICKETS FOR SCORE LEVEL		YES
SCORE		TICKETS
65		5
110		10
150		15
200		20
300		30
400		40
500		50
600		60
MERCY TICKETS		0
<b>TICKET SPECIALS</b>		
FULL STRIPE BONUS(SECONDS)		0,5
<b>LEADERBOARD TICKET BONUS</b>		
PLACE	1	25
PLACE	2	20
PLACE	3	18
PLACE	4	15
PLACE	5	12
PLACE	6	10
PLACE	7	8
PLACE	8	5
TICKETS IN DEMO MESSAGE VALUE		1000

## 7. MAINTENANCE, INSPECTION

### 7.1 SAFETY CHECK

Check the points listed before operating the machine. These checks are necessary for safe machine operation:

1. Try to run the game before operation each day.
2. Conduct monthly routine checks of game components to ensure good working condition
3. Check the machine regularly for dust and clean when necessary.

Note : Parts and components require preventative maintenance to be kept running smoothly

## 8. SPARE PARTS LIST

Part no.	Part
<b>Electronic parts</b>	
TMB-101	42" LED display
TMB-102	Main board
TMB-103	I/O board
TMB-104	12V 5V power supply
TMB-105	12V power supply
TMB-106	RGB LED driver and remote controler
TMB-107S	"Start" button with switch
TMB-107L	"Left cut" button with switch
TMB-107R	"Right cut" button with switch
TMB-107A	Button LED light
TMB-108	Speaker
TMB-109	Power socket with fuse
TMB-110	Power cord
TMB-111	12cm 12V cooling fan
TMB-112	Mechanical counter
TMB-113	Service button
<b>Wiring</b>	
EU2-1595	Button switches and lights wiring
EU2-1596	Counters and service button wire
EU2-1597	RGB LED extension wire
EU2-1598	Ticket dispenser wire
EU2-1308-2	I/O board to Main Board USB wire
EU2-1599	Coin acceptor wire
EU2-1600	LED power wire
EU2-1607	Bill acceptor wire
EU2-1608a	Cooling fan wiring
EU2-1626	Main Board power wire
EU2-1627	RGB LED controller power wire
EU3-1628	I/O board wiring
EU2-1629	I/O board power wire

Part no.	Part
EU2-1630-1	Socket to power supply wire
EU2-1630a-2	Power supply extension
EU2-1644	Speakers wiring
TMB-113	3m HDMI cord
<b>Deacals and decorative</b>	
TMB-301	Display cover with decal
TMB-302	Front panel cover
TMB-303	Lower front logo
TMB-304L	Left side sticker
TMB-304R	Right side sticker
TMB-305	Base front sticker set
TMB-306L	Base left side sticker
TMB-306R	Base right side sticker
TMB-307	Marquee complete
TMB-307-T	Timberman marquee plexi
TMB-307-B	Timberman logo marquee letters
TMB-308T	Upper display aluminium profile with sticker
TMB-308M	Lower display aluminium profile with sticker
TMB-308B	Lower front aluminium profile with sticker
TMB-309	Front panel with LED's
TMB-310B	Bill acceptor cover
TMB-310C	Coin acceptor cover
TMB-311	Electronic coin acceptor mounting panel
<b>Mechanical parts</b>	
TMB-401	Base wheel
TMB-402	Leg leveler
TMB-403	28mm lock with keys
TMB-404	Fan cover
TMB-405	Tickets holder
TMB-406	Cashbox
TMB-407	Front panel fastener

# 9. ELECTRICAL DIAGRAM

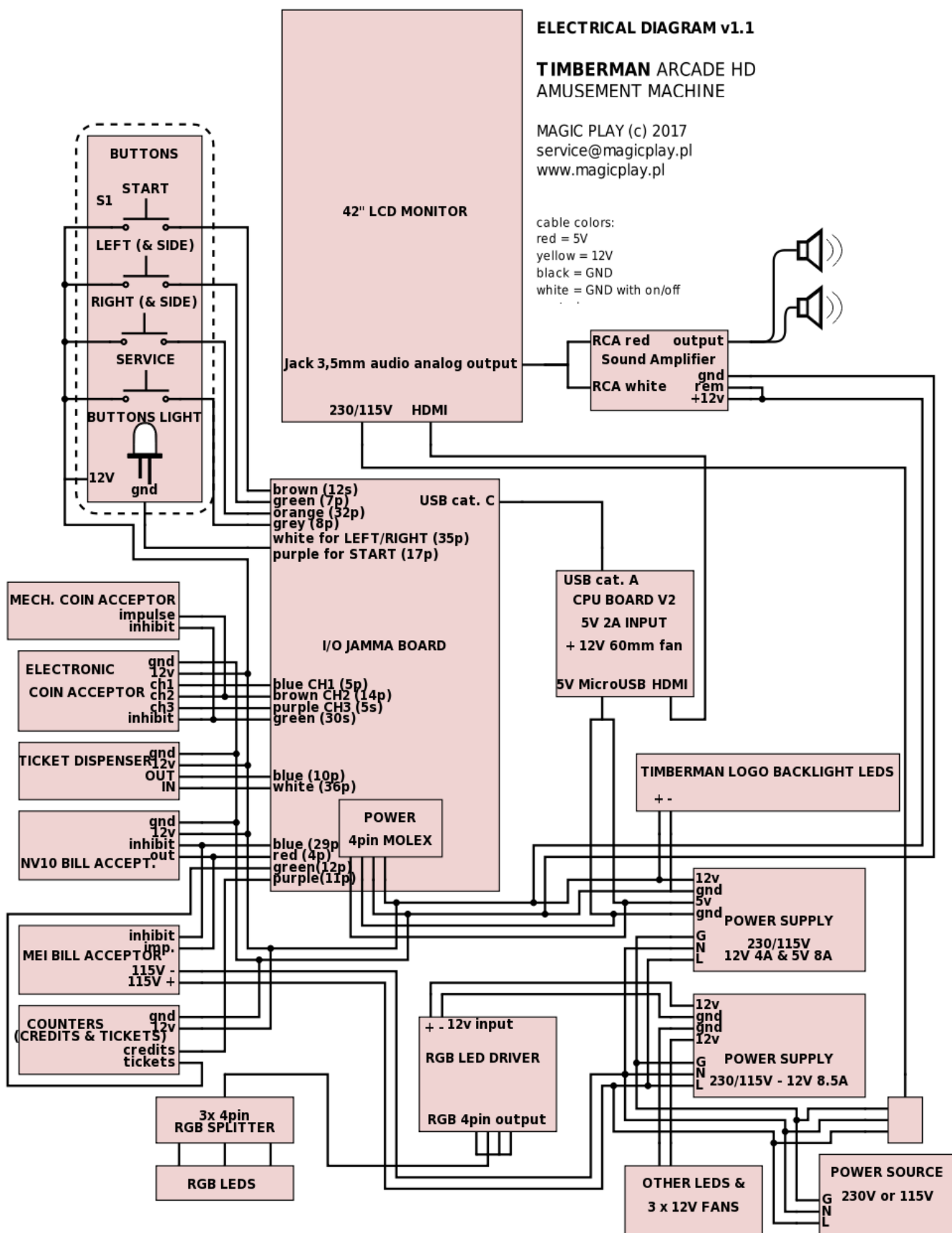

## 8. TROUBLESHOOTING

### 8.1 SYSTEM MICROSD CARD LOCATION

The MicroSD card is located at back of CPU board, near top-right installation screw. It is possible to pull it without CPU board disassembly. See picture.

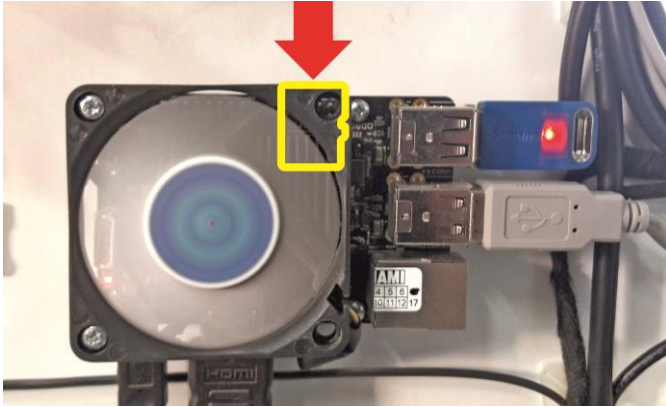

CPU board front view

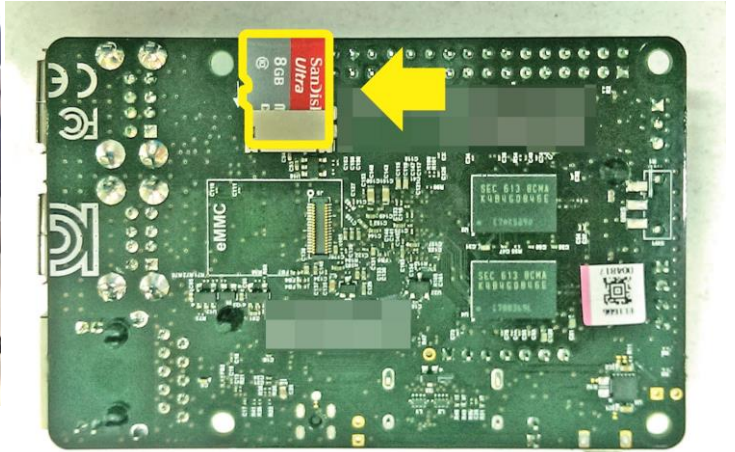

CPU board back view

### 8.2 „NO SIGNAL” ALERT ON SCREEN

1. Observe CPU board placed behind bottom rear service door when machine is plugged in.

#### RED LED light:

**Solid:** 5V power is on: OK

**Blinking:** Problems with power supply, check power supply (2nd point) or wiring connections or CPU board failure atleast.

**No red LED light:** No 5V power. Check power supply, check power supply voltage, check wirings and connections. CPU board failure is not common but possible.

#### BLUE light:

**Solid RED LED light is required to see BLUE LED status!**

**Solid or no blue LED light:** MicroSD Card/software failure. Put backup MicroSD card provided with machine and check results. There is a possibility to write image on old MicroSD card if it is not physically damaged.

**Blinking:** Normal operating state – everything seems to be ok with CPU board software.



2. Check two power supplies placed behind bottom rear service door.

**Solid green LED signal means:** Everything is ok.

**Blinking green LED signal means:** Power supply failure.

a) Too low power load due disconnected some components of the machine

b) Short circuit in installation

No green LED signal means:

a) Power supply failure

b) No power on supply cables

### 8.3 BLACK SCREEN WITHOUT COMMUNICATES

1. Check screen power plug
2. Check if the screen is turned ON:

Open big rear service door and check POWER LED signal.

**Solid RED:** means that TV is turned off (sometimes it could happen). If you see RED LED signal, click by the nearest button to turn it on(see picture) or use provided tv remote.

**No LED:** Screen is ON and it working properly. Check input source using tv remote. Or no power supplied/screen failure.



3. Check CPU board (1st step of „No signal alert on screen”)

### 8.4 PROBLEMS WITH TICKET DISPENSING, GAME CRASHING/FREEZING, SETTINGS ARE NOT SAVED

Caution: This will erase your game settings/electrical counters and stats! Game will need to be configured if default settings does not fit your requirements

1. Open the lower rear service door, locate the CPU board (see picture) and plug USB mouse.



2. Leave the Timberman application by clicking the right mouse button.



3. Go to application list in bottom center of the screen

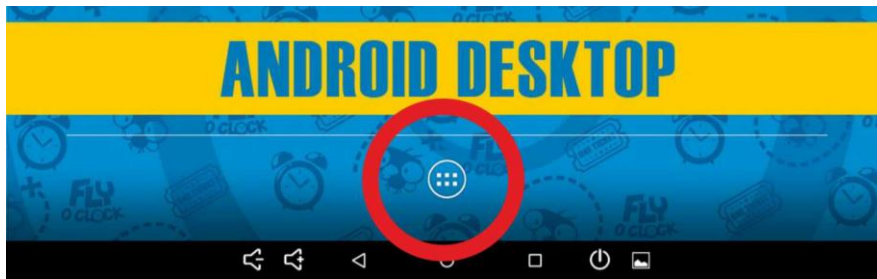

4. Select Settings

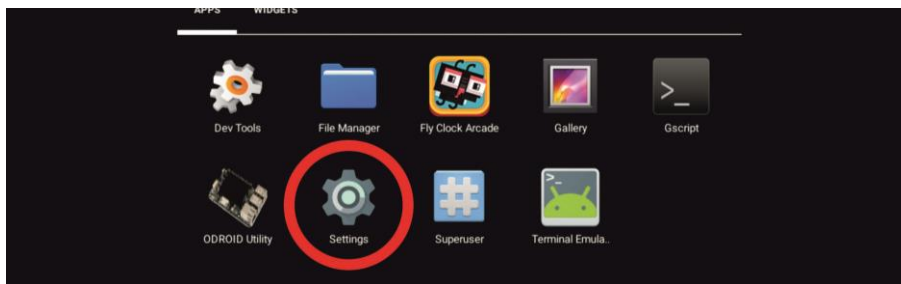

5. Select „Apps“

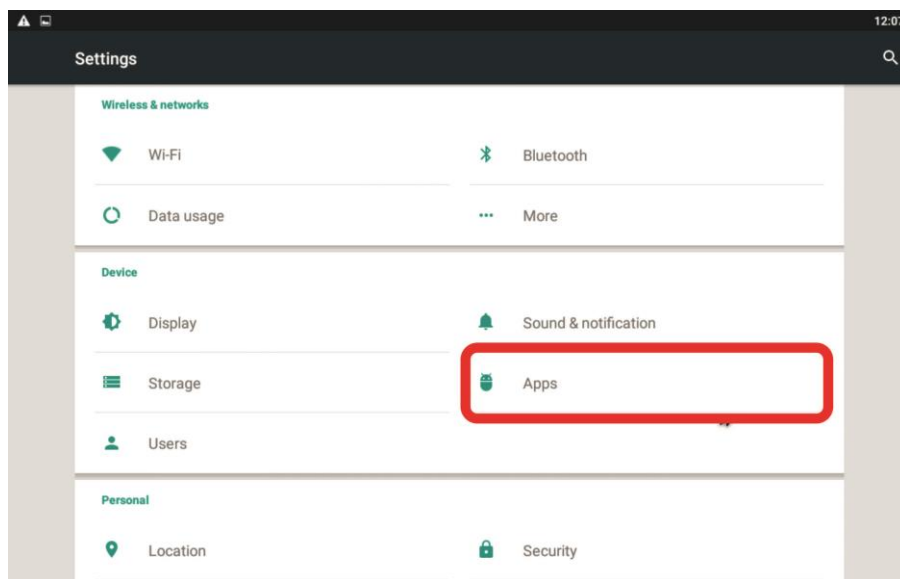

6. Find and click on Timberman application

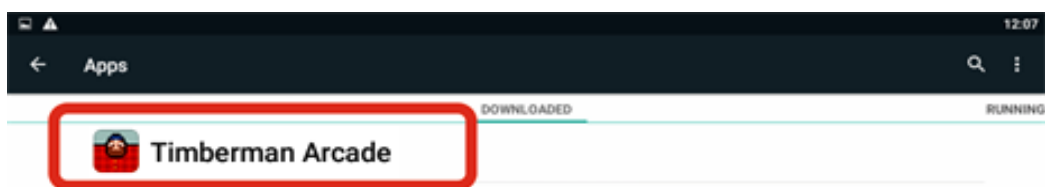

7. Click „CLEAR DATA“

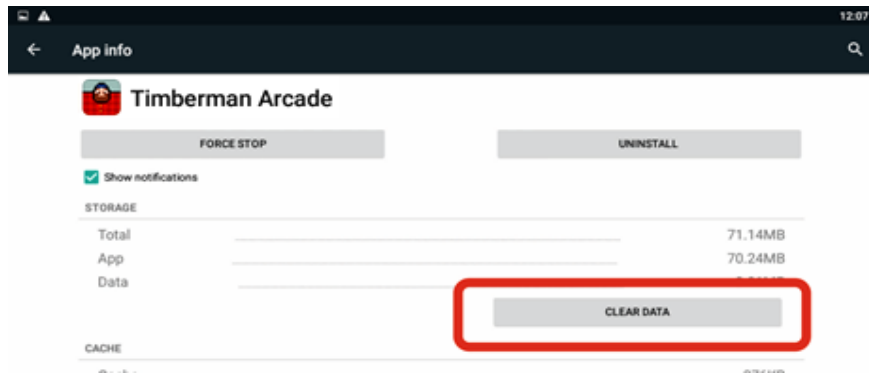

8. App refreshed, click on the circle at the bottom of the screen to back to machine desktop.

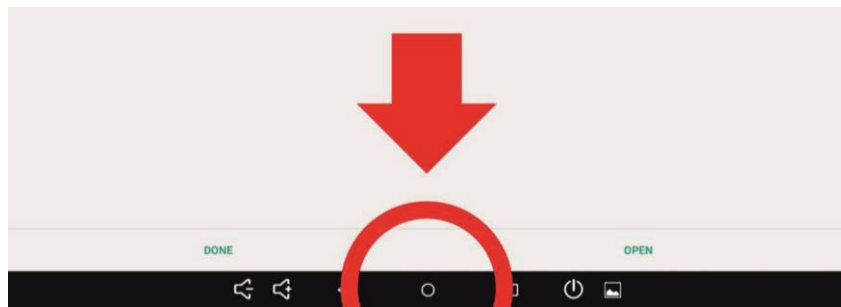

9. Disconnect USB mouse. Game need to be configured.

## 8.5 PROBLEMS WITH COIN ACCEPTORS/BILL ACCEPTORS

1. Possible problems with acceptors firmware
2. Check wirings for acceptors
3. Not accepted permission to acces USB device for I/O board (see „Buttons/coins not working“)

## 8.6 BUTTONS/COINS MECH NOT WORKING

1. Check wiring connections to I/O board
2. If new CPU board, I/O board or LED driver connected you will be asked to confirm USB Access permission to USB device. Check everything as described on picture below. Check use by default[...] → click OK. Often three times this pop-up occur.

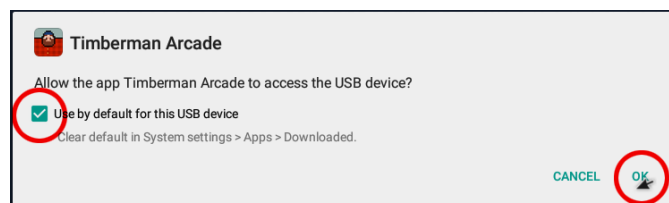

3. If You accidently press CANCEL after selecting checkbox for „Use default..“ follow steps from (Problems with ticket dispensing, game crashing/freezing, settings are not saved) and additionally click **CLEAR DEFAULTS at step 10!** Run Timberman from desktop and follow step 2 from this section.

## 8.7 MICROSD CARD REPAIR TUTORIAL for Windows OS

1. Download Win32 Disk Imager (link)

<https://sourceforge.net/projects/win32diskimager/files/Archive/Win32DiskImager-0.9.5-binary.zip/download>

2. Extract downloaded program



3. Select extract location and click extract

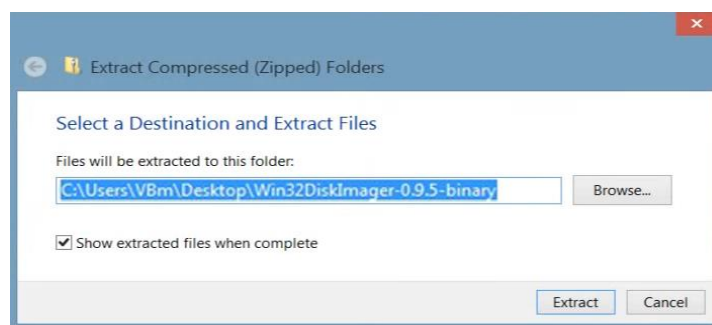

4. Insert Micro SDCard (8GB SDHC Class 10) from your CPU board or new into your card reader and run Win32DiskImager



5. Select provided image file and select proper device letter (CPU board Micro SD card)

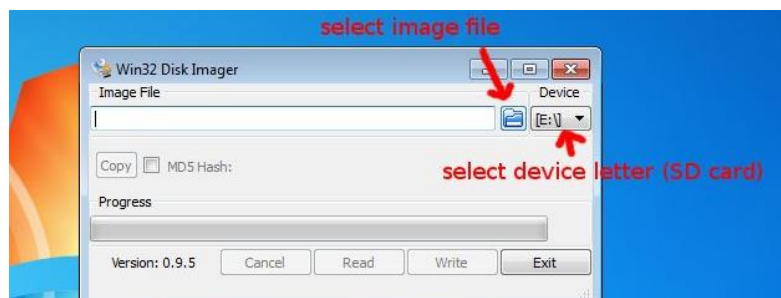

6. When image file and drive letter is selected properly, click "Write" and wait for finish. Put SD card back into CPU board unit and turn the machine on. Solid RED and blinking BLUE LED light on CPU board means that everything is ok. (refer to other "Troubleshooting" steps)

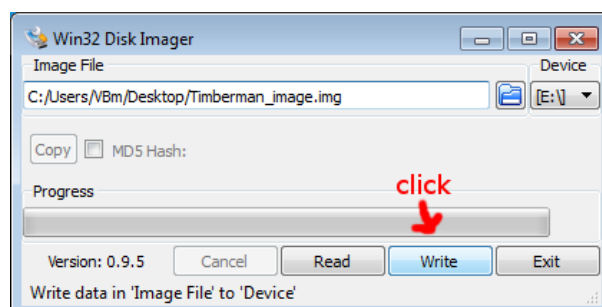

## 8.8 CPU BOARD VERSIONS

All units above the serial number 0400916 are equipped with CPU board v2.

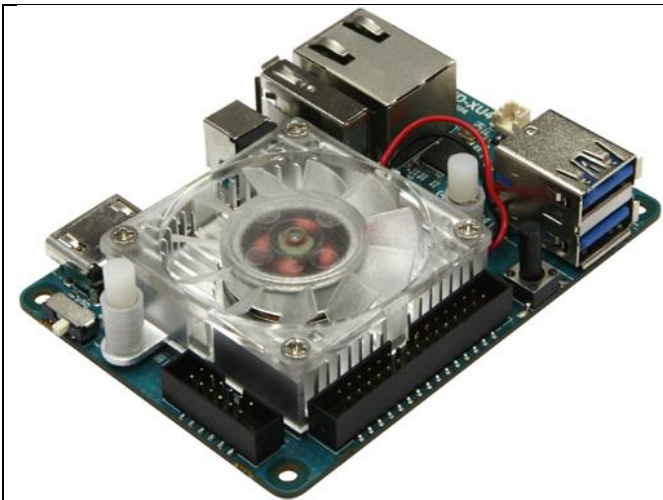

CPU board v1 (older)



CPU board v2 (new)

## 10. TERMS OF WARRANTY

Magic Play Sp. z o.o. warrants that the TIMBERMAN game will be free from defects in electronics for a period of 12 months from the date of delivery.

Warranty covers:

- Display
- Main board
- I/O board
- Power supplies
- LED driver
- LED lighting

Warranty terms do not cover parts not included above.

### Definition of defect:

It will be considered as defective if any connection between subcomponents on a particular board fails or any of them stops working itself. It does not include damages which occurred due to misuse, unauthorized connection or modifications.

**Should the product prove defective during the warranty period, Magic Play, at its option, shall:**

1. Repair the defective part by means of telephone support or depot service at no charge for parts or labor.
2. Replace the defective part with a comparable product which may be new or refurbished.

Provided that

1. Magic Play is informed of the defect immediately after it occurred. The faulty part should be dispatched to Magic Play or its authorized distributor as soon as possible.
2. Magic Play diagnoses the defects were not caused by improper use, neglect, unauthorized modifications, repair, setup or testing.
3. Only parts recommended and approved by Magic Play are covered by Magic Play Terms of Warranty.

**UNDER NO CIRCUMSTANCES SHALL MAGIC PLAY SP. Z O.O. BE HELD RESPONSIBLE FOR  
LOSSES IN PROFIT, USAGE OR ACCIDENTAL SERIOUS DAMAGE TO THE MACHINE!**

**Magic Play sp. z o.o.**

**Address:** Chocimska 6

62800 Kalisz, POLAND

**Phone:** +48 62 753 21 88

**Website:** [www.magicplay.eu](http://www.magicplay.eu)