

User's Guide

TRENDNET[®]



N300 High Power PoE Access Point

TEW-735AP

Table of Contents

Table of Contents	2	Product Preset Information.....	7
Product Overview	4	Mounting Accessories	7
Features	4	Hardware Installation	8
Installation	4	Use two P3.5 pan head screws to secure the TEW-735AP. The distance between mounting points is 2 and 3/4 inches (7cm).....	8
Quick Setup	4	Mount on the T-Bar	8
Plenum Rated	4	Wireless Performance Considerations	9
Housing.....	4	Operation Modes	10
Power over Ethernet (PoE)	4	Access Point	10
LED Control.....	4	WDS Bridge	10
Performance	4	WDS AP	10
Wireless Coverage.....	4	Universal Repeater.....	10
Wireless Speed	4	Application Diagram	11
Backward Compatible.....	4	System configurations	12
Management	5	System Management and Default Settings	12
Operation Modes.....	5	Logging-in to the TEW-735AP for the First Time.....	12
IPv6.....	5	Status	15
SSIDs	5	Main status	15
System Log	5	IPv6.....	16
SNMP.....	5	Wireless Client List	16
Security	5	System Log.....	17
Encrypted Wireless.....	5	Multiple Language	17
VLAN Management	5	System	18
Network Access	5	Operation Mode.....	19
Package Contents.....	5	Access Point	19
Front View	6	WDS AP	19
Rear View	6		
Connectors.....	6		

WDS Bridge	19	Regulations.....	39
Universal Repeater	19	Federal Communication Commission Interference Statement	39
IP Settings	20	FCC Radiation Exposure Statement	39
Bridge Address	20	Industry Canada	40
DHCP Server	21	Radiation Exposure Statement:	40
Spanning Tree	21	Europe – EU Declaration of Conformity	41
Wireless.....	22	Safety.....	41
Basic	22	EMC.....	41
Security	23	Radio Spectrum & Health	41
Advanced.....	26	Energy Efficiency	41
MAC Filter	28	Directives	41
WPS Wi-Fi Protected Setup	30	RoHS.....	42
Management.....	31	ErP Statement.....	43
Administration.....	31	Limited Warranty.....	45
Management VLAN	32		
SNMP Setting.....	33		
Backup / Restore Settings.....	34		
Auto Reboot Settings.....	34		
Firmware Upgrade.....	35		
Time Setting.....	35		
Schedule	36		
Diagnosis.....	36		
LED Control.....	37		
Logout.....	37		
Appendix.....	38		
Command Line Interface (CLI).....	38		
SSH.....	38		
Telnet.....	38		

Product Overview



TEW-735AP

Features

TRENDnet's plenum rated business class N300 High Power PoE Access Point, model TEW-735AP, greatly increases wireless coverage as compared to standard access points. A variety of installation scenarios are supported with Access Point, WDS AP, WDS Bridge, and Repeater modes. Save installation time and costs with PoE.

Installation

Quick Setup

Get up and running in minutes with an intuitive guided setup

Plenum Rated

Plenum rating expands installation options

Housing

Off white color and smoke detector shape blends into most environments

Power over Ethernet (PoE)

Save installation time and costs with PoE (Optional power port for non-PoE installations)

LED Control

Disable diagnostic LEDs to further reduce visual attention

Performance

Wireless Coverage

High power radio greatly expands wireless coverage

Wireless Speed

Proven 300 Mbps wireless n

Backward Compatible

Compatible older wireless g devices

Management

Operation Modes

Access Point, WDS AP, WDS Bridge, and Repeater modes

IPv6

IPv6 pass through support

SSIDs

Create up to four wireless virtual LANs (SSIDs)

System Log

System log aids network troubleshooting

SNMP

Extend network monitoring to this device with SNMP support

Security

Encrypted Wireless

Support for encryption up to WPA2

VLAN Management

Up to four SSIDs with VLAN management support

Network Access

Create MAC filter tables to reduce network access risk

Package Contents

TEW-735AP package includes:

- TEW-735AP
- Multi-Language Quick Installation Guide
- CD-ROM (User's Guide)
- Network Cable (1.5 m / 5 ft.)

- Power Adapter (12 V, 1 A)

If any package content is missing or damaged, please contact the retail store, online retailer, or reseller/distributor from which the product was purchased.

Front View

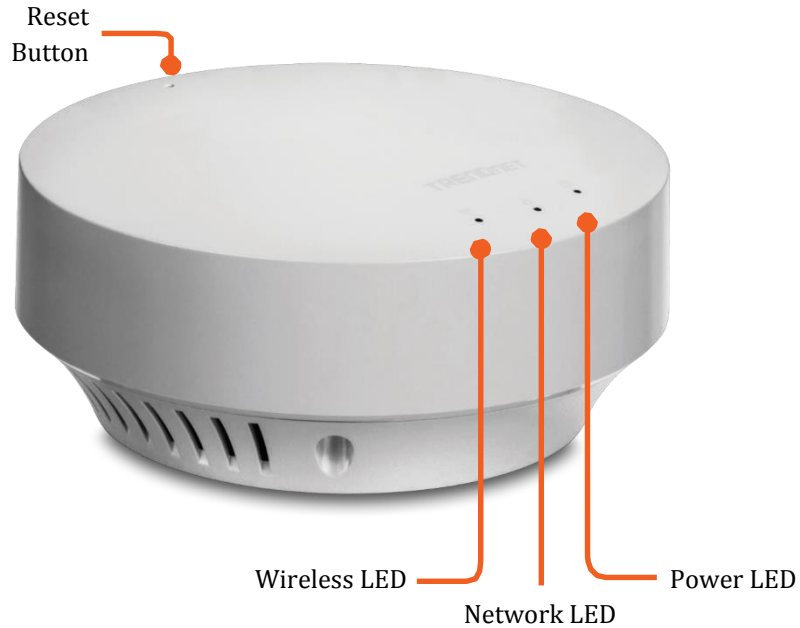

Rear View

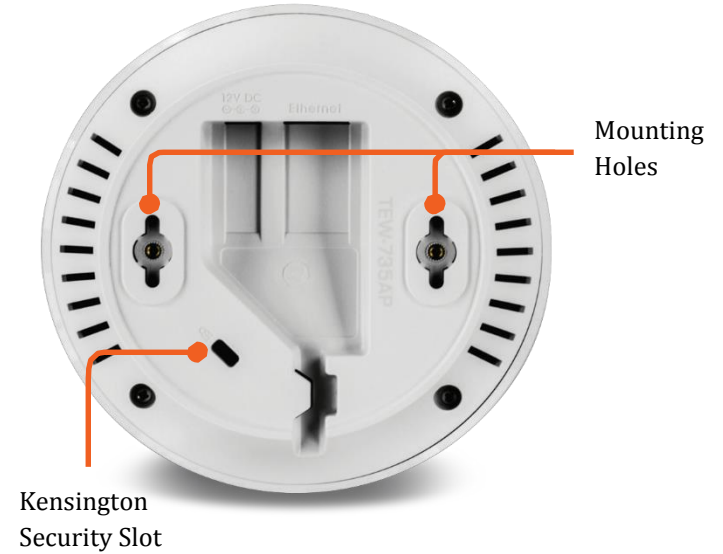

Connectors

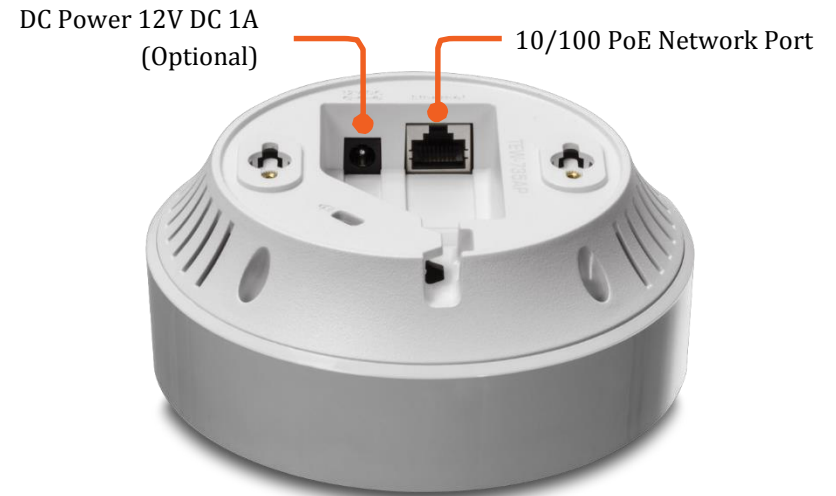

Reset Button

- Push and hold for 2 seconds to reset TEW-735AP
- Push and hold for more than 10 seconds to reset all settings to factory default.

Power LED

ON: Powered on

OFF: Powered off or LED display has been disabled.

Network LED

ON: Network connected through network port.

Flashing: Network activities are detected on network port.

OFF: No network connection detected on the network port or LED display has been disabled.

Wireless LED

Flashing: Wireless network activities are detected.

OFF: No wireless network connection or LED display has been disabled.

Product Preset Information

There are two preset labels that come with the package. The first label is located on plastic wrapping of the TEW-735AP. The second label is located on the bottom of the TEW-735AP. The default SSID, wireless key, administrator account, and administrator password can be found there. The default static management IP is 192.168.10.100.

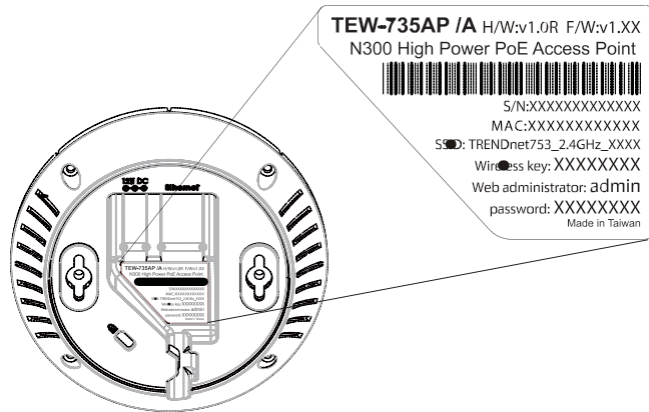

Mounting Accessories

The mounting accessories are provided for easier hardware installation, including two sets of T-Bar clippers, two sets of screws, and a set of spacers.

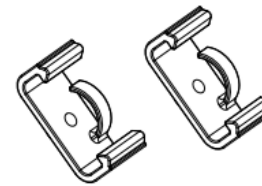

15/16" T-bar clips

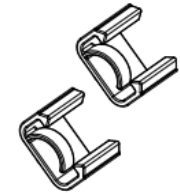

9/16" T-bar clips



P2.6 * 10 screws



P2.6 * 25 screws

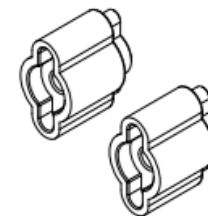

spacers

Hardware Installation

Mount on Wall or Ceiling

Use two P3.5 pan head screws to secure the TEW-735AP. The distance between mounting points is 2 and 3/4 inches (7cm).

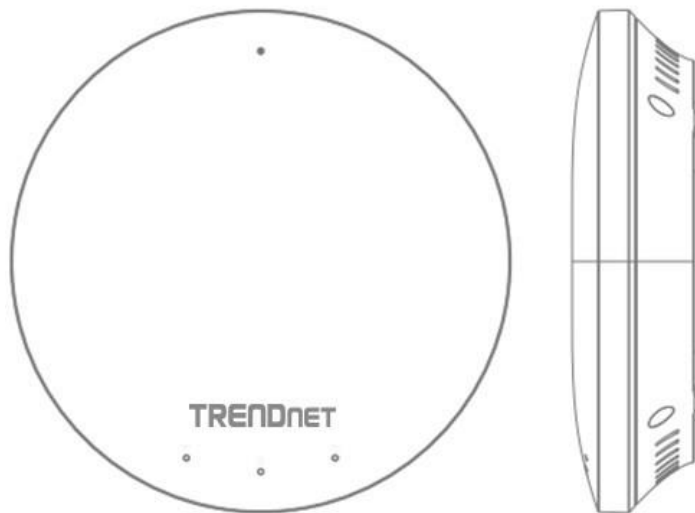

Mount on the T-Bar

Two additional bronze screw holes are provided for T-Bar mounting. Use two P2.6 screws to secure the TEW-735AP to the T-Bar clip and then clip on the T-Bar.

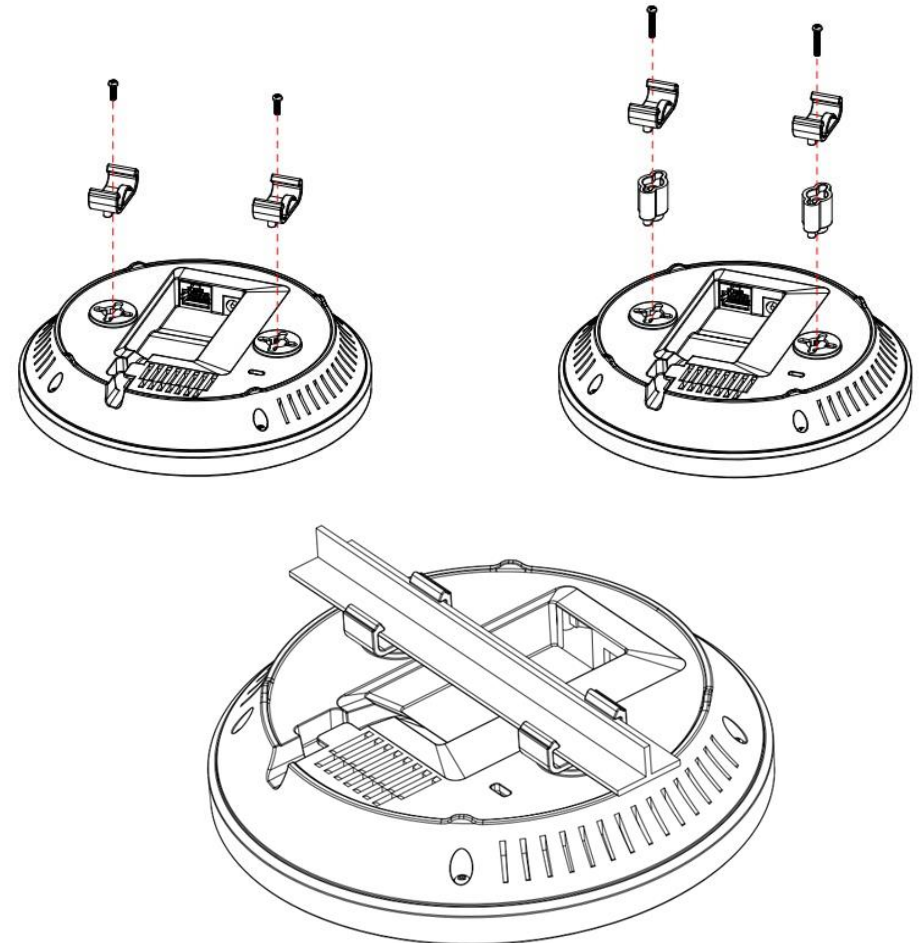

Wireless Performance Considerations

There are a number of factors that can impact the range of wireless devices. Adjust your wireless devices so that the signal is traveling in a straight path, rather than at an angle. The more material the signal has to pass through the more signal you will lose. Keep the number of obstructions to a minimum. Each obstruction can reduce the range of a wireless device. Position the wireless devices in a manner that will minimize the amount of obstructions between them.

Building materials can have a large impact on your wireless signal. In an indoor environment, try to position the wireless devices so that the signal passes through less dense material such as dry wall. Dense materials like metal, solid wood, glass or even furniture may block or degrade the signal.

Antenna orientation can also have a large impact on your wireless signal. Use the wireless adapter's site survey tool to determine the best antenna orientation for your wireless devices.

Interference from devices that produce RF (radio frequency) noise can also impact your signal. Position your wireless devices away from anything that generates RF noise, such as microwaves, radios and baby monitors.

Any device operating on the 2.4GHz frequency will cause interference. Devices such as 2.4GHz cordless phones or other wireless remotes operating on the 2.4GHz frequency can potentially drop the wireless signal. Although the phone may not be in use, the base can still transmit wireless signal. Move the phone's base station as far away as possible from your wireless devices.

Adjust the wireless power setting on your AP if you have more than one AP covering a large area. Covering only the neighbor hop APs in wireless range is a good design. Covering more than neighbor APs will experience wireless interference and slow down the communication.

Operation Modes

There are four operating modes provided by the TEW-735AP, Access Point, WDS Bridge, WDS, AP, and Universal Repeater. Configure the TEW-735AP to different operation modes which best serve your network needs.

Access Point

This is the default operation mode. The TEW-735AP services wireless end points in this mode. You can setup local or remote wireless authentication, setup up to 4 sets of SSID and separation of SSID or STA traffic can be configured.

WDS Bridge

When WDS mode is selected, the TEW735AP functions as a wireless bridge and is able to wirelessly communicate to other WDS bridges to make a wireless backbone. A WDS link is bidirectional; both end points must support WDS and each access point must know the MAC Address of the other. Each access point will be configured with the remote access point's MAC address and vice versa. Make sure all access points are configured with the same SSID, wireless channel and wireless encryption settings.

WDS AP

This is a hybrid mode. The TEW735AP can be set as a WDS bridge and as an access point at the same time.

Universal Repeater

When Repeater Mode is selected, the TEW-735AP functions as a wireless repeater and is able to repeat the wireless signal of an access point. This feature is used to expand your existing wireless network to areas your current access point is unable to reach. Make sure all the settings of the TEW-735AP match the wireless access points you want to repeat, including the SSID, channel, and wireless encryption settings.

Application Diagram

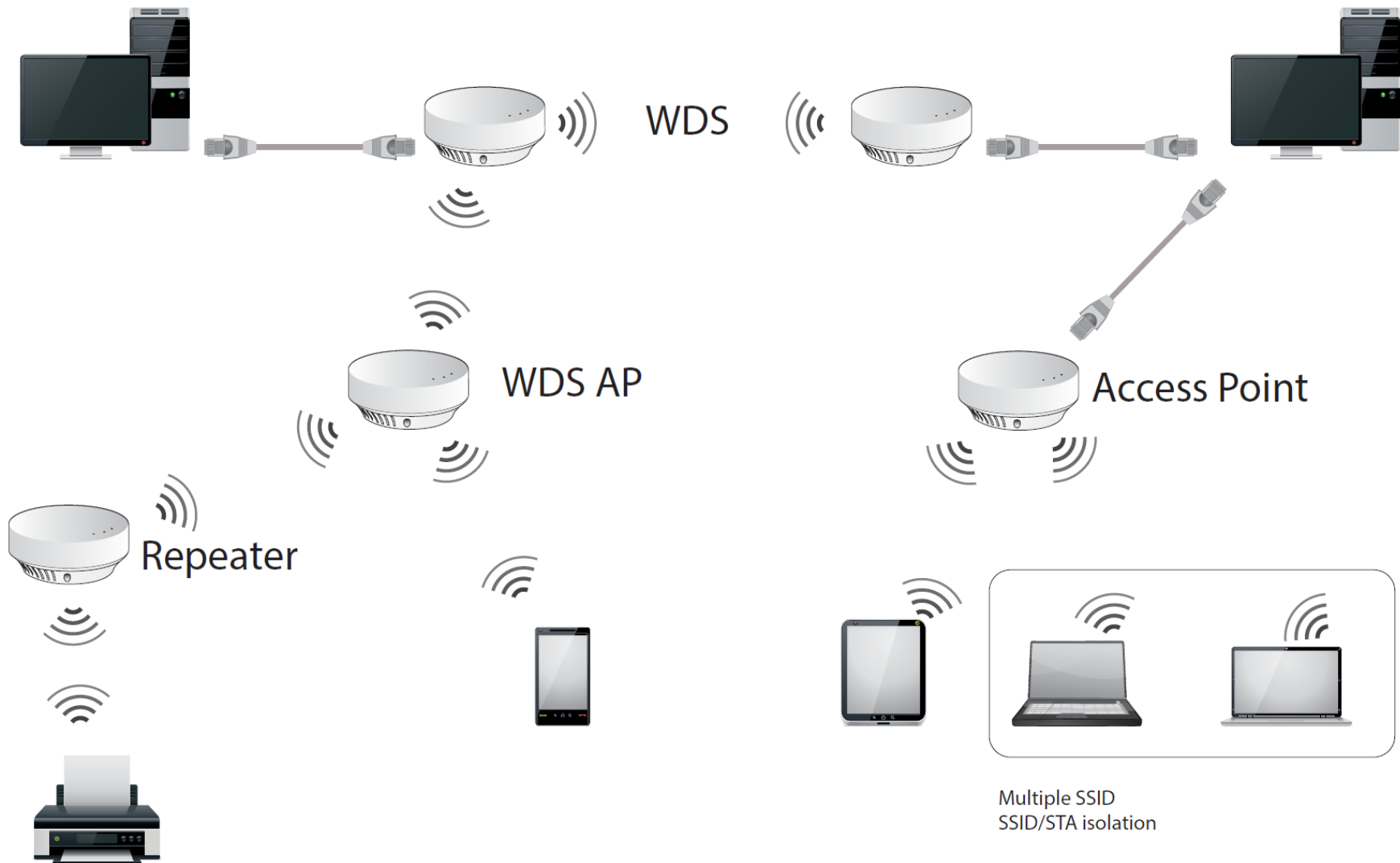

System configurations

System Management and Default Settings

If you have a brand new TEW-735AP, or if you just reset the TEW-735AP to factory defaults by pressing and holding reset button for over 10 seconds, your TEW-735AP has following settings:

System Default	
Management IP:	192.168.10.100
Administrator name:	admin
Administrator password:	admin
Default SSID:	(printed on pre-set label)
Default SSID passphrase:	(printed on pre-set label)

Logging-in to the TEW-735AP for the First Time

1. Power on your TEW-735AP by connecting a network cable to a PoE switch or by plugging-in the power adapter that comes with the package. The power LED will turn on.

2. Search for available wireless connections in your computer's network settings. The default SSID of the TEW-735AP is shown on the preset label. The default wireless security settings are set to WPA2 and the passphrase is printed on the device label as well.



Or, connect a network cable from your computer to the TEW-735AP network port.

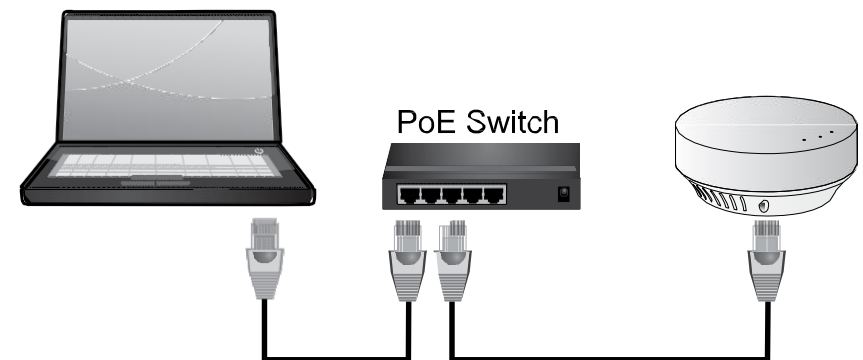

- Open a web browser and enter `http://tew-735ap` to access the administration page.

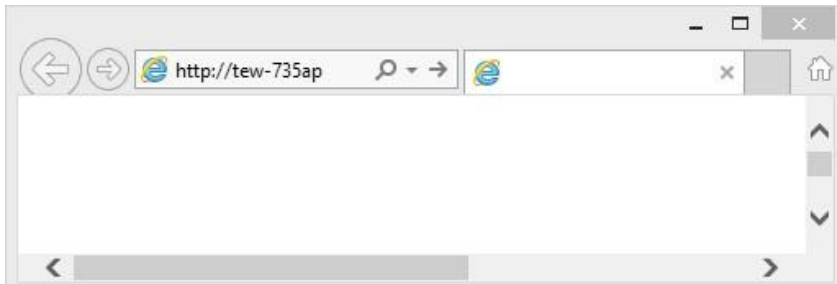

If you have a static IP set on your PC, please open a web browser and then enter `http://192.168.10.100` The TEW-735AP login page will show up.

 A screenshot of the TEW-735AP login page. The page header includes the TRENDnet logo and the text "N300 High Power PoE Access Point TEW-735AP". The main content area is titled "TEW-735AP LOGIN" and contains a form with the following fields:

- Username :
- Password :
- Multiple Language : (dropdown menu)

 Below the form is a blue "Login" button. At the bottom of the page, there is a copyright notice: "© Copyright 2013 TRENDnet. All Rights Reserved."

Enter the administrator login information (The default user name is **admin** and the password is **admin**)

** Please reference the troubleshooting section if you cannot access the administration web page.*

- Change your administration login password away from the factory default setting and then click **Apply** to continue.

 A screenshot of the TEW-735AP password change page. The page has a dark theme with a sidebar on the left containing navigation options: Status, System, Wireless, and Management. The Management section is expanded to show sub-options: Administration, Management VLAN, SNMP Setting, Backup/Restore Setting, Auto Reboot Settings, and Firmware Upgrade. The main content area is titled "Status" and contains the following text: "You can change the password that you use to access the device, this is not your ISP account password." Below this text are four input fields: "Old Password", "New Password", "Confirm password", and "System Name" (pre-filled with "tew-735ap"). There is also an "Idle Timeout" field set to "10" (1~10 Minutes). At the bottom of the form are two buttons: "Apply" and "Reset".

- TEW-735AP will apply the password change and then reboot. Login again with your new password.

Module is reloading, please wait seconds.

** If you connected to the TEW-735AP wirelessly, please make sure you are still connecting to the TEW-735AP after it reboot.*

Setup Wizard

The setup wizard is provided as part of the web configuration utility. It assists in the basic setup of the administrator password and management IP address. Click the **Wizard** button in the **System menu** to access the setup wizard. The following screen will appear. Enter a new administrator password and then click **Next** to continue.

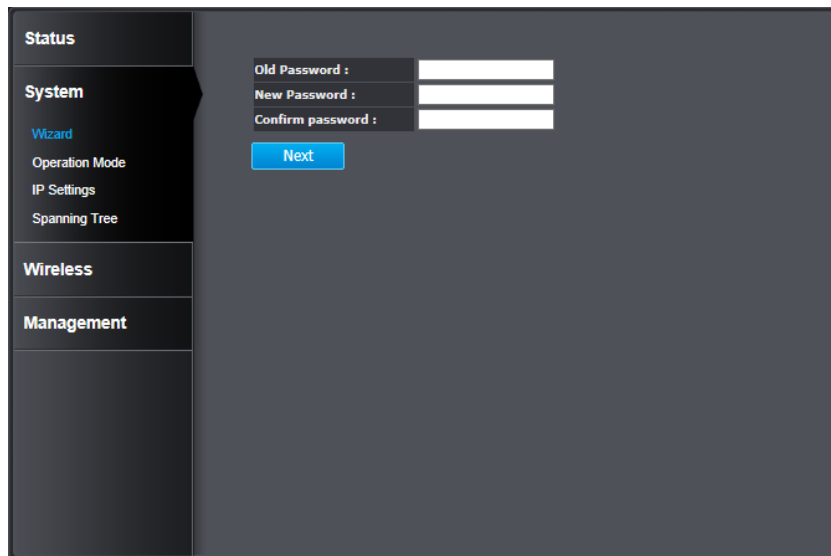

The screenshot shows the Setup Wizard interface. On the left is a navigation menu with sections: Status, System (highlighted), Wireless, and Management. Under the System section, the 'Wizard' option is selected. The main area contains three password input fields: 'Old Password', 'New Password', and 'Confirm password'. A blue 'Next' button is positioned below the 'Confirm password' field.

Enter the management IP address for the TEW-735AP. The default IP address is 192.168.10.100. Assign a unique IP address within the management subnet. The management subnet. You can leave it on default if you have only one TEW-735AP, but you have to change the IP address if you have more than one TEW-735AP.

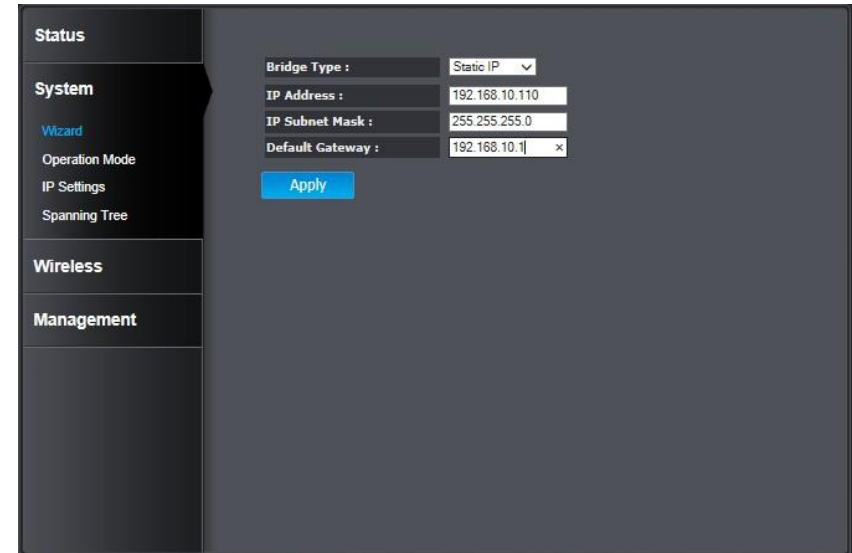

The screenshot shows the Setup Wizard interface for IP configuration. The left navigation menu is the same as in the previous screenshot, but 'System' is selected and 'Wizard' is highlighted. The main area shows configuration fields: 'Bridge Type' (Static IP), 'IP Address' (192.168.10.110), 'IP Subnet Mask' (255.255.255.0), and 'Default Gateway' (192.168.10.1). A blue 'Apply' button is located below the 'Default Gateway' field.

Click **Apply** to save the changes and reboot the TEW-735AP.

Module is reloading, please wait 11 seconds.

Status

Main status

The **Main status** page shows the TEW-735AP's basic information.

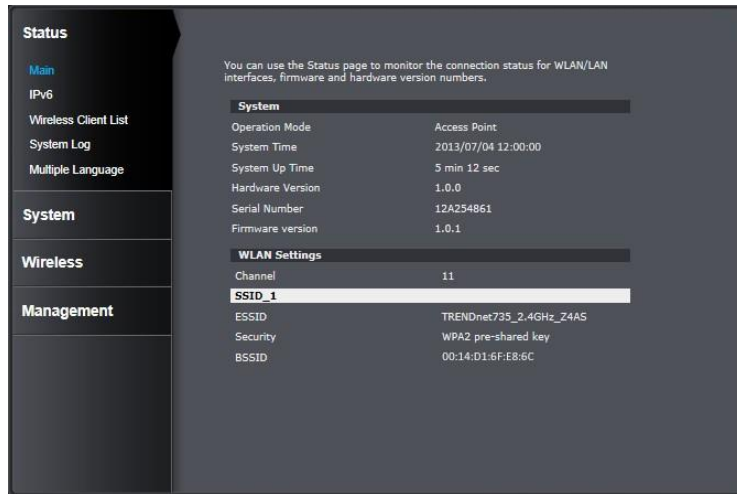

System

Operation Mode: Shows which operation mode is currently in use: Access Point, WDS AP, WDS Bridge, Universal Repeater.

System Time: Shows the system time on the TEW-735AP. This is important for schedule control and log accuracy.

System Up Time: Shows the amount of time the TEW-735AP has been running.

Hardware Version: Shows the hardware version of the TEW-735AP.

Serial Number: Shows the serial number of the TEW-735AP.

Firmware version: Shows the firmware version currently in use.

WLAN Settings

Channel: Shows the wireless channel currently in use.

SSID_1 - 4: Shows current Service Set Identifier is currently in use. This SSID is human readable and performs as ESSID to setup wireless groups. You can activate up to 4 SSIDs on a single TEW-735AP.

Security: Shows which type of security encryption is currently in use for this wireless connection.

BSSID: Basic SSID. This is a strictly unique SSID to identify this wireless access point (WAP). It is also the MAC address of the wireless interface.

IPv6

This page shows the TEW-735AP's IPv6 link local address. You can manage the TEW-735AP using this IPv6 link local address if your computer is IPv6 enabled and is in the same broadcast domain. Put a pair of brackets around your IPv6 address to visit the management site. (i.e. [http://\[IPv6 address\]](http://[IPv6 address]))

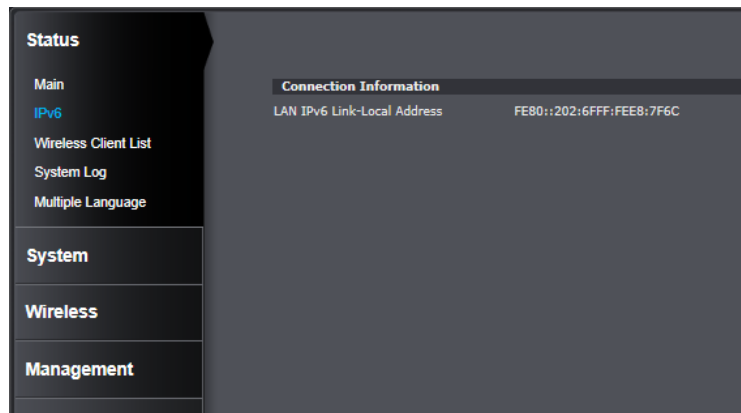

Wireless Client List

This page shows all wireless clients connected to the TEW-735AP.

The screenshot shows the 'Wireless Client List' page. It features a table with columns: Interface, MAC Address, Rx, Tx, Signal(%), Connected Time, and Idle Time. The table contains two entries for interface '735-2'. A 'Refresh' button is located below the table.

Interface	MAC Address	Rx	Tx	Signal(%)	Connected Time	Idle Time
735-2	00:14:D1:00:14:D1	1.0 MBytes	3.1 MBytes	69	24 min 23 secs	0 secs
735-2	00:14:D1:CA:5C:57	902.7 KBytes	4.7 MBytes	84	20 min 33 secs	0 secs

WLAN Client Table

Interface: Shows which SSID the wireless client is currently associated with.

MAC Address: Shows the MAC address of wireless client.

Rx: Receiving data statistics.

Tx: Transmitting data statistics.

Signal(%): Signal strength of the wireless client.

Connected Time: Connection time since wireless association starts.

Idle Time : Accumulated non-active time.

Refresh: Click this button to refresh the list.

System Log

This page allows users to view a running log of the access point's system statistics, events and activities.

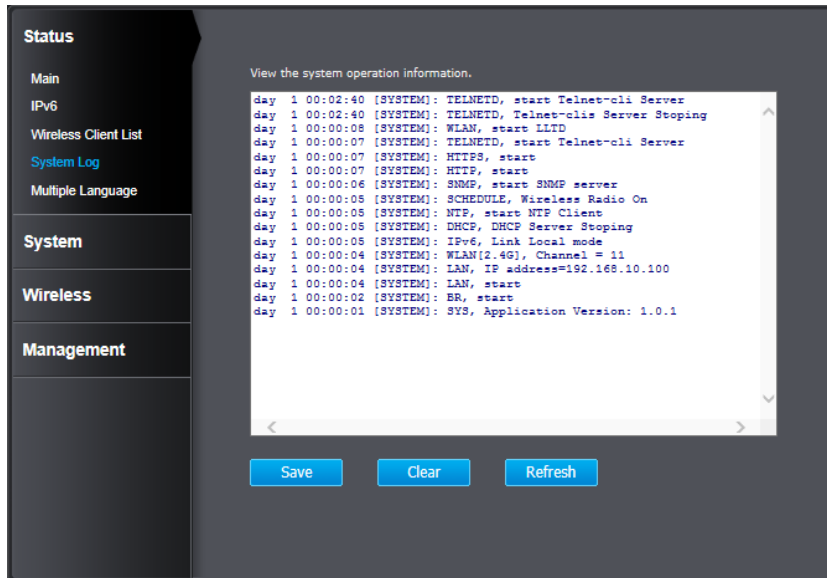

Save: Click this button to save the log on your computer.

Clear: Click this button to clear up the system logs.

Refresh: Click this button to refresh the logs display on this page.

Multiple Language

You can keep the language you selected in the login page or you can change your language setting here.

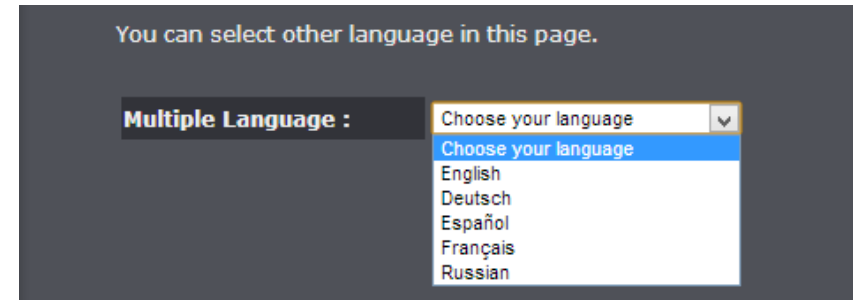

System

Setup Wizard

The setup wizard is provided as part of the web configuration utility. It assists in the basic setup of the administrator password and management IP address. Click the **Wizard** button in the **System** menu to access the setup wizard. The following screen will appear. Enter a new administrator password and then click **Next** to continue.

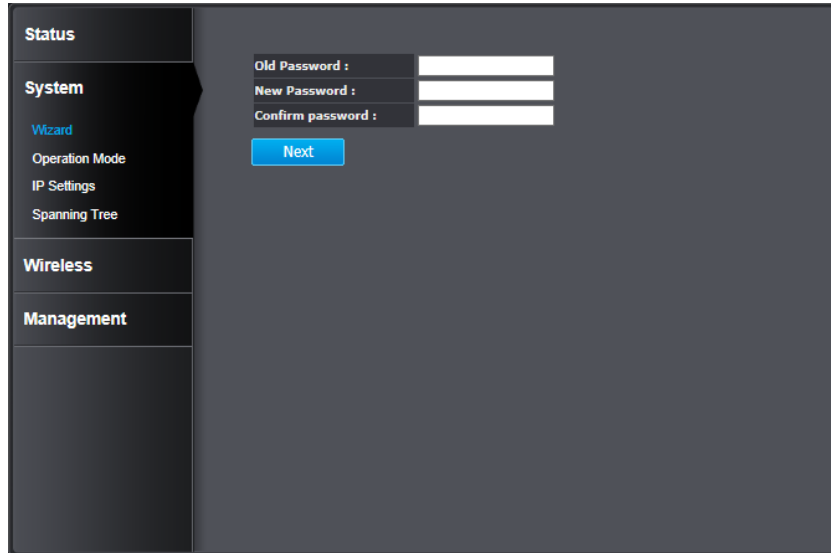

The screenshot shows the 'System' menu with 'Wizard' selected. The main area contains three password input fields: 'Old Password', 'New Password', and 'Confirm password'. A blue 'Next' button is positioned below the 'Confirm password' field.

Enter the management IP address for the TEW-735AP. The default IP address is 192.168.10.100. Assign a unique IP address within the management subnet. The management subnet. You can leave it on default if you have only one TEW-735AP, but you have to change the IP address if you have more than one TEW-735AP.

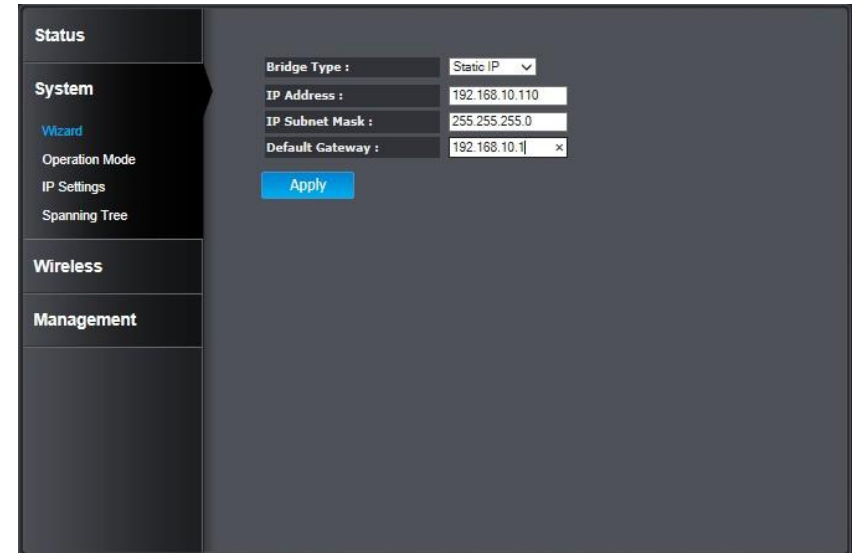

The screenshot shows the 'System' menu with 'Wizard' selected. The main area displays configuration options for the management IP: 'Bridge Type' (Static IP), 'IP Address' (192.168.10.110), 'IP Subnet Mask' (255.255.255.0), and 'Default Gateway' (192.168.10.1). A blue 'Apply' button is located below these fields.

Click **Apply** to save the changes and reboot the TEW-735AP.

Module is reloading, please wait 11 seconds.

Operation Mode

You can choose the mode that best suits your network: Access Point, WDS AP, WDS Bridge and Universal Repeater.

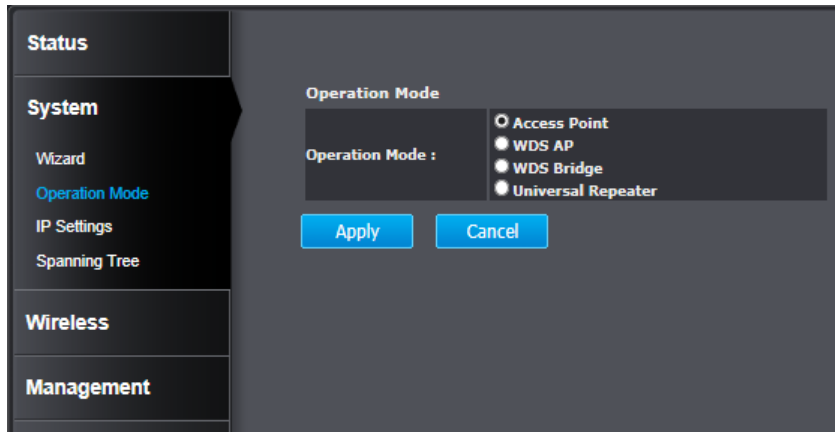

Access Point

This is the default operation mode. Wireless clients, known as wireless stations (STAs), can wirelessly associate with the TEW-735AP and connect to the Internet via the network port.

WDS AP

In this operation mode, the TEW-735AP wirelessly connects to other WDS (Wireless Distribution System) enabled devices for backbone communication and provides wireless connectivity to clients (STAs) at the same time.

WDS Bridge

In this operation mode, the TEW-735AP connects ONLY to other WDS (Wireless Distribution System) enabled devices as a backbone bridge.

Universal Repeater

When Repeater Mode is selected, the TEW-735AP functions as a wireless repeater and is able to repeat the wireless signal of an access point. This feature is used to expand your existing wireless network to areas your current access point is unable to reach. Make sure all the settings of the TEW-735AP match the wireless access points you want to repeat, including the SSID, channel, and wireless encryption settings.

IP Settings

The TEW-735AP has a static IP (192.168.10.100) set for management purposes. You can change this IP address to fit your network plan or manage multiple TEW-735AP. You can also set TEW-735AP to DHCP client to accept an IP dynamically.

You can enable the device's DHCP server to dynamically allocate IP Addresses to your LAN client PCs. The device must have an IP Address for the Local Area Network.

Bridge Type : Static IP

IP Address : 192.168.10.110

IP Subnet Mask : 255.255.255.0

Default Gateway : 192.168.10.1

DNS Type : Static

First DNS Address : 192.168.10.1

Second DNS Address : 192.168.10.1

DHCP Server

DHCP Server : Disabled

Lease Time : Forever

Start IP : 192.168.10.129

End IP : 192.168.10.190

Domain Name : tew735ap

First DNS Address :

Second DNS Address :

Apply Cancel

You can enable the device's DHCP server to dynamically allocate IP Addresses to your LAN client PCs. The device must have an IP Address for the Local Area Network.

Bridge Type : Dynamic IP

DNS Type : Dynamic

Apply Cancel

Bridge Address

Bridge Type: Select Static IP or Dynamic IP from the drop-down list. If you select Static IP, you have to specify an IP address and subnet mask of your choice. If Dynamic IP is selected, then the IP address is received automatically from the external DHCP server.

IP Address: Specify an IP address

IP Subnet Mask: Specify a subnet mask for the IP address

Default Gateway: Default route for the TEW-735AP

DNS Type: Static or Dynamic

First DNS Address: Primary DNS server address

Second DNS Address: Secondary DNS server address

DHCP Server

The TEW-735AP is equipped with a DHCP server to assign IPv4 addresses dynamically. The assigning IP address range must be in the subnet that was used in **IP Settings**. By default, the DHCP server is disabled. If you want to enable it, select **Enabled** from the DHCP Server drop down list. Enter the requested information and click **Apply** to save the change and activate DHCP server.

DHCP Server

DHCP Server : Choose **Enabled** or **Disabled** from the drop down list.

Lease Time : How long the assigning IP will be valid.

Half hour
One hour
Two hours
Half day
One day
Two days
One week
Two Weeks
Forever

Start IP : Starting IP address of DHCP pool.

End IP : Last IP address of DHCP pool.

First DNS Address : Primary DNS server address you want to assign with DHCP lease.

Second DNS Address : Secondary DNS server address you want to assign with DHCP lease.

Spanning Tree

The TEW-735AP is designed for end point access as well as backbone connection. To avoid network looping, you can enable 802.1d Spanning Tree Protocol (STP).

Spanning Tree

Spanning Tree Status: Enable or disable 802.1d spanning tree protocol to avoid network looping.

Bridge Hello Time: The time between each bridge protocol data unit (BPDU). Default: 2 sec.

Bridge Max Age: Maximum time a BPDU kept in bridge. Default: 20 sec

Bridge Forward Delay: The time spent in listen and learning state. Default: 15 sec.

Bridge Priority: Priority number for root bridge selection. (MAC number is listed on Status > Main page)

Apply: Click this button to save and activate

Cancel: Click this button to abandon the change

Wireless

Basic

General setup for your wireless connection. You can setup up to four SSIDs for different groups of users.

Wireless Basic Setup

Radio: Enable or Disable overall wireless signals.

Mode: The operation mode setting in the **System** section.

Band: Choose the Wi-Fi connection protocols that you want to run on the AP.

Enabled SSID#: Choose the number of SSIDs you want to enable (Range: 1 ~ 4).

ESSID1 - 4: SSID names for enabled groups.

Auto Channel: Enable or disable auto channel selection.

Channel: (for fixed channel) specify channel number.

Channel : 11

Check Channel Time: (for auto channel) specify how often the TEW-735AP checks the channel status

Apply: Click this button to save and activate

Cancel: Click this button to abandon the change

Security

Set up wireless security settings in this page. Select the SSID you want to set up, change the value and then click on **Apply** to complete the changes. Enabling security prevents any unauthorized wireless clients to connect into your network.

ESSID Selection: Select the SSID which you want to set up the wireless security.

Separate: **SSID:** If you check this box, clients associated with this SSID cannot communicate with wireless clients associated with other SSIDs directly.

STA: If you check this box, wireless clients (a.k.a. STAs) associated with this SSID cannot communicate to each other directly, even if they are in the same wireless group.

Broadcast ESSID : Select **Enable** or **Disable** from the drop-down list. This is the SSID broadcast feature. When this option is set to Enable, your wireless network name is broadcast to anyone within wireless signal range. When this is disabled, you must enter the Wireless Network Name (SSID) on the client manually to connect to the network.

WMM : Choose to **Enable** or **Disable** WMM. This is the Quality of Service (QoS) feature to prioritizing voice and video packets.

Encryption : Choose between **Disabled**, **WEP**, **WPA**, **WPA2**, or **802.1X** for your wireless security.

Encryption (Disabled): Choosing **Disable** allows wireless clients to connect to the TEW-735AP without a password. You can relay the authentication to remote RADIUS server by checking **Enable 802.1X Authentication** and entering RADIUS server information.

Encryption :	WEP
Authentication Type :	<input type="radio"/> Open System <input checked="" type="radio"/> Shared Key <input type="radio"/> Auto
Key Length :	64-bit
Key Type :	ASCII (5 characters)
Default Key :	Key 1
Encryption Key 1 :	<input type="text"/>
Encryption Key 2 :	<input type="text"/>
Encryption Key 3 :	<input type="text"/>
Encryption Key 4 :	<input type="text"/>
<input type="checkbox"/> Enable 802.1x Authentication	
<input type="button" value="Apply"/> <input type="button" value="Cancel"/>	

Encryption (WEP): WEP, Wire Equivalent Protection, provides basic wireless security.

Authentication Type : Select Open System, Shared Key, or Auto:

Open System: Open system allows any client to authenticate as long as it conforms to any MAC address filter policies that may have been set. All authentication packets are passing without encryption.

Shared Key: Shared key sends an unencrypted challenge text string to any device attempting to communicate with the AP. The device requesting authentication encrypts the challenge text and sends it back to the access point. If the challenge text is encrypted correctly, the access point

allows the requesting device to authenticate.

Auto: It is recommended to select Auto if you are not sure which authentication type has been used on your network.

Key Length : Select a 64-bit or 128-bit WEP key length from the drop-down list

Key Type: Select a key type from the drop-down list. 128-bit encryption requires a longer key than 64-bit encryption. Keys are defined by entering in a string in HEX (hexadecimal - using characters 0-9, A-F) or ASCII (American Standard Code for Information Interchange - alphanumeric characters) format. ASCII format is provided so you can enter a string that is easier to remember.

Default Key: You may choose one of your 4 different WEP keys from below

Encryption Key 1-4 : You may enter four different WEP keys

Enable 802.1X Authentication: Check this box if you would like to use static WEP plus 802.1X authentication. This option works with a RADIUS Server to authenticate wireless clients. Wireless clients can either use Static WEP or 802.1X authentication in order to connect to the network. For 802.1X, clients should have necessary credentials to be authenticated by the server. Furthermore, it is necessary to specify the RADIUS server's IP address, service port number, and shared secret.

Encryption (WPA pre-shared key):

Wi-Fi Protected Access (WPA) pre- shared key

WPA Type: Select TKIP, AES, or WPA2 Mixed. This is the encryption algorithm used to secure the data communication. TKIP (Temporal Key Integrity Protocol) provides per- packet key generation and is based on WEP. AES (Advanced Encryption Standard) is a very secure block based encryption. Note that, if the bridge uses the AES option, the bridge can associate with the access point only if the access point is also set to use only AES.

Pre-shared Key Type: The key type can be passphrase or Hex format.

Pre-shared Key: The key is entered as a pass-phrase of up to 63 alphanumeric characters in ASCII (American Standard Code for Information Interchange) format at both ends of the wireless connection. It cannot be shorter than eight characters, although for proper security it needs to be of ample length and should not be a commonly known phrase. This phrase is used to generate session keys that are unique for each wireless client.

Encryption (WPA RADIUS): Use RADIUS server manage your wireless authentication keys for easier account management.

WPA Type: Select TKIP, AES, or WPA2 Mixed. The encryption algorithm used to secure the data communication. TKIP (Temporal Key Integrity Protocol) provides per- packet key generation and is based on WEP. AES (Advanced Encryption Standard) is a very secure block based encryption. Note that, if the bridge uses the AES option, the bridge can associate with the access point only if the access point is also set to use only AES.

RADIUS Server IP Address: IP address of RADIUS server.

RADIUS Server Port: RADIUS service port number. Default: 1812.

RADIUS Server Shared Secret: RADIUS service shared secret to authenticate this credential agent.

Apply: Click this button to save and activate

Cancel: Click this button to abandon the change

Advanced

Fine tuning your wireless settings on this page.

These settings are only for expert users who are familiar with the Wireless LAN procedure. Do not change these settings unless you know what effect the changes will have on your AP. Incorrect settings might reduce wireless performance.

Fragment Threshold :	2346	(256-2346)
RTS Threshold :	2347	(1-2347)
Beacon Interval :	100	(20-1000 ms)
DTIM Period :	1	(1-255)
Data Rate :	Auto	
N Data Rate:	Auto	
Channel Bandwidth	<input type="radio"/> Auto 20/40 MHz <input checked="" type="radio"/> 20 MHz	
Preamble Type :	<input checked="" type="radio"/> Long Preamble <input type="radio"/> Short Preamble	
CTS Protection :	<input checked="" type="radio"/> Auto <input type="radio"/> Always <input type="radio"/> None	
Tx Power :	26 dBm	

Apply Cancel

Fragment Threshold: Packets over the specified size will be fragmented in order to improve performance on noisy networks. Specify a value between 256 and 2346. The default value is 2346.

RTS Threshold: Packets over the specified size will use the RTS/CTS mechanism to maintain performance in noisy networks and preventing hidden nodes from degrading the performance. Specify a value between 0 and 2347. The default value is 2347.

Beacon Interval: Beacons are packets sent by a wireless access point to synchronize wireless devices. Specify a Beacon Interval value between 24 and 1024. The default value is set to 100 milliseconds.

DTIM Period: A DTIM is a countdown informing clients of the next window for listening to broadcast and multicast messages. When the wireless Access Point has buffered broadcast or multicast messages for associated clients, it sends the next DTIM with a DTIM Period value. Wireless clients detect the beacons and awaken to receive the broadcast and multicast messages. The default value is 1. Valid settings are between 1 and 10.

Data rate: You can select a data rate from the drop-down list, however, it is recommended to select auto. In auto mode, TEW735AP will choose the maximum data rate to fit the instant wireless channel quality automatically.

N Data Rate: Select different 802.11n Modulation and Coding Scheme (MCS) against particular wireless noise or select auto for the TEW-735AP to select MCSs dynamically.

Channel Bandwidth: Set channel bandwidth to 1) Dynamic select 20 MHz and 40MHz channels or 2) fixed in 20MHz channels only.

Preamble Type: Select a short or long preamble. For optimum performance, it is recommended to also configure the client device to the same preamble type.

CTS Protection: Clear to Send, CTS, can be set to always enabled, auto, or disabled. By enabling CTS, the Access Point and clients will wait for a 'channel cleared' signal before transmitting. The recommended setting is to auto.

Tx Power: Wireless signal transmission power. Setting transmission power to an appropriate value can make your multiple AP deployment easier. The default value is 26 dBm for FCC version

and 17 dBm for CE version. Valid settings are between 11 and 26 for FCC and 17 for CE.

Apply: Click this button to save and activate

Cancel: Click this button to abandon the change

MAC Filter

Set up a list of clients and policies allow only the clients on the list to associate with this AP or to reject clients on the list from associating with this AP. Set up the list with MAC addresses. A MAC address is a unique ID assigned by the manufacturer of the network adapter.

Enable Wireless Access Control:

Check this box to enable the feature (Click **Apply** to commit the change)

Deny / Allow Policy:

Choose “Deny all clients with MAC address listed below to access the network” to allow clients that aren’t on the list to associate with the TEW-735AP.
Choose “Allow all clients with MAC address listed below to access the network” to deny clients that aren’t on the list to associate with the TEW-735AP.

Encryption: **MAC address:** Enter the device’s MAC address.
ADD: Click to add a MAC address into the table.
Reset: Click to reset entry.
Delete Selected: Allows you to delete the selected entry.
Delete All: Deletes all entries in the MAC address table.
Reset: Reset all entries.
Apply: Click to apply changes made.
Cancel: Click to cancel any new changes made.

Description: Enter readable information about this client.
MAC Address: Enter the device’s MAC address.

Description	MAC Address
<input type="text"/>	<input type="text"/>
Add	Reset

Add: Click this button to add a MAC address to the list.

Reset: Click this button to abandon the change.

Only the following MAC Addresses can access the network:

NO.	Description	MAC Address	Select
1	PC in front	00:14:D1:07:83:45	<input checked="" type="checkbox"/>
2	PC in back	00:14:D1:63:81:63	<input type="checkbox"/>

Delete Selected Delete All Reset

Delete Selected: Click this button to delete the selected entry.

Delete All: Click this button to clear the list.

Reset: Click this button to abandon the change.

Apply: Click this button to save and activate

Cancel: Click this button to abandon the change

WPS Wi-Fi Protected Setup

WPS is the simplest way to connect a wireless client to the TEW-735AP. You don't have to select the encryption mode and fill in a long encryption passphrase every time you want to setup a wireless connection. You only need to press a button on both the wireless client and the TEW-735AP, and WPS will do the rest for you.

The TEW-735AP supports two types of WPS: WPS via Push Button and WPS via PIN code. If you want to use the Push Button, you have to push a specific button on the wireless client or in the utility of the wireless client to start the WPS pairing, and click the Start to Process button in this page under **WPS via Push Button** to start WPS pairing.

If you want to use the PIN code, you have to know the PIN code of the wireless client and switch it to WPS mode. Then fill-in the PIN code of the wireless client through the web configuration interface of the wireless router.

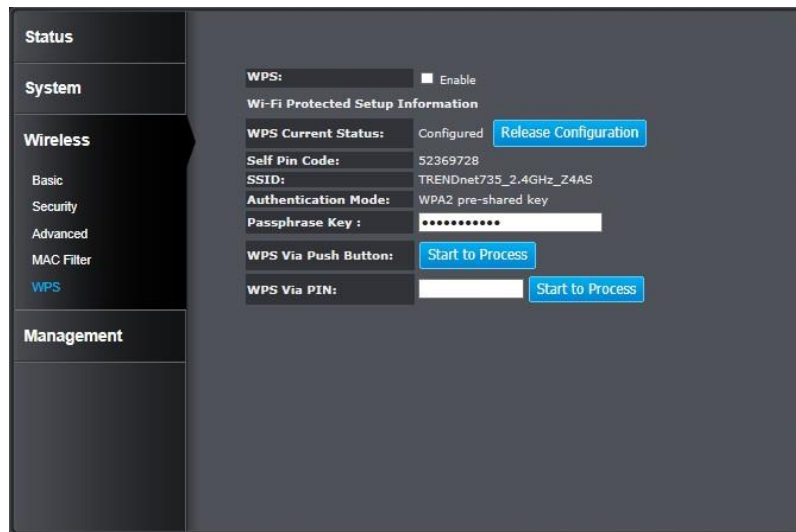

WPS:	Check this box to enable the WPS feature.
WPS Current Status:	Displays the current status of the WPS configuration.
Self Pin Code:	Displays the PIN code for the TEW-735AP.
SSID:	Displays the SSID for WPS pairing. Only the first SSID (SSID_1) can proceed WPS pairing.
Authentication Mode:	Displays the authentication mode of SSID_1
Passphrase Key:	Current passphrase
WPS Via Push Button:	Click on the Start to Process button if you would like to enable WPS through the push button instead of the PIN. After pressing this button you will be required to press the WPS on the client device within two minutes. Click on the OK button in the dialog box.
WPS via PIN:	Specify a PIN, which unique number that can be used to add the router to an existing network or to create a new network. Then click on the Start to Process button.

Management

Administration

Change the password required to log into the access point's web-based management. Passwords can contain 0 to 12 alphanumeric characters, and are case sensitive. Enter your password and system information and then click **Apply** to save the changes.

The screenshot shows the 'System' configuration page in the web management interface. The left sidebar lists various settings categories: Status, System, Wireless, and Management. Under 'Management', 'Administration' is selected. The main area contains a heading 'You can change the password that you use to access the device, this is not your ISP account password.' Below this are four input fields: 'Old Password', 'New Password', 'Confirm password', and 'System Name' (pre-filled with 'tew-735ap'). The 'Idle Timeout' is set to '10' minutes. At the bottom are 'Apply' and 'Reset' buttons.

Old Password: Enter the current password to allow the password change.

New Password: Enter your new password here.

Confirm Password: Type your new password again for verification purposes.

System Name: The system name can be identified on your local network. Changing this system name can change the way you access this AP. For example, if you change the system name to "lobbyfront", you can access this AP by typing `http://lobbyfront/` in Windows and log on to the management page. Default system name is "tew-735ap".

Idle Timeout: Logout automatically after a period of idle. The default period is 10 minutes.

Management VLAN

This feature is only available under Access Point or WDS AP mode and allows users to configure the 802.1q VLAN settings to for all wireless clients. Enter VLAN ID you want to tag to clients associated with specific SSID. Different SSID should set to different VLAN ID. Enable Virtual LAN service and click Apply to save the changes.

LAN VLAN MGMT is a special VLAN to manage TEW-735AP. Enabling management VLAN tagging will keep all services, for example DHCP server and client, in this VLAN.

A virtual LAN, commonly known as a VLAN, is a group of hosts with a common set of requirements that communicate as if they were attached to the same wire, regardless of their physical location.

Virtual LAN : Enable Disable

SSID 1 Tag: Tag 100 (1~4094)

SSID 2 Tag: Tag 200 (1~4094)

SSID 3 Tag: Tag 300 (1~4094)

SSID 4 Tag: Tag 400 (1~4094)

LAN VLAN MGMT : Enable Disable

MGMT Tag: 4094 (1~4094)

Apply Cancel

Virtual LAN: Choose to Enable or Disable the VLAN features.

SSID 1 - 4 Tag: Enter VLAN tag you want to add for associated clients. Check the leading check box to enable tagging. All SSIDs have to have different VLAN tag. Valid settings are between 1 and 4094.

LAN VLAN MGMT: Enable or disable TEW-735AP services on a specific VLAN. If management VLAN tagging is enabled, all service packets, including web management, DHCP server/ client, will be tagged with a specified tag.

MGMT Tag: VLAN number for TEW-735AP services. This number has to be different from all above VLAN numbers.

Apply: Click this button to save and activate

Cancel: Click this button to abandon the change

SNMP Setting

SNMP Setting allows you to assign the contact details, location, community name, and trap settings for SNMP. This is a networking management protocol used to monitor network-attached devices. SNMP allows messages (called protocol data units) to be sent to various parts of a network. Upon receiving these messages, SNMP-compatible devices (called agents) return data stored in their Management Information Bases.

SNMP is used in network management systems to monitor network-attached devices for conditions that warrant administrative attention.

SNMP Active :	Disabled
SNMP Version :	All
SNMP Manager IP :	0.0.0.0
Read Community :	public
Set Community :	private
System Location :	US
System Contact :	admin
Trap Active :	Disabled
Trap Manager IP :	192.168.1.100
Trap Community :	public

Apply Cancel

SNMP Active: Choose to enable or disable the SNMP feature.

SNMP Version: Select SNMP version from the drop-down list.

SNMP Manager IP: Specify the SNMP manager IP address.

Read Community Name: Specify the password to access the SNMP community for read only access.

Set Community Name: Specify the password for access to the SNMP community with read/write access.

System Location: Specify the location of the TEW-735AP.

System Contact: Specify the contact details of the TEW-735AP.

Trap Active: Choose to enable or disable the SNMP trapping feature.

Trap Manager IP: Specify the IP address of the SNMP trap community.

Trap Community: Specify the name of SNMP trap community.

Apply: Click this button to save and activate

Cancel: Click this button to abandon the change

Backup / Restore Settings

This page allows you to save the current configurations. Click **Save** to save your current configuration.

To load configurations saved previously, click **Browse...** to find configuration file and then click **Upload**.

In case you want to reset TEW-735AP configuration back to factory default, click **Reset** in this page. All configurations will be set back to the factory default settings.

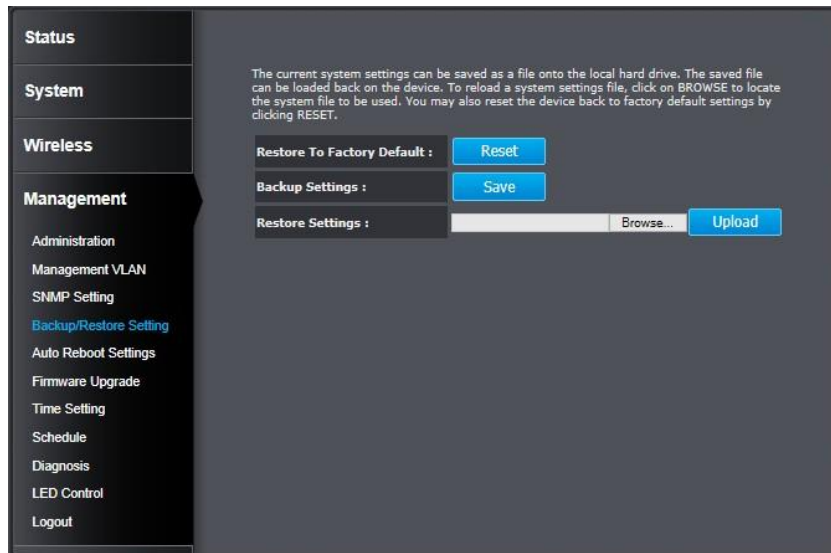

Auto Reboot Settings

Click on **Apply**, the TEW-735AP will go through the reboot process automatically.

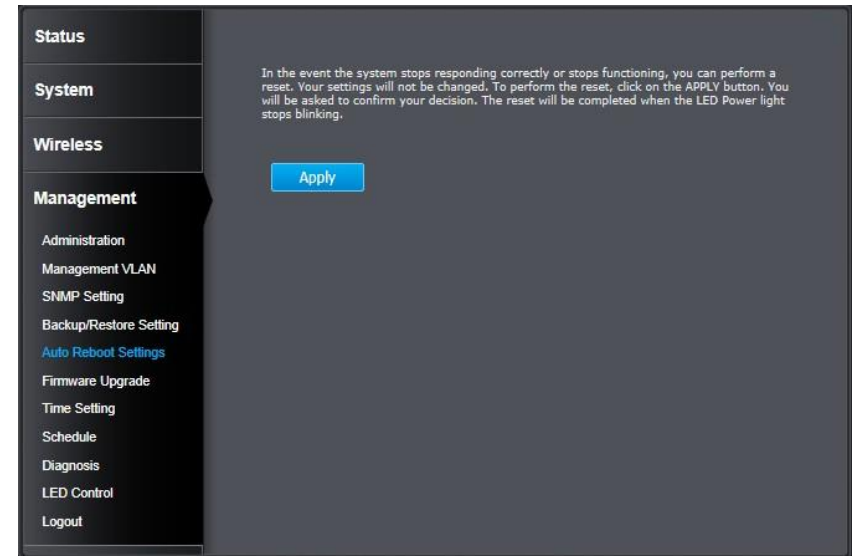

Firmware Upgrade

TRENDnet may periodically release firmware upgrades that might add features or fix problems associated with your TRENDnet model and version. To find out if there is a firmware upgrade available for your device, please check your TRENDnet model and version using the link.

<http://www.trendnet.com/downloads/>

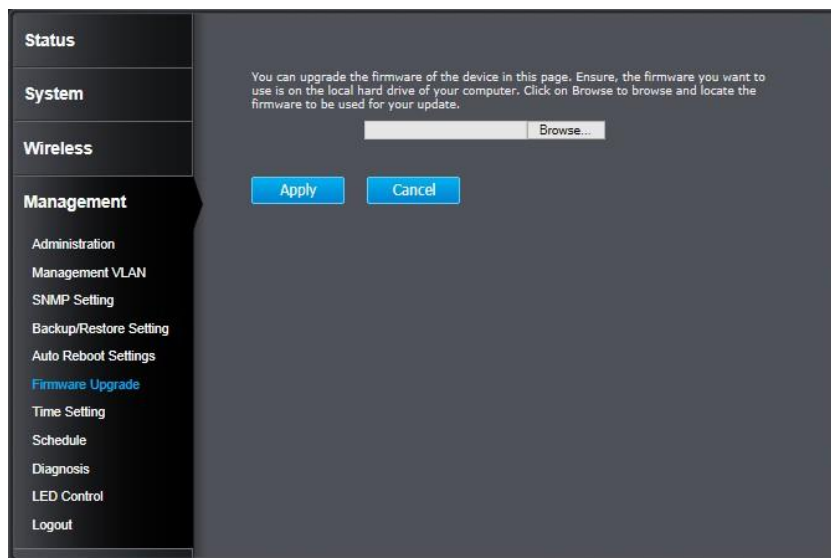

1. If a firmware upgrade is available, download the firmware to your computer.
2. Unzip the file to a folder on your computer.
3. Log into the TEW-735AP.
4. Click on Management and then Firmware Upgrade.
5. Click Browse... and then navigate to the folder on your computer in which the unzipped firmware file (.bin) is.
6. Located and select it the firmware file.
7. Click **Apply**.

Time Setting

The Time Setting allows your access point to reference or base its time on the settings configured here, which will affect functions such as log entries and schedules.

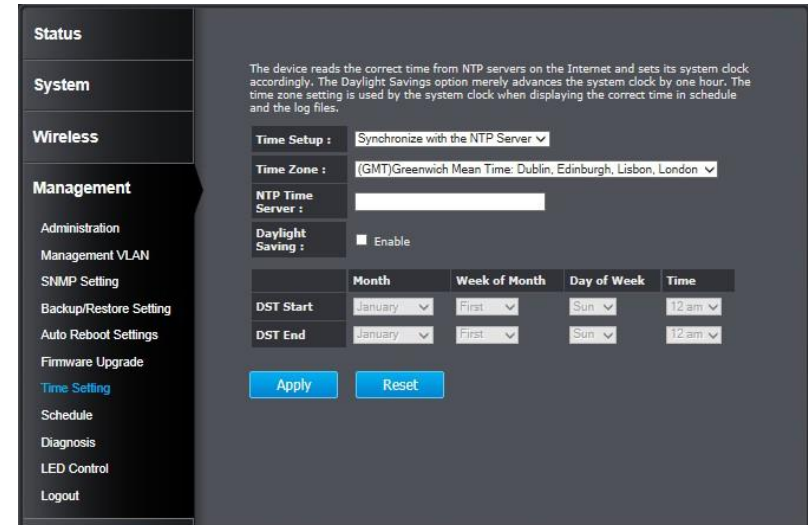

Time Setup: Choose a source of time to synchronize with. You can choose to synchronize the TEW-735AP with a NTP server or your PC.

Time Zone: Select the time zone of the country you are currently in. The TEW-735AP will set its time based on your selection.

NTP Time Server: Specify a time server (NTP server) to synchronize with. (e.g. pool.ntp.org)

Daylight Savings: Check this box if your time zone has daylight savings.

DST Start / DST End: Specify the starting date and end date of daylight savings.

Apply: Click this button to save and activate

Cancel: Click this button to abandon the change

Schedule

Service schedule can be set up daily or weekly for power saving and security reasons. Click **Add** to add a schedule rule entry. Select an entry and click **Edit** or **Delete Selected** to change the entry. Click **Delete All** to remove all entries. After schedule editing, click **Apply** to save your schedule. Check **Enabled Schedule Table** to make AP services work with schedule.

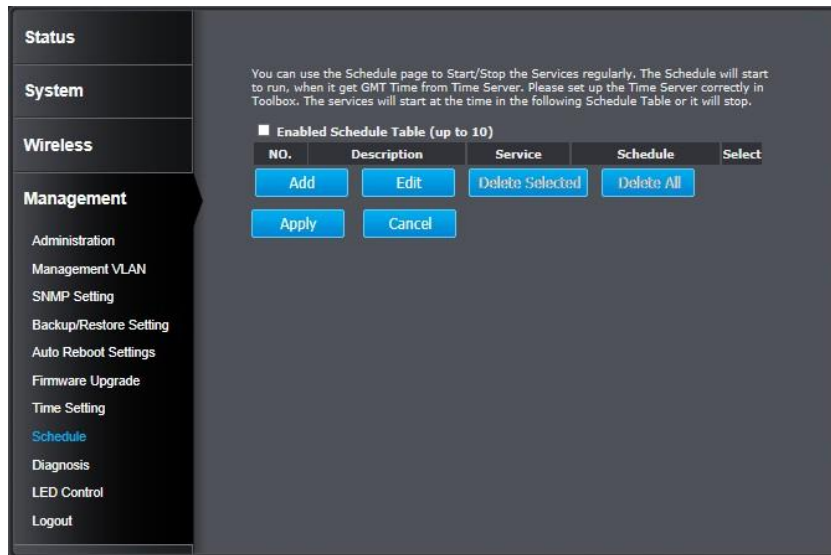

Add: Add scheduled service.

Edit: Edit selected scheduled service.

Delete Selected: Click this button to delete the selected entry.

Delete All: Click this button to clear the list.

Apply: Click this button to save and activate

Cancel: Click this button to abandon the change

Diagnosis

To check your network connection, you can use the PING tool from your TEW-735AP. Enter the IPv4 address you want to ping and click **Start**. The result will be showed in the terminal down below.

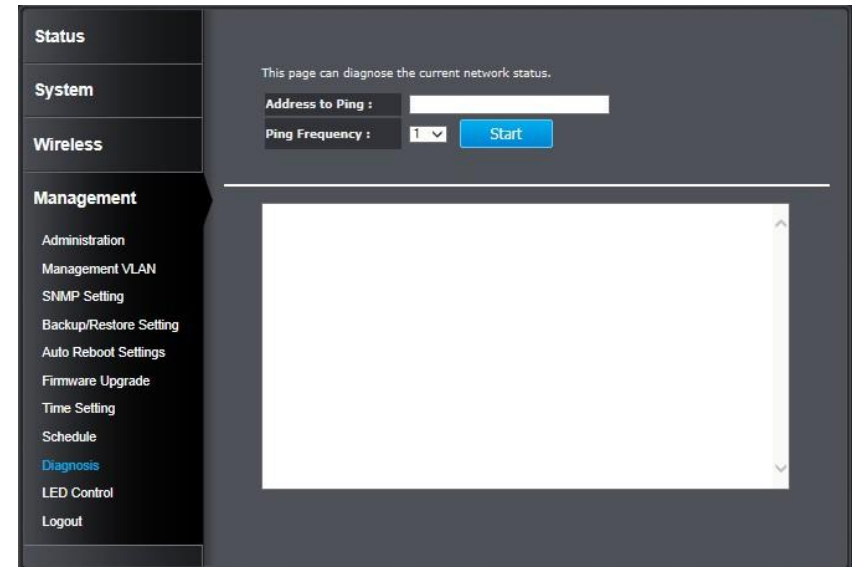

LED Control

All LED indicators are turned on by default. You can turn any one of them or all of them on or off. Click the LED you want to change the action and then click **Apply** to save the changes.

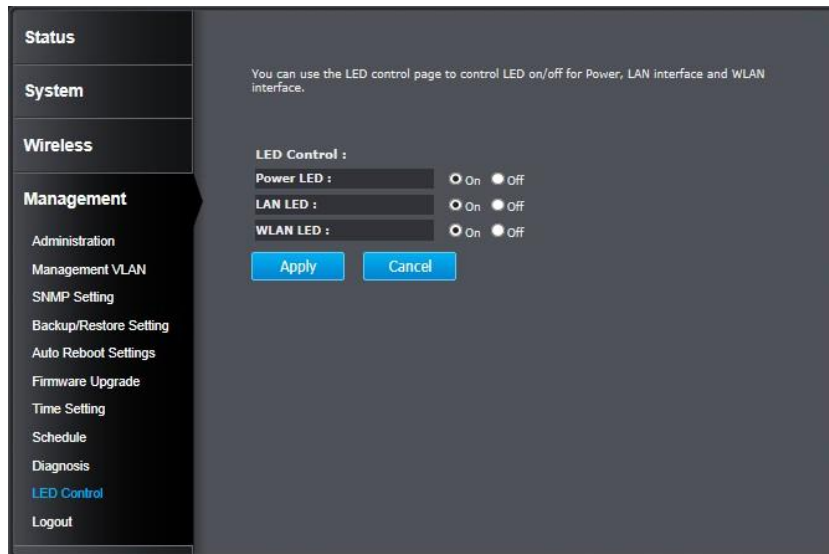

Logout

Logout from the management page. The TEW-735AP allows only one management login at the same time. If you want to access the TEW-735AP from different computer, remember to logout of the web management page first.

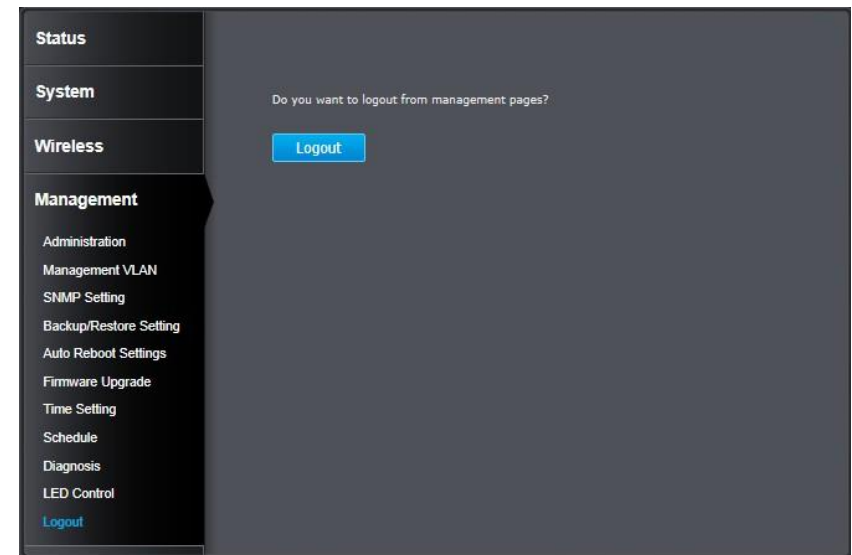

Appendix

Command Line Interface (CLI)

SSH

The Command Line Interface (CLI) is default enabled for Telnet and SSH access. Access the CLI interface using SSH with the administrator user name and password. For example:

```
$ ssh admin@192.168.10.100
The authenticity of host '192.168.10.100
(192.168.10.100)' can't be established.
RSA key fingerprint is b2:41:6e:0f:4b:2a:f3:03:18:60:
0b:c4:eb:74:9d:9c.
Are you sure you want to continue connecting (yes/
no)? yes
admin@192.168.10.100's password:
*** Hi admin, welcome to use cli ***
----- Commands Help -----
    sys -- System
    net -- Networks
upgrade -- Upgrade
config -- Configure
    help -- List all commands
    apply -- Apply the changes
            (Also store modified settings)
reboot -- Reboot the system
            (Also store modified settings)
    tree -- Menu tree
    exit -- Exit this session

cmd>
```

Telnet

Access the CLI interface using Telnet with the administrator user name and password. For example:

```
$ telnet 192.168.10.100
Trying 10.10.10.253...
Connected to 10.10.10.253.
Escape character is '^]'.
Name: admin
Password:
*** Hi admin, welcome to use cli ***
----- Commands Help -----
    sys -- System
    net -- Networks
upgrade -- Upgrade
config -- Configure
    help -- List all commands
    apply -- Apply the changes
            (Also store modified settings)
reboot -- Reboot the system
            (Also store modified settings)
    tree -- Menu tree
    exit -- Exit this session

cmd>
```

Regulations

Federal Communication Commission Interference Statement

This equipment has been tested and found to comply with the limits for a Class B digital device, pursuant to Part 15 of the FCC Rules. These limits are designed to provide reasonable protection against harmful interference in a residential installation. This equipment generates uses and can radiate radio frequency energy and, if not installed and used in accordance with the instructions, may cause harmful interference to radio communications. However, there is no guarantee that interference will not occur in a particular installation. If this equipment does cause harmful interference to radio or television reception, which can be determined by turning the equipment off and on, the user is encouraged to try to correct the interference by one of the following measures:

- Reorient or relocate the receiving antenna.
- Increase the separation between the equipment and receiver.
- Connect the equipment into an outlet on a circuit different from that to which the receiver is connected.
- Consult the dealer or an experienced radio/TV technician for help.

FCC Caution: Any changes or modifications not expressly approved by the party responsible for compliance could void the user's authority to operate this equipment.

This device complies with Part 15 of the FCC Rules. Operation is subject to the following two conditions: (1) This device may not cause harmful interference, and (2) this device must accept any interference received, including interference that may cause undesired operation.



IMPORTANT NOTE:

FCC Radiation Exposure Statement

This equipment complies with FCC radiation exposure limits set forth for an uncontrolled environment. This equipment should be installed and operated with minimum distance 20cm between the radiator & your body.

This transmitter must not be co-located or operating in conjunction with any other antenna or transmitter.

The availability of some specific channels and/or operational frequency bands are country dependent and are firmware programmed at the factory to match the intended destination. The firmware setting is not accessible by the end user.

Industry Canada

This device complies with Industry Canada license-exempt RSS standard(s). Operation is subject to the following two conditions: (1) this device may not cause interference, and (2) this device must accept any interference, including interference that may cause undesired operation of the device.

Le présent appareil est conforme aux CNR d'Industrie Canada applicables aux appareils radio exempts de licence. L'exploitation est autorisée aux deux conditions suivantes: (1) l'appareil ne doit pas produire de brouillage, et (2) l'utilisateur de l'appareil doit accepter tout brouillage radioélectrique subi, même si le brouillage est susceptible d'en compromettre le fonctionnement.

Radiation Exposure Statement:

This equipment complies with IC radiation exposure limits set forth for an uncontrolled environment. This equipment should be installed and operated with minimum distance 20cm between the radiator & your body.

Déclaration d'exposition aux radiations:

Cet équipement est conforme aux limites d'exposition aux rayonnements IC établies pour un environnement non contrôlé. Cet équipement doit être installé et utilisé avec un minimum de 20 cm de distance entre la source de rayonnement et votre corps.

Europe – EU Declaration of Conformity

TRENDnet hereby declare that the product is in compliance with the essential requirements and other relevant provisions under our sole responsibility.



Safety

EN 60950-1:2006+A11:2009+A1:2010+A12:2011
IEC 60950-1:2005 (2nd Edition) Am 1:2009

EMC

EN 55022: 2010 + AC: 2011 Class B
EN 55024: 2010
EN 301 489-1 V1.9.2: 09-2011
EN 301 489-17 V2.2.1: 09-2012

Radio Spectrum & Health

EN 300 328 V1.8.1 : (2012-06) Class B
EN 50385: 2002

Energy Efficiency

Regulation (EC) No. 1275/2008, Regulation, No. 278/2009, No. 801/2013

This product is herewith confirmed to comply with the Directives.

Directives

Low Voltage Directive 2006/95/EC
EMC Directive 2004/108/EC
R&TTE Directive 1999/5/EC
Ecodesign Directive 2009/125/EC
RoHS Directive 2011/65/EU
REACH Regulation (EC) No. 1907/2006

This device is a 2.4 GHz wideband transmission system (transceiver), intended for use in all EU member states and EFTA countries, except in France and Italy where restrictive use applies.

In Italy the end-user should apply for a license at the national spectrum authorities in order to obtain authorization to use the device for setting up outdoor radio links and/or for supplying public access to telecommunications and/or network services.

This device may not be used for setting up outdoor radio links in France and in some areas the RF output power may be limited to 10 mW EIRP in the frequency range of 2454 – 2483.5 MHz. For detailed information the end-user should contact the national spectrum authority in France.

Česky [Czech]	TRENDnet tímto prohlašuje, že tento TEW-735AP je ve shodě se základními požadavky a dalšími příslušnými ustanoveními směrnice 1999/5/ES, 2006/95/ES a 2009/125/ES.
Dansk [Danish]	Undertegnede TRENDnet erklærer herved, at følgende udstyr TEW-735AP overholder de væsentlige krav og øvrige relevante krav i direktiv 1999/5/EF, 2006/95/EF og 2009/125/EF.
Deutsch [German]	Hiermit erklärt TRENDnet, dass sich das Gerät TEW-735AP in Übereinstimmung mit den grundlegenden Anforderungen und den übrigen einschlägigen Bestimmungen der Richtlinie 1999/5/EG, 2006/95/EG und 2009/125/EG befindet.
Eesti [Estonian]	Käesolevaga kinnitab TRENDnet seadme TEW-735AP vastavust direktiivi 1999/5/ EÜ, 2006/95/ EÜ ja 2009/125/ EÜ põhinõuetele ja nimetatud direktiivist tulenevatele teistele asjakohastele sätetele.
English	Hereby, TRENDnet, declares that this TEW-735AP is in compliance with the essential requirements and other relevant provisions of Directive 1999/5/CE, 2006/95/CE and 2009/125/CE.
Español [Spanish]	Por medio de la presente TRENDnet declara que el TEW-735AP cumple con los requisitos esenciales y cualesquiera otras disposiciones aplicables o exigibles de la Directiva 1999/5/CE, 2006/95/CE y 2009/125/CE.
Ελληνική [Greek]	ΜΕ ΤΗΝ ΠΑΡΟΥΣΑ ΤΡΕΝΔΝΕΤ ΔΗΛΩΝΕΙ ΟΤΙ ΤΕW-735ΑΡ ΣΥΜΜΟΡΦΩΝΕΤΑΙ ΠΡΟΣ ΤΙΣ ΟΥΣΙΩΔΕΙΣ ΑΠΑΙΤΗΣΕΙΣ ΚΑΙ ΤΙΣ ΛΟΙΠΕΣ ΣΧΕΤΙΚΕΣ ΔΙΑΤΑΞΕΙΣ ΤΗΣ ΟΔΗΓΙΑΣ 1999/5/ΕΚ, 2006/95/ΕΚ, 2009/125/ΕΚ κατ.
Français [French]	Par la présente TRENDnet déclare que l'appareil TEW-735AP est conforme aux exigences essentielles et aux autres dispositions pertinentes de la directive 1999/5/CE, 2006/95/CE et 2009/125/CE.
Italiano [Italian]	Con la presente TRENDnet dichiara che questo TEW-735AP è conforme ai requisiti essenziali ed alle altre disposizioni pertinenti stabilite dalla direttiva 1999/5/CE, 2006/95/CE e 2009/125/CE.
Latviski [Latvian]	Ar šo TRENDnet deklarē, ka TEW-735AP atbilst Direktīvas 1999/5/EK, 2006/95/EK un 2009/125/EK būtiskajām prasībām un citiemar to saistītajiem noteikumiem.
Lietuvių [Lithuanian]	Šiuo TRENDnet deklaruoja, kad šis TEW-735AP atitinka esminius reikalavimus ir kitas 1999/5/EB, 2006/95/EB ir 2009/125/EB Direktyvos nuostatas.
Nederlands [Dutch]	Hierbij verklaart TRENDnet dat het toestel TEW-735AP in overeenstemming is met de essentiële eisen en de andere relevante bepalingen van richtlijn 1999/5/EG, 2006/95/EG en 2009/125/EG.

Malti [Maltese]	Hawnhekk, TRENDnet, jiddikjara li dan TEW-735AP jikkonforma mal-htigijiet essenzjali u ma provvedimenti oħrajn relevanti li hemm fid-Dirrettiva 1999/5/KE, 2006/95/KE u 2009/125/KE.
Magyar [Hungarian]	Alulírott, TRENDnet nyilatkozom, hogy a TEW-735AP megfelel a vonatkozó alapvető követelményeknek és az 1999/5/EK, 2006/95/EK és a 2009/125/EK irányelv egyéb előírásainak.
Polski [Polish]	Niniejszym TRENDnet oświadcza, że TEW-735AP jest zgodny z zasadniczymi wymogami oraz pozostałymi stosownymi postanowieniami Dyrektywy 1999/5/WE, 2006/95/WE i 2009/125/WE.
Português [Portuguese]	TRENDnet declara que este TEW-735AP está conforme com os requisitos essenciais e outras disposições da Directiva 1999/5/CE, 2006/95/CE e 2009/125/CE.
Slovensko [Slovenian]	TRENDnet izjavlja, da je ta TEW-735AP v skladu z bistvenimi zahtevami in ostalimi relevantnimi določili direktive 1999/5/ES, 2006/95/ES in 2009/125/ES.
Slovensky [Slovak]	TRENDnettýmto vyhlasuje, že TEW-735AP spĺňa základné požiadavky a všetky príslušné ustanovenia Smernice 1999/5/ES, 2006/95/ES a 2009/125/ES.
Suomi [Finnish]	TRENDnet vakuuttaa täten että TEW-735AP tyyppinen laite on direktiivin 1999/5/EY, 2006/95/EY ja 2009/125/EY oleellisten vaatimusten ja sitä koskevien direktiivin muiden ehtojen mukainen.
Svenska [Swedish]	Härmed intygar TRENDnet att denna TEW-735AP står i överensstämmelse med de väsentliga egenskapskrav och övriga relevanta bestämmelser som framgår av direktiv 1999/5/EG, 2006/95/EG och 2009/125/EG.

RoHS

This product is RoHS compliant.



ErP Statement

Česky [Czech]	Toto síťové zařízení je rok Energy Související produkt (ErP ou dopisem), automaticky přepne do úsporného pohotovostního módu do 10 minut bez datového přenosu síly. Když přístroj nepoužíváte, lze jej ict vypnut pomocí tlačítka napájení, nebo jednoduše odpojte napájecí adaptér pro další úspory energie. Síťové standby: 4, 87 W Off Mode: 0, 21 W
Dansk [Danish]	Denne netværksenhed er år Energy Related Produkt (ErP ou ved brev) skifter automatisk til en strømbesparende standby mode Inden for 10 minutter uden datatransmission. Når apparatet ikke er i brug kan det være ict drevet ned ved hjælp afbryderknappen, eller blot afbryde strømforsyningen til yderligere energibesparelser. Networked standby: 4.87 watt Slukket tilstand: 0.21 watt
Deutsch [German]	Dieses Netzwerkgerät ist ein Energy Related Product (ErP), das innerhalb von 10 Minuten ohne Datenübertragung automatisch in einen Stromsparmodus umschaltet. Wenn das Gerät nicht verwendet wird, kann es über die Ein-/Austaste heruntergefahren werden, oder ziehen Sie für zusätzliche Stromersparnis das Netzgerät aus der Steckdose. Vernetzt und in Bereitschaft: 4.87 Watt Ausgeschaltet: 0.21 Watt
Eesti [Estonian]	See võrguseade on aasta Energy Related Toode (ERP ou kirjas) Automaatselt lülitub energiasäästurežiimi ooterežiimis mood 10 minuti jooksul ei andmeedastust. Kui seade ei ole kasutuses võib see olla IKT väljalülitamisel kasutades toitenuppu või lihtsalt ühendage toiteadapter täiendava energiasäästu. Võrku ooterežiimis: 4.87 W Väljalülitatud olek: 0.21 W
English	This network device is an Energy Related Product (ErP) that automatically switches to a power saving standby mode within 10 minutes of no data transmission. When the device is not in use it can be powered down using its power button, or simply disconnect the power adapter for additional energy savings. Networked standby mode: 4.87 watts Off mode: 0.21 watts
Español [Spanish]	Este dispositivo de red es un producto relacionado con la energía (ErP) que pasa automáticamente a un modo en espera, de ahorro de energía, tras 10 minutos de ausencia de transmisión de datos. Cuando el dispositivo no está en uso, se
	puede apagar utilizando el botón de alimentación, o simplemente desconectar el adaptador de corriente para optimizar el ahorro de energía. Modo de espera en red: 4.87 W Modo apagado: 0.21 W
Ελληνική [Greek]	Αυτή η συσκευή δικτύου είναι η χρονιά Ενέργειας Σχετικά Προϊόν (ERP ou με επιστολή) μεταβαίνει αυτόματα σε κατάσταση εξοικονόμησης μόδας Μέσα σε 10 λεπτά χωρίς μετάδοση δεδομένων εξουσία. Όταν η συσκευή δεν είναι σε χρήση μπορεί να ΤΠΕ κινούνται προς τα κάτω χρησιμοποιώντας το κουμπί τροφοδοσίας, ή απλά αποσυνδέστε το τροφοδοτικό για πρόσθετη εξοικονόμηση ενέργειας. Δικτυωμένη αναμονής: 4.87 watts Κατάσταση εκτός λειτουργίας: 0.21 watts
Français [French]	Ce périphérique réseau est un Energy Related Product (ErP) qui passe automatiquement en mode veille, économisant l'énergie, après 10 minutes sans transfert de données. Lorsque le périphérique n'est pas utilisé, il peut être éteint en utilisant le bouton d'alimentation, ou simplement déconnecté en débranchant l'adaptateur secteur pour obtenir davantage d'économies d'énergie. Mode veille en réseau : 4.87 Watt Mode éteint : 0.87 Watt
Italiano [Italian]	Questo apparato di rete è un Energy Related Product (ErP) il quale commuta automaticamente in una modalità standby entro 10 minuti dall'interruzione della trasmissione di dati. Quando l'apparato non viene utilizzato, può essere spento tramite il tasto di accensione, o si può scollegare l'alimentatore, per ottenere un maggior risparmio di energia. Modalità standby in rete: 4.87 watt Modalità spento: 0.21 watt
Latviski [Latvian]	Šis tīkls ierīce ir gads enerģiju saistītiem ražojumiem (ERP ou ar vēstuli) Automātiski pārslēdzas uz enerģijas taupīšanas gaidstāves modi laikā 10 minūšu laikā bez datu pārraides. Ja ierīce nav izmantota to var IKT powered leju, izmantojot barošanas pogu, vai vienkārši atvienojiet strāvas adapteris papildu enerģijas ietaupījumu. Networked gaidīšanas: 4.87 vati Izslēgts režīms: 0.21 vati
Lietuvių [Lithuanian]	Šis tinklas įrenginys metus Energijos susiję produktai (ERP ou laišku) Automatiškai persijungia į energijos taupymo būdėjimo mados Per 10 minučių be duomenų perdavimo. Kai prietaisas nenaudojamas, jis gali būti ict išjungtas naudojant maitinimo

	mygtuką, arba tiesiog atjunkite maitinimo adapterį sutaupyti dar daugiau energijos. Tinklo budėjimo: 4.87 W Išjungimo būseną: 0.21 W
Nederlands [Dutch]	Dit netwerkapparaat is jaar-energie gerelateerde product (ErP ou per brief) schakelt automatisch naar een energiebesparende stand-by mode Binnen 10 minuten geen gegevensoverdracht. Wanneer het apparaat niet in gebruik kan worden ict uitgeschakeld met behulp van uit-knop, of koppelt gewoon een oplader voor een extra energiebesparing. Networked standby: 4.87 watt Off Mode: 0.21 watt
Malti [Maltese]	Dan il-mezz netwerk huwa sena Energija Prodott Related (ERP ou b'ittra) Awtomatikament swiċċijiet għal iffrankar ta 'energija moda standby Fi żmien 10 minuta ta' l-ebda trażmissjoni tad-data. Meta l-mezz ma jkunx qed jintuża jista 'jiġi ICT powered isfel bl-użu buttuna l-energija, jew sempliċiment skonnattja l-adapter energija għal iffrankar addizzjonali tal-energija. Standby f'network: 4.87 watts Modalità Mitfija: 0.21 watts
Magyar [Hungarian]	Ez a hálózat a készülék éves energiával kapcsolatos termék (ErP ou levélben), automatikusan átvált egy energiatakarékos készenléti mód 10 percen belül nincs adatátvitel. Ha a készülék nincs használatban, akkor lehet, IKT áramtalanítani a bekapcsoló gombot, vagy egyszerűen húzza ki a hálózati adaptert a további energia-megtakarítás. Hálózatba készenlét: 4.87 watt Kikapcsolt üzemmód: 0.21 watt
Polski [Polish]	To urządzenie sieciowe jest rok energetyczna produktu zwanego (ErP ou listownie) automatycznie przełącza się na energooszczędny gotowości modę W ciągu 10 minut bez transmisji danych. Kiedy urządzenie nie jest używane, można go ICT wyłączony za pomocą przycisku zasilania, lub po prostu odłączyć zasilacz na dodatkowe oszczędności energii. Networked standby: 4.87 watów Tryb wyłączenia: 0.21 watów
Português [Portuguese]	Este dispositivo de rede é um Produto de Consumo de Energia (ErP) que alterna automaticamente para modo de espera com economia de energia após 10 minutos sem transmissão de dados. Quando o dispositivo não está sendo usado pode ser desligado no botão de energia, ou simplesmente desligando o adaptador de corrente para economia de energia adicional. Modo de espera em rede: 4.87 watts

	Modo off: 0.21 watts
Slovensko [Slovenian]	Ta mreža naprava je leto Energy Podobni izdelek (ErP ou z dopisom), samodejno preklopi na varčevanje z energijo v stanju pripravljenosti moda roku 10 minut brez prenosa podatkov. Ko je naprava ni v uporabi, je lahko ict napaja navzdol z gumbom za vklop, ali pa preprosto odklopite napajalnik za dodatne prihranke energije. Networked pripravljenosti: 4.87 W Način izklopa: 0.21 W
Slovensky [Slovak]	Toto sieťové zariadenie je rok Energy Súvisiaci produkt (ErP ou listom), automaticky prepne do úsporného pohotovostného módu do 10 minút bez dátového prenosu sily. Keď prístroj nepoužívate, možno ho ict vypnúť pomocou tlačidla napájania, alebo jednoducho odpojte napájací adaptér pre ďalšie úspory energie. Sieťové standby: 4,87 W Off Mode: 0,21 W
Suomi [Finnish]	Tämä verkkolaite on vuosi Energy Related Product (ErP ou kirjeitse) Automaattinen vaihto virransäästö valmiustilassa muoti 10 minuutin kuluessa tiedon siirto. Kun laite ei ole käytössä se voidaan ICT sammutettu käyttämällä virtakytkintä, tai yksinkertaisesti irrota virtalähde ylimääräisiä energiasäästöjä. Verkottunut valmiustilassa: 4.87 wattia Pois päältä -tila: X.XX wattia
Svenska [Swedish]	Denna nätverksenhet är år Energy relaterad produkt (ErP ou per brev) Växlar automatiskt till ett energisparande vänteläge mode Inom 10 minuter utan dataöverföring. När enheten inte används kan det vara ict avstängd med hjälp av strömbrytaren, eller helt enkelt koppla loss nätadaptern för ytterligare energibesparingar. Networked standby: 4.87 watt Avstängd: 0.21 watt

Limited Warranty

TRENDnet warrants its products against defects in material and workmanship, under normal use and service, for the following lengths of time from the date of purchase.

- TEW-735AP – 3 Years Warranty
- AC/DC Power Adapter, Cooling Fan, and Power Supply carry 1 year warranty.

If a product does not operate as warranted during the applicable warranty period, TRENDnet shall reserve the right, at its expense, to repair or replace the defective product or part and deliver an equivalent product or part to the customer. The repair/replacement unit's warranty continues from the original date of purchase. All products that are replaced become the property of TRENDnet. Replacement products may be new or reconditioned. TRENDnet does not issue refunds or credit. Please contact the point-of purchase for their return policies.

TRENDnet shall not be responsible for any software, firmware, information, or memory data of customer contained in, stored on, or integrated with any products returned to TRENDnet pursuant to any warranty.

There are no user serviceable parts inside the product. Do not remove or attempt to service the product by any unauthorized service center. This warranty is voided if (i) the product has been modified or repaired by any unauthorized service center, (ii) the product was subject to accident, abuse, or improper use (iii) the product was subject to conditions more severe than those specified in the manual.

Warranty service may be obtained by contacting TRENDnet within the applicable warranty period and providing a copy of the dated proof of the purchase. Upon proper submission of required documentation a Return Material Authorization (RMA) number will be issued. An RMA number is required in order to initiate warranty service support for all TRENDnet products. Products that are sent to TRENDnet for RMA service must have the RMA number marked on the outside of return packages and sent to TRENDnet prepaid, insured and packaged appropriately for safe shipment. Customers shipping from outside of the USA and Canada are responsible for return shipping fees. Customers shipping from outside of the USA are responsible for custom charges, including but not limited to, duty, tax, and other fees.

WARRANTIES EXCLUSIVE: IF THE TRENDNET PRODUCT DOES NOT OPERATE AS WARRANTED ABOVE, THE CUSTOMER'S SOLE REMEDY SHALL BE, AT TRENDNET'S OPTION, REPAIR OR REPLACE. THE FOREGOING WARRANTIES

AND REMEDIES ARE EXCLUSIVE AND ARE IN LIEU OF ALL OTHER WARRANTIES, EXPRESSED OR IMPLIED, EITHER IN FACT OR BY OPERATION OF LAW, STATUTORY OR OTHERWISE, INCLUDING WARRANTIES OF MERCHANTABILITY AND FITNESS FOR A PARTICULAR PURPOSE.

TRENDNET NEITHER ASSUMES NOR AUTHORIZES ANY OTHER PERSON TO ASSUME FOR IT ANY OTHER LIABILITY IN CONNECTION WITH THE SALE, INSTALLATION MAINTENANCE OR USE OF TRENDNET'S PRODUCTS.

TRENDNET SHALL NOT BE LIABLE UNDER THIS WARRANTY IF ITS TESTING AND EXAMINATION DISCLOSE THAT THE ALLEGED DEFECT IN THE PRODUCT DOES NOT EXIST OR WAS CAUSED BY CUSTOMER'S OR ANY THIRD PERSON'S MISUSE, NEGLIGENCE, IMPROPER INSTALLATION OR TESTING, UNAUTHORIZED ATTEMPTS TO REPAIR OR MODIFY, OR ANY OTHER CAUSE BEYOND THE RANGE OF THE INTENDED USE, OR BY ACCIDENT, FIRE, LIGHTNING, OR OTHER HAZARD.

LIMITATION OF LIABILITY: TO THE FULL EXTENT ALLOWED BY LAW TRENDNET ALSO EXCLUDES FOR ITSELF AND ITS SUPPLIERS ANY LIABILITY, WHETHER BASED IN CONTRACT OR TORT (INCLUDING NEGLIGENCE), FOR INCIDENTAL, CONSEQUENTIAL, INDIRECT, SPECIAL, OR PUNITIVE DAMAGES OF ANY KIND, OR FOR LOSS OF REVENUE OR PROFITS, LOSS OF BUSINESS, LOSS OF INFORMATION OR DATA, OR OTHER FINANCIAL LOSS ARISING OUT OF OR IN CONNECTION WITH THE SALE, INSTALLATION, MAINTENANCE, USE, PERFORMANCE, FAILURE, OR INTERRUPTION OF THE POSSIBILITY OF SUCH DAMAGES, AND LIMITS ITS LIABILITY TO REPAIR, REPLACEMENT, OR REFUND OF THE PURCHASE PRICE PAID, AT TRENDNET'S OPTION. THIS DISCLAIMER OF LIABILITY FOR DAMAGES WILL NOT BE AFFECTED IF ANY REMEDY PROVIDED HEREIN SHALL FAIL OF ITS ESSENTIAL PURPOSE.

Governing Law: This Limited Warranty shall be governed by the laws of the state of California.

Some TRENDnet products include software code written by third party developers. These codes are subject to the GNU General Public License ("GPL") or GNU Lesser General Public License ("LGPL").

Go to <http://www.trendnet.com/gpl> or <http://www.trendnet.com> Download section and look for the desired TRENDnet product to access to the GPL Code or LGPL Code. These codes are distributed WITHOUT WARRANTY and are subject to the copyrights of the developers. TRENDnet does not provide technical support for these codes. Please go to <http://www.gnu.org/licenses/gpl.txt> or <http://www.gnu.org/licenses/lgpl.txt> for specific terms of each license.

11/21/2014

TEW-735AP v1.1R User's Guide V1.3



Product Warranty Registration

Please take a moment to register your product online.
Go to TRENDnet's website at <http://www.trendnet.com/register>

TRENDnet
20675 Manhattan Place
Torrance, CA 90501. USA