

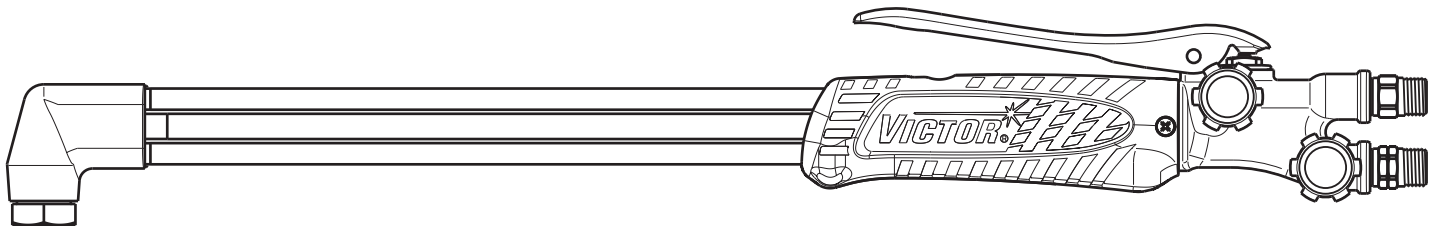

ST411C-1A

PARTS, SERVICE & REPAIR BULLETIN

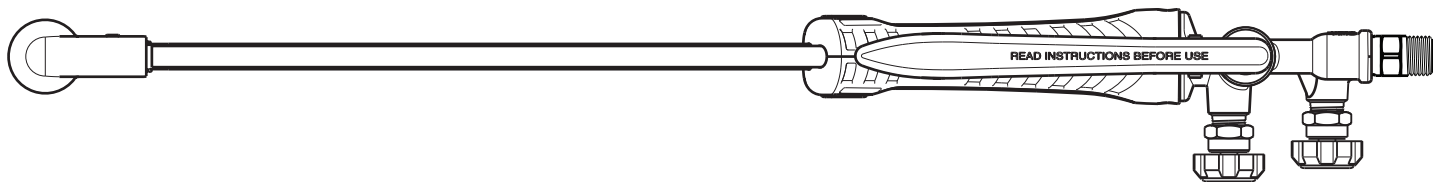

400 SERIES HEAVY DUTY STRAIGHT TORCH, TIP SERIES 1

Manual No: 0056-3761

Revision: AA

Issue Date: September 27, 2013

VictorTechnologies.com

Table of Contents

SECTION 1: GENERAL SAFETY INFORMATION.....	2
1.01 Commonly Used Terms	2
SECTION 2: SPECIFICATIONS.....	3
2.01 ST411C-1A Victor Straight Torch	3
2.02 Repair Parts List.....	3
SECTION 3: SERVICE & REPAIR INSTRUCTIONS.....	4
3.01 Recommended Tools & Supplies for Repair Procedures .	4
3.02 Cleaning Procedures	4
3.03 Handle for 400 Series Straight Torch.....	4
3.04 Control Valve Repair Kit.....	5
3.05 Cutting Lever	5
3.06 High Pressure (H.P.) Oxy Valve Repair Kit	6
3.07 Check Valve Repair Kit.....	6
3.08 Fuel and Oxygen Inlet Connections.....	7
3.09 400 Series Head Repair Kit.....	7
3.10 Gas Feed Tubes	8
SECTION 4: TEST PROCEDURES	9
4.01 Recommended Tools & Supplies for Test Procedures.....	9
4.02 Leak Testing the Torch.....	9
4.03 Flame Testing the Torch.....	9

SECTION 1: GENERAL SAFETY INFORMATION

Read and understand all safety and operating instructions provided before using this apparatus. RETAIN THESE INSTRUCTIONS IN A READILY AVAILABLE LOCATION FOR FUTURE REFERENCE.

WARNING

DO NOT attempt to use this apparatus unless you are trained in its proper use or are under competent supervision. For your safety, practice the safety and operating procedures described in this booklet every time you use the apparatus. Deviating from these procedures may result in fire, explosion, property damage, and/or operator injury. If at any time the apparatus you are using does not perform in its usual manner, or you have any difficulty in the use of the apparatus, STOP using it immediately. DO NOT use the apparatus until the problem has been corrected!

WARNING

Apparatus improperly operated, maintained or repaired can be dangerous. Some parts and accessories manufactured by others may fit VICTOR apparatus but not conform to VICTOR's exacting standards. For your own protection, specify and use ONLY VICTOR-made parts and accessories with your VICTOR apparatus.

WARNING

Service or repair of apparatus should be performed only by a qualified repair technician capable of servicing gas apparatus in strict accordance to applicable Part and Service bulletins for VICTOR manufactured products. Improper service repair, or modification of the product could result in damage to the product or injury to the operator.

WARNING

WARNING: This product contains chemicals, including lead, known to the State of California to cause birth defects and other reproductive harm. **Wash hands after handling.**

1.01 COMMONLY USED TERMS

BACKFIRE - The return of the flame into the torch, producing a popping sound. The flame will either extinguish or reignite at the tip.

SUSTAINED BACKFIRE - The return of the flame into the torch with continued burning within the torch. This condition may be accompanied by a popping sound followed by a continuous hissing or whistling sound.

FLASHBACK - The return of the flame through the torch into the hose and even into the regulator. It may also reach the cylinder. This condition could possibly cause an explosion in the system.

SECTION 2: SPECIFICATIONS

2.01 ST411C-1A VICTOR STRAIGHT TORCH

Cutting Tip Series 1

- Intuitive knobs: color coded, clearly marked lettering with increase/decrease label. Understandable in any language.
- Improved stainless lever provides increased comfort and reduced operator hand fatigue.
- Uses #000 - #8 cutting tips. One torch for all fuel gases (with proper tip).
- Inline stainless tubes for better visibility and reduced profile vs triangular design.
- Efficient universal head mixer reduces torch profile for better visibility. Optimized to use one cutting torch for all fuel gases.

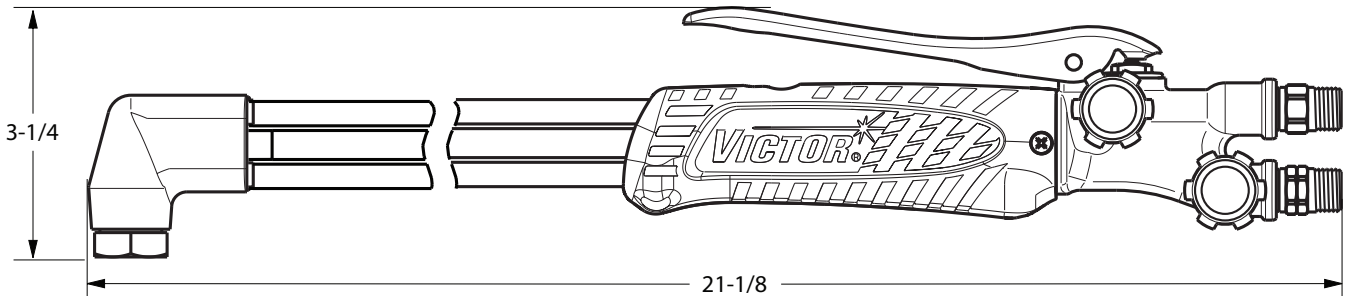
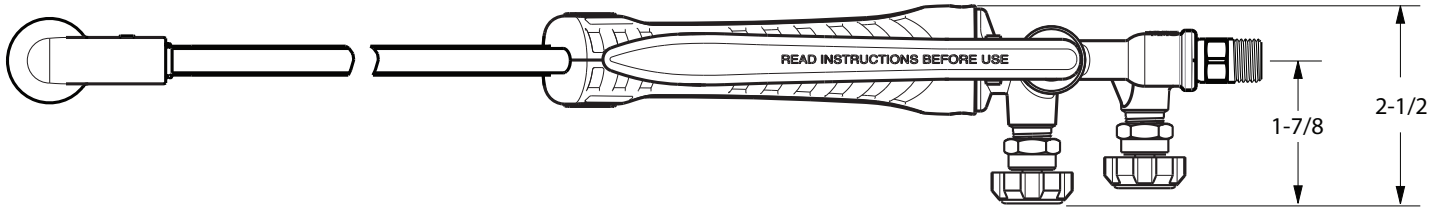

All dimensions are approximate.

2.02 REPAIR PARTS LIST

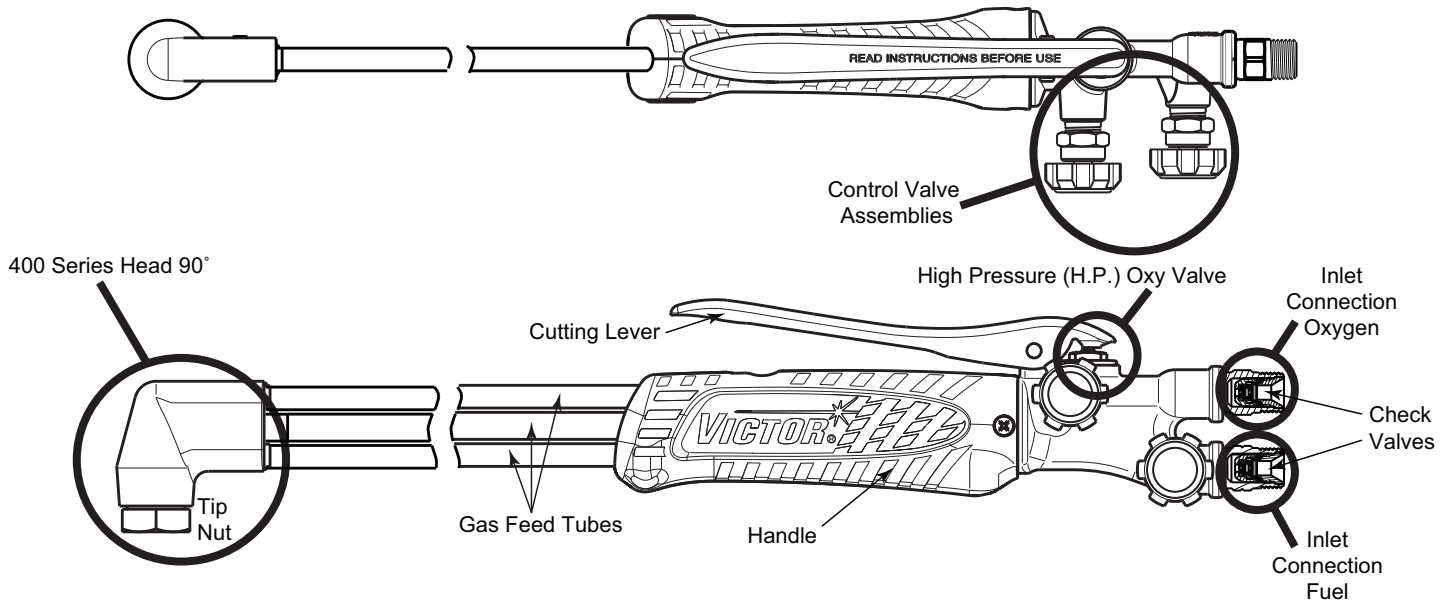

ST411C-1A

SECTION 3: SERVICE & REPAIR INSTRUCTIONS

3.01 RECOMMENDED TOOLS & SUPPLIES FOR REPAIR PROCEDURES

3/8", 5/8", 9/16", and 11/16" Open-End Wrenches	Vise
15/16" Box-End Wrench	45% Silver Solder
3/16" Drift Punch	Silver Solder Flux
Small Hammer	Loctite® #222 (Part Number 0028-0081)
1/4-20 Bolt	Christo-Lube® 129 (Part Number 0034-0021)
Brazing Torch	Hand Reamer RT-181
Pliers	Fixture RT-148
Phillips Head Screwdriver	Air Hose

NOTE

Disconnect the torch from any gas lines or other hardware before beginning any service or repair.

3.02 CLEANING PROCEDURES

Contact your local chemical supplier for recommended cleaning solvents applicable to the metals used in this product. Always use cleaning solvents in accordance with the manufacturer's instructions.

WARNING

DO NOT allow nonmetal components (seat, O-rings, dust seal, gaskets) to contact cleaning solvents! Cleaning solvents cause elastomeric and plastic parts to swell and stress crack. If these parts require cleaning, use a mild soap solution, followed by a thorough rinsing in water. Dry these parts completely before installing. REPLACE NONMETAL PARTS THAT HAVE COME IN CONTACT WITH OIL, GREASE OR ANY OTHER PETROLEUM-BASED SUBSTANCE! Petroleum-based substances become dangerously flammable in the presence of oxygen.

3.03 HANDLE FOR 400 SERIES STRAIGHT TORCH

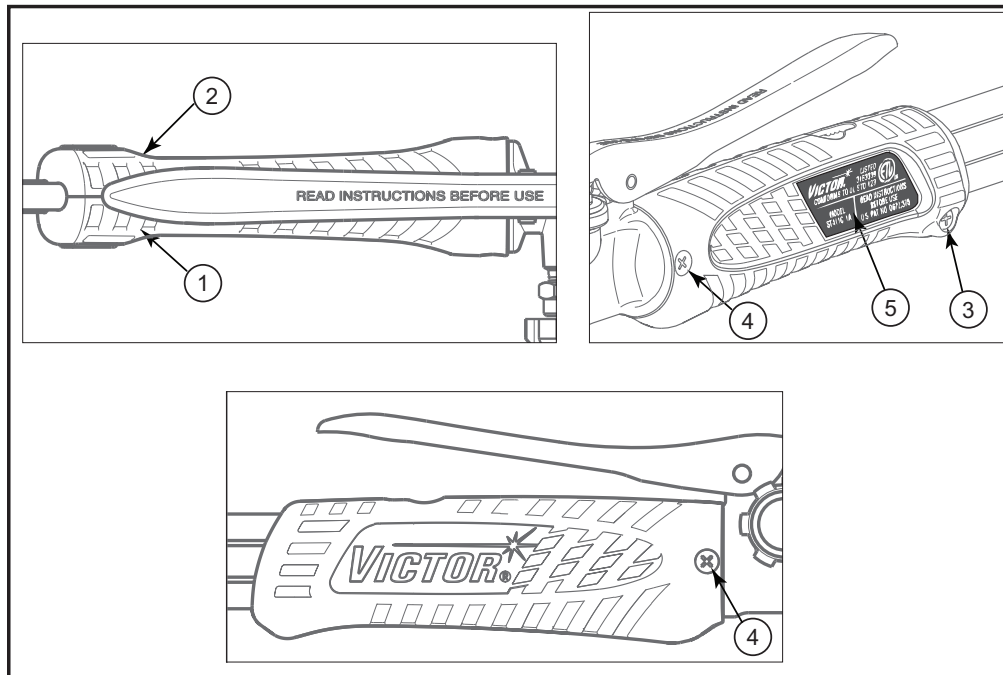

Figure 3-1

Item No.	Description	Part number	Qty
	Handle for 400 Series Straight Torch	0390-0096	1
1	Left Handle	0306-0296*	1
2	Right Handle	0306-0297*	1
3	Long screw (self-threading)	1400-0250*	1
4	Short screw (self-threading)	1400-0251*	2
5	Decal for ST411C-1A	1415-0847*	1

*Sold as part of kit only.

Disassembly

1. Use a phillips head screwdriver to remove the three screws from the handle.
2. Separate the left handle from the right handle and remove them from the torch.

Assembly

1. Position the right and left handles in place over the gas feed tubes. Ensure that the handles fit over the tubes correctly.
2. Align the screw hole in each handle with the holes in the torch and install both short, self-threading screws (see Figure 3-1).
3. Fasten the long, self-threading screw through the right handle into the left handle.
4. Place the decal on the right handle as shown in Figure 3-1.

3.04 CONTROL VALVE REPAIR KIT

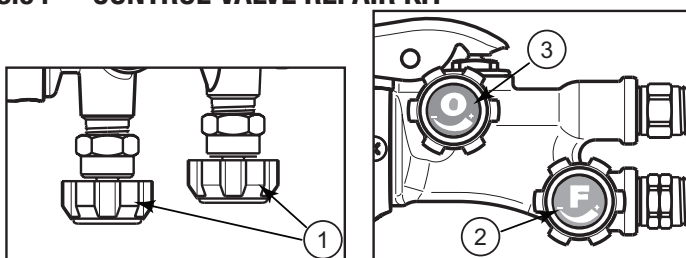

Figure 3-2

Item No.	Description	Part number	Qty
	Control Valve Repair Kit	0390-0086	2
1	Valve Stem Assembly	0662-0102*	1
2	Knob Decal (Red "F")	1415-0864*	1
3	Knob Decal (Green "O")	1415-0863*	1

*Sold as part of kit only.

NOTE

This torch uses two control valves. Follow these steps to service, disassemble, and assemble either control valve. The control valve repair kit includes only one valve stem assembly.

Service

- Wipe with a dry cloth. **Do not use any cleaning solvents.**
- Check for leaks.

Disassembly

Remove the handle before beginning this task (see Section 3.03).

1. Place fixture RT-148 in a vise and place the torch in the fixture.
2. Use a wrench to unscrew the control valve nut.

Assembly

1. Apply Christo-Lube® to the assembly threads.
2. Screw the control valve assembly into the torch body.
3. Use a wrench to tighten the control valve nut.
4. Place the correct decal on the knob (see Figure 3-2).
5. Remove the torch from RT-148 and reattach the handle.

3.05 CUTTING LEVER

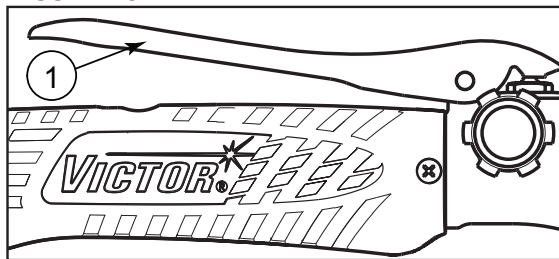

Figure 3-3

Item No.	Description	Part number	Qty
1	Cutting Lever	0307-0004	1

Service

- Check the roll pin for wear.
- Make sure the cutting lever tabs are aligned with the groove in the high pressure (H.P.) oxy valve stem.

Disassembly

Remove the handle before beginning this task (see Section 3.03).

1. Place fixture RT-148 in a vise and place the torch in the fixture.
2. Use a drift punch to tap the roll pin out of the cutting lever and the torch body. Inspect the roll pin and discard it if it is deformed.

NOTE

The replacement roll pin part number is 1404-0002.

3. Slide the cutting lever forward.

Assembly

If the roll pin was discarded, acquire a replacement roll pin before beginning this step.

1. Align the cutting lever tabs with the groove in the H.P. oxy valve stem.
2. Insert the roll pin into the cutting lever and torch body. Gently tap in the roll pin.
3. Make sure the cutting lever tabs are still properly aligned with the groove in the H.P. oxy valve stem.
4. Remove the torch from RT-148 and reattach the handle.

3.06 HIGH PRESSURE (H.P.) OXY VALVE REPAIR KIT

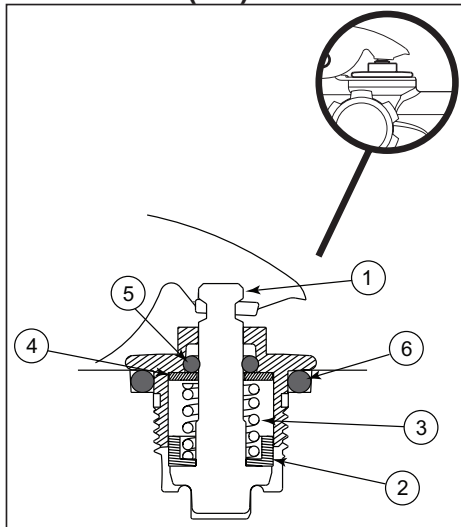

Figure 3-4

Item No.	Description	Part number	Qty
	H.P. Oxy Valve Repair Kit	0390-0043	1
1	Seat Assembly	0320-0079	1
2	Seat Assembly Bushing	0320-0108	1
3	Valve Spring	0320-0024	1
4	Washer	1406-0006	1
5	O-Ring (Small)	1407-0005	1
6	O-Ring (Large)	1407-0016	1



CAUTION

Discard the used O-rings, seat assembly, seat assembly bushing and washer. Replace them each time you reassemble the torch.

Service

- Wipe with a dry cloth. **Do not use any cleaning solvents.**
- Check for leaks. Replacing O-rings requires disassembly.

Disassembly

Remove the handle and cutting lever before beginning this task (see Sections 3.03 and 3.05).

1. Place fixture RT-148 in a vise and place the torch in the fixture.
2. Use a wrench to loosen and unscrew the H.P. oxy valve assembly from the torch body.
3. Remove the H.P. oxy valve assembly from the torch body. Make sure the large O-ring is also removed.

Assembly

NOTE

Check the valve cap for wear. If the valve cap was discarded, acquire a replacement valve cap before beginning these steps. The replacement valve cap part number is 0320-0017.

1. Install the seat assembly bushing on the valve stem with the open end facing up.
2. Install the spring on the valve stem until it is against the bushing.
3. Install the washer followed by the small O-ring on the valve stem.
4. Apply Christo-Lube® to the outside of the small O-ring and along the valve stem.
5. Insert the seat assembly with the bushing, spring, washer, and O-ring in through the valve cap.
6. Place the large O-ring around the outside of the valve cap and apply Christo-Lube® to the large O-ring.
7. Screw the oxy valve assembly into the torch body and wrench tighten. Confirm that the O-rings are seated properly.
8. Reattach the cutting lever.
9. Remove the torch from RT-148 and reattach the handle.
10. Check for leaks.

3.07 CHECK VALVE REPAIR KIT

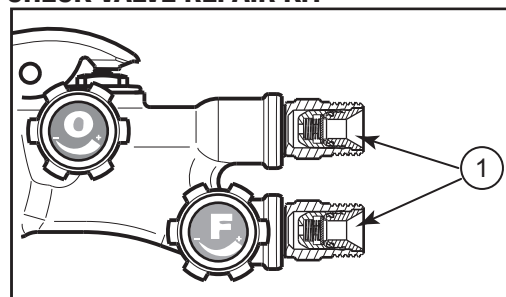

Figure 3-5

Item No.	Description	Part number	Qty
	Check Valve Repair Kit	0690-0027	1
1	Check Valve	0652-0029	2

NOTE

Follow these steps to disassemble and assemble either check valve.

Disassembly

1. Screw the 1/4-20 bolt into either check valve until it is finger tight.
2. Place the shank of the bolt in the vise. The head of the bolt must catch on the vise jaws, and the bolt must be able to move freely.
3. Grab the torch firmly and pull the torch up. The head of the bolt will catch on the vise jaws, and the check valve will pull out of the torch.
4. Repeat steps 1 through 3 for the other check valve.

Assembly

NOTE

This assembly requires a class "B" dual hose for oxygen and fuel. The red hose connects to the fuel inlet connection. The green hose connects to the oxygen inlet connection.

1. Press the check valve into the inlet connection.
2. Place the hose connection over the check valve and thread it onto the inlet connection. Use a wrench to tighten the hose connection onto the inlet connection until the check valve is properly seated.
3. Remove the hose.
4. Repeat steps 1 through 3 for the other check valve.

3.08 FUEL AND OXYGEN INLET CONNECTIONS

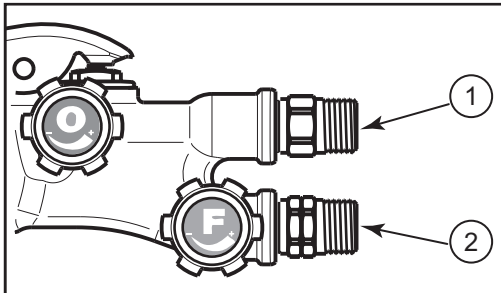

Figure 3-6

Item No.	Description	Part number	Qty
1	Inlet Connection Oxygen	0950-0099	1
2	Inlet Connection Fuel	0960-0073	1

NOTE

Follow these steps to disassemble and assemble either inlet connection.

Disassembly

Remove the handle before beginning this task (see Section 3.03).

1. Place fixture RT-148 in a vise and place the torch in the fixture.
2. Use a wrench to loosen and unscrew either inlet connection from the torch.
3. Clean all debris from the inlet connection threads.
4. Repeat steps 2 and 3 for the other inlet connection.

Assembly

1. Apply a small amount of Loctite® to the beginning of the inlet connection threads. Loctite® must *completely cover* the beginning two threads of the inlet connection.
2. Screw the inlet connection onto the torch and wrench tighten.
3. Repeat steps 1 and 2 for the other inlet connection.
4. Remove the torch from RT-148 and reattach the handle.
5. Install the check valves (see Section 3.07, Assembly).

3.09 400 SERIES HEAD REPAIR KIT

CAUTION

Always wear gloves when handling heated parts.

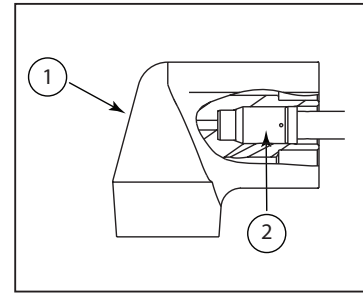

Figure 3-7

Item No.	Description	Part number	Qty
	90° Victor Series 1 Head Repair Kit	0390-0085	1
1	400 Series Head-90° Victor	0302-0247*	1
2	Mixer	0305-0519*	1

*Sold as part of kit only.

Service

- Remove the tip nut and tip and use an air hose to clear any debris from the opening. Reattach the tip nut and tip.

NOTE

The 400 Series Head Repair Kit does not include the tip nut. The tip nut part number is 0390-0088.

Disassembly

Remove the handle, control valves, cutting lever, H.P. oxy valve, inlet connections, tip, and tip nut before beginning this task (see Sections 3.03-3.06 and 3.08).

1. Place the torch body in a vise, positioned so that you have full access to the 400 Series head.
2. Heat the gas feed tubes until the solder liquefies. Use pliers to remove the 400 Series head.

Assembly

1. Clean all solder and debris from the gas feed tubes.
2. Place the new 400 Series head on the gas feed tubes. Confirm correct orientation to the 400 Series body.
3. Ensure that the center tube is pressed firmly against the mixer of the head.
4. Solder the fittings and allow them to cool before beginning the next step.
5. Use RT-181 to finish hand reaming the torch seat.
6. Remove all chips and debris from around the torch seat area.
7. Reattach the tip nut, tip, inlet connections, H.P. oxy valve, cutting lever, control valves, and handle.
8. Check for leaks and remove the torch from the vise.

3.10 GAS FEED TUBES



CAUTION

Always wear gloves when handling heated parts.

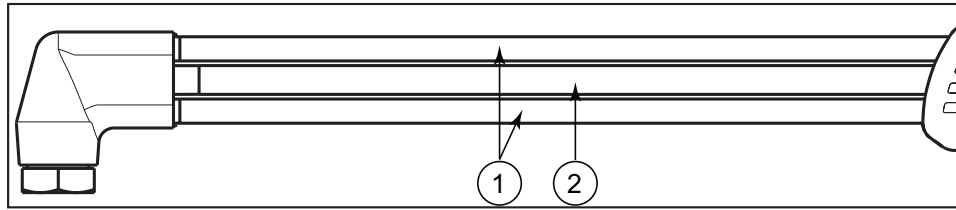

Figure 3-8

Item No.	Description	Part number	Qty
	Gas Feed Tubes	0390-0095	1
1	5/16" Tube	0303-0562*	2
2	3/8" Tube	0303-0564*	1

**Sold as part of kit only.*

Service

- Check the tubes for leaks and wear.

Disassembly

Remove the handle, control valves, cutting lever, H.P. oxy valve, inlet connections, tip, tip nut, and 400 Series head before beginning this task (see Sections 3.03-3.06 and 3.08-3.09).

1. Place the torch body in a vise, positioned so that you have full access to the gas feed tubes.
2. Heat the gas feed tubes until the solder liquefies. Use pliers to remove all tubes.
3. Allow the torch body to cool before beginning assembly.

Assembly

1. Clean all solder and debris from the torch body.
2. Place a new 400 Series head in a vise, positioned so that the tube bores face up.
3. Insert the gas feed tubes into the 400 Series head, followed by the torch body. Confirm correct orientation to the 400 Series head.
4. Ensure that the center tube is pressed firmly against the mixer of the head.
5. Solder the fitting around the 400 Series head and repeat for the torch body side. Allow all parts to cool before beginning the next step.
6. Complete steps 5 - 8 in Section 3.09, 400 Series Head Repair Kit, Assembly.

SECTION 4: TEST PROCEDURES

4.01 RECOMMENDED TOOLS & SUPPLIES FOR TEST PROCEDURES

Oil-free air or dry nitrogen supplies	2-1-101 Cutting tip
Oxygen and acetylene gas supplies	3/8", 5/8", 9/16", and 11/16" Open-end wrenches
Small water tank	15/16" Box-end wrench

4.02 LEAK TESTING THE TORCH

1. Connect the torch to oil-free air or dry nitrogen supply lines with a matching type regulator.
2. Insert a plugged cutting tip into the torch.
3. Pressurize the hoses to 50+/-5 PSIG.
4. Completely submerge the torch in water.
5. Open the valve stem assemblies. Check for leaks around all external connections. Observe the valve stem assemblies. If bubbles are escaping from around the valve stem assembly packing, tighten the packing nut until it takes 1-1/4 to 2 in-lbs of torque to adjust the valve stem assembly knobs.
6. Close the valve stem assembly knobs to a torque of 7-8 in-lbs.
7. Remove the plugged cutting tip from the torch. Observe the torch head. If bubbles appear at the torch head, one or both of the valve stem assemblies is leaking. Ream the valve seating surface using the RT-33 reseating tool. Repeat steps 2 through 7.

4.03 FLAME TESTING THE TORCH

1. Remove the torch from the water. Open the valve stem assemblies for 10 seconds. Once all the water has been removed from the torch, disconnect the hoses from the oil-free air or dry nitrogen supply. Attach them to oxygen and acetylene gas supplies.
2. Install a 2-1-101 cutting tip in the head. Tighten the tip nut to 15-20 ft-lbs of torque.
3. Adjust the oxygen to deliver 50+/-5 PSIG. Adjust the acetylene to deliver 7+/-2 PSIG.
4. Open the oxygen valve and purge the oxygen line for five seconds. Then, close the oxygen valve. Open the fuel valve and purge the fuel line for five seconds.
5. Open the fuel valve stem assembly about 1/8 of a turn. Ignite the gas with a spark lighter. Continue opening the fuel valve until the flame stops smoking.
6. Open the oxygen valve until a bright neutral flame appears.
7. Place the tip on a fire brick at approximately 10° from the vertical (See Figure 4-1). Depress the cutting oxygen lever. Rock the torch from side to side for 5-8 seconds. The torch will "pop" during this operation.

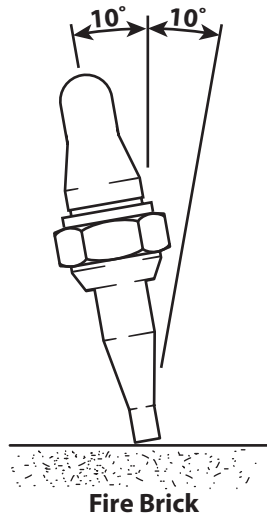

Figure 4-1

 **WARNING**

*If you experience a backfire or backflash (flame disappears suddenly and/or a hissing sound IS heard when the flame is burning inside the torch), IMMEDIATELY turn OFF **first** the oxygen valve and **then** the fuel valve. Allow the torch to cool before reusing it. If the trouble reoccurs, disassemble the torch. Replace any damaged parts.*

8. After testing is completed, release the cutting oxygen lever. Close the oxygen valve and the fuel valve.
9. Close the cylinder valve or gas supply.
10. Open the oxygen valve. Release the oxygen from the system. Once all the oxygen is released from the system, close the oxygen valve.
11. Open the fuel valve. Release the fuel gas from the system. Once all the fuel gas is released from the system, close the fuel valve.
12. Remove the hoses from the torch.

This page intentionally blank

THE AMERICAS

Denton, TX USA

U.S. Customer Care

Ph 1-800-426-1888 (tollfree)
Fax: 1-800-535-0557 (tollfree)

International Customer Care

Ph 1-940-381-1212
Fax: 1-940-483-8178

Miami, FL USA

Sales Office, Latin America

Ph 1-954-727-8371
Fax: 1-954-727-8376

Oakville, Ontario, Canada

Canada Customer Care

Ph 1-905-827-4515
Fax: 1-800-588-1714 (tollfree)

EUROPE

Chorley, United Kingdom

Customer Care

Ph +44 1257-261755
Fax: +44 1257-224800

Milan, Italy

Customer Care

Ph +39 0236546801
Fax: +39 0236546840

ASIA/PACIFIC

Cikarang, Indonesia

Customer Care

Ph 6221-8990-6095
Fax: 6221-8990-6096

Rawang, Malaysia

Customer Care

Ph +603 6092-2988
Fax: +603 6092-1085

Melbourne, Australia

Australia Customer Care

Ph 1300-654-674 (tollfree)
Ph 61-3-9474-7400

Fax: 61-3-9474-7391

International

Ph 61-3-9474-7508
Fax: 61-3-9474-7488

Shanghai, China

Sales Office

Ph +86 21-64072626
Fax: +86 21-64483032

Singapore

Sales Office

Ph +65 6832-8066
Fax: +65 6763-5812



INNOVATION TO SHAPE THE WORLD™

U.S. Customer Care: 800-426-1888 / FAX 800-535-0557
Canada Customer Care: 905-827-4515 / FAX 800-588-1714
International Customer Care: 940-381-1212 / FAX 940-483-8178
