

# Whirlpool®

## Model WHES60

How to install, operate  
and maintain your Demand  
Controlled Water Softener

### PRODUCT AND WARRANTY REGISTRATION

Register your product  
online to validate and  
extend your warranty.  
See warranty page for  
details.



[www.whirlpoolwatersolutions.com](http://www.whirlpoolwatersolutions.com)

If you have any questions or concerns when  
installing, operating or maintaining your water  
softener, call our toll free number:

**1-866-986-3223**

or visit **[whirlpoolwatersolutions.com](http://whirlpoolwatersolutions.com)**

When you call, please be prepared to provide  
the model and serial number of your product,  
found on the rating decal, located on  
the back of the controller's top cover.

System tested and certified by NSF International  
against NSF/ANSI Standard 44  
for hardness reduction and efficiency,  
and certified to NSF/ANSI Standard 372.



Manufactured and warranted by  
Ecodyne Water Systems  
1890 Woodlane Drive  
Woodbury, MN 55125

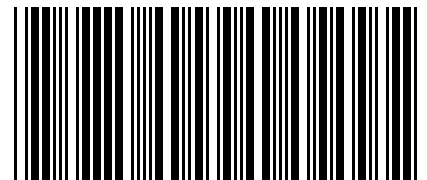

7368629 (Rev. A 9/25/17)

**Installation and Operation Manual**



# TABLE OF CONTENTS

	Page
Specifications & Performance Claims .....	3
Water Softener Safety .....	4
Before You Start .....	4
Inspect Shipment .....	5
Water Conditioning Information .....	5
Installation Requirements .....	6-7
Installation Instructions .....	8-11
Programming the Water Softener .....	12-13
Customizing Features / Options .....	13-16
Routine Maintenance .....	16-17
Troubleshooting .....	18-19
Exploded View & Parts List .....	20-23
Warranty .....	24

## Dimensions

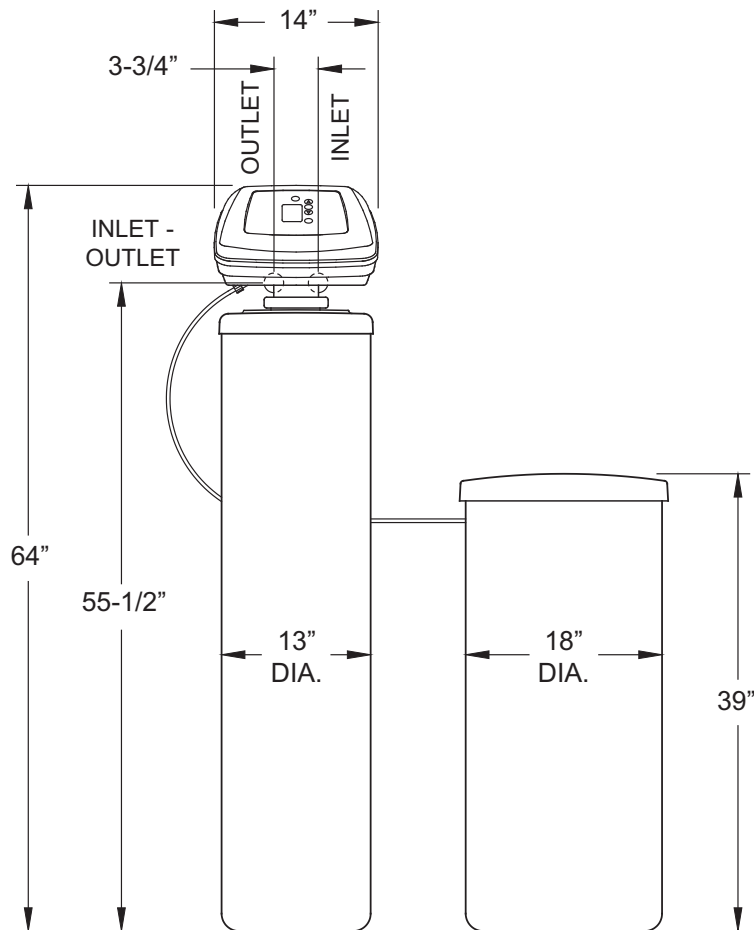

FIG. 1

# Specifications & Performance Claims

This model is efficiency rated. The efficiency rating is valid only at the minimum salt dose and rated service flow. The softener has a demand initiated regeneration (D.I.R.) feature that complies with specific performance specifications intended to minimize the amount of regenerant brine and water used in its operation.

This softener has a rated softener efficiency of not less than 3,350 grains of total hardness exchange per pound of salt (based on sodium chloride) and shall not deliver more salt than its listed rating or be operated at a sustained maximum service flow rate greater than its listed rating. This softener has been proven to deliver soft water for at least ten continuous minutes at the rated service flow rate. The rated salt efficiency is measured by laboratory tests described in NSF/ANSI Standard 44. These tests represent the maximum possible efficiency that the system can achieve. Operational efficiency is the actual efficiency after the system has been installed. It is typically less than the rated efficiency, due to individual application factors including water hardness, water usage, and other contaminants that reduce a softener's capacity.

	<b>Model WHES60</b>
Model Code	LL60
Rated Softening Capacity (Grains @ Salt Dose)	17,800 @ 3.5 lbs. 47,600 @ 13.2 lbs. 60,200 @ 22.7 lbs.
Rated Efficiency (Grains/Pound of Salt @ Minimum Salt Dose)	5,080 @ 3.5 lbs.
Water Used During Regeneration @ Minimum Salt Dose	5.0 gal. / 1,000 grains
Total Water Used Per Regeneration @ Maximum Salt Dose	87.4 gallons
Rated Service Flow Rate	10 gpm
Amount of High Capacity Ion Exchange Resin	1.67 cu. ft.
Pressure Drop at Rated Service Flow	8.7 psig
Water Supply Max. Hardness	120 gpg
Water Supply Max. Clear Water Iron	16 ppm*
Water Pressure Limits (minimum / maximum)	20 - 125 psi
Water Temperature Limits (minimum / maximum)	40 - 120 °F
Minimum Water Supply Flow Rate	3 gpm
Intermittent Flow @ 30 PSI	21 gpm**
Maximum Drain Flow Rate	2.0 gpm
Salt Storage Capacity	200 lbs.

\*Capacity to reduce clear water iron is substantiated by laboratory test data. State of Wisconsin requires additional treatment if water supply contains clear water iron exceeding 5 ppm.

\*\*Intermittent flow rate does not represent the maximum service flow rate used for determining the softener's rated capacity and efficiency. Continuous operation at flow rates greater than the service flow rate may affect capacity and efficiency performance.

This system conforms to NSF/ANSI 44 for the specific performance claims as verified and substantiated by test data.

**Variable Salt Dose:** The salt dose is selected by the electronic controls at regeneration time based on the amount needed.

**Questions? Call Toll Free 1-866-986-3223** or visit [whirlpoolwatersolutions.com](http://whirlpoolwatersolutions.com)

When you call, please be prepared to provide the model and serial number, found on the rating decal, located on the back of the controller's top cover.

# Water Softener Safety

## Your safety and the safety of others are very important.

We have provided many safety messages in this manual and on your appliance. Always read and obey all safety messages.



This is the safety alert symbol.

This symbol alerts you to potential hazards that can kill or hurt you and others.

All safety messages will follow the safety alert symbol and either the word "DANGER" or "WARNING". These words mean:

**⚠ DANGER**

**You can be killed or seriously injured if you don't immediately follow instructions.**

**⚠ WARNING**

**You can be killed or seriously injured if you don't follow instructions.**

All safety messages will tell you what the potential hazard is, tell you how to reduce the chance of injury, and tell you what can happen if the instructions are not followed.

In the state of Massachusetts: The Commonwealth of Massachusetts plumbing code 248-CMR shall be adhered to. A licensed plumber shall be used for this installation.

In the state of California: You must turn the Salt Efficiency Feature setting to ON. This may initiate more frequent recharges. However, it will operate at 4,000 grains per pound of salt or higher. To turn on the Salt Efficiency Feature, follow the instructions in the "Salt Efficiency" section of this manual.

## Before You Start

- The water softener requires a minimum water flow of 3 gallons per minute at the inlet. Maximum allowable inlet water pressure is 125 psi. If daytime pressure is over 80 psi, nighttime pressure may exceed the maximum. Use a pressure reducing valve if necessary (Adding a pressure reducing valve may reduce the flow). If your home is equipped with a back flow preventer, an expansion tank must be installed in accordance with local codes and laws.
- The water softener works on 24V DC electrical power, supplied by a direct plug-in power supply (included). Be sure to use the included power supply and plug it into a nominal 120V, 60 Hz household outlet that is in a dry location only, grounded and properly protected by an overcurrent device such as a circuit breaker or fuse.
- Do not use this system to treat water that is microbiologically unsafe or of unknown quality without adequate disinfection upstream or downstream of the system.



European Directive 2002/96/EC requires all electrical and electronic equipment to be disposed of according to Waste Electrical and Electronic Equipment (WEEE) requirements. This directive or similar laws are in place nationally and can vary from region to region. Please refer to your state and local laws for proper disposal of this equipment.

## Do not return the water softener to store.

If you have any questions, or there are missing parts or damage, please call **Toll Free 1-866-986-3223** or visit **[www.whirlpoolwatersolutions.com](http://www.whirlpoolwatersolutions.com)**

When you call, please be prepared to provide the model and serial number, found on the rating decal, located on the back of the controller's top cover.

# Inspect Shipment

The parts required to assemble and install the water softener are included with the unit. Thoroughly check the water softener for possible shipping damage and parts loss. Also inspect and note any damage to the shipping carton.

Remove and discard (or recycle) all packing materials. To avoid loss of small parts, we suggest you keep the small parts in the parts bag until you are ready to use them.

## Packing List

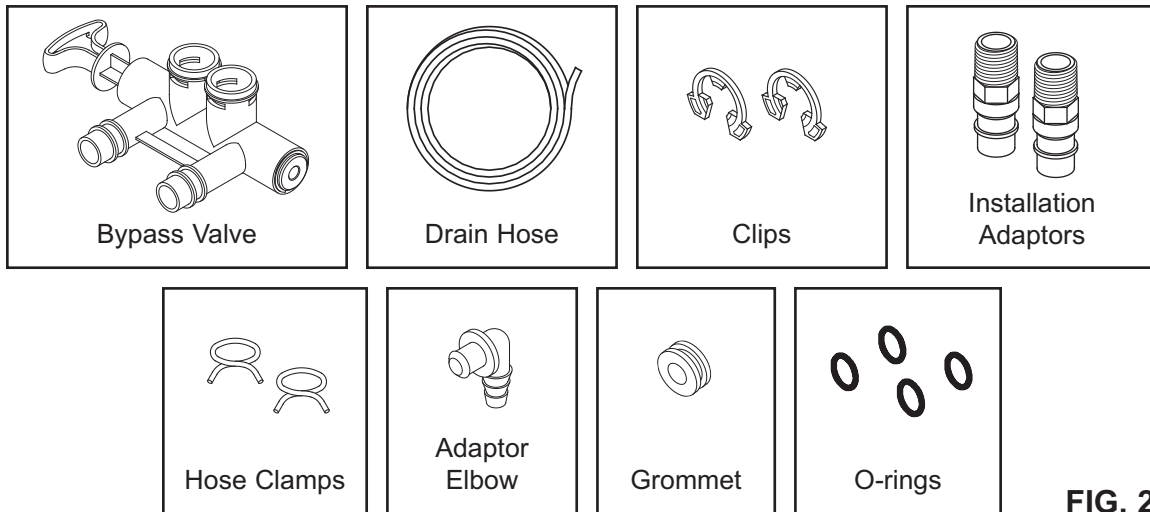

FIG. 2

## Water Conditioning Information

### IRON

Iron in water can cause stains on clothing and plumbing fixtures. It can negatively affect the taste of food, drinking water, and other beverages. Iron in water is measured in parts per million (ppm). The total\* ppm of iron, and type or types\*, is determined by chemical analysis. Four different types of iron in water are:

- Ferrous (clear water) iron
- Ferric (red water) iron
- Bacterial and organically bound iron
- Colloidal and inorganically bound iron (ferrous or ferric)

Ferrous (clear water) iron is soluble and dissolves in water. This water softener will reduce moderate amounts of this type of iron (see specifications).\*\*

Ferrous (clear water) iron is usually detected by taking a sample of water in a clear bottle or glass.

Immediately after taking, the sample is clear. As the water sample stands, it gradually clouds and turns slightly yellow or brown as air oxidizes the iron. This usually occurs in 15 to 30 minutes.

When using the softener to reduce Ferrous (clear water) iron, add 5 grains to the hardness setting for every 1 ppm of Ferrous (clear water) iron. See "Set Water Hardness Number" section.

Ferric (red water), and bacterial and organically bound irons are insoluble. This water softener will not remove ferric or bacterial iron. This iron is visible

immediately when drawn from a faucet because it has oxidized before reaching the home. It appears as small cloudy yellow, orange, or reddish suspended particles. After the water stands for a period of time, the particles settle to the bottom of the container. Generally these irons are removed from water by filtration. Chlorination is also recommended for bacterial iron.

Colloidal and inorganically bound iron is of ferric or ferrous form that will not filter or exchange out of water. This water softener will not remove colloidal iron. In some instances, treatment may improve colloidal iron water. Colloidal iron water usually has a yellow appearance when drawn. After standing for several hours, the color persists and the iron does not settle, but remains suspended in the water.

### SEDIMENT

Sediment is fine, foreign material particles suspended in water. This water softener will not remove sediment. This material is most often clay or silt. Extreme amounts of sediment may give the water a cloudy appearance. A sediment filter installed upstream of the water softener normally corrects this situation.

\* Water may contain one or more of the four types of iron and any combination of these. Total iron is the sum of the contents.

\*\* Capacity to reduce clear water iron is substantiated by laboratory test data.

# Installation Requirements

## LOCATION REQUIREMENTS

Consider all of the following when selecting an installation location for the water softener.

- Do not locate the water softener where freezing temperatures occur. Do not attempt to treat water over 120°F. Freezing temperatures or hot water damage voids the warranty.
- To condition all water in the home, install the water softener close to the water supply inlet, and upstream of all other plumbing connections, except outside water pipes. Outside faucets should remain on hard water to avoid wasting conditioned water and salt.
- A nearby drain is needed to carry away regeneration discharge (drain) water. Use a floor drain, laundry tub, sump, standpipe, or other options (check your local codes). See "Air Gap Requirements" and "Valve Drain Requirements" sections.
- The water softener works on 24V DC electrical power, supplied by a direct plug-in power supply (included). Provide nearby a 120V, 60 Hz electrical outlet in accordance with NEC and local codes.
- Always install the water softener between the water inlet and water heater. Any other installed water conditioning equipment should be installed between the water inlet and water softener (See Figure 4 below).
- Avoid installing in direct sunlight. Excessive sun heat may cause distortion or other damage to non-metallic parts.

## PLUMBING CODES

All plumbing must be completed in accordance with national, state and local plumbing codes.

In the state of Massachusetts: The Commonwealth of Massachusetts plumbing code 248-CMR shall be adhered to. A licensed plumber shall be used for this installation.

## AIR GAP REQUIREMENTS

A drain is needed for regeneration water (See Figure 3). A floor drain, close to the water softener, is preferred. A laundry tub, standpipe, etc. are other drain options. Secure valve drain hose in place. Leave an air gap of 1-1/2" between the end of the hose and the drain. This gap is needed to prevent backflow of sewer water into the water softener. Do not put the end of the drain hose into the drain.

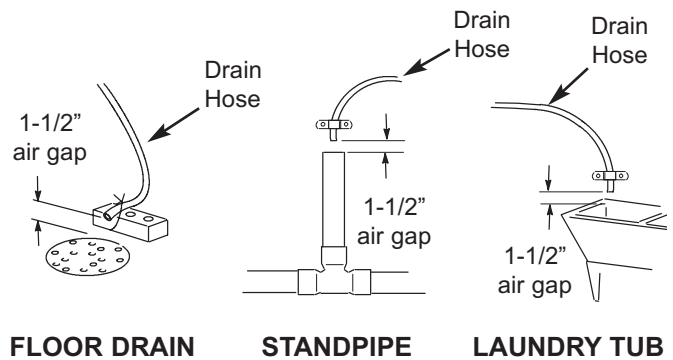

FIG. 3

## THE PROPER ORDER TO INSTALL WATER TREATMENT EQUIPMENT

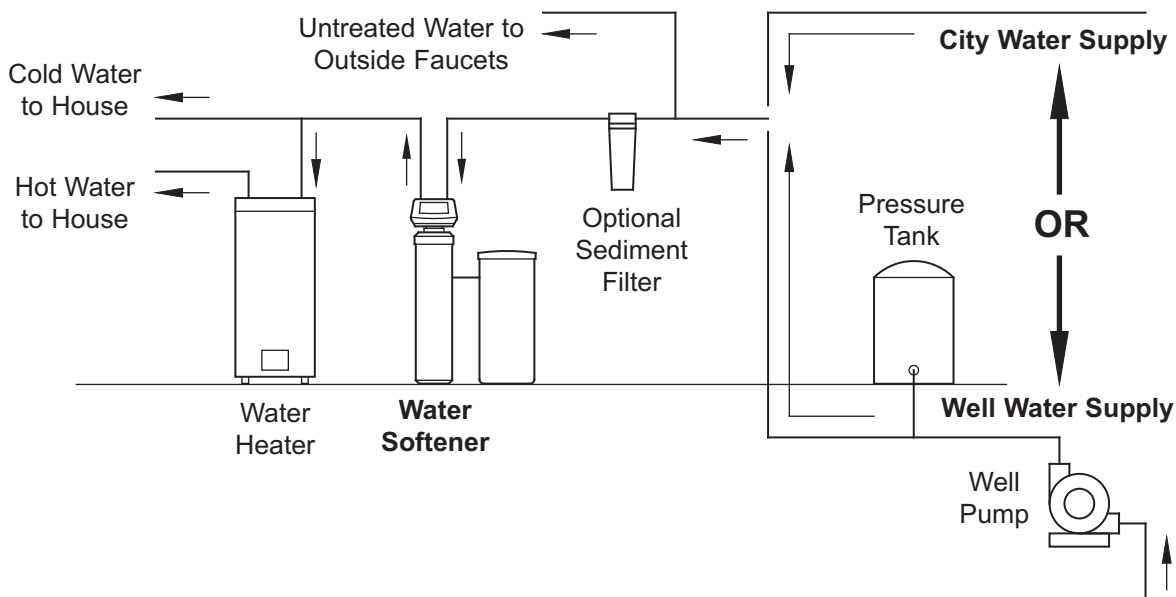

FIG. 4

# Installation Requirements

## VALVE DRAIN REQUIREMENTS

Using the flexible drain hose (included), measure and cut to the length needed. Flexible drain hose is not allowed in all localities (check your plumbing codes). If local codes do not allow use of a flexible drain hose, a rigid valve drain run must be used. Purchase a compression fitting (1/4 NPT x 1/2 in. minimum tube) and 1/2" tubing from your local hardware store. Plumb a rigid drain as needed (See Figure 6).

**NOTE:** Make the valve drain line as short and direct as possible.

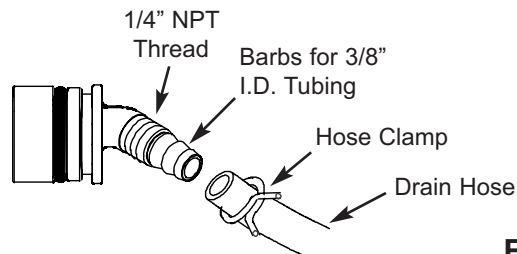

FIG. 5

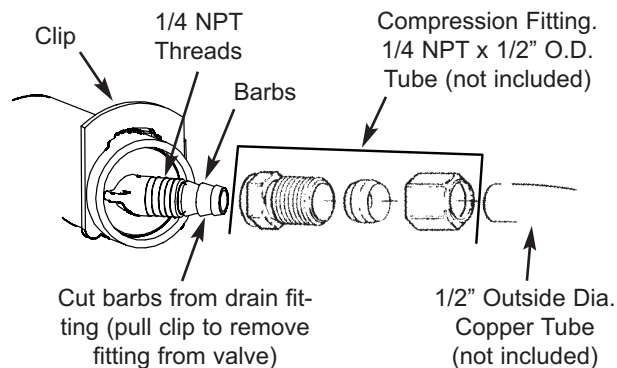

FIG. 6

**⚠ WARNING**

**Electrical Shock Hazard**

**Prior to installation on metallic plumbing, securely install two grounding clamps and a #4 copper wire per installation instructions.**

**Failure to follow these instructions can result in death or electrical shock.**

## INLET / OUTLET PLUMBING OPTIONS

Always install either a single bypass valve (provided), as shown in Figure 7, or, if desired, parts for a 3 valve bypass system (not included) can be purchased and assembled, as shown in Figure 8. Bypass valves allow you to turn off water to the softener for maintenance if needed, but still have water in house pipes. Pipe fittings must be 3/4" minimum.

Use:

- Copper pipe
- Threaded pipe
- PEX (Crosslinked Polyethylene) pipe
- CPVC plastic pipe
- Other pipe approved for use with potable water

**IMPORTANT:** Do not solder with plumbing attached to installation adaptors and single bypass valve. Soldering heat will damage the adaptors and valve.

### SINGLE BYPASS VALVE

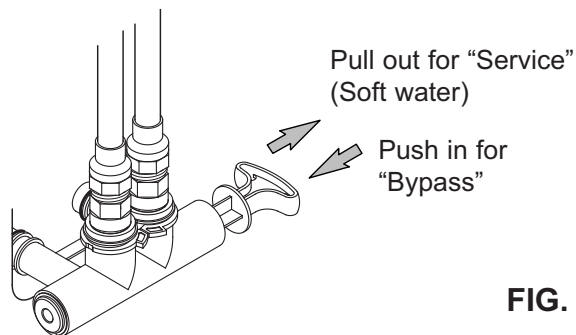

FIG. 7

### 3 VALVE BYPASS

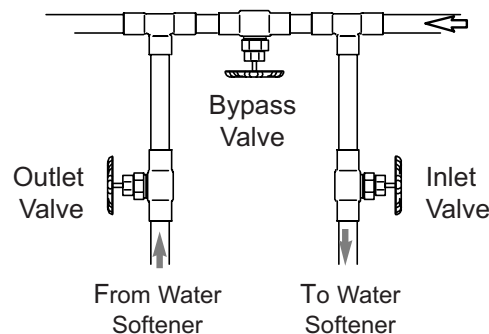
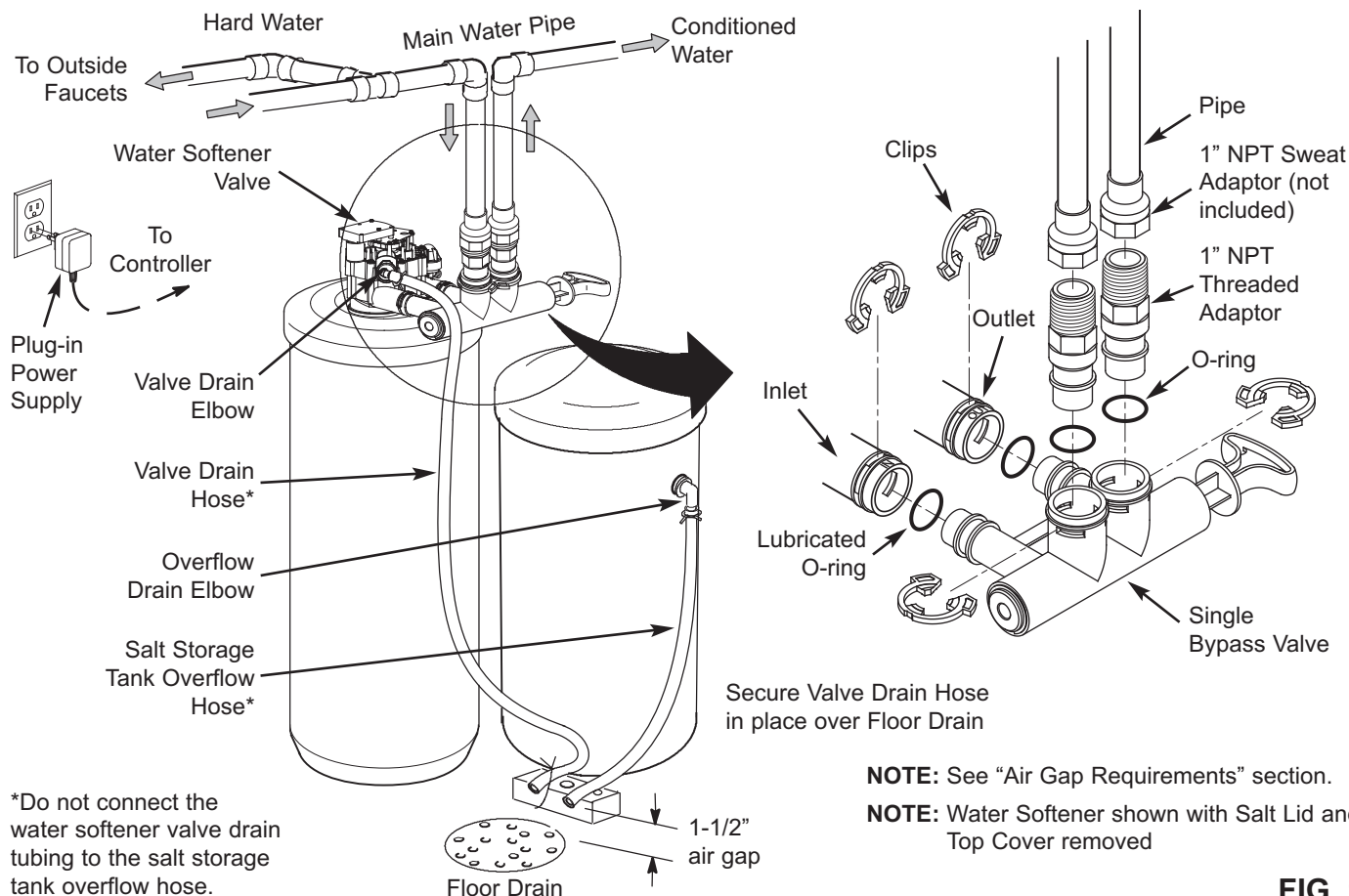

FIG. 8



# Installation Instructions

## TYPICAL INSTALLATION



**FIG. 9**

### TURN OFF WATER SUPPLY

1. Close the main water supply valve, located near the well pump or water meter.
2. Open all faucets to drain all water from house pipes.

**NOTE:** Be sure not to drain water from the water heater, as damage to the water heater elements could result.

### MOVE THE WATER SOFTENER INTO PLACE

## ⚠ WARNING

### Excessive Weight Hazard

Use two or more people to move and install water softener.

Failure to do so can result in back or other injury.

1. Move the water softener into the desired location. Set it on a solid, level surface.

**IMPORTANT:** Do not place shims directly under the salt storage tank to level the softener. The weight of the tank, when full of water and salt, may cause the tank to fracture at the shim.

2. Visually check and remove any debris from the water softener valve inlet and outlet ports.
3. Make sure the turbine assembly spins freely in the "out" port of the valve.
4. If not already done, put a light coating of silicone grease on the single bypass valve o-rings.
5. Push the single bypass valve into the softener valve as far as it will go. Snap the two large holding clips into place, from the top down as shown in Figures 11 & 12.

**IMPORTANT:** Be sure the clips snap firmly into place so the single bypass valve will not pull out.



# Installation Instructions

## ⚠ WARNING



### Electrical Shock Hazard

Prior to installation on metallic plumbing, securely install two grounding clamps and a #4 copper wire per installation instructions.

Failure to follow these instructions can result in death or electrical shock.

## GROUNDING INFORMATION (for Installations on Metal Pipe)

The house main incoming water pipe is often used to ground electrical outlets in the home. Grounding protects you from electrical shock. Installing the water softener with a plastic bypass valve will break this ground. Before beginning installation, purchase and securely install two grounding clamps and a #4 copper wire across the location where the softener will be, tightly clamping it at both ends, as shown in Figure 10.

**NOTE:** Check local plumbing and electrical codes for proper installation of the ground wire. The installation must conform to them. In Massachusetts, plumbing codes of Massachusetts shall be conformed to. Consult with your licensed plumber.

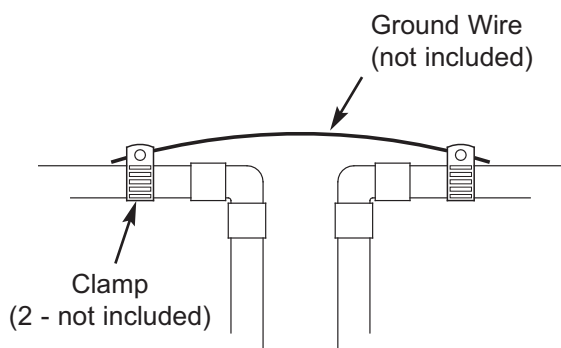

FIG. 10

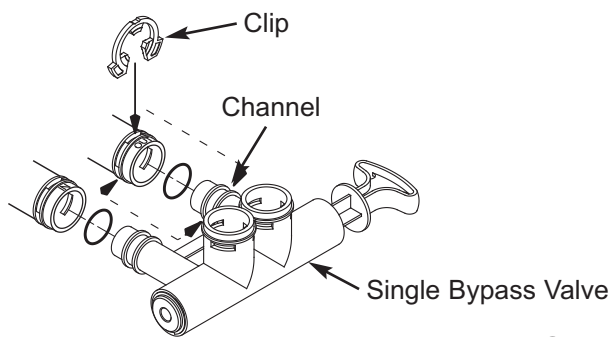

FIG. 11

### CORRECT ASSEMBLY

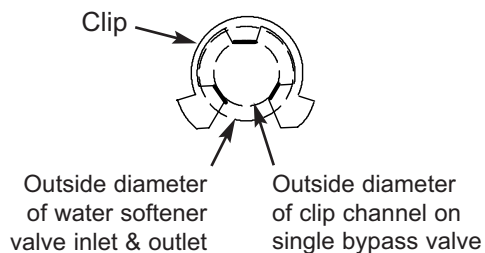
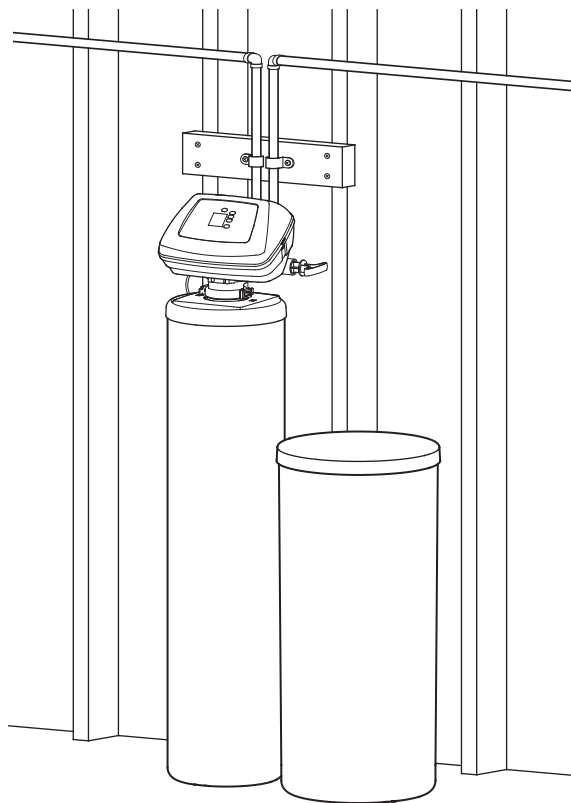

FIG. 12

**NOTE:** Be sure all 3 tabs of the clip go through the matching holes on the water softener valve inlet or outlet, and fully into the channel on the single bypass valve. Make sure that the tabs are fully seated.



Secure the unit with its inlet/outlet plumbing connections to a wall or other rigid surface to prevent tipping.

FIG. 13

# Installation Instructions

## COMPLETE INLET AND OUTLET PLUMBING

Measure, cut, and loosely assemble pipe and fittings from the main water pipe to the inlet and outlet ports of the water softener valve. Be sure to keep fittings fully together, and pipes squared and straight.

Be sure hard water supply pipe goes to the water softener valve inlet side.

**NOTE:** Inlet and outlet are marked on the water softener valve. Trace the water flow direction to be sure hard water is to inlet.

**IMPORTANT:** Be sure to fit, align and support all plumbing to prevent putting stress on the water softener valve inlet and outlet. Stress from misaligned or unsupported plumbing may cause damage to the valve.

Complete the inlet and outlet plumbing for the type of pipe you will be using. Secure the unit with its inlet/outlet plumbing connections to a wall or other rigid surface to prevent tipping (See Figure 13 on the previous page).

## INSTALL VALVE DRAIN HOSE

1. Measure, cut to needed length and connect the 3/8" drain line (provided) to the water softener valve drain fitting. Use a hose clamp to hold the hose in place.

**NOTE:** Make the valve drain line as short and direct as possible.

**IMPORTANT:** If codes require a rigid drain line see "Valve Drain requirements" section.

2. Route the drain hose or copper tubing to the floor drain. Secure drain hose. This will prevent "whipping" during regenerations. See "Air Gap Requirements" section.

## CONNECT BRINE TUBING

Route the brine tubing out, through the largest hole in the salt storage tank sidewall. Connect the tubing to the nozzle/venturi housing, as shown in Figure 14, using a ferrule nut. Tighten the nut by hand. Then, using a wrench or pliers, tighten it a half turn more.

## INSTALL SALT STORAGE TANK OVERFLOW ELBOW AND HOSE

1. Install the brine tank overflow grommet and elbow in the 13/16" diameter hole in the salt storage tank sidewall.

**NOTE:** The brine tank overflow elbow accepts either 1/2" or 3/8" I.D. hose.

2. Measure, cut to needed length and connect the 3/8" drain line (provided) to the salt storage tank overflow elbow and secure in place with a hose clamp.

3. Route the hose to the floor drain, or other suitable drain point no higher than the drain fitting on the salt storage tank (This is a gravity drain). If the tank overfills with water, the excess water flows to the drain point. Cut the drain line to the desired length and route it neatly out of the way.

**IMPORTANT:** For proper operation of the water softener, do not connect the water softener valve drain tubing to the salt storage tank overflow hose.

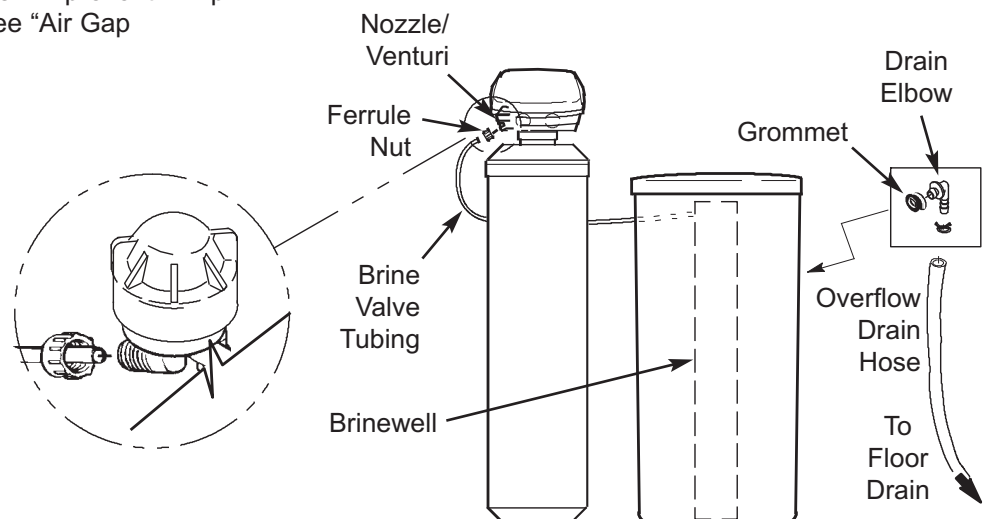

FIG. 14

# Installation Instructions

## TEST FOR LEAKS

To prevent air pressure in the water softener and plumbing system, complete the following steps in order:

1. Fully open two or more softened cold water faucets close to the water softener, located downstream from the water softener.
2. Place the bypass valve (single or 3 valve) into the "bypass" position. See Figures 7 & 8 on Page 7.
3. Slowly open the main water supply valve. Run water until there is a steady flow from the opened faucets, with no air bubbles.
4. Place bypass valve(s) in "service" or soft water position as follows:
  - Single bypass valve: Slowly move the valve stem toward "service," pausing several times to allow the water softener to fill with water.
  - 3 valve bypass: Fully close the bypass valve and open the outlet valve. Slowly open the inlet valve, pausing several times to allow the water softener to fill with water.
5. After about three minutes, open a hot water faucet until there is a steady flow and there are no air bubbles, then close this faucet.
6. Close all cold water faucets and check for leaks at the plumbing connections that you made.
7. Check for leaks around clips at softener's inlet and outlet. If a leak occurs at a clip, depressurize the plumbing (turn off the water supply and open faucets) before removing clip. When removing clips at the softener's inlet or outlet, push the single bypass valve body toward the softener (See Figure 15). Improper removal may damage clips. Do not reinstall damaged clips.

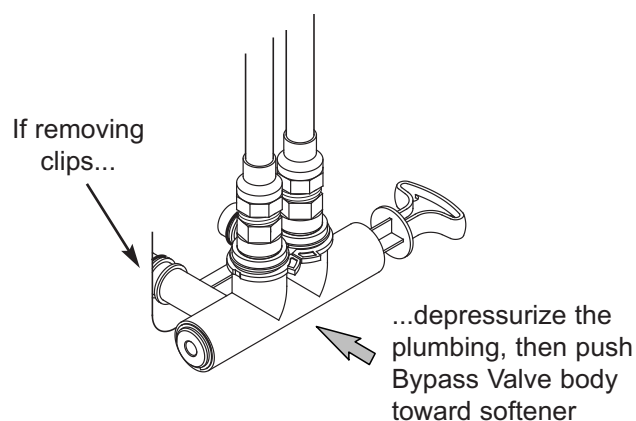

FIG. 15

## ADD WATER AND SALT TO THE SALT STORAGE TANK

### **! WARNING**

#### **Excessive Weight Hazard**

**Use two or more people to move and lift salt bags.**

**Failure to do so can result in back or other injury.**

1. Using a container, add about three gallons of clean water into the salt storage tank.
2. Add salt to the storage tank. Use nugget, pellet or coarse solar salts with less than 1% impurities.

## PLUG IN THE POWER SUPPLY

During installation, the water softener wiring may be moved or jostled from place. Be sure all leadwire connectors are secure on the back of the electronic board and be sure all wiring is away from the valve gear and motor area, which rotates during regenerations.

1. Plug the power supply into an electrical outlet that is not controlled by a switch.

**NOTE:** The water heater is filled with hard water and, as hot water is used, it will refill with conditioned water. In a few days, the hot water will be fully conditioned. To have fully conditioned hot water immediately, wait until the initial recharge is over. Then, drain the water heater (following instructions for water heater) until water runs cold.

## SANITIZE THE WATER SOFTENER / SANITIZE AFTER SERVICE

1. Open salt lid, remove the brinewell cover and pour about 3 oz. (6 tablespoons) of household bleach into the softener brinewell. Replace the brinewell cover.
2. Make sure the bypass valve(s) is in the "service" (open) position.
3. Start a recharge (regeneration). See "Start a Recharge" on Page 13.
4. After the recharge has completed, fully open a cold water faucet, downstream from the softener, and allow 50 gallons of water to pass through the system. This should take at least 20 minutes. Close the faucet.

# Programming the Water Softener

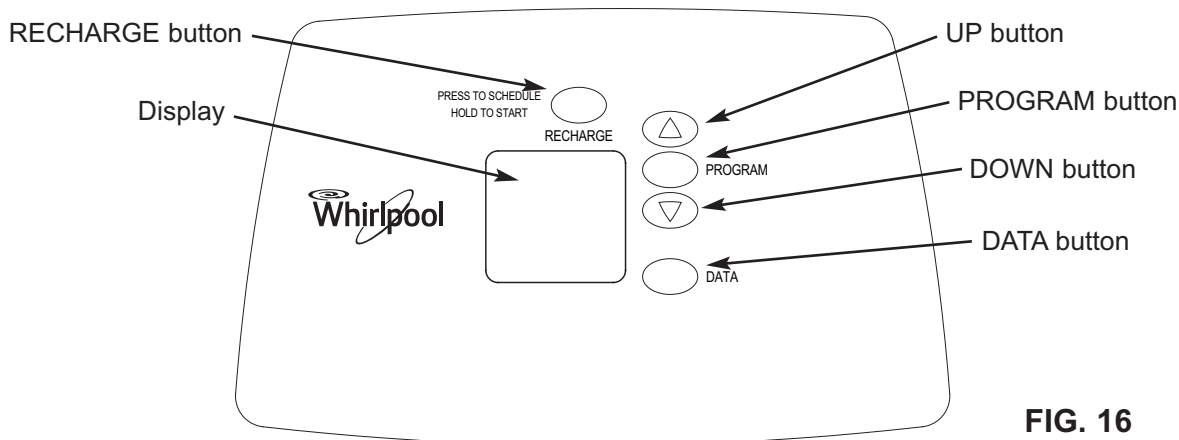

FIG. 16

## PROGRAM THE SOFTENER

When the power supply is plugged into the electrical outlet, the model code (LL60) and a test number (example: J3.8), are briefly shown in the display. Then the words "PRESENT TIME" appear and 12:00 PM begins to flash.

## SET TIME OF DAY

If the words "PRESENT TIME" do not show in the display, press the PROGRAM button until they do.

1. Press the  $\triangle$  UP or  $\nabla$  DOWN buttons to set the present time. Up moves the display ahead; down sets the time back. Be sure AM or PM is correct.

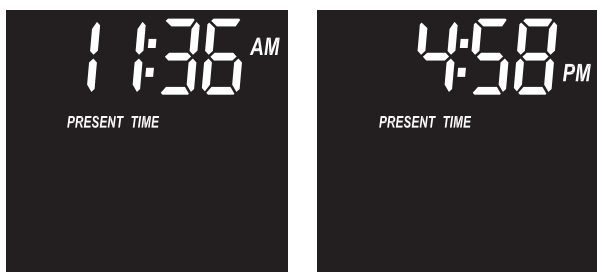

FIG. 17

**NOTE:** Press buttons and quickly release to slowly advance the display. Hold the buttons down for fast advance.

## SET WATER HARDNESS NUMBER

1. Press the PROGRAM button once again to display a flashing "25" and the word "HARDNESS".



FIG. 18

2. Press the  $\triangle$  UP or  $\nabla$  DOWN buttons to set your water's hardness number.

**NOTE:** If your water supply contains iron, compensate for it by adding to the water hardness number. For example, assume your water is 20 gpg hard and contains 2 ppm iron. Add 5 to the hardness number for each 1 ppm of iron. In this example, you would use 30 for your hardness number.

$$\begin{array}{r}
 20 \text{ gpg hardness} \\
 2 \text{ ppm iron} \times 5 = 10 \\
 \text{(times)} \quad \quad \quad \underline{+10} \\
 \quad \quad \quad \quad \quad \quad 30 \text{ HARDNESS NUMBER}
 \end{array}$$

3. Press the PROGRAM button once again to return to normal operating display.

continued on next page

**Questions? Call Toll Free 1-866-986-3223** or visit [whirlpoolwatersolutions.com](http://whirlpoolwatersolutions.com)

When you call, please be prepared to provide the model and serial number, found on the rating decal, located on the back of the controller's top cover.

# Programming the Water Softener

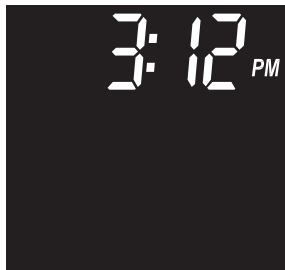

FIG. 19

## START A RECHARGE

1. Press the RECHARGE button and hold for three seconds, until "RECHARGE" begins to flash in the display, starting a recharge. This recharge draws the sanitizing bleach into and through the water softener. Any air remaining in the water softener is purged to the drain. During this time, periodically check for leaks.

**NOTE:** As with all other water system applications, leaks may occur. Leaks may not be immediately apparent. Recheck for leaks 24 hours after first recharge cycle is complete.

## POWER OUTAGE MEMORY

If electrical power to the water softener is lost, "memory" built into the timer circuitry will keep all settings for several hours. While the power is out, the display is blank and the water softener will not regenerate. When electrical power is restored, the following will occur:

Reset the present time only if the display is flashing. The HARDNESS and RECHARGE TIME never require resetting unless a change is desired. Even if the clock is incorrect after a long power outage, the softener operates as it should to keep your water soft. However, regenerations may occur at the wrong time of day until you reset the clock to the correct time of day.

**NOTE:** If the water softener was regenerating when power was lost, it will now finish the cycle.

# Customizing Features / Options

## RECHARGE NOW

The RECHARGE button is used to initiate an immediate recharge.

1. Press and hold the RECHARGE button until the words "RECHARGE NOW" flash in the display.

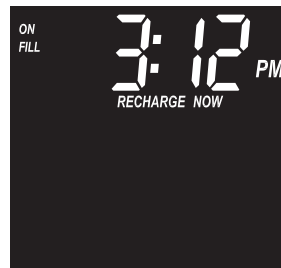

FIG. 20

RECHARGE NOW initiated

The softener enters the fill cycle of regeneration right away. "RECHARGE NOW" will flash during the regeneration. When completed, full water conditioning capacity is restored.

**NOTE:** Avoid using hot water while the softener is regenerating, because the water heater will refill with bypass hard water.

## RECHARGE TONIGHT

If you do not want to start an immediate recharge, but would like to schedule an extra recharge at the next preset recharge time, do the following:

1. Press and release (do not hold) the RECHARGE button.

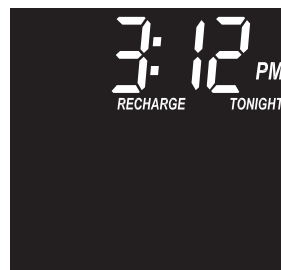

FIG. 21

RECHARGE TONIGHT initiated

The words "RECHARGE TONIGHT" flash in the display, and the softener will recharge at the next recharge time. The words "RECHARGE NOW" will flash during the regeneration. When completed, full water conditioning capacity is restored.

# Customizing Features / Options

## DATA DISPLAYS

With repeated presses of the DATA button, you can obtain operational information about your water softener.

### Capacity (remaining)

This is the percentage of water softening capacity remaining. Immediately after a regeneration, 100% shows. Then, as water is used, the percentage decreases until the next regeneration. During regenerations, the percentage increments upward.

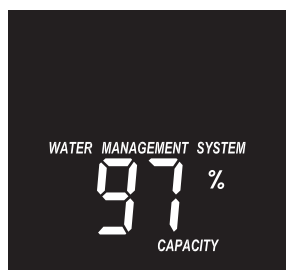

FIG. 22

**NOTE:** Zero (0%) shows until after the first regeneration begins, after connecting to electrical power.

### Flow Rate, GPM\*

When using soft water, this display shows the gallons per minute flow rate passing through the softener. Zero shows if water is not in use.

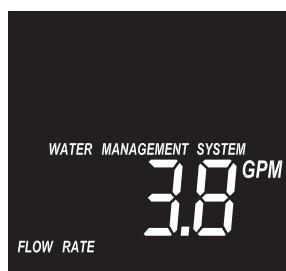

FIG. 23

### Gallons\* Today

Each day, beginning at midnight, the timer keeps a running count of the total gallons of water passing through the softener.

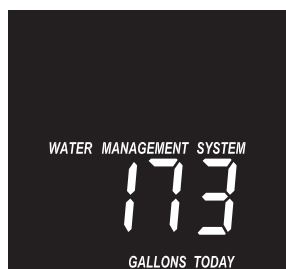

FIG. 24

### Average Daily Gallons\*

The figure displayed is the average gallons of water used by the household each day, over the past seven day period.

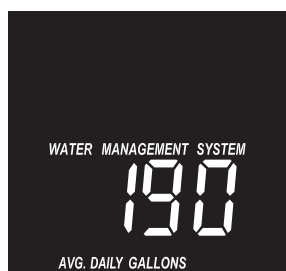

FIG. 25

\*If preferred, you can set the timer to show the reading in liters instead of gallons. If gallons today, or average daily gallons exceeds 1999, a (x 10) indicator appears. This means you must multiply the number shown times 10.

## SET RECHARGE (REGENERATION) TIME

1. Press the PROGRAM button and hold for three seconds, until a flashing "2:00AM" and the words "RECHARGE TIME" are displayed. This is a good time for the recharge to start in most households, because water is not in use.



FIG. 26

2. If you want to change the recharge start time, press the  $\Delta$  UP or  $\nabla$  DOWN buttons until the desired time shows. Be sure AM or PM is correct.
3. Press the PROGRAM button four times to return to the normal run display (See Fig. 19).

## MAXIMUM DAYS BETWEEN REGENERATIONS

The water softener automatically controls regeneration frequency. This provides the greatest operating efficiency and, under most conditions, this feature should be left in this automatic mode. However, you may modify this feature if you want to force a regeneration every set number of days. For example, if your water supply contains clear water iron, you may want the softener to regenerate every few days to keep the resin bed clean. The maximum days between recharges may be set from 1 to 15 days, as follows:

**NOTE:** The softener will recharge on its own if needed, even if it is before the set number of days.

1. Press the PROGRAM button and hold for three seconds, until the "Recharge Time" screen (Figure 26) is displayed.
2. Once in this display, press the PROGRAM button again and the display in Figure 27 is shown.

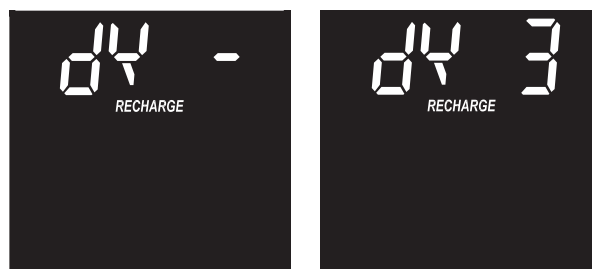

FIG. 27



# Customizing Features / Options

3. Press the  $\triangle$  UP or  $\nabla$  DOWN buttons to set the number of days.
4. Press the PROGRAM button three times to return to the normal time of day screen.

## SALT EFFICIENCY

When this feature is ON, the water softener will operate at salt efficiencies of 4000 grains of hardness per pound of salt or higher (May recharge more often using smaller salt dosage and less water). The softener is shipped with this feature set OFF.

1. Press the PROGRAM button and hold for three seconds, until the "Recharge Time" screen (Figure 26) is displayed.
2. Once in this display, press the PROGRAM button twice and the display in Figure 28 is shown.

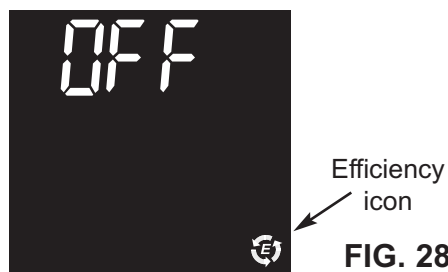

3. Press the  $\triangle$  UP or  $\nabla$  DOWN buttons to set ON or OFF. When set to ON, the efficiency icon will be displayed in the lower left hand corner of the normal run display.
4. Press the PROGRAM button twice to return to the normal run display.

In the state of California: You must turn the Salt Efficiency Feature ON. This may initiate more frequent recharges. However, it will operate at 4,000 grains per pound of salt or higher.

## HEAVY DUTY BACKWASH

When set to ON, the backwash cycle of regeneration will be 22 minutes long instead of the normal 15 minute length. This is beneficial on some water supplies high in iron or sediment content. To conserve water, when this softener is installed on clean water supplies, be sure OFF is set.

1. Press the PROGRAM button and hold for three seconds, until the "Recharge Time" screen (Figure 26) is displayed.
2. Once in this display, press the PROGRAM button three times and the "Heavy Backwash" screen (Figure 29) is displayed.



3. Press the  $\triangle$  UP or  $\nabla$  DOWN buttons to set ON or OFF.
4. Press the PROGRAM button once again to return to the normal run display.

## MODEL CODE

The model code is factory set at assembly and testing. The model code should never require resetting, but to check, or to set if previously omitted, follow the steps below.

1. Press the PROGRAM button and hold for three seconds, until the "Recharge Time" screen (Figure 26) is displayed.
2. Again, press the PROGRAM button and hold for three seconds. Either " - - - " or the previously set code "LL60" will appear.



3. Use the  $\triangle$  UP or  $\nabla$  DOWN buttons to select the correct model code (LL60).
4. Press the PROGRAM button three times to return to the normal time of day screen.



# Customizing Features / Options

## 12 OR 24 HOUR CLOCK

All time displays are shown in standard clock time (AM and PM) at the 12 hour default setting. If 24 hour clock displays are desired, follow steps below:

1. Press the PROGRAM button and hold for three seconds, until the “Recharge Time” screen (Figure 31) is displayed.

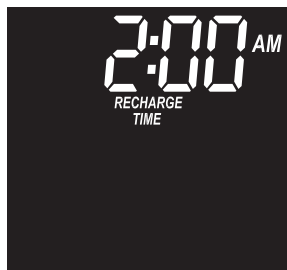

FIG. 31

2. Again, press the PROGRAM button and hold for three seconds, until the model code screen (Figure 32) is displayed.



FIG. 32

3. Once in this display, press the PROGRAM button again and one of the two displays in Figure 33 is shown.

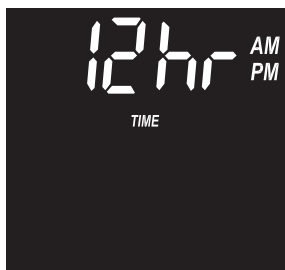

FIG. 33

4. Press the  $\triangle$  UP or  $\nabla$  DOWN buttons to select the time format.
5. Press the PROGRAM button twice to return to the normal time of day screen.

## GALLONS OR LITERS

All water flow rate and usage displays are in gallons with the default “GALS” setting. If reset to “LITER”, the same displays are shown in liters.

1. Press the PROGRAM button and hold for three seconds, until the “Recharge Time” screen (Figure 31) is displayed.
2. Again, press the PROGRAM button and hold for three seconds, until the model code screen (Figure 32) is displayed.
3. Once in this display, press the PROGRAM button twice and one of the two displays in Figure 34 is shown.

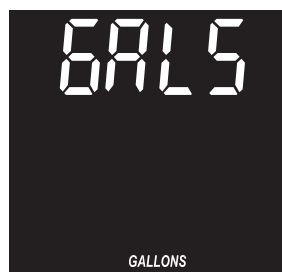

FIG. 34

4. Press the  $\triangle$  UP or  $\nabla$  DOWN buttons to select gallons or liters.
5. Press the PROGRAM button once again to return to the normal time of day screen.

# Routine Maintenance

## WATER SOFTENER CLEANSER

The manufacturer recommends that you use Whirlpool® WHE-WSC Water Softener Cleanser, as directed, every four months.

Lift the brinewell cover and pour in the entire 16 oz. bottle of Whirlpool® Water Softener Cleanser. Press the RECHARGE button and hold for three seconds,

until “RECHARGE” begins to flash in the display. This manual recharge will take about two hours. If taste, odor, or discoloration are detected in the water, manually recharge the softener again, then run a cold water faucet immediately downstream of the softener until water tastes, smells and appears normal.

# Routine Maintenance

## ADDING SALT

Lift the salt lid and check the salt storage level frequently. If the water softener uses all the salt before you refill it, you will experience hard water. Until you have established a refilling routine, check the salt every two or three weeks. Always add if less than 1/4 full. Be sure the brinewell cover is on.

**NOTE:** If using potassium chloride (KCl), do not fill the tank more than halfway.

**NOTE:** In humid areas, it is best to keep the salt storage level lower, and to refill more often to avoid salt "bridging".

Recommended Salt: Nugget, pellet or coarse solar salts with less than 1% impurities.

Salt Not Recommended: Rock salt, high in impurities, block, granulated, table, ice melting, ice cream making salts, etc.

## BREAKING A SALT BRIDGE

Sometimes, a hard crust or salt "bridge" forms in the brine tank. It is usually caused by high humidity or the wrong kind of salt. When the salt "bridges," an empty space forms between the water and the salt. Then, salt will not dissolve in the water to make brine. Without brine, the resin bed is not recharged and hard water will result.

If the storage tank is full of salt, it is difficult to tell if you have a salt bridge. A bridge may be underneath loose salt. Take a broom handle, or like tool, and hold it next to the water softener. Measure the distance from the floor to the rim of the water softener. Then, gently push the broom handle straight down into the salt. If a hard object is felt before the pencil mark is even with the top, it is most likely a salt bridge. Gently push into the bridge in several places to break it. Do not use any sharp or pointed objects as you may puncture the brine tank. Do not try to break the salt bridge by pounding on the outside of the salt tank. You may damage the tank.

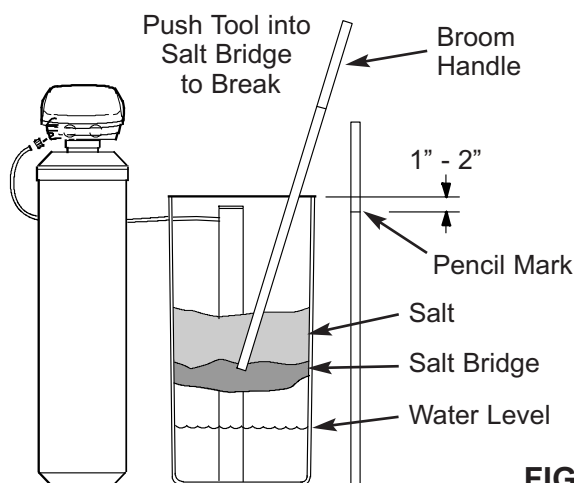
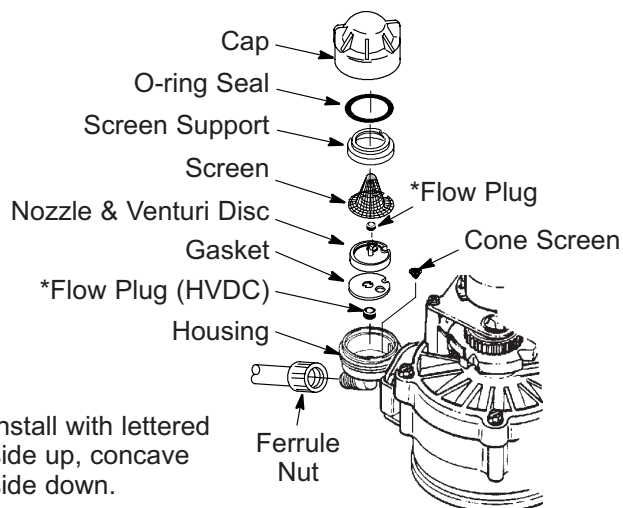

FIG. 35

## CLEANING THE NOZZLE & VENTURI

A clean nozzle & venturi (See Figure 36) is a necessity for the water softener to work properly. This small component creates the suction to move brine from the brine tank, into the resin tank. If it should become plugged with sand, silt, dirt, etc., the water softener will not work, and hard water will result.



\*Install with lettered side up, concave side down.

**IMPORTANT:** Be sure small hole in the gasket is centered directly over the small hole in the nozzle & venturi housing. Be sure the numbers are facing up

FIG. 36

To get access to the nozzle & venturi, remove the water softener's top cover. Put the bypass valve(s) into the bypass position. Be sure the water softener is in soft water (service) cycle (no water pressure at nozzle & venturi). Then, holding the nozzle & venturi housing with one hand, unscrew the cap. Do not lose the o-ring seal. Lift out the screen support and screen. Then, remove the nozzle & venturi disc, gasket and flow plug(s). Wash the parts in warm, soapy water and rinse in fresh water. Be sure to clean both the top and bottom of the nozzle & venturi disc. If needed, use a small brush to remove iron or dirt. Do not scratch, misshape, etc., surfaces of the nozzle & venturi.

Gently replace all parts in the correct order. Lubricate the o-ring seal with silicone grease and locate in place. Install and tighten the cap by hand, while supporting the housing. Overtightening may break the cap or housing. Put the bypass valve(s) into service (soft water) position.

Recharge the softener to reduce water level in the tank. This will also assure that the softener is completely recharged and ready to provide softened water again. Check the water level in the tank by looking down the brinewell. If the water level does not drop after a recharge, the problem has not been resolved. Call 1-866-986-3223.

# Troubleshooting

## AUTOMATIC ELECTRONIC DIAGNOSTICS

This water softener has a self-diagnostic function for the electrical system (except input power and/or water meter). The water softener monitors electronic components and circuits for correct operation. If a malfunction occurs, an error code appears in the display.



FIG. 37

While an error code appears in the display, all buttons are inoperable except the PROGRAM button. PROGRAM remains operational so the service person can perform the Manual Advance Diagnostics, see below, to further isolate the problem.

### Procedure for removing error code from display:

1. Unplug power supply from electrical outlet.
2. Correct problem.
3. Plug power supply back in.
4. Wait 8 minutes. The error code will return if the problem was not corrected.

## MANUAL ADVANCE DIAGNOSTICS

Use the following procedures to advance the water softener through the regeneration cycles to check operation.

Lift off the salt lid, remove the top cover by unlocking the tabs in the back and rocking forward, to observe cam and switch operation during valve rotation.

1. Press and hold the DATA button for 3 seconds until one of the two displays in Figure 38 is shown, then release. The number in the top part of the display, after "dY", is days since the last recharge.

**NOTE:** If the softener is in the middle of a regeneration, the top part of the display shows the cycle of regeneration, and minutes of the cycle remaining. If two cycle names are flashing, the valve is in transition between the cycles.

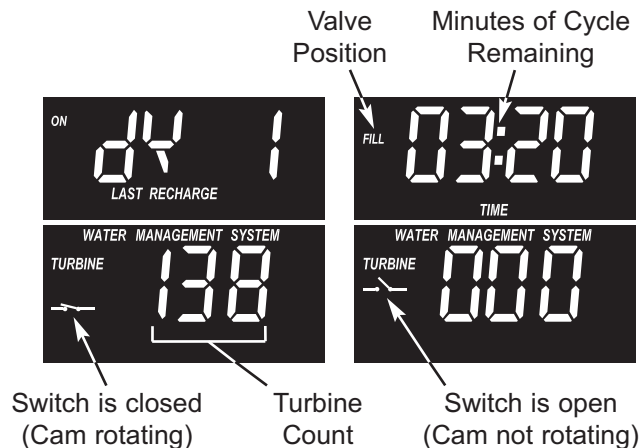

FIG. 38

2. The 3 digits under WATER MANAGEMENT SYSTEM indicate water meter operation as follows:

000 (steady) = Soft water not in use, and no flow through the meter.

Open a nearby soft water faucet.

000 to 140 (continual) = Repeats for each gallon of water passing through the meter.

3. Symbols in the display indicate POSITION switch operation (See Figure 38).
4. Use the RECHARGE button to manually advance the valve into each cycle and check correct switch operation.

**NOTE:** Be sure water is in contact with the salt, and not separated by a salt bridge (See "Breaking A Salt Bridge" section).

5. Press the DATA button again. The following information is available and may be beneficial for various reasons. This information is retained by the computer from the first time electrical power is applied to the face plate.

- a. The top half of the display shows the total number of recharges since the timer was connected to electrical power.
- b. The bottom half of the display shows the number of days since the timer was connected to electrical power. If over 1999 days, a (x 10) indicator shows, meaning you must multiply the number shown times 10.



FIG. 39

6. Press DATA once again to return to the normal time of day screen.

# Troubleshooting

## RESETTING TO FACTORY DEFAULTS

To reset the electronic controller to its factory default for all settings (time, hardness, etc.):

1. Press the PROGRAM button and hold it until the display changes twice to show the flashing model code.
2. Press the  $\triangle$  UP button (a few times, if necessary) to display a flashing "SoS".



FIG. 40

3. Press the PROGRAM button three times, and the electronic controller will restart.
4. Set the present time and hardness, as described on page 12.

## MANUAL ADVANCE REGENERATION CHECK

This check verifies proper operation of the valve motor, brine tank fill, brine draw, regeneration flow rates, and other controller functions. Always make the initial checks, and the manual initiated diagnostics.

**NOTE:** The electronic control display must show a steady time (not flashing). If an error code shows, first press the PROGRAM button to enter the diagnostic display.

1. Press the RECHARGE button and hold in for 3 seconds. RECHARGE begins to flash as the softener's valve advances from the service to fill position. Remove the brinewell cover and, using a flashlight, observe fill water entering the tank.

If water does not enter the tank, look for an obstructed nozzle, venturi, fill flow plug, brine tubing, or brine valve riser pipe.

2. After observing fill, press the RECHARGE button to move the softener's valve into the brine position. A slow flow of water to the drain will begin. Verify brine draw from the brine tank by shining a flashlight into the brinewell and observing a noticeable drop in the liquid level. This may take 15 to 20 minutes.

**NOTE:** Be sure water is in contact with the salt, and not separated by a salt bridge (See "Breaking A Salt Bridge" section).

If the water softener does not draw brine, check for (most likely to least likely):

- Dirty or plugged nozzle and venturi, see "Cleaning the Nozzle and Venturi" section.
- Nozzle and venturi not seated on the gasket, or gasket deformed.
- Valve seals leaking (See Troubleshooting).
- Restriction in valve drain, causing a back-pressure (bends, kinks, elevated too high, etc.). See "Install Valve Drain Hose" section.
- Obstruction in brine valve or brine tubing.

**NOTE:** If water system pressure is low, a too-long or elevated drain hose may cause back pressure, stopping brine draw. Avoid drain hose runs longer than 30 feet. Avoid elevating the hose more than 8 feet above the floor.

3. Press the RECHARGE button to move the softener's valve into the backwash position. Look for a fast flow of water from the drain hose. Check that the drain can adequately handle the flow and volume.

An obstructed flow indicates a plugged top distributor, backwash flow plug, or drain hose.

4. Press the RECHARGE button to move the softener's valve into the fast rinse position. Again look for a fast drain flow. Allow the softener to rinse for a few minutes to flush out any brine that may remain in the resin tank from the brining cycle test.
5. To return the softener's valve to the service position, press the RECHARGE button.

**Need help troubleshooting? Call Toll Free 1-866-986-3223 or visit [whirlpoolwatersolutions.com](http://whirlpoolwatersolutions.com)**

When you call, please be prepared to provide the model and serial number, found on the rating decal, located on the back of the controller's top cover.

# Softener Exploded View

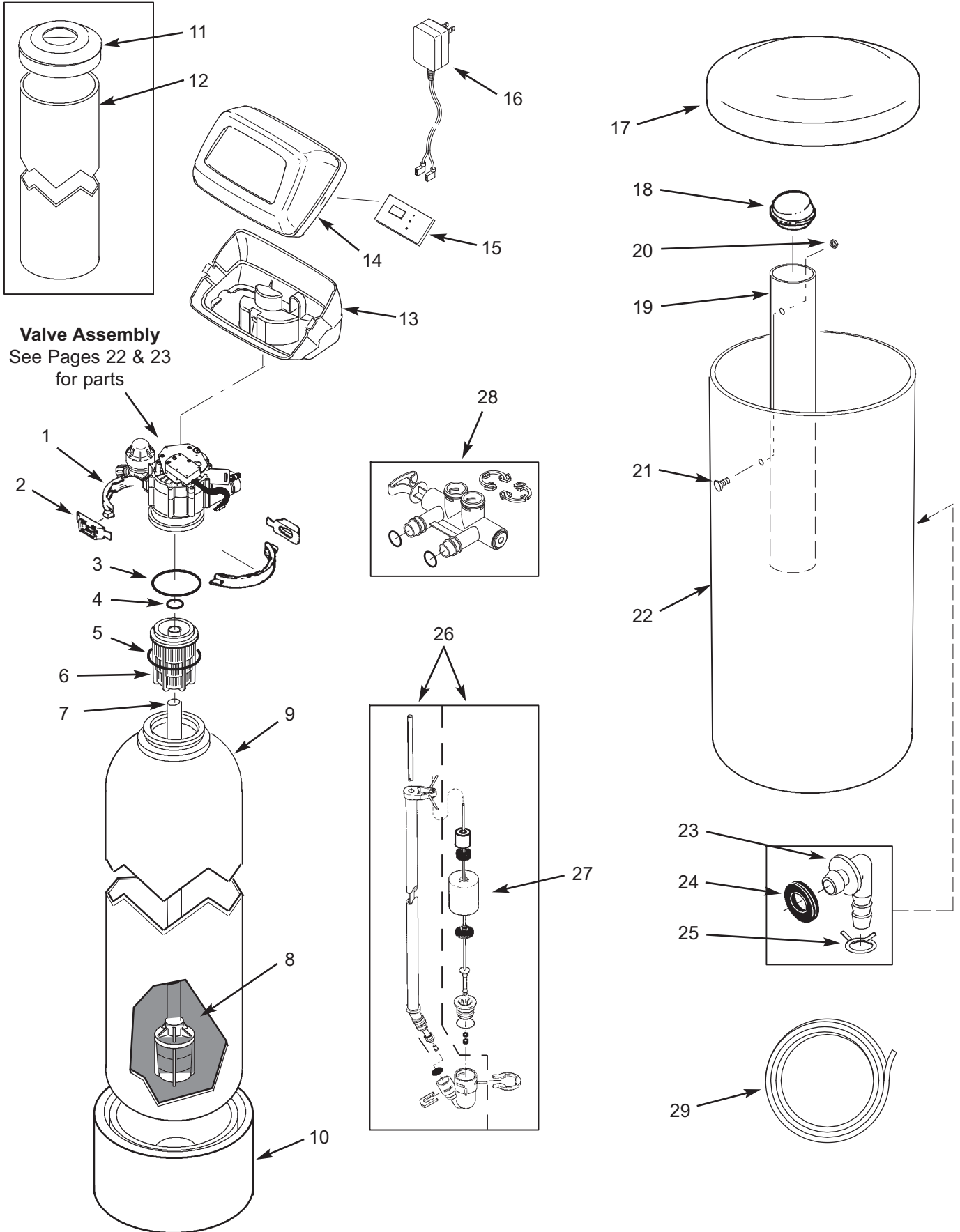

# Softener Parts List

Key No.	Part No.	Description
–	7331177	Tank Neck Clamp Kit (includes 2 ea. of Key Nos. 1 & 2)
1	↑	Clamp Section (2 req.)
2	↑	Retainer Clip (2 req.)
–	7112963	Distributor O-Ring Kit (includes Key Nos. 3-5)
3	↑	O-Ring, 2-7/8" x 3-1/4"
4	↑	O-Ring, 13/16" x 1-1/16"
5	↑	O-Ring, 2-3/4" x 3"
6	7077870	Top Distributor
7	7105047	Repl. Bottom Distributor
8	0502272	Resin, 1 cu. ft.
–	7348077	Resin Tank & Foot Assembly (includes Key Nos. 9 & 10)
9	↑	Resin Tank, 12" x 54"
10	↑	Foot, Tank
11	7204689	Cap, Tank
12	7348085	Shroud, Tank
13	7189449	Bottom Cover
14	7174868	Faceplate Cover (order decal below)
■	7345710	Faceplate Decal
15	7282996	Repl. Electronic Control Board (PWA)

Key No.	Part No.	Description
16	7351054	Power Supply, 24V DC
17	7180437	Salt Cover (order decal below)
■	7345786	Instruction Decal
18	7155115	Cover, Brinewell
19	7109871	Brinewell
–	7331648	Brinewell Mounting Hardware Kit (includes Key Nos. 20 & 21)
20	↑	Wing Nut, 1/4-20
21	↑	Screw, 1/4-20 x 5/8"
22	7112612	Repl. Brine Tank (includes Key Nos. 19-21)
–	7331258	Overflow Hose Adaptor Kit (includes Key Nos. 23-25)
23	↑	Adaptor Elbow
24	↑	Grommet
25	↑	Hose Clamp
26	7310210	Repl. Brine Valve Assembly
27	7327568	Float, Stem & Guide Assembly
28	7214383	Bypass Valve Assembly, 1", including 2 ea. Clips & O-Rings (See Key Nos. 121 & 123)
29	7139999	Drain Hose
■	7368629	Owner's Manual

■ Not illustrated.

To order repair parts call toll free 1-866-986-3223.

Manufactured and warranted by  
Ecodyne Water Systems  
1890 Woodlane Drive  
Woodbury, MN 55125

**Questions? Call Toll Free 1-866-986-3223** or visit [whirlpoolwatersolutions.com](http://whirlpoolwatersolutions.com)

When you call, please be prepared to provide the model and serial number, found on the rating decal, located on the back of the controller's top cover.



# Valve Exploded View

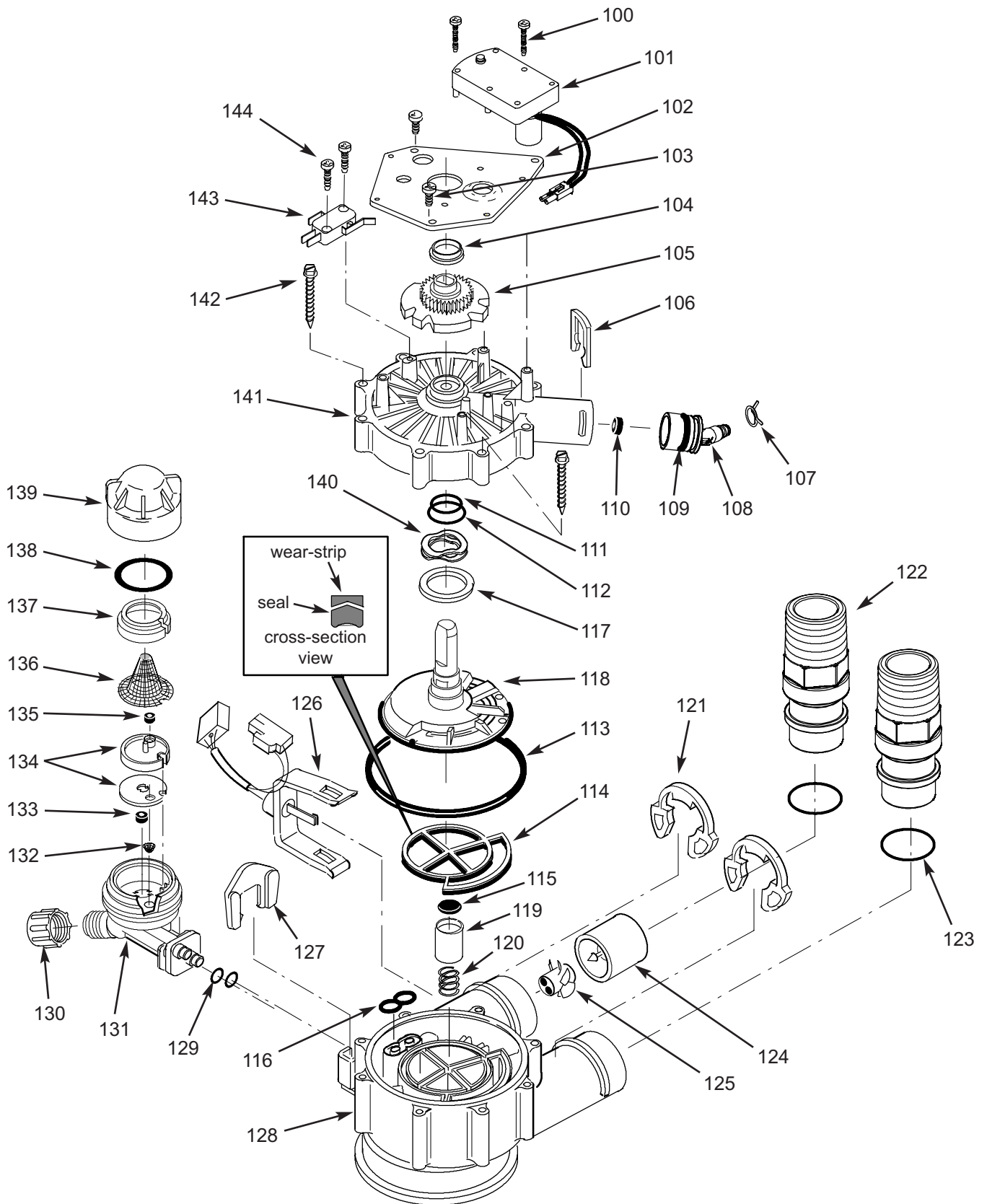



# Valve Parts List

Key No.	Part No.	Description
100	7224087	Screw, #8-32 x 1" (2 req.)
101	7286039	Motor (incl. 2 ea. of Key No. 100)
102	7231393	Motor Plate
103	0900857	Screw, #6-20 x 3/8" (3 req.)
104	7171250	Bearing
105	7283489	Cam & Gear
-	7332660	Drain Hose Adaptor Kit (includes Key Nos. 106-110)
106	↑	Clip, Drain
107	↑	Hose Clamp
108	↑	Drain Hose Adaptor
109	↑	O-Ring, 15/16" x 1-3/16"
110	↑	Flow Plug, 3.0 gpm
-	7185487	Seal Kit (includes Key Nos. 111-116)
111	↑	O-Ring, 5/8" x 13/16"
112	↑	O-Ring, 1-1/8" x 1-1/2"
113	↑	O-Ring, 4-1/2" x 4-7/8"
114	↑	Rotor Seal
115	↑	Seal
116	↑	Seal, Nozzle & Venturi
117	7174313	Bearing, Wave Washer
118	7185500	Rotor & Disc
-	7342712	Drain Plug Kit, 1" (includes Key Nos. 115, 119 & 120)
119	↑	Plug, Drain Seal
120	↑	Spring
121	7337589	Clip, 1", pack of 4
122	7342704	Installation Adaptor, 1", pack of 2, including 2 ea. Clips & O-Rings (See Key Nos. 121 & 123)

Key No.	Part No.	Description
123	7337597	O-Ring, 1-1/16" x 1-5/16", pack of 4
-	7290931	Turbine & Support Assembly, including 2 O-Rings (See Key No. 123) & 1 ea. of Key Nos. 124 & 125
124	↑	Turbine Support & Shaft
125	↑	Turbine
126	7309811	Wire Harness, Sensor
127	7081201	Retainer, Nozzle & Venturi
128	7171145	Valve Body
129	7342649	O-Ring, 1/4" x 3/8", pack of 2
130	1202600	Nut - Ferrule
-	7197777	Nozzle & Venturi Assembly (incl. Key Nos. 127, 129 & 131-139)
131	7081104	Housing, Nozzle & Venturi
132	7095030	Cone Screen
133	1148800	Flow Plug, .3 gpm
134	7114533	Nozzle & Venturi Gasket Kit
	7204362	Gasket Only
135	7147798	Flow Plug, .22 gpm
136	7146043	Screen
137	7167659	Screen Support
138	7170262	O-Ring, 1-1/8" x 1-3/8"
139	7199729	Cap
140	7175199	Wave Washer
141	7171161	Valve Cover
142	7342681	Screw, #10 x 2-5/8", pack of 8
143	7305150	Switch
144	7140738	Screw, #4-24 x 3/4" (2 req.)
■	3479901	Adaptor Kit, 1" to 1-1/4"

■ Not illustrated.

To order repair parts call toll free 1-866-986-3223.

Manufactured and warranted by  
Ecodyne Water Systems  
1890 Woodlane Drive  
Woodbury, MN 55125

**Questions? Call Toll Free 1-866-986-3223** or visit [whirlpoolwatersolutions.com](http://whirlpoolwatersolutions.com)

When you call, please be prepared to provide the model and serial number, found on the rating decal, located on the back of the controller's top cover.

**EXTEND YOUR WARRANTY:**  
**Use Whirlpool® WHE-WSC Water Softener Cleaner**  
**and register at [whirlpoolwatersolutions.com](http://whirlpoolwatersolutions.com)**

The factory warranty for your water softener is shown below. The two year full warranty period on parts and labor can be extended to ten (10) years from the date of purchase if you use Whirlpool® WHE-WSC Water Softener Cleaner on your system, and register your purchase of Whirlpool® WHE-WSC Water Softener Cleaner at [whirlpoolwatersolutions.com](http://whirlpoolwatersolutions.com). Use one bottle of Whirlpool® WHE-WSC Water Softener Cleaner, as directed, every four months from the date of purchase of the water softener. Purchase of no more than three (3) bottles of Whirlpool® WHE-WSC Water Softener Cleaner in a 12 month period may be applied toward compliance with this warranty. Use of any water softener additive other than Whirlpool® WHE-WSC will not provide extended warranty coverage.

**WATER SOFTENER WARRANTY - MODEL WHES60**

**Warrantor: Ecodyne Water Systems, 1890 Woodlane Drive, Woodbury, MN 55125**

Warrantor guarantees, to the original owner, that:

**Two Year Full Warranty:**

- When installed by a Lowe's Professional Series installer,\* for a period of two (2) years from the date of purchase, all parts will be free from defects in materials and workmanship and will perform their normal functions.
- When installed by a Lowe's Professional Series installer,\* for a period of two (2) years from the date of purchase, labor to repair or replace any part deemed to be defective in materials or workmanship, will be provided at no additional cost.

**Limited Warranties:**

- For a period of ten (10) years from the date of purchase, the salt storage tank and fiberglass mineral tank will not rust, corrode, leak, burst, or in any other manner, fail to perform its proper functions.
- For a period of three (3) years from the date of purchase, the electronic control board will be free of defects in materials and workmanship and will perform its normal functions.

If, during such respective period, a part proves to be defective, Warrantor will ship a replacement part, directly to your home, without charge. After the second year, labor necessary to maintain this product is not covered by the product warranty. If you have questions regarding a warranted product, need assistance with installation or troubleshooting, wish to order a part or report a warranty issue, we are just a phone call away. SIMPLY DIAL 1-866-986-3223 for assistance.

**General Provisions**

The above warranties are effective provided the water softener is operated at water pressures not exceeding 125 psi, and at water temperatures not exceeding 120°F; provided further that the water softener is not subject to abuse, misuse, alteration, neglect, freezing, accident or negligence; and provided further that the water softener is not damaged as the result of any unusual force of nature such as, but not limited to, flood, hurricane, tornado or earthquake.

Warrantor is excused if failure to perform its warranty obligations is the result of strikes, government regulation, materials shortages, or other circumstances beyond its control.

**THERE ARE NO WARRANTIES ON THE WATER SOFTENER BEYOND THOSE SPECIFICALLY DESCRIBED ABOVE. ALL IMPLIED WARRANTIES, INCLUDING ANY IMPLIED WARRANTY OF MERCHANTABILITY OR OF FITNESS FOR A PARTICULAR PURPOSE, ARE DISCLAIMED TO THE EXTENT THEY MIGHT EXTEND BEYOND THE ABOVE PERIODS. THE SOLE OBLIGATION OF WARRANTOR UNDER THESE WARRANTIES IS TO REPLACE OR REPAIR THE COMPONENT OR PART WHICH PROVES TO BE DEFECTIVE WITHIN THE SPECIFIED TIME PERIOD, AND WARRANTOR IS NOT LIABLE FOR CONSEQUENTIAL OR INCIDENTAL DAMAGES. NO WARRANTOR DEALER, AGENT, REPRESENTATIVE, OR OTHER PERSON IS AUTHORIZED TO EXTEND OR EXPAND THE WARRANTIES EXPRESSLY DESCRIBED ABOVE.**

Some states do not allow limitations on how long an implied warranty lasts or exclusions or limitations of incidental or consequential damage, so the limitations and exclusions in this warranty may not apply to you. This warranty gives you specific legal rights, and you may have other rights which vary from state to state. This warranty applies to consumer-owned installations only.

\* Warranty period will be one (1) year from the date of purchase if installation is not purchased from Lowe's. Proof of purchase of the softener and installation are required to validate warranty.

®/TM ©2017 Whirlpool. All rights reserved.

Manufactured under license by Ecodyne Water Systems, Woodbury, Minnesota.

Limited warranty provided by manufacturer.