

HP xw4600 Workstation

Service and Technical Reference Guide



Copyright Information

© 2007 Copyright Hewlett-Packard Development Company, L.P.

Warranty

Hewlett-Packard Company shall not be liable for technical or editorial errors or omissions contained herein or for incidental or consequential damages in connection with the furnishing, performance, or use of this material. The information in this document is provided "as is" without warranty of any kind, including, but not limited to, the implied warranties of merchantability and fitness for a particular purpose, and is subject to change without notice. The warranties for HP products are set forth in the express limited warranty statements accompanying such products.

Nothing herein should be construed as constituting and additional warranty.

This document contains proprietary information that is protected by copyright. No part of this document may be photocopied, reproduced, or translated to another language without the prior written consent of Hewlett-Packard Company.

Trademark Credits

Microsoft and Windows are U.S. registered trademarks of Microsoft Corporation.

Intel is a trademark of Intel Corporation in the U.S. and other countries.

ENERGY STAR is a U.S. registered mark of the United States Environmental Protection Agency.

453080-001

First Edition, September 2007

Table of contents

1 Product overview

Product features	2
System board architecture	2
Workstation components	2
Front panel components	4
Rear panel components	5
Serial number and COA label location	6
Maximizing the airflow	6
Workstation specifications	7
80 Plus power supply	7
Power supply specifications	8
Power consumption and cooling	8
Power supply example configuration 1	8
Power supply example configuration 2	9
Power supply example configuration 3	10
System fans	11
Resetting the power supply	12
Environmental specifications	12
ENERGY STAR	13
Dual- and quad-core processors	14
HP Cool Tools	14

2 Configuring and restoring the operating system

Setting up Microsoft Windows Vista Business software	15
Configuring the Windows Vista Business operating system	15
Configuring the software	15
Selecting a language	16
Creating recovery disks	16
Installing or upgrading device drivers	16
Restoring the Windows Vista Business operating system	16
Using the HP Backup and Restore process	16
Creating system recovery DVDs or CDs	17
Restoring from HPBR DVDs or CDs	17
Restoring a system directly from the recovery partition	17
Reclaiming hard drive space from the recovery partition	17
Ordering backup software	18
Transferring files and settings using Windows Easy Transfer	18
Setting up Microsoft Windows XP Professional	18
Configuring Windows XP Professional	19

Selecting a language	19
Creating recovery disks	19
Installing or upgrading device drivers	19
Restoring the Windows XP Professional operating system	20
The RestorePlus! process	20
Creating a RestorePlus! CD	20
Restoring your system from RestorePlus! CDs	20
Restoring your system from RestorePlus! on the recovery partition	20
Reclaiming hard drive space from the recovery partition	21
Using the HP Backup and Restore process	21
Creating system recovery DVDs or CDs	21
Restoring from HPBR DVDs or CDs	22
Restoring a system directly from the recovery partition	22
Ordering backup software	22
Protecting your software	22
HP software	22
Setting up Red Hat Linux	23
Linux preinstalled workstations	23
Starting the Linux operating system	23
Restoring the Linux operating system on preloaded workstations	23
Creating restore media	23
Downloading the latest HP driver CD contents	24
Reinstalling the factory Linux image with the HP driver CD	24
Upgrading device drivers	24
Linux-enabled workstations	24
Verifying hardware compatibility	25
Setting up Red Flag Linux	25

3 System management

Computer Setup (F10) Utility	27
BIOS ROM	28
Using the Computer Setup (F10) Utility	28
Computer Setup (F10) Utility menu	29
Workstation management	35
Initial workstation configuration and deployment	35
Installing a remote system	36
Replicating the setup	36
Copying a setup configuration to a single workstation	36
Copying a setup configuration to multiple workstations	37
Updating and managing software	37
HP Client Manager Software	37
Altiris Client Management Solutions	38
System Software Manager	38
Proactive Change Notification	38
Subscriber's Choice	39
ROM Flash	39
Remote ROM Flash	39
HPQFlash	39
FailSafe Boot Block ROM	39

Asset tracking and security	40
Password security	41
Establishing a setup password using the Computer Setup (F10) Utility	41
Establishing a power-on password using workstation setup	42
Entering a power-on password	42
Entering a Setup Password	43
Changing a power-on or setup password	43
Deleting a power-on or setup password	44
National keyboard delimiter characters	44
Clearing passwords	45
DriveLock	45
Hood Sensor (Smart Cover Sensor) (optional)	47
Setting the Hood Sensor protection level	47
Hood Lock (Smart Cover Lock) (optional)	47
Locking the Hood Lock	48
Unlocking the Hood Lock	48
Using the FailSafe key	48
Cable lock (optional)	48
Security lock (Padlock loop) (optional)	49
Universal chassis clamp lock (optional)	49
Fault notification and recovery	49
Drive Protection System	49
ECC fault prediction	49
Thermal sensors	49
Dual-state power button	49

4 Removal and replacement procedures

Warnings and cautions	52
Service considerations	53
Cautions, warnings, and safety precautions	53
ESD information	53
Generating static	53
Preventing ESD equipment damage	54
Personal grounding methods and equipment	54
Grounding the work area	55
Recommended ESD prevention materials and equipment	55
Tools and software requirements	56
Screws	56
Special handling of components	57
Cables and connectors	57
Hard drives	57
Lithium coin cell battery	58
Customer Self-Repair	58
Predisassembly procedures	58
System board components	59
Removing and replacing components	60
Disassembly order	61
Security lock (Padlock loop) (optional)	62
Removing the security lock	62

Cable lock (optional)	62
Removing the cable lock	63
Universal chassis clamp lock (optional)	63
Removing the chassis clamp lock	63
Side access panel	64
Removing the side access panel	64
Replacing the side access panel	65
Hood Sensor (Smart Cover Sensor) (optional)	65
Removing the Hood Sensor	66
Smart Cover Lock solenoid (optional)	66
Removing the Smart Cover Lock solenoid	66
Front bezel	67
Removing the front bezel	68
Replacing the front bezel	68
Bezel blanks	68
Removing bezel blanks	68
Front panel I/O device assembly	69
Removing the front panel I/O device assembly	69
Installing the front panel I/O device assembly	71
Power button assembly	71
Removing the power button assembly	71
System speaker	72
Removing the system speaker	73
Power supply	73
Removing the power supply	73
System fan assembly	74
Removing the system fan assembly	74
Memory	75
Removing a memory module	75
Installing a memory module	76
Supported DIMM configurations	76
Memory module requirements	76
Required DIMM installation order	77
Installing a memory module	77
PCI card slots	79
PCI card support bracket	80
Removing a PCI card support bracket	80
Installing a PCI card support bracket	80
PCI Express cards	81
Removing a PCI Express card	81
Installing a PCI Express card	82
PCI card	83
Removing a PCI card	83
Installing a PCI card	84
IEEE-1394 card (optional)	85
Removing an IEEE-1394 card	85
Front PCI card guide and fan removal (optional)	86
Removing the front PCI card guide and fan	86
Battery	87
Removing the battery	88

Installing the battery	88
Power connections to drives	89
Optical drive (minitower configuration)	90
Removing an optical drive (minitower configuration)	90
Installing an optical drive (minitower configuration)	91
Optical drive (desktop configuration)	92
Removing an optical drive (desktop configuration)	92
Installing an optical drive (desktop configuration)	94
Diskette drive (optional)	95
Removing a diskette drive	95
SAS hard drive	96
Removing a SAS hard drive	96
Installing a SAS hard drive	97
SATA hard drive	99
Removing a SATA hard drive	99
Installing a SATA hard drive	100
Installing SATA hard drives in the optical drive bays (optional)	102
Processor heatsink	103
Removing the processor heatsink	103
Installing the processor heatsink	105
System processor	105
Removing a system processor	105
Installing a system processor	106
System board	107
Removing the system board	107
Installing the system board	108
Product recycling	108

5 System diagnostics and troubleshooting

Customer Self Help	110
Help and Support Center	110
HP SoftPaq Download Manager	110
Diagnostic LED codes	110
Troubleshooting scenarios and solutions	113
Solving minor problems	113
Solving power supply problems	114
Testing power supply	115
Solving diskette problems	116
Solving hard drive problems	117
Solving display problems	118
Solving audio problems	120
Solving printer problems	121
Solving keyboard and mouse problems	122
Solving front panel component problems	123
Solving hardware installation problems	123
Solving network problems	125
Solving memory problems	126
Solving processor problems	127
Solving DVD problems	127
Solving Internet access problems	128

Troubleshooting checklist	129
LED color definitions	129
HP Insight Diagnostics Offline Edition	131
Key features and benefits	131
Theory of operation	131
Diagnostic utility on CD	131
Downloading the latest diagnostic utility	132
User Interface	132
Navigation	132
Survey tab	132
Test tab	133
Status tab	134
Log tab	134
Help tab	135
POST error messages	135

6 Configuring RAID devices

Configuring SAS RAID devices	141
Supported configurations	141
SAS RAID 0 configuration	142
SAS RAID 1 configuration	142
SAS RAID 1E configuration	143
Configuring SATA RAID devices	144
Attaching SATA HDDs	144
Configuring system BIOS	144
Creating RAID volumes	145
Deleting RAID volumes	145

7 Configuring password security and resetting CMOS

Preparing to configure passwords	148
Resetting the password jumper	149
Clearing and Resetting the CMOS	150
Using the CMOS Button	150
Using the Computer Setup (F10) Utility to Reset CMOS	151

Appendix A Appendix A—Connector pins

Connector pin descriptions	153
----------------------------------	-----

Appendix B Appendix B—System board designators

Appendix C Appendix C—Routine care

General cleaning safety precautions	165
Cleaning the workstation case	166
Cleaning the keyboard	166
Cleaning the monitor	166
Cleaning the mouse	167

1 Product overview

This chapter presents an overview of the hardware components of the HP xw4600 Workstation, including the following topics:

- [Product features on page 2](#)
- [Workstation specifications on page 7](#)
- [ENERGY STAR on page 13](#)
- [Dual- and quad-core processors on page 14](#)
- [HP Cool Tools on page 14](#)

See <http://partsurfer.hp.com> for current information on supported spare parts.

Figure 1-2 Workstation components view

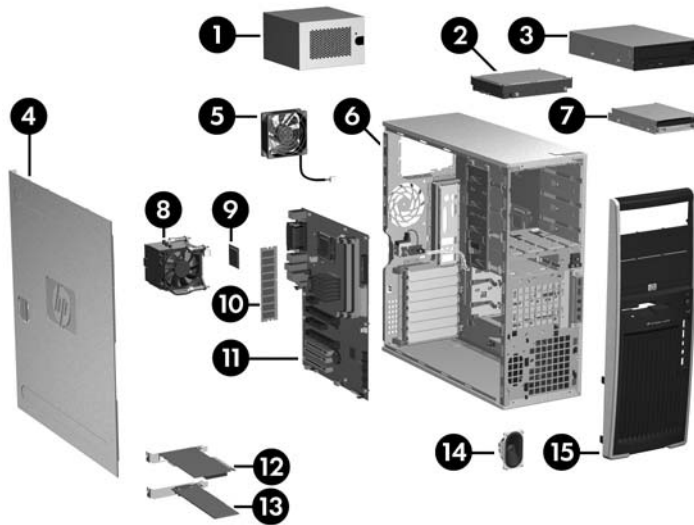

Table 1-1 Component view

Item	Description	Item	Description
1	Power supply	9	Processor
2	Hard drive	10	Memory module
3	Optical drive	11	System board
4	Side access panel	12	PCI Express card
5	System fan	13	PCI card
6	Chassis	14	Speaker
7	Diskette drive	15	Front bezel
8	Processor heatsink		

Front panel components

The following figure shows the front panel components of a typical HP xw4600 Workstation. Drive configurations can vary.

Figure 1-3 Front panel components

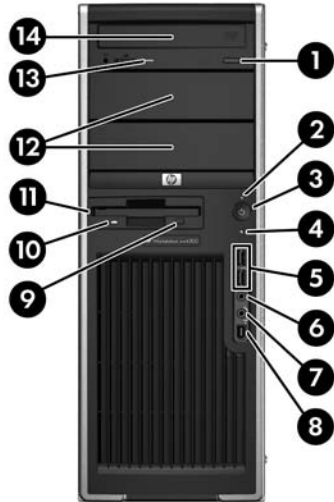







Table 1-2 Front panel components

Item	Symbol	Description	Item	Symbol	Description
1		Optical drive eject button	8		IEEE-1394 Connector (optional)
2		Power on light	9		Diskette drive eject button
3		Power button	10		Diskette drive activity light
4		Hard drive activity light	11		Diskette drive (optional)
5		USB 2.0 (2)	12		5.25-inch drive bays (2)
6		Headphone connector	13		Optical drive activity light
7		Microphone connector	14		Optical drive

Rear panel components

The following figure shows the rear panel components of a typical HP xw4600 Workstation.

Figure 1-4 Rear panel components

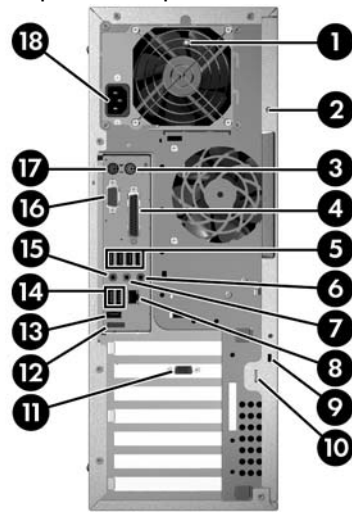













Table 1-3 Rear panel components

Item	Symbol	Description	Item	Symbol	Description
1		Power supply Built-In Self Test (BIST) LED	10		Padlock loop
2		Universal chassis clamp opening	11		Graphics adapter
3		PS/2 mouse connector (green)	12		eSATA adapter
4		Parallel connector (red)	13		USB 2.0 (1)
5		USB 2.0 (4)	14		USB 2.0 (2)
6		Audio line-in connector (blue)	15		Microphone connector (pink)
7		Audio line-out connector (green)	16		Serial connector (blue-green)
8		RJ-45 network connector	17		PS/2 keyboard connector
9		Cable lock slot	18		Power cord connector

 **NOTE:** The rear panel connectors are labeled with industry-standard icons and colors to assist you in connecting your peripheral devices.

Serial number and COA label location

Each workstation has two unique serial number labels (1) and a Certificate of Authentication (COA) label (2) (for Microsoft® Windows® preinstalled systems only). The serial number labels can usually be found on the top panel or on the side or rear of the workstation. Keep this number available when contacting customer service for assistance.

Figure 1-5 Location of serial number and COA label



Maximizing the airflow

- Keep your workstation in an area where the airflow is not obstructed.
- Keep the workstation off of surfaces where dust can gather.
- Keep the front of the workstation clear of any obstruction.
- Remove any dust on the front panel (vent area) and the rear fans with a small vacuum, compressed air, or dust rag.
- Keep the back of the workstation at least 0.15 m (6 in.) away from a wall or other obstruction.

Figure 1-6 Maintain proper clearance

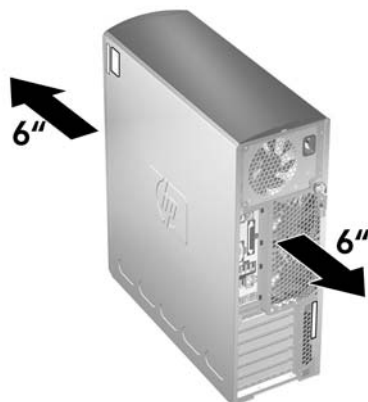

Workstation specifications

The following table lists the physical characteristics of the HP xw4600 Workstation.

Table 1-4 Physical characteristics

Weight (typical configuration)	16 kg (35 lb.)
Tower dimensions	45 cm (17.7 in.) high
	16.8 cm (6.6 in.) wide
	45.6 cm (17.9 in.) deep

80 Plus power supply

The HP xw4600 Workstation includes a 475W energy efficient 80 Plus® power supply compatible with Energy Star requirements. This section describes the power supply and lists its specifications.

Table 1-5 Power supply source voltages

Source voltage	Description
+3.3V	PCI, PCI Express, audio, CK505, ICH9R, super I/O, BIOS ROM, and onboard logic
+5.1V	Storage (hard drive, optical drive, diskette drive), PCI, PCI Express, ICH9R, audio, keyboard/mouse
+12 V-B	PCI, PCI Express, and system fans
+12 V-D	Storage (hard drive, optical drive, diskette drive), PCI Express x16 auxiliary connector
+12 VCPU	Input to onboard regulator that supplies power to the processor.
-12V	PCI, serial ports
+5 VSB	Sleep circuitry

Table 1-6 Maximum current per rail

Voltage rail	Maximum continuous current
+3.3V	15A
+5.1V	21A
+12 VCPU	15A
+12 V-B	17.5A
+12 V-D	12A
-12V	0.3A
+5 VSB	2.25A

⚠ WARNING! Do not exceed 110W of 5-V and 3.3-V power combination.

Do not exceed 34.5A (414W) of 12V (CPU/B/D) power combination.

Do not exceed 475W of total continuous output power.

Power supply specifications

Table 1-7 Power supply specifications

Item	Description
Power supply	475 watt custom power supply – (Wide Ranging, Active PFC)
Operating voltage range	90 – 269 VAC
Rated voltage range	100–240 VAC 118 VAC
Rated line frequency	50–60 Hz 400 Hz
Operating line frequency range	47–66 Hz 393–407 Hz
Rated input current	10A @ 100-127 VAC 10A @ 118 VAC 6A @ 200–240 VAC
Heat dissipation (Configuration and software dependent)	Typical 1419 BTU/hr = (358 kg-cal/hr) Maximum 2027 BTU/hr = (511 kg-cal/hr)
Power supply fan	92x25 mm variable speed
ENERGY STAR 4.0 compliant	Yes
80 Plus compliant	Yes
FEMP Standby Power compliant @115V (<2W in S5 – Power Off)	Yes
Power Consumption in ES Mode – Suspend to RAM (S3) (Instantly Available PC)	< 5W

Power consumption and cooling

This section lists the energy consumption and heat dissipation figures for three typical workstation configurations.

NOTE: To reach zero power consumption, unplug the workstation from the power outlet or use a power strip with an on/off switch. For additional information about power-saving features, see your operating system documentation.

NOTE: This product is in compliance with U.S. Executive Order 13221, WOL (wake on LAN) disabled.

Power supply example configuration 1

- One 2.20-GHz Intel® Pentium™ Dual Core E4500 processor
- Two 512-MB 667-MHz memory modules
- Nvidia NVS290 graphics card

- One 160-GB SATA hard drive
- One optical drive
- One diskette drive
- One monitor, powered separately

Table 1-8 Power supply example configuration 1 energy consumption

	115 VAC		230 VAC		100 VAC	
	LAN Enabled	LAN Disabled	LAN Enabled	LAN Disabled	LAN Enabled	LAN Disabled
Windows Idle (S0)	67.4W		66.4W		65.5W	
Windows Busy Typ (S0)	89.7W		88.4W		88.2W	
Windows Busy Max (S0)	114.1W		109.6W		110.0W	
Sleep (S3)*	3.61W	2.82W	3.89W	3.12W	3.61W	2.82W
Power Off (S5)	1.51W	1.30W	1.81W	1.60W	1,50W	1.28W

* ENERGY STAR low energy mode.

Table 1-9 Power supply example configuration 1 heat dissipation**

	115 VAC		230 VAC		100 VAC	
	LAN Enabled	LAN Disabled	LAN Enabled	LAN Disabled	LAN Enabled	LAN Disabled
Windows Idle (S0)	230.1 BTU/hr		226.6 BTU/hr		223.6 BTU/hr	
Windows Busy Typ (S0)	306.3 BTU/hr		301.6 BTU/hr		300.9 BTU/hr	
Windows Busy Max (S0)	389.4 BTU/hr		374.1 BTU/hr		375.4 BTU/hr	
Sleep (S3)*	12.3 BTU/hr	9.62 BTU/hr	13.3 BTU/hr	10.6BTU/hr	12.3 BTU/hr	9.62 BTU/hr
Power Off (S5)	5.15 BTU/hr	4.44 BTU/hr	6.18 BTU/hr	5.46 BTU/hr	5.12 BTU/hr	4.37 BTU/hr

* ENERGY STAR low energy mode.

** Heat dissipation is calculated based on the measured watts, assuming the service level is attained for one hour.

 **NOTE:** To reach zero power consumption, unplug the workstation from the power outlet or use a power strip with a switch. For additional information on power-saving features, see your operating system documentation.

Power supply example configuration 2

- One 3.0 -GHz Intel® Core™ 2 Extreme QX6850 processor
- Two 1-GB 800-MHz memory modules
- Nvidia FX1700 graphics card
- Two 73-GB SAS hard drives

- 2 optical drives
- 1 diskette drive

Table 1-10 Power supply example configuration 2 energy consumption

	115 VAC		230 VAC		100 VAC	
	LAN Enabled	LAN Disabled	LAN Enabled	LAN Disabled	LAN Enabled	LAN Disabled
Windows Idle (S0)		113W		108W		113W
Windows Busy Typ (S0)		138W		133W		138W
Windows Busy Max (S0)		186W		178W		183W
Sleep (S3)*	3.70W	2.90W	3.95W	3.20W	3.70W	2.90W
Power Off (S5)	1.52W	1.30W	1.81W	1.58W	1.50W	1.28W

* ENERGY STAR low energy mode.

Table 1-11 Power supply example configuration 2 heat dissipation**

	115 VAC		230 VAC		100 VAC	
	LAN Enabled	LAN Disabled	LAN Enabled	LAN Disabled	LAN Enabled	LAN Disabled
Windows Idle (S0)		386 BTU/hr		369 BTU/hr		386 BTU/hr
Windows Busy Typ (S0)		471 BTU/hr		454 BTU/hr		471 BTU/hr
Windows Busy Max (S0)		635 BTU/hr		608 BTU/hr		625 BTU/hr
Sleep (S3)*	12.6 BTU/hr	9.89 BTU/hr	13.5 BTU/hr	10.9 BTU/hr	12.6 BTU/hr	9.89 BTU/hr
Power off (S5)	5.19 BTU/hr	4.44 BTU/hr	6.18 BTU/hr	5.39 BTU/hr	5.12 BTU/hr	4.37 BTU/hr

* ENERGY STAR low energy mode

** Heat dissipation is calculated based on the measured watts, assuming the service level is attained for one hour.

Power supply example configuration 3

- One 3.0-GHz Intel® Pentium™ Dual Core E6850 processor
- Two 1-GB 667-MHz memory modules
- Nvidia FX1700 graphics card
- Two 160-GB SATA hard drives
- 1 optical drives

Table 1-12 Power supply Example configuration 3 energy consumption

	115 VAC	230 VAC	100 VAC
On-idle, ENERGY STAR	76.3W	75.3W	76.6W

Table 1-12 Power supply Example configuration 3 energy consumption (continued)

	115 VAC	230 VAC	100 VAC
Idle (S0)			
ENERGY STAR Ptec (Total energy consumption)	162.3W	159.6W	163.2W
Windows running Linpack and Viewperf			
ENERGY STAR	3.7W	4.1W	3.8W
Sleep (S3)*			
ENERGY STAR	1.5W	1.8W	1.5W
Standby (Off) (S5)			

ⁱ¹ * ENERGY STAR low energy mode

Table 1-13 Power supply example configuration 3 heat dissipation**

	115 VAC	230 VAC	100 VAC
On-idle, ENERGY STAR	260 BTU/hr	257 BTU/hr	261 BTU/hr
Idle (S0)			
ENERGY STAR Ptec (Total energy consumption)	554 BTU/hr	545 BTU/hr	557 BTU/hr
Windows running Linpack and Viewperf			
ENERGY STAR	12.6 BTU/hr	14.0 BTU/hr	13.0 BTU/hr
Sleep (S3)*			
ENERGY STAR	5.12 BTU/hr	6.14 BTU/hr	5.12 BTU/hr
Standby (Off) (S5)			

* ENERGY STAR low energy mode

** Heat dissipation is calculated based on the measured watts, and assumes that the service level is attained for one hour.

System fans

This workstation includes one rear system fan, one processor heatsink fan, and one power supply fan. In addition, an optional front system fan is available for special environments, and some graphics cards include onboard fans.

Resetting the power supply

If an overload triggers the power supply overload protection, all power is immediately disconnected. To reset the power supply:

1. Disconnect the power cord from the workstation..
2. Determine what caused the overload and fix the problem. See [System diagnostics and troubleshooting on page 109](#) for troubleshooting information.
3. Reconnect the power cord and reboot the workstation.

When you power off the workstation through the operating system, power consumption falls below what is considered low power consumption, but does not reach zero. This low power consumption feature extends the life of the power supply.

Environmental specifications

This section describes the environmental specifications of your workstation.

Table 1-14 Environmental specifications

Temperature (operating)	5° to 35°C (40° to 95°F)
Temperature (nonoperating)	-40° to 60°C (-40° to 140°F)
Humidity (operating)	8% to 85% RH, noncondensing
Humidity (nonoperating)	8% to 90% RH, noncondensing
Altitude (operating)	0 to 3,048m (10,000 ft)
Altitude (nonoperating)	0 to 9,144m (30,000 ft)
Shock (operating)	1/2-sine: 40G, 2–3 ms
Shock (nonoperating)	1/2-sine: 160 cm/s, 2–3 ms (~100g) Square: 20G, 422 cm/s NOTE: Values represent individual shock events and are not indicative of repetitive shock events.
Vibration (operating)	Operating random: 0.5G (rms), 5–300 Hz
Vibration (nonoperating)	Random: 2.0G (rms), 10–500 Hz NOTE: Values are not indicative of continuous vibration.

ENERGY STAR

HP computers marked with the ENERGY STAR logo are compliant with the applicable U.S. Environmental Protection Agency (EPA) ENERGY STAR specifications for computers. The EPA ENERGY STAR logo does not imply endorsement by the EPA. As an ENERGY STAR Partner, Hewlett-Packard Company has determined the products marked with the ENERGY STAR logo are ENERGY STAR qualified per the applicable ENERGY STAR guidelines for energy efficiency. The following logo appears on all ENERGY STAR qualified computers.

Figure 1-7 ENERGY STAR logo



The ENERGY STAR Computers Program was created by the EPA to promote energy efficiency and reduce air pollution through more energy-efficient equipment in homes, offices, and factories. One way products achieve this energy efficiency is by reducing power consumption when not being used through the Microsoft Windows Power Management feature.

The Power Management feature enables the workstation to enter a low-power (or “sleep”) mode after a period of inactivity. When used with an external monitor that is ENERGY STAR compliant, this feature also supports the monitor's similar power management features.

To take advantage of this energy savings:

- The Power Management feature has been preset to power down the computer after 30 minutes of inactivity.
- The Power Management feature has been preset to power down the monitor after 15 minutes of inactivity.

Both the computer and monitor can be woken from “sleep” mode through user interaction with any of the computer input devices (mouse, keyboard, and so on). When configured with Wake On LAN (WOL) enabled, the workstation can also be awoken by a network signal.

See the EPA ENERGY STAR Power Management Web site for more information about the energy and financial savings potential of the Power Management Feature: <http://www.energystar.gov/powermanagement>.

See the EPA ENERGY STAR Web site for more information about the ENERGY STAR program and its environmental benefits: <http://www.energystar.gov>.

△ **CAUTION:** Using the Energy Save Monitor feature with monitors that are not ENERGY STAR compliant can cause video distortion when an Energy Save timeout occurs.

📄 **NOTE:** ENERGY STAR is not supported on Linux workstations.

If it is necessary to restore the operating system, you must also reset the ENERGY STAR settings (if applicable) after the restore.

To verify the factory default power settings for your workstation, select **Start>Control Panel** and double-click **Power Options**.

Dual- and quad-core processors

The HP xw4600 Workstation supports dual- and quad-core processors that provide two or four true processors in a single socket. Dual- and quad-core processors are better at handling the load of multi-threaded applications (such as rendering images in Digital Content Creation) and highly multi-tasked environments (such as running several productivity applications while listening to music).

HP Cool Tools

HP xw4600 Workstation includes additional software preloaded that is not automatically installed when you first boot your system. Additionally, there are a number of preinstalled tools on your workstation that can enhance your workstation experience. To access or learn more about these applications:

- Open the HP Cool Tools folder by selecting **Start>All Programs>HP Cool Tools**.
- Select the **HP Cool Tools** icon on the desktop.

To learn more about these applications, select **HP Cool Tools—Learn More**.

To install or launch the applications, select the appropriate application.

2 Configuring and restoring the operating system

This chapter describes how to install and restore the operating system and includes the following topics.

- [Setting up Microsoft Windows Vista Business software on page 15](#)
- [Setting up Microsoft Windows XP Professional on page 18](#)
- [Protecting your software on page 22](#)
- [HP software on page 22](#)
- [Setting up Red Hat Linux on page 23](#)

If your workstation includes a preinstalled operating system, it is configured automatically the first time you power on the workstation.

-
- △ **CAUTION:** Do not add optional hardware or third-party devices to the HP workstation until the operating system is successfully installed. Adding hardware might cause errors and prevent the operating system from installing correctly.
-

Setting up Microsoft Windows Vista Business software

This section describes how to install and restore Microsoft Windows Vista® Business on your workstation.

Configuring the Windows Vista Business operating system

This section describes how to configure the Windows Vista Business operating system on your HP workstation.

Configuring the software

When you first power on the workstation, the operating system is configured. Configuration takes approximately 5 to 10 minutes. Carefully follow the instructions on the screen to complete the configuration.

-
- △ **CAUTION:** After the automatic configuration has begun, do not power off your workstation until this process is complete. Powering off your workstation during the process might damage the software that runs the system.
-

If it is necessary to reinstall the operating system, see the operating system documentation included with your workstation. Additional information is available from the online help tool after you have successfully configured the operating system.

Selecting a language

When the preinstalled operating system is first booted, you might be prompted to select a language for the operating system. After selecting the language, read and follow the instructions on the screen to complete the installation of the operating system. This process might take a while, depending on the system hardware configuration and the language choice. During the process, do not power off your workstation unless you are prompted to do so.

After you have selected a language during the initial boot of the operating system, the language is locked on the hard drive. If the system is restored using HP Backup and Recovery, only the previously selected language can be installed. If using RestorePlus! DVDs, the RestorePlus! DVD looks for the language stored on the hard drive and restores only the original preinstalled language. If a new hard drive is installed or no language is found on the disk, the RestorePlus! DVD installs any language requested.

Creating recovery disks

For more information about the HP Backup and Recovery, see [Restoring the Windows Vista Business operating system on page 16](#).

Installing or upgrading device drivers

To install hardware devices after the operating system installation is complete, the appropriate device drivers must be installed before the devices are installed. In addition, for optimum performance, your operating system must have the most recent updates, patches, and software fixes. For driver and software updates, access the following resources:

- The Microsoft Web site provides updates for your operating system, including current patches and software fixes.
- Device drivers are provided on CDs supplied with peripheral devices.
- Some peripheral device drivers developed for Windows XP or Vista might not be included with your workstation. Current device drivers are available at http://www.hp.com/support/workstation_swdrivers.
- Driver installation and workstation operation documentation is available at http://www.hp.com/support/workstation_manuals/.

Restoring the Windows Vista Business operating system

There are several methods to restore the Windows Vista Business operating system on your workstation to a near-factory state, or to the state of the system at a predefined restore point. Your workstation has a recovery partition on the system hard drive that contains the software and data required for the restore process as described in the following sections.

If you must restore the operating system with Windows Vista Business Original Equipment Manufacturer (OEM) DVDs (that is, installing without using the Restore Plus! DVDs), you must call Microsoft and provide your Stock Keeping Unit (SKU) number. The SKU information is listed on the service tag. It appears as the OS product number in the lower right hand portion of the tag in this format: "OS: XXXXXXXX," where "XXXXXXX" is the OS product number.

Using the HP Backup and Restore process

The Windows operating system and device drivers (for devices included with the system) are reinstalled using the HP Backup and Restore (HPBR) process. This process can be executed from a DVD, CD, or from the recovery partition on your system hard drive.

To launch the HPBR, select **Start>All Programs>HP Backup & Recovery>HP Backup and Recovery Manager**.

△ **CAUTION:** Before you attempt any operating system restore, backup your data. All data on the Windows partition is deleted when you perform a system restore using the HPBR process. However, the recovery partition on the system drive and other partitions will not be affected.

Creating system recovery DVDs or CDs

You can create a set of system recovery DVDs or CDs if you have a writable optical drive. After launching the HP Backup and Restore Manager, you can create International Standards Organization (ISO) images of the factory image, or write them directly to CD or DVD. You can also create a supplemental HP Backup and Recovery Manager CD. (There may be additional CDs you can create depending on the options purchased.) You can also move CD images to another location, such as a network share, or to be copied to a DVD or CD at a later time or from another system.

Restoring from HPBR DVDs or CDs

To start the system recovery process, boot from the DVD or CD you created previously, then carefully follow the online instructions.

Restoring a system directly from the recovery partition

Follow these steps to start the HPBR system restore process from the Recovery Manager:

1. Boot the workstation.
2. When prompted on the boot splash screen to enter the Recovery Manager, press **F11**.
3. Follow the prompts to restore the system to factory-like condition.

Reclaiming hard drive space from the recovery partition

To free up hard drive space, you can remove only the recovery partition, or you can completely uninstall the HP Backup and Recovery Manager application.

△ **CAUTION:** If the recovery partition is removed:

- The **F11** Emergency Recovery function becomes unavailable.
 - The ability to recover the system is lost.
 - Any recovery images contained in the recovery partition are deleted.
 - The ability to create a recovery media set is lost.
-

△ **CAUTION:** If you uninstall the HP Backup and Recovery Manager application, emergency recovery and data backup and recovery are no longer possible.

- **Removing only the recovery partition**—The recovery partition can be removed by selecting **Remove HP Recovery Partition** from the HP Backup and Recovery program folder. When the HP Recovery Partition is removed, the recovery partition is deleted, the user partition is extended to reclaim the unused hard drive space, and the F11 boot prompt is removed. The HP Backup and Recovery Manager application remains and can be used for data backup and restore.
- **Uninstalling the HP Backup and Recovery Manager application**—The HP Backup and Recovery Manager application can be uninstalled using the Programs and Features utility under

Windows Control Panel>Programs and Features. When the application is uninstalled, the recovery partition is deleted, the user partition is extended to reclaim the unused space, and the F11 boot prompt is removed. After the application is uninstalled, emergency recovery and data backup and recovery can no longer be performed.

△ **CAUTION:** Deleting the recovery partition or uninstalling the HP Backup and Recovery Manager application reduces or eliminates the ability to recover the system.

Ordering backup software

If you are unable to create system recovery CDs or DVDs, you can order a recovery disk set from the HP support center. Before calling HP to order the software, have your workstation serial number available.

To obtain the support center telephone number for your region:

1. Go to http://welcome.hp.com/country/us/en/wwcontact_us.html.
2. Select your region.
3. Under the Call HP heading, select **Technical support after you buy**.

Transferring files and settings using Windows Easy Transfer

Windows Easy Transfer, a Microsoft data migration tool, provides a guide that helps you choose what files and data to transfer from another Windows computer to your Windows Vista Business workstation and explains how to transfer it. You can use one of the following interconnect or storage methods with Windows Easy Transfer to migrate data from another Windows computer to your workstation:

- **Network**—can be used when both the source computer and your workstation are connected to the same network.
- **Easy Transfer cable**—a specially designed USB cable that connects the source computer to your workstation when performing a Windows Easy Transfer. While an Easy Transfer cable is not a standard USB cable, it is commonly available from local electronics suppliers.
- **DVDs or CDs**—can be used if you have writeable DVD or CD drives on the source computer and your workstation.
- **USB flash drive or an external hard drive**—can access both the source computer and your workstation.

To use the Windows Easy Transfer tool, select **Start>All Programs>Accessories>System Tools>Windows Easy Transfer**.

 **NOTE:** For more information about using Windows Easy Transfer with your workstation, see <http://www.microsoft.com/windows/products/windowsvista/features/details/easytransfer.mspx>.

Setting up Microsoft Windows XP Professional

This section describes how to configure and restore Microsoft® Windows XP™ Professional on your workstation.

Configuring Windows XP Professional

This section describes how to configure Windows XP on your workstation.

When you first power on to the workstation, the operating system is configured. Configuration takes approximately 5 to 10 minutes. Carefully follow the instructions on the screen to complete the configuration.

△ **CAUTION:** After configuration begins, do not power off your workstation until the process is complete. Powering off your workstation during the configuration process might damage the software that runs the system.

If it is necessary to reinstall the operating system, see the operating system documentation included with your workstation. Additional information is available from the online help tool after you have successfully configured the operating system.

Selecting a language

When the preinstalled operating system is first booted, you might be prompted to select a language for the operating system. After selecting the language, read and follow the instructions on the screen to complete the installation of the operating system. This process might take quite a while, depending on the system hardware configuration and the language choice. During the process, do not power off your workstation unless you are prompted to do so.

📄 **NOTE:** After you have selected a language during the initial boot of the operating system, the language is locked on the hard drive. If the system is restored using HP Backup and Recovery, only the previously selected language can be installed. If using RestorePlus! DVDs, the RestorePlus! DVD looks for the language stored on the hard drive and restores only the original preinstalled language. If a new hard drive is installed, or no language is found on the disk, the RestorePlus! DVD installs any language requested.

Creating recovery disks

Refer to or [Restoring the Windows XP Professional operating system on page 20](#) for details on the HP Backup and Recovery process.

Installing or upgrading device drivers

To install hardware devices after the operating system installation is complete, the appropriate device drivers must be installed before the devices are installed. In addition, for optimum performance, your operating system must have the most recent updates, patches, and software fixes. For driver and software updates, access the following resources:

- The Microsoft Web site provides updates for your operating system, including current patches and software fixes.
- Device drivers are provided on CD supplied with peripheral devices.
- Some peripheral device drivers developed for Windows XP or Vista might not be included with your workstation. Current device drivers are available at: <http://www.hp.com/support/>.
- For documentation on installing drivers and workstation operation, see http://www.hp.com/support/workstation_manuals/.

Restoring the Windows XP Professional operating system

There are several methods to restore the Windows XP operating system on your workstation to a near-factory state, or to the state of the system at a predefined snapshot in time. Your workstation has a recovery partition on the system hard drive that contains the software and data required for the restore process as described in the following sections.

The RestorePlus! process

The Windows operating system and device drivers (for devices included with the system) are reinstalled using the RestorePlus! process. Some application software might not be restored using this process. If specific application software was not restored, you must install the application software from the appropriate application CD. The RestorePlus! process can be executed from a CD or from the recovery partition on your system hard drive.

△ **CAUTION:** Before you attempt any operating system restore, back up your data . All data on the Windows partition is deleted when you perform a system restore using the RestorePlus! process. However, the recovery partition on the system drive and other partitions are not affected.

Creating a RestorePlus! CD

You can create a set of the system recovery CDs if you have a writable optical drive. When you first boot the workstation, you are prompted to create CDs for RestorePlus!, the Windows operating system, and a supplemental HP Backup and Recovery Manager. (There might be additional CDs you can create, depending on the options purchased.) You also have the option to move CD images to another location, such as a network share, to be copied to CD at a later time, or from another system.

Restoring your system from RestorePlus! CDs

Start the RestorePlus! process by booting from the RestorePlus! CD.

Restoring your system from RestorePlus! on the recovery partition

Follow these steps to start the RestorePlus! process from the Emergency Recovery menu:

1. Boot the workstation.
2. When prompted during the boot process to select the Emergency Recovery menu, press **F11** . The F11 prompt appears briefly during the boot process.

If you have a recovery partition but the F11 prompt is not visible:

- a. To access the setup menu, press **F10**. (See [Using the Computer Setup \(F10\) Utility on page 28](#) for details.)
 - b. From the drop down menu, select **Advanced**.
 - c. Select **Power-On Options**.
 - d. Ensure that the F11 prompt is set to **Displayed**.
 - e. Ensure that Factory Recovery Boot Support is set to **Enabled**.
 - f. Reboot the workstation and press **F11** when prompted.
3. Select **Recover PC's factory installed operating system, drivers, utilities, and applications** from the Emergency Recovery menu.

 **NOTE:** Some applications might not be restored using this method.

Reclaiming hard drive space from the recovery partition

The recovery partition can be removed to reclaim the hard drive space.

△ **CAUTION:** If the recovery partition is removed:

- The **F11** Emergency Recovery function becomes unavailable.
- The ability to recover the system from data on the recovery partition is lost.
- Any recovery images contained in the recovery partition are deleted.
- The ability to create a recovery media set is lost.

To free up hard drive space, you can remove only the recovery partition, or you can completely uninstall the HP Backup and Recovery Manager application.

△ **CAUTION:** If you uninstall the HP Backup and Recovery Manager application, Emergency Recovery and data backup and recovery can no longer be performed.

- **Removing only the recovery partition**—The recovery partition can be removed by selecting **Remove HP Recovery Partition** from the HP Backup and Recovery program folder. When the HP Recovery Partition is removed, the recovery partition is deleted, the user partition is extended to reclaim the unused hard drive space, and the F11 boot prompt is removed. The HP Backup and Recovery Manager application remains, and can be used for data backup and restore.
- **Uninstalling the HP Backup and Recovery Manager application**—The HP Backup and Recovery Manager application can be uninstalled using the Programs and Features utility under **Windows Control Panel>Programs and Features**. When the application is uninstalled, the recovery partition is deleted, the user partition is extended to reclaim the unused space, and the F11 boot prompt is removed. After the application is uninstalled, emergency recovery as well as data backup and recovery can no longer be performed.

△ **CAUTION:** Deleting the recovery partition or uninstalling the HP Backup and Recovery Manager application reduces or eliminates the ability to recover the system.

Using the HP Backup and Restore process

The Windows operating system and device drivers (for devices included with the system) are reinstalled using the HP Backup and Restore (HPBR) process. This process can be executed from a DVD, CD, or from the recovery partition on your system hard drive.

To launch the HPBR, select **Start>All Programs>HP Backup & Recovery>HP Backup and Recovery Manager**.

△ **CAUTION:** Before you attempt any operating system restore, backup your data. All data on the Windows partition is deleted when you perform a system restore using the HPBR process. However, the recovery partition on the system drive and other partitions will not be affected.

Creating system recovery DVDs or CDs

You can create a set of system recovery DVDs or CDs if you have a writable optical drive. After launching the HP Backup and Restore Manager, you can create International Standards Organization (ISO) images of the factory image, or write them directly to CD or DVD. You can also create a supplemental HP Backup and Recovery Manager CD. (There may be additional CDs you can create depending on

the options purchased.) You can also move CD images to another location, such as a network share, or to be copied to a DVD or CD at a later time or from another system.

Restoring from HPBR DVDs or CDs

To start the system recovery process, boot from the DVD or CD you created previously, then carefully follow the online instructions.

Restoring a system directly from the recovery partition

Follow these steps to start the HPBR system restore process from the Recovery Manager:

1. Boot the workstation.
2. When prompted on the boot splash screen to enter the Recovery Manager, press **F11**.
3. Follow the prompts to restore the system to factory-like condition.

Ordering backup software

If you are unable to create system recovery CDs or DVDs, you can order a recovery disk set from the HP support center.

 **NOTE:** Before calling HP to order the software, have your workstation serial number available.

To obtain the support center telephone number for your region:

1. Visit <http://www.hp.com/support/contactHP>.
2. Select your region.
3. Under the Call HP heading, select **Technical support after you buy**.

Protecting your software

To protect your software from loss or damage, keep a backup copy of all system software and related files stored on the hard drive. For instructions on making backup copies of data files, see the operating system or backup utility documentation.

HP software

The following HP software might be installed on your workstation, depending on the operating system and options purchased:

- Computer Setup (F10) Utility and diagnostics
- HP support software, including device drivers
- Security management tools (optional)
- Software support management tools

Additional software is available for download:

- HP Client Manager Software is available at <http://www.hp.com/go/easydeploy>
- System Software Manager is available at <http://www.hp.com/go/ssm>

 **NOTE:** In certain situations, additional HP software might be required

Setting up Red Hat Linux

This section describes how to install and restore the Red Hat Linux operating system on your workstation.

Linux preinstalled workstations

With Linux preinstalled, follow the instructions in this section to set up your operating system and software.

After the boot process is complete, you can view additional HP Linux documentation by opening your Web browser (the browser is automatically set to use the local HP documentation page as its default). You can also access Linux links for Red Hat (Internet access is required) by using your Web browser.

For additional information about setting up Linux-preinstalled or Linux-enabled workstations, see the *HP User Manual for Linux* at: http://www.hp.com/support/linux_user_manual.

For more information about HP and Linux, see <http://www.hp.com/linux>.

Starting the Linux operating system

The first time you boot your workstation, the Red Hat First Boot utility displays. This program enables you to enter your password, network, graphics, time, and keyboard settings for your workstation.

 **CAUTION:** After the automatic installation has begun, do not power down your workstation until the process is complete. Powering down your workstation during the installation process might damage the software that runs your workstation or prevent its proper installation.

When you enable the YPBind feature in the Network tab of the Linux Setup Tool, you might get a blank screen for approximately 15–30 seconds after you have selected and saved all of your settings and exited the utility. This behavior is expected. The boot process continues its execution after the screen returns.

Restoring the Linux operating system on preloaded workstations

The HP Driver CD and Red Hat Enterprise Linux (RHEL) restore media are required to restore the Linux operating system. Download the most recent HP Driver CD to obtain new enhancements.

 **NOTE:** Linux does not support mixed drive types in a manufacturing preload. When restoring the operating system, mixed drive types can be handled with the restoration media.

Creating restore media

HP Red Hat Enterprise Linux includes a Red Hat ISO icon on the desktop. You can click on this icon to go to the `/iso` directory. The `/iso` directory contains all the iso images used to preload your workstation.

To recover or restore the original image, follow the instructions in the readme file in the `/iso` directory to copy the ISO image file onto CDs

 **NOTE:** HP recommends that you copy the ISO recovery images to CD as backup files in case your workstation experiences a hard drive failure.

The `/iso` directory also contains an ISO image of the HP Driver CD used to create your preloaded system. You can use this version or download the latest version from the HP Website.

Downloading the latest HP driver CD contents

To download the latest HP Driver CD:

1. Go to <http://www.hp.com> and select **Software and Drive Downloads**.
2. Locate your workstation and operating system.
3. Select your driver CD and then follow the directions under the Release Notes.

Reinstalling the factory Linux image with the HP driver CD

1. Boot your workstation from the Red Hat box set, Binary CD 1.
2. When prompted, insert the Linux operating system restore media CDs.
3. Continue following the installation prompts until the operating system is successfully installed.
4. Configure the X server to start on reboot.
5. Reboot your workstation.
6. Follow the onscreen prompts to set up your system with the Red Hat First Boot utility.
7. When prompted by First Boot to add additional CDs, insert the HP Driver CD into the optical drive of your workstation.
8. Select **Install** next to Additional CDs. The HP Driver CD window opens.
9. To begin the installation, select **Press to continue**.

When installation is complete, you are given two options— **Reboot now...** (on the left side), and **Press to continue, reboot later...** (on the right side).

10. Select **Reboot now...**

Upgrading device drivers

To upgrade a Linux device driver, see http://www.hp.com/support/workstation_swdrivers.

Linux-enabled workstations

Linux-enabled workstations do not have Linux preinstalled, nor do they include installation media for a Linux distribution. To install Linux, you must have the installation binary set for a Linux distribution (CD or DVD media, or a version on your network), and the HP Installer Kit for Linux. The HP Installer kit includes the HP CDs necessary to complete the installation of all versions of the distribution box set that are supported by HP workstation hardware. See the Linux hardware support matrix at http://www.hp.com/support/linux_hardware_matrix to determine which versions of are supported on your workstation.

 **NOTE:** If you want to use the drivers available in the HP Installer kit with Linux distributions other than RHEL, you must manually extract the drivers from the HP Driver CD and install them. HP does not test the installation of these drivers on other Linux distributions, nor does HP support this type of operation.

Verifying hardware compatibility

To determine which Linux versions are supported on your HP workstation hardware:

1. See http://www.hp.com/support/linux_hardware_matrix.
2. Select your HP workstation model.

Setting up Red Flag Linux

Hewlett-Packard offers the Red Flag Linux operating system as a preloaded option on the HP xw4600 Workstation in certain countries, but HP does not support the Red Flag Linux operating system. For more information about Red Flag Linux and the Red Flag operating system software, see <http://www.redflag-linux.com>.

3 System management

This section describes the various tools and utilities that provide system management for your workstation and includes the following topics:

- [Computer Setup \(F10\) Utility on page 27](#)
- [Workstation management on page 35](#)

Computer Setup (F10) Utility

The Computer Setup (F10) Utility enables you to:

- Change factory default settings and set or change the system configuration, which might be necessary when you add or remove hardware.
- Determine if all of the devices installed on the workstation are recognized by the system and functioning properly.
- Determine information about the operating environment of the workstation.
- Solve system configuration errors that are detected but not automatically fixed during the Power-On Self-Test (POST).
- Establish and manage passwords and other security features.
- Establish and manage energy-saving time-outs (not supported on Linux platforms).
- Modify or restore factory default settings.
- Set the system date and time.
- Set, view, change, or verify the system configuration, including settings for processor, graphics, memory, audio, storage, communications, and input devices.
- Modify the boot order of installed mass storage devices such as SATA, SAS, diskette drives, optical drives, network drives, and LS-120 drives.
- Configure the boot priority of SATA and SAS hard-drive controllers.
- Enable or disable Network Server Mode, that enables the workstation to boot the operating system when the power-on password is enabled with or without a keyboard or mouse attached. When attached to the system, the keyboard and mouse remain locked until the power-on password is entered.
- Select POST Messages Enabled or Disabled to change the display status of POST messages. POST Messages suppresses most POST messages, such as memory count, product name, and other non-error text messages. If a POST error occurs, the error is displayed regardless of the

mode selected. To manually switch to POST Messages Enabled during POST, press any key except **F1** through **F12**.

- Establish an Ownership Tag, the text of which is displayed each time the system is powered on or restarted.
- Enter the Asset Tag or property identification number assigned by your company to this workstation.
- Enable power-on password prompts during system restarts (warm-boots) and power on.
- Hide or show the integrated I/O functionality, including serial, USB, or parallel ports, audio, or embedded NIC. Any hidden devices are inaccessible which increases overall system security.
- Enable or disable removable media boot ability.
- Enable or disable removable media write ability (if supported by hardware).
- Replicate your system setup by saving system configuration information on CD or diskette and restoring it on one or more workstations.
- Execute self-tests on specified SATA and SAS hard drives (if supported by the drive).

BIOS ROM

The BIOS ROM is a collection of machine language programs stored as firmware in ROM. It includes functions such as POST, PCI device initialization, Plug and Play support, power management, and the Computer Setup (F10) Utility. The BIOS ROM is a 1-MB Serial Peripheral Interface (SPI) port. The firmware contained in the BIOS ROM supports the following systems and specifications:

- Microsoft Windows Hardware Quality Labs (WHQL)
- Alert-On-LAN (AOL) and Wake-On-LAN (WOL)
- Advanced Configuration and Power Interface (ACPI) 1.0 and OnNow
- System Management BIOS (SMBIOS) 2.3.5
- PC98/99/00 and NetPC
- Preboot Execution Environment (PXE) boot ROM for the integrated LAN controller
- BIOS Boot Specification 1.01
- Enhanced Disk Drive Specification 3.0
- "El Torito" Bootable CD Format Specification 1.0
- AT Attachment Packet Interface (ATAPI) Removable Media Device BIOS Specification 1.0
- Multiprocessor Specification (MPS) 1.4 (for booting Linux SMP)

Using the Computer Setup (F10) Utility

You can only open the Computer Setup (F10) Utility by powering on or restarting the workstation.

To access the Computer Setup (F10) Utility menu:

1. Power on or restart the workstation.
2. As soon as your display is active and **F10=Setup** appears in the lower right corner of the screen, press the **F10** key .

 **NOTE:** If you do not press **F10** at the appropriate time, try again. Turn the workstation off, then on, and press **F10** again to access the utility. You can also press the **Ctrl + Alt + Delete** keys before boot if you miss the opportunity to press **F10**.

3. Select your language from the list and press the **Enter** key. In the Computer Setup (F10) Utility menu, five headings are displayed: **File**, **Storage**, **Security**, **Power**, and **Advanced**.
4. Use the left and right arrow keys to select the appropriate heading. Use the up and down arrow keys to select an option, and then press **Enter**.
5. To apply and save changes, select **File>Save Changes**, and then select **F10=YES**.
 - If you have made changes that you do not want applied, select **Ignore Changes** and then select **F10=YES**.
 - To reset to factory settings, select **File>Default setup>Restore Factory Settings as Default**. Press **F10** to accept the changes. Select **Apply Defaults and Exit**. This option restores the original factory system defaults.

 **CAUTION:** Do not power off the workstation while the ROM is saving your Computer Setup (F10) Utility changes because the Complementary Metal-Oxide Semiconductor (CMOS) could become corrupted. After you exit the F10 Setup screen, it is safe to disconnect power from the workstation.

Computer Setup (F10) Utility menu

 **NOTE:** With new BIOS releases, the following content is subject to change , so your menu might appear different than shown.

Table 3-1 Computer Setup (F10) Utility menu descriptions

Heading	Option	Description
File	System Information	• Product Name
		• SKU Number
		• Processor Type/Speed/Stepping
		• Cache Size (L1/L2)
		• Installed Memory Size
		• Integrated MAC
		• System BIOS
		• Chassis Serial Number
	• Asset Tracking Number	
	About	Displays copyright information.
	Set Time and Date	Enables you to set system time and date.

Table 3-1 Computer Setup (F10) Utility menu descriptions (continued)

Heading	Option	Description
	Flash System ROM	CD-ROM—Enables you to upgrade the BIOS from a ROM image on a CD.
		USB—Enables you to upgrade the BIOS from a ROM image on a USB drive or memory stick.
	Replicated Setup	Save to Removable Media—Saves the system configuration, including CMOS, in the qsetup.txt file. This file can be saved to a formatted, blank 1.44-MB diskette, or to a USB device.
		Restore from Removable Media—Restores the system configuration from a diskette.
	Default Setup	Save Current Settings as Default—Saves the current settings as default settings for the next operation.
		Restore Factory Settings as Default—Restores the factory settings as the default settings for the next operation.
	Apply Defaults and Exit	Restores factory default settings.
	Ignore Changes and Exit	Exits computer setup without applying or saving any changes.
	Save Changes and Exit	Saves changes to system configuration and exits the computer setup.
Storage	Device Configuration	Lists all installed nonSCSI storage devices (except SATA devices) and provides options for obtaining specific information about each device.
		Hard Disk—Provides information about the hard disk drives in the system.
		CD-ROM—Provides information about the optical drives in the system.
		Diskette Type (for legacy diskette drives only)— Identifies the highest capacity media type accepted by the diskette drive. Options are 3.5" (1.44 MB), 5.25" (1.2 MB), and Not Installed.
		Default Values—Resets devices to their default configuration (SATA is the default).
		Multisector Transfers options are 8, 16, and Disable (16 is the default).
		Transfer Mode specifies the active data transfer mode. Options (which are subject to device capabilities) are: Max UDMA, PIO 0, Max PIO, Enhanced DMA, and Ultra DMA0 (Max UDMA is the default).
Translation Mode enables the BIOS to automatically determine the translation mode used to configure a previously formatted SATA or USB mass storage device. This prevents you from having to know how the mass storage device was previously formatted.		
		Ordinarily, the translation mode selected automatically by the BIOS should not be changed. If the selected translation mode is not compatible with the translation mode that was active when the drive was partitioned and formatted, the data on the disk is inaccessible.
		Translation Mode Options are: Automatic, Bit Shift, LBA Assisted, Use (Cylinders, Heads, Sectors), and Off (Automatic is default).
	Storage Options	Removable Media Boot—Enables and disables the ability to boot the system from removable media.
		Legacy Diskette Write—Enables and disables the ability to write data to removable media.

Table 3-1 Computer Setup (F10) Utility menu descriptions (continued)

Heading	Option	Description
		<p>SATA Emulation—Sets the SATA emulation mode with the following options:</p> <ul style="list-style-type: none"> • RAID—RAID OPROM executes. This emulation mode offers the best performance and most functionality. • IDE—Offers standard SATA support (four ports only). • AHCI—Offers full SATA and SATA-II functionality with no support for RAID.
	DPS Self-test	Enables you to select a drive test for a SATA drive. It is not displayed by default and not available for RAID and AHCI configurations.
	Boot Order	<p>Enables you to configure the boot, diskette drive, and hard drive orders by physically reordering the menu entries. The default boot order presents the following selections:</p> <ul style="list-style-type: none"> • Optical Drive • Diskette Drive • USB Device • Hard Drive • Broadcom Ethernet controller <p>Press Enter to drag a device to a preferred place. Press F5 to remove the device from consideration as a bootable device.</p> <p>NOTE: MS-DOS drive lettering assignments might not apply after an operating system other than MS-DOS has started.</p> <p>Boot devices can be disabled in the boot order process. These order changes are stored in the physical ROM when the F10 Setup changes are confirmed with File>Save Changes and Exit.</p> <p>You can temporarily override the boot order:</p> <p>You can temporarily override the boot order. To boot one time from a device other than the default device specified in Boot Order, restart the workstation and press F9 when the F9=Boot Menu message appears on the screen. After POST completes, a list of bootable devices is displayed. Use the arrow keys to select the preferred bootable device and press Enter. The workstation then boots from the selected nondefault device for this one time.</p> <p>To boot one time from a device other than the default device specified in Boot Order, restart the workstation and press F9 when the F9=Boot Menu message appears on the screen. After POST completes, a list of bootable devices is displayed. Use the arrow keys to select the preferred bootable device and press Enter. The workstation then boots from the selected nondefault device this time only.</p>
Security	Setup Password	<p>Enables you to set and enable setup (administrator) password.</p> <p>NOTE: If the setup password is set, it is required to change computer setup options, flash the ROM, and make changes to certain Plug and Play settings under Windows.</p>
	Power-On Password	Enables you to set and enable the power-on password.
	Password Options	<p>Lock Legacy Resources—Prevents the operating system from changing resources to Serial, Parallel, and Diskette controller.</p> <p>Setup Browse Mode—If a setup password is created, this mode enables read-only access to the F10 Setup menu for users without a password.</p>
	Smart Cover	Allows you to disable the cover removal sensor or to notify you if the sensor has been activated.
	Device Security	Makes the following devices available or unavailable to the system:

Table 3-1 Computer Setup (F10) Utility menu descriptions (continued)

Heading	Option	Description
	<ul style="list-style-type: none"> • Serial port • Parallel port • Front USB port • Rear USB port • Internal USB port • System audio • Network controller • Legacy diskette • Embedded Security Device • SATA0–5 	<p>For each device, Device Available is the default setting and allows the operating system to access the device. Device Hidden makes the device unavailable; it is disabled by the BIOS and cannot be enabled by the operating system. When enabled, Embedded Security Device offers these options:</p> <ul style="list-style-type: none"> • Embedded Security Device Support • Enable/Disable—Turns the Trusted Platform Mechanism (TPM) on and off. If this option is enabled, the following options become available: <ul style="list-style-type: none"> ◦ Power-On Authentication Support—Enables and disables an authentication feature that requires you to enter a TPM user key password to boot the system. This feature uses the TPM to generate and store the authentication password. ◦ Reset Authentication Credential—Resets the authentication functionality and clears all authentication credentials. <p>NOTE: A setup password must be set to enable the Embedded Security Device and to access any security features associated with the Embedded Security Device.</p>
	Network Service Boot	Enables or disables the ability to boot to the network using the F12 key or the boot order.
	System IDs	<p>Asset Tag—A 16-byte string identifying the system.</p> <p>Ownership Tag—An 80-byte string identifying ownership of the system. This tag is displayed on the screen during POST.</p> <p>Universal Unique Identifier (UUID)—Can only be updated if the current chassis serial number is invalid. (These ID numbers are normally set in the factory and are used to uniquely identify the system.)</p> <p>Keyboard—Enables you to set the keyboard locale for System ID entry.</p>
	DriveLock Security	<p>Allows you to select a hard drive, enable or disable DriveLock security on that drive, and set a DriveLock password. This option appears only if your drive supports DriveLock.</p> <p>CAUTION: Enabling DriveLock can render a hard drive permanently inaccessible if the master password is lost or forgotten. No method exists to recover the password or access the data.</p>
	System Security	<p>Data Execution Prevention—Enables or disables Data Execution Prevention mode in the processors. This mode prohibits code from running in pages that were set up as data pages, and prevents attacks such as buffer overflows. Operating system support is required for this feature.</p> <p>Virtualization Technology (VTx)—Enables Intel Virtualization Technology to increase workstation performance.</p>

Table 3-1 Computer Setup (F10) Utility menu descriptions (continued)

Heading	Option	Description
		Virtualization Technology Directed
		OS Management of Embedded Security Device—Enables or disables the ability of the operating system to control the TPM device, including turning it on and off, initializing it, and resetting it.
		Reset of Embedded Security Device through OS—Enables or disables the ability of the operating system to reset the TPM.
	Setup Security Level	Enables the administrator to selectively set the security level for each setup feature. The options are: Setup Password and None. Browser mode must be enabled to use this option.
Power	OS Power Management	Enables or disables: <ul style="list-style-type: none"> • Runtime Power Management • ACPI S3 Hard Disk Reset • ACPI S3 PS 2 Mouse Wakeup • USB Wake on Device Insertion • Unique Sleep State Blink Rates
	Hardware Power Management	Enables or disables SATA Power Management
	Thermal	Enables you set the rate of the system fan when the processor is in idle.
Advanced**	Power-On Options	Allows you to set: <ul style="list-style-type: none"> • POST Mode (QuickBoot, FullBoot, or FullBoot every 1–30 days). • POST Messages (Enable or Disable). • F9 Prompt (Enable or Disable). Enabling this feature displays F9=Boot Menu during POST. Disabling this feature prevents the text from being displayed. However, pressing the F9 key still accesses the boot menu. • F10 Prompt (Enable or Disable)—Enabling this feature displays F10=Setup during POST. Disabling this feature prevents the text from being displayed, but pressing F10 still accesses the Setup screen. • F11 Prompt (Enable or Disable)—Makes the Factory Recovery option visible during POST. Disabling this feature prevents the text from being displayed, but pressing F10 still accesses the Setup screen. Factory Recovery Boot Support must be enabled to use this option. • F12 Prompt (Enable or Disable)—Enabling this feature displays F12=Network Service Boot during POST. Disabling this feature prevents the text from being displayed but pressing F12 still forces the system to attempt booting from the network. • Factory Recovery Boot Support (Enable or Disable)—Recovery partition hard disk drive (HDD) option available. Vista leaves the factory with this support in place. • Option ROM prompt* (Enable or Disable)—Enabling this feature causes the system to display a message before loading options ROMs. • Remote Wakeup Boot Source • After Power Loss (On or Off)—Enabling this option directs the previous state to be the default. • POST Delay (in seconds) (Enable or Disable)—Enabling this feature adds a user-specified delay to the POST process. This delay is sometimes needed for hard drives on some PCI cards that spin up slowly (so slowly that they are not ready to boot by the time POST is

Table 3-1 Computer Setup (F10) Utility menu descriptions (continued)

Heading	Option	Description
		finished). The POST delay also gives you more time to select F10 to enter the Computer Setup (F10) Utility.
		<ul style="list-style-type: none"> Limit (CPUID Maximum Value to 3) (Enable/Disable)
	Execute Memory Test	Tests workstation memory. The workstation reboots, and any changes that have been made are lost. The workstation might boot with memory in a sub optimal configuration.
	BIOS Power-On	Enables you to disable or specify a weekday and time for BIOS power-on.
	Onboard Devices	Enables you to set resources for or disable onboard system devices such as serial ports, parallel ports, and diskette controllers. Operating system parameters generally override Onboard Devices settings.
	PCI Devices	<p>Enables you to set the IRQ for or disable the following devices during POST:</p> <ul style="list-style-type: none"> Intel USB controllers Intel HD audio device Intel RAID controller nVidia VGA controller Broadcom Ethernet controller <p>Operating system parameters generally override PCI Devices settings.</p> <p>Available IRQ values are 5, 10, and 11.</p>
	Bus Options	<p>The options are:</p> <ul style="list-style-type: none"> PCI SERR# Generation (Enable/Disable) PCI VGA Palette Snooping (Enable/Disable) ECC Support (Enable/Disable)
	Device Options	<ul style="list-style-type: none"> Printer Mode (EPP + ECP, Output-Only, Bi-Directional) Num Lock State at Power-On (On or Off) S5 Wake-on-LAN (Enable or Disable) Multi-Processor-Turns multi-core function to single-core Internal Speaker (Enable or Disable) Monitor Tracking (Enable or Disable) NIC PxE Option ROM Download (Enable or Disable) SATA RAID Option ROM Download (Enable or Disable)
	Slot 1 (PCI Express x 1)	Slot 1 option ROM download (Enable/Disable)
	Slot 2 (PC Express x16)	Slot 2 option ROM download (Enable/Disable) and latency timer.
	Slot 3 (PCI Express 4)	Slot 3 option ROM download (Enable/Disable).
	Slot 4 (PCI Express x16)	Slot 4 option ROM download (Enable/Disable).

Table 3-1 Computer Setup (F10) Utility menu descriptions (continued)

Heading	Option	Description
	Slot 5 (PCI)	Slot 5 option ROM download (Enable/Disable) and latency timer.
	Slot 6 (PCI)	Slot 6 option ROM download (Enable/Disable) and latency timer.
	Slot 7 (PCI)	Slot 7 option ROM download (Enable/Disable) and latency timer.

* Available on selected models.

**These options should be used by advanced users only.

Workstation management

The HP Client Management Solutions (CMS) which are available for download from <http://www.hp.com/go/easydeploy> are standards-based solutions for managing and controlling workstations in a networked environment. This section summarizes capabilities, features, and key components of workstation management including:

- [Initial workstation configuration and deployment on page 35](#)
- [Installing a remote system on page 36](#)
- [Replicating the setup on page 36](#)
- [Updating and managing software on page 37](#)
- [ROM Flash on page 39](#)
- [FailSafe Boot Block ROM on page 39](#)
- [Asset tracking and security on page 40](#)
- [Fault notification and recovery on page 49](#)
- [Dual-state power button on page 49](#)

 **NOTE:** Support for specific features described in this guide can vary by model and software version.

Initial workstation configuration and deployment

Your workstation includes a preinstalled system software image. After a brief software unbundling process, the workstation is ready to use.

If you prefer to replace the preinstalled software image with a customized set of system and application software, several methods are available for deploying a customized software image, including:

- Installing additional software applications after unbundling the preinstalled software image
- Using a disk cloning process to copy the contents from one hard drive to another

The best deployment method depends on your information technology environment and processes. The PC Deployment section of the HP Lifecycle Solutions Web site (<http://www.hp.com/support/HPLS>) provides information to help you select the best deployment method.

The Restore Plus! CD, ROM-based setup, and ACPI hardware provide further assistance with recovery of system software, configuration management and troubleshooting, and power management.

Installing a remote system

Remote system installation enables you to start and set up your system using the software and configuration information located on a network server. This feature is usually used as a system setup and configuration tool and can be used for the following tasks:

- Deploying a software image on one or more new PCs
- Formatting a hard drive
- Installing application software or drivers
- Updating the operating system, application software, or drivers

To initiate a remote system installation, press **F12** when **F12=Network Service Boot** appears in the lower right corner of the HP logo screen. Follow the onscreen instructions to continue the installation process. The default boot order is a BIOS configuration setting that can be changed to always attempt a PXE boot.

Replicating the setup

The following procedures enable you to copy one setup configuration to other workstations of the same model for faster, more consistent configuration of multiple workstations. Both procedures require a diskette drive or a USB device such as an HP Drive Key.

Copying a setup configuration to a single workstation

△ **CAUTION:** A setup configuration is model-specific. File system corruption can result if source and target workstations are not the same model. For example, do not copy the setup configuration from an HP xw4200 Workstation to an HP xw4600 Workstation.

1. Select a setup configuration to copy, and then reboot the workstation.
2. As soon as the workstation powers on, press and hold the **F10** key until you enter the Computer Setup (F10) Utility. If necessary, press **Enter** to bypass the title screen.

 **NOTE:** If you do not press the **F10** key at the appropriate time, you must restart the workstation, and then press and hold the **F10** key again to access the utility.

If you are using a PS 2 keyboard, you may see a keyboard error message—disregard it.

3. If you are using a diskette or other storage device, insert it now. If not, proceed to the next step.
4. Select **File>Replicated Setup>Save to Removable Media**. Follow the instructions on the screen to create the configuration diskette.
5. Power off the workstation you are configuring and insert the configuration diskette into the diskette drive.
6. Power on the workstation you are configuring.
7. Press and hold the **F10** key until you enter the Computer Setup (F10) Utility. If necessary, press **Enter** to bypass the title screen.
8. Select **File>Replicated Setup>Restore from Removable Media**, and then follow the instructions on the screen.
9. Restart the workstation when the configuration is complete.

Copying a setup configuration to multiple workstations

- △ **CAUTION:** A setup configuration is model-specific. If source and target workstations are not the same model, file system corruption can result. For example, do not copy the setup configuration from an HP xw4200 Workstation to an HP xw4600 Workstation.

This method takes a little longer to prepare the configuration diskette, but copying the configuration to target workstations is fast.

- 📝 **NOTE:** A bootable diskette is required for this procedure. If Windows XP is not available to create a bootable diskette, use the method for copying to a single workstation instead (see [Copying a setup configuration to a single workstation on page 36.](#))

1. Create a bootable diskette.
2. Select a setup configuration to copy.
3. Restart the workstation.
4. As soon as the workstation powers on, press and hold the **F10** key until you enter the Computer Setup (F10) Utility. If necessary, press **Enter** to bypass the title screen.

- 📝 **NOTE:** If you do not press the **F10** key at the appropriate time, you must restart the workstation, and then press and hold the **F10** key again to access the utility.

If you are using a PS 2 keyboard, you might see a keyboard error message—disregard it.

5. If you are using a diskette or other storage device, insert it now. If not, proceed to the next step.
6. Select **File>Replicated Setup>Save to Removable Media**. Follow the instructions on the screen to create the configuration diskette.
7. Download a BIOS utility for replicating setup (repset.exe) and copy it to the configuration diskette. To obtain this utility, see <http://www.hp.com/support/files>. Enter the model number of the workstation.
8. On the configuration diskette, create an autoexec.bat file containing `repset.exe` and `cpqsetup.txt`.
9. Power off the workstation you are configuring. Insert the configuration diskette, and then power on the workstation. The configuration utility runs automatically.
10. Restart the workstation when the configuration is complete.

Updating and managing software

HP provides several tools for managing and updating software on desktops and workstations: HP Client Manager Software, Altiris Client Management Solutions, System Software Manager, Proactive Change Notification, and Subscriber's Choice.

HP Client Manager Software

HP Client Manager Software (HP CMS) assists customers in managing workstation hardware. It offers:

- Detailed views of hardware inventory for asset management
- PC health-check monitoring and diagnostics
- Proactive notification of changes in the hardware environment

- Web-accessible reporting of business-critical details such as thermal warnings, memory alerts, and more
- Remote updating of system software such as device drivers and ROM BIOS
- Remote changing of boot order
- Configuration of system BIOS settings

For more information about the HP Client Manager, see <http://www.hp.com/go/ssm>.

Altiris Client Management Solutions

Altiris and HP have partnered to provide comprehensive, tightly integrated systems management solutions to reduce the cost of owning HP client PCs. The HP Client Manager Software is the foundation for additional Altiris Client Management Solutions that address:

- Inventory and asset management
- Deployment and migration
- Help desk and problem resolution
- Software and operations management

For more information about the following topics, go to <http://www.hp.com/go/ssm>:

- How HP Client Manager Software works
- Which solutions are compatible with your operating system
- How to download a fully functional, 30-day evaluation version of Altiris solutions

System Software Manager

System Software Manager (SSM) is a utility that enables you to update system-level software on multiple systems simultaneously. When executed on a PC client system, SSM detects both hardware and software versions, and then updates the appropriate software from a central repository, also known as a *file store*. Driver versions that are supported by SSM are denoted with a special icon on the software, the driver download Web site, and on the Support Software CD. To download the utility or to obtain more information about SSM, see <http://www.hp.com/go/ssm>.

Proactive Change Notification

The Proactive Change Notification program uses the Subscriber's Choice Web site to proactively and automatically:

- Send you Proactive Change Notification (PCN) emails informing you up to 60 days in advance about hardware and software changes to most commercial workstations and servers
- Send you e-mails containing customer bulletins, customer advisories, customer notes, and driver alerts for most commercial workstations and servers

You can create your own profile to ensure that you only receive the information relevant to your specific IT environment. To learn more about the PCN program and to create a custom profile, see [Subscriber's Choice on page 39](#).

Subscriber's Choice

Subscriber's Choice is a client-based service from HP that supplies you with personalized product tips, feature articles, and driver and support alerts and notifications based on your individual profile. Subscriber's Choice Driver and Support Alerts and Notifications delivers email notifying you that the information you subscribed to in your profile is available for review and retrieval. To learn more about Subscriber's Choice and create a custom profile, see <http://www.hp.com/subscriberschoice>.

ROM Flash

Your HP workstation comes with a programmable flash ROM. By establishing a setup password in the Computer Setup (F10) Utility, you can protect the ROM from being inadvertently updated or overwritten. This function is important to ensure the operating integrity of the workstation. To upgrade the ROM, download the latest SoftPaq images from <http://www.hp.com/support/files>.

 **NOTE:** For maximum ROM protection, be sure to establish a setup password. The setup password prevents unauthorized ROM upgrades. System Software Manager enables you to create the setup password on one or more workstations simultaneously. For more information, see <http://www.hp.com/go/ssm>.

Remote ROM Flash

Remote ROM Flash allows system administrators to safely upgrade the ROM on remote HP workstations directly from a centralized network management console, resulting in a consistent deployment of, and greater control over, HP PC ROM images over the network.

To use Remote ROM Flash, the workstation must be powered on, or turned on using Remote Wakeup.

For more information about Remote ROM Flash, see the HP Client Manager Software or System Software Manager sections at <http://www.hp.com/go/ssm>.

HPQFlash

The HPQFlash utility is used to locally update or restore the system ROM on individual PCs through a Windows operating system.

For more information about HPQFlash, visit <http://www.hp.com/go/ssm>, and enter the name of your workstation.

FailSafe Boot Block ROM

The FailSafe Boot Block ROM enables system recovery in the unlikely event of a ROM flash failure. For example, if a power failure occurs during a ROM upgrade, the Boot Block uses a flash-protected section of the ROM to check for a valid system ROM flash when power to the system is restored.

- If the system ROM is valid, the system starts normally.
- If the system ROM fails the validation check, the FailSafe Boot Block ROM provides enough support to start the system from a BIOS image CD created from a SoftPaq. The BIOS image CD programs the system ROM with a valid image.

When Boot Block detects an invalid system ROM, the workstation power LED blinks red eight times and beeps eight times, then the workstation pauses for two seconds. Also, eight simultaneous beeps will be heard. A Boot Block recovery mode message is displayed on the screen (some models).

In preparation for system recovery, use the BIOS CD media file in the SoftPaq to create a BIOS image CD.

To recover the system after it enters Boot Block recovery mode:

1. If there is media in the diskette or optical drives, remove it.
2. Insert a BIOS image CD into the CD drive. USB media (such as an HP DriveKey) can also be used.
3. Power off, then power on the workstation.

If no BIOS image CD or USB is found, you are prompted to insert one and restart the workstation.

If a setup password has been established, the Caps Lock light illuminates and you are prompted for the password.

4. Enter the setup password.

If the system successfully starts from the CD or USB and successfully reprograms the ROM, then the three keyboard lights illuminate. A rising-tone series of beeps also signals successful recovery.

5. Remove the CD or USB media and power off the workstation.
6. Restart the workstation.

The following table lists the various keyboard light combinations used by the Boot Block ROM (when a PS 2 keyboard is attached to the workstation) and explains the meaning and action associated with each combination.

Table 3-2 Keyboard light combinations used by Boot Block ROM

FailSafe Boot Block mode	Keyboard LED activity*	State/Message
Num Lock	On	SoftPaq media is not present, is bad, or the drive not ready
Caps Lock	On	Enter password
Num, Caps, Scroll Lock	Flash in sequence, one at a time—N,C, SL	Keyboard locked in network mode
Num, Caps, Scroll Lock	On	Boot Block ROM Flash successful. Reboot the system

*Diagnostic lights do not flash on USB keyboards.

Asset tracking and security

Asset tracking features incorporated into your workstation provide asset tracking data that can be managed using HP Systems Insight Manager (SIM), HP Client Manager Software, or other systems management applications. Seamless, automatic integration between asset tracking features and these products enables you to choose the management tool that is best suited to your environment and to leverage investments in existing tools.

HP also offers several solutions for controlling access to valuable components and information. HP ProtectTools Embedded Security, if installed, prevents unauthorized access to data, checks system integrity, and authenticates third-party users attempting system access. Security features such as ProtectTools and the Hood Sensor (Smart Cover Sensor) help prevent unauthorized access to your data and to the internal components of the workstation. By disabling parallel, serial, or USB ports, or by disabling removable-media boot capability, you can protect valuable data assets. Memory Change and Hood Sensor (Smart Cover Sensor) alerts can be automatically forwarded to system management applications to deliver proactive notification of tampering with a workstation's internal components.

 **NOTE:** ProtectTools, the Hood Sensor (Smart Cover Sensor), and the (Smart Cover Lock) are available as options on select systems.

Use the following utilities to manage security settings on the HP workstation:

- Locally, using the Computer Setup (F10) Utility
- Remotely, using the HP Client Manager Software or System Software Manager which enables the secure, consistent deployment and control of security settings from a simple command line utility

The following table and sections refer to the management of workstation security through the Computer Setup (F10) Utility

Table 3-3 Security features overview

Feature	Purpose	How it is established
Removable Media Boot Control	Prevents booting from the removable media drives	From the Computer Setup (F10) Utility menu
Serial, Parallel, USB, or Infrared Interface Control	Prevents transfer of data through the integrated serial, parallel, USB, or infrared interface	From the Computer Setup (F10) Utility menu
Power-On Password	Prevents use of the workstation until the password is entered (applies to both initial system startup and restarts)	From the Computer Setup (F10) Utility menu
Setup Password	Prevents reconfiguration of the workstation (use of the Setup utility) until the password is entered	From the Computer Setup (F10) Utility menu
Network Server Mode	Provides unique security features for workstations used as servers	From the Computer Setup (F10) Utility menu

NOTE: For more information about the Computer Setup (F10) Utility, see [Computer Setup \(F10\) Utility menu on page 29](#).

Password security

The power-on password prevents unauthorized use of the workstation by requiring entry of a password to access applications or data each time the workstation is powered on or restarted. The setup password specifically prevents unauthorized access to the Computer Setup (F10) Utility and can also be used as an override to the power-on password. When prompted for the power-on password, entering the setup password instead enables access to the workstation.

You can establish a network-wide setup password to enable the system administrator to log in to all network systems to perform maintenance without having to know the power-on password.

 **NOTE:** System Software Manager and HP Client Manager Software enable remote management of setup passwords and other BIOS settings in a networked environment. For more information, see <http://www.hp.com/go/easydeploy>.

Establishing a setup password using the Computer Setup (F10) Utility

Establishing a setup password through the Computer Setup (F10) Utility prevents reconfiguration of the workstation (through the use of the Computer Setup (F10) Utility) until the password is entered.

To establish a setup password using the Computer Setup (F10) menu:

1. Power on or restart the workstation.
2. As soon as the computer is powered on, press and hold the **F10** key until you enter the Computer Setup (F10) Utility. Press **Enter** to bypass the title screen, if necessary.

 **NOTE:** If you do not press the **F10** key at the appropriate time, you must restart the workstation, and then press and hold the **F10** key again to access the utility.

If you are using a PS 2 keyboard, you might see a keyboard error message—disregard it.

3. Select **Security>Setup Password**, and then follow the onscreen instructions.
4. Before exiting, select **File>Save Changes**, and then select **Exit**.

Establishing a power-on password using workstation setup

Establishing a power-on password through the Computer Setup (F10) Utility prevents access to the workstation when power is connected, unless the password is entered. When a power-on password is set, the Computer Setup (F10) Utility presents Password Options in the Security menu. The password options include Network Server Mode and Password Prompt on Warm Boot.

When Network Server Mode is disabled, the password must be entered each time the workstation is powered on when the key icon appears on the monitor. When Password Prompt on Warm Boot is enabled, the password must also be entered each time the workstation is rebooted. When Network Server Mode is enabled, the password prompt is not presented during POST, but any attached PS 2 keyboard remains locked until you enter the power-on password.

To enable Network Server Mode, a power-on password must be set. The option to set this password is available under **Advanced>Password Options**. This option enables the system to boot without requiring the power-on password, but the keyboard and mouse are locked until you enter the password. The keyboard LEDs rotate constantly when the system is in locked mode.

To establish a power-on password through the Computer (F10) menu:

1. Power on or restart the workstation.
2. As soon as your workstation is powered on, press and hold the **F10** key until you enter the Computer Setup (F10) Utility. Press **Enter** to bypass the title screen, if necessary.

 **NOTE:** If you do not press the **F10** key at the appropriate time, you must restart the workstation, and then press and hold the **F10** key again to access the utility.

If you are using a PS 2 keyboard, you might see a keyboard error message—disregard it.

3. Select **Security>Power-On Password**, and then follow the onscreen instructions.
4. Before exiting, select **File>Save Changes**, and then **Exit**.

Entering a power-on password

1. Restart the workstation.
2. When the key icon appears on the monitor, enter the current password, and then press **Enter**.

 **NOTE:** Type carefully. For security reasons, the characters you enter do not appear on the screen.

If you enter the password incorrectly, a broken key icon appears. Try again. After three unsuccessful tries, you must restart the workstation before you can continue.

Entering a Setup Password

If a setup password has been established on the workstation, you will be prompted to enter it each time you run the Computer Setup (F10) Utility.

To enter a setup password:

1. Restart the workstation.
2. As soon as the workstation is powered on, press and hold the **F10** key until you enter the Computer Setup (F10) Utility. Press **Enter** to bypass the title screen, if necessary.

 **NOTE:** If you do not press the **F10** key at the appropriate time, you must restart the workstation and press and hold the **F10** key again to access the utility.

If you are using a PS 2 keyboard, you might see a keyboard error message—disregard it.

3. When the key icon appears on the monitor, enter the setup password, and press **Enter**.

 **NOTE:** Type carefully. For security reasons, the characters you enter do not appear on the screen.

If you enter the password incorrectly, a broken key icon appears. Try again. After three unsuccessful tries, you must restart the workstation before you can continue.

Changing a power-on or setup password

1. Restart the workstation.
2. To change the power-on password, go to step 4.
3. To change the setup password, as soon as the workstation is powered on, press and hold the **F10** key until you enter the Computer Setup (F10) Utility. Press **Enter** to bypass the title screen, if necessary.

 **NOTE:** If you do not press **F10** at the appropriate time, you must restart the workstation, and then press and hold the **F10** key again to access the utility.

If you are using a PS 2 keyboard, you might see a keyboard error message—disregard it.

4. When the key icon appears, enter the current password, a slash (/) or alternative delimiter character, your new password, another slash (/) or alternative delimiter character, and your new password again as shown:

current password/new password/new password

See [National keyboard delimiter characters on page 44](#) for information about the alternative delimiter characters.

 **NOTE:** Type carefully. For security reasons, the characters you enter do not appear on the screen.

5. Press **Enter**.

The new password takes effect the next time you power on the workstation.

The power-on and setup passwords can also be changed using the Security options in the Computer Setup (F10) Utility.

Deleting a power-on or setup password

1. Power on or restart the workstation.
2. To delete the power-on password, go to step 4.
3. To delete the setup password, as soon as the workstation is powered on, press and hold the **F10** key until you enter the Computer Setup (F10) Utility. (Press **Enter** to bypass the title screen, if necessary.)

 **NOTE:** If you do not press the **F10** key at the appropriate time, you must restart the computer and then press and hold the **F10** key again to access the utility.

Use the appropriate operating system shutdown process.

4. When the key icon appears, enter your current password followed by a slash (/) or alternative delimiter character: *current password/*.

 **NOTE:** See [National keyboard delimiter characters on page 44](#) for information about the alternative delimiter characters.

5. Press **Enter**.

National keyboard delimiter characters

Each keyboard is designed to meet country-specific requirements. The syntax and keys that you use for changing or deleting passwords depend on the keyboard included with your workstation.

Table 3-4 National keyboard delimiter characters

Language	Delimiter	Language	Delimiter	Language	Delimiter
Arabic	/	Greek	-	Russian	/
Belgian	=	Hebrew	.	Slovakian	-
BHCSY*	-	Hungarian	-	Spanish	-
Brazilian	/	Italian	-	Swedish/Finnish	/
Chinese	/	Japanese	/	Swiss	-
Czech	-	Korean	/	Taiwanese	/
Danish	-	Latin American	-	Thai	/
French	!	Norwegian	-	Turkish	.
French Canadian	é	Polish	-	U.K. English	/
German	-	Portuguese	-	U.S. English	/

NOTE: * Bosnia-Herzegovina, Croatia, Slovenia, and Yugoslavia

Clearing passwords

If you forget your password, you cannot access the workstation. See [Resetting the password jumper on page 149](#) for instructions about clearing passwords.

DriveLock

⚠ WARNING! Enabling DriveLock can render a hard drive permanently inaccessible if the master password is lost or forgotten. No method exists to recover the password or access the data.

DriveLock uses an industry-standard security feature that prevents unauthorized access to the data on an ATA hard drive. DriveLock has been implemented as an extension to Computer Setup (F10) functions. It is only available when hard drives that support the ATA security command set are detected. On HP workstations, it is not available when the SATA emulation mode is RAID+AHCI or RAID.

DriveLock is intended for HP customers for whom data security is a paramount concern. For such customers, the cost of a hard drive and the loss of the data stored on it is inconsequential when compared to the damage that could result from unauthorized access to its contents.

In order to balance this level of security with the practical need to address the issue of a forgotten password, the HP implementation of DriveLock employs a two-password security scheme. One password is intended to be set and used by a system administrator, while the other is typically set and used by the end-user. There is no "back door" that can be used to unlock the drive if both passwords are lost. Therefore, DriveLock is most safely used when the data contained on the hard drive is replicated on a corporate information system or is regularly backed up. In the event that both DriveLock passwords are lost, the hard drive is rendered unusable. For users who do not fit the previously defined customer profile, this may be an unacceptable risk. For users who do fit this profile, it may be a tolerable risk, given the nature of the data stored on the hard drive.

DriveLock applications

The most practical use of the DriveLock security feature is in a corporate environment. The system administrator would be responsible for configuring the hard drive, which involves setting the DriveLock master password and a temporary user password. In the event that the user forgets the user password or the equipment is passed on to another employee, the master password can always be used to reset the user password and regain access to the hard drive.

HP recommends that corporate system administrators who choose to enable DriveLock also establish a corporate policy for setting and maintaining master passwords. This should be done to prevent a situation where an employee intentionally or unintentionally sets both DriveLock passwords before leaving the company. In such a scenario, the hard drive is rendered unusable and requires replacement. Likewise, by not setting a master password, system administrators might find themselves locked out of a hard drive and unable to perform routine checks for unauthorized software, other asset control functions, and support.

For users with less stringent security requirements, HP does not recommend enabling DriveLock. Users in this category include personal users, or users who do not maintain sensitive data on their hard drives as a common practice. For these users, the potential loss of a hard drive resulting from forgetting both passwords is much greater than the value of the data DriveLock has been designed to protect.

Access to Computer Setup (F10) and DriveLock can be restricted through the setup password. By specifying a setup password and not giving it to end users, system administrators are able to restrict users from enabling DriveLock.

Using DriveLock

When one or more hard drives that support the ATA security command set are detected, the DriveLock option appears under the Security menu in Computer Setup (F10). You are presented with options to set the master password and to enable DriveLock. A user password must be provided to enable DriveLock. Since the initial configuration of DriveLock is typically performed by a system administrator, a master password should be set first. HP encourages system administrators to set a master password whether they plan to enable DriveLock or not. This gives the administrator the ability to modify DriveLock settings if the drive is locked in the future. Once the master password is set, the system administrator might enable DriveLock or choose to leave it disabled.

If a locked hard drive is present, POST requires a password to unlock the device. If a power-on password is set and it matches the device's user password, POST does not prompt the user to re-enter the password. Otherwise, the user is prompted to enter a DriveLock password. For a cold-boot, use the master or user password. For a warm-boot, you must enter the same password used to unlock the drive during the preceding cold-boot. Users are given two attempts to enter a correct password. During cold-boot, if neither attempt succeeds, POST continues but the drive remains inaccessible. During a warm-boot or restart from Windows, if neither attempt succeeds, POST halts and the user is instructed to cycle power.

To enable and set the DriveLock user password:

1. Power on or restart the workstation.
2. As soon as the workstation is powered on, press and hold the **F10** key until you enter the Computer Setup (F10) Utility. Press **Enter** to bypass the title screen, if necessary.

 **NOTE:** If you do not press the **F10** key at the appropriate time, you must restart the workstation, and then press and hold the **F10** key again to access the utility.

If you are using a PS2 keyboard, you might see a keyboard error message—disregard it.

3. Select **Security>DriveLock Security**.
 4. For each DriveLock-capable drive, select a drive by pressing the **F10** key to accept.
 5. Under Enable/Disable DriveLock options, select **Enable**, and then press the **F10** key to enable DriveLock for a particular drive.
-
-  **CAUTION:** Forgetting the DriveLock password renders the drive unusable.
-
6. Enter a new user password, and then press the **F10** key to accept. This password may be 1 to 32 characters long.
 7. Enter the password again in the Enter New Password Again field. If you forget this password, the drive is rendered permanently disabled.
 8. Select **File>Save Changes and Exit**, and then press the **F10** key. After you press the **F10** key, the system performs a cold-boot before invoking the DriveLock function.

 **NOTE:** This process can also be used to set the DriveLock master password by selecting **Master** in Step 5.

When the workstation starts, you are prompted to enter the DriveLock password for each DriveLock-capable drive for which you have previously set a password. You are given two attempts to enter the password correctly. If the password is not entered correctly, the workstation attempts to boot anyway. However, the boot process most likely fails because data from a locked drive cannot be accessed.

In a single drive workstation, if the drive has DriveLock enabled, the workstation might not be able to boot to the operating system, and might try to boot from the network or from another storage device instead (depending on the boot ordering options). Regardless of the outcome of the boot attempts, the drive-locked drive remains inaccessible without the DriveLock password.

In a two-drive workstation that has a boot drive and a data drive, you can apply the DriveLock feature to the data drive only. In this case, the workstation can always boot, but the data drive is accessible only when the DriveLock password is entered.

Cold-boots require that you enter DriveLock passwords. However, DriveLock passwords are also required for warm-boots. For example, if you boot to DOS and enter **Ctrl-Alt-Del**, you must enter the DriveLock password before the workstation completes the next boot cycle. This warm-boot behavior is consistent with the DriveLock feature.

Hood Sensor (Smart Cover Sensor) (optional)

The optional Hood Sensor is a combination of hardware and software technology that can alert you when the workstation side access panel has been removed (if the sensor has been properly configured in the Computer Setup (F10) Utility). There are three levels of Hood Sensor protection:

Table 3-5 Hood Sensor protection levels

Level	Setting	Description
Level 0	Disabled	Hood Sensor is disabled (default).
Level 1	Notify User	When the workstation restarts, a message is displayed indicating that the workstation side access panel has been removed.
Level 2	Setup Password	When the workstation is restarted, a message is displayed indicating that the workstation side access panel has been removed. You must enter the setup password to continue.

Hood Sensor settings can be changed using the Computer Setup (F10) Utility.

Setting the Hood Sensor protection level

1. Power on or restart the workstation.
2. As soon as the workstation is powered on, press and hold the **F10** key until you enter the Computer Setup (F10) Utility. Press **Enter** to bypass the title screen, if necessary.

 **NOTE:** If you do not press the **F10** key at the appropriate time, you must restart the computer, and then press and hold the **F10** key again to access the Computer Setup (F10) Utility.

If you are using a PS 2 keyboard, you might see a keyboard error message—disregard it.

3. Select **Security>Smart Cover>Cover Removal Sensor**, and follow the onscreen instructions.
4. Before exiting, select **File>Save Changes**, and then select **Exit**.

Hood Lock (Smart Cover Lock) (optional)

The is an optional solenoid that secures the workstation access cover to the chassis. It is controlled by a BIOS password. When installed, the Hood Lock can prevent unauthorized access to the internal workstation components.

 **CAUTION:** For maximum cover lock security, be sure to establish a setup password. The setup password prevents unauthorized access to the Computer Setup utility.

Locking the Hood Lock

1. Power on or restart the workstation.
2. As soon as the workstation is powered on, press and hold the **F10** key until you enter the Computer Setup (F10) Utility. Press **Enter** to bypass the title screen, if necessary.

 **NOTE:** If you do not press the **F10** key at the appropriate time, you must restart the workstation and press and hold the **F10** key again to access the utility.

If you are using a PS2 keyboard, you might see a keyboard error message—disregard it.

3. Select **Security>Smart Cover>Cover Lock>Lock**.
4. Select **File>Save Changes and Exit**.

Unlocking the Hood Lock

1. Turn on or restart the workstation.
2. As soon as the workstation is powered on, press and hold the **F10** key until you enter the Computer Setup (F10) Utility. Press **Enter** to bypass the title screen, if necessary.

 **NOTE:** If you do not press the **F10** key at the appropriate time, you must restart the workstation and press and hold the **F10** key again to access the utility.

If you are using a PS2 keyboard, you might see a keyboard error message—disregard it.

3. Select **Security>Smart Cover>Cover Lock>Unlock**.
4. Select **File>Save Changes and Exit**.

Using the FailSafe key

If you enable the Hood Lock and cannot enter your password to disable it, you must have a FailSafe key to open the workstation side access panel. The FailSafe key is required in any of the following circumstances:

- Power outage
- Startup failure
- PC component failure (such as a processor or power supply)
- Forgotten password

 **CAUTION:** The side access panel FailSafe key is a specialized tool available from HP. Be sure to order the key from HP in advance so it is available when you need it.

To obtain the FailSafe Key, contact HP post sales support by telephone at: 1-800-hp-invent, or by visiting http://welcome.hp.com/country/us/en/wwcontact_us.html.

Cable lock (optional)

To prevent theft, the rear chassis panel of your workstation accommodates a keyed cable lock. This cable lock attaches to the chassis and secures it to the work area.

Security lock (Padlock loop) (optional)

The rear chassis panel of your workstation provides a padlock loop. A padlock can be attached in this loop to prevent workstation access panel removal.

Universal chassis clamp lock (optional)

The universal chassis clamp lock secures the access panel to the chassis using a screw-type attachment. A built in key lock prevents access to the securing screw. In addition, cables can be added to the universal chassis clamp lock to secure workstation peripherals, and to secure the workstation to the work area.

Fault notification and recovery

Fault notification and recovery features combine innovative hardware and software technology to prevent the loss of critical data and minimize unplanned downtime.

If the workstation is connected to a network that is managed by HP Client Manager Software, the computer sends a fault notice to the network management application. With HP Client Manager Software, you can also remotely schedule diagnostics to automatically run on all managed PCs and create a summary report of failed tests.

Drive Protection System

The Drive Protection System (DPS) is a diagnostic tool built into the hard drives that is installed in select HP workstations. The DPS is designed to help diagnose problems that might result in unwarranted hard drive replacement.

When HP workstations are built, each installed hard drive is tested using the DPS, and a permanent record of key information is written onto each drive. Every time the DPS is run, test results are written to the hard drive. The service provider can use this information to help diagnose conditions that required you to run the DPS software.

ECC fault prediction

When the workstation encounters an excessive number of error checking and correcting (ECC) memory errors, it displays a local alert message. This message contains detailed information about the errant memory module, enabling you to take action before you experience noncorrectable memory errors. ECC memory modules are standard on the HP xw4600 Workstation.

Thermal sensors

There are several thermal sensors in your HP xw4600 Workstation that regulate the workstation fans to maintain an acceptable, efficient chassis temperature.

Dual-state power button

With ACPI enabled, the power button can function either as an on/off switch or as a button. This feature does not completely turn off power, but instead causes the workstation to enter a low-power standby state. This allows you to power of the wovrkstation without closing applications, and to return to the same operational state without any data loss.

To change the power button configuration:

1. Select **Start**, and then select **Control Panel>Power Options**.
2. In Power Options Properties, select the **Advanced** tab.
3. In the Power Button section, select **Hibernate**. (Hibernate must be enabled in the Hibernate tab.)

After configuring the power button to function as a button, press the power button to put the system in a very low power state. Press the button again to bring the system out of this very low power state to full power state. To completely turn off all power to the system, press and hold the power button for four seconds.

△ **CAUTION:** Do not use the power button to power off the workstation unless the system is not responding; turning off the power without operating system interaction could cause damage to or loss of data on the hard drive.









4 Removal and replacement procedures

This chapter describes the removal and replacement procedures for most internal workstation components including the following topics:

- [Warnings and cautions on page 52](#)
- [Service considerations on page 53](#)
- [Customer Self-Repair on page 58](#)
- [Predisassembly procedures on page 58](#)
- [System board components on page 59](#)
- [Removing and replacing components on page 60](#)
- [Product recycling on page 108](#)

Warnings and cautions

Observe the following warnings and cautions when performing the removal and replacement procedures.

-
-  **WARNING!**  Any product shipped in packaging marked with this symbol indicates the product must always be lifted by two persons to avoid personal injury due to product weight.
-
-  **WARNING!**  Any surface or area of the equipment marked with this symbol indicates the presence of a hot surface or hot component. If this surface is contacted, the potential for injury exists. To reduce the risk of injury from a hot component, enable the surface to cool before touching.
-
-  **WARNING!**  Any surface or area of the equipment marked with this symbol indicates the presence of an electrical shock hazard. To reduce the risk of injury from electrical shock, do not open any enclosed area marked with this symbol.
-
-  **WARNING!** To reduce the risk of electric shock or damage to your equipment:
- Do not disable the power cord grounding plug. The grounding plug is an important safety feature.
 - Plug the power cord in a grounded (earthed) outlet that is easily accessible at all times.
 - Disconnect power from the equipment by unplugging the power cord from the electrical outlet.
-
-  **WARNING!** To reduce the risk of serious injury, read the *Safety & Comfort Guide*. It describes proper workstation setup, posture, health, and work habits for computer users, and provides important electrical and mechanical safety information. This guide is located at <http://www.hp.com/ergo> and on the documentation CD (if one is included with the product).
-
-  **CAUTION:** Static electricity can damage the electronic components of the workstation. Before beginning these procedures, be sure you discharge static electricity by briefly touching a grounded metal object.
- CAUTION:** Observe the following cautions when removing or replacing a processor:
- Installing a processor incorrectly can damage the system board. Contact an HP authorized reseller or service provider to install the processor. If you plan to install the processor yourself, read all of the instructions carefully before you begin.
 - Failure to follow the workstation preparation instructions can result in an improperly installed processor, causing extensive workstation damage.
 - Processor socket pins are delicate and bend easily. Use extreme care when placing the processor in the socket.
-

- △ **CAUTION:** To prevent damage to the workstation, observe the following Electrostatic Discharge (ESD) precautions while performing the system parts removal and replacement procedures:
 - Work on a static-free mat.
 - Wear a static strap to ensure that any accumulated electrostatic charge is discharged from your body to the ground.
 - Create a common ground for the equipment you are working on by connecting the static-free mat, static strap, and peripheral units to that piece of equipment.
- 📄 **NOTE:** HP accessories are for use in HP Workstation products. They have been extensively tested for reliability and are manufactured to high quality standards.

Service considerations

The following sections describe service considerations that should be reviewed and practiced before removing and replacing any system components.

- △ **WARNING!** When lifting or moving the workstation, do not use the front bezel as a handle or lifting point. Lifting the workstation from the front bezel, or lifting it incorrectly, can cause the workstation to fall, possibly harming you and damaging the workstation. To properly and safely lift the workstation, lift it from the bottom.

Cautions, warnings, and safety precautions

For your safety, review [Warnings and cautions on page 52](#) before accessing the workstation components. Also, review the *Safety and Regulatory Guide* that came with your workstation for more information.

ESD information

A sudden discharge of static electricity from your finger or other conductor can destroy static-sensitive devices or microcircuitry. Often, the discharge is neither felt nor heard, but damage occurs nonetheless. An electronic device exposed to electrostatic discharge (ESD) might not appear to be affected at all and can function normally for a while, but it has been degraded in the internal layers, reducing its life expectancy.

Networks built into many integrated circuits provide some protection, but in many cases, the discharge contains enough power to alter device parameters or melt silicon junctions.

Generating static

The following table shows that different activities generate different amounts of static electricity. Static electricity increases as humidity decreases.

Table 4-1 Static electricity

Event	Relative humidity		
	55%	40%	10%
Walking across carpet	7,500V	15,000V	35,000V
Walking across vinyl floor	3,000V	5,000V	12,000V

Table 4-1 Static electricity (continued)

	Relative humidity		
Motions of bench worker	400V	800V	6,000V
Removing bubble pack from PCB	7,000V	20,000V	26,500V
Packing PCBs in foam-lined box	5,000V	11,000V	21,000V

CAUTION: 700 volts can degrade a product.

Preventing ESD equipment damage

Many electronic components are sensitive to ESD. Circuitry design and structure determine the degree of sensitivity. The following packaging and grounding precautions are necessary to prevent damage to electric components and accessories:

- Transport products in static-safe containers such as tubes, bags, or boxes, to avoid hand contact.
- Protect all electrostatic parts and assemblies with nonconductive or approved containers or packaging.
- Keep electrostatic-sensitive parts in their containers until they arrive at static-free stations.
- Place items on a grounded surface before removing them from their containers.
- When handling or touching a sensitive component or assembly, ground yourself by touching the chassis.
- Avoid contact with pins, leads, or circuitry.
- Place reusable electrostatic-sensitive parts from assemblies in protective packaging or nonconductive foam.

Personal grounding methods and equipment

Use the following items to help prevent ESD damage to equipment:

- **Wrist straps**—flexible straps with a maximum of one megohm \pm 10% resistance in the ground cords. To provide a proper ground, wear the strap against bare skin. The ground cord must be connected and fit snugly into the banana plug connector on the grounding mat or workstation.
- **Heel straps, toe straps, and boot straps**—can be used at standing workstations and are compatible with most types of shoes or boots. On conductive floors or dissipative floor mats, use them on both feet with a maximum of one megohm \pm 10% resistance between the operator and ground.

Table 4-2 Static shielding protection levels

Method	Voltage
Antistatic plastic	1,500V
Carbon-loaded plastic	7,500V
Metallized laminate	15,000V

Grounding the work area

To prevent static damage in your work area:

- Cover the work surface with approved static-dissipative material. Use a wrist strap connected to the work surface, and properly grounded tools and equipment.
- Use static-dissipative mats, foot straps, or air ionizers to give added protection.
- Handle electrostatic-sensitive components, parts, and assemblies by the case or PCB laminate. Handle them only in static-free work areas.
- Disconnect power and input signals before inserting and removing connectors or test equipment.
- Use fixtures made of static-safe materials when fixtures must directly contact dissipative surfaces.
- Keep work area free of nonconductive materials, such as ordinary plastic assembly aids and Styrofoam.
- Use field service tools that are conductive, such as cutters, screwdrivers, and vacuums.

Recommended ESD prevention materials and equipment

Materials and equipment that are recommended for use in preventing static electricity include:

- Antistatic tape
- Antistatic smocks, aprons, and sleeve protectors
- Conductive bins and other assembly or soldering aids
- Conductive foam
- Conductive tabletop workstations with a ground cord of one megohm \pm 10% resistance
- Static-dissipative table or floor mats with a hard-tie to ground
- Field service kits
- Static awareness labels
- Wrist straps and footwear straps providing one megohm \pm 10% resistance
- Material-handling packages
- Conductive plastic bags
- Conductive plastic tubes
- Conductive tote boxes
- Opaque shielding bags
- Transparent metallized shielding bags
- Transparent shielding tubes

Tools and software requirements

- Torx T-15 driver
- Flat blade and cross-tip screwdrivers
- Diagnostics software

Screws

The screws used in the workstation are not interchangeable. Metric screws are used for optical and diskette devices, and American National Standards Institute (ANSI) screws are used for hard drives. If an incorrect screw is used during the reassembly process, it can damage the workstation. HP strongly recommends that you keep all screws removed during disassembly with the removed part, and then returned to their proper locations.

 **NOTE:** Metric screws have a black finish. ANSI (unified) screws have a silver finish.

As each subassembly is removed from the workstation, place the subassembly away from the work area to prevent damage.

Additional drive-guide screws are provided on the system chassis in case they are needed. The [Figure 4-1 Metric and ANSI screw identification on page 56](#) figure shows the eight metric M3 screws (1) located on the chassis near the 5.25-inch optical drive bays. These screws can be used to mount additional optical drives or an optional diskette drive. There are four ANSI 6–32 screws (2) located on the chassis near the hard drive. These screws can be used to mount additional hard drives in the 3.5 inch hard drive cage.

 **NOTE:** The metric (black) and ANSI (silver) screws are not interchangeable.

Figure 4-1 Metric and ANSI screw identification

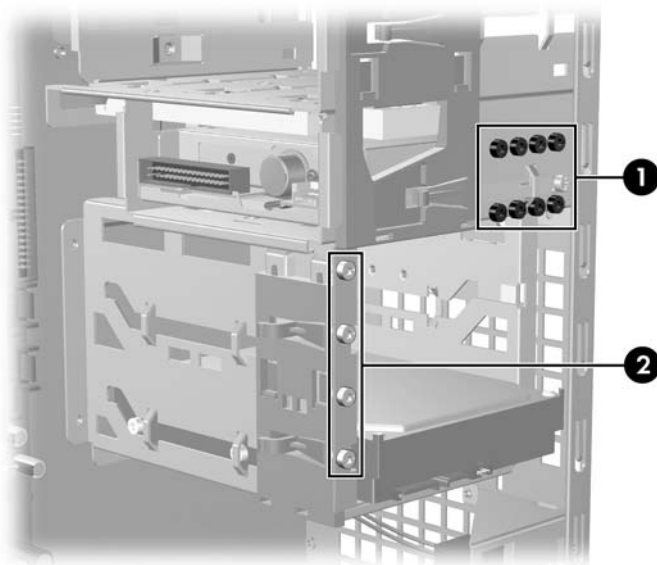

Table 4-3 Screw ID

Item	Description
1	Metric screws (M3)
2	ANSI screws (6–32)

Special handling of components

The components included in this section require special handling when servicing the workstation.

- △ **WARNING!** Do not use the front bezel as a handle or lifting point when lifting or moving the workstation. Lifting the workstation from the front bezel, or lifting it incorrectly, could cause the workstation to fall, causing possible injury to you, and damage to the workstation. To properly and safely lift the workstation, lift from the bottom of the workstation for either the desktop or minitower configuration.

Cables and connectors

Cables must be handled with care to avoid damage. Apply only the tension required to seat or unseat cables during insertion or removal from the connector. Handle cables by the connector or pull-strap whenever possible. In all cases, avoid bending or twisting the cables, and be sure that the cables are routed in such a way that they cannot be caught or snagged by parts being removed or replaced.

- △ **CAUTION:** When servicing this workstation, be sure that cables are placed in their proper location during the reassembly process. Improper cable placement can damage the workstation.

Hard drives

Hard drives are fragile, precision components. Therefore, you must avoid subjecting them to physical shock and vibration. This guideline applies to failed drives and replacement drives and spares.

- Do not remove hard drives from the shipping package for storage. Keep hard drives in their protective packaging until they are actually mounted in the workstation.
- Avoid dropping hard drives from any height.
- If you are inserting or removing a hard drive, power off the workstation. Do not remove a hard drive while the workstation is powered on or in standby mode.
- Before handling a drive, be sure that you discharge static electricity. While handling a drive, avoid touching the connector. For more information about preventing electrostatic damage, see [ESD information on page 53](#).

- △ **CAUTION:** To prevent possible ESD damage when the drive is installed, always connect the drive power cable before connecting the data cable. This discharges accumulated static electricity through the drive power cable to the workstation chassis.

- Do not use excessive force when inserting a drive.
- Avoid exposing a hard drive to liquids, temperature extremes, or products with magnetic fields such as monitors or speakers.

Lithium coin cell battery

The battery included with the workstation provides power to the real-time clock and has a minimum lifetime of about three years.

For instructions on battery removal and replacement, see [Battery on page 87](#).

 **WARNING!** This workstation contains a lithium battery. There is a risk of fire and chemical burn if the battery is handled improperly. Do not disassemble, crush, puncture, short the external contacts, dispose of in water or fire, or expose the battery to temperatures higher than 60° Centigrade (140° Fahrenheit).

 **NOTE:** Batteries, battery packs, and accumulators should not be disposed of with general household waste.

Customer Self-Repair

Customer Self-Repair enables you to obtain replacement parts and install them yourself on the workstation. For more information, see: <http://www.hp.com/go/selfrepair/>.

Predisassembly procedures

Perform the following steps before servicing the workstation:

1. Close all open software applications.
2. Remove all diskettes, CDs, and DVDs from the workstation.
3. Shut down the operating system.
4. Power off the workstation and all peripheral devices connected to it.
5. Remove or disengage all security devices that prevent you from opening the workstation.
6. Disconnect the power cord from the electrical outlet and then from the workstation.
7. Disconnect all peripheral device cables from the workstation.

System board components

The following figure shows the system board connectors and sockets on the HP xw4600 Workstation.

Figure 4-2 System board component identification

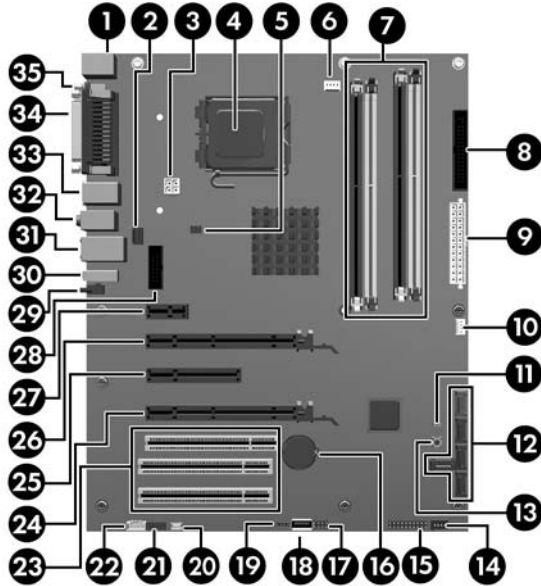

Table 4-4 System board components

No.	Component	No.	Component	No.	Component
1	Keyboard/mouse	13	Clear CMOS button	25	PCI Express x8 (4)*
2	Rear chassis fan	14	Front chassis fan	26	PCI Express x16
3	Processor power	15	Front control panel	27	PCI Express x1
4	Processor	16	Battery	28	2nd serial adapter port
5	Solenoid hood lock	17	Front USB	29	eSATA
6	Processor fan	18	USB	30	USB
7	Memory module sockets	19	Internal USB	31	Network/USB
8	Diskette drive	20	Speaker	32	Audio
9	Main power	21	Front audio	33	USB
10	Chassis intrusion switch	22	Auxiliary audio	34	Parallel
11	Password jumper	23	PCI 32/33	35	Serial
12	SATA	24	PCI Express x16		

* Electrically x4 bandwidth

Removing and replacing components

This section provides procedures to remove and install hardware components on your workstation. Before servicing your workstation, review the safety information and precautions in the [Service considerations on page 53](#), and the *Safety and Regulatory Information* for your workstation.

1. Read all safety information and precautions.
2. Locate and clear a suitable work area.
3. Power down the workstation and disconnect power from the workstation.
4. Gather your tools.
5. Service the workstation.
6. Restore power to the workstation.

Disassembly order

Use the following table to determine the sequence in which to remove major workstation components.

Table 4-5 Workstation component disassembly order

Predisassembly (Predisassembly procedures on page 58)
Security lock (Security lock (Padlock loop) (optional) on page 62)
Side access panel (Side access panel on page 64)
Hood Sensor (Hood Sensor (Smart Cover Sensor) (optional) on page 65)
Smart Cover Lock solenoid (Smart Cover Lock solenoid (optional) on page 66)
Front bezel (Front bezel on page 67)
Bezel blanks (Bezel blanks on page 68)
Front panel I/O device assembly (Front panel I/O device assembly on page 69)
Power button assembly (Power button assembly on page 71)
Optical drives (Optical drive (minitower configuration) on page 90 , Optical drive (desktop configuration) on page 92)
Diskette drive (Diskette drive (optional) on page 95)
System speaker (System speaker on page 72)
Power supply (Power supply on page 73)
System fan (System fan assembly on page 74)
PCI card guide and front fan (optional) (Front PCI card guide and fan removal (optional) on page 86)
Memory (Memory on page 75)
PCI retainer (PCI card support bracket on page 80)
PCI slots (PCI card slots on page 79)
PCI Express card (PCI Express cards on page 81)
PCI card (PCI card on page 83)

Table 4-5 Workstation component disassembly order (continued)

Hard drives (SAS hard drive on page 96), SATA hard drive on page 99)
Processor heatsink (Processor heatsink on page 103)
Processor (System processor on page 105)
System board (System board on page 107)
Battery (Battery on page 87)

Security lock (Padlock loop) (optional)

If a security padlock is installed on your workstation, remove it before servicing the workstation.

Removing the security lock

To remove the padlock, unlock it and slide it out of the padlock loop as shown in the following figure.

Figure 4-3 Removing the security lock



Cable lock (optional)

If a cable lock is installed on your workstation, remove it before servicing the workstation.

Removing the cable lock

To remove the cable lock, unlock it and pull it out of the cable lock slot as shown in the following figure.

Figure 4-4 Removing the cable lock



Universal chassis clamp lock (optional)

If a universal chassis clamp lock is installed on your workstation, remove it before servicing the workstation.

Removing the chassis clamp lock

To remove the lock:

1. Unlock the device and remove the locking mechanism.

Figure 4-5 Unlocking the device



2. Remove the screw attaching the lock to the chassis.

Figure 4-6 Removing the lock screws



Side access panel

Before accessing the internal components of the workstation, the side access panel must be removed.

This section describes how to remove and replace the side access panel.

Removing the side access panel

To remove the side access panel:

⚠ WARNING! Before removing the workstation side access panel, be sure that the workstation is powered off and that the power cord is disconnected from the electrical outlet.

1. Disconnect power from the system
([Predisassembly procedures on page 58](#)).
2. Unlock any locks that may be present (cable lock or padlock).

3. Pull open the access panel handle (1).

Figure 4-7 Removing the access panel

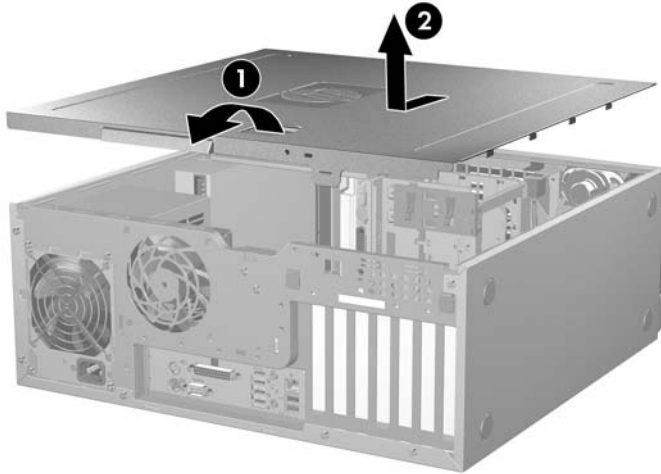

4. Slide the access panel toward the rear of the workstation and lift off the cover (2).

Replacing the side access panel

To replace the side access panel:

1. Place the access panel over the chassis and align the tabs along the edges of the access panel with the slots in the chassis.
2. Press the access panel down, fitting the tabs into the slots.
3. Slide the access panel toward the front of the chassis until it locks into place.

Figure 4-8 Installing the access panel

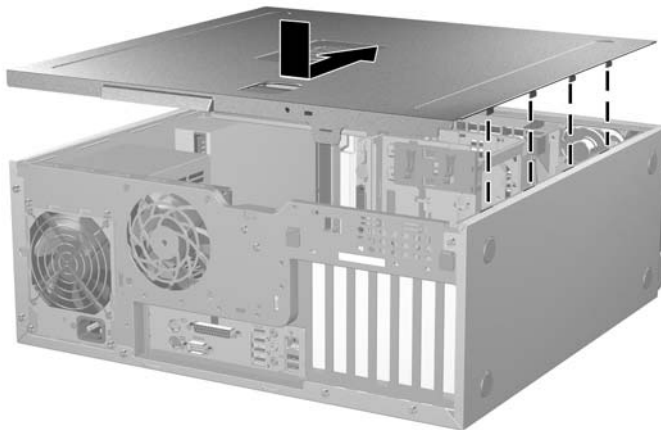

Hood Sensor (Smart Cover Sensor) (optional)

This section describes how to remove the Hood Sensor.

Removing the Hood Sensor

To remove the Hood Sensor:

1. Disconnect power from the system ([Predisassembly procedures on page 58](#)) and remove the side access panel ([Removing the side access panel on page 64](#)).
2. Disconnect the Hood Sensor connector from system board (1).

Figure 4-9 Removing the Hood Sensor

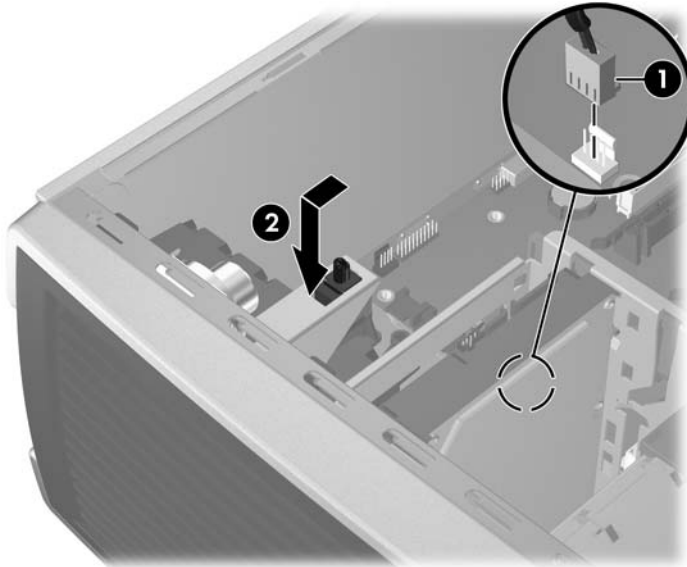

3. Slide the Hood Sensor forward, push it down, and then remove it from the chassis (2).

NOTE: To replace the Hood Sensor, reverse the previous steps.

Smart Cover Lock solenoid (optional)

This section describes how to remove the Smart Cover Lock solenoid

Removing the Smart Cover Lock solenoid

To remove the Smart Cover Lock solenoid:

NOTE: To purchase a FailSafe key, contact your authorized HP reseller or service provider, or visit the HP Web site for ordering information.

1. Disconnect power from the system ([Predisassembly procedures on page 58](#)) and remove the side access panel ([Removing the side access panel on page 64](#)).

2. Disconnect the solenoid cable from the system board (1).

Figure 4-10 Removing the Smart Cover Lock solenoid assembly

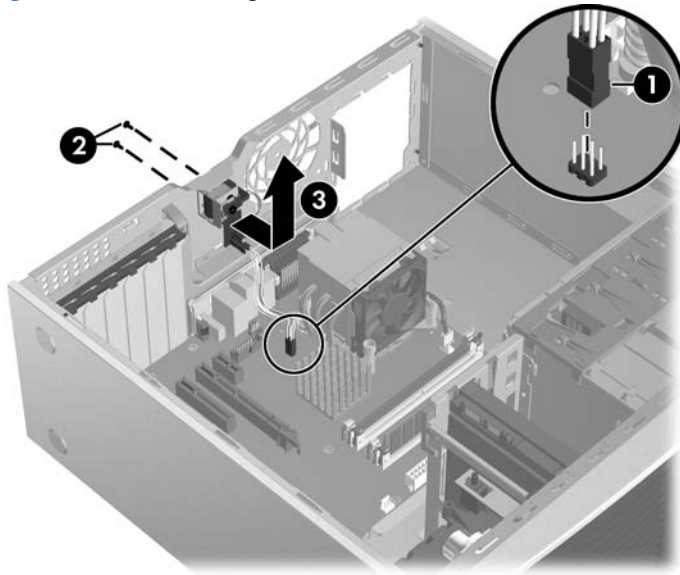

3. Using the FailSafe key (T-15 wrench), unscrew the two screws from the back of the chassis (2).
4. Slide the solenoid assembly away from the chassis and out of the workstation (3).

 **NOTE:** To install the Smart Cover Lock solenoid assembly, reverse the previous steps.

Front bezel

This section describes how to remove and replace the front bezel.

Removing the front bezel

To remove the front bezel:

1. Lift the two release snaps located on the front bezel (1).

Figure 4-11 Removing the front bezel

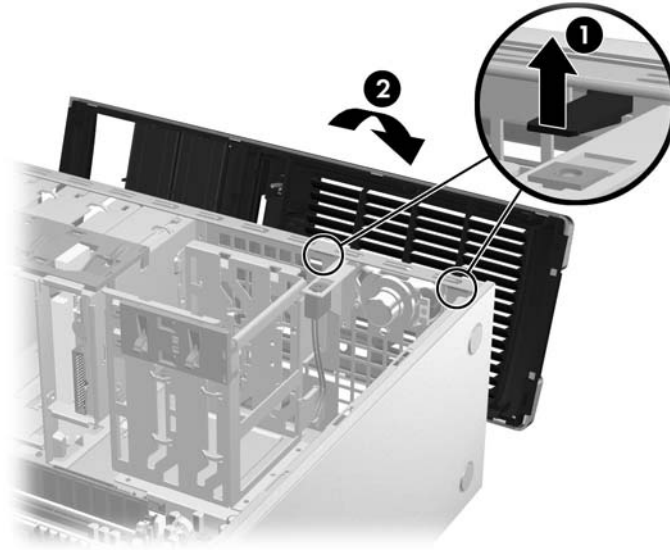

2. Rotate the front bezel away from the chassis to remove the bezel (2).

Replacing the front bezel

To replace the front bezel, align front bezel on the bottom and rotate in until it snaps into place.

Bezel blanks

This section describes how to remove bezel blanks

Removing bezel blanks

To remove bezel blanks:

1. Disconnect power from the system ([Predisassembly procedures on page 58](#)) and remove the front bezel ([Removing the front bezel on page 68](#)).

2. Gently push the subpanel out the back of the front bezel (1).

Figure 4-12 Removing the bezel blanks

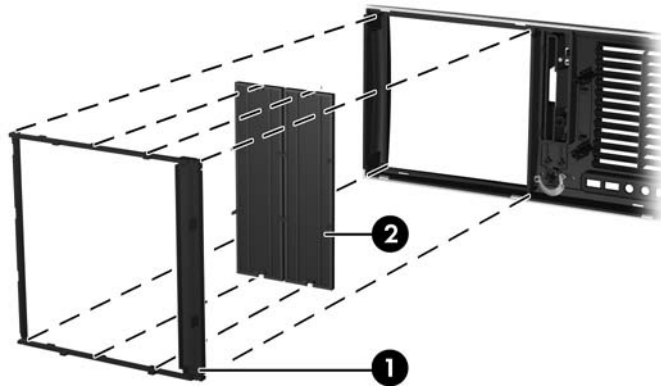

3. Remove the desired bezel blank by applying outward pressure on the subpanel (1) and pulling the blank away (2).

 **NOTE:** The bezel blanks are keyed to assist you in replacing them. Also, the subpanel can be rotated 90 degrees to install optical drives in a desktop orientation.

Front panel I/O device assembly

This section describes how to remove and install a front panel I/O device assembly.

Removing the front panel I/O device assembly

To remove the front panel I/O device assembly:

1. Disconnect power from the system ([Predisassembly procedures on page 58](#)), remove the side access panel ([Removing the side access panel on page 64](#)), and then remove the front bezel ([Removing the front bezel on page 68](#)).

2. If necessary, unlatch the plastic snap that secures the cables inside the chassis (1), and then disconnect the front panel I/O device assembly cables from the system board (2).

Figure 4-13 Removing front panel I/O device cables

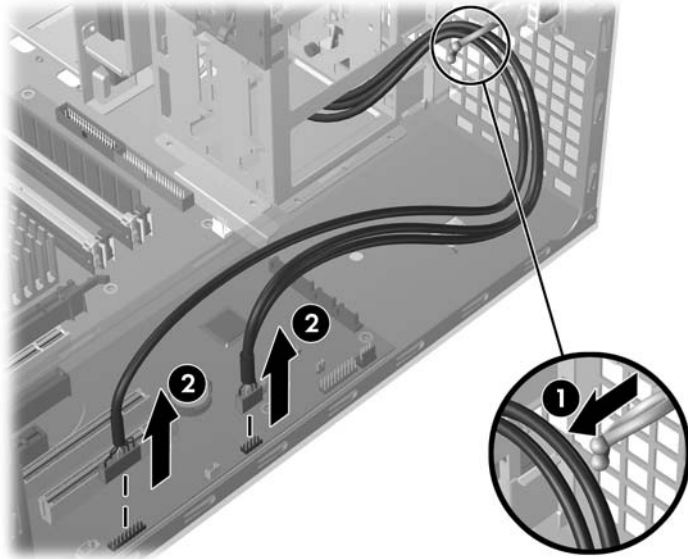

3. Remove the two smaller Torx screws (1) that hold the front panel I/O device assembly and bracket to the chassis (3).

Figure 4-14 Removing the front panel I/O device assembly

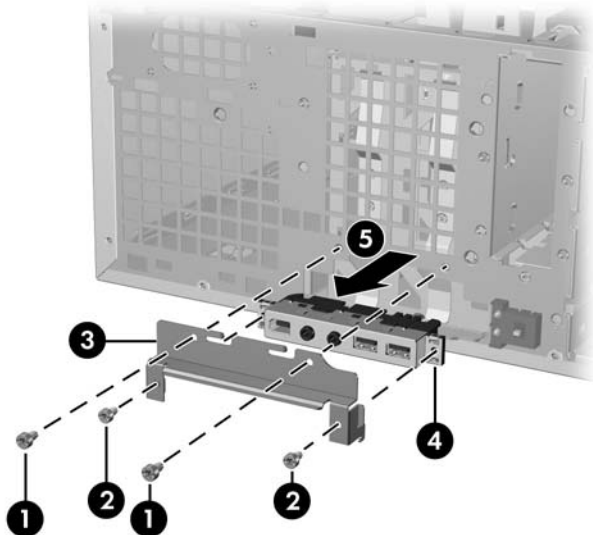

4. Remove the two larger Torx screws (2) that hold the front panel I/O device assembly to the bracket (3).
5. Separate the bracket from the front panel I/O device assembly.
6. Pull the front panel I/O device assembly out about two inches from the chassis (5).
7. Pull the front panel cables through the chassis and through the front of the workstation. You might have to slide the cables out one at a time.

Installing the front panel I/O device assembly

To instal the front panel I/O device assembly:

1. Thread each front panel I/O device assembly cable through the same holes from which they were removed.
2. Push the front panel I/O device assembly into the chassis. Using your fingers, orient the cables so that there is enough room for the front panel I/O device assembly to easily fit in its slot.
3. Loosely place the bracket on the front panel I/O device assembly and hook the bracket to the chassis.
4. Screw the bracket to the front panel I/O device assembly, and then screw the bracket to the chassis.
5. Connect the front audio cable to the audio connector (1). Connect the front USB cable to the USB connector (2). Connect the front control panel cable to the control panel connector (3). If an IEEE-1394 card is installed, connect the front IEEE-1394 cable to the card connector.

Figure 4-15 Attaching the front panel I/O device assembly cables

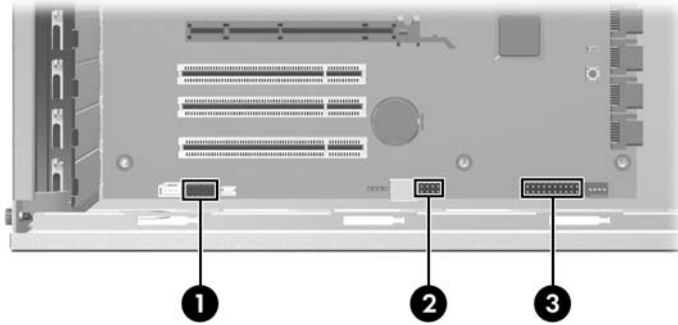

Power button assembly

This section describes how to remove the power button assembly.

Removing the power button assembly

To remove the power button assembly:

1. Disconnect power from the system ([Predisassembly procedures on page 58](#)), remove the side access panel ([Removing the side access panel on page 64](#)), remove the front bezel ([Removing the front bezel on page 68](#)), and then remove the front panel I/O device assembly ([Removing the front panel I/O device assembly on page 69](#)).

2. Disconnect the power button assembly cable from the system board.

Figure 4-16 Removing the power button assembly cable

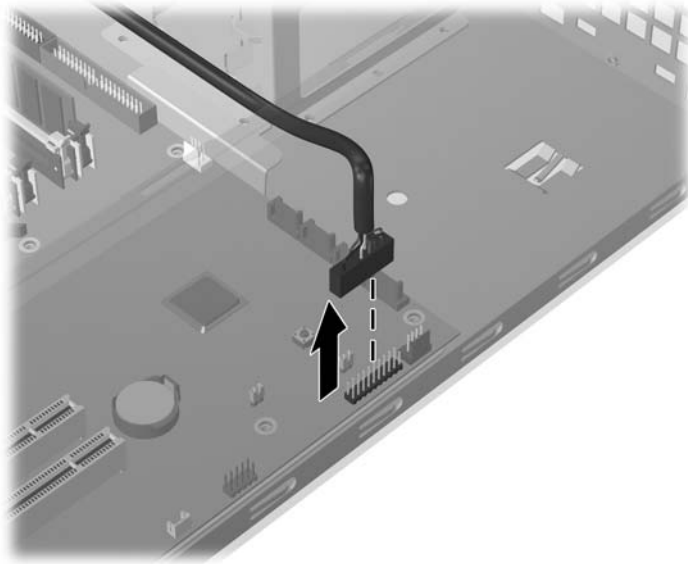

3. Press in on the clips that secure the power button assembly to the chassis (1).

Figure 4-17 Removing the power button assembly

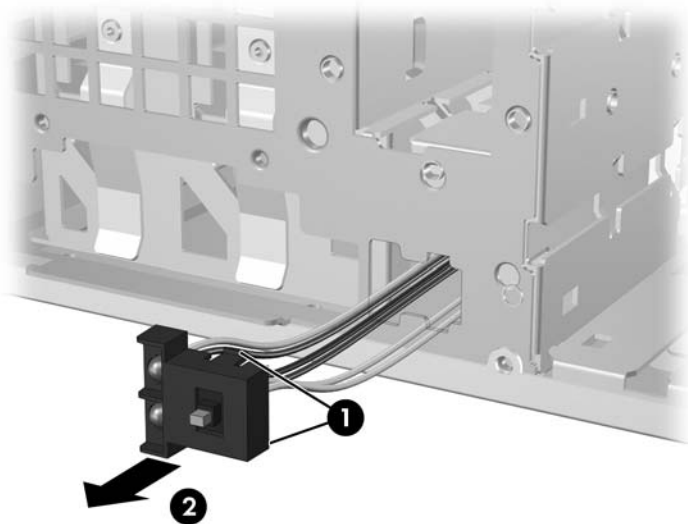

4. Dislodge the metal clip from the chassis by rocking the power button assembly back and forth, and then slide the power button assembly out from the front of the chassis (2).

 **NOTE:** To replace the power button assembly, reverse the previous steps.

System speaker

This section describes how to remove the system speaker.

Removing the system speaker

To remove the system speaker:

1. Disconnect power from the system ([Predisassembly procedures on page 58](#)) and remove the side access panel ([Removing the side access panel on page 64](#)).
2. Disconnect the speaker cable from the system board (1).

Figure 4-18 Removing a system speaker

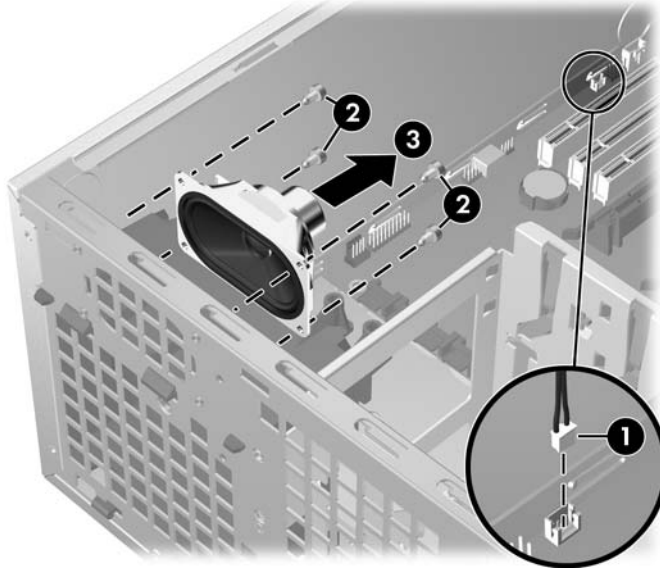

3. Remove the four screws (2) securing the speaker to the chassis and remove the speaker from the chassis (3).

 **NOTE:** To replace the speaker, reverse the previous steps.

Power supply

This section describes how to remove the power supply.

Removing the power supply

To remove the power supply:

1. Disconnect power from the system ([Predisassembly procedures on page 58](#)) and remove the side access panel ([Removing the side access panel on page 64](#)).

 **TIP:** The next step requires disconnecting several power cables. To ease the installation of the power supply, it is helpful to write down the numbers on the cables so you can easily reconnect the cables to the correct devices.

2. Disconnect all cables from the system board, drives, and cards.

3. Remove the four screws from the back panel (1).

Figure 4-19 Removing the power supply

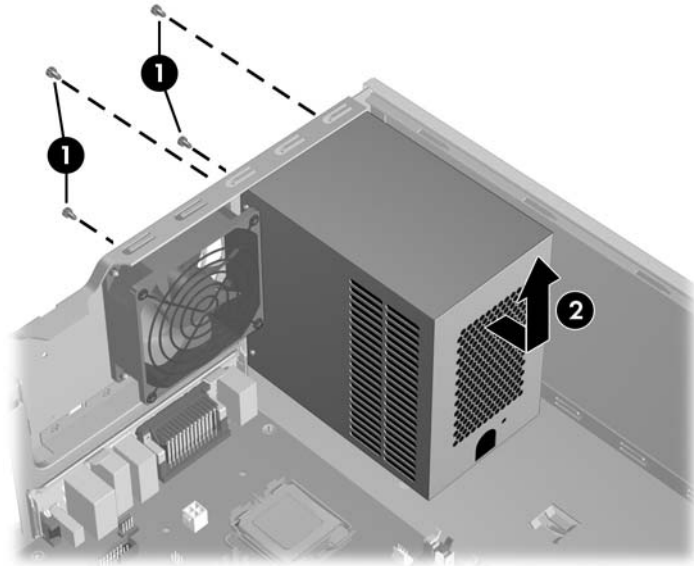

4. Slide the power supply toward the front of the chassis and lift it out of the chassis (2).

 **NOTE:** To replace the power supply, reverse the previous steps.

System fan assembly

This section describes how to remove the system fan assembly.

Removing the system fan assembly

To remove the system fan assembly:

1. Disconnect power from the system ([Predisassembly procedures on page 58](#)) and remove the side access panel ([Removing the side access panel on page 64](#)).

2. Disconnect the fan plug from the system board (1).

Figure 4-20 Removing the system fan

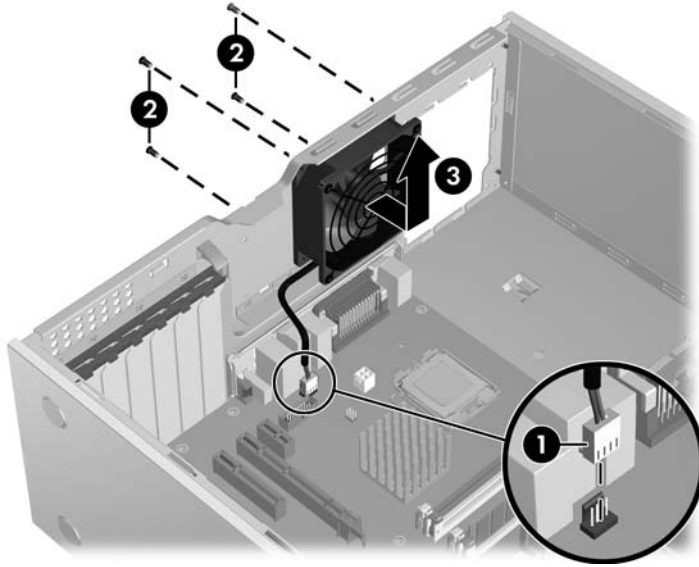

3. Use a cross-tip screwdriver to remove the four screws from the rear of the chassis (2).
4. Lift the system fan out of the chassis (3).

△ **CAUTION:** When replacing the system fan, be sure that the fan is seated with the airflow direction arrow pointing toward the rear of the chassis.

📝 **NOTE:** To install the system fan assembly, reverse these steps.

Memory

This section describes how to remove and install a memory module.

Removing a memory module

1. Disconnect power from the system ([Predisassembly procedures on page 58](#)) and remove the side access panel ([Removing the side access panel on page 64](#)).

△ **CAUTION:** To ensure that memory modules are not damaged during removal or installation, power off the workstation and unplug the power cord from the AC power outlet. If you do not unplug the power cord before installing memory, the modules might be damaged and the system will not recognize the memory changes.

2. Push gently outward on the socket levers (1).

Figure 4-21 Removing a memory module

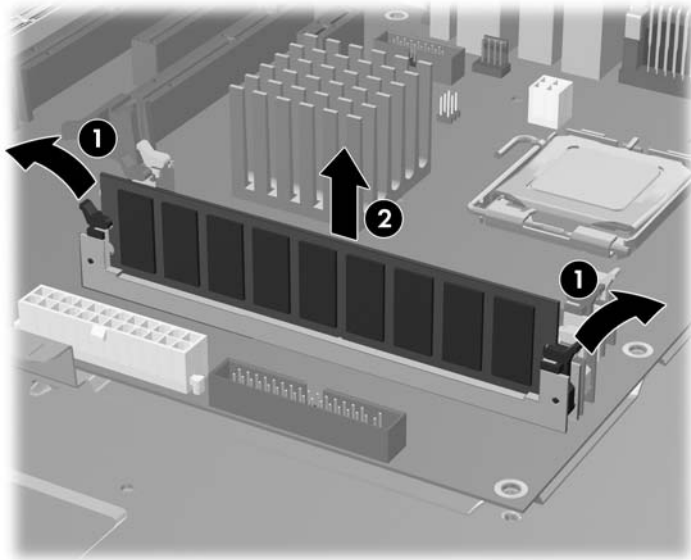

3. Lift the DIMM straight up and out of the socket. Store the DIMM in an anti static bag (2).

Installing a memory module

This section describes how to install a memory module.

Supported DIMM configurations

The HP xw4600 Workstation supports these memory module configurations:

- Four DIMM slots
- Memory configuration from 512 MB to 2 GB
- Dual-channel DIMMs

Memory module requirements

△ **CAUTION:** HP only ships DIMMs that are electrically and thermally compatible with this workstation. Because third-party DIMMs might not be electrically or thermally compatible, they are not supported by HP.

📄 **NOTE:** DIMMs and their sockets are keyed for proper installation. Be sure these guides line up when installing DIMMs.

Use only industry-standard, unbuffered, PC2–5300E (667 MHz) or PC2–6400E (800 MHz) DIMMs.

If multiple DIMMs are installed in a workstation, they must be installed in pairs of the same size and type in each channel.

Required DIMM installation order

Use the following illustration as a guide for installing memory:

- If installing only one DIMM, it must be installed in socket (1).
- The first DIMM pair must be installed in sockets (1) and (3).
- The second DIMM pair must be installed in sockets (2) and (4).

Figure 4-22 Required DIMM installation order

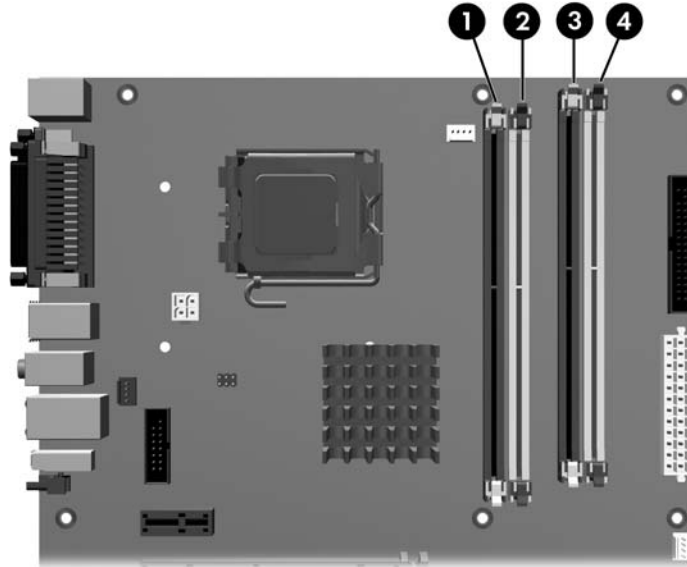

Installing a memory module

To install a memory module:

1. Disconnect power from the system ([Predisassembly procedures on page 58](#)), and then remove the side access panel ([Removing the side access panel on page 64](#)).

2. Push gently outward on the socket levers.

Figure 4-23 Opening the DIMM socket levers

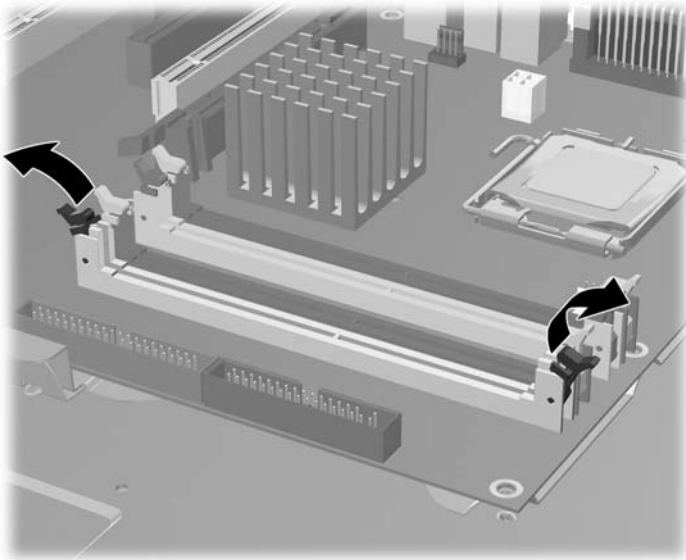

3. Align the DIMM connector key with the DIMM socket key, and then seat the DIMM firmly in the socket (1).
4. Secure the socket levers (2).

Figure 4-24 Installing a memory module

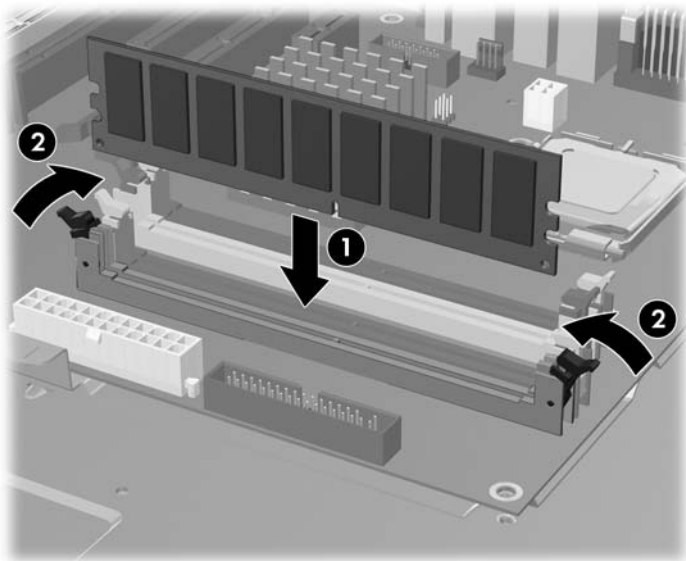

PCI card slots

The following figure illustrates the xw4600 Workstation PCI card slots.

Figure 4-25 Identifying PCI card slots

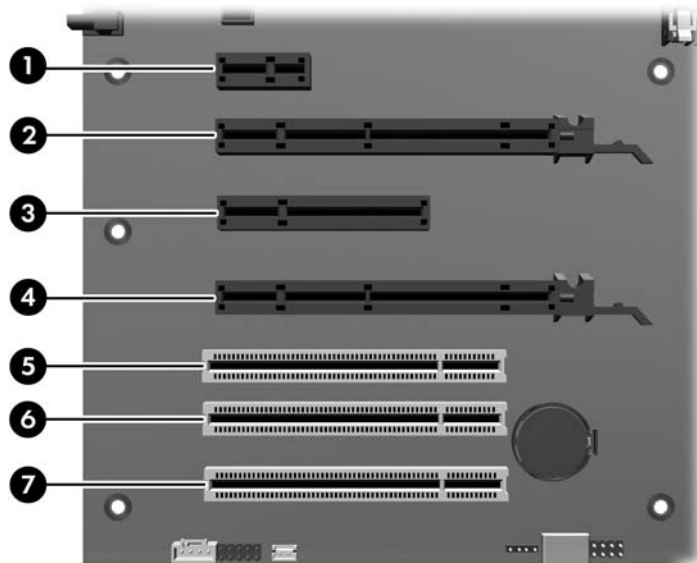

Table 4-6 PCI slots

Slot	Type	Slot power (Maximum)
1	PC-Express x1	25W
2	PCI-Express x16*	75W
3	PCI-Express x8 (x4)	25W
4	PCI-Express x16*	75W
5	PCI 32/33	25W
6	PCI 32/33	25W
7	PCI 32/33	25W

* The maximum graphics configuration can be: two 75W cards (one in slot two; one in slot four), or one 150W card, preferably in slot 2. If a 150W card is used, HP suggests that the adjacent slot remain empty.

in either slot 2 or slot 4. If a 150W card is used, the adjacent slot must remain empty.

in either slot 2 or slot 4. If a 150W card is used, the adjacent slot must remain empty.

Graphics cards greater than 75W require the use of a graphics cable adapter.

NOTE: In addition to these slot power specifications, the overall power consumption of the system (including I/O cards, processor, and memory) must not exceed the maximum rating of the system power supply.

PCI card support bracket

Some PCI cards have retainers installed to prevent movement during shipping.

Removing a PCI card support bracket

To remove a PCI card support bracket:

1. Disconnect power from the system ([Predisassembly procedures on page 58](#)) and remove the side access panel ([Removing the side access panel on page 64](#)).
2. Remove the two screws that attach the bracket to the chassis (1).

Figure 4-26 Removing a PCI card support bracket

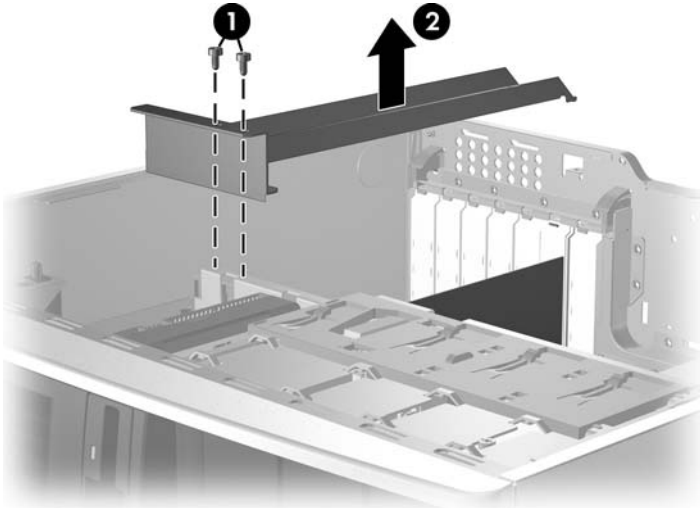

3. Lift the bracket out of the chassis (2).

Installing a PCI card support bracket

To install the PCI card support bracket:

1. Disconnect power from the system ([Predisassembly procedures on page 58](#)) and remove the side access panel ([Removing the side access panel on page 64](#)).

2. Align the rear bracket with the holes in the rear of the chassis (1), and then rotate the bracket down into position (2).

Figure 4-27 Installing a PCI card support bracket

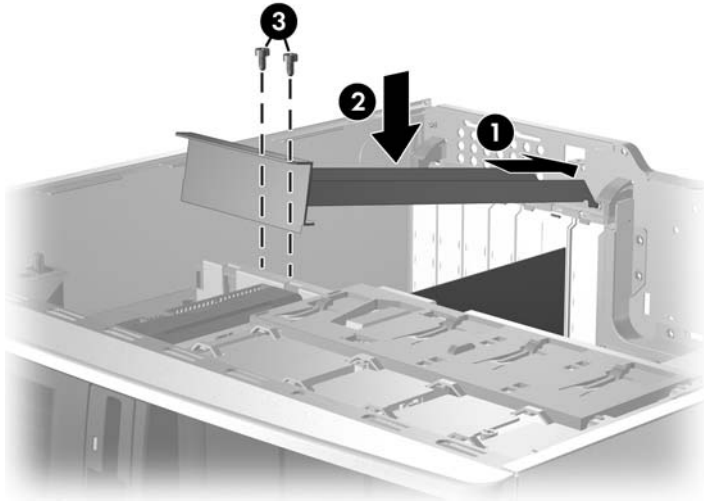

3. Secure the bracket to the chassis with two screws (3).

PCI Express cards

PCI Express improves system attributes and enables a low-power, scalable, high-bandwidth communication path using a small number of connections, or wires, compared to traditional parallel interfaces such as PCI. The PCI Express I/O slots can support other PCI Express cards with less bus bandwidth than what is physically defined for the slot. Use the following table to determine PCI Express card compatibility.

Table 4-7 PCI Express compatibility matrix for the HP xw4600 Workstation

Slot type	Mechanical compatibility	Electrical compatibility
PCI Express x1 slot	x1 cards	x1 modes
PCI Express x8 (x4) slot	x1, x4, and x8	x1 and x4 modes
PCI Express x16 slot	x1, x4, x8 and x16 cards	x1, x4, x8, and x16 modes

Removing a PCI Express card

To remove a PCI Express card:

1. Disconnect power from the system ([Predisassembly procedures on page 58](#)), remove the side access panel ([Removing the side access panel on page 64](#)), and then remove the PCI retainer, if installed ([PCI card support bracket on page 80](#)).

2. Open the PCI card retention clamp. Press the retention clamp levers down to unsnap, and then rotate them up (1).

Figure 4-28 Removing a PCI Express card

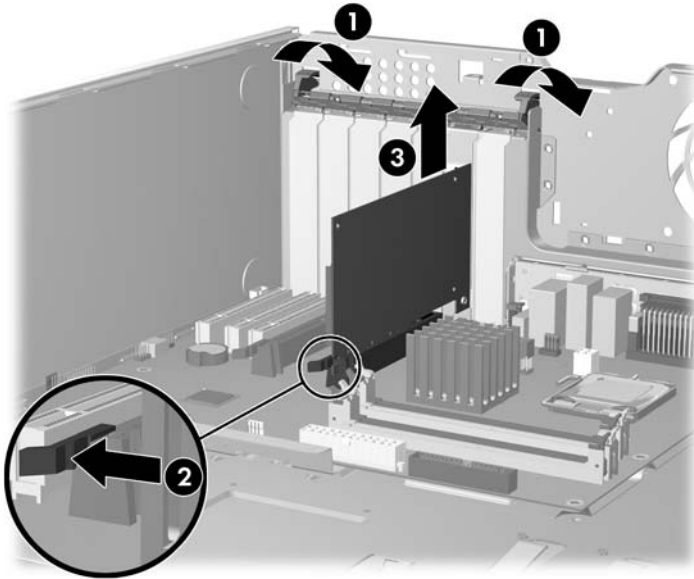

3. If removing a PCI Express x16 graphics card, press in on the release lever (2) while lifting the card (3) out of the chassis. Store the card in an anti-static bag.

If removing a PCI Express card without a release lever, simply lift the card out of the chassis.

4. Install a PCI slot cover and close the PCI retention clamp. If the PCI retention clamp levers do not close, ensure that all cards are properly seated, and then try again.

Installing a PCI Express card

To install a PCI Express card:

1. Disconnect power from the system ([Predisassembly procedures on page 58](#)), remove the side access panel ([Removing the side access panel on page 64](#)), and remove the PCI retainer ([PCI card support bracket on page 80](#)), if installed.

2. Open the PCI card retention clamp. Press the retention clamp levers down to unsnap, and then rotate them up (1).

Figure 4-29 Installing a PCI Express card

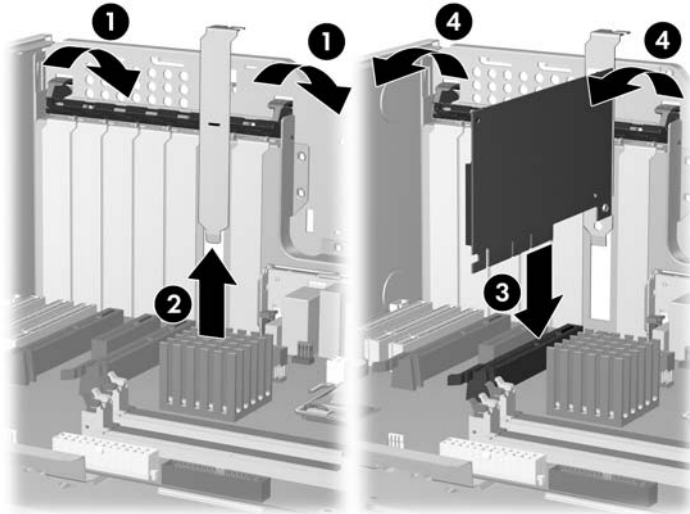

3. Remove the PCI slot cover (2).
4. Align the keyed components of the PCI card with the slot, and then firmly seat the card in the slot (3).
5. Close the PCI card retention clamp by rotating the clamp downward and pressing the two green clamp levers from the rear panel of the chassis (4).

PCI card

This section describes removing and installing PCI cards.

Removing a PCI card

To remove a PCI card:

1. Disconnect power from the system ([Predisassembly procedures on page 58](#)), remove the side access panel ([Removing the side access panel on page 64](#)), and then remove the PCI card support bracket, if installed ([PCI card support bracket on page 80](#)).

2. Open the PCI card retention clamp. Press the retention clamp levers down to unsnap, and then rotate them up (1).

Figure 4-30 Removing a PCI card

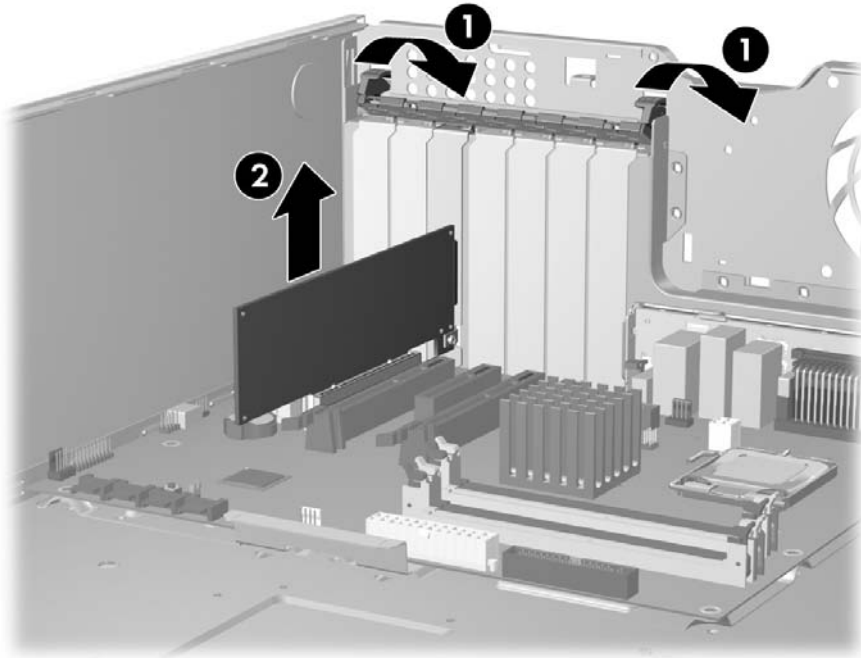

3. Lift the PCI card out of the chassis (2). Store the card in an anti static bag.
4. Install a PCI slot cover and close the PCI retention clamp. If the PCI retention clamp levers do not close, ensure that all cards are properly seated, and then try again.

Installing a PCI card

To install a PCI card:

1. Disconnect power from the system ([Predisassembly procedures on page 58](#)), remove the side access panel ([Removing the side access panel on page 64](#)), and then remove the PCI card support bracket, if installed ([PCI card support bracket on page 80](#)).

2. Open the PCI card retention clamp. Press the retention clamp levers down to unsnap, and then rotate them up (1).

Figure 4-31 Installing a PCI card

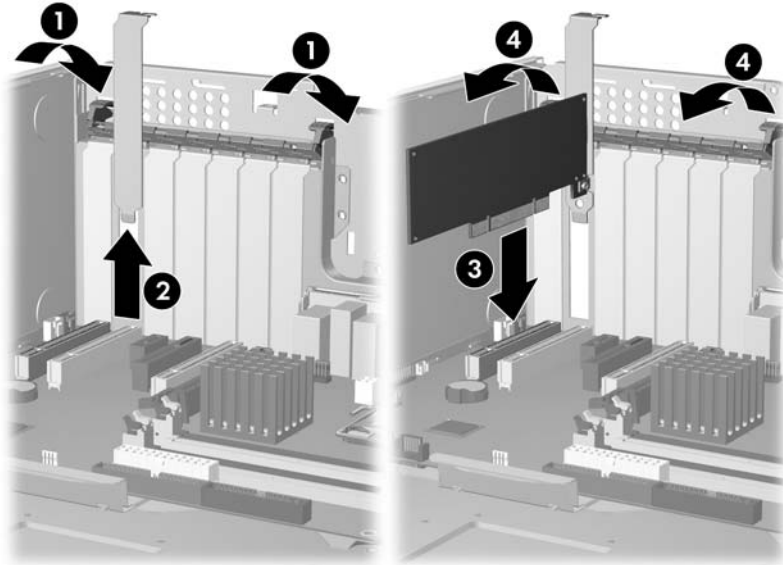

3. Remove the PCI slot cover (2).
4. Align the keyed components of the PCI card with the slot , and then firmly seat the card in the slot (3).
5. Close the PCI retention clamp by rotating the clamp downward and pressing the two green clamp levers from the rear panel of the chassis (4).

IEEE-1394 card (optional)

This section describes how to remove an IEEE-1394 card.

Removing an IEEE-1394 card

To remove an IEEE-1394 card:

1. Disconnect power from the system ([Predisassembly procedures on page 58](#)), remove the side access panel ([Removing the side access panel on page 64](#)), and then remove the front bezel ([Removing the front bezel on page 68](#)).

2. Open the PCI card retention clamp. Press the retention clamp levers down to unsnap, and then rotate them up (1).

Figure 4-32 Removing an IEEE-1394 card

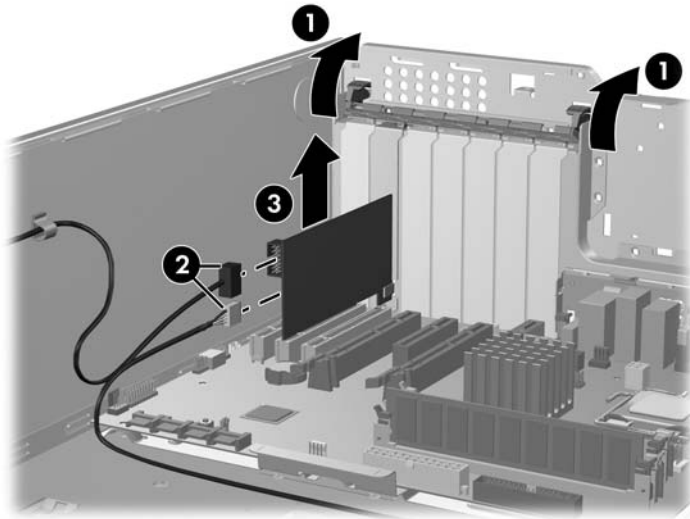

3. Disconnect the front I/O cable and power cable from the card (2).
4. Lift the IEEE-1394 card out of the chassis (3). Store the card in an anti static bag.
5. Install a PCI slot cover and close the PCI card retention clamp. If the PCI levers do not close, ensure that all cards are properly seated, and then try again.

 **NOTE:** To install an IEEE-1394 card, reverse the previous steps.

Front PCI card guide and fan removal (optional)

This unit acts as a front fan housing and card guide. This section describes how to remove and replace the fan housing/card guide and the front fan.

 **NOTE:** The fan is only used for special configurations, but the card guide is used with all full-length add-in cards.

Removing the front PCI card guide and fan

To remove the front PCI card guide and fan:

1. Disconnect power from the system ([Predisassembly procedures on page 58](#)), remove the side access panel ([Removing the side access panel on page 64](#)), and then remove the front bezel ([Removing the front bezel on page 68](#)).

2. Disconnect the fan wire from the connector on the system board and thread it out of the card guide (1).

Figure 4-33 Removing the front fan housing/card guide

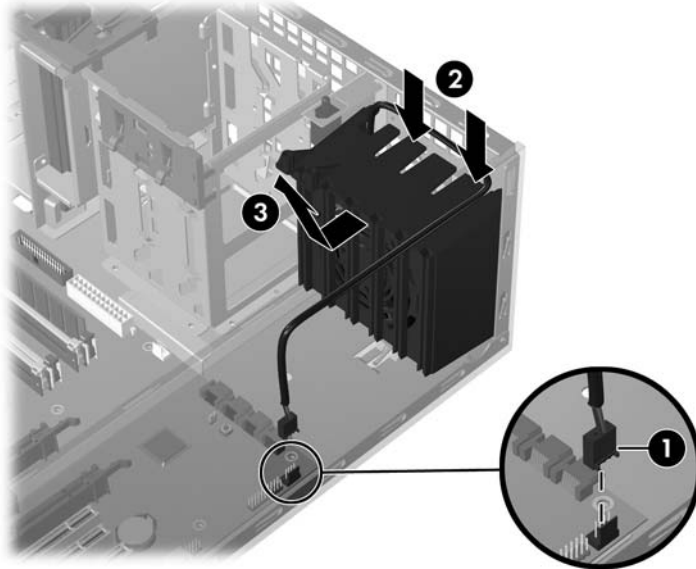

3. Unsnap the fan housing/card guide from the chassis (2) and lift it out of the chassis (3).
4. Remove the fan from the fan housing/card guide by applying outward pressure on the fan housing while pushing the fan out of the housing.

Figure 4-34 Removing the fan from fan housing/card guide

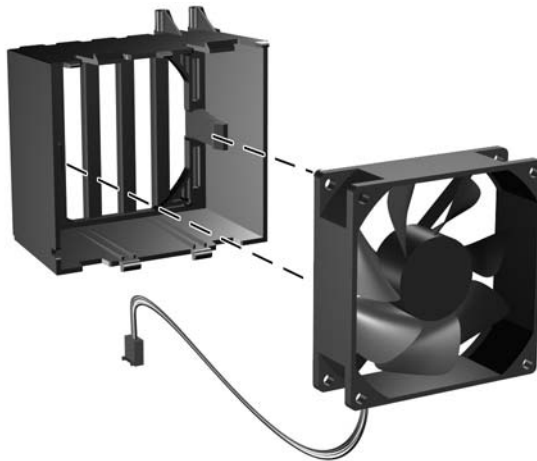

 **NOTE:** To replace the front fan, reverse the previous steps, ensuring that the airflow direction arrow on the side of the fan points to the rear of the chassis.

Battery

This section describes how to remove and install the battery.

The battery that comes with the workstation provides power to the real-time clock and has a minimum lifetime of about three years.

⚠ **WARNING!** This workstation includes a lithium battery. There is a risk of fire and chemical burn if the battery is handled improperly. Do not disassemble, crush, puncture, short external contacts, dispose in water or fire, or expose it to temperatures higher than 60°C (140°F).

⚠ **CAUTION:** Before removing the battery, ensure that the CMOS settings are backed up in case they are lost when the battery is removed. To back up the CMOS settings, select the **Save to Diskette** option in the Computer Setup (F10) Utility.

📄 **NOTE:** Batteries, battery packs, and accumulators should not be disposed of together with general household waste.

Removing the battery

To remove the battery:

1. Disconnect power from the system ([Predisassembly procedures on page 58](#)) and remove the side access panel ([Removing the side access panel on page 64](#)).
2. On the system board, press the release tab of the battery holder.
3. Rotate the battery just enough to get beyond the latch, and then lift it straight up.

Installing the battery

To install the battery:

1. Confirm the polarity (positive or negative) of the battery to position it correctly in the battery holder.
2. Place the battery edge under the plastic housing tab.

Figure 4-35 Removing the battery

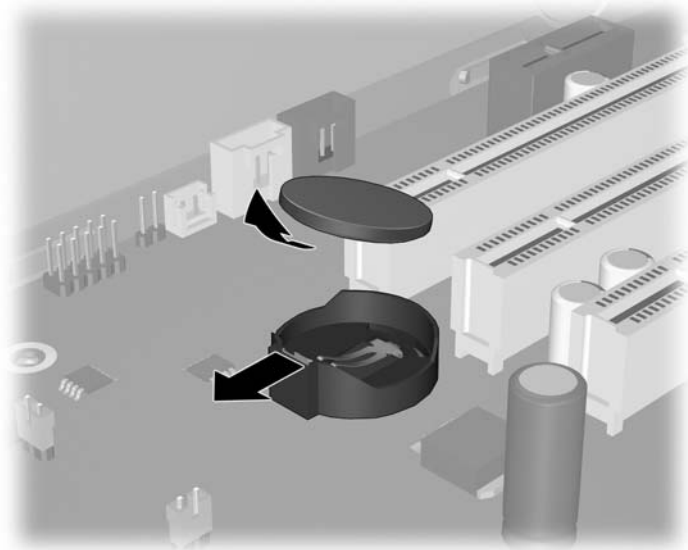

3. Press down on the battery until the metal snaps engage.

Power connections to drives

For help identifying power cables, see the following figure. Ensure that all cables are routed or tied so that they cannot interfere with the processor heatsink fans.

Figure 4-36 Identifying workstation power connectors for a typical configuration

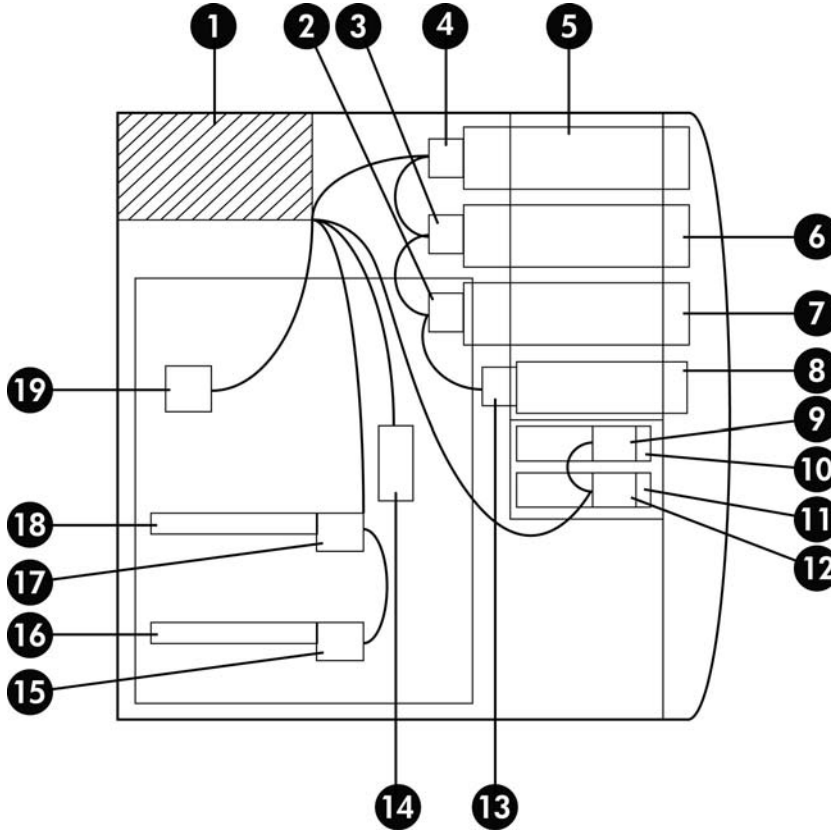

Table 4-8 Workstation power connector description

Item	Description
1	Power supply
2	P8
3	P6/P7
4	P4/P5
5	Optical drive 1
6	Optical drive 2 and Hard drive 4
7	Optical drive 3 and Hard drive 3
8	Diskette
9	P11
10	Hard drive 2
11	Hard drive 1
12	P10

Table 4-8 Workstation power connector description (continued)

Item	Description
13	P9
14	P1
15	P13
16	1394 card
17	P12
18	Graphics card
19	P3

Optical drive (minitower configuration)

This section describes how to remove and install an optical disk drive in a minitower workstation configuration.

Removing an optical drive (minitower configuration)

1. Disconnect power from the system ([Preassembly procedures on page 58](#)), remove the side access panel ([Removing the side access panel on page 64](#)), and then remove the front bezel ([Removing the front bezel on page 68](#)).
2. Disconnect the power (1) and data (2) cables from the optical drive.

Figure 4-37 Disconnecting the optical drive cables

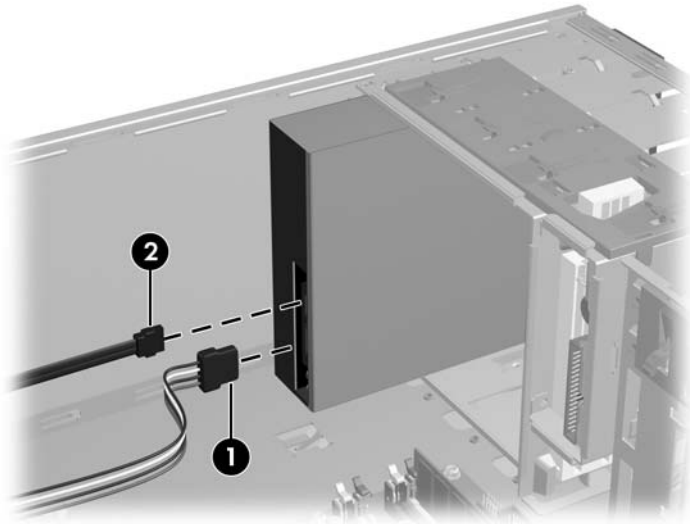

3. Lift the green drive-lock release lever (1) and gently slide the drive out of the chassis (2).

Figure 4-38 Removing the optical drive from the chassis

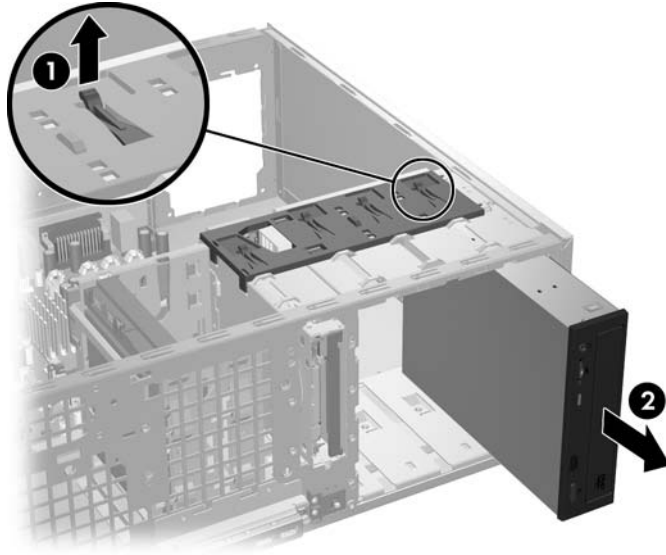

4. After removing the optical drive (1), if you plan to install another drive, remove only the four guide screws from the drive casing (2).

Figure 4-39 Removing the optical drive screws

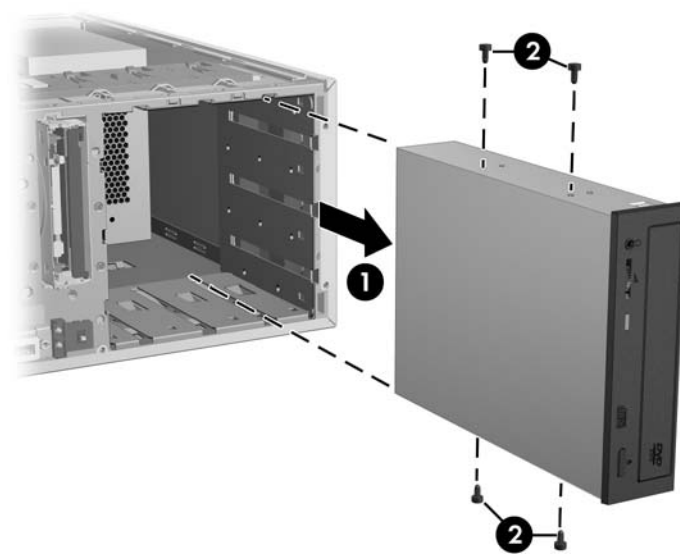

Installing an optical drive (minitower configuration)

1. Disconnect power from the system ([Predisassembly procedures on page 58](#)), remove the side access panel ([Removing the side access panel on page 64](#)), and then remove the front bezel ([Removing the front bezel on page 68](#)).

2. Insert the four black metric M3 guide screws into the drive casing (1).

Figure 4-40 Installing the optical drive

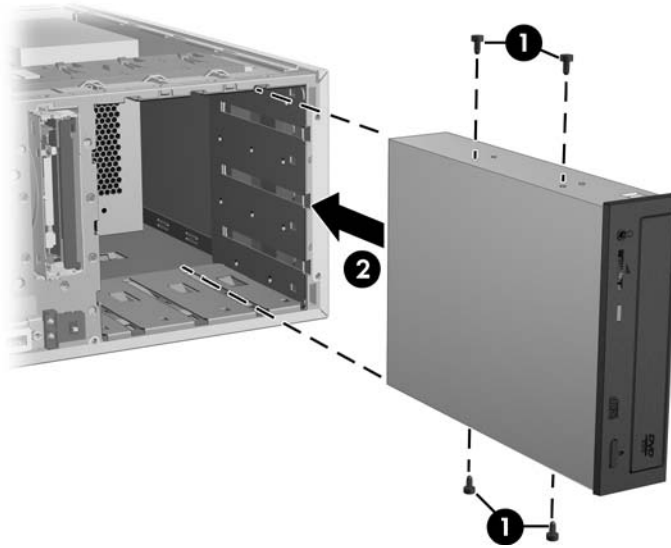

3. Align the screws with the grooves in the drive bay, and then gently slide the drive into the workstation until it snaps into place (2).

△ **CAUTION:** Ensure that the optical drive is secure in the workstation chassis by pulling on the drive to see if it can become easily disengaged. Failure to properly secure the drive can damage the drive when moving the workstation.

4. Connect the power and data cables to the drive and system board.

NOTE: SATA optical drives can be configured in a workstation with SATA hard drives. When the SATA Configuration Mode for this workstations is set to:

IDE Mode—Only SATA ports 0 and 2 are functional for any SATA devices.

AHCI Mode—All SATA ports are functional for any SATA devices.

RAID + AHCI Mode—You will not be able to update system BIOS from the SATA optical drive.

Optical drive (desktop configuration)

This section describes how to remove and install an optical drive in the workstation desktop configuration.

Removing an optical drive (desktop configuration)

1. Disconnect power from the system ([Predisassembly procedures on page 58](#)), remove the side access panel ([Removing the side access panel on page 64](#)) and then remove the front bezel ([Removing the front bezel on page 68](#)).

2. Disconnect the data (1), power (2) cables from the drive. The connector colors might be different than shown in the following figure.

Figure 4-41 Disconnecting the optical drive cables

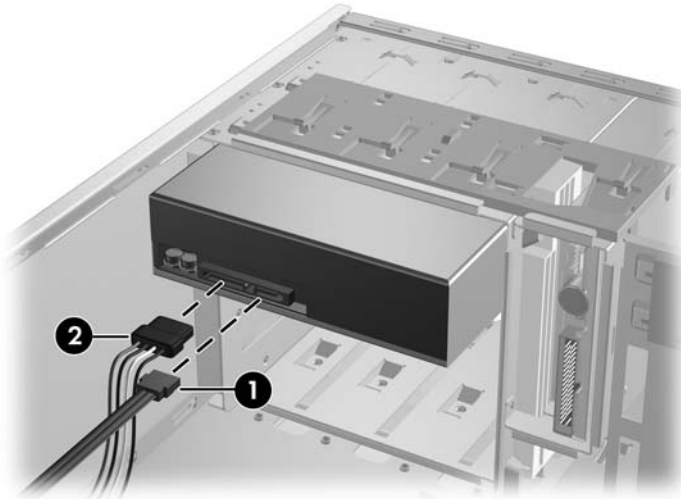

3. Press down on the yellow drive-lock release lever (1) and gently slide the drive out of the chassis (2).

Figure 4-42 Removing the optical drive from chassis

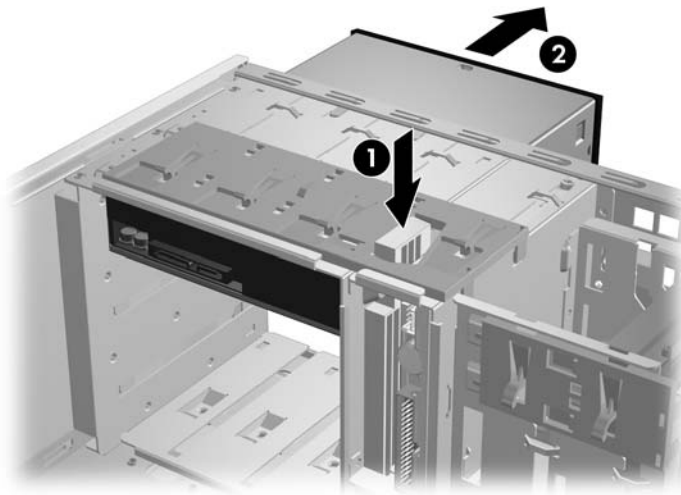

4. After pulling the drive out (1), if you plan to install another drive, remove only the four guide screws from the drive (2).

Figure 4-43 Removing the optical drive screws



Installing an optical drive (desktop configuration)

1. Disconnect power from the system ([Predisassembly procedures on page 58](#)), remove the side access panel ([Removing the side access panel on page 64](#)), remove the front bezel ([Removing the front bezel on page 68](#)), and then remove the bezel blank ([Removing bezel blanks on page 68](#)) where the drive is being added.
2. Install the four black metric M3 guide screws into the drive (1).

Figure 4-44 Installing the optical drive



3. Align the screws with the grooves in the drive bay and gently slide the drive into the casing until it snaps into place (2).
- △ **CAUTION:** Ensure that the optical drive is secure in the workstation chassis by pulling the drive to see if it can become disengaged. Failure to properly secure the drive can cause damage to the drive when moving the workstation.
4. Connect the power and drive cables to the drive and system board.

📄 **NOTE:** SATA optical drives can be configured in a workstation with SATA hard drives. When the SATA Configuration Mode for this workstations is set to:

IDE Mode—Only SATA ports 0 and 2 are functional for any SATA devices.

AHCI Mode—All SATA ports are functional for any SATA devices.

RAID + AHCI Mode—You will not be able to update system BIOS from the SATA optical drive.

Diskette drive (optional)

This section describes how to remove and install a diskette drive.

Removing a diskette drive

1. Disconnect power from the system ([Predisassembly procedures on page 58](#)), remove the side access panel ([Removing the side access panel on page 64](#)), and then remove the front bezel ([Removing the front bezel on page 68](#)).
2. Disconnect the power (1) and data (2) cables from the back of the diskette drive.

Figure 4-45 Disconnecting the diskette drive cables

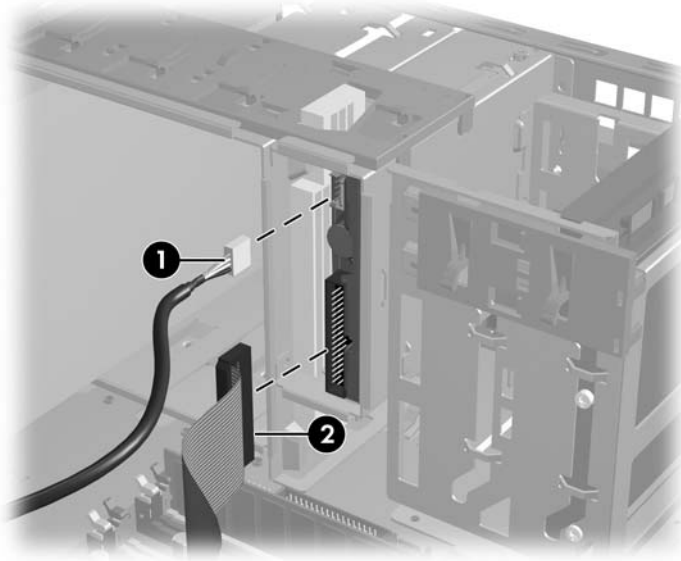

3. Lift the green drive-lock release tab (1) and gently slide the drive out of the chassis at the same time (2).

Figure 4-46 Removing the diskette drive from chassis

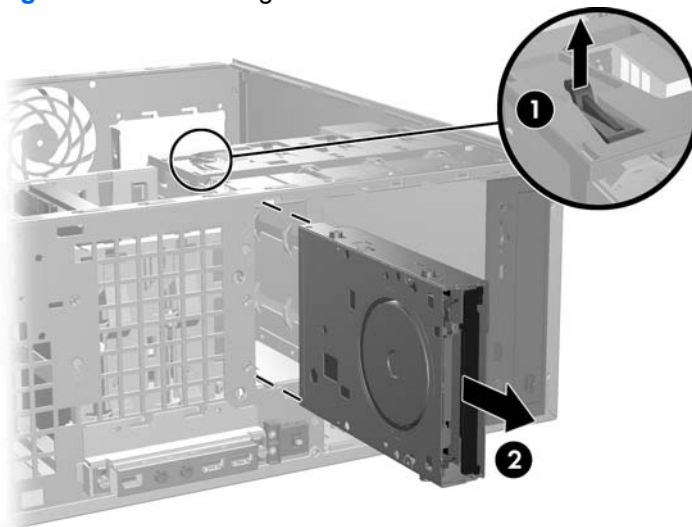

 **NOTE:** To install a diskette drive, reverse the previous steps. You might need to remove the front bezel to install the drive.

SAS hard drive

This section describes how to remove and install a SAS hard drive.

Removing a SAS hard drive

1. Disconnect power from the system ([Predisassembly procedures on page 58](#)), and then remove the side access panel ([Removing the side access panel on page 64](#)).
2. Disconnect the power (1) and data (2) cables from the hard drive.

Figure 4-47 Disconnecting the SAS hard drive cables

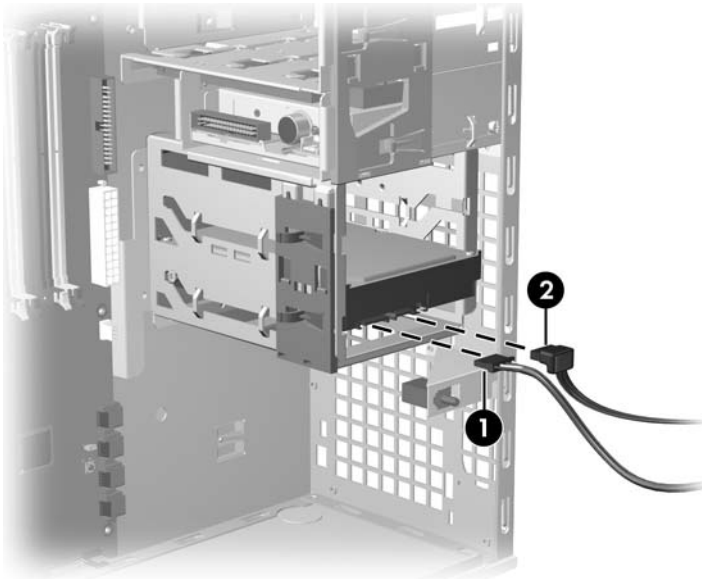

3. Lift the green drive-lock release tab (1), and then slide the hard drive out of the chassis (2).

Figure 4-48 Removing the SAS hard drive

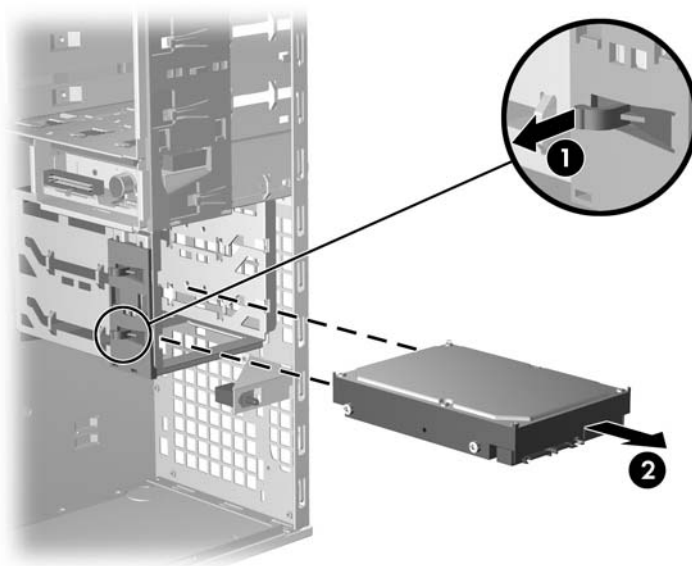

4. Remove the four guide screws from the hard drive and retain them for later use.



Installing a SAS hard drive

1. Disconnect power from the system ([Predisassembly procedures on page 58](#)), and then remove the side access panel ([Removing the side access panel on page 64](#)).
2. Attach a SAS-to-SATA cable adapter to the connector on the SAS hard drive.

Figure 4-49 Attaching the SAS-SATA adapter to the SAS hard drive

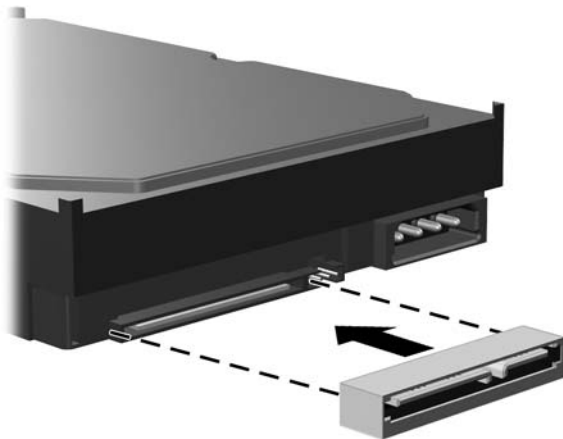

3. Install the four silver, ANSI 6–32 guide screws into the hard drive.



4. Push the drive into the selected bay until it snaps into place (1).

Figure 4-50 Installing the SAS hard drive

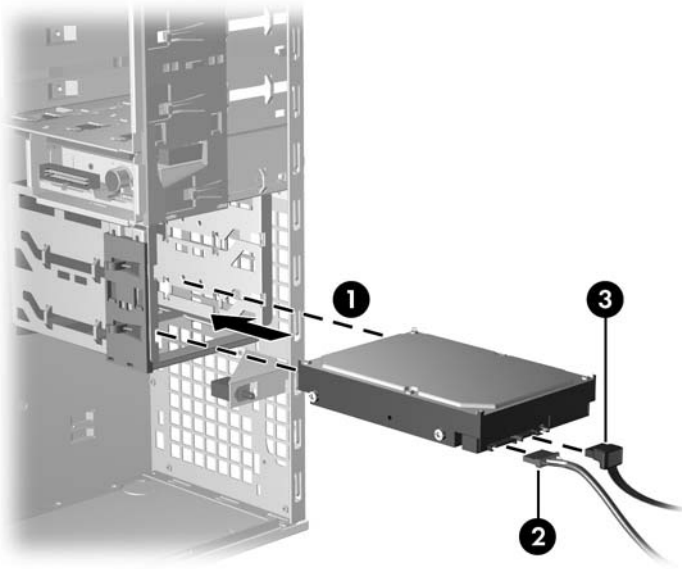

5. Attach the power (2) and data (3) cables to the SAS drive.
6. Insert the SAS controller card into an available PCI slot in the workstation chassis.
7. Connect the data cable from the hard drive (1) to the controller card (2).

Figure 4-51 Connecting the SAS cable to SAS hard drive

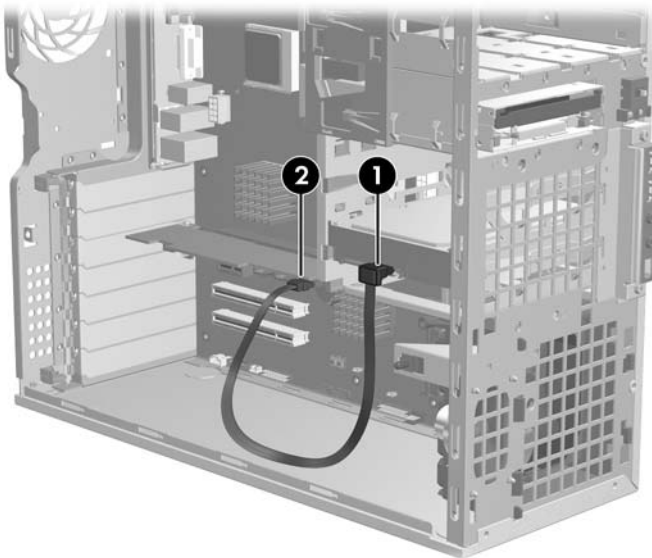

8. If necessary, install the SAS card in an empty PCI Express slot, and then install the LED cable from the card to the system board. You can find the location of this connector on the service label on the inside of the side access panel.

 **NOTE:** To install three or four SAS drives, install the third and fourth drives in the workstation optical drive bays. See [Installing SATA hard drives in the optical drive bays \(optional\) on page 102](#) for instructions.

SATA hard drive

For more information about SATA hard drives and SATA RAID configurations, see [Configuring RAID devices on page 141](#).

This section describes how to remove and install a SATA hard drive.

Removing a SATA hard drive

To remove a SATA hard drive:

1. Disconnect power from the system ([Predisassembly procedures on page 58](#)), and then remove the side access panel ([Removing the side access panel on page 64](#)).
2. Disconnect the data (1) and power (2) cables from the SATA hard drive.

Figure 4-52 Disconnecting the SATA hard drive cables

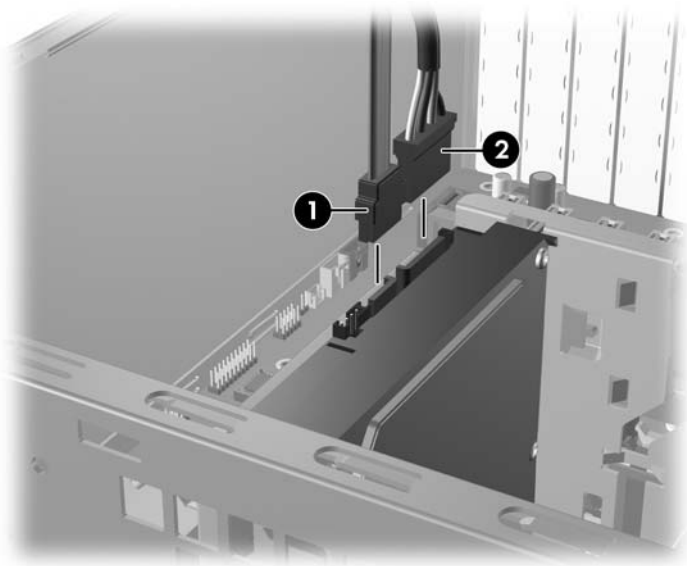

3. Lift the green drive-lock release tab (1) and slide the hard drive out of the chassis (2).

Figure 4-53 Removing the SATA hard drive

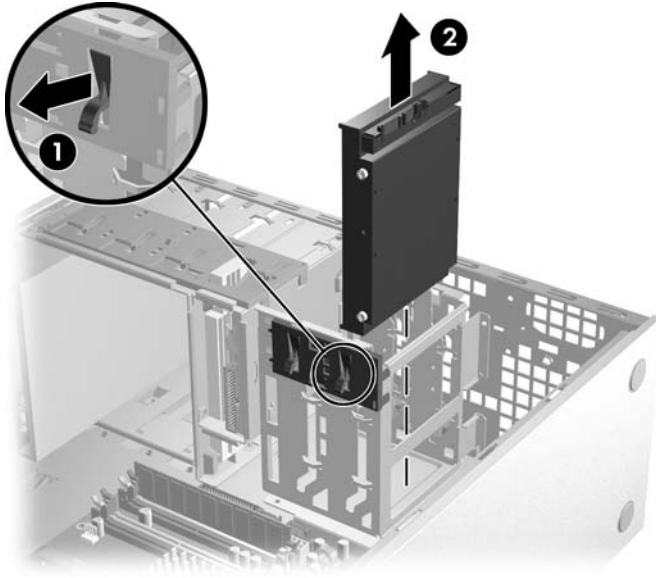

4. Remove the four guide screws from the hard drive and retain them for later use.



Installing a SATA hard drive

To install one or two SATA hard drives:

1. Disconnect power from the system ([Predisassembly procedures on page 58](#)), and then remove the side access panel ([Removing the side access panel on page 64](#)).
2. Select a drive bay in which to install the SATA hard drive.
3. Install the four silver, ANSI 6–32 guide screws into the hard drive.



4. Slide the SATA drive into the selected bay until it snaps into place.

5. Attach the data (1) and power (2) cables to the SATA drive.

Figure 4-54 Connecting the SATA cables to the SATA drive

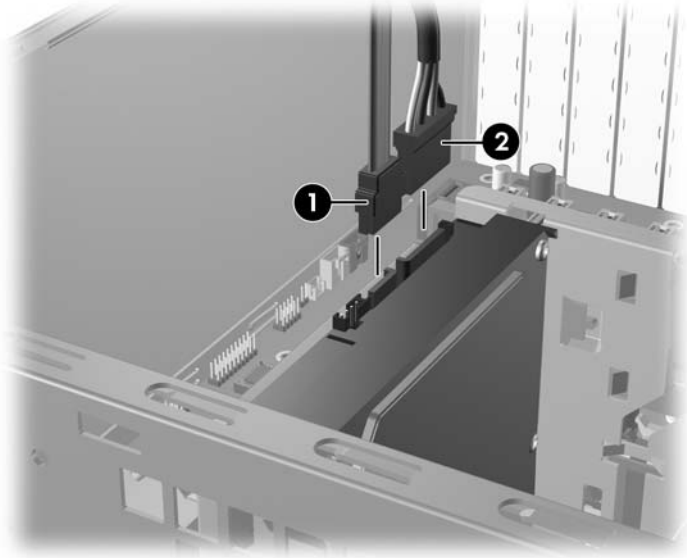

6. For a single SATA drive, connect the SATA 0 data cable from the hard drive (1) to the SATA0 port (2) in the workstation chassis.

For a second SATA drive, connect the SATA 1 data cable from the hard drive to the SATA1 port in the workstation chassis.

Figure 4-55 Connecting the SATA data cable to the workstation SATA port

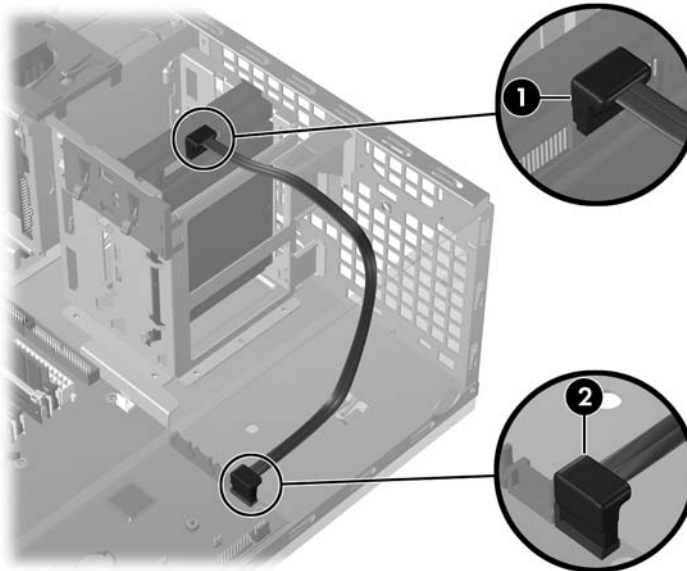

 **NOTE:** To install three or four SATA drives, install the third and fourth drives in the workstation optical bays. See [Installing SATA hard drives in the optical drive bays \(optional\) on page 102](#) for instructions.

Installing SATA hard drives in the optical drive bays (optional)

1. If necessary, remove the EMI shield.
2. Disconnect power from the system ([Predisassembly procedures on page 58](#)), remove the side access panel ([Removing the side access panel on page 64](#)), and then remove the front bezel ([Removing the front bezel on page 68](#)).
3. Place the SATA hard drive in the drive bracket (1), and then install four silver, ANSI 6–32 screws through the bracket and into the hard drive as shown in the following figure (2).

Figure 4-56 Installing the hard drive in bracket

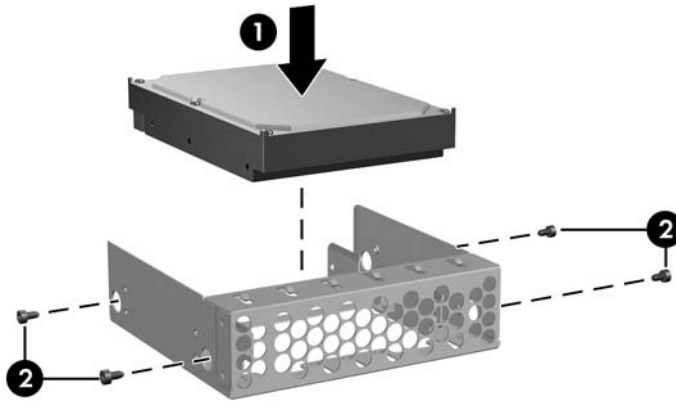

4. Install additional black, metric M3 screws into the bracket (1). Align the screws with the grooves in the optical drive bay, and then slide the drive into the workstation chassis (2).

Figure 4-57 Installing the hard drive in the optical drive bay

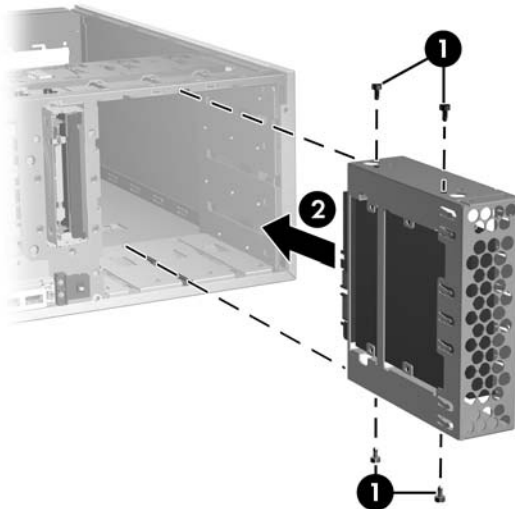

5. Connect the data cable to the hard drive (1) and to the system board (2).

Figure 4-58 Connecting the data cable

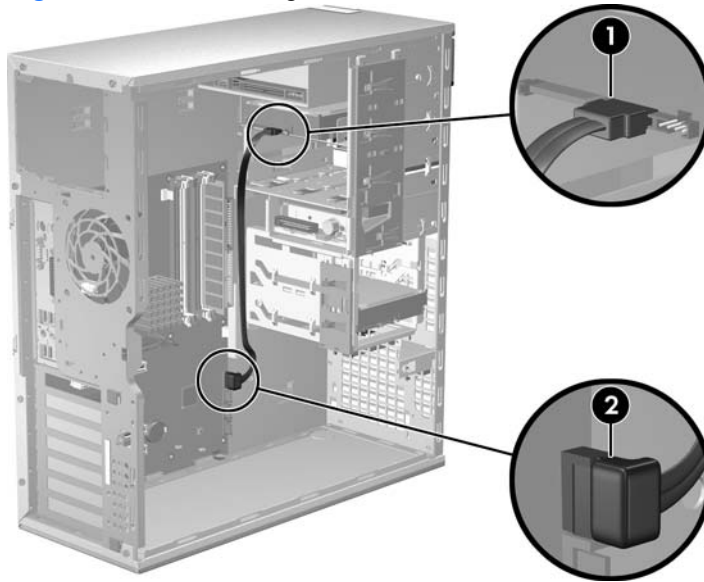

6. Connect the power cable (not shown).

Processor heatsink

This section describes how to remove and install a processor heatsink.

 **NOTE:** Not all heatsinks are the same. Therefore, the heatsink shown in the following figures is an example of what might be installed in your workstation.

Removing the processor heatsink

To remove a heatsink:

1. Power down the workstation ([Predisassembly procedures on page 58](#)), disconnect power from the workstation ([Predisassembly procedures on page 58](#)), and then remove the side access panel ([Removing the side access panel on page 64](#)).

2. Slowly and evenly loosen one pair of diagonally opposite screws (1) from the processor until the screw shanks disengage from the system board. Loosen the remaining pair (2).

△ **CAUTION:** Do not fully loosen one screw, and then move on to the next. Loosen all screws a little at a time, ensuring that the processor remains level.

Figure 4-59 Identify proper screw loosening sequence

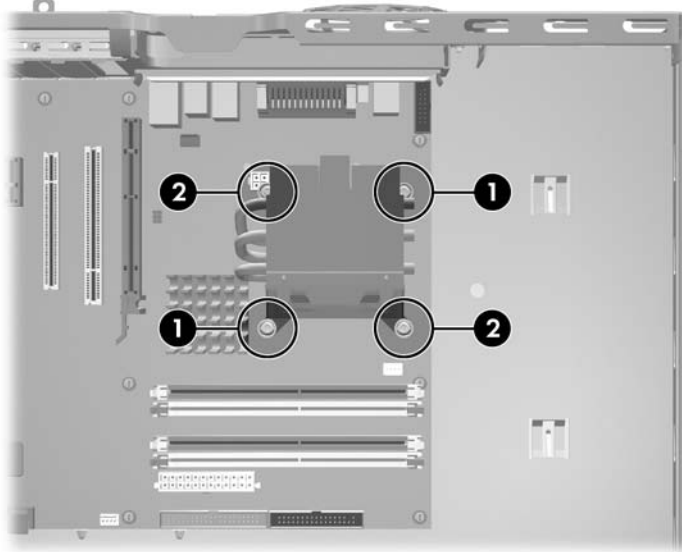

3. Disconnect the processor heatsink fan cable from the system board (1).
4. Gently twist the heatsink to break the thermal grease binding.
5. Lift the processor heatsink out of the chassis (2).

Figure 4-60 Removing the processor heatsink

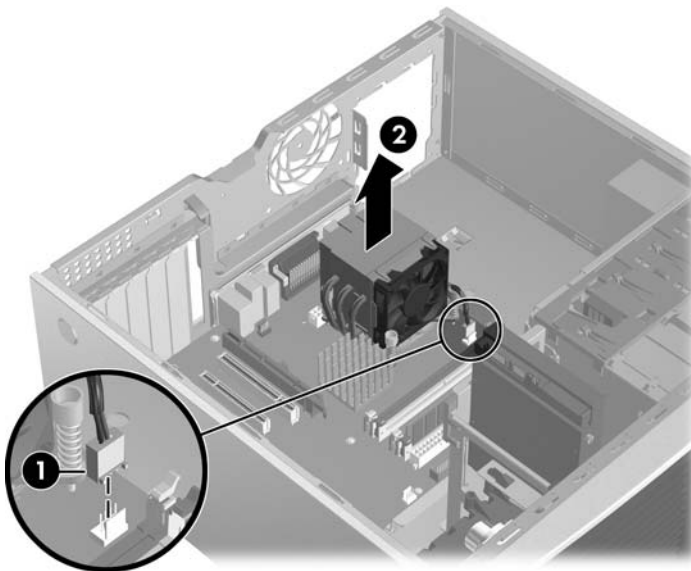

6. Use alcohol and a soft cloth to clean all of the thermal interface residue from the processor and the heatsink.

△ **CAUTION:** Allow the alcohol on the processor and processor heatsink to dry completely.

Installing the processor heatsink

To install a heatsink:

1. Disconnect power from the system ([Predisassembly procedures on page 58](#)), remove the side access panel ([Removing the side access panel on page 64](#)), and then remove the processor heatsink ([Removing the processor heatsink on page 103](#)).
2. If reusing the original heatsink, apply thermal grease to the center of the processor top surface. If using a new processor heatsink, do not apply thermal grease to the processor; the a new heat sink will have grease already applied to the heatsink surface. In this case, discard the thermal grease protective liner from the bottom of the new heatsink before installing.
3. Carefully seat the processor heatsink onto the system board.
 - △ **CAUTION:** Do not overtighten the heatsink screws. If you overtighten them, you might strip the threads in the system board tray.
4. Carefully tighten the four screws a little at a time, that is, do not fully tighten one screw and move onto the next. If you have a torque-limited driver available, tighten the screws to 6 in-lbs.
 - △ **CAUTION:** Ensure that the processor remains level as you tighten the screws.

System processor

This section describes how to remove and install a system processor.

Removing a system processor

1. Disconnect power from the system ([Predisassembly procedures on page 58](#)), remove the side access panel ([Removing the side access panel on page 64](#)), and then remove the processor heatsink ([Removing the processor heatsink on page 103](#)).

2. Raise the processor socket lever (1) and open the cover (2).

Figure 4-61 Removing the system processor

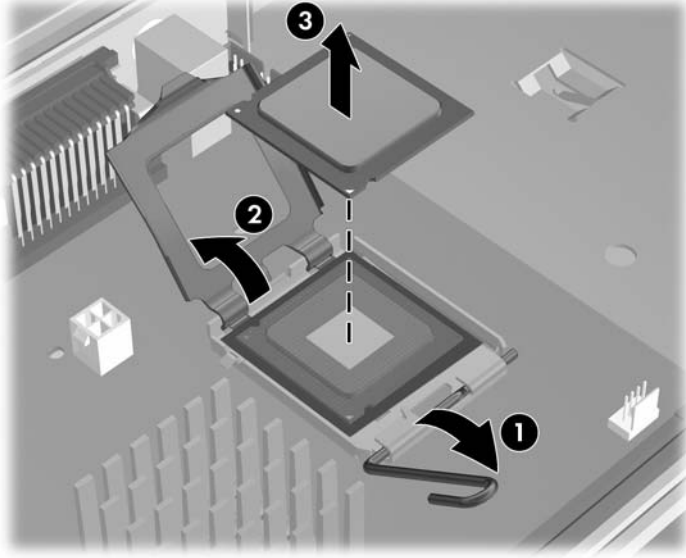

△ **CAUTION:** The processor socket contacts are delicate. To avoid bending the contacts, use extreme care when handling the processor.

3. Pull the processor straight out of the socket (3).

△ **CAUTION:** Do not touch the processor socket pins or the gold pads underneath the processor. Handle the processor by the edges.

 **NOTE:** Store the processor in a static free container in a safe place where it cannot be damaged.

Installing a system processor

1. Disconnect power from the system ([Predisassembly procedures on page 58](#)), remove the side access panel ([Removing the side access panel on page 64](#)), remove the processor heatsink ([Removing the processor heatsink on page 103](#)), and then remove the processor ([Removing a system processor on page 105](#)).

2. Raise the processor socket lever and cover fully.

△ **CAUTION:** The processor socket contacts are delicate. To avoid bending the contacts, use extreme care when installing the processor in the socket.

3. Align the triangle on the top of the processor with the triangle on the corner of the processor socket, and then install the processor into the socket. Ensure that the underside of the processor is level with the top of the processor socket. Close the socket cover and lightly press down on processor while closing the socket lever.

Figure 4-62 Seating the processor

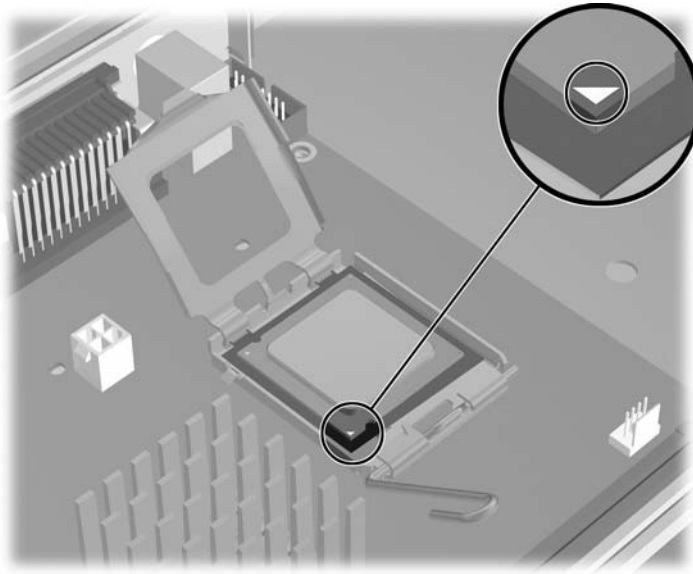

System board

This section describes removing and installing the system board.

Removing the system board

To remove the system board:

1. Disconnect power from the system ([Predisassembly procedures on page 58](#)) and remove the side access panel ([Removing the side access panel on page 64](#)).

 **NOTE:** Although the processor heatsink can remain in place, you might want to remove it for convenience.

2. Remove all expansion boards and graphics cards ([Removing a PCI Express card on page 81](#), [Removing a PCI card on page 83](#)), and then remove the processor heatsink ([Removing the processor heatsink on page 103](#)).

 **TIP:** Make a note of the cable connections before disconnecting them from the system board. For more information, refer to [Power connections to drives on page 89](#).

3. Disconnect all cabling from the system board.

4. Press the release tab as shown in the following illustration (1).

Figure 4-63 Removing the system board

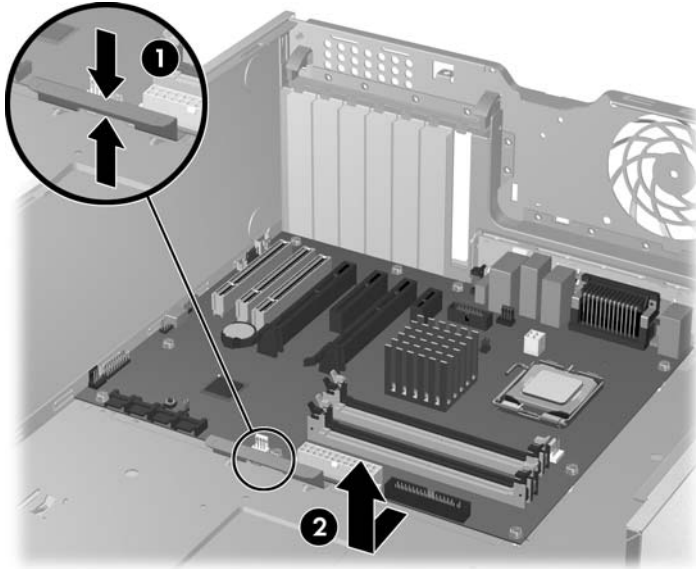

5. Slide the system board toward the front of the chassis and then lift it out of the workstation (2).

Installing the system board

To install the system board:

1. Set the system board in the chassis, slightly away from the rear of the chassis. The mounting hooks will seat in the recesses of the tray so that the tray lies flat on the chassis base.
2. Slide the tray towards the rear of the chassis until the heat sink mounting holes are aligned.
3. Reinstall the processor heatsink, cards, and cables.

Product recycling

The Planet Partners recycling service provides an easy way to recycle computer equipment, rechargeable batteries, or HP printing supplies. HP processes ensure that unwanted hardware or empty HP printing supplies are recycled responsibly.

For information about recycling HP components or products, visit <http://www.hp.com/go/recycle>.

5 System diagnostics and troubleshooting

This chapter describes the tools available for diagnosing and troubleshooting system issues, and includes the following topics:

- [Customer Self Help on page 110](#)
- [Troubleshooting checklist on page 129](#)
- [LED color definitions on page 129](#)
- [HP Insight Diagnostics Offline Edition on page 131](#)
- [POST error messages on page 135](#)

Customer Self Help

Help and Support Center

The HP Help and Support Center (HSC) provides online access to technical support information, software updates and downloads, diagnostic tools, and HP support contact information.

To open the online HSC from your desktop, select **Start>Help and Support**.

HSC contains four support areas:

- HP Product Information (requires Internet access)—Links to the HP Technical Support website for your product. You can access all related documentation, downloads and updates, tools, and more.
- HP Software and Driver Downloads (requires Internet access)—Links to software downloads and updates specific to HP products.
- HP Support Tools (requires Internet access)—Links to self-help tools and diagnostics offered by HP Instant Support Professional Edition.
- Contact HP for Support (does not require Internet access)—Provides two options:
 - Chat with an expert online (requires Internet access)—Provides a tool to communicate with a support specialist online through Active Chat.
 - Call a support agent—Provides hardware details about your workstation and HP support phone numbers worldwide.

HP SoftPaq Download Manager

The HP SoftPaq Download Manager enables you to download software updates for your workstation from the HP support site. To use the download manager:

1. Go to <http://h20331.www2.hp.com/Hpsub/cache/509658-0-0-225-121.html>.
2. Select your workstation model, operating system, and language, and then click **Find Available SoftPaqs**. All available SoftPaqs matching the selected criteria are displayed.
3. Select the updates you want to download.
4. Select **Download**.

Diagnostic LED codes

 **NOTE:** Workstation beeps are emitted from the onboard piezo speaker, the chassis speaker. The flashing lights and beeps repeat for five cycles. After five cycles, only the flashing lights repeat.

Table 5-1 Diagnostic LED codes

Chassis indicator LEDs	
Power LED and sound activity	Diagnosis and service action
None	<p>Workstation does not power on. Press the power button. If the hard drive LED is GREEN, then:</p> <ol style="list-style-type: none">1. Remove expansion cards one at a time.2. Replace the system board. <p>OR</p> <p>Press the power button. If the hard drive LED does not illuminate, then:</p> <ol style="list-style-type: none">1. Verify that the workstation is plugged into a working AC outlet.2. Open the access panel and verify that the power button harness is properly connected to the inline front panel I/O device assembly connector.3. Verify that the power supply cables are properly connected to the system board.4. Verify power supply functionality.<ol style="list-style-type: none">a. Disconnect AC power.b. Remove all internal power supply cables from the system board.c. Plug in AC power.<ul style="list-style-type: none">◦ If the power supply fan spins and the BIST LED illuminates, then the power supply is good. Replace the system board.◦ If the power supply fan does not spin or the BIST LED does not illuminate, then replace the power supply.
Blinks red 2 times (once per second), then a 2-second pause, and then 2 beeps	<p>Thermal shutdown has occurred:</p> <ol style="list-style-type: none">1. Ensure that the workstation air vents are not blocked and the cooling fan is running.2. Open the access panel, press power button, and determine whether the processor fan spins. If it does not spin, ensure the fan cable is plugged into the system board. Ensure that the fan is properly seated.3. If the fan is plugged in and seated but not spinning, then replace processor fan.4. Reseat the processor heatsink and verify that the fan assembly is properly attached.
Blinks red 3 times (once per second), then a 2-second pause, and then 3 beeps	<p>Processor not installed</p> <ol style="list-style-type: none">1. Install processor.2. Reseat processor.

Table 5-1 Diagnostic LED codes (continued)

Chassis indicator LEDs	
Power LED and sound activity	Diagnosis and service action
Blinks red 4 times (once per second), then a 2-second pause, and then 4 beeps	<p>Power supply failure.</p> <ol style="list-style-type: none">1. Open the access panel, and be sure the four-wire power supply cable is properly connected to the system board.2. Locate a faulty device by removing all devices and then reinstalling one at a time until the workstation fails. Replace the device causing the failure. Continue adding devices to ensure all are functioning properly.3. Verify the power supply functionality.<ol style="list-style-type: none">a. Disconnect AC power.b. Remove all internal power supply cables from the system board.c. Plug in AC power.<ul style="list-style-type: none">• If the power supply fan spins and the BIST LED illuminates, then the power supply is good. Replace the system board.• If the power supply fan does not spin or the BIST LED does not illuminate, replace the power supply.
Blinks red 5 times (once per second), then a 2-second pause, and then 5 beeps	<p>Pre-video memory error.</p> <ol style="list-style-type: none">1. Reseat memory modules.2. Replace memory modules one at a time to find the faulty module.3. Replace third-party modules with HP memory.4. Replace the system board.
Blinks red 6 times (once per second), then a 2-second pause, and then 6 beeps	<p>Pre-video graphic card error.</p> <p>For systems with integrated graphics, replace the system board.</p> <p>For systems with graphic cards:</p> <p>Pre-video graphic card error. For systems with integrated graphics, replace the system board. For systems with graphic cards:</p> <ol style="list-style-type: none">1. Reseat the graphic card. Power on the workstation.2. Replace the graphic card.3. Replace the system board.
Blinks red 7 times (once per second), then a 2-second pause, and then 7 beeps	<p>System board failure (ROM detected a failure before video).</p> <p>Replace system board.</p>

Table 5-1 Diagnostic LED codes (continued)

Chassis indicator LEDs	
Power LED and sound activity	Diagnosis and service action
Blinks red 8 times (once per second), then a 2-second pause, and then 8 beeps	Invalid ROM based on bad checksum. <ol style="list-style-type: none"> 1. Reflash the ROM. 2. Replace the system board.
Blinks red 9 times (once per second), then a 2-second pause, and then 9 beeps	System powers on, but is unable to boot. <ol style="list-style-type: none"> 1. Replace the system board. 2. Replace the processor.

Troubleshooting scenarios and solutions

This section presents an extensive overview of various troubleshooting scenarios and includes possible solutions for each.

Solving minor problems

Table 5-2 Minor problems

Problem	Cause	Possible Solution
Workstation appears frozen and does not shut down when the power button is pressed.	Software control of the power switch is not functional.	<ol style="list-style-type: none"> 1. Press and hold the power button for at least four seconds until the workstation shuts down. 2. Disconnect the electrical plug from outlet. 3. Restart the workstation.
Workstation seems to be frozen.	Program in use has stopped responding to commands.	<ol style="list-style-type: none"> 1. Attempt the normal Windows shutdown procedure. 2. Restart the workstation using the power button.
Workstation date and time display is incorrect.	Real-time clock (RTC) battery might need replacement.	<ol style="list-style-type: none"> 1. Reset the date and time under the Control Panel. 2. Replace the RTC battery.
Workstation appears to pause periodically.	Network driver is loaded and no network connection is established.	Establish a network connection, or use the Computer Setup (F10) Utility or the Microsoft Windows Device Manager to disable the network controller.
Cursor does not move using the arrow keys on the keypad.	The Num Lock key might be on.	Press the Num Lock key. The Num Lock key can be disabled (or enabled) in the Computer Setup (F10) Utility.
Poor performance is experienced.	Processor is hot.	<ol style="list-style-type: none"> 1. Be sure airflow to the workstation is not blocked. 2. Be sure the fans are connected and working properly (some fans only operate when needed). 3. Be sure the processor heatsink is installed properly.
	Hard drive is full.	Transfer data from the hard drive to create more space on the hard drive.

Table 5-2 Minor problems (continued)

Problem	Cause	Possible Solution
Workstation powered off automatically and the Power LED flashes red 2 times (once every second), followed by a 2-second pause, and then two simultaneous beeps sounded.	Processor thermal protection activated. A fan might be blocked or not turning. OR The processor heatsink is not properly attached to the processor.	<ol style="list-style-type: none"> 1. Be sure workstation air vents are not blocked and the cooling fan is running. 2. Open the access panel, press the power button, and then verify that the processor fan spins. If not spinning, ensure that the fan cable is plugged into the system board header. Ensure that the fan is fully/properly seated or installed. 3. Replace the processor fan. 4. Reseat processor heatsink and verify that the fan assembly is properly attached.
System does not power on, and the LEDs on the front of the workstation are not flashing.	System is unable to power on.	<p>Press and hold the power button for less than 4 seconds. If the hard drive LED turns green, then:</p> <ol style="list-style-type: none"> 1. Remove the expansion cards. 2. Replace the system board. <p>OR</p> <p>OR Press and hold the power button for less than 4 seconds. If the hard drive LED does not illuminate, then:</p> <p>Press and hold the power button for <i>less than</i> 4 seconds. If the hard drive LED does not illuminate, then:</p> <p>Press and hold the power button for <i>less than</i> 4 seconds. If the hard drive LED does not illuminate, then:</p> <ol style="list-style-type: none"> 1. Verify that the workstation is plugged into a working AC outlet. 2. Open the access panel and verify that the power button harness is properly connected to the inline front panel I/O device assembly connector. 3. Verify that the power supply cables are properly connected to the system board. 4. Verify the power supply functionality: <ol style="list-style-type: none"> a. Disconnect AC power. b. Remove all internal power supply cables from the system board. c. Plug in AC power. <ul style="list-style-type: none"> • If the power supply fan spins and the BIST LED illuminates, then the power supply is good. Replace the system board. • If the power supply fan does not spin or the BIST LED does not illuminate, replace the power supply.

Solving power supply problems

This section presents power supply troubleshooting scenarios.

Testing power supply

Before replacing the power supply, use the Built-In Self-Test (BIST) feature to learn if the power supply still works.

To test the power supply:

1. Unplug the AC power.
2. Disconnect all internal power supply cables from the system board.
3. Plug in AC power.
 - If the green BIST LED (illustrated below) on the rear of the workstation is illuminated *and* the fan is spinning, the power supply is functional.
 - If the green BIST LED is not illuminated **or** the fan is not spinning, replace the power supply.

Figure 5-1 Testing power supply with BIST LED

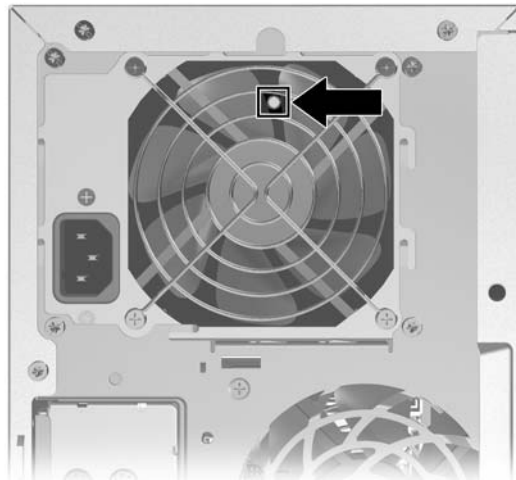

Table 5-3 Power supply problems

Problem	Cause	Solution
Power supply shuts down intermittently.	Power supply fault.	Replace the power supply.

Table 5-3 Power supply problems (continued)

Problem	Cause	Solution
Workstation powered off automatically and the Power LED flashes red 2 times (once every second), followed by a 2-second pause.	Processor thermal protection activated.	1. Be sure that the workstation air vents are not blocked and the cooling fan is running.
	A fan might be blocked or not turning. OR The processor heatsink fan assembly is not properly attached to the processor.	2. Open the access panel, press the power button, and determine whether the processor fan spins. If the processor fan is not spinning, be sure the fan's cable is plugged into the system board header. Be sure the fan is properly seated or installed. 3. Replace the processor fan. 4. Reseat processor heatsink and verify that the fan assembly is properly attached.
Power LED flashes red (once every 2 seconds).	Power failure (power supply is overloaded).	1. Determine whether a device is causing the problem by removing all attached devices. Power on the system. If the system enters the POST, then power off and replace one device at a time and repeat this procedure until a failure occurs. Replace the device causing the failure. Continue adding devices one at a time to ensure all devices are functioning properly. 2. Verify the power supply functionality. <ul style="list-style-type: none"> a. Disconnect AC power. b. Remove all internal power supply cables from the system board. c. Plug in AC power. <ul style="list-style-type: none"> • If the power supply fan spins and the BIST LED illuminates, then the power supply is good. Replace the system board. • If the power supply fan does not spin or the BIST LED does not illuminate, replace the power supply.

Solving diskette problems

Table 5-4 Diskette problems

Problem	Cause	Solution
Diskette drive light stays on.	Diskette is damaged.	Right-click Start , select Explore , and then select a drive. Select File>Properties>Tools . Under Error-checking, select Check Now .
	Diskette is incorrectly inserted.	Remove and reinsert diskette.
	Files on diskette are damaged.	Verify the program diskettes.
Drive not found.	Drive cable is not properly connected.	Reconnect power cable. Be sure that all four pins are connected.
	Cable is loose.	Reseat diskette drive data and power cables.
Diskette drive cannot write to a diskette.	Removable drive is not seated properly.	Reseat the drive.
	Diskette is not formatted.	Format the diskette.

Table 5-4 Diskette problems (continued)

Problem	Cause	Solution
	Diskette is write-protected.	Use another diskette or remove the write protection.
	Writing to the wrong drive.	Verify the drive letter in the path statement.
	Not enough space is left on the diskette.	Use another diskette.
	Diskette write-control is enabled.	Use the Computer Setup (F10) Utility to verify the storage security feature disabled settings.
	Diskette is damaged.	Replace the damaged disk.
Cannot format diskette.	Invalid media reported.	When formatting a disk in MS-DOS, you might need to specify diskette capacity. For example, to format a 1.44-MB diskette, enter the following command at the MS-DOS prompt: FORMAT A: /F:1440
A problem has occurred with a disk transaction.	The directory structure is bad, or there is a problem with a file.	Right-click Start , select Explore , and then select a drive. Select File>Properties>Tools . Under Error-checking, select Check Now .
Diskette drive cannot read a diskette.	Diskette is not formatted.	Format the diskette.
	You are using the wrong diskette type for the drive type.	Verify the type of drive that you are using and use the correct diskette type.
	You are reading the wrong drive.	Verify the drive letter in the path statement.
	Diskette is damaged.	Replace the diskette with a new one.
"Invalid system disk" message is displayed.	A diskette that does not contain the system files needed to start the workstation has been inserted into the drive.	When drive activity stops, remove the diskette and press the Spacebar . The workstation should start up.
	Diskette error has occurred.	Restart the workstation by pressing the power button.
Cannot Boot to Diskette.	Diskette is not bootable.	Replace with a bootable diskette.
	Diskette boot has been disabled in Computer Setup.	Run Computer Setup and enable diskette boot in Storage>Boot Order .
	Removable media boot has been disabled in Computer Setup.	Run Computer Setup and enable Removable Media Boot in Storage>Storage Options .
	Diskette MBR validation is enabled.	Run the Computer Setup (F10) Utility and disable Diskette MBR Validation in Storage>Storage Options .

Solving hard drive problems

Table 5-5 Hard drive problems

Problem	Cause	Solution
Hard drive error occurs.	Hard disk has bad sectors or has failed.	Use a utility to locate and block usage of bad sectors. If necessary, reformat the hard disk. Or, if the drive is detected by the BIOS, then run DPS Self-test .

Table 5-5 Hard drive problems (continued)

Problem	Cause	Solution
Disk transaction problem.	The directory structure is bad, or there is a problem with a file.	Right-click Start , select Explore , and select a drive. Select File>Properties>Tools . Under Error-checking, select Check Now .
Drive not found (identified).	Loose cable.	Verify cable connections.
	The system might not have automatically recognized a newly installed device.	<ol style="list-style-type: none"> 1. Run the Computer Setup (F10) Utility. 2. If the system still does not recognize the new device, verify that the device is listed in the Computer Setup (F10) Utility. If it is listed, the probable cause is a driver problem. If it is not listed, the probable cause is a hardware problem. 3. If this drive is newly installed, enter Setup and try adding a POST delay under Advanced>Power-On.
	Drive jumper settings might be incorrect.	If the drive is a secondary drive that has just been installed on the same cable as the primary drive, verify that the jumpers for both drives are set correctly.
	Drive responds slowly immediately after power-up.	Run the Computer Setup (F10 utility, and then increase the POST Delay in Advanced>Power-On Options .
Nonsystem disk or NTLDR missing message.	System is trying to start from a nonbootable diskette.	Remove the diskette from the diskette drive.
	System is trying to start from a damaged hard drive.	<ol style="list-style-type: none"> 1. Insert a bootable diskette into the diskette drive and restart the workstation. 2. If the hard drive is still inaccessible and MBR Security is enabled, try restoring the previously saved MBR image by entering Setup, and then selecting Security>Restore Master Boot Record.
	System files missing or not properly installed.	<ol style="list-style-type: none"> 1. Insert a bootable system diskette and restart. 2. Verify that the hard drive is partitioned and formatted. 3. Install the system files for the appropriate operating system, if necessary.
	Hard drive boot disabled in Computer Setup.	Run the Computer Setup (F10) Utility, and then enable the hard drive entry in the Storage>Boot Order list.
Workstation will not start.	Hard drive is damaged.	Observe the beeps and LEDs on the front of the workstation. Refer to POST error messages on page 135 .

Solving display problems

Table 5-6 Display problems

Problem	Cause	Solution
Blank screen (no video).	The cable connections are not correct.	Verify the cable connections from the monitor to the workstation and to a working electrical outlet.
	The monitor is off.	Switch the monitor on (LED is on). You might need to refer to the monitor manual for an explanation of the LED signals.

Table 5-6 Display problems (continued)

Problem	Cause	Solution
	Screen blanking utility installed or energy saver features enabled.	Press any key or press the mouse button, and, if set, enter your password.
	System ROM is bad; system is running in FailSafe Boot Block mode (indicated by 8 beeps).	Reflash the ROM using a SoftPak.
	Fixed-sync monitor does not sync at the resolution specified.	Be sure that the monitor can accept the same horizontal scan rate as the resolution specified.
	Computer is in Hibernate mode.	Press the power button to resume from Hibernate mode.
	Workstation monitor settings are not compatible with the monitor.	<ol style="list-style-type: none"> 1. When you see Press F8 in the bottom-right corner of the screen, restart the workstation and press F8 during startup. 2. Using the keyboard arrow keys, select Enable VGA Mode and then press Enter. 3. In Windows Control Panel, double-click the Display icon and then select the Settings tab. 4. Use the sliding control to reset the resolution.
The display works properly during the POST but goes blank when the operating system starts.	The display settings in the operating system are incompatible with your graphics card and monitor.	<ol style="list-style-type: none"> 1. Restart your workstation in VGA mode. 2. After the operating system starts, change the display settings to match those supported by your graphics card and monitor. 3. Refer to your operating system and graphics card documentation for information about changing display settings.
Power LED flashes red 6 times (once every second), followed by a 2-second pause, and then the workstation beeps 6 times.	Pre-video graphics error.	<p>For systems with a graphics card:</p> <ol style="list-style-type: none"> 1. Reseat the graphics card. 2. Replace the graphics card. 3. Replace the system board.
Monitor does not function properly when used with Energy Saver features.	Monitor without Energy Saver capabilities is being used with Energy Saver features enabled.	Disable monitor Energy Saver feature.
Dim characters	The brightness and contrast controls are not set properly.	Adjust the monitor brightness and contrast controls.
	Cables are not properly connected.	Verify that the graphics cable is securely connected to the graphics card and the monitor.
Blurry video or requested resolution cannot be set.	If the graphics controller was upgraded, the correct video drivers might not be loaded.	Install the video drivers included in the upgrade kit.
	Monitor is not capable of displaying requested resolution.	Change requested resolution.

Table 5-6 Display problems (continued)

Problem	Cause	Solution
The picture is broken up, rolls, jitters, or flashes.	The monitor connections might be incomplete, or the monitor might be incorrectly adjusted.	<ol style="list-style-type: none"> 1. Be sure the monitor cable is securely connected to the workstation. 2. In a two-monitor system, or if another monitor is in close proximity, ensure that the monitors are not interfering with each other's electromagnetic field by moving them apart. 3. Fluorescent lights or fans might be too close to the monitor.
	Monitor must be degaussed.	Degauss the monitor.
Vibrating or rattling noise coming from inside a CRT monitor when powered on.	Monitor degaussing coil has been activated.	None. It is normal for the degaussing coil to be activated when the monitor is powered on.
Clicking noise coming from inside a CRT monitor.	Electronic relays have been activated inside the monitor.	None. It is normal for some monitors to make a clicking noise when turned on and off, when going in and out of Standby mode, and when changing resolutions.
High pitched noise coming from inside a flat-panel monitor.	Brightness and contrast settings are too high.	Lower brightness and contrast settings.
Fuzzy focus; streaking, ghosting, or shadowing effects; horizontal scrolling lines; faint vertical bars; or unable to center the picture on the screen (flat-panel monitors using an analog VGA input connection only.)	Flat-panel monitor's internal digital conversion circuits might be unable to correctly interpret the output synchronization of the graphics card.	<ol style="list-style-type: none"> 1. Select the monitor's Auto-Adjustment option in the monitor's onscreen display menu. 2. Manually synchronize the Clock and Clock Phase onscreen display functions. Download SoftPaq SP20930 or SP22333 (depending on the monitor) to assist with the synchronization).
Certain typed symbols do not appear correctly.	The font you are using does not support that particular symbol.	Use the Character Map to locate and select the appropriate symbol. Select Start>All Programs>Accessories>System Tools>Character Map . You can copy the symbol from the Character Map into a document.

Solving audio problems

Table 5-7 Audio problems

Problem	Cause	Solution
Sound does not come out of the speaker or headphones.	Software volume control is turned down.	Double-click the Speaker icon on the taskbar and use the volume slider to adjust the volume.
	The external speakers are not turned on.	Turn on the external speakers.
	External speakers plugged into the wrong audio jack.	See your sound card documentation for proper speaker connection.
	Audio cable not connected.	Connect audio cable between CD or DVD-ROM drive and the system board.
	Digital CD audio is not enabled.	<p>Enable digital CD audio:</p> <ol style="list-style-type: none"> 1. From the Control Panel, select System. 2. On the Hardware tab, select the Device Manager button.

Table 5-7 Audio problems (continued)

Problem	Cause	Solution
		<ol style="list-style-type: none"> Right-click the CD/DVD device and select Properties. On the Properties tab, ensure that Enable digital CD audio for this CD-ROM device is selected.
	Headphones or devices connected to the line-out connector have muted the internal speaker.	Turn on and use headphones or external speakers, if connected, or disconnect headphones or external speakers.
	Volume is muted.	<ol style="list-style-type: none"> From the Control Panel, select Sound, Speech and Audio Devices, and then select Sounds and Audio Devices. Deselect the Mute checkbox.
	Computer is in Standby mode.	Press the power button to resume from Standby mode.
Noise or no sound comes out of the speakers or headphones.		<ol style="list-style-type: none"> If using digital speakers that have a stereo jack and you want the system to auto switch to digital, use a stereo-to-mono adapter to properly engage the auto sense feature, or use the multimedia device properties to manually switch the audio signal from analog to digital. If the headphones have a mono jack, use the multimedia device properties to switch the system to analog out.
<p>NOTE: If you set digital as the Output Mode, the internal speaker and external analog speakers no longer output audio until you switch back to an auto sense or analog mode.</p> <p>If you set analog as the Output Mode, external digital speakers do not function until you change the output mode back to an auto-sense or digital mode.</p>		
Sound occurs intermittently.	Processor resources are being used by other open applications.	Shut down all open processor-intensive applications.
Workstation appears to be locked up while recording audio.	The hard disk might be full.	<ol style="list-style-type: none"> Before recording, be sure there is enough free space on the hard disk. Try recording the audio file in a compressed format.

Solving printer problems

Table 5-8 Printer problems

Problem	Cause	Solution
Printer does not print.	Printer is not turned on and online.	Turn the printer on and be sure it is online.
	The correct printer driver for the application is not installed.	<ol style="list-style-type: none"> Install the correct printer driver for the application. Try printing using the MS-DOS command: DIR C:\> [printer port] where <i>printer port</i> is the address of the printer used. If the printer works, reload the printer driver.

Table 5-8 Printer problems (continued)

Problem	Cause	Solution
	If you are on a network, you might not have made a connection to the printer.	Make the proper network connection to the printer.
	Printer might have failed.	Run printer self-test.
Printer does not turn on.	The cables might not be connected properly.	Reconnect all cables.
Printer prints garbled information.	The correct printer driver is not installed.	Install the correct printer driver for the application.
	The cables might not be connected properly.	Reconnect all cables.
	Printer memory might be overloaded.	Reset the printer by turning it off for one minute, then turn it back on.
Printer is offline.	The printer might be out of paper.	<ol style="list-style-type: none"> 1. Verify that the paper tray and refill it if it is empty. 2. Select Online.

Solving keyboard and mouse problems

Table 5-9 Keyboard and mouse problems

Problem	Cause	Solution
Keyboard commands and typing are not recognized by the workstation.	Keyboard connector is not properly connected.	<ol style="list-style-type: none"> 1. Power off the workstation. 2. Reconnect the keyboard to the back of the workstation and restart the workstation.
	Program in use has stopped responding to commands.	Shut down the workstation using the mouse, and then restart the workstation.
	Keyboard needs repairs.	Replace the keyboard.
	Keyboard key is stuck down.	Remove any debris from the keyboard.
	Workstation is in Hibernate mode.	Press the power button to resume from Hibernate mode.
Cursor will not move using the arrow keys on the keypad.	The Num Lock key might be on.	Press the Num Lock key. The Num Lock light should not be on if you want to use the arrow keys. The Num Lock key can be disabled or enabled in the Computer Setup (F10) Utility.
Mouse does not respond to movement or is too slow.	Mouse connector is not properly plugged into the back of the workstation.	<ol style="list-style-type: none"> 1. Shut down the workstation using the keyboard. 2. Plug the mouse connector into the PS/2 mouse connector slot in the workstation, and then restart the workstation.
	Program in use has stopped responding to commands.	Shut down the workstation using the keyboard and then restart the workstation.
	Mouse needs repairs.	Replace the mouse.

Table 5-9 Keyboard and mouse problems (continued)

Problem	Cause	Solution
	Workstation is in Standby mode.	Press the power button to resume from Standby mode.
Mouse only moved vertically or horizontally, or the movement is jerky.	Mouse rollerball is dirty.	Remove the rollerball cover from the bottom of the mouse, clean it, and then replace cover.

Solving front panel component problems

If you are experiencing problems with one of the front panel ports, you might be able to try your device in the corresponding port on the back side of the computer. If this does not fix the problem, or you must use the front panel ports, continue troubleshooting.

Some problems in this section are also discussed in other troubleshooting suggestions in this chapter.

Table 5-10 Front panel component problems

Problem	Cause	Solution
A USB device, headphone, or microphone is not recognized by the workstation.	The device is not properly connected.	<ol style="list-style-type: none"> 1. Power off the workstation. 2. Reconnect the device to the front of the workstation and restart the workstation.
	The device does not have power.	If the USB device requires AC power, be sure one end is connected to the device and one end is connected to a live outlet.
	The correct device driver is not installed.	<ol style="list-style-type: none"> 1. Install the correct driver for the device. 2. You might need to reboot the workstation.
	The cable from the device to the computer does not work.	<ol style="list-style-type: none"> 1. If possible, replace the cable. 2. Restart the workstation.
	The device is not working.	<ol style="list-style-type: none"> 1. Replace the device. 2. Restart the workstation.
A USB, audio, or IEEE-1394 device is not working.	The internal cables might not be connected to the system board or the PCI card.	<ol style="list-style-type: none"> 1. Power off the workstation. 2. Connect the cables correctly.
A device in the IEEE-1394 port is not responsive.	Cables of the external device are loose, or power cables are unplugged.	Be sure that all cables are properly and securely connected.
	The power switch on the device is not turned on.	Power off the workstation, power on the external device, then power on the workstation to integrate the device with the workstation system.
The IEEE-1394 port is not active.	The port is not there because it was not purchased with the system.	You can buy an IEEE 1394 PCI adapter card. Contact an HP seller.

Solving hardware installation problems

You might need to reconfigure the workstation when you add or remove hardware, such as an additional diskette drive. If you install a Plug and Play (PnP) device, the operating system automatically recognizes

the device and configures the workstation. If you install a nonPnP device, you must reconfigure the workstation after completing installation of the new hardware.

Table 5-11 Hardware installation problems

Problem	Cause	Solution
A new device is not recognized as part of the system.	Device is not seated or connected properly.	Be sure that the device is properly and securely connected and that pins in the connector are not bent.
	Cables of new external device are loose, or power cables are unplugged.	Be sure that all cables are properly and securely connected and that pins in the cable or connector are not bent.
	Power switch of new external device is not turned on.	Power off the workstation, power on the external device, and then power on the workstation to integrate the device into the workstation system.
	When the system advises you about changes to the configuration, you do not accept them.	Reboot the workstation and follow the instructions for accepting the changes.
	A PnP board might not automatically configure when added if the default configuration conflicts with other devices.	Use Windows XP Device Manager to deselect the automatic settings for the board and choose a basic configuration that does not cause a resource conflict. You can also use the Computer Setup (F10) Utility to reconfigure or disable devices to resolve the resource conflict.
Workstation does not start.	Device hardware is not properly jumpered or otherwise configured.	Read the device-specific configuration information and check for incorrect settings or conflicts with other devices already installed in the system.
	Wrong memory modules were used in the upgrade, or memory modules were installed in the wrong location.	<ol style="list-style-type: none"> 1. Review the documentation that came with the system to determine if you are using the correct memory modules and to verify the proper installation. 2. Observe the beeps and LEDs on the front of the workstation. Refer to POST error messages on page 135 to determine possible causes.
Power LED flashes red 5 times (once every second), followed by a 2-second pause, and then the workstation beeps 5 times.	PCI Express power cable might be plugged into the wrong connector on the system board.	Connect the auxiliary PCI Express power cable to the PCI Express card.
	Memory is installed incorrectly or is bad.	<ol style="list-style-type: none"> 1. Reseat DIMMs. 2. Replace DIMMs one at a time to isolate the faulty module. 3. Replace third-party memory with HP memory. 4. Replace the system board.
Power LED flashes red 6 times (once every second), followed by a 2-second pause, and then the workstation beeps 6 times.	Video card is not seated properly or is bad, or system board is bad.	<p>For systems with a graphics card:</p> <ol style="list-style-type: none"> 1. Reseat the graphics card. 2. Replace the graphics card. 3. Replace the system board.

Solving network problems

The following table provides fixes for common network problems.

Table 5-12 Network problems

Problem	Cause	Solution
Wake-on-LAN feature is not functioning.	Wake-on-LAN is not enabled.	Use the network control application to enable Wake-on-LAN.
Network driver does not detect network controller.	Network controller is disabled.	Run the Computer Setup (F10) Utility to enable network controller.
	Incorrect network driver.	Review the network controller documentation to verify the correct driver, or obtain the latest driver from the manufacturer's website.
Network status link light does not illuminate or never flashes.	No active network is detected.	Verify cabling and network equipment for proper connection.
The network status light does not flash when there is network activity.	Network controller is not set up properly.	Use the network control application to verify that the device is working properly.
	Network driver is not properly loaded.	Reinstall network drivers.
	System cannot auto sense the network.	Disable auto sensing capabilities and force the system into the correct operating mode.
Diagnostics reports a failure.	The cable is not securely connected.	Be sure that both ends of the data cable are securely connected.
	The cable is attached to the incorrect connector.	Be sure that the cable is attached to the correct connector.
	There is a problem with the cable or a device at the other end of the cable.	Be sure that the cable and device at the other end are operating correctly.
	Network controller interrupt is shared with an expansion board.	Under the Computer Setup (F10) Utility Advanced menu, change the resource settings for the board.
Diagnostics passes, but the workstation does not communicate with the network.	The network controller is defective.	Replace the NIC.
	Network drivers are not loaded, or driver parameters do not match current configuration.	<ol style="list-style-type: none"> 1. Be sure the network drivers are loaded and that the driver parameters match the configuration of the network controller. 2. Be sure the correct network client and protocol is installed.
	The network controller is not configured for this workstation.	Double-click the Network icon in the Control Panel and configure the network controller.
Network controller stopped working when an expansion board was added to the workstation.	Network controller interrupt is shared with an expansion board.	Under the Computer Setup (F10) Utility Advanced menu, change the resource settings for the board.
	The network controller requires drivers.	Verify that the drivers were not accidentally deleted when the drivers for the expansion board were installed.

Table 5-12 Network problems (continued)

Problem	Cause	Solution
	The expansion board installed is a network card and conflicts with the embedded network card.	Under the Computer Setup (F10) Advanced menu, change the resource settings for the board.
Network controller stops working without apparent cause.	The files containing the network drivers are corrupted.	Reinstall the network drivers using the <i>Restore Plus!</i> CD.
	The cable is not securely connected.	Be sure that both ends of the cable are securely attached to the correct devices.
	The network controller is defective.	Replace the NIC.
New network card does not boot.	New network card might be defective or might not meet industry-standard specifications.	Install a working, industry-standard NIC, or change the boot sequence to boot from another source.
Cannot connect to network server when attempting remote system installation.	The network controller is not configured properly.	Verify network connectivity, that a DHCP server is present, and that the Remote System Installation Server contains the NIC drivers for your NIC.
Computer Setup (F10) Utility reports unprogrammed EEPROM.	Unprogrammed EEPROM.	Flash the ROM.

Solving memory problems

- △ **CAUTION:** For those systems that support ECC memory, HP does not support mixing ECC and nonECC memory. The operating system does not boot with mixed-ECC memory.

Table 5-13 Memory problems

Problem	Cause	Solution
System does not boot (or does not function properly) after installing additional memory modules.	A memory module is not the correct type or speed or the new memory module is not seated properly.	Replace module with the correct, industry-standard device for the workstation.
		On some models, ECC and nonECC memory modules cannot be mixed.
Out of memory error.	Memory configuration might not be set up correctly.	Use the Device Manager to verify memory configuration.
	You have run out of memory to run the application.	Review the application documentation to determine the memory requirements.
Memory count during POST is wrong.	The memory modules might not be installed correctly.	Verify that the memory modules have been installed correctly and that proper modules are used.
Insufficient memory error during operation.	Too many Terminate and Stay Resident (TSR) programs are installed.	Delete any TSRs that you do not need.
	You have run out of memory for the application.	Verify the memory requirements for the application or add more memory to the workstation.
Power LED flashes red 5 times (once every second), followed by a 2-second pause, and then the workstation beeps 5 times.	Memory is installed incorrectly or is bad.	<ol style="list-style-type: none"> 1. Reseat DIMMs. 2. Replace DIMMs one at a time to isolate the faulty module.

Table 5-13 Memory problems (continued)

Problem	Cause	Solution
		<ol style="list-style-type: none"> 3. Replace third-party memory with HP memory. 4. Replace the system board.

Solving processor problems

Table 5-14 Processor problems

Problem	Cause	Solution
Poor performance is experienced.	Processor is hot.	<ol style="list-style-type: none"> 1. Be sure the airflow to the workstation is not blocked. 2. Be sure the fans are connected and working properly (some fans only operate when needed). 3. Be sure the processor heatsink is installed properly.
Power LED is red and stays on.	Processor is not seated properly or not installed.	<ol style="list-style-type: none"> 1. Verify that the processor is present. 2. Reseat the processor.

Solving DVD problems

Table 5-15 DVD problems

Problem	Cause	Solution
System does not boot from DVD drive.	The DVD boot is not enabled through the Computer Setup (F10) Utility.	Run the Computer Setup (F10) Utility and enable booting to removable media and verify boot order settings.
	Nonbootable CD in drive.	Try a bootable CD in the drive.
DVD devices are not detected or the driver is not loaded.	Drive is not connected properly or not properly configured.	<ol style="list-style-type: none"> 1. Reconnect power and data cables to the drive. 2. Install correct device driver.
Movie does not play in the DVD drive.	Movie might be regionalized for a different country.	See the documentation included with the DVD drive.
	Decoder software is not installed.	Install decoder software.
Cannot eject CD (tray-load unit).	Disc not properly seated in the drive.	<ol style="list-style-type: none"> 1. Power off the workstation and insert a thin metal rod (such as a paper clip) into the emergency eject hole and push firmly. 2. Slowly pull the tray out from the drive until the tray is fully extended, and then remove the disc.
CD-RW or DVD-R/RW drive cannot read a disc or takes too long to start.	CD has been inserted upside down.	Reinsert the CD with the label facing up.
	The DVD-ROM drive takes longer to start because it has to determine the type of media played, such as audio or video.	Wait at least 30 seconds to let the DVD-ROM drive determine the type of media being played. If the disc still does not start, read the other solutions listed for this topic.
	DVD disc is dirty.	Clean DVD with a CD cleaning kit.

Table 5-15 DVD problems (continued)

Problem	Cause	Solution
	Windows does not detect the DVD-ROM drive.	<ol style="list-style-type: none"> 1. Use Device Manager to remove or uninstall the device. 2. Restart the workstation and allow Windows to detect the device.
Recording audio CDs is difficult or impossible.	Wrong or poor-quality media type.	<ol style="list-style-type: none"> 1. Use a slower recording speed. 2. Verify that you are using the correct media for the drive. 3. Try a different brand of media. Quality varies widely between manufacturers.

Solving Internet access problems

Table 5-16 Internet access problems

Problem	Cause	Solution
Unable to connect to the Internet.	Internet Service Provider (ISP) account is not set up properly.	Verify Internet settings or contact the ISP for assistance.
	Modem is not set up properly.	Reconnect the modem. Verify the connections are correct using the quick setup documentation.
	Web browser is not set up properly.	Verify that the Web browser is installed and set up to work with your ISP.
	Cable/DSL modem is not plugged in.	Plug in cable/DSL modem. When properly connected, the power LED on the front of the cable/DSL modem should be illuminated.
	Cable/DSL service is not available or has been interrupted because of bad weather.	Try connecting to the Internet at a later time, or contact your ISP. If the cable/DSL service is connected, the cable LED light on the front of the cable/DSL modem is on.
	The CAT5 10/100/1000 cable is disconnected.	Connect the CAT5 10/100/1000 cable between the cable modem and the workstations's RJ-45 connector. (If the connection is good, the "PC" LED on the front of the cable/DSL modem will be on.)
	IP address is not configured properly.	Contact the ISP for the correct IP address.
	Cookies are corrupted.	<ol style="list-style-type: none"> 1. Select Start>Control Panel. 2. Double-click Internet Options. 3. On the General tab, select the Delete Cookies button.
Cannot automatically launch Internet programs.	You must log on to the ISP before some programs will start.	Log on to the ISP and launch the desired program.
Internet takes too long to download websites.	Modem is not set up properly.	<ol style="list-style-type: none"> 1. Select Start>Control Panel. 2. Double-click System, and then select the Hardware tab. 3. In the Device Manager area, select the Device Manager button.

Table 5-16 Internet access problems (continued)

Problem	Cause	Solution
		4. Double-click Ports (COM & LPT).
		5. Right-click the COM port that your modem uses, and then select Properties .
		6. Under Device status, verify that the modem is working properly.
		7. Under Device usage, verify that the modem is enabled.
		8. If there are further problems, select the Troubleshoot button and follow the onscreen instructions.

Troubleshooting checklist

Before running any of the diagnostic utilities, use the following checklist to find possible solutions for workstation or software problems.

- Is the workstation and monitor connected to a working electrical outlet?
- Is the workstation powered on?
- Is the green power light illuminated?
- Is the monitor on?
- Is the green monitor light illuminated?
- If the monitor is dim, adjust the monitor brightness and contrast controls .
- Press and hold any key. If the system beeps, then the keyboard is operating correctly.
- Check all cables for loose or improper connections.
- After installing a nonPnP expansion board or other option (such as a diskette drive), reconfigure the workstation.
- Are all of the necessary device drivers installed?
- Have all printer drivers been installed for each application?
- Have you removed all diskettes and CDs from the drives before you power on the workstation?
- Are you running the latest version of BIOS, drivers, and software?

LED color definitions

The following table describes what each LED light on your workstation front panel signifies.

Table 5-17 LED color definitions

LED state	LED color	System status
Solid	Green	System is on

Table 5-17 LED color definitions (continued)

LED state	LED color	System status
Flashing	Green	System is in Standby
Solid or flashing	Red	System has experienced an error. See Diagnostic LED codes on page 110
None	No light	System is in Hibernate, or it is off

HP Insight Diagnostics Offline Edition

The diagnostics utility enables you to perform testing and to view critical computer hardware and software configuration information from various sources. This utility enables you to:

- Run diagnostics
- View the hardware configuration of the system

Key features and benefits

HP Insight Diagnostics simplifies the process of effectively identifying, diagnosing, and isolating hardware issues.

In addition to robust management tools, service tools can be invaluable in quickly resolving system problems. To streamline the service process and resolve problems quickly, it is necessary to have the right information available at the time that a service call is placed. The primary information requirement, which is also the one that provides the greatest insight into potential system issues, is the configuration of the system. Insight Diagnostics helps provide higher system availability. Typical uses of the Insight Diagnostics are:

- Testing and diagnosing apparent hardware failures
- Documenting system configurations for upgrade planning, standardization, inventory tracking, disaster recovery, and maintenance
- Sending configuration information to another location for more in-depth analysis

Theory of operation

Insight Diagnostics Offline Edition operates in offline mode only. The operating system is not running and software information from the system is not available to the diagnostics.

Offline Survey is available to display the current system configuration.

The Insight Diagnostics Test feature provides the capability to test functionality of all the major hardware components in the system. The Test feature is designed with flexibility to enable you to customize test selections by specifying different modes and types of testing.

A Quick Test provides a predetermined script where a sample of each hardware component is tested and requires no user intervention.

A Complete Test provides a predetermined script during which each hardware component is fully tested. You can select Interactive or Unattended tests. This changes the devices tested during the Complete Test. There are more tests available in the interactive mode, but these require user intervention.

A Custom Test provides the most flexibility in controlling the testing of a system. The Custom Test mode enables you to specifically select which devices, tests, and test parameters are run. You can select tests that do not require any user interaction through the Interactive and Unattended tests modes.

Diagnostic utility on CD

HP Insight Diagnostics is available on the Documentation Library CD included with your workstation.

To start the diagnostic utility on the Documentation Library CD:

1. To enter the Computer Setup (F10) Utility, power on your workstation and press **F10** during the initial boot process .
2. Select your language from the list and press the **Enter** key. In the Computer Setup Utilities menu, four headings are displayed: **File**, **Storage**, **Security**, and **Advanced**. There might be other headings, depending on your workstation.
3. Use the right arrow key to select **Storage**.
4. Use the down arrow key to select **Boot Order**, and then press **Enter**.
5. Select **CD-ROM Drive**, and then press **F5** to enable it as a bootable device. (If the CD drive is not already enabled, pressing **F5** again disables it.) The default setting is Enabled.
6. Set the optical drive at the top of the boot order. To do this, select **CD-ROM**, press the **Enter** key, and then use the up arrow to move it to the top of the boot order.
7. To apply and save changes, press the **F10** key, and then select **File>Save Changes** and **Exit**.
8. Insert the Documentation Library CD into the workstation.
9. Restart your system and HP Insight Diagnostics launches automatically.

Downloading the latest diagnostic utility

1. Go to <http://www.hp.com>.
2. Select the **Support & Drivers** link.
3. Select the **Download driver and software** radio button.
4. Enter your product number (for example, xw4600) in the text box, and then press **Enter**.
5. Select your operating system.
6. Select the **Diagnostic** link.
7. Locate **HP Insight Diagnostics Offline** and select **Download**.

User Interface

Navigation

The Insight Diagnostics home page contains these tabs: Survey, Test, Status, Log, and Help. These tabs separate the major functions of Insight Diagnostics.

Survey tab

When the Survey tab is selected, the Survey menu is displayed and enables you to view important system configuration information. The Summary view limits the amount of data displayed, while the Advanced view shows all the data in the selected category. Regardless of whether you choose **Advanced** or **Summary**, the following categories of information are available on the Survey menu:

Overview—Provides a listing of general information about the computer.

All—Provides a listing of *all* information about the computer.

Architecture—Displays the workstation bus type and BIOS information. In addition, if the bus is PCI, information about the PCI configuration is displayed.

Asset Control—Displays the serial number of the computer and also provides processor information.

Communication—Displays information about the computer parallel (LPT) and serial (COM) port settings, USB, and network controller information.

Graphics—Displays information about the graphics subsystem of the computer.

Input Devices—Displays information about the type of keyboard and mouse.

Memory—Displays information about all memory in the computer, including memory on the board and any memory modules installed.

Miscellaneous—Displays information obtained from the computers configuration memory (CMOS), BIOS data area, Interrupt Vector table, and diagnostics component information.

Storage—Displays information about storage media connected to the computer, including all fixed disks, diskette drives, and optical drives.

System—Displays product type, processor type and speed, coprocessor information, and information about all ROMs in the computer.

Test tab

The Insight Diagnostics utility provides the capability to test all the major hardware components in the workstation. You can select from several types of tests:

Quick Test—Provides a predetermined script that samples most hardware components and requires no user intervention.

Complete Test—Provides a predetermined script during which most hardware components are fully tested. You can select **Interactive** or **Unattended** tests. This changes the devices tested during the Complete Test. More tests are available in the interactive mode, but these require user intervention.

Custom Test—Provides the most flexibility in controlling the testing of a system. The Custom Test mode enables you to specifically select which devices, tests, and test parameters to run. You can select tests that do not require any user interaction through the Interactive and Unattended test modes. More tests are available in the interactive mode, but these tests require user intervention.

To begin diagnostics testing:

1. Select the **Test** tab.
2. Select **Type of Test** to perform, select **Test Mode**, and then select either **Interactive** or **Unattended**.
3. Choose how you want the test to be executed, either **Number of Loops** or **Total Test Time**.
 - When choosing to run the test over a specified number of loops, enter the number of loops to perform.
 - If you want to run the diagnostic test for a specified time period, enter the amount of time in minutes.
4. To start the test, select **Begin Testing** in the lower right corner of the display.

While tests are performed, you can monitor the progress by viewing the Status tab. Any errors that are detected are summarized in the Error Log. Select **Save** to save the report to a diskette or a USB key drive (if attached).

If the diagnostics utility detects an error during a test, the user can mouse over the failed text in the Status tab to display additional information about the type of error and the error code.

To view all test failure information, select **Error Log**. To view the status of all testing that has been performed, select the **Log** tab.

Status tab

The Status tab displays the status of the selected tests. The type of test executed (for example, Quick, Complete, or Custom) is displayed. The main progress bar displays the percentage of completion of the current set of tests. While testing is in progress, the Cancel Testing button is displayed. Select this to cancel the test.

After testing is complete, the Cancel Testing button is replaced with the Select New Tests and Retest buttons. Select New Tests enables you to go back to the previous test selection page to select a new set of tests. The Retest button retests the last set of tests executed. This enables you to rerun a set of tests without having to go back to the test selection page.

The Status page also shows:

- Devices being tested
- Tests currently running
- Overall test time
- Individual test times
- Condition status of each test

Log tab

The Log tab consists of the following views.

Test Log—Displays all tests that have been executed, number of times a test was executed, the number of times a test failed, and the time it took to complete the test. The Clear Test Log button clears the contents of the Test Log.

Error Log—Displays the tests that have failed during diagnostic testing. Besides displaying the device and test, this section might also include error details. The description section describes the error that the diagnostic test found. The Recommended Repair will give a recommended action that should be performed to resolve the hardware problem. The error count is the number of times the test has failed. The Clear Error Log button clears the contents of the Error Log.

Help tab

The Help tab provides three views:

- **HP Insight Diagnostics**—Provides introductory and detailed information about Insight Field Diagnostics.
- **Error Codes**—Provides error code listings, including devices tested, messages, and recommended repair information.
- **Test Components**—Reloads and refreshes all components and displays component details after the refresh.

POST error messages

Power On Self Test (POST) is a program run at startup that initializes and runs tests on installed hardware. An audible and/or visual message appears if the POST encounters a problem. POST checks the following items to ensure that the workstation system is functioning properly:

 **NOTE:** If the power-on password is set, a key icon appears on the screen while POST is running. You must enter the password before continuing.

Table 5-18 POST error messages

Screen message	Probable cause	Recommended action
101—Option ROM Error	System ROM checksum	Verify the correct ROM: <ol style="list-style-type: none">1. Flash the ROM, if needed.2. If an expansion card was recently added, remove it to find out if the problem remains.3. Clear CMOS. If the message disappears, there might be a problem with the expansion card4. Replace the system board.
102—System Board Failure	DMA, timers, and so on	<ol style="list-style-type: none">1. Clear CMOS.2. Remove expansion boards.3. Replace the system board.
103—System Board Failure	DMA, timers, and so on	<ol style="list-style-type: none">1. Clear CMOS.2. Remove expansion boards.3. Replace the system board.
110—Out of Memory for Option ROMs	Option ROM for a device was unable to run due to memory constraints.	Run the Computer Setup (F10) Utility to enable the ACPO/USB Buffers at Top of Memory under the Advanced>Power-On option.
162—System Options Not Set	Configuration incorrect. RTC battery might need replacement.	<ol style="list-style-type: none">1. Run Computer Setup (F10) Utility.2. Set the date and time from the Control Panel or in the setup utility (depending on the operating system).3. If the problem persists, replace the RTC battery.

Table 5-18 POST error messages (continued)

Screen message	Probable cause	Recommended action
163—Time and Date Not Set	Invalid time or date in configuration memory. RTC battery might need replacement. CMOS jumper might not be properly installed.	<ol style="list-style-type: none">1. Set the date and time from the Control Panel or in the Computer Setup (F10) Utility (depending on the operating system).2. If the problem persists, replace the RTC battery.
164—Memory Size Error	Memory configuration is incorrect.	<ol style="list-style-type: none">1. Run the Computer Setup (F10) Utility or Windows utilities.2. Verify that the memory modules (if any) are installed properly.3. If third-party memory has been added, test using HP memory only.4. Verify proper memory module type.
201—Memory Error	RAM failure.	<ol style="list-style-type: none">1. Run the Computer Setup (F10) utility or Windows utilities.2. Be sure that memory and continuity modules are installed correctly.3. Verify proper memory module type.4. Remove and replace memory modules one at a time to isolate faulty modules.5. Replace faulty memory modules.6. If error persists after replacing memory modules, replace the system board.
202—Memory Type Mismatch	Memory modules do not match.	Replace memory modules with matched sets.
207—ECC Corrected Single Bit Errors in Memory Socket(s) y,y	Single-bit ECC error.	<ol style="list-style-type: none">1. Verify proper memory module type.2. Insert the DIMM in another memory socket.3. Replace memory module if problem persists.
212—Failed Processor	Processor has failed to initialize.	<ol style="list-style-type: none">1. Reseat the processor in its socket.2. If the processor does not respond, replace it.
213—Incompatible memory Module in memory Socket(s) x,x	A memory module in memory socket identified in the error message is missing critical SPD information or is incompatible with the chipset.	<ol style="list-style-type: none">1. Verify proper memory module type.2. Insert the DIMM in another memory socket.3. Replace module with a DIM conforming to the SPD standard.
214—DIMM Configuration Warning	DIMMs not installed correctly (not paired correctly).	See the illustration on the side access panel for the correct memory configurations, and reseat the DIMMs accordingly.
215—Memory Mismatch Warning	There are one or more mismatched pairs of DIMMs between channel A and channel B. Some memory has been disabled. Install matching pairs or remove the mismatched DIMMs from channel B.	See the illustration on the side access panel for the correct memory configurations, and reseat the DIMMs accordingly.

Table 5-18 POST error messages (continued)

Screen message	Probable cause	Recommended action
216—Memory Size Exceeds Maximum Supported	The amount of memory installed exceeds that supported by the hardware.	<ol style="list-style-type: none">1. Verify how much memory your system supports.2. Remove the excess memory.
219—ECC Memory Module Detected.	ECC modules not supported on this platform.	Remove the ECC module.
301—Keyboard Error	Keyboard failure.	<ol style="list-style-type: none">1. Reconnect the keyboard with the workstation powered off.2. Check the connector for bent or missing pins.3. Be sure that none of the keys are pressed.4. Replace the keyboard.
303—Keyboard Controller Error	I/O board keyboard controller.	<ol style="list-style-type: none">1. Reconnect keyboard with workstation turned off.2. Replace the system board.
304—Keyboard or System Unit Error	Keyboard failure.	<ol style="list-style-type: none">1. Reconnect the keyboard with workstation turned off.2. Be sure that none of the keys are pressed.3. Replace keyboard.4. Replace system board.
411—Network Interface Card Interrupt Conflict	IRQ address conflicts with another device.	Reset the IRQ.
501—Display Adapter Failure	Graphics display controller.	<ol style="list-style-type: none">1. Reseat the graphics card (if applicable).2. Clear CMOS.3. Verify that the monitor is attached and turned on.
510—Splash Screen image corrupted	Splash Screen image has errors.	To restore the image, install the latest SoftPaq.
511—CPU, CPUA, or CPUB Fan not detected	Fan is not connected, or might have malfunctioned.	<ol style="list-style-type: none">1. Reseat the fan cable.2. Reseat the fan.3. Replace the fan.
512—Chassis, rear chassis, or front chassis fan not detected	Fan is not connected, might have malfunctioned.	<ol style="list-style-type: none">1. Reseat the chassis, rear chassis, or front chassis fan cable.2. Reseat the chassis, rear chassis, or front chassis fan.3. Replace the chassis, rear chassis, or front chassis fan.
514—CPU or Chassis Fan not detected	Processor fan is not connected or might have malfunctioned.	<ol style="list-style-type: none">1. Reseat the processor or chassis fan.2. Replace the processor or chassis fan.
601—Diskette Controller Error	Diskette controller circuitry or diskette drive circuitry incorrect.	<ol style="list-style-type: none">1. Run the Computer Setup (F10) utility.2. Verify and replace cables.3. Clear CMOS.

Table 5-18 POST error messages (continued)

Screen message	Probable cause	Recommended action
		<ol style="list-style-type: none"> 4. Replace diskette drive. 5. Replace the system board.
605—Diskette Drive Type Error	Mismatch in drive type.	<ol style="list-style-type: none"> 1. Run the Computer Setup (F10) Utility. 2. Disconnect any other diskette controller devices (tape drives). 3. Clear CMOS.
912—Computer Cover Has Been Removed Since Last System Start Up	N/A	No action required.
914—Coil is not Connected	Mechanism is missing or not connected.	<ol style="list-style-type: none"> 1. Reconnect or replace ing mechanism. 2. Reseat or replace ing mechanism cable.
916—Power Button Not Connected	The power button is not connected.	Connect power button.
917—Front Audio Not Connected	The front audio cable is not connected.	Connect front audio cable.
918—Front USB Not Connected	Front USB is not connected.	Connect front USB cable.
960—CPU Overtemp occurred	The ambient temperature could exceed operating limits (maximum=95F), or there are obstructions to airflow, including dust buildup.	<ol style="list-style-type: none"> 1. Be sure you are not operating the system in an environment that exceeds 95F. 2. Disconnect power and open the access panel. 3. Verify that cables are not blocking processor heatsink fans or front fan (if installed). 4. Verify that there is not excessive dust on major components. 5. If airflow is acceptable and there is not excessive dust, the thermal sensing circuitry has failed on the processors or on the system board. You must replace the processors and/or the system board.
1720—SMART Hard Drive Detect Imminent Failure	Hard drive is about to fail. (Some hard drives have a firmware patch that fixes erroneous error messages.)	<ol style="list-style-type: none"> 1. Determine if hard drive is giving correct error message. 2. Run the Drive Protection System test (if applicable). 3. Apply firmware patch (if applicable). See http://www.hp.com/support. 4. Back up contents and replace the hard drive.
1780—Disk 0 Failure	The drive is not installed correctly or has failed.	<ol style="list-style-type: none"> 1. Be sure that any jumpers are set correctly, and that power and drive cables are connected, both to the drive and the system board. 2. Verify that the cables are the correct cables for your computer model. If this message persists, your workstation might require service.

Table 5-18 POST error messages (continued)

Screen message	Probable cause	Recommended action
1781—Disk 1 Failure	The drive is not installed correctly or has failed.	<ol style="list-style-type: none">1. Be sure that any jumpers are set correctly and that power and drive cables are connected, both to the drive and the system board.2. Verify that the cables are the correct cables for your computer model. If this message persists, your workstation might require service.
1782—Disk Controller Failure	Hard drive circuitry error.	<ol style="list-style-type: none">1. Run the Computer Setup (F10) utility.2. Clear CMOS.3. Verify cable seating and jumper settings.4. Run hard-drive diagnostics.5. Disconnect additional drives.6. Run the Drive Protection System test (if available).7. Replace the hard drive.8. Replace the system board.
1790—Disk 0 Error	The drive is not installed correctly or has failed.	<ol style="list-style-type: none">1. Be sure that any jumpers are set correctly and that power and drive cables are connected to both the hard drive and the system board.2. Verify that the cables are the correct cables for your computer model. If this message persists, you may need service for your workstation.
1791—Disk 1 Error	The drive is not installed correctly or has failed.	<ol style="list-style-type: none">1. Be sure that any jumpers are set correctly and that power and drive cables are connected to both the hard drive and the system board.2. Verify that the cables are the correct cables for your computer model. If this message persists, you may need service for your workstation.
1792—Secondary Disk Controller Failure	Hard drive circuitry error.	<ol style="list-style-type: none">1. Run the Computer Setup (F10) utility.2. Clear CMOS.3. Verify cable seating/jumper settings.4. Run hard-drive diagnostics.5. Disconnect additional drives.6. Run the Drive Protection System test (if available).7. Replace the hard drive.
1793—Secondary Controller or Disk Failure	Hard drive circuitry error.	<ol style="list-style-type: none">1. Run the Computer Setup (F10) Utility.2. Clear CMOS.3. Verify cable seating and jumper settings.4. Run hard-drive diagnostics.5. Disconnect additional drives.

Table 5-18 POST error messages (continued)

Screen message	Probable cause	Recommended action
		<ol style="list-style-type: none">6. Run the Drive Protection System test (if available).7. Replace the hard drive.
1801—Microcode Patch Error	Processor not supported by ROM BIOS.	Upgrade BIOS to proper version.
1802—Processor Not Supported	The system board does not support the processor.	Replace the processor with a compatible one.
1803-BIOS Update Needed for Processor	This BIOS revision does not support the installed processor.	Install the latest BIOS downloaded from http://www.hp.com .
1998—Master Boot Record has been lost	The previously saved copy of the MBR is corrupted.	Run the Computer Setup (F10) Utility and save the MBR of the current bootable disk.
Invalid Electronic Serial Number	Electronic serial number is corrupted	<ol style="list-style-type: none">1. Run the Computer Setup (F10) Utility.2. If the setup utility already has data in the field, or it will not allow the serial number to be entered, see http://www.hp.com.3. Download and run the sp5572.exe (snzero.exe) utility.4. Run the Computer Setup (F10) Utility again and try to enter the serial number under Security>System ID.5. Ssave the changes.
ECC Multiple Bit Error Detected in Memory Module	The chipset has detected more than one bad bit in a 64-bit quadword of the memory array.	Replace the memory module.
Parity Check 2	Parity RAM failure.	Run the Computer Setup (F10) Utility and the Diagnostic utilities.

6 Configuring RAID devices

This chapter describes how to configure SAS and SATA RAID devices:

- [Configuring SAS RAID devices on page 141](#)
- [Configuring SATA RAID devices on page 144](#)

For additional information about configuring RAIDs, see http://www.hp.com/support/RAID_FAQs. For information about preparing your workstation for RAID configuration, see http://www.hp.com/support/workstation_manuals.

Configuring SAS RAID devices

Supported configurations

The following RAID configurations are supported on the HP xw4600 Workstation.

 **NOTE:** This section does not apply to configuring RAID in the Linux environment. For RAID in the Linux environment, configure RAID configurations as provided by Red Hat Enterprise Linux.

- Up to four internal SAS hard disk drives
- SAS to SATA data and power converter
- LSI MegaRAID Storage Manager (MSM) for Windows

The following RAID configurations are supported on the HP xw4600 Workstation:

- RAID 0 – Striped disk array
 - Two drive minimum
 - Improved I/O performance
 - No fault tolerance
- RAID 1 — Mirrored disk array
 - Two drives
 - 100% redundancy

- Can recover from single drive failure
- Improved read performance
- RAID 1E
 - Three drives minimum
 - Can be an odd number of drives
 - Can always recover from a single drive failure and, in some cases, can recover from two drive failures

SAS RAID 0 configuration

Follow the steps below to configure an Integrated Striped (IS) volume with the BIOS-based configuration utility. The configuration procedure assumes that the system already has the required disk and disk controllers.

1. On the Main menu screen of the BIOS-based configuration utility, use the arrow keys to select an adapter.
2. Press **Enter** to go to the Adapter Properties screen.
3. On the Adapter Properties screen, use the arrow keys to select **RAID Properties**.
4. Press **Enter** to go to the RAID Properties screen.
5. In the RAID Properties screen, use the arrow keys to select the first disk for the IS volume. Then use the arrow keys to move to the Array Disk column for this disk, and press the **SPACE**, **+**, or **-** key to select **Yes** as the value for this column. If partitions are defined on the selected disk, a message appears warning you that data on the disk will be lost when the striped volume is created. Press the **M** key to migrate, or the **D** key to delete the data on the drive.
6. Repeat the previous step to select up to three more disks for the striped volume.
7. Press the **C** key to create the array once all drives have been chosen, then press **Esc** and select **Save**.

SAS RAID 1 configuration

Follow the steps below to configure an Integrated Mirroring (IM) volume with the BIOS-based configuration utility. The configuration procedure assumes that the system already has the required disk and disk controllers.

1. On the Main menu screen of the BIOS-based configuration utility, use the arrow keys to select an adapter.
2. Press **Enter** to go to the Adapter Properties screen.
3. On the Adapter Properties screen use the arrow keys to select **RAID Properties**.
4. Press **Enter** to go to the RAID Properties screen. .
5. Chose one of the following options:

To configure a two-disk mirrored volume with an optional hot spare disk:

- In the RAID Properties screen, use the arrow keys to select the primary disk for the IM volume (the disk with the data you want to mirror.)
- Use the arrow keys to move to the Array Disk column for this disk and use the **SPACE** key to select **Yes** as the value. If partitions are defined on the selected disk, a message appears warning you that data on the disk will be lost when the striped volume is created. Press the **M** key to migrate, or the **D** key to delete the data on the drive.
- When the **Keep Data/Erase Disk** message appears, press **F3** to keep the data currently on this disk. The value in the Array Disk column changes to **Primary**.
- Use the arrow keys to select the secondary (mirrored) disk for the IM volume. Select **Yes** as the value for the Array Disk column.

If partitions are defined on this disk, a message warns you that data on the disk will be lost when the mirrored volume is created. Press **Delete** to confirm erasing data from the disk, or press any other key to deselect the disk. Continue with Step 6.

SAS RAID 1E configuration

Follow the steps below to configure an Integrated Mirroring Extended (IME) volume with the BIOS-based configuration utility. The configuration procedure assumes that the system already has the required disk and disk controllers.

1. On the Main menu screen of the BIOS-based configuration utility, use the arrow keys to select an adapter.
2. Press **Enter** to go to the Adapter Properties screen.
3. On the Adapter Properties screen use the arrow keys to select **RAID Properties** on the screen.
4. Press **Enter** to go to the RAID Properties screen. Continue with Step 5 to configure a two-disk mirrored volume. Go to Step 6 to configure a mirrored volume with three to six disks.
5. To configure a mirrored volume with three to six disks, or three to five disks with an optional hot spare disk:
 - In the RAID Properties screen, use the arrow keys to select the first disk for the IME volume.
 - Use the arrow keys to move to the Array Disk column for this disk, and use the **+** and **-** keys to select **Yes** as the value.
 - When the **Keep Data/Erase Disk** message appears, press **Delete** to erase the disk.
 - Use the arrow keys to select the next disk for the IME volume. Select **Yes** as the value for the Array Disk column.

If partitions are defined on this disk, a message warns you that data on the disk will be lost when the mirrored volume is created. Press **Delete** to confirm erasing data from the disk, or press any other key to deselect the disk.

 - Repeat the previous steps to select up to four more disks for the IME volume. If you want to configure a hot spare disk for the volume, you can only select up to three more disks.

6. (Optional) Use the arrow keys to select a hot spare disk for the IME volume. Select **Yes** as the value for the Hot Spare column.
7. When you have selected all disks for the IME volume, press **Esc** and select **Save changes, then exit this menu**. If you do not want to create the IME volume, select **Discard changes, then exit this menu**.

The IME volume exists as soon as you save the changes. The RAID Properties screen now displays the IME volume properties and status.

Configuring SATA RAID devices

This section describes how to use the Intel Matrix Storage Manager option ROM Configuration utility to set up and manage SATA RAID volumes.

 **NOTE:** If only a single HDD is attached, the Intel Matrix Storage Manager option ROM will not execute. All associated messages will not be displayed.

The Intel SATA AHCI BIOS always executes when RAID/AHCI is selected for the SATA emulation mode. This BIOS is only used to support serial attached optical drives. When an HDD is attached, the AHCI BIOS properly identifies the HDD that is connected to the appropriate SATA port and displays **Device not supported in this configuration**. This message is expected and does not indicate a problem.

Attaching SATA HDDs

Attach the required number of SATA hard drives for the desired RAID level.

- RAID 0: two to three hard drives
- RAID 1: two hard drives
- RAID 5: three hard drives
- RAID 10: four hard drives

Configuring system BIOS

Configure the system BIOS to enable embedded SATA RAID functionality.

1. Press **F10** to enter the system BIOS setup.
2. Use the arrow keys to highlight the desired language, then press **Enter**.
3. Use the arrows on your keyboard to highlight **Storage>Storage Options**, then press **Enter**.
4. Use the up or down arrow key to highlight **SATA Emulation**.
5. Use the left or right arrow key to select **RAID/AHCI**.
6. Press **F10** to accept the new setting.
7. Use the arrows on your keyboard to highlight **Advanced > Power-On Options**, then press **Enter**.
8. Use the up or down arrow key to highlight **POST Messages**.
9. Use the left or right arrow key to select **Enable**.

10. Press **F10** to accept the new setting.
11. Use the arrow keys to highlight **Advanced>Device Options**, and press **Enter**.
12. Use the up or down arrow key to highlight **SATA RAID Option ROM Download**, and press **Enter**.
13. Use the left or right arrow key to select **Enable**.
14. Press **F10** to accept the new setting.
15. Use the arrows on your keyboard to highlight **File>Save Changes and Exit**, and press **Enter**.
16. Press **F10** when prompted.

Creating RAID volumes

Use the Intel Matrix Storage Manager option ROM Configuration utility to create RAID volumes.

1. Press **Ctrl+I** when prompted to enter the Intel Matrix Storage Manager option ROM Configuration utility.
2. If required, see [Deleting RAID volumes on page 145](#) to make enough physical drives available to create the desired RAID volume.
3. Use the up or down arrow key to highlight **1. Create RAID Volume**, and press **Enter**.
4. Type the desired RAID volume name in the “Name:” field, and press **Tab**.
5. Use the up or down arrow key to select the desired RAID level in the RAID Level: field, then press **Tab**.
6. Press **Enter** to display the Select Disks dialog.
7. Use the up and down arrow keys and Space to mark individual physical disks as members of the volume.
8. Press **Enter** to exit the Select Disks dialog and return to the Create Volume Menu dialog.
9. If appropriate, use the up or down arrow key to select the Strip Size in the Strip Size: field, and press **Tab**.
10. Type the desired volume size in the Capacity: field, and press **Tab**.
11. Press **Enter** to initiate volume creation.
12. When prompted, press **Y** to acknowledge the warning message and create the volume.
13. Return to step 3 to create additional RAID volumes, or use **?** or **?** to highlight **4. Exit**, and press **Enter**.
14. Press **Y** when prompted to confirm the exit.

Deleting RAID volumes

Use the Intel Matrix Storage Manager option ROM Configuration utility to delete RAID volumes.

1. Use the up or down arrow key to highlight **2. Delete RAID Volume**, and press **Enter**.
2. Use the up or down arrow key to highlight the RAID volume to be deleted, and press **Del**.

3. When prompted, press **Y** to confirm the deletion of the selected RAID volume.
4. Choose one of the following steps:
 - Return to step 1 to delete additional RAID volumes.
 - To create RAID volumes, see [Creating RAID volumes on page 145](#).
 - Use the up or down arrow key to highlight **4. Exit**, and press **Enter**.
 - Use the up or down arrow key to highlight **3. Reset Disks to Non-RAID**, and press **Enter**.
5. Use the up and down arrow keys and Space to mark individual physical disks to be reset.
6. Press **Enter** to complete the selection.
7. When prompted, press **Y** to confirm the reset action.
8. Choose one of the following steps:
 - Return to step 1. to delete additional RAID volumes.
 - To create RAID volumes, see [Creating RAID volumes on page 145](#).
 - Use the up or down arrow key to highlight **4. Exit**, and press **Enter**.

7 Configuring password security and resetting CMOS

This chapter describes how to configure password security and to reset CMOS, and includes these topics:

- [Preparing to configure passwords on page 148](#)
- [Resetting the password jumper on page 149](#)
- [Resetting the password jumper on page 149](#)

Preparing to configure passwords

The Computer Setup (F10) Utility enables you to create setup and power-on passwords.

When you create a setup password, only the power-on password is required to access the Computer Setup (F10) Utility and any other information on the workstation. When you create both passwords, only the setup password gives you access to the Computer Setup (F10) Utility.

When both passwords are created, the setup password can also be used in place of the power-on password as an override to log into the workstation (a useful feature for a network administrator).

If you forget a password, two methods are available for clearing the password to gain access to the information on the workstation:

- Reset the password jumper
- Press the **Clear CMOS** button

△ **CAUTION:** Pressing the Clear CMOS button resets CMOS values to factory defaults and erases any customized information, including passwords, asset numbers, and special settings. It is important to back up your workstation CMOS settings before resetting them in case they are necessary later. To back up the CMOS settings, run the Computer Setup (F10) Utility and select **Save to Diskette** from the File menu.

Resetting the password jumper

To disable the power-on or setup password features and clear the power-on and setup passwords:

- △ **WARNING!** To reduce the risk of personal injury from electrical shock and hot surfaces, be sure to disconnect the power cord from the wall outlet and allow the internal system components to cool before touching.
 - △ **CAUTION:** When the workstation is plugged in, the power supply always has voltage applied to the system board even when the workstation is turned off. Failure to disconnect the power cord can result in damage to the system.
 - △ **CAUTION:** Static electricity can damage the electronic components of the workstation or optional equipment. Before beginning these procedures, be sure that you are discharged of static electricity by briefly touching a grounded metal object.
1. Shut down the operating system, and then power off the workstation and any external devices. Disconnect the workstation power cord and any external devices from the power outlets.
 2. Disconnect the keyboard, monitor, and any other external devices that are connected to the workstation.
 3. Remove the access panel.
 4. Locate the password header and jumper. The password header is E49.

 **NOTE:** Ensure that the AC power cord is disconnected from the power outlet. The CMOS button does not clear CMOS if the power cord is connected.

The password jumper is green so that it can be easily identified. For assistance locating the password jumper and other system board components, see the service label located on the inside of the workstation access panel, or see [System board components on page 59](#).

5. Remove the jumper from either pin 1 or 2. Place the jumper on pins 1 and 2 (connecting both pins together).
6. Replace the access panel.
7. Reconnect the external equipment.
8. Plug in and power on the workstation. Allow the operating system to start. This process clears the current passwords and disables the password features.
9. To establish new passwords, repeat steps 1 through 4, replace the password jumper on either pin 1 or pin 2 (but not both), and repeat steps 6 through 8. Establish the new passwords using the Computer Setup (F10) Utility.

Clearing and Resetting the CMOS

The CMOS of the workstation stores password information and information about the workstation configuration. This section describes the steps necessary to successfully clear and reset the CMOS.

Using the CMOS Button

Follow the steps below to clear CMOS using the Clear CMOS button:

⚠ **WARNING!** To reduce the risk of personal injury from electrical shock and hot surfaces, be sure to disconnect the power cord from the wall outlet and allow the internal system components to cool before touching.

⚠ **CAUTION:** When the workstation is plugged in, the power supply always has voltage applied to the system board even when the workstation is powered off. Failure to disconnect the power cord can result in damage to the system

CAUTION: Static electricity can damage the electronic components of the workstation or optional equipment. Before beginning these procedures, be sure that you are discharged of static electricity by briefly touching a grounded metal object.

1. Shut down the operating system, and then power off the workstation and any external devices. Disconnect the workstation power cord and any external devices from the power outlets.

2. Disconnect the keyboard, monitor, and any other external devices that are connected to the workstation.

3. Remove the access panel.

⚠ **CAUTION:** Pushing the Clear CMOS button resets CMOS values to factory defaults and erases any customized information, including passwords, asset numbers, and special settings. It is important to back up the workstation CMOS settings before resetting them in case they are necessary later. To back up the CMOS settings, use the Computer Setup (F10) Utility and select **Save to Diskette** from the File menu.

4. Locate, press, and hold the CMOS button for five seconds.

📝 **NOTE:** Be sure that the AC power cord is disconnected from the power outlet. The CMOS button does not clear CMOS if the power cord is connected.

NOTE: For assistance locating the CMOS button and other system board components, see [System board components on page 59](#).

5. Replace the access panel.

6. Reconnect any external devices.

7. Plug in and power on the workstation.

📝 **NOTE:** The workstation passwords and any special configuration information, including the system date and time, must be reset.

The workstation powers up for three to five seconds, then powers down.

Using the Computer Setup (F10) Utility to Reset CMOS

1. Access the Computer Setup (F10) Utility menu. When the Computer Setup message appears in the lower-right corner of the screen, press **F10**. Press **Enter** to bypass the title screen, if necessary.



 **NOTE:** If you do not press the **F10** key while the message is displayed, the workstation must be powered off, then on again, to access the utility.

2. From the Computer Setup (F10) Utility menu, select **File>Set Defaults**, and then select **Exit**. This restores the settings that include boot sequence order and other factory settings. However, it does not force hardware rediscovery.

 **NOTE:** The workstation passwords and any special configuration information, including the system date and time, must be reset.

A Appendix A—Connector pins

Connector pin descriptions

Workstation	Pin	Signal
Workstation keyboard connector		
	1	Data
	2	Unused
	3	Ground
	4	+5 VDC
	5	Clock
	6	Unused
Workstation mouse connector		
	1	Data
	2	Unused
	3	Ground
	4	+5 VDC
	5	Clock
	6	Unused

Workstation Ethernet connector	Pin	10/100-MbSignal	1000-Mb signal
	1	(+) Transmit Data	TX/RX 0 +
	2	(-) Transmit Data	TX/RX 0 -
	3	(+) Receive Data	TX/RX 1 +
	4	Unused	TX/RX 2 +
	5	Unused	RX/RX 2 -
	6	(-) Receive Data	TX/RX 1 -
	7	Unused	TX/RX 3 +
	8	Unused	TX/RX 3 -

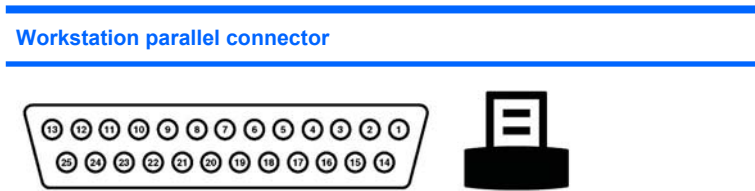

Pin	Signal	Pin	Signal	Pin	Signal
1	Strobe	7	Data Bit 5	13	Select
2	Data Bit 0	8	Data Bit 6	14	Auto Linefeed
3	Data Bit 1	9	Data Bit 7	15	Error
4	Data Bit 2	10	Acknowledge	16	Initialize Printer
5	Data Bit 3	11	Busy	17	Select IN Signal
6	Data Bit 4	12	Paper End	18-25	Ground

Workstation serial connector	Pin	Signal
	1	Carrier Detect
	2	Receive Data
	3	Transmit Data
	4	Data Terminal Ready
	5	Signal Ground
	6	Data Set Ready
	7	Request to Send
	8	Clear to Send
	9	Ring Indicator

Workstation USB connector	Pin	Signal
	1	+5 VDC
	2	- Data
	3	+ Data
	4	Ground

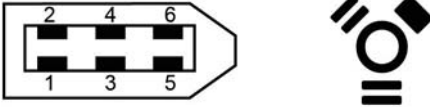
Workstation IEEE 1394 connector	Pin	Signal
	1	Power
	2	GND
	3	TPB-
	4	TPB+
	5	TPA-
	6	TPA+

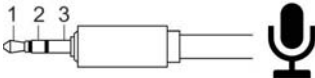
Microphone cable connector (1/8 inch)	Pin	Signal
	1 (Tip)	Audio
	2 (Ring)	Power
	3 (Shield)	Ground

Headphone cable connector (1/8 inch)	Pin	Signal
	1 (Tip)	Audio_Left
	2 (Ring)	Audio_Right
	3 (Shield)	Ground

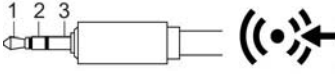
Line-in audio cable connector (1/8 inch)	Pin	Signal
	1 (Tip)	Audio_In_Left
	2 (Ring)	Audio_In_Right
	3 (Shield)	Ground

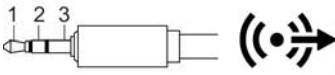
Line-out audio cable connector (1/8 inch)	Pin	Signal
	1 (Tip)	Audio_Out_Left
	2 (Ring)	Audio_Out_Right

Line-out audio cable connector (1/8 inch)	Pin	Signal
	3 (Shield)	Ground

SATA drive connector

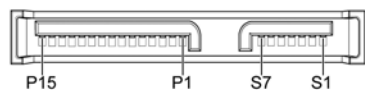

Pin	Signal	Pin	Signal	Pin	Signal
Data Cable		Power Cable		Power Cable	
S1	Ground	P1	3.3V power	P8	5V power
S2*	A+	P2	3.3V power	P9	5V power
S3*	A-	P3	3.3V power	P10	Ground
S4	Ground	P4	Ground	P11	Reserved
S5**	B-	P5	Ground	P12	Ground
S6**	B+	P6	Ground	P13	12V power
S7	Ground	P7	5V power	P14	12V power
				P15	12V power

* S2 and S3 differential signal pair

**S5 and S6 differential signal pair

SAS drive connector

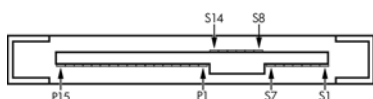

Segment	Pin	Backplane receptacle	Plug and cable receptacles
Primary signal segment	S1	SIGNAL GROUND	
	S2	TP+	RP+
	S3	TP-	RP-
	S4	SIGNAL GROUND	
	S5	RP-	TP-
	S6	RP+	TP+
	S7	SIGNAL GROUND	

SAS drive connector

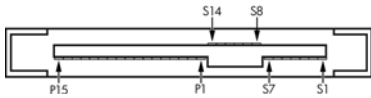

Segment	Pin	Backplane receptacle	Plug and cable receptacles
Secondary signal segment	S8	SIGNAL GROUND	
	S9	TS+	RS+
	S10	TS-	RS-
	S11	SIGNAL GROUND	
	S12	RS-	TS-
	S13	RS+	TS+
	S14	SIGNAL GROUND	
Power segment	P1	V_{33}^c	
	P2	V_{33}^c	
	P3	V_{33}^c precharge ^c	
	P4	GROUND	
	P5	GROUND	
	P6	GROUND	
	P7	V_5^c precharge ^c	
	P8	V_5^c	
	P9	V_5^c	
	P10	GROUND	
	P11	READY LED ^d	
	P12	GROUND	
	P13	V_{12} precharge ^c	
	P14	V_{12}^c	
	P15	V_{12}^c	

Workstation VGA connector

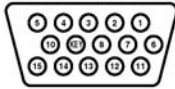

Pin	Signal	Pin	Signal	Pin	Signal
1	Red Analog	6	GND	11	Monitor ID
2	Green Analog	7	GND	12	DDC Serial Data
3	Blue Analog	8	GND	13	Horizontal Sync
4	Monitor ID	9	+5 VDC	14	Vertical Sync
5	GND	10	GND	15	DDC Serial Clock

DVI-I cable connector

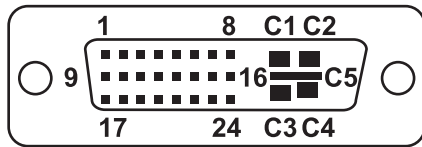

Pin	Signal	Pin	Signal
1	T.M.D.S DATA 2-	16	HOT PLUG DETECT
2	T.M.D.S DATA 2+	17	T.M.D.S DATA 0-
3	T.M.D.S DATA 2/4 SHIELD	18	T.M.D.S DATA 0+
4	T.M.D.S DATA 4-	19	T.M.D.S DATA 0/5 SHIELD
5	T.M.D.S DATA 4+ 2	0	T.M.D.S DATA 5-
6	DDC CLOCK	21	T.M.D.S DATA 5+
7	DDC DATA	22	T.M.D.S CLOCK SHIELD
8	ANALOG VERT. SYNC	23	T.M.D.S CLOCK+
9	T.M.D.S DATA 1-	24	T.M.D.S CLOCK-
10	T.M.D.S DATA 1+		
11	T.M.D.S DATA 1/3 SHIELD	C1	ANALOG RED
12	T.M.D.S DATA 3-	C2	ANALOG GREEN
13	T.M.D.S DATA 3+	C3	ANALOG BLUE
14	+5V POWER	C4	ANALOG HORZ SYNC
15	GND	C5	ANALOG GROUND

24-pin main power cable connector

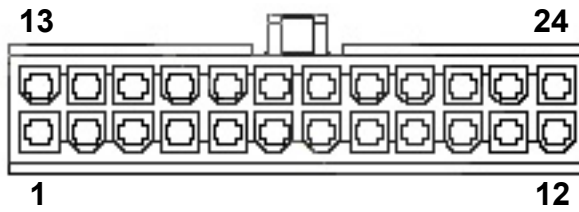

1	+3.3V	7	GND	13	+3.3V	19	GND
2	+3.3V	8	POK	14	-12V	20	GND
3	GND	9	+5 Vaux	15	GND	21	+5V
4	+5V	10	+12 V-B	16	PS_ON_L	22	+5V
5	GND	11	+12 V-B	17	GND	23	Unused
6	+5V	12	Unused	18	GND	24	GND

4-pin power (CPU/memory/aux. sys. board) cable connector



Pin	Color	Signal
1	BLK	GND
2	BLK	GND
3	WHT	+12 VCPU
4	WHT	+12 VCPU

6-pin power (auxiliary PCI Express) cable connector

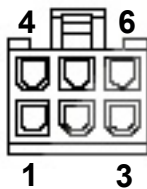

1	YEL	+12 V-D
2	YEL	+12 V-D
3	YEL	+12 V-D
4	BLK	GND
5	BLK	GND
6	BLK	GND

CAUTION: Ensure that you can differentiate between which power cable connects to the PCI Express x16 graphics card and which power cable connects to the system board. These two cables have different pin counts and different colors. The PCI Express power cable has a 6-pin black connector, and the system board power cable has a 4-pin white connector. When power is present, you must never connect the PCI Express power cable to the system board. If you do so, the system board can be damaged and your warranty voided. To see a picture of the PCI Express cable and where it must be connected, see [PCI Express cards on page 81](#).

6-pin power (auxiliary PCI Express) cable connector	Pin	Color	Signal
---	-----	-------	--------

NOTE: The 6-pin power (auxiliary PCI Express) is only required with high-powered graphics cards.

Workstation AUX_IN connector	Pin	Signal
------------------------------	-----	--------

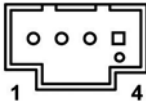

1	AUX_LEFT
2	AGND
3	AGND
4	AUX_RIGHT

Internal USB system board 2x5 connector	Pin	Signal
---	-----	--------

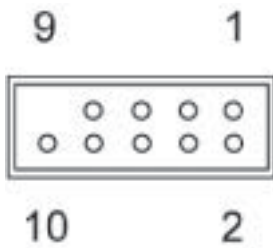

1	+5V
2	+5V
3	USB6#
4	USB7#

CAUTION: Possible equipment damage.

The 2x5 system board connector can be mated to either a wide 2x5 option cable connector or a narrow 1x5 option cable connector.

To prevent damage to the connectors, always connect a narrow 1x5 option cable connector to pins 1,3,5, and 7 only of the 2x5 system board connector (pin 9 is not keyed on the system board connector).

5	USB6
6	USB7
7	GND
8	GND
9	(not keyed)
10	Not connected

Workstation processor, PCI, and rear chassis fan connector	Pin	Signal
	1	Ground
	2	+12V
	3	Tach
	4	CMD
	5	MT

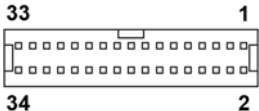
Workstation FDD connector	Pin	Signal	Pin	Signal
	1	Ground	18	FLP_DIR#
	2	FLP_LOWDEN#	19	Ground
	3	Tach	20	FLP_STEP#
	4	FLP_WDO	21	Ground
	5	MT	22	FLP_STEP#
	6	Unused	23	Ground
	7	Ground	24	FLP_WRTEN#
	8	FLP_INDEX#	25	Ground
	9	Ground	26	FLP_TRACK#
	10	FLP_MOTOR#	27	Ground
	11	Ground	28	FLP_WP#
	12	Unused	29	Ground
	13	Ground	30	FLP_RD_D#
	14	FLP_SEL_A#	31	Ground
	15	Ground	32	FLP_HD_SEL#
	16	Unused	33	Ground
	17	Ground	34	FLP_DSKCHG#

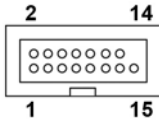
Workstation	Pin	Signal	Pin	Signal
internal serial connector				
	1	DTR2#	9	+5V
	2	RXD2	10	+3.3V AUX
	3	CTS2#	11	RTS2#
	4	DSR2#	12	+3.3V
	5	TXD2	13	DCD2#
	6	+3.3V AUX	14	-12V
	7	Ground	15	+12V
	8	Ground		

B Appendix B—System board designators

This appendix lists the system board designators for this system.

Designator	Silkscreen	Component
MTG1-MTG10	N/A	Mounting holes
E14	E14	Boot block header/jumper
E49	E49	Clear password header/jumper
J20	SLOT 5 PCI	PCI slot
J21	SLOT 6 PCI	PCI slot
J22	Slot 7 PCI	PCI slot
J33	SLOT 3 PCIe x8 (4)	PCI Express slot
J31	SLOT1 PCIe x1	PCI Express slot
J32	SLOT4 PCIe2 x16 75W + 75W	PCI Express slot
J41	SLOT2 PCIe2 x16 75W + 75W	PCI Express slot
P60-64	SATA0 – SATA4	SATA Connectors
CN6	CN6	External SATA
J50, P53	PARALLEL/SERIAL	Parallel port and serial port stack connector
P52	P52	Optional serial port
J68	KBD_MS	Stacked keyboard/mouse connector
J9	J9	Stacked RJ 45/dual USB
J10	QUAD USB	Quad stacked USB
CN7	USB	Single vertical USB
J83	J83	Triple stacked audio jack
SW50	CMOS	Clear CMOS switch/push button
P1	P1	Power supply connector (24-pin)
P3	PWRCPU	Processor power
P10	FDD	Diskette driver connector
P11	AUX-IN	Auxiliary audio connector

Designator	Silkscreen	Component
P23	FRNT AUDIO	Front panel audio header
P24	FRNT USB	Front panel USB header
P25	INT USB	Internal USB header
U1037	U1037	Internal Type A USB
P29	P29	HDD LED connector
P5	CONTROL PANEL	Main power/HDD LED/internal speaker connector
P70	CPU FAN	Primary processor fan header
P8	SYS FAN	Chassis fan header
P9	PCI FAN	PCI fan header
XBT1	BATTERY	Battery retainer
XMM1	DIMM1	Memory slot
XMM2	DIMM3	Memory slot
XMM3	DIMM2	Memory slot
XMM4	DIMM4	Memory slot
U1	XU1	Primary processor socket
E15	E15	Crisis recovery header/jumper

C Appendix C—Routine care

General cleaning safety precautions

- Never use solvents or flammable solutions to clean the workstation.
- Never immerse any component in water or cleaning solutions; apply any liquids to a clean cloth and then use the cloth on the component.
- Always unplug the workstation before cleaning the keyboard, mouse, or air vents.
- Always disconnect the keyboard before cleaning it.
- Wear safety glasses equipped with side shields when cleaning the keyboard.

Cleaning the workstation case

- Follow the service consideration ([Service considerations on page 53](#)) presented before cleaning the workstation.
- To remove light stains or dirt, use plain water with a clean, lint-free cloth or swab.
- For stronger stains, use a mild dish washing liquid diluted with water. Rinse well by wiping it with a cloth or swab dampened with clear water.
- For stubborn stains, use isopropyl (rubbing) alcohol. No rinsing is required because the alcohol evaporates quickly and does not leave a residue.
- After cleaning, always wipe the workstation with a clean, lint-free cloth.
- Occasionally, clean the air vents on the workstation. Lint and other foreign matter can block the vents and limit the airflow.

Cleaning the keyboard

△ **CAUTION:** Use safety glasses equipped with side shields before attempting to clean debris from under the keys.

- Follow the safety precautions presented in [Service considerations on page 53](#) before cleaning the keyboard.
- Visible debris underneath or between the keys can be removed by vacuuming or shaking.
- Canned, pressurized air can be used to clean debris from under the keys. Use caution because too much air pressure can dislodge lubricants applied under the wide keys.
- If you remove a key, use a specially designed key remover to prevent damage to the keys. This tool is available from many electronic supply outlets.

△ **CAUTION:** Never remove a wide key (like the space bar key) from the keyboard. If these keys are improperly removed or installed, the keyboard might not function properly.

- Clean under a key with a swab moistened with isopropyl alcohol and squeezed out. Be careful not to wipe away lubricants necessary for proper key functions. Allow the parts to air dry before reassembly.
- Use tweezers to remove any fibers or dirt in confined areas.

Cleaning the monitor

- Follow the safety precautions presented in [Service considerations on page 53](#) before cleaning the monitor.
- To clean the monitor, wipe the monitor screen with a towelette designed for cleaning monitors or a clean cloth moistened with water.

△ **CAUTION:** Do not use sprays or aerosols directly on the screen—the liquid might seep into the housing and damage a component.

Never use solvents or flammable liquids on the monitor because display or housing damage may result.

Cleaning the mouse

1. Follow the safety precautions presented in [Service considerations on page 53](#) before cleaning the mouse.
2. Remove the mouse ball from the housing by removing the retaining plate.
3. Clean the mouse ball.
4. Pull out any debris from the ball socket, and wipe the ball with a clean, dry cloth.
5. Reassemble the mouse.

