



International Commercial  
Supply Corporation, LLC

2007-2008 EDITION

Toll Free Phone: 800-243-1290  
Toll Free Fax: 800-253-8499  
International Fax: 860-738-7104  
Website: [www.icseparts.com](http://www.icseparts.com)





## COPYRIGHT AND TRADEMARK INFORMATION

THIS ENTIRE CATALOG, COPY, PART NUMBERS AND UNIQUE METHOD OF SHOWCASING PRODUCTS IS COPYRIGHT 2006 INTERNATIONAL COMMERCIAL SUPPLY CORPORATION, LLC. ALL RIGHTS RESERVED.

NO PORTION OF THIS CATALOG MAY BE REPRODUCED IN ANY FORM OR BY ANY MEANS, IN WHOLE OR IN PART, WITHOUT THE WRITTEN PERMISSION OF INTERNATIONAL COMMERCIAL SUPPLY CORPORATION, LLC

© 2006 INTERNATIONAL COMMERCIAL SUPPLY CORPORATION, LLC



IS A REGISTERED TRADEMARK OF INTERNATIONAL COMMERCIAL SUPPLY CORPORATION, LLC

COVER PHOTOGRAPHS CONNECTICUT - © GETTYIMAGES.COM

NEVADA - © GETTYIMAGES.COM

### LIMITED WARRANTY POLICY

NO WARRANTY IS OFFERED TO CONSUMERS, AS DEFINED IN THE MAGNUSON-MOSS WARRANTY ACT. ALL ITEMS SOLD ARE INTENDED FOR RESALE, BUSINESS USE OR EQUIPMENT MANUFACTURE AND WARRANTED AGAINST DEFECTS IN WORKMANSHIP OR MATERIALS ONLY TO THE EXTENT OF THE WARRANTY SUPPLIED BY THE MANUFACTURER.

EACH ITEM CARRIES THE FULL WARRANTY OF THE MANUFACTURER. INTERNATIONAL COMMERCIAL SUPPLY CORPORATION, LLC. ASSUMES NO OBLIGATION ON THE PART OF ANY MANUFACTURER EXCEPT TO PROCESS WARRANTY CLAIMS TO THE MANUFACTURER ON BEHALF OF OUR CUSTOMERS, INDIVIDUAL MANUFACTURER'S WARRANTY POLICIES WILL BE PROVIDED UPON REQUEST.

ILLUSTRATIONS AND DESCRIPTIONS ARE PROVIDED FOR IDENTIFICATION PURPOSES. WE TAKE NO RESPONSIBILITY THAT AN ITEM WILL SUIT A SPECIFIC PURPOSE. ANY LIABILITY CLAIM WILL BE LIMITED TO THE PURCHASE PRICE.

### IN CASE OF DAMAGE OR SHORTAGES IN TRANSIT VIA U.P.S.

UPON DELIVERY OF SHIPMENT, MERCHANDISE SHOULD BE CAREFULLY INSPECTED BY YOU FOR DAMAGES/SHORTAGES DURING SHIPMENT. IF YOU RECEIVE DAMAGED ITEMS, PLEASE FOLLOW THE PROCEDURE BELOW:

1. HOLD THE FOLLOWING ITEMS AT THE ORIGINAL DESTINATION FOR INSPECTION BY U.P.S.:
  - A. THE OUTSIDE CARTON
  - B. ALL INSIDE PACKING MATERIAL
  - C. ANY BROKEN ARTICLES
2. HAVE OUR SHIPPER NUMBER AND TRACING NUMBER LOCATED ON THE U.P.S. LABEL AVAILABLE FOR U.P.S. FROM CT SHIPPER #017055, FROM NV SHIPPER #8X5814.
3. CONTACT U.P.S. IN YOUR AREA TO REQUEST U.P.S. INSPECTION NO LATER THAN 24 HOURS OF RECEIPT OF PACKAGE.
4. OBTAIN AN LDI# (LOSS DAMAGE INSPECTION #) FROM U.P.S. AND REPORT IT TO US SO THAT A DAMAGE CLAIM MAY BE FILED.

FOR ASSISTANCE FOR CARRIERS OTHER THAN U.P.S., CALL 800-243-1290 OR 860-738-7112.

# TABLE OF CONTENTS

<b>INDEX - SPECIFIC USE ITEMS</b> .....	<b>i3 - i8</b>
<b>INDEX - MULTI-USE ITEMS</b> .....	<b>i9 - i15</b>
<b>BEVERAGE</b> .....	<b>1 - 29</b>
COFFEE MAKERS, DISPENSING EQUIPMENT	
<b>SANITATION</b> .....	<b>30 - 95</b>
BOOSTERS, DISHWASHERS, GLASS WASHERS, WASTE DISPOSERS	
<b>FRYERS, GREASE FILTERS, WATER COOKERS</b> .....	<b>96 - 160</b>
<b>GRILLS</b> .....	<b>161 - 242</b>
CHAR BROILERS, GRIDDLES, HOT DOG MACHINES, SKILLETTS, WAFFLE BAKER	
<b>OVENS, RANGES, BROILERS</b> .....	<b>243 - 375</b>
<b>PREPARATION</b> .....	<b>376 - 429</b>
BLENDERS, CAN OPENERS, CHOPPERS, CUTTERS, JUICERS, MIXERS, SHREDDERS, SLICERS	
<b>STEAMERS</b> .....	<b>430 - 501</b>
BOILERS, COOKERS, KETTLES	
<b>TOASTERS</b> .....	<b>502 - 535</b>
<b>WARMERS</b> .....	<b>536 - 600</b>
CHEESE MELTERS, FOOD WARMERS, POPCORN MACHINES	
<b>ELECTRICAL SUPPLIES</b> .....	<b>601 - 645</b>
<b>GAS SUPPLIES</b> .....	<b>646 - 692</b>
<b>HARDWARE, SERVICE SUPPLIES</b> .....	<b>693 - 712</b>
<b>PLUMBING SUPPLIES</b> .....	<b>713 - 760</b>
<b>REFRIGERATION</b> .....	<b>761 - 788</b>
<b>THERMOMETERS, GAUGES</b> .....	<b>789 - 794</b>
<b>TOOLS, CHEMICALS, LUBRICANTS</b> .....	<b>795 - 820</b>
<b>TECHNICAL INFORMATION</b> .....	<b>821 - 845</b>
<b>FUNCTIONAL REPLACEMENT CROSS REFERENCE</b> .....	<b>846 - 932</b>
<b>STOCK NUMBER TO PAGE INDEX</b> .....	<b>933 - 964</b>
<b>FORMS</b> .....	<b>965 - 969</b>
CUSTOM GASKET, CUSTOM SHELF, ORDER, CREDIT APPLICATION, PASSWORD REQUEST	

# SALES POLICY

- 1 POSSESSION OF THIS CATALOG DOES NOT OBLIGATE US TO ACCEPT A PURCHASE ORDER OR CONSTITUTE AN OFFER TO SELL. THIS CATALOG IS INTENDED FOR USE BY THE SERVICE TRADE.
- 2 MINIMUM ORDER IS \$10.00.
- 3 CHARGE ACCOUNTS MAY BE ESTABLISHED BY REQUESTING A CREDIT APPLICATION. CUSTOMERS WITHOUT APPROVED CREDIT MAY ARRANGE FOR PAYMENT WITH A CREDIT CARD, CHECK IN ADVANCE OR PAYMENT UPON DELIVERY.
- 4 A SIGNED RESALE CERTIFICATE OR TAX EXEMPT CERTIFICATE MUST BE PROVIDED OR APPLICABLE SALES TAXES MAY BE CHARGED. CUSTOMERS ARE RESPONSIBLE FOR ALL LOCAL, COUNTY, STATE OR FEDERAL TAXES DUE.
- 5 SHIPPING, HANDLING AND INSURANCE COSTS ARE PAYABLE BY THE CUSTOMER.
- 6 MANUFACTURERS PART NUMBERS ARE LISTED ONLY AS A GUIDE AND ARE NOT INTENDED TO IMPLY THAT THE ITEMS WE SUPPLY WERE PURCHASED FROM OR MADE FOR A PARTICULAR MANUFACTURER.

ALL PART NUMBERS SHOWN ARE FOR IDENTIFICATION AND REFERENCE PURPOSES ONLY.

MANUFACTURERS PART NUMBERS LISTED REPRESENT AN ACCUMULATION OF INFORMATION WE HAVE COMPILED FROM TRADE PUBLICATIONS, OTHER DISTRIBUTORS, CUSTOMERS AND OUR OWN INVESTIGATION. ALTHOUGH WE HAVE ATTEMPTED TO VERIFY THE ACCURACY OF THE INFORMATION, WE CANNOT GUARANTEE THAT THE CONTENTS ARE CORRECT.

- 7 RETURNED GOODS WILL NOT BE ACCEPTED UNLESS PRIOR APPROVAL IS ISSUED BY US AND MAY BE SUBJECT TO A RESTOCKING FEE. SPECIAL ORDERS ARE NOT RETURNABLE.

WE ACCEPT THESE CREDIT CARDS:





# International Commercial Supply Corporation, LLC

P.O. Box 999 \* 200 International Way \* Winchester Business Park

Winsted, Connecticut 06098

800-243-1290 \* (Fax) 800-253-8499

E-Mail - ICS@ICSCPARTS.COM

## ORDER FORM

PLEASE TYPE OR PRINT NEATLY

Date: \_\_\_\_\_

Ship Via: \_\_\_\_\_

Bill To

Ship To

\_\_\_\_\_  
 \_\_\_\_\_  
 \_\_\_\_\_  
 \_\_\_\_\_

\_\_\_\_\_  
 \_\_\_\_\_  
 \_\_\_\_\_  
 \_\_\_\_\_

Your Cust No.	Purchase Order Number	Your Phone Number	Your Name
---------------	-----------------------	-------------------	-----------

	Qty	Part Number	Description	Ea Price	Ext Price
1					
2					
3					
4					
5					
6					
7					
8					
9					
10					
11					
12					
13					
14					
15					

Comment: \_\_\_\_\_

# HOURS OF OPERATION

PHONE: 800-243-1290

FAX: 800-253-8499

E-MAIL: ICS@ICSPARTS.COM

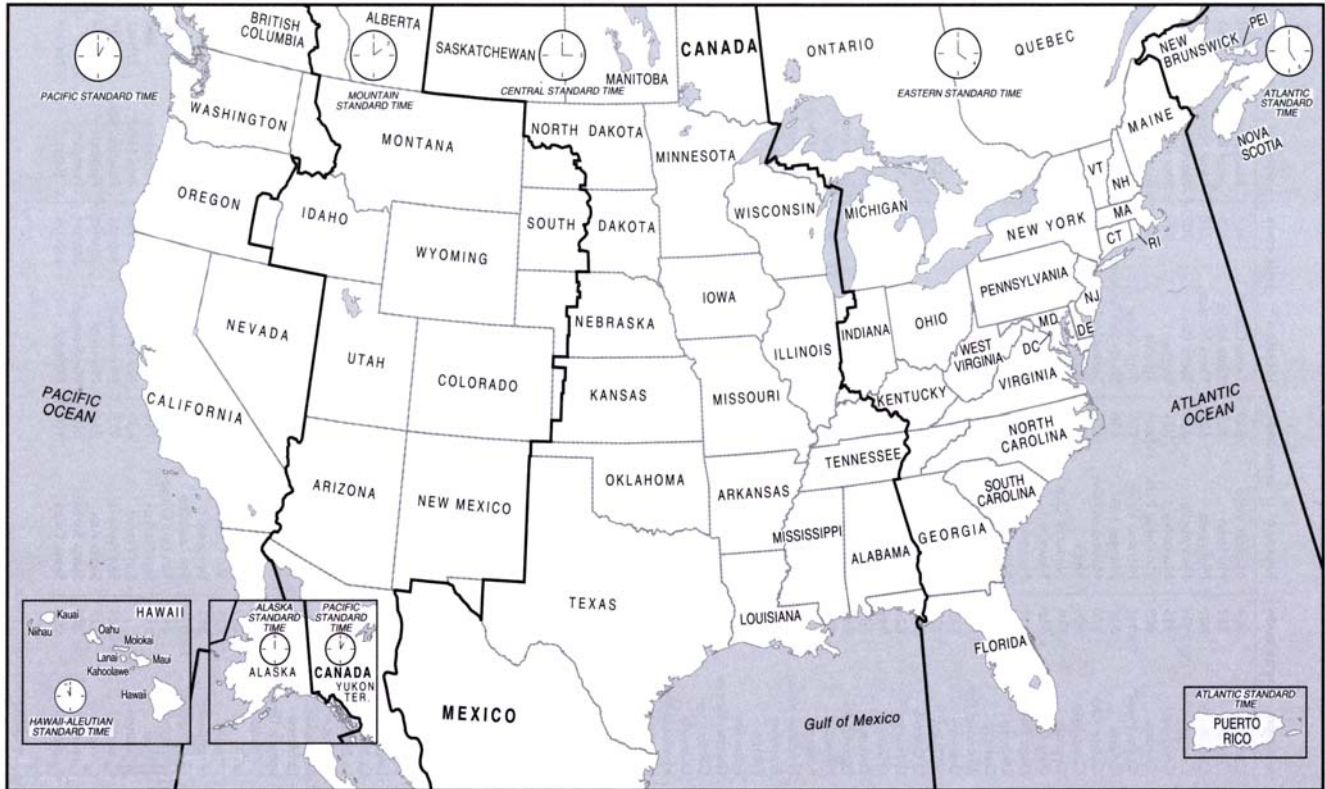

## EASTERN AND CENTRAL TIME ZONE:

SERVED BY WINSTED, CT. SALES AND DISTRIBUTION CENTER.

MONDAY THRU FRIDAY 8:00 AM - 5:45 PM EASTERN TIME.

(NOTE: FOR EMERGENCY ORDERS BETWEEN 5:45 - 7:00 PM EASTERN TIME,  
CONTACT OUR LAS VEGAS FACILITY AT 702-876-0667)

## MOUNTAIN AND PACIFIC TIME ZONE:

SERVED BY LAS VEGAS, NV. SALES AND DISTRIBUTION CENTER.

MONDAY THRU FRIDAY 7:00 AM - 4:30 PM PACIFIC TIME.



International Commercial Supply Corporation, LLC

P.O. Box 999 \* 200 International Way \* Winchester Business Park

Winsted, Connecticut 06098

860-738-7112 \* (Fax) 860-738-7140

E-Mail - ICS@ICSCPARTS.COM

CREDIT APPLICATION

PLEASE TYPE OR PRINT NEATLY

Date: \_\_\_\_\_

Company: \_\_\_\_\_

Address: \_\_\_\_\_

City, State, Zip: \_\_\_\_\_

Phone: ( \_\_\_\_\_ ) \_\_\_\_\_

Fax: ( \_\_\_\_\_ ) \_\_\_\_\_

E-MAIL: \_\_\_\_\_

WEBSITE: \_\_\_\_\_

Type Of Business: \_\_\_\_\_

Date Business Was Established: \_\_\_\_\_

Name Of Person Authorized To Approve Purchases And Payments: \_\_\_\_\_

Estimated Yearly Dollar Amount To Be Purchased: \_\_\_\_\_

TRADE REFERENCES

ACCOUNT No.	NAME	ADDRESS	FAX #
-------------	------	---------	-------

1 \_\_\_\_\_

City, St, Zip: \_\_\_\_\_

2 \_\_\_\_\_

City, St, Zip: \_\_\_\_\_

3 \_\_\_\_\_

City, St, Zip: \_\_\_\_\_

4 \_\_\_\_\_

City, St, Zip: \_\_\_\_\_

BANK REFERENCE(S)

ACCOUNT No.	NAME	ADDRESS	PHONE	FAX #
-------------	------	---------	-------	-------

City, St, Zip: \_\_\_\_\_

The information provided in this application is true and accurate. I authorize the bank named herein as reference to reveal normal credit information to International Commercial Supply Corp LLC for purposes of credit consideration.

Authorized Signature: \_\_\_\_\_ Title \_\_\_\_\_ Date: \_\_\_\_\_

# WARMERS

## QUICK REFERENCE TO MULTI-USE AND MANUFACTURERS

THIS PAGE IS A QUICK REFERENCE TO FIND PARTS FOR WARMERS AND HOT DOG DISPLAY BROILER EQUIPMENT, IT INCLUDES CHEESE MELTERS, COOK & HOLD CABINETS AND HOT FOOD WELLS.



MANUFACTURER INDEX	PAGE
ALTO SHAAM	539-542
APW (WYOTT)	543-547
ADCRAFT	548
ATLAS	548
CADCO	549-550
CARTER HOFFMANN	551-553
CECILWARE	553
CRESCOR	554-557
DELFIELD	558
DUKE	559-561
DUKE/THERMOTAINER	561
EAGLE	562
FWE (FOOD WARMING EQ)	563
GE/HOBART	564
GLENRAY(TOMLINSON)	565-566
HATCO	567-572
HENNY PENNY	573
HOLMAN	574
KEATING	574
LANG	574
MERCO	575-576
METRO	577-579
NEMCO	580
RANDELL	580
ROUND-UP (AJ ANTUNES)	581
SECO	582-583
STAR METAL	583
STAR MFG	584-586
TOASTMASTER	587-588
TOASTSWELL (STAR)	589
TOMLINSON	589-590
VOLLRATH/IDEA-MEDALIE	591-593
VULCAN HART	593
WELLS	594-599
WITTCO	600

### MULTI-USE INDEX

DESCRIPTION	PAGE	DESCRIPTION	PAGE
• BURNERS	668-669	• RING HEATERS	617
• DIALS	609	• ROCKER SWITCHES	635-637
• GAS VALVES	690	• SIGNAL LIGHTS	627-630
• HINGES	772-776	• SOLID HOT PLATE HEATERS	619
• INFINITE SWITCHES	619-621	• STEAM TABLE HEATERS	615-616
• INFRA-RED FOOD WARMERS	567	• STRIP HEATERS	618
• KNOBS	670	• THERMOMETERS	538
• LAMPS	622	• THERMOSTATS	537-538
• LATCHES	776-779	• TOGGLE SWITCHES	632-633
• LEGS	705-707		
• ORIFICES	680-682		



# WARMERS

## MULTI-USE THERMOSTATS



G-101



G-101A



G-101RS



G-200



G-413

G-432



G-412



A-248



A-246



A-1552



A-1553

### SINGLE POLE THERMOSTATS AND DIALS

STOCK No.	STYLE	TEMP. RANGE	BULB	CAPILLARY	COMMENTS	DIAL ONLY
G-101	TB	60-250°F	3/8" X 4-1/2"	36"	WITH 60-250°F DIAL	A-248
G-101A				48"	WITH 1-10 DIAL	A-246
G-101RS	EA		48"	WITH 60-250°F DIAL	A-248	
G-200	SP		5/16" X 6-1/8"		60"	A-1552
G-432	EA		3/8" X 4-1/2"		72"	
G-412	SP	100-200°F	1/4" X 12-1/2"	36"	WITH 100-200°F DIAL	A-1553
G-413			3/8" X 5-5/8"	60"		



G-164A



G-164RS



G-379



A-246



A-252

### SINGLE POLE THERMOSTATS AND DIALS

DESIGNED TO SENSE AIR TEMPERATURE FOR APPLICATIONS WHERE SENSING BULB IS MOUNTED UNDER THE WARMING PAN

STOCK No.	STYLE	TEMP. RANGE	BULB	CAPILLARY	COMMENTS	DIAL ONLY
G-164A	TB	175-550°F	3/16" X 11-5/8"	60"	WITH 1-10 DIAL	A-246
G-164RS	S	175-550°F	3/16" X 11-5/8"	60"	WITH 200-550°F DIAL	A-252
G-379	K	100-550°F	1/4" X 5-5/8"	36"	WITH 1-10 DIAL	A-246

WARMERS

# WARMERS

## MULTI-USE THERMOSTATS, THERMOMETERS



G-116



G-166A



A-248



A-246

### DOUBLE POLE THERMOSTATS AND DIALS

STOCK No.	STYLE	TEMP. RANGE	BULB	CAPILLARY	COMMENTS	DIAL ONLY
G-116	D1/D18	60-250°F	3/8" X 4-1/2"	60"	WITH DIAL 3/8" STUFFING BOX	A-248
G-166A		100-550°F	3/16" X 13"		WITH 1-10 DIAL	A-246

NOTE: USE G-116 FOR WATER APPLICATIONS, USE G-166A FOR AIR APPLICATIONS



G-321



G-366



H-1129



A-248

### GAS THERMOSTATS AND DIAL

STOCK No.	STYLE	TEMP. RANGE	BULB	CAPILLARY	PIPE SIZE	COMMENTS	DIAL ONLY
G-321	BJWA	100-200°F	3/16" X 12"	36"	7/16" REAR	WITH DIAL 3/8" STUFFING BOX	-
G-366	GS	60-250°F	3/8" X 4-1/2"	60"	3/8"	3/8" STUFFING BOX	A-248
H-1129	710	100-250°F	1/4" X 2-1/2"	36"	3/8"	USED ON CATERING TRUCKS	-



J-128



J-129



J-131

### THERMOMETERS

STOCK No.	TEMP. RANGE	SIZE	CAPILLARY	DESCRIPTION
J-128	40-240°F	2" DIAL - 3" FLANGE	48"	FRONT FLANGE MOUNT
J-129		2" DIAL - 3-1/2" FLANGE		REAR FLANGE MOUNT
J-131	(-40)-450°F	2" DIAL - 3" FLANGE	39"	FRONT FLANGE MOUNT ELECTRONIC LCD DISPLAY

# WARMERS/OVENS

## ALTO-SHAAM SPECIFIC PARTS

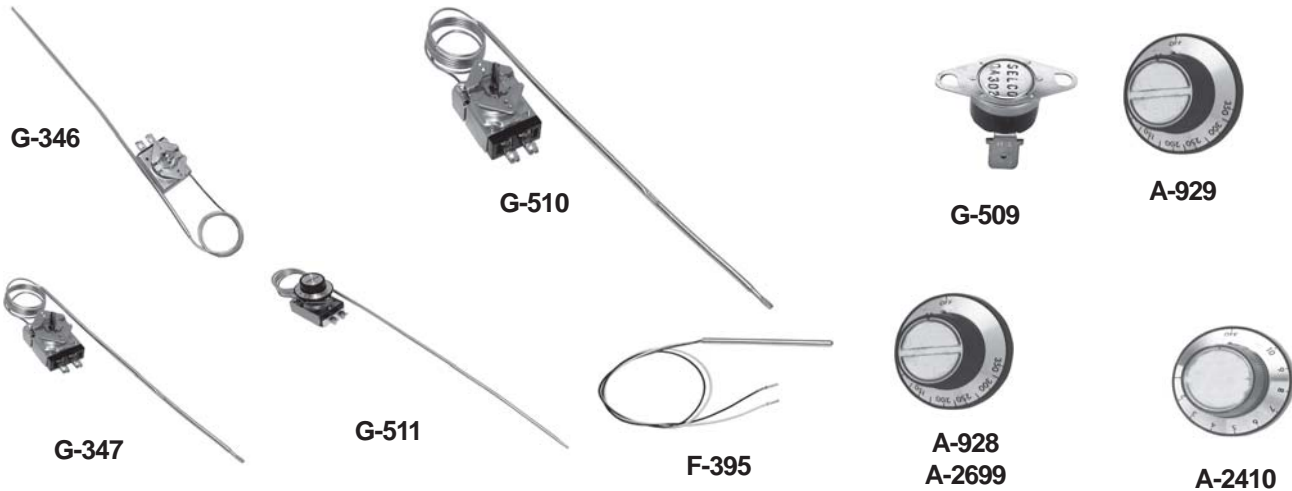

### CONTROL RELATED PARTS

STOCK No.	TYPE	RANGE	REPLACES	DESCRIPTION	MODELS
G-346	B10	60°-200°F	TT-3057	HOLD THERMOSTAT	COOK/HOLD OVENS
G-347	S	100°-350°F	TT-3329	COOK THERMOSTAT	
G-510	S	100°-450°F	TT-3498	THERMOSTAT	300-HFT/CB, 300-TMC
G-511	B10	60°-250°F	TT-3978	THERMOSTAT	100-HSL/C-LUX, 300-HST
G-509	-	RESET	TT-3859	HI LIMIT	500-ID
F-395	-	-	14785	SENSOR PROBE	TH-III SERIES

DIAL ONLY
A-928
A-929
A-2410
A-2699



### SWITCHES

STOCK No.	SPECIFICATIONS	REPLACES	COMMENTS
E-344	16A, 125/250V, SPST	SW-3409	FOR MODELS 100-PC, 200-CT, 500-1D, 500-2D, 500-3A
E-292	20A, 250V, DPST	SW-3040	USED BEFORE 1985 FOR MODELS 500-TH, 750-TH, 1000-TH-1, TH-11, 750-B/TRP
E-345	20A, 250V, DPST	SW-3528	FOR MODELS 500-TH, 750-TH, 1000-TH-1, 1000-TH-11, 767-SK
E-113	10A, 250V, SPST	SW-3041	FOR MODELS 100-HSL, HSL/CBD, 200-SWL, 300-HFT, 300-SB
E-115	10A, 250V, DPDT-CTR-OFF	SW-3616	FOR ALL DELI CASES

WARMERS



# WARMERS/OVENS

## ALTO-SHAAM SPECIFIC PARTS

NOTE: ONE KIT IS  
NEEDED PER  
CAVITY.



C-622  
C-623  
C-843



C-844  
C-1167

### CARTRIDGE HEATERS AND CABLE HEATING KITS

STOCK No.	SPECIFICATIONS	REPLACES	COMMENTS
C-622	210' OF HEATER WIRE AND ALL HARDWARE NEEDED FOR INSTALLATION (WIRE IS CREAM OR TAN COLOR)	4881	HIGH TEMP HEATER CABLE KIT FOR MODELS 750-TH-11, 750-TH-11/D, 767-SK, 1000-TH-1 (SERIES), 1000-TH-11-SPLIT, 1000-TH-11/D-SPLIT, AS-2000
C-623	134' OF HEATER WIRE AND ALL HARDWARE NEEDED FOR INSTALLATION (WIRE IS CREAM OR TAN COLOR)	4880	HIGH TEMP HEATER CABLE KIT FOR MODELS 500-TH-11, 500-TH-11/D, 750-TH-11, 750-TH-11/D, 767-SK, 1000-TH-1 (SERIES), 1000-TH-11-SPLIT, 1000-TH-11/D-SPLIT, AS-2000
C-843	106' OF HEATER WIRE AND ALL HARDWARE NEEDED FOR INSTALLATION (WIRE IS SILVER METALIC COLOR)	4874	LOW TEMP HEATER CABLE KIT FOR MODELS 500-1D, 500-2D, 500-3D, 500-S, 500-PH, 500-PH/GD, 750-S, 1000-S, 1000-UP, 1000-UPS
C-1167	120V CARTRIDGE HEATER	CB-3537	FOR MODEL 767SK, CHS76
C-844	240V CARTRIDGE HEATER	CB-3538	FOR MODEL 767SK



\*E-258  
\*E-529



A-1462



A-1638



M-164



A-1695



M-165

### TIMERS AND FAN MOTORS

STOCK No.	SPECIFICATIONS	REPLACES	COMMENTS
*E-258	240 VOLT	TR-3318	12 HOUR TIMER FOR COOK/HOLD OVENS
*E-529	120 VOLT	TR-3504	
A-1462	-	KN-3765	KNOB ONLY FOR E-258, E-529
A-1638	-	PA-3766	FACE PLATE ONLY FOR E-258 AND E-529
M-164	230 VOLT	FA-3342	FAN MOTOR FOR 500-TH-11, 750-TH-11, 767-SK, 1000-TH-11
A-1695	3"	FA-3343	FAN BLADE FOR 500-TH-11, 750-TH-11, 767-SK, 1000-TH-11
M-165	115 VOLT	FA-3485	FAN MOTOR FOR 767-SK, 500-1D, 500-2D, 500-3D, 500-E, COOK-HOLD-115V UNITS

\* FACE PLATE NOT INCLUDED.

# WARMERS/OVENS

## ALTO-SHAAM SPECIFIC PARTS



D-105



D-193



D-277



D-167



D-125



D-252



L-278



L-263

## SIGNAL LIGHTS AND WIRING COMPONENTS

STOCK No.	SPECIFICATIONS	REPLACES	DESCRIPTION	MODELS
D-105	1/2" HOLE, 250V RED	LI-3025	SIGNAL LIGHT	ALL 208-240V UNITS
D-193	1/2" HOLE, 120V RED	LI-3027		ALL 115V UNITS
D-277	RECTANGLE, 120V RED	LI-3493		767-SK, HOLDING CABINETS
D-167	RECTANGLE, 250V AMBER/RED	LI-3024		1000-TH, 750-B/TRP
D-125	SC-15	FU-3298	FUSE	-
D-252	3 POLE	BK-3019	TERMINAL BLOCK	-
L-278	6 FT	CD-3029	CORD SET	HOLDING UNITS 125V
L-263	15A-125V	IT-3001	FLANGED INLET	500S, 750S, 1000S



A-1022



A-1023



A-1024



A-1198



A-2404



A-1189

## DOOR HARDWARE

STOCK No.	SPECIFICATIONS	REPLACES	COMMENTS
A-1022	4-1/2" OUTSIDE SCREW CENTERS	HD-2007	HANDLE WITH STRIKE FOR COOK/HOLD OVENS
A-1023	5-7/8" OUTSIDE SCREW CENTERS	HD-2566	MAGNETIC HANDLE FOR COOK/HOLD OVENS
A-1024	1-1/8" OFFSET	HG-2014	HINGE FOR COOK/HOLD OVENS
A-1198	7/8" OFFSET, CAM LIFT	HG-2535	HINGE FOR MODEL 1000-UP, 1000-S
A-2404	-	LT-2040	BALL CATCH FOR MODELS 500-PH, 500-PH/GD, 750-B/TRP
A-1189	5/8" OFFSET	HG-2015	HINGE FOR COOK AND HOLD OVENS

WARMERS

# WARMERS/OVENS

## ALTO-SHAAM SPECIFIC PARTS



### DOOR GASKET AND GAUGE THERMOMETERS

STOCK No.	SPECIFICATIONS	REPLACES	COMMENTS
B-424	10 FT LENGTH	GS-2398	GRAY DOOR GASKET
B-424-1	CUT TO LENGTH	GS-2398	GRAY DOOR GASKET
J-147	100-350°F	GU-33384	GAUGE FOR COOK/HOLD OVENS
J-174	70-220°F	GU-3273	GAUGE FOR COOK/HOLD OVENS



B-774  
B-775  
B-776  
B-777

### FORMED DOOR GASKETS

STOCK No.	SIZE	REPLACES	MODELS
B-774	21-3/8" X 15"	GS-23790	500-S, AFTER S/N 5918-00
B-775	21-1/8" X 23"	GS-23778	750-S, AFTER S/N 5885-00
B-776	19-1/2" X 28-1/2"	GS-23794	1000-S, AFTER S/N 5876-00
B-777	22" X 30-1/2"	GS-23796	1000-UP/VS1-VPS/SR, AFTER S/N 5932-00



B-778

### DOOR WINDOW GASKET

STOCK No.	REPLACES	DESCRIPTION
B-778	GS-2721	CUT TO LENGTH



A-3112

### CASTER

STOCK No.	REPLACES	DESCRIPTION
A-3112	CS-2026	5" WHEEL WITH BRAKE



A-2406



A-2405



A-2403



A-2902

### DRAWER COMPONENTS

STOCK No.	SPECIFICATIONS	REPLACES	COMMENTS
A-2406	(SET OF 2) 21-5/8" LONG	5331	DRAWER RAILS FOR MODEL 500-1D, 500-2D, 500-3D
A-2405	29/32" OD WITH 1/4"-20 STUD	BG-2410	BEARING FOR MODEL 500-1D, 500-2D, 500-3D
A-2403	1/4"-20	NU-2187	ACORN NUT FOR MODEL 500-1D, 500-2D, 500-3D
A-2902	-	PN-2123	DRAWER PAN



# HOT DOG DISPLAY BROILER

A P W / WYOTT SPECIFIC PARTS FOR MODELS DR-1A, DR-2A

E-671  
E-672



A-2113

## INFINITE CONTROLS AND DIAL

STOCK No.	SPECIFICATIONS	REPLACES	COMMENTS
E-671	120V - 13 AMP	55564-EGO	INFINITE CONTROL
E-672	240V - 13 AMP	87053-EGO	
A-2113	-	55825	DIAL FOR E-671, E-672



E-470



D-250



D-240



E-841

## SWITCHES AND LIGHTS

STOCK No.	SPECIFICATIONS	REPLACES	COMMENTS
E-470	16 AMP DPST	89406	ON-OFF LIGHTED ROCKER
D-250	-	55682	INDICATOR LIGHT
D-240	120V - 40 WATT	75916	LIGHT BULB
E-841	20A DPST	89491	ON-OFF ROCKER

M-289



## CONVEYOR MOTOR

STOCK No.	SPECIFICATIONS	REPLACES	COMMENTS
M-289	120 VOLT	48609300	DRIVE MOTOR

WARMERS

# WARMERS

## A P W DROP-IN HOT FOOD WELLS



### INSULATED TOP MOUNT-DROP-IN EZ-LOCK WELL 21-3/4" X 13-3/4" OPENING

STOCK No.	VOLTS	WATTS	COMMENTS
C-1185	120	1500	WITH 1/2" FPT DRAIN
C-1186	208/240	1200/1600	

NOTE: THERMOSTAT CAN BE MOUNTED UP TO 24" FROM HOT FOOD WELL.



### 20-3/8" X 12-3/8" OPENING TOP MOUNT-DROP-IN EZ-LOCK WELLS

STOCK No.	VOLTS	WATTS	COMMENTS
C-1029	120	1200	3/4" FLANGE - NO DRAIN
C-1030			3/4" FLANGE - WITH 1/2" FPT DRAIN
C-1031	208/240	1200/1600	3/4" FLANGE - NO DRAIN
C-1032			3/4" FLANGE - WITH 1/2" FPT DRAIN

NOTE: THERMOSTAT CAN BE MOUNTED UP TO 24" FROM HOT FOOD WELL.



### ROUND DROP-IN EZ-LOCK SOUP WELLS - NO DRAIN

STOCK No.	SIZE/CAPACITY	VOLTS	WATTS	FITS OPENING
C-1021	8-1/2" - 7 QT.	120	800	8-3/4"
C-1022		208/240	500/660	
C-1023	10-1/2" - 11 QT.	120	800	10-3/4"
C-1024		208/240	500/660	

NOTE: THERMOSTAT CAN BE MOUNTED UP TO 24" FROM HOT FOOD WELL.



### ROUND DROP-IN EZ-LOCK SOUP WELLS - WITH 1/2" FPT DRAIN

STOCK No.	SIZE/CAPACITY	VOLTS	WATTS	FITS OPENING
C-1025	8-1/2" - 7 QT.	120	800	8-3/4"
C-1027	10-1/2" - 11 QT.	120	800	10-3/4"
C-1028		208/240	500/660	

NOTE: THERMOSTAT CAN BE MOUNTED UP TO 24" FROM HOT FOOD WELL.

# WARMERS

## A P W HOT FOOD WARMERS

### 120V COUNTER TOP FOOD WARMER

STOCK No.	SIZE	WATTS	AMPS	COMMENT
C-1176	12" X 20" PAN	1200	10	WET OR DRY OPERATION

COMES WITH 120V CORD AND PLUG



### 19-7/8" X 11-7/8" OPENING - BOTTOM MOUNT - ROUND CORNER WELLS

STOCK No.	VOLTS	WATTS	COMMENTS
C-1033	120	1200	NO DRAIN
C-1034			1/2" FPT DRAIN
C-1035	208/240	1200/1600	NO DRAIN
C-1036			1/2" FPT DRAIN

NOTE: THERMOSTAT CAN BE MOUNTED UP TO 24" FROM HOT FOOD WELL.



### 19-7/8" X 11-7/8" OPENING - BOTTOM MOUNT - SQUARE CORNER WELLS

STOCK No.	VOLTS	WATTS	COMMENTS
C-1037	120	1200	NO DRAIN
C-1038			1/2" FPT DRAIN
C-1039	208/240	1200/1600	NO DRAIN
C-1040			1/2" FPT DRAIN

NOTE: THERMOSTAT CAN BE MOUNTED UP TO 24" FROM HOT FOOD WELL.

WARMERS



# WARMERS

## A P W SPECIFIC PARTS



G-322



G-429



G-606



A-2431



A-2904



A-3274



A-2113



A-2433



E-671  
E-672



G-514



A-3313



G-512



D-250



D-291

CONTROL COMPONENT PARTS			
STOCK No.	SPECIFICATIONS	REPLACES	DESCRIPTION
G-322	100-550°F 1/4" X 5-1/2" BULB	56540	THERMOSTAT
G-429	100-450°F 1/4" X 5-3/16" BULB	60320	
G-606	100-200°F 3/8" X 5-1/2" BULB	69120	
A-2431	1-10	56505	THERMOSTAT DIAL
A-2904	OFF-100-200°F	56577	
A-2433	100-450°F	60321	
A-3274	100-500°F	60352	
E-671	120V 2 SCREW MOUNT	55564-EGO	INFINITE CONTROL
E-672	240V 2 SCREW MOUNT	87053-EGO	
A-2113	LO-2-6-HI	55825	INFINITE DIAL
G-514	200°F BIMET	69138	THERMOSTAT
A-3313	1-1/8" DIA	87146	KNOB FOR G-514
G-512	345°F BIMET	69106	LIMIT THERMOSTAT
D-250	250V, SIDE MOUNTED	55682	SIGNAL LIGHT
D-291	250V, AMBER 1/2" HOLE	56530	



A-2415



A-2439



A-3862



A-3863



A-3864



A-3493

MECHANICAL COMPONENT PARTS			
STOCK No.	SPECIFICATIONS	REPLACES	DESCRIPTION
A-2415	1" OD FITS 1/2" DRAIN	56655	DRAIN STRAINER
A-2439	3/4" DIA. X 9/16" HIGH	55768	FOOT
A-3862	9" X 14"	55567	REFLECTOR PAN
A-3863	9-1/2" X 17"	55608	BOTTOM COVER
A-3864	9" X 14"	56547	INSULATION
A-3493	1-1/8" DIA	33858	DRAWER SLIDE ROLLER

# WARMERS

## A P W SPECIFIC PARTS



E-143



E-671  
E-672



A-2113

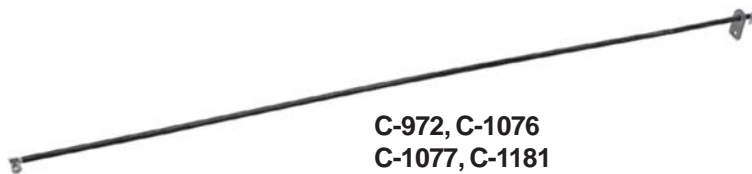

C-972, C-1076  
C-1077, C-1181  
C-1182, C-1183  
C-1184, C-1251  
C-1271, C-1283

### MODEL FD OVERHEAD FOOD WARMERS

STOCK No.	SPECIFICATIONS	REPLACES	COMMENTS
E-143	DPDT (ON/ON)	67005	TOGGLE SWITCH
E-671	120V 13 AMP	55564-EGO	INFINITE HEAT SWITCH
E-672	240V 13 AMP	87053-EGO	
A-2113	-	55825	DIAL FOR E-671, E-672
C-972	120V 575W	75461	ELEMENT FOR 24" UNIT
C-1181	208V 575W	75813	
C-1076	120V 920W	75803	ELEMENT FOR 36" UNIT
C-1182	208V 920W	75804	
C-1183	240V 920W	75805	
C-1077	120V 1265W	75806	ELEMENT FOR 48" UNIT
C-1251	208V 1265W	75807	
C-1184	120V 1600W	75817	ELEMENT FOR 60" UNIT
C-1271	208V 1610W	75809	
C-1283	240V 1980W	75812	ELEMENT FOR 72" UNIT

### HEATING ELEMENTS

STOCK No.	SPECIFICATIONS	REPLACES
C-649	120V-750W 7-1/2" X 16"	55445
C-650	120V-1200W 7-1/2" X 16"	55446
C-651	240V-1600W 7-1/2" X 16"	55441
C-670	277V-1600W 7-1/2" X 16"	55440
C-855	115V-1500W 7-1/2" X 16"	56322
C-852	208V-1600W 6-1/4" X 16"	54051
C-853	120V-500W 6-1/2" X 8-1/2"	55959
C-916	120V-800W 6-1/2" X 8-1/2"	55960
C-971	240V-800W 6-1/4" X 8-1/2"	55962
C-854	240V-660W 6-1/2" X 8-1/2"	55964
C-314	120V-500W 6-19/32" DIA	56602
C-856	120V-1250W 6" DIA	63411
C-970	120V-450W 22-1/4" X 8"	54018
C-1252	120V-400W 1-3/4" X 20-1/2"	56843



C-649, C-650, C-651,  
C-670, C-852, C-855



C-853, C-854  
C-916, C-971



C-314



C-856



C-970



C-1252

WARMERS

# WARMERS

## ADCRAFT AND ATLAS SPECIFIC PARTS

### ADCRAFT



G-687



A-3533



G-688



C-650

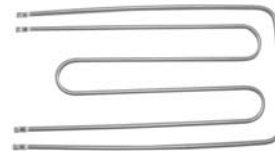

C-1284



D-105

### MODEL FW1200W FOOD WARMER PARTS

STOCK No.	DESCRIPTION	COMMENTS
G-687	THERMOSTAT	EGO - 1/4" X 4" BULB
A-3533	DIAL	OFF-WARM-HOLD
G-688	HI LIMIT	OVAL MOUNT
*C-650	ELEMENT 1 PC (O/S)	120V 1200W - 16" X 7-1/2"
*C-1284	ELEMENT 2 PC (N/S)	120V 750W EACH ELEMENT
D-105	SIGNAL LIGHT	120V

\*NOTE: C-650 IS USED BEFORE DATE CODE 10/04.  
C-1284 IS USED AFTER DATE CODE 10/04.

### ATLAS



G-378



A-1403



D-101

C-1059  
C-1060  
C-1061  
C-1119



### ELECTRICAL COMPONENTS

STOCK No.	SPECIFICATIONS	REPLACES	COMMENTS
G-378	STYLE K	1096	THERMOSTAT
A-1403	-	1097	DIAL FOR G-378
D-101	RED LENS	1099	SIGNAL LIGHT
C-1059	208V 850W	1054	HEATING ELEMENT
C-1060	240V 850W	1055	
C-1061	120V 1000W	1056	
C-1119	208V 1000W	1058	



# WARMERS

## CADCO SPECIFIC PARTS



E-707



A-3320



C-1080



D-372



D-373



A-3321

MODEL VSK-1 COMPONENT PARTS		
STOCK No.	REPLACES	DESCRIPTION
E-707	VS-703	120V INFINITE HEAT SWITCH
A-3320	VS-706	DIAL FOR E-707
C-1080	VS-707	120V 600W HEATING ELEMENT
D-372	VS-704	120V SIGNAL LIGHT
D-373	VS-702	FUSE
A-3321	VS-701	STAINLESS LINER
A-3645	VS-709	ALUMINUM WELL
A-4160	VS-700	S/S COVER LID



A-3645



A-4160

WARMERS



G-712



A-3549



G-713

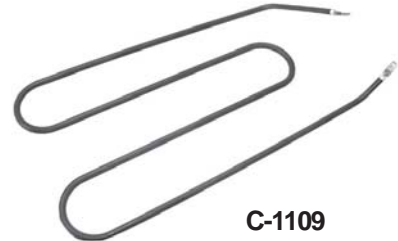

C-1109



E-779



D-381



H-1252



B-825

MODEL TS-9000 COMPONENT PARTS		
STOCK No.	REPLACES	DESCRIPTION
G-712	9037	THERMOSTAT
A-3549	9038	THERMOSTAT DIAL FOR G-712
G-713	9013	SAFETY THERMOSTAT
C-1109	9026	120V 1200W HEATING ELEMENT
E-779	9032	20A ROCKER SWITCH
D-381	9035	SIGNAL LIGHT
H-1252	9023	1/2" MPT FAUCET
B-825	9022	FAUCET SEAL

# WARMERS

## CADCO SPECIFIC PARTS



G-747



A-3931



C-1178



C-1179

### BUFFET RANGE WARMER PARTS

STOCK No.	REPLACES	DESCRIPTION	MODELS
G-747	BRS-117	THERMOSTAT	BRC-S1, BRC-D1
A-3931	BRS-114	KNOB FOR THERMOSTAT	-
C-1178	BRD-203	120V, 825W ELEMENT ASSY	BRC-D1
C-1179	BRS-112	120V, 1100W ELEMENT ASSY	BRC-S1



G-748



A-3931

### WARMING TRAY PARTS

STOCK No.	REPLACES	DESCRIPTION
G-748	THWT	THERMOSTAT
A-3931	BRS-114	KNOB FOR THERMOSTAT



### WARMING CONTROL

STOCK No.	REPLACES	DESCRIPTION
G-764	PROBE	THERMOSTAT WITH 120V CORD

# WARMERS

## CARTER HOFFMANN SPECIFIC PARTS



G-543



G-564  
G-518



G-517



A-2472



A-2473



G-516



G-717

## CONTROL COMPONENT PARTS

STOCK No.	DESCRIPTION	REPLACES	MODELS
G-543	THERMOSTAT	18600-0010	FH80, TH-U, TH15, SH15, PH913, FS-DMCH
G-564		18600-0016	FH90
G-518		18600-0070	CC, BC-SERIES
G-517	TEMP CONTROL BOARD	18616-0100	TH40, TH60
A-2472	DIAL FOR G-543 & G-518	18608-0010	FH80, TH-U, TH15, PH913, CC, BC-SERIES, FS-DMCH
A-2473	DIAL FOR G-564	18608-0013	FH90
G-516	HIGH LIMIT	18600-0046	TH-U, FS-DMCH
G-717	HIGH LIMIT 400°F	18600-0053	FH90



E-113



E-324



D-296  
D-297

## SWITCHES AND SIGNAL LIGHTS

STOCK No.	DESCRIPTION	REPLACES	MODELS
E-113	TOGGLE SWITCH	18602-0030	FH80, CC, BC-SERIES, FS-DMCH
E-324	LIGHTED ROCKER SWITCH	18602-0056	TH15, CC, BC-SERIES
D-296	120V WHITE SIGNAL LIGHT	18601-0070	FH90, FH80, SH15, TH15, TH-U
D-297	240V WHITE SIGNAL LIGHT	18601-0080	FH80, TH15, SH15, TH-U

WARMERS

# WARMERS

## CARTER HOFFMANN SPECIFIC PARTS



C-866



C-1078



C-863

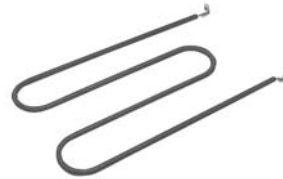

C-670



C-864

### HEATING ELEMENTS

STOCK No.	SPECIFICATIONS	REPLACES	MODELS
C-866	120V 1500W	16090-1528	TH-U, SH15
C-1078	120V 1500W	16090-1531	TH15
C-863	120V 1500W	18612-0210	FH80, NCW105
C-670	277V 1600W	18612-0260	CC, BC-SERIES
C-864	120V 1600W	18612-0261	FH90



M-214



A-3932



M-216



A-2470



A-2471



M-212  
M-213

### FAN MOTORS, COOLING FANS AND BLADES

STOCK No.	DESCRIPTION	REPLACES	MODELS
M-214	120V FAN MOTOR	18603-0025	FH80
A-3932	4" DIA. FAN BLADE	18603-5017	
M-216	120V/240V FAN MOTOR	18614-0360	TH40, TH60, SH15, TH15, FH90, TH-U
A-2470	4" DIA. FAN BLADE	18603-5090	PIE CABINETS ONLY
A-2471	3-3/4" DIA. BLOWER FAN	18614-0321	TH40, TH60, SH15, TH15, FH90, TH-U
M-212	120V COOLING FAN	18614-0314	TH15, TH-U
M-213	240V COOLING FAN	18614-0315	TH15, TH-U, TH40, TH60



# WARMERS

CARTER HOFFMANN AND CECILWARE SPECIFIC PARTS

## CARTER HOFFMANN



LATCHES, HINGE, THERMOMETER, GASKETS			
STOCK No.	DESCRIPTION	REPLACES	MODELS
A-1214	10-1/2" LATCH	18302-0040	CABINET
A-2474	SLIDE HATCH	18302-0332	CD252H, CD260H
A-1193	5" HINGE	18304-0030	-
J-157	20-220°F, 2" DIAL	18616-0015	FS-H, TH15, TH-U
B-783	14-11/16" X 47-3/4" DOOR GASKET	17020-2090	PH1200, PH1225, PH1250
B-893	23" X 59" DOOR GASKET	17020-2048	PH-1830
B-1013	23-1/2" X 59-1/2" DOOR GASKET	17020-2034	PH-1825
B-837	SOLDBYTHEFOOT DOOR GASKET	29034-0270	CABINET

## CECILWARE/CORY



CECILWARE/CORY QUARTZ ELEMENTS, SOCKET AND DIAL					
STOCK No.	COMMENTS	VOLTAGE	WATTAGE	REPLACES	MODELS
C-243	22" (1/4" MALE TERMINALS)	120V	575W	G133A	FW, FFW
C-246	34" (1/4" MALE TERMINALS)	120V	750W	G138A	
C-247		208V		G139A	
C-944	34" - SNAP-IN TERMINALS	120V	900W	G304A	
C-249	46" (1/4" MALE TERMINALS)			G143A	
C-250		208V	G144A		
C-945	46" - SNAP-IN TERMINALS	120V	1000W	G305A	
D-231	SOCKET FOR SNAP-IN UNITS	-	-	-	-
C-252	19-1/4" (1/4" MALE TERMINALS)	120V	575W	G132A	FFW575
C-979	31-1/2" (1/4" MALE TERMINALS)	208V	900W	G191A	CM36Q
C-980		240V		G192A	
A-4145	DIAL (1-10)	-	-	M008A	FW-20, HW7-11

NOTE: LENGTHS ARE APPROXIMATE.

WARMERS

# WARMERS

## CRES-COR SPECIFIC PARTS



G-364



G-394



A-3619



A-1728



A-1379



G-776



A-3620



F-419

### CONTROL COMPONENTS

STOCK No.	DESCRIPTION	REPLACES
G-364	MECHANICAL THERMOSTAT KIT	0848-062-K-KIT
G-776	MECHANICAL THERMOSTAT ONLY	0848-062-K
G-394	SOLID STATE THERMOSTAT	0848-008-ACK
A-3619	KNOB AND HARDWARE KIT FOR G-394	-
A-1728	DIAL FOR G-364 OLD STYLE	0595-002
A-1379	KNOB FOR G-394	0595-061
A-3620	LABEL ONLY FOR G-394	0595-064
F-419	TEMP PROBE FOR G-394	0848-008-3



C-544



C-546  
C-547  
C-548



C-720



C-722



C-1192

### HEATING ELEMENTS

STOCK No.	VOLTS	WATTS	DESCRIPTION	REPLACES	FOR MODELS
C-544	120	1000	RESERVOIR ELEMENT	0811-005-K	120 & 121 SERIES PROOFERS
C-546	120	2000	HOT CABINET ELEMENT	0811-022-K	H130, H131, H137 & H138
C-547	240			0811-023-K	
C-548	120	1470		0811-019-K	H133 SERIES
C-720	120	900	AUXILLARY AIR HEATER	0811-229-K	PHU1874718
C-722	120	300	INSULATED WALL / BASE HEATERS	0811-066-K	H339, H349, H2339, H83112, HK139, IFW69STH2, IFW80STH2
C-1192	120	960	HEATING ELEMENT	0811-214-K	PHU1874735, PHU1874744

# WARMERS

## CRES-COR SPECIFIC PARTS



L-268



L-313



L-314

## ELECTRICAL SUPPLY COMPONENTS

STOCK No.	SPECIFICATIONS	REPLACES	MODELS
L-268	2 POLE, 3 WIRE, 15A 125V, TWIST-LOCK	0713-011	R171, HJ, HJR, H339, 133, 1939 HU AND PROOFER SERIES
L-313	14/3, 15A 125V CORD SET	0810-031-1	
L-314	12/3, 20A 125V CORD SET	0810-065-1	130, 131, H137, H138, 120PH, 120CF



## BLOWER ASSEMBLIES

STOCK No.	SPECIFICATIONS	REPLACES	MODELS
M-135	120V	0769-005-K	HJ, HJR, 120V HOT UNITS
M-174	240V	0769-006-K1	HJ, HJR, 240V HOT UNITS
M-359		0769-069-K	CXO



E-373  
E-374



E-345



E-376



E-378



E-670



E-131A

## TIMERS AND SWITCHES

STOCK No.	SPECIFICATIONS	REPLACES	MODELS
E-373	120V 18HR TIMER	0849-008-K	ALL 120V UNITS
E-374	240V 18 HR TIMER	0849-009-K	ALL 240V UNITS
E-345	SWITCH, DPST, 20A	0808-020	747-29, 30, 32, 33, HJ, HJR
E-376	SWITCH, SPDT, 20A	0808-082	747-18
E-378	LIGHTED SWITCH, 20A	0808-103-1	H339, 747-36, PROBE OVENS 747-35
E-670	LIGHTED SWITCH KIT, 20A	0808-113-K	H339
E-131A	SWITCH - 20A	0808-116-K	B SERIES - BOTTOM MOUNT UNITS

WARMERS

# WARMERS

## CRES-COR SPECIFIC PARTS



<b>SIGNAL LIGHTS</b>			
STOCK No.	SPECIFICATIONS	REPLACES	MODELS
D-235	120V AMBER	0766-048	ALL HOT AND PROOF UNITS
D-236	240V AMBER	0766-045	
D-237	120V RED	0766-047	
D-238	240V RED	0766-046	
D-195	120V AMBER	0766-094	120B, 130B, H137B, H138B



<b>THERMOMETERS</b>			
STOCK No.	SPECIFICATIONS	REPLACES	FOR MODELS
J-149	100-280°F	5238-008-K	HOLDING CABINETS
J-152	70-220°F	5238-018-K	120 PH, 121 PH, PROOF/HOT UNITS
J-168	DIGITAL 0-250°F	5238-034-K2	BOTTOM MOUNT HOT CABINETS
J-171	(-20)-220°F	5238-030	BOTTOM MOUNT PROOF/HOT CABINETS



<b>HOT UNIT PAN</b>			
STOCK No.	SPECIFICATIONS	REPLACES	FOR MODELS
A-1730	BOTTOM MOUNT PAN WITH COVER	1017-001-03	H133, H302, 140 SERIES (EXCEPT 141)



# WARMERS

## CRES-COR SPECIFIC PARTS



A-1546



A-3976



A-3331



A-1548



B-449



B-482



B-1026



B-483

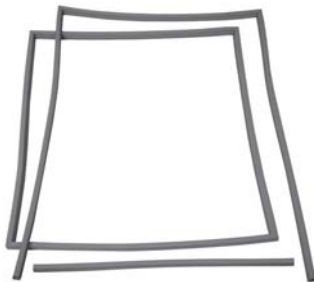

B-898

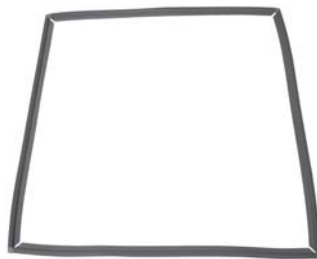

B-899



A-3977



A-3978

WARMERS

### CABINET PARTS

STOCK No.	SPECIFICATIONS	REPLACES	FOR MODELS
A-1546	LATCH ASSY KIT	1006-108-K1	INSULATED CABINETS H339, 135BK
A-3976	LATCH	1006-142-K1	
A-3331	SPRING LOADED LATCH ASSY	1246-011	INSULATED CABINETS
A-1548	RECESSED LATCH	1006-062	
B-449	GASKET SOLD BY THE FOOT	-	
B-482	CORNER FOR B-449	0861-082	
B-1026	UNIVERSAL GASKET KIT	0861-175	
B-483	25-3/4" LONG WIPER STRIP	0861-155-1	INSULATED CABINETS W/DOUBLE DOORS
B-898	DOOR GASKETS	0861-203-K	H137UA12B
B-899	DOOR GASKET WITH CORNERS	0861-077	H339, H309
A-3977	HINGE KIT	0519-087-K	H137B, H138B SERIES
A-3978	2-1/2" DIA VENT	0847-051	ALL INSULATED CABINETS W/ VENT

# WARMERS

## DELFIELD SPECIFIC PARTS

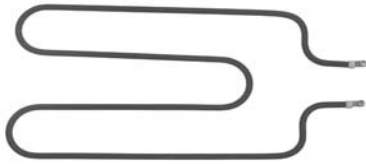

C-1154  
C-1155



E-816  
E-817



G-731



G-732



G-733



G-734



A-3754



A-3755



E-126



D-315



D-243



G-802



F-513

## ELECTRICAL COMPONENTS AND DIALS

STOCK No.	REPLACES	SPECIFICATIONS	COMMENT
C-1154	2194006	115V 1000W ELEMENT	9-1/2" X 17"
C-1155	2194007	208/230V 1000W ELEMENT	
E-816	2194107	120V INFINITE SWITCH	-
E-817	2194110	240V INFINITE SWITCH	
G-731	2194335	NON-ADJUSTABLE THERMOSTAT	
G-732	2194202	THERMOSTAT	3/8" X 5" BULB, 60" CAP. - 2 TERM.
+G-733	2194012		3/8" X 3" BULB, 48" CAP. - 2 TERM.
#G-734	2193984		3/8" X 3" BULB, 48" CAP. - 4 TERM.
A-3754	3234557	DIAL, INFINITE SWITCH	USED WITH E-816 AND E-817
A-3755	3234556	DIAL, THERMOSTAT	USED WITH G-732, G-733 AND G-734
E-126	2194212	SWITCH	DPST
D-315	2194190	SIGNAL LIGHT RED 115V	-
D-243	2194095	SIGNAL LIGHT AMBER 230V	
G-802	2194372	SOLID STATE CONTROL	HEATED CABINET
F-513	2194370	TEMPERATURE SENSOR	

+ G-733 MODELS DFW, N8631 TO N8687, N8831 TO N8859.  
# G-734 MODELS N8873 TO N8887.

# WARMERS

## DUKE SPECIFIC PARTS

WARMERS



G-324



A-2688



G-321



H-369



A-459



A-457  
A-458



A-1635  
A-1636



A-1698



H-337



H-527



L-338

### PARTS FOR GAS & ELECTRIC EQUIPMENT

STOCK No.	REPLACES	DESCRIPTION
G-324	2081-2	KA TYPE ELECTRIC THERMOSTAT
A-2688	2190-2	DIAL 1-10 FOR G-324
G-321	3509-2	BJWA THERMOSTAT WITH DIAL
H-369	3530-2	GAS BURNER VALVE 1/4" TUBE
A-459	3511-2	KNOB FOR H-369
A-457	3532-2	NAT GAS BURNER
A-458	3533-2	LP GAS BURNER
A-1635	3546-2	BURNER CAP FOR A-457
A-1636	3554-2	BURNER CAP FOR A-458
A-1698	3502-2	BURNER BASE ELBOW
H-337	3508-2	PILOT SAFETY VALVE
H-527	3505-2	PILOT VALVE
L-338	2246-2	PORCELAIN BULB SOCKET

### INFRA-RED HEAT LAMPS (SOLD EACH)

D-130	250W 130V RED HEAT LAMP
D-131	250W 130V CLEAR HEAT LAMP
D-260	250W 130V TEFLON COATED RED HEAT LAMP
D-261	250W 130V TEFLON COATED CLEAR HEAT LAMP



SOLD EACH

### INFRA-RED HEAT LAMPS (SOLD CASE 12)

D-130C	250W 130V RED HEAT LAMP
D-131C	250W 130V CLEAR HEAT LAMP
D-260C	250W 130V TEFLON COATED RED HEAT LAMP
D-261C	250W 130V TEFLON COATED CLEAR HEAT LAMP



SOLD IN CASE OF 12

# WARMERS

## DUKE SPECIFIC PARTS



### DOME HEATING ELEMENTS

STOCK No.	VOLTS	WATTS	REPLACES
C-729	120	500	2402-2
C-534			2403-2
C-535	208	750	2404-2
C-536	240		2405-2
C-537	208	1000	2406-2
C-538	240		2407-2



### LOOP HEATING ELEMENTS

STOCK No.	VOLTS	WATTS	REPLACES
C-539	120	750	2238-2
C-540	208		2239-2
C-541	240		2240-2
C-542	208	1000	2241-2
C-543	240		2242-2



NO LONGER AVAILABLE

### OLD STYLE FIGURE 8 CONVERSION PLATE

STOCK No.	DESCRIPTION
A-3690	CONVERSION PLATE KIT

A-3690



NOTE: TO CONVERT OLD STYLE FIGURE 8 ELEMENTS YOU NEED A-3690 CONVERSION KIT AND LOOP TYPE HEATING ELEMENT. SELECT PROPER VOLTAGE AND WATTAGE FROM LOOP HEATING ELEMENTS LISTED ABOVE.



C-707



C-708

### "W" HEATING ELEMENTS

STOCK No.	VOLTS	WATTS	REPLACES
C-707	120	750	2420-2
C-708		1200	2426-2



E-698  
E-699  
E-700



A-257



A-768

### INFINITE HEAT SWITCHES, DIAL AND PALNUT

STOCK No.	VOLTAGE	REPLACES	DESCRIPTION
E-698	120	5580-2	INFINITE SWITCH
E-699	208	5578-2	
E-700	240	5579-2	
A-257	-	2164-2	DIAL FOR SWITCH
A-768	-	-	PALNUT FOR SWITCH



# WARMERS

## DUKE/FRANKLIN THERMOTAINER SPECIFIC PARTS

### THERMOSTATS, DIALS AND SIGNAL LIGHTS

STOCK No.	DESCRIPTION	REPLACES
G-207	KP, 1 PHASE THERMOSTAT	TA-21
G-206	D338, 3 PH THERMOSTAT	TA-22
A-2446	DIAL ONLY FOR G-207	TA-24
A-587	DIAL ONLY FOR G-206	TA-24A
D-101	RED SIGNAL LIGHT	TA-25
D-102	AMBER SIGNAL LIGHT	TA-26

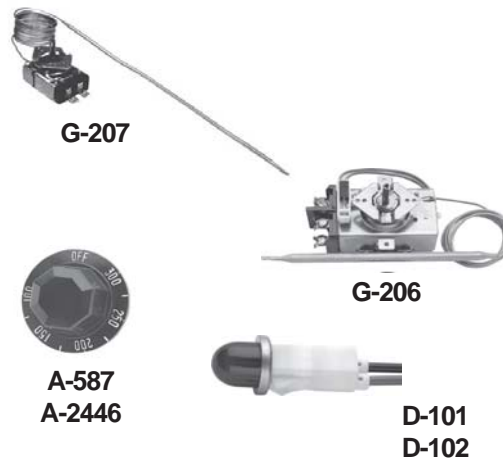

### STRIP HEATING ELEMENTS

STOCK No.	SPECIFICATIONS	REPLACES
C-355	500W 120V	TA-16
C-356	750W 120V	TA-17
C-357	1000W 120V	TA-18
C-262	375W 240V	TA-15B
C-263	500W 240V	TA-16B
C-264	750W 240V	TA-17B
C-265	1000W 240V	TA-18B



### DOOR HINGE AND PARTS

STOCK No.	DESCRIPTION	REPLACES
A-544	COMPLETE HINGE ASSY	TA-120
A-545	CAP	TA-6
A-546	HINGE PIN	TA-122
A-547	SET PIN	TA-10
A-548	HINGE BASE	TA-2
A-549	TENSION ADJUSTER	TA-9
A-550	HINGE TOP	TA-1
A-551	SPRING	TA-3
A-552	TOP SCREW	TA-11
A-553	SCREW	TA-12
A-554	RETAINER WASHER	TA-5
A-555	HINGE PIN SCREW	TA-8
A-2447	UNI-DOOR SPRING	TA-36K



WARMERS

# WARMERS

## EAGLE (METAL MASTERS) SPECIFIC PARTS



H-1149



A-2920



A-3681  
A-3682

### GAS EQUIPMENT COMPONENTS

STOCK No.	DESCRIPTION	REPLACES	COMMENT
H-1149	GAS VALVE	302102	FOR FOOD TABLES
A-2920	KNOB	302095	FOR H-1149
A-3681	NAT JET BURNER	302073	1/8" MPT #63
A-3682	LP JET BURNER	302123	1/8" MPT #75



E-174  
E-175



E-648



A-2919



G-605



D-359



C-982  
C-983  
C-984

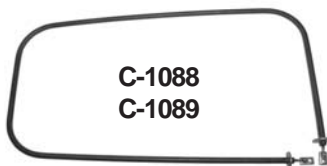

C-1088  
C-1089



C-1090

### ELECTRIC EQUIPMENT COMPONENTS

STOCK No.	SPECIFICATIONS	REPLACES	DESCRIPTION
E-174	120V	301785	INFINITE SWITCH
E-648	208V	301876	
E-175	240V	301752	
A-2919	OFF-L0-2-8-HI	301681	DIAL
G-605	HIGH LIMIT	301679	LIMIT SWITCH
D-359	AMBER	302055	SIGNAL LIGHT
C-982	120V 500W	303163	DOME TYPE ELEMENT
C-983	208V 750W	303173	
C-984	240V 750W	303174	
C-1088	120V 1200W	301674	HEATING ELEMENT
C-1089	240V 1200W	301675	
C-1090	120V 1200W	606207	

# WARMERS

## FWE FOOD WARMING EQUIPMENT SPECIFIC PARTS



### ELECTRICAL COMPONENT PARTS

STOCK No.	DESCRIPTION	REPLACES
G-773	THERMOSTAT	T-STAT-H1
E-174	120V INFINITE CONTROL	T-STAT-INF1
E-491	ON-OFF ROCKER SWITCH	SWH-RCK E1
E-492	ON-OFF LIGHTED ROCKER SWITCH	SWHRCKLE1
M-348	115V MOTOR	MTRJK12092
C-1245	115V 1250W HEATING ELEMENT	EL1250/115HT
C-1246	115V 1500W HEATING ELEMENT	EL1500/115HT



### MECHANICAL COMPONENT PARTS

STOCK No.	DESCRIPTION	REPLACES
*B-918	DOOR GASKET (SOLD BY THE FOOT)	GSKT-DR
A-4087	DOOR LATCH 5-1/2" CTR OUTSIDE HOLES	LTHDR
A-1189	5" HINGE 1-3/4" CTR OUTSIDE HOLES	HNG214
A-4088	DIAL FOR G-773 THERMOSTAT	KNBH1
A-4089	KNOB FOR E-174 INFINITE CONTROL	KNBINFN
A-4090	5-1/2" FAN BLADE	BLDFANHR
A-4432	3" FAN BLADE	BLDFANAL

\*B-918 SOLD BY THE FOOT.

WARMERS

# WARMERS

## G.E./HOBART SPECIFIC PARTS



G-203



G-205

## THERMOSTATS

STOCK No.	SPECIFICATIONS	REPLACES	DESCRIPTION
G-203	STYLE K - 72" CAPILLARY	351422-10	THERMOSTAT
G-205	STYLE KA	343577-3	

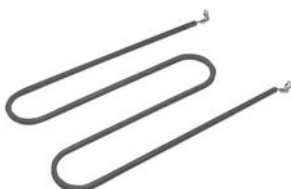

## HEATING ELEMENTS

STOCK No.	VOLTS	WATTS	REPLACES
C-184	120V	1000W	351265-1
C-185	208V		351265-2
C-186	240V		351265-3
C-448	120V	1600W	351358-1
C-449	208V		351358-2



## SIGNAL LIGHTS

STOCK No.	VOLTAGE	REPLACES	COMMENTS
D-105	208/230	347336-1	RED LENS
D-106	115V	347336-2	



# HOT DOG DISPLAY BROILERS

## GLENRAY/TOMLINSON SPECIFIC PARTS



E-626



E-627



E-628



M-240



A-2854

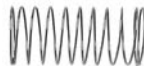

A-2855



A-2998



A-3001



A-3002



A-3643



A-3644

WARMERS

### GLENRAY HOT DOG MACHINE PARTS FOR MODELS MINI 12 AND 56

STOCK No.	DESCRIPTION	REPLACES	COMMENTS
E-626	DPST MASTER SWITCH	1909067	MINI 12 AND MODEL 56
E-627	SPST MOTOR SWITCH	1909069	
E-628	4-WAY TEMPERATURE SWITCH	1909436	
M-240	115V GEAR MOTOR	1010303	
A-2854	COUPLING FOR GEAR MOTOR	1909055	MINI 12 AND MODEL 56
A-2855	SPRING FOR SPIT SHAFT	1909645	
A-2998	RETAINER RING	1909058	
A-3001	NYLON BEARING	1909342	
A-3002	KNURLED HINGE SCREW	1909019	
A-3643	6" JUMPER	1906818	
A-3644	12" JUMPER	1906821	

# WARMERS

## GLENRAY/TOMLINSON SPECIFIC PARTS



E-623



A-2833



D-353



D-354



C-950



A-2830



A-2831



A-3645

## GLENRAY KETTLE PARTS

STOCK No.	DESCRIPTION	REPLACES	COMMENTS
E-623	120V INFINITE SWITCH	1911792	
A-2833	INFINITE SWITCH DIAL	1910814	
D-353	FUSE	1910834	
D-354	SIGNAL LIGHT	1910812	
C-950	120V 475W HEATER	1910835	
A-2830	S/S LID ASSY	1410867	BAND HEATER FITS 9" DIA. INSERT 9-1/2" DIA. WITH KNOB AND HINGE
A-2831	10-1/2 QT SS FOOD INSERT	1910807	8-1/2" INSIDE DIA. 10-1/4" DEEP
A-3645	ALU. INSERT	1910808	9" INSIDE DIA

**FRUSTRATED WITH VOICE MAIL?**

**AT ICS YOUR CALL WILL ALWAYS BE ANSWERED  
PROMPTLY BY A LIVE PERSON!**

**800-243-1290**

# WARMERS

## HATCO FOOD WARMERS

STOCK UNITS ARE EQUIPPED WITH ON-OFF TOGGLE SWITCHES.

UNITS EQUIPPED WITH INFINITE SWITCHES WILL BE SHIPPED FROM THE FACTORY.



NOTE: SHOWN WITH OPTIONAL C-LEG

WARMERS

### - AVAILABLE ACCESSORIES -

- ADJUSTABLE TUBULAR STAND  
10-14"
- NON-ADJUSTABLE TUBULAR STAND  
10", 16"
- C-LEG STAND  
10", 13-1/2"
- T-LEG STAND  
10", 13-1/2", 16", 18"
- ADJUSTABLE ANGLE BRACKETS
- CHAIN SUSPENSION
- REMOTE INFINITE CONTROL
- REMOTE CONTROL ENCLOSURE
- PILOT LIGHT
- CORD AND PLUG SET-120V
- INCANDESCENT LIGHTS
- BREATH PROTECTORS

## HATCO GLO-RAY INFRARED FOOD WARMERS

STOCK No.	MODEL No.	VOLTAGE	WATTAGE	LENGTH
C-686	GRAH-18	120V	350W	18"
C-687	GRAH-24		500W	24"
C-690	GRAH-36	120V	800W	36"
C-691		208V		
C-693	GRAH-48	120V	1100W	48"
C-694		208V		
C-696	GRAH-60	120V	1400W	60"
C-697		208V		
C-995	GRAH-72			1725W

NOTE: OTHER MODELS AVAILABLE UPON REQUEST.

# WARMERS

## HATCO SPECIFIC PARTS



## CONTROL COMPONENT PARTS

STOCK No.	DESCRIPTION	REPLACES	MODELS
G-535	TEMPERATURE THERMOSTAT	02.16.002	FS, FST, FSHC, FDWI, FDWIX, GRSDS
G-538	HUMIDITY THERMOSTAT	02.16.021	FS, FST, FSHC
G-539	BASE THERMOSTAT	02.16.028	GRS, GRDW, GRBW, GRHW, GRSDH, GRSDS
G-540	THERMOSTAT	R02.16.046	HDW1, 2, 3, 4, HDW1B, 2B, 3B
G-534	HIGH LIMIT SWITCH	R02.16.118	FS, FSHC, FSTMN, AFST, FDW, AFST, FSHC, FSD, FS, FSTMN, WFST
E-248	120V INFINITE SWITCH	R02.19.018	GR-SERIES, FDW-SERIES
E-249	240V INFINITE SWITCH	R02.19.019	
E-388	208V INFINITE SWITCH	R02.19.017	
G-755	200°F THERMOSTAT	R02.16.039	FSD, FSDT
G-756	253°F THERMOSTAT	R02.16.066	GR2S, GRSBF
G-809	THERMOSTAT CONTROL	02.01.049	GRCW



## KNOBS

STOCK No.	DESCRIPTION	REPLACES	MODELS
A-1699	D-STEM KNOB (HARPCO)	05.30.018	GR-SERIES
A-2172	SET SCREW KNOB (EGO CONTROL)	05.30.043	
A-1903	1/4" HOLE KNOB	05.30.019	FDW1, FDW1X, FS, FST, FSHC, HDW1, 2, 3, 4
A-3753	D-STEM KNOB	05.30.047	FITS G540 HDW1, 2, 3, 4, HDW1B, 2B, 3B

# WARMERS

## HATCO SPECIFIC PARTS



### 3/16" O.D. OLD STYLE WARMING ELEMENTS

STOCK No.	WARMER LENGTH	VOLTS	WATTS	REPLACES
C-560	18"	120	350	R02.08.126
C-561		240		R02.08.135
C-498	24"	120	500	R02.08.101
C-499		208		R02.08.102
C-500		240		R02.08.103
C-728	30"	120	660	R02.08.127
C-821		208		R02.08.128
C-822		240		R02.08.129
C-501	36"	120	800	R02.08.104
C-502		208		R02.08.105
C-503		240		R02.08.106
C-823	42"	120	950	R02.08.107
C-824		208		R02.08.108
C-825		240		R02.08.109
C-504	48"	120	1100	R02.08.110
C-505		208		R02.08.111
C-506		240		R02.08.112

### 3/16" O.D. OLD STYLE WARMING ELEMENTS

STOCK No.	WARMER LENGTH	VOLTS	WATTS	REPLACES
C-826	54"	120	1250	R02.08.125
C-827		208		R02.08.130
C-828		240		R02.08.131
C-557	60"	120	1400	R02.08.113
C-558		208		R02.08.114
C-559		240		R02.08.115
C-829	66"	120	1560	R02.08.132
C-830		208		R02.08.133
C-831		240		R02.08.134
C-832	72"	120	1725	R02.08.116
C-833		208		R02.08.117
C-834		240		R02.08.118
C-835	84"	208	2050	R02.08.120
C-836		240		R02.08.121
C-837	96"	208	2400	R02.08.123
C-838		240		R02.08.124

OTHER LENGTHS, VOLTAGES AND WATTAGES AVAILABLE UPON REQUEST.

NOTE: HEATING ELEMENTS ARE APPROXIMATELY 3-1/2" SHORTER THEN WARMER LENGTH.

### 1/4" O.D. NEW STYLE WARMING ELEMENTS

STOCK No.	WARMER LENGTH	VOLTS	WATTS	REPLACES
C-1215	18"	120	350	R02.08.126D
C-1216	24"	120	500	R02.08.101D
C-1217		208		R02.08.102D
C-1218		240		R02.08.103D
C-1219	30"	120	660	R02.08.127D
C-1220		208		R02.08.128D
C-1221	36"	120	800	R02.08.104D
C-1222		208		R02.08.105D
C-1223		240		R02.08.106D
C-1224	42"	120	950	R02.08.107D
C-1225		208		R02.08.108D

### 1/4" O.D. NEW STYLE WARMING ELEMENTS

STOCK No.	WARMER LENGTH	VOLTS	WATTS	REPLACES
C-1265	48"	120	800	R02.08.010D
C-1266		208		R02.08.011D
C-1226		120	1100	R02.08.110D
C-1227	208	R02.08.111D		
C-1228	54"	120	1250	R02.08.125D
C-1229		208		R02.08.130D
C-1230	60"	120	1400	R02.08.113D
C-1231		208		R02.08.114D
C-1232	72"	120	1725	R02.08.116D
C-1233		208		R02.08.117D
C-1234	84"	208	2050	R02.08.120D
C-1235	96"	208	2400	R02.08.123D

NOTE: WHEN USING A NEW STYLE ELEMENT IN OLD STYLE UNIT YOU MUST NOTCH THE END PLATES TO FIT THE LARGER DIAMETER WARMING ELEMENT.

WARMERS



# WARMERS

## HATCO SPECIFIC PARTS



C-1106  
C-1107  
C-1170

### CERAMIC STYLE HEATERS

STOCK No.	SIZE	VOLTS	WATTS	REPLACES
C-1106	9-5/8"	120	750	02.07.001
C-1107			650	02.07.008
C-1170	4-7/8"		375	02.07.006



D-239



D-240



L-293



L-279

### TEFLON LAMPS AND LAMP HOLDERS

STOCK No.	DESCRIPTION	REPLACES
D-239	60W, 120V LAMP	02.30.043
D-240	40W, 120V LAMP	02.30.049
L-293	SINGLE LAMP HOLDER	02.30.044
L-279	DUAL LAMP HOLDER	02.30.045



C-879



C-881, C-886



C-880



C-882



C-884  
C-885

### HEATING ELEMENTS

STOCK No.	DESCRIPTION	REPLACES	MODELS
C-879	120V, 600W CARTRIDGE HEATER	R02.05.002	FS, FST, FSHC
C-881	120V, 1050W AIR HEATER	R02.05.007	
C-886	120V, 800W AIR HEATER	R02.08.010A	
C-880	120V, 325W WATER HEATER	R02.05.006	FDWI, FDWIX
C-882	120V, 1050W AIR HEATER	R02.05.011	
C-884	208V, 450W HEATING ELEMENT	02.05.051T	HDW1, 2, 3, 4, HDW1B, 2B, 3B
C-885	120V, 450W HEATING ELEMENT	02.05.052T	



E-222



E-568



E-566



E-567



E-565

### SWITCHES

STOCK No.	DESCRIPTION	REPLACES	MODELS
E-222	DPST-20A TOGGLE SWITCH	R02.19.008A	GR-SERIES
E-568	SPST-20A TOGGLE SWITCH	R02.19.016	GRSDS
E-566	DPST LIGHTED ROCKER SWITCH	02.19.022	CSC5, 10, HDW1, 2, 3, 4, HDW1B, 2B, 3B
E-567	SPST LIGHTED ROCKER SWITCH	02.19.033	
E-565		02.19.027	GRS, GRDW, GRBW, GRHW

# WARMERS

## HATCO SPECIFIC PARTS



D-315



D-243  
D-328



F-328



F-329



F-327



L-300



E-789



L-342

### ELECTRICAL COMPONENTS

STOCK No.	DESCRIPTION	REPLACES	MODELS
D-315	120V-1/2" HOLE, RED SIGNAL LIGHT	02.19.154	FS, FST, FSHC
D-243	240V 1/2" HOLE, RED SIGNAL LIGHT	02.19.151	GR, GRH, GRA, GRAH
D-328	120V 1/2" HOLE, RED SIGNAL LIGHT	02.19.153	
F-328	120V LATCHING RELAY	02.01.028	FDW1, FDW1X, FS, FST, FSHC
F-329	RELAY	R02.01.050	GRSDS
F-327	120V/240V FLOAT SWITCH	R02.01.029	FS, FST, FSHC, FDW1, FDW1X
L-300	CORD SET FOR M-226	02.12.001A	FDW1, FDW1X
E-789	SWITCH	02.19.080	FSD, FSdT
L-342	LAMP SOCKET	02.30.073	



M-226



M-227



M-299



M-257



M-300



M-298

### BLOWER AND DRIVE MOTORS

STOCK No.	DESCRIPTION	REPLACES	MODELS
M-226	BLOWER MOTOR	02.12.001	FDW1, FDW1X
M-227		02.12.003B	FS, FST, FSHC
M-299		R02.12.066	FSHC-CB
M-257	RACK DRIVE MOTOR	02.12.005R	FS, FST, FSHC
M-300	RACK MOTOR	02.12.004	FDW-1
M-298	MOTOR	R02.12.003	FS, FSHC

WARMERS

# WARMERS

## HATCO SPECIFIC PARTS



J-161



J-175



J-182

## TEMPERATURE DISPLAYS

STOCK No.	DESCRIPTION	REPLACES	MODELS
J-161	VERTICLE DRUM THERMOMETER	02.16.049	FS, FST, FSHC
J-175	HORIZONTAL TEMPERATURE DISPLAY	02.16.050	FDW-1, FDW-2
J-182	TEMPERATURE DISPLAY	02.16.057	FSD, FSDT



A-2556



A-2544



B-789



A-2562



A-2563



A-2558



A-2560



H-1267



B-841



E-795

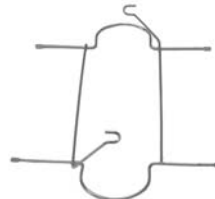

A-4330



A-3939



A-4329

## DOOR AND HARDWARE COMPONENTS

STOCK No.	DESCRIPTION	REPLACES	MODELS
A-2556	10-5/8" CTR HANDLE	R04.16.533	HDW1, 2, 3, 4, HDW1B, 2B, 3B
A-2544	DOOR MAGNET	05.30.005	FS, FST, FSHC
B-789	DOOR GASKET	R00.01.0105	FSHC
A-2562	STATIONARY ROLLER	R04.16.500	HDW1, 2, 3, HDW1B, 2B, 3B
A-2563	MOVEABLE ROLLER	04.16.638	
A-2558	HINGE PIN	04.24.023	FDW1, FDW1X
A-2560	4" PLASTIC LEG	05.30.007	GRHD2P, 3P, 4P, HDW1, 2, 3, 4, HDW1B, 2B, 3B
H-1267	CEILING DRAIN	R03.40.055	FDW, FSHC SR#5143899510 AND LATER
B-841	PLASTIC DRAIN TUBE	R03.40.054	
E-795	PROXIMITY SWITCH	02.19.084	FSD, FSDT
A-4330	WIRE GUARD	04.37.100	GR SERIES
A-3939	MAGNET FOR PROXIMITY SWITCH	02.19.084A	FSD, FSDT
A-4329	RUBBER FOOT	05.06.038	FDW

# WARMERS

## HENNY PENNY SPECIFIC PARTS



### ELECTRICAL COMPONENTS, KNOB AND FAN BLADE

STOCK No.	SERIES	REPLACES	DESCRIPTION
G-542	HC900, HC930	14209	THERMOSTAT
A-2581		25863	KNOB FOR G-542
G-541	HC900	18201	HIGH LIMIT
C-896		25759	120V, 1000W HEATING ELEMENT
E-345		22198	POWER SWITCH
D-193		16624	SIGNAL LIGHT
E-630	HC930	28856	FLOAT SWITCH
M-229	HC900	25751	120V BLOWER MOTOR (ONLY)
A-2579		25706	COOLING FAN BLADE FOR M-229
M-230		25753	120V BLOWER MOTOR ASSEMBLY
C-1273	BW4, 43, 6, 8	44529	120V 800W HEATING ELEMENT
M-360	LM, CMT, HM, HMT, HS-HST	39216	240V BLOWER MOTOR ASSEMBLY
F-501	HC900, HC903	29523	PROBE ASSEMBLY
F-502	HC900	40645	RELAY



J-162



A-1023



A-1198

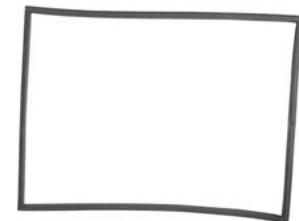

B-719

### MECHANICAL COMPONENTS

STOCK No.	SERIES	REPLACES	DESCRIPTION
J-162	HC900, HC930	14250	THERMOMETER
A-1023	HC900	25837	DOOR LATCH AND STRIKE
A-1198		25702	DOOR HINGE
B-719		25643	DOOR GASKET

WARMERS

# CHEESE MELTERS/WARMERS

HOLMAN, KEATING, LANG SPECIFIC PARTS

## HOLMAN



### MODEL F36 REPLACEMENT PARTS

STOCK No.	REPLACES	DESCRIPTION
C-943	187708	208 VOLT QUARTZ HEATER TUBE
D-231	200409	SOCKET FOR C-943
E-358	200538	240V INFINITE HEAT SWITCH
A-1700	2R-200702	DIAL FOR E-358
G-442	2E-200566	LIMIT SWITCH

## KEATING



### HEAT LAMP SOCKET

STOCK No.	REPLACES	COMMENT
L-308	14252	KEEP KRISP

## LANG SPECIFIC PARTS



### QUARTZ HEATERS AND SOCKET

STOCK No.	SPECIFICATIONS	VOLTAGE	WATTAGE	REPLACES	MODELS
C-652	19-1/2" - SNAP-IN	208	1200	11160-07	MM2, MM4
C-653		240		11160-08	
C-654	29-1/4" - SNAP-IN	208	1800	11160-09	MM3
C-656	19-1/2" - WIRE LEADS	208	1200	11160-15	MM24, MM48
C-657		240		11160-16	
C-658	31-3/4" - WIRE LEADS	208	1800	11160-17	MM36
C-659		240		11160-18	
*C-660	19-1/2" - (RED) WIRE LEADS	104	1200	11160-19	MM24, MM48
*C-1150	19-1/2" - (WHITE) WIRE LEADS				
*C-661	19-1/2" - (RED) WIRE LEADS	120	1800	11160-20	MM36
*C-1151	19-1/2" - (WHITE) WIRE LEADS				
*C-662	31-3/4" - (RED) WIRE LEADS	104	1800	11160-21	MM36
*C-1152	31-3/4" - (WHITE) WIRE LEADS				
*C-663	31-3/4" - (RED) WIRE LEADS	120	1800	11160-22	MM36
*C-1153	31-3/4" - (WHITE) WIRE LEADS				
D-231	SOCKET ONLY FOR SNAP-IN	-	-	31602-01	-

\*104V IS USED IN 208V EQUIPMENT AND 120V IS USED IN 240V EQUIPMENT.



# WARMERS

## MERCO SPECIFIC PARTS



D-194

### ELECTRICAL COMPONENTS

STOCK No.	SPECIFICATIONS	REPLACES
E-174	120V INFINITE SWITCH	050377
E-175	240V INFINITE SWITCH	050378
A-2583	KNOB WITH POINTER	000320
E-429	ROCKER SWITCH	001469
E-179	TOGGLE SWITCH	000711
E-113		000716
D-194	SIGNAL LIGHT	000274
D-231	QUARTZ HEATING TUBE SOCKET	000672
A-3696	COLLAR FOR OLD STYLE TUBE SOCKET	-
*D-130	250W 130V RED HEAT LAMP	000372
*D-131	250W 130V CLEAR HEAT LAMP	000371
*D-260	250W 130V TEFLON COATED RED HEAT LAMP	-
*D-261	250W 130V TEFLON COATED CLEAR HEAT LAMP	
D-365	230V 40W COATED LIGHT BULB	000378
L338	PORCELAIN BULB SOCKET	060025



D-231



A-3696

FOR USE ON D-231 WHEN OLD SOCKET HAS LARGER DIAMETER.



D-130, D-131  
D-260, D-261



D-365



L-338

\*D-130, D-131, D-260, D-261 AVAILABLE IN CASE OF 12 AT A LOWER PRICE. ADD C TO STOCK NO.



### QUARTZ HEATING ELEMENTS FOR EZT UNITS

STOCK No.	SPECIFICATIONS	VOLTAGE	WATTAGE	REPLACES
C-675	14 1/4" (EZ-PIN)	120	550	110649
C-1087		208		110772
C-676	20-1/4" (EZ-PIN)	120	680	110650
C-910		208		110773
C-912		240		110893
C-904	26-1/4" (EZ-PIN)	120	750	110653
C-911		208		110776
C-913		240		110896
C-677	32-1/4" (EZ-PIN)	120	825	110655
C-936		208		110778
C-914		240		110898
C-678	44-1/4" (EZ-PIN)	120	1100	110657
C-935		208		110780
C-915		240		110900

WARMERS

# WARMERS

## MERCO SPECIFIC PARTS



### QUARTZ HEATING ELEMENTS FOR EZT-1220 UNITS

STOCK No.	SPECIFICATIONS	VOLTS	WATTS	REPLACES	MODELS
C-906	26-7/8" (EZ-PIN)	120	440	110659	EZT-1220-2-3P
C-907	38" (EZ-PIN)		550	110660	EZT-1220-3-4P
C-905			825	110656	EZT-1220-3P, EZT-1826-2P
C-908	25-5/16" (EZ-PIN)		440	110661	EZT-1220-4-5P
C-903			680	110652	EZT-1220-4P, EZT-1826-3P
C-1249	38" (EZ-PIN)	240	550	110903	EZT-1220-3-4P
C-1248	25-5/16" (EZ-PIN)		440	110904	EZT-1220-4-5P



### QUARTZ HEATING ELEMENTS FOR T TYPE UNITS

STOCK No.	SPECIFICATIONS	VOLTS	WATTS	REPLACES
C-897	23" LONG (WIRE LEADS)	120	680	110005
C-898	35" LONG (WIRE LEADS)		825	110007
C-900			208	110154
C-899	47" LONG (WIRE LEADS)	120	1100	110008
C-901		208		110155



### METAL HEATING ELEMENT FOR HWEZTM UNIT

STOCK No.	SPECIFICATIONS	VOLTS	WATTS	REPLACES
C-909	20-1/2" (END TO END)	120	825	110674

# WARMERS

## METRO SPECIFIC PARTS



G-663



G-664



A-3293

### THERMOSTATS AND DIAL

STOCK No.	DESCRIPTION	REPLACES	MODELS
G-663	THERMOSTAT	RPC13-113	C190, TC90S, TC90B
G-664		RPC13-129	HM2000, HM15LW, CM15LW
A-3293	DIAL	RPC06-313	FOR ALL MODELS ABOVE



C-1071



C-1073



C-1070



C-1072

### HEATING ELEMENTS

STOCK No.	VOLTS	WATTS	SPECIFICATIONS	REPLACES	FOR MODELS
C-1070	120	700	2-1/2" X 7-1/4"	RPC13-055	CM1500, VH1500, HM1500, PM1500
C-1071		2000	7" X 10-1/4"	RPC13-093	HM2000
C-1072		1360		RPC13-114	C190, HM15LW, CM15LW
C-1073		675	4" X 7"	RPC13-162	CM15LW

WARMERS

# WARMERS

## METRO SPECIFIC PARTS



B-771

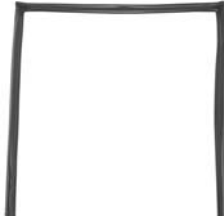

B-773

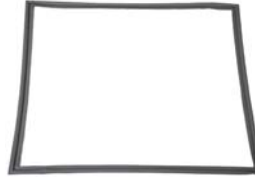

B-904



B-905  
B-1016



B-772

## DOOR GASKETS

STOCK No.	SPECIFICATIONS	REPLACES	MODELS
B-771	23" X 24-3/8"	RPC06-331	C190
B-772	2" X 23-1/2"	RPC07-03223.2	C199N
B-773	25-1/2" X 27", 3 SIDED SNAP IN	RPC06-317	
B-904	25" X 27-3/4" GREY	RPC06-809	199 SERIES DOUBLE DOOR UNITS
B-905	22-1/4" X 54-1/4" BLACK SNAP IN	RPC06-316	C175 OLD STYLE
B-1016	15" X 28-3/4"	RPC06-325	TC905



M-265



M-266



M-267

## BLOWER ASSEMBLIES

STOCK No.	SPECIFICATIONS	REPLACES	MODELS
M-265	120V - 4-3/4" X 2-1/2" MT CTRS	RPC13-087	C190, VH1500
M-266	120V - 7-1/4" X 2-1/2" MT CTRS	RPCM15-1016	CM1500, HM1500, PM1500
M-267	120V	RPHM20-2103	CM2000, HM15LW, CM15LM, C200, HM2000

# WARMERS

## METRO SPECIFIC PARTS

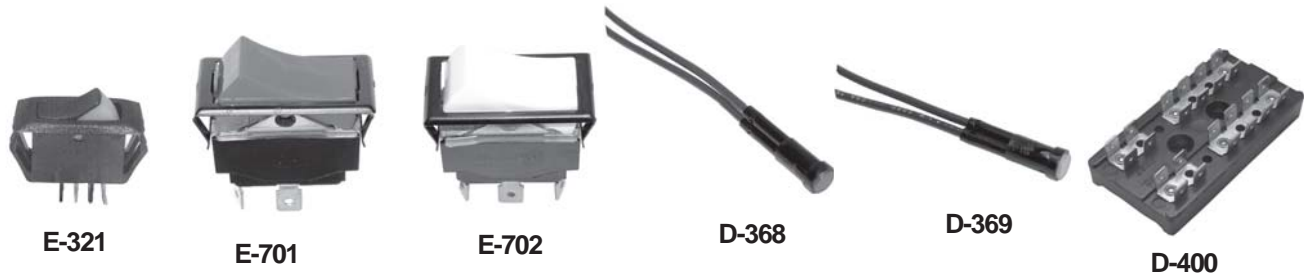

ELECTRICAL COMPONENTS			
STOCK No.	SPECIFICATIONS	REPLACES	MODELS
E-321	POWER SWITCH, SPST (ON/OFF)	RPC13-073	CM1500, HM1500, PM1500, VH1500
E-701	ROCKER SWITCH, SPST (ON/OFF)	RPC13-127	C190, HM15LW, TC90B, TC90S
E-702	ROCKER SWITCH, DPDT (ON/ON)	RPC13-128	CM15LW
D-368	120V RED SIGNAL LIGHT	RPC13-064	CM1500, CM15LW, DM2800, HM1500, HM15LW, HM2000, PM1500, TC90B/S
D-369	120V AMBER SIGNAL LIGHT	RPC13-105	C200, CM1500, HM1500, HM2000, HM15LW, M1500, TC90B/S
D-400	TERMINAL BLOCK	RPC13-096	FITS MOST MODELS

WARMERS



MECHANICAL COMPONENTS			
STOCK No.	SPECIFICATIONS	REPLACES	MODELS
J-172	(-40)-199°F DIGITAL THERMOMETER	RPC13-122	CM15LW, HM15LW, HM2000
J-173	20-220°F THERMOMETER	RPC13-109	C190, TC90B/S
A-3294	STRIKE	RPC175-STRIKE	C175N, C199N
A-2544	MAGNET	RPC14-038	C190, C175N, C199N, C85N, C200



# WARMERS

## NEMCO AND RANDELL SPECIFIC PARTS

### NEMCO



C-1103



C-1195



D-131



L-308



E-851



E-852



G-435



A-4001



D-395



G-765



A-1549

### ELECTRICAL COMPONENTS, KNOB AND DIAL

STOCK No.	DESCRIPTION	REPLACES	MODELS
C-1103	120V 1400W ELEMENT	67368	FOR 6450 SERIES
C-1195	120V 1800W ELEMENT	67100	6060A, 6062A
D-131	120V 250W CLEAR LAMP	45376	INFRA-RED WARMERS
L-308	LAMP SOCKET	45372	
E-851	ROCKER SWITCH	45379	
E-852	ROCKER SWITCH	47862	
G-435	THERMOSTAT	45764	
A-4001	KNOB FOR G-435	45740	6100, 6101, 02, 03, 10, 20
D-395	120V RED SIGNAL LIGHT	45380-1	6060A, 6062A
G-765	THERMOSTAT	47656	
A-1549	1-10 DIAL	47309/11/12	

### RANDELL



G-569



A-3470



C-1260

### HOT FOOD CABINET COMPONENT PARTS

STOCK No.	DESCRIPTION	CONTROL NUMBERS
G-569	THERMOSTAT WITH DIAL	CAP-054-270, CAP-086-230R, 275-3150-00
A-3470	DIAL ONLY FOR G-569	-
C-1260	ELEMENT 240V 1150W	EL - ELM 1150

# WARMERS

## ROUND-UP (AJ ANTUNES) SPECIFIC PARTS



B-915



B-916



H-1392

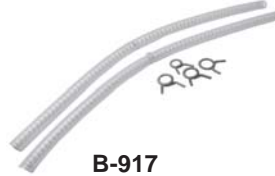

B-917



B-1007

### MECHANICAL COMPONENTS

STOCK No.	DESCRIPTION	REPLACES	MODELS
B-915	COVER GASKET KIT 44"	7000122	DFWT-100, 150, 200
B-916	COVER GASKET KIT 51"	7000123	
H-1392	QUICK DISCONNECT KIT	7000139	
B-917	SILICONE TUBE KIT	7000134	
B-1007	O-RING	0200121	VS-200ASB, VS-200ADB



G-771



G-774



G-775



G-772



C-1238



E-860



E-858



E-859



E-861



F-487



F-486



F-488



F-489



H-1393



H-1397

### ELECTRICAL COMPONENTS

STOCK No.	DESCRIPTION	REPLACES	MODELS
G-771	CONTROL BOARD	7000392	DFWT-100, 150, 200
G-774	THERMOSTAT	403K157	VS-200ASB, VS-200ADB
G-775	HI-LIMIT THERMOSTAT	7000344	
G-772		7000135	DFWT-100, 150, 200
C-1238	208V GENERATOR	7000430	TBS-1X, 2X
E-860	MOMENTARY SWITCH	4010166	DFWT-100, 150, 200
E-858	ROCKER SWITCH DPST	4010137	
E-859	LIGHTED ROCKER SWITCH DPST	4010151	
E-861	SWITCH KIT W/ COVER	401K107	CCC-20
F-487	RELAY KIT	7000652	DFWT-100, 150, 200
F-486	THERMOCOUPLE	4050214	MS-150, 155, 250, 255, 355
F-488	THERMISTER PROBE	7000462	DFWT-100, 150, 200
F-489	TRANSFORMER	7000319	DFWT-100, 150, 200, MS-SERIES
H-1393	24V SOLENOID VALVE	4040145	
H-1397	240V SOLENOID VALVE	0010575	TBS-1RR, 2RR

WARMERS

# WARMERS

## SECO SPECIFIC PARTS

### SECO



C-398  
C-399  
C-400



C-401  
C-402  
C-403

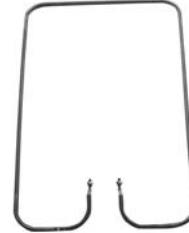

C-568  
C-569  
C-1002



C-562  
C-563  
C-564



C-1000  
C-1001

### HEATING ELEMENTS

STOCK No.	VOLTAGE	WATTAGE	REPLACES	ELEMENT SIZE
C-398	120	1000	0156500	8-1/2" X 15"
C-399	208		0156550	
C-400	240		0156600	
C-401	120		0156250	10-1/2" X 18"
C-402	208		0156150	
C-403	240		0156200	
C-1002	120		0157075	10-1/4" X 17-1/2"
C-568	208		0157100	10-1/4" X 17-3/4"
C-569	240		0157125	
C-562	120		0156400	10-1/4" X 15-3/4"
C-563	208		0156300	
C-564	240		0156350	
C-1000	120		500	0156800
C-1001	208	0156850		

# WARMERS

## SECO/STAR METAL SPECIFIC PARTS

### SECO

#### CONTROL RELATED PARTS

STOCK No.	SPECIFICATIONS	REPLACES	COMMENTS
G-323	STYLE S	0349950	THERMOSTAT
A-1403	-	0178525	DIAL FOR G-323
E-254	120 VOLT	0083100	INFINITE HEAT SWITCH
E-255	208 VOLT	0083150	
E-256	240 VOLT	0083200	
A-770	-	0177950	DIAL FOR INFINITE SWITCH
D-101	RED LENS	0189400	SIGNAL LIGHT



G-323



A-1403



E-254  
E-255  
E-256



A-770



D-101

#### FINNED STRIP HEATERS

STOCK No.	VOLTS	WATTAGE	REPLACES
C-593	120	750	0652225
C-594		900	0151200



### STAR METAL



#### HEATING ELEMENT

STOCK No.	VOLTAGE	WATTAGE	REPLACES	ELEMENT SIZE
C-187	240	900	SP144-1	5-1/2" X 11-1/2"

WARMERS

# HOT DOG WARMERS/STEAMERS

## STAR SPECIFIC PARTS



G-402



G-767



G-728

E-729



E-762



A-3540



C-1141, C-1142  
C-1214



E-856

### MODEL 8A-35SXE, 8A-70SXE, 8A-35SSA, 8A-70SSA REPLACEMENT PARTS

STOCK No.	MODEL	REPLACES	DESCRIPTION
G-402	35SXE, 70SXE	2T-Z4189	THERMOSTAT
G-767	35SSA, 70SSA	2T-Z7202	
G-728	35SXE	2T-Z0622	HI LIMIT
E-729	35SXE, 70SXE	2E-Z5884	SWITCH
E-762	35SSA, 70SSA	2E-Z1858	
A-3540	35SXE, 70SXE	2R-Z1854	KNOB
C-1141	35SXE, 70SSA	2N-Z4058	120V WARMING ELEMENT
C-1142	70SXE	2N-Z4059	
C-1214	35SSA	2N-Z5252	
E-856	35SSA, 70SSA	2E-Z6503	FLOAT SWITCH



G-402



A-2680



A-1072

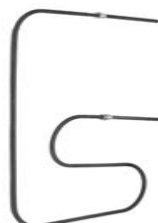

C-189



C-612



C-920



E-118



E-321



E-117



B-645

### MODEL 35 SS AND 36 REPLACEMENT PARTS

STOCK No.	MODEL	REPLACES	DESCRIPTION
G-402	35, 36	2T-Z4189	THERMOSTAT
A-2680	35	2R-Y6353	DIAL FOR G-402
A-1072	36	2R-7885	DIAL FOR G-402
C-189	35S, 178, 179, 180	A2-178023	120V HEATING ELEMENT WITH COMPRESSION FITTINGS (OLD STYLE)
C-612	35SS	2N-Y6366	120V HEATING ELEMENT WITH THREADED FITTINGS (NEW STYLE)
C-920	36	A3-36116	120V HEATING ELEMENT
E-118	35, 36	2E-8343	SWITCH - OLD STYLE
E-321	35	2E-Y6144	SWITCH - NEW STYLE
E-117	36	2E-Y3070	
B-645	35, 36	A3-35219	DRAIN CAP WITH CHAIN



# DISPLAY WARMERS/STEAMERS

## STAR SPECIFIC PARTS



G-581



A-2680



E-634



C-962



C-189

### MODELS 178A, 179A AND 180A REPLACEMENT PARTS

STOCK No.	REPLACES	DESCRIPTION
G-581	2T-Y6368	THERMOSTAT
A-2680	2R-Y6353	DIAL FOR G-581
E-634	PS-178070	SWITCH KIT
C-962	2N-Y7348	120V HEATING ELEMENT
*C-189	A2-178023	

\*C-189 IS OLD STYLE WITH COMPRESSION FITTING FOR MODELS 178, 179, 180.



G-582



A-2859



E-317  
E-318



A-2868



G-746



M-321



A-4138



G-807  
G-808

### REPLACEMENT PARTS

STOCK No.	MODEL	REPLACES	DESCRIPTION
G-582	130R	2T-6447	THERMOSTAT
A-2859		2R-9750	DIAL FOR G-582
E-317	130DIR, 138DIR, 139DIR	2J-6402	120V INFINITE HEAT SWITCH
E-318		2J-6403	240V INFINITE HEAT SWITCH
A-2868		2R-9781	DIAL FOR E-317, E-318
G-746	HFD-2, HFD-3	2T-Y9113	THERMOSTAT
M-321		2U-Y9144	FAN 115V
A-4138		2R-Y9116	DIAL
G-807	HPD, SPDE	2T-Z4666	165°F THERMOSTAT
G-808	CSD	2T-Z6504	150°F THERMOSTAT

WARMERS

# POPCORN MACHINES

## STAR SPECIFIC PARTS



E-118



E-729



E-321



E-473



A-2296



C-925



C-922



G-568



G-558



G-556



M-232



M-186

## ELECTRICAL COMPONENTS AND KNOB

STOCK No.	MODEL	REPLACES	DESCRIPTION
E-118	49, 59, 89	2E-8343	TOGGLE SWITCH
E-729	G8, G12, G14, G18	2E-Z5884	ON/OFF RED LIGHT SWITCH
E-321	39A, 49, 59, 89	2E-Y6144	PUSH SWITCH
E-473	49, 59, 89	2E-3966	ROTARY SWITCH
A-2296		2R-Y2303	KNOB FOR E-473
C-925	49, 59, 89, G8, G12	2N-Y5592	120V 1420W KETTLE HEATER
C-922	39A, 86S	2N-Y7413	120V 1000W KETTLE HEATER
G-568	49, 59, 89, G8, G12, G14, G18	2T-6213	120V. THERMOSTAT
G-558	39A, 86S	2T-Y7422	
G-556		2T-Y9419	HIGH LIMIT
M-232	49, 59, 89	C3-59049	120V. AGITATOR MOTOR
M-186	39A, 86S	2U-Y6914	

# WARMERS

## TOASTMASTER SPECIFIC PARTS

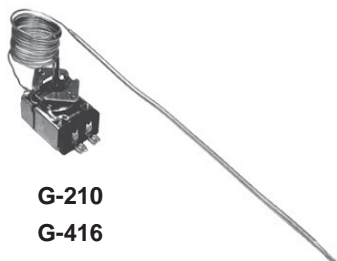

G-210  
G-416



G-212



A-246



A-2872



A-587

### THERMOSTATS AND DIALS FOR DRAWER WARMERS

STOCK No.	SPECIFICATIONS	REPLACES	COMMENTS
G-210	STYLE K	E336A8713	150-200° F THERMOSTAT
A-246	1-10 MULTI-USE	-	DIAL FOR G-210
G-416	STYLE K	3B70A8929	100-200° F THERMOSTAT
A-2872	-	A710E8737	DIAL FOR G-416
G-212	STYLE D1/D18	3B8S67	100-300° F THERMOSTAT
A-587	100-300°F FLAT RIGHT	-	DIAL FOR G-212

### INFINITE HEAT SWITCHES AND DIAL

STOCK No.	VOLTAGE	REPLACES	COMMENTS
E-174	120 VOLT	15028721	INFINITE SWITCH
E-175	240 VOLT	15028727	
A-947	-	A710E8761	DIAL FOR SWITCH



E-174  
E-175



A-947

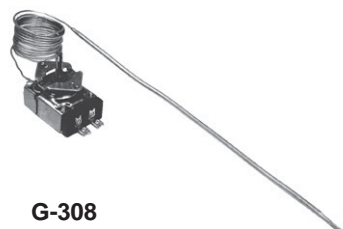

G-308



A-2938



G-599

### COMPONENTS FOR DROP IN WARMERS

STOCK No.	SPECIFICATIONS	REPLACES	DESCRIPTION
G-308	STYLE S	2662A8723	THERMOSTAT
A-2938	OFF-0-10	2100087	DIAL FOR G-308
G-599	-	7002332	HIGH LIMIT THERMOSTAT

WARMERS

# WARMERS

## TOASTMASTER SPECIFIC PARTS



C-724  
C-725



C-726

DRAWER WARMER HEATING ELEMENTS				
STOCK No.	VOLTS	WATTAGE	REPLACES	SIZE
C-724	110	500	3B82D8701	2-1/4" X 15"
C-725		675	3D8XD8701	
C-726	115	450	3A81D8701	14" X 24"



A-494



A-495



A-935



A-585  
A-3230



A-586  
A-3231

## DRAWER COMPONENT PARTS

STOCK No.	REPLACES	COMMENT	MODELS
A-494	3101758	DRAWER HANDLE	ALL MODELS
A-495	3B82D8807	SCREW FOR A-494	
A-935	3B82D0087S	DRAWER CATCH ASSEMBLY	
A-585	3B82D0067S	15-5/8" - RH DRAWER SLIDE	3A80A, 81D, 3B80A, 82D, 3B84, 3C80
A-586	3B82D0069S	15-5/8" - LH DRAWER SLIDE	
A-3230	3B22D0041S	19" - RH DRAWER SLIDE	3A20A, 3B20A, 3B22A
A-3231	3B22D0045S	19" - LH DRAWER SLIDE	

# WARMERS

## TOASTSWELL-STAR/TOMLINSON SPECIFIC PARTS

### TOASTSWELL/STAR



G-621



A-1873



C-1063  
C-942

### DRAWER WARMER COMPONENTS

STOCK No.	REPLACES	DESCRIPTION
G-621	2T-05-FW-0003	THERMOSTAT
A-1873	2R-09-07-0006	DIAL FOR G-621
C-1063	2N-05-FW-0007	10-3/4" - 115V 500W HEATING ELEMENT
C-942	2N-05-FW-0002	13" - 115V 600W HEATING ELEMENT

NOTE: 230V UNITS USE 115V ELEMENTS

### TOMLINSON



E-621



A-2828



G-576



G-575



D-348



C-315



C-946, C-948



B-793

### ECONOMY AND DELUXE FRONTIER KETTLE PARTS

STOCK No.	DESCRIPTION	REPLACES	COMMENTS
E-621	120V INFINITE SWITCH	1912206	DELUXE FRONTIER KETTLES
A-2828	INFINITE SWITCH DIAL	1915623	
G-576	LIMIT CONTROL (SNAP SWITCH)	1418348	
G-575	THERMOSTAT	1406891	ECONOMY FRONTIER KETTLES
D-348	115V SIGNAL LIGHT	1906721	DELUXE FRONTIER KETTLES
C-315	120V 750W RING HEATER	28-155-115	DELUXE FRONTIER KETTLES (OLDER UNITS)
C-948	120V 450W TUBULAR HEATER	1906888	ECONOMY FRONTIER KETTLES
C-946	120V 1250W TUBULAR HEATER	1906746	DELUXE FRONTIER KETTLES
B-793	10" DIA. ELEMENT INSULATION	1906906	FRONTIER KETTLES

WARMERS



# WARMERS

## TOMLINSON SPECIFIC PARTS



A-2820  
A-2824



A-2819



A-2823



A-2821



A-2825



A-2822  
A-2826

### LIDS, COLLARS AND INSERTS FOR DELUXE AND ECONOMY FRONTIER KETTLES

STOCK No.	DESCRIPTION	REPLACES	COMMENTS
A-2820	8 QT. LID AND HINGE	1406804	9" DIAMETER
A-2824	12 QT. LID AND HINGE	1406806	10-1/4" DIAMETER
A-2819	8 QT. LID HINGE	1906813	FOR USE ON A-2820
A-2823	12 QT. LID HINGE	1907545	FOR USE ON A-2824
A-2821	8 QT. BLACK COLLAR	1908501	13-1/4" DIA. - HOLE DIA. 8-1/4"
A-2825	12 QT. BLACK COLLAR	1908502	13-1/4" DIA. - HOLE DIA. 9-3/4"
A-2822	8 QT. S/S FOOD INSERT	1906625	8" INSIDE DIA. 9-3/4" DEEP
A-2826	12 QT. S/S FOOD INSERT	1906626	9" INSIDE DIA. 11" DEEP

# WARMERS

## VOLLRATH/IDEA-MEDALIE SPECIFIC PARTS



G-396  
G-435



G-436A



G-601A



G-574  
G-623



G-437



G-571



A-1602



A-1028



A-3192



E-831

WARMERS

## CONTROL RELATED PARTS

STOCK No.	DESCRIPTION	REPLACES	MODELS
G-435	THERMOSTAT 1-1/4" STEM 340°F	17037	SS4, TW24
G-396	THERMOSTAT 2" STEM 320°F	17109	2000, 2001, SS202, SS260
G-436A	THERMOSTAT KIT	44282	PC7, HT7
G-601A	THERMOSTAT KIT	44283	HT11, PC11, HOTSHOT 11
G-574	THERMOSTAT	17074-1	1001, 3001D, 3002D, 1776, 1777
G-437	HIGH LIMIT THERMOSTAT	17234	1777
G-571		17504	MOST MODELS
A-1602	CONTROL KNOB	17012	HT1000, HT7, HT11, PC7, PC11
A-1028		17097	2000, 2001, SS260
A-3192		23423	1001, 3001D, 3002D, 1776, 1777
G-623	THERMOSTAT	17124	SERVEWELL UNITS
E-831	TOGGLE SWITCH (LIGHTED)	23540-1	

# WARMERS

## VOLLRATH/IDEA-MEDALIE SPECIFIC PARTS

A-4314



\*C-1269  
\*C-1270



A-4317



B-989

### COMPONENT PARTS

STOCK No.	DESCRIPTION	REPLACES	MODELS
A-4314	PAN ONLY	17532	SERVEWELL UNITS
*C-1269	PAN ASSEMBLY 120V 480W	38100	
*C-1270	PAN ASSEMBLY 208/240V 800W	38303	
A-4317	DRAIN ADAPTER	17362-1	
B-989	O-RING	17365-1	

\* INCLUDES ELEMENT AND DRAIN ADAPTER WITH O-RING

## FREE FREIGHT UPGRADES!

ICS OFFERS A FREE UPGRADE TO UPS 2ND DAY AIR AT GROUND RATES FOR SHIPMENTS THAT ARE LESS THAN 20 POUNDS DIMENSIONAL WEIGHT, PROVIDING YOUR "SHIP TO" LOCATION IS 3 DAYS OR MORE FROM EITHER WAREHOUSE LOCATION.

# WARMERS/CHEESE MELTERS

## VOLLRATH/IDEA-MEDALIE & VULCAN HART SPECIFIC PARTS

### VOLLRATH/IDEA-MEDALIE

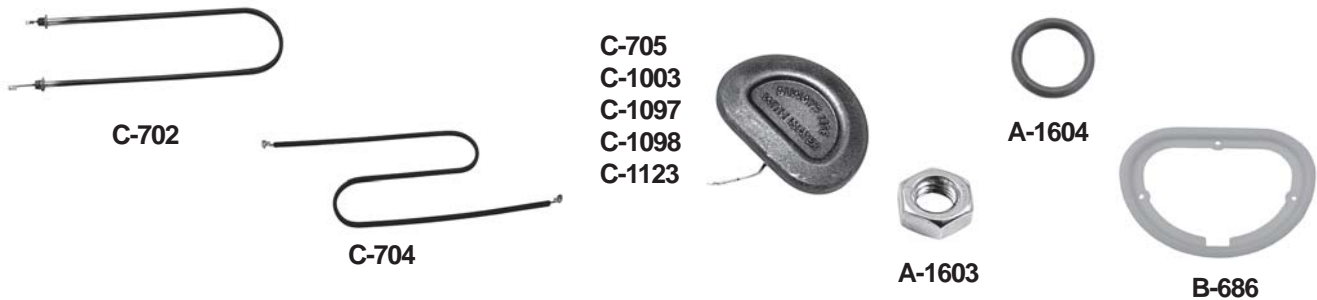

### HEATING ELEMENTS AND RELATED PARTS

STOCK No.	DESCRIPTION	REPLACES	MODELS
C-702	ELEMENT 120V 750W	17204	HT1000
C-704	ELEMENT 120V 1000W	17107	2000, 2001
*C-705		44250	PC11
*C-1123	ELEMENT 120V 800W	44287	HS-11
*C-1003	ELEMENT 120V 700W	44204	1001, 3001, 3000L
*C-1097	ELEMENT 120V 480W	44200	HT11, HOT SHOT II
*C-1098	ELEMENT 208V 700W	44227	SERVEWELL
A-1603	ELEMENT NUT	17206	HT1000
A-1604	ELEMENT O-RING	17070	
B-686	SILICONE GASKET	17021	FOR KIDNEY SHAPED HEATERS

\* KIDNEY SHAPED HEATER

### VULCAN HART



### CHEESE MELTER QUARTZ TUBES

STOCK No.	LENGTH	VOLTS	WATTAGE	REPLACES	MODELS
C-816	19-5/8"	208	1050	825300	V1048
C-817		240		825301	
C-818		208	1200	825536	V1024
C-819		240		825538	
C-800	29-1/8"	208	1800	825331	V1036
C-801		240		825332	



NOTE: WHEN REPLACING QUARTZ TUBES IT IS RECOMMENDED THAT THE SOCKETS BE REPLACED - FOR SOCKET ONLY ORDER STOCK No. D-231

WARMERS

# WARMERS

## WELLS HOT FOOD WARMERS

### BUILT-IN WARMERS WITH INFINITE CONTROLS AND 1/2" NPT DRAINS



#### ROUND FOOD WARMERS

STOCK No.	SIZE	VOLTS	WATTS	FITS OPENING
C-1196	10-1/16" - 7 QT.	120	450	9"
C-1197		208/240	338/450	
C-1198	12" - 11 QT.	120	450	11"
C-1199		208/240	338/450	



#### 12" X 20" TOP MOUNT

STOCK No.	VOLTS	WATTS	FITS OPENING
C-1200	120	1200	12-3/4" X 20-3/4"
C-1201	208/240	900/1200	



#### 12" X 20" BOTTOM MOUNT-SQUARE CORNERS

STOCK No.	VOLTS	WATTS	FITS OPENING
C-1202	208/240	900/1200	12-1/32" X 20-1/16"



#### 12" X 20" BOTTOM MOUNT-ROUND CORNERS

STOCK No.	VOLTS	WATTS	FITS OPENING
C-1203	208/240	900/1200	12-1/8" X 20-1/8"

# WARMERS

## WELLS SPECIFIC PARTS

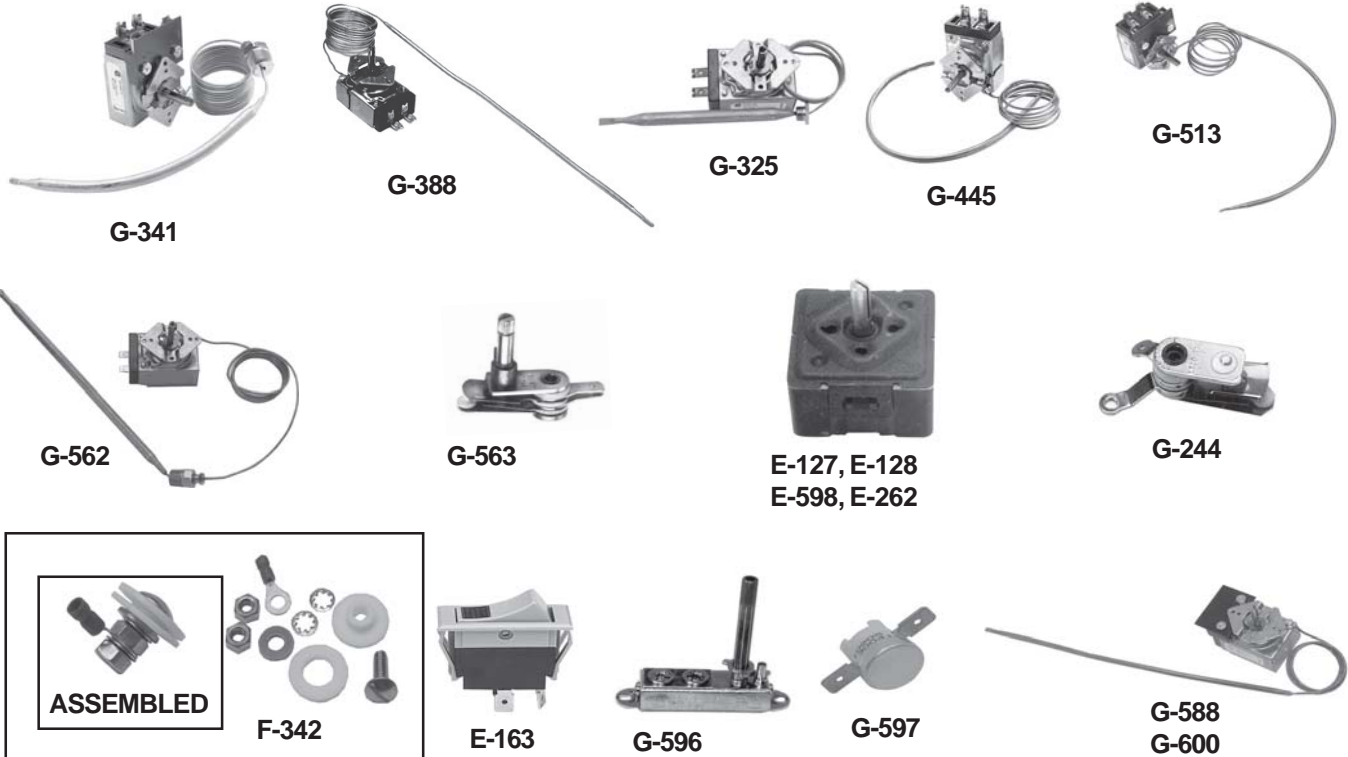

WARMERS

## CONTROL COMPONENT PARTS

STOCK No.	DESCRIPTION	REPLACES	MODELS
G-341	KA-TYPE, 3/8" STUFFING FITTING THERMOSTAT	50290	HW10, HW106
G-388	K-TYPE THERMOSTAT	58968	100T, SS206ET, SS206T, SMPT, SS100T
G-325	K-TYPE, PANEL NUT, THERMOSTAT	58936	RW
G-445	K-TYPE THERMOSTAT	60282	SS4T, 8T, 10T, HSW
G-513	KA-TYPE THERMOSTAT	66269	SS4, SS8, SS10UL
G-562	K-TYPE, 3/8" STUFFING FITTING THERMOSTAT	60509	HW, SMP
G-563	215°F THERMOSTAT	65970	LLW1220, LLCH1220, LLW4, LLW7, LLW11
E-127	120V, FLAT UP, INFINITE SWITCH	50570	H63, H70, H33, SS4, 8, 10, SW8, SMP, TMP
E-128	240V, FLAT UP, INFINITE SWITCH	50562	
E-598	120V, FLAT UP, B-CAM, INFINITE SWITCH	54594	
E-262	240V, FLAT UP, B-CAM, INFINITE SWITCH	54593	SS206, SS276
G-244	SAFETY THERMOSTAT	50374	ALL
F-342	SENSOR	503713	100TDM, 200TDM, 300TDM, 400TDM, 500TDM, 600TDM
E-163	LIGHTED ROCKER SWITCH	55127	FT200, QW24, QW36, PCI
G-596	THERMOSTAT	67496	6407, 6411, 6423
G-597	HI-LIMIT	67499	
G-588	KA THERMOSTAT 42" CAP	65917	SS206, SS276
G-600	KA THERMOSTAT 96" CAP	66551	



# WARMERS

## WELLS SPECIFIC PARTS



A-948



A-2629



A-2641



A-949



A-1028

DIALS AND KNOB		
STOCK No.	DESCRIPTION	REPLACES
A-948	FLAT UP, INFINITE DIAL	50371
A-2629	FLAT UP, 70-205°F, T-STAT DIAL	55972
*A-2641	FLATRIGHT, REVERSE INFINITE DIAL	60498
A-949	FLAT UP, REVERSE INFINITE DIAL	50372
A-1028	1/4" HOLE KNOB	65644

\* A-2641 DIAL IS USED ON SOME UNITS WITH THERMOSTATS.



D-109



D-105



D-321

SIGNAL LIGHTS		
STOCK No.	DESCRIPTION	REPLACES
D-109	240V, RED, 5/16" HOLE	-
D-105	240V, RED, 1/2" HOLE	51157
D-321	240V, RED, 5/16" HOLE	50385



A-2713, A-2714  
A-2715, A-2716



A-2633



A-3195  
A-4298



A-3418

FOOD WELL POTS AND DRAIN SCREEN		
STOCK No.	DESCRIPTION	REPLACES
A-2714	8" POT, NO DRAIN HOLE	50391
A-2716	8" POT, WITH DRAIN HOLE	50504
A-2713	10" POT, NO DRAIN HOLE	51232
A-2715	10" POT, WITH DRAIN HOLE	50392
A-2633	DRAIN SCREEN FOR A-2716, A-2715	21709
A-4298	TOP MOUNT PAN WITHOUT DRAIN FOR SS206D, 100D SERIES	50401
A-3195	TOP MOUNT PAN WITH DRAIN FOR MODELS SS206D, 100D SERIES	50402
A-3418	BOTTOM MOUNT PAN WITH DRAIN FOR SS206ETD THERMOSTAT MODELS ONLY	62604

# WARMERS

## WELLS SPECIFIC PARTS



A-3414



A-2405



A-3615



A-3420



A-3421



A-3779

<b>DRAWER WARMER COMPONENTS (RW SERIES)</b>		
STOCK No.	DESCRIPTION	REPLACES
A-3414	DRAWER CATCH	50471
A-2405	ROLLER BEARING (SOLD EACH)	50483
A-3615	DRAWER STOP (SINGLE)	55988
A-3420	DRAWER STOP KIT (RW-STD)	65337
A-3421	DRAWER STOP KIT (RW-HD)	65923
A-3779	DRAWER HANDLE	52112



F-342



F-466



H-1363

<b>WARMERS WITH LOW WATER CONTROL</b>		
STOCK No.	DESCRIPTION	REPLACES
F-342	LOW WATER SENSOR	503713
F-466	LOW WATER CONTROL	67444
H-1363	240V SOLENOID VALVE	66529

WARMERS

# WARMERS

## WELLS SPECIFIC PARTS



C-487, C-488  
C-872, C-873



C-404  
C-607



C-926  
C-927

### HEATING ELEMENTS

STOCK No.	VOLTAGE	WATTAGE	SPECIFICATIONS	REPLACES	MODELS
C-487	120	450	6" ROUND	50353	SS8, SS10, SW8, SW10
C-488	230			506275	
C-872	120	825		506272	SS4, 8, 10, HSW, SW8, 10
C-873	240			60408	
C-404	120	1650	9" ROUND	55693	HW10, HW106
C-607	240			55967	
C-926	120	450	6" ROUND ELEMENT KIT	50387	SS4, 8, 10
C-927	240			50389	

**WE SPECIALIZE IN HARD TO FIND PARTS!  
OUR CUSTOMER SERVICE REPRESENTATIVES ARE  
AVAILABLE TO ASSIST YOU IN LOCATING MOST ANY  
PART YOU NEED.**

**800-243-1290**

# WARMERS

## WELLS SPECIFIC PARTS



C-188, C-211  
C-613, C-614  
C-928



C-933  
C-934  
C-1267



C-1102



A-3961



C-929  
C-930  
C-1131  
C-1188



C-931  
C-932



C-1006  
C-1007



A-3233



A-3234

WARMERS

## HEATING ELEMENTS, CLIPS AND COVER

STOCK No.	VOLTAGE	WATTAGE	SPECIFICATIONS	REPLACES	MODELS
C-188	120	1200	15-1/2" X 7-1/2"	50396	SS206, SS276, SMP, TMP
C-211	240			50398	
C-613	120			60454	
C-614	240			60409	
C-933	120			66681	
C-1267	208	1650	17-1/2" X 8-1/2"	500166	
C-934	240			503375	
C-928	120	900	13-1/2" X 7-1/2"	50465	TMP
C-1102		750	13" X 2-1/8"	65431	HMP-6
A-3961	-	-	16-1/4" X 4"	61462	
C-929	240	450	22-1/4" X 11"	50482	RW, RWN, RWHD
C-930	120			50519	
C-931	240	1800	18-3/4" X 11"	60456	HW/SMP
C-932				60457	
C-1006	120	1200	11-3/4" X 16-1/2" ELEMENT KIT	64486	SS206, 276
C-1007	240			64485	
*A-3233	-	-	SHORT ELEMENT CLIPS	50397	MOST MODELS
*A-3234			LONG ELEMENT CLIPS	50467	SS206, SS276
C-1131	120	1200	17-1/2" X 7-3/4"	66131	BMW-206
C-1188	240			66660	SS206, 276, LLW-1220, LLCH1220

\*A-3233 AND A-3234 ARE SOLD IN PACKS OF 6.

# WARMERS

## WITTCO SPECIFIC PARTS



G-778



G-779



G-780



G-781



E-868



M-353



M-354

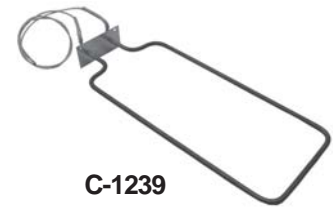

C-1239

### ELECTRICAL COMPONENT PARTS

STOCK No.	DESCRIPTION	REPLACES
G-778	THERMOSTAT	WP-110
G-779	CONTROLLER	AD-247-2000-2
G-780	THERMOSTAT	AD-251-0000-0
G-781	HI LIMIT	AD-241-1000-0
E-868	ROCKER SWITCH	AD-212-0000-0
M-353	COOLING FAN	AD-305-2000-0
M-354	BLOWER MOTOR 208/240V	AD-301-2000-0
C-1239	ELEMENT 120V 600W	WP-104-1



A-4176



J-188



A-1022



A-4165



B-1014

### MECHANICAL COMPONENT PARTS

STOCK No.	DESCRIPTION	REPLACES
A-4176	KNOB	WP-242
J-188	THERMOMETER 20-220°F	WP-109
A-1022	DOOR LATCH	WP-107
A-4165	DOOR LATCH W/KEY	AD-134-0000-0
B-1014	DOOR GASKET (SOLD BY THE FOOT)	WP-302