

Getting Started

© 2008 Autodesk, Inc. All rights reserved. Except as otherwise permitted by Autodesk, Inc., this publication, or parts thereof, may not be reproduced in any form, by any method, for any purpose.

Certain materials included in this publication are reprinted with the permission of the copyright holder.

Trademarks

The following are registered trademarks or trademarks of Autodesk, Inc., in the USA and other countries: 3DEC (design/logo), 3December, 3December.com, 3ds Max, ActiveShapes, Actrix, ADI, Alias, Alias (swirl design/logo), AliasStudio, AliasWavefront (design/logo), ATC, AUGI, AutoCAD, AutoCAD Learning Assistance, AutoCAD LT, AutoCAD Simulator, AutoCAD SQL Extension, AutoCAD SQL Interface, Autodesk, Autodesk Envision, Autodesk Insight, Autodesk Intent, Autodesk Inventor, Autodesk Map, Autodesk MapGuide, Autodesk Streamline, AutoLISP, AutoSnap, AutoSketch, AutoTrack, Backdraft, Built with ObjectARX (logo), Burn, Buzzsaw, CAiCE, Can You Imagine, Character Studio, Cinestream, Civil 3D, Cleaner, Cleaner Central, ClearScale, Colour Warper, Combustion, Communication Specification, Constructware, Content Explorer, Create>what's>Next> (design/logo), Dancing Baby (image), DesignCenter, Design Doctor, Designer's Toolkit, DesignKids, DesignProf, DesignServer, DesignStudio, DesignStudio (design/logo), Design Your World, Design Your World (design/logo), DWF, DWG, DWG (logo), DWG TrueConvert, DWG TrueView, DXF, EditDV, Education by Design, Extending the Design Team, FBX, Filmbox, FMDesktop, Freewheel, GDX Driver, Gmax, Heads-up Design, Heidi, HOOPS, HumanIK, i-drop, iMOUT, Incinerator, IntroDV, Inventor, Inventor LT, Kaydara, Kaydara (design/logo), LocationLogic, Lustre, Maya, Mechanical Desktop, MotionBuilder, ObjectARX, ObjectDBX, Open Reality, PolarSnap, PortfolioWall, Powered with Autodesk Technology, Productstream, ProjectPoint, Reactor, RealDWG, Real-time Roto, Render Queue, Revit, Showcase, SketchBook, StudioTools, Topobase, Toxik, Visual, Visual Bridge, Visual Construction, Visual Drainage, Visual Hydro, Visual Landscape, Visual Roads, Visual Survey, Visual Syllabus, Visual Toolbox, Visual Tugboat, Visual LISP, Voice Reality, Volo, and Wiretap.

The following are registered trademarks or trademarks of Autodesk Canada Co. in the USA and/or Canada and other countries: Backburner, Discreet, Fire, Flame, Flint, Frost, Inferno, Multi-Master Editing, River, Smoke, Sparks, Stone, Wire.

All other brand names, product names or trademarks belong to their respective holders.

Disclaimer

THIS PUBLICATION AND THE INFORMATION CONTAINED HEREIN IS MADE AVAILABLE BY AUTODESK, INC. "AS IS." AUTODESK, INC., DISCLAIMS ALL WARRANTIES, EITHER EXPRESS OR IMPLIED, INCLUDING BUT NOT LIMITED TO ANY IMPLIED WARRANTIES OF MERCHANTABILITY OR FITNESS FOR A PARTICULAR PURPOSE REGARDING THESE MATERIALS.

Published by:

Autodesk, Inc.

111 McInnis Parkway

San Rafael, CA 94903, USA

Contents

	Make the Transition from Paper to CAD	1
	Draw to Scale	3
	Lay Out Your Drawing	5
	Organize Drawing Information	7
	Establish Drafting Standards	9
	Draw Efficiently	11
	Draw Accurately	13
	View Your Drawing	15
	Create Dimensions and Text	17
	Modify Your Drawing	19
Chapter 1	Introduction	21
	Why You Should Use this Guide.	22
	Tutorials and Command Access	22
	Get Additional Information	23
Chapter 2	Work with Commands	29
	Use the Mouse	30
	Cancel a Command.	30
	Start a Command	30
	Undo or Redo Commands.	34
Chapter 3	Change Views	37
	Zoom to Magnify a View	38
	Pan to Reposition a View	39
Chapter 4	Drawing Setup.	43
	Start a Drawing	44
	Plan the Drawing Units and Scale	46
	Understand Models and Layouts.	48
	Organize Drawings with Layers	50
	Tutorial: Tour a Drawing	52

Chapter 5	Draw Objects	55
	Object Properties Overview	56
	Draw Lines	64
	Draw Circles and Arcs	67
Chapter 6	Precision Drawing	71
	Set Grid and Snap Values	72
	Draw with Coordinates	74
	Snap to Precise Points on Objects	76
	Object Snap Descriptions	78
	Specify Angles and Distances	79
Chapter 7	Make Modifications	85
	Select Objects to Edit	86
	Erase, Extend, and Trim Objects	87
	Duplicate Objects	90
	Move and Rotate Objects	93
	Fillet Corners	94
	Use Editing Aids	109
	Analyze Drawings	111
Chapter 8	Add Symbols and Hatches	115
	Overview of Blocks	116
	Insert Blocks	117
	Overview of Hatches	119
	Insert Hatches or Solid Fills	120
Chapter 9	Add Text to a Drawing	125
	Create and Modify Text	126
	Work with Text Styles	128
	Set Text Size for the Viewport Scaling	129
Chapter 10	Add Dimensions	133
	Dimensions Overview	134
	Create Dimensions	135
	Use Dimensioning Options	138
	Create and Modify Dimension Styles	140
	Modify Dimensions	142

Chapter 11	Create Layouts and Plots	.147
	Work with Layouts	148
	Choose and Configure Plotters	151
	Plot from a Layout	153
	Glossary	.159
	Index	.169

Make the Transition from Paper to CAD

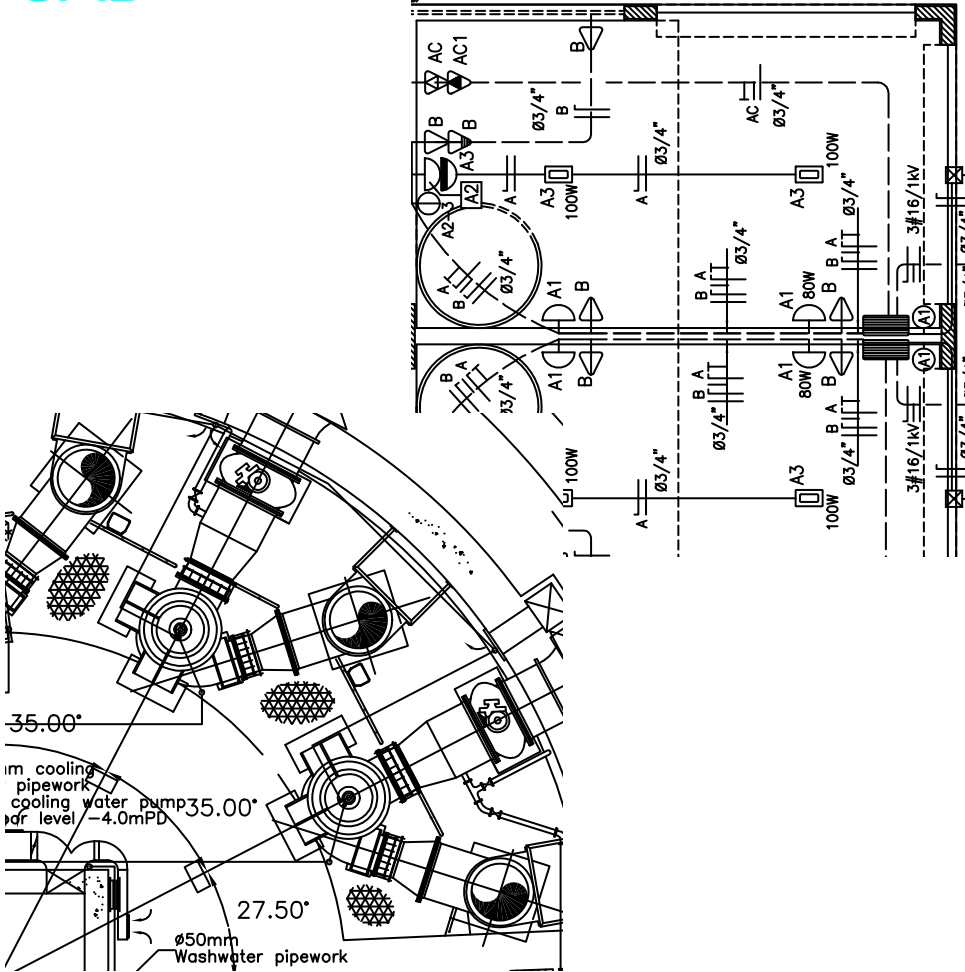

Intro

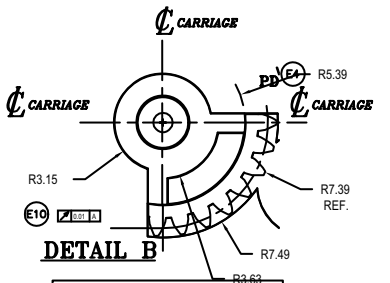

DETAIL B

TABLE 1	
GEAR DATA	
GEAR TYPE	SPUR
TOOTH FORM	25° FULL DEPTH INVOLUTE
PITCH(CIRC)	1.6(.063)
PITCH(DIAM)	1.96(.077)
PITCH DIA	13.77(.542)
NO. OF TEETH	8
O.D.	14.79(.582)
ADDENDUM	.51(.020)
DEDENDUM	.64(.025)

- 3D MODEL IS THE MASTER. -

THIS DRAWING IS BASED ON A PARAMETRIC MODEL WHICH WILL BE USED TO INSPECT THE FINISHED PART. PARTING LINES AND DRAFT MUST BE IN ACCORD WITH THIS DRAWING FOR ACCEPTANCE.

- DENOTES ORIGINAL "RELEASED FOR PRODUCTION" DIMENSIONS AND ARE RELATED TO CUSTOMER MOUNTING OR MATING PARTS.
 XXX - DENOTES DIMENSIONS THAT WERE ADDED TO FULLY DIMENSION THE DRAWING.

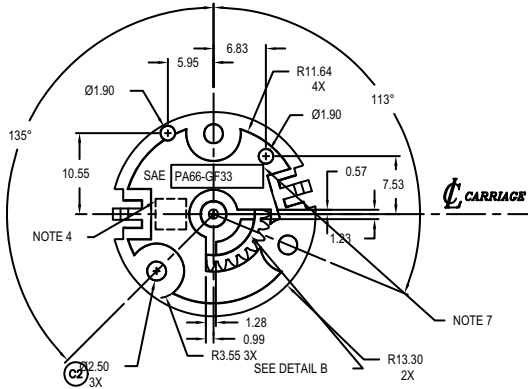

- NOTES:**
- MATERIAL: POLYAMIDE THERMOPLASTIC (NYLON) TYPE 6-6, 33% SHORT GLASS FIBER FILLED: DUPONT ZYTEL 70G-33-HS1-L OR INDAK ENGINEERING APPROVED EQUIVALENT. MAXIMUM ALLOWABLE REGRIND SHALL BE 10%.
 FORD SPEC ESE-M4D287-A
 COLOR: NATURAL
 - UNLESS OTHERWISE SPECIFIED, TOLERANCES INCLUDE ALLOWABLE DRAFT.
 - GATE, PARTING LINE, EJECTOR PIN, CAVITY SYMBOL AND MATERIAL IDENTIFICATION MARKING LOCATIONS SHALL BE APPROVED BY INDAK ENGINEERING BEFORE MOLD CONSTRUCTION IS BEGUN.
 - FOR MOLDS OF MORE THAN ONE CAVITY, PART MUST BEAR CAVITY SYMBOL IN AREA NOTED. CAVITY SYMBOL MAY BE FLUSH TO 0.25 RECESSED.
 - PARTS SHALL BE DIMENSIONALLY STABLE AS RECEIVED.
 - MATERIAL IDENTIFICATION MARKING, PER LATEST REVISION OF SAE J1344, SHALL BE MOLDED INTO PART IN AREA NOTED. CHARACTERS SHALL BE 1.25 X 0.25 RAISED. SYMBOL FRAME SHALL BE 3.0 X 12.0 LONG.
 - NOTED DIMENSIONS ARE TO SHARP CORNER INTERSECTION OF LINES.
 - PROVIDE INSERT IN MOLD PER DIMENSIONS SHOWN TO FACILITATE FUTURE SHAFT VARIATIONS. SUCH VARIATIONS MUST BE READILY INTERCHANGEABLE.
 - PARTS MUST MEET THE FOLLOWING FORD WSS-M15P4-E SPECIFICATIONS:
 FOGGING - SAE J1756
 COLOR - SAE J1351/FLTM BO 131-01
 FLAMMABILITY - ISO 3795/SAE J369

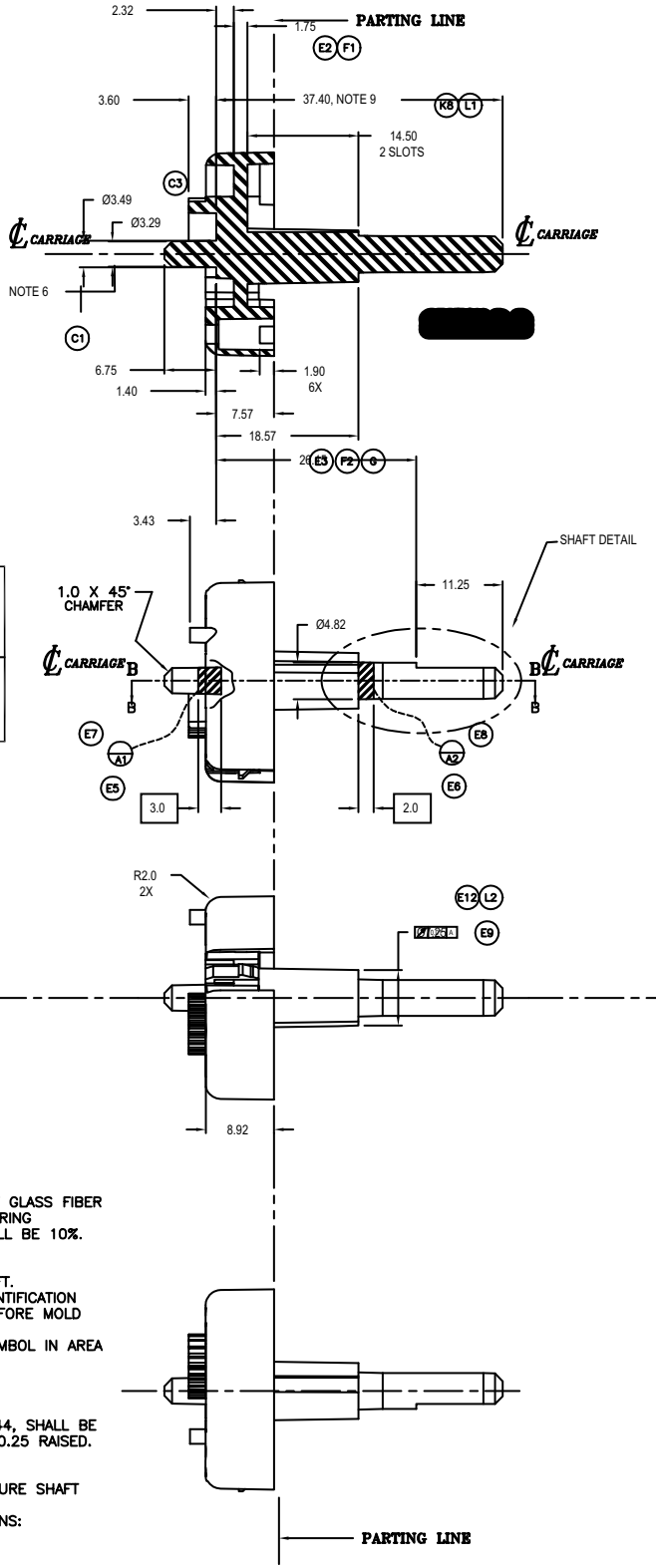

Draw to Scale

Drawing scale is something you consider when laying out your drawing. You establish scale differently in CAD than you do with manual drafting.

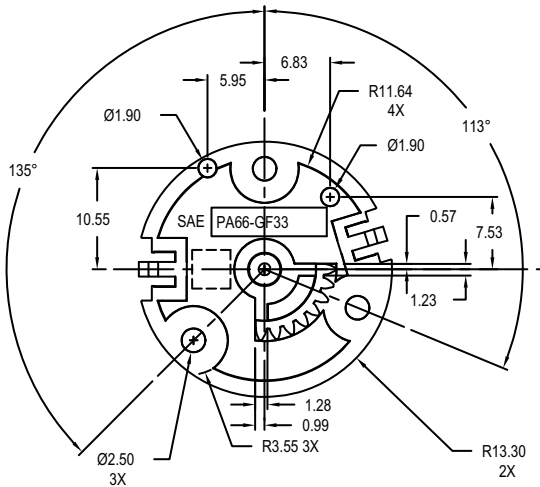

Draw the object at 1:1 scale in the units you choose.

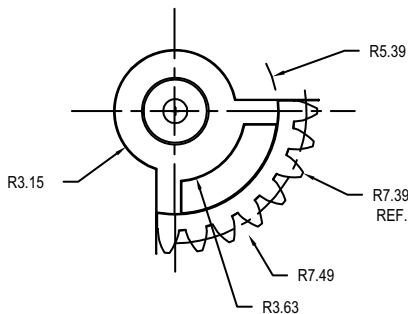

When you lay out and plot your drawing, you can specify any scale.

With manual drafting, you must determine the scale of a view before you start drawing. This scale compares the size of the actual object to the size of the model drawn on paper.



With AutoCAD and AutoCAD LT, you first decide what units of measurement you will use, and then draw your model at 1:1 scale.



For example, when you draw a motor part, the length of one unit might equal one millimeter or one inch. When you draw a map, one unit might equal one kilometer or one mile.

This drawing of a mechanical carriage uses millimeters for the length of one unit. Views of the part were scaled later to create the layout for the printed drawing.

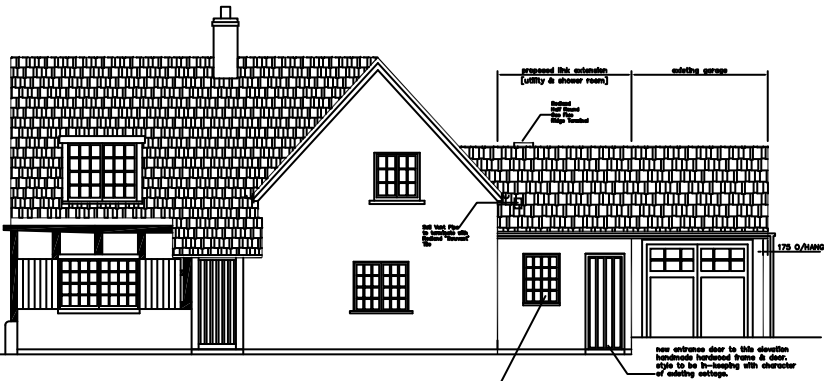

PROPOSED ELEVATION 'A-A' [SOUTH].

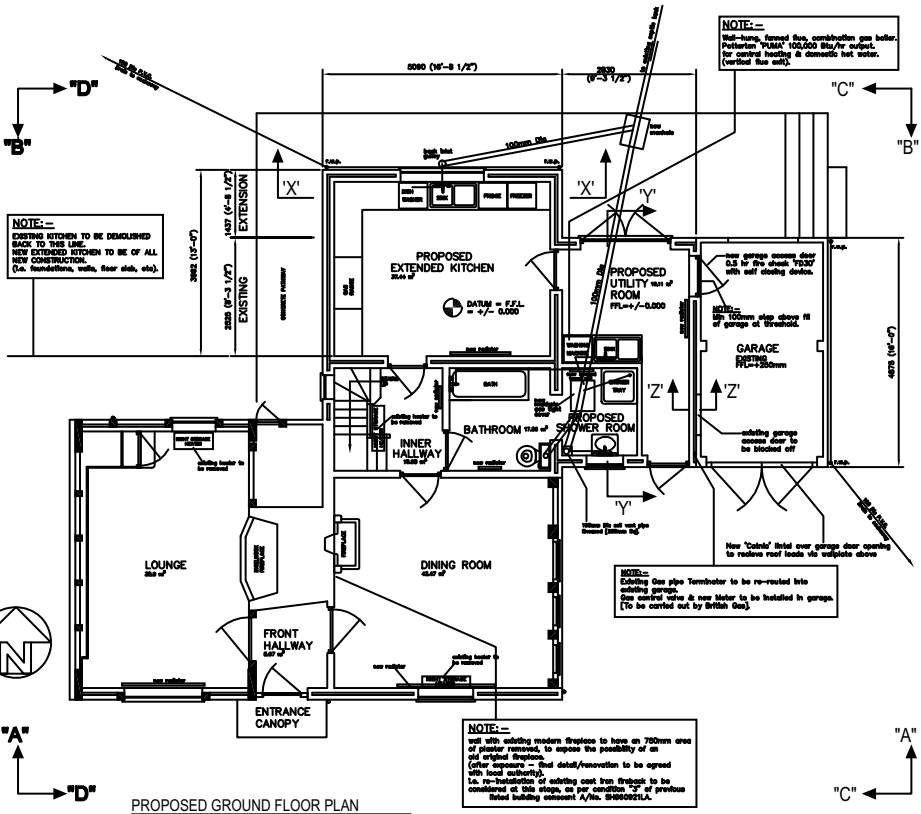

PROPOSED GROUND FLOOR PLAN

project no.
contract
drawing title

Lay Out Your Drawing

On paper, a layout is constrained by the sheet size you use. In CAD, you are not limited to one particular layout or sheet size.

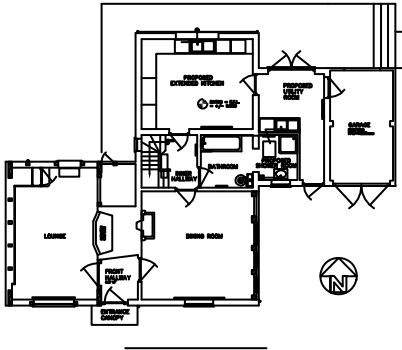

You create your basic design, or model, in a drawing area called *model space*.

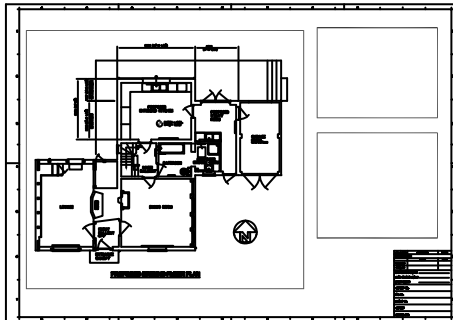

When you're ready to print, you can arrange different views of your model in a layout.

When you draft manually, you first select a sheet, which usually includes a preprinted border and title block. Then you determine the location for views—plans, elevations, sections, and details. Finally, you start to draw.



With AutoCAD and AutoCAD LT, you first draw your design, or model, in a working environment called *model space*. You can then create a layout for that model in an environment called *paper space*.



A layout represents a drawing sheet. It typically contains a border, title block, dimensions, general notes, and one or more views of the model displayed in layout viewports. *Layout viewports* are areas, similar to picture frames or windows, through which you can see your model. You scale the views in viewports by *zooming* in or out.

In this drawing of a cottage, layout viewports display the model in plan and elevation views.

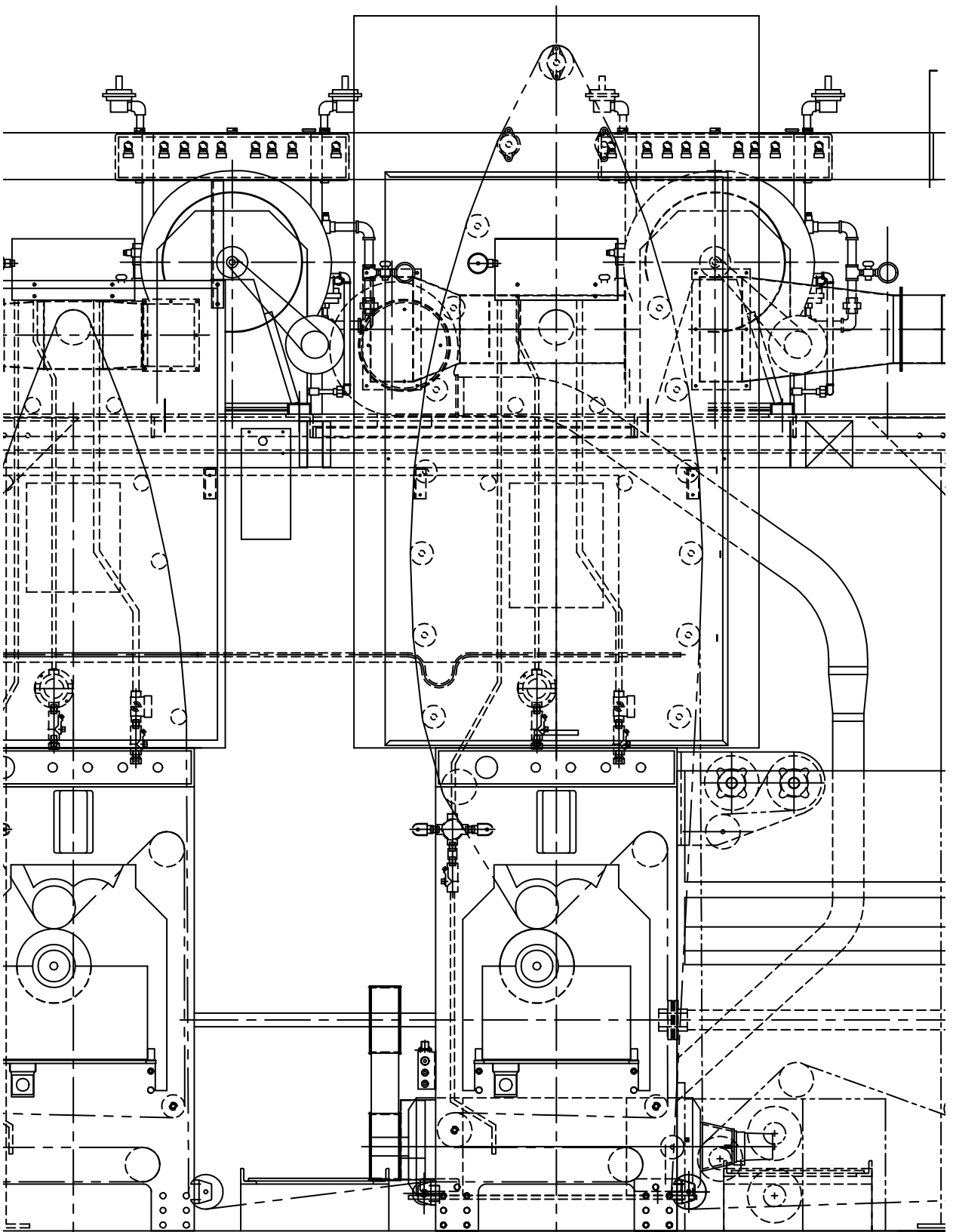

Organize Drawing Information

In both manual drafting and CAD, you need a way to organize your drawing content—a method for separating, sorting, and editing specific drawing data.

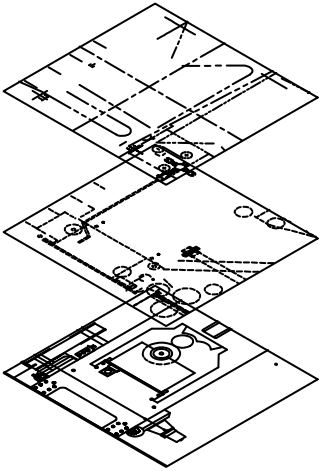

Turn off layers to hide complex details as you work.

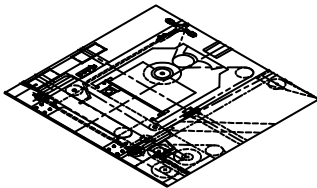

Display layers when you need to see all components.

With manual drafting, you can separate information onto individual transparent overlays. For example, a building plan might contain separate overlays for its structural, electrical, and plumbing components.



With AutoCAD and AutoCAD LT, *layers* are equivalent to transparent overlays. As with overlays, you can display, edit, and print layers separately or in combination.



You can name layers to help track content, and lock layers so they can't be altered. Assigning settings such as *color*, *linetype*, or *lineweight* to layers helps you comply with industry standards.

You can also use layers to organize drawing objects for plotting. Assigning a *plot style* to a layer makes all the objects drawn on that layer plot in a similar manner.

This drawing of a press uses layers to define different linetypes and colors.

LENA ROAD

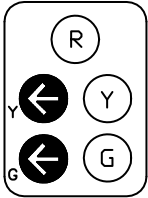

DETAIL "A"
ND SCALE

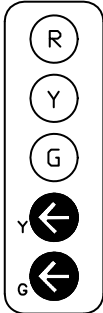

DETAIL "B"
ND SCALE

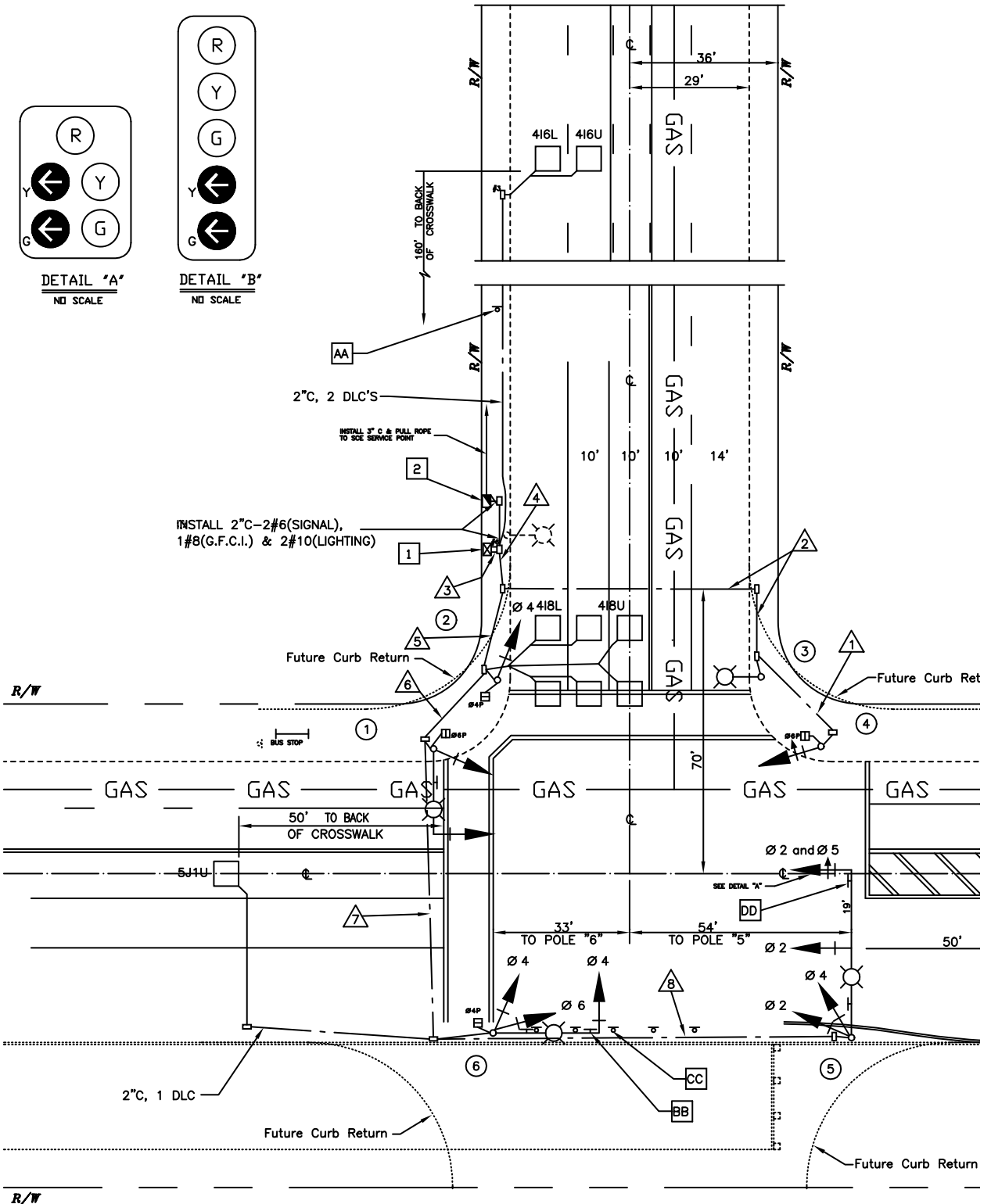

R/W

Establish Drafting Standards

Whether you work as a member of a team or on an individual project, developing standards is a requirement for efficient communication.

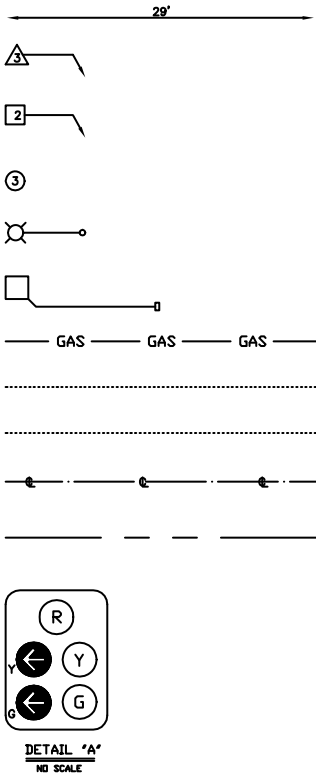

Dimension, text, and linetype styles can be established in a template drawing and used for creating new drawings.

Manual drafting requires meticulous accuracy in drawing linetypes, lineweights, text, dimensions, and more. Standards must be established in the beginning and applied consistently.



With AutoCAD and AutoCAD LT, you can ensure conformity to industry or company standards by creating styles that you can apply consistently.



You can create styles for text, dimensions, and linetypes. A text style, for example, establishes font and format characteristics such as height, width, and slant.

You can save styles, layers, layouts, title block and border information, and some command settings in *drawing template files*. Using drawing templates helps you quickly start new drawings that conform to standards.

This drawing of a roadway plan uses styles to maintain drafting standards for text, dimensioning, and linetypes.

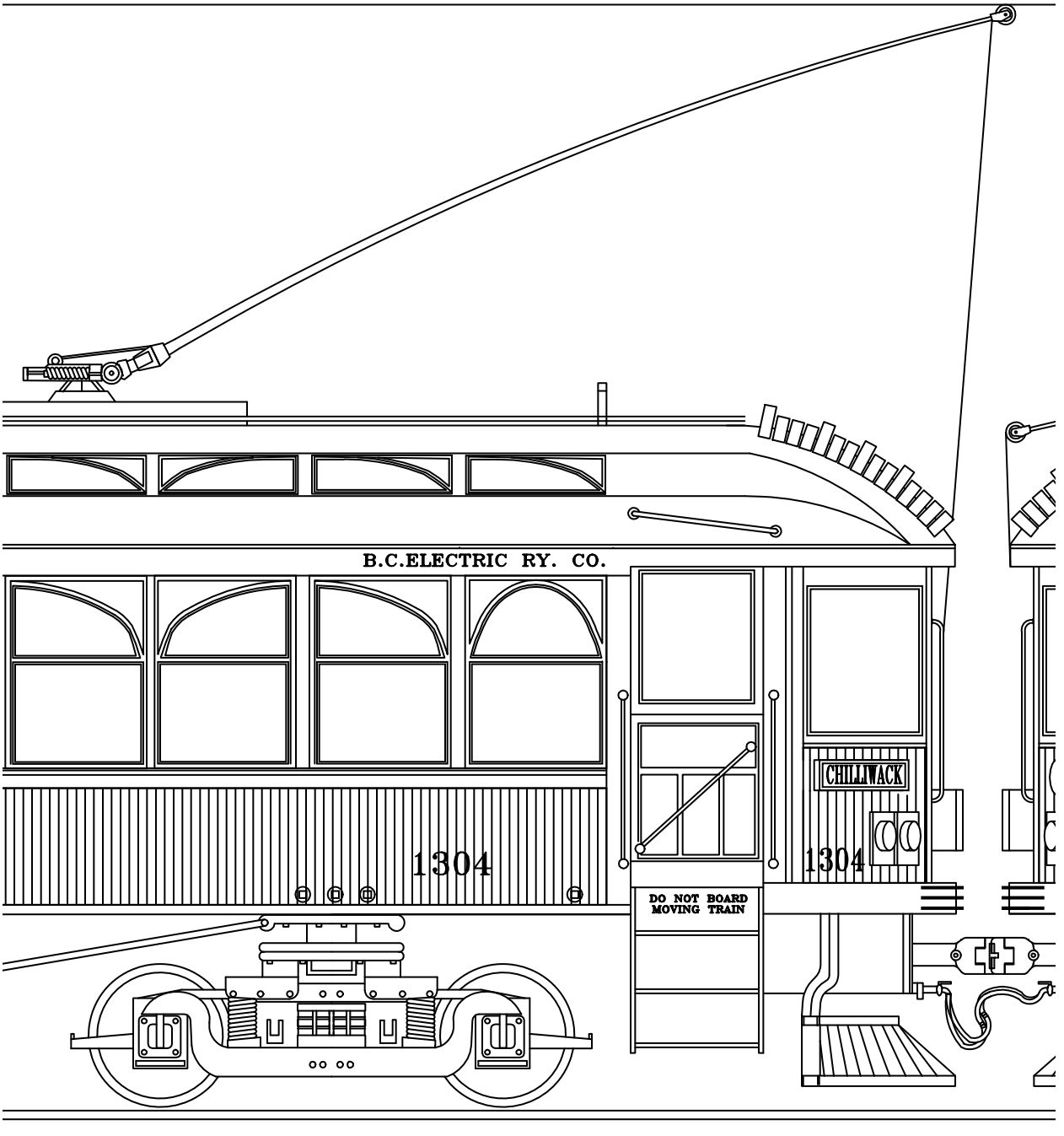

B.C.ELECTRIC RY. CO.

1304

1304

CHILLWACK

DO NOT BOARD
MOVING TRAIN

Ray Parker

Draw Efficiently

Draw with less effort and revise with more speed: these are two primary reasons you use CAD. You are provided with a complete set of drawing and editing tools to help eliminate repetitive, time-consuming drafting tasks.

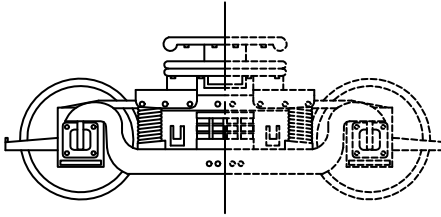

You can save drafting time by drawing one half of an item and then mirroring it to create the other half.

With manual drafting, you use drawing tools that include pencils, scales, compasses, parallel rules, templates, and erasers. Repetitive drawing and editing tasks must be done manually.

In AutoCAD and AutoCAD LT, you can choose from a variety of drawing tools that create lines, circles, spline curves, and more.

You can easily move, copy, offset, rotate, and mirror objects. You can also copy objects between open drawings.

In this drawing of a trolley, copying and mirroring were used to create repeated and symmetrical features. Offsetting was also used to draw parallel lines more efficiently.



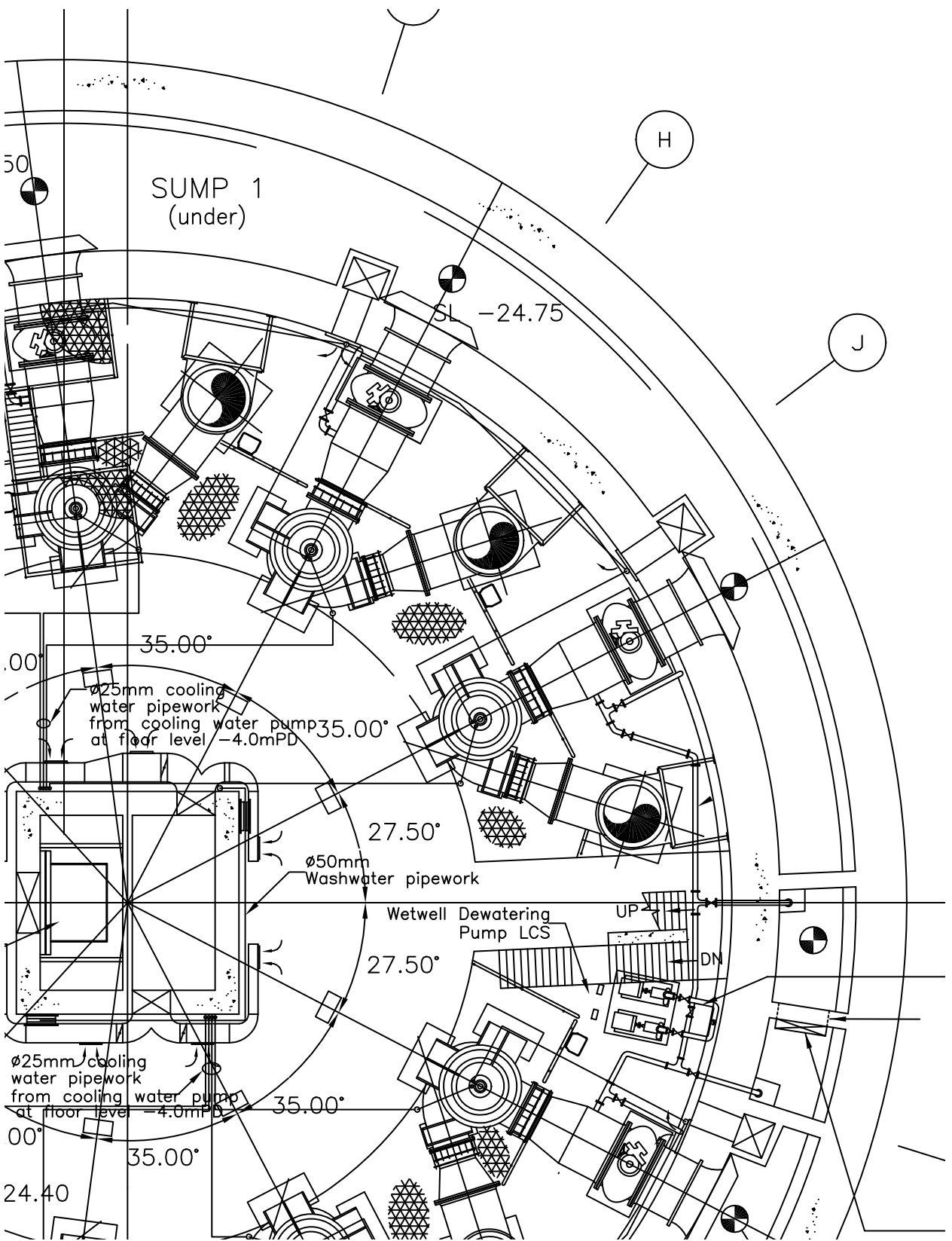

SUMP 1
(under)

H

J

SL -24.75

35.00°

ø25mm cooling
water pipework
from cooling water pump
at floor level -4.0mPD

35.00°

27.50°

ø50mm
Washwater pipework

Wetwell Dewatering
Pump LCS

UP

DN

27.50°

ø25mm cooling
water pipework
from cooling water pump
at floor level -4.0mPD

35.00°

35.00°

24.40

Draw Accurately

Engineering and architectural drawings require a high degree of accuracy. With CAD, you draft more accurately than with manual methods.

With object snaps, when you place your cursor here...

you can snap to the center point automatically.

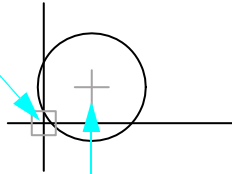

With manual drafting, you must draw objects carefully to ensure correct size and alignment. Objects drawn to scale must be manually verified and dimensioned.



With AutoCAD and AutoCAD LT, you can use several methods to obtain exact dimensions.

The simplest method is to locate points by snapping to an interval on a rectangular grid.



Another method is to specify exact *coordinates*. Coordinates specify a drawing location by indicating a point along an *X* and *Y* axis or a distance and angle from another point.

With *object snaps*, you can snap to locations on existing objects, such as an endpoint of an arc, the midpoint of a line, or the center point of a circle.

With *polar tracking*, you can snap to previously set angles and specify distances along those angles.

In this drawing of a pumping station, *object snaps* were used to ensure that lines connected perfectly. *Polar tracking* was used to draw lines at correct angles.

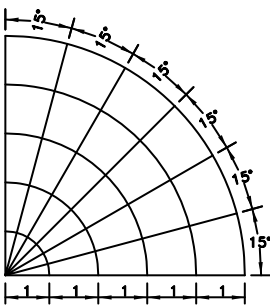

The polar tracking feature displays visual guidelines at specific angles and can snap the cursor to an angle.

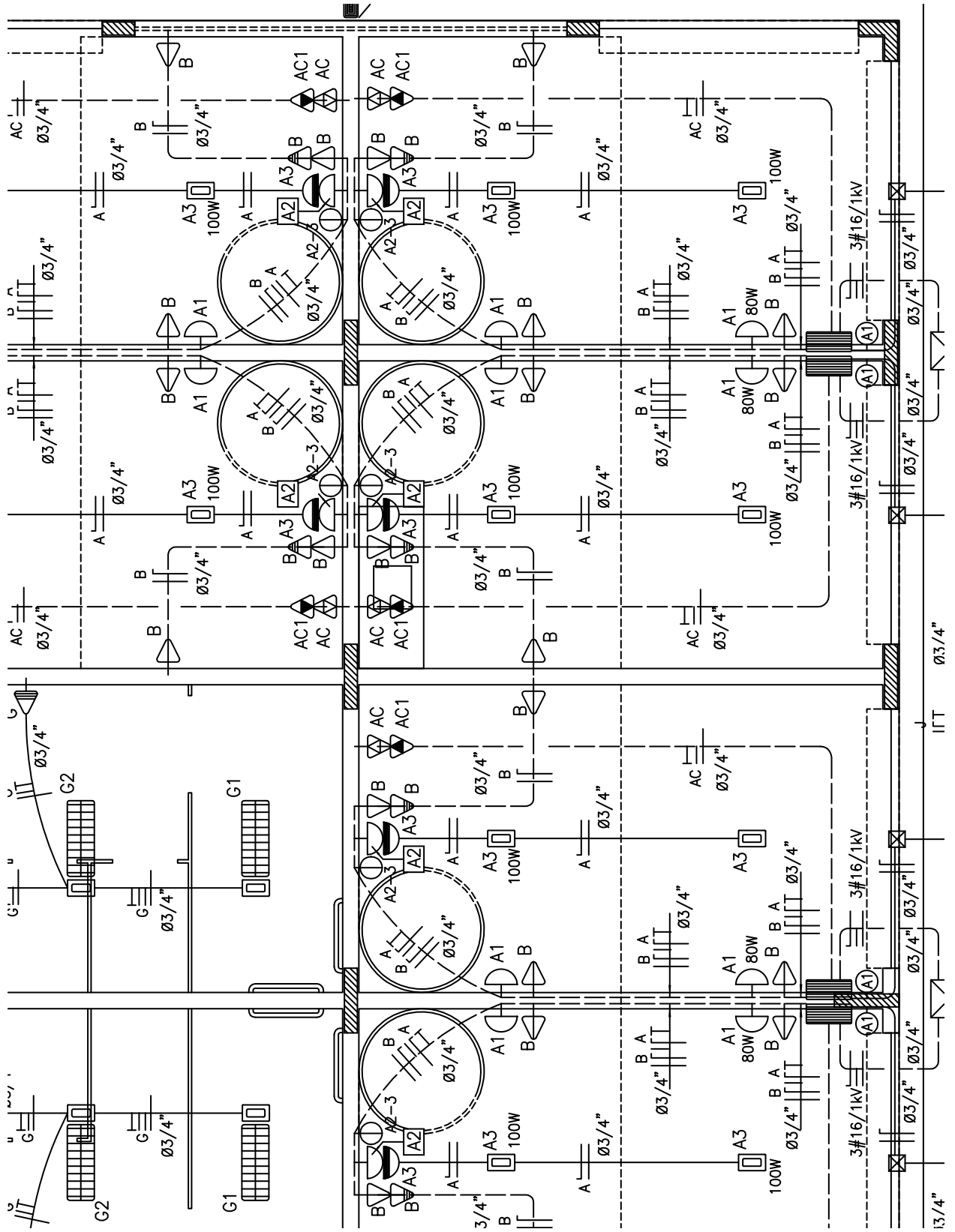

View Your Drawing

The power of CAD makes it easy for you to quickly view different parts of your design at different magnifications.

You can zoom out to see more of your design, or zoom in to see more detail.

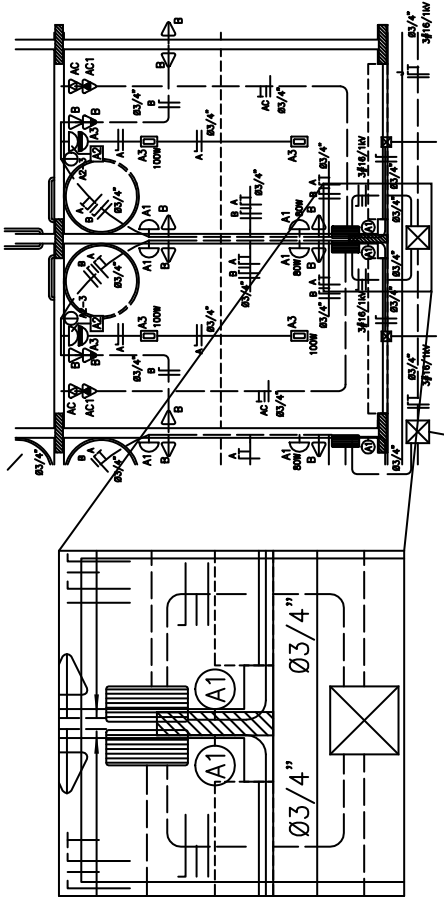

You can pan to shift to another area of your design.

With manual drafting, the size and resolution of your drawing is fixed.

With AutoCAD and AutoCAD LT, the size and resolution of your drawing can be changed as needed.

To do detailed work, you can increase display size by *zooming* in. You can zoom out to display more of the drawing. To move to another section of a drawing, you *pan* the drawing without changing magnification.

You can zoom and pan to create the best working conditions. This can be invaluable when working on large and detailed drawings, such as this health spa plan.



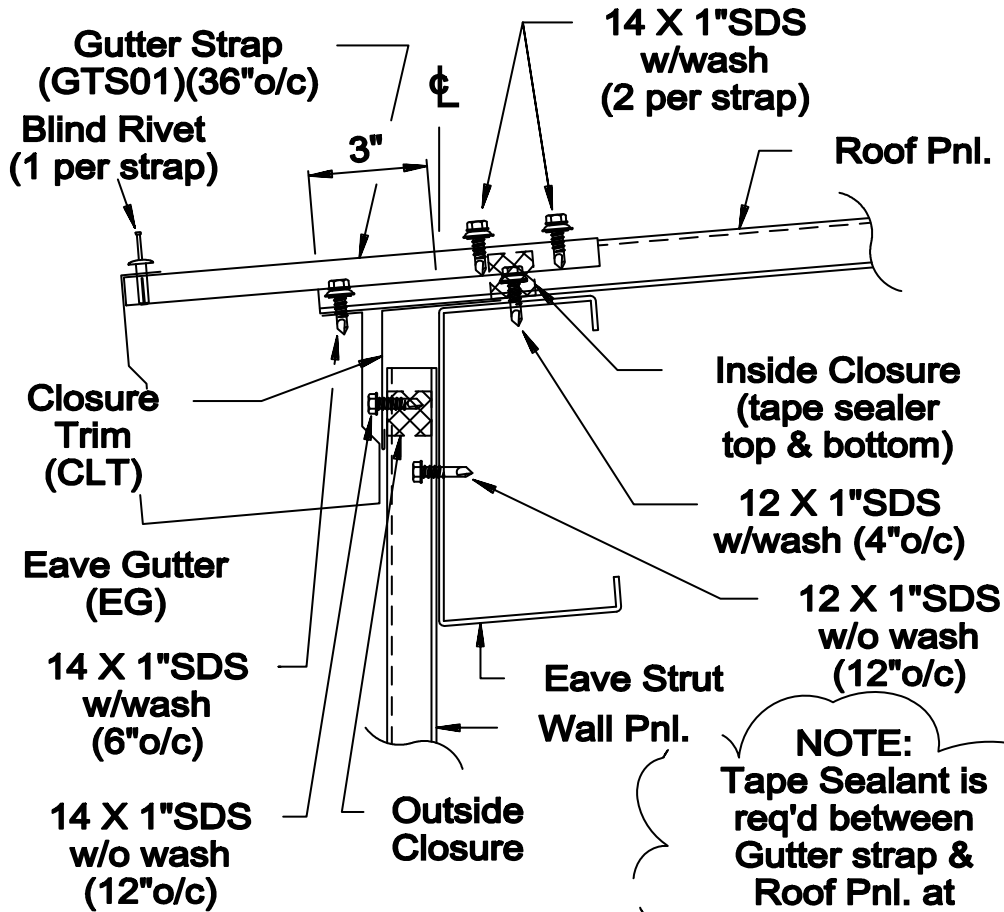

NOTE:
Tape Sealant is req'd between Gutter strap & Roof Pnl. at Screw Locations

NOTES:

1. Field Trim Both Flanges of Inside Gutter Section as Shown.
2. Apply 1/4" Bead of Sealant 2" From Outer Edge on Outer Section.
3. Place Gutter Sections Together with 2" Lap.
4. Secure Gutter Sections Together with Pop Rivets.

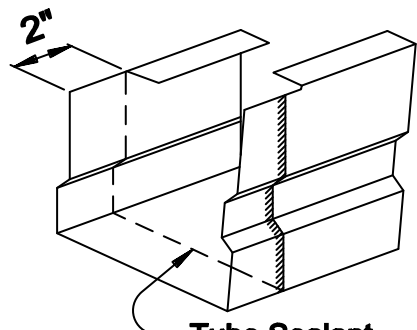

Tube Sealant Gutter Splice Assembly

PL105

Create Dimensions and Text

Creating accurate dimensions and consistent, legible text is a time-consuming task for the manual drafter. CAD provides ways to streamline this task.

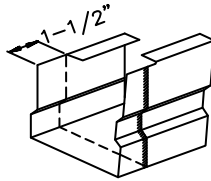
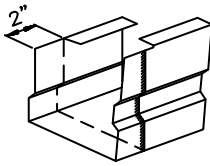

If you make dimensions associative, you can update the dimension size and value automatically when you stretch or scale the dimensioned object.

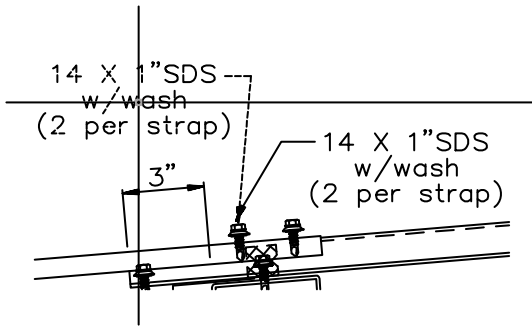

You can create leader lines with associated text. If you move the text, the leader is adjusted automatically.

With manual drafting, if you resize any part of the drawing, you must erase and then redraw the dimensions. Changing text can often involve relettering the whole drawing.



With AutoCAD and AutoCAD LT, you create *associative dimensions* and text on the layout in paper space.



Associative dimensions are tied to the underlying model. Changes to the model automatically update the dimension values.

Standard types of dimensions include linear, radial, ordinate, angular, baseline, and more.

You can easily revise the content, font, size, spacing, and rotation of text in dimensions and notes.

In this detail drawing of a gutter, the text, leaders, and dimensions describe the required hardware.



Modify Your Drawing

Revisions are a part of any drawing project. Whether you work on paper or with CAD, you will need to modify your drawing in some way.

On paper, you must erase and redraw to make revisions to your drawing manually.

CAD eliminates tedious manual editing by providing a variety of editing tools. If you need to copy all or part of an object, you don't have to redraw it. If you need to remove an object, you can erase it with a few clicks of the mouse. And if you make an error, you can quickly undo your actions.

Once you draw an object, you never need to redraw it. You can modify existing objects by mirroring, rotating, scaling, stretching, trimming, and more. You can also change object properties, such as linetype, lineweight, color, and layer, at any time.

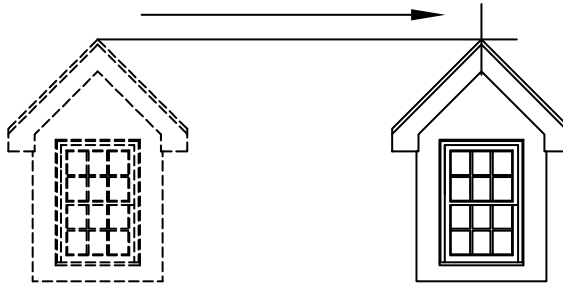

Once you draw something, you can easily copy it without having to re-create it.

These before-and-after drawings show some typical edits to a house elevation. The *revision cloud* feature is used to mark areas of change.

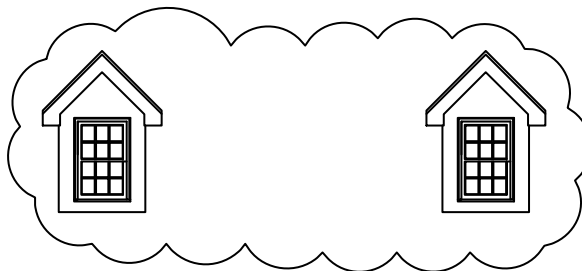

Introduction

Why You Should Use this Guide	22
Tutorials and Command Access	22
Get Additional Information	23

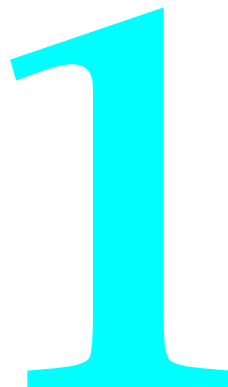

Why You Should Use this Guide

This *Getting Started* guide provides an introduction to the most commonly used features of both AutoCAD and AutoCAD LT. Use it to learn the basic features so you can begin working quickly.

Because you are provided with a rich set of features, there are often many ways of accomplishing a task. This guide focuses on the following:

- What do you need to know to get started?
- What is the recommended method for using the features presented?

After you become more familiar with the features, you will find your own ways of working efficiently based on the type of work that you do.

Tutorials and Command Access

There are several ways you can access commands in AutoCAD and AutoCAD LT. They can be accessed through the command line, the ribbon, toolbars, palettes, and the Menu Browser.

Because the ribbon might have been customized, and some commands are not accessible from the ribbon, the tutorials in this guide usually direct you to access commands through the Menu Browser.

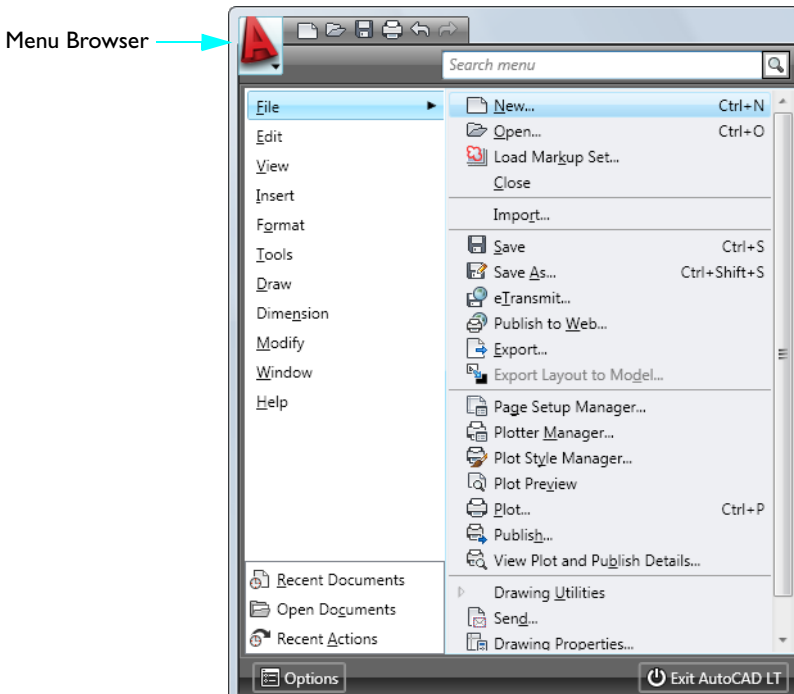

NOTE All screen shots and dialog boxes in this guide display AutoCAD LT in the title bar. For the explanations and tutorials in the *Getting Started* guide, there is no difference whether you use AutoCAD or AutoCAD LT. The features presented are identical.

Get Additional Information

Additional resources are available when you need more information. From the Help menu, you can access the following resources:

- **Help** provides procedures, conceptual information, and command descriptions. You can also press F1 at the Command prompt, in a dialog box, or at a prompt within a command to display Help information.
- **New Features Workshop** provides a series of overviews about new features.
- **Additional Resources** provides several options for additional help from the Web.

Access Related Topics in the Help System

Keyword references are displayed at the end of most Getting Started topics. For example, the following information indicates that you can find concepts, procedures, commands, and system variables related to the LINE command by entering line in the Index tab of the Help window.

LINE

Try it: Locate a Help topic using a keyword

- Start AutoCAD or AutoCAD LT and press the F1 key. Then follow the steps in the illustration.

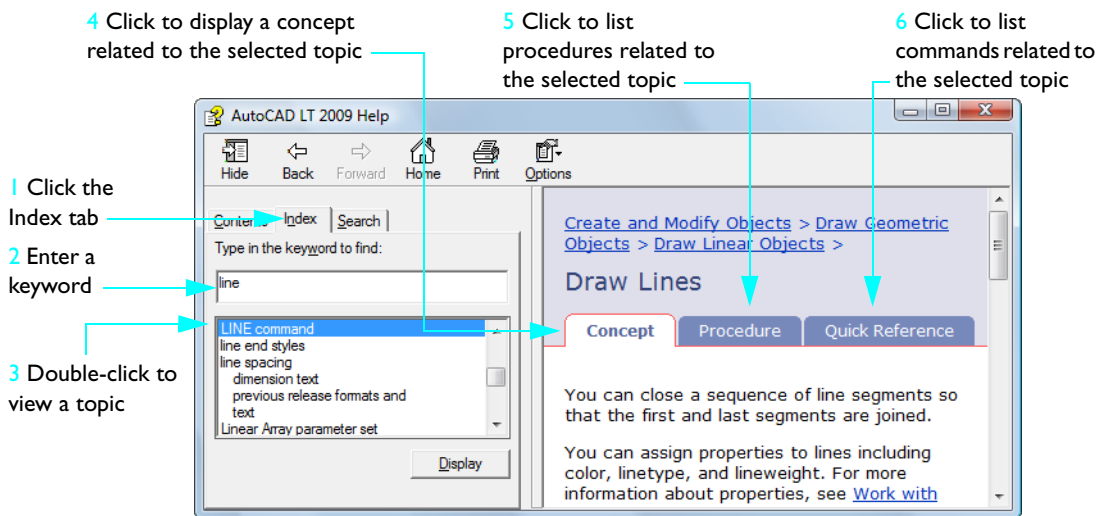

Tutorial: Use the Help System

In this tutorial, you will use the Help system to find information about how to start a drawing with a template file and how to create a layout.

NOTE It is important to learn how to use the Help system effectively. The Help system can provide answers to save you from needless frustration.

- 1 Start AutoCAD or AutoCAD LT and press F1 to display the Help window.
- 2 In the left pane of the Help window, click the Contents tab if necessary to display the table of contents. Then click the plus sign (+) next to *User's Guide*.

The *User's Guide* expands to display a list of chapters.

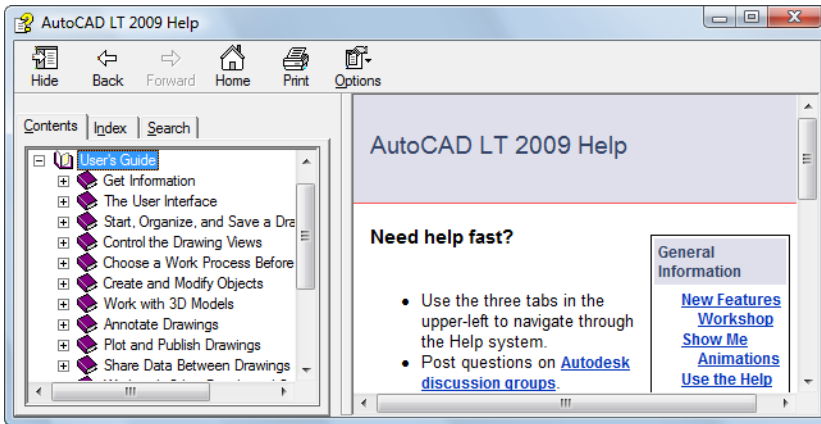

- 3 In the left pane, click directly on the title, *Start, Organize, and Save a Drawing*. The right pane of the Help window displays links to several topics, with descriptions for each one.
- 4 In the right pane, click *Start a Drawing*. Then click *Use a Template File to Start a Drawing*.

You have navigated to a destination topic in the Help system. Notice that the table of contents in the left pane displays the topic structure for easy navigation.

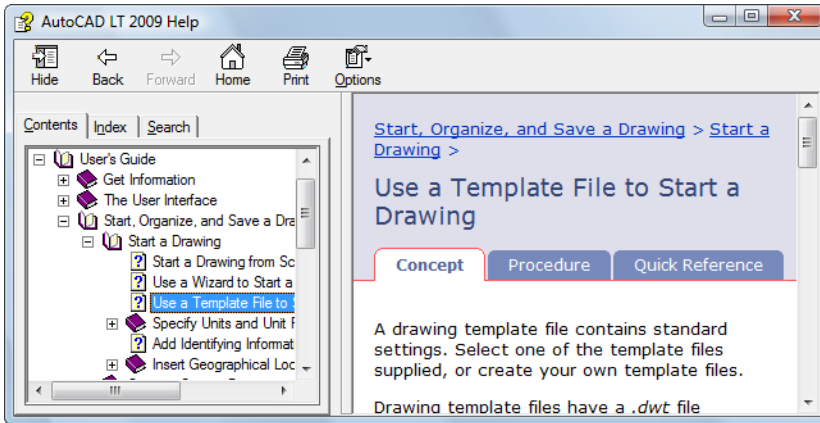

- 5 Click the Procedure tab. Then click the first procedure on the list. Click the Procedure tab to redisplay the list.
- 6 Click the Quick Reference tab. The Quick Reference tab lists all commands and system variables that are associated with this topic.

If you click a link on this tab, the *Command Reference* is opened in Help, and provides details about command and dialog box options.

- 7 Next, in the left pane, click the Search tab.

You will now locate topics that contain the word *layout*.

- 8 Type the word **layout** and press ENTER.

Several topics that contain the word *layout* are displayed. For the best results, enter several keywords or an exact phrase in quotes.

NOTE You can click the column labeled *Title* to sort the list of topics alphabetically. Then, click the column labeled *Location* to sort the list of topics by book: *Command Reference*, *User's Guide*, and so on.

- 9 Scroll down to find the User's Guide topic, *Work on a Layout Tab*. Then double-click the topic. The topic is displayed. But how do you know where you are in the table of contents? How can you display an adjacent, related topic?

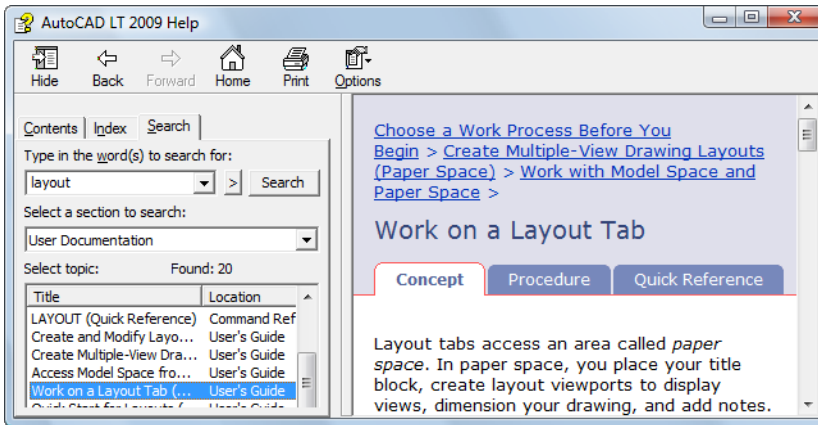

I0 In the left pane, click the Contents tab.

The table of contents opens to the current topic. Use this method to find related topics easily.

NOTE If the table of contents does not automatically open to the current topic, click the Concept tab in the right pane.

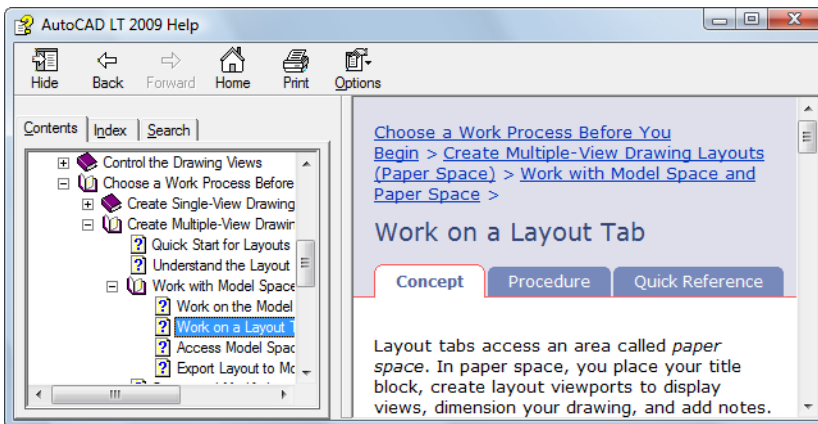

I1 In the left pane, right-click any topic and then click Close All.

This is a quick method for collapsing the table of contents when too many subtopics are displayed.

I2 Close the Help window.

For more information, read *Use the Help System Efficiently*. In the Help system, on the Contents tab, click User's Guide ► Get Information ► Find the Information You Need ► Use the Help System Efficiently.

To get started

Action

Access the Help system

Use New Features Workshop

Find training resources

Menu Browser

Help ► Help

Help ► New Features Workshop

Help ► Additional Resources ►
Online Training Resources

Help system

HELP

Review and Recall

- 1 What is the purpose of the tabs in the right pane of the Help window?
- 2 In the left pane of the Help window, when would you use the Contents tab rather than the Index tab?
- 3 From what menu can you get information about new features?

Work with Commands

Use the Mouse	30
Cancel a Command.....	30
Start a Command	30
Undo or Redo Commands.....	34



Use the Mouse

Most people use a mouse as their pointing device. On a two-button mouse, the left button is usually the *pick* button, used to specify points or select objects in the drawing area. With the right button, you can display a *shortcut menu* that contains relevant commands and options. Different shortcut menus are displayed depending on where you move the cursor.

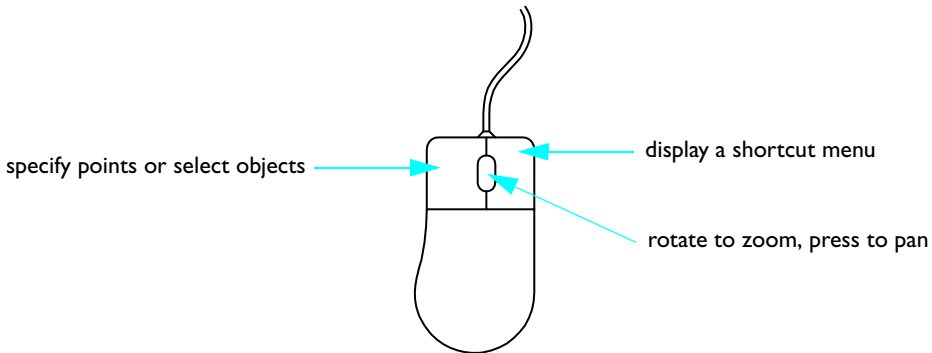

NOTE To see what options are available in any situation, try right-clicking to display a shortcut menu.

A *wheel mouse* is a two-button mouse with a small wheel between the buttons. This wheel can be rotated or pressed down to zoom and pan your drawing quickly. It is highly recommended that you use a wheel mouse.

Cancel a Command

If you accidentally click in the screen, display a shortcut menu, or start a command, you can always escape by pressing the ESC key on your keyboard.

Try it: Cancel a selection

- Click in the drawing area and move the mouse. You are now in an object selection mode. Press ESC to cancel.

Start a Command

You can start a command using the Menu Browser, a toolbar, a palette, or the command line. Because AutoCAD and AutoCAD LT are very flexible, you can work in the way that feels most comfortable to you.

You can choose commands from several different kinds of menus:

- **Menu Browser** access is from the bright red button at the top-left corner of the application window. All the commands for the tutorials in this book are accessible from these menus.
- **The Object Snap menu** is displayed when you hold down SHIFT and click the right mouse button. Object snaps facilitate precision drawing by snapping the cursor onto a feature on an object such as the endpoint of a line or the center of a circle.
- **Shortcut menus** are displayed when you click the right mouse button. Different menus are displayed when you right-click an object, right-click in the drawing area, right-click a toolbar, or right-click within a dialog box, palette, or window.

Start Commands on the Command Line

You can initiate commands by typing them on the *command line* within the *command window* instead of using toolbars or menus. Additionally, some commands *must* be completed on the command line, regardless of how they are started.

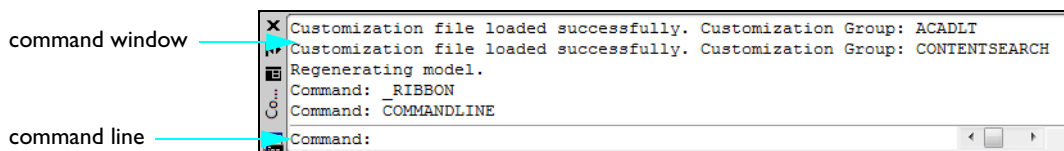

Some commands have abbreviated names or *command aliases*. For example, you can enter **c** as an alias for CIRCLE.

After you type the command on the command line, press ENTER or SPACEBAR to start the command. You can also repeat the previous command by pressing ENTER or SPACEBAR.

NOTE In this guide and in the Help system, when you are instructed to *enter* something, type the bold-face value on the command line, and then press the ENTER key.

Specify a Command Option

When you start a command, you will often see a set of options on the command line. For example, when you enter the CIRCLE command, the following prompt is displayed on the command line:

Specify center point for circle or [3P/2P/Ttr (tan tan radius)]:

The default option, “Specify center point for circle,” is displayed *before* the square brackets. Alternate options are displayed between the square brackets.

- To accept the default option, enter coordinate values, or use the pointing device to click a center point in the drawing area.
- To choose a different option, enter the capitalized letters in the option name. For example, type **2P** and press ENTER to choose the Two-Point option.

Use the Dynamic Prompt

In addition to the prompt on the command line, a similar prompt is displayed next to the cursor called the *dynamic prompt*.

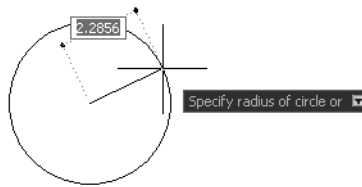



With the dynamic prompt, you can keep your eyes on your work and you don't have to look down to the command line.

To display command options in the dynamic input prompt, press the DOWN ARROW key, and then click an option on the menu.

Try it: Use the Menu Browser to draw a line

- 1 Click Menu Browser ► Click Draw ► Click Line.
- 2 At the Specify First Point prompt, click anywhere in the drawing area to locate a point.
The prompt changes: Specify Next Point or [Undo].
- 3 At the Specify Next Point or [Undo] prompt, click anywhere else in the drawing area to specify the endpoint of the line segment.
- 4 Create a second line segment by clicking again to locate another point.
The Specify Next Point or [Undo] prompt is repeated so you can continue to draw segments until you end the LINE command.
- 5 Press ENTER to end the LINE command.
The two line segments that you just created share an endpoint, but are separate objects.
- 6 Click Modify ► Erase, and click each line. Then press ENTER to end the erase command.

Try it: Use the ribbon to draw a line

- 1 Home tab ► Draw panel ► Click the Line button. 
- 2 Draw two line segments.
- 3 Home tab ► Modify panel ► Click the Erase button. 
- 4 Click each line and then press ENTER to erase the lines.

Try it: Use the command line to draw a line

- 1** On the command line, type **line** or the letter **L**. Press ENTER.
- 2** Click anywhere in the drawing area to locate a point.
- 3** At the Specify Next Point or [Undo] prompt, click anywhere else in the drawing area to specify the endpoint of the line segment.
- 4** At the Specify Next Point or [Undo] prompt, click anywhere else in the drawing area to specify the endpoint of the line segment.
- 5** Type **u** and press ENTER to undo the last line segment and click another location for the endpoint.
- 6** Then type **c** (Close) and press ENTER to add a third line segment that connects to the initial point and ends the command.

Try it: Use the command line to draw a circle

- 1** On the command line, enter **circle** or the letter **c** (type **c** and press ENTER).
- 2** At the Specify Center Point for Circle prompt, click anywhere in the drawing area to locate a point.
- 3** At the Specify Radius of Circle prompt, enter **5** (type **5** and press ENTER).
- 4** On the command line, press ENTER to repeat the CIRCLE command.
- 5** Enter **2P** to create a circle using two points (type **2P** and press ENTER).
- 6** Click anywhere in the drawing to locate each point.
- 7** Repeat the CIRCLE command several more times, using each of the other options.
- 8** When you're done, enter **erase** or **e**, and click each circle to select it. Then press ENTER to erase the selected circles.

Try it: Use the dynamic prompt to draw a circle

- 1** At the dynamic prompt, enter **circle** or the letter **c**.
- 2** At the Specify Center Point for Circle prompt, press the DOWN ARROW key.
- 3** Click one of the CIRCLE options on the menu and complete the command.

Undo or Redo Commands

Occasionally you will need to undo some of your work. Two Standard toolbar buttons reverse mistakes in your drawings.

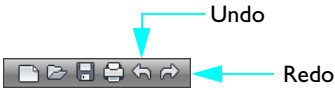

- **Undo.** You can backtrack previous actions. For example, click Undo to delete an object that you just created.
- **Redo.** You can reinstate the actions that you backtracked with Undo. For example, click Redo to restore the object that you just undid.

To get started

Action	Shortcut Menu	Keyboard
End a command	Right-click ► Enter	ENTER or SPACEBAR
Repeat a command	Right-click ► Repeat <action>	ENTER or SPACEBAR
Cancel a command	Right-click ► Cancel	ESC
Undo the previous command	Right-click ► Undo <action>	U and press ENTER

Help system

OPTIONS, U, UNDO, REDO

Review and Recall

- 1 What are three ways that you can start a command?
- 2 What other key can you use to end or repeat a command in addition to ENTER?
- 3 What should you do to cancel a command?

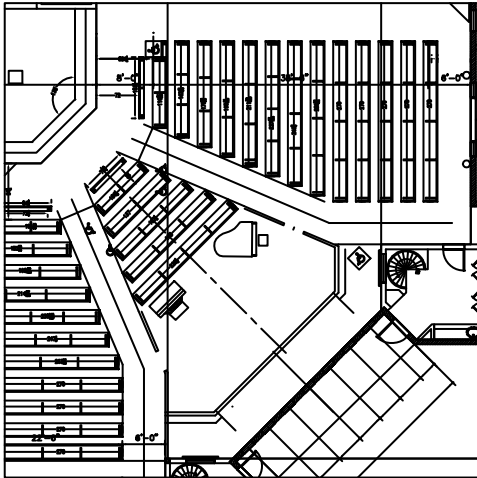

It will be easier to create or modify objects in this drawing by zooming in to magnify the view.

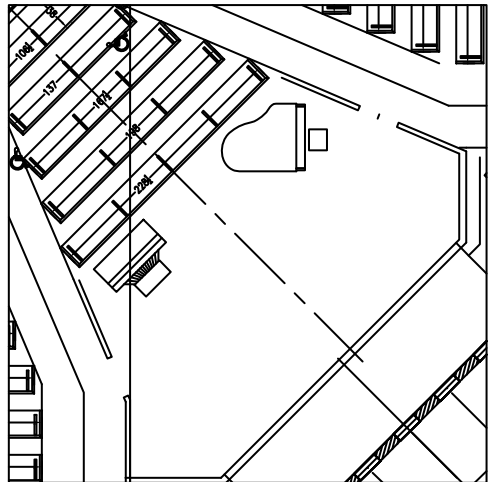

Once you have zoomed in, you can pan the view to center the objects you are working on.



After you finish working on an area, you can zoom out to get a better overall view.

Change Views

Zoom to Magnify a View.....	38
Pan to Reposition a View.....	39



Zoom to Magnify a View

A *view* is a specific magnification, position, and orientation of your design. The most common way to change a view is *zooming*. Zooming increases or decreases the magnification of the image displayed in the drawing area.

There are several methods for zooming in your drawings.

Zoom by Moving the Cursor

You can use a pointing device to zoom in real time—that is, to zoom in or out by moving the cursor. With the Realtime option of the ZOOM command, you drag the cursor up to zoom in; drag it down to zoom out. If you use a wheel mouse, rotate the top of the wheel forward to zoom in and rotate it backward to zoom out.

Zoom to a Specified Area

With the Window option of the ZOOM command, you can quickly zoom in on a specific area by using the mouse to define a rectangular zoom window. The area you define is centered in the new view.

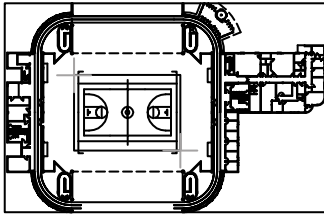

zoomed out

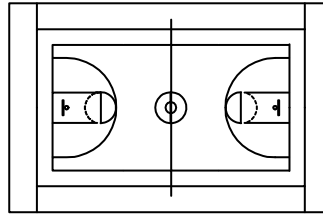

zoomed in

Zoom to Display the Entire Drawing

Use the Extents option of the ZOOM command to display the entire drawing. This is useful when you need to return to an overall view quickly. This option is also useful if your drawing area is blank as a result of zooming in too close on a blank area or panning too far off the drawing area.

Pan to Reposition a View

Panning is another common way to change a view. Panning moves the position of the image displayed in any two-dimensional direction.

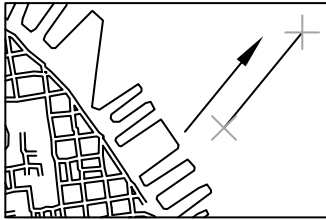

before PAN

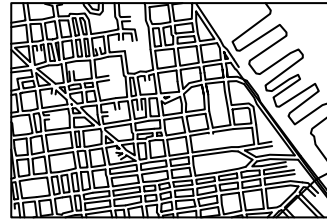

after PAN

Pan by Moving the Cursor

You can pan in real time—that is, use the pointing device to reposition the image in the drawing area. Within the PAN command, drag the cursor to pan the image to a new location. If you use a wheel mouse, hold the wheel down and move the mouse to pan.

Tutorial: Zoom and Pan

In this tutorial, you can practice zooming and panning operations using the commands in the Menu Browser or directly with a wheel mouse.

- 1 Click Menu Browser ► File ► Open.
- 2 In the Open dialog box, find the *Sample* folder in the AutoCAD or AutoCAD LT program files folder. Click on each drawing file and open one that looks interesting.
- 3 Click Menu Browser ► View ► Zoom ► Window.
- 4 Click somewhere near the center of the drawing. Move your cursor to form a rectangular area and click again.
- 5 Click Menu Browser ► View ► Pan ► Realtime.
- 6 Drag the cursor in any direction to reposition the view. Press ESC to end the operation.
- 7 Continue to practice zooming and panning with these options:
 - Zoom Realtime (or use the wheel on a wheel mouse)
 - Zoom Previous
 - Zoom Window
 - Zoom Extents
 - Pan Realtime (or hold the wheel down and move the mouse)

Practice these options until you are comfortable with zooming and panning. These are the most common options for drawing in 2D.

NOTE If you zoom in and you notice that arcs and circles lose their smoothness, or if you can't zoom in or out beyond a limit, you can regenerate the display. Click View menu ► Regen All. This command also removes stray pixels.

- 8 (Optional) If you have a wheel mouse, you can zoom and pan without entering a command. Try the following operations:
 - Move your cursor to an area in the drawing and rotate the wheel forward and backward to zoom in and out. Notice that your cursor location determines the stationary reference point of your zoom operation.
 - Press the wheel down and drag the view to pan it.
 - Double-click the wheel to zoom to the extents of the drawing.
- 9 Close the sample drawing without saving it.

To get started

Action	Menu Browser	Ribbon
Pan	View ► Pan	Home tab ► Utilities panel ► Pan
Zoom	View ► Zoom	Home tab ► Utilities panel ► Realtime
Reset the display limit for zooming	View ► Regen	
Smooth arcs and circles	View ► Regen	

Help system

PAN, ZOOM, REGEN, REGENALL

Review and Recall

- 1 What ZOOM option should you use to fit your entire drawing into the drawing area?
- 2 What is a fast way to redisplay the previous view?
- 3 What command smooths the display of curves and removes stray pixels?

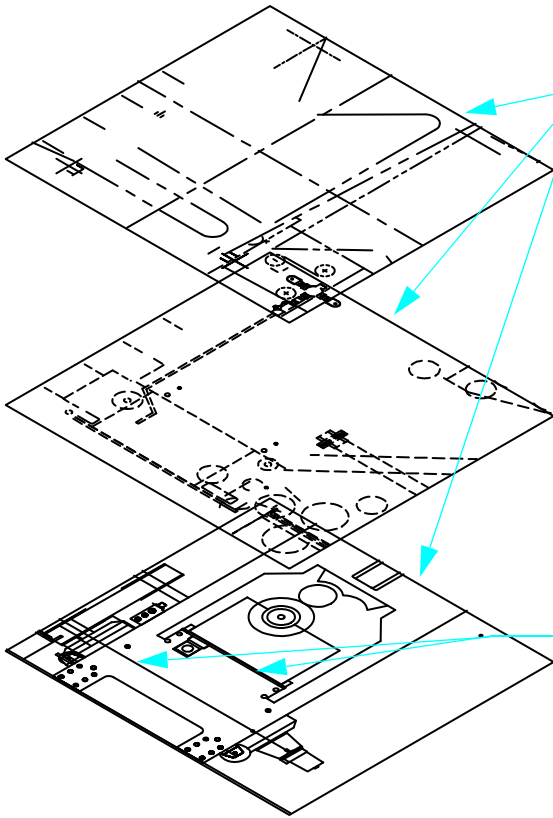

Establish layers to organize information as if on transparent drawing overlays.

Assign standard lineweights to ensure that lines will plot the same way regardless of drawing scale.

Use various linetypes to help identify different types of objects.

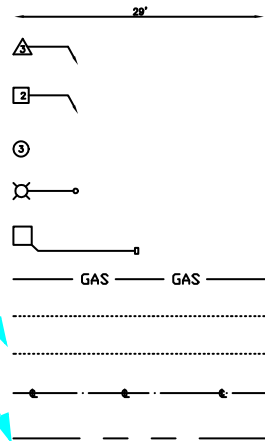
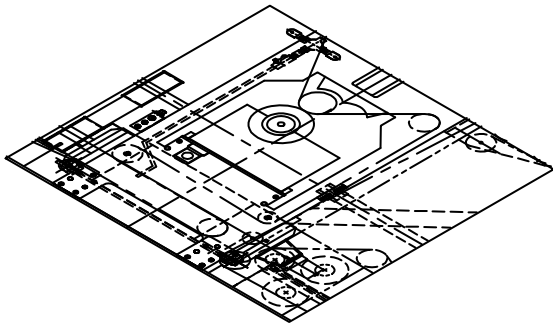

Drawing Setup

Start a Drawing	44
Plan the Drawing Units and Scale	46
Understand Models and Layouts	48
Organize Drawings with Layers	50
Tutorial: Tour a Drawing	52



Start a Drawing

There are several ways to start a new drawing. The recommended method is to start with a *drawing template* file.

A drawing template file contains predefined settings, standards, and definitions that will save you significant setup time. When you start a drawing with a drawing template, these settings are passed on to the new drawing. Drawing template files include settings and basic drawing elements that you will use often, such as

- Unit type and precision
- Tool settings and preferences
- Layer organization
- Title blocks, borders, and logos
- Dimension styles
- Text styles
- Linetypes and lineweights
- Plot styles

drawing template file with
included title block

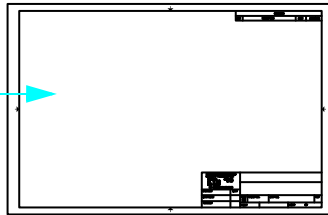

Your product includes several drawing template files, including some that facilitate compliance with ANSI, DIN, ISO, and JIS standards. Nevertheless, it is very likely that you will customize one or more of these, or build your own drawing template files to meet your standards and requirements.

You can create a drawing template file by saving a drawing using the *.dwt* extension.

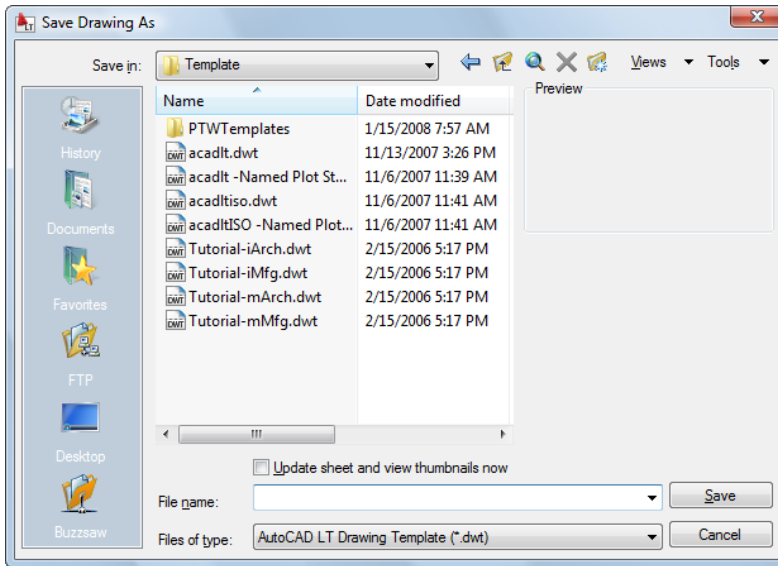

Try it: Open a drawing template file

- 1 Start a new drawing.
- 2 In the Select Template dialog box, click one of the following drawing template files and then click Open.
 - **Tutorial-mArch.dwt.** Sample architectural template (metric)
 - **Tutorial-mMfg.dwt.** Sample mechanical design template (metric)
 - **Tutorial-iArch.dwt.** Sample architectural template (imperial)
 - **Tutorial-iMfg.dwt.** Sample mechanical design template (imperial)

The metric template files are scaled to use millimeters as the drawing unit, and the imperial template files are scaled to use inches as the drawing unit.

Plan the Drawing Units and Scale

Unlike manual drafting, you don't need to worry about setting a scale before you start drawing. Even though you eventually print or plot to paper at a specified scale, you create the *model* at 1:1 scale. However, before you start a drawing, you must first decide what *drawing units* you will use.

Choose the Drawing Units

In AutoCAD and AutoCAD LT, distances are measured in drawing units. In a drawing, one drawing unit may equal one inch, one millimeter, one meter, or one mile.

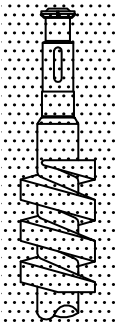

Shaft
1 unit = 1 mm
(grid spacing = 2 mm)

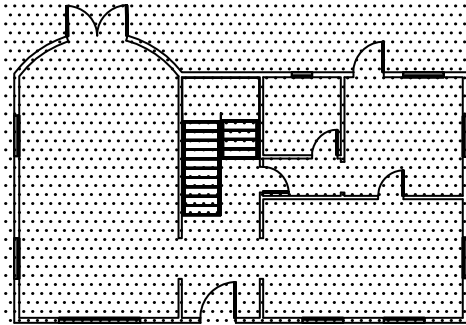

Office plan
1 unit = 1 inch
(grid spacing = 12 inches)

Before you begin drawing, you decide what one drawing unit will represent—there is no setting that determines the length of a drawing unit.

Set the Format of Drawing Units

After you decide what drawing units to use, you can set the format of the drawing units. The format settings available for linear units are as follows:

- **Architectural.** A length of 15.5 units displays as 1'-3 1/2"
- **Decimal.** A length of 15.5 units displays as 15.5000
- **Engineering.** A length of 15.5 units displays as 1'-3.5"
- **Fractional.** A length of 15.5 units displays as 15 1/2
- **Scientific.** A length of 15.5 units displays as 1.5000E+1

For example, if you are a mechanical engineer who normally works in millimeters, you would set the format for linear units to decimal. If you are an architect who normally works in feet and inches, you would set the format to architectural.

The drawing unit format controls only the display style of the drawing units on-screen, such as in the display of coordinates and values in the Properties palette, dialog boxes, and prompts.

Try it: Check the drawing unit format and precision

- 1 Click Menu Browser ► Format ► Units. In the Drawing Units dialog box, notice the display style selected for linear and for angular units.

NOTE Think of this dialog box as the Drawing Units *Format* dialog box.

- 2 Notice the value displayed under Precision. This represents the decimal or fractional rounding of values displayed on-screen.
- 3 Close the dialog box.

Understand Models and Layouts

The Model and layout buttons on the status bar provide two working environments. You use Model space to draw a full-size model of your subject. With layout space you can create a multiple-view layout for plotting.

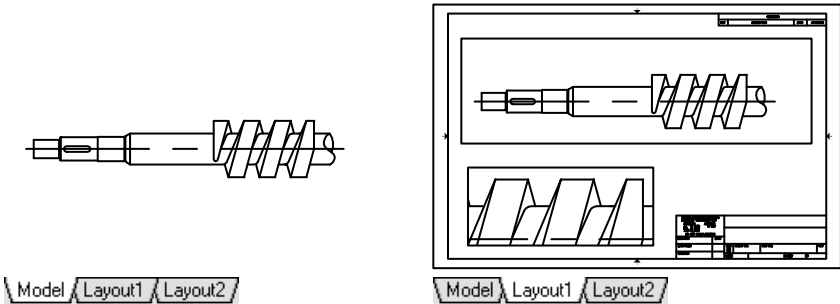

full-size model of a part created at 1:1 scale

layout with title block and rectangular layout viewports that contain scaled views

- **Model space accesses a limitless drawing area.** In *model space*, you first decide whether one unit represents one millimeter, one meter, one inch, or some other drawing unit. Next, you set the drawing unit format. Then you draw at 1:1 scale.
- **Layout space accesses drawing layouts.** When you set up a layout, you specify the paper size you want to use. The layout represents a printed drawing sheet in which you can display one or more views of the model at various scales. This layout environment is called *paper space*. Here you create *layout viewports* that act as windows into model space. Each layout viewport can contain a different view of the model.

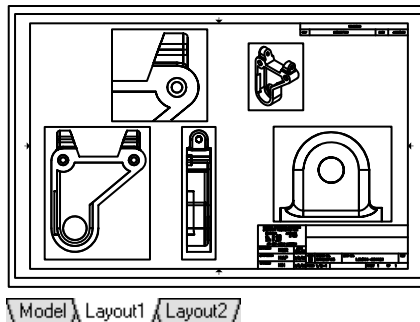

layout with viewports using different scales

Try it: Switch between the Model and layout space

- 1** At the bottom-center of the application window toward the right side, click the Model button. This action displays Model space, where you create and modify the geometry for your model. The strip along the bottom of the application window is called the *drawing status bar*.
- 2** Right-click the same Model button and click the Display Model and Layout Tabs option. This displays tabs at the bottom-left of your drawing area.
When you are learning, it's easier to work with the tabs. You can hide the tabs and return to using buttons by right-clicking a tab and then clicking Hide Model and Layout tabs from the shortcut menu.
- 3** Click the layout tab to the right of the Model tab. Layouts are used to create printed drawings. The layout has already been prepared, including a sample title block and a layout viewport, the blue rectangle.
- 4** On the layout, double-click anywhere within the rectangular viewport area. This is how you access model space from a layout to pan the model space view and to add dimensions.
Notice that the border of the layout viewport becomes thicker and the crosshairs cursor is active only within the layout viewport.
- 5** Double-click in a blank area outside the rectangular viewport. This returns you to paper space. The border of the layout viewport is no longer as thick and the crosshairs cursor is active within the entire drawing area.
- 6** Click the Model tab to return to Model space.

Organize Drawings with Layers

Layers are the equivalent of the overlays used in manual drafting. In CAD, they are an important organizational tool.

Each layer includes an assigned color, linetype, and lineweight. Before you create objects, you set the layer on which the objects are to be created. This is called the *current* layer. By default, the current layer's color, linetype, and lineweight are assigned automatically to the new objects you create.

Assign Layers

You can organize the drawing by assigning similar components to the same layer. For example, you can create a layer called Electrical and assign it the color green. Whenever you draw electrical objects, you switch to that layer. The objects you draw are created on the Electrical layer and are colored green.

Later, if you don't want to view or plot electrical objects, you can turn off that layer.

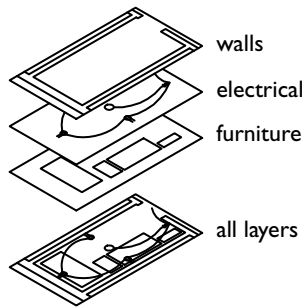

NOTE It is very important to establish and maintain a company-wide layer standard. With a layer standard, drawing organization will be more logical, consistent, compatible, and maintainable over time. Layer standards are essential for team projects.

Try it: Display the list of layers in a drawing

- 1 Click Menu Browser ► Format ► Layer.
- 2 In the Layer Properties Manager, notice the name and default properties assigned to each layer. These layers are just a sample of the types of layers that you will need to use in a well-organized drawing. There are many layer standards already in use, including those specified in companies and those recommended by professional organizations.
- 3 Enlarge the right side of the dialog box to display all of the columns. Click the titles of the Status, Color, and Name columns to rearrange the order of the layers.

Review the descriptions of each layer in the column on the far right.

Control Layers

To make objects on a layer invisible, you can turn off the layer or freeze it in the Layer Properties Manager. You can also lock layers to reduce the possibility of modifying objects accidentally.

- **Turn off layers.** Use this option rather than freezing if you frequently need to switch a layer's visibility.



- **Freeze layers.** Use this option if you don't need a layer to be visible for a long time. Thawing a frozen layer causes an automatic regeneration of the drawing and is slower than turning a layer on.



- **Lock layers.** Use this option to prevent objects on a layer from being modified. You can still use the objects on a locked layer for operations that don't modify the objects. For example, you can snap to these objects to use them as guides for precision drawing.







Tutorial: Tour a Drawing

In this tutorial, you tour a drawing of an arbor and picket fence design.

- 1** Click Menu browser ► File ► Open.
- 2** In the Select File dialog box, find the `\Help\GettingStarted` folder in the AutoCAD or AutoCAD LT product folder and open *arbor.dwg*.
For you don't see the drawing files, check to make sure that the Files of Type drop down list in the dialog box is set to Drawing (.dwg).
- 3** Click the Model tab (or click the Model button on the status bar).
- 4** As you move the mouse over the objects in the drawing, notice that the objects are automatically highlighted.
- 5** Zoom and pan in model space to inspect the arbor design.
- 6** Perform a Zoom Extents to display the entire design.
- 7** Click the ANSI C Layout tab.
- 8** Zoom and pan in paper space to inspect the drawing layout.
- 9** Perform a Zoom Extents to display the entire layout.
- 10** Click Menu browser ► Format ► Layer. In the Layer Properties Manager, review the list of layers that were created to organize this drawing.
Notice that the current layer has a green check next to it.
- 11** Click several lightbulb icons to turn off several layers.
- 12** Click the column labeled On to arrange the layers according to whether they are on or off. Then turn the layers back on.
- 13** Click the Color column to arrange the layers according to color.
- 14** Click the Name column and click OK.
- 15** Close the drawing without saving it.

To get started

Action	Menu Browser	Icon
Start a new drawing	File ► New	
Save a drawing template	File ► Save As	
Set the display style of the units	Format ► Units	
Create a layout	Insert ► Layout ► New Layout	
Create and modify layers	Format ► Layer	

Help system

NEW, SAVEAS, STARTUP, UNITS, MODEL, LAYOUT, LAYER

Review and Recall

- 1 Why is it important to start a drawing from a drawing template file?
- 2 What is the difference between choosing drawing units and setting the drawing unit format?
- 3 What is the difference between the Model tab and a layout tab?
- 4 What are several benefits to creating a drawing with layers?

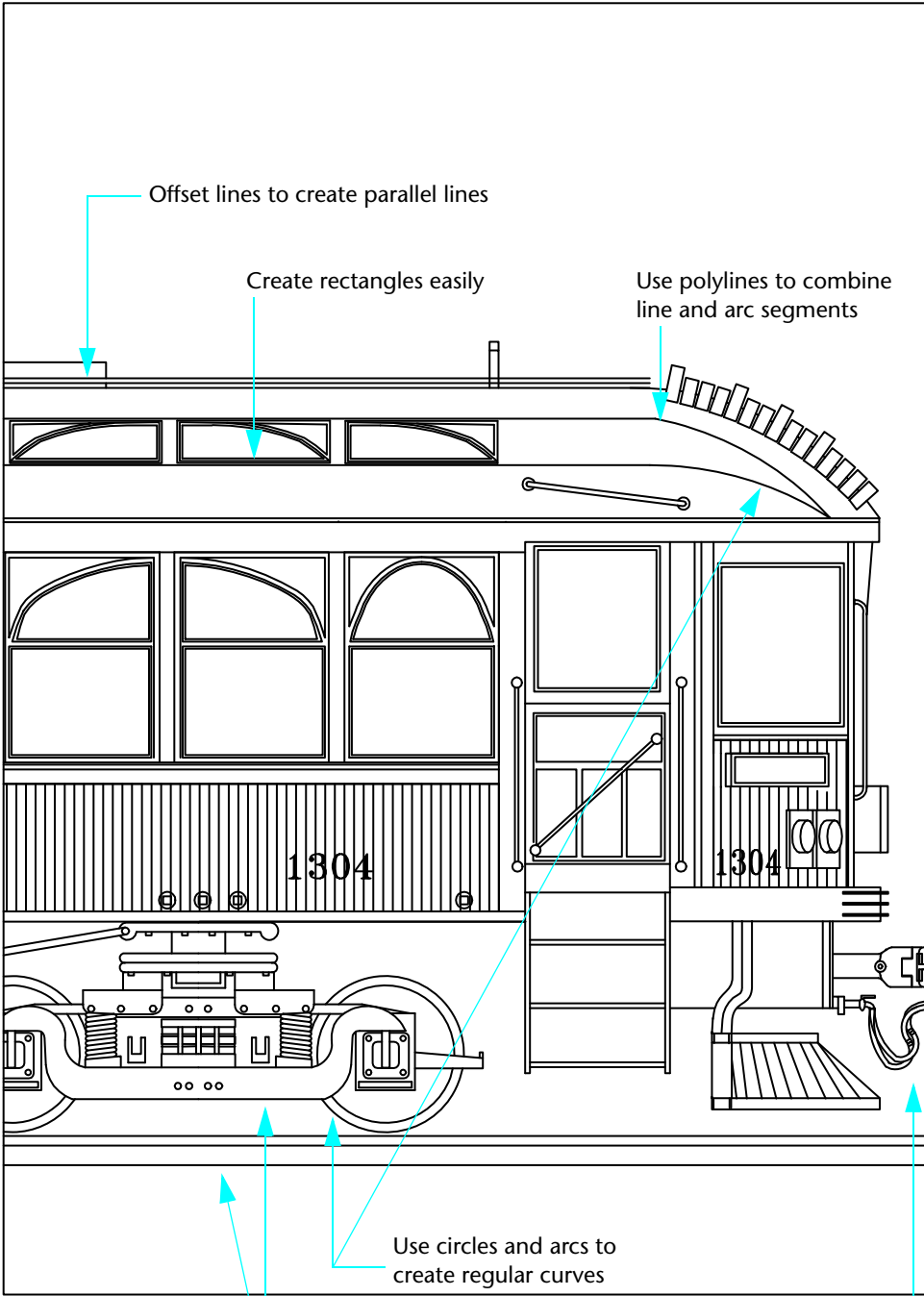

Offset lines to create parallel lines

Create rectangles easily

Use polylines to combine line and arc segments

1304

1304

Use circles and arcs to create regular curves

Use lines for drawing objects and for construction geometry

Use splines to create smooth, non-uniform curves

Draw Objects

Object Properties Overview	56
Draw Lines	64
Draw Circles and Arcs	67



Object Properties Overview

All objects that you create have properties. Object properties are settings that control the appearance and geometric characteristics of an object. The general properties that are common to all objects are listed below. All other object properties are specific to the type of object.

<i>Color</i>	<i>Linetype scale</i>	<i>Hyperlink</i>
<i>Layer</i>	<i>Plot style</i>	<i>Lineweight</i>
<i>Linetype</i>	<i>Thickness</i>	

Assign Object Properties

Typically, you assign object properties using one of the following strategies:

- **By layer.** Properties are assigned to a layer. Objects that are drawn on that layer automatically use those properties.
- **Individual properties.** Properties are assigned to objects individually, regardless of the layer that they are drawn on.

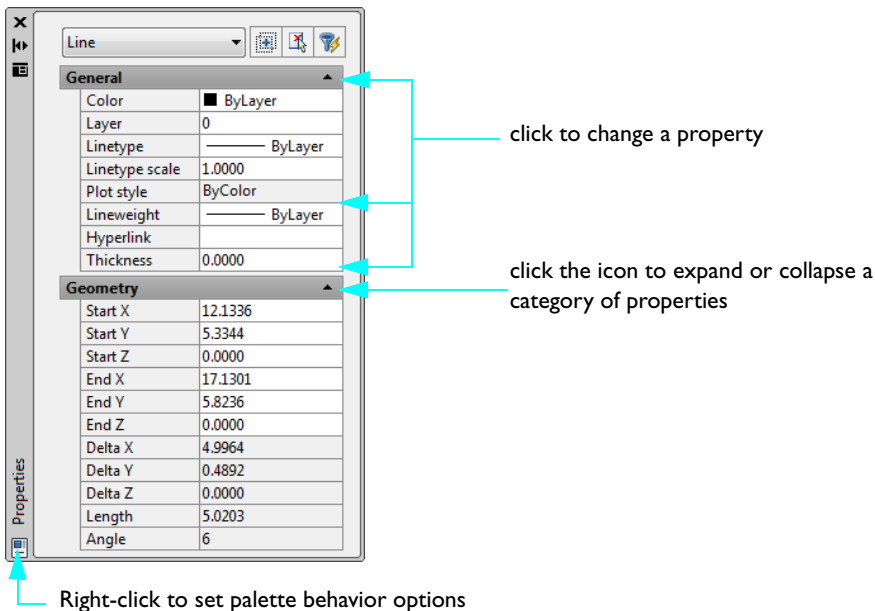

Use the Properties Palette

The Properties palette is the primary tool for viewing, setting, and modifying the properties of objects. The Properties palette operates as follows:

- If no objects are selected, the Properties palette displays the current default property settings, and you can set the default properties for all subsequently created objects.
- When you click an object, the Properties palette displays the properties of that object, and you can change its properties.
- If you click multiple objects, the Properties palette displays all the properties that they have in common, and you can change their common properties.

Try it: Display the Properties palette

- 1 Click Menu Browser ► File ► New.
- 2 In the Select Template dialog box, click one of the drawing template files and then click Open.
- 3 Click Menu Browser ► Modify ► Properties.

Leaving the palette open keeps it handy. You can turn on Auto-hide to make the Properties palette appear and disappear when your cursor moves over the Properties palette title bar.

Try it: Change the Auto-hide behavior of the Properties palette

- 1 Right-click the Properties palette title bar. Click Auto-hide on the shortcut menu.
- 2 Move the cursor on and off the Properties palette. Leave the Properties palette open.

Use the Properties Panel

You can use the controls in the Properties panel and the Layers panel to view, set, and modify the properties the same way as the Properties palette. By default, these panels are displayed in the Home tab of the ribbon located above the drawing area.

The Properties panel provides convenient access to the most important object properties.

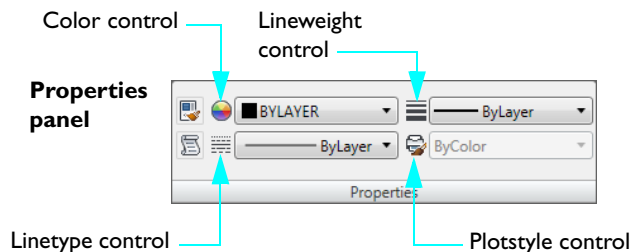

Use the Layers Panel

The Layers panel controls layers and layer properties. Use the Layer Properties Manager button to change layer settings. The Layer control, a drop-down list, provides a quick method for changing several layer properties and for changing the current layer.

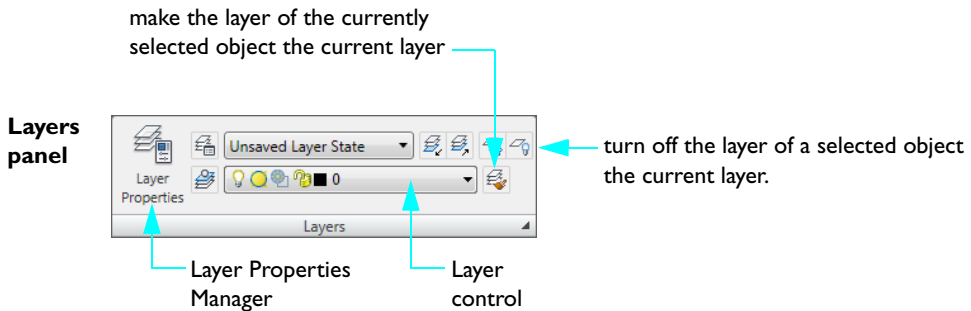

Tutorial: Change Object Properties

In this tutorial, you will use several controls to view and change the properties of layers and objects.

- 1 Click Menu Browser ► File ► Open.
- 2 In the Select File dialog box, find the `\Help\GettingStarted` folder in the AutoCAD or AutoCAD LT product folder and open `arbor.dwg`.
- 3 Click the Model tab.
- 4 Move your cursor onto the title bar of the Properties palette to open it.
Examine the current default properties settings.
- 5 Click a dimension object in the drawing to select it.
Notice that several properties of this object are displayed in the Properties panel on the ribbon. The layer of the object is Dimension. The color, linetype, and lineweight properties of the object are set to ByLayer. The color of the Dimension layer is red.
- 6 Move your cursor onto the title bar of the Properties palette to open it.
Examine the additional properties of the dimension object displayed in the Properties palette.
- 7 Click several more objects with different colors. Move your cursor onto the title bar of the Properties palette.
Notice that only the common properties of the objects are listed.
- 8 Move your cursor off the Properties palette and press ESC to cancel the selection.

Change the default color of a layer

- 1 Click Menu Browser ► Format ► Layer.
- 2 In the Layer Properties Manager, click the red box under the Color column of the Dimension layer.
- 3 In the Select Color dialog box, click the green box and click OK. Close the Layer Properties Manager.

Notice that all the objects on the Dimension layer are now green. Because all of the dimensions are on a single layer, you can change the properties of all objects on that layer in one operation.

Change the color of an individual object

- 1 Click any green dimension object to select it.
- 2 Properties panel ► Click the Color control ► Click Magenta.

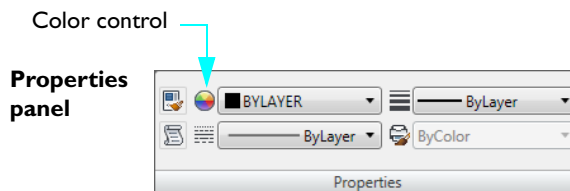

The color of the selected object changes to magenta, *overriding* the green color of the object's layer. If you change the layer color, the dimension object's color will remain magenta.

- 3 Press ESC to exit.
- 4 Click the same dimension object.
- 5 Click the Color control and click ByLayer. This restores the color property behavior of the dimension object.

Change the current layer

- 1 Click the Layer control on the Layers panel.

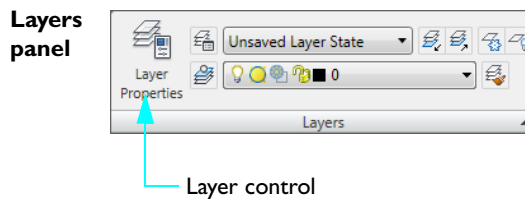

- 2 Click a different layer to make it the current layer.
All new objects will be created on this layer until you change the current layer to a different one.
- 3 Click Menu Browser ► Format ► Layer
- 4 In the Layer Properties Manager, click a layer to select it.

- 5** Click the green check mark button at the top of the Layer Properties Manager. Click OK to make the selected layer the current layer.
- 6** On the Layers panel, click the Layer control again.
- 7** Click the lightbulb image for the Dimension layer to turn it off. Then click anywhere in the drawing area.
All objects on the Dimension layer are now hidden.
- 8** Use the Layer Properties Manager to turn the Dimension layer back on.
- 9** Close the drawing without saving it.

Use Linetypes

You can associate a single linetype with all of the objects drawn on the same layer or you can assign linetypes individually to objects.

—————	CONTINUOUS
- - - - -	HIDDEN
- - — - -	CENTER
—— - - —	PHANTOM

To use a linetype, you must first load it into your drawing using the Linetype Manager.

Try it: Load a linetype and make it current

- 1 Click Menu Browser ► File ► New, and select a drawing template file.
- 2 Click Menu Browser ► Format ► Linetype.

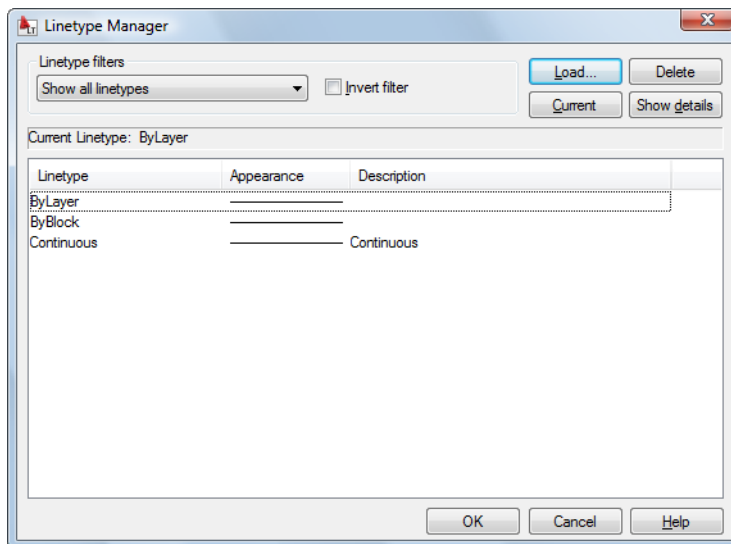

- 3 In the Linetype Manager, click Load.
- 4 In the Load or Reload Linetypes dialog box, scroll down the list of linetypes and click HIDDENX2. Click OK.
- 5 Click Show Details.

Several linetype scaling options are displayed. Notice the Use Paper Space Units for Scaling option. You check this option if you want linetypes automatically scaled in layout viewports.

- 6 Click the HIDDENX2 linetype and click Current. Click OK.

Notice that the Properties panel in the ribbon displays the HIDDENX2 linetype as current rather than BYLAYER. All subsequently created objects will be displayed using this linetype. This setting overrides the linetype assigned to the current layer.

- 7 Click the Model tab.
- 8 Click Menu Browser ► Draw ► Line, and click several locations in the drawing area to draw line segments. Press ENTER to end the command.
- 9 Use the Linetype Manager or the Properties panel to return the current linetype to BYLAYER. All subsequently created objects will be displayed using the linetype assigned to the current layer.

Scale Linetypes

When you scale views in layout viewports, you can create inconsistencies in the appearance of linetypes. In noncontinuous linetypes, the length of dashes and dots, and the space between them, may increase or decrease. You can set the scaling to correspond to the model or layout scale or to remain the same at any zoom scale.

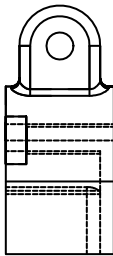

scaled to the model

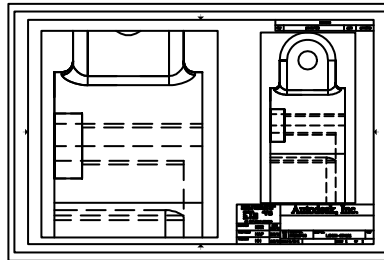

the Dashed linetype
scaled to the layout

Use the Details area of the Linetype Manager to control the linetype scale in layout viewports.

- **Global Scale Factor.** Sets the global scale factor for all linetypes.
- **Current Object Scale.** Sets the linetype scale for newly created objects.
- **Use Paper Space Units for Scaling.** Scales the linetypes in paper space and model space identically.

To update a linetype scale, you need to regenerate the model space display within a layout viewport on the layout tab. The steps required are

- 1 Click a layout tab.
- 2 Double-click within a layout viewport to enter model space.
- 3 Click Menu Browser ► View ► Regen.

The linetypes within the layout viewport are scaled according to the viewport display scale setting.

Assign Lineweights

Using lineweights, you can create heavy and thin lines to show cuts in sections, depth in elevations, dimension lines and tick marks, and differences in details. Lineweights are independent of the current display scale. Objects with a heavier lineweight always appear at the specified line width regardless of display scale.

Try it: Choose a lineweight and make it current

- 1 Click the Model tab.
- 2 Click Menu Browser ► Format ► Lineweight.
- 3 In the Lineweight Settings dialog box, under Lineweights, click a heavier lineweight such as 0.50 mm or 0.020".
- 4 Click Display Lineweight and click OK.
Notice that the Properties panel displays the new lineweight as current. From now on, objects that are created will be displayed using the heavier lineweight.
- 5 Click Menu Browser ► Draw ► Line, and draw several line segments. Press ENTER.
- 6 Use the Lineweight Settings dialog box or the Properties toolbar to return the current linetype to BYLAYER.
From now on, objects that are created will be displayed using the lineweight assigned to the current layer.
- 7 Practice setting linetypes and lineweights.

NOTE You can assign a color, linetype, or lineweight to individual objects, regardless of the default layer setting. Whether you choose to assign these properties individually or by layer settings depends on your drawing organization and company standards.

Draw Lines

The line is the most basic object that you will use. A line can be one segment or a series of successive segments, but each segment is a separate line object. If you need to draw a series of line segments as a single object, such as in a contour map, you create a polyline object instead.

Create Parallel Lines

An offset line is an exact replica of a line that is drawn at a specified distance from the original line. You can use the OFFSET command to create parallel lines as well as concentric circles and parallel curves.

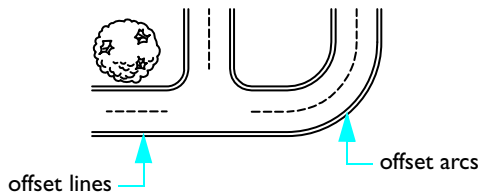

Offsetting objects is a very efficient construction method.

Try it: Offset a line to create parallel lines

- 1 Draw a line.
- 2 Click Menu Browser ► Modify ► Offset.
- 3 At the offset distance prompt, enter **10**.
- 4 Click the line that you want to offset.
- 5 Click on one side of the line.
- 6 Press ENTER to end the command.

Draw Polylines and Polygons

A *polyline* is a connected sequence of line or arc segments created as a single object. Use polylines for creating objects such as

- Traces on printed circuit boards
- Borders
- Contour lines, roads, and rivers in maps
- Segments with fixed or tapered widths

Polygons are closed polylines with equal-length sides and angles. The Polygon command is the simplest method for creating equilateral triangles, squares, pentagons, hexagons, and so on.

Draw Polylines

To draw each polyline segment, you specify a start point and an endpoint. To draw additional segments, continue to specify points in your drawing.

Try it: Create a polyline

- 1 Click Menu Browser ► Draw ► Polyline.
- 2 At each prompt, click a point. After several points, do one of the following:
 - Press ENTER to end the command.
 - Enter **c** to create a closed loop.
- 3 Click the polyline. Notice that the segments all belong to a single object.

You can include arc segments in polylines.

Try it: Create a polyline with arc segments

- 1 Click Menu Browser ► Draw ► Polyline.
- 2 Draw a polyline segment (1 and 2).
- 3 At the next prompt, enter **a** to switch to Arc mode and continue with an arc segment (3).
- 4 Enter **L** to return to Line mode, and then draw another line segment.
- 5 End the command.

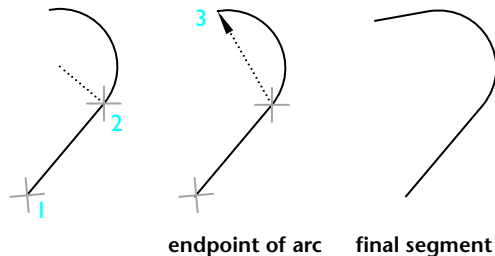

Try it: Create a rectangle

- 1 Click Menu Browser ► Draw ► Rectangle.
- 2 Click a location on the screen.
- 3 Move the cursor diagonally and click another location.

The resulting object is a closed polyline in the shape of a rectangle.

Try it: Create a polygon

- 1 Click Menu Browser ► Draw ► Polygon.
- 2 Enter the number of sides, for example, 6.
- 3 Click a location for the center of the polygon.
- 4 Specify either the Inscribed or the Circumscribed option. This determines how the distance that you enter in the next prompt is measured.

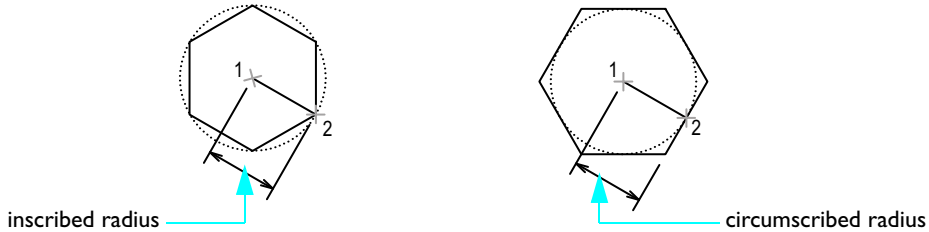

- 5 To specify a “radius” of the polygon, do one of the following:
 - Move the cursor and click a location.
 - Enter a distance.

The resulting object is also a closed polyline.

You can draw polylines of various widths by using the Width and Halfwidth options after you specify a starting point for a polyline. You can also make polyline segments taper.

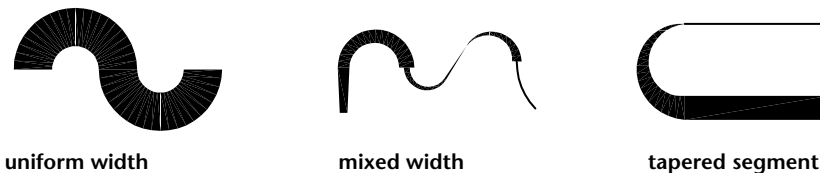

Once you create a polyline, you can

- Separate the polyline into independent segments with the EXPLODE command.
- Join a polyline to another polyline, line or arc with the JOIN command.

Draw Circles and Arcs

You can create a variety of curved objects, including circles and arcs.

Draw Circles

To create circles, use one of the following methods:

- Specify the center and radius (default method).
- Specify the center and diameter.
- Define the circumference of the circle with two or three points.
- Create the circle tangent to two existing objects.
- Create the circle tangent to two objects and specify a radius.

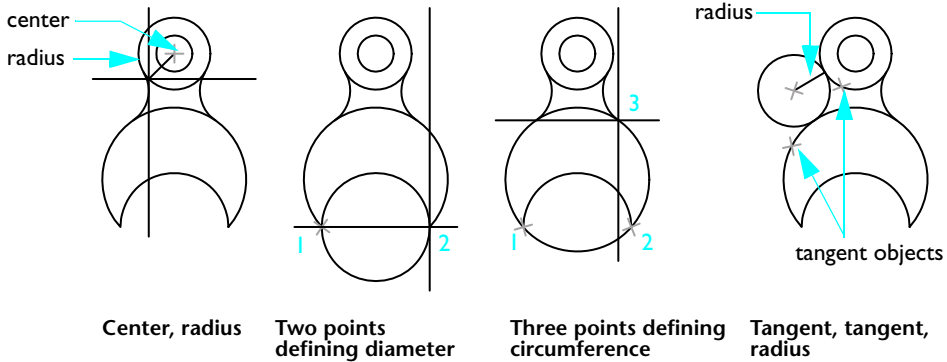





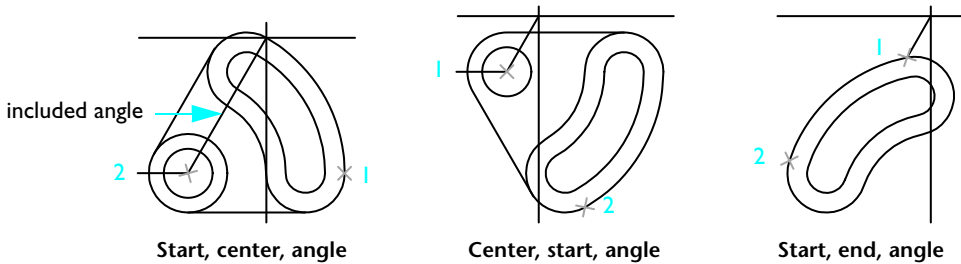



Draw Arcs

To create arcs, you can specify various combinations of center, endpoint, start point, radius, angle, chord length, and direction values. The following examples illustrate three ways to specify two points and an included angle.



NOTE The FILLET command creates an arc tangent to two existing objects. This is often the preferred method for creating arcs and will be covered later.

To get started

Action	Menu Browser	Icon
Set properties	Modify menu ► Properties	
Load, scale, and manage linetypes	Format ► Linetype	
Change lineweight settings	Format ► Lineweight	
Draw lines	Draw ► Line	
Draw parallel lines	Modify ► Offset	
Draw polylines	Draw ► Polyline	
Draw polygons	Draw ► Polygon	
Separate polyline segments	Modify ► Explode	
Join polylines	Modify ► Join	
Draw circles	Draw ► Circle	
Draw arcs	Draw ► Arc	

Help system

PROPERTIES, COLOR, LAYER, LINETYPE, LTSCALE, CELTSCALE, PSLTSCALE, LINEWEIGHT, LINE, OFFSET, PLINE, POLYGON, RECTANG, PEDIT, JOIN, EXPLODE, CIRCLE, ARC

Review and Recall

- 1 What is the result of setting the color of an object to ByLayer?
- 2 What is the fastest way to change the current layer to a different one?
- 3 What would you do to access a complete list of the properties of an object?
- 4 What command is recommended for creating parallel lines and curves?
- 5 What type of object is composed of a series of connected segments?

Enter coordinate values to locate points precisely

Turn on polar tracking to draw along specified angles

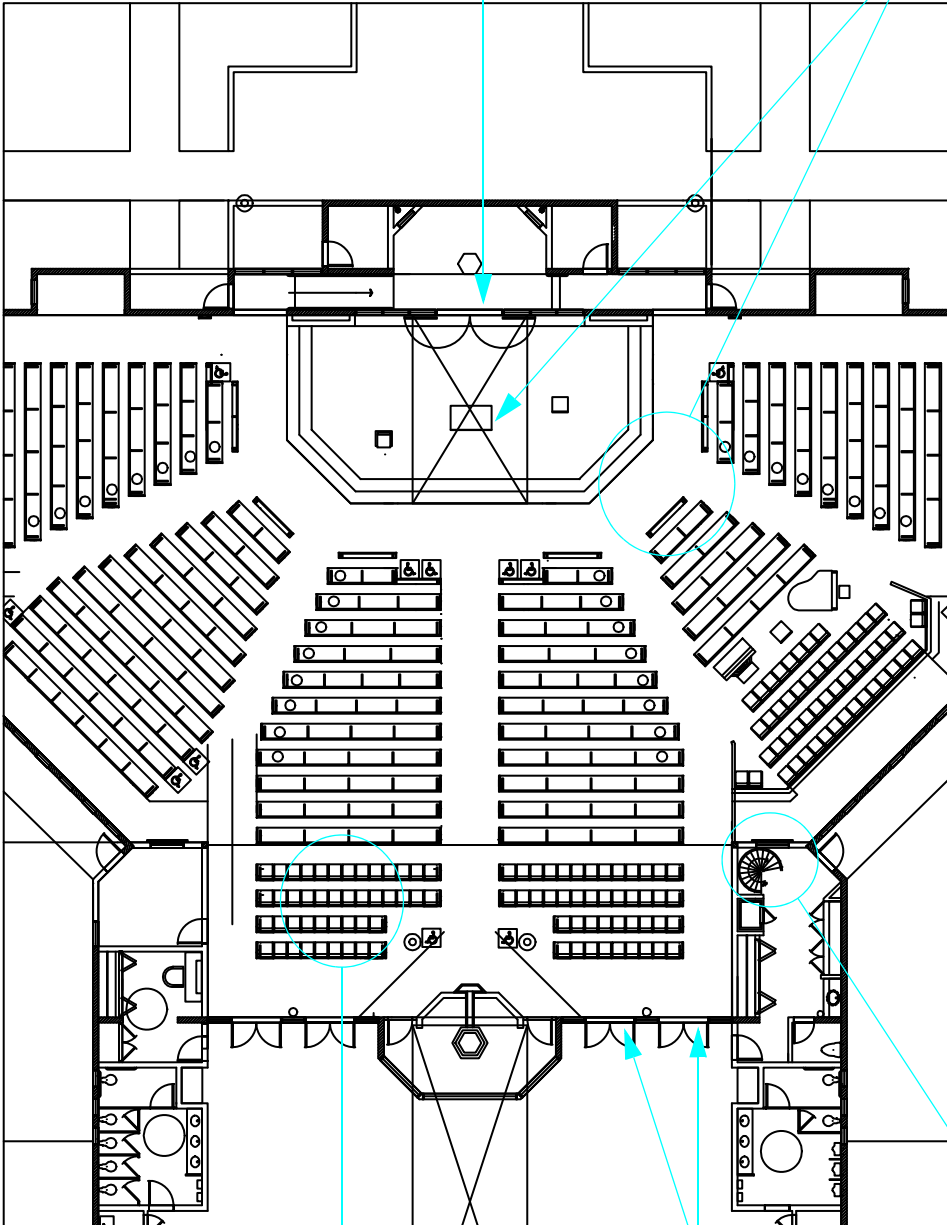

Turn on Ortho to draw horizontal and vertical lines

Turn on Grid and Snap to draw within a predefined framework

Use object snaps to locate precise points on objects

Precision Drawing

- Set Grid and Snap Values72
- Draw with Coordinates74
- Snap to Precise Points on Objects76
- Object Snap Descriptions78
- Specify Angles and Distances79



Set Grid and Snap Values

The grid and snap features set up a framework that you can use as a guide while drawing.

- **Grid** displays a rectangular pattern of dots that extends over the area specified by the drawing *grid limits*. The grid helps you align objects and visualize the distances between them. The grid does not appear in the plotted drawing.
- **Snap** restricts the movement of the crosshairs to intervals that you have defined. When Snap is on, the cursor seems to adhere, or “snap,” to an invisible grid. Snap is useful for specifying precise points with the cursor.

Set Grid and Snap Spacing

The grid does not necessarily correspond to the current snap interval. You might set a wide grid spacing to be used as a reference but maintain a closer snap spacing for accuracy in specifying points. For example, you might set the grid spacing to 10 times the snap spacing in a metric drawing or 12 times the snap spacing in an imperial drawing.

Try it: Constrain the cursor with Snap

- 1 Start a new drawing.
- 2 Click the Snap button on the status bar.



Notice that the button changes color to indicate that Snap has been turned on.

- 3 Move the pointer around in the drawing area while Snap is turned on.
Notice that the cursor seems to adhere, or “snap,” to points at equal intervals in the drawing area.

Try it: Display a grid

- 1 Click the Grid button on the status bar.



Notice that the grid dots cover a limited area, the grid limits.

- 2 Turn Grid and Snap off.

If you zoom in or out, you might need to adjust grid spacing to be more appropriate for the new magnification.

Try it: Change the Grid and Snap spacing

- 1 Right-click either the Grid or Snap button on the status bar.
- 2 Click Settings on the shortcut menu.
- 3 In the Drafting Settings dialog box, specify new spacings for Grid and Snap. Click OK.
- 4 Turn on Grid and Snap.

Set Grid Limits

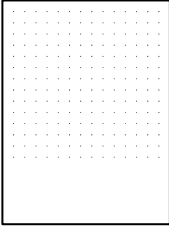

Grid limits shown by
range of grid dots

Try it: Change the grid limits

- 1 Click Menu Browser ► Format ► Drawing Limits.
- 2 Click two points to represent the lower-left and the upper-right corners of a rectangular area.
- 3 Repeat using two different points.

Draw with Coordinates

Coordinates represent locations in your drawing. When a command prompts you for a point, you can use the cursor to specify a point in the drawing area or you can enter coordinate values.

Use Cartesian and Polar Coordinates

In two-dimensional space, you specify points on a plane that is similar to a flat sheet of grid paper. You can enter two-dimensional coordinates as either *Cartesian* (X,Y) or *polar* ($distance<angle$) coordinates.

- **Cartesian coordinates** are measured from two perpendicular lines, the X axis and the Y axis. The X value specifies horizontal distance, and the Y value specifies vertical distance. For example, the coordinates 5,3 represent a point 5 units along the X axis and 3 units along the Y axis. The *origin* (0,0) indicates where the two axes intersect.
- **Polar coordinates** use a distance and an angle to locate a point. For example, the coordinates $5<30$ specifies a point that is a distance of 5 units from the origin and at a 30 degree angle from the X axis.

You can use *absolute* or *relative* values with each method. Absolute coordinate values are based on the origin. Relative coordinate values are based on the last point entered.

Draw with Absolute Cartesian Coordinates

Use absolute Cartesian coordinates when you know the precise X and Y values of the location of the point. For example, the line in the illustration begins at an X value of -2 and a Y value of 1 and ends at $3,4$. The entries on the command line were as follows:

Command: **line**
Specify first point: **#-2,1**
Specify next point or [Undo]: **#3,4**

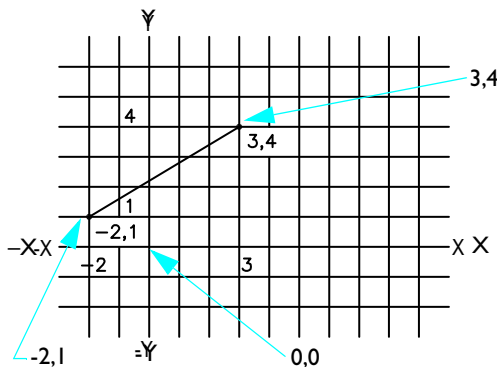

Entering the # identifies the coordinates as absolute coordinates.

Draw with Relative Cartesian Coordinates

Use relative Cartesian coordinates when you know the location of a point in relation to the previous point. For example, to locate a point relative to the absolute coordinates $-2,1$, start the next coordinates with the @ symbol.

Command: **line**

Specify first point: **#-2,1**

Specify next point or [Undo]: **@5,3**

Entering @5,3 locates the same point in this example as entering #3,4 in the previous example.

NOTE Absolute coordinates are entered differently if the Dynamic Input button on the left side of the status bar is turned off. In that case, the # is not used to specify absolute coordinates.

Snap to Precise Points on Objects

Using *object snaps* is the most important way to specify an exact location on an object without having to use coordinates. For example, you can use an object snap to draw a line to the exact center of a circle, to the endpoint of another line segment, or to the tangent on an arc.

You can specify an object snap whenever you are prompted for a point. When you move your cursor over an object, an active object snap point is identified with *AutoSnap markers* and tooltips.

Use Single Object Snaps

At any prompt for a point, you can specify a single object snap by holding down SHIFT, right-clicking, and choosing an object snap from the Object Snap menu.

Once you have specified an object snap, use the cursor to select a location on an object.

Press SHIFT and right-click to display the object snap menu

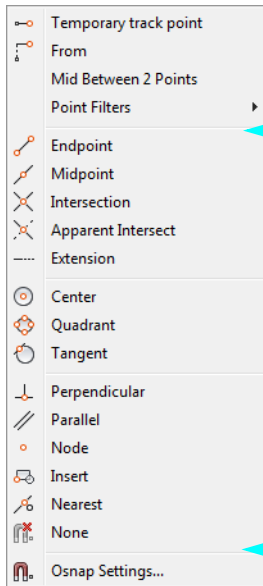

object snaps

NOTE To cycle through all the object snap points available for a particular object, press TAB.

Set Running Object Snaps

To use the same object snap repeatedly, set it as a *running* object snap. It will stay active until you turn it off. For example, you might set Center as a running snap if you need to connect the centers of a series of circles with a line.



You can set multiple running object snaps, such as Endpoint and Center, as running object snaps. Running object snaps can be turned on and off from the status bar.

Try it: Change the running object snap settings

- 1 Right-click Object Snap on the status bar.
- 2 On the shortcut menu, click Settings.
- 3 On the Drafting Settings dialog box, select the object snaps you want to use. Click OK.
- 4 Draw several lines and circles using object snaps to locate points precisely.

Object Snap Descriptions

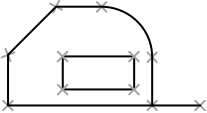
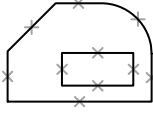
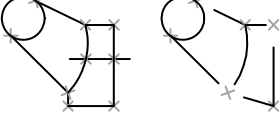
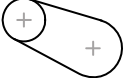
The following table illustrates commonly used object snaps.

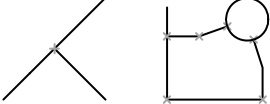
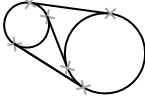
Object snap		Snaps to
Endpoint		Object endpoints
Midpoint		Object midpoints
Intersection		Object intersections or, for single object snaps, locations where intersections would occur if objects were extended
Center		Center points of circles, arcs, or ellipses
Quadrant		Quadrants of arcs, circles, or ellipses
Perpendicular		Points on objects that form a perpendicular alignment with the last point specified
Tangent		Point on a circle or arc that, when connected to the last point, forms a line tangent to the object

Specify Angles and Distances

You can quickly specify angles and distances using the polar tracking, direct-distance entry, and angle override features.

Use Polar Tracking

As you draw lines or move objects, you can use *polar tracking* to restrict the movement of the cursor to specified angle increments (the default value is 90 degrees). For example, you can create a series of perpendicular lines by turning on Polar before you start drawing. Because the lines are constrained to the horizontal and vertical axes, you can draw faster, knowing that the lines are perpendicular.

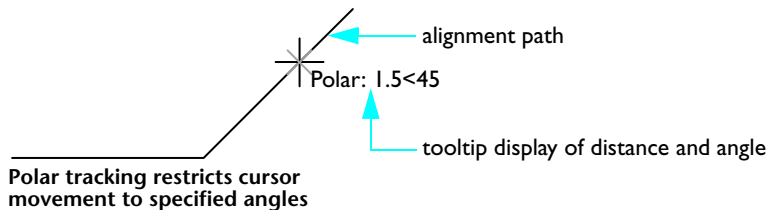

Try it: Use polar tracking

- 1 Click Polar Tracking on the status bar to turn it on.



- 2 Draw several lines at 90 degrees from each other.

Specify Distances

Use *direct distance entry* to specify an exact line length quickly—by moving the cursor to indicate a direction and then entering the distance from the first point. When polar tracking is on, using direct distance entry helps you draw perpendicular lines of a specified length efficiently.

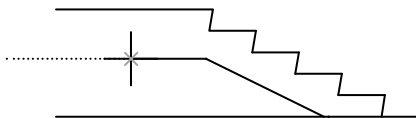

Polar tracking constrains the cursor to an angle, in this case 180 degrees...

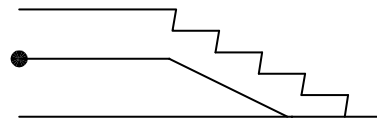

then direct distance entry determines the exact length of the line, in this case, 1000

Try it: Draw several lines of specified lengths

- 1 Click Menu Browser ► Draw ► Line.
- 2 Click a point and then move the cursor to the right (0 degrees).
- 3 Enter a value.
- 4 Move the cursor up (90 degrees) and enter another value.
- 5 Repeat several more times and then press ENTER.

Specify an Angle

If the angle that you want to use is not going to be used frequently, you can enter an *angle override*. For example, if you start drawing a line at the coordinates $-2,1$, and want that line to be at a 10 degree angle with a length of 50, you would enter

Command: **line**

Specify first point: **#-2,1**

Specify next point or [Undo]: **<10**

(Move the cursor in the desired direction)

Specify next point or [Undo]: **50**

Tutorial: Draw with Precision

In this tutorial, you will practice using several precision tools to create the following drawing, which can be the beginning of a design for

- A health spa with exercise pool
- A catch for a window lock
- A housing for a motor assembly

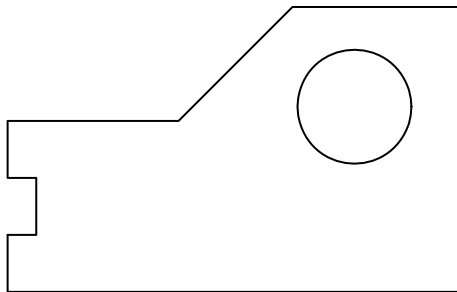

NOTE It is important that you save this drawing as you work. It will be used in several future tutorials in this guide.

Start a new drawing

- 1 Click Menu Browser ► File ► New.
- 2 Select the tutorial drawing template file that is closest to your intended application and units of measurement:
 - **Tutorial-mArch.dwt.** Sample architectural template (metric)
 - **Tutorial-mMfg.dwt.** Sample mechanical design template (metric)
 - **Tutorial-iArch.dwt.** Sample architectural template (imperial)
 - **Tutorial-iMfg.dwt.** Sample mechanical design template (imperial)
- 3 Click the Model tab.
- 4 Click File ► Save. Use **MyDesign** as the file name.

Use Grid and Snap to create a drawing

- 1 On the status bar, turn on Grid and Snap. Dynamic Input should also be turned on.
- 2 Click Menu Browser ► Draw ► Line and click several locations to create a series of line segments to create the previously illustrated design. The exact dimensions don't matter, but use reasonable distances for the design. Press ENTER to end the command.
- 3 Click Menu Browser ► Draw ► Circle ► Center, Radius.
- 4 Click a point to locate the center of the circle, and then click another point to specify its radius.
- 5 Turn Grid and Snap off.

Create a line using object snaps

- 1 Click Menu Browser ► Modify ► Erase.
The crosshairs cursor changes into a square *pickbox* cursor.
- 2 Click directly on one of the lines that you created and then press ENTER.
The line is erased, but how do you create another line to take its place with precision?
- 3 Click Menu Browser ► Draw ► Line.
- 4 Press SHIFT and right-click. From the object snap menu, click Endpoint.
- 5 Move the cursor over an endpoint of a line. When you see an AutoSnap marker, click.
- 6 Press SHIFT and right-click again. From the object snap menu, click Endpoint.
- 7 Move the cursor over the opposite endpoint and click. Press ENTER to end the command.
The endpoints of the new line are located exactly at the endpoints of the adjacent lines.

- 8 Do the following:
 - Experiment with creating lines using the following object snaps: Midpoint, Center, Perpendicular, and Tangent.
 - Turn running object snaps on and create several more lines.
 - Create a line from the center of the circle at a 30 degree angle and 10 units long.
- 9 Erase any objects that are not part of the illustrated result.
- 10 Save the drawing. **MyDesign** should be the file name.

To get started

Action	Menu Browser
Set Snap and Grid spacing	Tools ► Drafting Settings, Snap and Grid tab
Use single object snaps	SHIFT+right-click for the object snap menu
Set running object snaps	Tools ► Drafting Settings, Object Snap tab
Change AutoSnap settings	Tools ► Options, Drafting tab
Change polar settings	Tools ► Drafting Settings

Help system

GRID, SNAP, DSETTINGS, LIMITS, UCS, DYNMODE, OSNAP, OPTIONS

Review and Recall

- 1 How do you turn off the grid dots in your drawing area?
- 2 The term *origin* refers to what coordinate values?
- 3 Pressing SHIFT while you right-click displays what shortcut menu?
- 4 What button can you turn on to ensure that the line you are drawing is exactly vertical?
- 5 What is meant by the term *direct distance entry*?

Use OFFSET to create parallel lines and concentric circles

Use TRIM to remove the parts of objects that extend beyond cutting edges that you specify

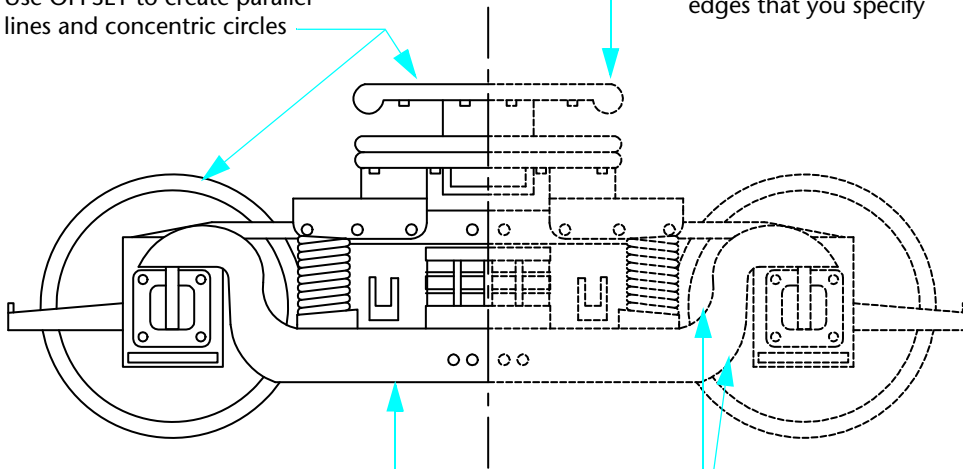

Use FILLET to connect two lines with an arc

Use COPY to create duplicates at locations that you specify

Use DIST to measure the distance between two points

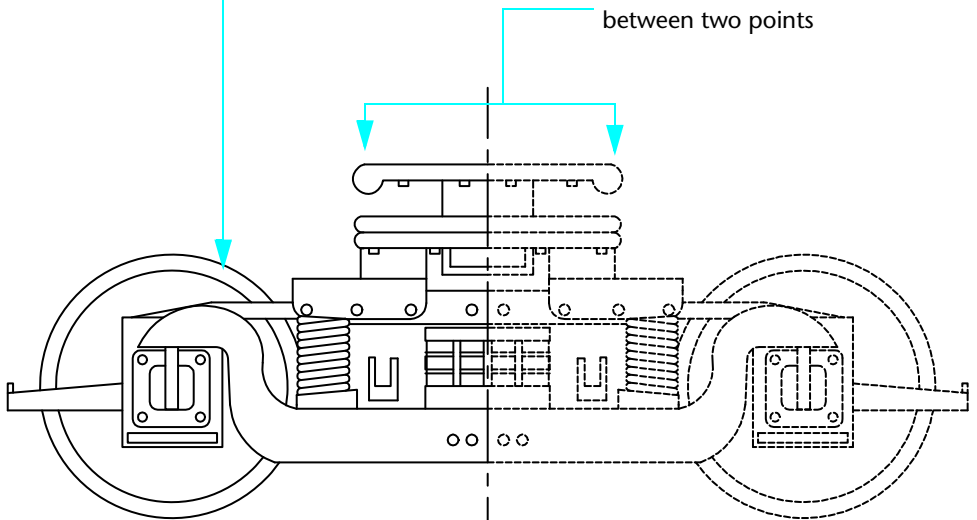

Use MIRROR to create an exact replica of objects across a mirror line

Make Modifications

Select Objects to Edit	86
Erase, Extend, and Trim Objects	87
Duplicate Objects	90
Move and Rotate Objects	93
Fillet Corners	94
Use Editing Aids	109
Analyze Drawings	111



Select Objects to Edit

When you edit objects, you select one or more objects to specify a *selection set* of the objects. You can use two methods to specify which objects to modify:

- **Choose the command first.** Choose an editing command and then select objects to modify.
- **Choose the objects first.** Select objects and then start the editing command. In addition, when you use this method, *grips* are displayed on the objects that you can use to modify the objects directly. You can clear a selection by pressing ESC.

Object Selection Methods

The two most common methods to select objects are

- **Select individual objects.** Click objects individually.
- **Specify a selection area.** Click a rectangular area around the objects to be selected.

Specify a Selection Area

You can select objects by enclosing them in a rectangular selection area. You define a rectangular selection area in the drawing area by clicking opposite corners. The order in which you specify the corners makes a difference.

- **Drag from left to right** to create a *window selection*, which selects only objects entirely within the selection area.

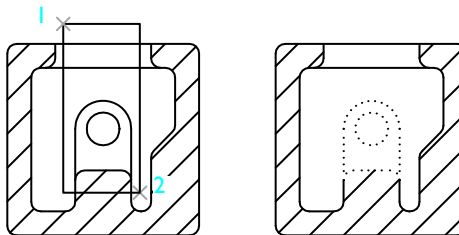

Objects selected using window selection

- **Drag from right to left** to create a *crossing selection*, which selects objects within and crossing the selection area.

NOTE You can remove objects from the selection set by pressing SHIFT and then clicking them.

Erase, Extend, and Trim Objects

These methods delete objects or change their lengths:

- **Erase** deletes the entire object.
- **Extend** lengthens an object to a precise boundary.
- **Trim** shortens an object to a precise boundary and removes the excess.

Erase Objects

You can use all the object selection methods with the ERASE command. The example shows how you use window selection to erase a section of piping.

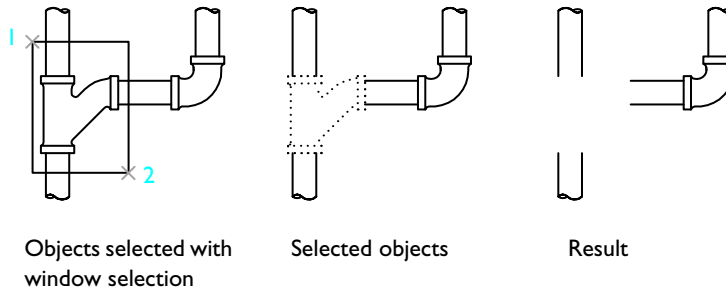

Try it: Practice using window and crossing selection

- 1 Click Menu Browser ► File ► New.
- 2 Create some lines, arcs, and circles.
- 3 Click Menu Browser ► Modify ► Erase.
- 4 Select several objects using a crossing selection and press ENTER.
Notice which objects are selected and erased.
- 5 Select several more objects using a window selection and press ENTER.
Again, notice which objects are selected and erased.
- 6 Select the other objects that you created in step 1 individually and press ENTER to erase them.

Extend Objects

You can extend objects so that they end precisely at a boundary defined by other objects. If you press ENTER instead of selecting boundary objects, all visible objects in the drawing become potential boundaries. The illustration shows lines extended precisely to the circle, which is the nearest boundary.

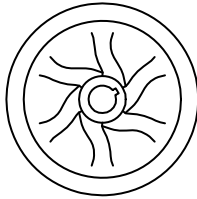

Press ENTER to accept all objects as boundaries

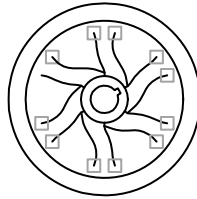

Select objects to extend nearest to the end to be extended

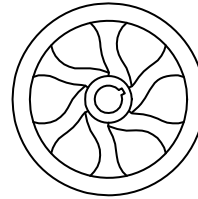

Result

Try it: Extend an object

- 1 Create a short line. Then create circle that encompasses the line.
- 2 Click Menu Browser ► Modify ► Extend.
- 3 At the Select Objects prompt, click the circle.
Notice that you select the boundary objects first. The next step is easy to forget.
- 4 Press ENTER to end boundary selection.
- 5 At the next Select Objects prompt, click one end of the line and then the other end of the line. Press ENTER to end the command.

Trim Objects

Trimming objects is very similar to extending them. To trim, you cut an object at an edge defined by one or more objects. By default, objects defined as cutting edges must intersect the object to be trimmed.

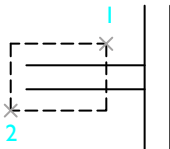

Cutting edges selected with a crossing selection

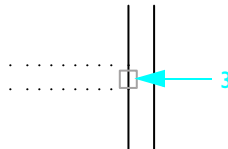

Object to trim selected

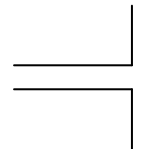

Result

Try it: Trim an object

- 1** Create two horizontal lines and two vertical lines as shown in the left side of the previous illustration.
You can use the Perpendicular object snap to make sure that the two horizontal lines intersect the vertical line at a right angle.
- 2** Click Menu Browser ► Modify ► Trim.
- 3** At the Select Objects prompt, click locations 1 and 2 as previously illustrated.
Notice that you select the boundary objects first.
- 4** Press ENTER to end boundary selection.
- 5** At the next Select Objects prompt, click the vertical line at point 3 as shown. Press ENTER to end the command.

NOTE With both EXTEND and TRIM, you must accept the selection set of boundary objects by pressing ENTER, and then select the objects to be trimmed. If you press ENTER without selecting any boundary objects, all objects become potential boundaries.

Duplicate Objects

There are several ways to make copies of objects:

- **Copy** creates new objects at a specified location.
- **Offset** creates new objects at a specified distance from selected objects or through a specified point.
- **Mirror** creates a mirror image of objects around a specified mirror line.

Copy Objects

To copy an object, you select one or more objects to copy, specify a start point, called a *base point*, and then specify a second point to determine the distance and direction of the copy. The two points can be anywhere within the drawing. For example, in the following illustration, the circle is copied from one rectangle to a corresponding location on the second rectangle.

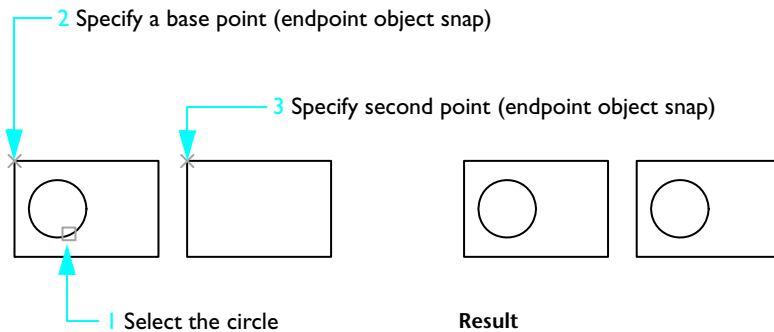

Try it: Copy an object

- 1 Create two rectangles and a circle as shown on the left side of the previous illustration.
- 2 Click Menu Browser ► Modify ► Copy.
- 3 At the Select Objects prompt, click the circle and press ENTER.
- 4 At the Specify Base Point prompt, press SHIFT and right-click to display the object snap menu. Click Endpoint.
- 5 Click the corner of the rectangle at point 2 as shown.

- 6 At the Specify Second Point prompt, press SHIFT and right-click to display the object snap menu. Click Endpoint.
- 7 Click the corner of the other rectangle at point 3 as shown.
- 8 Press ENTER to end the command.

The copied circle is at the same location relative to its enclosing rectangle as the original circle.

You can also copy objects specifying a base point followed by direct distance entry, typically with polar snap turned on.

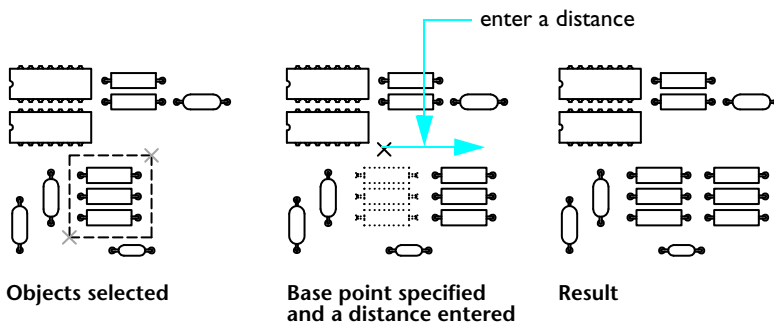

The Copy command automatically repeats so you can easily create multiple copies.

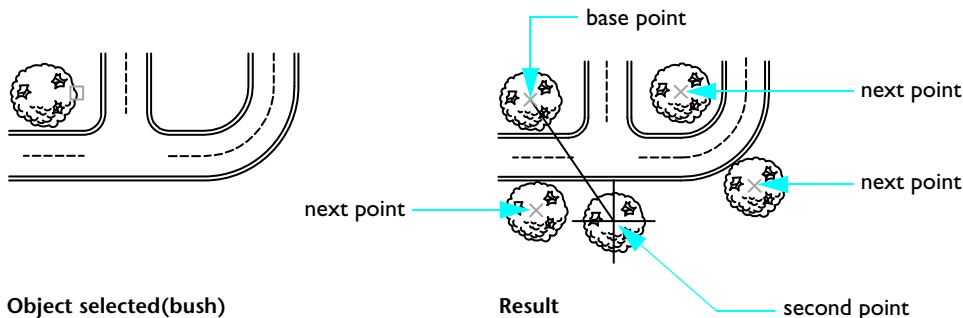

Offset Objects

Offsetting creates a new object that seems to trace a selected object at a specified distance. Offsetting circles creates larger or smaller circles depending on the offset side. For an easy way to create parallel lines or concentric circles, use offsetting.

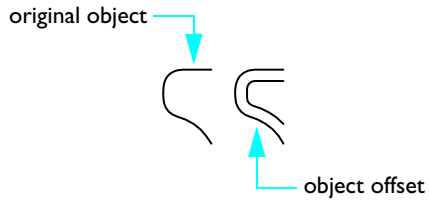

NOTE Offsetting several objects followed by trimming or extending them is a very efficient drawing technique.

Mirror Objects

You mirror objects around a mirror line, which you define with two points. You then choose to delete or retain the original objects.

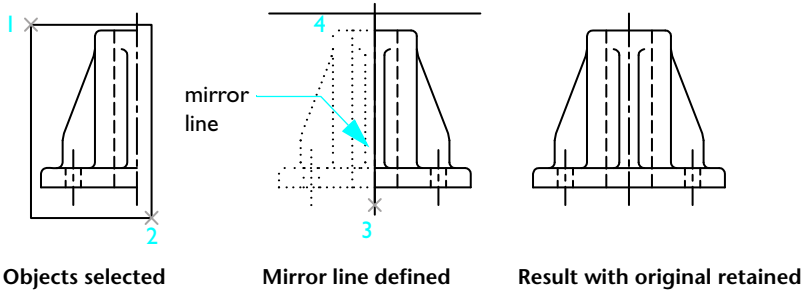

Mirroring is useful for creating symmetrical objects. You can draw half the object and quickly mirror it rather than draw the whole object.

Move and Rotate Objects

An important drawing technique is to create one or more objects and then move or rotate them into place.

Move Objects

You move objects the same way that you copy them. You select the object to move, specify the base point (1), and then specify a second point to determine the distance and direction of the move (2). In the illustration, these steps move the window higher and away from the door.

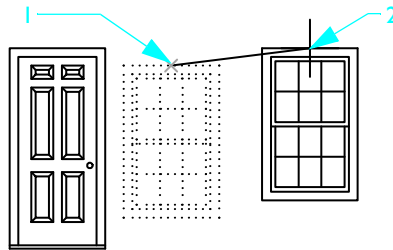

Select objects, specify base point and new location of the selected objects.

Rotate Objects

You rotate objects by specifying a base point and a rotation angle. You can specify the rotation angle by specifying a point or entering a value for the angle.

In the following example, you specify the base point (1) and a second point (2) that determines the angle of rotation (2) for the orientation of a house.

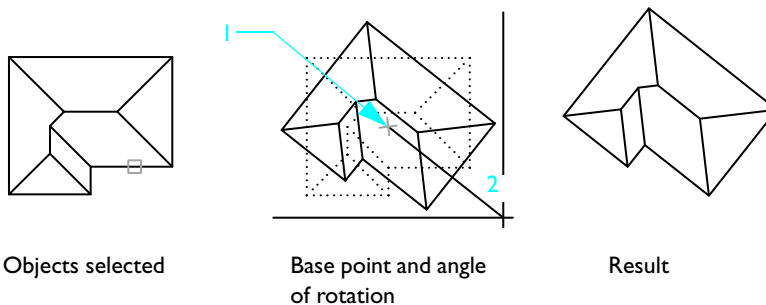

Instead of specifying the second point in the example, you could have entered **-35** to specify the rotation in degrees.

NOTE By default, a positive angle results in a counter-clockwise rotation. However, this setting can be changed using the Units command.

Fillet Corners

Filleting connects two objects with an arc of a specified radius that is tangent to the objects.

Use the Radius option of the Fillet command to specify arc radius of the fillet. Changing the radius sets the default radius for subsequent fillets. By default, the filleted objects are trimmed as shown in the illustration.

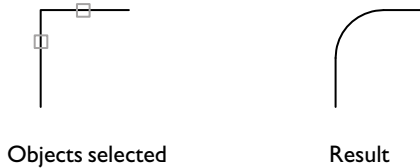

One useful technique is to set the fillet radius to 0. This results in two objects intersecting in a sharp corner as illustrated. No arc is created.

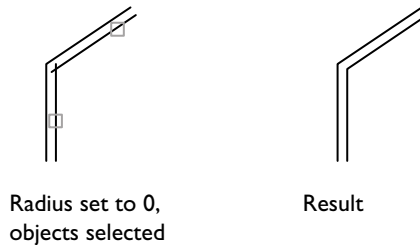

NOTE You can hold down SHIFT while selecting the objects to override the current fillet radius with a value of 0.

You can also fillet circles, arcs, and polylines. More than one possible fillet can exist between circles and arcs depending on where you select the objects.

Tutorial: Modify Objects with Precision

In the following tutorial, you will use precision drawing techniques to modify part of an assessor's map.

The adjoining property owners of an empty city lot persuaded their city council to allow them to acquire the lot. The only requirement was that the property owners agree on an equitable division.

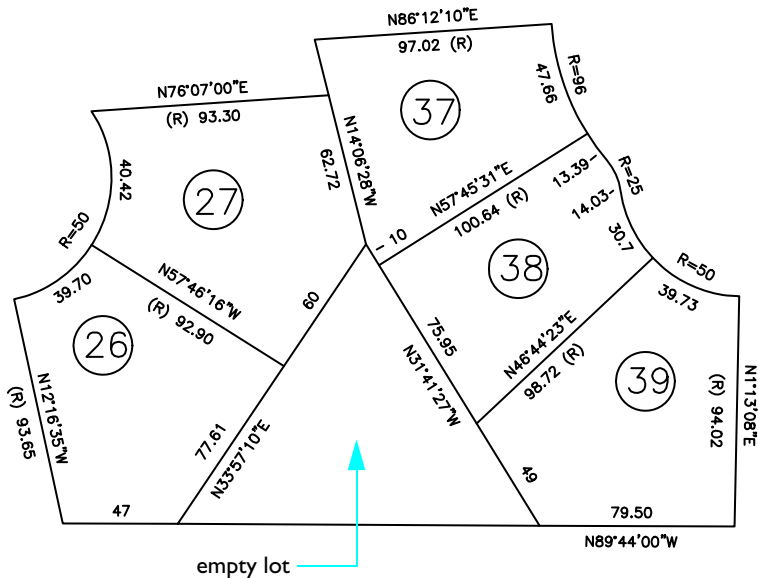

How would you divide the empty lot?

The proposal accepted by the property owners expanded lots 26 and 27 to make their total lot sizes equal. The fence between lots 38 and 39 was extended. Lot 38 was larger than the others, but this benefit was offset by its irregular shape.

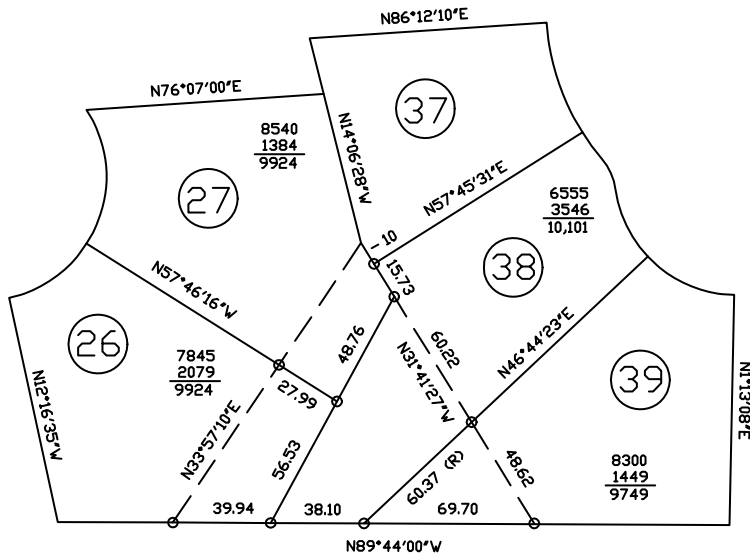

Use the following procedure to change the boundaries of the lots.

- 1 Click Menu Browser ► File ► Open.
- 2 In the Select File dialog box, find the *\Help\GettingStarted* folder in the AutoCAD or AutoCAD LT product folder and open *map.dwg*.
- 3 To simplify the display, turn off the Text layer.

You first create a new property line on the left side of the triangular lot. The top end of the new property line will be displaced 25.73 feet; and the bottom end of the new property will be displaced by 39.94 feet. These distances were determined using trial-and-error to make lots 26 and 27 about equal in area, but without making lot 38 too narrow or too large.

To accomplish this task, you create some “construction geometry” that makes the task easier.

- 4 Use the Circle command and object snaps to create a circle with a radius of 25.73 and a circle with a radius of 39.94 centered on the intersections as shown in the illustration.

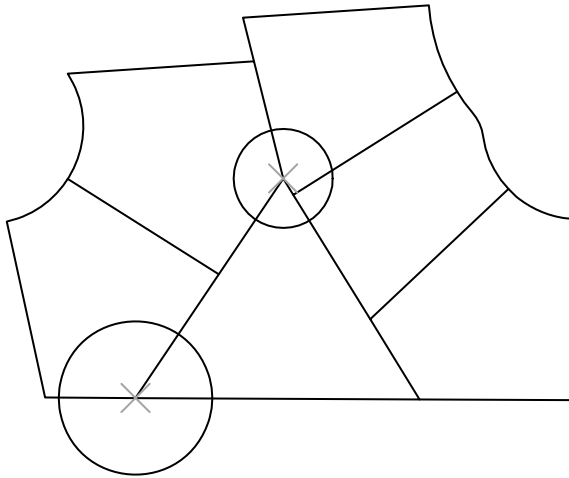

5 Use intersection object snaps to create a new property line as shown in the illustration.

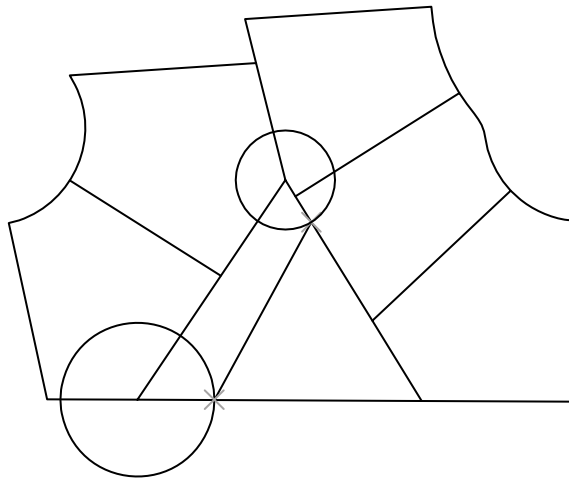

6 Erase the old property line and the two construction circles.

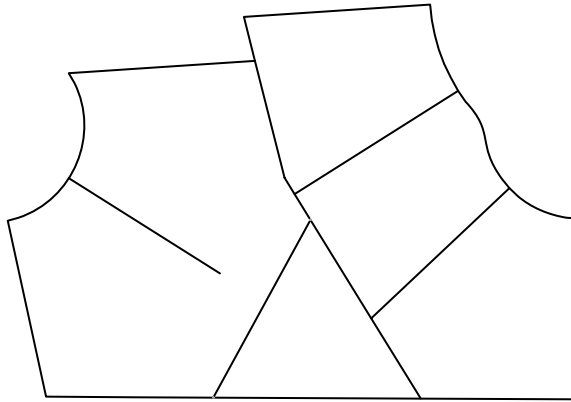

Next, extend the old property line to the new one.

- 7** Click Menu Browser ► Modify ► Extend.
- 8** Click the new property line. This line is the boundary for extending the old property line.

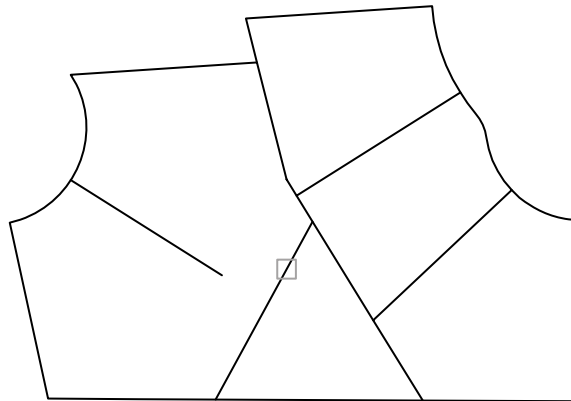

- 9** Press ENTER. This action is important and easily forgotten. It separates the objects that serve as boundaries from the objects to be extended.
- 10** Click the old property line near the end to be extended as shown.

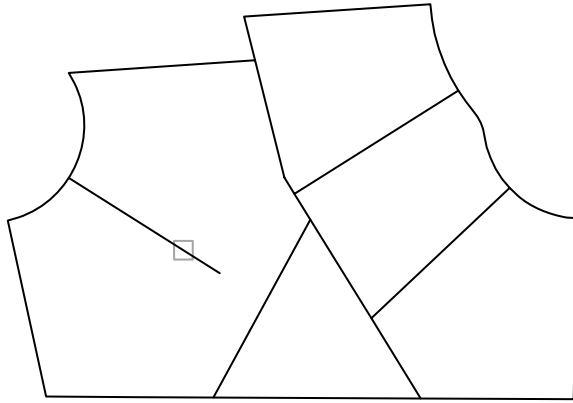

11 Press ENTER to end the command.

12 Use the same method to extend the other property line to the lower border.

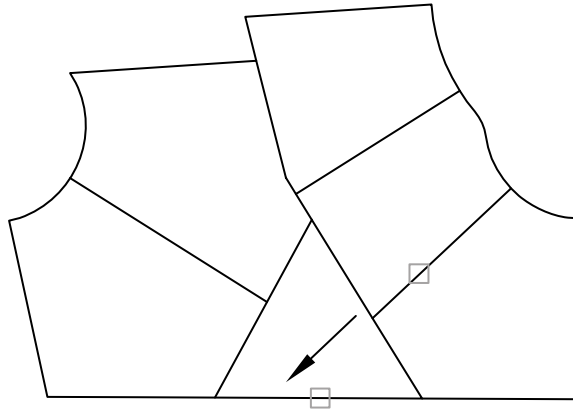

13 Erase the old property lines to open the long, narrow lot.

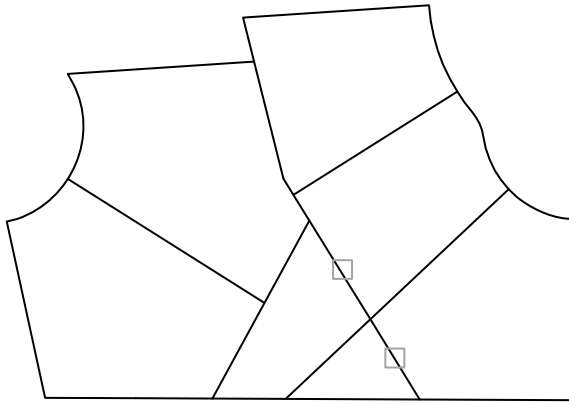

14 Draw a short property line using the endpoint object snap between the end points of the property lines as shown.

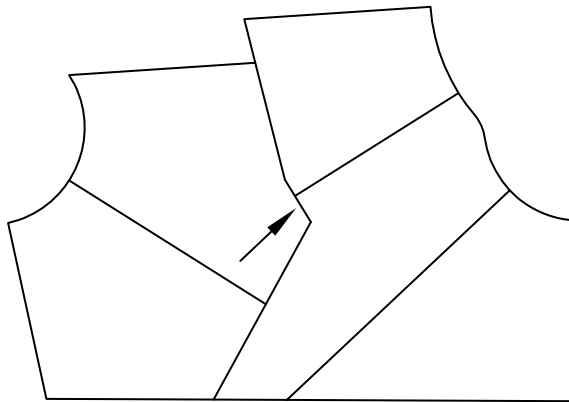

The new property lines are complete. But how can you find the new areas of the lots?

Find the areas of the lots

- 1** On the command line, enter **boundary**.
- 2** In the Boundary Creation dialog box, click Pick Points. Then click inside each of the lots. Press ENTER to end the command.

A closed polyline object is created using the property lines for each lot. These closed polylines are superimposed upon the existing property lines and can later be erased.

NOTE As you move your cursor over the map, different polylines highlight. Where the polylines share a common boundary, only one of them is highlighted. Press SHIFT and SPACEBAR on a shared boundary repeatedly to cycle through the overlapping objects at that location.

- 3 Click Menu Browser ► Modify ► Properties.
- 4 Click one of the boundaries and find the area listed in the Properties palette.
- 5 Press ESC to clear the selection.
- 6 Find the area of each of the other lots.
- 7 Close the map drawing without saving it.

Tutorial: Create a New Drawing with Precision

In the following tutorial, you will create a detail drawing of a type of jet engine mount used to attach jet engines to commercial aircraft. You will be happy to know that this part is made of a high-strength, nickel-chromium-iron alloy.

NOTE Each step in this tutorial is not specified in detail. When in doubt, feel free to review earlier portions in this guide or use the Help system. You can access all the commands in this tutorial using the Draw and Modify menus.

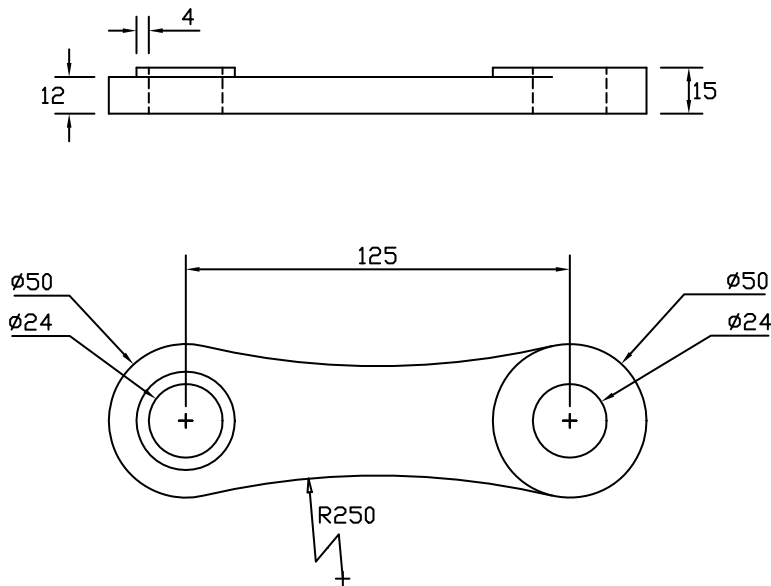

- 1 Start a new drawing using the drawing template file, *Tutorial-mMfg.dwt*.

This template is for mechanical design drawings using metric units. All distances are assumed to be in millimeters.

- 2 On the status bar, click the Model button.
- 3 Make sure that the Polar and Osnap buttons on the status bar are turned on. The current layer should be *Model-Front*.

Create the front view

- 1 Create a circle with a diameter (not radius) of 50 mm at the coordinates 180,100.

NOTE The precise location of this circle is not critical in this tutorial, but it's a good idea to make sure that several significant features coincide with snap locations. For single-view drawings or 3D models, it's a good idea to have a significant feature located at the origin (0,0). This is convenient when referencing a drawing from another drawing such as with assembly drawings.

- 2 Use the Center object snap to draw a circle with a diameter of 24 using the center point of the previous circle.

The Center object snap might not be a default running object snap. Press SHIFT and right-click to access the object snap menu.

- 3 Using PolarSnap to lock the angle at 0 degrees, copy the two circles to a location 125 mm to the right.

Command: copy

Select objects: *Select the two circles and press ENTER*

Specify base point or [Displacement/mOde]: <Displacement> *Click the center of the circles and move your cursor to the right*

Specify second point or <use first point as displacement>: **125**

Specify second point or [Exit/Undo]: *Press ENTER*



- 4 Offset the inner circle on left by 4 mm to the outside.

Command: offset

Specify offset distance or [Through/Erase/Layer]: **4**

Select object to offset or [Exit/Undo]: *Select the left inner circle*

Specify point on side to offset or [Exit/Multiple/Undo]: *Click anywhere outside the circles*



- 5 Create a circle using the tangent-tangent-radius (Ttr) option. The radius should be 250 mm. Notice that the AutoSnap marker for tangent is turned on automatically.

Command: circle

Specify center point for circle or [3P/2P/Ttr (tan tan radius)]: t

Specify point on object for first tangent of circle: *Select an outer circle near the expected tangent location*

Specify point on object for second tangent of circle: *Select the other outer circle as shown*

Specify radius of circle: **250** (only part of the circle is shown in the illustration)

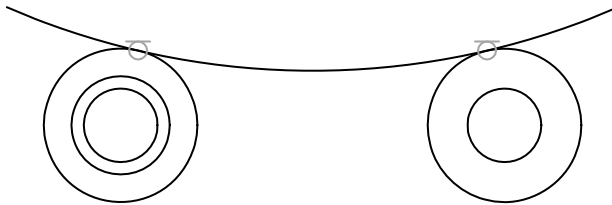

- 6 Trim the large circle as shown below.

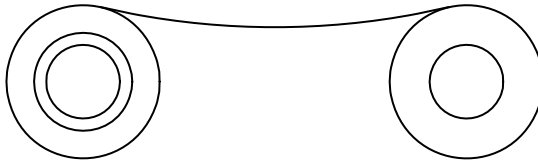

- 7** Use the Mirror command to mirror the arc using the center points of the left and right circles to define the mirror line. Again, use SHIFT and right-click to access the object snap menu. There are often alternative methods for each step. For example, to create the lower arc, you could have used the Fillet command to fillet the two outer circles with a radius of 250 mm.

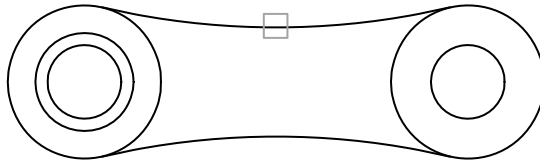

- 8** Trim the outer-left circle as shown.

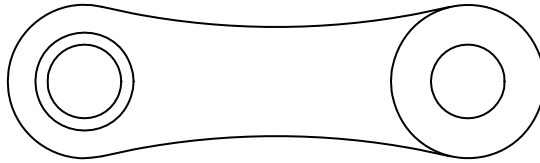

The front view of the part is complete. Next, you will use the objects in the front view to create the top view of the part.

Create the top view

- 1** Set the current layer to *Model-Top*. You can use the Layer control on the Layers toolbar, or the Layer Properties Manager.
- 2** Use the Quadrant object snap to create a line starting from the left side of the part. With polar snap on, move the cursor upward and enter **100** to make the line 100 mm long. Create another 100 mm line on the right side of the part.

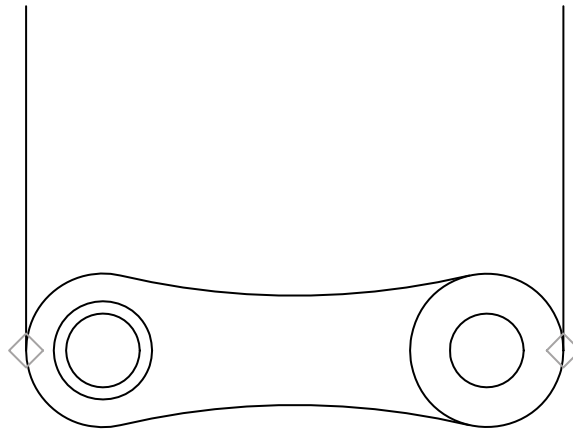

- 3 Use the Endpoint object snap to create a line connecting the upper ends of the vertical lines.
- 4 Offset the horizontal line downward by 12 mm.

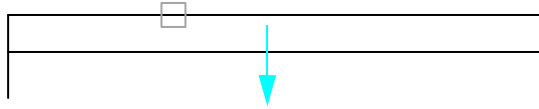

- 5 Trim the lower ends of the vertical lines to create the rectangular outline of the top view.
- 6 Offset the topmost horizontal line upward by 3 mm. Create vertical lines from the quadrants of the other circles as shown.

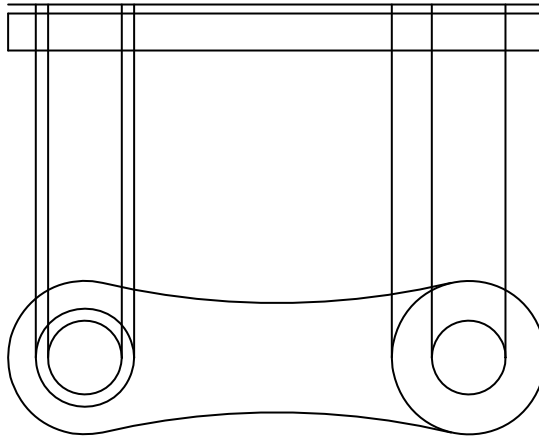

- 7 Trim the four vertical lines representing the silhouette edges of the holes as shown. Don't forget to press ENTER after selecting the horizontal boundary line for the trimming.

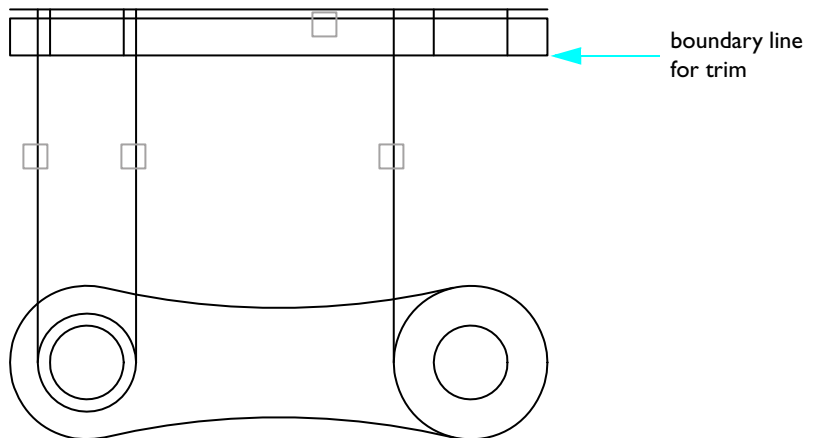

- 8 Trim the other vertical lines as shown. Zoom and pan as needed.

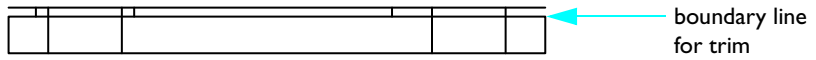

9 Trim the topmost horizontal line as shown.

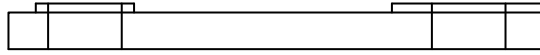

10 Create a vertical line that starts from the endpoint of the arc and ends perpendicular to the horizontal line as shown. This line will be the trim boundary for the runout on the part.

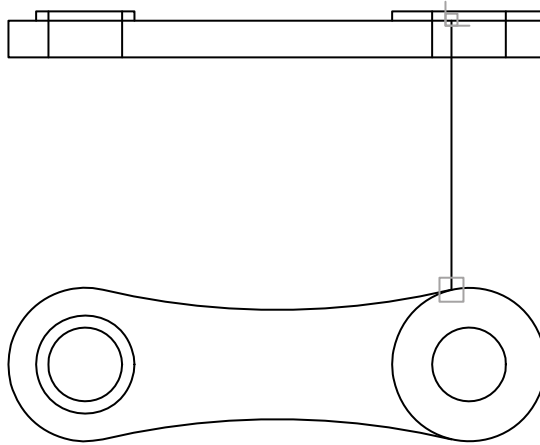

11 Trim the horizontal line to the boundary line as shown.

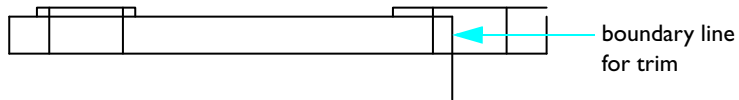

12 Erase the vertical trim boundary line.

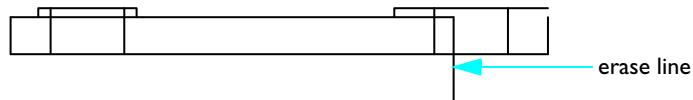

13 Extend the remaining vertical line as shown.

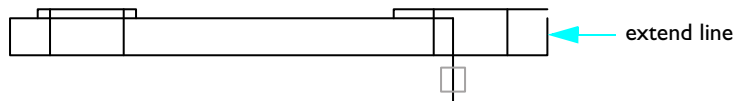

14 Add 1 mm fillets to the outside corners.

The top view is almost complete. You still need to change the hidden silhouette edges of the holes to a dashed linetype.

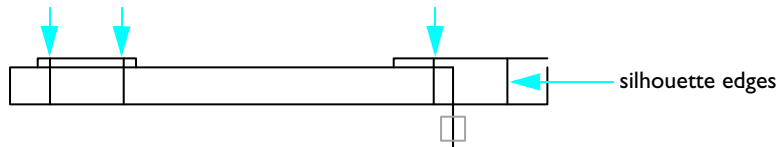

To change the linetype of the four vertical lines, you will override the linetype property currently assigned to the lines. As you remember, you can select the objects and then use either the Properties palette or the Properties panel to specify the required linetype.

Change linytypes

- 1 Select the four vertical silhouette edges of the holes.
- 2 Click Menu Browser ► Modify ► Properties.
Notice that because you selected more than one object, only the common properties are listed.
- 3 On the Properties palette, click Linetype. Click the arrow and, from the list, click ACAD_ISO02W100.
- 4 Click Linetype Scale. Type **0.3** for the new linetype scale and press ENTER.
- 5 Move your cursor off the Properties palette and press ESC to clear the selection.

The four lines are now displayed with a dashed linetype.

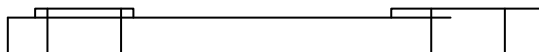

NOTE Instead of changing the linetype of the four lines individually, you could have created a new layer for hidden lines. The linetype property of that layer could then be set to ACAD_ISO02W100. Then, to change the linetype of the four lines, you would change the layer assignment of the lines to the new layer.

- 6 The tutorial is complete. If you want to keep this drawing, save it now.

Match Properties

You can easily copy properties of one object to other objects. You can choose to match color, layer, linetype, linetype scale, lineweight, thickness, plot style, and in some cases dimension styles, text styles, and hatch patterns.

Try it: Copy the properties from one object to other objects

- 1 Start a new drawing.
- 2 Draw several objects with different color properties.
- 3 Click Menu Browser ► Modify ► Match Properties.
- 4 Click the source object from which you want to copy properties.
- 5 Click the objects to which you want to copy the properties.

You can use the Settings option of the command to select the properties you want to match and clear the ones you don't.

Use Editing Aids

The following editing aids help you modify drawings efficiently:

- **Grips** edit objects using your cursor and a shortcut menu.
- **Revision clouds** identify areas that have been updated.

Edit with Grips

Grips are small squares and arrows that appear on an object after it has been selected. They mark control locations and are powerful editing tools.

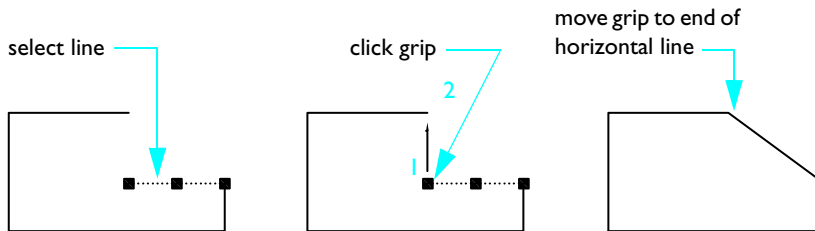

After you select an object, you can click a grip and move it with your cursor. For more options, click a grip and right-click to display a shortcut menu. Then choose a grip edit mode.

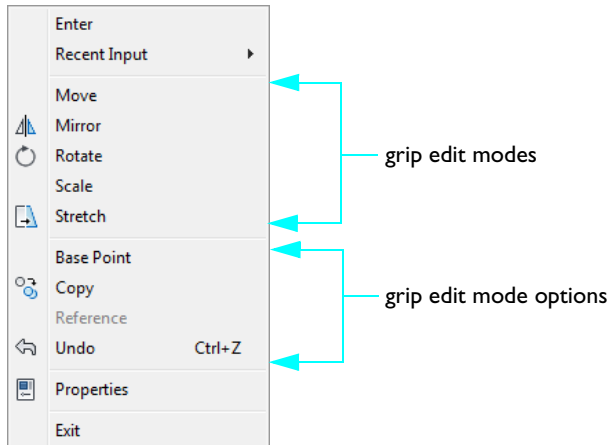

Try it: Edit objects using grips

- 1 Draw several objects.
- 2 Click several objects to select them and to display their grips.
- 3 Click a grip on an object and click its new location. This is the default stretch mode.
 - Notice the grip behavior when object snaps are turned on.
 - Notice the grip behavior when you stretch a grip onto another grip.
- 4 Click a grip on an object and then right-click.
- 5 Choose a different grip mode such as Move, Mirror, Rotate, or Scale.
- 6 Press ESC to exit grip editing.

Create Revision Clouds

If you review or redline drawings, you can increase your productivity by using revision clouds to highlight your markups. You draw the revision cloud around the objects you want to emphasize, creating a polyline in the shape of a cloud, as shown in the following illustration.

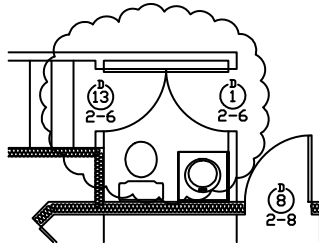

Try it: Create a revision cloud

- 1 Click Menu Browser ► Draw ► Revision Cloud.
- 2 Click anywhere in the drawing area and move your cursor to encompass an area.
- 3 Repeat the command and see whether the revision cloud always creates the arcs outward or if you can trick it.

Analyze Drawings

You can extract information from your model using the inquiry commands. The most commonly used one is the DIST command.











Use DIST to quickly determine the relationship between two points. You can display the following information for two points you specify:

- Distance between them in drawing units
- Angle between the points in the *XY* plane
- Angle of the points from the *XY* plane
- Delta, or difference, between the *X*, *Y*, and *Z* coordinate values of each point



Try it: Find the distance and angle between two points

- 1 Click Menu Browser ► Tools ► Inquiry ► Distance.
- 2 Use an object snap to locate a point on an object.
- 3 Use another object snap to locate a point on a different object.
- 4 Review the data displayed in the command window.
- 5 Press F2 to see the data in a larger window called the *Text window*.

To get started

Action	Menu Browser	Icon
Erase objects	Modify ► Erase	
Extend objects	Modify ► Extend	
Trim objects	Modify ► Trim	
Copy objects in a drawing Copy objects between drawings	Modify ► Copy Edit ► Copy	
Offset objects	Modify ► Offset	
Mirror objects	Modify ► Mirror	
Move objects	Modify ► Move	
Rotate objects	Modify ► Rotate	
Fillet objects	Modify ► Fillet	
Edit properties	Modify ► Properties	

To get started

Action	Menu Browser	Icon
Match properties	Modify ► Match Properties	
Create revision clouds	Draw ► Revision Cloud	
Extract information from objects	Tools ► Inquiry ► Distance	

Help system

ERASE, EXTEND, TRIM, COPY, COPYCLIP, COPYMODE, PASTECLIP, OFFSET, MIRROR, MOVE, ROTATE, UNITS, FILLET, PROPERTIES, MATCHPROP, OPTIONS, REVLOUD, DIST

Review and Recall

- 1 What is the difference between a *crossing selection* and a *window selection*?
- 2 What is the fastest way to create several parallel lines?
- 3 What is the easiest way to create an arc that is tangent to two other objects?
- 4 When creating or modifying an object, what do you do to display the object snap menu?
- 5 What is an easy way to find the distance between two points in a drawing?

These symbols, called blocks, represent standard items such as trees or bushes

Create blocks when you want to use drawings or parts of drawings repeatedly

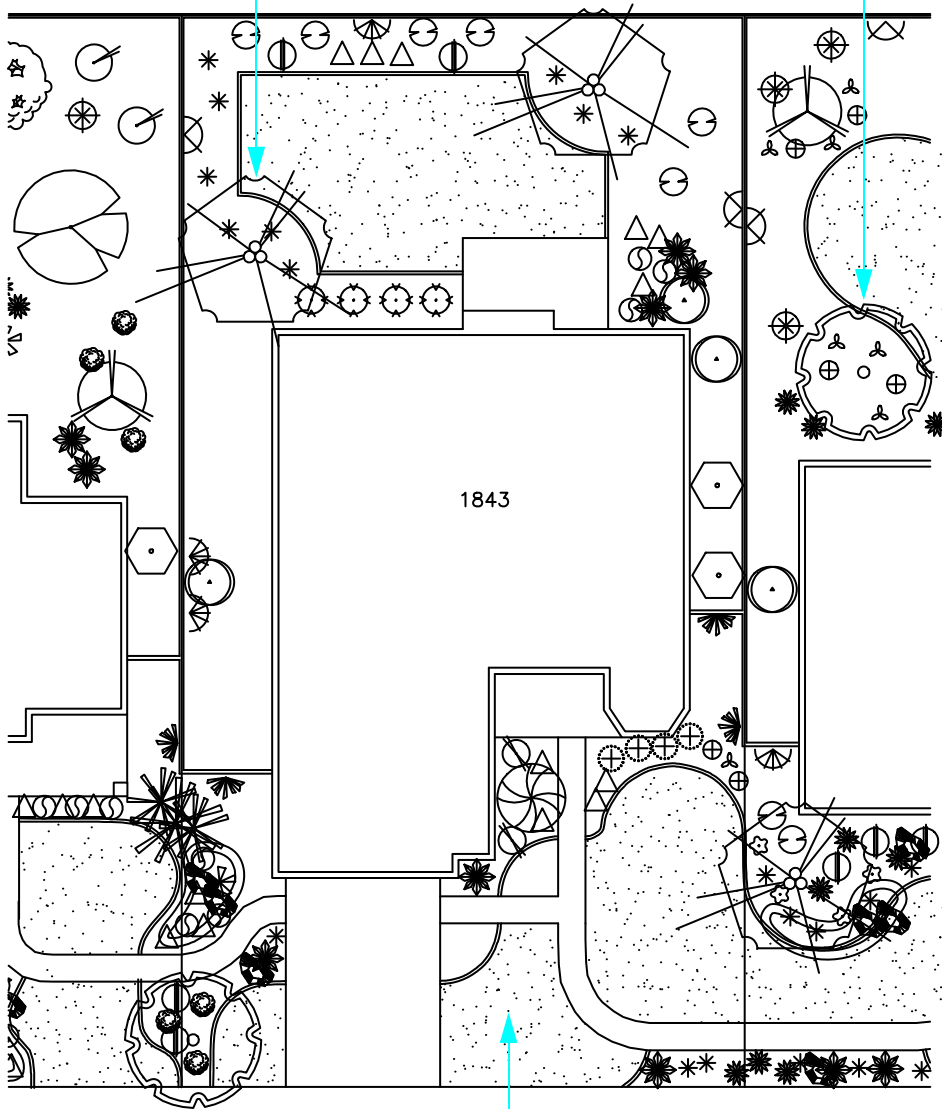

Hatch to fill areas with patterns or solid colors that help identify the subject matter or material

Add Symbols and Hatches

Overview of Blocks	116
Insert Blocks	117
Overview of Hatches	119
Insert Hatches or Solid Fills	120



Overview of Blocks

In AutoCAD and AutoCAD LT, symbols are called *blocks*. A block is a collection of objects that are associated into a single object. Use blocks to represent objects such as a trees, fasteners, or doors.

Blocks are typically defined and stored in drawings called *block libraries*, or *symbol libraries*, from which they can be inserted into other drawings. An entire drawing can also be inserted as a block.

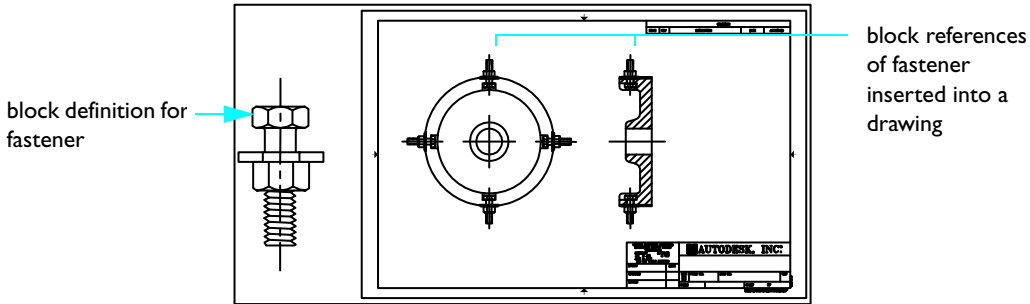

Blocks may also include *block attributes*, which store data such as part numbers, dates, and performance ratings.

Benefits of Blocks

Using blocks makes it easier and faster to get your work done:

- Draw efficiently by inserting, relocating, and copying blocks rather than individual objects.
- Build a standard library of frequently used symbols, components, or standard parts.
- Store associated data with block attributes which can be extracted to create reports.
- Manage blocks with *DesignCenter*. DesignCenter provides convenient organization and access to thousands of symbols on your computer, on your local network, and on the World Wide Web.

Sources of Blocks

There are several sources of blocks that you can use in your drawings.

- **Your computer.** Over 300 standard blocks in 15 symbol library drawings are available in the *DesignCenter* folder.
- **Your company network.** You can also create your own blocks and block libraries, or your company may already have its own standard libraries.
- **The World Wide Web.** Numerous Autodesk and commercial symbol libraries containing thousands of blocks are available. Access these using the DC Online tab in DesignCenter.

NOTE Creating blocks, block attributes, or block libraries are more advanced topics and are not covered in this guide.

Insert Blocks

You can choose from the following three methods to insert blocks into drawings:

- **Insert dialog box.** Place a block by specifying its insertion point, scale, and rotation angle.
- **DesignCenter.** Locate symbol libraries and place or drag a block into a drawing or onto a tool palette. Use DesignCenter to locate and manage a large number of blocks and block libraries.
- **Tool Palettes window.** Place or drag a block into a drawing. Use tool palettes to organize and access your most commonly used blocks.

Tutorial: Adding Blocks

- 1 Open *MyDesign*, the drawing that you created and saved in a previous tutorial.

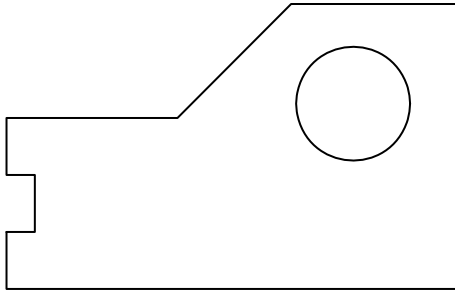

- 2 Offset the lines to create walls (if it's a health spa or motor housing) or ridges (if it's a catch for a window lock). Use a value for the offset distance that is appropriate for what you are creating. Clean up the corners using Fillet with the fillet radius set to 0.

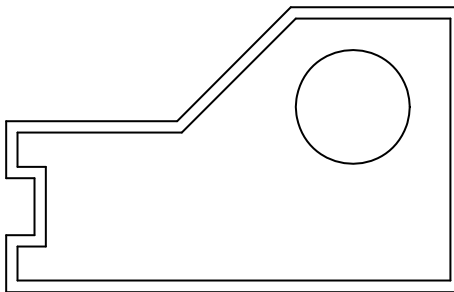

Open a block library

- 1 Click Menu Browser ► Tools ► DesignCenter.

The DesignCenter window is divided into the tree view on the left side and the content area on the right side.

- 2 On the DesignCenter window, click the Folders tab if necessary. In the tree view, navigate to the *Help\GettingStarted\Symbol Libraries* folder.
- 3 Click the plus sign (+) on the block library that's appropriate for your drawing:
 - *Fasteners - Metric.dwg*
 - *Fasteners - US.dwg*
 - *Office - Metric.dwg*
 - *Office - US.dwg*
- 4 Click the Blocks item under the drawing that you just expanded. The blocks become visible in the Content area of DesignCenter.

Place and relocate blocks with DesignCenter

- 1 Drag one of the blocks from DesignCenter into your drawing. The precise location is not important.
- 2 Click the block. Notice the colored grip that displays. Drag the grip to move the block into place.
- 3 Click the grip and right-click. On the shortcut menu, click Rotate. Rotate the block either with the cursor or by entering a rotation angle.
- 4 In DesignCenter, double-click a different block.
- 5 In the Insert dialog box, under Rotation, click Specify On-Screen. Click OK.
- 6 Click a location in your drawing. You are prompted to specify a rotation angle. Rotate the block either with the cursor or by entering a rotation angle.
- 7 Close the DesignCenter window.

Place blocks with the Insert dialog box

- 1 Click Menu Browser ► Insert ► Block.
- 2 In the Insert dialog box, click the arrow next to the Name box. These are the block definitions stored in your drawing file. Click one of them and click OK. Specify the location for the block.
- 3 Add several more blocks to your drawing. Save the drawing.

Access block libraries from the Web

- 1 Open DesignCenter again.
- 2 Click the DC Online tab. If you have an Internet connection, you can explore the commercial symbol libraries that are available.

Overview of Hatches

A *hatch pattern* is a standard pattern of lines or dots used to highlight an area in a drawing, or to identify a material such as concrete, steel, or grass. A hatch pattern can also be a solid fill.

Use Standard Hatch Patterns

The DesignCenter folder contains more than 60 industry-standard ISO and imperial hatch patterns. You can also use hatch patterns from hatch pattern libraries supplied by other companies. Hatch patterns are stored in hatch pattern files with PAT extensions.

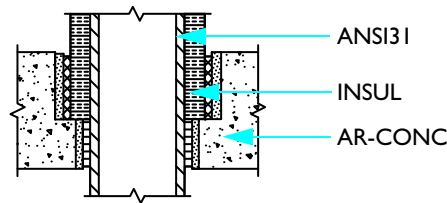

Industry-standard hatch patterns

Associative Hatches

By default, hatches are *associative*. Associative hatches are linked to their boundaries and are updated when the boundaries are modified. You can remove associativity from a hatch at any time.

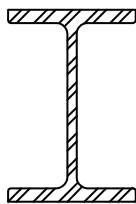

Hatched object

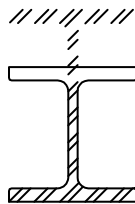

Result of editing boundary with nonassociative hatch

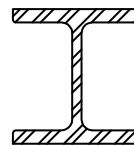

Result of editing boundary with associative hatch

Insert Hatches or Solid Fills

You can hatch or fill objects in a drawing using one of these methods:

- Choose Hatch from the Draw menu or toolbar to create hatches and solid fills.
- Use DesignCenter to drag hatches into the drawing or onto a tool palette.
- Use a tool palette to drag commonly used hatches into a drawing quickly.

Define Hatch Boundaries

Hatch boundaries can be any combination of objects such as lines, arcs, circles, polylines, text, and blocks. Hatch boundaries must enclose an area, but they can include *islands* (enclosed areas within the hatch area) that you choose to hatch or leave unhatched.

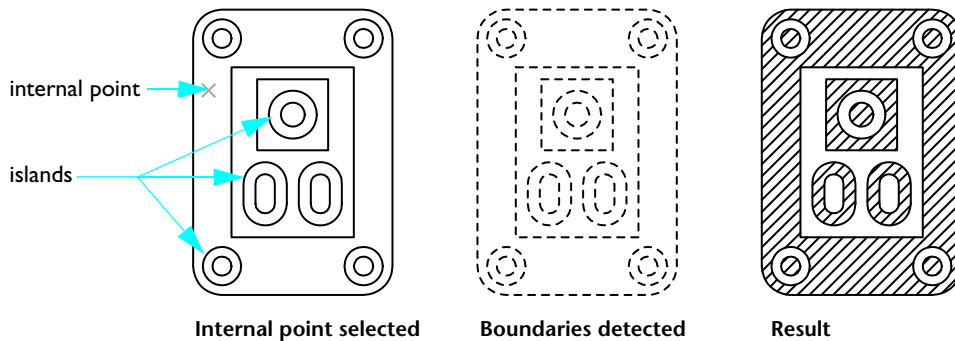



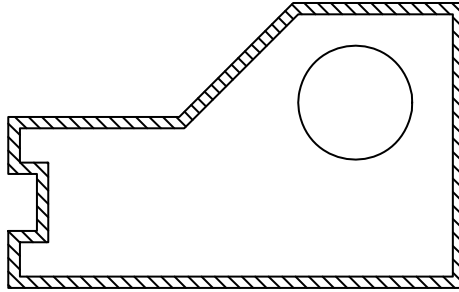

Tutorial: Add Hatches to a Drawing

In this tutorial, you will hatch part of your drawing to look something like this:



- 1** Open *MyDesign*, the drawing that you created and saved in the previous tutorial.
- 2** Click Menu Browser ► Draw ► Hatch.
- 3** On the Hatch tab, under Type and Pattern, notice the name of the hatch pattern and the swatch. Choose a different hatch pattern.
- 4** Under Boundaries, click Add: Pick Points. Then click anywhere between the parallel lines for the walls and press ENTER.
- 5** At the bottom of the dialog box, click Preview.
There are probably several things that you'll want to change, including the circle being hatched, the hatch angle, and the hatch spacing.
- 6** Press ESC to return to the dialog box.
- 7** Click the > (More Options) button at the bottom-right corner of the dialog box.
- 8** Under Islands, click Outer. Then click the < (Less Options) button.
- 9** Under Angle and Scale, change the values for the angle and for the scale. If the hatch is too dense, increase the value for the scale by a factor of 10.
- 10** Click Preview. If the hatch is still not acceptable, return to step 6. Otherwise, right-click or press ENTER to accept the hatch.
- 11** Save your drawing file.

To get started

Action	Menu Browser	Icons
Insert a blocks	Insert ► Block	
Open DesignCenter	Tools ► Palettes ► DesignCenter	
Open the Tool Palettes window	Tools ► Palettes ► Tool Palettes	
Hatch an area	Draw ► Hatch Tools ► Palettes ► DesignCenter Tools ► Palettes ► Tool Palettes	

Help system

ADCENTER, BLOCK, EXPLODE, INSERT, TOOLPALETTES, HATCH

Review and Recall

- 1 What is a block?
- 2 What is a block library?
- 3 How can you use object snaps with blocks?
- 4 What are three ways to hatch an area in a drawing?
- 5 How do you fill an area with a solid color?

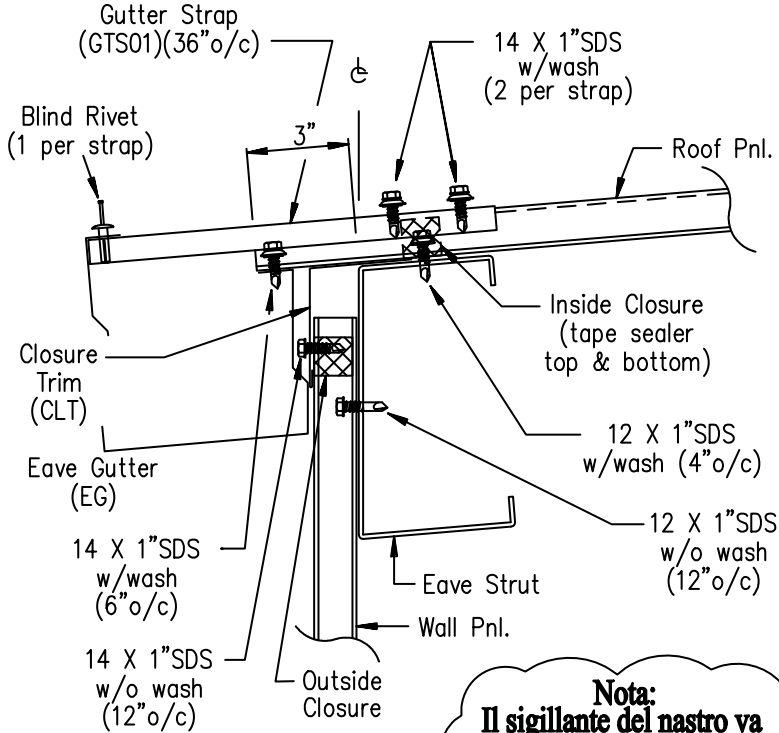

NOTES:

1. Ajuster les deux brides de la gouttière intérieure comme montré.
2. Geben Sie auf den äußeren Teil, und 6 cm vom äußeren Rand entfernt, einen 6 mm großen Tropfen des Dichtungsmittels.
3. Disporre le sezioni della grondaia in modo che si sovrappongano le une alle altre di 5 cm.
4. Asegure con remaches la unión de las secciones del canal.

Nota:
 Il sigillante del nastro va posto fra la cinghia della grondaia ed il pannello del tetto in corrispondenza delle viti.

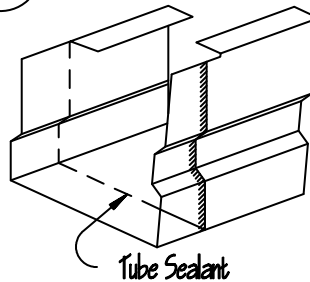

Rimmenspleiß-Montage

PLIOS

Add Text to a Drawing

Create and Modify Text	126
Work with Text Styles	128
Set Text Size for the Viewport Scaling.....	129



Create and Modify Text

AutoCAD and AutoCAD LT provide a text editor to add text to drawings. The text editor consists of a tab on the ribbon with a set of panels, and a text bounding box with a ruler at the top. These two components display automatically when you use the Multiline Text command.

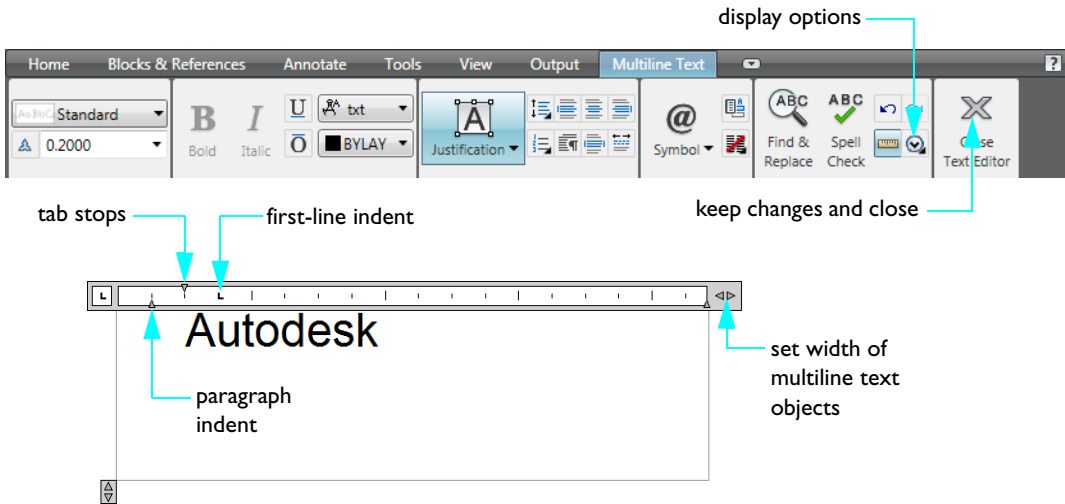

With the Multiline Text command, you can choose formatting that affects the entire text object or only selected text. You can also control indents and specify one or more columns.

Before creating the text, you define the width of the text by specifying the two opposite corners of a text boundary. Only the width of the box has an effect. The text you enter is inserted in the dialog box within the width limit and words that don't fit wrap to the next line.

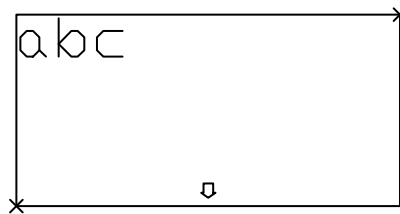

When using the text editor, you can easily change the width by dragging the right side of the ruler.

NOTE The fastest way to make changes to an existing text object is to double-click it. This opens the text editor and displays the text in the bounding box.

Additional features that are available for text in drawings include the following:

- Check spelling using a spell checker with customizable dictionaries
- Locate and correct text with the Find and Replace dialog box
- Specify several columns of text and adjust the column widths easily
- Create mirrored text

Try it: Create multiline text objects

- 1 Start a new drawing.
- 2 Click Menu Browser ► Draw ► Text ► Multiline Text.
- 3 Click two points to determine the width of the text object.
- 4 In the bounding box, type your text.
- 5 Highlight a word and click some of the formatting options.
These options are similar to those in most word processing applications.
- 6 Click Close Text Editor on the ribbon.

Try it: Modify an existing multiline text object

- 1 Double-click the text object.
- 2 Highlight more words or the entire paragraph and click more formatting options.
- 3 Click Close Text Editor on the ribbon.

Work with Text Styles

Every text object in a drawing has a text *style* associated with it. When you enter text, the current text style is applied, which determines the following properties:

- **Font** controls the shapes of the characters
- **Font style** controls the italic and boldface formatting for TrueType fonts
- **Height** controls the size in drawing units of the text
- **Obliquing angle** controls the forward or backward slant of the text
- **Orientation** controls the vertical or horizontal alignment of single-line text
- **Other text characteristics** controls effects such as wide text and backwards text

Create and Modify Text Styles

Except for the default STANDARD style, you must define any text style that you want to use. Once you've created a style, you can modify its settings, change its name, or delete it when you no longer need it. When you create or modify a text style, you use the Text Style dialog box.

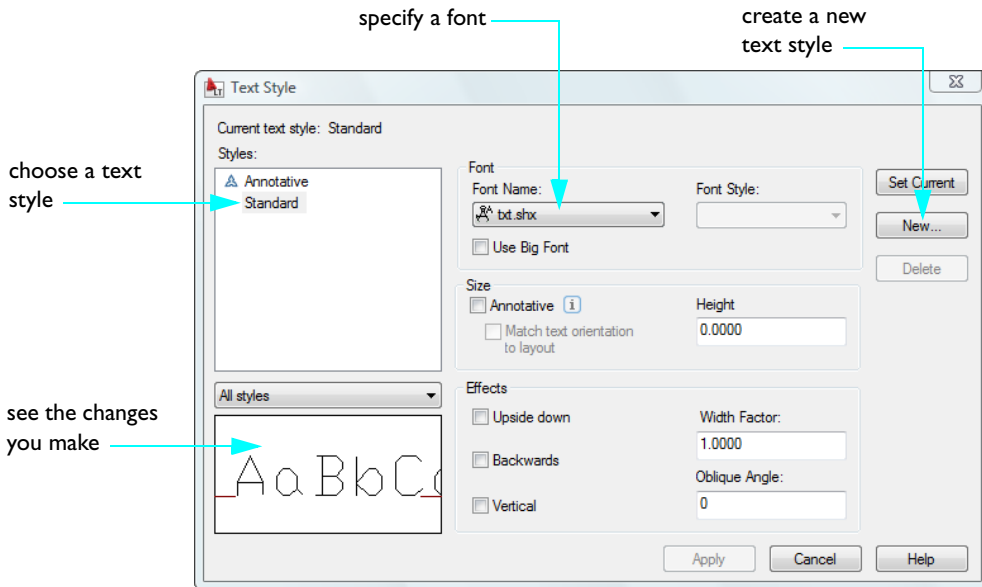

If you change an existing style's font, all text in the drawing that uses that style is regenerated using the new font.

NOTE If you create notes and labels directly on a layout in paper space, no scaling is necessary. Notes and labels created in model space must be sized to accommodate the scale of the layout viewport.

Set Text Size for the Viewport Scaling

You can create text either in model space or on the layout in paper space. The space in which you create text depends on the circumstances.

- If the text is more closely associated with the layout, you should create the text in paper space. With this option, there are no scaling considerations and you create the text at its full size (1:1).
- If the text is more closely associated with the model, and you anticipate referencing the model and the text from other drawings or other views, you should create the text in model space. With this option, the text must usually be scaled.

Preparing one or more views on a drawing layout usually involves displaying them in layout viewports at various scales other than 1:1. If you create text in model space, you must size it for correct display and plotting in paper space.

Set Text Size in Model Space





Set the text size in model space using the following formula:

Text size in model space = desired text size / scale of the layout viewport

- Example 1: If the desired text size is 3 mm and the viewport scale is 1:4 (0.25), then use $3/0.25 = 12$ mm for the text size in model space.
- Example 2: If the desired text size is 1/8 inch and the viewport scale is 1"=4' (1:48), then use $(1/8)/(1/48) = 48/8 = 6$ inches for the text size in model space.

Creating text directly on the layout is much easier because no scaling is required. It is recommended that you create view-specific text in model space, and general notes, tables, and labels in paper space.

To get started

Action	Menu Browser	Icon
Create multiline text	Draw ► Text ► Multiline Text	
Modify text	Modify ► Object ► Text	
Check the spelling in a drawing	Tools ► Spelling	
Find and replace text	Edit ► Find	
Create text styles	Format ► Text Style	

Help system

FIND, MTEXT, MIRRTEXT, MTEXTED, SPELL, STYLE, SCALETEXT, JUSTIFYTEXT, STYLE, SPACETRANS

Review and Recall

- 1 What is the fastest way to open the multiline text editor when you need to change existing text?
- 2 What are some advantages to creating additional text styles?
- 3 How do you decide whether to create text in paper space or in model space?
- 4 What text height should you use in model space if the desired text height in paper space is 2.5 mm and the display scale of the layout viewport is 1/50 (0.02)?

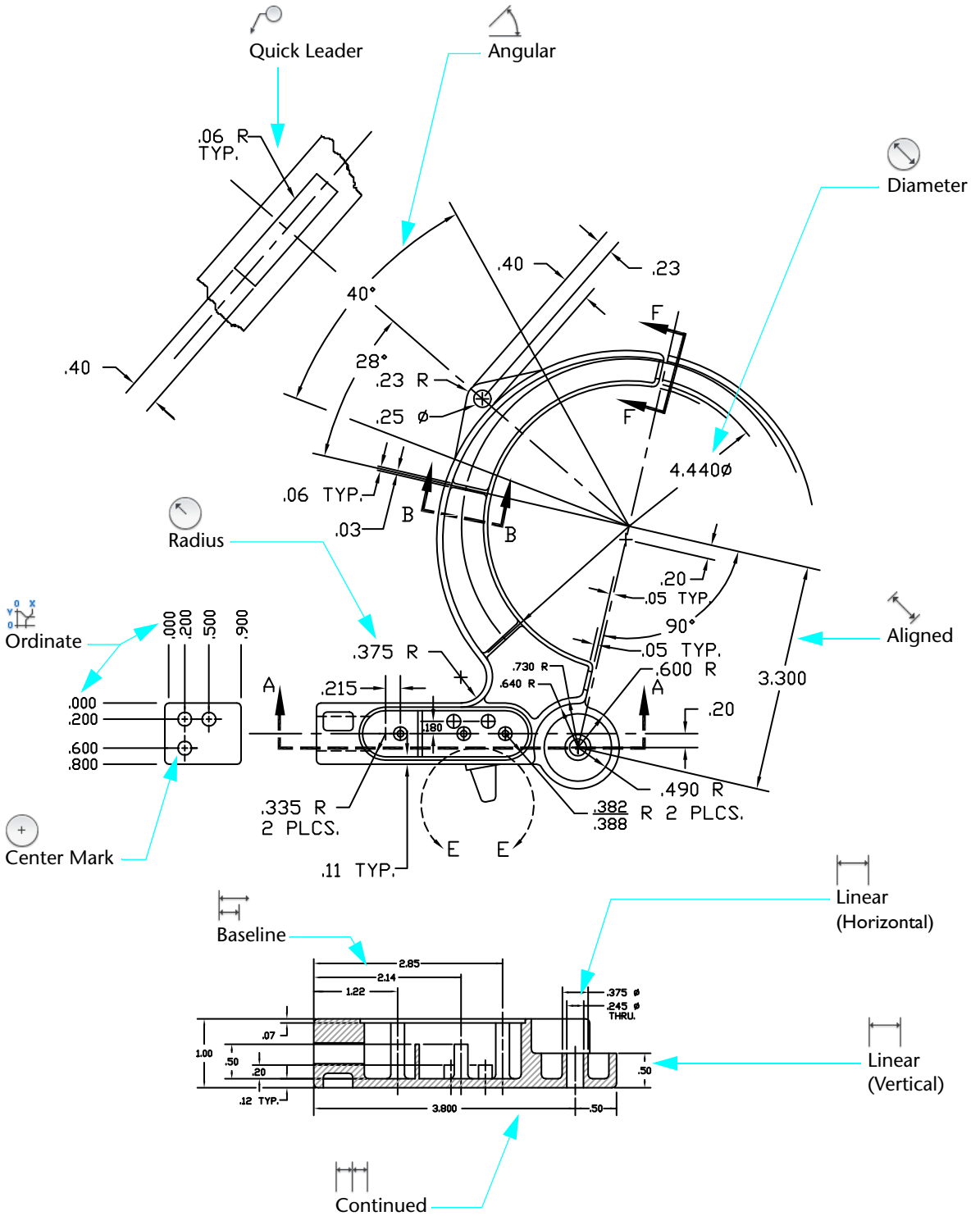

Add Dimensions

Dimensions Overview.....	134
Create Dimensions.....	135
Use Dimensioning Options.....	138
Create and Modify Dimension Styles.....	140
Modify Dimensions.....	142

10

Dimensions Overview

Dimensions show the geometric measurements of objects, the distances or angles between objects, or the location of a feature. Four general types of dimensions are available:

- **Linear.** Measures distances using horizontal, vertical, aligned, rotated, baseline (parallel), and continued (chain) dimensions.
- **Ordinate.** Measures the distance of a point from a specified origin point.
- **Radial.** Measures the radii and diameters of arcs and circles.
- **Angular.** Measures the angle formed by two lines or three points.

Parts of a Dimension

Dimensions have several distinct elements:

- **Dimension line.** Indicates the direction and extent of a dimension. For angles, the dimension line is an arc.
- **Extension line.** Extends from the feature being dimensioned to the dimension line.
- **Dimension text.** Reflects dimension value and may include prefixes, suffixes, and tolerances. Alternatively, you can supply your own text or suppress the text entirely.
- **Arrowhead.** Indicates an end of the dimension line. Several types of arrowheads are available, including architectural ticks and dots.
- **Leader.** Forms a solid line leading from an annotation to the referenced feature. Depending on the dimension style, leaders can be created automatically when dimension text won't fit between extension lines. You can also create *leader lines* to connect text or a block with a feature.

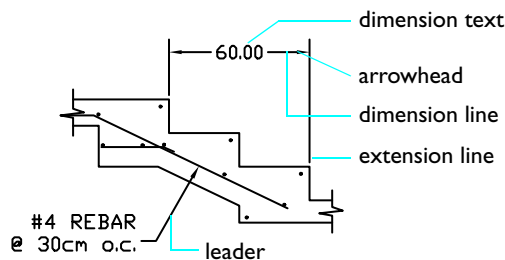

Associative Dimensions and Leaders

By default, dimensions are *associative*. The measurements displayed by associative dimensions are updated automatically as you modify the objects with which they are associated.

Leader objects are composed of text, a leader line, and an arrowhead.

- If the text portion of a leader object is moved, the leader line is also adjusted.
- If a leader object is associated with a geometric object, and the object is moved, stretched, or scaled, the arrowhead and the leader portion of the leader object are also updated.

Create Dimensions

You can dimension lines, arcs, circles, and several other types of objects. There are two primary methods for creating dimensions:

- Select an object to dimension (1) and specify the dimension line location (2) as shown in the following examples.

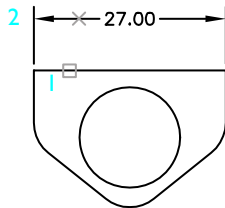

Result of selecting a line
for a dimension

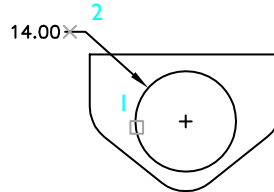

Result of selecting a circle
for a dimension

- Use object snaps to specify the extension line origins, and then specify the dimension line location. The extension line origin points can be on separate objects.

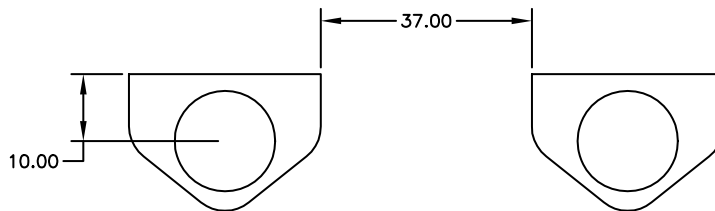

Tutorial: Create Dimensions

In this tutorial, you will set the scale for your drawing and add several dimensions to your design.

- 1 Open *MyDesign*, the drawing that you created and saved in previous tutorials.
- 2 Click the layout tab.

Set the display scale of the viewport.

- 1 Click the blue layout viewport border to select it.
- 2 Click Menu Browser ► Modify ► Properties.
- 3 On the Properties palette, click Display Locked and then No.

NOTE It is strongly recommended that you keep the display in layout viewports locked unless you're setting the display scale of the viewport. This prevents you or someone else from accidentally zooming in or out and changing the display scale.

- 4 Double-click inside the layout viewport. You are now accessing model space from the layout.
- 5 Click Menu Browser ► View ► Zoom ► Extents.
This step centers your view within the layout viewport.
- 6 Double-click outside the layout viewport to return to paper space.
You can now specify the precise scale for the floor plan or part.
- 7 Click the blue layout viewport border to select it. On the Properties palette, under the Misc category, click Standard Scale.
- 8 Click the arrow to display a list of scales. Click the one that seems the most appropriate for the sheet size and the size of your floor plan or part. You can always choose a different scale if necessary.
- 9 Lock the layout viewport to prevent accidental changes.

Add dimensions

- 1 Change the current layer to the Dimensions layer.
It is a good practice to use a separate layer reserved for dimension objects.
- 2 Double-click inside the layout viewport to access model space.
There is a good reason why you are creating dimensions from the layout tab rather than the Model tab. When you dimension in model space from the layout tab, the dimensions are automatically scaled relative to the viewport scale.
- 3 Click Menu Browser ► Dimension ► Linear. Follow the prompts to create several linear dimensions.

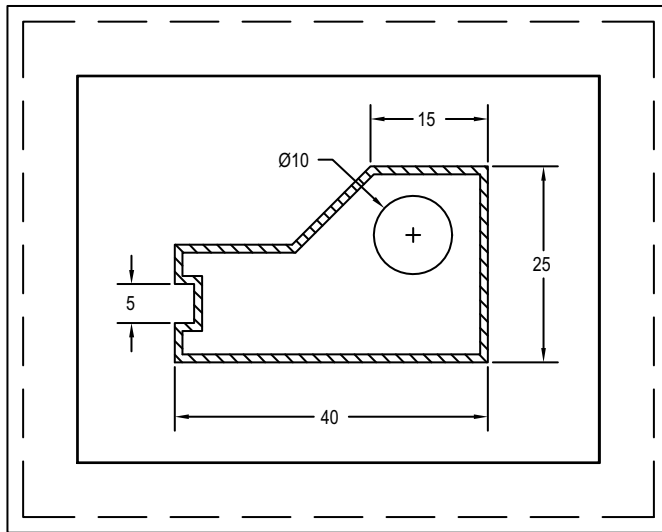

4 Experiment with several other types of dimensions.

NOTE Automatic dimension scaling is not turned on in all drawings or drawing template files. It works only when the system variable DIMSCALE is set to 0. You can enter DIMSCALE on the command line. Check the Help system topic on DIMSCALE for more information.

Add Text

- 1 Double-click outside the layout viewport to return to paper space.
- 2 Change the current layer to the Text layer.
- 3 Create several notes using the Multiline Text command.
- 4 Save your drawing.

Use Dimensioning Options

In addition to the basic types of dimensions, the following options are available on the Dimension menu and toolbar:

- **Center marks and centerlines** locate the exact center of circles or arcs.
- **Leader lines** connect annotation to drawing features.
- **Geometric tolerances** show deviations of form, profile, orientation, location, and runout of drawing features.

Create Center Marks and Lines

You can easily create a center mark or centerline on a circle or arc. The size and style of center marks and centerlines are controlled by the dimension style.

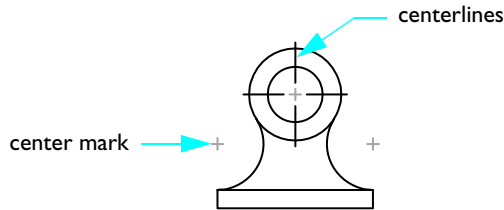

Try it: Create center marks and lines

- 1 Start a new drawing and click the Model tab.
- 2 Draw a small circle.
- 3 Click Menu Browser ► Dimension ► Center mark
- 4 Click the circle.

Two lines in the shape of a plus are created at the center of the circle.

You can also create center marks automatically with radius and diameter dimensions.

Create Leaders with Annotation

You can create a leader from any point or feature in a drawing. A *multileader* can use straight line segments or smooth spline curves. Leader color, scale, and arrowhead style are controlled by the current *multileader style*. A small line known as a *leader landing* usually connects the annotation to the leader line. Multileader annotations can be multiline text, a feature control frame, or a block reference.

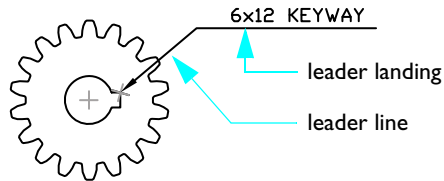

Try it: Create a multileader

- 1 Click Menu Browser ► Dimension ► Multileader
- 2 Click a location for the arrowhead.
- 3 Click a location for the leader landing.
- 4 Enter text in the bounding box.
- 5 Click Close Text Editor on the ribbon.

Create and Modify Dimension Styles

Every dimension has a *dimension style* associated with it. Dimension styles help you establish and enforce drafting standards. Dimension styles also make changing dimension formats and behavior easy. A dimension style defines

- Format and position of dimension lines, extension lines, arrowheads, and center marks
- Appearance, position, and behavior of dimension text
- Rules governing text placement and dimension lines
- Overall dimension scale
- Format and precision of primary, alternate, and angular dimension units
- Format and precision of tolerance values

New dimensions use the current settings in the Dimension Style Manager dialog box. The default STANDARD style is assigned to dimensions until you set another style as current.

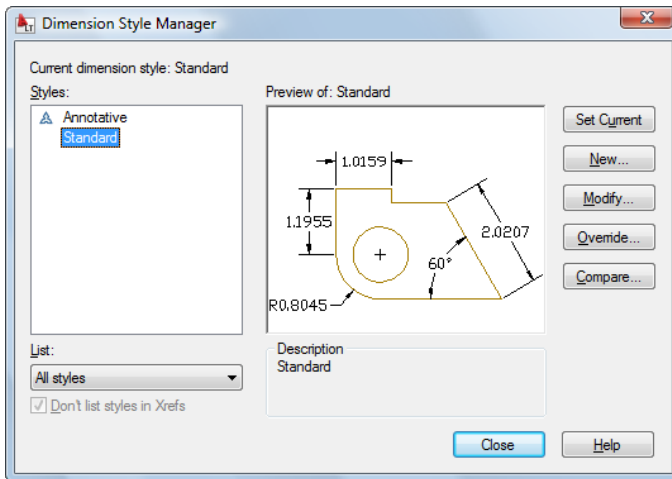

Overrides allow for style modifications to the current dimension style. Overrides apply to all subsequent dimensions created with that style until you make a new style current. They do not permanently modify a dimension style. You can also override properties of dimensions using the Properties palette.

Specify Dimension Style Options

Regardless of whether you choose New, Modify, or Override in the Dimension Style Manager, the same set of options are available:

- **Lines** sets the appearance and behavior of dimension lines and extension lines.
- **Symbols and Arrows** sets the appearance and behavior of dimension arrowheads, center marks, and centerlines.
- **Text** sets the dimension text appearance, placement, and alignment.
- **Fit** sets options governing placement of dimension lines, extension lines, and text. It also includes the setting for automatic dimension scaling.
- **Primary Units** sets the format (for example, scientific, decimal, architectural) and precision of linear and angular dimension units.
- **Alternate Units** sets alternate unit format and precision. This feature supports dual dimensions that display, for example, both metric and imperial units.
- **Tolerances** sets tolerance values and precision.

NOTE Creating a dimension style to conform with industry or company standards requires agreement on many settings. It is important that your organization creates and maintains one or more official dimension styles.

Modify Dimensions

You can modify dimensions with grips or with editing commands. You can also modify or override dimension styles, as discussed in the previous topic. For significant modifications to a dimension, it is usually easier to erase and re-create the dimension.



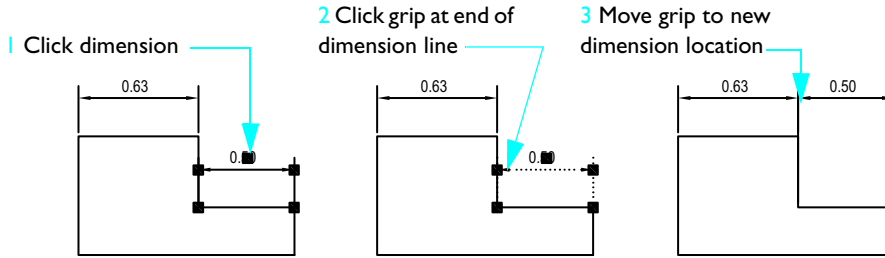



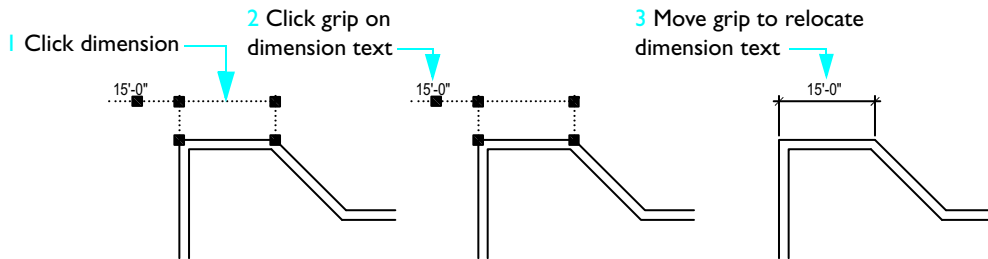





The easiest way to make minor modifications in a dimension is to use grips. For example, you can easily drag a dimension line to align it with another dimension line.



You can also drag dimension text to a different location.



To get started

Action	Menu Browser	Icon
Create linear dimensions	Dimension ► Linear	
Create aligned dimensions	Dimension ► Aligned	
Create ordinate dimensions	Dimension ► Ordinate	
Create radius dimensions	Dimension ► Radius	
Create diameter dimensions	Dimension ► Diameter	
Create angular dimensions	Dimension ► Angular	
Create baseline dimensions	Dimension ► Baseline	
Create continued dimensions	Dimension ► Continue	
Create and modify a dimension style	Dimension ► Dimension Style	
Update an existing dimension to reflect a style change	Dimension ► Update	
Create a center mark	Dimension ► Center mark	
Create leaders with annotation	Dimension ► Multileader	

Help system

DIMALIGNED, DIMANGULAR, DIMBASELINE, DIMCONTINUE, DIMDIAMETER, DIMJOGGED, DIMLINEAR, DIMORDINATE, DIMRADIUS, DIMSCALE, DIMSTYLE, DIMEDIT, DIMTEDIT, DIMOVERRIDE, DIMCENTER, DIMSTYLE, DIMREGEN, MLEADER

Review and Recall

- 1 What is the behavior of associative leaders and associative dimensions?
- 2 Why should you lock layout viewports?
- 3 To ensure that dimensions are scaled according to the layout viewport scale, what dimension variable should be set to 0?
- 4 What is the easiest way to modify the location of a dimension feature such as the dimension line or dimension text?

The model

Created at full size (1:1). Text and dimensions in model space are scaled to compensate for the scale factors used in layout viewports

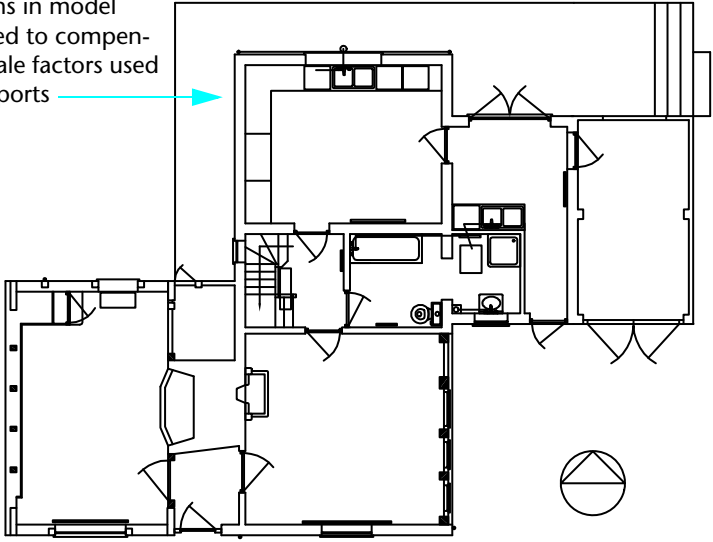

Layout viewports

Display one or more views of the model, each of which can be scaled separately

Plot styles

Temporarily override properties such as color and lineweight when plotting

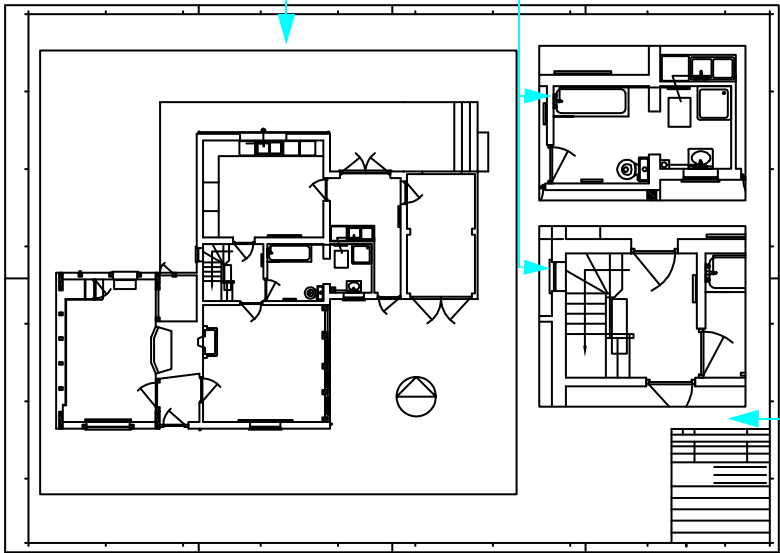

Page Setups

Save plot settings by name and associate them with a layout

Layout
Represents a drawing sheet that includes a title block, one or more layout viewports, and text objects

Create Layouts and Plots

Work with Layouts	148
Choose and Configure Plotters	151
Plot from a Layout.	153



Work with Layouts

You use a layout to compose the plotted page. A layout typically includes the following objects:

- General notes and tables
- View-specific label blocks and callout blocks (this is an advanced topic not covered in this guide)
- Layout viewports

Layouts show the page border and actual printing area. The page size and actual printing area depend on the printer or plotter assigned to the layout.

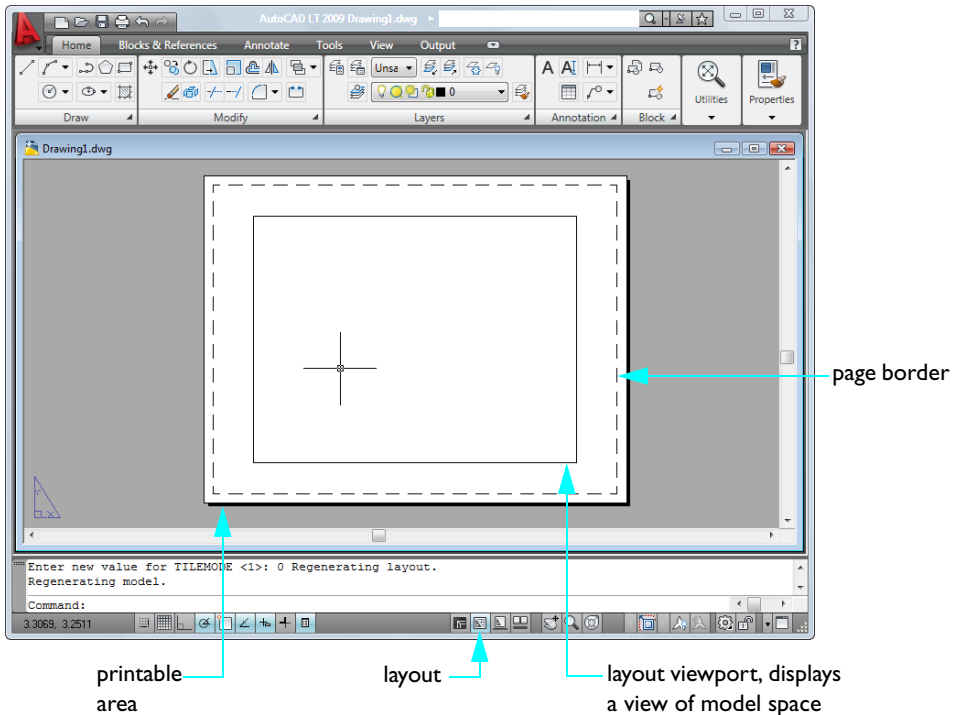

Create a New Layout

The two most common reasons for creating a new layout are

- Creating a new drawing template file that includes a different paper size and orientation.
- Adding a layout with a different paper size, orientation, and title block to an existing drawing.

The easiest way to create a new layout is to use the Create Layout wizard. Once you create a layout, you can replace the title block and create or delete layout viewports.

Try it: Create a layout

- 1 Start a new drawing.
- 2 Click Menu Browser ► Tools ► Wizards ► Create Layout.
- 3 Follow the steps in the wizard to create a layout with a different paper size and matching title block.
- 4 Right-click the layout tab. On the shortcut menu, click Rename. Enter a new name for the layout.

To save this drawing as a new drawing template file, click Menu Browser ► File menu ► Save As. In the Save Drawing As dialog box, under Files of Type, specify a DWT extension.

Use Layout Viewports

Layout viewports on a layout tab display views of model space. The following points summarize the relationship of layout viewports and model space:

- The majority of the objects in your drawings are created in model space on the Model tab.
- To display and scale one or more views of model space in a layout, you create layout viewports.
- To pan the view and to set layer visibility, enter model space through a layout viewport. You can control the visibility of layers separately in each layout viewport.
- For any significant editing of your model, use the Model tab.
- To create correctly scaled dimensions, enter model space from the layout tab and then dimension the model.

When you create a new layout, a single layout viewport is added by default. You can add more layout viewports for independent views such as details and 3D views. Each viewport can have its own scale, plot properties, and layer visibility settings.

Tutorial: Work with Layout Viewports

In this tutorial, you will practice the most common operations used with layout viewports.

Change the display scale of a view in a layout viewport

- 1 Click Menu Browser ► File ► Open.
- 2 In the Select File dialog box, find the `\Help\GettingStarted` folder in the AutoCAD or AutoCAD LT product folder and open `arbor.dwg`.
- 3 Click Menu Browser ► Format ► Layer. In the Layer Properties Manager, click the lightbulb icon on the Viewport layer to display the objects on that layer.

The blue borders of the layout viewports are now visible.

- 4 Click Menu Browser ► Modify ► Properties. Click the blue border of the upper-right layout viewport.

- 5 In the Properties palette, under Misc, click Display Locked. Click the arrow and click No.

The display properties for the layout viewport are now unlocked. Next, you will change the precise scale of the view displayed in this layout viewport.

- 6 In the Properties palette, click Standard Scale.
- 7 Click the arrow to display a list of scales and click 1:40.
Notice that the view changes immediately to reflect the new display scale.
- 8 Double-click inside the layout viewport to enter Model Space. Pan the view as needed, but do not change the view scale with Zoom. Then double-click anywhere outside the layout viewports to return to Paper Space.
- 9 Use the Properties palette to lock the layout viewport.

You lock the layout viewport to prevent accidental panning and zooming in it. Thus, the view position and scale in the viewport are protected.

Erase a layout viewport

- 1 Click Menu Browser ► Modify ► Erase.
- 2 Click the border of the upper-right layout viewport and press ENTER.

A layout viewport is an object. Just as other objects, they can be moved, copied, and erased.

Create a new layout viewport

- 1 Make the Viewport layer the current layer.
- 2 Click Menu Browser ► View ► Viewports ► 1 Viewport.
- 3 Click two points in a blank area on the layout. The two points are the diagonal corners of the new layout viewport.
The new layout viewport can overlap an existing viewport.
- 4 Click the border of the layout viewport to display its grips.
- 5 Adjust the size of the layout viewport by clicking a grip, moving the cursor, and clicking a new location. Move the layout viewport with the Move command.
- 6 Use the Properties palette to set the display scale of the view in the layout viewport.
- 7 Double-click within the layout viewport and pan the view. Double-click outside of all viewports to return to paper space.
- 8 Use the Properties palette to lock the layout viewport.
- 9 Turn the Viewport layer off.
- 10 Close the drawing without saving it.

NOTE Always create layout viewports on a separate layer assigned to viewport objects. When you are ready to plot, turn off the layer to prevent the viewport borders from being plotted.

Choose and Configure Plotters

AutoCAD and AutoCAD LT support a wide range of printers and plotters. Devices with a Windows printer driver installed are available automatically when you plot unless the plotting option to hide system printers has been selected. Many plotters that do not have Windows drivers (nonsystem plotters) can be configured using drivers provided either by Autodesk or by the plotter manufacturer.

You can also configure drivers to save drawings in several file formats. Formats include DWF™ (Design Web Format) files to view drawings in a web browser or external viewer, PostScript files for use with page layout programs, and raster files.

If an output device is not listed in the Plot or Page Setup dialog boxes, or if its settings are incorrect, you can easily add or edit printer and plotter configurations.

Add a Plotter Configuration

The Plotter Manager is a folder that provides a method for adding, deleting, and changing plotter configurations. Plotter configuration files have a .pc3 extension and are stored in the *Plotters* folder. To display the *Plotters* folder, click Menu Browser ► File menu ► Plotter Manager.

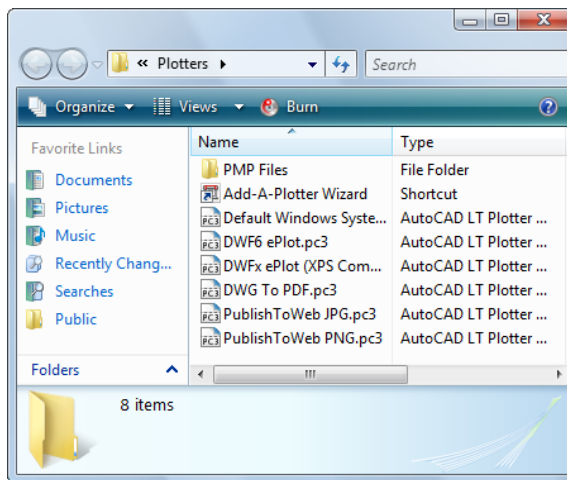

The Plotter Manager

The Plotter Manager includes plotter configuration (PC3) files for every nonsystem printer that you install. Plotter configuration files can also be created for Windows® system printers if you want to use default properties different from those used by Windows.

To add a plotter configuration, double-click the Add-A-Plotter wizard in the Plotter Manager. The Add-A-Plotter wizard prompts you for information about your plotter, any network settings, custom plotter properties, uotupt quality settings, and so on.

Once a new PC3 file is created, the plotter configuration is available for layouts and plotting.

Change a Plotter Configuration

The Plotter Configuration Editor is used to

- Edit the port or file output information
- Change or add paper sizes and layouts
- Control vector and raster graphic output
- Calibrate your plotter
- Set any of your plotter's custom properties

To start the Plotter Configuration Editor, either double-click the PC3 file or choose Properties in the Plot dialog box.

Use Plot Styles to Override Properties (Optional)

A *plot style* is an optional method to control how each object or layer is plotted. Assigning a plot style to an object or layer overrides properties such as color and lineweight for plotting. Only the appearance of plotted objects is affected.

Plot style tables collect groups of plot styles and save them in a file that you can later specify when plotting. The Plot Style Manager is a folder that contains all the available plot style tables and the Add-A-Plot Style wizard.

There are two types of plot style tables:

- **Color-dependent plot style tables.** An object's color determines how it is plotted. The files have the extension *.ctb*. You cannot assign color-dependent plot styles directly to objects. Instead, to control how an object is plotted, you change its color. For example, all red objects in a drawing can be set to plot with a 0.50 mm lineweight.
- **Named plot style tables.** Plot styles are assigned directly to objects and layers. The files have the extension *.stb*. Using them enables each object in a drawing to be plotted differently, independent of its color.

Use the Plot Style Manager to add, delete, rename, copy, and edit plot style tables. You can access the Plot Style Manager from the Files menu.

Plot from a Layout

After you have completed your drawing, you are ready to plot. In the Plot dialog box, you select the printer or plotter and many other settings that give you complete control of your output.

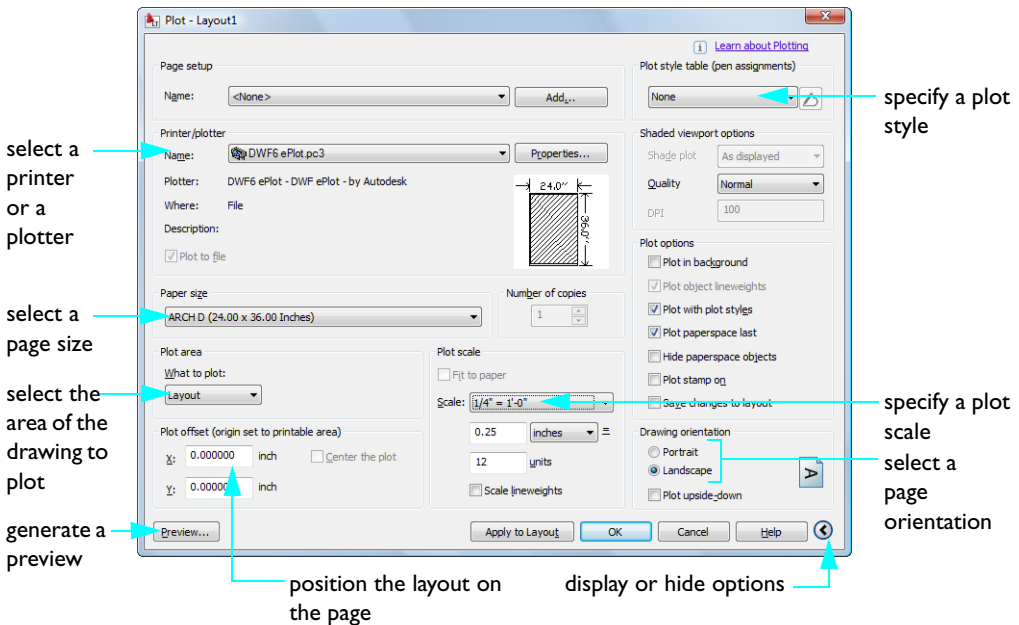

Before you plot your drawing, it is a good practice to generate a full plot preview. If the image is not correct, make changes to the plot settings, page setup, and the plot style table attached to the layout.

Page Setups

Because there are so many plot settings, you can name and save them as a *page setup* using the Page Setup Manager. When you are ready to plot, you can specify the name of the page setup in the Plot dialog box.

For example, let's say you switch to a different plotter for color output. You can quickly restore all settings associated with that plotter by specifying the name of a previously saved page setup. To switch back, you can specify the name of the original page setup.

Each layout tab can have an associated named page setup. Page setups are saved in the drawing.

Try it: Create a page setup

- 1 Start a new drawing. If necessary, click a layout tab.
- 2 Click Menu Browser ► File ► Page Setup Manager.

- 3 Click New.
- 4 In the New Page Setup dialog box, enter **My_New_Plotter**. Click OK.
- 5 Change some settings in the Page Setup dialog box. Click OK.
The new page setup name is displayed in the Page Setup Manager.
- 6 Click My_New_Plotter and click Set Current.
The My_New_Plotter page setup is now associated with the current layout tab.
- 7 Click Close.

If you don't specify all the settings in the Page Setup dialog box when you create a layout, you can set up the page just before you plot.

Tutorial: Plot a Drawing

In this exercise, you edit the page setup for an existing layout, create a new layout, insert a title block into the new layout, and plot the drawing.

Edit an existing layout

To prepare for plotting from a layout tab, you set up a layout, set up a viewport, and create dimensions.

- 1 Click Menu Browser ► File ► Open.
- 2 In the Select File dialog box, locate the `\Help\GettingStarted` folder, select *plan.dwg*, and click Open.
This is a drawing of a floor plan and elevation.
- 3 Click the Elevation layout tab.
The Elevation layout uses a page setup that defines the plot area and page size. A specific plotter configuration is also associated with the Elevation layout.
- 4 Click Menu Browser ► File ► Page Setup Manager.
- 5 In the Page Setup Manager, click Modify.
- 6 Under Plot Style Table (Pen Assignments), open the drop-down list and click the *monochrome.ctb* file. If prompted, choose not to apply the plot style table to all other layouts.
- 7 Select Display Plot Styles. Click OK.
- 8 Click Close to close the Page Setup Manager.
The drawing is now black and white because the layout shows a preview of the drawing as it will be plotted with the monochrome plot style table.
- 9 Click the Model button. Note that the model is still displayed in color.

Create a new layout

- 1 Make the Viewport layer the current layer.
- 2 Click Menu Browser ► Tools ► Wizards ► Create Layout.

The Create Layout wizard guides you through the creation of a layout.

- 3 In the Create Layout wizard, on the Begin page, enter a name for the new layout. Type **Elevation and Floor Plan**. Click Next.
- 4 On the Printer page, select the printer that you want to use to plot this layout. Select *DWF6 ePlot.pc3*. Click Next.

For this tutorial, you will plot the drawing to a DWF file rather than to a plotter. DWF (Design Web Format) files are convenient for distributing drawings using email, FTP sites, project websites, or CDs. DWF files are smaller, faster, and provide greater resolution than other popular options. DWF files can be viewed using Autodesk® Design Review, a viewer available as a free download from the Autodesk website.
- 5 On the Paper Size page, the paper sizes available in the list are based on the printer that you selected. Select Letter or ANSI A (8.5 x 11.0 inches) for the paper size. Make sure that Paper Size in Units lists a width of 11.0 inches and a height of 8.5 inches. Click Next.
- 6 On the Orientation page, click Portrait for that orientation. Click Next.
- 7 On the Title Block page, click None from the list of available title blocks. Click Next. (You insert a title block once the layout is created.)
- 8 On the Define Viewports page, under Viewport Setup, click Array. Leave the Viewport Scale as Scaled to Fit. (You change the scale later.) In the Rows box, type **2**. In the Columns box, type **1**. In the Spacing Between Rows box, type **0.25**. In the Spacing Between Columns box, type **0.1**. This creates two viewports, vertically aligned, with a gap between them. Click Next.

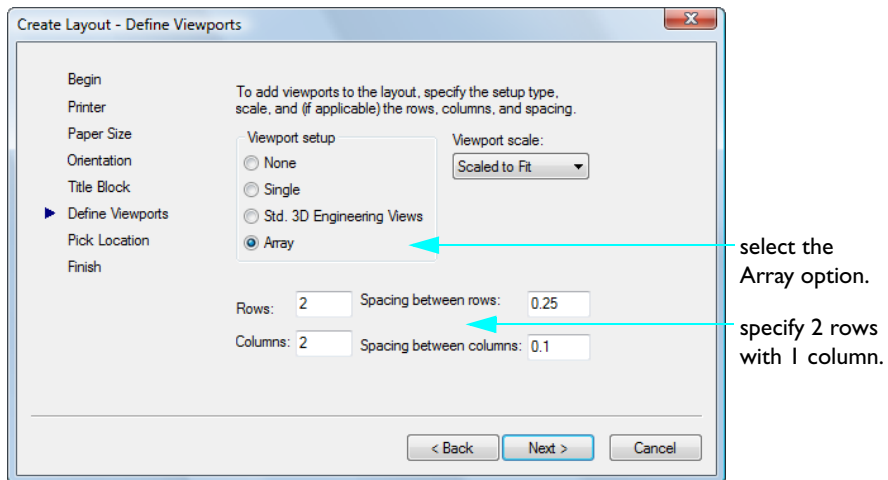

- 9 On the Pick Location page, select Select Location. In the drawing area, click and drag to create a rectangular layout viewport that is just inside the printable area (the dashed lines).
- 10 On the Finish page, click Finish to complete the creation of the new layout and viewports.

Notice that two viewports have been created.

Insert a title block into a layout

- 1 Make sure that you are on the Elevation and Floor Plan layout tab.
- 2 Make the Title Block layer the current layer.
- 3 Click Menu Browser ► Insert ► Block.
- 4 In the Insert dialog box, in the Name list, click Letter (portrait).
- 5 Under Insertion Point, make sure that the Specify On-screen check box is checked.
- 6 Under Scale, make sure that the Specify On-screen check box is cleared. If necessary, in the X, Y, and Z boxes, type **1** to set the layout to be plotted full scale.
- 7 Under Rotation, make sure that the Specify On-screen check box is cleared. If necessary, in the Angle box, type **0** to keep the title block horizontal. Click OK.
- 8 Move the cursor to center the title block, and then click to place it on the layout.

Set up the viewports to plot

Now that the layout viewports have been created, you can specify the scale of the model space view displayed in each viewport.

- 1 Select both of the viewports by clicking their borders.
- 2 On the Modify menu, click Properties.
- 3 In the Properties palette, click Layer and select the Viewports layer from the drop-down list.

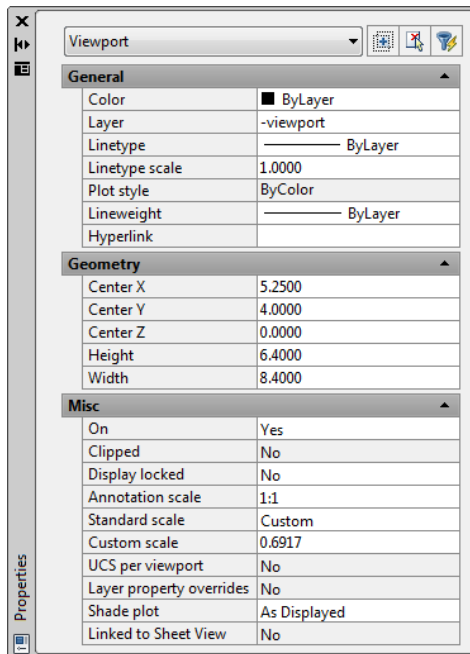

- 4 In the Properties palette, click the Standard Scale box and select 3/32"=1' from the drop-down list of scales.
- 5 The model space objects are scaled correctly for plotting at 3/32"=1' (1:128).
- 6 Double-click inside the top viewport to switch to model space. Pan the image in the viewport until only the elevation view is displayed.
- 7 Click inside the bottom viewport to make it current. Pan the image in the viewport until only the floor plan is displayed.
- 8 Click Menu Browser ► Format ► Layer.
- 9 In the Layer Properties Manager, in the Name column, select the Viewports layer. In the Plot column, click the Plot/No Plot icon to turn off plotting for the Viewport layer.
- 10 Double-click anywhere outside the viewports to return to paper space. Then lock both viewports. Plotting is turned off for the viewport borders, but the objects displayed in the viewport are still plotted. Alternatively, you could have turned off the Viewport layer.

Plot the layout

Now that you have created a layout and have prepared the layout viewports for plotting, you are ready to plot the drawing.

- 1 Click Menu Browser ► File ► Plot.
The plotter you chose in the wizard is still selected.
- 2 If necessary, click the > button at the bottom-right corner of the Plot dialog box to display more plot options.
- 3 Under Plot Style Table (Pen Assignments), in the Name list, select the *monochrome.ctb* file.
- 4 Under Plot Area, click Extents.
- 5 Under Drawing Orientation, click Portrait.
- 6 Under Plot Scale, set the scale of the plot to 1:1.
- 7 Under Plot Offset, click Center the Plot.
- 8 Click Preview at the bottom of the dialog box. After previewing the plot, press ESC. Click OK to close the Plot dialog box and plot the drawing to the DWF file.
You could now send the DWF file to a client for review.
- 9 Click Menu Browser ► File menu ► Save As. In the Save Drawing As dialog box, enter **Plan Complete** in the File Name box, and then click Save.

To get started

Action	Menu Browser	Ribbon Panel
Create a new layout	Insert ► Layout	Viewports
Create a layout viewport	View ► Viewports ► 1 Viewport	Viewports
Scale a view in a layout viewport	Tools ► Properties	Viewports
Add a plotter or modify a plotter configuration	File ► Plotter Manager	Plot
Override properties when plotting	File ► Plot Style Manager	Plot
Restore saved settings for plotting	File ► Page Setup Manager	Plot
Plot a layout	File ► Plot	Plot

Help system

LAYOUT, LAYOUTWIZARD, MVIEW, PLOTTERMANAGER, OPTIONS, PAGESETUP, PLOTSTAMP, PLOT, STYLESMANAGER, PLOTSTYLE, CONVERTPSTYLES, CONVERTCTB

Review and Recall

- 1 What types of objects are commonly found on a layout tab?
- 2 How do you specify the scale of a layout viewport?
- 3 How do you turn off the display of layout viewport borders?
- 4 How can you use a plot style table?
- 5 What is a fast way to save plot settings by name?

Glossary

Commands and system variables associated with definitions are shown in parentheses at the end of the definition.

Term	Definition
absolute coordinates	Coordinate values measured from a coordinate system's origin. <i>See also origin, relative coordinates, user coordinate system (UCS), world coordinates, and world coordinate system (WCS).</i>
aligned dimension	A dimension that measures the distance between two points at any angle. The dimension line is parallel to the line connecting the dimension's definition points. (DIMALIGNED)
angle override	Locks the cursor for the next point entered. To specify an angle override, enter a left angle bracket (<) followed by an angle whenever a command prompts you to specify a point.
angular dimension	A dimension that measures angles or arc segments and consists of text, extension lines, and leaders. (DIMANGULAR)
angular unit	The unit of measurement for an angle. Angular units are measured in decimal degrees, degrees/minutes/seconds, grads, or radians.
annotation	Text, dimensions, tolerances, symbols, or notes.
array	1. Multiple copies of selected objects in a rectangular or polar (radial) pattern. (ARRAY) 2. A collection of data items, each identified by a subscript or key, arranged so a computer can examine the collection and retrieve data with the key.
arrowhead	A terminator, such as an arrowhead, slash, or dot, at the end of a dimension line showing where a dimension begins and ends.
associative dimension	A dimension that automatically adapts as the associated geometry is modified. Controlled by the DIMASSOC system variable. <i>See also exploded dimension.</i>
associative hatching	Hatching that conforms to its bounding objects such that modifying the bounding objects automatically adjusts the hatch. (BHATCH)
attribute definition	An object that is included in a block definition to store alphanumeric data about the block. Attribute values can be predefined or specified when the block is inserted. Attribute data can be extracted from a drawing and inserted into external files. (ATTDEF)

Term	Definition
Auto-hide	A palette setting that causes palettes to hide automatically when the cursor moves off of it and to open automatically when the cursor moves onto its title bar.
baseline dimensions	Multiple dimensions measured from the same baseline. Also called <i>parallel dimensions</i> .
base point	1. In the context of editing grips, the grip that changes to a solid color when selected to specify the focus of the subsequent editing operation. 2. A point for relative distance and angle when copying, moving, and rotating objects. 3. The insertion base point of the current drawing. (BASE) 4. The insertion base point for a block definition. (BLOCK)
block	A generic term for one or more objects that are combined to create a single object. Commonly used for either block definition or block reference. <i>See also</i> block definition and block reference . (BLOCK)
block definition	The name, base point, and set of objects that are combined and stored in the symbol table of a drawing. <i>See also</i> block and block reference .
block definition table	The nongraphical data area of a drawing file that stores block definitions.
block instance	<i>See</i> block reference .
block reference	A compound object that is inserted in a drawing and displays the data stored in a block definition. Also called <i>instance</i> . <i>See also</i> block and block definition . (INSERT)
B-spline curve	A blended piecewise polynomial curve passing near a given set of control points. (SPLINE)
BYBLOCK	A special object property used to specify that the object inherits the color or linetype of any block containing it. <i>See also</i> BYLAYER .
BYLAYER	A special object property used to specify that the object inherits the color or linetype associated with its layer. <i>See also</i> BYBLOCK .
command alias	A shortcut for a command. For example, <i>CP</i> is an alias for COPY, and <i>Z</i> is an alias for ZOOM. You define aliases in the PGP file.
command line	A text area reserved for keyboard input, prompts, and messages.
command window	A text area that displays the command line and a history of prompts and messages.
continued dimension	A type of linear dimension that uses the second extension line origin of a selected dimension as its first extension line origin, breaking one long dimension into shorter segments that add up to the total measurement. Also called <i>chain dimension</i> . (DIMCONTINUE)
crosshairs	A type of cursor consisting of two lines that intersect.

Term	Definition
crossing selection	A rectangular area drawn to select objects fully or partly within its borders. <i>See also</i> window selection .
cursor	<i>See</i> crosshairs .
cursor menu	<i>See</i> shortcut menu .
CTB file	A color-dependent plot style table.
default	A predefined value for a program input or parameter. Default values and options are denoted by angle brackets (<>).
definition table	The nongraphical data area of a drawing file that stores block definitions.
DesignCenter	Browses, finds, and previews content, and inserts content, which includes blocks, hatches, and external references (xrefs). (ADCENTER)
digital signature	Identifies an individual or an organization through a digital ID (certificate), and enables you to validate (verify the authenticity of) a file. (SIGVALIDATE)
dimension style	A named group of dimension settings that determines the appearance of the dimension and simplifies the setting of dimension system variables. (DIMSTYLE)
dimension text	The measurement value of dimensioned objects.
dimension variables	A set of numeric values, text strings, and settings that control dimensioning features. (DIMSTYLE)
direct distance entry	A method to specify a second point by first moving the cursor to indicate direction and then entering a distance.
drawing area	The area in which your drawings are displayed and modified.
drawing extents	The smallest rectangle that contains all objects in a drawing, positioned on the screen to display the largest possible view of all objects. (ZOOM)
drawing limits	<i>See</i> grid limits .
drawing template file	A drawing file with preestablished settings for new drawings. Drawing template files have a DWT extension.
drawing units	The unit of measurement that is used in a drawing. Depending on the drawing, one drawing unit may equal one inch, one millimeter, one kilometer, one mile, or some other distance.
DWF	For <i>Design Web Format</i> . A highly compressed file format that is created from a DWG file. DWF files are easy to publish and view on the Web. <i>See also</i> DWG , DWT , and DXF .
DWT	For <i>drawing template</i> . A drawing file that contains standard settings to be used when creating new drawings. <i>See also</i> DWG .

Term	Definition
DXF	For <i>drawing interchange format</i> . An ASCII or binary file format of an AutoCAD drawing file for exporting drawings to other applications or for importing drawings from other applications. <i>See also</i> DWF , DWG , and DWT .
explode	To disassemble a complex object, such as a block, dimension, or polyline, into simpler objects. In the case of a block, the block definition is unchanged. The block reference is replaced by the components of the block. <i>See also</i> block , block definition , and block reference . (EXPLODE)
extents	<i>See</i> drawing extents .
external reference (xref)	A drawing file referenced by another drawing. (XREF)
fill	A solid color covering an area bounded by lines or curves. (FILL)
floating viewports	<i>See</i> layout viewports .
font	A character set, which includes letters, numbers, punctuation marks, and symbols of a distinctive proportion and design.
freeze	A setting that suppresses the display of objects on selected layers. Objects on frozen layers are not displayed, regenerated, or plotted. Freezing layers shortens regenerating time. <i>See also</i> thaw . (LAYER)
geometry	All graphical objects such as lines, circles, arcs, polylines, and dimensions. Nongraphical objects, such as linetypes, lineweights, text styles, and layers are not considered geometry. <i>See also</i> named object .
graphics area	<i>See</i> drawing area .
graphics screen	<i>See</i> drawing area .
grid	An area covered with regularly spaced dots to aid drawing. The spacing between grid dots is adjustable. Grid dots are not plotted. <i>See also</i> grid limits . (GRID)
grid limits	The user-defined rectangular boundary of the drawing area covered by dots when the grid is turned on. Also called <i>drawing limits</i> . (LIMITS)
Grip modes	The editing capabilities activated when grips are displayed on an object: stretching, moving, rotating, scaling, and mirroring.
grips	Small squares that appear on objects you select. After selecting the grip, you edit the object by dragging it with the pointing device instead of entering commands.
i-drop	A method by which a drawing file can be dragged from a web page and inserted into another drawing.

Term	Definition
InfoCenter	A tool in the upper-right edge of the application window that accepts keywords to search multiple sources and locations for information at one time (for example, Help, the New Features Workshop, web locations, and specified files).
instance	See block reference .
island	An enclosed area within a hatched area.
layer	A logical grouping of data that are like transparent acetate overlays on a drawing. You can view layers individually or in combination. (LAYER)
layout	The tabbed environment in which you create and design paper space layout viewports to be plotted. Multiple layouts can be created for each drawing.
layout viewports	Objects that are created in paper space that display views. See also paper space . (VPORTS)
limits	See grid limits .
line font	See linetype .
line width	See lineweight .
linetype	How a line or type of curve is displayed. For example, a continuous line has a different linetype than a dashed line. Also called <i>line font</i> . (LINTYPE)
lineweight	A width value that can be assigned to all graphical objects except TrueType® fonts and raster images.
mirror	To create a new version of an existing object by reflecting it symmetrically with respect to a prescribed line or plane. (MIRROR)
mode	A software setting or operating state.
model	A two- or three-dimensional representation of an object.
model viewports	A type of display that splits the drawing area into one or more adjacent rectangular viewing areas. See also layout viewports and viewport . (VPORTS)
model space	One of the two primary spaces in which objects reside. Typically, a geometric model is placed in a three-dimensional coordinate space called model space. A final layout of specific views and annotations of this model is placed in paper space. See also paper space . (MSPACE)
named object	Describes the various types of nongraphical information, such as styles and definitions, stored with a drawing. Named objects include linetypes, layers, dimension styles, text styles, block definitions, layouts, views, and viewport configurations. Named objects are stored in definition (symbol) tables.

Term	Definition
node	An object snap specification to locate points, dimension definition points, and dimension text origins.
NURBS	For <i>nonuniform rational B-spline curve</i> . A B-spline curve or surface defined by a series of weighted control points and one or more knot vectors. <i>See also</i> B-spline curve .
object	One or more graphical elements, such as text, dimensions, lines, circles, or polylines, treated as a single element for creation, manipulation, and modification. Formerly called <i>entity</i> .
object properties	Settings that control the appearance and geometric characteristics of objects. Properties that are common to all objects include color, layer, linetype, linetype scale, and 3D thickness. (PROPERTIES)
object snap markers	A geometric symbol that is displayed when the cursor moves over an object. <i>See also</i> object snap mode .
object snap menu	The menu that is displayed in the drawing area at the cursor location when you hold down SHIFT and right-click the pointing device. <i>See also</i> shortcut menu .
object snap mode	Methods for selecting commonly needed points on an object while you create or edit a drawing. <i>See also</i> running object snap and object snap override .
object snap override	Turning off or changing a running Object Snap mode for input of a single point. <i>See also</i> Object Snap mode and running object snap .
origin	The point where coordinate axes intersect. For example, the origin of a Cartesian coordinate system is where the X, Y, and Z axes meet at 0,0,0.
ortho mode	Limits pointing device input to horizontal or vertical (relative to the current snap angle and the user coordinate system). <i>See also</i> snap angle and user coordinate system (UCS) . (ORTHO)
page setup	A method of naming and saving plot settings. <i>See also</i> zoom . (PAGESETUP)
pan	To shift the view of a drawing without changing magnification. <i>See also</i> zoom . (PAN)
paper space	One of two primary spaces in which objects reside. Paper space is used for creating a finished layout for printing or plotting, as opposed to doing drafting or design work. You design your paper space viewports using a layout tab. Model space is used for creating the drawing. You design your model using the Model tab. <i>See also</i> model space . (PSPACE)
pick button	The button on a pointing device that is used to select objects or specify points on the screen. For example, on a two-button mouse, the pick button is the left button.

Term	Definition
pickbox	The square cursor used to select an object in the drawing area.
plan view	A view orientation from a point on the positive Z axis toward the origin (0,0,0). (PLAN)
pline	See polyline .
point	1. A location in three-dimensional space specified by X, Y, and Z coordinate values. 2. An object consisting of a single coordinate location. (POINT)
pointing device	A device, such as a mouse or a digitizing puck, that can be used to interact with the interface and create and edit drawing objects in the drawing area. A pointing device usually has several buttons, some of which may be customized to perform commands you specify.
polar array	Objects copied around a specified center point a specified number of times. (ARRAY)
PolarSnap	A precision drawing tool used to snap to incremental distances along the polar tracking alignment path. See also polar tracking .
polar tracking	A precision drawing tool that displays temporary alignment paths defined by user-specified polar angles. See also PolarSnap .
polyline	An object composed of one or more connected line segments or circular arcs treated as a single object. Also called <i>pline</i> . (PLINE, PEDIT)
plot style	An object property that specifies a set of overrides for color, dithering, gray scale, pen assignments, screening, linetype, lineweight, endstyles, jointstyles, and fill styles. Plot styles are applied at plot time.
plot style table	A set of plot styles. Plot styles are defined in plot style tables and apply to objects only when the plot style table is attached to a layout or viewport.
prompt	A message on the command line that asks for information or requests action such as specifying a point.
properties	See object properties .
properties palette	Lists and changes properties of the selected object or set of objects or, if no objects are selected, the values of default properties common to all objects. (PROPERTIES)
purge	A feature that removes unused definitions such as block definitions, layers, and text styles from a drawing. (PURGE)
relative coordinates	Coordinates specified in relation to previous coordinates.

Term	Definition
running object snap	Setting an Object Snap mode so it continues for subsequent selections. <i>See also</i> Object Snap mode and object snap override . (OSNAP)
scale	1. The size of an object compared with other objects. 2. The display size of the components of noncontinuous linetypes and hatches. 3. The apparent size of objects in a view with respect to a drawing sheet. (SCALE, HPSCALE, LTSCALE, CELTSCALE, ZOOM)
selection set	One or more selected objects that a command can act upon at the same time.
shortcut keys	Keys and key combinations that start commands; for example, CTRL+S saves a file. The function keys (F1, F2, and so on) are also shortcut keys. Also known as <i>accelerator keys</i> .
shortcut menu	The menu displayed at your cursor location when you right-click your pointing device. The shortcut menu and the options it provides depend on the pointer location and other conditions, such as whether an object is selected or a command is in progress.
snap	<i>See</i> snap angle , snap grid , snap resolution , and PolarSnap .
snap angle	The invisible grid that locks the pointer into alignment with the grid points according to the spacing set by Snap. Snap grid does not necessarily correspond to the visible grid, which is controlled separately by GRID. (SNAP)
snap grid	The invisible grid that locks the pointer into alignment with the grid points according to the spacing set by Snap. Snap grid does not necessarily correspond to the visible grid, which is controlled separately by GRID. (SNAP)
snap mode	A mode for locking a pointing device into alignment with an invisible rectangular grid. When Snap mode is on, the screen crosshairs and all input coordinates are snapped to the nearest point on the grid. The snap resolution defines the spacing of this grid. <i>See also</i> object snap mode . (SNAP)
spline	<i>See</i> B-spline curve and NURBS .
status bar	The area at the bottom of the application window that contains buttons controlling the mode of operation of the program and displays the coordinates of the cursor location in the drawing area.
STB file	For <i>plot style table</i> file. Contains plot styles and their characteristics.
symbol	A representation of an item commonly used in drawings. <i>See</i> block .
symbol library	A collection of block definitions stored in a single drawing file. <i>See also</i> block library .
symbol table	<i>See</i> definition table and block definition table .

Term	Definition
system variable	A name similar to a command used as a mode, size, or limit. Read-only system variables, such as DWGNAME, cannot be modified directly by the user.
template drawing	A drawing file with preestablished settings for new drawings such as <i>aclt.dwt</i> and <i>acltiso.dwt</i> ; however, any drawing can be used as a template.
text style	A named, saved collection of settings that determines the appearance of text characters—for example, stretched, compressed, oblique, mirrored, or set in a vertical column.
thaw	A setting that displays previously frozen layers. <i>See also freeze.</i> (LAYER)
tiled viewports	<i>See model viewports.</i>
tool palette	tabbed areas within the Tool Palettes window that provide an efficient method for organizing, sharing, and placing blocks and hatches.
tree view	A hierarchical list that can be expanded or collapsed to control the amount of information displayed. Tree views are available in DesignCenter, the Purge dialog box, and the Help system.
UCS	<i>See user coordinate system (UCS).</i>
UCS icon	An icon that indicates the orientation of the UCS axes. (UCSICON)
user coordinate system (UCS)	A user-defined coordinate system that defines the orientation of the X, Y, and Z axes in 3D space. The UCS determines the default placement of geometry in a drawing. <i>See also world coordinate system (WCS).</i>
vertex	A location where edges or polyline segments meet.
view	A graphical representation of a model from a specific location (viewpoint) in space. <i>See also viewport.</i> (VPOINT, DVIEW, VIEW)
viewport	<i>See model viewports and layout viewports. See also view.</i> (VPORTS)
window selection	A rectangular area specified in the drawing area to select multiple objects at the same time. <i>See also crossing selection and polygon window selection.</i>
xref	<i>See external reference (xref).</i>
zoom	To reduce or increase the apparent magnification of the drawing area. (ZOOM)

Index

A

- absolute coordinates, 74, 159
- accelerator keys (shortcut keys), 166
- actions, undoing, 34
- Add-A-Plotter wizard, 151
- aliases, command, 31, 160
- aligned dimensions, 132, 143, 159
- aligning text, 128
- analyzing drawings, 111
- angles
 - angle overrides, 80, 159
 - angular units, 159
 - calculating, 111
 - hatch patterns, 121
 - polar coordinates, 74
 - polar tracking, 79
 - rotation angles, 93
 - specifying for arcs, 67
 - text characters, 128
- angular dimensions, 132, 134, 143, 159
- angular units, 159
- annotations, 134, 139, 159
- architectural drawing unit format, 46
- architectural template files, 45
- arcs
 - drawing, 67
 - drawing polylines with, 65
 - filletting, 68, 94
 - regenerating view of, 40
- areas
 - finding for objects, 100
 - selection areas, 86
- arrays, 155, 159
- arrowheads, 134, 141, 159

- associative dimensions, 17, 134, 159
- associative hatches, 119, 159
- attribute definitions, 159
- Autodesk Design Review (DWF viewer), 155
- Auto-hide and palettes, 57
- Auto-hide feature, 160
- AutoSnap markers, 76, 81
- axes for coordinates, 74

B

- B-spline curves, 160
- backwards-reading text, 128
- base points, 90, 93, 160
- baseline dimensions, 132, 143
- black-and-white plotting, 154
- blank areas within hatches (islands), 120, 163
- block attributes, 116
- block definition tables, 160
- block definitions, 160
- block instances (block references), 160
- block libraries, 116, 118
- block references, 160
- blocks, 114, 116, 160
 - block attributes, 116
 - block definition tables, 160
 - block definitions, 160
 - block references, 160
 - inserting, 117
 - moving, 118
 - sources of, 116
 - title blocks, 156
 - typical uses, 116
 - See also* block libraries

- boundaries
 - editing, 96
 - extending objects, 88
 - hatched areas, 120
 - polylines, 101
 - text objects, 126
 - trim boundaries, 106
- BYBLOCK property, 160
- BYLAYER property, 59, 62, 63, 160

C

- calculating distances, angles, or coordinates, 111
- callouts (leader lines), 17, 134, 139
- Cancel command, 34
- Cartesian coordinates, 74, 75
- center marks, 132, 138, 141
- Center object snap, 78
- centering views in layout viewports, 136
- centerlines, 138, 141
- chain dimensions (continued dimensions), 132, 143, 160
- chord length, specifying for arcs, 67
- circles, 33, 67, 94, 103
 - regenerating view of, 40
- circumscribed polygons, 66
- closing polylines, 65
- color-dependent plot style tables (CTB), 152, 161
- colors
 - applying to objects, 59
 - assigning to layers, 7, 50, 59
 - color-dependent plot style tables, 152, 161
- command aliases, 31, 160
- command line, 31, 160
- command window, 31, 160
- commands
 - aliases, 31, 160
 - canceling or undoing, 34
 - choosing, 30
 - dynamic prompts, 32
 - editing commands, 86
 - ending, 34
 - help and information, 25
 - options, 31
 - repeating, 34
 - starting at command line, 31
- continued dimensions, 132, 143, 160
- coordinates and coordinate systems
 - absolute and relative coordinates, 74, 75, 159, 165
 - calculating delta, 111
 - Cartesian coordinates, 74
 - dynamic input and, 75
 - origin point, 74, 102
 - overview, 74
 - polar coordinates, 74
 - specifying, 13

- COPY command, 84
- copying
 - multiple copies of objects, 91
 - objects, 84, 90
 - properties to other objects, 108
- corners, filleting, 94
- counter-clockwise rotation, 93
- crosshairs, 160
 - See also* cursors
- crossing selection areas, 86, 161
- CTB files (color-dependent plot style tables), 152, 161
- current layer, 50, 59
- current object scale settings, 62
- cursor menus. *See* shortcut menus
- cursors
 - dynamic prompts displayed by, 32
 - panning with, 39
 - pickbox cursor, 81
 - snapping to a grid, 72
 - zooming in or out with, 38
- cutting edges, 88

D

- DC Online tab (in DesignCenter), 118
- decimals
 - drawing unit format, 46
 - rounding on screen, 47
- defaults
 - defined, 161
 - property settings, 57
- definition tables, 161
- deleting objects, 87
- delta, calculating, 111
- deselecting objects, 86
- Design Web Format (DWF) files, 151, 155
- DesignCenter, 161
 - DC Online tab, 118
 - hatch patterns in, 120
 - sources of block libraries, 116
- diameter dimensions, 132, 143
- diameters, 67
- digital signatures, 161
- dimension lines, 134
- Dimension Style Manager dialog box, 140
- dimension styles, 140, 161
 - extension lines, 141
 - overriding, 140
- dimension text, 134, 161
- dimension variables, 161
- dimensions and dimensioning
 - accuracy, 13
 - associative dimensions, 17, 134
 - center marks and centerlines, 138, 141
 - creating, 135, 143
 - dimension styles, 140, 161

- dimension variables, 161
- editing dimensions, 142
- editing properties, 58
- elements of dimensions, 134
- grips, 142
- layers for, 135, 136
- moving dimensions, 142
- overview, 134
- saving styles in templates, 9
- scaling, 149
- standards for, 141
- text, 141, 161
- types of, 17, 134, 143
- units of measurement, 141
- DIMSCALE system variable, 137
- direct distance entry, 79, 91, 161
- displaying
 - command options, 32
 - display scale, 136
 - grid, 72
 - layers, 51
 - properties, 57
 - Properties palette, 57
 - regenerating jagged display, 40
 - viewport properties, 149
- DIST command, 84, 111
- distances
 - calculating, 111
 - direct distance entry, 79, 161
 - measuring, 84
 - polar coordinates, 74
 - polar tracking, 79
- dividing polylines, 66
- Drafting Settings dialog box, 73, 77
- drawing area, 161
- drawing extents, 161
- drawing interchange format (DXF) files, 162
- drawing limits (grid limits), 72, 162
- drawing objects
 - arcs, 67
 - circles, 33, 67
 - filleting, 94
 - lines, 32, 64
 - overview, 11
 - polygons, 64
 - polylines, 64
 - rectangles, 65
- drawing scale. *See* scales and scaling
- drawing template files. *See* template files
- drawing units, 3, 45, 46, 161
- drawings and drawing files
 - coordinate systems, 74
 - displaying entire drawing, 38
 - grids, 72
 - inserting blocks, 117
 - new drawings, starting, 44
 - panning a view, 39
 - plotting, 153
 - revising, 19
 - revision clouds, 110
 - Snap mode, 72
 - template files, 44
 - touring, 52
 - zooming in or out, 15
- drivers, printer, 151
- DWF (Design Web Format) files, 151, 155, 161
- DWT files. *See* template files
- DXF files, 162
- dynamic input, 75
- Dynamic Input button, 75

E

- editing objects
 - associative hatches and, 119
 - copying properties, 108
 - dimensions, 142
 - duplicating objects, 90
 - erasing objects, 87
 - extending objects, 88
 - filleting, 94
 - grip edit mode, 109
 - mirroring, 92
 - object boundaries, 96
 - offsetting copies, 91
 - overview, 19
 - precision editing, 95
 - properties, 57, 107
 - revising drawings, 19
 - revision clouds, 19, 110
 - selecting objects to edit, 86
 - text, 126
 - text styles, 128
 - trimming objects, 88
- editing plotter configurations, 152
- editing text, 126, 128
- ellipses, 94
- ending commands, 34
- Endpoint object snap, 78, 105
- endpoints, 65, 67
- engineering drawing unit format, 46
- entities. *See* objects
- ERASE command, 87
- erasing layout viewports, 150
- ESC key, 30
- EXPLODE command, 66
- exploding objects, 66, 162
- EXTEND command, 88
- extending objects, 88, 98
- extension lines, 134, 141
- extents, drawing, 162
- external references (xrefs), 162

F

- FILLET command, 68, 84
- filleting objects, 68, 84, 94
- fills, 119, 120, 162
- fitting options for dimensions, 141
- flipping objects (mirroring objects), 84, 92, 104
- floating viewports (layout viewports), 146, 163
- fonts, 128, 162
- formatting
 - dimensions, 140
 - drawing units, 46
 - Text Formatting, 126
- fractions, 46, 47
- freezing layers, 51, 162

G

- geometry, 162
- global scale factor for linetypes, 62
- graphics area of screen (drawing area), 161
- grid limits, 72, 162
- grids, 162
 - displaying or hiding, 72
 - grid limits, 72, 162
 - overview, 72
 - spacing, 72
 - turning off and on, 72
- grip modes, 162
- grips, 162
 - block grips, 118
 - displaying, 86
 - editing dimensions, 142
 - editing objects, 109
 - grip modes, 162
 - viewport grips, 150

H

- hatches and hatch patterns, 114, 119
 - associative hatches, 119
 - inserting, 120
 - internal points, 121
 - islands within boundaries, 120
 - sources of, 119
- height of text characters, 128
- Help
 - command Help, 25
 - Help system, 23
 - procedural, 25
 - table of contents (Contents tab), 25
 - tutorial, 24
- hiding
 - layers, 51, 60
 - Properties palette, 57
- hook lines, 139

- horizontal alignment of text, 128
- horizontal dimensions, 132

I

- i-drop, 162
- imperial measurement drawing template files, 45
- Info palette, 163
- inquiry commands, 111
- inscribed polygons, 66
- Insert dialog box, 118
- inserting blocks, 117, 118, 156
- instances (block references), 163
- Intersection object snap, 78
- intersection snap, 97
- islands, 120, 163
- ISO standards, 44, 119
- italic fonts, 128

J

- jagged display, 40
- JIS standards, 44
- JOIN command, 66
- joining polylines, 66

K

- keyboard shortcuts (shortcut keys), 166
- keywords in Help system, 23

L

- labels in model and paper space, 128
- Layer Properties Manager, 50, 51, 60, 149
- layers, 163
 - color assignments, 7, 50, 59
 - current layer, 50, 59
 - dimensions on, 135, 136
 - editing properties, 58
 - freezing, 51
 - hiding or displaying, 51, 60, 149
 - Layer Properties Manager, 50, 51, 59, 149
 - Layers panel, 57
 - linetype assignments, 7, 62
 - locking, 51
 - naming, 7
 - organizing drawings with, 42, 50
 - overview, 7, 50
 - plot styles, 7
 - properties and, 56, 58
 - rearranging, 50
 - viewports layer, 156
- Layers panel, 57

- layout tab, 48
- layout viewports, 146, 163
- layouts, 146, 163
 - compared to models, 48
 - display scale, 136
 - linetypes in, 62
 - overview, 5, 48
 - page setups and, 153
 - plotting from, 153
 - scale and drawing units, 3, 46
 - switching to model space, 49
 - text size and, 129
 - viewports, 146, 163
- leader lines (callouts), 17, 134, 139
- leader objects, 134
- left mouse button, 30
- lengthening objects, 88
- libraries
 - block libraries, 116
 - DesignCenter, 118
 - DesignCenter Online, 118
- limits, grid, 72, 162
- line fonts. *See* linetypes
- line widths (lineweights), 7, 42, 63, 163
- linear dimensions, 132, 134, 143
- linear measurements, 47
- lines
 - angles, 80
 - centerlines, 138, 141
 - dimension styles, 141
 - drawing, 32, 64
 - exact length, 79
 - extension lines on dimensions, 134
 - filleting, 94
 - hook lines, 139
 - leader lines, 134, 139
 - linetypes. *See* linetypes
 - lineweights, 7, 42, 63, 163
 - offsetting, 11
 - parallel, 64
 - perpendicular, 79
 - polylines, 64
 - tapering, 66
- Linetype Manager, 61
- linetypes, 163
 - editing properties, 107
 - global scale factor, 62
 - identifying objects with, 42
 - layer assignments, 7, 62
 - Linetype Manager, 61
 - overview, 61
 - saving styles in templates, 9
 - scaling, 61, 62
- Lineweight Settings dialog box, 63
- lineweights, 7, 42, 63, 163
- locking
 - layers, 51

M

- magnifying view in viewports. *See* zooming in or out
- markup revision clouds, 110
- matching properties between objects, 108
- measurement units, 3, 45, 46, 141
- mechanical drawing template files, 45
- mechanical drawing unit format, 102
- menus, 30, 31, 166
- metric measurement template files, 45
- Midpoint object snap, 78
- mirroring objects, 84, 92, 104, 163
- Model tab, 48
- model viewports, 163
- models and model space, 5, 146, 163
 - compared to layouts, 48
 - dimensioning and, 136
 - drawing in model space, 48
 - extracting information from, 111
 - formulas for text size, 129
 - linetypes in, 62
 - notes and labels in, 128
 - scale and drawing units, 3
 - scale and drawing units, 46
 - switching to layouts, 49
 - switching to paper space, 150
 - text size in, 129
 - viewports, 163
 - zooming in or out, 156
- modes, defined, 163
- mouse devices, 30, 165
- moving
 - blocks, 118
 - dimensions, 142
 - objects, 93
 - panning a view, 39
 - rotating objects, 93
 - text in dimensions, 134
- Multiline Text panel, 126
- multiple copies of objects, 91

N

- named layers, 7
- named objects, 163
- named plot style tables, 152
- navigation
 - Help system, display, 24
- New Features Workshop, 23
- New Page Setup dialog box, 154
- nodes, 164
- nonuniform rational B-spline curves, 164
- notes, in model and paper space, 128
- NURBS (nonuniform rational B-spline curves), 164

O

- object properties, 164
- object snap markers, 164
- Object Snap menu, 31, 76, 164
- Object Snap mode, 164
- object snap overrides, 164
- object snaps
 - accuracy and, 13
 - AutoSnap markers, 81
 - cycling through snap points, 76
 - dimensions and, 135
 - markers, 164
 - overriding, 164
 - overview, 72
 - running object snaps, 77
 - snap angles, 166
 - snap grid, 166
 - Snap mode, 164, 166
 - spacing, 72
 - types of, 78
- objects, 164
 - associative dimensions, 134
 - colors, 59
 - copying properties, 108
 - displaying on layers, 149
 - drawing, 11
 - duplicating, 90
 - editing properties, 57, 58
 - erasing, 87
 - filletting, 94
 - grips, 109
 - hatch patterns, 119
 - linetypes, 61
 - lineweights, 63
 - mirroring, 92
 - moving, 93
 - offsetting copies, 91
 - properties, 56, 107, 164
 - rotating, 93
 - selecting, 86
 - trimming edges, 88
- oblique text, 128
- OFFSET command, 64, 84
- offsetting objects, 11, 64, 84, 91, 102
- opening
 - block libraries, 118
 - template files, 45
- ordinate dimensions, 132, 134, 143
- orientation
 - pages, 153
 - text, 128
- origin point, 102
- origin points, 74, 164
- Ortho mode, 164
- overlays, 7
- overriding dimension styles, 140

P

- page orientation, 153
- Page Setup Manager, 153
- page setups, 146, 153, 164
- paper size, 153
- PAN command, 39
- panels
 - Layers panel, 57
 - Properties panel, 57
- panning, 15, 39, 164
- paper size, 152, 155
- paper space, 5, 164
 - compared to model space, 48
 - notes and labels in, 128
 - scaling linetypes in, 62
 - switching to model space, 49, 150
 - text size and, 129
- parallel dimensions (baseline dimensions), 132, 143
- parallel lines, 64
- PAT files, 119
- PC3 files, 151
- perpendicular lines, 79
- Perpendicular object snap, 78
- pick button, 30, 164
- pickbox cursor, 81, 165
- plan views, 165
- plines. *See* polylines
- Plot dialog box, 153
- plot scales, 153
- Plot Style Manager, 152
- plot style tables (STB) files, 152, 165, 166
- plot styles, 7, 146, 152, 165
- plotter configuration (PC3) files, 151
- Plotter Configuration Editor, 152
- Plotter Manager, 151
- plotters and plotting
 - configuring plotters, 151
 - driver support for, 151
 - page setups, 153
 - plot styles, 146, 152
 - Plotter Configuration Editor, 152
 - plotting from layouts, 153
 - previewing, 153
 - printing viewport borders, 150
 - scaling in model space, 157
 - setting up, 153
- Plotters* folder, 151
- pointing devices, 30, 38, 40, 165
- points, 165
 - absolute coordinates, 74, 159
 - AutoSnap markers, 76, 81
 - calculating distance or coordinates, 111
 - coordinate systems. *See* coordinates and coordinate systems
 - origin point, 102
 - origin points, 74, 164
 - polar coordinates, 74
 - relative coordinates, 75, 165

- specifying for arcs, 67
- specifying for circles, 67
- polar arrays, 165
- polar coordinates, 74
- polar tracking, 13, 79, 165
- PolarSnap, 102, 165
- polygons, 64
- polylines, 64, 165
 - closing, 65
 - dividing or joining, 66
 - filletting, 94
 - highlighting boundaries, 101
 - widths, 66
- ports, 152
- PostScript files, 151
- previewing plot areas and settings, 153
- printers
 - plot styles and plot style tables, 152
 - Plotter Configuration Editor, 152
 - selecting plotters, 153
 - support for, 151
- procedural Help, 25
- prompts, 31, 32, 165
- properties, 56
 - assigning, 56
 - copying to other objects, 108
 - editing, 58, 107
 - layer assignments, 56
 - matching, 108
 - Properties palette, 57, 107, 165
 - Properties panel, 57, 107
 - viewing, 58
- Properties palette, 57, 107, 165
- Properties panel, 57
- pull-down menus, 30
- purging, 165

Q

- Quadrant object snap, 78, 104
- Quick Leader dimensions, 132

R

- radius
 - filletting objects, 94
 - specifying for arcs, 67
 - specifying for circles, 67
 - specifying for polygons, 66
- radius dimensions, 132, 134, 143
- raster files, 151
- rectangles, 65
- redline drawings, 110
- regenerating jagged display, 40
- relative coordinates, 75, 165
- relative values, 74

- removing objects, 87
- repeating commands, 34, 91
- resizing
 - linetypes, 62
 - text objects, 126
 - viewports, 150
- revising drawings, 19, 110
 - See also* editing objects
- revision clouds, 19, 110
- right mouse button, 30
- right-click actions, 30
- rotating objects, 93, 118
- running object snap, 77, 166

S

- saving
 - files as DWF files, 155
 - files in other formats, 151
- scales and scaling, 166
 - dimensions, 137
 - drawing units compared to scale, 3, 46
 - hatch patterns, 121
 - linetypes, 61, 62
 - lineweights and, 63
 - overview, 3
 - plot scales, 153
 - setting display scale, 136
 - text, 129
 - views in viewports, 5
- scientific drawing unit format, 46
- secondary dimension styles, 140
- Select Template dialog box, 45
- selecting
 - deselecting objects, 86
 - objects, 86
- selection areas, 86
- selection sets, 86, 166
- sharp corners on objects, 94
- shortcut keys, 166
- shortcut menus, 30, 31, 166
- shortcuts
 - cycling through snap points, 76
 - editing text, 126
 - shortcut keys, 166
- sizing
 - linetypes, 62
 - text objects, 126
 - viewports, 150
- slant of text characters, 128
- smoothing display, 40
- Snap and snapping. *See* object snaps
- snap angles, 166
- snap grids, 166
- Snap mode, 166
- snaps
 - creating drawings with, 81

- solid fills, 120, 162
- spacing
 - grid and snap settings, 72
 - hatch patterns, 121
- splines, 94, 160, 164
- STANDARD style, 128, 140
- start points, 65, 67
- starting drawings, 44
- status bar, 166
- STB files (named plot style tables), 152, 166
- styles
 - dimension styles, 140, 161
 - drafting standards, 9
 - plot styles, 152
 - text styles, 128
- switching
 - between model space and paper space, 150
 - between models and layouts, 49
 - between page setups, 153
- symbol libraries, 116, 166
 - DesignCenter Online, 118
 - opening, 118
- symbols
 - defined, 166
 - in dimensions, 141
 - See also* blocks
- system variables, 167

T

- table of contents in Help system, 25
- tangent method for drawing circles, 67, 103
- Tangent object snap, 78
- tapering lines, 66
- template files, 44
 - opening, 45
 - sample files, 45
- templates, 161, 167
 - drafting standards and, 9
 - DWT files, 161
- text
 - annotations, 134, 139
 - dimension text, 134, 141, 161
 - model space and paper space, 128
 - saving styles in templates, 9
 - styles, 128, 167
 - text editor, 126
 - Text Formatting, 126
 - viewports and, 129
 - width of, 126
- text editor, 126
- Text Style dialog box, 128
- text styles, 9, 128, 167
- thawing, 51, 167
- tiled viewports (model viewports), 167
- title blocks, 156
- tolerance options for dimensions, 141

- tool palettes, 167
- tooltips, 76
- topics in Help system, display, 24
- tree views, 167
- trim boundaries, 106
- TRIM command, 84, 88
- TrueType fonts, 128
- tutorial drawing template files, 45

U

- UCS (user coordinate system), 167
- UCS icon, 167
- undoing actions, 34
- units of measurement
 - in dimensions, 141
 - drawing units, 3, 46
 - template files, 45
- updating dimensions and leader lines, 134
- upside-down text, 128
- user coordinate system (UCS), 167

V

- variables
 - dimension variables, 161
 - system variables, 167
- vertical alignment of text, 128
- vertical dimensions, 132
- vertices, 167
- viewports, 146
 - changing settings, 155
 - creating, 149
 - display scale, 136
 - displaying layers in, 149
 - erasing, 150
 - grips, 150
 - linetype scaling in, 62
 - model space and paper space overview, 48
 - modifying, 149
 - multiple viewports, 155
 - overlapping, 150
 - overview, 5
 - panning, 39
 - plotting borders, 150
 - properties, 149
 - scaling views, 5, 38
 - sizing, 150
 - zooming in or out, 156
- views, 38, 167
 - displaying entire drawing, 38
 - panning, 15, 39
 - repositioning, 39
 - See also* viewports
- visibility of layers, 51

W

- wheel mouse, 30, 38, 40
- width
 - polylines, 66
 - text characters, 128
 - text objects, 126
- window selection areas, 86, 167
- Windows printer drivers, 151

X

- X and Y values, 74
- xrefs (external references), 161, 167

Z

- ZOOM command, 38
- zooming in or out, 167
 - overview, 15, 38
 - scaling views in viewports, 5, 156

