



FOREWORD

This Arctic Cat Service Manual contains service, maintenance, and troubleshooting information for the 2011 Arctic Cat 450 XC ATV. The complete manual is designed to aid service personnel in service-oriented applications.

This manual is divided into sections. Each section covers a specific ATV component or system and, in addition to the standard service procedures, includes disassembling, inspecting, and assembling instructions. When using this manual as a guide, the technician should use discretion as to how much disassembly is needed to correct any given condition.

The service technician should become familiar with the operation and construction of each component or system by carefully studying the complete manual. This manual will assist the service technician in becoming more aware of and efficient with servicing procedures. Such efficiency not only helps build consumer confidence but also saves time and labor.

All Arctic Cat ATV publications and decals display the words Warning, Caution, Note, and At This Point to emphasize important information. The symbol  **WARNING** identifies personal safety-related information. Be sure to follow the directive because it deals with the possibility of severe personal injury or even death. A **CAUTION** identifies unsafe practices which may result in ATV-related damage. Follow the directive because it deals with the possibility of damaging part or parts of the ATV. The symbol  **NOTE:** identifies supplementary information worthy of particular attention. The symbol  **AT THIS POINT** directs the technician to certain and specific procedures to promote efficiency and to improve clarity.

At the time of publication, all information, photographs, and illustrations were technically correct. Some photographs used in this manual are used for clarity purposes only and are not designed to depict actual conditions. Because Arctic Cat Inc. constantly refines and improves its products, no retroactive obligation is incurred.

All materials and specifications are subject to change without notice.

Keep this manual accessible in the shop area for reference.

**Product Service and
Warranty Department
Arctic Cat Inc.**

TABLE OF CONTENTS

Note: To navigate through this manual, use the PAGE UP/PAGE DOWN buttons on the keyboard, click on the Table of Contents bookmarks on the left side of the screen, or click the blue text below. To return to this page, click the Manual Table of Contents button at the bottom of each page.

General Information	2	Testing Oil Pump Pressure.....	69
General Specifications.....	2	Liquid Cooling System	70
Torque Specifications.....	2	Electric Fuel Pump/Fuel Level Sensor	72
Torque Conversions (ft-lb/N-m).....	3	Troubleshooting	74
Break-In Procedure	3	Electrical System	75
Gasoline - Oil - Lubricant.....	3	Specifications	75
Genuine Parts.....	4	Electrical Connections.....	75
Preparation For Storage	4	Battery.....	75
Preparation After Storage	5	RPM Limiter	76
Periodic Maintenance.....	6	Testing Electrical Components.....	76
Periodic Maintenance Chart	6	Accessory Receptacle/Connector.....	76
Lubrication Points	7	Brakelight Switch (Pressure).....	76
Air Filter	7	Engine Coolant Temperature (ECT) Sensor.....	77
Valve/Tappet Clearance.....	8	Fan Motor	77
Testing Engine Compression.....	9	Power Distribution Module (PDM)	78
Spark Plug	9	Ignition Coil	78
Liquid Cooling System	10	Speed Sensor	79
Muffler/Spark Arrester	10	Ignition Switch.....	79
Adjusting Throttle Cable	11	Handlebar Control Switches.....	80
Adjusting Engine RPM (Idle).....	11	Front Drive Selector Switch.....	80
Engine/Transmission Oil - Filter	11	Front Drive Selector Actuator	81
Front Differential/Rear Drive Lubricant	12	Stator Coil	81
Tires.....	12	Starter Relay	82
Driveshaft/Coupling	13	Starter Motor	82
Nuts/Bolts/Cap Screws	13	Electronic Control Unit (ECU).....	83
Ignition Timing	13	Regulator/Rectifier	83
Lights.....	13	Lights.....	83
Shift Lever.....	15	Ignition Timing.....	85
Frame/Welds.....	16	Diagnostic Trouble Codes (DTC).....	85
Hydraulic Brake Systems.....	16	Tilt Sensor	86
Burnishing Brake Pads	17	Throttle Position Sensor (TPS).....	87
Checking/Replacing V-Belt	17	Troubleshooting.....	89
Engine/Transmission	21	Drive System	91
Specifications	21	Front Drive Actuator	91
Troubleshooting	22	Front Differential.....	92
Removing Engine/Transmission	25	Drive Axles	103
Top-Side Components	27	Rear Gear Case	104
Removing Top-Side Components.....	27	Hub.....	104
Servicing Top-Side Components.....	30	Hand Brake Lever/Master Cylinder Assembly.....	105
Installing Top-Side Components.....	37	Hydraulic Brake Caliper.....	106
Left-Side Components.....	41	Troubleshooting Drive System.....	109
Removing Left-Side Components.....	41	Troubleshooting Brake System.....	109
Servicing Left-Side Components.....	43	Suspension.....	110
Installing Left-Side Components.....	45	Shock Absorbers	110
Right-Side Components	47	Front A-Arms	110
Removing Right-Side Components	47	Rear A-Arms	111
Servicing Right-Side Components.....	50	Wheels and Tires	112
Installing Right-Side Components	51	Troubleshooting.....	113
Center Crankcase Components	54	Steering/Frame	114
Separating Crankcase Halves	54	Steering Post/Tie Rods	114
Disassembling Crankcase Half.....	55	Speedometer/LCD Gauge.....	115
Servicing Center Crankcase Components	57	Handlebar Grip.....	116
Assembling Crankcase Half.....	61	Throttle Control	116
Joining Crankcase Halves	64	Steering Knuckles	117
Installing Engine/Transmission	65	Measuring/Adjusting Toe-Out.....	118
Fuel/Lubrication/Cooling	67	Front Bumper Assembly	119
Electronic Fuel Injection	67	Front Body Panel/Fender.....	119
Throttle Body	67	Exhaust System	120
Throttle Cable Free-Play.....	68	Rear Body Panel	120
Gas Tank.....	68	Seat.....	121
Oil Filter/Oil Pump.....	69	Troubleshooting.....	122

General Information

■NOTE: Some photographs and illustrations used in this section are used for clarity purposes only and are not designed to depict actual conditions.

General Specifications

CHASSIS	
Brake Type	Hydraulic w/Brake Lever Lock
Tire Size	23 x 8-12 (Front); 23 x 10-12 (Rear)
Tire Inflation Pressure	40.0 kPa (5.7 psi)
MISCELLANY	
Gas Tank Capacity	16.3 L (4.3 U.S. gal.)
Rear Drive Capacity	250 ml (8.5 fl oz)*
Front Differential Capacity	275 ml (9.3 fl oz)**
Coolant Capacity	1.8 L (1.9 U.S. qt)
Engine Oil Capacity	3.3 L (3.5 U.S. qt) - Overhaul 2.8 L (3.0 U.S. qt) - Change
Gasoline (recommended)	87 Octane Regular Unleaded
Engine Oil (recommended)	Arctic Cat ACX All Weather (Synthetic)
Differential/Rear Drive Lubricant	SAE Approved 80W-90 Hypoid
Drive Belt Width (minimum)	28.5 mm (1.12 in.)
Brake Fluid	DOT 4
Taillight/Brakelight	12V/5W/21W (2)
Headlight	12V/35W (4)
Running Light	5W (2)

Specifications subject to change without notice.

* One inch below plug threads.

** At the plug threads.

Torque Specifications

EXHAUST COMPONENTS			
Part	Part Bolted To	Torque	
		ft-lb	N-m
Exhaust Pipe	Engine	20	27
Spark Arrester	Muffler	48 in.-lb	5.5
BRAKE COMPONENTS			
Brake Disc*	Hub	15	20
Brake Hose	Caliper	20	27
Brake Hose	Master Cylinder	20	27
Brake Hose	Brake Cylinder	20	27
Master Cylinder (Rear)	Frame	8	11
Master Cylinder Clamp (Front)	Master Cylinder	5.5	8
Hydraulic Caliper****	Knuckle	20	27
Brake Pedal	Frame	20	27
ELECTRICAL COMPONENTS			
Coil	Frame	12	16
Starter Motor Positive Cable	Starter Motor	8	11
Stator**	Housing	8	11
CHASSIS COMPONENTS			
Footrest	Frame	20	27
Bumper	Frame (8 mm)	20	27

SUSPENSION COMPONENTS (Front)			
Part	Part Bolted To	Torque	
		ft-lb	N-m
A-Arm	Frame	35	47
Knuckle	Ball Joint	35	47
Shock Absorber	Frame	35	47
Shock Absorber	Upper A-Arm	35	47
Knuckle	A-Arm	35	47
SUSPENSION COMPONENTS (Rear)			
Shock Absorber (Upper)	Frame	35	47
Shock Absorber (Lower)	Lower A-Arm	35	47
A-Arm	Frame	35	47
Knuckle	A-Arm	35	47
STEERING COMPONENTS			
Steering Post Bearing Housing	Frame	20	27
Handlebar Cap	Steering Post	20	27
Lower Steering Post Bearing Cap Screw	Steering Post	40	54
Tie Rod End**	Steering Post Arm	30	41
ENGINE/TRANSMISSION			
Clutch Shoe**	Crankshaft	147	199
Clutch Cover/Housing Assembly	Crankcase	8	11
Left-Side Cover	Crankcase	8	11
Crankcase Half (6 mm)	Crankcase Half	10	13.5
Crankcase Half (8 mm)	Crankcase Half	21	28
Cylinder Nut	Crankcase Half	8	11
Cylinder Head (Cap Screw)	Crankcase	28	38
Cylinder Head Nut	Cylinder	20	27
Cylinder Head Cover	Cylinder Head	8	11
Oil Pump Drive Gear**	Crankshaft	63	86
Driven Pulley Nut**	Driveshaft	147	199
Ground Cable	Engine	8	11
Magneto Rotor Flange Nut	Crankshaft	107	146
One-Way Clutch**	Flywheel	26	35
Cam Sprocket**	Camshaft	11	15
V-Belt Cover	Clutch Cover	8	11
Valve Adjuster Jam Nut	Valve Adjuster	7	9.5
Starter Motor	Crankcase	8	11
Oil Fitting	Engine	8	11
Oil Pump**	Crankcase	8	11
Movable Drive Face Nut**	Clutch Shaft	147	199
Output Shaft Flange Nut	Output Shaft	59	80
Cam Chain Tensioner Guide	Cylinder	11	15
Valve Cover	Cylinder	8	11
Tappet Cover	Valve Cover	8	11
Cam Chain Tensioner	Cylinder	10	13.5
Magneto Cover	Crankcase	8	11
Rear Driveline	Output Drive Flange	20	27
Water Pump Cover/Housing	Magneto Cover	8	11
Water Pump Drive Gear	Crankshaft	28	38
Intake Clamp	Intake Boot	30 in.-lb	3.4

* w/Blue Loctite #243

** w/Red Loctite #271

*** w/Green Loctite #609

****w/"Patch-Lock"

DRIVE TRAIN COMPONENTS			
Part	Part Bolted To	Torque	
		ft-lb	N-m
Engine Mounting Through-Bolt	Frame	38	52
Front Differential	Frame/Differential Bracket	38	52
Output Flange	Rear Flange Output Joint	20	27
Input Shaft Housing	Differential Housing	18	25
Pinion Housing	Gear Case Housing	18	25
Differential Housing Cover***	Differential Housing	18	25
Drive Bevel Gear Nut**	Shaft	59	80
Driven Bevel Gear Nut**	Driven Shaft	59	80
Thrust Button**	Gear Case Cover	8	11
Hub Nut	Shaft/Axle (max)	200	272
Oil Drain Plug	Front Differential/Rear Drive	45 in.-lb	5
Oil Fill Plug	Front Differential/Rear Drive	16	22
Oil Drain Plug	Engine	20	27
Rear Drive Input Shaft Housing	Differential Housing	23	31
Lock Collar	Differential Housing	125	169
Wheel	Hub	40	54
Rear Drive Gear Case	Frame	38	52
Engine Output Flange	Rear Gear Case Input Flange	20	27

* w/Blue Loctite #243
 ** w/Red Loctite #271
 *** w/Green Loctite #609

Torque Conversions (ft-lb/N-m)

ft-lb	N-m	ft-lb	N-m	ft-lb	N-m	ft-lb	N-m
1	1.4	26	35.4	51	69.4	76	103.4
2	2.7	27	36.7	52	70.7	77	104.7
3	4.1	28	38.1	53	72.1	78	106.1
4	5.4	29	39.4	54	73.4	79	107.4
5	6.8	30	40.8	55	74.8	80	108.8
6	8.2	31	42.2	56	76.2	81	110.2
7	9.5	32	43.5	57	77.5	82	111.5
8	10.9	33	44.9	58	78.9	83	112.9
9	12.2	34	46.2	59	80.2	84	114.2
10	13.6	35	47.6	60	81.6	85	115.6
11	15	36	49	61	83	86	117
12	16.3	37	50.3	62	84.3	87	118.3
13	17.7	38	51.7	63	85.7	88	119.7
14	19	39	53	64	87	89	121
15	20.4	40	54.4	65	88.4	90	122.4
16	21.8	41	55.8	66	89.8	91	123.8
17	23.1	42	57.1	67	91.1	92	125.1
18	24.5	43	58.5	68	92.5	93	126.5
19	25.8	44	59.8	69	93.8	94	127.8
20	27.2	45	61.2	70	95.2	95	129.2
21	28.6	46	62.6	71	96.6	96	130.6
22	29.9	47	63.9	72	97.9	97	131.9
23	31.3	48	65.3	73	99.3	98	133.3
24	32.6	49	66.6	74	100.6	99	134.6
25	34	50	68	75	102	100	136

www.mymowerparts.com

Break-In Procedure

A new ATV and an overhauled ATV engine require a “break-in” period. The first 10 hours (or 200 miles) are most critical to the life of this ATV. Proper operation during this break-in period will help assure maximum life and performance from the ATV.

During the first 10 hours (or 200 miles) of operation, always use less than 1/2 throttle. Varying the engine RPM during the break-in period allows the components to “load” (aiding the mating process) and then “unload” (allowing components to cool). Although it is essential to place some stress on the engine components during break-in, care should be taken not to overload the engine too often. Do not pull a trailer or carry heavy loads during the 10-hour break-in period.

When the engine starts, allow it to warm up properly. Idle the engine several minutes until the engine has reached normal operating temperature. Do not idle the engine for excessively long periods of time.

During the break-in period, a maximum of 1/2 throttle is recommended; however, brief full-throttle accelerations and variations in driving speeds contribute to good engine break-in.

After the completion of the break-in period, the engine oil and oil filter should be changed. Other maintenance after break-in should include checking of all prescribed adjustments and tightening of all fasteners.

Gasoline - Oil - Lubricant

RECOMMENDED GASOLINE

The recommended gasoline to use is 87 minimum octane regular unleaded. In many areas, oxygenates (either ethanol or MTBE) are added to the gasoline. Oxygenated gasolines containing up to 10% ethanol, 5% methane, or 5% MTBE are acceptable gasolines.

When using ethanol blended gasoline, it is not necessary to add a gasoline antifreeze since ethanol will prevent the accumulation of moisture in the fuel system.

CAUTION

Do not use white gas. Only Arctic Cat approved gasoline additives should be used.

RECOMMENDED ENGINE/TRANSMISSION OIL

CAUTION

Any oil used in place of the recommended oil could cause serious engine damage. Do not use oils which contain graphite or molybdenum additives. These oils can adversely affect clutch operation. Also, not recommended are racing, vegetable, non-detergent, and castor-based oils.

The recommended oil to use is Arctic Cat ACX All Weather synthetic engine oil, which has been specifically formulated for use in this Arctic Cat engine. Although Arctic Cat ACX All Weather synthetic engine oil is the only oil recommended for use in this engine, use of any API certified SM 5W-50 oil is acceptable.

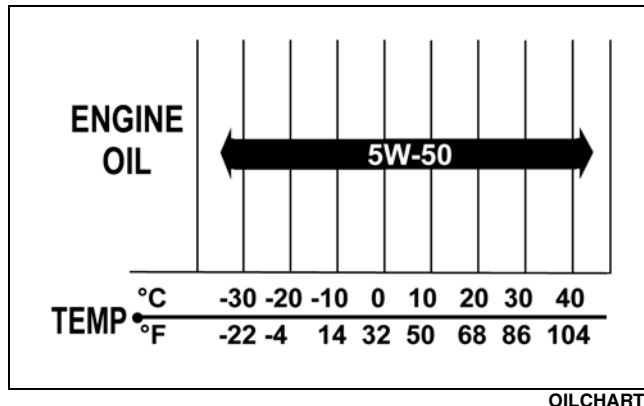

RECOMMENDED FRONT DIFFERENTIAL/REAR DRIVE LUBRICANT

The recommended lubricant is Arctic Cat Gear Lube or an equivalent gear lube which is SAE approved 80W-90 hypoid. This lubricant meets all of the lubrication requirements of the Arctic Cat ATV front differentials and rear drives.

CAUTION

Any lubricant used in place of the recommended lubricant could cause serious front differential/rear drive damage.

FILLING GAS TANK

WARNING

Always fill the gas tank in a well-ventilated area. Never add fuel to the ATV gas tank near any open flames or with the engine running. DO NOT SMOKE while filling the gas tank.

Since gasoline expands as its temperature rises, the gas tank must be filled to its rated capacity only. Expansion room must be maintained in the tank particularly if the tank is filled with cold gasoline and then moved to a warm area.

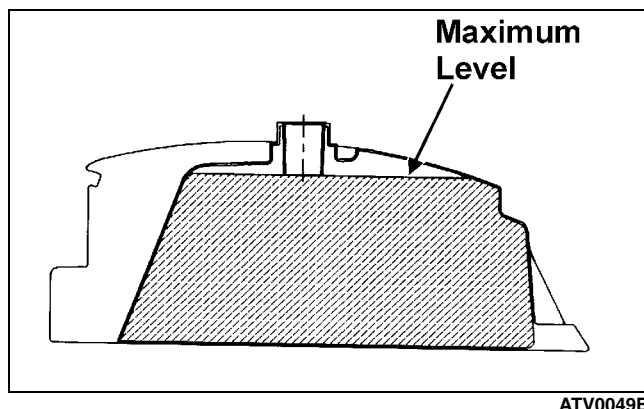

WARNING

Do not overflow gasoline when filling the gas tank. A fire hazard could materialize. Always allow the engine to cool before filling the gas tank.

Tighten the gas tank cap securely after filling the tank.

WARNING

Do not over-fill the gas tank.

Genuine Parts

When replacement of parts is necessary, use only genuine Arctic Cat ATV parts. They are precision-made to ensure high quality and correct fit. Refer to the Illustrated Parts Manual for the correct part number, quantity, and description.

Preparation For Storage

CAUTION

Prior to storing the ATV, it must be properly serviced to prevent rusting and component deterioration.

1. Clean the seat cushion (cover and base) with a damp cloth and allow it to dry.
2. Clean the ATV thoroughly by washing dirt, oil, grass, and other foreign matter from the entire ATV. Allow the ATV to dry thoroughly. DO NOT get water into any part of the engine or air intake.
3. Either drain the gas tank or add Fuel Stabilizer to the gas in the gas tank. Remove the air filter housing cover and air filter. Start the engine and allow it to idle; then using Arctic Cat Engine Storage Preserver, rapidly inject the preserver into the air filter opening for a period of 10 to 20 seconds; then stop the engine. Install the air filter and housing cover.

CAUTION

If the interior of the air filter housing is dirty, clean the area before starting the engine.

4. Plug the exhaust outlet on the muffler with a clean cloth.
5. Apply light oil to the upper steering post bushing and plungers of the shock absorbers.
6. Tighten all nuts, bolts, cap screws, and screws. Make sure rivets holding components together are tight. Replace all loose rivets. Care must be taken that all calibrated nuts, cap screws, and bolts are tightened to specifications.
7. Fill the cooling system to the bottom of the stand pipe in the radiator neck with properly mixed coolant.

8. Disconnect the battery cables; then remove the battery, clean the battery posts and cables, and store in a clean, dry area.
9. Store the ATV indoors in a level position.

CAUTION

Avoid storing outside in direct sunlight and avoid using a plastic cover as moisture will collect on the ATV causing rusting.

Preparation After Storage

Taking the ATV out of storage and correctly preparing it will assure many miles and hours of trouble-free riding.

1. Clean the ATV thoroughly.
2. Clean the engine. Remove the cloth from the muffler.
3. Check all control cables for signs of wear or fraying. Replace if necessary.
4. Change the engine/transmission oil and filter.

5. Check the coolant level and add properly mixed coolant as necessary.
6. Charge the battery; then install. Connect the battery cables.

CAUTION

The ignition switch must be in the OFF position prior to installing the battery or damage may occur to the ignition system.

CAUTION

Connect the positive battery cable first; then the negative.

6. Check the entire brake systems (fluid level, pads, etc.), all controls, lights, and headlight aim; adjust or replace as necessary.
7. Tighten all nuts, bolts, cap screws, and screws making sure all calibrated nuts, cap screws, and bolts are tightened to specifications.
8. Check tire pressure. Inflate to recommended pressure as necessary.
9. Make sure the steering moves freely and does not bind.
10. Check the spark plug. Clean or replace as necessary.

Periodic Maintenance

This section has been organized into sub-sections which show common maintenance procedures for the Arctic Cat ATV.

SPECIAL TOOLS

A number of special tools must be available to the technician when performing service procedures in this section. Refer to the current Special Tools Catalog for the appropriate tool description.

Description	p/n
Compression Tester Kit	0444-213
Oil Filter Wrench	0644-389
Tachometer	0644-275
Timing Light	0644-296
Valve Clearance Adjuster	0444-078

■NOTE: Special tools are available from the Arctic Cat Service Department.

Periodic Maintenance Chart

A = Adjust I = Inspect C = Clean L = Lubricate R = Replace T = Tighten

Item	Initial Service After Break-In (First Mo or 100 Mi)	Every Day	Every Month or 100 Miles	Every 3 Months or 300 Miles	Every 6 Months or 500 Miles	Every Year or 1500 Miles	As Needed
Battery	I		I				C
Fuses				I			R
Air Filter/Drain Tube	I	I	C*				R
Valve/Tappet Clearance	I				I		A
Engine Compression						I	
Spark Plug	I			I			R (4000 Mi or 18 Mo)
Muffler/Spark Arrester					C		R
Gas Hoses	I	I					R (2 Yrs)
Throttle Cable	I	I			C-L		A-R
Engine-Transmission Oil Level		I					A
Engine-Transmission Oil/Filter	R			R*/R**/R***			
Front Differential/Rear Drive Lubricant	I		I				R (4 Yrs)
Tires/Air Pressure	I	I					R
Steering Components	I	I		I			R
V-Belt	I				I		R
Suspension (Ball joint boots, drive axle boots front and rear, tie rods, differential and rear drive bellows)	I	I					R
Nuts/Cap Screws/Screws	I		I				A
Ignition Timing						I	
Lights	I	I					R
Switches	I	I					R
Shift Lever					I		A-L
Handlebar Grips		I					R
Handlebar	I	I					R
Gauges/Indicators	I	I					R
Frame/Welds	I				I		
Electrical Connections	I				I		C
Complete Brake System	I	I		C			L-R
Brake Pads	I			I*			R
Brake Fluid	I			I			R (2 Yrs)
Brake Hoses	I			I			R (4 Yrs)
Coolant/Coolant System	I		I				R (2 Yrs)

* Service/Inspect more frequently when operating in adverse conditions. ** When using an API certified SM 5W-50 oil.

*** When using Arctic Cat ACX All Weather synthetic oil, oil change interval can be increased to every 1,000 miles or every year.

Lubrication Points

It is advisable to lubricate certain components periodically to ensure free movement. Apply light oil to the throttle lever and brake lever pivots.

Air Filter

CLEANING AND INSPECTING FILTER

1. Loosen the clamp securing the front air inlet boot to the air filter housing; then loosen the clamp securing the rear inlet boot to the air box. Remove the inlet pipe.

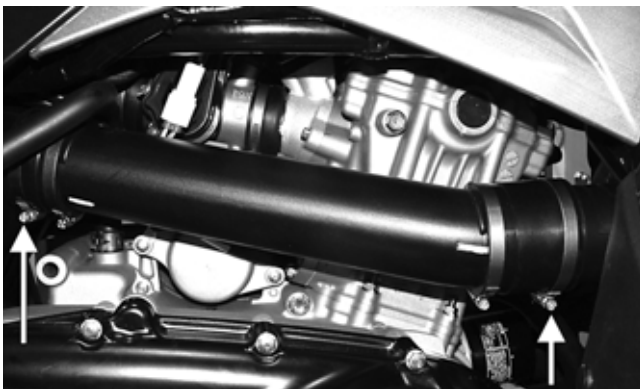

KC445A



KC446

2. Remove two reinstallable rivets from the air filter housing mounting bracket and slide the air filter housing rearward out of the mounting bracket.

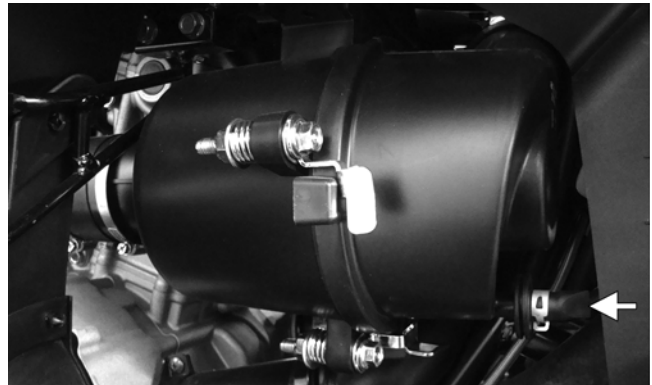

KC447A

3. Turn and release the three locking lugs on the air filter housing and separate the air filter cover from the housing; then remove the air filter element. Separate the foam element from the spring.

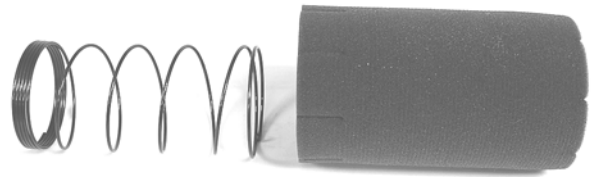

KC143

4. Fill a wash pan larger than the element with a non-flammable cleaning solvent; then dip the element in the solvent and wash it.

NOTE: Foam Air Filter Cleaner and Foam Air Filter Oil are available from Arctic Cat.

5. Dry the element.
6. Put the element in a plastic bag; then pour in air filter oil and work the oil into the element. Insert the forming spring into the element with the closely wrapped end of the spring toward the open end of the element.

CAUTION

A torn air filter element can cause damage to the ATV engine. Dirt and dust may get inside the engine if the element is torn. Carefully examine the element for tears before and after cleaning it. Replace the element with a new one if it is torn.

7. Clean any dirt or debris from inside the air filter housing.
8. Place the filter assembly in the air filter housing making sure it is properly positioned and properly seated with the filter element straight in the housing.



KC449

CAUTION

Failure to properly seat and align the filter element may cause severe engine damage.

9. Install the air filter housing cover and secure with the locking tabs.
10. Install the air filter housing assembly into the mounting bracket and secure with two reinstallable rivets.
11. Install the inlet pipe onto the air box; then connect to the air filter assembly making sure the boots are fully engaged. Tighten the clamps securely.

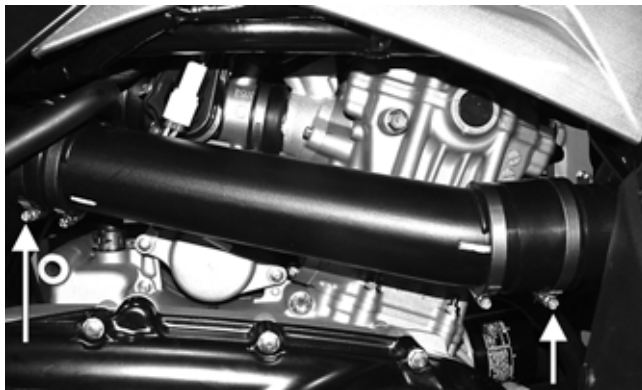

KC445A

CAUTION

Failure to fully engage the inlet boots to the indicator marks could result in ingestion of dirt and severe engine damage.

CHECKING AND CLEANING DRAIN

1. Inspect the drain on the filter housing cover and clean out any dirt or debris.

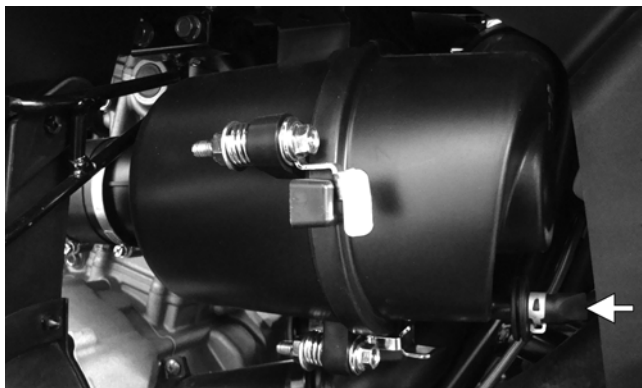

KC397B

2. Replace any drain that is cracked or shows any signs of hardening or deterioration.
3. Wipe any accumulation of oil or gas from the filter housing and drain.

Valve/Tappet Clearance

To check and adjust valve/tappet clearance, use the following procedure.

■NOTE: The seat, left-side and right-side engine covers, and gas tank must be removed for this procedure.

1. Remove the timing inspection plug and spark plug; then remove the tappet covers (for more detailed information, see Engine/Transmission - Servicing Top-Side Components).

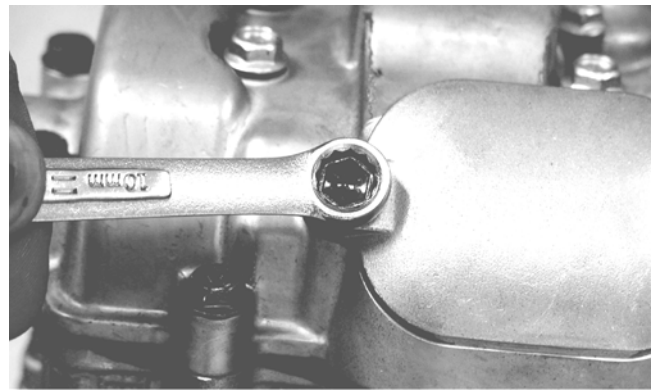

CF005

2. Rotate the crankshaft to the TDC position on the compression stroke.

■NOTE: At this point, the rocker arms and adjuster screws must not have pressure on them.

Feeler Gauge Procedure

Using a feeler gauge, check each valve/tappet clearance. If clearance is not within specifications, loosen the jam nut and rotate the tappet adjuster screw until the clearance is within specifications. Tighten each jam nut securely after completing the adjustment.

CAUTION

The feeler gauge must be positioned at the same angle as the valve and valve adjuster for an accurate measurement of clearance. Failure to measure the valve clearance accurately could cause valve component damage.

VALVE/TAPPET CLEARANCE

Intake	0.076-0.127 mm (0.003-0.005 in.)
Exhaust	0.152-0.203 mm (0.006-0.008 in.)

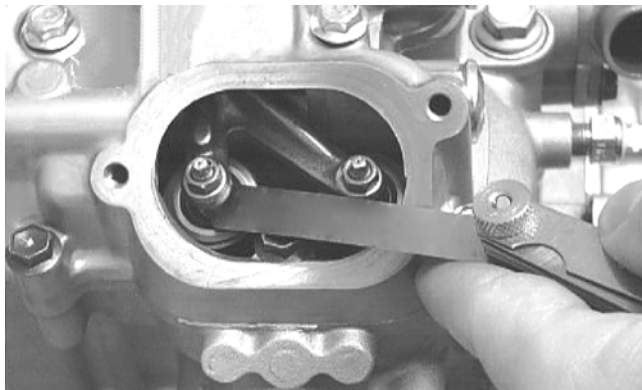

CC007DC

Valve Adjuster Procedure

- A. Place the Valve Clearance Adjuster onto the jam nut securing the tappet adjuster screw; then rotate the valve adjuster dial clockwise until the end is seated in the tappet adjuster screw.
- B. While holding the valve adjuster dial in place, use the valve adjuster handle and loosen the jam nut; then rotate the tappet adjuster screw clockwise until friction is felt.
- C. Align the valve adjuster handle with one of the marks on the valve adjuster dial.
- D. While holding the valve adjuster handle in place, rotate the valve adjuster dial counterclockwise until proper valve/tappet clearance is attained.

■NOTE: Refer to the appropriate specifications in Feeler Gauge Procedure sub-section for the proper valve/tappet clearance.

■NOTE: Rotating the valve adjuster dial counterclockwise will open the valve/tappet clearance by 0.05 mm (0.002 in.) per mark.

- E. While holding the adjuster dial at the proper clearance setting, tighten the jam nut securely with the valve adjuster handle.
3. Install the timing inspection plug.
4. Place the two tappet covers with O-rings into position; then tighten the covers securely.
5. Install the spark plug; then install the timing inspection plug.

Testing Engine Compression

To test engine compression, use the following procedure.

1. Remove the high tension lead from the spark plug.
2. Using compressed air, blow any debris from around the spark plug.

⚠ WARNING

Always wear safety glasses when using compressed air.

3. Remove the spark plug; then attach the high tension lead to the plug and ground the plug on the cylinder head well away from the spark plug hole.
4. Attach the Compression Tester Kit.

■NOTE: The engine must be warm and the battery must be fully charged for this test.

5. While holding the throttle lever in the full-open position, crank the engine over with the electric starter until the gauge shows a peak reading of 95-115 psi (five to 10 compression strokes).
6. If compression is abnormally low, inspect the following items.
 - A. Verify starter cranks engine over at normal speed (approximately 400 RPM).
 - B. Gauge functioning properly.
 - C. Throttle lever in the full-open position.
 - D. Valve/tappet clearance correct.
 - E. Valve not bent or burned.
 - F. Valve seat not burned.

■NOTE: To service valves, see Engine/Transmission.

7. Pour approximately 30 ml (1 fl oz) of oil into the spark plug hole, reattach the gauge, and retest compression.
8. If compression is now evident, service the piston rings (see Engine/Transmission).

Spark Plug

A light brown insulator indicates that a plug is correct. A white or dark insulator indicates that the engine may need to be serviced. To maintain a hot, strong spark, keep the plug free of carbon.

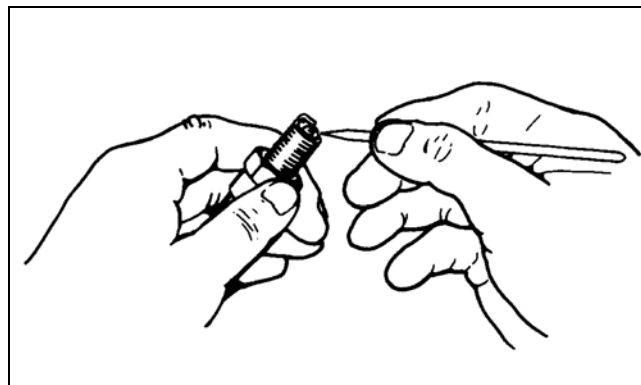

ATV-0051

CAUTION

Before removing a spark plug, be sure to clean the area around the spark plug. Dirt could enter engine when removing or installing the spark plug.

Adjust the gap to 0.7-0.8 mm (0.028-0.032 in.) for proper ignition. Use a feeler gauge to check the gap.

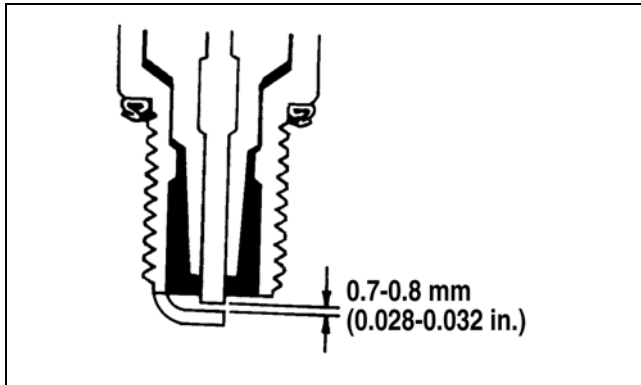

ATV0052C

When installing the spark plug, be sure to tighten it securely. A new spark plug should be tightened 1/2 turn once the washer contacts the cylinder head. A used spark plug should be tightened 1/8 - 1/4 turn once the washer contacts the cylinder head.

Liquid Cooling System

NOTE: Debris in front of the engine or packed between the cooling fins of the radiator can reduce cooling capability. Using a garden hose, wash the radiator to remove any debris preventing air flow.

CAUTION

Do not use a pressure washer to clean the radiator core. The pressure may bend or flatten the fins causing restricted air flow, and electrical components on the radiator could be damaged. Use only a garden hose with spray nozzle at normal tap pressure.

The cooling system capacity can be found in the specifications chart. The cooling system should be inspected daily for leakage and damage. If leakage or damage is detected, take the ATV to an authorized Arctic Cat ATV dealer for service. Also, the coolant level should be checked periodically.

CAUTION

Continued operation of the ATV with high engine temperature may result in engine damage or premature wear.

NOTE: High engine RPM, low vehicle speed, or heavy load can raise engine temperature. Decreasing engine RPM, reducing load, and selecting an appropriate transmission gear can lower the temperature.

When filling the cooling system, use a coolant/water mixture which will satisfy the coldest anticipated weather conditions of the area in accordance with the coolant manufacturer's recommendations. While the cooling system is being filled, air pockets may develop; therefore, run the engine for five minutes after the initial fill, shut the engine off, and then fill the cooling system to the bottom of the stand pipe in the radiator neck.

Checking/Filling

1. Locate the coolant reservoir on the right side behind the radiator.
2. Remove the cap and fill with the appropriate coolant until coolant level is between the LOW and FULL lines. Do not overfill.

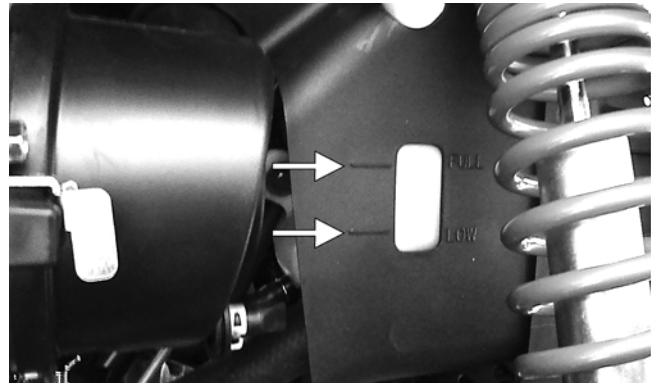

KC396A

3. Install the cap on the reservoir.

Muffler/Spark Arrester

At the intervals shown in the Periodic Maintenance Chart, clean the spark arrester using the following procedure.

WARNING

Wait until the muffler cools to avoid burns.

1. Remove the cap screws securing the spark arrester assembly to the muffler; then loosen and remove the arrester.

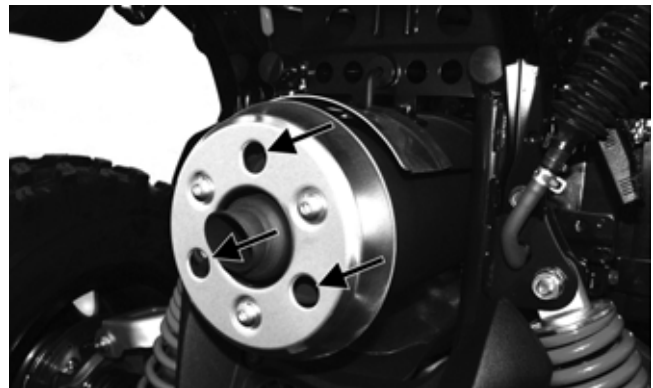

KC374A

2. Using a suitable brush, clean the carbon deposits from the screen taking care not to damage the screen.

NOTE: If the screen or gasket is damaged in any way, it must be replaced.

3. Install the spark arrester assembly with gasket; then secure with the cap screws. Tighten to 48 in.-lb.

Adjusting Throttle Cable

To adjust the throttle cable free-play, follow this procedure.

1. Slide the rubber boot away; then loosen the jam nut from the throttle cable adjuster.



AL611D

2. Turn the adjuster until the throttle cable has proper free-play of 3-6 mm (1/8-1/4 in.) at the lever.

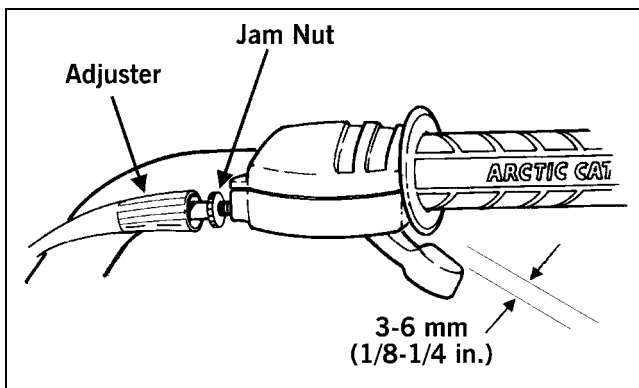

ATV-0047

3. Tighten the jam nut against the throttle cable adjuster securely; then slide the rubber boot over the adjuster.

Adjusting Engine RPM (Idle)

■NOTE: Engine idle RPM is not adjustable on this model.

Engine/Transmission Oil - Filter

The engine should always be warm when the oil is changed so the oil will drain easily and completely.

1. Park the ATV on level ground.
2. Remove the seat and left-side engine cover.

3. Remove the oil level stick/filler plug.



KC0051A

4. Remove the drain plug from the bottom of the engine and drain the oil into a drain pan.

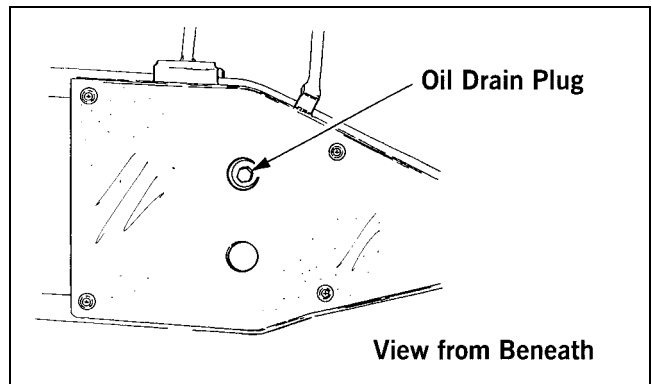

733-441A

5. Remove the oil filter plug from the filter mounting boss (located on the front side of the transmission case) and allow the filter to drain completely. Install the plug and tighten securely.

6. Using the adjustable Oil Filter Wrench and a suitable wrench, remove the old oil filter.

■NOTE: Clean up any excess oil after removing the filter.

7. Apply oil to a new filter seal ring and check to make sure it is positioned correctly; then install the new oil filter. Tighten securely.

8. Install the engine drain plug and tighten to 20 ft-lb. Pour the specified amount of the recommended oil in the filler hole. Install the oil level stick/filler plug.

CAUTION

Any oil used in place of the recommended oil could cause serious engine damage. Do not use oils which contain graphite or molybdenum additives. These oils can adversely affect clutch operation. Also, not recommended are racing, vegetable, non-detergent, and castor-based oils.

9. Start the engine (while the ATV is outside on level ground) and allow it to idle for a few minutes.

10. Turn the engine off and wait approximately one minute.

11. Remove the oil level stick and wipe it with a clean cloth.

12. Install the oil level into engine case.

■NOTE: The oil level stick should be threaded into the case for checking purposes.

- Remove the oil level stick; the engine oil level should be above the illustrated "L" mark but not higher than the illustrated "F" mark.

CAUTION

Do not over-fill the engine with oil. Always make sure that the oil level is above the "L" mark but not higher than the "F" mark.

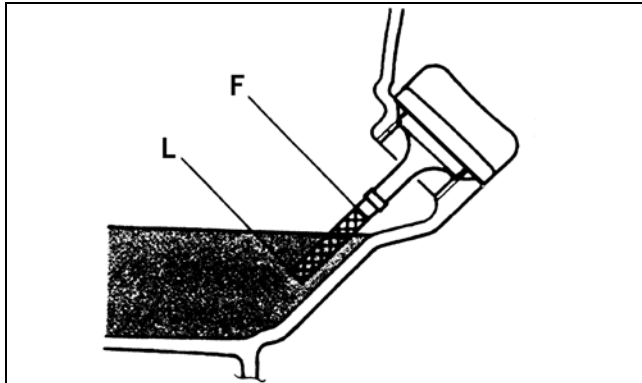

ATV-0100AA

- Inspect the area around the drain plug and oil filter for leaks.
- Install the left-side engine cover and the seat.

Front Differential/Rear Drive Lubricant

When changing the lubricant, use approved SAE 80W-90 hypoid gear lube.

To check lubricant, remove the rear drive filler plug; the lubricant level should be 1 in. below the threads of the plug. If low, add SAE approved 80W-90 hypoid gear lubricant as necessary.

To change the lubricant, use the following procedure.

- Place the ATV on level ground.
- Remove each fill plug.

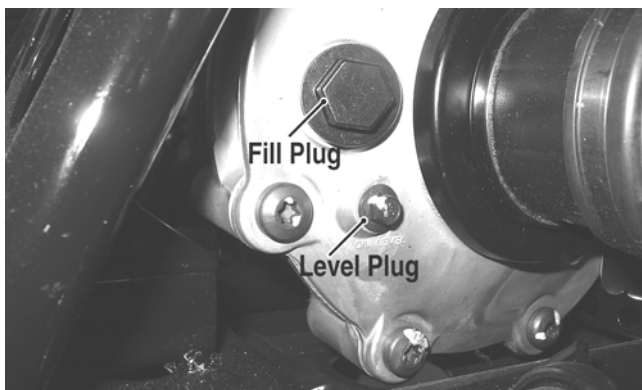

KC0077A

- Drain the lubricant into a drain pan by removing the drain plug from each.

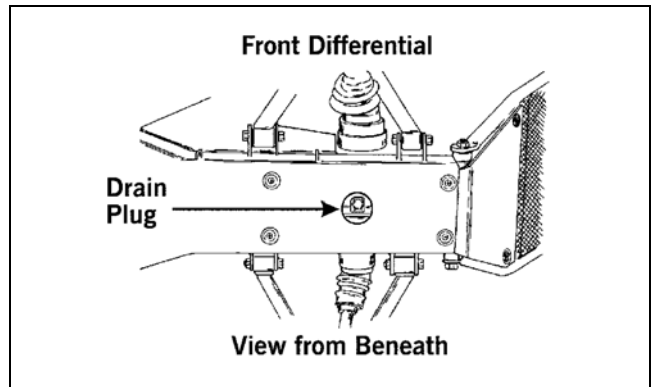

ATV0082A

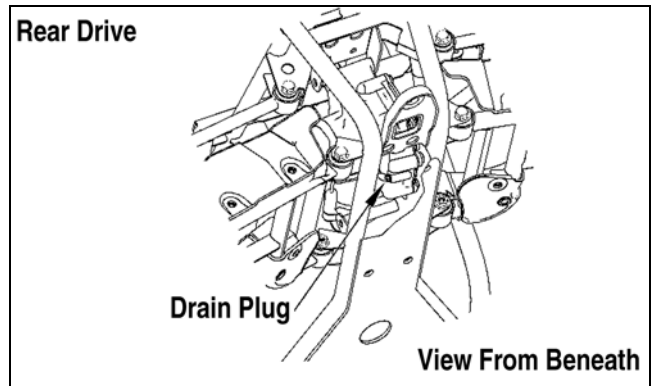

737-651B

- After all the oil has been drained, install the drain plugs and tighten to 45 in.-lb.
- Pour the appropriate amount of approved SAE 80W-90 hypoid gear lubricant into the filler hole.
- Install the fill plugs and tighten to 16 ft.-lb.

■NOTE: If the differential/rear drive oil is contaminated with water, inspect the drain plug, filler plug, and/or bladder.

CAUTION

Water entering the outer end of the axle will not be able to enter the rear drive unless the seals are damaged.

Tires

TIRE SIZES

The ATV is equipped with low-pressure tubeless tires of the size and type listed (see General Information). Do not under any circumstances substitute tires of a different type or size.

⚠ WARNING

Always use the size and type of tires specified. Always maintain proper tire inflation pressure.

TIRE INFLATION PRESSURE

Front and rear tire inflation pressure should be 40.0 kPa (5.7 psi).

Driveshaft/Coupling

The following drive system components should be inspected periodically to ensure proper operation.

- A. Spline lateral movement (slop).
- B. Coupling cracked, damaged, or worn.

Nuts/Bolts/Cap Screws

Tighten all nuts, bolts, and cap screws. Make sure rivets holding components together are tight. Replace all loose rivets. Care must be taken that all calibrated nuts, bolts, and cap screws are tightened to specifications.

Ignition Timing

The ignition timing cannot be adjusted; however, verifying ignition timing can aid in troubleshooting other components. To verify ignition timing, use the following procedure.

1. Attach the Timing Light to the spark plug high tension lead; then remove the timing inspection plug from the left-side crankcase cover.
2. Using the Tachometer, start the engine and run at 1500 RPM; ignition timing should be 10° BTDC.
3. Install the timing inspection plug.

If ignition timing cannot be verified, the rotor may be damaged, the key may be sheared, the trigger coil bracket may be bent or damaged, or the CDI unit/ECU may be faulty.

Lights

Rotate the ignition switch to the running lights position; the running lights and taillights should illuminate. Test the brakelights by compressing the brake lever. The brakelights should illuminate. Shift the Hi/Lo beam switch to the Lo position; the low beam headlights should illuminate. In the Hi position, the high beam headlights should illuminate. The running/tail lights will remain illuminated until the ignition switch is switched to the run position.

HEADLIGHTS

■**NOTE:** The bulb portion of a headlight is fragile. HANDLE WITH CARE. When replacing a headlight bulb, do not touch the glass portion of the bulb. If the glass is touched, it must be cleaned with a dry cloth before installing. Skin oil residue on the bulb will shorten the life of the bulb.

⚠ WARNING

Do not attempt to remove a bulb when it is hot. Severe burns may result.

To replace the headlight bulbs, use the following procedure.

1. Remove four screws securing the headlight access panel to the headlight housing.



KC429A

2. Remove the headlight bulb by rotating the bulb assembly and removing from the headlight housing; then spread the retaining clips and disconnect the bulb assembly from the connector.

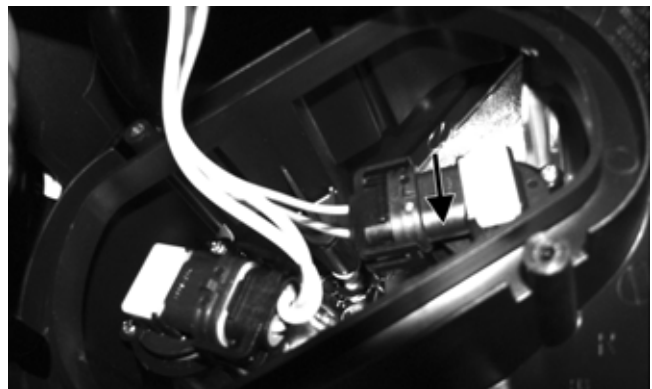

KC431A



KC432A

3. Install the new bulb assembly into the connector; then insert the bulb assembly into the housing and rotate to lock.
4. Install the access panel and secure with the screws.

TAILLIGHTS-BRAKELIGHTS

To replace a taillight-brakelight bulb, use the following procedure.

1. Remove the cap screw and screw securing the taillight housing cover to the taillight housing; then twist and remove the bulb socket.

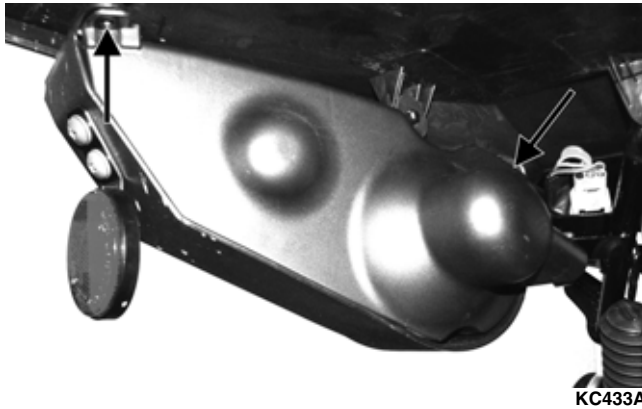

KC433A



KC428B

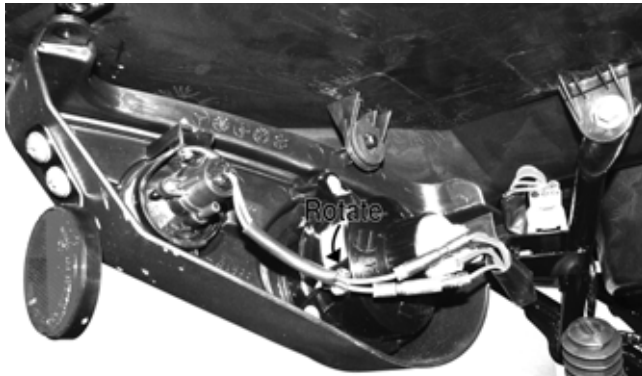

KC434A

2. Turn the bulb socket assembly counterclockwise and remove from the housing.
3. Press in and turn the bulb counterclockwise to remove. Press in and turn clockwise to install the bulb.
4. Insert the bulb socket assembly into the housing and turn it clockwise to secure.
5. Secure the housing cover with the two fasteners.

RUNNING LIGHTS

The running lights are located outboard of the headlights. To replace the running light bulbs, use the following procedure.

1. Rotate the bulb socket counterclockwise to release from light housing; then press in on the bulb and turn counterclockwise to release from the socket.



KC428A

2. Install a new bulb and press in rotating clockwise to secure; then place the socket into the light housing and turn clockwise to secure.

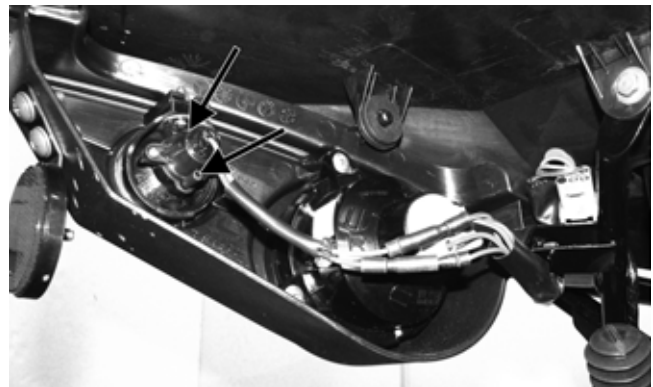

KC435A



KC436A

3. Twist the bulb counterclockwise and remove from the socket; then press in and rotate the new bulb clockwise.
4. Secure the socket to the housing making sure the gasket is in place.
5. Install the housing cover.

CHECKING/ADJUSTING HEADLIGHT AIM

The headlights can be adjusted vertically and horizontally. The geometric center of the HIGH beam light zone is to be used for vertical and horizontal aiming.

1. Position the ATV on a level floor so the headlights are approximately 6.1 m (20 ft) from an aiming surface (wall or similar aiming surface).

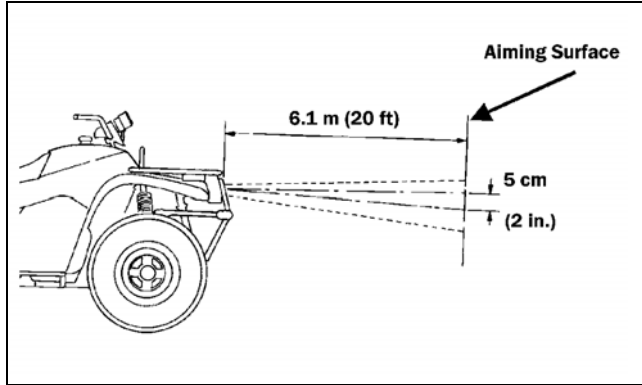

ATV-0070C

NOTE: There should be an average operating load on the ATV when adjusting the headlight aim.

2. Measure the distance from the floor to the mid-point of each headlight.
3. Using the measurements obtained in step 2, make horizontal marks on the aiming surface.
4. Make vertical marks which intersect the horizontal marks on the aiming surface directly in front of the headlights.
5. Switch on the lights. Make sure the HIGH beam is on. DO NOT USE LOW BEAM.
6. Observe each headlight beam aim. Proper aim is when the most intense beam is centered on the vertical mark 5 cm (2 in.) below the horizontal mark on the aiming surface.
7. Adjust each headlight by turning the adjuster screw clockwise to raise the beam or counterclockwise to lower the beam.

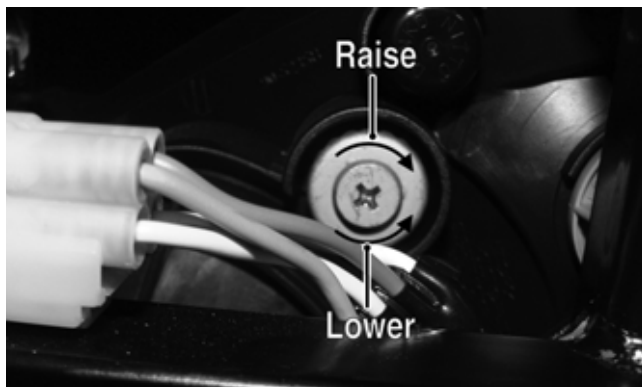

KC406A

Shift Lever

CHECKING ADJUSTMENT



KC165

With the engine stopped and the brake lever lock engaged, turn the ignition switch to the ON position; then shift the transmission into each of the gear positions and note that the gear position indicated on the LCD corresponds to the gear position selected by the lever.

If the indicator does not correspond to the selected gear, it will be necessary to test drive the ATV to determine if the gear position switch is faulty or the shift lever needs adjustment.

If the ATV functions in the gear selected by the shift lever, troubleshoot the gear position switch (see Electrical System).

If the ATV functions but the shift lever does not correspond with the gear indicated on the LCD, adjust the shift linkage. To adjust, proceed to ADJUSTING.

ADJUSTING

1. Remove the seat; then remove the left-side engine cover.
2. With the ignition switch in the ON position, loosen jam nut (A) (left-hand threads); then loosen jam nut (C) and with the shift lever in the reverse position, adjust the coupler (B) until the transmission is in reverse and the "R" icon appears on the LCD.

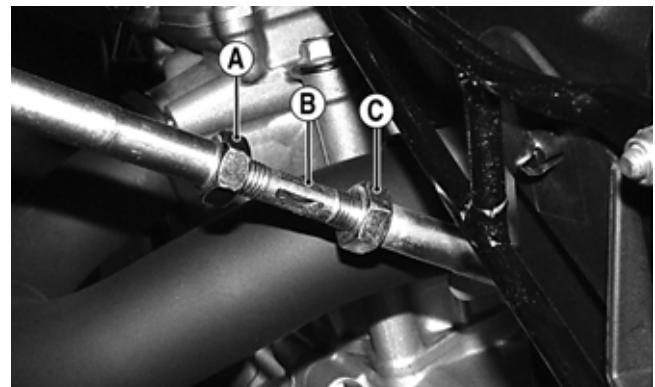

KC437A

3. Tighten the jam nuts securely; then shift the transmission to each position and verify correct adjustment.

4. Install the left-side engine cover and seat making sure the seat locks securely in place.

Frame/Welds

The frame and welds should be checked periodically for damage, bends, cracks, deterioration, broken components, and missing components. If replacement or repair constitutes removal, see Steering/Frame.

Hydraulic Brake Systems

CHECKING/BLEEDING

The hydraulic brake systems have been filled and bled at the factory. To check and/or bleed a hydraulic brake system, use the following procedure.

1. With the master cylinders in a level position, check the fluid level in the reservoirs. On the hand brakes if the level in the reservoir is adequate, the sight windows will appear dark. If the level is low, the sight windows will appear clear.



KC387A

2. Compress the brake levers/pedal several times to check for a firm brake. If the brake is not firm, the systems must be bled.
3. To bleed the brake systems, use the following procedure.
 - A. Remove the cover and fill the appropriate reservoir with DOT 4 Brake Fluid (left hand brake/foot pedal - rear system; right hand brake - front brake system).
 - B. Install and secure the cover; then slowly compress the brake lever several times.
 - C. Remove the protective cap, install one end of a clear hose onto one FRONT bleeder screw, and direct the other end into a container; then while holding slight pressure on the right brake lever, open the bleeder screw and watch for air bubbles. Close the bleeder screw before releasing the brake lever. Repeat this procedure until no air bubbles are present.



AF637D

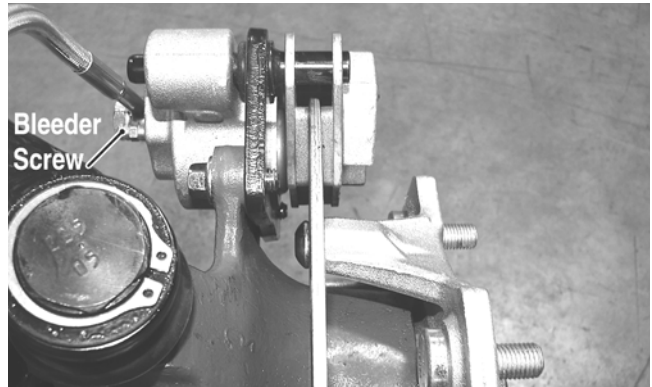

PR377C

■NOTE: During the bleeding procedure, watch the appropriate reservoir very closely to make sure there is always a sufficient amount of brake fluid. If low, refill the reservoir before the bleeding procedure is continued. Failure to maintain a sufficient amount of fluid in the reservoir will result in air in the system.

- D. Repeat step C until the brake lever is firm.
 - E. At this point, perform step B, C, and D on the other FRONT bleeder screw; then move to the REAR bleeder screw and follow the same procedure using the left brake lever or foot pedal.
4. Carefully check the entire hydraulic brake system that all hose connections are tight, the bleed screws are tight, the protective caps are installed, and no leakage is present.

CAUTION

Brake fluid that has been drained or bled from the brake system must NEVER be re-used or severe brake system corrosion and damage may occur. Always discard used brake fluid in an appropriate manner.

CAUTION

This hydraulic brake system is designed to use DOT 4 brake fluid only. If brake fluid must be added, care must be taken as brake fluid is very corrosive to painted surfaces.

INSPECTING HOSES

Carefully inspect the hydraulic brake hoses for cracks or other damage. If found, the brake hoses must be replaced.

CHECKING/REPLACING PADS

The clearance between the brake pads and brake discs is adjusted automatically as the brake pads wear. The only maintenance that is required is replacement of the brake pads when they show excessive wear. Check the thickness of each of the brake pads as follows.

1. Remove a front wheel.
2. Measure the thickness of each brake pad.
3. If thickness of either brake pad is less than 1.0 mm (0.039 in.), the brake pads must be replaced.

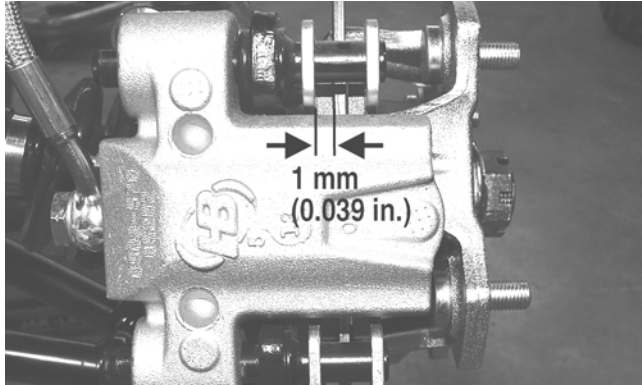

PR376B

■ **NOTE:** The brake pads should be replaced as a set.

4. To replace the brake pads, use the following procedure.
 - A. Remove the cap screws securing the caliper holder to the knuckle; then remove the pads.



PR237

- B. Install the new brake pads.
- C. Secure the caliper to the knuckle and/or axle housing with the cap screws. Tighten to 20 ft-lb.

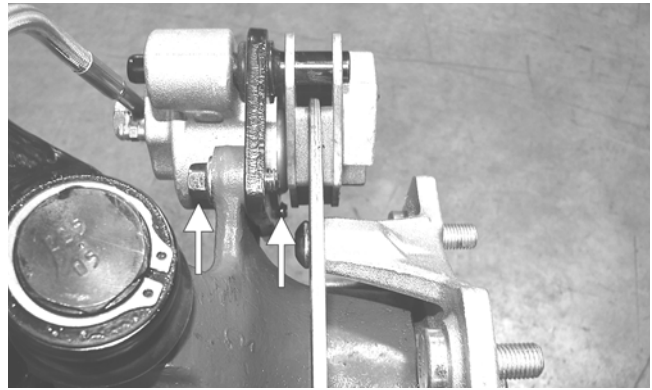

PR377B

5. Install the wheel. Tighten to 40 ft-lb.
6. Burnish the brake pads (see Burnishing Brake Pads in this section).

Burnishing Brake Pads

Brake pads must be burnished to achieve full braking effectiveness. Braking distance will be extended until brake pads are properly burnished. To properly burnish the brake pads, use the following procedure.

WARNING

Failure to properly burnish the brake pads could lead to premature brake pad wear or brake loss. Brake loss can result in severe injury.

1. Choose an area large enough to safely accelerate the ATV to 30 mph and to brake to a stop.
2. Accelerate to 30 mph; then compress brake levers or brake pedal to decelerate to 0-5 mph.
3. Repeat procedure on each brake system twenty times.
4. Verify the brakelights illuminate when the hand lever is compressed or the brake pedal is depressed.

Checking/Replacing V-Belt

REMOVING

1. Remove the cap screw securing the brake pedal to the frame. Account for a flat washer.

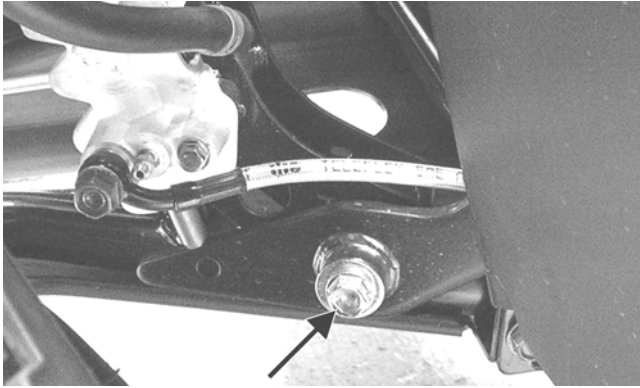

KC149A

2. Remove the cotter pin from the brake clevis pin; then slide the brake pedal away from the frame sufficiently to remove the clevis pin.

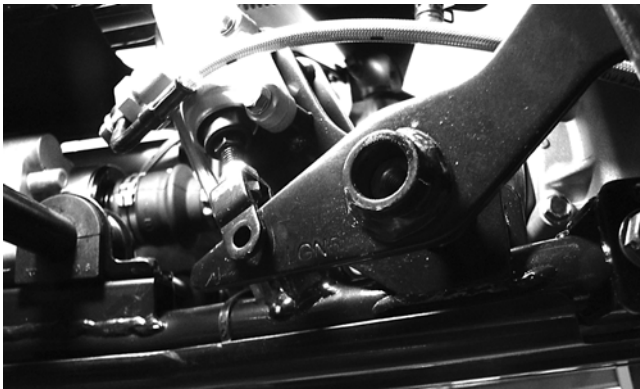

KC439

3. Lower the brake pedal down to the foot wells and remove the reinstallable rivet from the CVT cut-out in the foot well.
4. Remove the cap screws from the CVT cover and remove the cover accounting for two alignment pins.
5. Remove the nut securing the movable drive face to the clutch shaft; then remove the movable drive face assembly being careful not to let the rollers fall out. Account for a bushing.

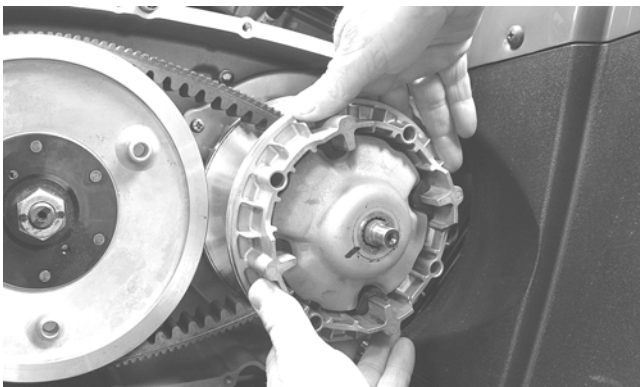

KC127

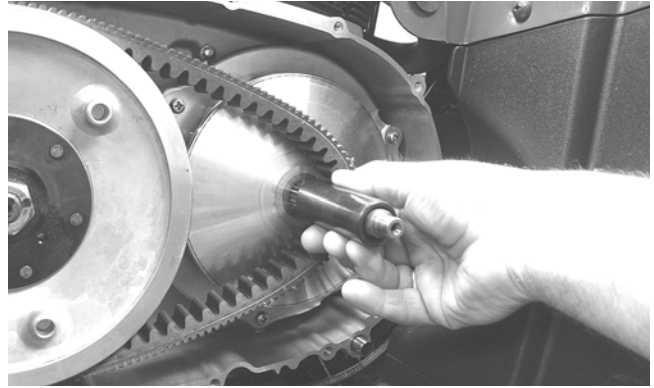

KC128

6. Thread a cap screw from the V-belt cover into the driven pulley fixed face and push the movable face open allowing the V-belt to drop down between the pulley faces approximately 3/4 in.

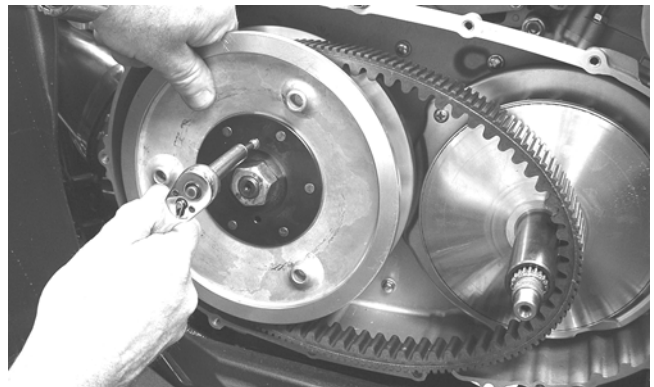

KC137

7. Pinching the V-belt together in front of the driven pulley, pull it forward and outward off the clutch shaft; then remove it from the driven pulley.

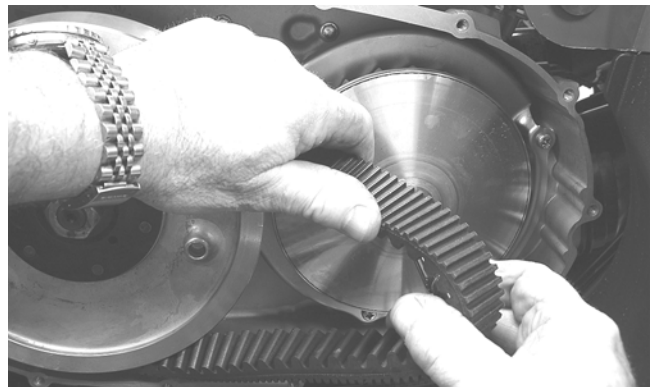

KC136

8. Inspect the faces of the drive and driven pulleys for scoring, pitting, cracks, or grooving; then clean any dirt and debris from the V-belt housing and cover.

INSTALLING

1. Place the V-belt onto the driven pulley making sure the arrows on the belt point in the direction of rotation; then pinch the belt together in front of the driven pulley and place it over the clutch shaft.

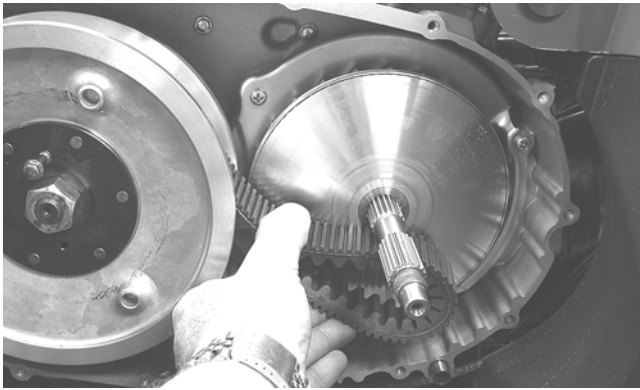

KC135

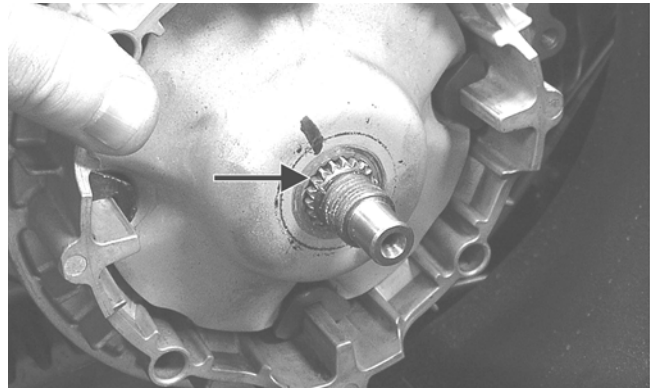

KC152A

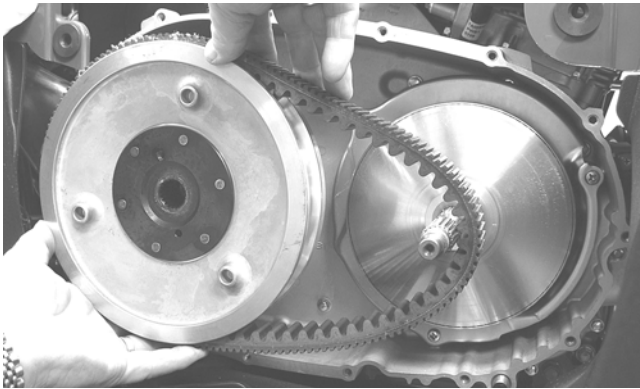

KC131

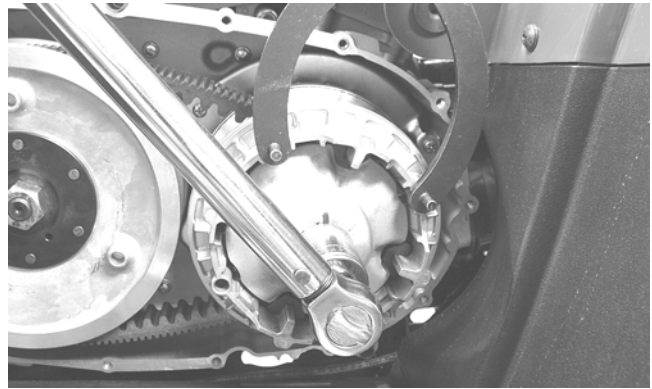

KC141

2. Install the bushing over the clutch shaft; then install the movable drive face assembly on the clutch shaft.

4. Remove the cap screw from the fixed driven face; then rotate the pulleys counterclockwise until the driven pulley faces are together.

5. With the two alignment pins installed in the V-belt housing and a new V-belt cover gasket in place, install the V-belt cover. Using the pattern shown, secure with the cap screws tightened to 8 ft-lb.

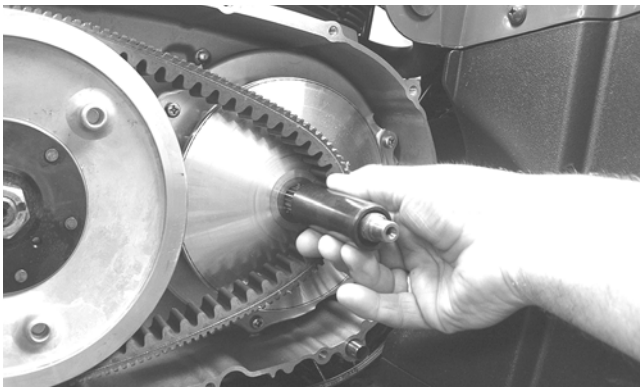

KC128

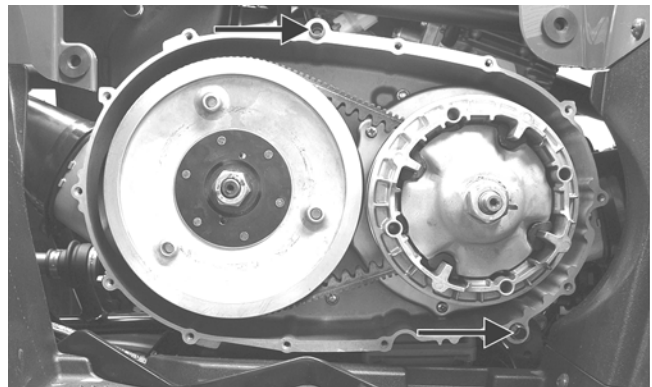

KC142A



KC138

3. With two drops of red Loctite #271 on the threads and with the splines of the clutch shaft protruding through the movable drive face, install the nut and tighten to 147 ft-lb.

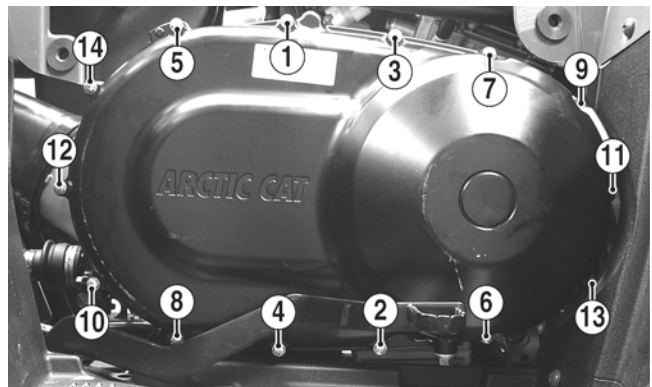

KC153A

6. Install the clevis pin connecting the brake pedal to the master cylinder and secure with a new cotter pin; then install the cap screw and flat washer securing the brake pedal to the frame and tighten to 20 ft-lb.



KC438A

Engine/Transmission

This section has been organized into sub-sections which show a progression for the complete servicing of the Arctic Cat ATV engine/transmission.

To service the center crankcase halves, the engine/transmission must be removed from the frame. To service top-side, left-side, and right-side components, the engine/transmission does not have to be removed from the frame.

■**NOTE: Use new gaskets, lock nuts, and seals and lubricate all internal components when servicing the engine/transmission.**

SPECIAL TOOLS

A number of special tools must be available to the technician when performing service procedures in this section. Refer to the current Special Tools Catalog for the appropriate tool description.

Description	p/n
Crankcase Separator/Crankshaft Remover	0444-152
Magneto Rotor Remover Set	0444-254
Oil Filter Wrench	0644-389
Piston Pin Puller	0644-328
Spanner Wrench	0444-251
Surface Plate	0644-016
V Blocks	0644-535

■**NOTE: Special tools are available from the Arctic Cat Service Department.**

Specifications

CYLINDER, PISTON, AND RINGS		
Piston Skirt/Cylinder Clearance		0.025-0.055 mm
Piston Diameter 8 mm from Skirt End		88.96-89.01 mm
Piston Ring Free End Gap (min)	(1st) (2nd)	8.0 mm 8.3 mm
Bore x Stroke		89.0 x 71.2 mm
Cylinder Trueness	(max)	0.01 mm
Piston Ring End Gap - Installed	(min)	0.15 mm
Piston Ring to Groove Clearance (max)	(1st/2nd)	0.06 mm
Piston Ring Groove Width	(1st) (2nd) (oil)	1.01-1.03 mm 1.21-1.23 mm 2.01-2.03 mm
Piston Ring Thickness	(1st/2nd)	1.97-1.99 mm
Piston Pin Bore	(max)	20.20 mm
Piston Pin	(min)	19.994 mm
VALVES AND GUIDES		
Valve Face Diameter	(intake) (exhaust)	35.0 mm 30.5 mm
Valve/Tappet Clearance (cold engine)	(intake) (exhaust)	0.10 mm 0.17 mm
Valve Guide/Stem Clearance (max)	(intake) (exhaust)	0.1 mm 0.3 mm
Valve Guide Inside Diameter		5.000-5.012 mm
Valve Stem Outside Diameter	(intake) (exhaust)	4.975-4.990 mm 4.955-4.970 mm
Valve Stem Runout	(max)	0.10 mm
Valve Margin (min)	(intake)	1.1 mm
Valve Face/Seat Width (min)	(intake)	0.99 mm
Valve Seat Angle	(intake/exhaust)	45°-75°
Valve Face Radial Runout	(max)	0.15 mm
Valve Spring Free Length	(min)	44.73 mm
Valve Spring Tension @ 32.5 mm	(outer)	17.23 kg (37.98 lb)
CAMSHAFT AND CYLINDER HEAD		
Cam Lobe Height (min)	(intake) (exhaust)	34.71 mm 34.48 mm
Camshaft Journal/Cylinder Head Clearance(max)		0.074 mm
Camshaft Journal Holder Inside Diameter	(right & center) (left)	22.01-22.04 mm 17.51-17.54 mm
Camshaft Journal Outside Diameter	(center) (left) (right)	21.959-21.980 mm 17.466-17.480 mm 21.966- 21.980 mm
Camshaft Runout	(max)	0.03 mm
Rocker Arm Inside Diameter		10.00-10.15 mm
Rocker Arm Shaft Outside Diameter		9.972-9.987 mm
Cylinder Head/Cover Distortion	(max)	0.05 mm
CRANKSHAFT		
Connecting Rod (small end)	(max)	20.021 mm
Connecting Rod (big end side-to-side)	(max)	0.7 mm
Connecting Rod (big end width)		21.95-22.00 mm
Connecting Rod (small end deflection)	(max)	0.15 mm
Crankshaft (web-to-web)		60.9 mm
Crankshaft Runout	(max)	0.03 mm

Specifications subject to change without notice.

Troubleshooting

Problem: Engine will not start or is hard to start (Compression too low)	
Condition	Remedy
<ol style="list-style-type: none"> 1. Valve clearance out of adjustment 2. Valve guides worn 3. Valves timing incorrect 4. Piston rings worn excessively 5. Cylinder bore worn 6. Starter motor cranks too slowly - does not turn 	<ol style="list-style-type: none"> 1. Adjust clearance 2. Replace cylinder head 3. Correct valve timing - check chain, sprockets, and cam chain tensioner 4. Replace rings 5. Replace cylinder 6. Check - replace starter motor
Problem: Engine will not start or is hard to start (No spark)	
Condition	Remedy
<ol style="list-style-type: none"> 1. Spark plug fouled 2. Spark plug wet 3. Crankshaft position sensor defective 4. ECU defective 5. Ignition coil defective 6. High-tension lead open - shorted 	<ol style="list-style-type: none"> 1. Clean - replace plug 2. Clean - dry plug 3. Replace stator assembly 4. Replace ECU 5. Replace ignition coil 6. Replace high tension lead
Problem: Engine will not start or is hard to start (No fuel reaching the throttle body)	
Condition	Remedy
<ol style="list-style-type: none"> 1. Fuel hose obstructed 2. Fuel screens obstructed 3. Fuel pump/relay defective 4. Fuel injector defective 	<ol style="list-style-type: none"> 1. Clean - replace hose 2. Clean - replace inlet screen - valve screen 3. Replace fuel pump/relay 4. Replace fuel injector
Problem: Engine stalls easily	
Condition	Remedy
<ol style="list-style-type: none"> 1. Spark plug fouled 2. Crank angle sensor defective 3. ECU defective 4. Valve clearance out of adjustment 	<ol style="list-style-type: none"> 1. Clean plug 2. Replace stator assembly 3. Replace ECU 4. Adjust clearance
Problem: Engine noisy (Excessive valve chatter)	
Condition	Remedy
<ol style="list-style-type: none"> 1. Valve clearance excessive 2. Valve spring(s) weak - broken 3. Rocker arm - rocker arm shaft worn 4. Camshaft worn 5. Valve tappets worn 	<ol style="list-style-type: none"> 1. Adjust clearance 2. Replace spring(s) 3. Replace arm - shaft 4. Replace camshaft 5. Replace tappets
Problem: Engine noisy (Noise seems to come from piston)	
Condition	Remedy
<ol style="list-style-type: none"> 1. Piston - cylinder worn 2. Combustion chamber carbon buildup 3. Piston pin bore worn 4. Piston pin worn 5. Piston rings - ring groove(s) worn 	<ol style="list-style-type: none"> 1. Replace - service piston - cylinder 2. Clean chamber 3. Replace piston 4. Replace piston pin 5. Replace rings - piston
Problem: Engine noisy (Noise seems to come from timing chain)	
Condition	Remedy
<ol style="list-style-type: none"> 1. Chain stretched 2. Sprockets worn 3. Tension adjuster malfunctioning 	<ol style="list-style-type: none"> 1. Replace chain 2. Replace sprockets 3. Repair - replace adjuster
Problem: Engine noisy (Noise seems to come from crankshaft)	
Condition	Remedy
<ol style="list-style-type: none"> 1. Bearing worn - burned 2. Lower rod-end bearing worn - burned 3. Connecting rod side clearance too large 	<ol style="list-style-type: none"> 1. Replace bearing 2. Replace crankshaft 3. Replace crankshaft

Problem: Engine noisy (Noise seems to come from transmission)	
Condition	Remedy
<ol style="list-style-type: none"> 1. Gears worn - rubbing 2. Splines worn 3. Primary gears worn - rubbing 4. Bearings worn 5. Bushing worn 	<ol style="list-style-type: none"> 1. Replace gears 2. Replace shaft(s) 3. Replace gears 4. Replace bearings 5. Replace bushing
Problem: Engine noisy (Noise seems to come from secondary bevel gear and final driven shaft)	
Condition	Remedy
<ol style="list-style-type: none"> 1. Drive - driven bevel gears damaged - worn 2. Backlash excessive 3. Tooth contact improper 4. Bearing damaged 5. Gears worn - rubbing 6. Splines worn 7. Final driven shaft thrust clearance too large 	<ol style="list-style-type: none"> 1. Replace gears 2. Adjust backlash 3. Adjust contact 4. Replace bearing 5. Replace gears 6. Replace shaft(s) 7. Replace thrust washer(s)
Problem: Engine idles poorly	
Condition	Remedy
<ol style="list-style-type: none"> 1. Valve clearance out of adjustment 2. Valve seating poor 3. Valve guides defective 4. Rocker arms - arm shaft worn 5. Crankshaft position sensor defective 6. ECU defective 7. Spark plug fouled - gap too wide 8. Ignition coil defective 9. Idle Step Control (ISC) malfunction 	<ol style="list-style-type: none"> 1. Adjust clearance 2. Replace - cylinder head - valves 3. Replace cylinder head 4. Replace arms - shafts 5. Replace stator assembly 6. Replace ECU 7. Adjust gap - replace plug 8. Replace ignition coil 9. Replace ISC
Problem: Engine runs poorly at high speed	
Condition	Remedy
<ol style="list-style-type: none"> 1. High RPM "cut out" against RPM limiter 2. Valve springs weak 3. Valve timing incorrect 4. Cam - rocker arms - tappets worn 5. Spark plug gap too narrow 6. Ignition coil defective 7. Air cleaner element obstructed 8. Fuel hose obstructed 9. Fuel pump defective 	<ol style="list-style-type: none"> 1. Shift into higher gear - decrease speed 2. Replace springs 3. Correct timing - check chain, sprockets, and cam chain tensioner 4. Replace cam - arms - tappets 5. Adjust gap 6. Replace ignition coil 7. Clean element 8. Clean or replace hose 9. Replace fuel pump
Problem: Exhaust smoke dirty or heavy	
Condition	Remedy
<ol style="list-style-type: none"> 1. Oil (in the engine) overfilled - contaminated 2. Piston rings - cylinder worn 3. Valve guides worn 4. Cylinder wall scored - scuffed 5. Valve stems worn 6. Stem seals defective 	<ol style="list-style-type: none"> 1. Drain excess oil - replace oil 2. Replace - service rings - cylinder 3. Replace cylinder head 4. Replace - service cylinder 5. Replace valves 6. Replace seals

Problem: Engine lacks power	
Condition	Remedy
<ol style="list-style-type: none"> 1. Valve clearance incorrect 2. Valve springs weak 3. Valve timing incorrect 4. Piston ring(s) - cylinder worn 5. Valve seating poor 6. Spark plug fouled 7. Rocker arms - shafts worn 8. Spark plug gap incorrect 9. Air cleaner element obstructed 10. Oil (in the engine) overfilled - contaminated 11. Intake manifold leaking air 12. Cam chain worn 	<ol style="list-style-type: none"> 1. Adjust clearance 2. Replace springs 3. Re-time valve gear 4. Replace - service rings - cylinder 5. Replace cylinder head/valves 6. Clean - replace plug 7. Replace arms - shafts 8. Adjust gap - replace plug 9. Clean element 10. Drain excess oil - change oil 11. Tighten - replace manifold 12. Replace cam chain
Problem: Engine overheats	
Condition	Remedy
<ol style="list-style-type: none"> 1. Carbon deposit (piston crown) excessive 2. Oil low 3. Octane low - gasoline poor 4. Oil pump defective 5. Oil circuit obstructed 6. Intake manifold leaking air 7. Fan malfunctioning 8. Fan switch malfunctioning 9. Radiator fins obstructed 10. Coolant level low 11. Thermostat sticking 	<ol style="list-style-type: none"> 1. Clean piston 2. Add oil 3. Drain - replace gasoline 4. Replace pump 5. Clean circuit 6. Tighten - replace manifold 7. Check fan fuse - replace fan 8. Replace fan switch 9. Clean radiator 10. Add coolant 11. Replace thermostat

Removing Engine/ Transmission

Many service procedures can be performed without removing the engine/transmission from the frame. Closely observe the note introducing each sub-section for this important information.

AT THIS POINT

If the technician's objective is to service Top-Side Components, Left-Side Components, or Right-Side Components, the engine/transmission does not have to be removed from the frame.

AT THIS POINT

If the technician's objective is to service/replace magneto cover oil seals or the oil strainer (from beneath the engine/transmission), the engine/transmission does not have to be removed from the frame.

Secure the ATV on a support stand to elevate the wheels.

WARNING

Make sure the ATV is solidly supported on the support stand to avoid injury.

1. Remove the battery case access cover and disconnect the negative battery cable; then remove the seat.
2. Remove three cap screws, two machine screws with nuts, and two reinstallable rivets from the left footwell. Remove the footwell.

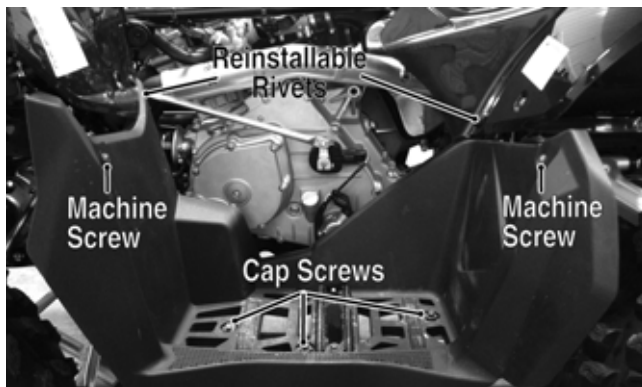

KC460A

3. Install short lengths of hose or other protective device over the support rods to prevent personal injury.

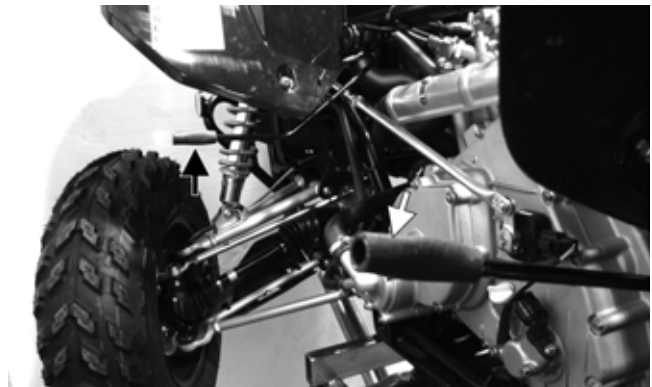

KC464A

4. Remove the water pump splash guard; then drain the coolant into a suitable container.

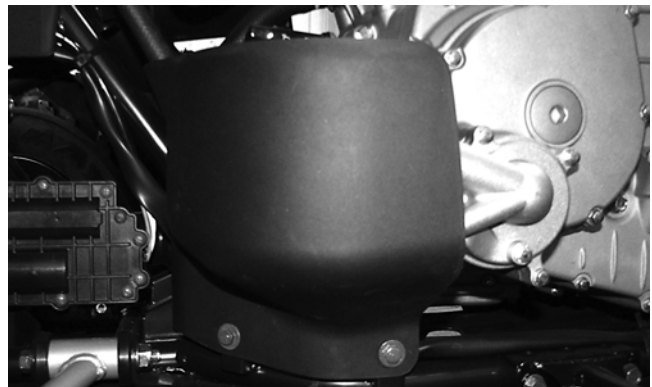

KC463

5. From the left side, remove the gear position switch connector (A) and the speed sensor connector (B).

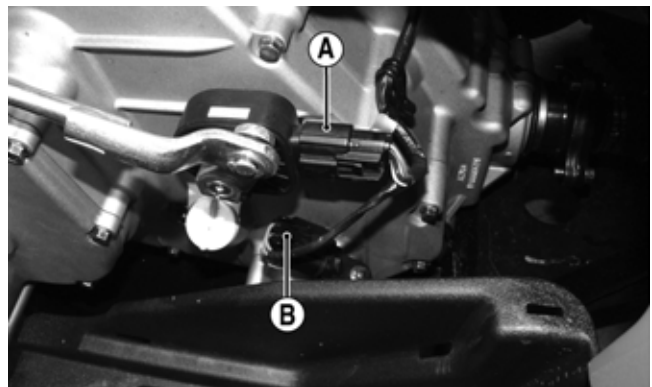

FI525A

6. Drain the engine oil into a suitable container.
7. Remove the gas tank (see Fuel/Lubrication/Cooling).
8. Remove the air inlet and outlet ducts from the CVT housing.
9. Remove the cap screws securing the exhaust pipe to the cylinder head; then remove the springs securing the muffler to the exhaust pipe.
10. Remove the muffler and exhaust pipe. Account for a grafoil seal on each end of the exhaust pipe.
11. Loosen the clamp securing the air box to the front air inlet duct.

12. Disconnect the crankcase breather hose from the air box; then loosen the clamp securing the air box boot to the throttle body and remove the air box.

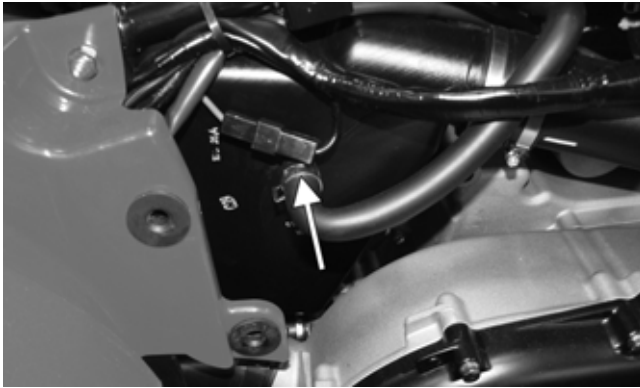

FI692A

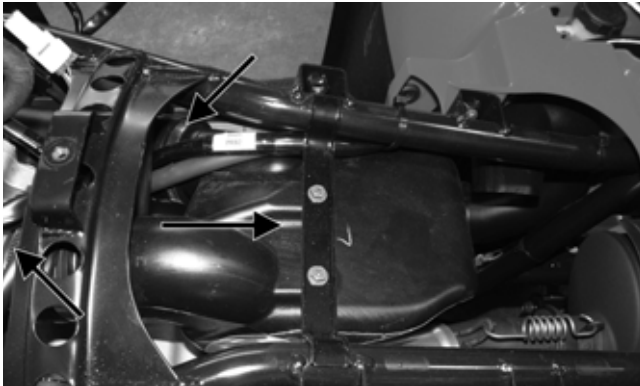

FI691A

13. Loosen the clamp securing the throttle body to the intake pipe and remove the throttle body. Secure the throttle body assembly clear of the work area.



FI695A

14. From the top side, remove the engine coolant temperature (ECT) sensor connector (C), fuel injector connector (D), manifold absolute pressure (MAP) sensor connector (E), idle step control (ISC) connector (F), and throttle position sensor (TPS) connector (G).

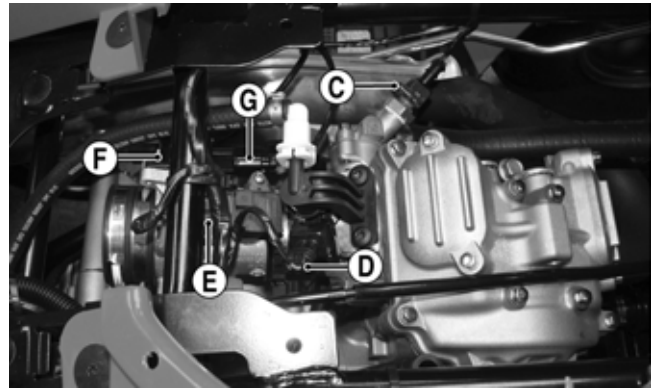

FI522A

15. From the right side, disconnect the stator connector (H) and crankshaft position sensor connector (I) from the main harness; then disconnect the positive cable from the starter motor and the engine ground cable from the starter mounting flange.

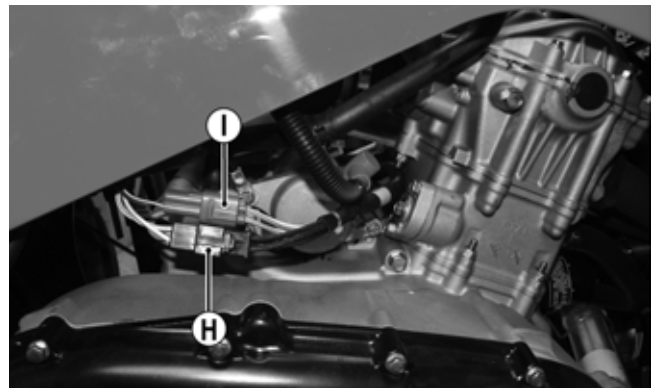

FI523A

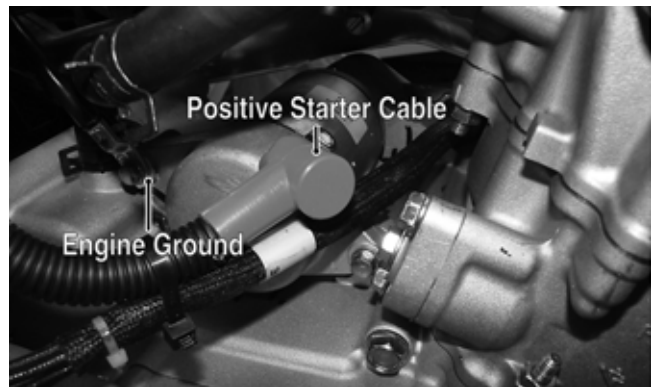

FI533A

16. Remove the spark plug cap from the spark plug and secure the wire away from the work area.
17. Remove coolant hoses (A) and (B) from the water pump; then remove the upper coolant hose from the thermostat housing.

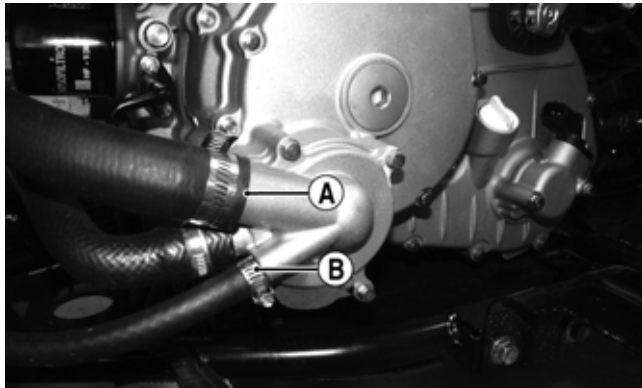

F1530B

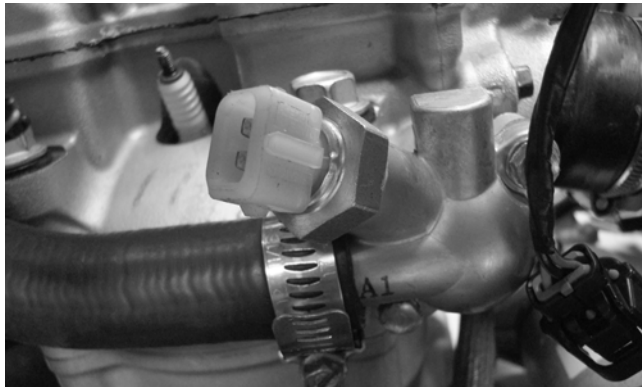

F1537

18. Remove the four cap screws securing the rear driveline to the output drive flange.
19. Support the engine and remove the two through-bolts securing the engine assembly to the frame; then move the engine rearward sufficiently to disengage the front driveline and remove the engine from the left side.

Top-Side Components

■NOTE: For efficiency, it is preferable to remove and disassemble only those components which need to be addressed and to service only those components. The technician should use discretion and sound judgment.

AT THIS POINT

To service any one specific component, only limited disassembly of components may be necessary. Note the AT THIS POINT information in each sub-section.

■NOTE: The engine/transmission does not have to be removed from the frame for this procedure.

Removing Top-Side Components

A. Cylinder Head Cover/ Rocker Arms

B. Cylinder Head/Camshaft

■NOTE: Remove the spark plug, timing inspection plug, and outer magneto cover; then using an appropriate wrench, rotate the crankshaft to top-dead-center of the compression stroke.

1. Remove the cap screws securing the two tappet covers. Remove the two tappet covers. Account for the O-rings.

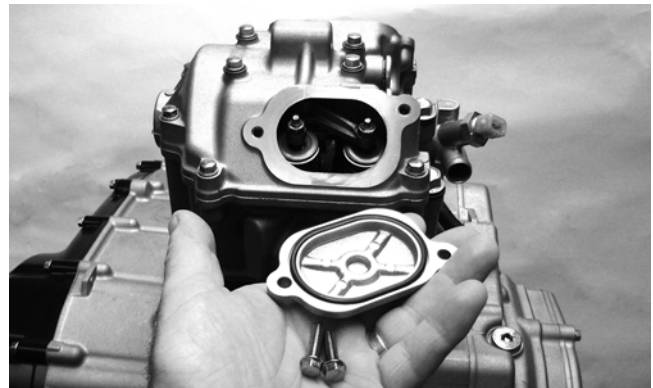

F1603

■NOTE: Keep the mounting hardware with the covers for assembly purposes.

2. Remove the cylinder head cover cap screws. Note the rubber washers on the four top-side cap screws; remove the cylinder head cover. Note the orientation of the cylinder head plug and remove it. Note the location of the two alignment pins.

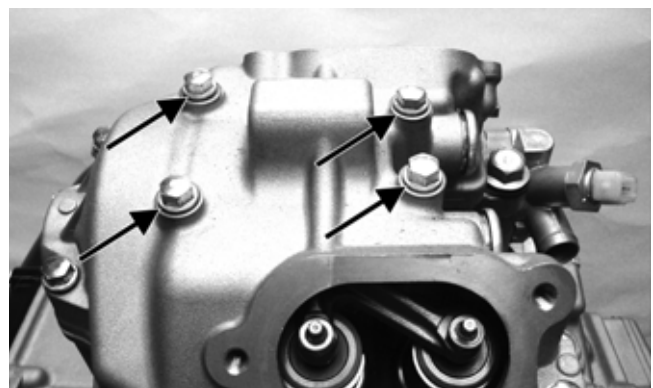

F1606A

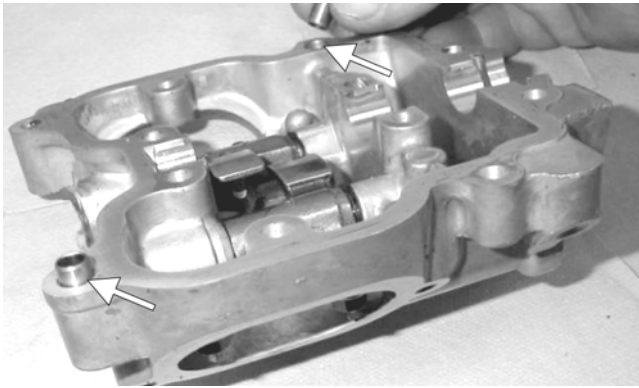

MD1354A

3. Remove the cap screw from the tension adjuster; then using a common screwdriver, relax the cam chain tension by rotating the adjuster screw clockwise until it locks.

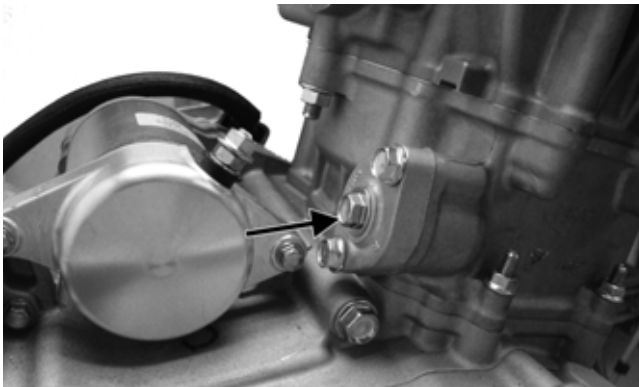

FI607A

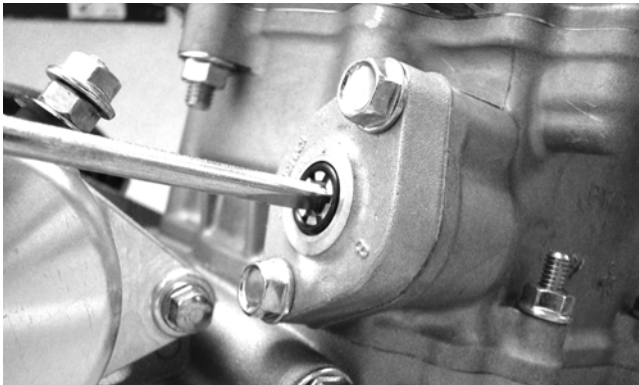

FI608

4. Bend the washer tabs and remove the two cap screws securing the sprocket to the camshaft.



FI612

5. Using an awl, rotate the C-ring in its groove until it is out of the cylinder head; then remove the C-ring.

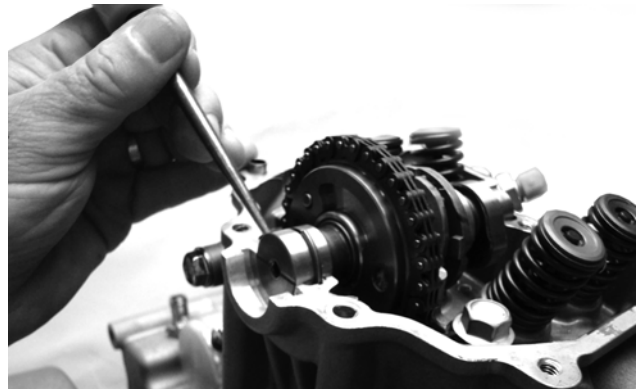

FI613

■NOTE: Care should be taken not to drop the C-ring down into the crankcase.

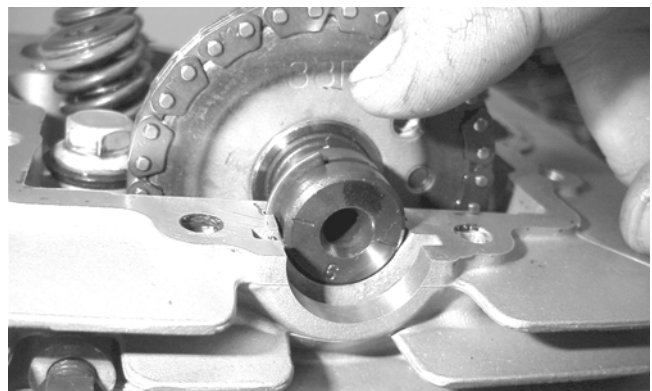

MD1131

6. Noting the timing marks for installing purposes, drop the sprocket off the camshaft. While holding the cam chain, slide the sprocket and camshaft out of the cylinder head. Account for an alignment pin.

■NOTE: Loop the chain over the cylinder and secure it to keep it from falling into the crankcase.



FI620



FI617A

7. Remove the cam chain tensioner pivot bolt and remove the chain tensioner; then remove the two nuts securing the cylinder head to the cylinder.

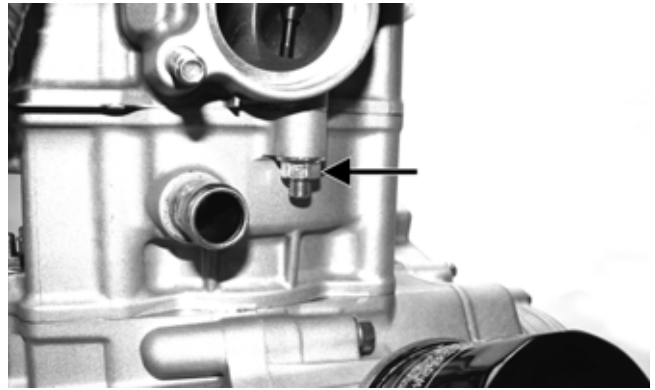

FI619A

8. Remove the four cylinder head cap screws and washers. Note that the two cap screws on the right side of the cylinder head nearest the cam sprocket are longer than the two cap screws on the left (spark plug) side.

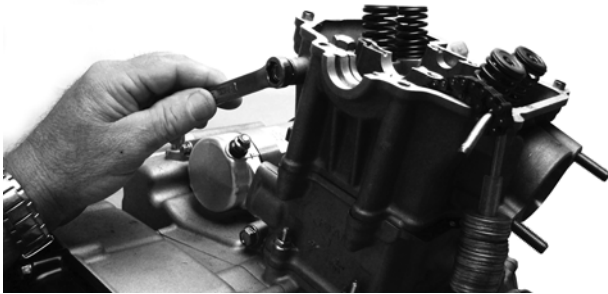

FI616

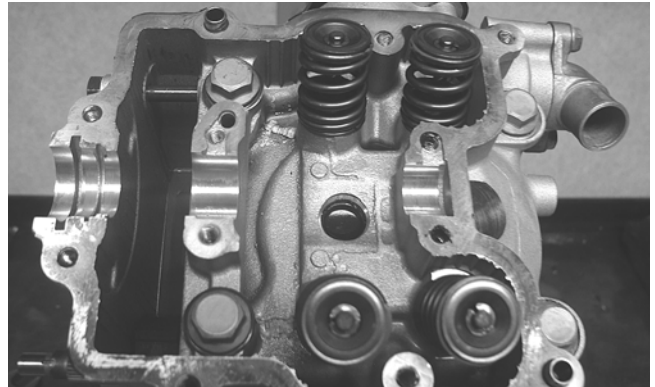

CD211

9. Remove the cylinder head from the cylinder, remove the gasket, and account for two alignment pins.

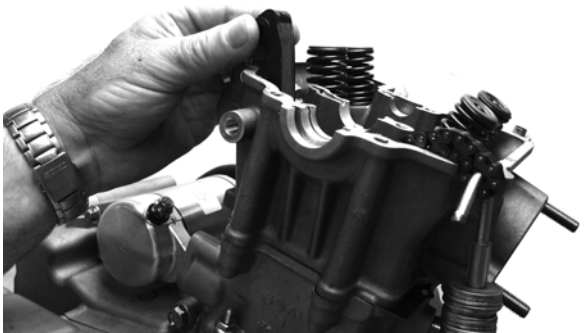

FI617



FI623A

AT THIS POINT

To service valves and cylinder head, see Servicing Top-Side Components sub-section.

10. Remove the cam chain guide.

AT THIS POINT

To inspect cam chain guide, see Servicing Top-Side Components sub-section.

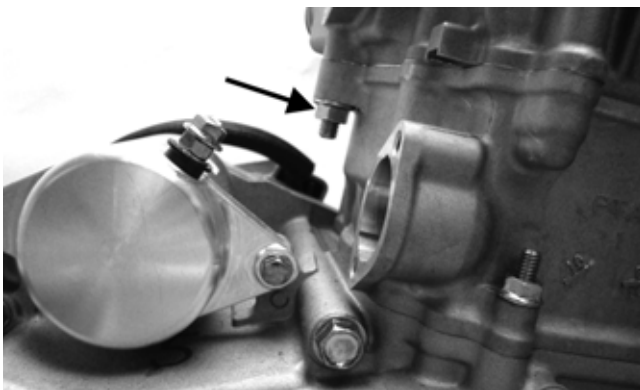

FI618A



F1621

C. Cylinder
D. Piston

■NOTE: Steps 1-10 in the preceding sub-section must precede this procedure.

11. Remove the two nuts securing the right side of the cylinder to the right-side crankcase half.

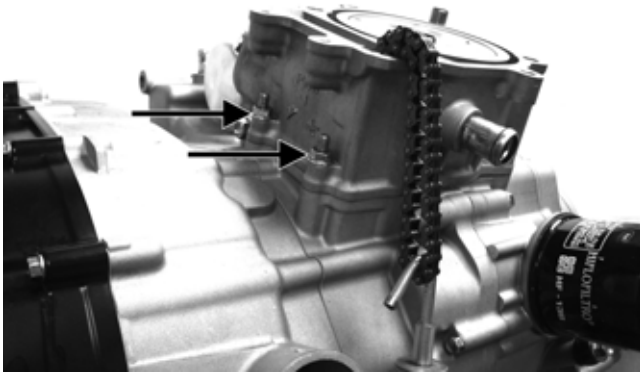

F1622A

12. Lift the cylinder off the crankcase taking care not to allow the piston to drop against the crankcase. Account for the gasket and two alignment pins.

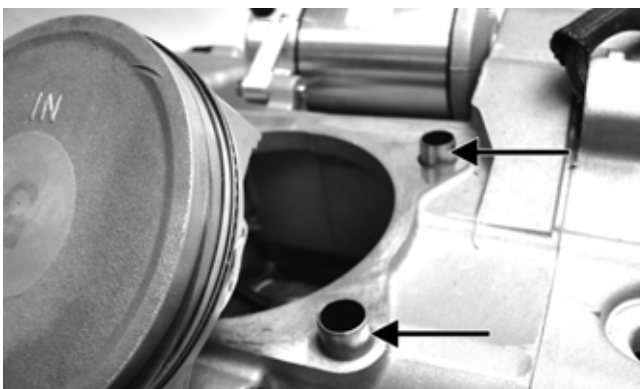

F1624A

AT THIS POINT

To service cylinder, see Servicing Top-Side Components sub-section.

CAUTION

When removing the cylinder, be sure to support the piston to prevent damage to the crankcase and piston.

13. Using an awl, remove one piston-pin circlip. Take care not to drop it into the crankcase.

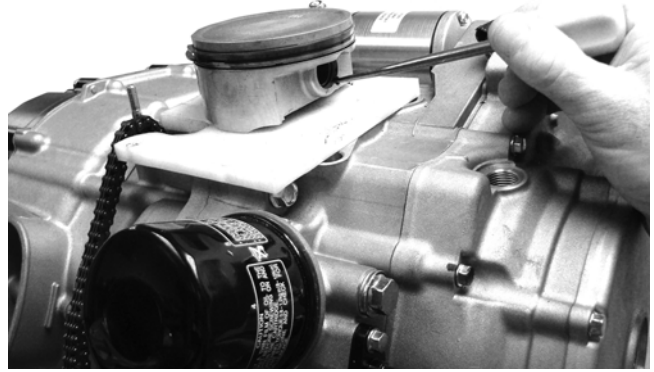

F1625

14. Using Piston Pin Puller, remove the piston pin. Account for the opposite-side circlip. Remove the piston.

■NOTE: It is advisable to remove the opposite-side circlip prior to using the puller.

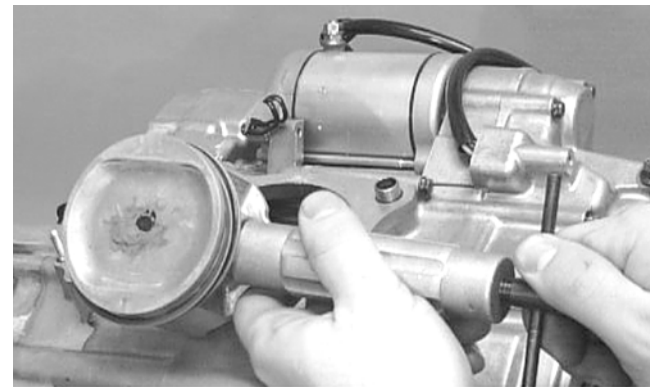

MD1219

■NOTE: Support the connecting rod with rubber bands to avoid damaging the rod or install a connecting rod holder.

CAUTION

Do not allow the connecting rod to go down inside the crankcase. If the rod is down inside the crankcase and the crankshaft is rotated, severe damage will result.

AT THIS POINT

To service piston, see Servicing Top-Side Components sub-section.

AT THIS POINT

To service center crankcase components only, proceed to Removing Left-Side Components.

Servicing Top-Side Components

■NOTE: Whenever a part is worn excessively, cracked, or damaged in any way, replacement is necessary.

VALVE ASSEMBLY

When servicing valve assembly, inspect valve seats, valve stems, valve faces, and valve stem ends for pits, burn marks, or other signs of abnormal wear.

■NOTE: Whenever a valve is out of tolerance, it must be replaced.

Cleaning/Inspecting Cylinder Head Cover

■NOTE: If the cylinder head cover cannot be trued, the cylinder head assembly must be replaced.

1. Wash the cylinder head cover in parts-cleaning solvent.
2. Place the cylinder head cover on the Surface Plate covered with #400 grit wet-or-dry sandpaper. Using light pressure, move the cylinder head cover in a figure eight motion. Inspect the sealing surface for any indication of high spots. A high spot can be noted by a bright metallic finish. Correct any high spots before assembly by continuing to move the cylinder head cover in a figure eight motion until a uniform bright metallic finish is attained.

CAUTION

Do not remove an excessive amount of the sealing surface or damage to the camshaft will result. Always check camshaft clearance when resurfacing the cylinder head cover.

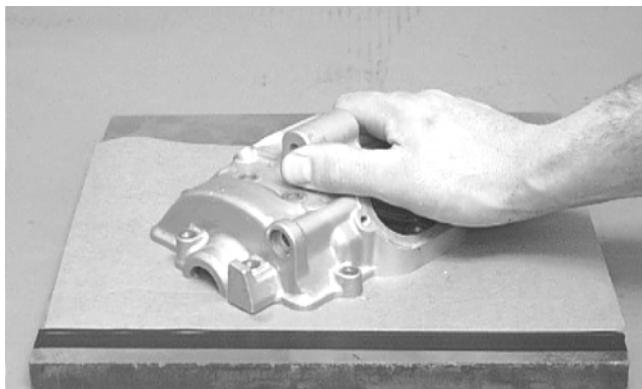

CC130D

CAUTION

Water or parts-cleaning solvent must be used in conjunction with the wet-or-dry sandpaper or damage to the sealing surface may result.

Removing Valves

■NOTE: Keep all valves and valve components as a set. Note the original location of each valve set for use during installation. Return each valve set to its original location during installation.

1. Using a valve spring compressor, compress the valve springs and remove the valve keepers. Account for an upper spring retainer.

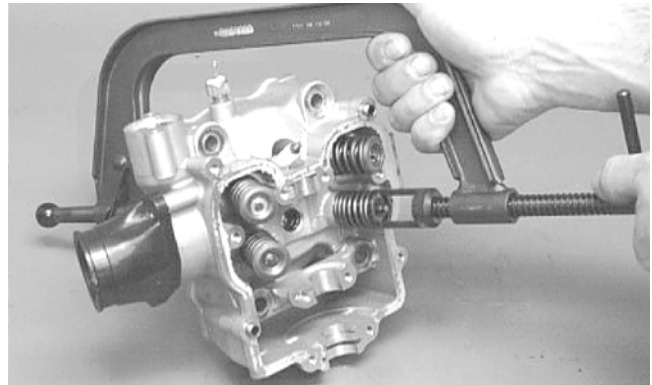

CC132D

2. Remove the valve seal and the lower remaining spring seat. Discard the valve seal.

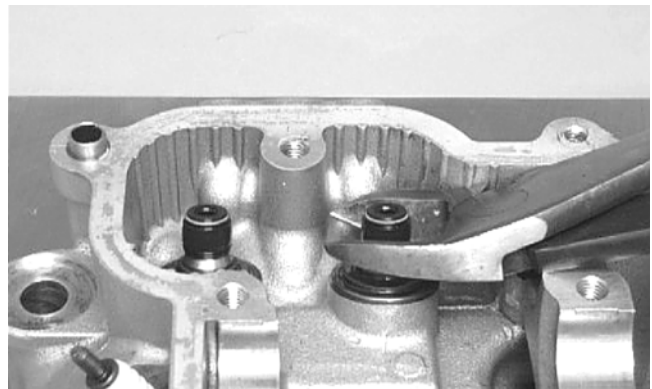

CC134D

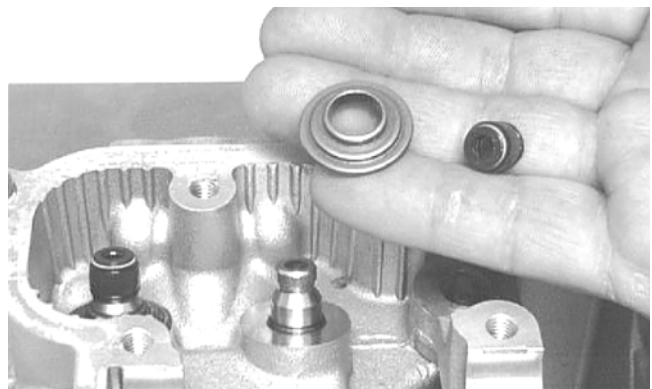

CC136D

■NOTE: The valve seals must be replaced.

3. Remove the valve springs; then invert the cylinder head and remove the valves.

Measuring Valve Stem Runout

1. Support each valve stem end with the V Blocks; then check the valve stem runout using a dial indicator.

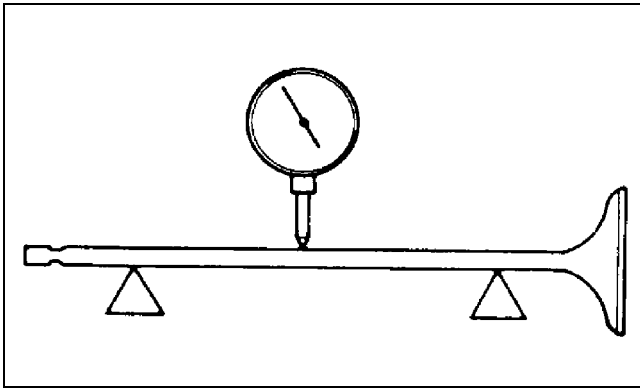

ATV-1082

2. Maximum runout must not exceed specifications.

Measuring Valve Stem Outside Diameter

1. Using a micrometer, measure the valve stem outside diameter.
2. Acceptable diameter ranges must be within specifications.

Measuring Valve Face/Seat Width

1. Using a calipers, measure the width of the valve face.

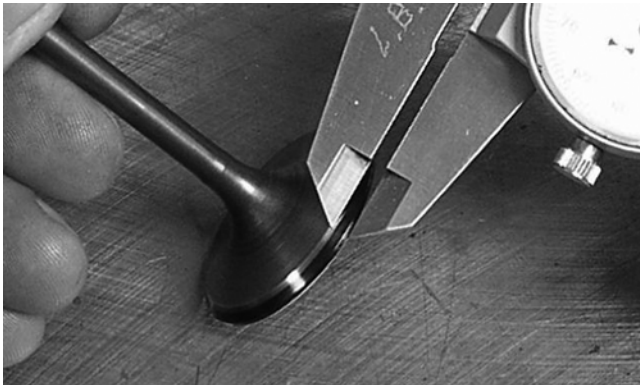

F1367

2. Acceptable width must be at or above specifications.

Measuring Valve Face Radial Runout

1. Mount a dial indicator on the surface plate; then place the valve stem on a set of V blocks.
2. Position the dial indicator contact point on the outside edge of the valve face; then zero the indicator.

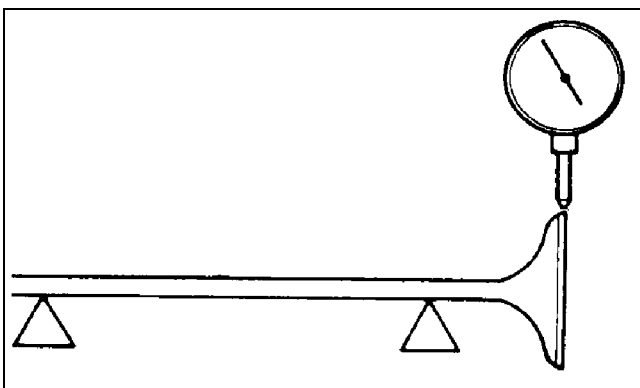

ATV1082A

3. Rotate the valve in the V blocks.
4. Maximum runout must not exceed specifications.

Measuring Valve Guide (Inside Diameter)

1. Insert a snap gauge 1/2 way down into each valve guide bore; then remove the gauge and measure it with a micrometer.
2. Acceptable inside diameter range must be within specifications.
3. If a valve guide is out of tolerance, the cylinder head must be replaced.

Servicing Valves/Valve Guides/Valve Seats

If valves, valve guides, or valve seats require servicing or replacement, Arctic Cat recommends that the components be taken to a qualified machine shop for servicing.

CAUTION

If valves are discolored or pitted or if the seating surface is worn, the valve must be replaced. Do not attempt to grind the valves or severe engine damage may occur.

Measuring Rocker Arm (Inside Diameter)

1. Using a dial calipers, measure the inside diameter of the rocker arm.
2. Acceptable inside diameter range must be within specifications.

Measuring Rocker Arm Shaft (Outside Diameter)

1. Using a micrometer, measure the outside diameter of the rocker arm shaft.
2. Acceptable outside diameter range must be within specifications.

Installing Valves

1. Apply grease to the inside surface of the valve seals; then place a lower spring seat and valve guide seal over each valve guide.

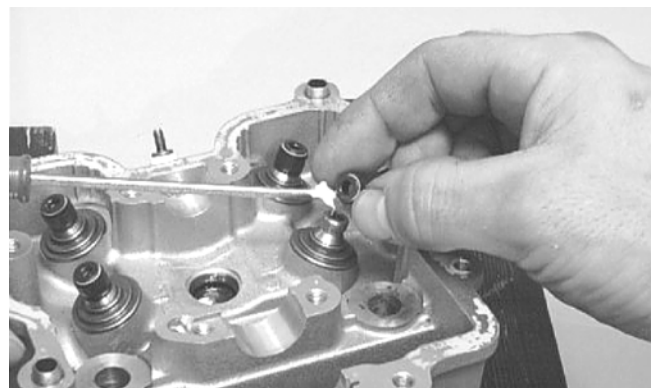

CC144D

2. Insert each valve into its original valve location.

3. Install the valve springs with the painted end of the spring facing away from the cylinder head.

■NOTE: If the paint is not visible, install the ends of the springs with the closest wound coils toward the head.

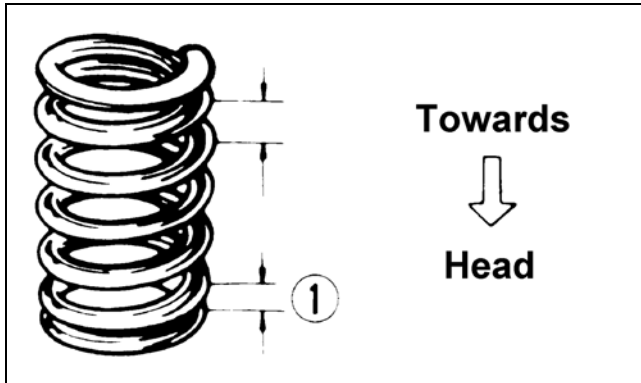

ATV-1011A

4. Place a spring retainer over the valve springs; then using the valve spring compressor, compress the valve springs and install the valve keepers.

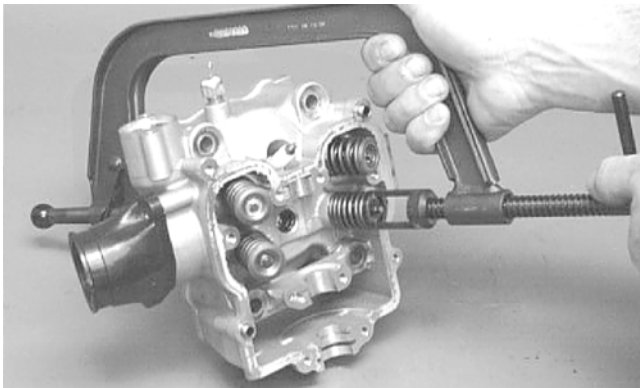

CC132D

PISTON ASSEMBLY

■NOTE: Whenever a piston, rings, or pin are out of tolerance, they must be replaced.

Cleaning/Inspecting Piston

1. Using a non-metallic carbon removal tool, remove any carbon buildup from the top of the piston.
2. Inspect the piston for cracks in the piston pin, boss, top, and skirt areas.
3. Inspect the piston for seizure marks or scuffing. If piston is scored or galled, replace it with a new one.
4. Inspect the perimeter of each piston for signs of "blowby" indicated by dark discoloration. "Blowby" is caused by worn piston rings, excessive carbon in ring grooves, or an out-of-round cylinder.

Removing Piston Rings

1. Starting with the top ring, slide one end of the ring out of the ring-groove.



CC400D

2. Remove each ring by working it toward the top of the piston while rotating it out of the groove.

■NOTE: When installing new rings, install as a complete set only.

Cleaning/Inspecting Piston Ring Grooves

1. Take an old piston ring and snap it into two pieces; then grind the end of the old ring to a 45° angle and to a sharp edge.
2. Using the sharpened ring as a tool, clean carbon from the ring grooves. Be sure to position the ring with its tapered side up.

CAUTION

Improper cleaning of the ring grooves by the use of the wrong type of ring groove cleaner will result in severe damage to the piston.

Measuring Piston-Ring End Gap (Installed)

1. Place each piston ring in the wear portion of the cylinder. Use the piston to position each ring squarely in the cylinder.
2. Using a feeler gauge, measure each piston-ring end gap. Acceptable ring end gap must be within specifications.

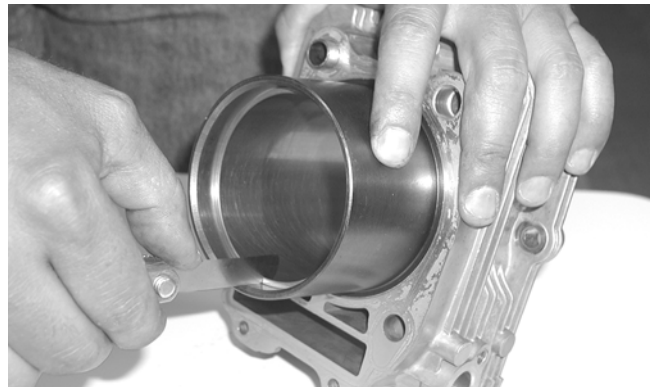

CC995

Measuring Piston Pin, Connecting Rod Small End, and Piston-Pin Bore

1. Measure the piston pin outside diameter at each end and in the center. If measurement does not meet specifications, the piston pin must be replaced.

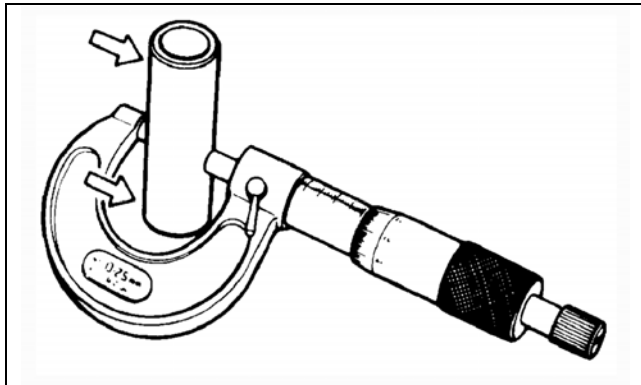

ATV-1070

2. Inspect and measure the connecting rod small end. If the measurement exceeds specifications, the connecting rod must be replaced (see Center Crankcase Components in this section).
3. Insert an inside dial indicator into the piston-pin bore. Take two measurements to ensure accuracy. The diameter must not exceed specifications. If the diameter exceeds specifications, the piston must be replaced.

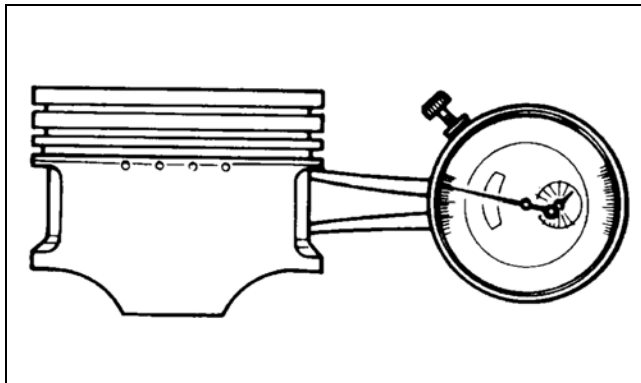

ATV-1069

Measuring Piston Skirt/ Cylinder Clearance

1. Measure the cylinder front to back in six places.

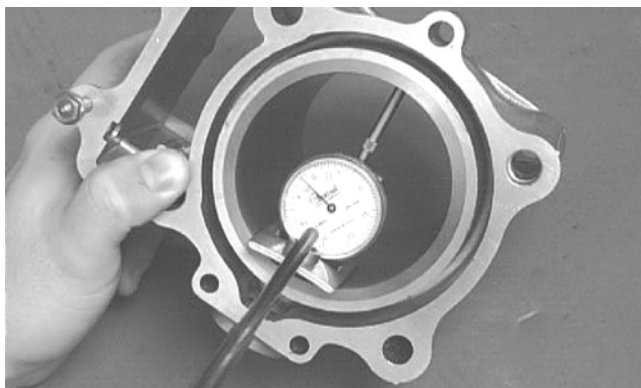

CC127D

2. Measure the corresponding piston diameter at a point 8 mm (0.3 in.) above the piston skirt at a right angle to the piston-pin bore. Subtract this measurement from the measurement in step 1. The difference (clearance) must be within specifications.

Installing Piston Rings

1. Install ring expander (4) in the bottom groove of the piston; then install the thin oil rings (3) over the expander making sure the expander ends do not overlap. Stagger the end gaps of the upper and lower thin oil rings according to the illustration.

■NOTE: Note the direction of the exhaust side of the piston (5) for correct ring end gap orientation.

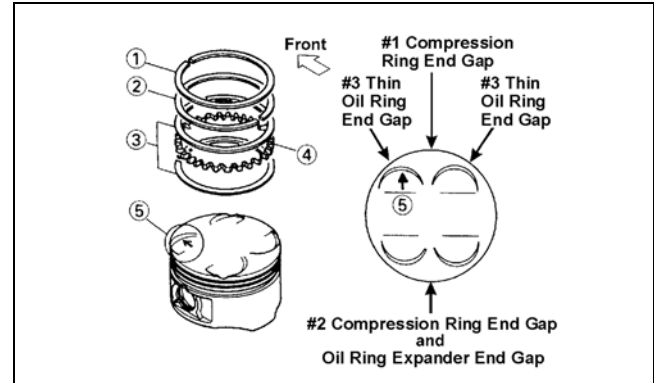

ATV-1085B

2. Install the compression rings (1 and 2) so the letter(s) on the top surface of each ring faces the dome of the piston. Rotate the rings until the ring end gaps are on directly opposite sides of the piston according to the illustration.

■NOTE: The chrome (silver) ring should be installed in the top position.

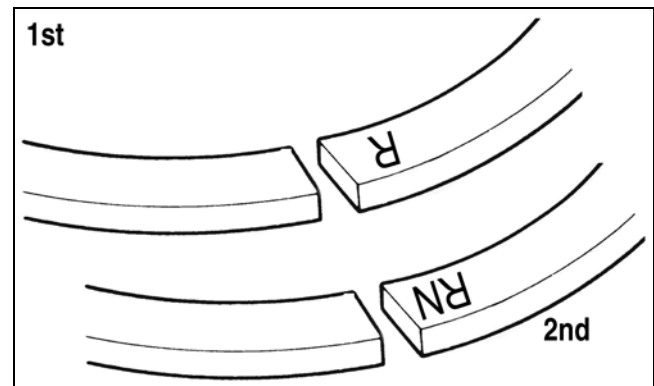

MD1343A

CAUTION

Incorrect installation of the piston rings will result in engine damage.

CYLINDER/CYLINDER HEAD ASSEMBLY

■NOTE: If the cylinder/cylinder head assembly cannot be trued, they must be replaced.

Cleaning/Inspecting Cylinder Head

CAUTION

The cylinder head studs must be removed for this procedure.

1. Using a non-metallic carbon removal tool, remove any carbon buildup from the combustion chamber being careful not to nick, scrape, or damage the combustion chamber or the sealing surface.

2. Inspect the spark plug hole for any damaged threads. Repair damaged threads using a “heli-coil” insert.
3. Place the cylinder head on the Surface Plate covered with #400 grit wet-or-dry sandpaper. Using light pressure, move the cylinder head in a figure eight motion. Inspect the sealing surface for any indication of high spots. A high spot can be noted by a bright metallic finish. Correct any high spots before assembly by continuing to move the cylinder head in a figure eight motion until a uniform bright metallic finish is attained.

CAUTION

Water or parts-cleaning solvent must be used in conjunction with the wet-or-dry sandpaper or damage to the sealing surface may result.

Measuring Cylinder Head Distortion

1. Remove any carbon buildup in the combustion chamber.
2. Lay a straightedge across the cylinder head; then using a feeler gauge, check the distortion factor between the head and the straightedge.
3. Maximum distortion must not exceed specifications.



CC141D

Cleaning/Inspecting Cylinder

1. Wash the cylinder in parts-cleaning solvent.
2. Inspect the cylinder for pitting, scoring, scuffing, warpage, and corrosion. If marks are found, repair the surface using a cylinder hone (see Honing Cylinder in this sub-section).
3. Place the cylinder on the surface plate covered with #400 grit wet-or-dry sandpaper. Using light pressure, move the cylinder in a figure eight motion. Inspect the sealing surface for any indication of high spots. A high spot can be noted by a bright metallic finish. Correct any high spots before assembly by continuing to move the cylinder in a figure eight motion until a uniform bright metallic finish is attained.

CAUTION

Water or parts-cleaning solvent must be used in conjunction with the wet-or-dry sandpaper or damage to the sealing surface may result.

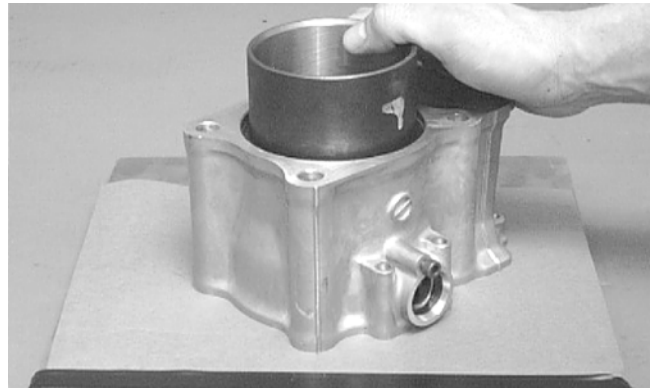

CC129D

Inspecting Cam Chain Guide

1. Inspect cam chain guide for cuts, tears, breaks, or chips.
2. If the chain guide is damaged, it must be replaced.

Honing Cylinder

1. Using a slide gauge and a dial indicator or a snap gauge, measure the cylinder bore diameter in three locations from top to bottom and again from top to bottom at 90° from the first measurements for a total of six measurements. The trueness (out-of-roundness) is the difference between the highest and lowest reading. Maximum trueness (out-of-roundness) must not exceed specifications.

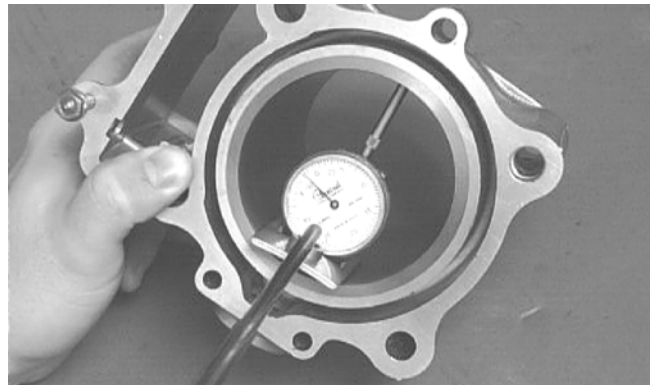

CC127D

2. Wash the cylinder in parts-cleaning solvent.
3. Inspect the cylinder for pitting, scoring, scuffing, and corrosion. If marks are found, repair the surface using a #320 grit ball hone.

NOTE: To produce the proper 60° cross-hatch pattern, use a low RPM drill (600 RPM) at the rate of 30 strokes per minute. If honing oil is not available, use a lightweight petroleum-based oil. Thoroughly clean cylinder after honing using soap and hot water. Dry with compressed air; then immediately apply oil to the cylinder bore. If the bore is severely damaged or gouged, replace the cylinder.

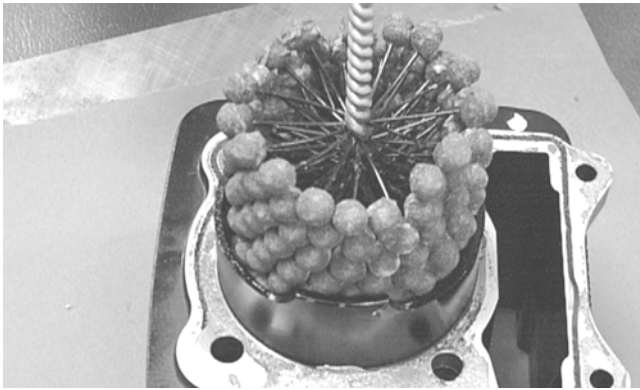

CC390D

4. If any measurement exceeds the limit, the cylinder and piston must be replaced.

Measuring Camshaft Runout

■NOTE: If the camshaft is out of tolerance, it must be replaced.

1. Place the camshaft on a set of V blocks; then position the dial indicator contact point against the shaft and zero the indicator.

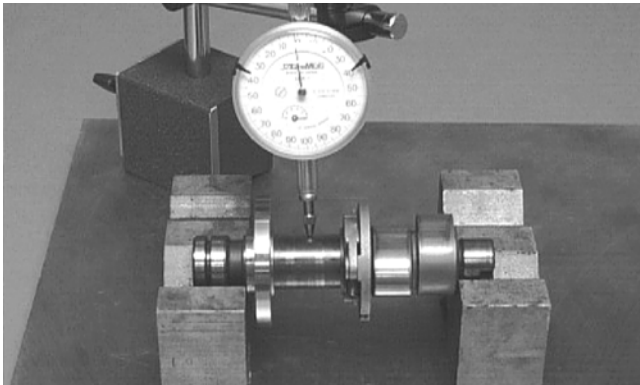

CC283D

2. Rotate the camshaft and note runout; maximum tolerance must not exceed specifications.

Measuring Camshaft Lobe Height

1. Using a calipers, measure each cam lobe height.

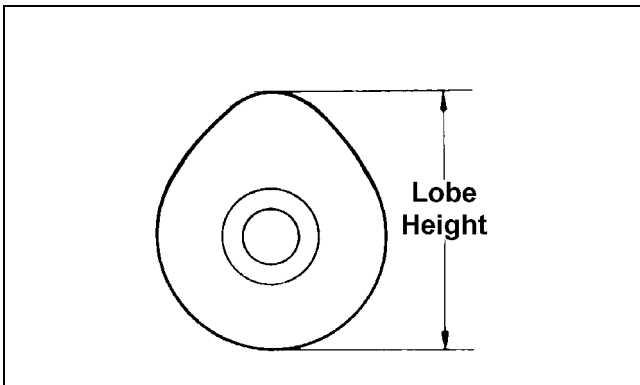

ATV1013A

2. The lobe heights must not exceed minimum specifications.

Inspecting Camshaft Bearing Journal

1. Inspect the bearing journal for scoring, seizure marks, or pitting.
2. If excessive scoring, seizure marks, or pitting is found, the cylinder head assembly must be replaced.

Measuring Camshaft to Cylinder Head Clearance

1. Loosen the jam nuts and adjuster screws.

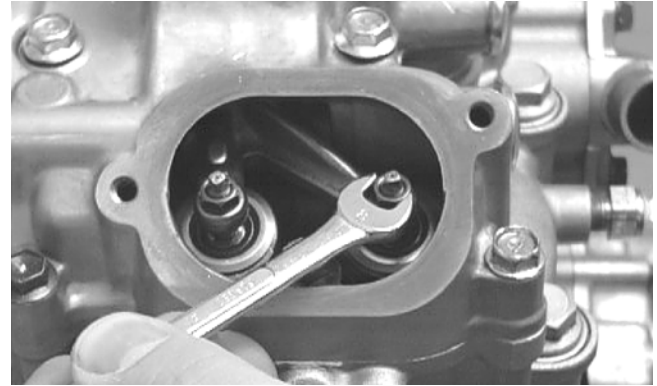

CC005D

2. Place a strip of plasti-gauge in each of the camshaft lands in the cylinder head.
3. Place the valve cover on the cylinder head and secure with the valve cover cap screws. Tighten securely.

■NOTE: Do not rotate the camshaft when measuring clearance.

4. Remove the cap screws securing the valve cover to the cylinder; then remove the valve cover and camshaft.

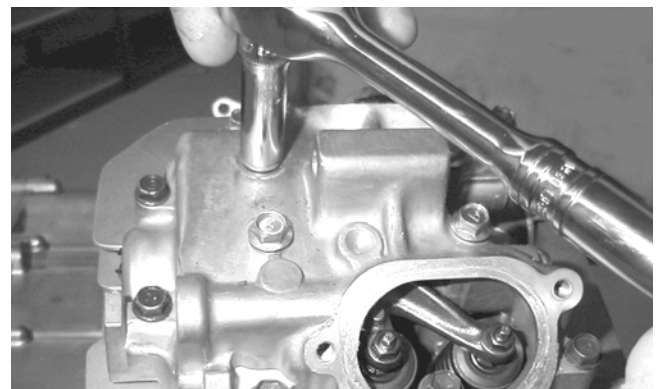

MD1261

5. Match the width of the plasti-gauge with the chart found on the plasti-gauge packaging to determine camshaft to cylinder head and valve cover clearance.

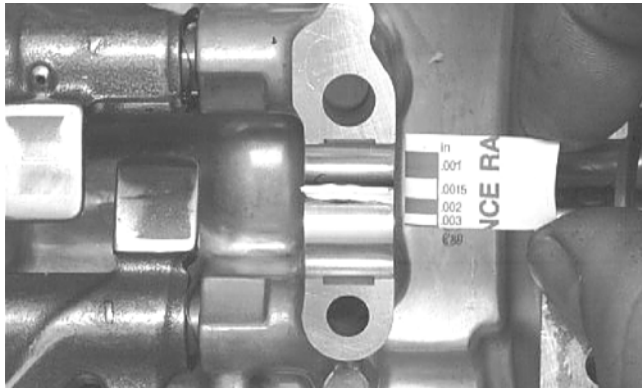

CC145D

6. If clearance is excessive, measure the journals of the camshaft.

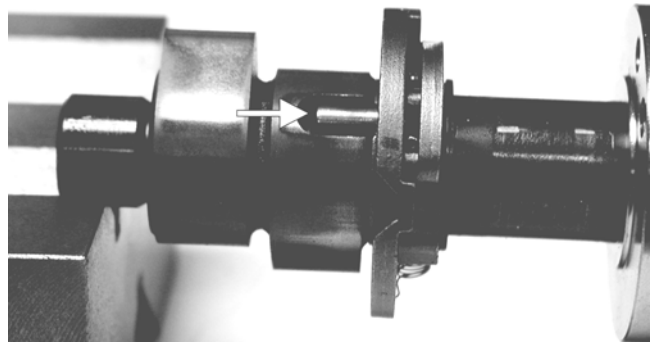

CF060A

2. If damaged, the camshaft must be replaced.

Installing Top-Side Components

A. Piston B. Cylinder

1. Lubricate the piston pin, connecting rod, and piston pin bore with motor oil; then install the piston on the connecting rod making sure there is a circlip on each side.

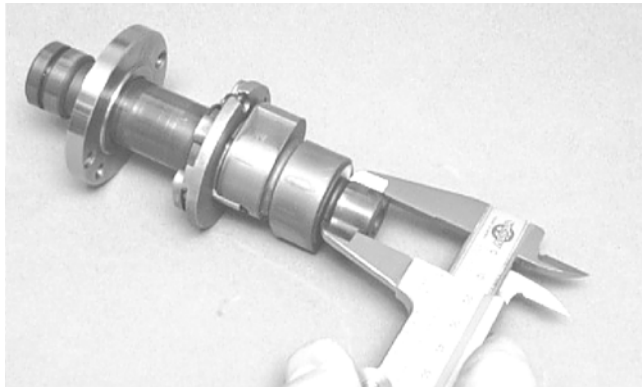

CC287D

■NOTE: If the journals are worn, replace the camshaft; then measure the clearance again. If it is still out of tolerance, replace the cylinder head.

Inspecting Camshaft Spring/Drive Pin

1. Inspect the spring and unloader pin for damage.

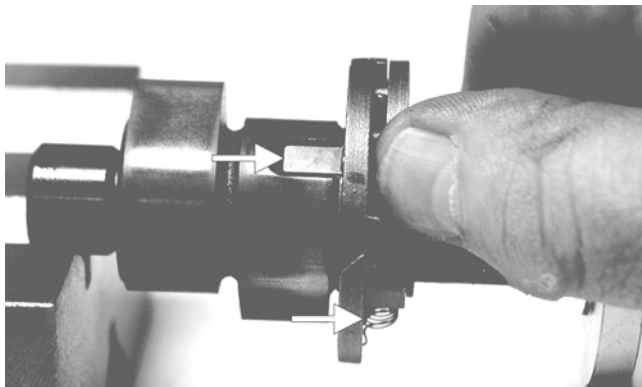

CF061A

■NOTE: With the weight extended, the unloader pin should be flat-side out; with the weight retracted, the unloader pin should be round-side out.



F1626

■NOTE: The piston should be installed so the IN points towards the intake side.

2. Place the two alignment pins into position. Place a new cylinder gasket into position; then place a piston holder (or suitable substitute) beneath the piston skirt and square the piston in respect to the crankcase.



MD1344

3. Lubricate the inside wall of the cylinder; then using a ring compressor or the fingers, compress the rings and slide the cylinder over the piston. Route the cam chain up through the cylinder cam chain housing; then remove the piston holder and seat the cylinder firmly on the crankcase.

CAUTION

The cylinder should slide on easily. Do not force the cylinder or damage to the piston, rings, cylinder, or crankshaft assembly may occur.

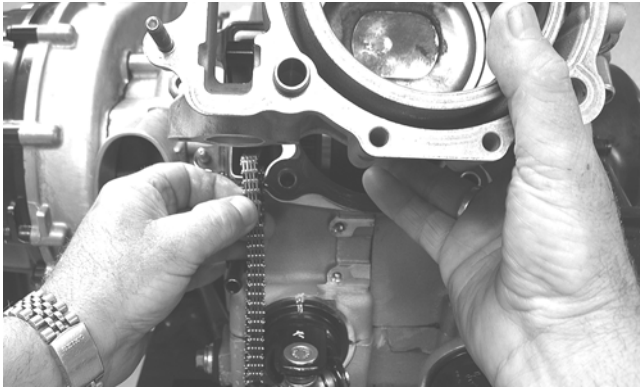

GZ142

4. Loosely install the two nuts securing the cylinder to the right-side crankcase half.

■NOTE: The two cylinder-to-crankcase nuts will be tightened in step 9.

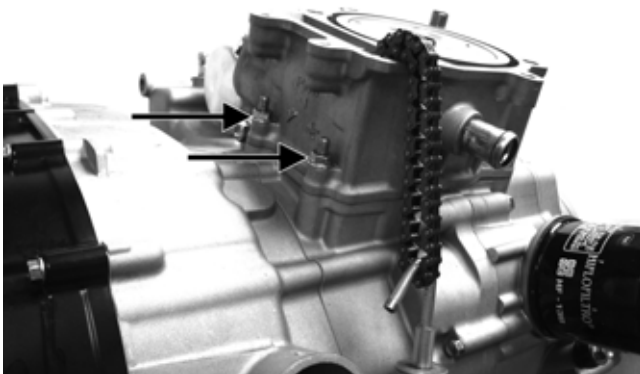

F1622A

C. Cylinder Head/Camshaft

D. Cylinder Head Cover/ Rocker Arms

■NOTE: Steps 1-4 in the preceding sub-section must precede this procedure.

5. While keeping tension on the cam chain, place the front cam chain guide into the cylinder.

CAUTION

Care should be taken that the bottom of the chain guide is secured in the crankcase boss.



F1621

6. Place a new gasket into position on the cylinder. Place the alignment pins into position; then place the head assembly into position on the cylinder making sure the cam chain is routed through the chain cavity.

CAUTION

Keep tension on the cam chain to avoid damaging the crankcase boss.

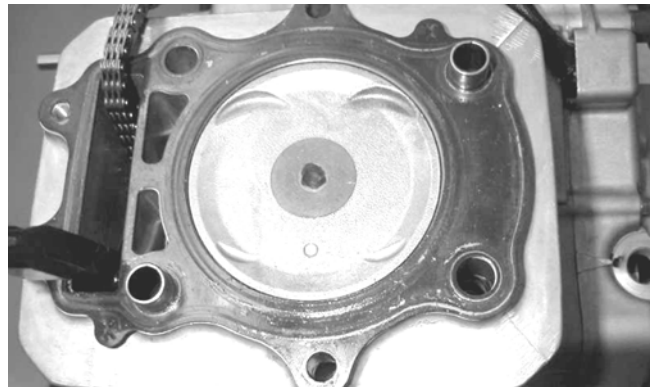

MD1347

7. Install the four cylinder head cap screws with washers. Note that the two cap screws on the right side of the cylinder head nearest the cam sprocket are longer than the two cap screws on the left (spark plug) side. Tighten only until snug.
8. Install the two lower nuts securing the cylinder head to the cylinder, one in front and one in rear.
9. In a crisscross pattern, tighten the four cylinder head cap screws (from step 7) to 28 ft-lb. Tighten the two lower cylinder head nuts (from step 8) to 20 ft-lb and the cylinder-to-crankcase nuts (from step 4) to 8 ft-lb.
10. With the timing inspection plug removed and the cam chain held tight, rotate the crankshaft until the piston is at top-dead-center.
11. While holding the cam chain to the front, install the rear cam chain tensioner guide into the cylinder head. Install the pivot cap screw and washer. Tighten to 11 ft-lb.

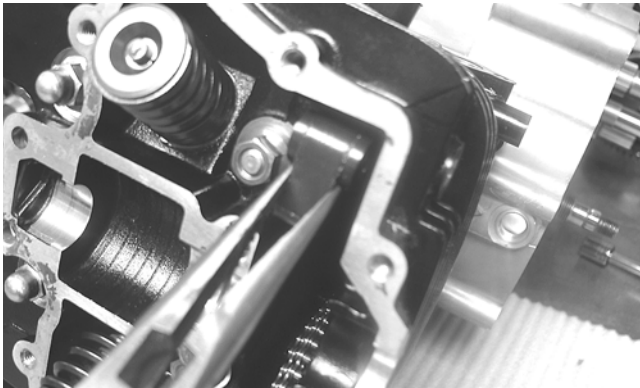

CD383

12. With the alignment pin installed in the camshaft and the cam lobes directed down (toward the piston), place the camshaft in position and verify that the timing mark on the magneto is visible through the inspection plug and that the timing marks on the camshaft sprocket are parallel with the valve cover mating surface.



GZ190C

■NOTE: When the camshaft assembly is seated, make sure the alignment pin in the camshaft aligns with the smallest hole in the sprocket.

13. With the alignment pin installed in the camshaft, loosely place the cam sprocket (with the recessed side facing the camshaft lobes) onto the camshaft and place it into position with the cam chain over the sprocket.

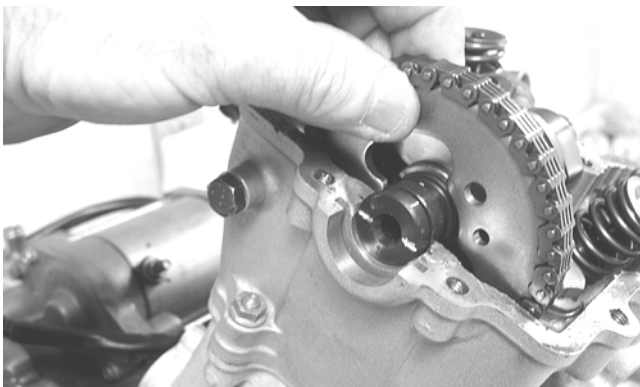

CD463

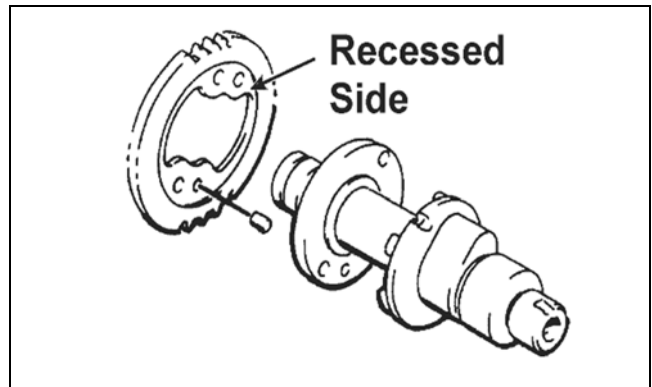

MD1359

14. Place the C-ring into position in its groove in the cylinder head.



F1615

■NOTE: At this point, oil the camshaft bearings, cam lobes, and the three seating journals on the cylinder head.

■NOTE: Note the position of the alignment marks on the end of the camshaft. They must be parallel with the valve cover mating surface. If rotating the camshaft is necessary for alignment, do not allow the chain and sprocket to rotate and be sure the cam lobes end up in the down position.

15. When the camshaft assembly is seated, ensure the following.
- A. Piston still at top-dead-center.
 - B. Camshaft lobes directed down (toward the piston).
 - C. Camshaft alignment marks parallel to the valve cover mating surface.
 - D. Recessed side of the sprocket directed toward the cam lobes.
 - E. Camshaft alignment pin and sprocket alignment hole (smallest) are aligned.

CAUTION

If any of the above factors are not as stated, go back to step 13 and carefully proceed.

16. Place the tab washer onto the sprocket making sure it covers the pin in the alignment hole.

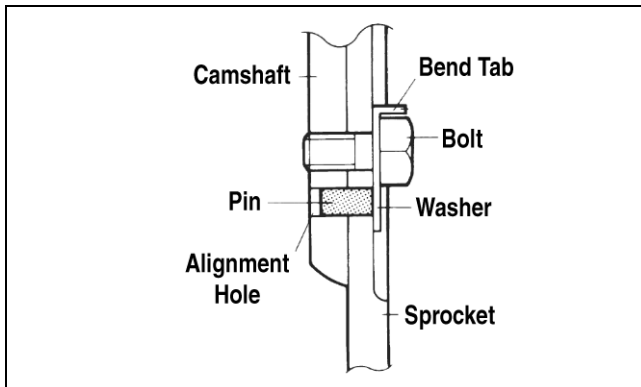

MD1363

CAUTION

Care must be taken that the tab washer is installed correctly to cover the alignment hole on the sprocket. If the alignment pin falls out, severe engine damage will result.

17. Apply red Loctite #271 to the first cap screw securing the sprocket and tab washer to the camshaft; then install the cap screw and tab washer. Tighten cap screw only until snug.

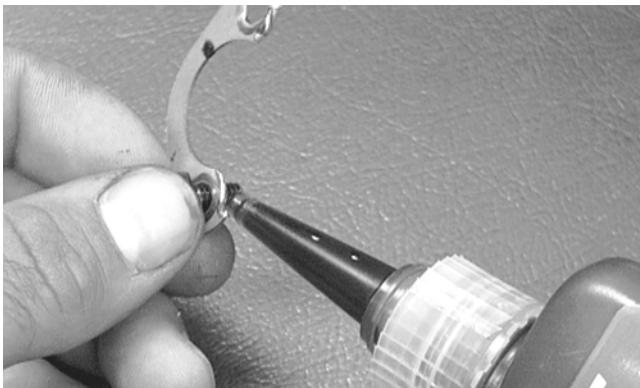

CC404D



FI612

18. Rotate the crankshaft until the second cap screw securing the sprocket to the camshaft can be installed; then install the cap screw (threads coated with red Loctite #271). Tighten to 11 ft-lb; then bend the tab to secure the cap screw.
19. Rotate the crankshaft until the first cap screw (from step 17) securing the sprocket to the camshaft can be addressed; then tighten to 11 ft-lb. Bend the tab to secure the cap screw.

20. Install the cylinder head plug with the cupped end facing the camshaft and the opening directed downwards.
21. Place the cam chain tensioner assembly and gasket into the cylinder. Tighten to 10 ft-lb.
22. Using a flat-blade screwdriver, turn the tensioner screw counterclockwise to apply tension to the cam chain; then install the cap screw plug and washer and tighten securely.

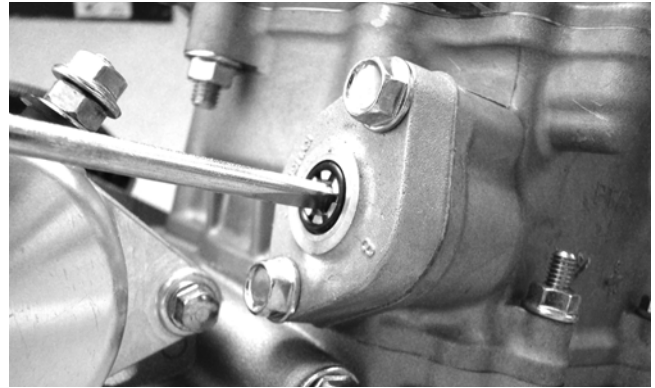

FI608

23. Loosen the adjuster screw jam nuts; then loosen the adjuster screws on the rocker arms in the valve cover.
24. Apply a thin coat of Three Bond Sealant to the mating surface of the valve cover; then place the valve cover into position. Note that the two alignment pins are properly positioned.

■NOTE: At this point, the rocker arms and adjuster screws must not have pressure on them.

25. Install the four top-side cap screws with rubber washers; then install the remaining cap screws. Tighten only until snug.

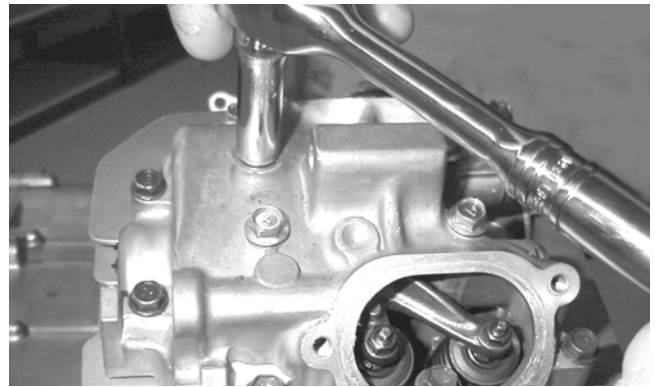

MD1261

26. In a crisscross pattern starting from the center and working outward, tighten the cap screws (from step 25) to 8 ft-lb.
27. Adjust valve/tappet clearance (see Periodic Maintenance).
28. Place the two tappet covers with O-rings into position; then install and tighten the cap screws to 8 ft-lb.

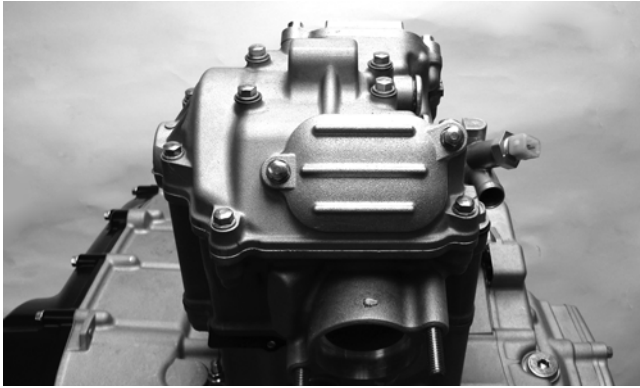

F1602

29. Install the spark plug and tighten securely; then install the timing inspection plug.

Left-Side Components

■NOTE: For efficiency, it is preferable to remove and disassemble only those components which need to be addressed and to service only those components. The technician should use discretion and sound judgment.

 AT THIS POINT
--

To service any one specific component, only limited disassembly of components may be necessary. Note the AT THIS POINT information in each sub-section.

■NOTE: The engine/transmission does not have to be removed from the frame for this procedure.

Removing Left-Side Components

- A. Water Pump
- B. Speed Sensor
- C. Magneto Cover/Stator Assembly

1. Remove the coolant hose connecting the water pump to the cylinder; then remove the water pump cover.



F1538

2. Remove the water pump housing assembly noting the location of the longer cap screw. Account for a gasket and two alignment pins.

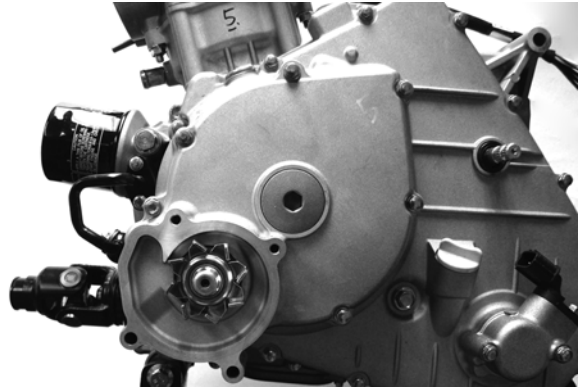

F1539

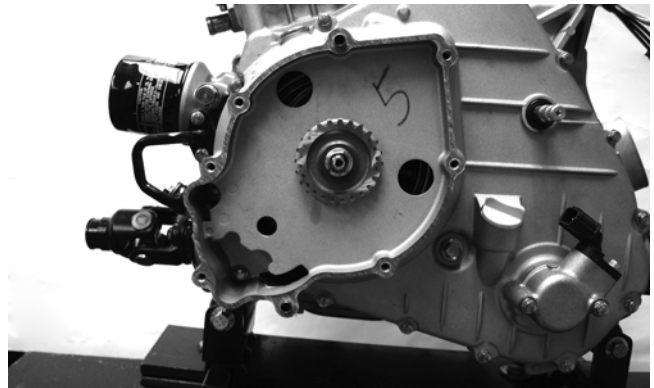

F1541

3. Remove two cap screws and the oil bolt securing the oil pressure relief line to the engine. Account for two crush washers and an O-ring.

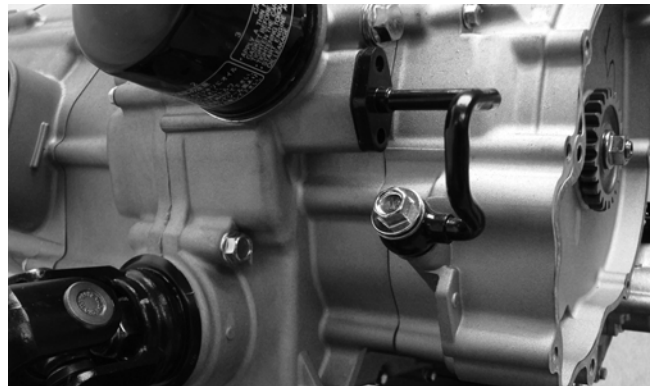

F1544

4. Remove the water pump drive gear; then remove the speed sensor housing assembly. Account for two alignment pins, a gasket, and two seal washers.

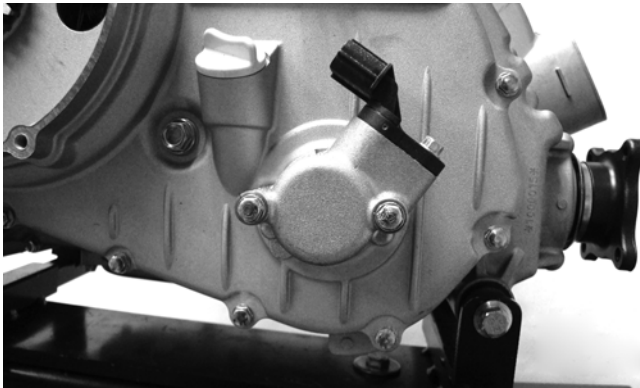

FI543

5. Remove the cap screws securing the magneto cover to the crankcase. Note the location of the two internal cap screws and the two longer cap screws.

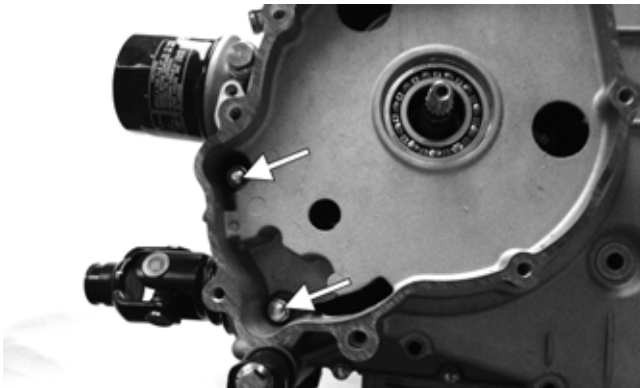

FI596A

6. Remove the magneto cover and account for two alignment pins and the gasket.

D. Rotor/Flywheel
E. Starter Clutch/Gear
F. Starter Motor

■NOTE: Steps 1-6 in the preceding sub-section must precede this procedure.

7. Remove the nut securing the rotor/flywheel on the crankshaft and install the crankshaft protector.

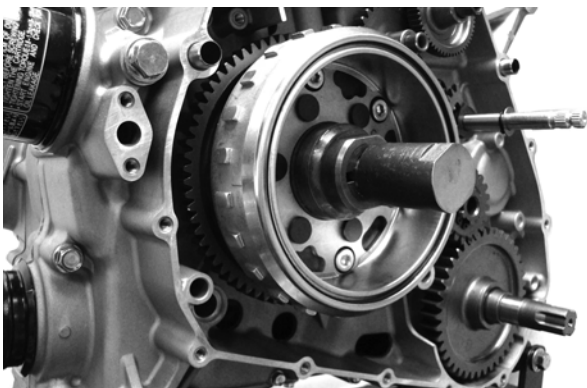

FI549

8. Using the Magneto Rotor Remover Set, break the rotor/flywheel loose from the crankshaft; then remove the puller and crankshaft protector and remove the rotor/flywheel.

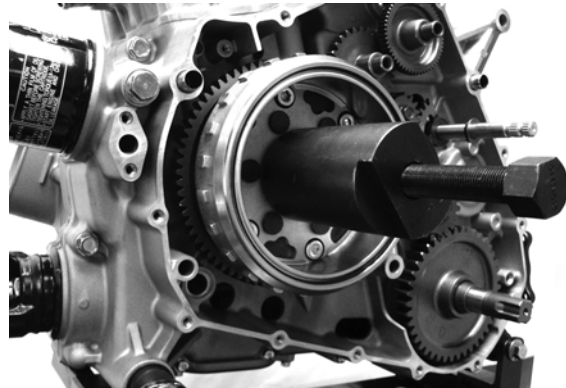

FI550

9. Remove the flywheel key from the crankshaft; then remove the starter clutch gear.



FI551A

10. Remove starter idler gears and their respective shafts; then remove the starter motor. Account for an O-ring on the starter drive housing.



FI555

G. Shift Shaft
H. Drive Gear

■NOTE: Steps 1-10 in the preceding sub-sections must precede this procedure.

11. Remove the shift shaft noting a washer on each end; then remove the cap screw securing the gear shift cam plate and remove the plate from the shaft.



F1559

12. Remove the shift detent cam arm and spring.



F1560

13. Remove the snap ring securing the output drive gear to the output shaft and remove the gear noting that the hub flange is directed toward the crankcase.



F1564

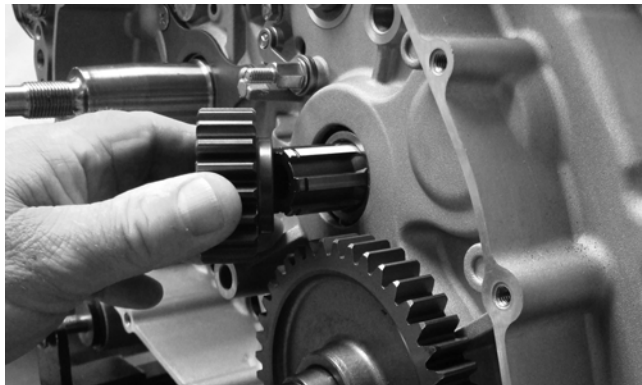

F1566

Servicing Left-Side Components

INSPECTING STARTER CLUTCH/GEAR

1. Place the starter clutch gear onto the rotor/flywheel and attempt to rotate the starter clutch gear clockwise. It should lock up to the rotor/flywheel. Rotate the gear counterclockwise and it should turn freely. If it moves or locks up both ways, the starter clutch must be replaced.
2. Inspect the starter clutch gear for chipped or missing teeth or discoloration/scoring of the clutch surface. Inspect the bearing for loose, worn, or discolored rollers. If bearing is damaged, it must be replaced.



F1569

3. Inspect the one-way bearing for chipped surfaces, missing rollers, or discoloration. If any of the above conditions exist, replace the starter clutch assembly.



F1572

REPLACING STARTER CLUTCH ASSEMBLY

1. Remove the cap screws securing the one-way clutch assembly to the flywheel; then remove from the flywheel.



FI570

2. Thoroughly clean the rotor/flywheel; then install the new one-way clutch and secure with the cap screws after applying a drop of red Loctite #271 to the threads. Tighten to 26 ft-lb using a crisscross pattern. Make sure the one-way bearing is installed with the notches directed away from the rotor/flywheel.



FI583

2. Thoroughly clean the gear hub; then apply a drop of green Loctite #620 to the bearing outer race and press into the gear hub until even with the lower chamfer radius.



FI576A



FI580

INSPECTING STATOR/MAGNETO COVER ASSEMBLY

1. Inspect the stator for burned or discolored wiring, broken or missing hold-down clips, or loose cap screws.
2. Inspect the bearings in the magneto housing for discoloration, roughness when rotated, and secure fit in bearing bores.
3. Inspect the oil pressure relief valve for evidence of metal chips or contamination. Do not disassemble the valve.



FI578

REPLACING STARTER GEAR BEARING

1. Support the starter clutch gear in a press making sure to support the hub around the entire circumference; then using a suitable bearing driver, press the bearing from the gear.



FI588

REPLACING STATOR/CRANKSHAFT POSITION SENSOR

1. Remove the three cap screws securing the stator coil, two cap screws securing the crankshaft position sensor, and one cap screw from the harness hold-down.
2. Lift the rubber grommet out of the housing; then remove the stator coil/crankshaft position sensor. Account for and note the position of the harness hold-down under the crankshaft position sensor.

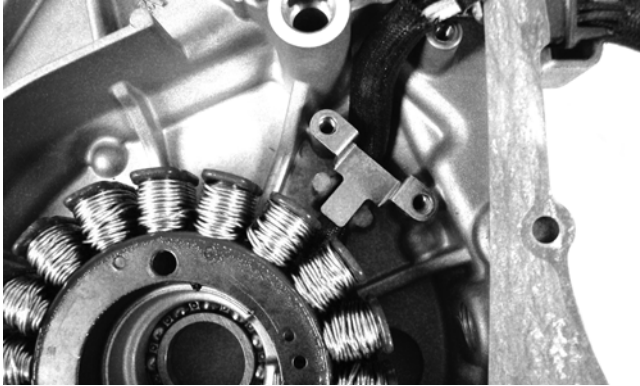

F1590

3. Install the new stator assembly and secure with three cap screws using a drop of red Loctite #271 on each. Tighten to 8 ft-lb.
4. Place the stator wire harness hold-down into position; then install the crankshaft position sensor and secure with two cap screws. Tighten securely.
5. Install the upper cable hold-down and secure with a cap screw. Tighten securely.

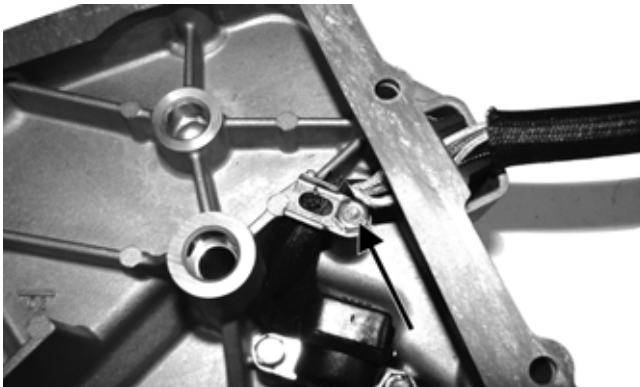

F1595A

REPLACING MAGNETO COVER BEARINGS

1. Using a suitable press and proper support, press the bearing from the housing as indicated (one from outside and one from inside).



F1593



F1594

2. Clean the bearing bores in the housing and inspect closely for cracks or shiny areas indicating bearing movement. Replace the housing if any of the above are evident.
3. With a drop of red Loctite #271 around the bearing bore, press a new bearing into the magneto cover until the bearing is firmly seated in the bearing bore.

Installing Left-Side Components

A. Starter Clutch/Gear B. Rotor/Flywheel

1. If removed, place the crankshaft bearing retainer into position. Apply red Loctite #271 to the three cap screws. Install and tighten the three cap screws securely.



MD1122

2. Install the starter motor and tighten the two cap screws to 8 ft-lb.
3. Install the shift detent cam making sure the washer is installed.



MD1086

4. Install the shift detent cam arm and spring.
5. Install the gear shift shaft assembly and washer making sure to align the alignment marks.



F1559

6. Install starter idler gears (1) and (2).



F1555A

7. Install the starter clutch gear onto the crankshaft; then install the rotor/flywheel key in the crankshaft.



F1551A

8. Install the rotor/flywheel and secure with the flange nut. Tighten to 107 ft-lb.

C. Magneto Cover

D. Water Pump

■NOTE: Steps 1-8 in the preceding sub-section must precede this procedure.

9. Install two alignment pins and place the magneto cover gasket into position. Install the magneto cover. Noting the different-lengthed 6 mm cap screws and the location of the two internal cap screws, tighten cap screws in a crisscross pattern to 8 ft-lb.

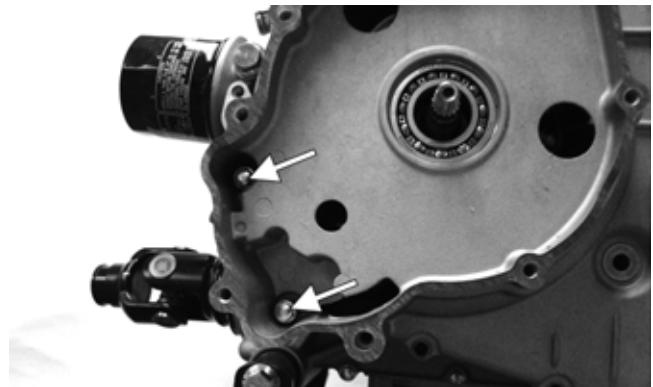

F1596A

10. Install the water pump drive gear and secure with the nut. Tighten to 28 ft-lb.

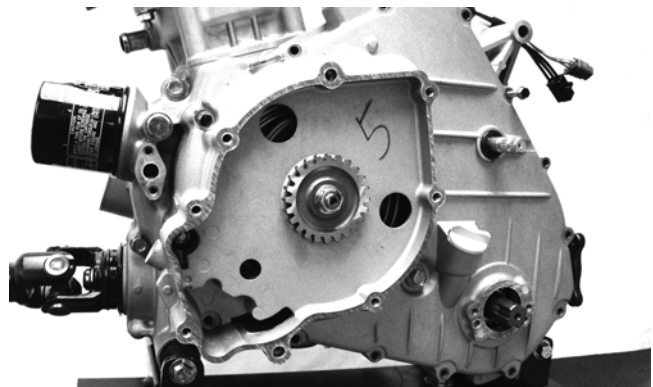

F1547

11. Install two alignment pins and a gasket on the magneto cover; then install the water pump housing assembly. Tighten the cap screws to 8 ft-lb.

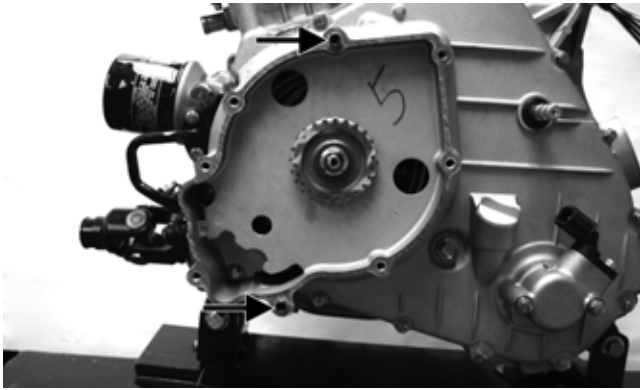

FI541A

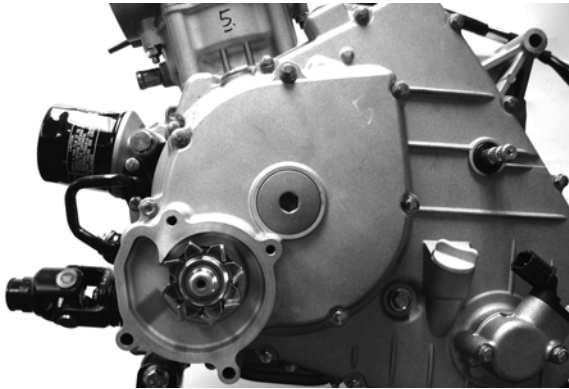

FI539

12. Install the water pump cover with a new O-ring and secure with the four cap screws. Tighten to 8 ft-lb.



FI538

13. Connect the coolant hoses to the water pump and secure with the hose clamps. Tighten securely.

Right-Side Components

AT THIS POINT

To service center crankcase components only, proceed to Removing Right-Side Components.

■NOTE: For efficiency, it is preferable to remove and disassemble only those components which need to be addressed and to service only those components. The technician should use discretion and sound judgment.

AT THIS POINT

To service any one specific component, only limited disassembly of components may be necessary. Note the AT THIS POINT information in each sub-section.

■NOTE: The engine/transmission does not have to be removed from the frame for this procedure.

Removing Right-Side Components

- A. V-Belt Cover
- B. Driven Pulley
- C. Clutch Cover

1. If the engine is still in the frame, remove the cap screw securing the brake pedal to the frame; then slide the pedal outward.



KC438A

2. Remove the cap screws securing the V-belt cover to the clutch cover; then slide the brake pedal outward and remove the V-belt cover. Account for two alignment pins and a gasket.

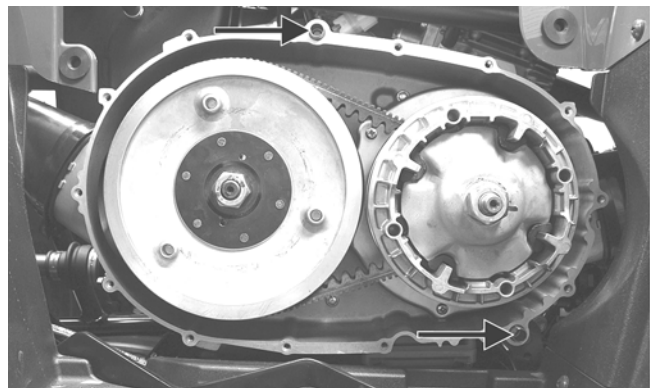

KC142A

3. Mark the movable drive face and the fixed drive face for installing purposes; then remove the nut holding the movable drive face onto the crankshaft.

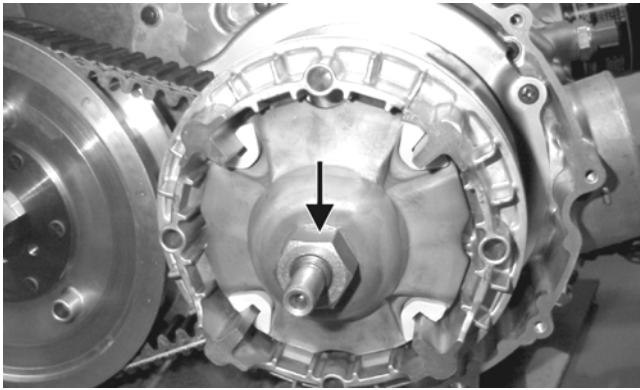

MD1033

4. Remove the movable drive face and spacer. Account for the movable drive face rollers and outer drive face cover.

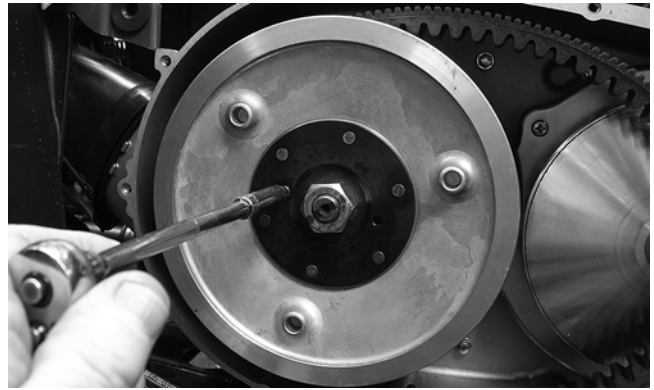

KC132

6. Remove the fixed drive face.

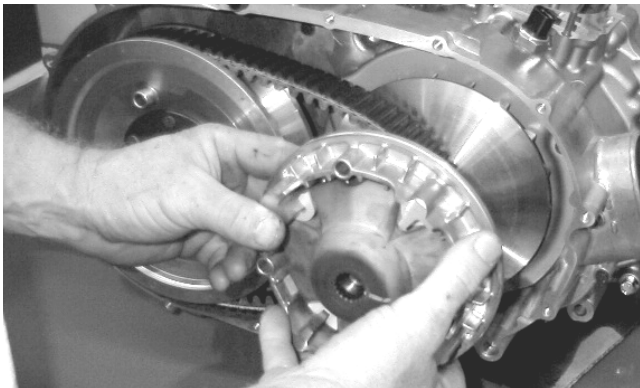

MD1035

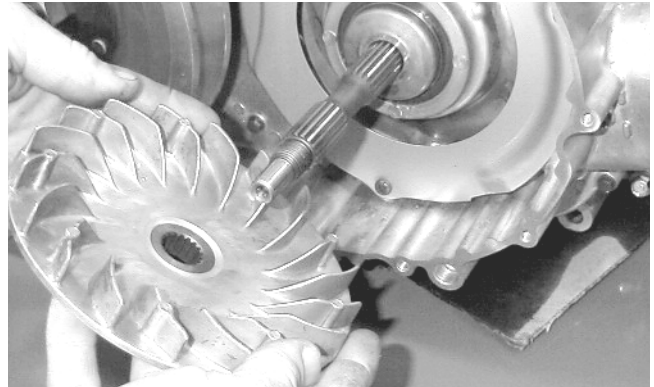

MD1094

7. Remove the nut holding the driven pulley assembly; then remove the driven pulley assembly.

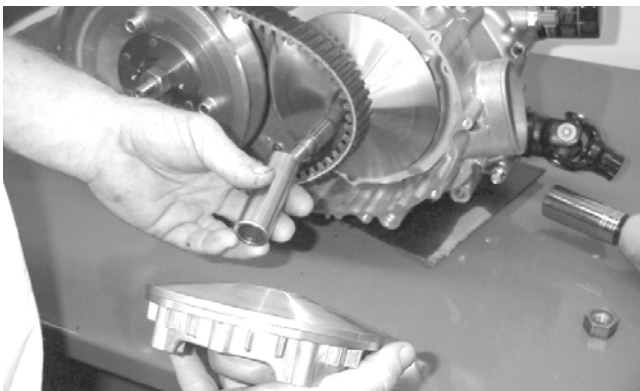

MD1034

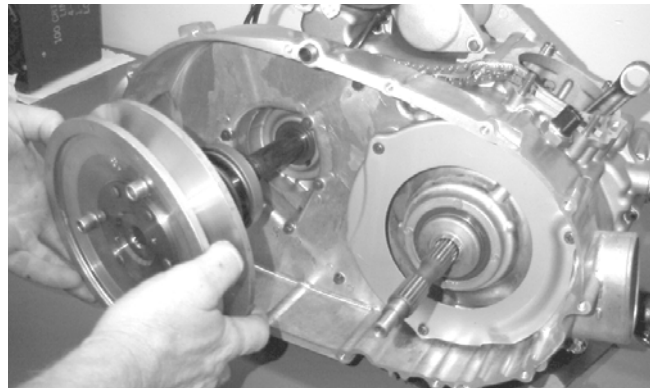

MD1068

8. Using an impact screwdriver, remove the three Phillips-head cap screws holding the air intake plate. Remove the air intake plate.

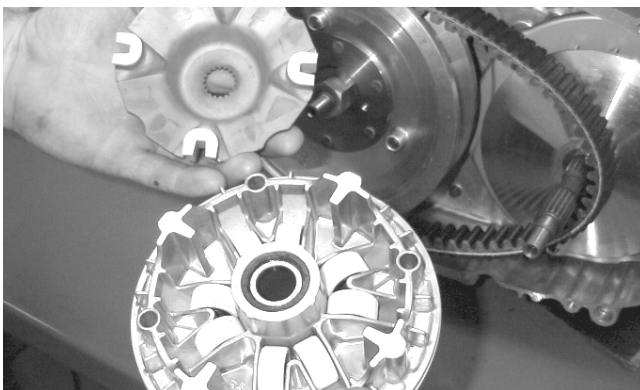

MD1036

5. Using a 6 mm cap screw threaded into the fixed driven face, spread the driven pulley by turning the cap screw clockwise; then remove the V-belt.

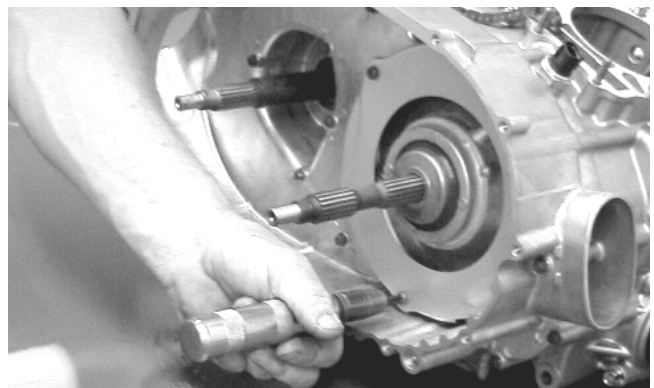

MD1092

9. Remove the cap screws holding the clutch cover onto the right-side crankcase half. Note the positions of the different-lengthed cap screws for installing purposes.
10. Using a rubber mallet, loosen the clutch cover; then pull it away from the right-side crankcase half. Account for two alignment pins and gasket.

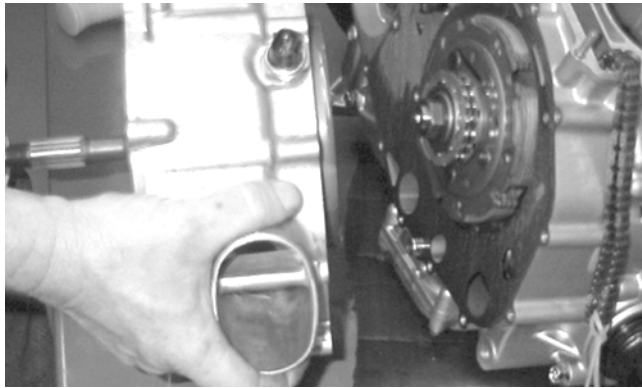

MD1115

D. Centrifugal Clutch Assembly
E. Oil Pump Drive Gear
F. Oil Pump Driven Gear

■NOTE: Steps 1-10 in the preceding sub-section must precede this procedure.

11. Remove the one-way clutch noting the direction of the green dot or the word OUTSIDE for installing purposes.



MD1286

12. Remove the left-hand threaded nut holding the centrifugal clutch assembly.

CAUTION

Care must be taken when removing the nut; it has "left-hand" threads.

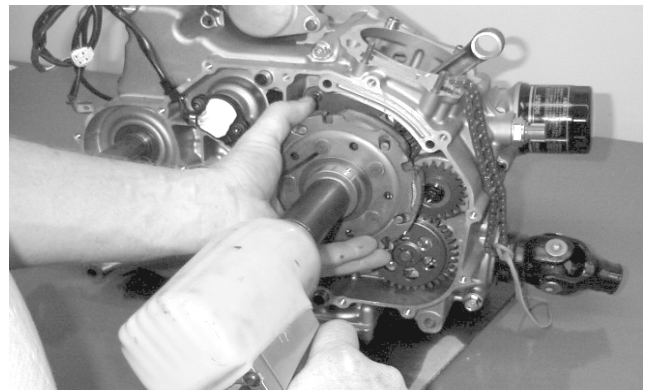

MD1014



MD1016

13. Remove the cam chain.

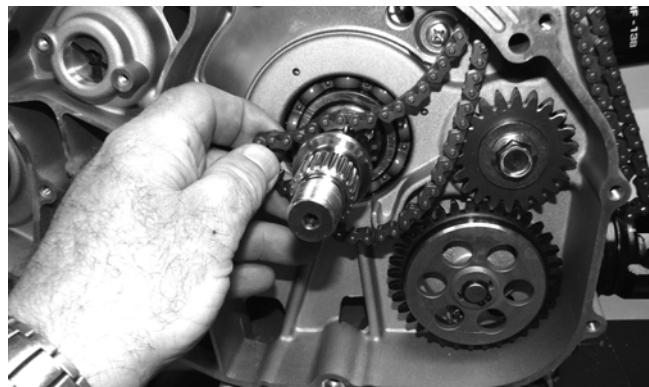

F1630

14. Remove the oil pump drive gear cap screw.

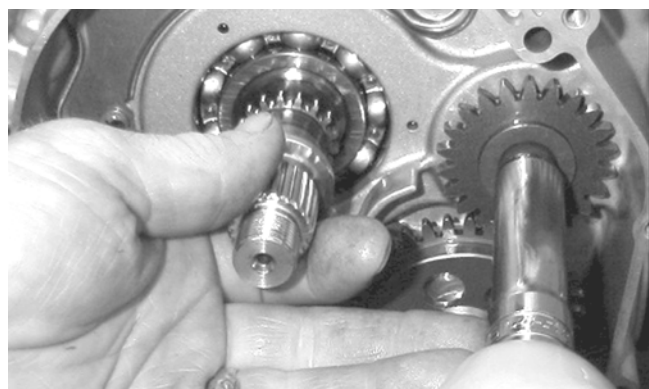

MD1018

15. Remove oil pump drive gear. Account for the pin.

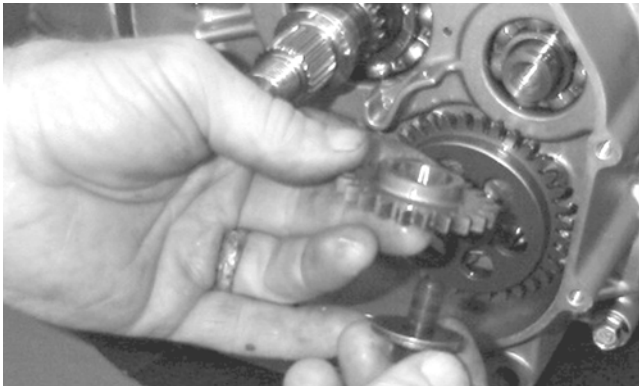

MD1017

16. Remove the snap ring holding the oil pump driven gear.

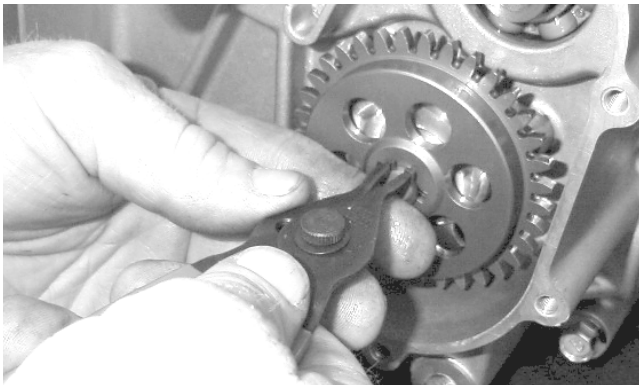

MD1019

■NOTE: Always use a new snap ring when installing the oil pump driven gear.

17. Remove oil pump driven gear. Account for the drive pin and thrust washer.

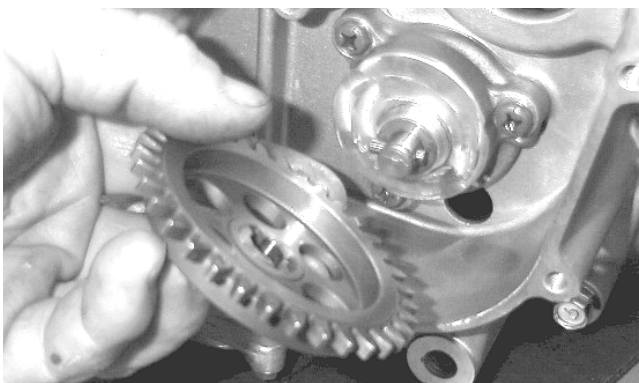

MD1020

AT THIS POINT

To service clutch components, see Servicing Right-Side Components sub-section.

G. Oil Pump/Oil Strainer

■NOTE: Steps 1-17 in the preceding sub-sections must precede this procedure.

18. Remove three cap screws holding the oil pump and remove the oil pump. Account for two alignment pins.

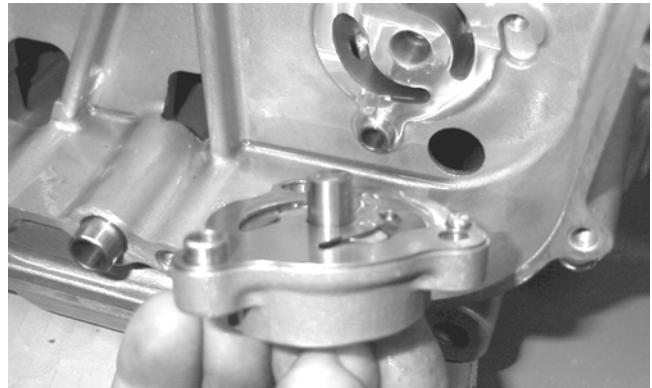

MD1060

19. Remove the four cap screws securing the oil strainer cap; then remove the Phillips-head screws securing the oil strainer. Account for the O-ring.

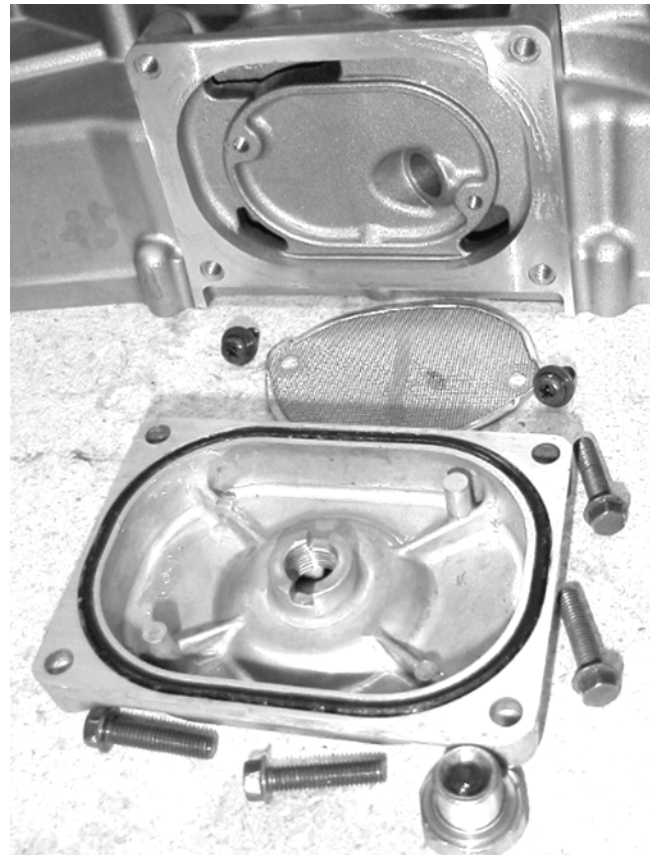

MD1207

AT THIS POINT

To service center crankcase components only, proceed to Separating Crankcase Halves.

Servicing Right-Side Components

■NOTE: Whenever a part is worn excessively, cracked, damaged in any way, or out of tolerance, replacement is necessary.

INSPECTING CENTRIFUGAL CLUTCH SHOE

1. Inspect the clutch shoe for uneven wear, chips, cracks, or discoloration.
2. Inspect the depth of the grooves in the clutch shoes. If any shoe is worn to the bottom of the groove, replace the complete set.

CAUTION

Always replace clutch shoes as a complete set or severe imbalance could occur.

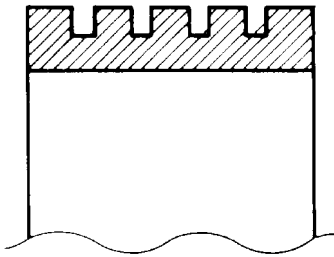

Inspecting clutch shoe groove

ATV1014

INSPECTING CENTRIFUGAL CLUTCH HOUSING

1. Inspect the clutch housing for burns, marks, scuffs, cracks, scratches, or uneven wear.
2. If the housing is damaged in any way, the housing must be replaced.

INSPECTING PRIMARY ONE-WAY DRIVE

1. Place the one-way clutch onto the clutch shoe assembly with the green dot or the word "OUTSIDE" directed away from the clutch shoe.

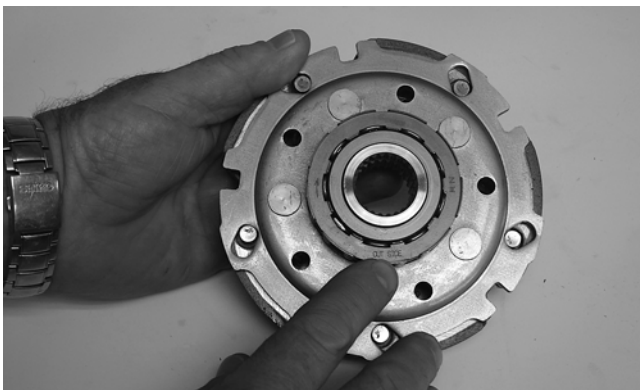

KC330

2. Place the clutch housing onto the clutch shoe/one-way clutch.

■NOTE: It will be necessary to rotate the clutch housing counterclockwise to properly seat the one-way clutch.

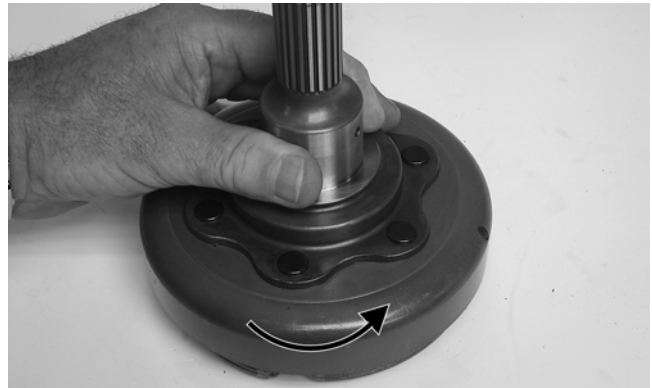

KC331A

3. Check that the clutch shoe can only be rotated counterclockwise in respect to the clutch housing. If the clutch shoe locks up or turns in both directions, the one-way clutch must be replaced.

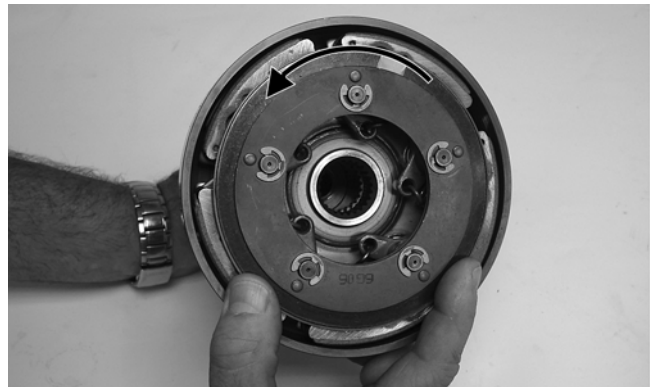

KC332A

INSPECTING OIL PUMP

1. Inspect the pump for damage.
2. It is inadvisable to remove the screw securing the pump halves. If the oil pump is damaged, it must be replaced.

■NOTE: The oil pump is a non-serviceable component and must be replaced as a complete assembly.

DRIVEN PULLEY ASSEMBLY

■NOTE: The driven pulley assembly is a non-serviceable component and must be replaced as a complete assembly.

Installing Right-Side Components

A. Oil Strainer/Oil Pump

1. Place the oil strainer into position beneath the crankcase. Tighten the Phillips-head screws securely.

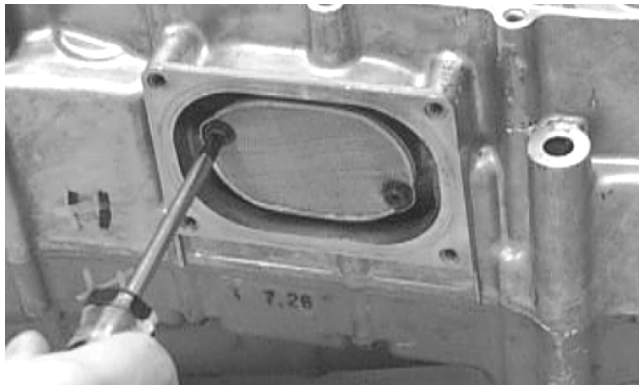

MD1337

2. Place the strainer cap into position on the crankcase making sure the O-ring is properly installed and secure with the four cap screws; then tighten the oil drain plug to 20 ft-lb.



MD1208

3. Place two alignment pins and the oil pump into position on the crankcase and secure with the Phillips-head screws coated with red Loctite #271. Tighten to 8 ft-lb.

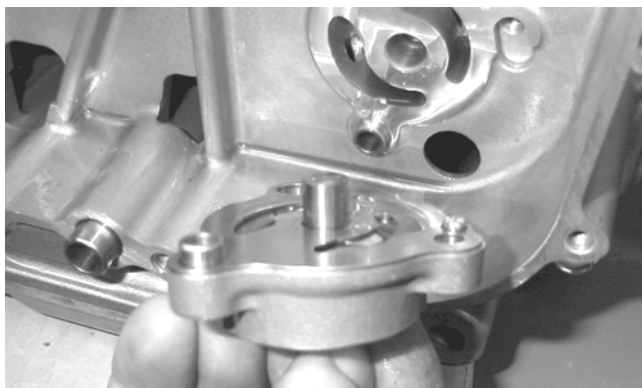

MD1060

4. Place the thrust washer and drive pin into position on the oil pump shaft, install the oil pump driven gear making sure the recessed side of the gear is directed inward, and secure with a new snap ring.

■NOTE: Always use a new snap ring when installing the oil pump driven gear.

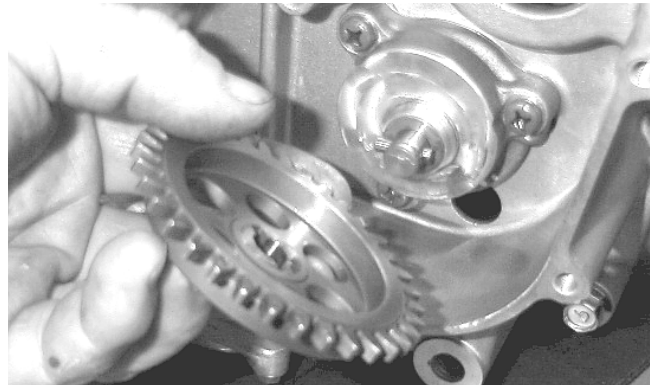

MD1020

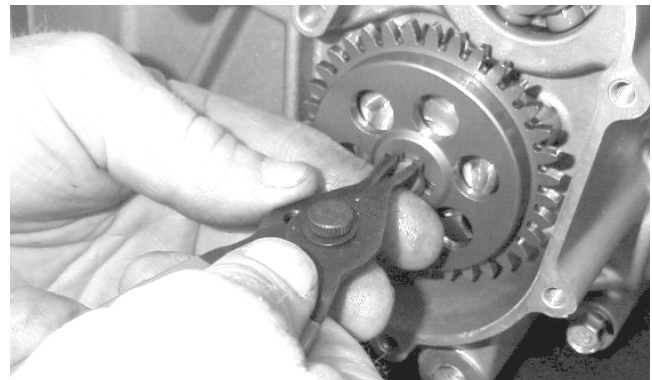

MD1019

5. Install the cam chain.

■NOTE: Keep tension on the cam chain to avoid damaging the crankcase boss.

6. Place the pin into position, install the oil pump drive gear, and tighten the cap screw (coated with red Loctite #271) to 63 ft-lb.

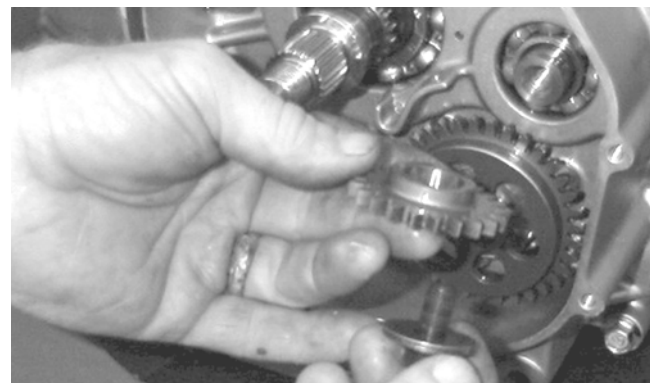

MD1017



MD1018

7. Install the clutch shoe assembly on the crankshaft; then install the flange nut (left-hand thread) (coated with red Loctite #271). Tighten to 147 ft-lb.

■NOTE: The flat side of the flange nut should be directed towards the clutch shoe.

CAUTION

Care must be taken when installing the flange nut; it has "left-hand" threads.

8. Install the one-way clutch making sure that the green dot or the word OUTSIDE is directed away from the crankcase.

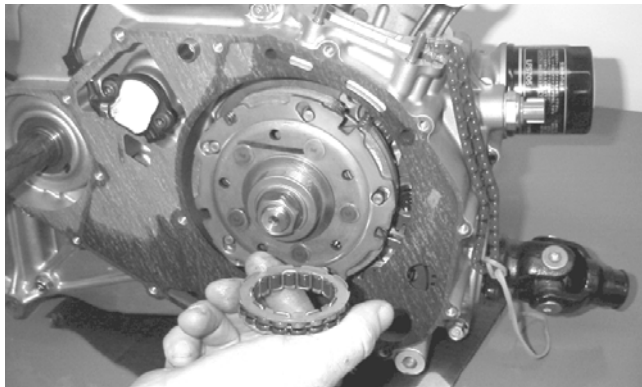

MD1286

- B. Clutch Cover
- C. Fixed Drive Face
- D. Movable Drive Face

■NOTE: Steps 1-8 in the preceding sub-section must precede this procedure.

9. Install two alignment pins and place the clutch cover gasket into position. Install the clutch cover.

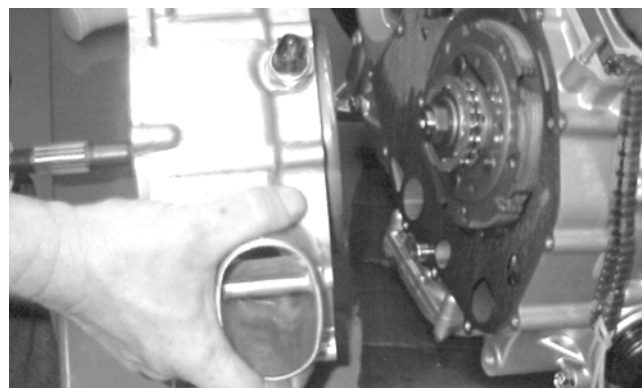

MD1115

10. Tighten the clutch cover cap screws to 8 ft-lb.

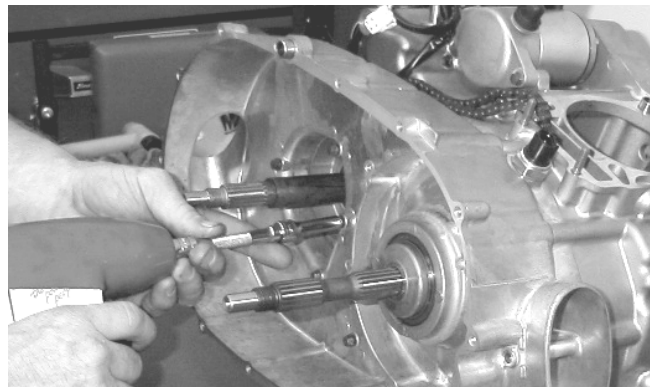

MD1117

11. Install the air intake plate. Apply red Loctite #271 to the threads of the three Phillips-head cap screws; then install and tighten securely.

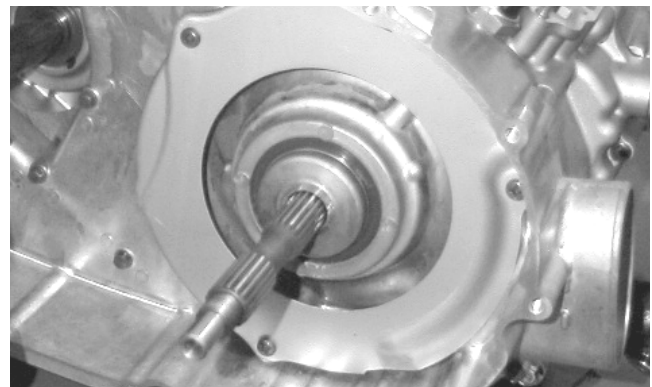

MD1342

12. Place the driven pulley assembly into position and secure with the nut (threads coated with red Loctite #271). Tighten to 147 ft-lb.

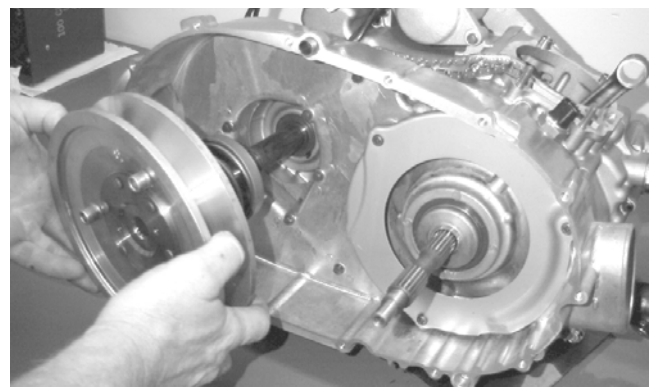

MD1068



KC134

- Slide the fixed drive face assembly onto the front shaft.
- Spread the faces of the driven pulley by threading a V-belt cover cap screw into the fixed driven face and tightening until the faces open sufficiently to allow the V-belt to drop into the pulley approximately 3/4 in.

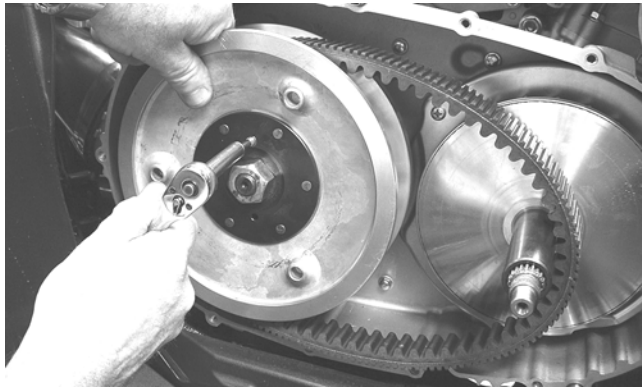

■NOTE: The arrows on the V-belt should point in direction of engine rotation.

- Making sure the movable drive face rollers are in position, pinch the V-belt together near its center and slide the spacer and movable drive face onto the shaft.

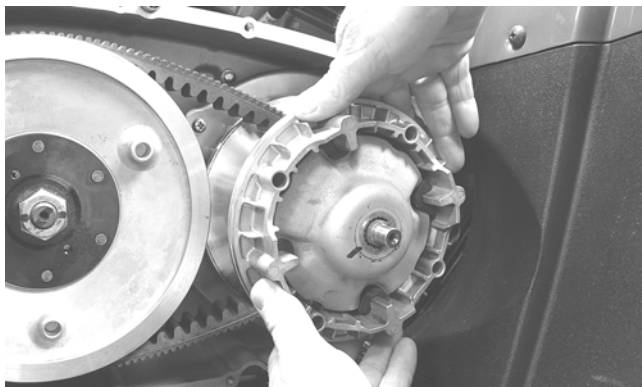

- Coat the threads of the nut with red Loctite #271; then making sure the splines of the clutch shaft protrude through the cover plate, secure with the nut and tighten to 147 ft-lb.

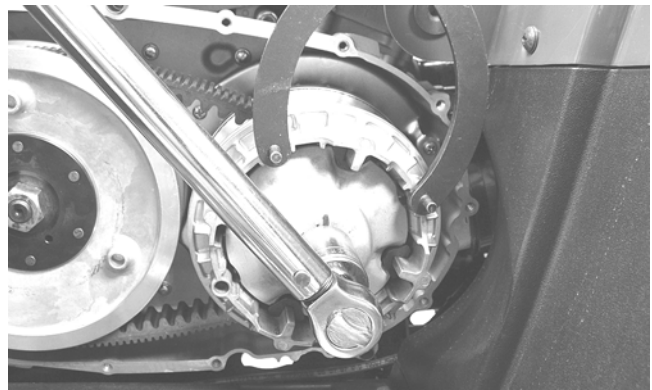

■NOTE: At this point, the cap screw can be removed from the driven pulley face.

- Rotate the V-belt and drive/driven assemblies until the V-belt is flush with the top of the driven pulley.
- Install two alignment pins and place a new V-belt cover gasket into position on the clutch cover. In a crisscross pattern, tighten cap screws to 8 ft-lb.

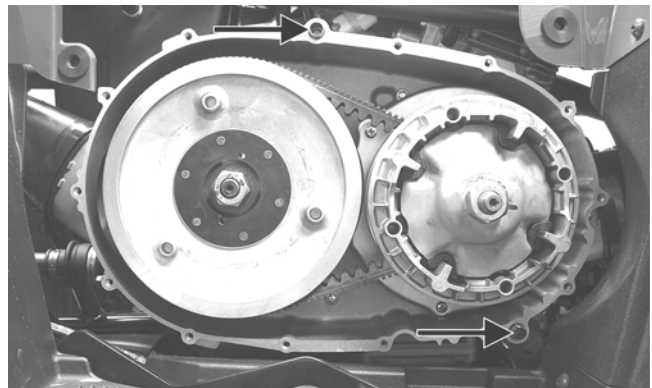

Center Crankcase Components

■NOTE: This procedure cannot be done with the engine/transmission in the frame. Complete Removing procedures for Top-Side, Left-Side, and Right-Side must precede this procedure.

■NOTE: For efficiency, it is preferable to remove and disassemble only those components which need to be addressed and to service only those components. The technician should use discretion and sound judgment.

Separating Crankcase Halves

- Remove the left-side and right-side cap screws securing the crankcase halves noting the position of the different-sized cap screws for joining purposes.

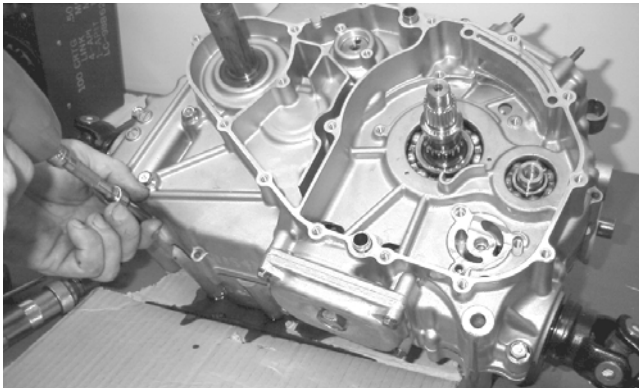

MD1006

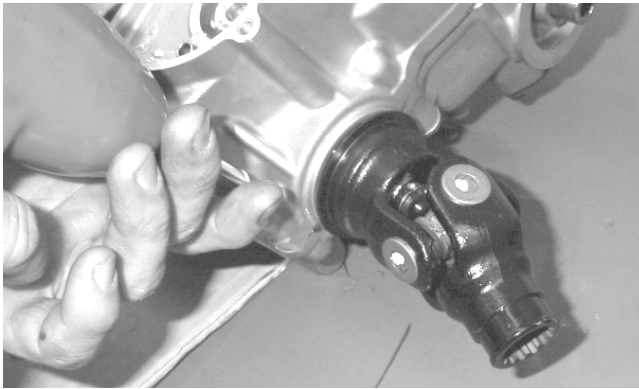

MD1012

2. Using Crankcase Separator/Crankshaft Remover and tapping lightly with a rubber mallet, separate the crankcase halves. Account for two alignment pins.

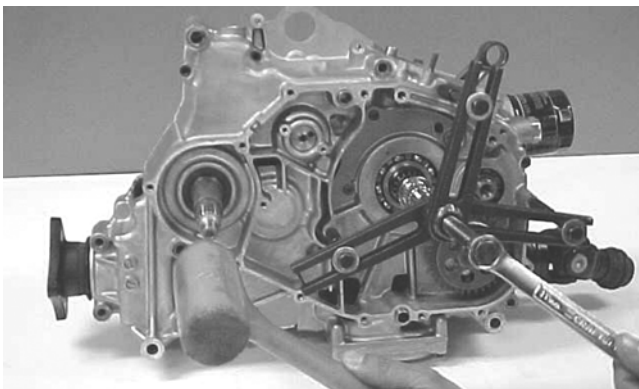

CC869

■NOTE: To keep the shaft/gear assemblies intact for identification, tap the shafts toward the left-side crankcase half when separating the halves.



MD1013

Disassembling Crankcase Half

■NOTE: To aid in installing, keep the assemblies together and in order.

■NOTE: For steps 1-6, refer to illustration FI639A.

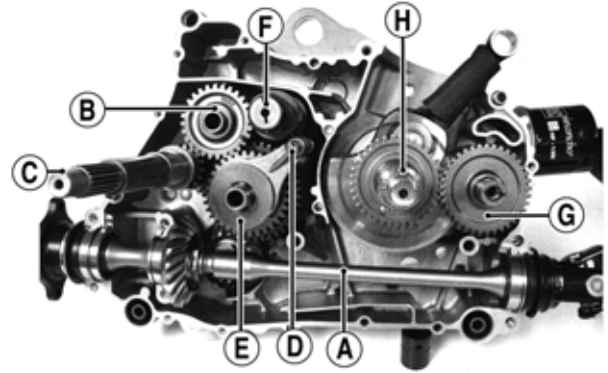

FI639A

1. Remove the secondary driven shaft assembly (A) noting the location of the front and rear bearing locating pins and the center bearing locating ring.

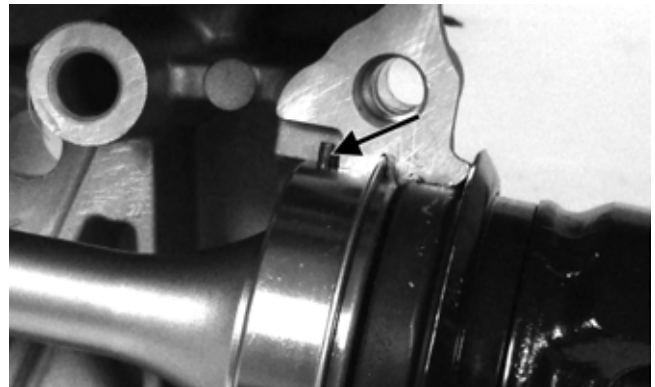

FI660A

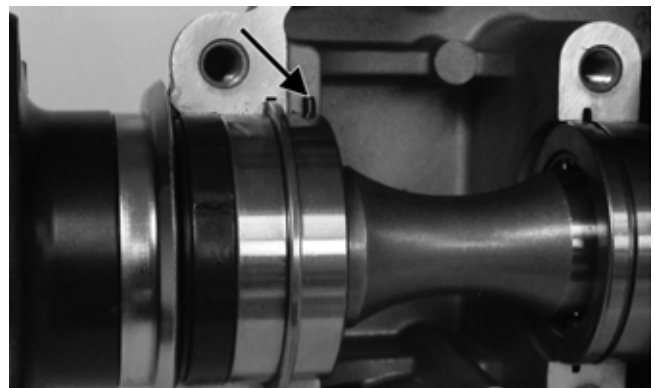

FI659A

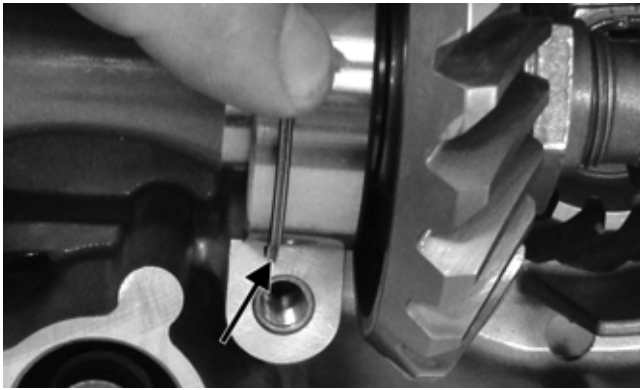

FI661A

2. Remove the reverse idler assembly (B). Account for and note the location of the inner bushing (1), idler shaft (2), and outer washer (3).

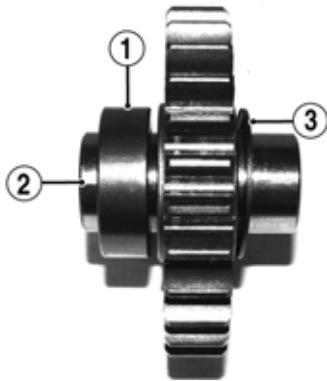

FI641A

3. Remove the driveshaft (C); then pull the shift fork locating shaft (D) out of the crankcase locating boss and allow the shift forks to disengage from the gear shift shaft (F).



FI646



FI656A

4. Remove the gear shift shaft (F) noting the inner and outer washers.



FI650A

5. Remove the countershaft assembly (E) along with the shift fork assembly.

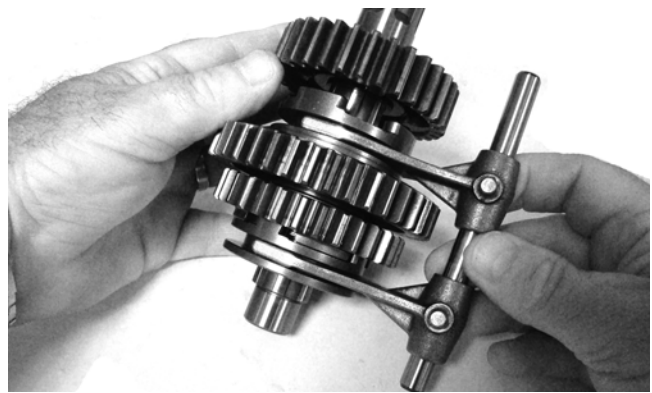

FI662

6. Remove the crank balancer driven gear (G) and account for a key; then remove the crankshaft balancer shaft.

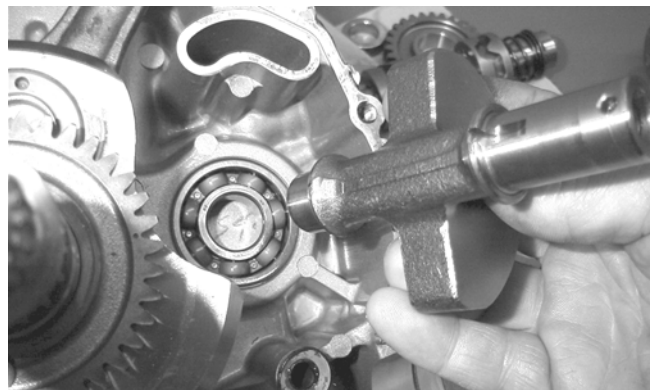

MD1024

7. Using Crankcase Separator/Crankshaft Remover with the appropriate crankshaft protector, remove the crankshaft.

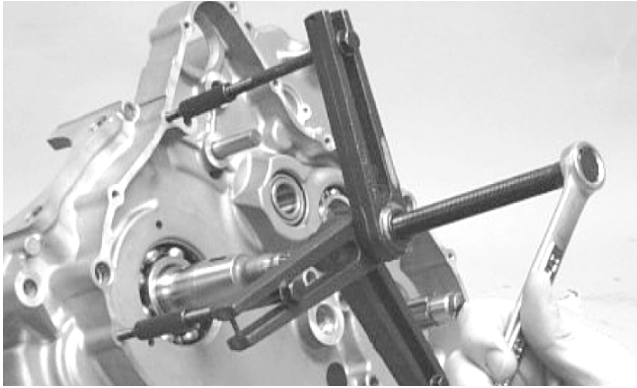

MD1330

CAUTION

Do not remove the remaining output shaft assembly unless absolutely necessary. If the shaft is removed, the shaft nut must be replaced with a new one and the shaft must be re-shimmed.

- Remove the secondary drive gear/secondary driven gear retaining nut. From inside the crankcase using a rubber mallet, drive out the output shaft assembly. Account for the output shaft, a shim, a washer, and the nut.

⚠ AT THIS POINT

To service crankshaft assembly, see Servicing Center Crankcase Components sub-section.

Servicing Center Crankcase Components

■NOTE: Whenever a part is worn excessively, cracked, damaged in any way, or out of tolerance, replacement is necessary.

SECONDARY GEARS

■NOTE: When checking and correcting secondary gear backlash and tooth contact, the universal joint must be secured to the front shaft or false measurements will occur.

Checking Backlash

■NOTE: The rear shaft and bevel gear must be removed for this procedure. Also, always start with the original shims on the rear shaft.

- Place the left-side crankcase cover onto the left-side crankcase half to prevent runout of the secondary transmission output shaft.
- Install the secondary driven output shaft assembly onto the crankcase.
- Mount the indicator tip of the dial indicator on the secondary driven bevel gear (centered on the gear tooth).

- While rocking the driven bevel gear back and forth, note the maximum backlash reading on the gauge.
- Acceptable backlash range is 0.05-0.33 mm (0.002-0.013 in.).

Correcting Backlash

■NOTE: If backlash measurement is within the acceptable range, no correction is necessary.

- If backlash measurement is less than specified, remove an existing shim, measure it, and install a new thinner shim.
- If backlash measurement is more than specified, remove an existing shim, measure it, and install a thicker shim.

■NOTE: Continue to remove, measure, and install until backlash measurement is within tolerance. Note the following chart.

Backlash Measurement	Shim Correction
Under 0.05 mm (0.002 in.)	Decrease Shim Thickness
At 0.05-0.33 mm (0.002-0.013 in.)	No Correction Required
Over 0.33 mm (0.013 in.)	Increase Shim Thickness

Checking Tooth Contact

■NOTE: After correcting backlash of the secondary driven bevel gear, it is necessary to check tooth contact.

- Remove the secondary driven output shaft assembly from the left-side crankcase half.
- Clean the secondary driven bevel gear teeth of old oil and grease residue.
- Apply a thin, even coat of a machinist-layout dye to several teeth of the gear.
- Install the secondary driven output shaft assembly.
- Rotate the secondary driven bevel gear several revolutions in both directions.
- Examine the tooth contact pattern in the dye and compare the pattern to the illustrations.

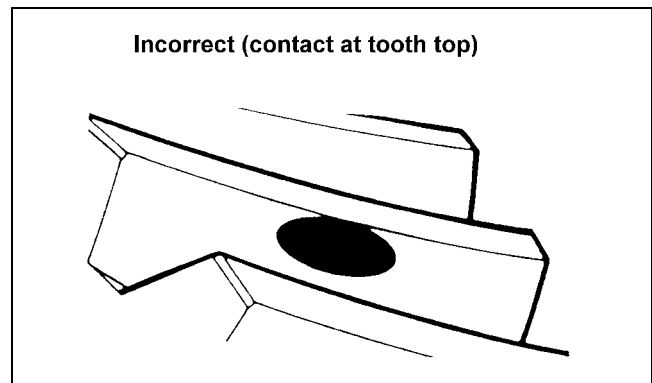

ATV-0103

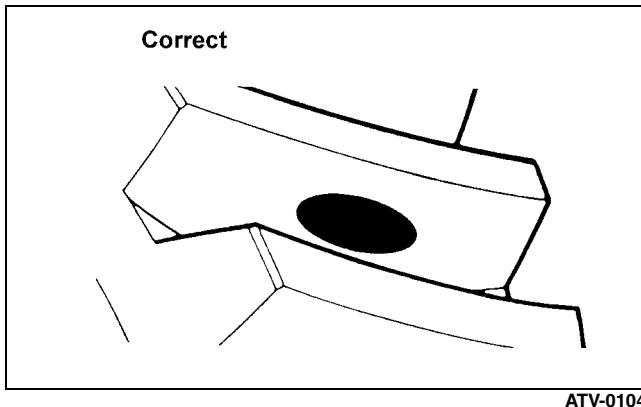
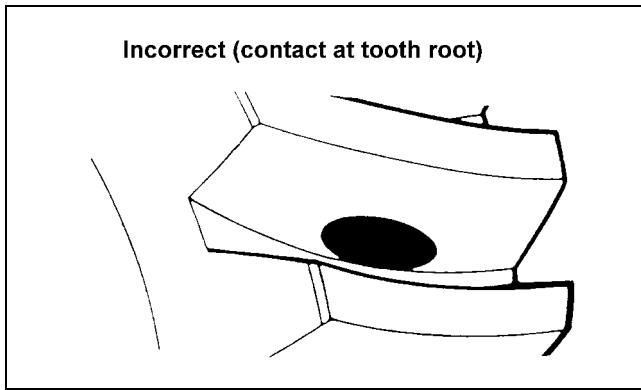

Correcting Tooth Contact

■NOTE: If tooth contact pattern is comparable to the correct pattern illustration, no correction is necessary.

If tooth contact pattern is comparable to an incorrect pattern, correct tooth contact according to the following chart.

Tooth Contact	Shim Correction
Contacts at Top	Decrease Shim Thickness
Contacts at Root	Increase Shim Thickness

■NOTE: To correct tooth contact, steps 1 and 2 (with NOTE) of “Correcting Backlash” must be followed and the above “Tooth Contact/Shim Correction” chart must be consulted.

CAUTION

After correcting tooth contact, backlash must again be checked and corrected (if necessary). Continue the correcting backlash/correcting tooth contact procedures until they are both within tolerance values.

CRANKSHAFT ASSEMBLY

■NOTE: The crankshaft and connecting rod is a non-serviceable assembly. If any component is out of specification, the assembly must be replaced.

Measuring Connecting Rod (Small End Inside Diameter)

1. Insert a snap gauge into the upper connecting rod small end bore; then remove the gauge and measure it with micrometer.

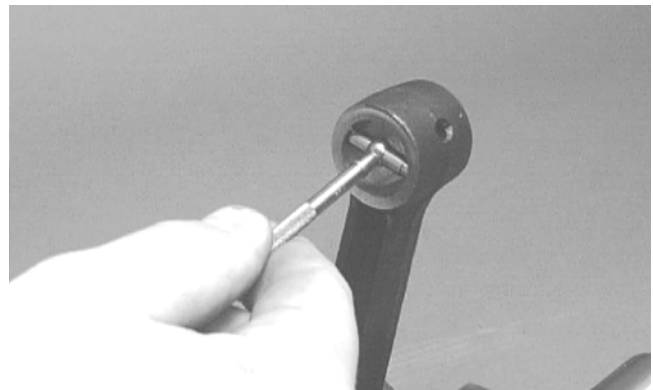

2. Maximum diameter must not exceed specifications.

Measuring Connecting Rod (Small End Deflection)

1. Place the crankshaft on a set of V blocks and mount a dial indicator and base on the surface plate. Position the indicator contact point against the center of the connecting rod small end journal.
2. Zero the indicator and push the small end of the connecting rod away from the dial indicator.
3. Maximum deflection must not exceed specifications.

Measuring Connecting Rod (Big End Side-to-Side)

1. Push the lower end of the connecting rod to one side of the crankshaft journal.
2. Using a feeler gauge, measure the gap between the connecting rod and crankshaft journal.

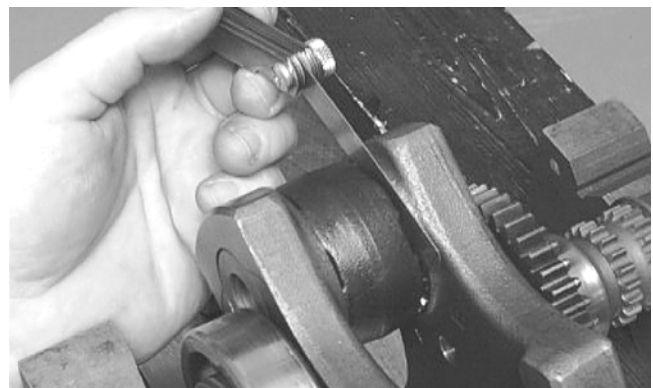

3. Acceptable gap range must be within specifications.

Measuring Crankshaft (Runout)

1. Place the crankshaft on a set of V blocks.
2. Mount a dial indicator and base on the surface plate. Position the indicator contact at point 1 of the crankshaft.

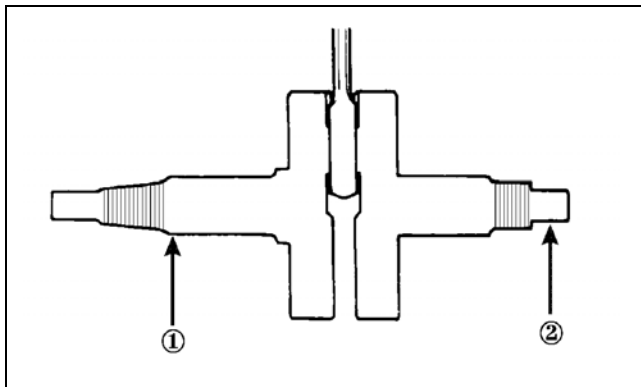

ATV-1074

3. Zero the indicator and rotate the crankshaft slowly.

CAUTION

Care should be taken to support the connecting rod when rotating the crankshaft.

4. Maximum runout must not exceed specifications.

■NOTE: Proceed to check runout on the other end of the crankshaft by positioning the indicator contact at point 2 and following steps 3-4.

Measuring Crankshaft (Web-to-Web)

1. Using a calipers, measure the distance from the outside edge of one web to the outside edge of the other web.

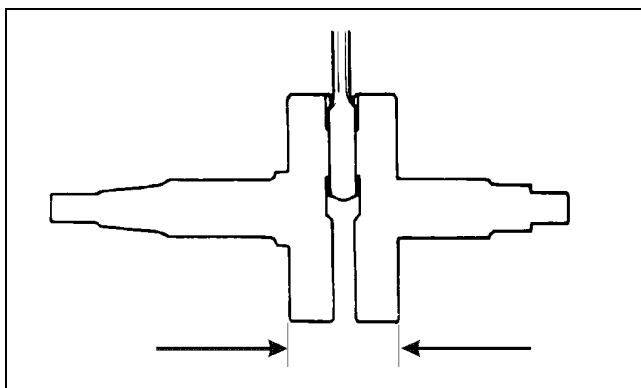

ATV-1017

2. Acceptable width range must be within specifications.

COUNTERSHAFT

CAUTION

When disassembling the countershaft, care must be taken to note the direction each major component (dog, gear) faces. If a major component is installed facing the wrong direction, transmission damage may occur and/or the transmission will malfunction. In either case, complete disassembly and assembly will be required.

Disassembling

1. Remove the reverse driven gear dog; then remove the circlip securing the reverse driven gear.



F1663



F1664

2. Remove the splined washer; then remove the reverse driven gear along with the bearing and bushing.



F1665

3. Remove the low driven gear washer; then remove the low driven gear along with the bearing and bushing.

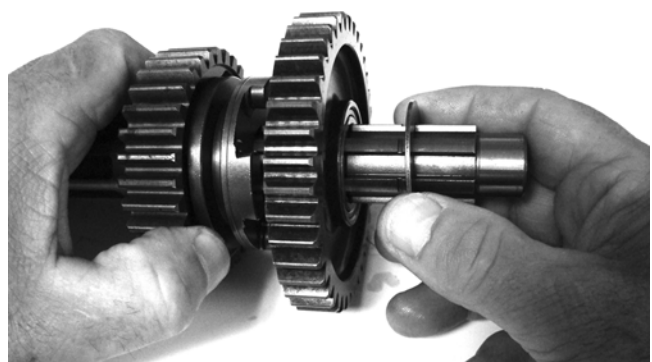

F1666



F1667

4. Remove the splined washer; then remove the circlip securing the high-low sliding dog. Remove the sliding dog.



F1668



F1671

ASSEMBLING

1. With the high driven washer (1) on the countershaft, install the high driven gear bushing (3), bearings (2), and gear (4) on the countershaft; then install the washers (5) and secure with the snap-ring.



F1671A

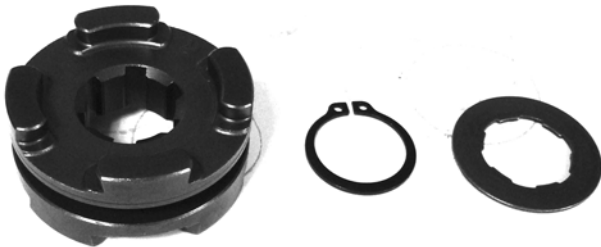

F1669

5. Remove the circlip securing the high driven gear; then remove a washer, the high driven gear along with the bearing and bushing, and remove the high driven washer.



F1670



F1670

2. Install the high/low shift dog (6) on the countershaft and secure with snap-ring (7); then install the splined washer (8).

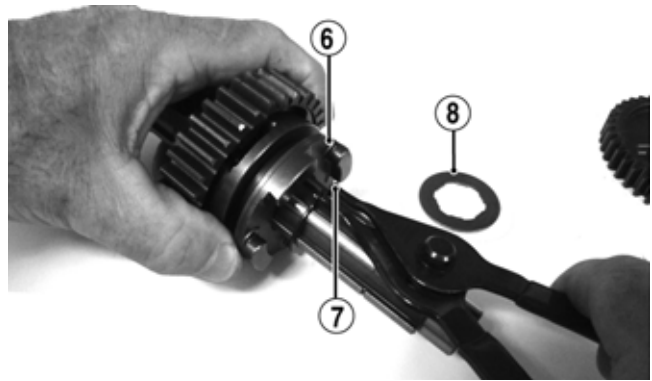

F1668A

3. Install the low driven bushing (10), bearing (9), and gear (11) on the countershaft; then install splined washer (12).

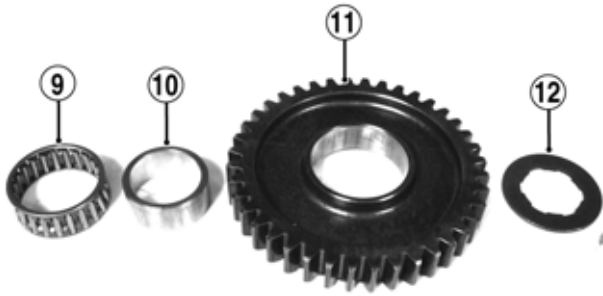

F1667A

5. Install the reverse dog on the shaft; then place the shift forks and shift shaft into position.

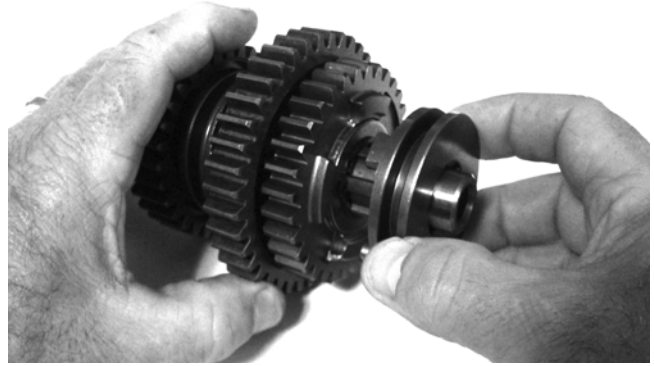

F1663

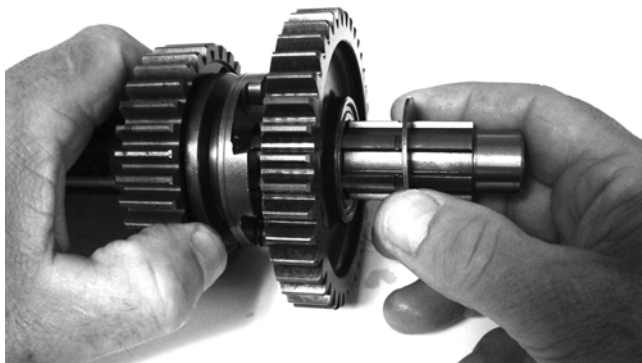

F1666

4. Place the reverse driven bushing (13) onto the shaft; then install the bearing (14), gear (15), and splined washer (16). Secure with a snap-ring.

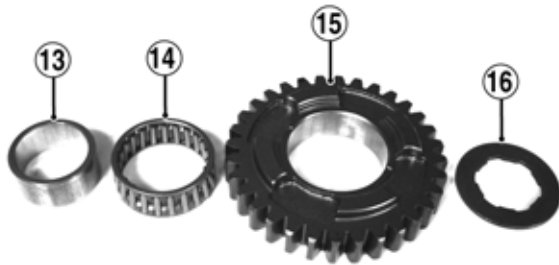

F1665A

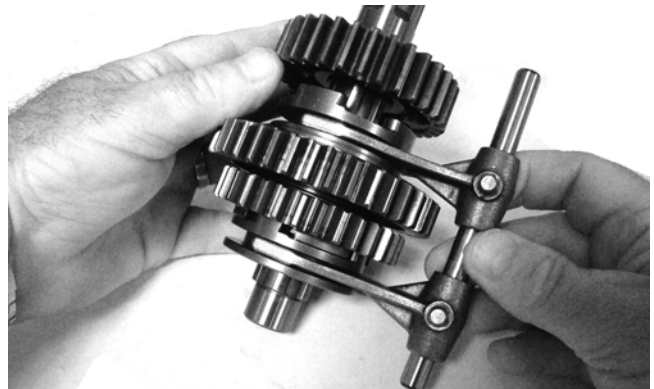

F1662

■NOTE: The countershaft assembly is now ready to be installed.

Assembling Crankcase Half

■NOTE: For ease of assembly, install components on the right-side crankcase half.

■NOTE: If the output shaft was removed, make sure that the proper shim is installed.

1. Install the output shaft into the crankcase making sure the two gears, shim, washer, and nut are in the correct order.



F1664

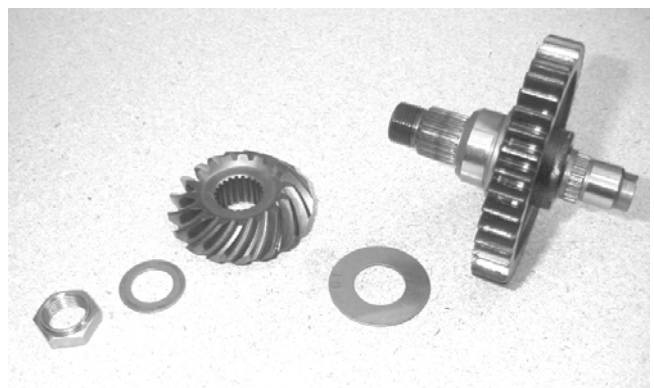

MD1199



MD1079

2. Install and tighten the output shaft flange nut to 59 ft-lb. Using a punch, peen the nut.

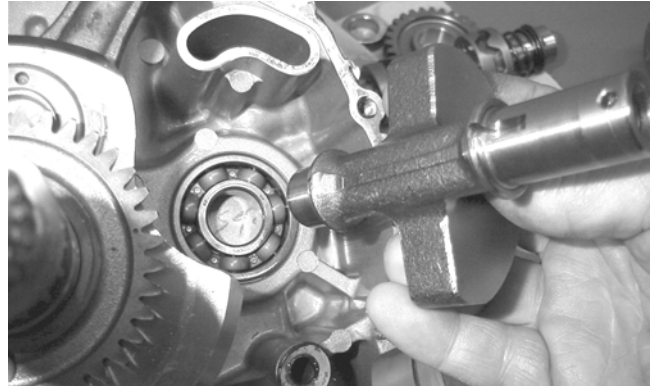

MD1024

5. Install the key in the crank balancer shaft; then install the gear and aligning the timing marks, slide the gear into place.

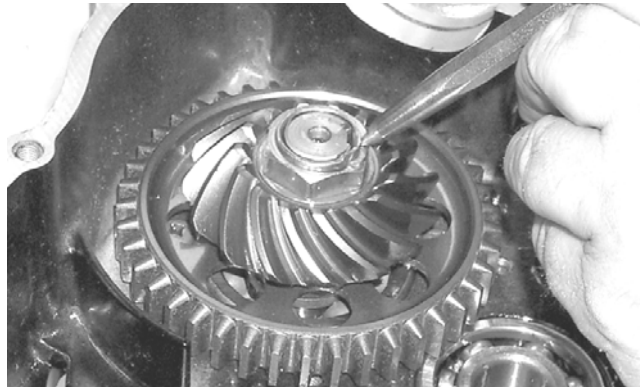

MD1333

3. Apply a liberal amount of oil to the crankshaft bearing. Using a propane torch, heat the bearing until the oil begins to smoke; then slide the crankshaft assembly into place.



F1658

6. Align the shift cam fork slots with the shift fork shaft locating boss and with a washer on each end, install in the crankcase.



MD1334

■NOTE: If heating the bearing is not possible, the crankshaft can be installed using a crankshaft installer.

4. Rotate the crankshaft so the counterweight is toward the rear of the engine. Install the crank balancer shaft.

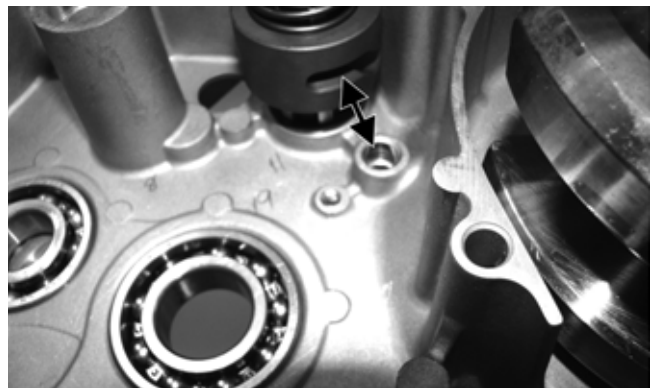

F1652A

7. Place the shift forks into position on the assembled countershaft and install into the crankshaft as an assembly.

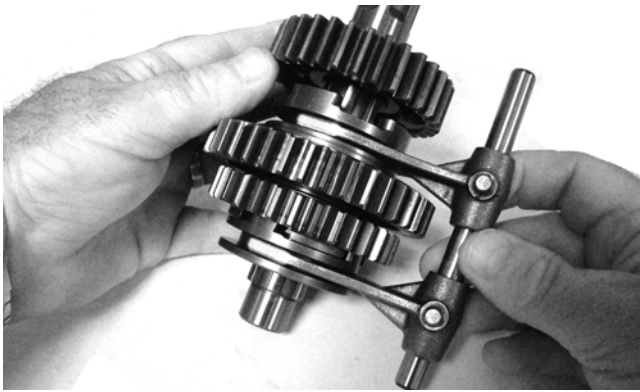

F1662



F1646

10. Install the spacer (1), shaft (2), reverse idler gear, and washer (3).

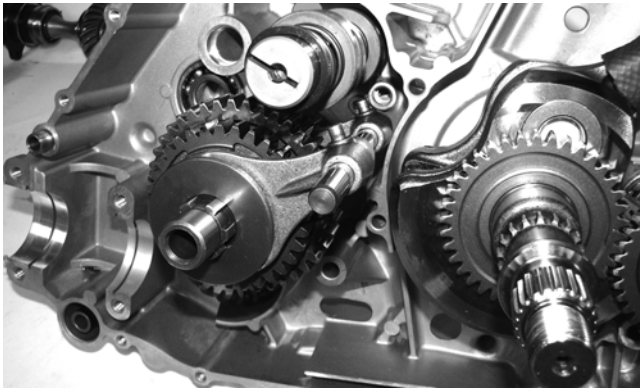

F1653

8. Align the shift forks to allow engagement with the shift cam; then engage the shift forks and slide the shift fork shaft into the locating boss in the crankcase.

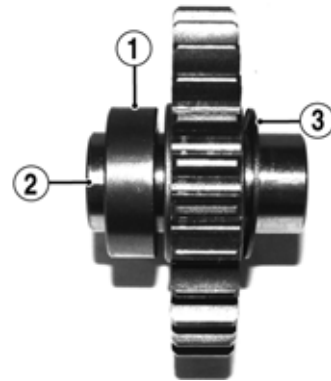

F1641A



F1653A

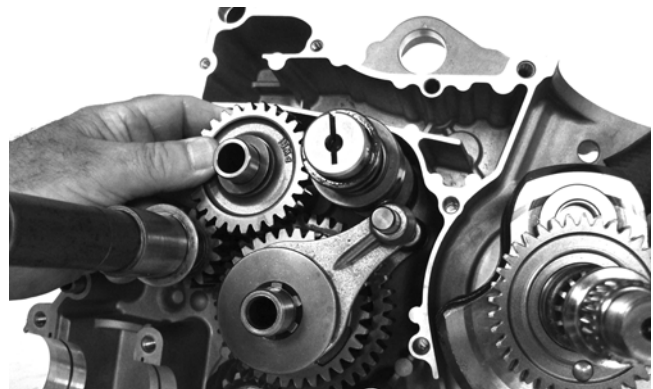

F1645

11. Install the secondary output driveshaft assembly into the crankcase half making sure the front and rear bearing alignment pins are seated in the recesses; then install the center carrier bearing alignment C-ring.



F1655A

9. Install the input driveshaft.

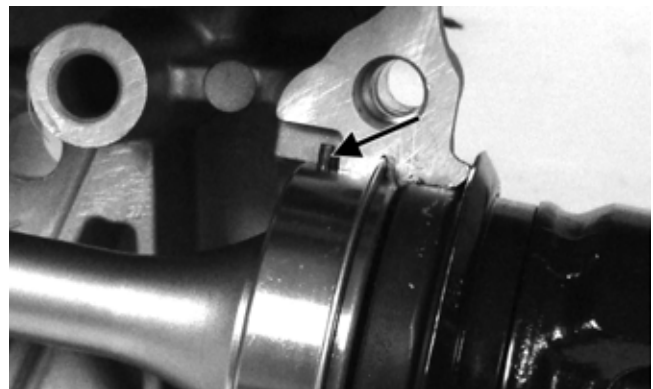

F1660A

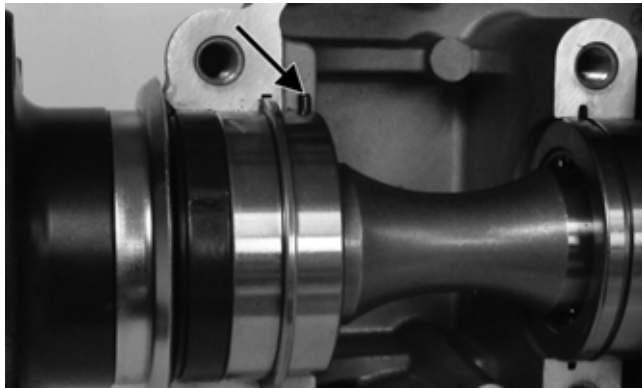

F1659A

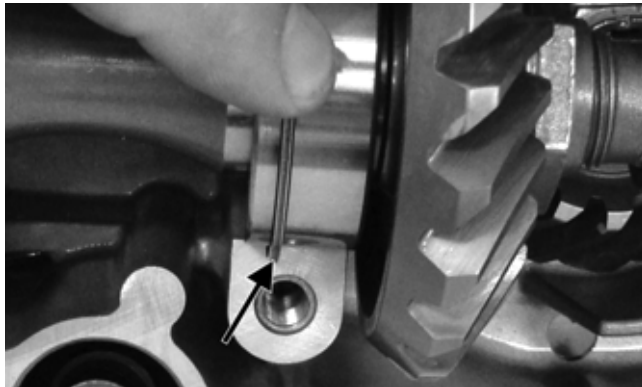

F1661A

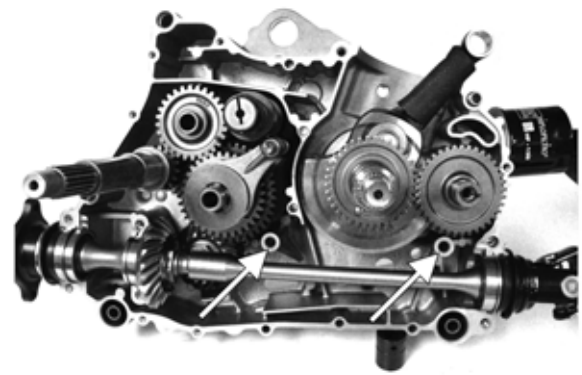

F1639C

2. Using a plastic mallet, lightly tap the case halves together until cap screws can be installed.
3. From the right side, install the crankcase cap screws noting the location of the different-sized cap screws; then tighten only until snug.

■NOTE: Rotate the shafts back and forth to ensure no binding or sticking occurs while tightening the cap screws.

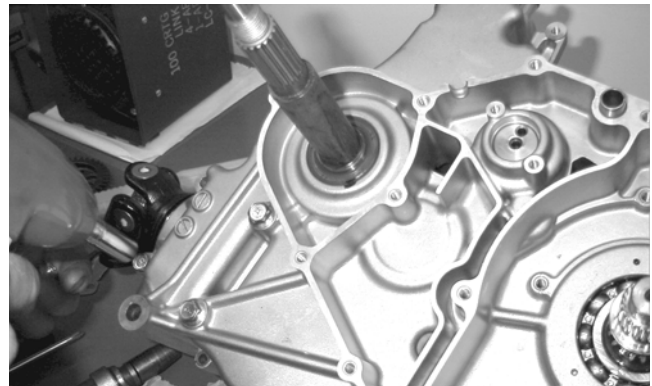

MD1008

Joining Crankcase Halves

1. Verify that the two alignment pins (A) are in place and that both case halves are clean and grease free. Apply Three Bond Sealant to the mating surfaces. Place the right-side half onto the left-side half.

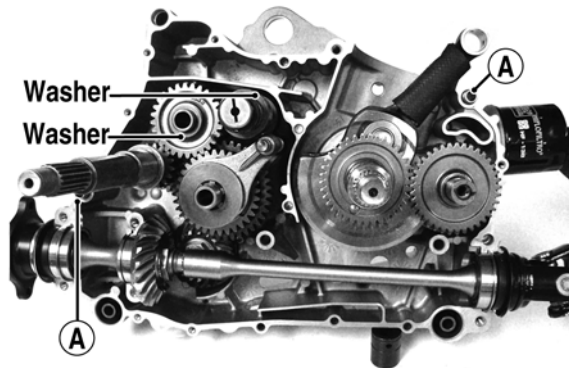

F1639B

■NOTE: Be sure to apply sealant to the inside radius of all cap screw locations and the entire surface of the internal cap screw bosses.

4. From the left side, install the remaining crankcase cap screws; then tighten only until snug.

■NOTE: Rotate the shafts back and forth to ensure no binding or sticking occurs while tightening the cap screws.

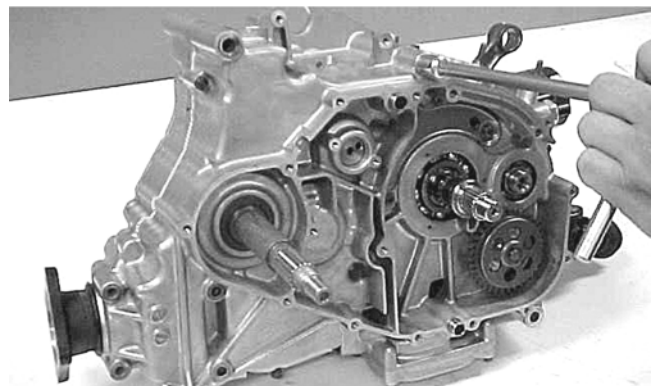

CC871

5. In a crisscross pattern, tighten the 8 mm cap screws until the halves are correctly joined; then tighten to 21 ft-lb.

■NOTE: Rotate the shafts back and forth to ensure no binding or sticking occurs.

- In a crisscross pattern, tighten the 6 mm cap screws to 10 ft-lb.

■NOTE: Rotate the shafts back and forth to ensure no binding or sticking occurs.

AT THIS POINT

After completing center crankcase components, proceed to Installing Right-Side Components, to Installing Left-Side Components, and to Installing Top-Side Components.

Installing Engine/ Transmission

- From the left side, place the engine into the frame (rear of engine first) tilting the rear up to allow cylinder head to clear frame.
- With engine moved rearward, engage the splines of the front driveline into the front output drive yoke; then move into position and install the two through-bolts. Secure with lock nuts and tighten to 38 ft-lb.
- Install the four cap screws securing the rear driveline to the output drive flange and tighten to 20 ft-lb.
- Connect coolant hoses (A) and (B) to the water pump and connect the upper coolant hose to the thermostat housing. Tighten all clamps securely.

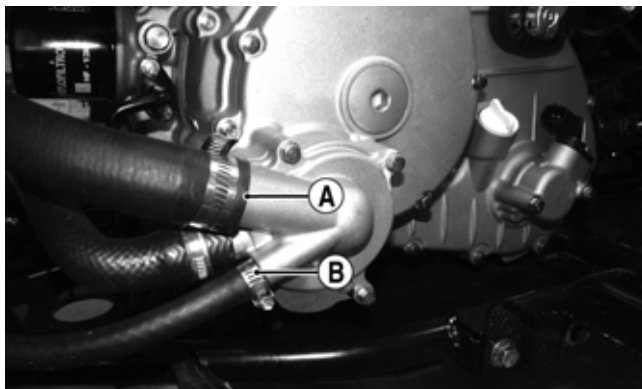

FI530B

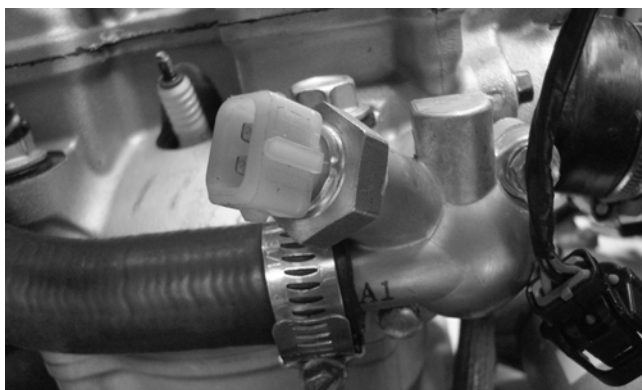

FI537

- Install the spark plug cap on the spark plug; then install the throttle body into the intake boot and tighten the intake clamp to 30 in.-lb.



FI695A

- Connect the stator connector (H) and crankshaft position sensor connector (I) to the main harness; then connect the positive cable to the starter motor and tighten securely.



FI534A

- Connect the engine ground cable to the starter mounting flange and secure with a cap screw tightened to 8 ft-lb.
- From the top side, install the ECT sensor connector (C), fuel injector connector (D), MAP sensor connector (E), ISC connector (F), and the TPS connector (G).

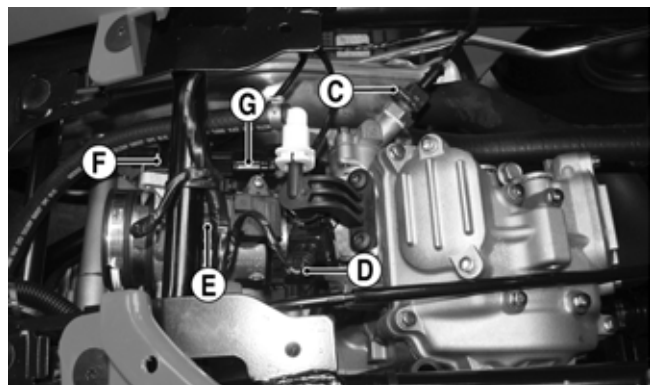

FI522A

- Place the air filter assembly into position and connect the crankcase breather securing with the clamp, then connect the air inlet boot to the throttle body and secure with a hose clamp.

10. Install the exhaust pipe using a new seal at the cylinder head and loosely install the retaining cap screws; then install the muffler with a new grafoil seal and secure with two springs. Tighten the exhaust pipe retainer cap screws to 20 ft-lb.
11. Connect the air ducts to the CVT housing and tighten the clamps securely; then connect the air inlet tube to the throttle body and secure with the clamps.
12. Install the gas tank (see Fuel/Lubrication/Cooling) and connect the negative battery cable; then install the battery case access cover.
13. From the left side, install the gear position switch connector (A) and the speed sensor connector (B).

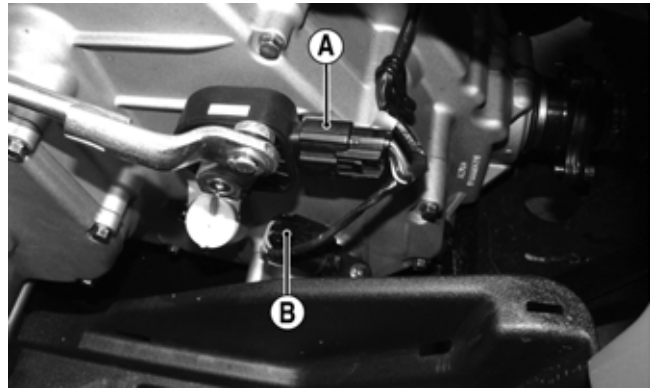

F1525A

14. Pour the specified amount of coolant into the radiator and the specified amount and grade of oil into the engine.
15. Install the water pump splash guard and left footwell. Tighten all fasteners securely.
16. Install the seat making sure it locks securely in place; then start the engine and allow to warm up while checking for leaks.
17. Shut engine off and inspect coolant and oil levels. Add fluids as required.

Fuel/Lubrication/Cooling

SPECIAL TOOLS

A number of special tools must be available to the technician when performing service procedures in this section. Refer to the current Special Tools Catalog for the appropriate tool description.

Description	p/n
Oil Pressure Test Kit	0644-495
Tachometer	0644-275
Fuel Pressure Test Kit	0644-571

■NOTE: Special tools are available from the Arctic Cat Service Department.

Electronic Fuel Injection

⚠ WARNING

Whenever any maintenance or inspection is performed on the fuel system during which there may be fuel leakage, there should be no welding, smoking, open flames, etc., in the area.

TROUBLESHOOTING

1. Verify that the electric fuel pump is operating by listening for a “whirring” sound for several seconds after the ignition switch is turned to the ON position. If no sound can be heard, see Electric Fuel Pump/Fuel Level Sensor in this section.
2. Check for a flashing Diagnostic Trouble Code (DTC) and a Malfunction Indicator Light (MIL) in the form of a wrench icon on the LCD. If a code is flashing, see Diagnostic Trouble Codes (DTC) in Electrical System.
3. Make sure there is sufficient, clean gas in the gas tank.
4. Verify that the battery is sufficiently charged to crank the engine over at normal speed.
5. Check the air filter housing and air filter for contamination. Clean or replace as necessary (see Periodic Maintenance).

Throttle Body

REMOVING

1. Remove the heat shields and seat.
2. Disconnect the negative battery cable; then remove the gas tank (see Gas Tank in this section).

⚠ WARNING

Gasoline may be under pressure. Place an absorbent towel under the connector to absorb any gasoline spray when disconnecting.

3. Loosen the clamp securing the intake boot to the throttle body; then loosen the clamp securing the intake boot to the intake housing and slide the intake housing rearward.

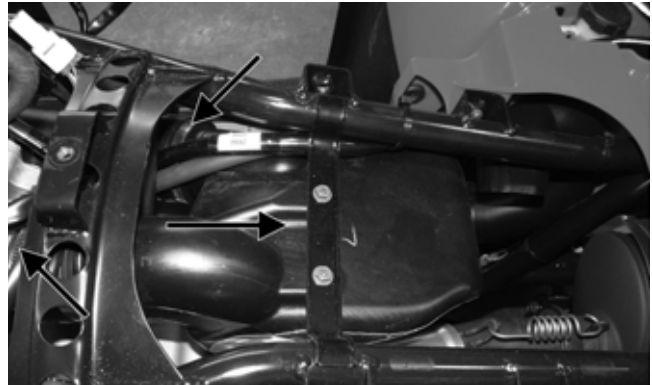

F1691A

4. Disconnect the MAP/IAT sensor connector, ISC connector, and TPS connector; then loosen the clamp securing the throttle body to the intake manifold boot and slide the throttle body out.

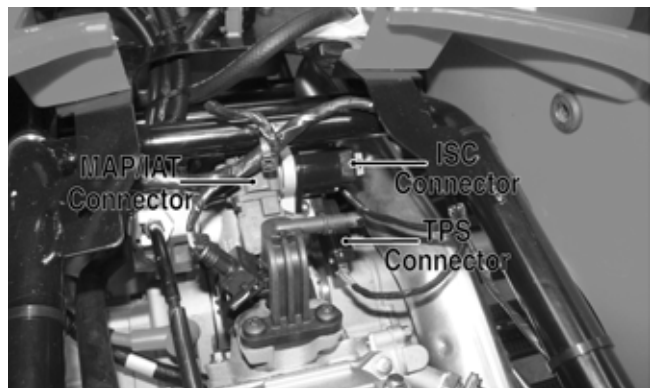

F1528A

5. Remove the throttle arm cover and loosen the throttle cable jam nut; then disconnect the throttle cable and remove the throttle body.

INSTALLING

1. Connect the throttle cable to the throttle arm; then install the throttle cable housing in the throttle body and tighten the jam nut. Install the throttle arm cover and secure with two machine screws.
2. Place the throttle body into the intake manifold boot and tighten the boot clamp securely.
3. Place the intake housing into the boots and tighten the boot clamps securely.
4. Install the gas tank; then the heat shields and seat.

Throttle Cable Free-Play

To adjust throttle cable free-play, see Periodic Maintenance.

Gas Tank

WARNING

Whenever any maintenance or inspection is made on the fuel system during which there may be fuel leakage, there should be no welding, smoking, open flames, etc., in the area.

REMOVING

1. Remove the battery case access cover from the battery case; then disconnect the negative battery cable and remove the seat.
2. Remove the reinstallable rivets securing the side panels (two on each side) and remove the side panels.



KC450A

■NOTE: The reinstallable rivets may be easily released by depressing the pin in the center of the head.

3. Remove two cap screws and four reinstallable rivets from the gas tank cover; then remove the gas tank cap and remove the cover panel. Reinstall the gas tank cap.

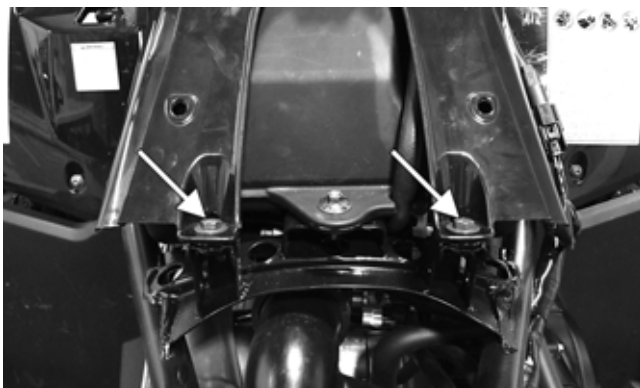

KC453A

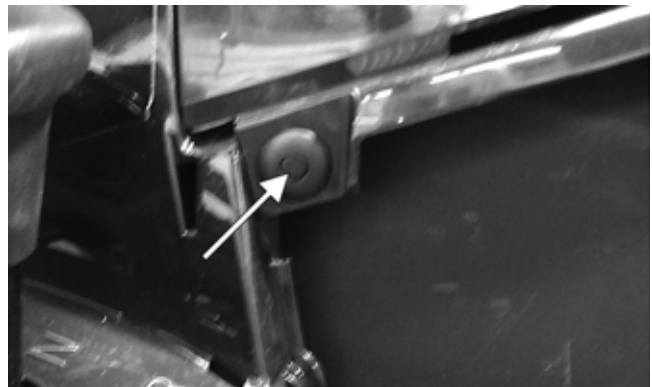

KC454A

4. Using a shop towel to catch any leaking gasoline, disconnect the gasoline hose from the fuel pump outlet; then disconnect the fuel pump/fuel gauge connector from the harness.



KC455



KC456

5. Remove the mounting bolt at the rear of the gas tank; then remove the gas tank.

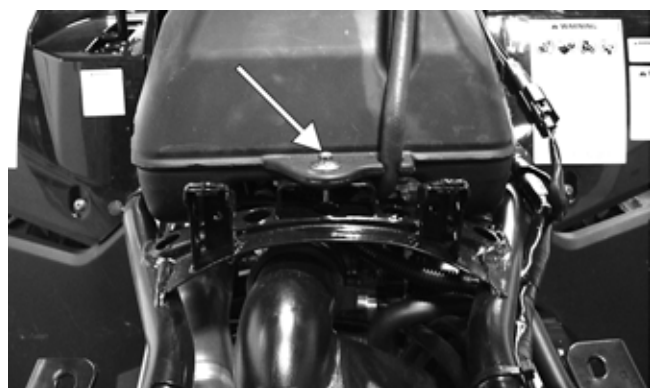

KC457A

6. Remove the heat shield by reaching under the front of the shield and compressing the retainer posts to release.

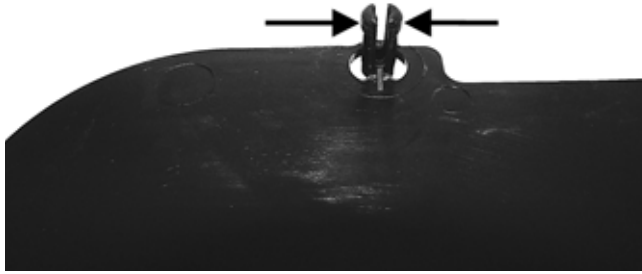

KC459A

CLEANING AND INSPECTING

■NOTE: Whenever a part is worn excessively, cracked, or damaged in any way, replacement is necessary.

1. Clean all gas tank components with parts-cleaning solvent.
2. Inspect all hoses for cracks or leaks.
3. Inspect tank cap and tank for leaks, holes, and damaged threads.

INSTALLING

1. Install the heat shield making sure the mounting studs lock in the bracket; then install the gas tank and secure with the mounting bolt. Tighten securely.

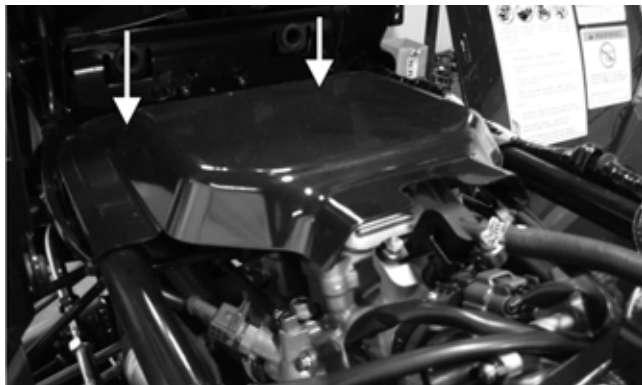

KC458A

2. Connect the gasoline connector to the fuel pump outlet making sure it locks securely in place; then connect the fuel pump/fuel gauge connector to the harness.
3. Remove the gas tank cap and place the gas tank cover over the gas tank. Install the gas tank cap; then secure the cover with two reinstallable rivets and two cap screws.
4. Install the side panels and secure with four reinstallable rivets making sure the tabs on the panels engage the slots on the gas tank cover.
5. Connect the negative battery cable and install the battery case access cover; then install the seat.

www.mymowerparts.com

Oil Filter/Oil Pump

■NOTE: Whenever internal engine components wear excessively or break and whenever oil is contaminated, the oil pump should be replaced. The oil pump is not a serviceable component.

Testing Oil Pump Pressure

1. Connect the Tachometer to the engine.
2. Connect the Oil Pressure Test Kit to the oil filter drain plug.

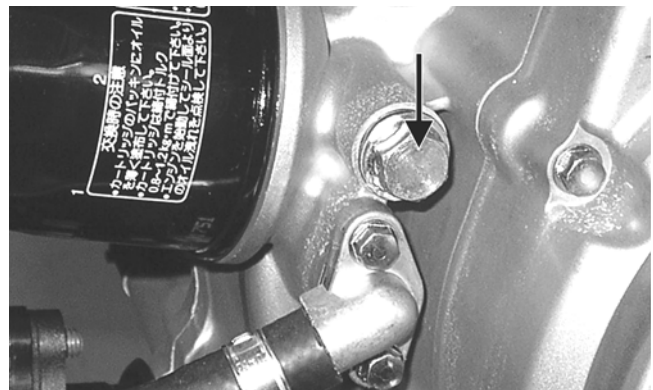

KC195A



KC267

■NOTE: Some oil seepage may occur when installing the oil pressure gauge. Wipe up oil residue with a cloth.

3. Warm up the engine to normal operating temperature (cooling fan cycling); then increase engine RPM to 3000 RPM. The oil pressure must read 0.6-0.7 kg/cm² (8.5-17 psi).

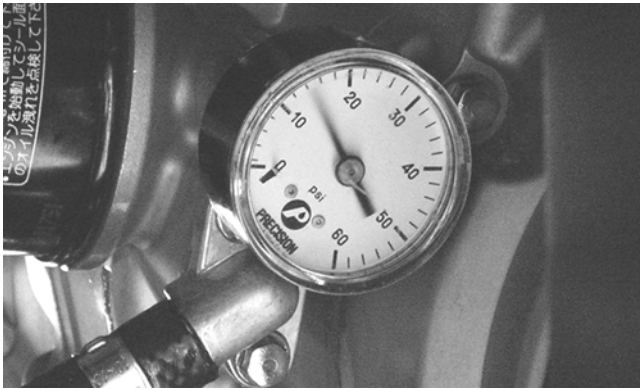

KC268

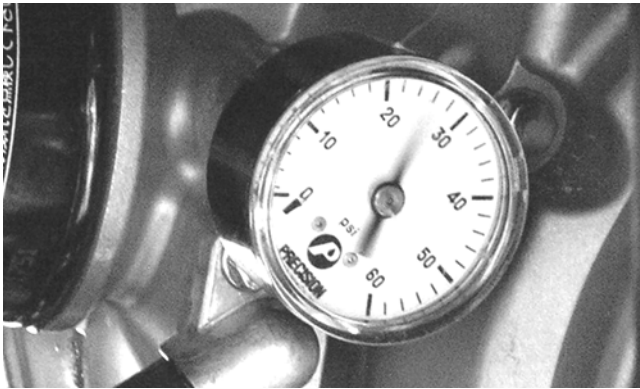

KC269

■NOTE: If the oil pressure is lower than specified, check for low oil level or defective oil pump.

■NOTE: If the oil pressure is higher than specified, check for clogged oil passage, clogged oil filter, or improper installation of the oil filter.

Liquid Cooling System

When filling the cooling system, use premixed Arctic Cat Antifreeze. While the cooling system is being filled, air pockets may develop; therefore, run the engine for five minutes after the initial fill, shut the engine off, and then fill the cooling system to the bottom of the stand pipe in the radiator neck.

CAUTION

After operating the ATV for the initial 5-10 minutes, stop the engine, allow the engine to cool down, and check the coolant level. Add coolant as necessary.

RADIATOR

Removing

1. Drain the coolant at the engine.
2. Remove the radiator/electrical access panel and front fender panel (see Steering/Frame).
3. Remove the upper and lower coolant hoses; then remove the fill hose and air bleed hose.
4. Remove the cap screws securing the radiator to the frame.

5. Disconnect the fan wiring from the main wiring harness; then remove the radiator/fan assembly and account for the grommets and collars.
6. Remove the fan/fan shroud assembly from the radiator.

Cleaning and Inspecting

■NOTE: Whenever a part is worn excessively, cracked, or damaged in any way, replacement is necessary.

1. Flush the radiator with water to remove any contaminants.
2. Inspect the radiator for leaks and damage.
3. Inspect all hoses for cracks and deterioration.
4. Inspect all fasteners and grommets for damage or wear.

Installing

1. Position the fan/fan shroud assembly on the radiator; then secure with existing hardware.
2. Place the radiator with grommets and collars into position on the frame; then install the cap screws. Tighten securely.
3. Install the upper and lower coolant hoses, fill hose, and air bleed hose; then secure with hose clamps.

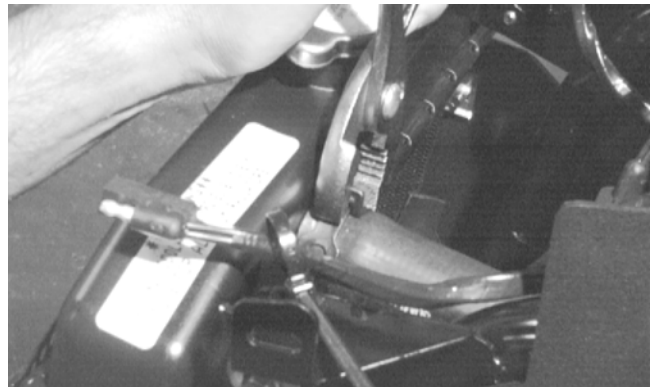

AF734D

4. Install the fender panel (see Steering/Frame).
5. Fill the cooling system with the recommended amount of antifreeze. Check for leakage.
6. Connect the fan wiring to the main wiring harness.

THERMOSTAT

Removing

1. Drain approximately one quart of coolant from the cooling system.
2. Remove the two cap screws securing the thermostat housing to the mounting bracket. Remove the thermostat housing cover and account for an O-ring and a thermostat.

Inspecting

■NOTE: Whenever a part is worn excessively, cracked, or damaged in any way, replacement is necessary.

1. Inspect the thermostat for corrosion or spring damage.
2. Using the following procedure, inspect the thermostat for proper operation.
 - A. Suspend the thermostat in a container filled with water.
 - B. Heat the water and monitor the temperature with a thermometer.
 - C. The thermostat should start to open at 71-86° C (160-187° F).
 - D. If the thermostat does not open, it must be replaced.
3. Inspect all coolant hoses, connections, and clamps for deterioration, cracks, and wear.

■NOTE: All coolant hoses and clamps should be replaced every four years or 4000 miles.

Installing

1. Place the thermostat and O-ring into the thermostat housing; then secure the thermostat housing to the mounting bracket with the two cap screws.
2. Fill the cooling system to the recommended level with antifreeze. Check for leakage.

WATER PUMP

■NOTE: The water pump is a non-serviceable component. It must be replaced as an assembly.

Removing

1. Remove the radiator cap; then remove the water pump drain and drain the coolant.

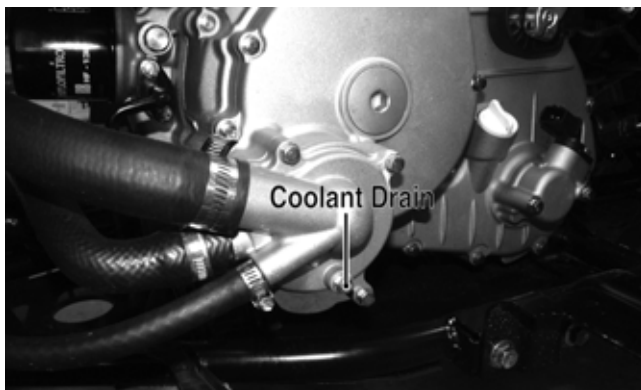

FI530A

2. Drain the oil from the engine/transmission.
3. Remove the four torx-head cap screws securing the front and rear fenders to the footrest; then remove the four cap screws securing the footrest to the frame. Remove the footrest.
4. Loosen the hose clamps and slide the clamps away from the hose ends approximately 2 in.; then remove the hoses from the water pump.
5. Remove the four cap screws securing the water pump to the engine; then remove the water pump.

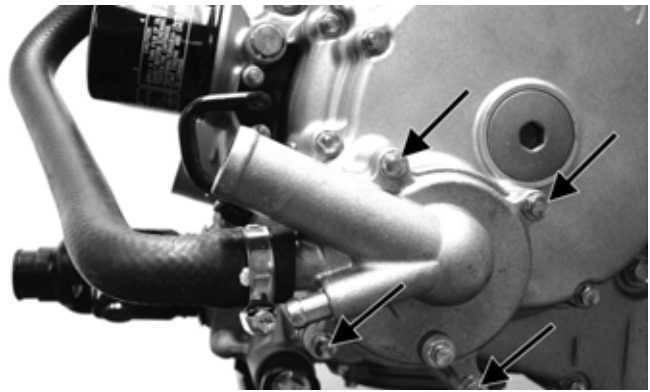

FI538A

Installing

1. Secure the water pump to the engine with the four cap screws tightened to 8 ft-lb.

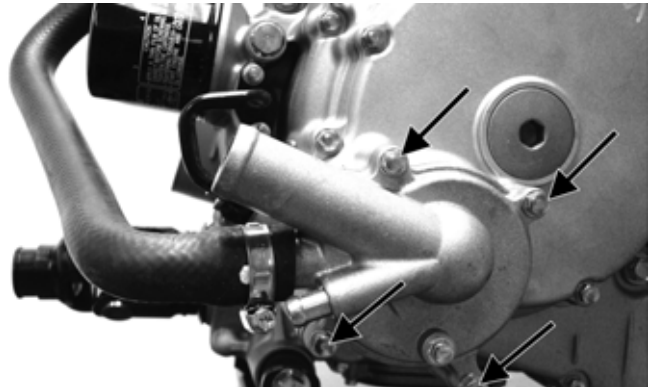

FI538A

2. Connect the coolant hoses to the water pump and secure with the clamps. Tighten securely.

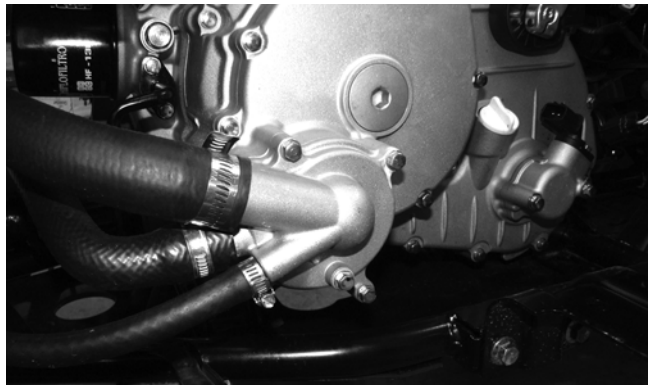

FI530

3. Place the footrest into position on the frame and loosely secure with four cap screws; then secure the front and rear fenders to the footrest with the four torx-head cap screws. Tighten the four torx-head cap screws securely; then tighten the remaining cap screws to 20 ft-lb.
4. Fill the engine/transmission with the proper amount of recommended oil.
5. Fill the cooling system with the proper amount of recommended coolant.

Electric Fuel Pump/Fuel Level Sensor

The electric fuel pump and fuel level sensor are not serviceable components. If either component fails, it must be replaced.

TESTING

⚠ WARNING

Whenever any maintenance or inspection is made on the fuel system during which there may be fuel leakage, there should be no welding, smoking, open flames, etc., in the area.

👉 AT THIS POINT

Prior to removing the electric fuel pump, the following check should be performed to determine that removal is necessary.

1. Turn the ignition switch ON and listen for a momentary “whirring” sound of the pump building pressure. If the sound is heard (10 seconds), no electrical checks are necessary. Turn the ignition switch OFF.
2. Disconnect the gasoline hose from the throttle body; then install a suitable pressure gauge.

⚠ WARNING

Gasoline may be under pressure. Place an absorbent towel under the connector to absorb any gasoline spray when disconnecting.

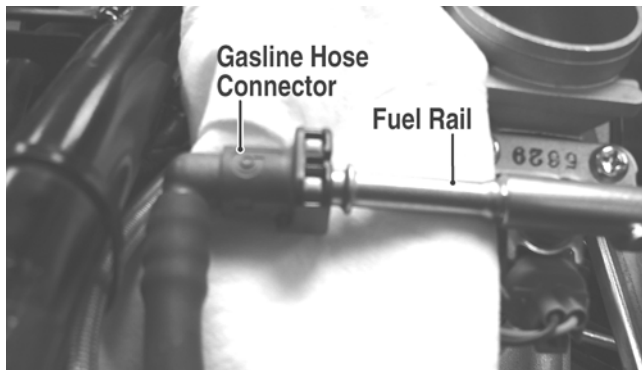

FI092A

3. Turn the ignition switch to the ON position. The fuel pressure should build until the pump shuts off. Pressure should read 3.0 kg-cm² (43 psi).
4. If the pump is not running, disconnect the fuel pump/tank sensor connector located behind the right side panel.
5. Connect a multimeter to the power supply leads with the red tester lead to the red wire and the black tester lead to the black wire; then turn the ignition switch to the ON position. The meter should read battery voltage. If battery voltage is indicated and the fuel pump does not run, replace the pump assembly. If no battery voltage is indicated, check the ECU and the vehicle tilt sensor.

REMOVING

1. Disconnect the negative battery cable from the battery.
2. Remove the side panels and gas tank cover (see Gas Tank in this section).

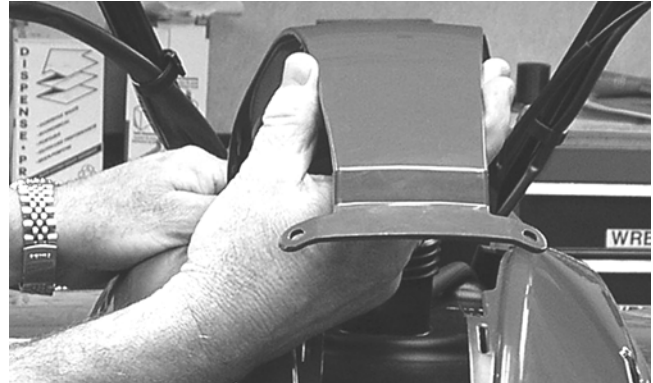

KC220

3. Mark the fuel pump and gas tank for proper orientation during assembly; then disconnect the fuel pump/fuel level sender connector.



KC423

4. Disconnect the gasoline connector from the fuel pump outlet.

⚠ WARNING

Gasoline may be under pressure. Place an absorbent towel under the connector to absorb any gasoline spray when disconnecting.

⚠ WARNING

Do not turn the ignition switch to the ON position with the hoses removed. Gasoline will be pumped by the electric fuel pump causing a safety hazard.

5. Remove the screws securing the fuel pump to the gas tank; then make a reference mark on the fuel pump and tank.
6. Lift out the fuel pump assembly and carefully guide the pump and float lever through the opening in the gas tank.

CAUTION

Take care not to damage the float or float arm or replacement of the entire assembly will be necessary.

- Using duct tape or other suitable means, cover the fuel pump opening.

INSPECTING

AT THIS POINT

If the pump has failed earlier test and must be replaced, proceed to INSTALLING.

- Inspect the fuel screen and blow clean with low pressure compressed air.
- Move the float lever and check for free movement. The float assembly should return to the lower position without force. If not, replace the fuel pump assembly.
- Test the fuel level sensor by connecting a multimeter (A) to the fuel level sensor leads (B); then select OHMS. The multimeter should show 5 ohms at full fuel position (C) and 95 ohms at empty fuel position (D).

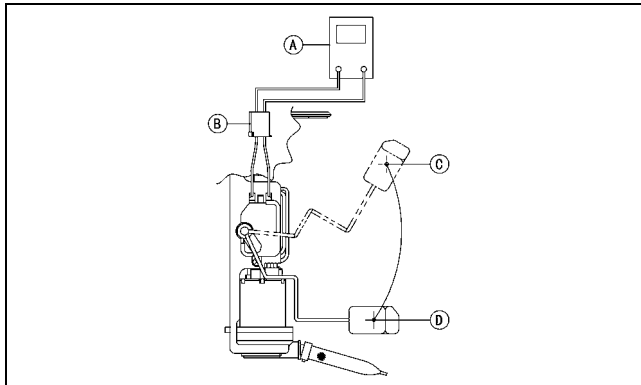

ATV2116

■NOTE: If readings are erratic, clean the resistor wiper and resistor with clean alcohol and retest. If still not correct, replace the fuel level sensor.

- To replace the fuel level sensor, use the following procedure.
 - Disconnect the two-wire connector (A); then press the fuel level sensor toward the top of the fuel pump to release it from the mounting slot (B).

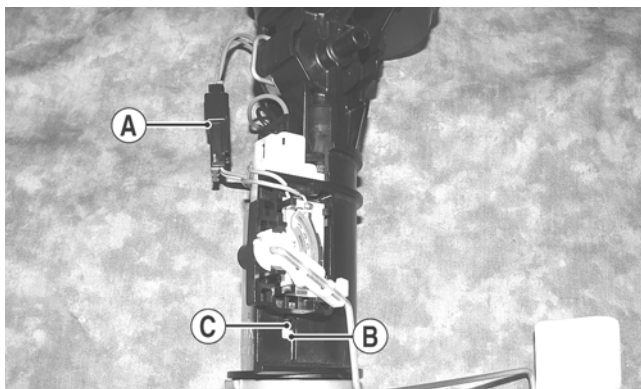

FI460A

- Engage the tabs (C) of the fuel level sensor into the mounting slot (B) and press toward the bottom of the fuel pump to latch in place; then connect the two-wire connector (A).

INSTALLING

- Mark the new fuel pump with a reference mark in the same location as the removed pump; then place the new gasket on the pump.
- Remove the material covering the fuel pump opening; then carefully guide the fuel pump into position taking care not to damage the float or float lever.

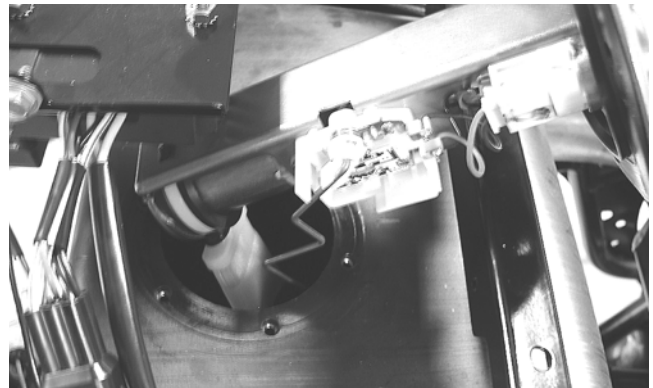

KX190

- Rotate the fuel pump until the match marks align; then install the mounting screws and tighten securely using a crisscross pattern.

■NOTE: It is important to install the fuel pump with the correct orientation to ensure adequate float lever clearance.

- Connect the wires and fuel hose; then connect the negative battery cable and turn the ignition switch to the ON position. Note that the fuel pump runs momentarily and the fuel gauge indicates the proper fuel level.
- With the transmission in neutral and brake lever lock engaged, start the engine and check for normal operation. Check for any fuel leaks.
- Install the side panels and gas tank cover (see Gas Tank in this section).

Troubleshooting

Problem: Starting impaired	
Condition	Remedy
1. Gas contaminated	1. Drain gas tank and fill with clean gas
Problem: Idling or low speed impaired	
Condition	Remedy
1. TPS out of adjustment	1. Adjust TPS
Problem: Medium or high speed impaired	
Condition	Remedy
1. High RPM "cut out" against RPM limiter	1. Decrease RPM speed

Electrical System

This section has been organized into sub-sections which show procedures for the complete servicing of the Arctic Cat ATV electrical system.

SPECIAL TOOLS

A number of special tools must be available to the technician when performing service procedures in this section. Refer to the current Special Tools Catalog for the appropriate tool description.

Description	p/n
Fluke Model 73 Multimeter	0644-191
Fluke Model 77 Multimeter	0644-559
MaxiClips	0744-041

■NOTE: Special tools are available from the Arctic Cat Service Department.

Specifications

Ignition Timing	10° BTDC @ 1500 RPM
Spark Plug Type	NGK CR7E
Spark Plug Gap	0.7-0.8 mm (0.028-0.032 in.)
Spark Plug Cap	5000 ohms
Ignition Coil Resistance (primary)	Less than 5.0 ohms (terminal (+) to terminal (-))
(secondary)	12k-19k ohms (high tension - plug cap to terminal (+))
Ignition Coil Primary Voltage	Battery Voltage (orange (+) to blue/white(-))
Stator Coil Resistance (crankshaft position sensor) (AC generator)	150-250 ohms (blue to green) Less than 1 ohm (black to black)
Crankshaft Position Sensor AC Voltage	2.5 volts or more (blue to green)
AC Generator Output (no load)	60 AC volts @ 5000 RPM (black to black)

Electrical Connections

The electrical connections should be checked periodically for proper function. In case of an electrical failure, check fuses, connections (for tightness, corrosion, damage), and/or bulbs.

Battery

After being in service, batteries require regular cleaning and recharging in order to deliver peak performance and maximum service life. The following procedure is recommended for cleaning and maintaining sealed batteries. Always read and follow instructions provided with battery chargers and battery products.

⚠ WARNING

Any time service is performed on a battery, the following must be observed: keep sparks, open flame, cigarettes, or any other flame away. Always wear safety glasses. Protect skin and clothing when handling a battery. When servicing battery in enclosed space, keep the area well-ventilated. Make sure battery venting is not obstructed.

1. Remove the battery case access cover; then disconnect the battery cables (negative cable first).
2. Remove the battery from the battery case; then thoroughly wash the battery and battery case with soap and water.

■NOTE: If battery posts, cable ends, or the battery case has a build-up of white/green powder residue, apply water and baking soda to neutralize acid; then flush off with warm soapy water.

3. Using a wire brush, clean the battery posts and cable ends removing all corrosive buildup. Replace damaged cables or cable ends.

⚠ WARNING

Battery acid is harmful if it contacts eyes, skin, or clothing. Care must be taken whenever handling a battery.

4. Using a multimeter, test the battery voltage. The meter must read 12.5 or more DC Volts for a fully charged battery.

■NOTE: At this point, if the meter reads as specified, the battery may be returned to service (see step 8).

5. If the meter reads less than specified voltage, charge the battery using the following guidelines.
 - A. When using an automatic battery charger, always follow the charger manufacturer's instructions.
 - B. When using a constant-current battery charger, use the following Battery Charging Chart.

CAUTION

Never exceed the standard charging rate.

⚠ WARNING

An overheated battery could explode causing severe injury or death. Always monitor charging times and charge rates carefully. Stop charging if the battery becomes very warm to the touch. Allow it to cool before resuming charging.

Battery Charging Chart (Constant-Current Charger)		
Battery Voltage (DC)	Charge State	Charge Time Required (at 1.5-2.0 Amps)
12.5 or more	100%	None
12.2-12.4	75%-99%	3-6 hours
12.0-12.2	50%-74%	5-11 hours
11.0-11.9	25%-49%	13 hours (minimum)
11.5 or less	0-24%	20 hours (minimum)

■NOTE: If the battery voltage is 11.5 DC Volts or less, some chargers may “cut off” and fail to charge. If this occurs, connect a fully charged booster battery in parallel (positive to positive and negative to negative) for a short period of time with the charger connected. After 10-15 minutes, disconnect the booster battery leaving the charger connected and the charger should continue to charge. If the charger “cuts off,” replace the battery.

- After charging the battery for the specified time, remove the battery charger and allow the battery to sit for 1-2 hours.
- Connect the multimeter and test the battery voltage. The meter should read 12.5 or more DC Volts. If the voltage is as specified, the battery is ready for service.

■NOTE: If voltage in step 7 is below specifications, charge the battery an additional 1-5 hours; then retest.

- Place the battery in the battery case; then coat the battery posts and cable ends with a light coat of multi-purpose grease.

CAUTION

Before installing the battery, make sure the ignition switch is in the OFF position.

- Connect the battery cables (positive cable first); then install the battery case access cover.

CAUTION

Connecting cables in reverse (positive to negative and negative to positive) can cause serious damage to the electrical system.

RPM Limiter

■NOTE: The ATV is equipped with an ECU that retards ignition timing when maximum RPM is approached. When the RPM limiter is activated, it could be misinterpreted as a high-speed misfire.

Testing Electrical Components

All of the electrical tests should be made using the Fluke Model 73 Multimeter or Fluke Model 77 Multimeter and when testing peak voltage, the Peak Voltage Reading Adapter must be used. If any other type of meter is used, readings may vary due to internal circuitry. When troubleshooting a specific component, always verify first that the fuse(s) are good, that the bulb(s) are good, that the connections are clean and tight, that the battery is fully charged, and that all appropriate switches are activated.

■NOTE: For absolute accuracy, all tests should be made at room temperature of 68° F.

Accessory Receptacle/Connector

■NOTE: This test procedure is for either the receptacle or the connector.

VOLTAGE

- Turn the ignition switch to the ON position; then set the meter selector to the DC Voltage position.
- Connect the red tester lead to the red wire; then connect the black tester lead to ground.
- The meter must show battery voltage.

■NOTE: If the meter shows no battery voltage, troubleshoot the battery, fuse, receptacle, connector, or the main wiring harness.

Brakelight Switch (Pressure)

The brakelight switch is located on the top of the brake master cylinder and is pressure activated by the hand brake or the brake pedal. This switch also activates the start-in-gear (SIG) relay in the power distribution module (PDM).

■NOTE: The ignition switch must be in the ON position.

VOLTAGE (Wiring Harness Side)

- Set the meter selector to the DC Voltage position.
- Connect the red tester to the brown/black wire; then connect the black tester lead to ground.
- The meter must show battery voltage.

■NOTE: If the meter shows no battery voltage, troubleshoot the battery, fuse, switch, or the main wiring harness.

■NOTE: If the meter shows battery voltage, the main wiring harness is good; proceed to test the switch/component or connector.

RESISTANCE (Switch)

1. Remove the spade connectors from the brake switch.
2. Set the meter selector to the OHMS position.
3. Connect the red tester lead to one switch terminal; then connect the black tester lead to the other switch terminal.

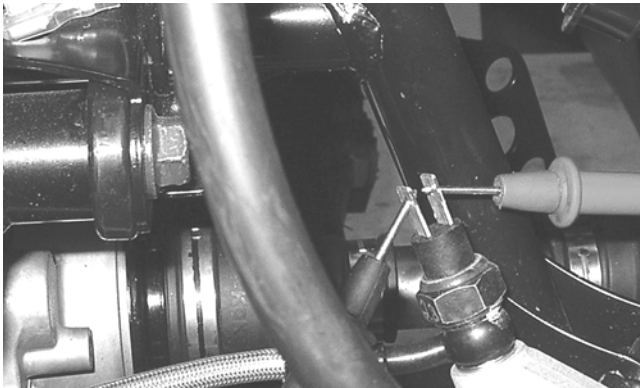

KC274

4. When the brake pedal is depressed, the meter must show less than 1 ohm.

■NOTE: If the meter shows more than 1 ohm of resistance, replace the switch.

Engine Coolant Temperature (ECT) Sensor

1. Connect the meter leads (selector in OHMS position) to the sensor terminals.
2. Suspend the sensor and a thermometer in a container of cooking oil; then heat the oil.

■NOTE: Neither the sensor nor the thermometer should be allowed to touch the bottom of the container or inaccurate readings will occur. Use wire holders to suspend the sensor and thermometer.

⚠ WARNING

Wear insulated gloves and safety glasses. Heated oil can cause severe burns.

3. On the ECT sensor when the temperature reaches 20° C (68° F), the meter should read approximately 2.45k ohms.

4. On the ECT sensor when the temperature reaches 50° C (122° F), the meter should read approximately 800 ohms.
5. On the ECT sensor when the temperature reaches 80° C (176° F), the meter should read approximately 318 ohms.
6. On the ECT sensor when the temperature reaches 110° C (230° F), the meter should read approximately 142 ohms.
7. If the readings are not as indicated, the sensor must be replaced.
8. Install the sensor and tighten securely.
9. Connect the leads.

Fan Motor

The connector is the black two-prong one located behind the fan assembly along the right-side frame tube.



KC270A

■NOTE: The ignition switch must be in the ON position.

VOLTAGE (Main Harness Connector to Fan Motor)

1. Set the meter selector to the DC Voltage position.
2. Connect the red tester lead to the orange wire; then connect the black tester lead to ground.
3. The meter must show battery voltage.

■NOTE: If the meter shows no battery voltage, troubleshoot the battery, fuse, motor, or the main wiring harness.

■NOTE: If the meter shows battery voltage, the main wiring harness is good. The connector should be checked for resistance.

RESISTANCE (Fan Motor Connector)

1. Set the meter selector to the OHMS position.
2. Connect the red tester lead to the red wire; then connect the black tester lead to the black wire.

3. The meter must show less than 1 ohm.

■NOTE: If the meter shows more than 1 ohm of resistance, troubleshoot or replace the switch/component, the connector, or the switch wiring harness.

■NOTE: To determine if the fan motor is good, connect the blue wire from the fan connector to the positive side of a 12 volt DC power supply; then connect the black wire from the fan connector to the negative side. The fan should operate.

⚠ WARNING

Care should be taken to keep clear of the fan blades.

Power Distribution Module (PDM)

The fuses are located in the power distribution module in front of the steering post under the radiator/electrical access panel.



KC466A

If there is any type of electrical system failure, always check the fuses first.

■NOTE: To remove a fuse, compress the locking tabs on either end of the PDM cover and lift off; then remove the applicable fuse.



2411-565

CAUTION

Always replace a blown fuse with a fuse of the same type and rating.

RELAYS

The relays are identical plug-in type located on the PDM. Relay function can be checked by switching relay positions. The relays are interchangeable.

■NOTE: The PDM and wiring harness are not a serviceable components and must be replaced as an assembly.

Ignition Coil

The ignition coil is on the frame above the radiator. To access the coil, the radiator/electrical access panel must be removed.



KC466B

RESISTANCE

■NOTE: For these tests, the meter selector must be set to the OHMS position and the primary plug disconnected.

Primary Winding

1. Connect the red tester lead to either terminal; then connect the black tester lead to the other terminal.
2. The meter reading must be within specification.

Secondary Winding

1. Remove the plug cap from the high tension lead; then connect the red tester lead to the high tension lead.
2. Connect the black tester lead to ground.
3. The meter reading must be within specification.

■NOTE: If the meter does not show as specified, replace ignition coil.

Spark Plug Cap

1. Connect the red tester lead to one end of the cap; then connect the black tester lead to the other end of the cap.

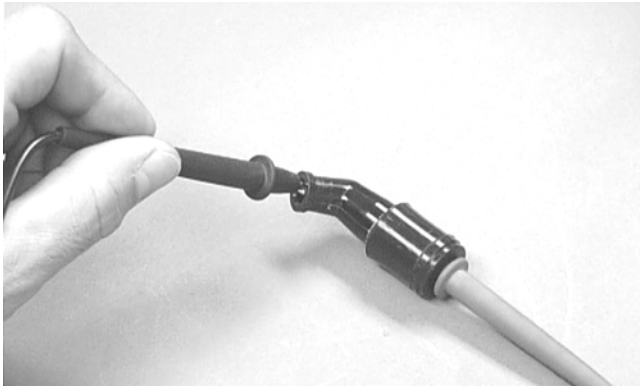

AR603D

2. The meter reading must be within specification.

■NOTE: If the meter does not read as specified, replace the spark plug cap.

Speed Sensor

1. Set the meter selector to the DC Voltage position.
2. With appropriate needle adapters on the meter leads, connect the red tester lead to the voltage lead (V); then connect the black tester lead to the ground lead (G).

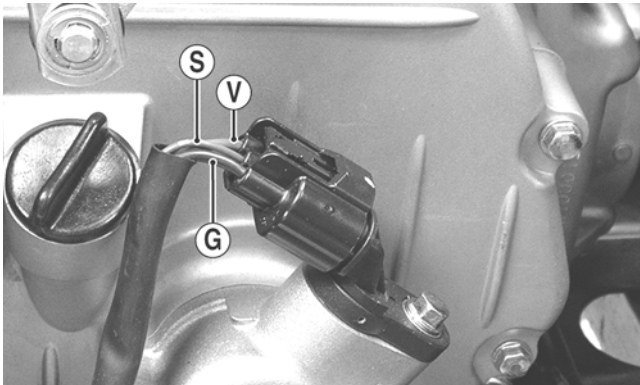

KC248A

3. Turn the ignition switch to the ON position.
4. The meter must show greater than 5.0 volts.
5. Leave the black tester lead connected; then connect the red tester lead to the signal lead pin (S).
6. Slowly move the ATV forward or backward; the meter must show 0 and >5 volts alternately.

■NOTE: If the sensor tests are within specifications, the speedometer/LCD gauge must be replaced (see Steering/Frame).

To replace a speed sensor, use the following procedure.

1. Disconnect the three-wire connector from the speed sensor; then remove the cap screw securing the sensor to the sensor housing.
2. Remove the sensor from the sensor housing accounting for an O-ring.

3. Install the new speed sensor into the housing with new O-ring lightly coated with multi-purpose grease; then secure the sensor with the cap screw (threads coated with blue Loctite #242). Tighten securely.

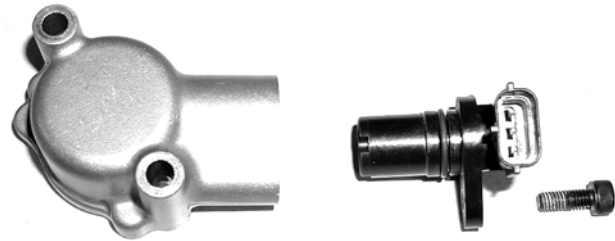

CD071

Ignition Switch

The ignition switch harness connects to the switch with a three-pin connector. To access the connector, remove the radiator/electrical access panel.



KC466C

VOLTAGE

■NOTE: Perform this test on the main harness connector.

1. Set the meter selector to the DC Voltage position.
2. Connect the red meter lead to the red/white wire; then connect the black meter lead to ground.
3. Meter must show battery voltage.

■NOTE: If the meter shows no battery voltage, troubleshoot the battery or the main wiring harness.

RESISTANCE

■NOTE: Perform this test on the switch harness using the following procedure.

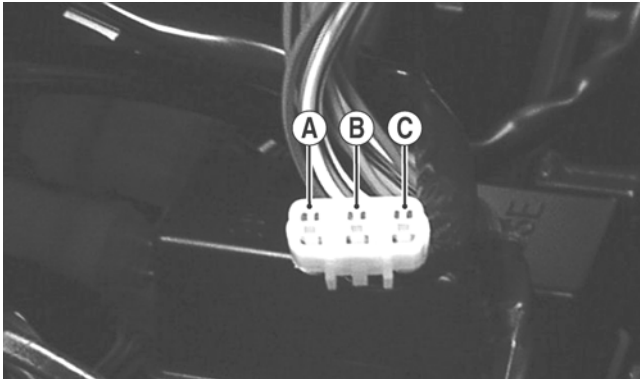

KC276A

1. Turn the ignition switch to the ON position.
2. Set the meter selector to the OHMS position.
3. Connect either tester lead to pin B; then connect the other tester lead to pin A.
4. The meter must show less than 1 ohm.
5. Turn the ignition switch to the LIGHTS position. The meter must show less than 1 ohm.
6. Leaving the tester lead on pin B, connect the other tester lead to pin C.
7. The meter must show less than 1 ohm.

■NOTE: If the meter shows more than 1 ohm of resistance, replace the switch.

Handlebar Control Switches

The connectors are located on the right side of the ATV next to the PDM. To access the connector, the radiator/electrical access panel must be removed.

■NOTE: These tests should be made on the switch side of the connector.

RESISTANCE (HI Beam)

1. Set the meter selector to the OHMS position.
2. Connect one tester lead to the brown/black wire; then connect the other tester lead to the lavender wire.
3. With the dimmer switch in the HI position, the meter must show less than 1 ohm.

■NOTE: If the meter shows more than 1 ohm of resistance, replace the switch.

RESISTANCE (LO Beam)

1. Connect one tester lead to the brown/black wire; then connect the other tester lead to the white wire.
2. With the dimmer switch in the LO position, the meter must show less than 1 ohm.

■NOTE: If the meter shows more than 1 ohm of resistance, replace the switch.

RESISTANCE (Emergency Stop)

1. Set the meter selector to the OHMS position.
2. Connect the one lead to the brown/lavender wire; then connect the other tester lead to the black/white wire.
3. With the switch in the OFF position, the meter must show an open circuit.
4. With the switch in the RUN position, the meter must show less than 1 ohm.

■NOTE: If the meter shows more than 1 ohm of resistance, replace the switch.

RESISTANCE (Reverse Override)

■NOTE: The handlebar control switch connectors are a six pin and a three pin. Both must be disconnected for this test.

1. Set the meter selector to the OHMS position.
2. Connect one tester lead to one lavender/red wire (three-pin connector); then connect the other tester wire to the green/red wire on the six-pin connector. The meter must show less than 1 ohm.
3. Depress and hold the reverse override button. The meter must show an open circuit.

■NOTE: If the meter does not show as specified, replace the switch.

Front Drive Selector Switch

The connector is the snap-lock one in front of the steering post. To access the connector, the radiator/electrical access panel cover must be removed.

■NOTE: Resistance tests should be made with the connector disconnected and on the selector-side of the connector.

RESISTANCE

1. Set the meter selector to the OHMS position.
2. Connect the one tester lead to the white/blue wire; then connect the other tester lead to the black wire.
3. With the selector switch in the 2WD position, the meter must show an open circuit.
4. With the selector switch in the 4WD position, the meter must show less than 1 ohm.

■NOTE: If the meter does not show as specified, replace the front drive selector switch.

VOLTAGE

■NOTE: The battery must be connected when performing voltage tests.

1. Set the meter selector to the DC Voltage position.
2. Connect the black tester lead to the negative battery terminal.
3. Connect the red tester lead to the white/blue wire on the harness side of the connector.
4. Turn the ignition switch to the RUN position.
5. The meter must show battery voltage.

■NOTE: If the meter shows other than specified, check the harness, connector, 30 amp fuse, and battery connections.

Front Drive Selector Actuator

■NOTE: With the engine stopped and the ignition switch in the ON position, a momentary “whirring” sound must be noticeable each time the selector switch is moved to 2WD and 4WD. Test the switch, 30 amp fuse, and wiring connections prior to testing the actuator.

VOLTAGE

1. Select the 2WD position on the front drive selector switch; then disconnect the connector on the actuator wiring harness.
2. With the ignition switch in the OFF position, connect the black tester lead to the black wire in the supply harness; then connect the red tester lead to either orange wire in the supply harness.
3. Turn the ignition switch to the ON position. The meter must show 12 DC volts.
4. Connect the red tester lead to the second orange wire in the supply harness. The meter must show 12 DC volts.
5. Connect the red tester lead to the white/green wire in the supply harness. The meter must show 12 DC volts.
6. Select the 4WD position on the front drive selector switch; then connect the red tester lead to the white/blue wire in the supply harness. The meter must show 0 DC volts.

■NOTE: The 4WD icon on the LCD should illuminate.

■NOTE: If the voltage readings are as specified and the actuator does not function correctly, replace the actuator (see Drive System).

Gear Position Switch

The gear position switch is located on the engine/transmission next to the shift arm.

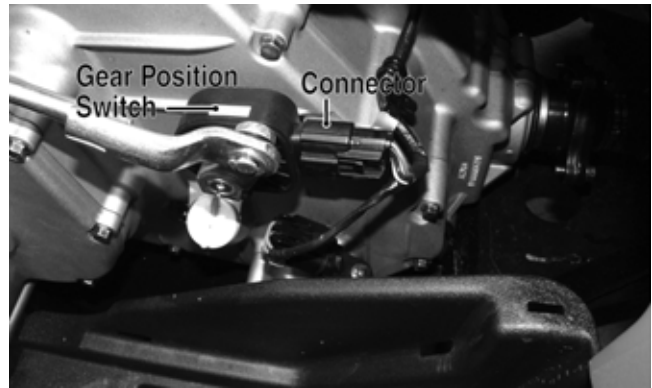

FI525B

To troubleshoot the switch, use the following procedure.

1. Disconnect the gear position switch connector; then using a multimeter, test the switch in each position as follows. Resistance must be less than 1 ohm for all tests.

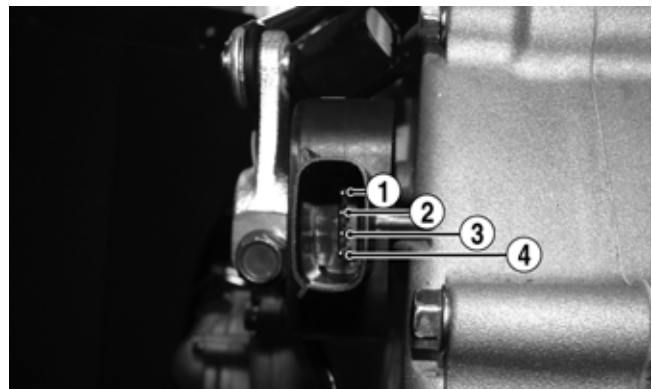

KC410A

- A. Neutral (N) Pins 3 to 4
 - B. Reverse (R) Pins 3 to 4 and 3 to 2
 - C. High (H) Pins 3 to 4 and 3 to 1
 - D. Low (L) Pins 3 to 1
2. Connect the harness to the gear position switch.

Stator Coil

VOLTAGE

(AC Generator - Regulated Output)

1. Set the meter selector to the DC Voltage position.
2. Connect the red tester lead to the positive battery post; then connect the black tester lead to the negative battery post.
3. With the engine running at a constant 3000 RPM (with the headlights on), the meter must show 14-15.5 DC volts.

CAUTION

Do not run the engine at high RPM for more than 10 seconds.

■NOTE: If voltage is lower than specified, test AC Generator coil - no load.

VOLTAGE (AC Generator Coil - No Load)

The connector is the black three-pin one on the right side of the engine just above the starter motor.

■NOTE: Test the engine-side of the connector.

1. Set the meter selector to the AC Voltage position.
2. Test between the three black wires for a total of three tests.
3. With the engine running at the specified RPM, all wire tests must show 60 AC volts.

CAUTION

Do not run the engine at high RPM for more than 10 seconds.

■NOTE: If both AC Generator coil tests failed, check all connections, etc., and test again. If no voltage is present, replace the stator assembly.

RESISTANCE (AC Generator Coil)

1. Set the meter selector to OHMS position.
2. Test between the three black wires for a total of three tests.
3. The meter reading must be within specification.

RESISTANCE (Crankshaft Position Sensor)

1. Disconnect the gray four-pin connector on the right side of the engine just above the starter motor.
2. Set the meter selector to the OHMS position.
3. Connect the red tester lead to the green wire; then connect the black tester lead to the blue wire. The meter reading must be within specification.

■NOTE: The battery must be at full charge for this test.

VOLTAGE (Crankshaft Position Sensor)

1. Set the meter selector to the DC Voltage position.
2. Connect the red tester lead to the green wire; then connect the black tester lead to the blue wire.
3. Crank the engine over using the electric starter.
4. The meter reading must be within specification.

Starter Relay

1. Remove the battery case access cover; then using the multimeter set to the DC Voltage position, check the relay as follows.

2. Connect the red tester lead to the positive battery terminal; then connect the black tester lead to the starter cable connection on the starter relay. The meter must show battery voltage.

■NOTE: Make sure that the ignition switch is in the ON position, transmission in neutral, brake lock released, and the emergency stop switch in the RUN position.

3. Depress the starter button while observing the multimeter. The multimeter should drop to 0 volts, a “click” should be heard from the relay, and the starter motor should run.

■NOTE: If a “click” is heard and any voltage is indicated by the multimeter, replace the starter relay. If no “click” is heard and the multimeter continues to indicate battery voltage, test the neutral start relay.

Starter Motor

■NOTE: The starter is a non-serviceable component. If the following test does not result as specified, the starter must be replaced.

TESTING VOLTAGE

Perform this test on the starter motor positive terminal. To access the terminal, slide the boot away.

■NOTE: The ignition switch must be in the ON position, the emergency stop switch in the RUN position, and the shift lever in the NEUTRAL position.

1. Set the meter selector to the DC Voltage position.
2. Connect the red tester lead to the starter terminal; then connect the black tester lead to ground.
3. With the starter button depressed, the meter must show approximately 10.0 DC volts and the starter motor should operate.



AR607D

■NOTE: If the meter showed correct voltage but the starter did not operate or operated slowly, the starter motor is defective.

■NOTE: If the meter showed no voltage, inspect ground connections, starter motor lead, battery voltage (at the battery), starter relay, or the neutral start relay.

REMOVING

1. Disconnect the battery.

CAUTION

Always disconnect the negative battery cable from the battery first; then disconnect the positive cable.

2. Remove the nut securing the positive cable to the starter; then remove the cable from the starter.
3. Remove the two cap screws securing the starter to the crankcase; then remove the starter. Account for an O-ring.

INSTALLING

1. Apply a small amount of grease to the O-ring seal on the starter; then install the starter into the crankcase. Secure with two cap screws making sure the engine ground is secured by the rear cap screws. Tighten to 8 ft-lb.

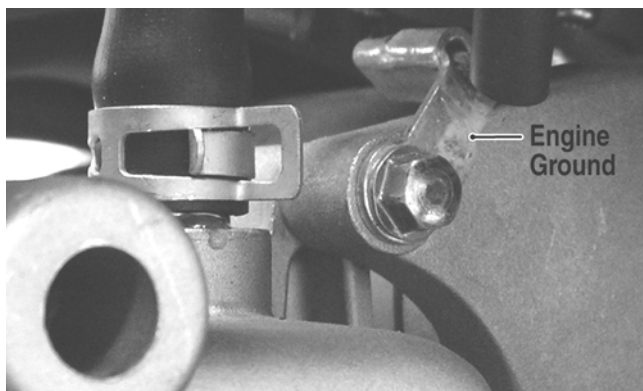

KC201A

2. Secure the positive cable to the starter with the nut. Tighten to 8 ft-lb.
3. Connect the battery.

Electronic Control Unit (ECU)

The electronic control unit (ECU) is located above the radiator under the radiator/electrical access panel.

■NOTE: The ECU is not a serviceable component. If the unit is defective, it must be replaced.

The ECU is rarely the cause for electrical problems; however, if the ECU is suspected, substitute another ECU of the same part number to verify the suspected one is defective.

Diagnostic Trouble Codes (DTC) can be cleared by following the procedures located in the Diagnostic Trouble Codes (DTC) sub-section in this section.

Regulator/Rectifier

The regulator/rectifier is located under the radiator/electrical access panel.

TESTING

1. Start engine and warm up to normal operating temperatures; then connect a multimeter to the battery as follows.
2. Select the DC Voltage position; then connect the red tester lead to the positive battery post and the black tester lead to the negative battery post.
3. Start the engine and slowly increase RPM. The voltage should increase with the engine RPM to a maximum of 15.5 DC volts.

■NOTE: If voltage rises above 15.5 DC volts, the regulator is faulty or a battery connection is loose or corroded. Clean and tighten battery connections or replace the regulator/rectifier. If voltage does not rise, check Voltage (Charging Coil - No Load) in this section. If charging coil voltage is normal, replace the regulator/rectifier.

Lights

HEADLIGHTS - RUNNING LIGHTS

The connectors are the two 4-pin ones snapped onto the front body panel support. To release the connectors from the frame, press the release tab with a small screwdriver.

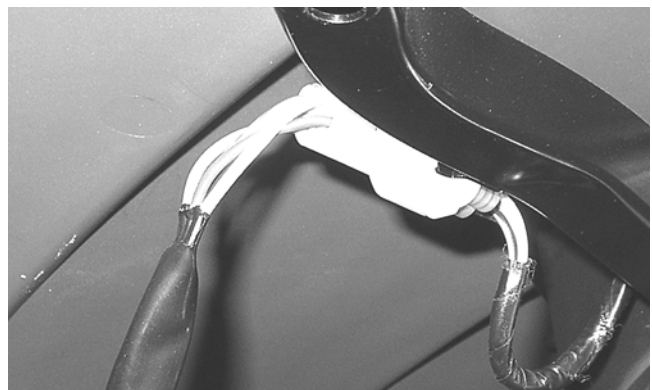

KC224

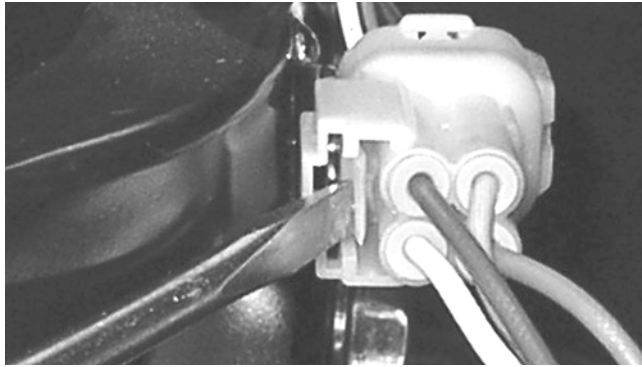

KC223

Voltage (Headlights)

■NOTE: Perform this test on the main harness side of the connectors. Also, the ignition switch must be in the LIGHTS position.

1. Set the meter selector to the DC Voltage position.
2. Connect the black tester lead to the black wire; then connect the red tester lead to the white wire.
3. With the dimmer switch in the LO position, the meter must show battery voltage.
4. Remove the red tester lead from the white wire and connect to the lavender wire.
5. With the dimmer switch in the HI position, the meter must show battery voltage.

■NOTE: If battery voltage is not shown in any test, inspect the fuses, battery, main wiring harness, connectors, or the left handlebar switch.

Voltage (Running Lights)

1. Release the wire connector from the frame; then release and separate the connectors.

■NOTE: Perform this test on the wiring harness side of the connectors.

2. Connect the black tester lead of the meter to the black wire; then with the tester in the DC Volts position, connect the red tester lead to the brown/black wire.
3. Turn the ignition switch to the LIGHTS position. The meter must show battery voltage.

■NOTE: If the meter does not show voltage, inspect the LIGHTS fuse, battery connections, or troubleshoot the main wiring harness.

TAILLIGHTS - BRAKELIGHTS

Voltage (Taillights)

■NOTE: Perform this test on the main harness side of the connector. Also, the ignition switch should be in the LIGHTS position.

1. Set the meter selector to the DC Voltage position.
2. Connect the black tester lead to the black wire; then connect the red tester lead to the brown/blue wire.

3. The meter must show battery voltage.

■NOTE: If the meter does not show voltage, inspect fuses, wiring harness, connectors, and switches.

Voltage (Brakelights)

■NOTE: Perform this test on the main harness side of the connector. Also, the ignition switch should be in the ON position and the brake (either foot pedal or hand lever) must be applied.

1. Set the meter selector to the DC Voltage position.
2. Connect the black tester lead to the black wire; then connect the red tester lead to the green/yellow wire.
3. The meter must show battery voltage.

■NOTE: If the meter does not show voltage, inspect bulb, fuses, wiring harness, connectors, and switches.

BACK-UP LIGHTS

The connectors are located on the rear frame supports attached by a metal tab. They may be released from the frame by depressing the release with a small screwdriver.

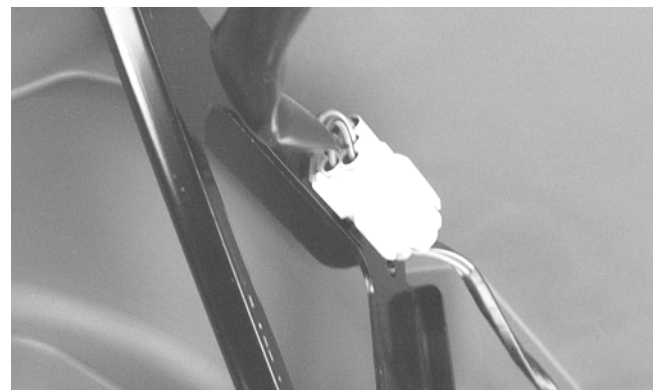

KC279

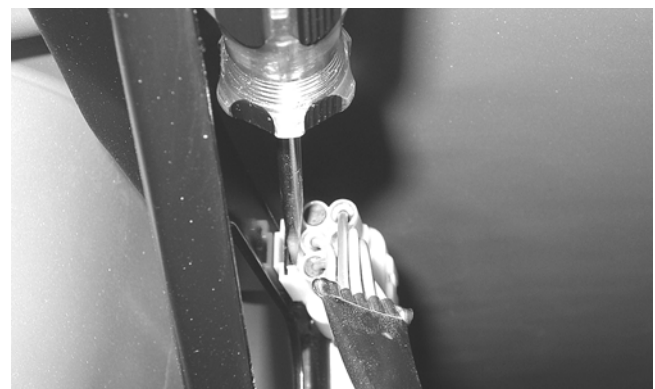

KC280

Voltage

1. Release the wire connectors from the frame; then disconnect the connectors.

■NOTE: Perform this test on the main harness side of the connectors.

2. Connect the black tester lead to the brown/lavender wire; then connect the red tester lead to the lavender/red wire.
3. Set the tester to DC VOLTS; then turn the ignition switch to the ON position and move the shift lever to the R (reverse) position. The meter must show battery voltage.

■NOTE: If the meter does not show battery voltage, use the following procedure to troubleshoot.

4. Remove the black tester lead from the brown/lavender wire and connect to a suitable ground.
 - A. If the meter shows battery voltage, troubleshoot the gear shift position switch connector or the gear shift position switch.
 - B. If the meter does not show battery voltage, inspect the LIGHTS fuse, ignition switch, or the main wiring harness.

Ignition Timing

The ignition timing cannot be adjusted; however, verifying ignition timing can aid in troubleshooting other components. To verify engine timing, see Periodic Maintenance.

Diagnostic Trouble Codes (DTC)

If an EFI or related chassis component fails or an out-of-tolerance signal is detected by the ECU, a diagnostic trouble code (DTC) will be generated in the ECU and displayed on the LCD. For the first thirty seconds, the LCD will go blank and the DTC will be displayed alternately with a wrench icon or malfunction indicator light (MIL). After thirty seconds, the digital display will return to normal; however, the MIL and DTC will continue to flash.

Code List

■NOTE: Each of the following numerical codes will have a one-letter prefix of C or P. A “C” prefix denotes a chassis malfunction and a “P” prefix denotes a power train malfunction.

■NOTE: Normal malfunction codes are cleared from the LCD when the component is replaced or the malfunction is corrected; however, intermittent codes must be cleared as noted in the code chart.

Code	ECU PIN	Description	Problem
C0063 ¹	D2	Tilt Sensor Circuit High	
C0064 ¹	D2	Tilt Sensor Circuit Low	SG/Open
P0107	F2	MAP Sensor Circuit Low	SG/Open
P0108	F2	MAP Sensor Circuit High	SP
P0112	F3	IAT Sensor Circuit Low	SG
P0113	F3	IAT Sensor Circuit High	Open
P0114 ¹	F3	IAT Sensor Circuit Intermittent	
P0116	F4	ECT Sensor Circuit Range/Performance	
P0117	F4	ECT Sensor Circuit Low	SG
P0118	F4	ECT Sensor Circuit High	Open/SP
P0119 ¹	F4	ECT Sensor Circuit Intermittent	
P0121	G3	TPS Range/Performance	
P0122	G3	TPS Circuit Low	SG
P0123	G3	TPS Circuit High	
P0219	N/A	Engine Over-Speed Condition	
P0231	J1	Fuel Pump Relay Circuit Low	SG/Open
P0232	J1	Fuel Pump Relay Circuit High	
P0233	J1	Fuel Pump Relay Circuit	
P0264 ²	K4	Cylinder Injector Circuit Low/SG	SG
P0265 ²	K4	Cylinder Injector Circuit High	
P0266 ²	K4	Cylinder Injector Balance	Open
P0336 ¹	D1/E1	CKP Sensor Synchronization	
P0337 ¹	D1/E1	CKP Sensor Circuit	SG
P0339 ¹	D1/E1	CKP Sensor Intermittent/Erratic	
P0480	K2	Fan Relay Control Circuit	
P0484	K2	Fan Relay Control Circuit High	
P0485	K2	Fan Relay Control Circuit Low	SG/Open
P0500		Vehicle Speed Sensor	
P0508	C4/D3/D4/E4	Idle Air Control System Circuit Low	SG
P0509	C4/D4	Idle Air Control System Circuit High	Open
P0562	L1	System Voltage Low	
P0563	L1	System Voltage High	
P0601	N/A	ECU Memory Check-Sum Error	
P0615 ¹	L3	Starter Relay Circuit	
P0616	L3	Starter Relay Circuit Low	
P0617	L3	Starter Relay Circuit High	
P0630	N/A	VIN Not Programmed or Incompatible	
P0642	A1	Sensor Power Circuit Low	
P0643	A1	Sensor Power Circuit High	
P2303 ²	M2	Ignition Coil Primary Circuit Low	Open
P2304 ²	M2	Ignition Coil Primary Circuit High	
P2531	A4	Ignition Switch Circuit Low	
P2532	A4	Ignition Switch Circuit High	
U0155	B1/C1	LCD Gauge Communication Lost	
*FUEL OFF		*Tilt Sensor Activation Operator-Code	

- High Signal Level too High (Possible Short-to-Battery (+))
- Low Signal Level too Low (Possible Short-to-Ground or Short-to-Chassis)
- SG Possible Short-to-Ground or Short-to-Chassis
- Open Open-Circuit (Possible Broken-Wire or No-Connection)
- ¹ These codes cleared by one complete power-cycle only (key-off, key-on)
- ² These codes cleared by one complete starting-cycle only (key-off, key-on, start, key-off, key-on)

Tilt Sensor

The tilt sensor is located above the radiator under the radiator/electrical access panel.

⚠ WARNING

Incorrect installation of the tilt sensor could cause sudden loss of engine power which could result in loss of vehicle control resulting in injury or death.

CAUTION

Do not drop the tilt sensor as shock can damage the internal mechanism.

SUPPLY VOLTAGE

1. Disconnect the three-wire connector from the sensor; then select DC Voltage on the multimeter and connect the red tester lead to the (C) pin and the black tester lead to the (A) pin.

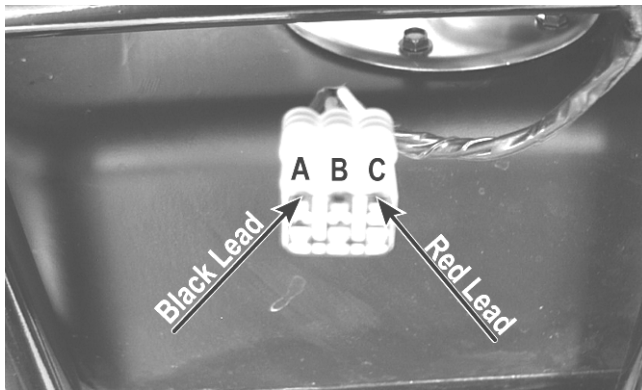

CD706A

2. Turn the ignition switch to the ON position. The multimeter should read approximately 5 DC volts. If correct voltage is not indicated, check the 30-amp main and 10-amp ignition fuses, wiring harness, or the ignition switch.
3. Remove the red tester lead and connect to the (B) pin. The multimeter should read approximately 0.5 DC volts. If the specified voltage is not indicated, check wire connections at the ECU or substitute another ECU to verify the test.

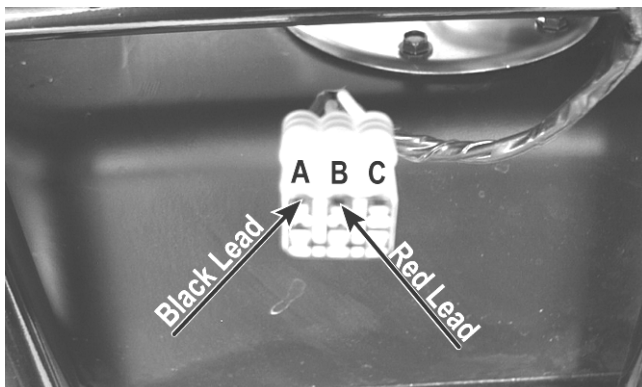

CD706B

OUTPUT VOLTAGE

■NOTE: Needle adapters or a “break-out” harness will be required on the multimeter leads as the following tests are made with the sensor connected.

1. Connect the three-wire plug to the sensor; then remove the mounting screws securing the sensor to the frame.

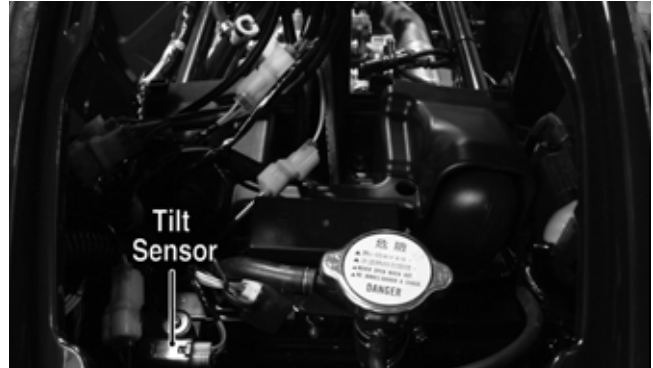

KC466F

2. Install the needle adapters to the multimeter leads; then select DC Voltage on the multimeter.
3. Connect the red tester lead to the blue/brown wire (B) and the black tester lead to the pink/black wire (A); then turn the ignition switch ON and observe the meter. The meter should read 0.3-1.5 DC volts.

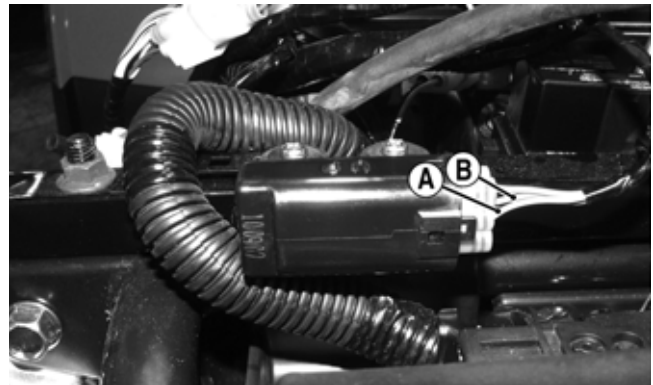

KC416A

4. Tilt the sensor 60° or more to the left and right observing the meter. The meter should read 3.0-7.0 DC volts after approximately one second in the tilted position. If the meter readings are not as specified, the tilt sensor is defective.

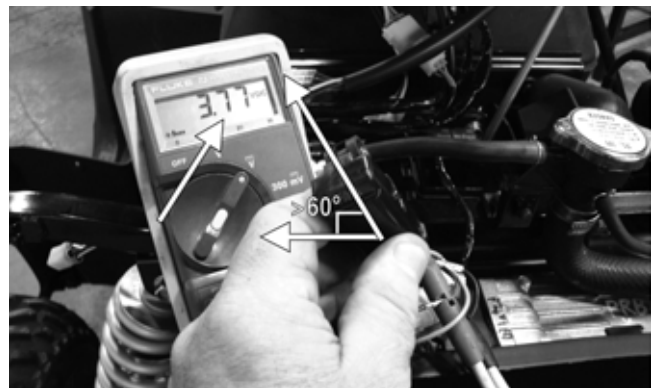

KC414A

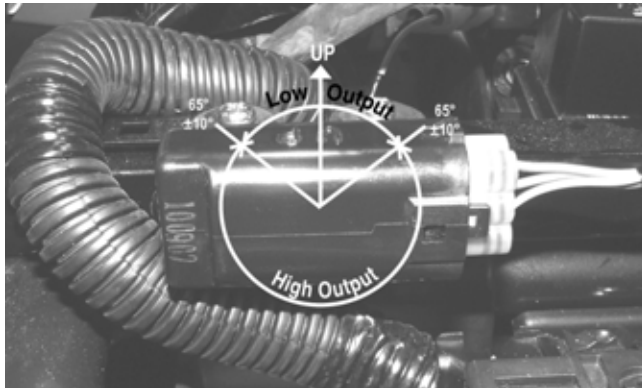

KC416B

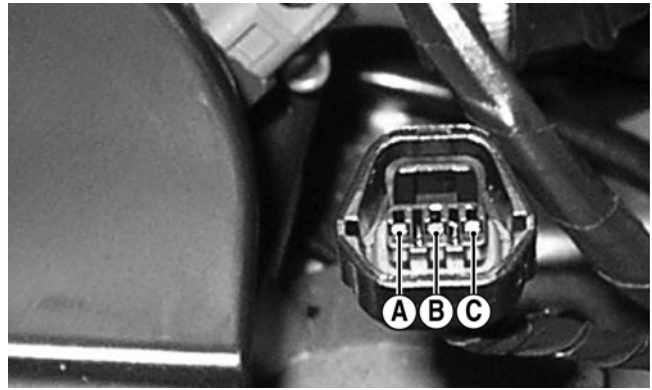

PR538A

Throttle Position Sensor (TPS)

INSPECTING

1. Remove the left-side engine cover; then disconnect the three-wire TPS connector plug.

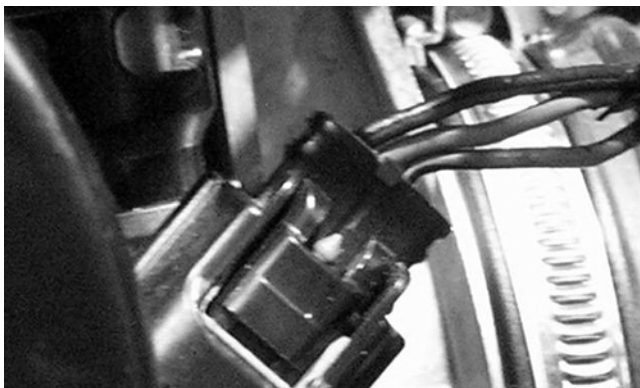

PR544

■NOTE: Prior to testing the TPS, inspect the three-wire plug connector on the main harness and the three-pin plug on the TPS for contamination, broken pins, and/or corrosion.

2. Make sure the ignition switch is in the OFF position; then select the DC Voltage position on the meter.
3. Connect the black tester lead to terminal B and the red tester lead to terminal A. Turn the ignition switch to the ON position. The meter should read approximately 5.0 DC volts.

■NOTE: If the meter does not read as specified, check for poor connections at the ECU or open/broken wires in the wiring harness.

CAUTION

Always make sure the ignition switch is in the OFF position before disconnecting the ECU.

4. Turn the ignition switch to the OFF position.
5. Select the OHMS position on the meter; then perform the following resistance tests on the TPS.
 - A. Pin (B) to ground - infinity (open circuit).
 - B. Pin (A) to pin (B) - approximately 1.22k ohms (throttle closed).
 - C. Pin (A) to pin (B) - approximately 4.5k ohms (throttle full-open).
 - D. Pin (A) to pin (C) - approximately 5.5k ohms.

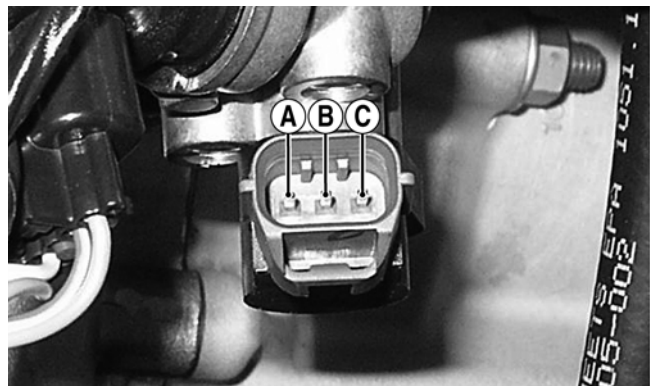

PR535A

■NOTE: If any meter reading is not as specified, replace or adjust the TPS (see INSTALLING/ADJUSTING in this sub-section).

6. Connect the positive lead to the battery; then connect the negative lead.
7. Connect the main harness TPS connector to the TPS; then using MaxiClips, connect the black tester lead to the black/green wire and the red tester lead to the green/black wire.

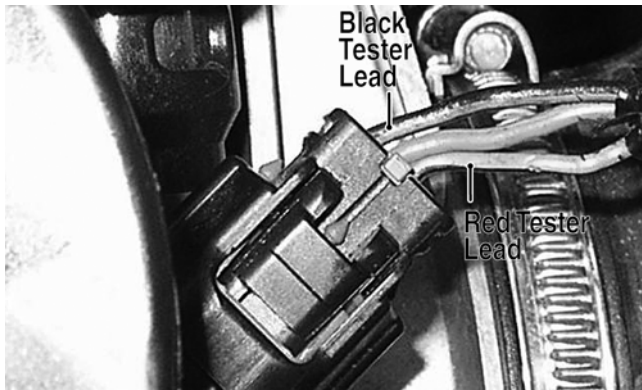

PR546A

8. Select the DC Voltage position on the meter and turn the ignition switch to the ON position. The meter should read approximately 4.5 DC volt with the throttle closed and approximately 1.5 DC volts with the throttle in the full-open position.

■ **NOTE:** If the meter readings are as specified, check the main harness connector at the ECU main harness wiring. If the meter readings are not as specified, replace the TPS and adjust to specifications (see **INSTALLING/ADJUSTING** in this sub-section).

CAUTION

Always make sure the ignition switch is in the OFF position before disconnecting the ECU.

9. Verify all malfunction codes are closed after servicing is complete (see Diagnostic Trouble Codes (DTC) in this section).

REMOVING

1. Remove the left-side engine cover; then disconnect the three-wire TPS connector plug.



PR544

2. Remove the screw securing the TPS to the throttle body and remove the TPS.

INSTALLING/ADJUSTING

1. Place the TPS into position on the throttle body and secure with the screw. Do not tighten at this time.

2. Connect the TPS Multi-Analyzer Harness connector #8 to the TPS; then connect the harness to the TPS Analyzer Tool.



F1672

3. Using a multimeter, connect the black tester lead to the black socket (GND) on the analyzer and the red tester lead to the white socket (VAR); then select the Voltage position.



F1673A

4. Adjust the TPS until a reading of 0.68 DC volts is obtained; then tighten the screw securely. Open and close the throttle and determine the reading returns to 0.68 DC volts. Readjust as necessary.



F1674

5. Disconnect the harness from the analyzer; then disconnect the harness from the TPS and reconnect the TPS main harness connector.
6. Tighten the mounting screws securely.

Troubleshooting

Problem: Spark absent or weak	
Condition	Remedy
<ol style="list-style-type: none"> 1. Ignition coil defective 2. Spark plug defective 3. Alternator defective 4. ECU defective 5. Pick-up coil defective 	<ol style="list-style-type: none"> 1. Replace ignition coil 2. Replace plug 3. Replace magneto 4. Replace ECU 5. Replace pick-up coil
Problem: Spark plug fouled with carbon	
Condition	Remedy
<ol style="list-style-type: none"> 1. Gasoline incorrect 2. Air cleaner element dirty 3. Spark plug incorrect (too cold) 4. Valve seals cracked - missing 5. Oil rings worn - broken 	<ol style="list-style-type: none"> 1. Change to correct gasoline 2. Clean element 3. Replace plug 4. Replace seals 5. Replace rings
Problem: Spark plug electrodes overheat or burn	
Condition	Remedy
<ol style="list-style-type: none"> 1. Spark plug incorrect (too hot) 2. Engine overheats 3. Spark plug loose 	<ol style="list-style-type: none"> 1. Replace plug 2. Service cooling system 3. Tighten plug
Problem: Alternator does not charge	
Condition	Remedy
<ol style="list-style-type: none"> 1. Lead wires/connections shorted - loose - open 2. Stator coils shorted - grounded - open 3. Regulator/rectifier defective 	<ol style="list-style-type: none"> 1. Repair - replace - tighten lead wires 2. Replace stator coils 3. Replace regulator/rectifier
Problem: Alternator charges, but charging rate is below the specification	
Condition	Remedy
<ol style="list-style-type: none"> 1. Lead wires shorted - open - loose (at terminals) 2. Stator coils grounded - open 3. Regulator/rectifier defective 4. Battery defective 	<ol style="list-style-type: none"> 1. Repair - tighten lead wires 2. Replace stator coils 3. Replace regulator/rectifier 4. Replace battery
Problem: Alternator overcharges	
Condition	Remedy
<ol style="list-style-type: none"> 1. Internal battery short circuited 2. Regulator/rectifier damaged - defective 3. Regulator/rectifier poorly grounded 	<ol style="list-style-type: none"> 1. Replace battery 2. Replace regulator/rectifier 3. Clean - tighten ground connection
Problem: Charging unstable	
Condition	Remedy
<ol style="list-style-type: none"> 1. Lead wire intermittently shorting 2. Alternator internally shorted 3. Regulator/rectifier defective 	<ol style="list-style-type: none"> 1. Replace lead wire 2. Replace stator coil 3. Replace regulator/rectifier
Problem: Starter button inoperative	
Condition	Remedy
<ol style="list-style-type: none"> 1. Battery charge low 2. Switch contacts defective 3. Starter motor defective 4. Starter relay defective 5. Emergency stop - ignition switch off 6. Wiring connections loose - disconnected 	<ol style="list-style-type: none"> 1. Charge - replace battery 2. Replace switch 3. Replace starter motor 4. Replace relay 5. Turn on switches 6. Connect - tighten - repair connections

Problem: Battery “sulfation” (Acidic white powdery substance or spots on surfaces of cell plates)	
Condition	Remedy
<ol style="list-style-type: none"> 1. Charging rate too low - too high 2. Battery run-down - damaged 3. Electrolyte contaminated 	<ol style="list-style-type: none"> 1. Repair charging system 2. Replace battery 3. Replace battery
Problem: Battery discharges too rapidly	
Condition	Remedy
<ol style="list-style-type: none"> 1. Electrolyte contaminated 2. Charging system not charging 3. Battery overcharged - damaged 4. Battery short-circuited 	<ol style="list-style-type: none"> 1. Replace battery 2. Check alternator - regulator/rectifier - circuit connections 3. Replace battery - correct charging system 4. Replace battery
Problem: Battery polarity reversed	
Condition	Remedy
<ol style="list-style-type: none"> 1. Battery incorrectly connected 	<ol style="list-style-type: none"> 1. Reverse connections - replace battery - repair damage

Drive System

GENERAL INFORMATION

Ring Gear Backlash	0.28-0.38 mm (0.011-0.015 in.)
Ring Gear End Play	0.1-0.2 mm (0.004-0.008 in.)

All gear cases are tagged beneath a cover bolt. This tag is marked with a production date code, sequence code, and a ratio code.

The “1” or “3.1” on the lower-right corner indicates a 3.1:1 gear set ratio (11:34 teeth).

SPECIAL TOOLS

A number of special tools must be available to the technician when performing service procedures in this section. Refer to the current Special Tools Catalog for the appropriate tool description.

Description	p/n
Backlash Measuring Tool	0544-010
CV Boot Clamp Tool	0444-120
Gear Case Seal Installer Tool	0444-224
Internal Hex Socket	0444-104
Pinion Gear/Shaft Removal Tool	0444-127
Slide Hammer Kit	0444-225
Multi-Seal Remover	0644-180

■NOTE: Special tools are available from the Arctic Cat Service Parts Department.

Front Drive Actuator

■NOTE: The actuator is not a serviceable component. If it is defective, it must be replaced.

■NOTE: The actuator will operate only when the ignition switch is in the ON position.

The front drive actuator is located on the side of the front drive input housing. With the engine stopped and the ignition switch in the ON position, a momentary “whirring” sound can be heard each time the front drive selector switch is shifted. If no sound is heard, see Electrical System. If the actuator runs constantly or makes squealing or grinding sounds, the actuator must be replaced.

REMOVING

1. Disconnect the connector on the actuator harness.
2. Remove the mounting cap screw from the driveshaft side of the actuator.

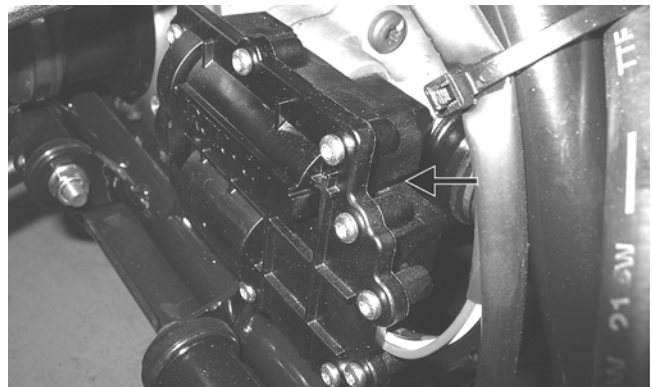

KC293A

3. Remove the mounting cap screw from below the actuator on the suspension side.

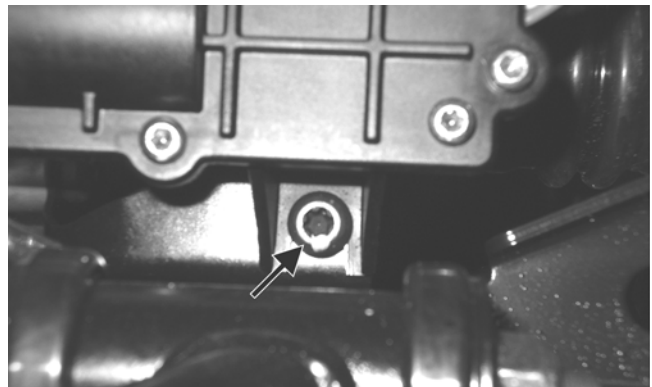

KC294A

4. Loosen but do not remove the mounting cap screw at the front of the actuator; then slide the actuator to the rear enough to clear the slotted mounting tab and the selector shaft.

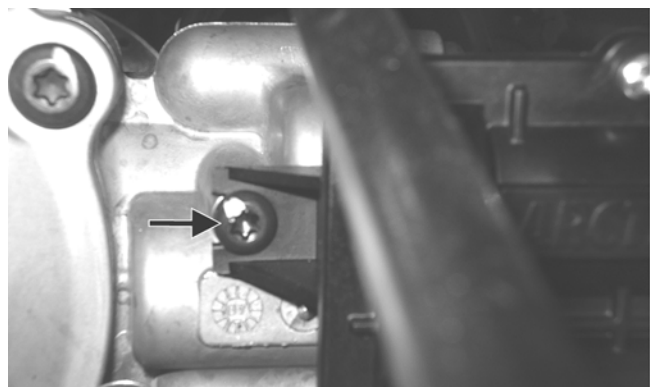

KC295A

INSTALLING

1. Lubricate the O-ring on the actuator; then ensure that all mounting surfaces are clean and free of debris.
2. Align the actuator with the selector shaft and slide it forward onto the shaft taking care to engage the cap screw in the slot of the front mounting tab.

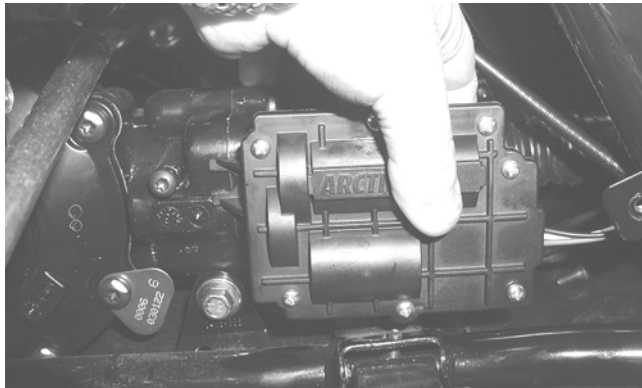

AG925

3. While holding the actuator firmly forward, tighten the front cap screw to hold the actuator in place; then install but do not tighten the two remaining cap screws.

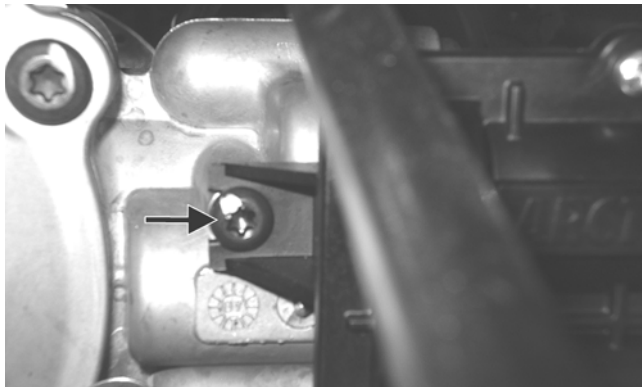

KC295A

4. Loosen the front cap screw; then tighten the cap screw on the driveshaft side.



AG926

■NOTE: It is important to tighten this cap screw while the others are loose to ensure proper seating of the actuator.

5. Tighten the remaining cap screws; then connect the electrical plug to the main harness.
6. Turn the ignition switch to the ON position and check the operation by shifting the selector switch several times.
7. Secure the wiring harness to the frame with a nylon cable tie.

Front Differential

REMOVING DIFFERENTIAL

1. Secure the ATV on a support stand to elevate the wheels.

⚠ WARNING

Make sure the ATV is solidly supported on the support stand to avoid injury.

2. Remove the drain plug and drain the gear lubricant into a drain pan; then reinstall the plug and tighten to 45 in.-lb.

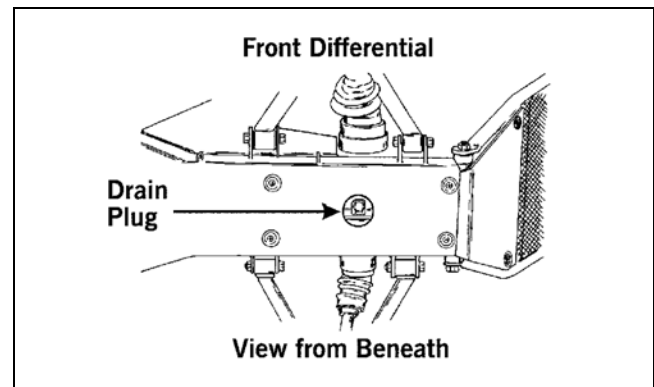

ATV0082A

3. Remove the front wheels.
4. Pump up the hand brake; then engage the brake lever lock.
5. Remove the cotter pin securing the hub nut; then remove the nut.
6. Release the brake lever lock.
7. Remove the upper and lower ball joint cap screws taking care not to strip the threads.

CAUTION

Apply pressure to hold the ball joint firmly in the knuckle or the threads will be stripped when the retaining cap screws are removed.

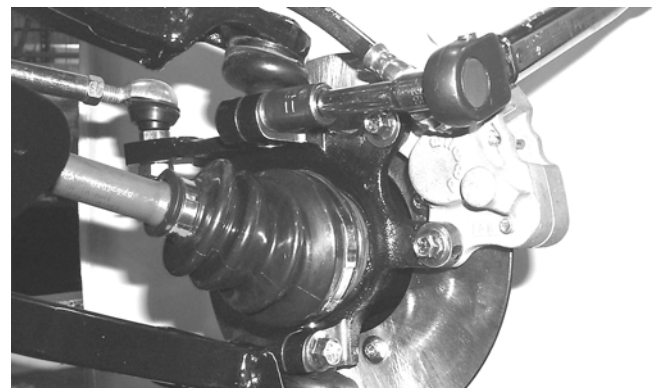

AF628D

8. Pull the steering knuckle away from the axle taking care not to damage the seals as the axle clears the knuckle.



KC314

9. Support the axle to not allow it to drop or hang.

CAUTION

The axle must be supported. If the axle is allowed to drop or hang, damage to the inner CV joint may occur.

10. Pull out on the axle until completely extended; then push it back in approximately one half inch and pull out sharply. Repeat until axle spline dislodges from the gear case.

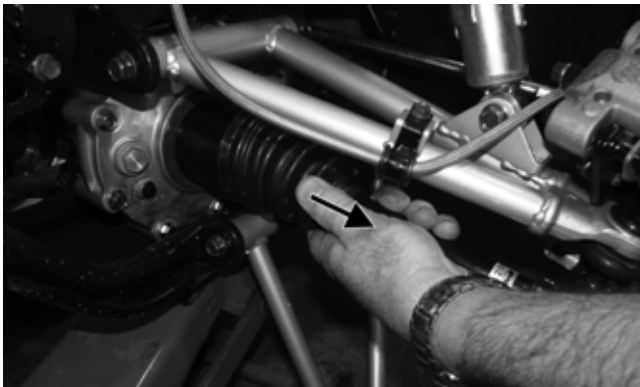

KC425A

■NOTE: In some instances it may be necessary to use a pry-bar between the gear case housing and axle coupler shoulder to dislodge the splines.



KC426A

11. Remove the cap screws from the drive coupler flange; then remove the upper and lower mounting cap screws and remove the differential from the frame.

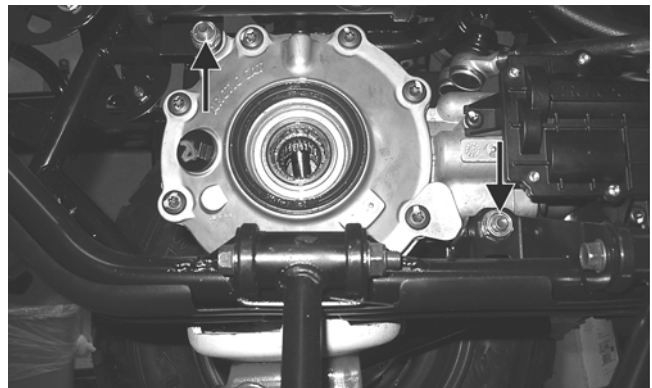

KC291A

Disassembling Input Shaft

■NOTE: This procedure can be performed on a rear gear case; however, some components may vary from model to model. The technician should use discretion and sound judgment.

1. Remove the cap screws securing the front drive actuator and remove the actuator; then remove the cap screws securing the pinion housing.



CD102

2. Using a rubber mallet, remove the housing. Account for a gasket. Remove the fork, collar, and spring. Note the location of all the components for assembling purposes.

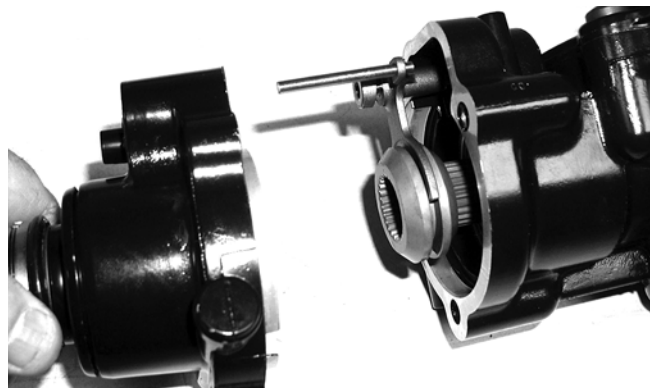

CD103

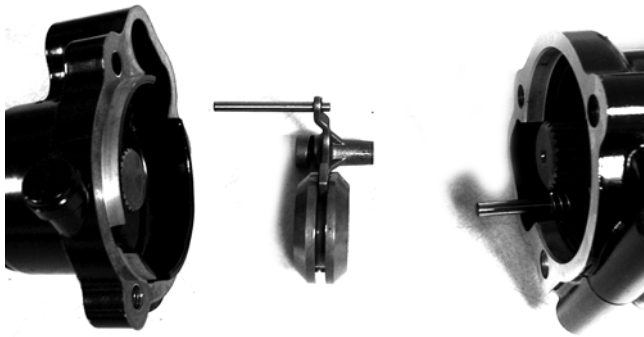

CD106

3. Using a side-cutter (or suitable substitute), remove the boot clamps; then remove the boots and splined drive from the input shaft.
4. Remove the input shaft from the pinion housing.



CD107

5. Using the Multi-Seal Remover, remove the input shaft seal. Account for a spacer.



AF982

6. Remove the snap ring securing the input shaft bearing; then place the pinion housing in a press and remove the bearing.



AF983

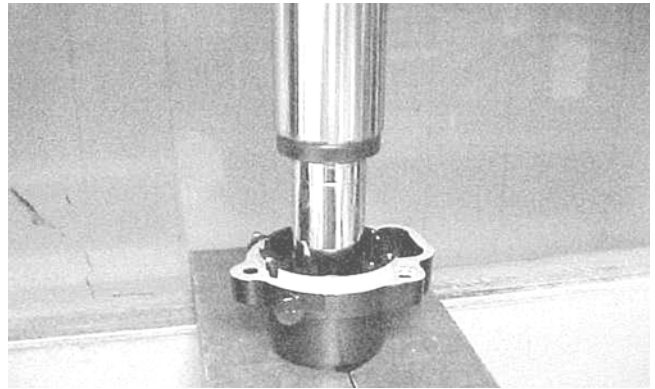

AF984



KX219

Assembling Input Shaft

1. Place the pinion housing in a press and install the input shaft bearing. Secure the bearing with the existing snap ring making sure the sharp edge of the snap ring making sure the sharp edge of the snap ring faces to the outside.

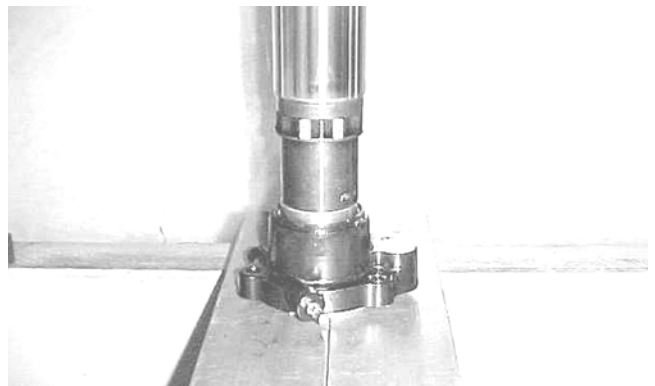

AF993



AF994

2. Install the input shaft seal making sure it is flush with the edge of the housing.
3. Lubricate the input shaft splines with High-Performance #2 Molybdenum Disulfide Grease.

■NOTE: Any time drive splines are separated, clean all splines with parts-cleaning solvent and dry with compressed air; then lubricate with recommended grease.



KX221



KX222

4. Install the input shaft into the housing; then install the front boot and secure with an appropriate boot clamp and the rear boot with an appropriate boot clamp.

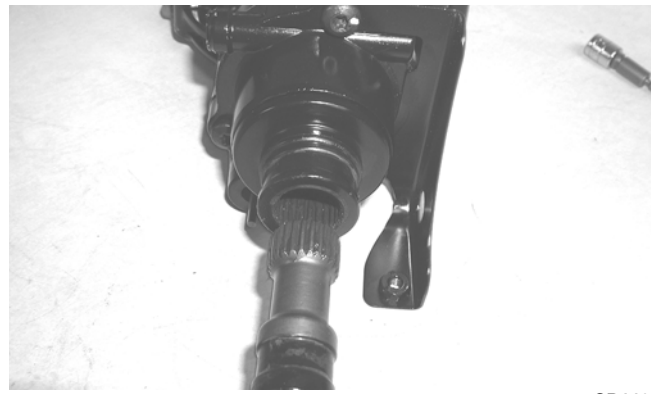

CD112

5. Using a new O-ring lubricated with grease, install the front drive actuator and secure with the cap screws.
6. Place the pinion housing with new gasket onto the gear case housing; then secure with the existing cap screws. Tighten to 18 ft-lb.

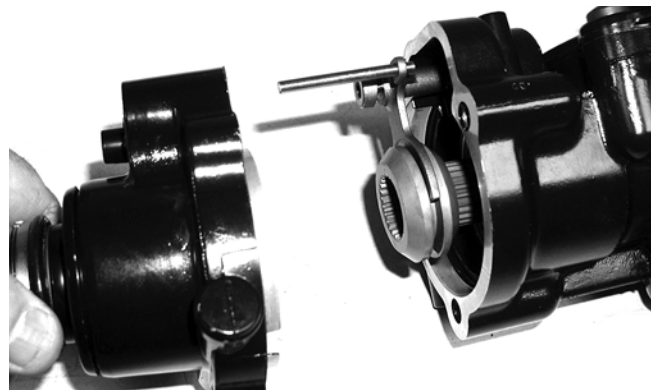

CD103

Disassembling Pinion Gear

■NOTE: This procedure can be performed on a rear gear case.

1. Remove the cap screws securing the pinion housing; then remove the housing and account for a gasket. Account for the coupler, fork, and spring.



KX209

2. Remove the cap screws securing the gear case cover. Account for and make note of the ID tag location for assembling purposes.

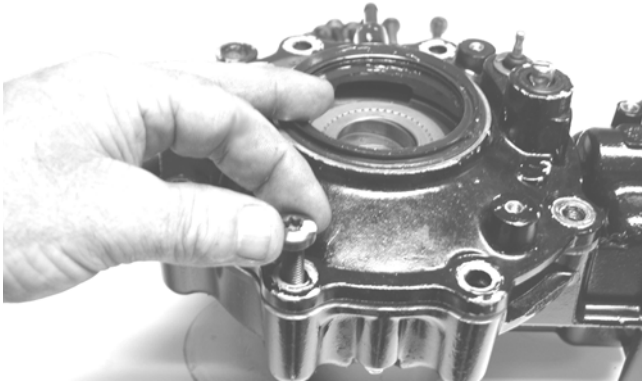

KX173

3. Using a plastic mallet, tap lightly to remove the differential cover. Account for an O-ring and a shim.

■NOTE: If the cover is difficult to remove, pry on the cover in more than one recessed location.



GC063

4. Place the differential with the open side down; then lift the housing off the spider assembly. Account for shim(s) and mark as right-side.



KX179

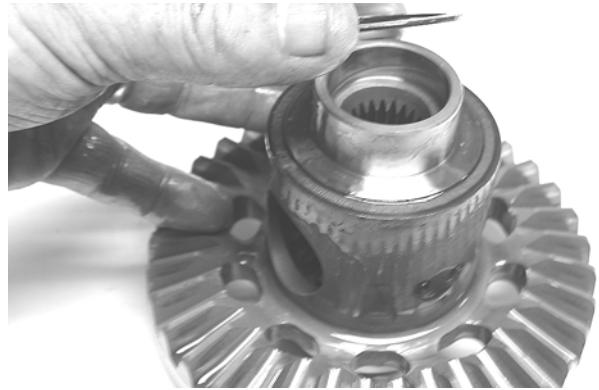

KX181

5. Unstake the lock collar; then using the 48 mm Internal Hex Socket, remove the lock collar securing the pinion gear assembly.

CAUTION

Failure to completely remove the staked material from the lock collar will result in the destruction of the threads in the gear case housing.

■NOTE: On a front differential, the lock collar has right-hand threads. On a rear gear case, the lock collar has left-hand threads.

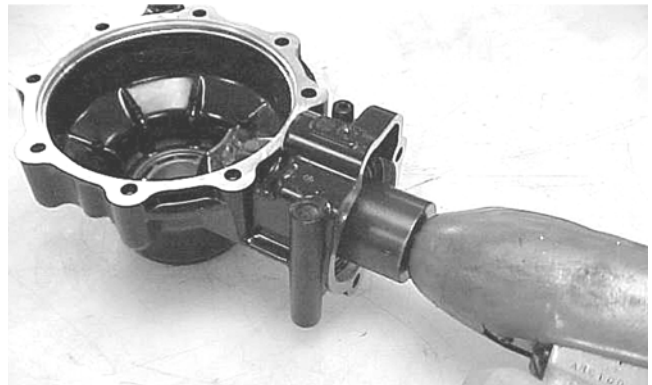

CC875



CC876

6. Using the Pinion Gear/Shaft Removal Tool and a hammer, remove the pinion gear from the gear case housing.

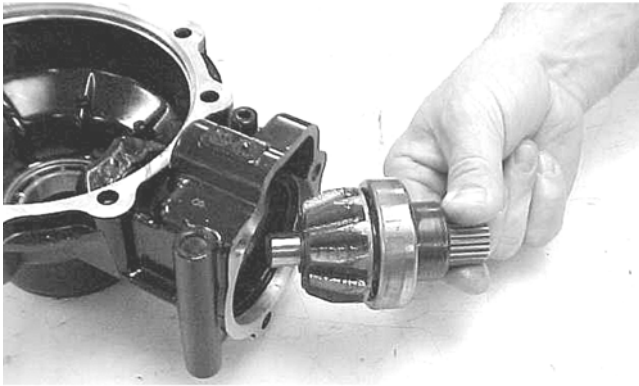

CC878

- Secure the pinion gear in a bearing puller; then remove the pinion bearing using a press. Account for a collar and a bearing.

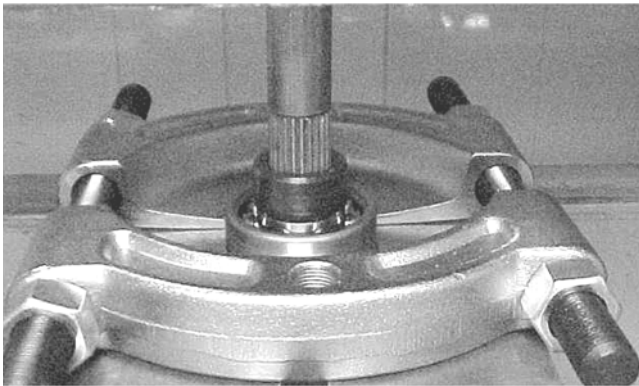

CC879

■NOTE: If gears are being replaced, use the existing shims.

■NOTE: If the gear case housing is being replaced, proceed to the following Shimming Procedure/Shim Selection sub-section.

Shimming Procedure/Shim Selection

Shims		
p/n	mm	in.
0402-405	1.3	0.051
0402-406	1.4	0.055
0402-407	1.5	0.059
0402-408	1.6	0.063
0402-409	1.7	0.067

It is very important to adjust bevel gears for the proper running tolerances. Gear life and gear noise are greatly affected by these tolerances; therefore, it is very important to properly adjust any gear set prior to final assembly.

The following procedure can be used on both front differential or rear drive gear case.

■NOTE: All bearings must be installed in the gear case and the pinion properly installed before proceeding.

Backlash

■NOTE: Always set backlash prior to any other shimming.

- Install the existing shim or a 0.051-0.055-in. shim on the gear case side of the ring gear assembly.



GC031A

- Install the ring gear with shim in the gear case; then while holding the pinion stationary, rock the ring gear forward and back to determine if any backlash exists. If no backlash exists, install a thicker shim and recheck.

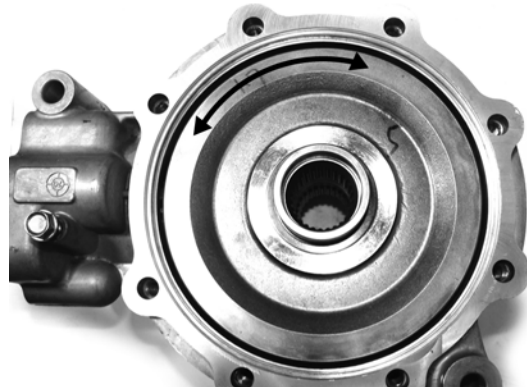

GC059A

- Install the bearing flange onto the gear case cover making sure the alignment/locating pin engages the locating hole in the cover; then make sure the bearing flange is completely seated in the cover.
- Install the existing shim or a 0.063 in. shim on the cover side of the ring gear; then place the assembled gear case cover onto the gear case and secure with three cap screws. Tighten evenly using a crisscross pattern.

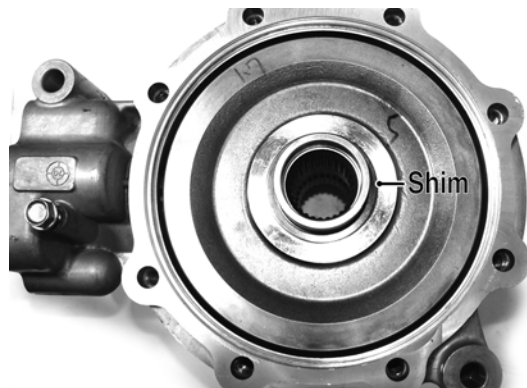

GC059B

- Place the Backlash Measuring Tool into the splines of the ring gear and install a dial indicator making sure it contacts the gauge at a 90° angle and on the index mark.



GC070

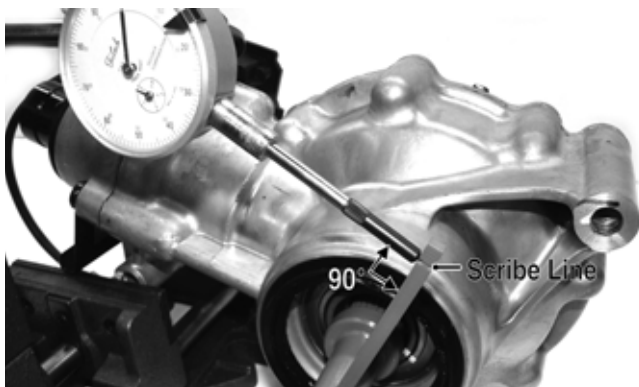

GC072A

- Zero the dial indicator; then while holding the pinion stationary, rock the ring gear assembly forward and back and record the backlash. Backlash must be 0.011-0.015 in. If backlash is within specifications, proceed to Ring Gear End-Play. If backlash is not within specifications, increase shim thickness to increase backlash or decrease shim thickness to decrease backlash.

■NOTE: Higher backlash settings usually result in quieter gear operation.

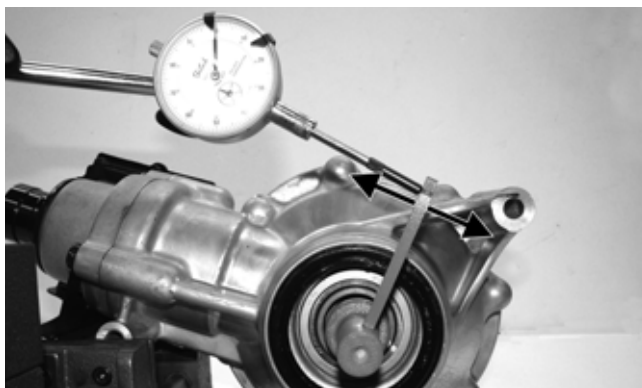

GC071A

Ring Gear End-Play

After correcting backlash, ring gear end-play can be adjusted. To adjust end-play, use the following procedure.

- Secure the gear case in a holding fixture with the cover side up; then install a dial indicator contacting the ring gear axle flange.



GC065

- Zero the dial indicator; then push the ring gear toward the dial indicator and release. End-play should be 0.004-0.008 in.
- To increase end-play, decrease the shim thickness. To decrease end-play, increase the shim thickness.

■NOTE: Once proper backlash and end play are established, the gear case can be assembled (see Assembling Differential Assembly in this sub-section).



CC888

RING GEAR/THRUST BUTTON

Removing

Remove the thrust button from the gear case cover (left-hand threads). Account for a shim.

Inspecting

- Inspect the ring gear for excessive wear or discoloration.
- Inspect the thrust button for excessive wear or discoloration.
- Inspect the bearings for discoloration, roughness, or excessive wear.

Installing/Shimming

■NOTE: Ring gear end-play must be adjusted prior to selecting shim for the thrust button.

- Install the thrust button with shim into the gear case and tighten securely (left-hand threads).

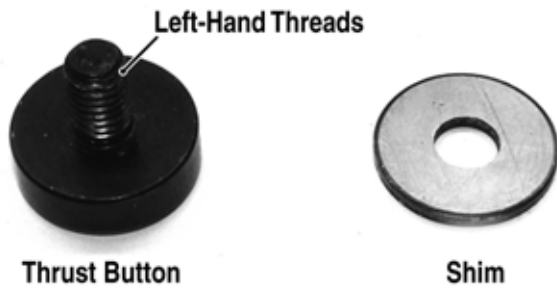

GC057A

- Place the ring gear with selected shim into the cover and measure the ring gear to thrust button clearance with a thickness gauge. Clearance should be 0.002-0.004 in.



GC058A

- If clearance is as specified, remove the ring gear and thrust button; then place a drop of red Loctite #271 on the threads and tighten to 8 ft-lb (left-hand threads).
- If clearance is not as specified, repeat steps 1 and 2 using thicker (clearance too great) or thinner (clearance too small) until correct specification is reached.

Assembling Differential Assembly

- With the pinion gear and new bearings installed, place the selected (backlash) shim on the gear case side of the ring gear with the chamfered side toward the ring gear; then install into gear case/differential housing.



GC031A



GC059

- Place the selected (end-play) shim, chamfered side toward the gear, onto the cover side of the ring gear.

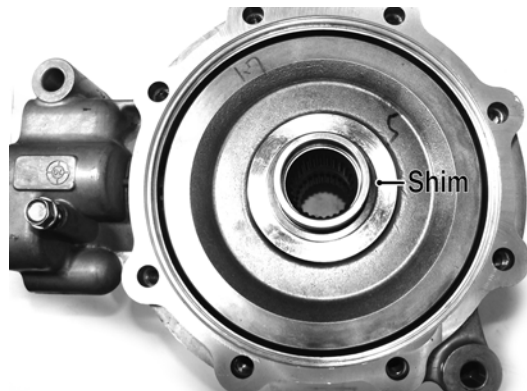

GC059B

NOTE: The spider and ring gear assembly must be replaced as a complete unit.

- Making sure the O-ring is properly positioned on the differential housing cover assembly, install the cover with existing cap screws (coated with green Loctite #609). Account for the ID tag. Tighten the cap screws evenly to 18 ft-lb.

NOTE: Grease can be applied to the O-ring for ease of assembling.

- Install the shift fork shaft w/spring into the housing making sure the shaft O-ring is positioned to the inside.

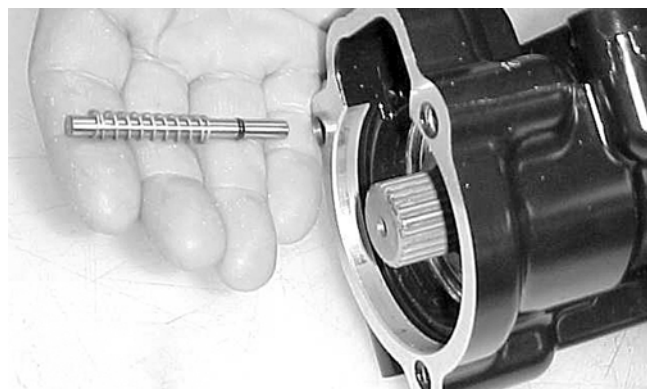

CC892

- Install the shift fork assembly making sure the fork leg is facing upward. Apply a small amount of oil to the gasket; then install the gasket.

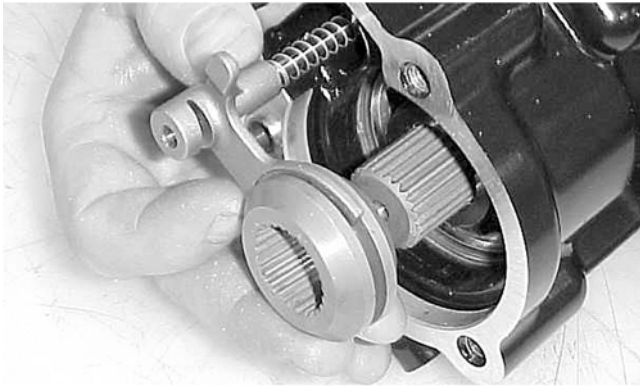

CC893

6. Place the input shaft housing assembly onto the gear case housing; then secure with the existing cap screws. Tighten to 18 ft-lb.

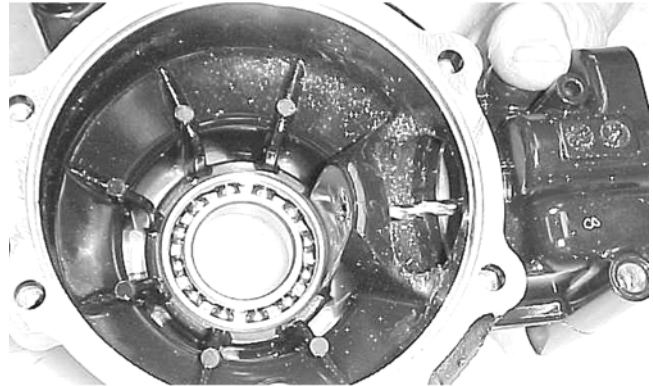

CC885

2. Using a propane torch, heat the area surrounding the needle bearing to soften the Loctite.

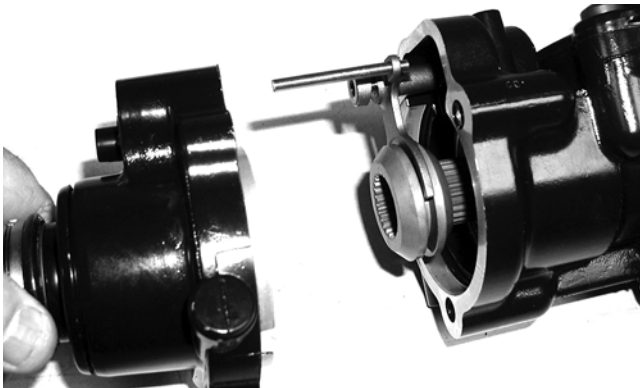

CD103



CC886

3. Using a flat-nosed punch, drive the bearing out of the housing.



CD110

Removing Needle Bearing

■NOTE: Removing the needle bearing is rarely necessary. Avoid removing the needle bearing unless the bearing is clearly damaged.

■NOTE: This procedure can be performed on a rear gear case.

1. Place a 1/4 in. drill bit on the inside surface of the needle bearing (against the bottom side); then drill through the pinion shaft needle bearing housing.



CC887

Installing Needle Bearing

1. Apply green Loctite #609 to the outside of a new bearing; then place the new bearing into the housing.



CC888

2. Using a suitable driver, install the needle bearing into the gear case housing making sure the bearing is seated.

■NOTE: Do not push the bearing too far into the housing.

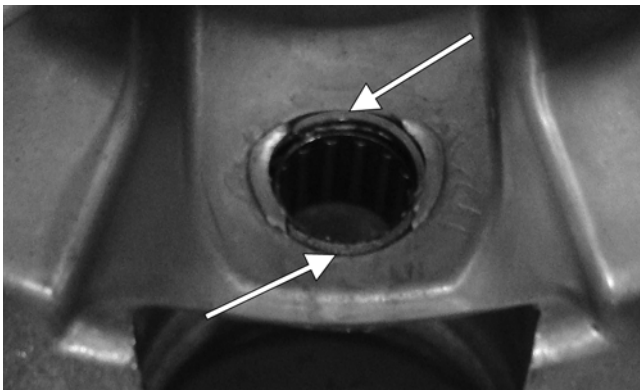

GC045A

3. Install the pinion shaft and secure with a new 48 mm lock collar. Tighten to 125 ft-lb.

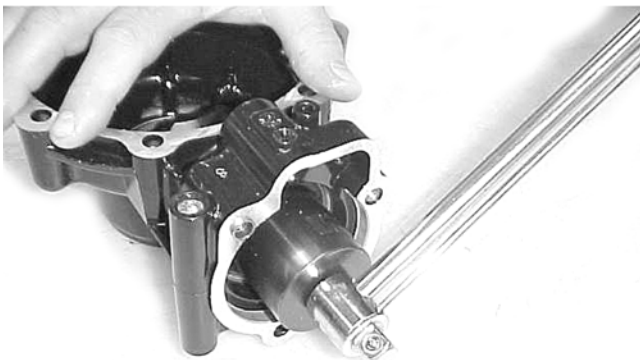

CC890

4. Place a punch on the edge of the lock collar in the oil gallery area; then using a hammer, stake the lock collar to ensure that the collar will remain securely tightened.

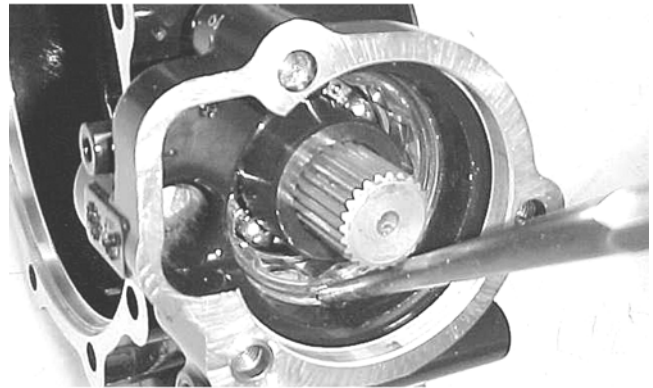

CC891

5. Install the pinion housing.

Removing/Installing Axle Seal

■NOTE: This procedure can be performed on a rear gear case.

1. Remove the seal using a seal removal tool.



GC066

2. Using a press, remove the bearing.



CC900

3. Using a press, install the new bearing into the housing.

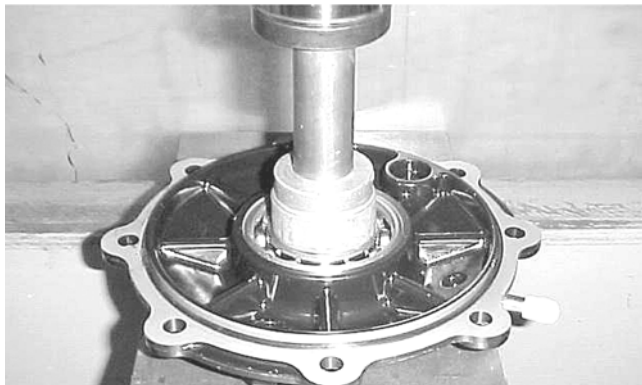

CC901

■ **NOTE:** Prior to installing the seal, apply High Performance #2 Molybdenum Disulfide Grease to the seal outside diameter.

- Using an appropriate seal installation tool, evenly press the seal into the cover bore until seated.

CAUTION

Make sure the tool is free of nicks or sharp edges or the seal will be damaged.



GC060

- Repeat steps 1-4 for the opposite side.

INSTALLING DIFFERENTIAL

- Align the input flange with the front output flange; then place the differential into position on the frame and install the cap screws and nuts. Tighten to 38 ft-lb.

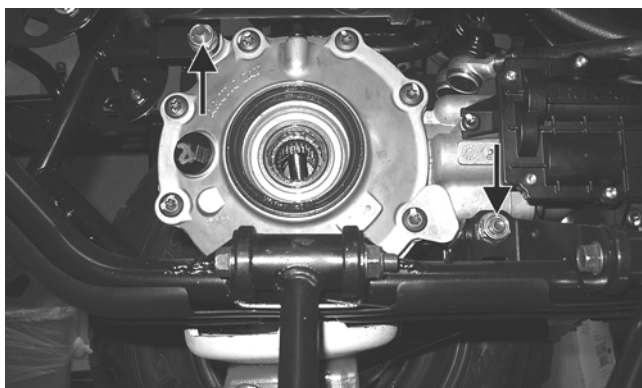

KC291A

- Install the cap screws securing the flange couplers together and tighten to 20 ft-lb.

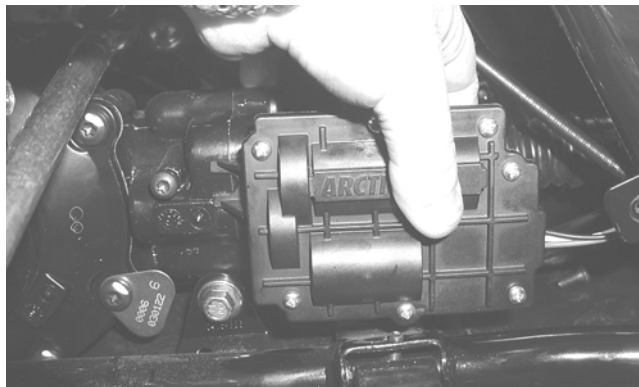

AG925

- Install the front axles (see Drive Axles in this section).

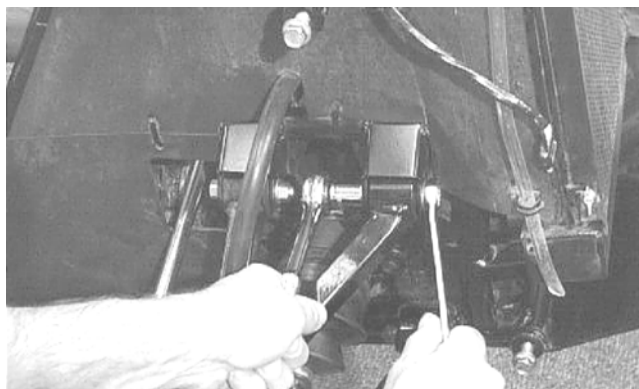

AF610D

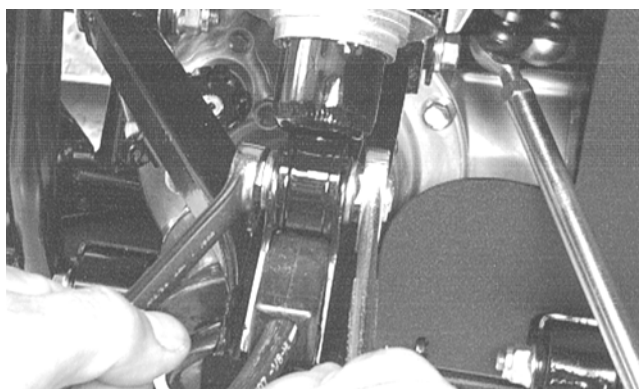

AF897D

- Install the wheels and tighten to 40 ft-lb.
- Pour 275 ml (9.3 fl oz) of SAE 80W-90 hypoid gear lubricant into the differential and install the fill plug. Tighten to 16 ft-lb.
- Remove the ATV from the support stand.

Drive Axles

REMOVING REAR DRIVE AXLE

1. Secure the ATV on a support stand to elevate the wheels.

⚠ WARNING

Make sure the ATV is solidly supported on the support stand to avoid injury.

2. Pump up the hand brake; then engage the brake lever lock.
3. Remove the rear wheels.
4. Remove the cotter pins securing the hex nuts; then remove the hex nuts. Release the brake lever lock.
5. Remove the cap screw and lock nut securing the knuckle to the upper A-arm. Discard the lock nut.



KC284

NOTE: Never reuse a lock nut. Once a lock nut has been removed, it must be replaced with a new lock nut.

6. While holding the drive axle stationary, pull the top of the knuckle out and down until it is free of the drive axle.



KC285

7. Place a drain pan under the ATV to contain any oil leakage; then pull out sharply on the axle to dislodge the splines from the gear case. Remove the axle.

REMOVING FRONT DRIVE AXLE

NOTE: For removing a front drive axle, see Front Differential in this section.

CLEANING AND INSPECTING

NOTE: Always clean and inspect the drive axle components to determine if any service or replacement is necessary.

1. Using a clean towel, wipe away any oil or grease from the axle components.
2. Inspect boots for any tears, cracks, or deterioration.

NOTE: If a boot is damaged in any way, it must be replaced with a boot kit.

3. Inspect the gear case seals for nicks or damage.

DISASSEMBLING AXLES

NOTE: To disassemble/assemble axles, refer to appropriate boot kit instructions.

INSTALLING REAR DRIVE AXLE

1. Slide the drive axle into place in the gear case.

NOTE: To assure proper seating of the axle, give it a light pull; the axle should remain "clipped" in place.

2. Swing the knuckle up and onto the drive axle; then place the knuckle into place in the upper A-arm. Secure the knuckle to the A-arm with a cap screw and a new lock nut. Tighten to 35 ft-lb.
3. Place the hub into position on the axle followed by a hex nuts. Tighten the hex nuts finger-tight at this time.
4. Pump up the hand brake lever; then engage the brake lever lock.
5. Tighten the hub hex nuts (from step 3) to 200 ft-lb; then install and spread a new cotter pin making sure each side of the pin is flush to the hub nut.
6. Install the wheel. Tighten to 40 ft-lb.
7. Remove the ATV from the support stand and release the brake lever lock.

INSTALLING FRONT DRIVE AXLE

1. Position the drive axle in the gear case and steering knuckle; then insert the upper A-arm ball joint into the steering knuckle. Secure with a cap screw tightened to 35 ft-lb.
2. Slide the hub w/brake disc into position in the steering knuckle followed by a washer and hex nut. Tighten finger-tight at this time.
3. Install the brake caliper on the steering knuckle. Tighten to 20 ft-lb; then pump up the hand brake lever and engage the brake lever lock.
4. Tighten the hub hex nut (from step 2) to 200 ft-lb; then install and spread a new cotter pin making sure each side of the pin is flush to the hub nut.

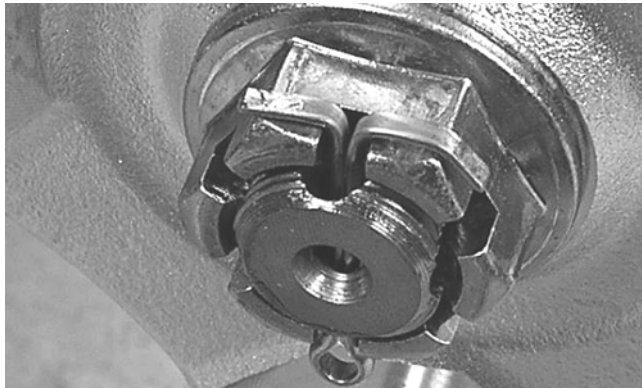

KC305

5. Install the wheel and tighten to 40 ft-lb.
6. Remove the ATV from the support stand and release the brake lever lock.
7. Check the front differential oil level and add oil as necessary.

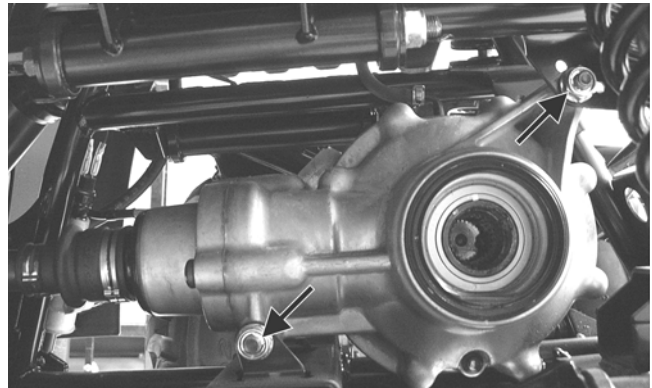

KC288A

⚠ AT THIS POINT

For servicing the input shaft, pinion gear, needle bearing, thrust button, and axle seal, see Front Differential in this section.

INSTALLING

1. Slide the gear case into position through the left side of the frame; then secure it to the frame with cap screws and lock nuts. Tighten to 38 ft-lb.
2. Secure the engine output flange to the rear gear case input flange with four cap screws and lock nuts. Tighten to 20 ft-lb.
3. Install the rear drive axles (see Drive Axles in this section).

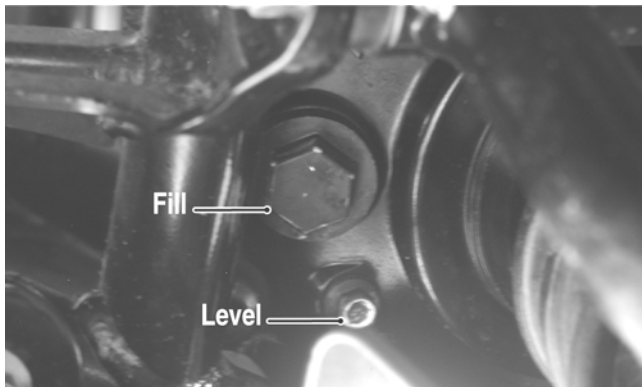

CF113A

Rear Gear Case

REMOVING

1. Remove both of the rear drive axles (see Drive Axles in this section).
2. Remove the four cap screws securing the engine output shaft to the rear gear case input flange.

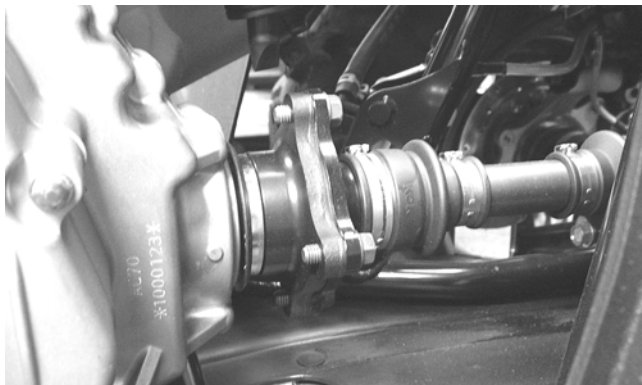

KC169

3. Remove the two cap screws and lock nuts securing the rear gear case to the frame; then remove the gear case through the left side.

Hub

REMOVING

1. Secure the ATV on a support stand to elevate the wheel; then remove the wheel.

⚠ WARNING

Make sure the ATV is solidly supported on the support stand to avoid injury.

2. Remove the cotter pin from the nut.

NOTE: During assembly, new cotter pins should be installed.

3. Remove the flange nut securing the hub.
4. Remove the brake caliper.

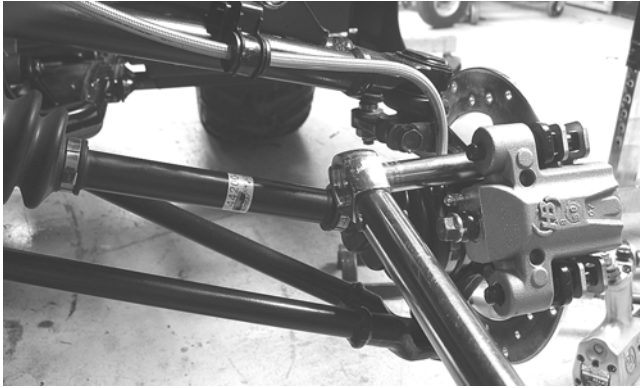

KC283

5. Remove the hub assembly.
6. Remove the four cap screws securing the brake disc.

CLEANING AND INSPECTING

■NOTE: Whenever a part is worn excessively, cracked, or damaged in any way, replacement is necessary.

1. Clean all hub components.
2. Inspect all threads for stripping or damage.
3. Inspect the brake disc for cracks or warping.
4. Inspect the hub for pits, cracks, loose studs, or spline wear.

INSTALLING

1. Secure the brake disc to the hub with the four cap screws coated with blue Loctite #243. Tighten to 15 ft-lb.
2. Apply grease to the splines in the hub.
3. Install the hub assembly onto the shaft.
4. Secure the hub assembly with the nut. Tighten only until snug.
5. Secure the brake caliper to the knuckle with the two cap screws. Tighten the caliper to 20 ft-lb.



KC283

6. Tighten the hub nut (from step 4) to 200 ft-lb; then install and spread a new cotter pin making sure each side of the pin is flush to the hub nut.

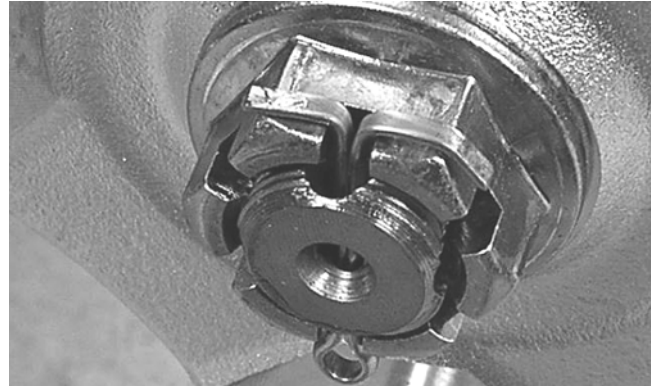

KC305

7. Install the wheel and tighten to 40 ft-lb.
8. Remove the ATV from the support stand.

Hand Brake Lever/Master Cylinder Assembly

■NOTE: The master cylinder is a non-serviceable component; it must be replaced as an assembly.

REMOVING

1. Slide a piece of flexible tubing over one of the wheel bleeder valves and direct the other end into a container. Remove the reservoir cover; then open the bleeder valve. Allow the brake fluid to drain completely.

■NOTE: Compressing the brake lever several times will quicken the draining process.



AF637D

2. Place an absorbent towel around the connection to absorb brake fluid. Remove the banjo-fitting bolt from the master cylinder. Account for two crush washers and a banjo-fitting bolt.

CAUTION

Brake fluid is highly corrosive. Do not spill brake fluid on any surface of the ATV.

3. Remove the clamp screws securing the brake housing to the handlebar, then remove the assembly from the handlebar.

INSPECTING

■NOTE: Whenever a part is worn excessively, cracked, or damaged in any way, replacement is necessary.

1. Inspect the pin securing the brake lever for wear.
2. Inspect the brake lever for elongation of the pivot hole.
3. Inspect the reservoir for cracks and leakage.
4. Inspect the banjo-fitting and bolt for cracks and deterioration and the condition of the fittings (threaded and compression).

INSTALLING

1. Position the brake housing on the handlebar. Secure with clamp screws; then tighten securely.
2. Using two new crush washers, connect the banjo-fitting to the master cylinder; then secure with the banjo-fitting bolt. Tighten to 20 ft-lb.
3. Bleed the brake system (see Periodic Maintenance).

Hydraulic Brake Caliper

⚠ WARNING

Arctic Cat recommends that only authorized Arctic Cat ATV dealers perform hydraulic brake service. Failure to properly repair brake systems can result in loss of control causing severe injury or death.

REMOVING/DISASSEMBLING

1. Secure the ATV on a support stand to elevate the wheel; then remove the wheel.

⚠ WARNING

Make sure the ATV is solidly supported on the support stand to avoid injury.

⚠ WARNING

Never let brake fluid contact the eyes. Damage to the eyes will occur. Always wear appropriate protective safety goggles and latex gloves when handling brake fluid.

2. Drain the brake fluid from the caliper, hose, and master cylinder through the bleed screw by pumping the brake lever/pedal.

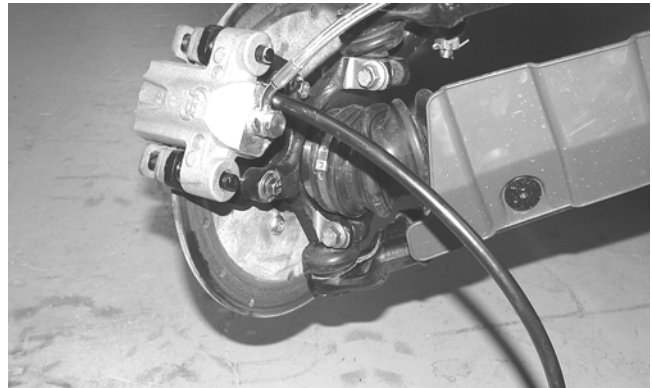

PR235

CAUTION

Brake fluid is highly corrosive. Do not spill brake fluid on any surface of the ATV and do not reuse brake fluid.

■NOTE: Whenever brake components are removed, disassembled, or repaired where brake fluid is exposed to air, drain all fluid and replace with new DOT 4 brake fluid from an unopened container. Brake fluid readily absorbs moisture from the air significantly lowering the boiling point. This increases the chance of vapor lock reducing braking power and increasing stopping distance.

3. Remove the brake hose from the caliper and close the bleed screw; then remove the caliper.
4. Compress the caliper holder against the caliper (opposite the O-ring side) and remove the outer brake pad; then remove the inner brake pad.

■NOTE: If brake pads are to be returned to service, do not allow brake fluid to contaminate them.



PR237A



PR238

- Remove the caliper holder from the caliper and discard the O-ring.

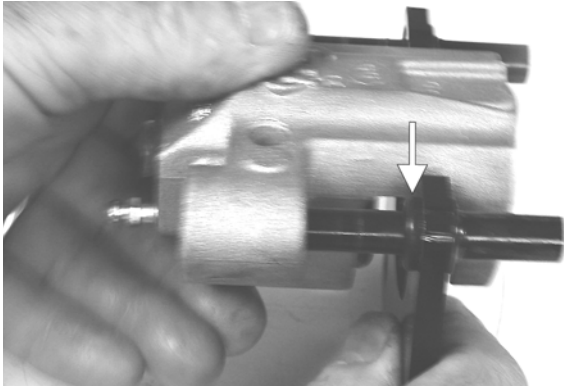

PR239B

■NOTE: The O-ring is used for shipping purposes and provides no function in operation.

- Cover the piston end of the housing with a shop towel; then keeping fingers clear of piston travel, apply compressed air to the fluid port to blow the piston free of the housing. Account for two seal rings in the housing.

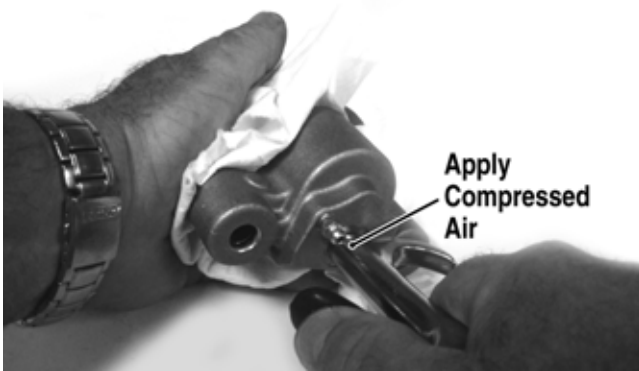

PR713A



PR715

⚠ WARNING

Make sure to hold the towel firmly in place or the piston could be ejected from the housing causing injury.

- Using an appropriate seal removal tool, carefully remove the seals from the brake caliper housing; then remove four O-rings from the brake caliper housing noting the location of the different sized O-rings. Discard all seals, O-rings, and crush washers.

CLEANING AND INSPECTING

- Clean all caliper components (except the brake pads) with DOT 4 brake fluid. Do not wipe dry.
- Inspect the brake pads for damage and excessive wear.

■NOTE: For measuring brake pads, see Periodic Maintenance.

- Inspect the brake caliper housings for scoring in the piston bores, chipped seal ring grooves, or signs of corrosion or discoloration.
- Inspect the piston surface for scoring, discoloration, or evidence of binding or galling.
- Inspect the caliper holder for wear or bending.

ASSEMBLING/INSTALLING

- Install new seals into the brake caliper housing and apply a liberal amount of DOT 4 brake fluid to the cylinder bore of the housing, seals, and brake piston.

CAUTION

Make sure the seals are properly in place and did not twist or roll during installation.



PR715



PR717A

- Press the piston into the caliper housing using hand pressure only. Completely seat the piston; then wipe off any excessive brake fluid.



PR711A



PR712

3. Apply high-temperature silicone grease (supplied with the O-ring kit) to the inside of the caliper holder bores and O-rings; then install the four O-rings into the caliper.

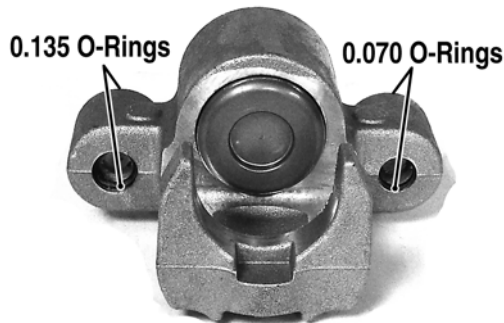

PR719C

4. Install the caliper onto the caliper holder making sure the caliper and holder are correctly oriented.

■NOTE: It is very important to apply silicone grease to the O-rings and caliper bores prior to assembly.

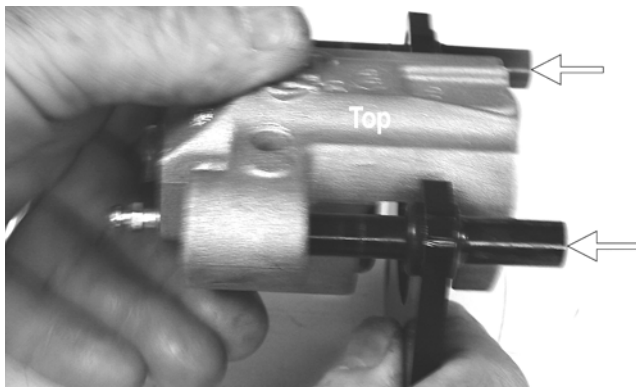

PR239D

5. Making sure brake fluid does not contact the brake pads, compress the caliper holder toward the caliper and install the inner brake pad; then install the outer pad.

CAUTION

If brake pads become contaminated with brake fluid, they must be thoroughly cleaned with brake cleaning solvent or replaced with new pads. Failure to do so will result in reduced braking and premature brake pad failure.



PR238

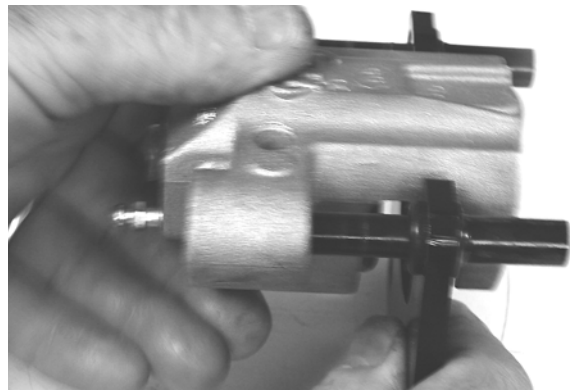

PR239

6. Place the brake caliper assembly into position and secure with new "patch-lock" cap screws. Tighten the caliper to 20 ft-lb.
7. Place a new crush washer on each side of the brake hose fitting and install it on the caliper. Tighten to 20 ft-lb.
8. Fill the reservoir; then bleed the brake system (see Periodic Maintenance).

⚠ WARNING

Never use brake fluid from an open container or reuse brake fluid. Moisture-contaminated brake fluid could cause vapor build-up (expansion) during hard braking resulting in greatly increased stopping distance or loss of control leading to injury or death.

9. Install the wheel. Tighten to 40 ft-lb.
10. Remove the ATV from the support stand and verify brake operation.

Troubleshooting Drive System

Problem: Power not transmitted from engine to wheels	
Condition	Remedy
1. Rear axle shafts serration worn - broken	1. Replace shaft
Problem: Power not transmitted from engine to either front wheel	
Condition	Remedy
1. Secondary drive - driven gear teeth broken	1. Replace gear(s)
2. Propeller shaft serration worn - broken	2. Replace shaft
3. Coupling damaged	3. Replace coupling
4. Coupling joint serration worn - damaged	4. Replace joint
5. Front drive - driven bevel gears broken - damaged	5. Replace gear(s)
6. Front differential gears/pinions broken - damaged	6. Replace gears - pinions
7. Sliding dogs/shaft fork worn - damaged	7. Replace gear(s)
8. Front drive axle worn - damaged	8. Replace axle
9. Front drive axle serration worn - damaged	9. Replace axle

Troubleshooting Brake System

Problem: Braking poor	
Condition	Remedy
1. Pad worn	1. Replace pads
2. Pedal free-play excessive	2. Replace pads
3. Brake fluid leaking	3. Repair - replace hydraulic system component(s)
4. Hydraulic system spongy	4. Bleed hydraulic system - correct or repair leaks
5. Master cylinder/brake cylinder seal worn	5. Replace master cylinder
Problem: Brake lever travel excessive	
Condition	Remedy
1. Hydraulic system entrapped air	1. Bleed hydraulic system
2. Brake fluid low	2. Add fluid to proper level
3. Brake fluid incorrect	3. Drain system - replace with correct fluid
4. Piston seal - cup worn	4. Replace master cylinder
Problem: Brake fluid leaking	
Condition	Remedy
1. Connection joints loose	1. Tighten joint
2. Hose cracked	2. Replace hose
3. Piston seal worn	3. Replace brake caliper

Suspension

The following suspension system components should be inspected periodically to ensure proper operation.

- A. Shock absorber rods not bent, pitted, or damaged.
- B. Rubber damper not cracked, broken, or missing.
- C. Shock absorber body not damaged, punctured, or leaking.
- D. Shock absorber eyelets not broken, bent, or cracked.
- E. Shock absorber eyelet bushings not worn, deteriorated, cracked, or missing.
- F. Shock absorber spring not broken or sagging.

Shock Absorbers

REMOVING

1. Secure the ATV on a support stand to elevate the wheels and to release load on the suspension.

WARNING

Make sure the ATV is solidly supported on the support stand to avoid injury.

2. Remove the two cap screws and nuts securing each front shock absorber to the frame and the upper A-arm. Account for bushings and sleeves from each.

CAUTION

Additional support stands are necessary to support the rear axle when the shock absorbers are removed or damage may occur.

3. Remove the two cap screws and nut securing each rear shock absorber to the frame and lower A-arm. Account for bushings and sleeves from each.

■**NOTE:** The shock absorbers are not serviceable components. If leaking, dented, or there are missing or broken parts, the shock absorber assembly must be replaced.

INSTALLING

1. Place bushings and sleeves (where appropriate) into shock eyelet; then install shock with cap screws and nuts. Tighten all nuts to 35 ft-lb.

CAUTION

Do not tighten the nuts beyond the 35 ft-lb specification or the shock eyelet or mount WILL be damaged.

2. Remove the ATV from the support stand.

Front A-Arms

REMOVING

1. Secure the ATV on a support stand to elevate the front wheels; then remove the wheels.

WARNING

Make sure the ATV is solidly supported on the support stand to avoid injury.

2. Remove the cotter pin from the nut. Discard the cotter pin.
3. Remove the nut securing the hub.
4. Remove the brake caliper. Account for two cap screws.

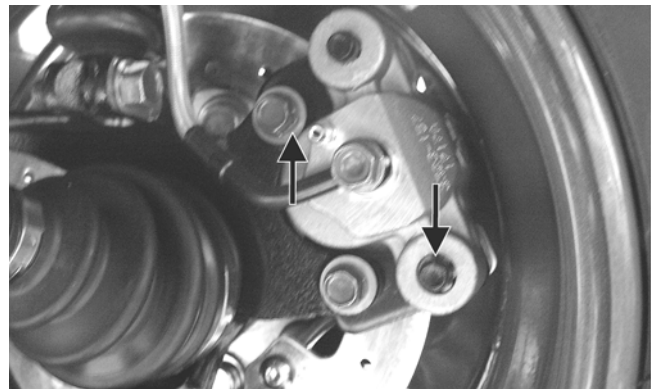

KC187A

5. Remove the hub assembly.
6. Remove the cap screws securing the ball joints to the knuckle.

CAUTION

Support the knuckle when removing the cap screws or damage to the threads will occur.

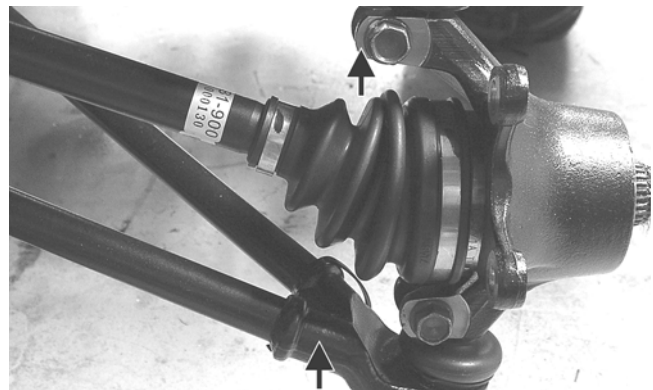

KC313A

7. Tap the ball joints out of the knuckle; then free the knuckle from the axle and swing out of the way.



KC297

8. Remove the lower shock absorber eyelet from the upper A-arm.
9. Remove the cap screws securing the A-arms to the frame.
10. Remove the circlip from the ball joint; then remove the ball joint from the A-arm.

CLEANING AND INSPECTING

NOTE: Whenever a part is worn excessively, cracked, or damaged in any way, replacement is necessary.

1. Clean all A-arm components using a pressure washer.
2. Clean the ball joint mounting hole of all residual Loctite, grease, oil, or dirt for installing purposes.
3. Inspect the A-arm for bends, cracks, and worn bushings.
4. Inspect the ball joint mounting holes for cracks or damage.
5. Inspect the frame mounts for signs of damage, wear, or weldment damage.

INSTALLING

1. Apply green Loctite #609 to the entire outside diameter of the ball joint; then install the ball joint into the A-arm and secure with the circlip.
2. Install the A-arm assemblies into the frame mounts and secure with the cap screws. Only finger-tighten at this time.
3. Secure the lower eyelet of the shock absorber to the upper A-arm. Tighten nut to 35 ft-lb.
4. Secure the A-arm assemblies to the frame mounts (from step 2). Tighten the cap screws to 35 ft-lb.

CAUTION

Do not tighten the nut beyond the 35 ft-lb specification or the shock eyelet or mount WILL be damaged.

5. Install the knuckle assembly onto the ball joints and secure with cap screws. Tighten to 35 ft-lb.
6. Apply grease to the hub and drive axle splines; then install the hub assembly onto the drive axle.

7. Secure the hub assembly with the nut. Tighten only until snug.
8. Secure the brake caliper to the knuckle with the two “patch-lock” cap screws. Tighten to 20 ft-lb.
9. Secure the hub nut (from step 7) to the shaft/axle. Tighten to 200 ft-lb.
10. Install a new cotter pin and spread the pin to secure the nut.
11. Install the wheel and tighten to 40 ft-lb.
12. Remove the ATV from the support stand.

Rear A-Arms

REMOVING

1. Secure the ATV on a support stand to elevate the wheels.

WARNING

Make sure the ATV is solidly supported on the support stand to avoid injury.

2. Pump up the hand brake; then engage the brake lever lock.
3. Remove the wheel.
4. Remove the cotter pin securing the hex nut; then remove the hex nut. Release the brake lever lock.
5. Remove the caliper (right side only).

NOTE: Do not allow the brake caliper to hang from the hose.

6. Remove the cap screws and lock nut securing the shock absorber to the frame and lower A-arm; then remove the shock absorber.

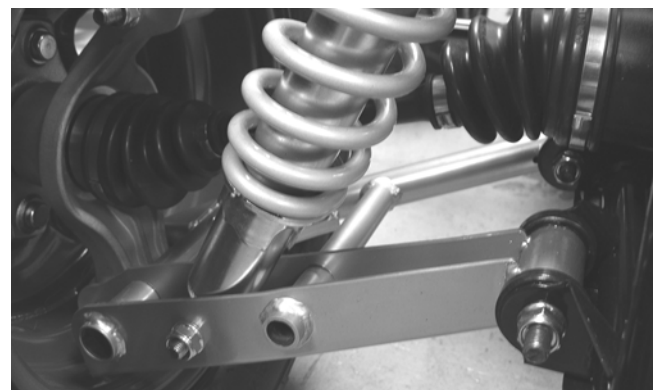

KC0100

7. Slide the hub out of the knuckle and set aside.
8. Remove the cap screws and lock nuts securing the knuckle to the A-arms. Discard the lock nuts.

NOTE: Never reuse a lock nut. Once a lock nut has been removed, it must be replaced with a new lock nut.

9. Remove the cap screws and lock nuts securing the A-arms to the frame; then remove the A-arms.

■NOTE: If removing the upper right A-arm, it will be necessary to disconnect the brake hose from the A-arm.

CLEANING AND INSPECTING

■NOTE: Whenever a part is worn excessively, cracked, or damaged in any way, replacement is necessary.

1. Clean all A-arm components using a pressure washer.
2. Inspect the A-arm for bends, cracks, and worn bushings.
3. Inspect the frame mounts for signs of damage, wear, or weldment damage.

INSTALLING

1. Install the A-arm assemblies into the frame mounts and secure with the cap screws and new lock nuts. Only finger-tighten at this time.
2. Slide the knuckle onto the drive axle and into position on the A-arms; then secure the knuckle to the A-arms with cap screws and new lock nuts. Tighten to 35 ft-lb.
3. Tighten the hardware securing the A-arms to the frame mounts (from step 1) to 35 ft-lb.
4. Apply grease on the drive axle splines; then install the hub assembly onto the drive axle.
5. Secure the hub assembly with the nut. Tighten only until snug.
6. Secure the brake caliper to the knuckle with the two “patch-lock” cap screws (right side only). Tighten the caliper to 20 ft-lb.
7. Compress the hand brake lever and engage the brake lever lock; then secure the hub nut (from step 5) to the drive axle. Tighten to 200 ft-lb.
8. Install a new cotter pin and spread the pin to secure the nut.
9. Secure the shock absorber to the frame with a cap screw and new lock nut. Tighten to 35 ft-lb.
10. Secure the shock absorber to the lower A-arm with a cap screw and new lock nut. Tighten to 35 ft-lb.
11. Secure the boot guard to the lower A-arm with the two cap screws. Tighten securely.
12. Install the wheel and tighten to 40 ft-lb.
13. Remove the ATV from the support stand.

Wheels and Tires

TIRE SIZE

WARNING

Use only Arctic Cat approved tires when replacing tires. Failure to do so could result in unstable ATV operation.

The ATV is equipped with low-pressure tubeless tires of the size and type listed in General Information. Do not under any circumstances substitute tires of a different type or size.

WARNING

Do not mix tire tread patterns. Use the same pattern type on front and rear. Failure to heed warning could cause poor handling qualities of the ATV and could cause excessive drive train damage not covered by warranty.

TIRE INFLATION PRESSURE

Front and rear tire inflation pressure should be 40.0 kPa (5.7 psi).

REMOVING

1. Secure the ATV on a support stand to elevate the wheels.

WARNING

Make sure the ATV is solidly supported on the support stand to avoid injury.

2. Remove the wheels.

■NOTE: Keep left-side and right-side wheels separated for installing them on their proper sides.

CLEANING AND INSPECTING

■NOTE: Whenever a part is worn excessively, cracked, or damaged in any way, replacement is necessary.

1. Clean the wheels and hubs using a pressure washer.
2. Inspect each wheel for cracks, dents, or bends.
3. Inspect each tire for cuts, wear, missing lugs, and leaks.

INSTALLING

Install each wheel on its hub. Tighten to 40 ft-lb.

■NOTE: Make sure each wheel is installed on its proper hub as noted in removing (the “rotation arrow” (if applicable) must indicate forward direction of rotation).



AF612D

CHECKING/INFLATING

1. Using an air pressure gauge, measure the air pressure in each tire. Adjust the air pressure as necessary to meet the recommended inflation pressure.
2. Inspect the tires for damage, wear, or punctures.

WARNING

Do not operate the ATV if tire damage exists.

■ **NOTE:** If repair is needed, follow the instructions found on the tire repair kit or remove the wheel and have it repaired professionally.

■ **NOTE:** Be sure all tires are the specified size and have identical tread pattern.

3. Check the front wheel toe-in and toe-out and adjust as necessary (see Steering/Frame).
4. Test drive the ATV on a dry, level surface and note any pulling to the left or right during acceleration, deceleration, and braking.

■ **NOTE:** If pulling is noted, measure the circumference of the front and rear tires on the pulling side. Compare the measurements with the tires on the opposite side. If pulling is noted during braking only, check and adjust the brakes as necessary and recheck operation (see Periodic Maintenance).

5. Increase the air pressure in the tires with the smallest circumference measurement until all tires are equal in circumference.
6. Repeat steps 4-5 as necessary to ensure proper handling.

Troubleshooting

Problem: Suspension too soft	
Condition	Remedy
<ol style="list-style-type: none"> 1. Spring(s) weak 2. Shock absorber damaged 3. Shock absorber preload too low 	<ol style="list-style-type: none"> 1. Replace spring(s) 2. Replace shock absorber 3. Adjust shock absorber preload
Problem: Suspension too stiff	
Condition	Remedy
<ol style="list-style-type: none"> 1. A-arm-related bushings worn 2. Shock absorber preload too high 	<ol style="list-style-type: none"> 1. Replace bushing 2. Adjust shock absorber preload
Problem: Suspension noisy	
Condition	Remedy
<ol style="list-style-type: none"> 1. Cap screws (suspension system) loose 2. A-arm-related bushings worn 	<ol style="list-style-type: none"> 1. Tighten cap screws 2. Replace bushings
Problem: Rear wheel oscillation	
Condition	Remedy
<ol style="list-style-type: none"> 1. Rear wheel hub bearings worn - loose 2. Tires defective - incorrect 3. Wheel rim distorted 4. Wheel hub cap screws loose 5. Brake adjusted incorrectly 6. Rear suspension arm-related bushing worn 7. Rear shock absorber damaged 8. Rear suspension arm nut loose 	<ol style="list-style-type: none"> 1. Replace bearings 2. Replace tires 3. Replace rim 4. Tighten cap screws 5. Adjust brake 6. Replace bushing 7. Replace shock absorber 8. Tighten nut

Steering/Frame

The following steering components should be inspected periodically to ensure safe and proper operation.

- A. Handlebar grips not worn, broken, or loose.
- B. Handlebar not bent, cracked, and has equal and complete full-left and full-right capability.
- C. Steering post bearing assembly/bearing housing not broken, worn, or binding.
- D. Ball joints not worn, cracked, or damaged.
- E. Tie rods not bent or cracked.
- F. Knuckles not worn, cracked, or damaged.
- G. Cotter pins not damaged or missing.

Steering Post/Tie Rods

REMOVING

1. Remove the front body panel/fender (see Front Body Panel/Fender in this section).
2. Remove the steering post cover; then remove the cap screws securing the handlebar caps and move the handlebar out of the way. Account for the two handlebar caps.

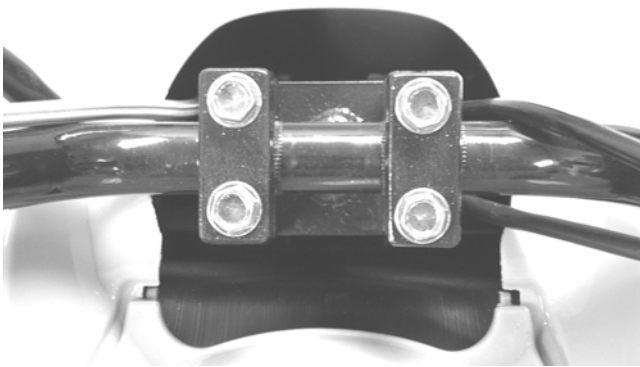

KC0058

3. Remove the cap screws securing the upper steering post to the frame. Account for the housing cap, outer housing, and inner housing.

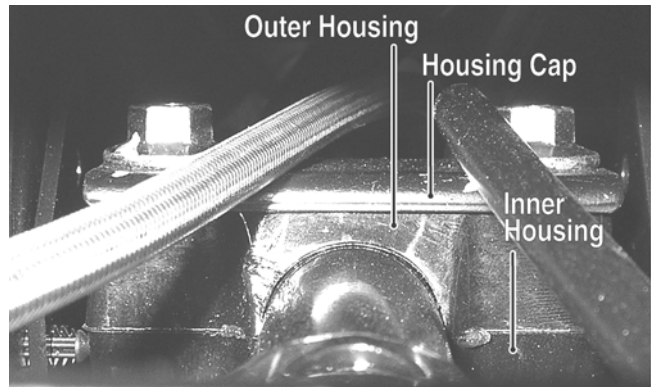

KC307A

4. Remove the cotter pins from the inner tie rod ends; then remove the nuts and disconnect the inner tie rod ends.

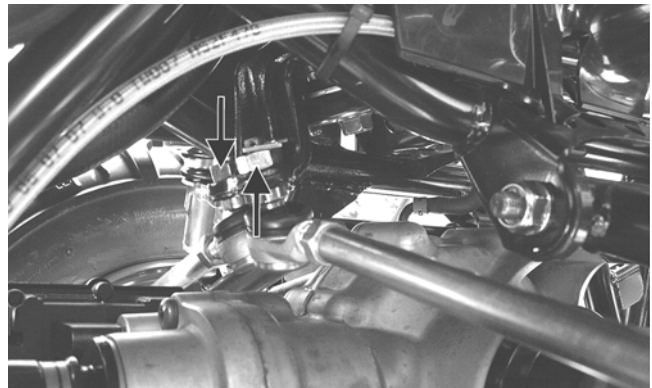

KC184A

■ **NOTE:** If tie rods are to be completely removed, remove the outer tie rod ends from the knuckles at this time.

5. Remove the cap screw securing the lower steering post to the bearing. Account for a flat washer.

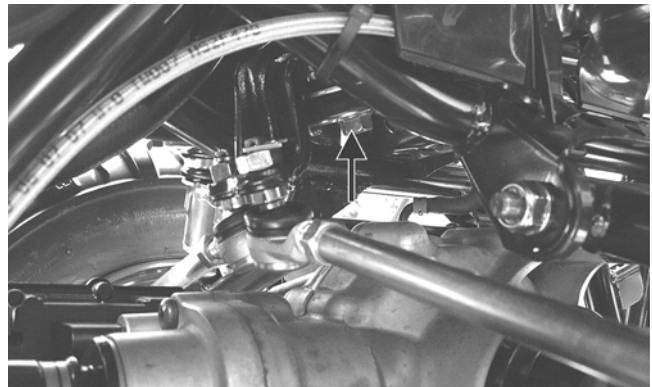

KC184B

6. Remove the steering post from the ATV.

CLEANING AND INSPECTING

■ **NOTE:** Whenever a part is worn excessively, cracked, or damaged in any way, replacement is necessary.

1. Wash the tie rod ends in parts-cleaning solvent. Dry with compressed air. Inspect the pivot area for wear. Apply a low-temperature grease to the ends.

⚠ WARNING

Always wear safety glasses when using compressed air.

2. Inspect the tie rods for damaged threads or wear.
3. Inspect the tie rods for cracks or unusual bends.
4. Inspect all welded areas for cracks or deterioration.
5. Inspect the steering post and steering-post brackets for cracks, bends, or wear.
6. Inspect the bearing halves, bearing caps, and bearing housings for cracks or wear.
7. Inspect the handlebar tube for cracks, wear, or unusual bends.
8. Inspect the handlebar grips for damage or wear.

INSTALLING

1. Install the steering post into the frame and secure the lower end in the bearing with a flat washer and cap screw. Tighten to 40 ft-lb.

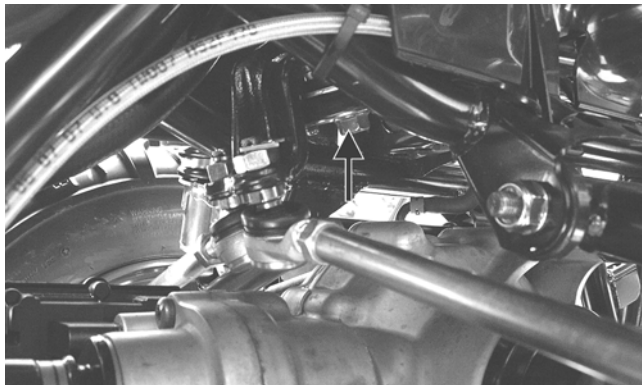

KC184B

2. Apply grease to the inner and outer housings of the upper steering post support; then with the housing cap in place, secure with the cap screws. Tighten to 20 ft-lb.

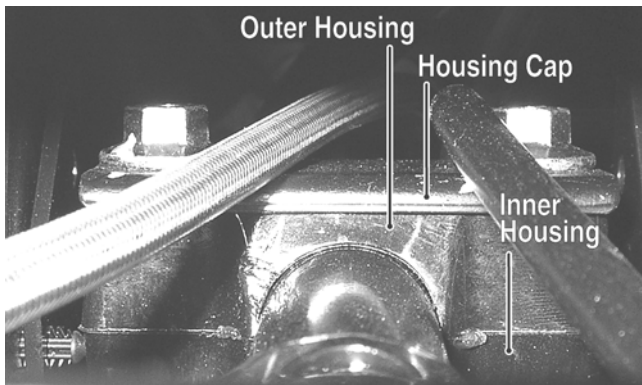

KC307A

3. Using red Loctite #271 on the threads, install the tie rod ends into the lower steering post arm and tighten to 30 ft-lb; then install new cotter pins.

3. Install the new gauge and secure with the mounting nuts; then plug the harness into the gauge and secure.

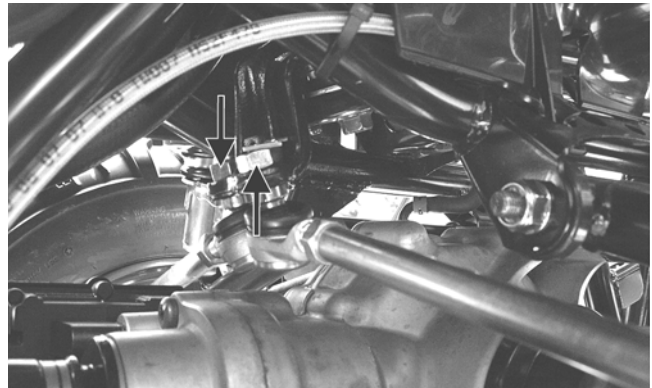

KC184A

4. Place the handlebar and caps in place on the steering post and with the handlebar correctly positioned, tighten the cap screws to 20 ft-lb.

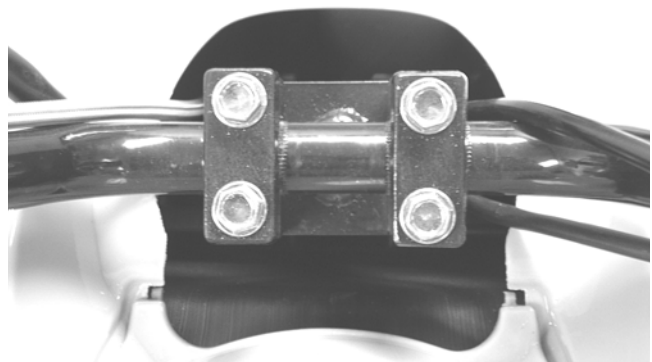

KC0058

5. Install the steering post cover; then install the front body panel/fender (see Front Body Panel/Fender in this section).

Speedometer/LCD Gauge

REPLACING

1. Remove two machine screws securing the gauge pod to the handlebar; then lift the gauge pod up and disconnect the harness plug from the gauge.



KC391B

2. Loosen the gauge mounting nuts and remove the gauge from the pod.

- the gauge pod with the machine screws. Tighten

Handlebar Grip

REMOVING

1. Loosen but do not remove the cap screw in the end of the handlebar; then tap lightly on the head to dislodge the handlebar plug.

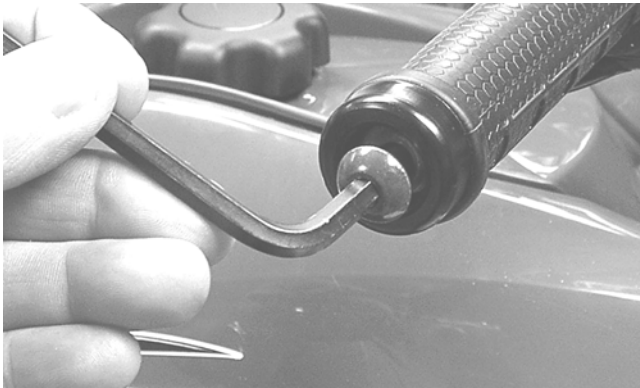

KC310

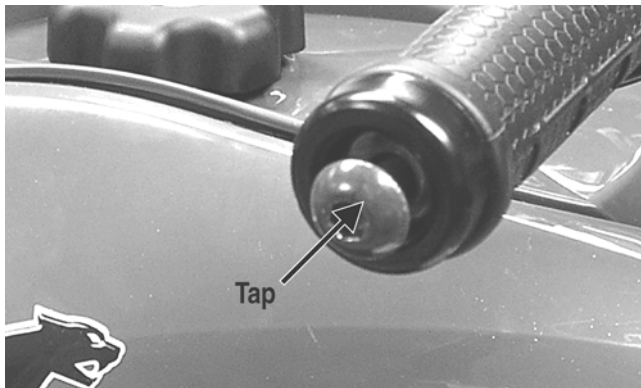

KC309A

2. Grasp the end and remove the cap screw, plug, and end cap.

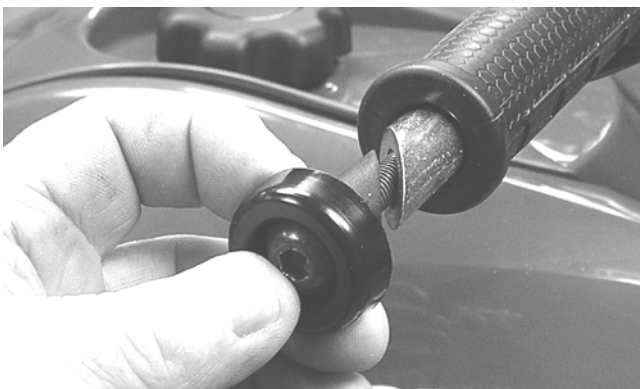

KC308

3. Using a sharp utility knife, split the handlebar grip from end to end and peel off the rubber.
4. Using an adhesive solvent, clean all glue residue from the handlebar.

INSTALLING

1. Apply a liberal amount of Handlebar Grip Adhesive to the inside of the new grip.

2. Slide the grip onto the handlebar until it is fully seated with the smooth part of the grip facing up.

■NOTE: A quick, firm push is required to seat the grip completely on the handlebar. Install while the glue is wet.

3. Wipe off any excess glue; then secure the grip with the plug, end cap, and cap screw.

Throttle Control

REMOVING

1. Remove the two machine screws securing the throttle control to the handlebar.
2. Slide the grommet out of the lower half of the throttle control; then remove the cable from the actuator arm.

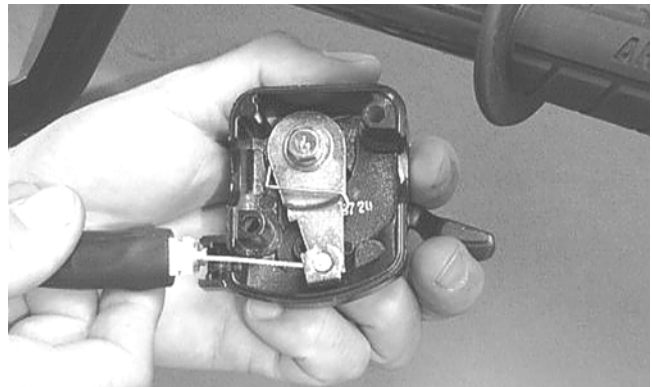

AF676D

3. Remove the cap screw, lock washer, and washer securing the actuator arm to the throttle control lever.

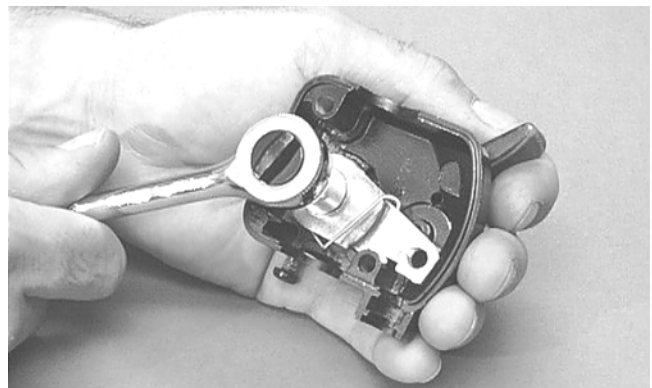

AF677D

4. Remove the actuator arm and account for a bushing. Note the position of the return spring for installing purposes.

Steering Knuckles

REMOVING AND DISASSEMBLING

1. Secure the ATV on a support stand to elevate the wheel; then remove the wheel.

⚠ WARNING

Make sure the ATV is solidly supported on the support stand to avoid injury.

2. Remove the wheel cap from the hub; then remove the cotter pin from the nut.
3. Remove the nut securing the hub.
4. Remove the brake caliper.
5. Remove the hub assembly.
6. Remove the cotter pin from the tie rod end and remove the tie rod end from the knuckle.
7. Remove the two cap screws securing the ball joints in the knuckle.
8. Tap the ball joint end out of the knuckle; then remove the knuckle.
9. Remove the snap ring from the knuckle; then remove the bearing.

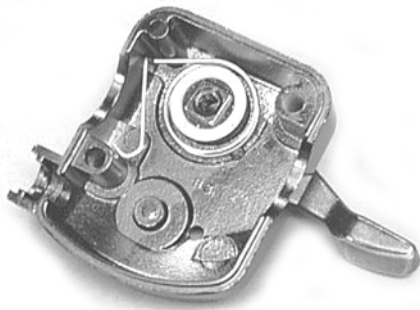

AF678D

INSTALLING

1. Place the return spring into the throttle control; then place the bushing and actuator arm into position. Secure with the cap screw, lock washer, and washer.

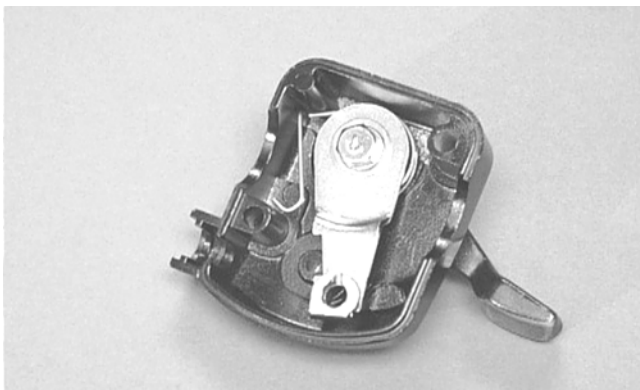

AF679D

2. Using a pair of needle-nose pliers, place the spring into position on the actuator arm.

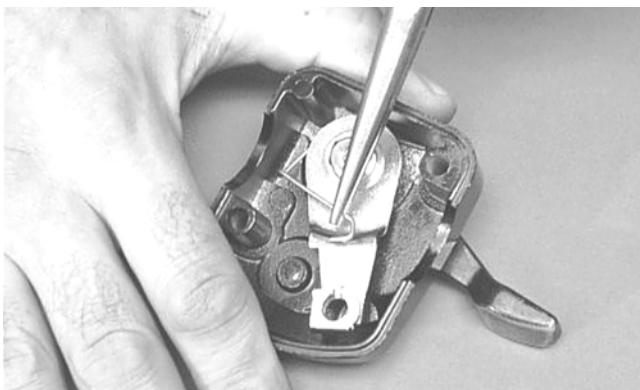

AF680D

3. Place the two halves of the throttle control onto the handlebar and secure with the two machine screws.

ADJUSTING

To adjust throttle cable free-play, see Periodic Maintenance.



PR287A



PR288

CAUTION

Use extreme care when removing the bearing. If the bearing is allowed to fall, it will be damaged and will have to be replaced.

CLEANING AND INSPECTING

■NOTE: Whenever a part is worn excessively, cracked, or damaged in any way, replacement is necessary.

1. Clean all knuckle components.
2. Inspect the bearing for pits, gouges, rusting, or premature wear.
3. Inspect the knuckle for cracks, breaks, or porosity.
4. Inspect threads for stripping or damage.

ASSEMBLING AND INSTALLING

1. Install the bearing; then install the snap ring making sure it seats into the knuckle.



PR287A

2. Install the knuckle to the upper and lower ball joints and secure with the two cap screws. Tighten to 35 ft-lb.

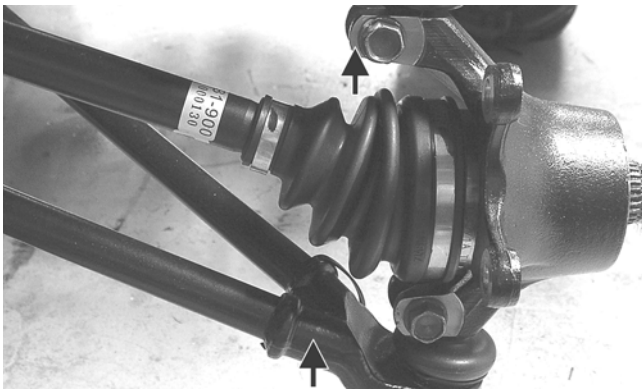

KC313A

3. Install the tie rod end and secure with the nut. Tighten to 30 ft-lb; then install a new cotter pin and spread the pin.

■NOTE: During assembling, new cotter pins should be installed.

4. Apply a small amount of grease to the hub splines.
5. Install the hub assembly onto the splines of the shaft.
6. Secure the hub assembly with the nut. Tighten only until snug.

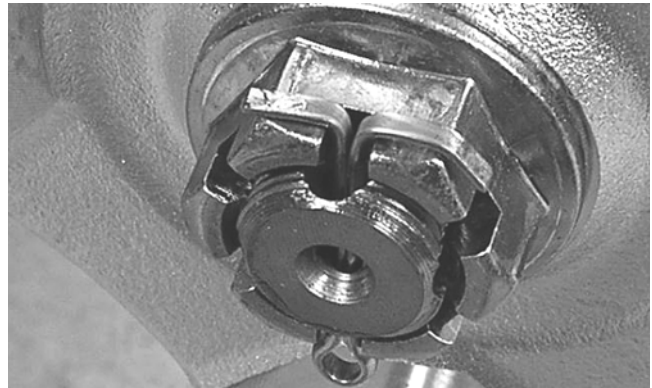

KC305

7. Secure the brake caliper to the knuckle with the "patch-lock" cap screws. Tighten to 20 ft-lb.

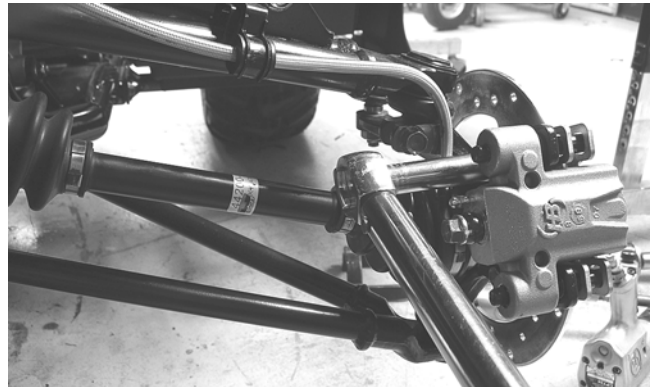

KC283

8. Pump the hand brake lever; then engage the brake lever lock.
9. Secure the hub nut (from step 6) to the shaft. Tighten to 200 ft-lb.
10. Install a new cotter pin and spread the pin to secure the nut.
11. Install the wheel; then using a crisscross pattern, tighten to 40 ft-lb.
12. Remove the ATV from the support stand.

Measuring/Adjusting Toe-Out

1. Thoroughly wash the ATV to remove excess weight (mud, etc.).
2. Refer to the specifications and ensure the tires are properly inflated to the recommended pressure.

■NOTE: Ensure the inflation pressure is correct in the tires or inaccurate measurements can occur.

3. Place the ATV in a level position taking care not to push down or lift up on the front end; then turn the handlebar to the straight ahead position.

■NOTE: When measuring and adjusting, there should be a normal operating load on the ATV (without an operator but with Arctic Cat approved accessories).

4. Measure the distance from the outside edge of each handlebar grip to equal reference points on each side.
5. Adjust the handlebar direction until the two measurements are equal; then secure the handlebar.

■NOTE: Care must be taken not to allow the handlebar to turn while securing it.

■NOTE: The front wheels do not have to be removed to adjust the tie rod. Also, care should be taken not to disturb the handlebar position.

6. Using a permanent marker of some type, mark the center of each front tire (at a height parallel to the belly panel).



AF789D

7. Measure the distance between the marks (at a height parallel to the belly panel) at the front side; then record the measurement.
8. Push the ATV forward until the marks are parallel to the belly panel on the back side; then measure the distance between the marks.
9. The difference in the measurements must show 1/8-1/4 in. toe-out (the front measurement 1/8-1/4 in. more than the rear measurement).
10. If the difference in the measurements is not within specifications, adjust both tie rods equally until within specifications.

■NOTE: Prior to locking the jam nuts, make sure the ball joints are at the center of their normal range of motion and at the correct angle.

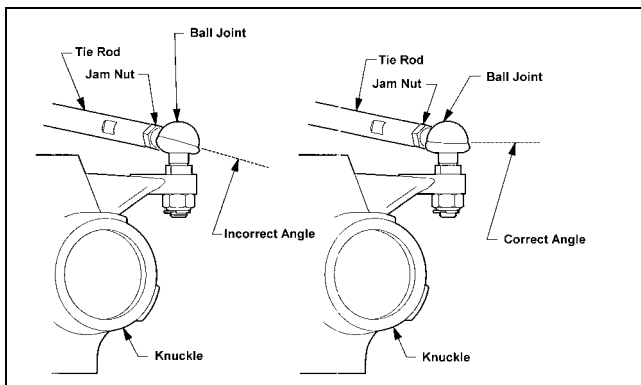

733-559A

Front Bumper Assembly

REMOVING

Remove the four front cap screws securing the bumper support tubes to the frame.

INSTALLING

Install the cap screws in the support tubes to frame. Tighten the cap screws securely.

Front Body Panel/Fender

REMOVING

1. Remove the seat; then remove four reinstallable rivets and the side panels.



KC450A

2. Remove two cap screws and two reinstallable rivets; then remove the gas tank cap and remove the gas tank cover. Reinstall the gas tank cap.

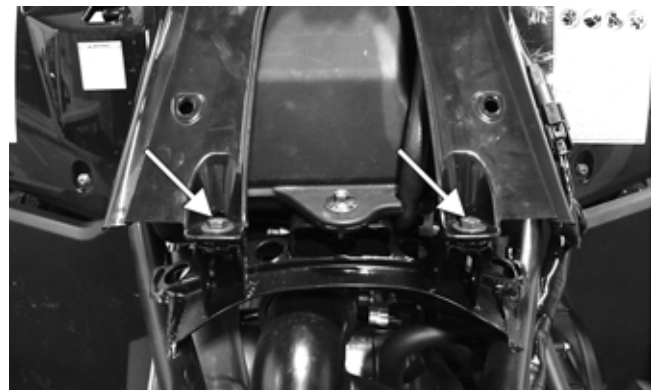

KC453A

3. Remove the shift lever knob.
4. Remove two reinstallable rivets, two fender bolts, and four cap screws; then lift the front fender panel off and set aside. Account for the shift lever spring.



KC469A

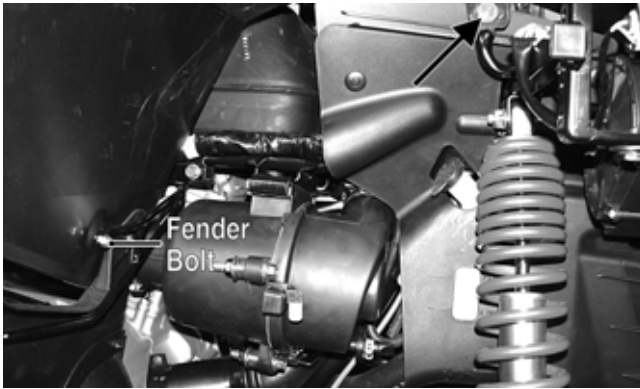

KC467A

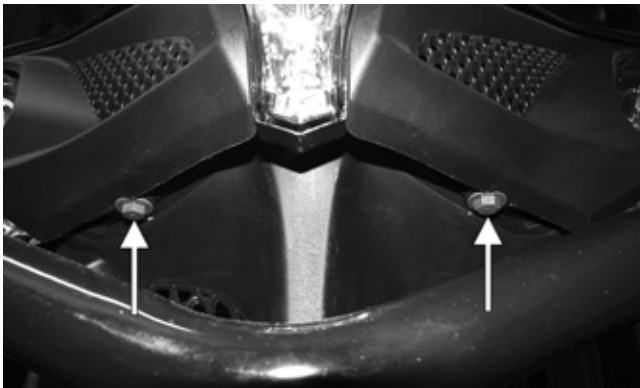

KC470A

CLEANING AND INSPECTING

■NOTE: Whenever a part is worn excessively, cracked, or damaged in any way, replacement is necessary.

1. Clean all fender components with warm soap and water.
2. Inspect fenders for cracks or other damage.
3. Inspect for any missing decals.

INSTALLING

1. Making sure the shift spring is in place and the shift lever is properly positioned, place the front body fender panel onto the ATV.
2. Loosely install the four cap screws and two fender bolts; then install and lock the two reinstallable rivets.

3. Place the gas tank cover into position and secure with the existing hardware; then install the two cap screws securing the rear of the panel to the frame. Tighten all cap screws and fasteners securely.
4. Install the side panels and secure with the four reinstallable rivets; then install the seat.

Exhaust System

REMOVING MUFFLER

1. Remove the two exhaust springs at the muffler/exhaust pipe juncture.

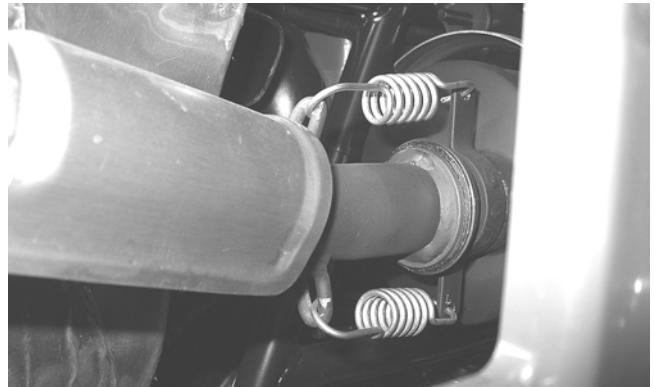

KC170

2. Slide the muffler rearward to clear the mounting lugs and remove the muffler. Account for a grafoil seal.

INSPECTING MUFFLER

■NOTE: Whenever a part is worn excessively, cracked, or damaged in any way, replacement is necessary.

1. Inspect muffler externally for cracks, holes, and dents.
2. Inspect the muffler internally by shaking the muffler back and forth and listening for rattles or loose debris inside the muffler.

■NOTE: For additional details on cleaning the muffler/spark arrester, see Periodic Maintenance.

INSTALLING MUFFLER

1. Using a new grafoil seal, place the muffler into position engaging the mounting lugs into the grommets; then slide the muffler forward.
2. Install the two exhaust springs.

Rear Body Panel

REMOVING

1. Remove the seat; then remove four cap screws securing the rear body panel/fender to the frame and the cap screws securing the rear fenders to the fender supports.

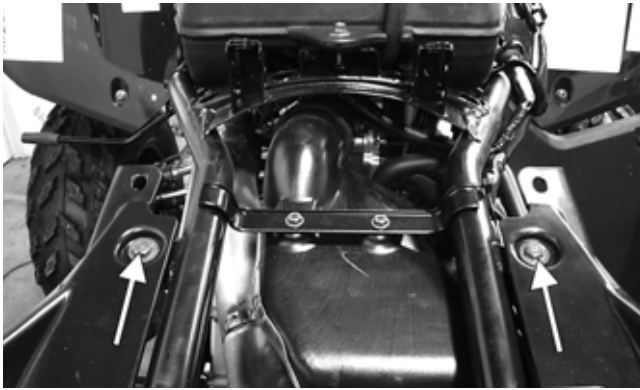

KC473A

1. Clean all rear body panel components with warm soap and water.
2. Inspect side panels and rear body panel for cracks and loose rivets.
3. Inspect threaded areas of all mounting bosses for stripping.
4. Inspect for missing decals.

INSTALLING

1. Place the rear body panel/fender in place on the ATV; then secure with the cap screws on the frame and fender supports. Tighten all fasteners securely.
2. Connect the light connectors and secure to the frame.



KC472A

2. Remove two reinstallable rivets securing the fenders to the footwells.



KC279

3. Secure the rear fenders to the footwells with the reinstallable rivets and lock.
4. Install the seat.



KC472A

3. Using a small screwdriver, remove the light connectors from the frame; then disconnect both connectors and remove the rear body panel/fender.

CLEANING AND INSPECTING

■NOTE: Whenever a part is worn excessively, cracked, or damaged in any way, replacement is necessary.

Seat

REMOVING/INSTALLING

1. To remove the seat, pull rearward on the latch release (located under the rear of the seat). Raise the rear of the seat and slide it rearward.
2. To lock the seat into position, slide the front of the seat into the seat retainers and push down firmly on the rear of the seat. The seat should automatically lock into position.

Troubleshooting

Problem: Handling too heavy or stiff	
Condition	Remedy
<ol style="list-style-type: none"> 1. Front wheel alignment incorrect 2. Lubrication inadequate 3. Tire inflation pressure low 4. Tie rod ends seizing 5. Linkage connections seizing 	<ol style="list-style-type: none"> 1. Adjust alignment 2. Lubricate appropriate components 3. Adjust pressure 4. Replace tie rod ends 5. Repair - replace connections
Problem: Steering oscillation	
Condition	Remedy
<ol style="list-style-type: none"> 1. Tires inflated unequally 2. Wheel(s) wobbly 3. Wheel hub cap screw(s) loose - missing 4. Wheel hub bearing worn - damaged 5. Tie rod ends worn - loose 6. Tires defective - incorrect 7. A-arm bushings damaged 8. Bolts - nuts (frame) loose 	<ol style="list-style-type: none"> 1. Adjust pressure 2. Replace wheel(s) 3. Tighten - replace cap screws 4. Replace bearing 5. Replace - tighten tie rod ends 6. Replace tires 7. Replace bushings 8. Tighten bolts - nuts
Problem: Steering pulling to one side	
Condition	Remedy
<ol style="list-style-type: none"> 1. Tires inflated unequally 2. Front wheel alignment incorrect 3. Wheel hub bearings worn - broken 4. Frame distorted 5. Shock absorber defective 	<ol style="list-style-type: none"> 1. Adjust pressure 2. Adjust alignment 3. Replace bearings 4. Repair - replace frame 5. Replace shock absorber
Problem: Tire wear rapid or uneven	
Condition	Remedy
<ol style="list-style-type: none"> 1. Wheel hub bearings worn - loose 2. Front wheel alignment incorrect 3. Tire inflation pressure incorrect 	<ol style="list-style-type: none"> 1. Replace bearings 2. Adjust alignment 3. Adjust pressure
Problem: Steering noise	
Condition	Remedy
<ol style="list-style-type: none"> 1. Cap screws - nuts loose 2. Wheel hub bearings broken - damaged 3. Lubrication inadequate 	<ol style="list-style-type: none"> 1. Tighten cap screws - nuts 2. Replace bearings 3. Lubricate appropriate components